

---

# Viccarbe

## Specification Guide

### Availability

**Electronic price list updated** with release 200.O (U.S.) and 156.O (Canada), dated October 21, 2024.

All specifications subject to change without notice. Reference the electronic catalog/Hedberg for current pricing.

Transitional products in this specification guide are **maintained for existing customers only** and are likely to be phased out over time. These products are indicated with a **T**. Products that are scheduled to be culled are indicated with an **X**, followed by the last order entry date.

Trademarks contained herein are the property of Viccarbe and their respective owner.

### Working with This Specification Guide

Ten Tips: How to Get the Most Out of This Book	2
Additional Resources	4

### Standard 4–6 Week Lead Time

Chairs and Stools	5
Tables and Benches	21

### Standard Import Lead Time

Chairs and Stools	43
Lounge Chairs	239
Sofas	293
Benches	373
Tables	389
Low Tables	497
Accessories	515

### Standard 4–6 Week Lead Time

Chairs and Stools	11
Tables and Benches	31

### Standard Import Lead Time

Chairs and Stools	87
Lounge Chairs	269
Sofas	349
Benches	381
Tables	423
Low Tables	507
Accessories	519

### Surface Materials

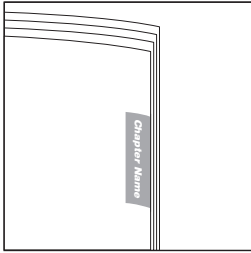
521

### Resources

531

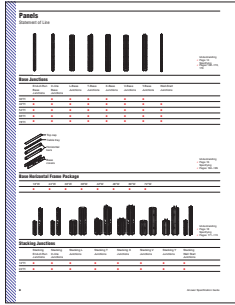
# Ten Tips: How to Get the Most Out of This Book

## Tip 1



**Watch** the tabs on the right-hand edges of the pages. They'll always indicate which chapter you are in.

## Tip 2



**Use the Statement of Line pages** for an overview of the available components, their sizes, and page references for additional information. Each *Understanding* chapter includes a statement of line after the table of contents.

## Tip 3



**Find cross references** by looking for page numbers flagged with an arrow.

## Tip 4

**Study the product detail pages** in the *Understanding* section to learn everything an expert knows about specific products. Each product detail page in this section contains the following features, where applicable:

- Product Drawing
- Actual Dimensions
- Product Details
- Connections
- Wiring and Cabling
- Surface Materials
- Application Topics

**Product Drawing** shows you what the product looks like and points out important features.

**Product Details** gives specific information on the product and how it is used.

**Connections** describes how the product is assembled or how it attaches to another product.

**Base Junctions—Thin Trim**

**Product Details**

**Connections**

**Surface Materials**

**Wiring and Cabling**

**Actual Dimensions** table lists the dimensions of the product.

**Wiring and Cabling** details the power and cable-management and cable routing capabilities of the product.

**Surface Materials** lists what material is used for each part of the product.



# Additional Resources

**Viccarbe products** are supported with informational materials, tools, and software to help you plan, specify, and order an installation efficiently.

## Computer Tools

### Electronic Catalog

Accurate sales quotations and purchase orders for Viccarbe products are created with specification software that uses Viccarbe Electronic Catalog data. Use the data to specify and price style numbers and options for every Viccarbe product. The data is updated bimonthly and provided to software programs including: the Hedberg Business System, and CET. A stand-alone extension of Viccarbe can be found in the CET Marketplace.

### Furniture Symbol Graphic Data

Viccarbe creates 2D and 3D furniture symbols (with attributes) for planning and initially specifying products. To access these files, reference the "Professionals" area of viccarbe.com.

## Support

**For ordering or product assistance**, please call your local dealer, or contact the Concierge team at 1.800.627.6770.

For warranty information, please go to [www.viccarbe.com/viccarbe-about-us/quality/](http://www.viccarbe.com/viccarbe-about-us/quality/)

## Sustainability

**At Viccarbe**, we believe business can be a force for good. We create long-lasting products that are better for people and better for the planet. Our products and operations use life cycle thinking to meet our commitment to reducing climate change. This commitment is reinforced by practices such as designing to minimize global warming and other life cycle impacts, ensuring material health, and enabling end-of-use strategies. To learn more at a corporate level, visit: [www.viccarbe.com/viccarbe-about-us/environmental-sustainability/](http://www.viccarbe.com/viccarbe-about-us/environmental-sustainability/) Product Environmental Profiles, which provide key environmental attributes such as recycled content, embodied carbon and recyclability, as well as product certifications can be found in the "Professionals" area of viccarbe.com.



---

# Understanding Chairs and Stools

Standard 4-6 Week Lead Time



**Statement of Line**

**6**



**Understanding**

Maarten

**8**

# Statement of Line

Chairs and Stools

## Maarten

Understanding  
▶ Page 8  
Specifying  
▶ Pages 12



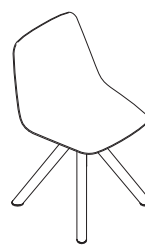
**Four Leg Chair**



**Four Leg Chair with Cushion**



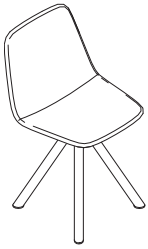
**Four Leg Chair with Upholstery**



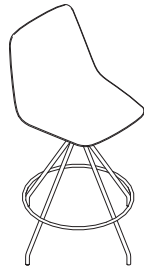
**Swivel Chair**



**Swivel Chair with Cushion**



**Swivel Chair with Upholstery**



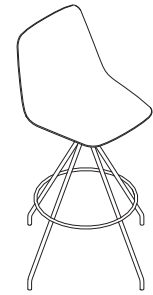
**Swivel Counter Stool with High Backrest**



**Swivel Counter Stool with High Backrest and Cushion**



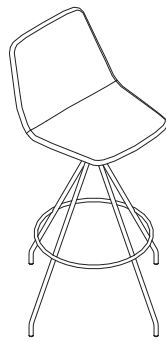
**Swivel Counter Stool with High Backrest and Upholstery**



**Swivel Bar Stool with High Backrest**



**Swivel Bar Stool with High Backrest and Cushion**



**Swivel Bar Stool with High Backrest and Upholstery**



# Maarten

**Maarten seating,**

designed by Victor Carrasco, is a versatile guest chair available in a wide range of shell and base options. It is available with a plastic shell, plastic shell with seat cushion, smooth upholstered seat and back, and soft upholstered seat and back.

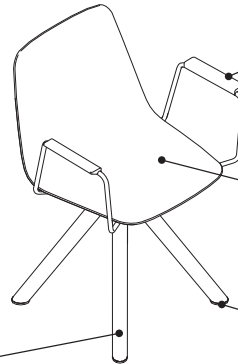
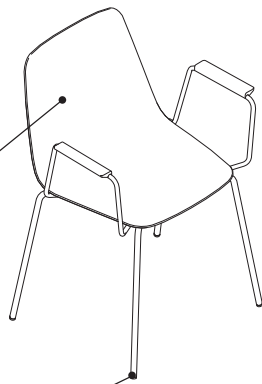
► Specifying, pages 12–19

*Tip: Maarten seating with standard Viccarbe delivery times could have slight differences in design and materials from product imported from Spain.*

*Tip: Leverage these standard 4-6 week lead time Maarten styles for faster shipping. When mixing base types, reference pages 168-219 and specify imported Maarten styles.*

**Upholstered seat and back** available in smooth and soft upholstery.

**Metal base in painted finishes.**



**Optional arms** are available on all chairs and high back stools. They are not available on the auditorium seat nor low back stools.

**Plastic seat and back** available in six finishes with optional seat cushion.

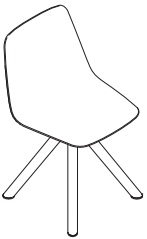
**Glides** available with or without felt.

**Product Details**

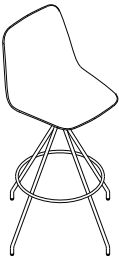
**Base Types**



**Four leg metal base chairs** are powder coated in black, white, or taupe. Glides are with or without felt.



**Metal swivel base chairs** are powder coated in black, white, or taupe. Glides are clear.

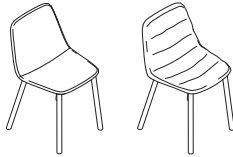


**Swivel base stools** are powder coated in black, white, or taupe. Glides are with or without felt.

**Stools** are available in counter or bar height for all styles.

**Stools** are available with high back.

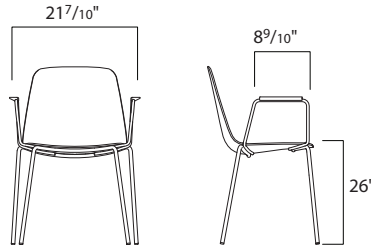
**Seat and Back Types**



**Upholstered seat and back** available in smooth or soft. *Tip: Soft upholstery includes intentional wrinkles that vary by chair.*

**Four leg metal chairs with plastic seat and back** are stackable up to 10 units. Upholstered versions are stackable up to four units.

**Optional Accessories**



**Arms** are available for all base and seat options.

**Metal arms** are available in a wide range of standard paints.

**Wooden armrests** are available in a wide range of standard paints with stained natural oak armrests.

**Surface Materials**

**Upholstery**

- Fabric
- Vinyl
- Leather
- COM (Customer's Own Material)
- COL (Customer's Own Leather)

**Metal base and arms**

- Accent paint
- Accessory paint
- Smooth metallic
- Smooth paint
- Textured paint
- Textured metallic
- Lux coatings

**Wood armrests**

- Ash
- Bleached oak
- Cognac
- Matte oak
- Walnut oak

**Plastic seat**

- 6052 Milk
- 6205 Black
- 6222 Valencia Taupe

► See *Surface Materials*, 522 for more information.

<b>Actual Dimensions</b>							
<b>Description</b>	<b>Style Number</b>	<b>Depth</b>	<b>Width</b>	<b>Height</b>	<b>Seat Depth</b>	<b>Seat Width</b>	<b>Weight</b>
<b>Four Leg Metal Base Chairs</b>							
Four Metal Legs Base	<b>VCBMAMCP</b>	19 <sup>9</sup> / <sub>10</sub> "	23 <sup>1</sup> / <sub>5</sub> "	31 <sup>9</sup> / <sub>10</sub> "	14 <sup>1</sup> / <sub>5</sub> "	17 <sup>7</sup> / <sub>10</sub> "	29.8 lb
Four Metal Legs Chair with Cushion	<b>VCBMAMCP</b>	19 <sup>9</sup> / <sub>10</sub> "	23 <sup>1</sup> / <sub>5</sub> "	31 <sup>9</sup> / <sub>10</sub> "	14 <sup>1</sup> / <sub>5</sub> "	17 <sup>7</sup> / <sub>10</sub> "	29.8 lb
Four Metal Legs Base Chair with Upholstery	<b>VCBMAMCU</b>	20 <sup>1</sup> / <sub>10</sub> "	23 <sup>1</sup> / <sub>5</sub> "	32 <sup>1</sup> / <sub>10</sub> "	14 <sup>1</sup> / <sub>5</sub> "	17 <sup>9</sup> / <sub>10</sub> "	29.8 lb
<b>Swivel Base Chairs</b>							
Swivel Chair	<b>VCBMAMSCP</b>	18 <sup>9</sup> / <sub>10</sub> "	18 <sup>1</sup> / <sub>2</sub> "	31 <sup>7</sup> / <sub>10</sub> "	14 <sup>1</sup> / <sub>5</sub> "	17 <sup>9</sup> / <sub>10</sub> "	21.8 lb
Swivel Chair with Cushion	<b>VCBMAMSCP</b>	18 <sup>9</sup> / <sub>10</sub> "	18 <sup>1</sup> / <sub>2</sub> "	31 <sup>7</sup> / <sub>10</sub> "	14 <sup>1</sup> / <sub>5</sub> "	18 <sup>3</sup> / <sub>10</sub> "	26.7 lb
Swivel Chair with Upholstery	<b>VCBMAMSCU</b>	19 <sup>1</sup> / <sub>10</sub> "	18 <sup>9</sup> / <sub>10</sub> "	31 <sup>9</sup> / <sub>10</sub> "	14 <sup>1</sup> / <sub>5</sub> "	17 <sup>1</sup> / <sub>2</sub> "	22.5 lb
<b>Swivel Counter and Bar Stool Base Chairs with High Backrest</b>							
Swivel Counter Stool	<b>VCBMASCSP</b>	18 <sup>1</sup> / <sub>2</sub> "	18 <sup>1</sup> / <sub>2</sub> "	40 <sup>3</sup> / <sub>5</sub> "	14 <sup>1</sup> / <sub>5</sub> "	26"	21.4 lb
Swivel Counter Stool with Cushion	<b>VCBMASCSP</b>	18 <sup>1</sup> / <sub>2</sub> "	18 <sup>1</sup> / <sub>2</sub> "	40 <sup>3</sup> / <sub>5</sub> "	14 <sup>1</sup> / <sub>5</sub> "	26"	22.6 lb
Swivel Counter Stool with Upholstery	<b>VCBMASCSU</b>	18 <sup>7</sup> / <sub>10</sub> "	18 <sup>9</sup> / <sub>10</sub> "	40 <sup>7</sup> / <sub>10</sub> "	14 <sup>1</sup> / <sub>5</sub> "	26 <sup>2</sup> / <sub>5</sub> "	22.0 lb
Swivel Bar Stool	<b>VCBMASBSP</b>	18 <sup>7</sup> / <sub>10</sub> "	18 <sup>1</sup> / <sub>2</sub> "	44 <sup>1</sup> / <sub>2</sub> "	14 <sup>1</sup> / <sub>5</sub> "	29 <sup>9</sup> / <sub>10</sub> "	24.5 lb
Swivel Bar Stool with Cushion	<b>VCBMASBSP</b>	18 <sup>1</sup> / <sub>2</sub> "	18 <sup>1</sup> / <sub>2</sub> "	40 <sup>1</sup> / <sub>2</sub> "	14 <sup>1</sup> / <sub>5</sub> "	29 <sup>9</sup> / <sub>10</sub> "	29.3 lb
Swivel Bar Stool with Upholstery	<b>VCBMASBSU</b>	18 <sup>7</sup> / <sub>10</sub> "	18 <sup>9</sup> / <sub>10</sub> "	44 <sup>7</sup> / <sub>10</sub> "	14 <sup>1</sup> / <sub>5</sub> "	30 <sup>3</sup> / <sub>10</sub> "	25.1 lb

---

# Specifying Chairs and Stools

Standard 4-6 Week Lead Time

---

## Specifying

Maarten

12

# Chairs and Stools

## Maarten



### Standard Includes

- Base: paint
- Shell: plastic
- Glides: plastic

### Options

Shell Finish	Plastic - PG1	No cost
	Plastic - PG2	+\$33
Base Finish	Paint Price Group 01	No cost
	Paint Price Group 02	+\$41
	Paint Price Group 03	+\$83
Cushion Option	No Cushion	No cost
	Cushion	+\$71
Cushion Finish	Fabric Customer's Own Material	No cost
	Fabric Price Group 01	No cost
	Vinyl Price Group 02	No cost
	Fabric Price Group 02	+\$27
	Fabric Price Group 03	+\$54
	Fabric Price Group 04	+\$92
	Fabric Price Group 05	+\$152
	Fabric Price Group 06	+\$213
	Fabric Price Group 07	+\$290
	Fabric Price Group 08	+\$359
Arm Option	No Arms	No cost
	Armrest	+\$75
	Wood Armrest	+\$155
Arms Finish	Paint Price Group 01	No cost
	Paint Price Group 02	+\$41
	Paint Price Group 03	+\$83
Glides	Felt Glides	No cost
	Standard Glides	No cost

### Specification Information

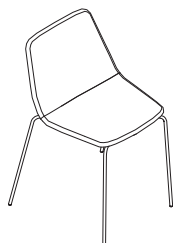
Dimensions			Style	Base
D	W	H	Number	Price

### Maarten Four Leg Chair

19 9/10"	23 1/5"	31 9/10"	<b>VCBAMMCP</b>	\$480
----------	---------	----------	-----------------	-------



# Chairs and Stools

**Maarten**


Tip: Smooth upholstery shown.

## Standard Includes

- Base: paint
- Upholstery: fabric price group 01
- Glides: plastic

## Options

Base Finish	Paint Price Group 01	No cost
	Paint Price Group 02	+\$41
	Paint Price Group 03	+\$83
Upholstery Finish	Fabric Customer's Own Material	No cost
	Fabric Price Group 01	No cost
	Vinyl Price Group 02	No cost
	Fabric Price Group 02	+\$37
	Fabric Price Group 03	+\$76
	Fabric Price Group 04	+\$128
	Fabric Price Group 05	+\$213
	Fabric Price Group 06	+\$298
	Fabric Price Group 07	+\$406
	Fabric Price Group 08	+\$503
Upholstery Type	Smooth Upholstery	No cost
	Soft Upholstery	+\$90
Arm Option	No Arms	No cost
	Armrest	+\$75
	Wood Armrest	+\$155
Arms Finish	Paint Price Group 01	No cost
	Paint Price Group 02	+\$41
	Paint Price Group 03	+\$83
Glides	Felt Glides	No cost
	Standard Glides	No cost

## Specification Information

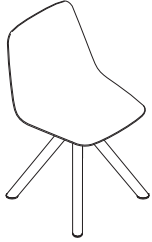
Dimensions			Style	Base
D	W	H	Number	Price

### Maarten Four Leg Chair with Upholstery

19 9/10"	23 1/5"	31 9/10"	<b>VCBMAMCU</b>	\$605
----------	---------	----------	-----------------	-------

# Chairs and Stools

## Maarten



### Standard Includes

- Base: paint
- Shell: plastic
- Glides: plastic

### Options

Shell Finish	Plastic - PG1	No cost
	Plastic - PG2	+\$33
Base Finish	Paint Price Group 01	No cost
	Paint Price Group 02	+\$41
	Paint Price Group 03	+\$83
Cushion Option	No Cushion	No cost
	Cushion	+\$71
Cushion Finish	Fabric Customer's Own Material	No cost
	Fabric Price Group 01	No cost
	Vinyl Price Group 02	No cost
	Fabric Price Group 02	+\$27
	Fabric Price Group 03	+\$54
	Fabric Price Group 04	+\$92
	Fabric Price Group 05	+\$152
	Fabric Price Group 06	+\$213
	Fabric Price Group 07	+\$290
	Fabric Price Group 08	+\$359
Arm Option	No Arms	No cost
	Armrest	+\$75
Arms Finish	Wood Armrest	+\$155
	Paint Price Group 01	No cost
	Paint Price Group 02	+\$41
	Paint Price Group 03	+\$83

### Specification Information

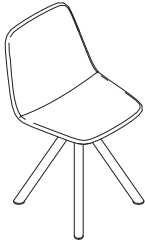
Dimensions			Style	Base
D	W	H	Number	Price

### Maarten Swivel Chair

18 9/10"   18 1/2"   31 7/10"   **VCBMAMSCP**   \$641

# Chairs and Stools

## Maarten



Tip: Smooth upholstery shown.

### Standard Includes

- Base: paint
- Upholstery: fabric price group 01
- Glides: plastic

### Options

Base Finish	Paint Price Group 01	No cost
	Paint Price Group 02	+\$41
	Paint Price Group 03	+\$83
Upholstery Finish	Fabric Customer's Own Material	No cost
	Fabric Price Group 01	No cost
	Vinyl Price Group 02	No cost
	Fabric Price Group 02	+\$37
	Fabric Price Group 03	+\$76
	Fabric Price Group 04	+\$128
	Fabric Price Group 05	+\$213
	Fabric Price Group 06	+\$298
	Fabric Price Group 07	+\$406
	Fabric Price Group 08	+\$503
Upholstery Type	Smooth Upholstery	No cost
	Soft Upholstery	+\$90
Arm Option	No Arms	No cost
	Armrest	+\$75
	Wood Armrest	+\$155
Arms Finish	Paint Price Group 01	No cost
	Paint Price Group 02	+\$41
	Paint Price Group 03	+\$83

### Specification Information

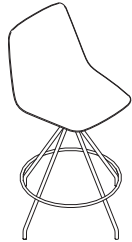
Dimensions			Style	Base
D	W	H	Number	Price

### Maarten Swivel Chair with Upholstery

18 9/10"   18 1/2"   31 7/10"   **VCBMAMSCU**   \$1100

# Chairs and Stools

## Maarten



### Standard Includes

- Base: paint
- Shell: plastic
- Footrest: powder coated paint in black
- Glides: plastic

### Options

Shell Finish	Plastic - PG1	No cost
	Plastic - PG2	+\$33
Base Finish	Paint Price Group 01	No cost
	Paint Price Group 02	+\$41
	Paint Price Group 03	+\$83
Cushion Option	No Cushion	No cost
	Cushion	+\$71
Cushion Finish	Fabric Customer's Own Material	No cost
	Fabric Price Group 01	No cost
	Vinyl Price Group 02	No cost
	Fabric Price Group 02	+\$27
	Fabric Price Group 03	+\$54
	Fabric Price Group 04	+\$92
	Fabric Price Group 05	+\$152
	Fabric Price Group 06	+\$213
	Fabric Price Group 07	+\$290
	Fabric Price Group 08	+\$359
Arm Option	No Arms	No cost
	Armrest	+\$75
	Wood Armrest	+\$155
Arms Finish	Paint Price Group 01	No cost
	Paint Price Group 02	+\$41
	Paint Price Group 03	+\$83
Glides	Felt Glides	No cost
	Standard Glides	No cost

### Specification Information

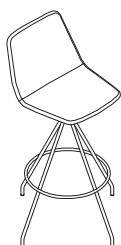
Dimensions			Style	Base
D	W	H	Number	Price

### Maarten Swivel Counter Stool with High Backrest

18 1/2"	18 1/2"	40 3/5"	<b>VCBMASCSP</b>	\$688
---------	---------	---------	------------------	-------

# Chairs and Stools

## Maarten



Tip: Smooth upholstery shown.

### Standard Includes

- Base: paint
- Upholstery: fabric price group 01
- Footrest: powder coated paint in black
- Glides: plastic

### Options

Base Finish	Paint Price Group 01	No cost
	Paint Price Group 02	+\$41
	Paint Price Group 03	+\$83
Upholstery Finish	Fabric Customer's Own Material	No cost
	Fabric Price Group 01	No cost
	Vinyl Price Group 02	No cost
	Fabric Price Group 02	+\$37
	Fabric Price Group 03	+\$76
	Fabric Price Group 04	+\$128
	Fabric Price Group 05	+\$213
	Fabric Price Group 06	+\$298
	Fabric Price Group 07	+\$406
	Fabric Price Group 08	+\$503
Upholstery Type	Smooth Upholstery	No cost
	Soft Upholstery	+\$90
Arm Option	No Arms	No cost
	Armrest	+\$75
	Wood Armrest	+\$155
Arms Finish	Paint Price Group 01	No cost
	Paint Price Group 02	+\$41
	Paint Price Group 03	+\$83
Glides	Felt Glides	No cost
	Standard Glides	No cost

### Specification Information

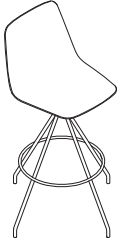
Dimensions			Style	Base
D	W	H	Number	Price

### Maarten Swivel Counter Stool with High Backrest and Upholstery

18 1/2"	18 1/2"	40 3/5"	<b>VCBMASCSU</b>	\$1047
---------	---------	---------	------------------	--------

# Chairs and Stools

## Maarten



### Standard Includes

- Base: paint
- Shell: plastic
- Footrest: powder coated paint in black
- Glides: plastic

### Options

Shell Finish	Plastic - PG1	No cost
	Plastic - PG2	+\$33
Base Finish	Paint Price Group 01	No cost
	Paint Price Group 02	+\$41
	Paint Price Group 03	+\$83
Cushion Option	No Cushion	No cost
	Cushion	+\$71
Cushion Finish	Fabric Customer's Own Material	No cost
	Fabric Price Group 01	No cost
	Vinyl Price Group 02	No cost
	Fabric Price Group 02	+\$27
	Fabric Price Group 03	+\$54
	Fabric Price Group 04	+\$92
	Fabric Price Group 05	+\$152
	Fabric Price Group 06	+\$213
	Fabric Price Group 07	+\$290
	Fabric Price Group 08	+\$359
Arm Option	No Arms	No cost
	Armrest	+\$75
	Wood Armrest	+\$155
Arms Finish	Paint Price Group 01	No cost
	Paint Price Group 02	+\$41
	Paint Price Group 03	+\$83
Glides	Felt Glides	No cost
	Standard Glides	No cost

### Specification Information

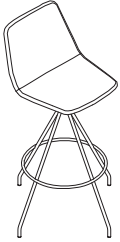
Dimensions			Style	Base
D	W	H	Number	Price

### Maarten Swivel Bar Stool with High Backrest

18 7/10"    18 1/2"    44 1/2"    **VCBMASBSP**    \$688

# Chairs and Stools

Maarten



Tip: Smooth upholstery shown.

## Standard Includes

- Base: paint
- Upholstery: fabric price group 01
- Footrest: powder coated paint in black
- Glides: plastic

## Options

Base Finish	Paint Price Group 01	No cost
	Paint Price Group 02	+\$41
	Paint Price Group 03	+\$83
Upholstery Finish	Fabric Customer's Own Material	No cost
	Fabric Price Group 01	No cost
	Vinyl Price Group 02	No cost
	Fabric Price Group 02	+\$37
	Fabric Price Group 03	+\$76
	Fabric Price Group 04	+\$128
	Fabric Price Group 05	+\$213
	Fabric Price Group 06	+\$298
	Fabric Price Group 07	+\$406
	Fabric Price Group 08	+\$503
Upholstery Type	Smooth Upholstery	No cost
	Soft Upholstery	+\$90
Arm Option	No Arms	No cost
	Armrest	+\$75
	Wood Armrest	+\$155
Arms Finish	Paint Price Group 01	No cost
	Paint Price Group 02	+\$41
	Paint Price Group 03	+\$83
Glides	Felt Glides	No cost
	Standard Glides	No cost

## Specification Information

Dimensions			Style	Base
D	W	H	Number	Price

### Maarten Swivel Bar Stool with High Backrest and Upholstery

18 7/10"   18 1/2"   44 1/2"   **VCBMASBSU**   \$1047





---

# Understanding Tables and Benches

Standard 4-6 Week Lead Time

  
**Statement of Line** **22**

  
**Understanding**

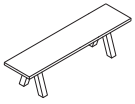
Trestle	<b>24</b>
Common	<b>28</b>

Tables and  
Benches

# Statement of Line

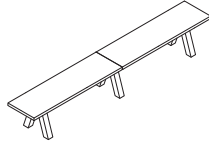
Tables and Benches

## Trestle Benches



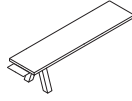
### Single Bench

Understanding  
▶ Page 24  
Specifying  
▶ Page 32



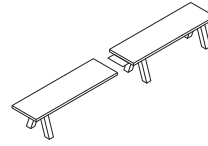
### Double Bench

Understanding  
▶ Page 24  
Specifying  
▶ Page 33



### Create-Your-Own Center Kit

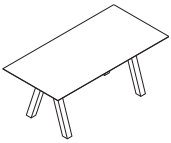
Understanding  
▶ Page 24  
Specifying  
▶ Page 34



### Create-Your-Own End Kit

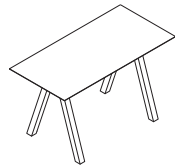
Understanding  
▶ Page 24  
Specifying  
▶ Page 35

## Trestle Tables



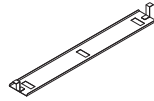
### Table Seated Height

Understanding  
▶ Page 26  
Specifying  
▶ Page 36



### Table Standing Height

Understanding  
▶ Page 26  
Specifying  
▶ Page 36



### Wire Management Tray

Understanding  
▶ Page 26  
Specifying  
▶ Page 39



### Leg Cable Cover

Understanding  
▶ Page 26  
Specifying  
▶ Page 39



### Power Kit

Understanding  
▶ Page 26  
Specifying  
▶ Page 40

## Common



### 47<sup>1</sup>/<sub>5</sub>"W Rectangle Bench

Understanding  
 ▶ Page 28  
 Specifying  
 ▶ Page 41



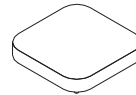
### 47<sup>1</sup>/<sub>5</sub>"W Rectangle Bench

Understanding  
 ▶ Page 28  
 Specifying  
 ▶ Page 41



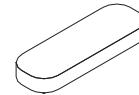
### 47<sup>1</sup>/<sub>5</sub>"W Rectangle Bench

Understanding  
 ▶ Page 28  
 Specifying  
 ▶ Page 41



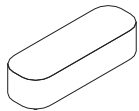
### 47<sup>1</sup>/<sub>5</sub>"W Square Bench

Understanding  
 ▶ Page 28  
 Specifying  
 ▶ Page 41



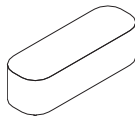
### 70<sup>9</sup>/<sub>10</sub>"W Rectangle Bench

Understanding  
 ▶ Page 28  
 Specifying  
 ▶ Page 42



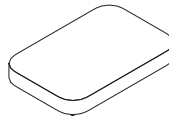
### 70<sup>9</sup>/<sub>10</sub>"W Rectangle Bench

Understanding  
 ▶ Page 28  
 Specifying  
 ▶ Page 42



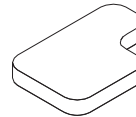
### 70<sup>9</sup>/<sub>10</sub>"W Rectangle Bench

Understanding  
 ▶ Page 28  
 Specifying  
 ▶ Page 42



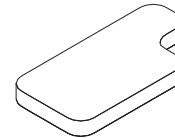
### 70<sup>9</sup>/<sub>10</sub>"W Rectangle Bench

Understanding  
 ▶ Page 28  
 Specifying  
 ▶ Page 42



### 70<sup>9</sup>/<sub>10</sub>"W Rectangle Bench with Indent

Understanding  
 ▶ Page 28  
 Specifying  
 ▶ Page 42

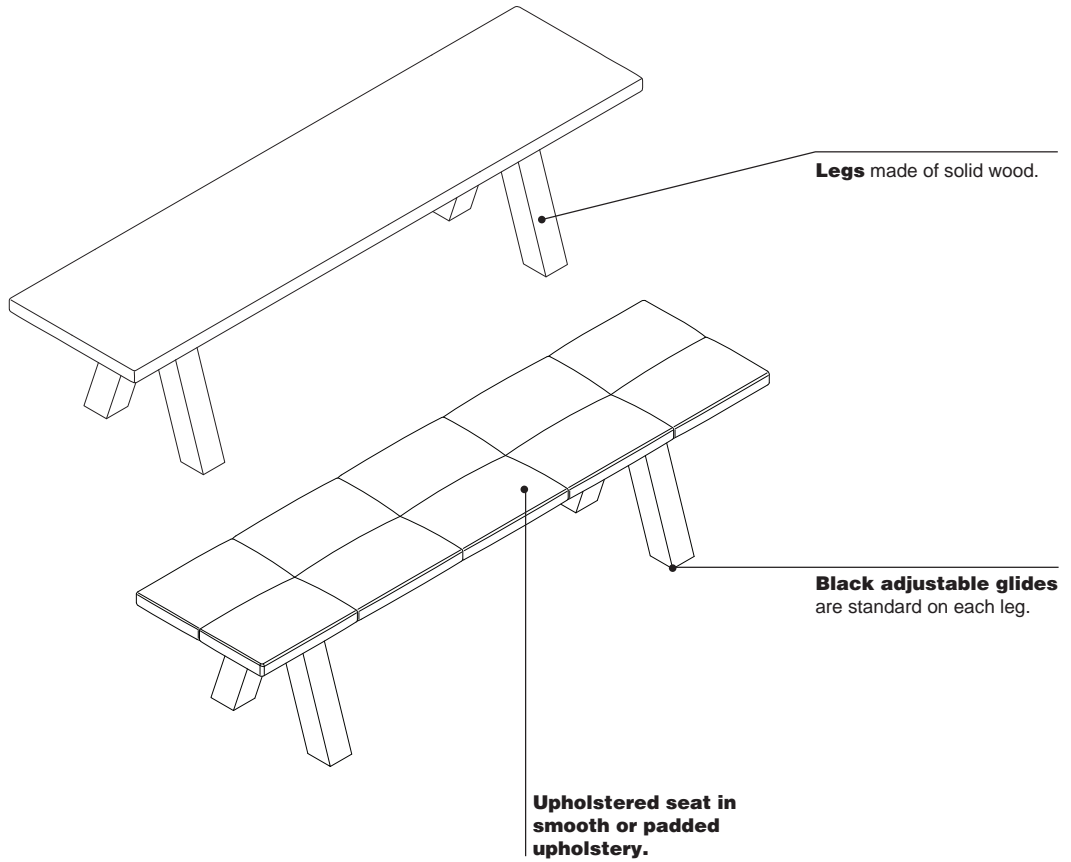


### 94<sup>1</sup>/<sub>2</sub>"W Rectangle Bench with Indent

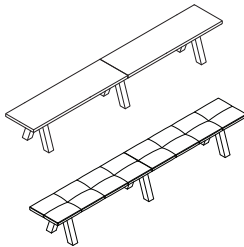
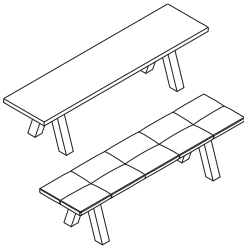
Understanding  
 ▶ Page 28  
 Specifying  
 ▶ Page 42

# Trestle Bench

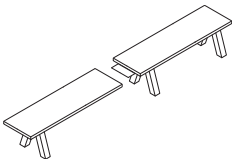
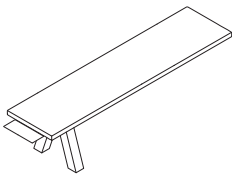
**Trestle bench**, designed by John Pawson, is a modular collaborative bench with solid oak legs and an upholstered seat. Pairs well with Trestle tables.  
▶ Specifying, pages 32-35



## Product Details



**Benches** available in two modular sizes; single and double.



**Create your own benches** are a customizable solution to create endless bench lengths. Consisting of two style numbers; end kits (**VCBTREB**) and center kits (**VCBTRCB**).

*Tip: When building create your own compositions, it is necessary to specify a single end kit and as many center kits required to achieve the desired length.*

**Create your own end kits** include two end bench seats and three pairs of legs. Create your own end kits can be standalone solutions.

**Create your own center kits** include one center bench seat and one pair of legs. Create your own center kits must be specified with an end kit.

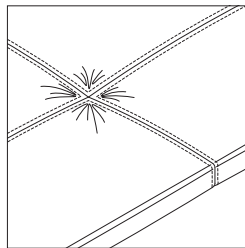
**Legs in stained finishes** will be solid oak.

*Tip: Finish may vary due to natural wood.*

**Support beam** is located underneath the bench seat and is always black.

**Seat inner structure** composed of compact wooden board and expanded polyurethane foam.

**Smooth upholstery** does not have stitched seams on the bench seat.  
*Tip: Leather is not available when smooth upholstery is selected. It is available on the padded upholstery.*



**Padded upholstery** has stitched seams in a quilted pattern on the bench seat.  
*Note: Padded upholstery has wrinkles at each of the quilted seams.*

**Black plastic glides** are adjustable for leveling on uneven floors. Adjustability range is  $\frac{3}{4}$ ".

## Surface Materials

### Upholstery

- Fabric
- Vinyl
- Leather
- COM (Customer's Own Material)
- COL (Customer's Own Leather)

### Stained Finishes

- Wood veneer
- Customiz stain

## Actual Dimensions

Description	Style Number	Depth	Width	Height
Single Bench	<b>VCBTRSB</b>	17 <sup>7</sup> / <sub>10</sub> "	70 <sup>9</sup> / <sub>10</sub> "	17 <sup>7</sup> / <sub>10</sub> "
Create-Your-Own Center Kit	<b>VCBTRCB</b>	17 <sup>7</sup> / <sub>10</sub> "	47 <sup>1</sup> / <sub>5</sub> "	17 <sup>7</sup> / <sub>10</sub> "
Double Bench	<b>VCBTRDB</b>	17 <sup>7</sup> / <sub>10</sub> "	118 <sup>1</sup> / <sub>10</sub> "	17 <sup>7</sup> / <sub>10</sub> "
Create-Your-Own End Kit	<b>VCBTREB</b>	17 <sup>7</sup> / <sub>10</sub> "	118 <sup>1</sup> / <sub>10</sub> "	17 <sup>7</sup> / <sub>10</sub> "

# Trestle Tables

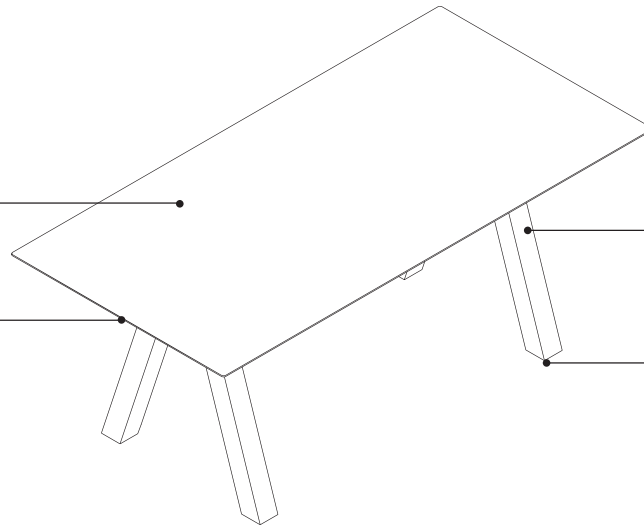
**Trestle table**, designed by John Pawson, is a minimalist system of tables and benches that are functional and visually light, acting as the center point for meeting rooms and collaborative spaces.  
▶ Specifying, pages 36–40

**Top surface** available in High-Pressure Laminate and oak veneer.

**Knife-edge** is standard on all table tops.

**Legs** available in painted metal and stained oak.

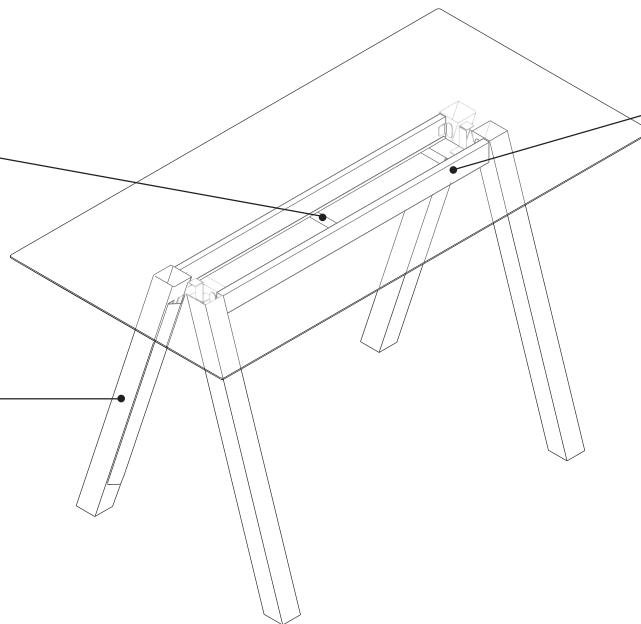
**Black adjustable glides** are standard on each leg.



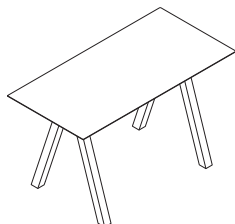
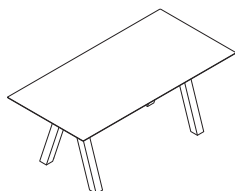
**MhoB power** is available as an option in three colors.

**Cable tray** is optional for cord management.

**Leg cable cover** is painted metal and optional for cord management.



## Product Details



**Trestle tables** are available in 29" seated height and 41" standing height.



**Top surfaces** are 1 1/8" thick with an exposed knife-edge. Tops are available in High-Pressure Laminates and oak wood veneer.

**Top shape** is only available in rectangle.

**Knife-edge** gives the appearance of a thinner top which is 1/8" thick and tapers to an overall thickness of 1 1/8". The knife-edge is clear coated.

**Legs** are available in painted metal and stained oak.

*Tip: Wood legs are composed of natural materials that will show color and grain variance.*

**Black plastic glides** are adjustable for leveling on uneven floors. Adjustability range is 3/4".

Long grain direction



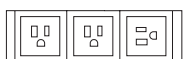
Rectangular Worksurface

**Grain direction on top surfaces** will always have the long grain direction.

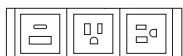
**Multi-piece tops** will occur when the top is larger than 120" width. The top will be split into two equal sections that ship with connecting hardware.

**For woodgrain multi-piece tops**, note that the grain patterns will differ.

## Power, Wiring, and Cabling



Power, Power, Power



**Surface power** is pop-up power available in two configurations and three color options.

**Power location** is always centered on the table top equally spaced between the table legs.

**Power infeed** is cord and plug. Seated height tables have 57" of cord; standing height tables have 45" of cord. When there are multiple power modules, they are chained together and have one plug.

**Cable tray** is an optional accessory for wire management. The cable tray is retrofittable and spans between each set of legs on the underside of the table. When specified with cable tray, tables will come with one tray per leg spacing. The tray houses the MhoB power box and manages cables. Cables can route out of the tray through the side access holes.

*Tip: Cable tray is automatically painted black to match the understructure of the Trestle table.*

**Leg cable cover** is an optional accessory for wire management. The cable cover is painted steel and attaches with magnets to both metal and wood legs. The cable is specifiable in matching or contrasting paint colors from the legs. The cable cover hides and routes the power infeed cord from the cable tray, down the length of any leg, and to a power outlet. Only one cable cover is necessary per table. The cable cover is available in two lengths for both seated and standing height tables.

## Trestle Power Matrix

Table Width	Power Module Quantity
72"	1
84"	1
96"	1
120"	2
132"	2
144"	2
168"	3
192"	3
216"	4
240"	4

*Tip: Power module quantity is fixed. Other quantities are available through Specials.*

## Trestle Table Seating Capacity

Table Size	Seating Capacity
36" x 72"	4-6
48" x 72"	6
36" x 84"	6
48" x 84"	6
36" x 96"	8
48" x 96"	8
36" x 120"	8-10
48" x 120"	8-10
36" x 132"	10
48" x 132"	10
36" x 144"	10-12
48" x 144"	10-12
36" x 168"	10-12
48" x 168"	10-12
36" x 192"	14
48" x 192"	14
36" x 216"	14-16
48" x 216"	14-16
36" x 240"	16-18
48" x 240"	16-18

## Surface Materials

### Table top

- High-Pressure Laminate
- Rift Cut Oak
- Customiz stain (optional on wood)

### Metal legs

- Paint

### Wood legs

- Oak wood stain
- Customiz stain

### Leg cable cover

- Paint

### MhoB power

- 4242 Milk
- 4710 Black
- 4799 Platinum Metallic

# Common Bench

**Common** is a modular system of benches designed by Naoto Fukasawa that work as a meeting point for collaborative spaces. Specify a single piece or generate infinite compositions with the entire collection.

► Specifying, pages 41–42

**Common side tables** are available to compliment the benches.

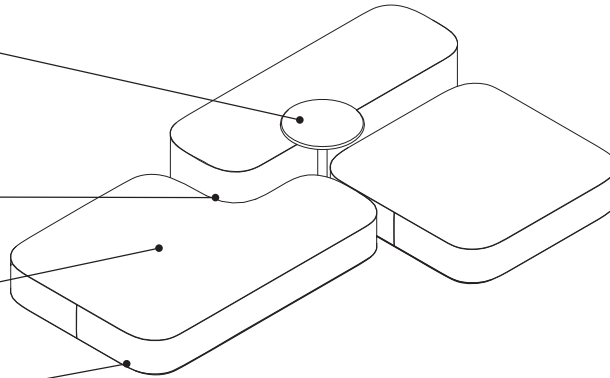
*Tip: Common side tables are an imported product.*

► Page 472

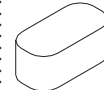
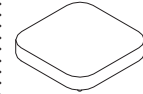
**Corner indent** specifiable on the left or the right.

**Upholstered in fabric or vinyl.**

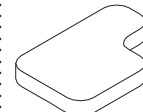
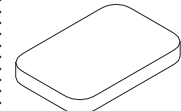
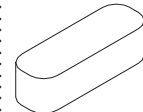
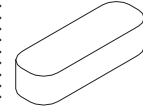
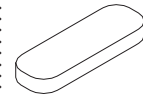
**Legs** are composed of natural beech wood.



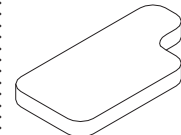
## Product Details



**Rectangle 47<sup>1</sup>/<sub>5</sub>"W Benches**



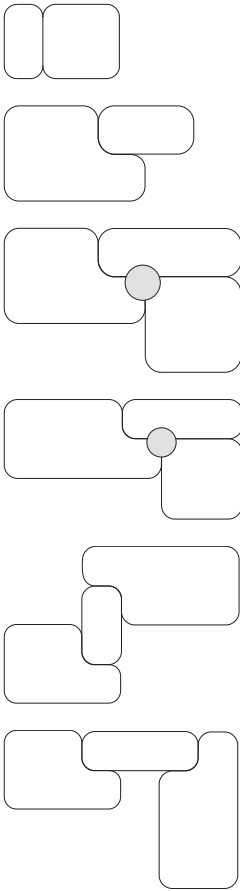
**Rectangle 70<sup>9</sup>/<sub>10</sub>"W Benches**



**Rectangle 94<sup>1</sup>/<sub>2</sub>"W Benches**

**Common bench** is fully upholstered and has a relaxed appearance. Benches may show soft comfort wrinkles upon use. *Tip: Some technical fabrics are manufactured with different seams.*





**Rectangle benches with indents** can be used in two positions. Specify indent left- or right-facing. Left and right is understood by looking at the module from above.

**Indent on 70<sup>9</sup>/<sub>10</sub>"W and 94<sup>1</sup>/<sub>2</sub>"W rectangle benches** is 23<sup>3</sup>/<sub>5</sub>" x 23<sup>3</sup>/<sub>5</sub>".

**Surface Materials**

**Upholstery**

- Fabric
- Vinyl
- COM (Customer's Own Material)

**Different settings** can be created through a variety of compositions.

**Legs** are natural beech finished in a matte varnish.

**Plastic glides** available with or without felt.

**Actual Dimensions**

Description	Style Number	Depth	Width	Height	Weight
47 <sup>1</sup> / <sub>5</sub> "W Rectangle Bench – Low Height	<b>VCBCB4724L</b>	23 <sup>3</sup> / <sub>5</sub> "	47 <sup>1</sup> / <sub>5</sub> "	15 <sup>3</sup> / <sub>5</sub> "	47.6 lb
47 <sup>1</sup> / <sub>5</sub> "W Rectangle Bench – Medium Height	<b>VCBCB4724M</b>	23 <sup>3</sup> / <sub>5</sub> "	47 <sup>1</sup> / <sub>5</sub> "	23 <sup>4</sup> / <sub>5</sub> "	61.5 lb
47 <sup>1</sup> / <sub>5</sub> "W Rectangle Bench – High Height	<b>VCBCB4724H</b>	23 <sup>3</sup> / <sub>5</sub> "	47 <sup>1</sup> / <sub>5</sub> "	27"	66.6 lb
47 <sup>1</sup> / <sub>5</sub> "W Square Bench – Low Height	<b>VCBCB4747L</b>	47 <sup>1</sup> / <sub>5</sub> "	47 <sup>1</sup> / <sub>5</sub> "	15 <sup>3</sup> / <sub>5</sub> "	97.9 lb
70 <sup>9</sup> / <sub>10</sub> "W Rectangle Bench – Low Height	<b>VCBCB7124L</b>	23 <sup>3</sup> / <sub>5</sub> "	70 <sup>9</sup> / <sub>10</sub> "	15 <sup>3</sup> / <sub>5</sub> "	74.1 lb
70 <sup>9</sup> / <sub>10</sub> "W Rectangle Bench – Medium Height	<b>VCBCB7124M</b>	23 <sup>3</sup> / <sub>5</sub> "	70 <sup>9</sup> / <sub>10</sub> "	23 <sup>4</sup> / <sub>5</sub> "	92.6 lb
70 <sup>9</sup> / <sub>10</sub> "W Rectangle Bench – High Height	<b>VCBCB7124H</b>	23 <sup>3</sup> / <sub>5</sub> "	70 <sup>9</sup> / <sub>10</sub> "	27"	95.0 lb
70 <sup>9</sup> / <sub>10</sub> "W Rectangle Bench – Low Height	<b>VCBCB7147L</b>	47 <sup>1</sup> / <sub>5</sub> "	70 <sup>9</sup> / <sub>10</sub> "	15 <sup>3</sup> / <sub>5</sub> "	137.8 lb
70 <sup>9</sup> / <sub>10</sub> "W Rectangle Bench with Indent – Low Height	<b>VCBCB7147CIL</b>	47 <sup>1</sup> / <sub>5</sub> "	70 <sup>9</sup> / <sub>10</sub> "	15 <sup>3</sup> / <sub>5</sub> "	125.2 lb
94 <sup>1</sup> / <sub>2</sub> "W Rectangle Bench with Indent – Low Height	<b>VCBCB9447CIL</b>	47 <sup>1</sup> / <sub>5</sub> "	94 <sup>1</sup> / <sub>2</sub> "	15 <sup>3</sup> / <sub>5</sub> "	176.4 lb



---

# Specifying Tables and Benches

Standard 4-6 Week Lead Time

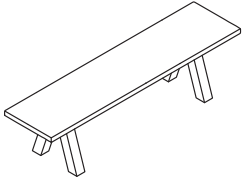
---

## Specifying

Trestle	32
Common	41

# Tables and Benches

## Trestle



*Tip: Leather is not available when smooth upholstery is selected. It is available on the padded upholstery.*

### Standard Includes

- Seat: upholstery
- Legs (base): veneer price group 01

### Options

Upholstery Type	Smooth Upholstery	No cost
	Padded Upholstery	+\$100
Leg Finish	Veneer Custom Stain	No cost
	Veneer Price Group 01	No cost

### Specification Information

Dimensions			Style Number	Base Prices										Leather PG1	Leather PG2	COM/ COL
D	W	H		Upholstery Grades:												
			1	2	3	4	5	6	7	8	9	10				

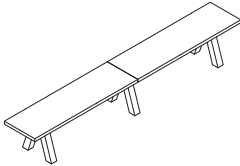
### Trestle Single Bench

17 7/10"	70 9/10"	17 7/10"	<b>VCBTRSB</b>	\$2425	\$2494	\$2556	\$2629	\$2740	\$2876	\$3033	\$3200	\$3348	\$3504	\$3596	\$4856	\$2425
----------	----------	----------	----------------	--------	--------	--------	--------	--------	--------	--------	--------	--------	--------	--------	--------	--------

# Tables and Benches

## Trestle

Tables and Benches



*Tip: Leather is not available when smooth upholstery is selected. It is available on the padded upholstery.*

### Standard Includes

- Seat: upholstery
- Legs (base): veneer price group 01

### Options

Upholstery Type	Smooth Upholstery	No cost
	Padded Upholstery	+\$150
Leg Finish	Veneer Custom Stain	No cost
	Veneer Price Group 01	No cost

### Specification Information

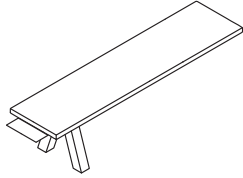
Dimensions			Style Number	Base Prices										Leather PG1	Leather PG2	COM/ COL
D	W	H		Upholstery Grades:												
				1	2	3	4	5	6	7	8	9	10			

#### Trestle Double Bench

17 7/10"	118 1/10"	17 7/10"	<b>VCBTRDB</b>	\$4225	\$4342	\$4446	\$4570	\$4757	\$4990	\$5255	\$5538	\$5787	\$6053	\$6218	\$8364	\$4225
----------	-----------	----------	----------------	--------	--------	--------	--------	--------	--------	--------	--------	--------	--------	--------	--------	--------

# Tables and Benches

## Trestle



*Tip: Leather is not available when smooth upholstery is selected. It is available on the padded upholstery.*

### Standard Includes

- Seat: upholstery
- Legs (base): veneer price group 01

### Options

Upholstery Type	Smooth Upholstery	No cost
	Padded Upholstery	+\$75
Leg Finish	Veneer Custom Stain	No cost
	Veneer Price Group 01	No cost

### Specification Information

Dimensions			Style Number	Base Prices										Leather PG1	Leather PG2	COM/ COL
D	W	H		Upholstery Grades:												
				1	2	3	4	5	6	7	8	9	10			

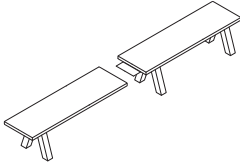
### Trestle Bench Create-Your-Own Center Kit

17 7/10"	47 1/5"	17 7/10"	<b>VCBTRCB</b>	\$2105	\$2156	\$2201	\$2254	\$2335	\$2435	\$2550	\$2671	\$2778	\$2893	\$2972	\$3896	\$2105
----------	---------	----------	----------------	--------	--------	--------	--------	--------	--------	--------	--------	--------	--------	--------	--------	--------

# Tables and Benches

## Trestle

Tables and Benches



*Tip: Leather is not available when smooth upholstery is selected. It is available on the padded upholstery.*

### Standard Includes

- Seat: upholstery
- Legs (base): veneer price group 01

### Options

Upholstery Type	Smooth Upholstery	No cost
	Padded Upholstery	+\$150
Leg Finish	Veneer Custom Stain	No cost
	Veneer Price Group 01	No cost

### Specification Information

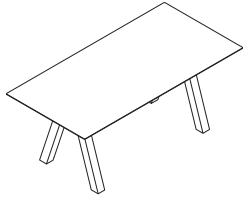
Dimensions			Style Number	Base Prices										Leather PG1	Leather PG2	COM/ COL
D	W	H		Upholstery Grades:												
				1	2	3	4	5	6	7	8	9	10			

### Trestle Bench Create-Your-Own End Kit

17 7/10"	118 1/10"	17 7/10"	<b>VCBTREB</b>	\$4225	\$4342	\$4446	\$4570	\$4757	\$4990	\$5255	\$5538	\$5787	\$6053	\$6218	\$8364	\$4225
----------	-----------	----------	----------------	--------	--------	--------	--------	--------	--------	--------	--------	--------	--------	--------	--------	--------

# Tables and Benches

## Trestle



*Tip: Knife-edge tops have an exposed, clear coated edge and underside. There is no edgeband.*

*Tip: All Trestle tops are long-grain. In multi-piece tops, no grain matching will occur between tops.*

*Tip: When power is specified, power module quantity is equal to the number of leg segments on the table.*

*Tip: Power location is automatically centered between the leg segments on each table top.*

*Tip: Power is available in three colors:*

- Milk 4242
- Black 4710
- Platinum Metallic 4799

*Tip: Cable tray is painted and will match understructure.*

*Tip: Leg cable cover attaches with magnets and is applicable for both metal and wood legs.*

### Standard Includes

- Top: High-Pressure Laminate price group 1 with exposed knife edge
- Metal legs: paint price group 01

### Options

Width	120"	Prices below
	132"	Prices below
	144"	Prices below
	168"	Prices below
	192"	Prices below
	216"	Prices below
	240"	Prices below
	72"	Prices below
	84"	Prices below
Depth	36"	Prices below
	48"	Prices below
Top Finish	Laminate HPL Price Group 01	No cost
	Veneer Custom Stain	No cost
	Veneer Price Group 01	Prices below
Leg Type	Metal	No cost
	Wood	+\$400 per set of legs
Leg Finish	Paint Price Group 01	No cost
	Paint Price Group 02	No cost
	Veneer Custom Stain	No cost
	Veneer Price Group 01	No cost
Power Option	Paint Price Group 03	Prices below
	No Power	No cost
	With Power	Prices below
Power Finish	Paint Price Group 01	No cost
	Paint Price Group 02	No cost
Power Configuration	3 Power	+\$400
	2 Power 1 USB A+C 20w	+\$500
Cable Tray	Without Tray	No cost
	With Tray	+\$200
Leg Cable Cover	No Leg Cable Cover	No cost
	With Leg Cable Cover	+\$200
Leg Cable Cover Finish	Paint Price Group 01	No cost
	Paint Price Group 02	No cost
	Paint Price Group 03	+\$78

► **Product Information continued on next page**



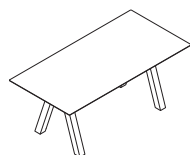
# Tables and Benches

## Trestle

► Product Information continued from previous page

### Specification Information

Style Number	Dimensions			Base Prices	Option (Add \$ to Base Price)		
	Depth	Width	Height		Laminate PG3	Wood Group 1	Leg Paint PG3



### Viccarbe Trestle Table - Seated Height

VCBTR	36"	72"	29"	\$2641	+\$133	+\$996	+\$313
	36"	84"	29"	\$2755	+\$146	+\$1126	+\$313
	36"	96"	29"	\$2954	+\$171	+\$1202	+\$313
	36"	120"	29"	\$3622	+\$216	+\$1414	+\$470
	36"	132"	29"	\$5368	+\$257	+\$1750	+\$470
	36"	144"	29"	\$5987	+\$286	+\$2215	+\$470
	36"	168"	29"	\$6851	+\$323	+\$2515	+\$626
	36"	192"	29"	\$7706	+\$378	+\$2856	+\$626
	36"	216"	29"	\$8368	+\$429	+\$3078	+\$783
	36"	240"	29"	\$9112	+\$482	+\$3373	+\$783
	48"	72"	29"	\$3725	+\$177	+\$1394	+\$313
	48"	84"	29"	\$4090	+\$199	+\$1538	+\$313
	48"	96"	29"	\$4455	+\$232	+\$1683	+\$313
	48"	120"	29"	\$5393	+\$281	+\$2013	+\$470
	48"	132"	29"	\$6039	+\$310	+\$2159	+\$470
	48"	144"	29"	\$6749	+\$339	+\$2426	+\$470
	48"	168"	29"	\$7685	+\$377	+\$2756	+\$626
	48"	192"	29"	\$8622	+\$432	+\$3128	+\$626
	48"	216"	29"	\$9338	+\$483	+\$3371	+\$783
	48"	240"	29"	\$10,153	+\$536	+\$3694	+\$783

► Product Information continued on next page

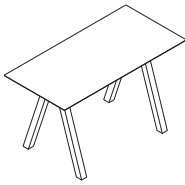
# Tables and Benches

## Trestle

► **Product Information continued from previous page**

### Specification Information

Style Number	Dimensions			Base Prices	Option (Add \$ to Base Price)		
	Depth	Width	Height		Laminate PG3	Wood Group 1	Leg Paint PG3

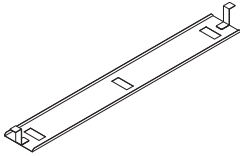


### Viccarbe Trestle Table - Standing Height

Style Number	Depth	Width	Height	Base Price	Laminate PG3	Wood Group 1	Leg Paint PG3
<b>VCBTRST</b>	36"	72"	41"	\$3041	+\$133	+\$996	+\$313
	36"	84"	41"	\$3155	+\$146	+\$1126	+\$313
	36"	96"	41"	\$3354	+\$171	+\$1202	+\$313
	36"	120"	41"	\$4222	+\$216	+\$1414	+\$470
	36"	132"	41"	\$5968	+\$257	+\$1950	+\$470
	36"	144"	41"	\$6587	+\$286	+\$2215	+\$470
	36"	168"	41"	\$7651	+\$323	+\$2515	+\$626
	36"	192"	41"	\$8506	+\$378	+\$2856	+\$626
	36"	216"	41"	\$9368	+\$429	+\$3078	+\$783
	36"	240"	41"	\$10,112	+\$482	+\$3373	+\$783
	48"	72"	41"	\$4125	+\$177	+\$1394	+\$313
	48"	84"	41"	\$4490	+\$199	+\$1538	+\$313
	48"	96"	41"	\$4855	+\$232	+\$1683	+\$313
	48"	120"	41"	\$5993	+\$281	+\$2013	+\$470
	48"	132"	41"	\$6639	+\$310	+\$2159	+\$470
	48"	144"	41"	\$7349	+\$339	+\$2426	+\$470
	48"	168"	41"	\$8485	+\$377	+\$2756	+\$626
	48"	192"	41"	\$9422	+\$432	+\$3128	+\$626
	48"	216"	41"	\$10,338	+\$483	+\$3371	+\$783
	48"	240"	41"	\$11,153	+\$536	+\$3694	+\$783

# Tables and Benches

## Trestle



### Standard Includes

- Wire manager: 6000 Black

### Specification Information

Style Number      Price

### Trestle Wire Management Tray

**VCBTRWMT**      \$200



*Tip: Leg cable cover attaches with magnets and is applicable for both metal and wood legs.*

### Standard Includes

- Leg cable cover: paint
- Height: seated height

### Options

Height	29"	No cost
	41"	No cost

### Specification Information

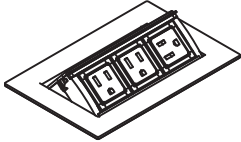
Style Number      Price

### Trestle Leg Cable Cover

**VCBTRCC**      \$200

# Tables and Benches

## Trestle



*Tip: When power configuration is specified, that configuration will be applied to all units in the kit.*

*Tip: Eight power units is the maximum number of accessories that can be ganged together with a single infeed.*

*Tip: Each power kit includes one infeed.*

### Standard Includes

- Power unit, quantity of 1
- Power module color:
  - 4242 Milk
  - 4710 Low Gloss Black
  - 4799 Platinum

### Options

Power Finish	Paint Price Group 01 Paint Price Group 02	No cost No cost
Power Configuration	2 Power 1 USB A+C 20w 3 Power	Prices below Prices below
Power Unit Quantity	1 Power Unit 2 Power Unit 3 Power Unit 4 Power Unit	Prices below Prices below Prices below Prices below

### Specification Information

Style Number	Power Configuration	Power Unit Quantity	Prices
<b>Trestle Power Kit</b>			
<b>VCBTRPWR</b>	3 Power	1	\$400
	2 Power + 1 USB A+C	1	\$500
	3 Power	2	\$800
	2 Power + 1 USB A+C	2	\$1000
	3 Power	3	\$1200
	2 Power + 1 USB A+C	3	\$1500
	3 Power	4	\$1600
	2 Power + 1 USB A+C	4	\$2000

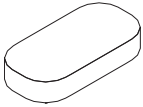
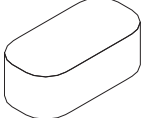


# Tables and Benches

Common

### Standard Includes

- Upholstery: fabric
- Legs: matte varnished natural beech
- Glides

### Specification Information

Dimensions				Style Number	Prices										
D	W	H	Upholstery Grades:		1	2	3	4	5	6	7	8	9	10	COM
<b>Common 47 1/5"W Rectangle Bench - Low Height</b>															
	23 3/5"	47 1/5"	15 3/5"	<b>VCBCB4724L</b>	\$2662	\$2850	\$2913	\$2998	\$3137	\$3275	\$3453	\$3611	\$3749	\$3927	\$2662
<b>Common 47 1/5"W Rectangle Bench - Medium Height</b>															
	23 3/5"	47 1/5"	23 4/5"	<b>VCBCB4724M</b>	\$2947	\$3178	\$3256	\$3360	\$3530	\$3700	\$3918	\$4112	\$4282	\$4501	\$2947
<b>Common 47 1/5"W Rectangle Bench - High Height</b>															
	23 3/5"	47 1/5"	27"	<b>VCBCB4724H</b>	\$3125	\$3377	\$3462	\$3576	\$3761	\$3947	\$4185	\$4397	\$4582	\$4821	\$3125
<b>Common 47 1/5"W Square Bench - Low Height</b>															
	47 1/5"	47 1/5"	15 3/5"	<b>VCBCB4747L</b>	\$3028	\$3304	\$3397	\$3521	\$3724	\$3928	\$4189	\$4420	\$4624	\$4885	\$3028


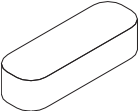
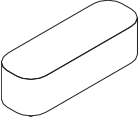

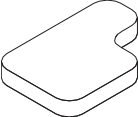
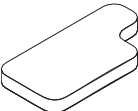
# Tables and Benches

## Common

### Standard Includes

- Upholstery: fabric
- Legs: matte varnished natural beech
- Glides

### Specification Information

				Prices											
Dimensions			Style	Upholstery Grades:											
D	W	H	Number	1	2	3	4	5	6	7	8	9	10	COM	
<b>Common 70 9/10"W Rectangle Bench - Low Height</b>															
	23 3/5"	70 9/10"	15 3/5"	<b>VCBCB7124L</b>	\$3522	\$3803	\$3898	\$4026	\$4233	\$4440	\$4706	\$4943	\$5150	\$5417	\$3522
<b>Common 70 9/10"W Rectangle Bench - Medium Height</b>															
	23 3/5"	70 9/10"	23 4/5"	<b>VCBCB7124M</b>	\$3722	\$4044	\$4153	\$4298	\$4536	\$4773	\$5078	\$5349	\$5586	\$5892	\$3722
<b>Common 70 9/10"W Rectangle Bench - High Height</b>															
	23 3/5"	70 9/10"	27"	<b>VCBCB7124H</b>	\$3901	\$4223	\$4332	\$4477	\$4715	\$4952	\$5257	\$5528	\$5765	\$6071	\$3901
<b>Common 70 9/10"W Rectangle Bench - Low Height</b>															
	47 1/5"	70 9/10"	15 3/5"	<b>VCBCB7147L</b>	\$4294	\$4661	\$4785	\$4951	\$5221	\$5492	\$5839	\$6148	\$6419	\$6767	\$4294
<b>Common 70 9/10"W Rectangle Bench with Indent - Low Height</b>															
	47 1/5"	70 9/10"	15 3/5"	<b>VCBCB7147CIL</b>	\$4481	\$4826	\$4942	\$5098	\$5351	\$5605	\$5932	\$6221	\$6476	\$6802	\$4481
<b>Common 94 1/2"W Rectangle Bench with Indent - Low Height</b>															
	47 1/5"	94 1/2"	15 3/5"	<b>VCBCB9447CIL</b>	\$5445	\$5882	\$6030	\$6228	\$6550	\$6872	\$7286	\$7654	\$7977	\$8391	\$5445

---

# Understanding Chairs and Stools

Standard Import Lead Time

---

**Statement of Line** **44**

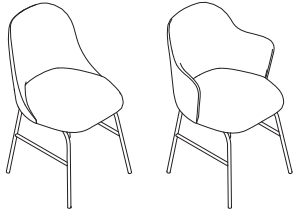
**Understanding**

Aleta	<b>56</b>
Aleta Executive	<b>60</b>
Copa	<b>62</b>
Ears	<b>64</b>
Funda	<b>68</b>
Klip	<b>70</b>
Last Minute	<b>73</b>
Maarten	<b>74</b>
Noha and Noha Executive	<b>80</b>
Perxa	<b>83</b>
Quadra	<b>84</b>
Season	<b>85</b>

# Statement of Line

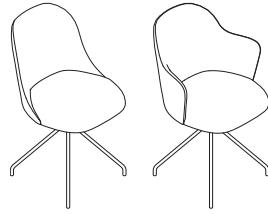
## Chairs and Stools

### Aleta



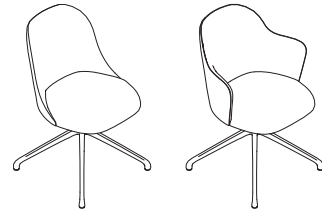
#### Four Metal Legs Base Chairs

Understanding  
▶ Page 56  
Specifying  
▶ Page 88



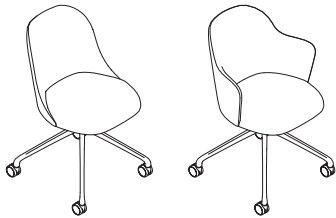
#### Swivel Base Chairs

Understanding  
▶ Page 56  
Specifying  
▶ Page 89



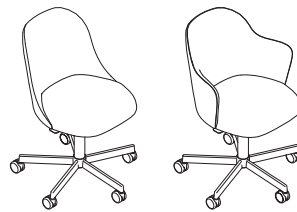
#### Pyramid Swivel Base Chairs

Understanding  
▶ Page 56  
Specifying  
▶ Page 90



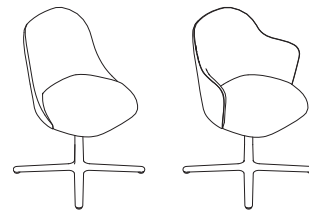
#### Pyramid Swivel Base Chairs with Casters

Understanding  
▶ Page 56  
Specifying  
▶ Page 91



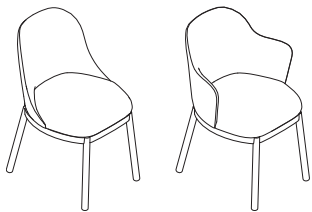
#### Five Caster Base Chairs

Understanding  
▶ Page 56  
Specifying  
▶ Page 92



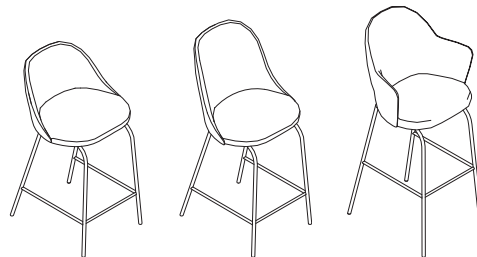
#### Flat Swivel Base Chairs

Understanding  
▶ Page 56  
Specifying  
▶ Page 93



#### Four Wooden Legs Base Chairs

Understanding  
▶ Page 56  
Specifying  
▶ Page 94

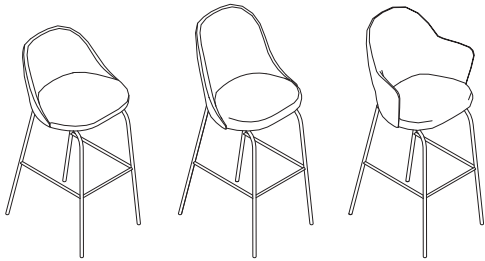


#### Fixed Metal Counter Stools

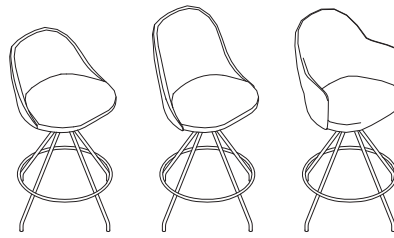
Understanding  
▶ Page 56  
Specifying  
▶ Page 95



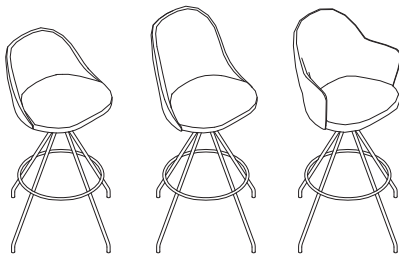
**Aleta, continued**



**Fixed Metal Bar Stools**  
 Understanding  
 ▶ Page 56  
 Specifying  
 ▶ Page 97



**Swivel Metal Counter Stools**  
 Understanding  
 ▶ Page 56  
 Specifying  
 ▶ Page 99



**Swivel Metal Bar Stools**  
 Understanding  
 ▶ Page 56  
 Specifying  
 ▶ Page 81

**Aleta Executive**

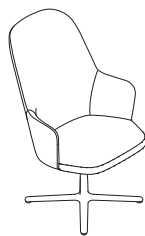
Understanding  
 ▶ Page 60  
 Specifying  
 ▶ Pages 103–107



**Fully Upholstered Five Casters Nylon or Aluminum Base Executive Chair**



**Wooden Outer Back Five Casters Nylon or Aluminum Base Executive Chair**



**Fully Upholstered Flat Swivel Base Executive Chair**



**Wooden Outer Back Flat Swivel Base Executive Chair**

**Copa**

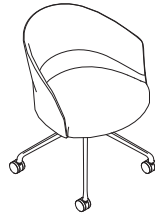
Understanding  
▶ Page 62  
Specifying  
▶ Pages 109–122



**Metal Chair**



**Pyramid Swivel Chair**



**Pyramid Swivel Chair  
with Casters**



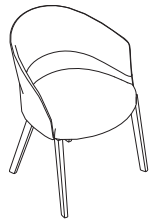
**Five Caster Chair**



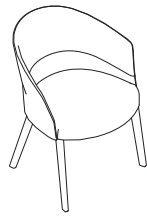
**Cantilever Chair**



**Flat Swivel Chair**



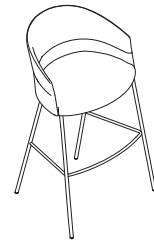
**Wooden Legs Chair**



**Upholstered Wooden  
Legs Chair**



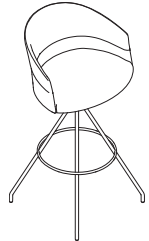
**Fixed Counter Stool**



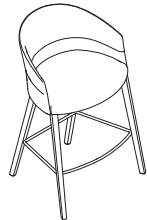
**Fixed Bar Stool**



**Swivel Counter Stool  
Stool**



**Swivel Bar Stool Stool**



**Fixed Wooden Legs  
Counter Stool**



**Fixed Wooden Legs Bar  
Stool**

**Ears**

Understanding  
 ▶ Page 64  
 Specifying  
 ▶ Pages 123–134



**Four Leg Metal Base Chair**



**Four Leg Metal Base Chair with Cushion**



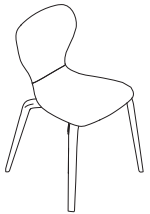
**Four Leg Metal Base Chair with Smooth Upholstery**



**Four Leg Wooden Base Chair**



**Four Leg Wood Base Chair with Cushion**



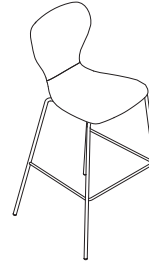
**Four Leg Wooden Base Chair with Smooth Upholstery**



**Fixed Bar Stool**



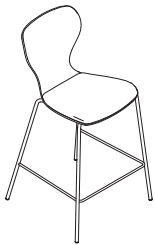
**Fixed Bar Stool with Cushion**



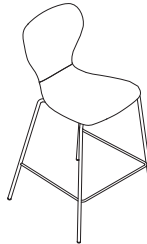
**Fixed Bar Stool with Smooth Upholstery**



**Fixed Counter Stool**



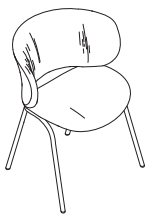
**Fixed Counter Stool with Cushion**



**Fixed Counter Stool with Smooth Upholstery**

**Funda**

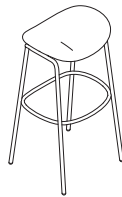
Understanding  
 ▶ Page 68  
 Specifying  
 ▶ Pages 135–136



**Chair**



**Fixed Counter Stool**



**Fixed Bar Stool**

**Klip**

Understanding  
 ▶ Page 70  
 Specifying  
 ▶ Pages 137–167



**Four Metal Legs Base Chair**



**Four Metal Legs Base Chair with Upholstery**



**Four Metal Legs Base Chair with Cushion**



**Swivel Chair**



**Swivel Chair with Upholstery**



**Swivel Chair with Cushion**



**Pyramid Swivel Chair**



**Pyramid Swivel Chair with Upholstery**



**Pyramid Swivel Chair with Cushion**



**Pyramid Swivel Chair with Casters**



**Pyramid Swivel Chair with Casters and Upholstery**



**Pyramid Swivel Chair with Casters and Cushion**



**Chair with Casters**



**Chair with Casters and Upholstery**



**Chair with Casters and Cushion**



**Flat Swivel Chair**



**Flat Swivel Chair with Upholstery**



**Flat Swivel Chair with Cushion**



**Swivel Counter Stool**



**Swivel Counter Stool with Upholstery**



**Klip, continued**

Understanding  
 ▶ Page 70  
 Specifying  
 ▶ Pages 137–167



**Swivel Counter Stool with Cushion**



**Swivel Bar Stool**



**Swivel Bar Stool with Upholstery**



**Swivel Bar Stool with Cushion**



**Fixed Counter Stool**



**Fixed Counter Stool with Upholstery**



**Fixed Counter Stool with Cushion**



**Fixed Bar Stool**

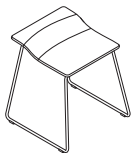


**Fixed Bar Stool with Upholstery**

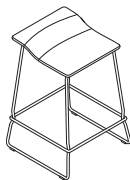


**Fixed Bar Stool with Cushion**

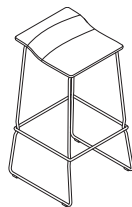
**Last Minute**



**Stool—Low Height**  
 Understanding  
 ▶ Page 73  
 Specifying  
 ▶ Page 168



**Stool—Medium Height**  
 Understanding  
 ▶ Page 73  
 Specifying  
 ▶ Page 168



**Stool—High Height**  
 Understanding  
 ▶ Page 73  
 Specifying  
 ▶ Page 169

**Maarten**

Understanding  
▶ Page 74  
Specifying  
▶ Pages 170–221



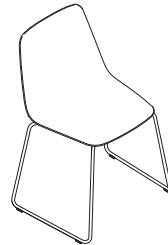
**Four Leg Chair**



**Four Leg Chair with Cushion**



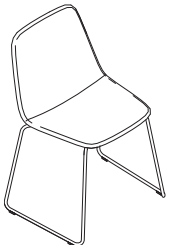
**Four Leg Chair with Upholstery**



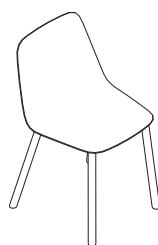
**Sled Chair**



**Sled Chair with Cushion**



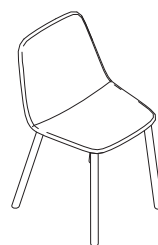
**Sled Chair with Upholstery**



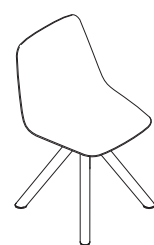
**Four Wooden Leg Chair**



**Four Wooden Leg Chair with Cushion**



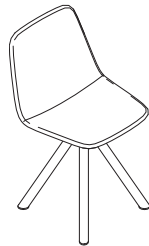
**Four Wooden Leg Chair with Upholstery**



**Swivel Chair**



**Swivel Chair with Cushion**



**Swivel Chair with Upholstery**



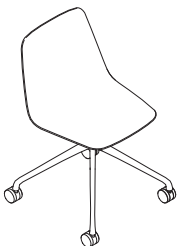
**Pyramid Swivel Chair**



**Pyramid Swivel Chair with Cushion**



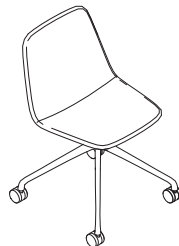
**Pyramid Swivel Chair with Upholstery**



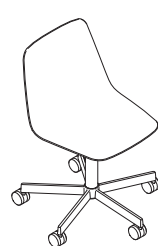
**Pyramid Swivel Chair with Casters**



**Pyramid Swivel Chair with Casters and Cushion**



**Pyramid Swivel Chair with Casters and Upholstery**



**Five Caster Chair**



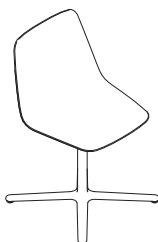
**Five Caster Chair with Cushion**

**Maarten, continued**

Understanding  
▶ Page 74  
Specifying  
▶ Pages 170–221



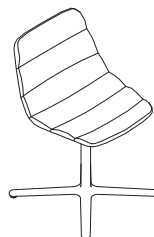
**Five Caster Chair with Upholstery**



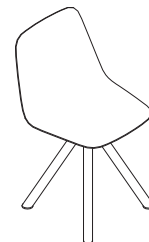
**Flat Swivel Chair**



**Flat Swivel Chair with Cushion**



**Flat Swivel Chair with Upholstery**



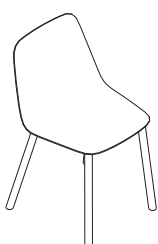
**Wooden Swivel Chair**



**Wooden Swivel Chair with Cushion**



**Wooden Swivel Chair with Upholstery**



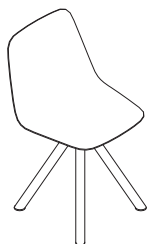
**Four Upholstered Leg Chair**



**Four Upholstered Leg Chair with Cushion**



**Four Upholstered Leg Chair with Upholstery**



**Upholstered Leg Swivel Chair**



**Upholstered Leg Swivel Chair with Cushion**



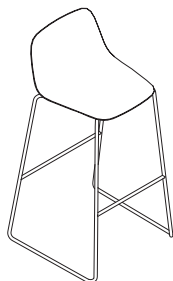
**Upholstered Leg Swivel Chair with Upholstery**



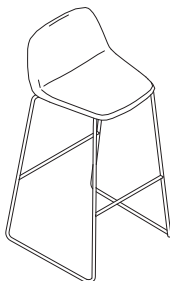
**Sled Counter Stool with Low Backrest**



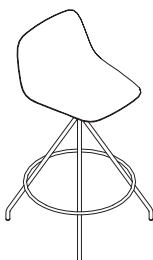
**Sled Counter Stool with Low Backrest and Upholstery**



**Sled Bar Stool with Low Backrest**



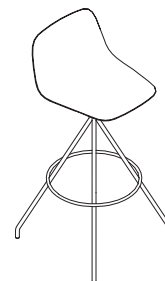
**Sled Bar Stool with Low Backrest and Upholstery**



**Swivel Counter Stool with Low Backrest**



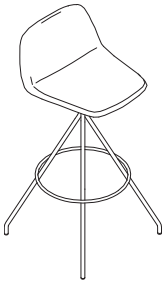
**Swivel Counter Stool with Low Backrest and Upholstery**



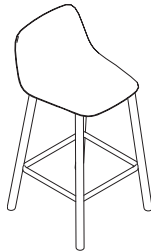
**Swivel Bar Stool with Low Backrest**

**Maarten, continued**

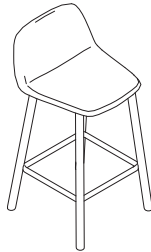
Understanding  
▶ Page 74  
Specifying  
▶ Pages 170–221



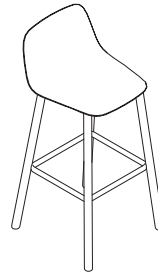
**Swivel Bar Stool with Low Backrest and Upholstery**



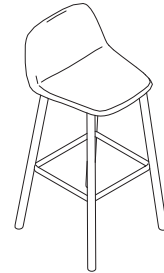
**Four Wooden Leg Counter Stool with Low Backrest**



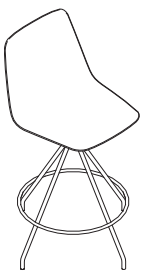
**Four Wooden Leg Counter Stool with Low Backrest and Upholstery**



**Four Wooden Leg Bar Stool with Low Backrest**



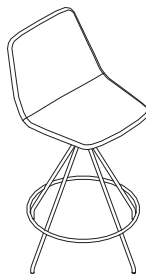
**Four Wooden Leg Bar Stool with Low Backrest**



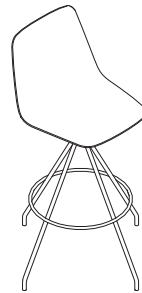
**Swivel Counter Stool with High Backrest**



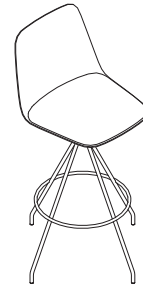
**Swivel Counter Stool with High Backrest and Cushion**



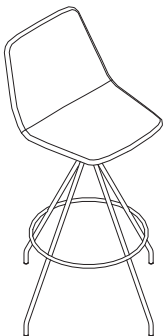
**Swivel Counter Stool with High Backrest and Upholstery**



**Swivel Bar Stool with High Backrest**



**Swivel Bar Stool with High Backrest and Cushion**



**Swivel Bar Stool with High Backrest and Upholstery**



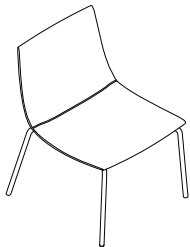
**Auditorium Chair with Upholstery**



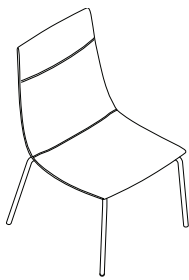


## Noha

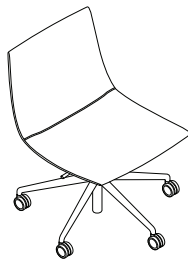
Understanding  
▶ Page 80  
Specifying  
▶ Pages 222–227



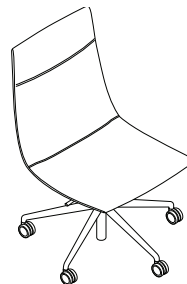
**Four Leg Metal Base Standard Chair**



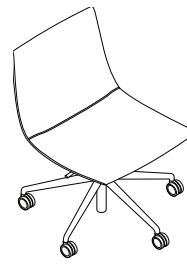
**Four Leg Metal Base Executive Chair**



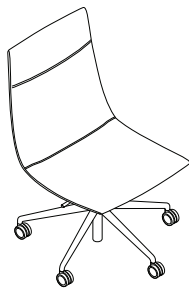
**Five Caster Nylon Base Standard Chair**



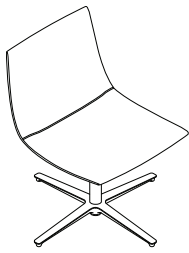
**Five Caster Nylon Base Executive Chair**



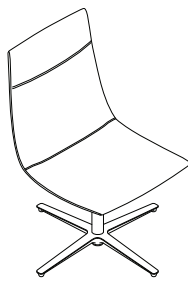
**Five Caster Aluminum Base Standard Chair**



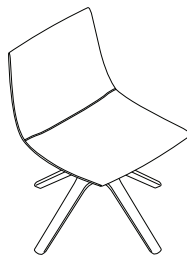
**Five Caster Aluminum Base Executive Chair**



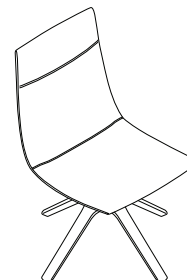
**Flat Swivel Base Standard Chair**



**Flat Swivel Base Executive Chair**



**Wooden Swivel Base Standard Chair**



**Wooden Swivel Base Executive Chair**

## Perxa

Understanding  
▶ Page 83  
Specifying  
▶ Pages 229–231



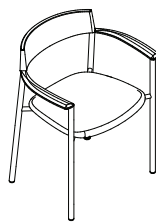
**Chair**



**Stackable Chair**



**Chair with Cushion**



**Chair with Cushion and Upholstered Backrest**

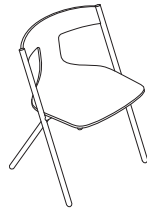
---

**Quadra**

Understanding  
▶ Page 84  
Specifying  
▶ Pages 232–236



**Chair**



**Stackable Chair**



**Chair with Cushion**

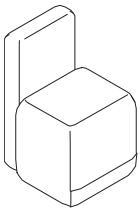


**Chair with Cushion and Upholstered Backrest**

---

**Season**

Understanding  
▶ Page 85  
Specifying  
▶ Page 237



**Chair**



# Aleta

**Aleta seating**, designed by Jaime Hayon, is inspired by the physiognomy and movement of sharks. ▶ Specifying, pages 88–101

**Upholstered backrest** available in fabric, leather, or vinyl.

**Metal base** is available in brass finish or powder coated paint in black, white, or taupe.

**Plastic glides for metal base** are available in black or white with or without felt.

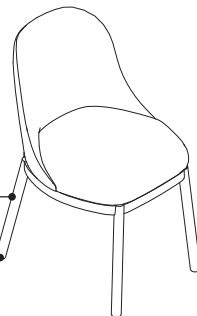
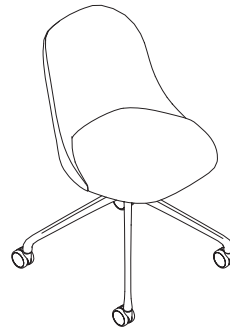
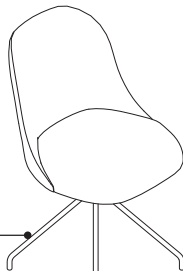
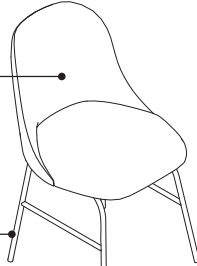
**Pyramid and flat swivel bases** are aluminum construction powder coated paint in black or white.

**Plastic glides for pyramid swivel base** are available with or without felt.

**Five caster base** is aluminum construction coated in black or white high gloss paint. Base is height-adjustable.

**Solid oak stained wood base** available.

**Plastic glides for wood base** are available with or without felt.



**Chairs** are available with a high backrest rest as well as with and without arms. Arms are fully integrated into the seat shell.

**Pyramid and flat swivel bases** are aluminum construction powder coated paint in black or white.

**Swivel base** is powder coated paint in black or white.

**Plastic glides for swivel base** are available in black or white with or without felt.

## Product Details

### Four leg metal and swivel base chairs

are available in brass finish or powder coated paint in black, white, or taupe. Legs have plastic black or white glides with or without felt.

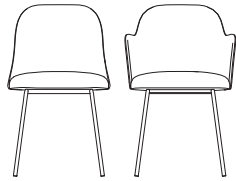
**Pyramid swivel base chairs** are aluminum construction and powder coated paint. Legs have plastic black or white glides with or without felt.

**Flat swivel base chairs** are aluminum construction with powder coated paint. Legs have plastic black or translucent glides with or without felt.

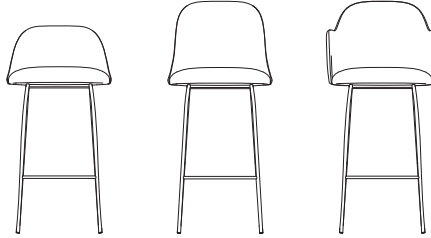
**Pyramid swivel base chairs with casters** are aluminum construction powder coated in paint. Legs have soft casters suitable for use on hard floors.

**Five caster base chairs** are powder coated in black or white high gloss paint. Chair is height-adjustable. Soft casters are suitable for use on hard floors.

**Wood leg base chairs** are solid oak wood stained. Legs have plastic glides with or without felt.



**Seats** are available with either high backrest or high backrest with arms.



**Stools** are available with low backrest, high backrest, or high backrest with arms.

**Stools** are available in a bar or counter stool height. Stools are powder coated paint. Legs have plastic glides with or without felt.

**Stool bases** are available in four leg metal or swivel.

**Seats** are plywood construction covered with polyurethane foam.

**Stools** have a foot ring.

**Contrasting fabric** is available for seat and back.

*Tip: If contrasting upholstery is specified, seat finish group and back finish group will be specified separately, and pricing will be based on highest finish group selected.*

## Surface Materials

### Upholstery

- Fabric
- Vinyl
- Leather
- COM (Customer's Own Material)
- COL (Customer's Own Leather)

### Metal base

- 1019 Taupe RAL
- 9003 White RAL
- 9005 Black RAL
- Brass finish

### Wood base

- Ash
- Bleached oak
- Cognac
- Matte oak
- Walnut oak

**Dimensions**

Description	Style Number	Depth	Width	Height	Seat Depth	Seat Height	Arm Height from Floor	Footrest Height from Floor	Weight
<b>Four Metal Legs Base Chairs</b>									
Chair	<b>VCBALSIME</b>	21½"	19¾"	32¾"	16½"	197/10"	N.A.	N.A.	28.2 lb
Chair with Arms	<b>VCBALSIMEBR</b>	219/10"	209/10"	32¾"	16½"	197/10"	26¾"	N.A.	30.6 lb
<b>Swivel Base Chairs</b>									
Base Chair	<b>VCBALSIG</b>	219/10"	19¾"	33¾"	16½"	201/10"	N.A.	N.A.	31.5 lb
Base Chair with Arms	<b>VCBALSIGBR</b>	22½"	209/10"	33¾"	16½"	201/10"	27¾"	N.A.	34.0 lb
<b>Pyramid Swivel Base Chairs</b>									
Swivel Base Chair	<b>VCBALSIFI</b>	219/10"	19¾"	317/10"	16½"	18¾"	N.A.	N.A.	29.3 lb
Swivel Base Chair with Arms	<b>VCBALSIFIBR</b>	22½"	209/10"	317/10"	16½"	18¾"	26½"	N.A.	31.7 lb
Swivel Base Chair with Casters	<b>VCBALSIFIRU</b>	219/10"	199/10"	321/10"	16½"	181/10"	N.A.	N.A.	29.5 lb
Swivel Base Chair with Casters and Arms	<b>VCBALSIFIRUBR</b>	22½"	209/10"	321/10"	16½"	181/10"	26¾"	N.A.	32.4 lb
<b>Five Caster Base Chairs</b>									
Caster Base Chair	<b>VCBALSIBR</b>	23¾"	23¾"	30½"–36"	16½"	17½"–22¾"	N.A.	N.A.	29.5 lb
Caster Base Chair with Arms	<b>VCBALSIBRBR</b>	23¾"	23¾"	30½"–36"	16½"	22¾"	22¾"–30½"	N.A.	32.0 lb
<b>Flat Swivel Base Chairs</b>									
Swivel Base Chair	<b>VCBALSIFLA</b>	219/10"	19¾"	317/10"	16½"	181/10"	N.A.	N.A.	29.5 lb
Swivel Base Chair with Arms	<b>VCBALSIFLABR</b>	22½"	209/10"	317/10"	16½"	181/10"	26½"	N.A.	32.0 lb
<b>Four Wood Legs Base Chairs</b>									
Chair	<b>VCBALSIMA</b>	219/10"	19¾"	319/10"	16½"	19¾"	N.A.	N.A.	29.5 lb
Chair with Arms	<b>VCBALSIMABR</b>	22½"	209/10"	319/10"	16½"	19¾"	26¾"	N.A.	32.0 lb
<b>Four Metal Legs Base Stools</b>									
Counter Stool	<b>VCBALTAFC</b>	201/10"	161/10"	35½"	14½"	27¾"	N.A.	7½"	27.3 lb
Counter Stool with High Backrest	<b>VCBALTAFCBH</b>	201/10"	161/10"	40¾"	14½"	27¾"	N.A.	7½"	28.0 lb
Counter Stool with High Backrest and Arms	<b>VCBALTAFCBHBR</b>	201/10"	211/10"	40¾"	14½"	27¾"	35½"	7½"	30.4 lb
Bar Stool	<b>VCBALTA</b>	209/10"	161/10"	38¾"	14½"	309/10"	N.A.	11½"	28.2 lb
Bar Stool with High Backrest	<b>VCBALTAA</b>	209/10"	161/10"	441/10"	14½"	309/10"	N.A.	11½"	28.7 lb
Bar Stool with High Backrest and Arms	<b>VCBALTAHBR</b>	209/10"	211/10"	441/10"	14½"	309/10"	301/10"	11½"	31.1 lb
<b>Swivel Base Stools</b>									
Counter Stool	<b>VCBALTACO</b>	197/10"	197/10"	35½"	14½"	27¾"	N.A.	79/10"	28.9 lb
Counter Stool with High Backrest	<b>VCBALTACOH</b>	201/10"	197/10"	40¾"	14½"	27¾"	N.A.	79/10"	29.5 lb
Counter Stool with High Backrest and Arms	<b>VCBALTACOHBR</b>	20½"	211/10"	40¾"	14½"	27¾"	35¾"	79/10"	31.1 lb
Bar Stool	<b>VCBALTABAR</b>	197/10"	197/10"	38¾"	14½"	31¾"	N.A.	12"	26.7 lb
Bar Stool with High Backrest	<b>VCBALTABARH</b>	201/10"	197/10"	441/10"	14½"	31¾"	N.A.	12"	30.0 lb
Bar Stool with High Backrest and Arms	<b>VCBALTABARHBR</b>	201/10"	21¾"	441/10"	14½"	31¾"	39½"	12"	32.4 lb



# Aleta Executive

**Aleta Executive**, designed by Jaime Hayon, is an elegant designer chair with multiple possibilities that will keep users well seated and focused for as long as they require. An expansion of the Aleta collection, the executive chair features a distinctive back that can be specified in eco-leather, leather, or wood.

► Specifying, pages 88–107

**Outer back** can be specified in eco-leather, leather, or wood.

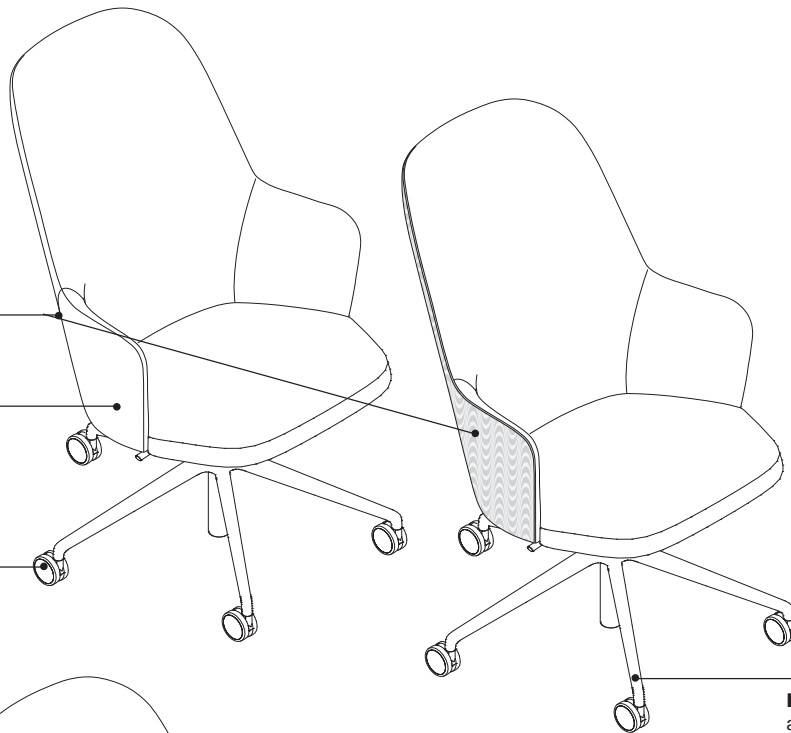
**Fully upholstered seat shell** made of plywood covered with non-deformable expanded polyurethane.

**Five caster aluminum base** is powder coated in white or black with soft casters for hard floors. Chair is height-adjustable.

**Five caster nylon base** available in black with soft casters for hard floors. Chair is height-adjustable.

**Outer back** can be specified in eco-leather, leather, or wood.

**Flat swivel aluminum base** is powder coated in black or white paint. Glides are black or translucent with or without felt.

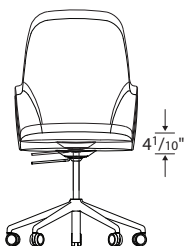




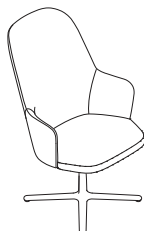
**Product Details**



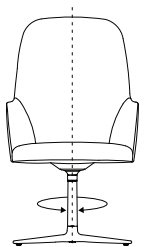
**Five-caster base** available in black nylon or powder coated black or white aluminum with soft casters for hard floors.



**Height adjustment system on five caster base** provides an adjustment range of 4 1/10"H.



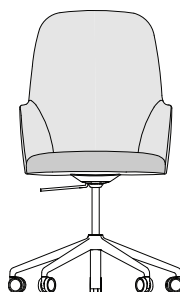
**Flat swivel base** is powder coated in black or white paint. Glides are black or translucent with or without felt.



**Self-return system** is available as an option only on the flat swivel base that brings the chair to its original position after use.



**Tilting mechanism** is available as an option for all bases. On the five-star caster base, the tilting mechanism can be locked by the user.



**Contrasting fabric** is available for seat and inner back.  
*Tip: If contrasting upholstery is specified, seat finish group and back finish group will be specified separately, and pricing will be based on highest finish group selected.*



**Outer back** available in three different options:

- Standard back—outer back upholstered in the same finish as the rest of the chair
- Eco-leather/leather outer back—outer back upholstered in eco-leather or leather
- Wood outer back—outer back in polished oak veneer

**Surface Materials**

**Upholstery**

- Fabric
- Eco-Leather
- Leather
- COM (Customer's Own Material)
- COL (Customer's Own Leather)

**Wood outer back—oak**

- Ash
- Bleached oak
- Cognac
- Matte oak
- Walnut oak

**Nylon/aluminum base**

- 9003 White RAL
- 9005 Black RAL

**Actual Dimensions**

Description	Style Number	Depth	Width	Height	Seat Depth	Seat Width	Seat Height	Weight
Aleta Executive Chair—Fully Upholstered Five Casters Nylon Base	<b>VCBALEXBRNY</b>	26 2/3"	26 2/3"	37 4/5"—42 1/8"	18 1/8"	23 1/5"	17"—21 3/8"	38.58 lb
Aleta Executive Chair—Wooden Outer Back Five Casters Nylon Base	<b>VCBALEXBRRONY</b>	26 2/3"	26 2/3"	37 4/5"—42 1/8"	18 1/8"	23 1/5"	17"—21 3/8"	41.88 lb
Aleta Executive Chair—Fully Upholstered Five Casters Aluminum Base	<b>VCBALEXBR</b>	26 2/3"	26 2/3"	37 4/5"—42 1/8"	18 1/8"	23 1/5"	17"—21 3/8"	40.12 lb
Aleta Executive Chair—Wooden Outer Back Five Casters Aluminum Base	<b>VCBALEXBRRO</b>	26 2/3"	26 2/3"	37 4/5"—42 1/8"	18 1/8"	23 1/5"	17"—21 3/8"	43.40 lb
Aleta Executive Chair—Fully Upholstered Flat Swivel Base	<b>VCBALEXPLA</b>	28 2/3"	28 2/3"	39 1/5"	18 1/8"	23 1/5"	19 1/8"	39.00 lb
Aleta Executive Chair—Wooden Outer Back Flat Swivel Base	<b>VCBALEXPLARO</b>	28 2/3"	28 2/3"	39 1/5"	18 1/8"	23 1/5"	19 1/8"	42.32 lb

# Copa

**Copa seating**, designed by Ramos and Bassols, is an upholstered seating collection inspired by an elegant crystal glass. Its generous seat and enveloping design are designed for comfort.

**Copa** has a fully upholstered shell. The outer back has an indented sewn line to provide visual interest. (thread used is defaulted to the fabric used). The upholstered shell is available in a smooth upholstery application which has a matching sewn in line on the inner back. The soft upholstery option provides additional visual and physical comfort. The inner back has built in comfort wrinkles.

► Specifying, pages 109–122

**Wooden base** is stained solid oak.

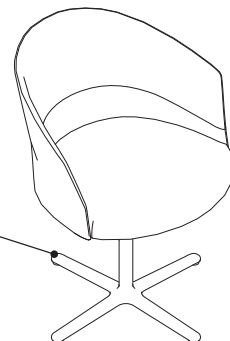
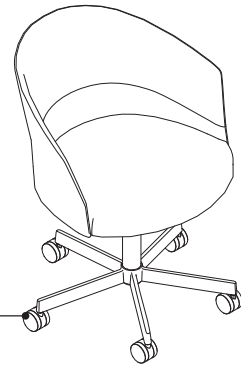
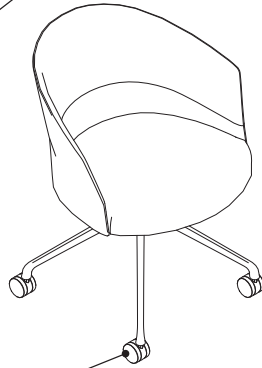
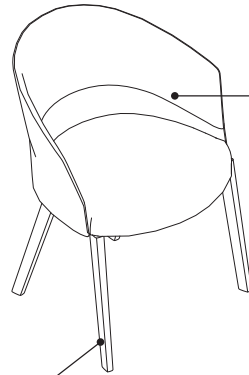
**Solid oak wood leg base** available stained. Glides are with or without felt.

**Solid oak upholstered wood leg base** available in leather. Glides are with or without felt.

**Pyramid swivel base** available with glides or soft casters for hard wood floors.

**Five caster aluminum base** is powder coated in black or white high gloss with soft casters for hard floors.

**Flat swivel aluminum base** is powder coated in black or white paint. Glides are with or without felt.



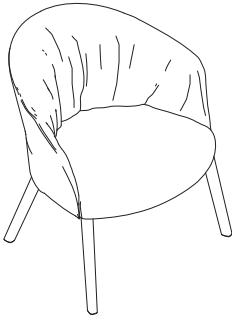
**Seat and back** made of plywood covered with non-deformable expanded polyurethane.

**Pyramid swivel aluminum base** is powder coated in black or white paint. Glides are with or without felt.

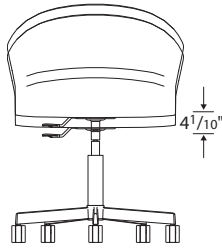
**Cantilever base** is powder coated in black or white paint. Glides are with or without felt.

**Four leg metal base** is powder coated in black or white paint. Glides are with or without felt.

## Product Details

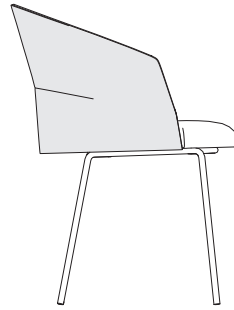


**Soft upholstery**, available on the backrest, adds comfort wrinkles providing a warm, cozy environment. All shells are available in smooth and soft upholstery options.



**Height adjustment system on five caster base** provides an adjustment range of 4<sup>1</sup>/<sub>10</sub>"H.

*Tip: When white base is specified, the gas lift tube is chrome.*



**Contrasting outer backrest in leather** is available when contrasting option is selected. If contrasting is not specified, the backrest will be upholstered with the same fabric as the seat.

**Plastic glides** available with or without felt.

**Soft casters** available for hard floors on pyramid swivel and five caster bases.

**Stool bases** are available in four leg metal, swivel, and solid oak wood leg.

**Stools** are available in counter or bar height.

**Stool footrests for metal leg base** are same color as legs.

**Stool footrests for wood leg base** are black powder coated paint.

**Glides for stools** are available with or without felt.

## Surface Materials

### Upholstery

- Fabric
- Vinyl
- Leather
- COM (Customer's Own Material)
- COL (Customer's Own Leather)

### Metal base

- 9003 White RAL
- 9005 Black RAL

### Wood base

- Ash
- Bleached oak
- Cognac
- Matte oak
- Walnut oak

## Actual Dimensions

Description	Style Number	Depth	Width	Height	Seat Depth	Seat Height	Integrated Arm Height	Footrest Height from Floor	Weight
Four Leg Metal Base	<b>VCBCOME</b>	24 <sup>2</sup> / <sub>5</sub> "	24 <sup>4</sup> / <sub>5</sub> "	30 <sup>7</sup> / <sub>10</sub> "	18 <sup>9</sup> / <sub>10</sub> "	18 <sup>1</sup> / <sub>2</sub> "	25 <sup>1</sup> / <sub>5</sub> "	N.A.	24.5 lb
Pyramid Swivel Base	<b>VCBCOPI</b>	24 <sup>2</sup> / <sub>5</sub> "	24 <sup>4</sup> / <sub>5</sub> "	30 <sup>9</sup> / <sub>10</sub> "	18 <sup>9</sup> / <sub>10</sub> "	18 <sup>3</sup> / <sub>10</sub> "	25 <sup>2</sup> / <sub>5</sub> "	N.A.	33.7 lb
Pyramid Swivel Base with Casters	<b>VCBCOPIRU</b>	24 <sup>2</sup> / <sub>5</sub> "	24 <sup>4</sup> / <sub>5</sub> "	31 <sup>1</sup> / <sub>10</sub> "	18 <sup>9</sup> / <sub>10</sub> "	18 <sup>9</sup> / <sub>10</sub> "	25 <sup>3</sup> / <sub>5</sub> "	N.A.	33.5 lb
Five Caster Base	<b>VCBCOBR</b>	24 <sup>2</sup> / <sub>5</sub> "	24 <sup>4</sup> / <sub>5</sub> "	30 <sup>9</sup> / <sub>10</sub> "–35"	18 <sup>9</sup> / <sub>10</sub> "	19"-23 <sup>3</sup> / <sub>5</sub> "	29 <sup>1</sup> / <sub>2</sub> "	N.A.	33.6 lb
Cantilever Base	<b>VCBCOCL</b>	20 <sup>1</sup> / <sub>10</sub> "	24 <sup>4</sup> / <sub>5</sub> "	31 <sup>1</sup> / <sub>10</sub> "	14 <sup>3</sup> / <sub>5</sub> "	18 <sup>9</sup> / <sub>10</sub> "	25 <sup>3</sup> / <sub>5</sub> "	N.A.	39.0 lb
Flat Swivel Base	<b>VCBCOPLA</b>	24 <sup>2</sup> / <sub>5</sub> "	24 <sup>4</sup> / <sub>5</sub> "	29 <sup>9</sup> / <sub>10</sub> "	18 <sup>9</sup> / <sub>10</sub> "	18 <sup>1</sup> / <sub>2</sub> "	26 <sup>4</sup> / <sub>5</sub> "	N.A.	33.5 lb
Wood Leg Base	<b>VCBCOMA, VCBCOPTP</b>	24 <sup>2</sup> / <sub>5</sub> "	24 <sup>4</sup> / <sub>5</sub> "	31 <sup>1</sup> / <sub>10</sub> "	18 <sup>9</sup> / <sub>10</sub> "	18 <sup>9</sup> / <sub>10</sub> "	26 <sup>4</sup> / <sub>5</sub> "	N.A.	24.7 lb
Four Leg Metal Base Stool – Counter	<b>VCBCOT4MECO</b>	19 <sup>3</sup> / <sub>10</sub> "	23 <sup>1</sup> / <sub>5</sub> "	34 <sup>3</sup> / <sub>10</sub> "	15"	24 <sup>4</sup> / <sub>5</sub> "	29 <sup>1</sup> / <sub>2</sub> "	9 <sup>1</sup> / <sub>10</sub> "	19.4 lb
Four Leg Metal Base Stool – Bar	<b>VCBCOT4MEBAR</b>	19 <sup>3</sup> / <sub>10</sub> "	23 <sup>1</sup> / <sub>5</sub> "	38 <sup>1</sup> / <sub>5</sub> "	15"	28 <sup>7</sup> / <sub>10</sub> "	33 <sup>1</sup> / <sub>2</sub> "	13"	20.3 lb
Swivel Base Stool – Counter	<b>VCBCOTGCO</b>	19 <sup>3</sup> / <sub>10</sub> "	21 <sup>9</sup> / <sub>10</sub> "	36 <sup>3</sup> / <sub>5</sub> "	15"	27 <sup>1</sup> / <sub>2</sub> "	21 <sup>9</sup> / <sub>10</sub> "	7 <sup>9</sup> / <sub>10</sub> "	21.6 lb
Swivel Base Stool – Bar	<b>VCBCOTGBAR</b>	20 <sup>1</sup> / <sub>10</sub> "	22 <sup>1</sup> / <sub>5</sub> "	40 <sup>3</sup> / <sub>5</sub> "	15"	31 <sup>1</sup> / <sub>10</sub> "	35 <sup>4</sup> / <sub>5</sub> "	12 <sup>1</sup> / <sub>5</sub> "	22.5 lb
Wood Leg Base Stool – Counter	<b>VCBCOT4MACO</b>	19 <sup>3</sup> / <sub>10</sub> "	22 <sup>2</sup> / <sub>5</sub> "	34 <sup>3</sup> / <sub>10</sub> "	15"	24 <sup>4</sup> / <sub>5</sub> "	29 <sup>1</sup> / <sub>2</sub> "	9 <sup>1</sup> / <sub>10</sub> "	21.4 lb
Wood Leg Base Stool – Bar	<b>VCBCOT4MABAR</b>	19 <sup>3</sup> / <sub>10</sub> "	22 <sup>2</sup> / <sub>5</sub> "	38 <sup>1</sup> / <sub>5</sub> "	15"	28 <sup>7</sup> / <sub>10</sub> "	33 <sup>1</sup> / <sub>2</sub> "	13"	22.3 lb

# Ears

**Ears**, designed by Piero Lissoni, is a versatile wooden chair with a comfortable and enveloping design. Light in material and resistant to aging.  
▶ Specifying, pages 123–134

**Wooden seat and back** available in five finishes with optional seat cushion.

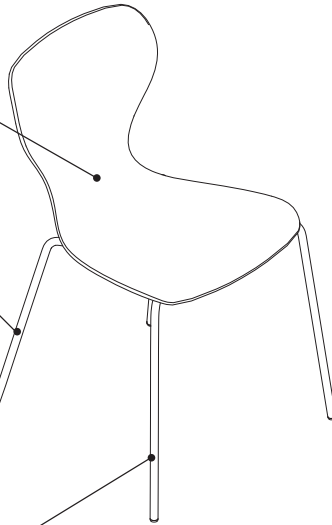
**Metal base** is available in black or white paint.

**Glides** available in plastic or felt.

**Four leg base chairs** are stackable.

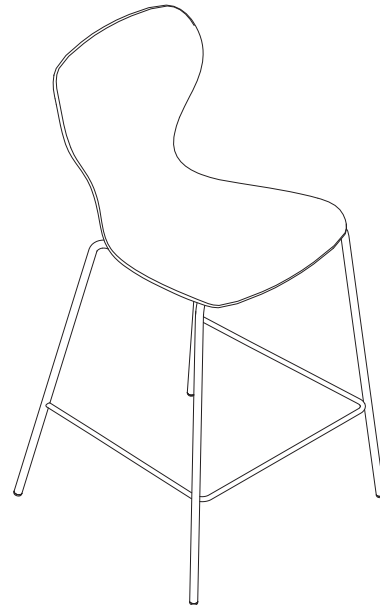
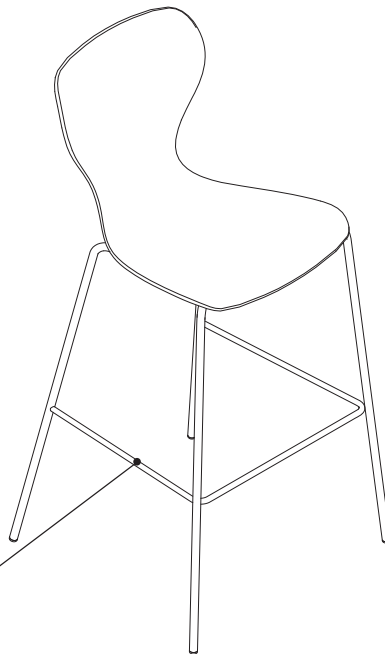
**Stools** are available in counter and bar height.

**Stools footrest** is available in black or white and will always match frame finish.



**Upholstered seat and back** available in smooth upholstery.

**Wooden base** is available in five stained finishes.



### Product Details

**Curved wooden seat and back** is stained oak plywood available in stained finishes.

*Tip: Finish may vary in natural wood.*

**Chair with an upholstered seat cushion** is available. Chair with upholstered seat and back available in smooth upholstery.

**Four leg metal base chair** is powder coated in black or white.

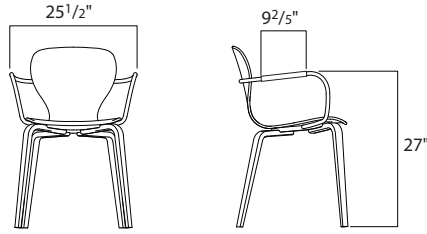
**Four leg wooden base chair** is natural oak plywood available in stained finishes or white open pore.

**Four leg metal base chairs** are stackable up to 10 high when non-upholstered. Chairs with upholstery are stackable up to four high.

**Four leg fixed metal base stools** are available in bar or counter height. Stools are powder coated in black or white.

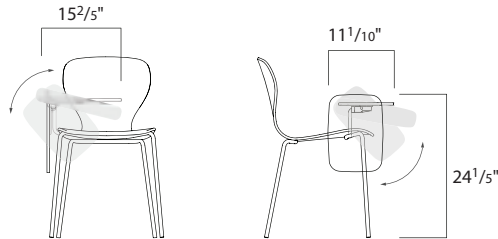
**Footstools footrests** are 9<sup>1</sup>/<sub>10</sub>" for counter height and 13" for bar height.

**Glides** are available in plastic or felt for metal base chairs. Wood base chairs are available with plastic glides only.



**Arms** are available for all bases and seats in metal or metal with solid wood and upholstered metals options. Metal portions of the arms are black or white powder coat. Natural wood arms are available in stained finishes. Upholstered portions of the arms are leather.

*Tip: Chairs with arms are not stackable.*



**Optional side table** available in black High-Pressure Laminate with an aluminum mechanism and anti-panic system in right and left-handed versions. Side table is only available on four leg metal base chairs.

*Tip: Side table paint color is defaulted to metal base color selection.*

### Surface Materials

#### Upholstery

- Fabric
- Vinyl
- Leather
- COM (Customer's Own Material)
- COL (Customer's Own Leather)

#### Metal base

- 9003 White RAL
- 9005 Black RAL

#### Wood base

- Ash
- Bleached oak
- Cognac
- Matte oak
- Walnut oak
- White open pore

**Actual Dimensions**

Description	Style Number	Depth	Width	Height	Seat Height	Arm Height	Footrest Height	Weight
<b>Four Leg Metal Base Chairs</b>								
Four Leg Metal Base Chair	<b>VCBEA4PRO</b>	19 <sup>9</sup> / <sub>10</sub> "	19 <sup>1</sup> / <sub>2</sub> "	31 <sup>3</sup> / <sub>10</sub> "	18 <sup>3</sup> / <sub>10</sub> "	27"	N.A.	18.0 lb
Four Leg Metal Base Chair with Cushion	<b>VCBEA4PROC</b>	19 <sup>9</sup> / <sub>10</sub> "	19 <sup>1</sup> / <sub>2</sub> "	31 <sup>3</sup> / <sub>10</sub> "	18 <sup>7</sup> / <sub>10</sub> "	27"	N.A.	18.5 lb
Four Leg Metal Base Chair	<b>VCBEA4PT</b>	19 <sup>9</sup> / <sub>10</sub> "	19 <sup>1</sup> / <sub>2</sub> "	31 <sup>1</sup> / <sub>2</sub> "	18 <sup>3</sup> / <sub>10</sub> "	27"	N.A.	18.3 lb with Smooth Upholstery
<b>Four Leg Wooden Base Chairs</b>								
Four Leg Wooden Base Chair	<b>VCBEA4PMRO</b>	20 <sup>1</sup> / <sub>10</sub> "	20 <sup>3</sup> / <sub>10</sub> "	31 <sup>3</sup> / <sub>10</sub> "	18 <sup>7</sup> / <sub>10</sub> "	27"	N.A.	15.7 lb
Four Leg Wooden Base Chair with Cushion	<b>VCBEA4PMROC</b>	20 <sup>1</sup> / <sub>10</sub> "	20 <sup>3</sup> / <sub>10</sub> "	31 <sup>3</sup> / <sub>10</sub> "	18 <sup>7</sup> / <sub>10</sub> "	27"	N.A.	15.7 lb
Four Leg Wooden Base Chair	<b>VCBEA4PMT</b>	20 <sup>1</sup> / <sub>10</sub> "	20 <sup>3</sup> / <sub>10</sub> "	31 <sup>1</sup> / <sub>2</sub> "	18 <sup>7</sup> / <sub>10</sub> "	27"	N.A.	15.4 lb with Smooth Upholstery
<b>Fixed Counter Stool Base Chairs</b>								
Fixed Counter Stool	<b>VCBEATC4PRO</b>	19 <sup>9</sup> / <sub>10</sub> "	20 <sup>1</sup> / <sub>2</sub> "	38 <sup>3</sup> / <sub>5</sub> "	25 <sup>3</sup> / <sub>5</sub> "	34 <sup>3</sup> / <sub>10</sub> "	9 <sup>1</sup> / <sub>10</sub> "	18.3 lb
Fixed Counter Stool with Cushion	<b>VCBEATC4PROC</b>	19 <sup>9</sup> / <sub>10</sub> "	20 <sup>1</sup> / <sub>2</sub> "	38 <sup>3</sup> / <sub>5</sub> "	26"	34 <sup>3</sup> / <sub>10</sub> "	9 <sup>1</sup> / <sub>10</sub> "	20.0 lb
Fixed Counter Stool with Smooth Upholstery	<b>VCBEATC4PT</b>	19 <sup>9</sup> / <sub>10</sub> "	20 <sup>1</sup> / <sub>2</sub> "	38 <sup>3</sup> / <sub>5</sub> "	26"	34 <sup>3</sup> / <sub>10</sub> "	9 <sup>1</sup> / <sub>10</sub> "	19.6 lb
<b>Fixed Bar Stool Base Chairs</b>								
Fixed Bar Stool	<b>VCBEATB4PRO</b>	20 <sup>9</sup> / <sub>10</sub> "	21 <sup>1</sup> / <sub>2</sub> "	42 <sup>1</sup> / <sub>2</sub> "	29 <sup>1</sup> / <sub>2</sub> "	38 <sup>1</sup> / <sub>5</sub> "	13"	19.4 lb
Fixed Bar Stool with Cushion	<b>VCBEATB4PROC</b>	20 <sup>9</sup> / <sub>10</sub> "	21 <sup>1</sup> / <sub>2</sub> "	42 <sup>1</sup> / <sub>2</sub> "	29 <sup>9</sup> / <sub>10</sub> "	38 <sup>1</sup> / <sub>5</sub> "	13"	20.9 lb
Fixed Bar Stool with Smooth Upholstery	<b>VCBEATB4PT</b>	20 <sup>9</sup> / <sub>10</sub> "	21 <sup>1</sup> / <sub>2</sub> "	42 <sup>1</sup> / <sub>2</sub> "	29 <sup>9</sup> / <sub>10</sub> "	38 <sup>1</sup> / <sub>5</sub> "	13"	20.7 lb

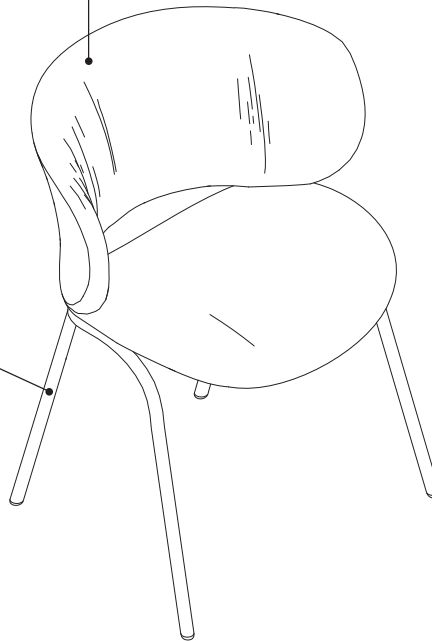


# Funda

**Funda** is an upholstered seating collection designed by Stefan Diez with a commitment to maximum sustainability and comfort through an innovative and light chair. The chair is made of two different pieces: a metal structure that works as a skeleton and a wrinkled upholstered seat that shapes and brings comfort.

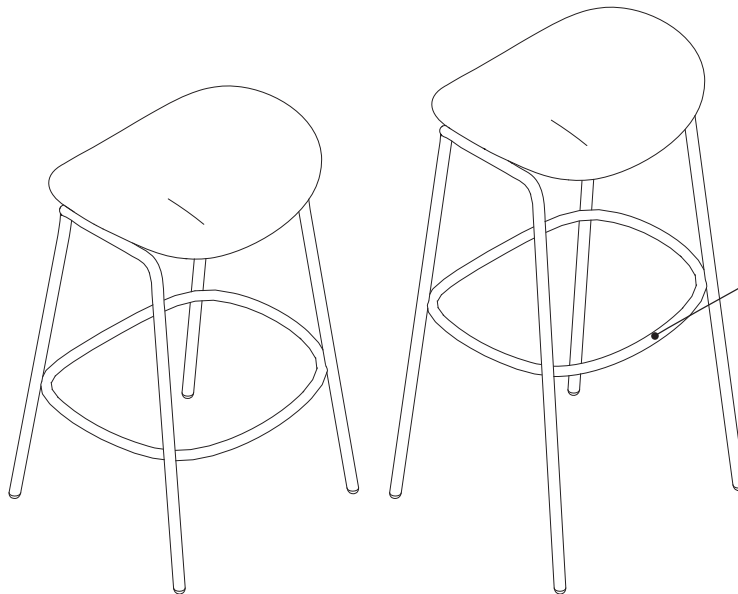
► Specifying, pages 135–136

**Upholstered seat and back** can be separated from the structure for easy recycling.



**Four leg metal base** is powder coated in black or white.

**Plastic glides** are suitable for all surfaces.



**Footrest** is standard on counter and bar height stools. The stool footrests are at 9<sup>3</sup>/<sub>10</sub>" for counter height and 13<sup>1</sup>/<sub>5</sub>" for bar height.



**Product Details**



**Funda seating collection** is composed of upholstered chairs, and stools in bar and counter height.



**Soft upholstery** creates a comfortable, inviting silhouette that is standard on all styles.



**Armless stools** available in bar and counter height.

**Stool footrest** is painted to match base.

**Funda seating** is not stackable.

**Surface Materials**

**Upholstery**

- Fabric
- Vinyl
- Leather
- COM (Customer's Own Material)
- COL (Customer's Own Leather)

**Metal four-leg base**

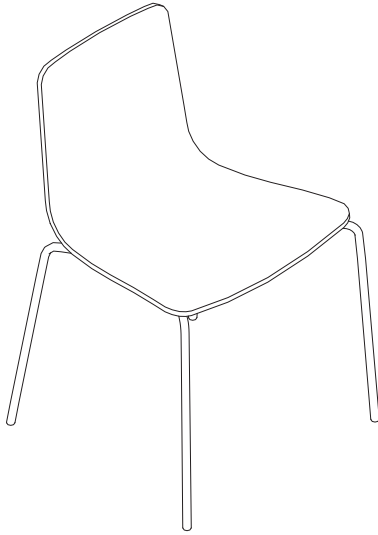
- 9003 White RAL
- 9005 Black RAL

**Actual Dimensions**

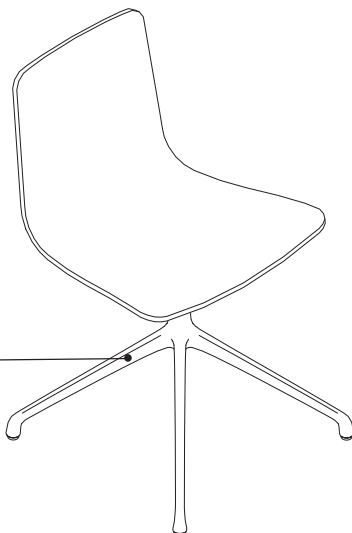
Description	Style Number	Depth	Width	Height	Seat Height	Weight
Chair	<b>VCBFUS</b>	22"	23 <sup>4</sup> / <sub>5</sub> "	30 <sup>7</sup> / <sub>10</sub> "	17 <sup>3</sup> / <sub>10</sub> "	17.0 lb
Counter Stool	<b>VCBFUTC</b>	14 <sup>4</sup> / <sub>5</sub> "	15 <sup>3</sup> / <sub>5</sub> "	28 <sup>3</sup> / <sub>10</sub> "	25 <sup>3</sup> / <sub>5</sub> "	14.3 lb
Bar Stool	<b>VCBFUTB</b>	15 <sup>1</sup> / <sub>5</sub> "	15 <sup>7</sup> / <sub>10</sub> "	32 <sup>3</sup> / <sub>10</sub> "	29 <sup>1</sup> / <sub>2</sub> "	16.5 lb

# Klip

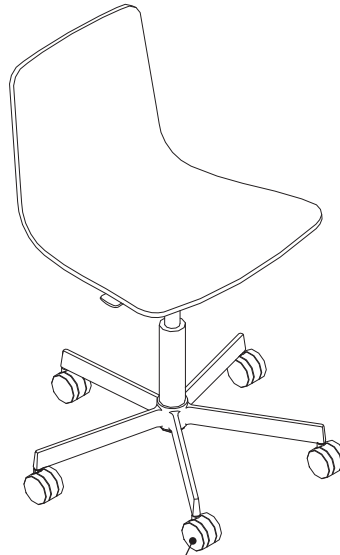
**Klip**, designed by Victor Carrasco, is a plywood oak chair available in multiple base styles and with or without upholstery. Klip is in reference to the slot in its back which serves as both a handle and as a place for hangbags. ▶ Specifying, pages 137–167



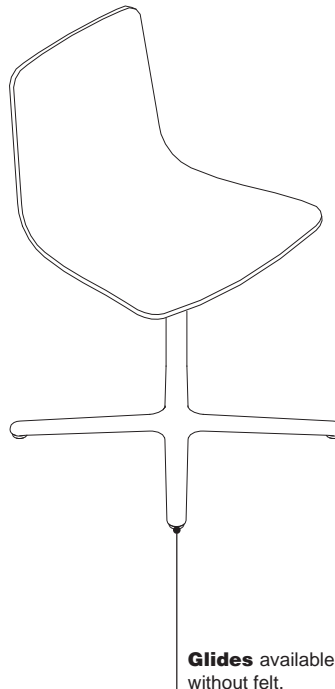
**Upholstered seat and back** available in smooth and soft/lined upholstery.



**Metal base** available in painted finishes.



**Casters** available on pyramid swivel and five caster bases.



**Glides** available with or without felt.

## Product Details

### Base Types



**Four leg metal base chairs** are powder coated in black, white, taupe, or fluorescent orange. Glides are with or without felt.



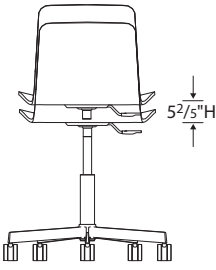
**Metal swivel base chairs** are powder coated in black or white. Glides are with or without felt.



**Pyramid swivel aluminum base** is powder coated in black, white, or taupe. Glides are with or without felt. Soft casters are for hard wood floors.



**Five caster aluminum base** is powder coated in black or white high gloss with soft casters for hard floors.



**Height adjustment system on five-caster base** provides an adjustment range of 5<sup>2</sup>/<sub>5</sub>"H.  
*Tip: When white base is specified, the gas lift tube is chrome.*



**Flat swivel aluminum base** is powder coated in black or white. Glides are with or without felt.



**Stool bases** are powder coated in black, white, or taupe.

**Stools** are available fixed or swivel in counter or bar height.

**Stool footrests** are same color as legs.

**Glides for stools** are available with or without felt.

**Seat and Back Types**



**Plywood seat and back** available with or without handle.  
*Tip: Finish will vary in natural wood.*

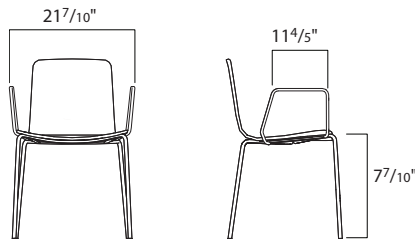
**Plywood seat and back with upholstered cushion** available with or without handle.  
*Tip: Fully upholstered chair not available with handle.*

**Plywood shell** is solid oak when stained and solid beech when lacquered.

**Upholstered seat and back** available in smooth or soft lined upholstery.  
*Tip: Soft upholstery includes intentional wrinkles that vary by chair.*

**Metal leg base chairs with plywood seat and back** are stackable up to 10 units. Upholstered versions are stackable up to four units.  
*Tip: It is not recommended to stack upholstered chairs for long periods of time without using the optional stacking pad (VCBKLCO).*

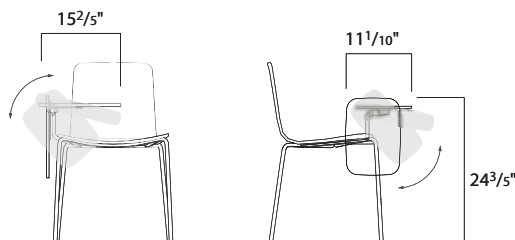
**Optional Accessories**



**Arms** are available for all base and seat combinations.

**Metal arms** are powder coated in black, white, or taupe.

**Upholstered armrests** are powder coated in black, white, or taupe with selectable leather finish.



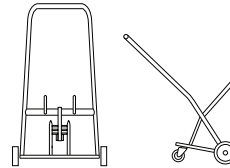
**Optional side table** available in black High-Pressure Laminate with an aluminum mechanism and anti-panic system in right- and left-handed versions. Side table is only available on four leg metal base chairs.  
*Tip: Side table paint color is defaulted to metal base color selection.*



**Stacking pad (VCBKLCO)** is available to stack upholstered four leg chairs for longer periods of time.



**Linking device (VCBKLUN)** is available to link four leg chairs together. Available in black only.



**Transportation trolley (VCBKLCCT)** is available to transport up to 10 chairs simultaneously. Trolley is available in black lacquer only. Trolley works with Klip stacking chairs only.

**Surface Materials**

**Upholstery**

- Fabric
- Vinyl
- Leather
- COM (Customer's Own Material)
- COL (Customer's Own Leather)

**Metal base and arms**

- 1019 Taupe RAL
  - 2005 Fluorescent Orange RAL
  - 9003 White RAL
  - 9005 Black RAL
- Tip: Fluorescent orange only available on four leg metal base.*

**Seat and wood base**

- Ash
- Bleached oak
- Cognac
- Matte oak
- Walnut oak

**Side table**

- High-Pressure Laminate

Actual Dimensions							
Description	Style Number	Depth	Width	Height	Seat Depth	Seat Height	Weight
<b>Four Leg Metal Base Chairs</b>							
Four Metal Legs Base	<b>VCBKL4PN</b>	20½"	207/10"	31½"	14½"	18½"	30.9 lb
Four Metal Legs Base Chair with Upholstery	<b>VCBKL4PW</b>	207/10"	207/10"	317/10"	14½"	187/10"	21.4 lb
Four Metal Legs Base Cushion Chair	<b>VCBKL4PC</b>	207/10"	20½"	31½"	14½"	19¼"	22.5 lb
<b>Swivel Base Chairs</b>							
Swivel Chair	<b>VCBKLGN</b>	19¾"	19¾"	31½"	14½"	18½"	30.0 lb
Swivel Chair with Upholstery	<b>VCBKLGW</b>	19½"	199/10"	317/10"	14½"	187/10"	30.0 lb
Swivel Cushion Chair	<b>VCBKLC</b>	19¾"	19¾"	31½"	14½"	19¼"	30.0 lb
<b>Pyramid Swivel Base Chairs</b>							
Pyramid Swivel Chair	<b>VCBKLPIN</b>	19¾"	19¾"	31¾"	14½"	177/10"	27.8 lb
Pyramid Swivel Chair with Upholstery	<b>VCBKLPW</b>	19½"	199/10"	31½"	14½"	179/10"	28.4 lb
Pyramid Swivel Cushion Chair	<b>VCBKLPIC</b>	19¾"	199/10"	31¾"	14½"	187/10"	28.4 lb
Pyramid Swivel Chair with Casters	<b>VCBKLPURUN</b>	199/10"	199/10"	317/10"	14½"	18¼"	28.9 lb
Pyramid Swivel Cushion Chair with Casters and Upholstery	<b>VCBKLPURW</b>	199/10"	199/10"	319/10"	14½"	18¾"	28.9 lb
Pyramid Swivel Cushion Chair with Casters	<b>VCBKLPURUC</b>	199/10"	199/10"	317/10"	14½"	187/10"	28.9 lb
<b>Caster Base Chairs</b>							
Chair with Casters	<b>VCBKLB RN</b>	22¾"	23¾"	287/10" – 34¼"	14½"	15¾" – 20½"	27.6 lb
Chair with Casters and Upholstery	<b>VCBKLB RW</b>	22¾"	23¾"	289/10" – 34¾"	14½"	16¾" – 207/10"	27.6 lb
Cushion Chair with Casters	<b>VCBKLB RC</b>	22¾"	23¾"	287/10" – 34¼"	14½"	159/10" – 20¼"	27.6 lb
<b>Flat Swivel Base Chairs</b>							
Flat Swivel Chair	<b>VCBKLPAN</b>	189/10"	19¾"	31½"	14½"	18¾"	37.9 lb
Flat Swivel Chair with Upholstery	<b>VCBKLP AW</b>	19¼"	199/10"	317/10"	14½"	18½"	39.2 lb
Flat Swivel Cushion Chair	<b>VCBKLP AC</b>	189/10"	19¾"	31½"	14½"	189/10"	39.2 lb
<b>Swivel Counter and Bar Stool Base Chairs</b>							
Swivel Counter Stool	<b>VCBKLT CN</b>	189/10"	19¾"	39½"	14½"	26½"	37.9 lb
Swivel Counter Stool with Upholstery	<b>VCBKLT CW</b>	19¼"	199/10"	39¾"	14½"	26¾"	37.9 lb
Swivel Cushion Counter Stool	<b>VCBKLT CC</b>	19¼"	199/10"	39½"	14½"	26¾"	37.9 lb
Swivel Bar Stool	<b>VCBKLT BN</b>	189/10"	19¾"	43¼"	14½"	30¼"	39.2 lb
Swivel Bar Stool with Upholstery	<b>VCBKLT BW</b>	19¼"	199/10"	43¾"	14½"	30¾"	39.2 lb
Swivel Cushion Bar Stool	<b>VCBKLT BC</b>	189/10"	19¾"	43¼"	14½"	307/10"	39.2 lb
<b>Fixed Counter and Bar Stool Base Chairs</b>							
Fixed Counter Stool	<b>VCBKLTFC ON</b>	189/10"	19¾"	39½"	14½"	26"	18.3 lb
Fixed Cushion Counter Stool with Upholstery	<b>VCBKLTFC OW</b>	19¼"	19¾"	40"	14½"	26¾"	21.6 lb
Fixed Cushion Counter Stool	<b>VCBKLTFC OC</b>	189/10"	19¾"	39½"	14½"	26¾"	21.2 lb
Fixed Bar Stool	<b>VCBKLTFB ARN</b>	19¼"	199/10"	43¾"	14½"	25½"	19.4 lb
Fixed Bar Stool with Upholstery	<b>VCBKLTFB ARW</b>	19¼"	199/10"	43½"	14½"	299/10"	22.7 lb
Fixed Cushion Bar Stool	<b>VCBKLTFB ARC</b>	19¼"	199/10"	43¾"	14½"	299/10"	22.3 lb

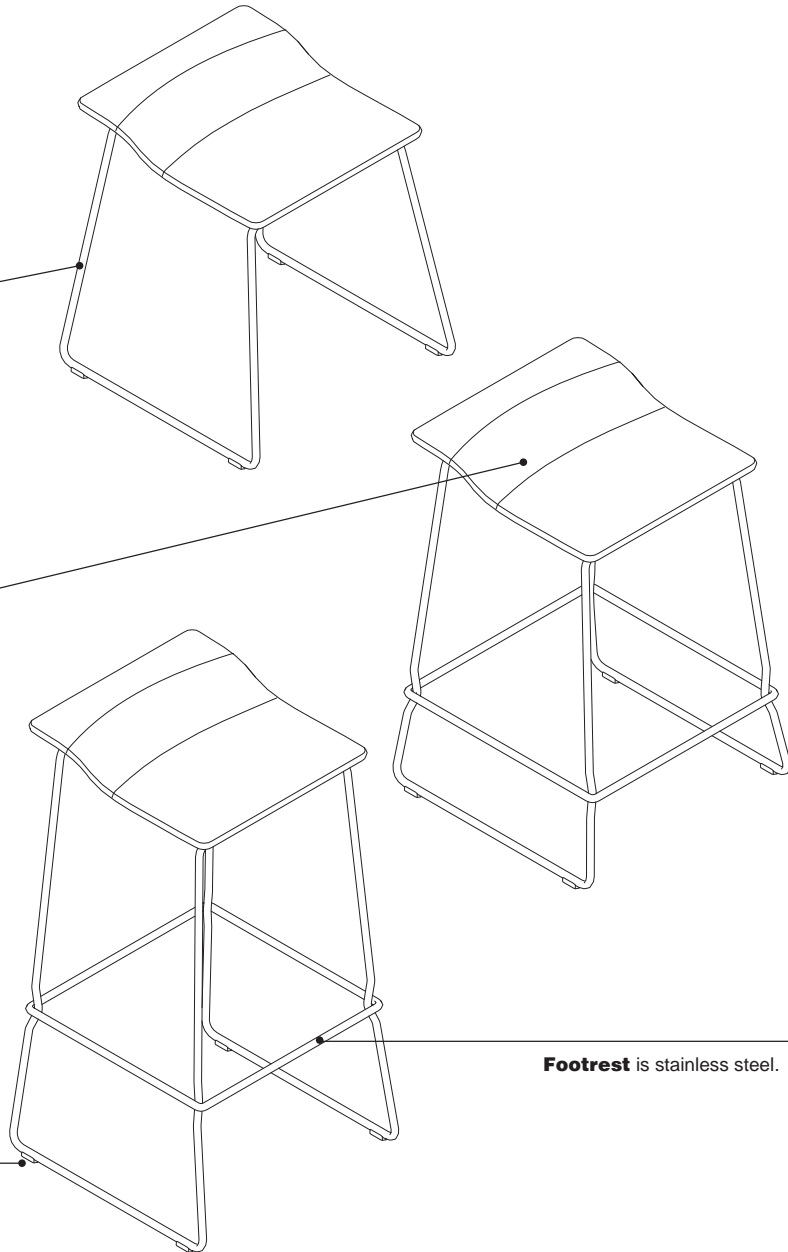
**Last Minute stools** are lightweight with a painted steel frame, designed by Patricia Urquiola. A versatile design stool with a footrest for additional comfort.  
 ▶ Specifying, pages 168–169

**Sled base** is powder coated in black, white, or taupe.

*Tip: Taupe only available for the medium and high stools.*

**Seat** is molded plastic in black, white, or taupe. Seat can also be upholstered in fabric or leather.

**Glides** are available in plastic or felt.



**Footrest** is stainless steel.

## Product Details

**Stools** are available in three heights: low, medium, and high.

**Seat** is contoured for comfort. When upholstered, seat will include saddle stitch details.

## Surface Materials

### Upholstery

- Fabric
- Vinyl
- Leather
- COM (Customer's Own Material)
- COL (Customer's Own Leather)

### Base

- 1019 Taupe\* RAL
- 9003 White RAL
- 9005 Black RAL

### Footrest

Stainless steel

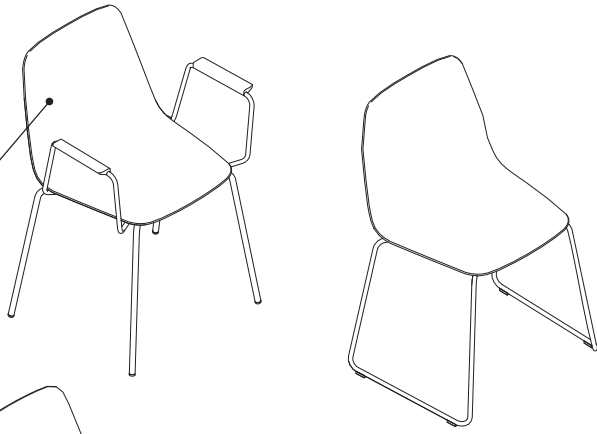
*\*Taupe only available for the medium and high stools.*

## Actual Dimensions

Description	Style Number	Depth	Width	Height	Seat Height	Footrest Height	Weight
Low Stool	<b>VCBLMB</b>	17 <sup>1</sup> / <sub>10</sub> "	17 <sup>7</sup> / <sub>10</sub> "	19 <sup>3</sup> / <sub>10</sub> "	18 <sup>1</sup> / <sub>10</sub> "	N.A.	13.0 lb
Medium Stool	<b>VCBLMM</b>	17 <sup>1</sup> / <sub>10</sub> "	17 <sup>7</sup> / <sub>10</sub> "	25 <sup>2</sup> / <sub>5</sub> "	24"	6 <sup>9</sup> / <sub>10</sub> "	17.4 lb
High Stool	<b>VCBLMA</b>	17 <sup>1</sup> / <sub>10</sub> "	17 <sup>7</sup> / <sub>10</sub> "	31 <sup>3</sup> / <sub>10</sub> "	29 <sup>7</sup> / <sub>10</sub> "	11"	20.1 lb

# Maarten

**Maarten seating,** designed by Victor Carrasco, is a versatile guest chair available in a wide range of shell and base options. It is available with a plastic shell, plastic shell with seat cushion, smooth upholstered seat and back, and soft upholstered seat and back.  
► Specifying, pages 170–221



**Upholstered seat and back** available in smooth and soft upholstery.



**Wooden base in stained solid oak.**

**Optional arms** are available on all chairs and high back stools. They are not available on the auditorium seat nor low back stools.

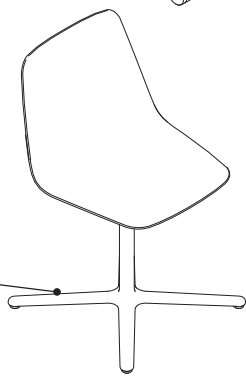


**Plastic seat and back** available in six finishes with optional seat cushion.

**Glides** available with or without felt.

**Casters** available as an option on pyramid swivel and five caster bases.

**Metal base in painted finishes.**

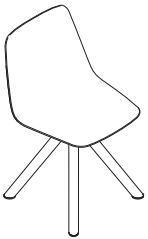


**Product Details**

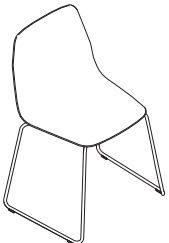
**Base Types**



**Four leg metal base chairs** are powder coated in black, white, taupe, or fluorescent orange. Glides are with or without felt.



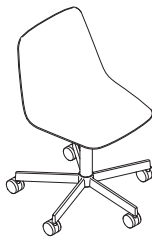
**Metal swivel base chairs** are powder coated in black, white, or taupe. Glides are clear.



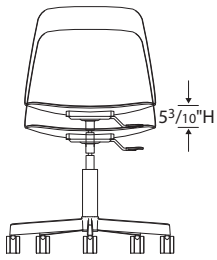
**Sled base chairs** are powder coated in black or white. Glides are with or without felt.  
*Tip: Four leg metal base chairs with plastic seat and back have a minimum order quantity of two.*



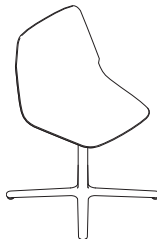
**Pyramid swivel aluminum base** is powder coated in black or white. Soft casters are for hard wood floors.



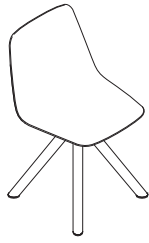
**Five caster aluminum base** is powder coated in black or white high gloss with soft casters for hard floors.



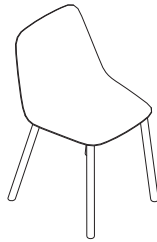
**Height adjustment system on five caster base** provides an adjustment range of 5<sup>3/10</sup>"H.  
*Tip: When white base is specified, the gas lift tube is chrome.*



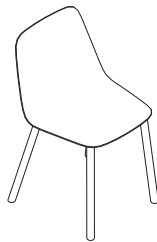
**Flat swivel aluminum base** is powder coated in black or white. Glides are included.



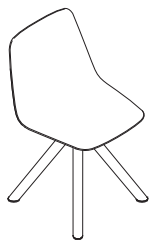
**Wooden swivel base** is steel internal structure, finished with oak veneer in stained finishes. Glides are clear.



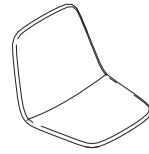
**Four leg wooden base** is solid oak in stained finishes. Plastic glides with or without felt.



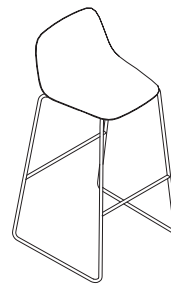
**Four leg upholstered wooden base** is solid oak upholstered with leather. Plastic glides with or without felt.



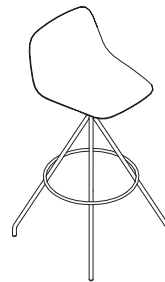
**Upholstered swivel base** is metal upholstered in leather. Glides are clear.



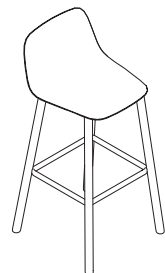
**Auditorium plastic seat** is available in black, white, taupe, ochre, or brick. Screws for anchoring are not included. Seat available with smooth or soft upholstery. Arms are not an option on auditorium seats.



**Sled base stools** are powder coated in black or white.



**Swivel base stools** are powder coated in black, white, or taupe. Glides are with or without felt.



**Four wooden leg stools** have stained solid oak wooden legs. Footrest powder coated black. Glides are with or without felt.

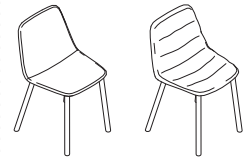
**Stools** are available in counter or bar height for all styles.

**Stools** are available with low or high back.

**Stool footrest height** is 7<sup>9/10</sup>"H for the swivel counter stools and 12<sup>1/5</sup>"H for swivel bar stools.

**Stool footrest height** is 9<sup>1/10</sup>" for the four wooden leg counter stool and 13" for four wooden leg bar stools.

**Seat and Back Types**

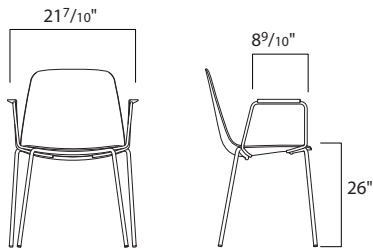


**Upholstered seat and back** available in smooth or soft.

*Tip: Soft upholstery includes intentional wrinkles that vary by chair.*

**Four leg metal and sled base chairs with plastic seat and back** are stackable up to 10 units. Upholstered versions are stackable up to four units. Sled base stools without upholstery are stackable up to four units.

**Optional Accessories**

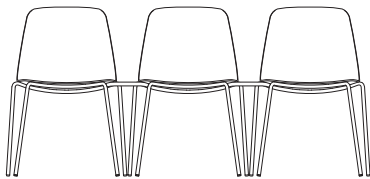


**Arms** are available for all base and seat options (excluding auditorium seat and low back stools).

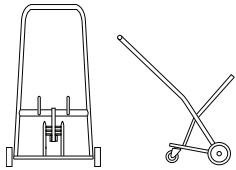
**Metal arms** are powder coated in black, white, or taupe.

**Upholstered armrests** are powder coated in black, white, or taupe with selectable leather finish.

**Wooden armrests** are powder coated in black, white, or taupe with stained natural oak armrests.



**Linking device (VCBMAAUN)** is available to link four leg chairs together. Available in black only.



**Transportation trolley (VCBKLCT)** is available to transport up to 10 chairs simultaneously. Trolley is available in black lacquer only. Trolley works with Maarten four leg metal base chairs only.

**Surface Materials**

**Upholstery**

- Fabric
- Vinyl
- Leather
- COM (Customer's Own Material)
- COL (Customer's Own Leather)

**Metal base and arms**

- 9003 White RAL
- 9005 Black RAL
- 1019 Taupe RAL
- 2005 Fluorescent Orange RAL

*Tip: Fluorescent orange only available on four leg metal base.*

**Wood base and wood armrests**

- Ash
- Bleached oak
- Cognac
- Matte oak
- Walnut oak

**Plastic seat**

- 050 50 30 Brick RAL
- 1011 Ochre RAL
- 1019 Taupe RAL
- 7034 Dusty Green RAL
- 9003 White RAL
- 9005 Black RAL



Actual Dimensions							
Description	Style Number	Depth	Width	Height	Seat Depth	Seat Width	Weight
<b>Four Leg Metal Base Chairs</b>							
Four Metal Legs Base	<b>VCBMAAPL4P</b>	19 <sup>9</sup> / <sub>10</sub> "	23 <sup>1</sup> / <sub>5</sub> "	31 <sup>9</sup> / <sub>10</sub> "	14 <sup>1</sup> / <sub>5</sub> "	17 <sup>7</sup> / <sub>10</sub> "	29.8 lb
Four Metal Legs Chair with Cushion	<b>VCBMAAPL4C</b>	19 <sup>9</sup> / <sub>10</sub> "	23 <sup>1</sup> / <sub>5</sub> "	31 <sup>9</sup> / <sub>10</sub> "	14 <sup>1</sup> / <sub>5</sub> "	17 <sup>7</sup> / <sub>10</sub> "	29.8 lb
Four Metal Legs Base Chair with Upholstery	<b>VCBMAA4P</b>	20 <sup>1</sup> / <sub>10</sub> "	23 <sup>1</sup> / <sub>5</sub> "	32 <sup>1</sup> / <sub>10</sub> "	14 <sup>1</sup> / <sub>5</sub> "	17 <sup>9</sup> / <sub>10</sub> "	29.8 lb
<b>Sled Base Chairs</b>							
Sled Chair	<b>VCBMAAPLPT</b>	19 <sup>3</sup> / <sub>10</sub> "	22"	32 <sup>3</sup> / <sub>10</sub> "	14 <sup>1</sup> / <sub>5</sub> "	18 <sup>1</sup> / <sub>10</sub> "	22.7 lb
Sled Chair with Cushion	<b>VCBMAAPLPTC</b>	19 <sup>3</sup> / <sub>10</sub> "	22"	32 <sup>3</sup> / <sub>10</sub> "	14 <sup>1</sup> / <sub>5</sub> "	18 <sup>1</sup> / <sub>10</sub> "	22.7 lb
Sled Chair with Upholstery	<b>VCBMAAPT</b>	19 <sup>1</sup> / <sub>2</sub> "	22"	32 <sup>1</sup> / <sub>2</sub> "	14 <sup>1</sup> / <sub>5</sub> "	18 <sup>3</sup> / <sub>10</sub> "	22.7 lb
<b>Four Wooden Leg Base Chairs</b>							
Four Wood Leg Chair	<b>VCBMAAPL4PM</b>	19 <sup>3</sup> / <sub>10</sub> "	19 <sup>3</sup> / <sub>10</sub> "	32 <sup>1</sup> / <sub>10</sub> "	14 <sup>1</sup> / <sub>5</sub> "	17 <sup>9</sup> / <sub>10</sub> "	16.1 lb
Four Wood Leg Chair with Cushion	<b>VCBMAAPL4PMC</b>	19 <sup>3</sup> / <sub>10</sub> "	19 <sup>3</sup> / <sub>10</sub> "	31 <sup>1</sup> / <sub>10</sub> "	14 <sup>1</sup> / <sub>5</sub> "	18 <sup>3</sup> / <sub>10</sub> "	18.5 lb
Four Wood Leg Chair with Upholstery	<b>VCBMAA4PM</b>	19 <sup>1</sup> / <sub>2</sub> "	18 <sup>9</sup> / <sub>10</sub> "	31 <sup>3</sup> / <sub>10</sub> "	14 <sup>1</sup> / <sub>5</sub> "	17 <sup>1</sup> / <sub>2</sub> "	19.0 lb
<b>Swivel Base Chairs</b>							
Swivel Chair	<b>VCBMAAPL</b>	18 <sup>9</sup> / <sub>10</sub> "	18 <sup>1</sup> / <sub>2</sub> "	31 <sup>7</sup> / <sub>10</sub> "	14 <sup>1</sup> / <sub>5</sub> "	17 <sup>9</sup> / <sub>10</sub> "	21.8 lb
Swivel Chair with Cushion	<b>VCBMAAPLC</b>	18 <sup>9</sup> / <sub>10</sub> "	18 <sup>1</sup> / <sub>2</sub> "	31 <sup>7</sup> / <sub>10</sub> "	14 <sup>1</sup> / <sub>5</sub> "	18 <sup>3</sup> / <sub>10</sub> "	26.7 lb
Swivel Chair with Upholstery	<b>VCBMAA</b>	19 <sup>1</sup> / <sub>10</sub> "	18 <sup>9</sup> / <sub>10</sub> "	31 <sup>9</sup> / <sub>10</sub> "	14 <sup>1</sup> / <sub>5</sub> "	17 <sup>1</sup> / <sub>2</sub> "	22.5 lb
<b>Pyramid Swivel Base Chairs</b>							
Pyramid Swivel Chair	<b>VCBMAAPLPI</b>	19 <sup>3</sup> / <sub>10</sub> "	18 <sup>9</sup> / <sub>10</sub> "	31 <sup>1</sup> / <sub>10</sub> "	14 <sup>1</sup> / <sub>5</sub> "	17 <sup>3</sup> / <sub>10</sub> "	20.5 lb
Pyramid Swivel Chair with Cushion	<b>VCBMAAPLPIC</b>	19 <sup>3</sup> / <sub>10</sub> "	18 <sup>9</sup> / <sub>10</sub> "	31 <sup>1</sup> / <sub>10</sub> "	14 <sup>1</sup> / <sub>5</sub> "	17 <sup>3</sup> / <sub>10</sub> "	25.4 lb
Pyramid Swivel with Upholstery	<b>VCBMAAPI</b>	19 <sup>1</sup> / <sub>2</sub> "	18 <sup>9</sup> / <sub>10</sub> "	31 <sup>3</sup> / <sub>10</sub> "	14 <sup>1</sup> / <sub>5</sub> "	17 <sup>1</sup> / <sub>2</sub> "	21.2 lb
Pyramid Swivel Chair with Casters	<b>VCBMAAPLPIRU</b>	19 <sup>9</sup> / <sub>10</sub> "	19 <sup>9</sup> / <sub>10</sub> "	32 <sup>1</sup> / <sub>10</sub> "	14 <sup>1</sup> / <sub>5</sub> "	17 <sup>9</sup> / <sub>10</sub> "	21.6 lb
Pyramid Swivel Chair with Casters and Cushion	<b>VCBMAAPLPIRUC</b>	19 <sup>9</sup> / <sub>10</sub> "	19 <sup>9</sup> / <sub>10</sub> "	32 <sup>1</sup> / <sub>10</sub> "	14 <sup>1</sup> / <sub>5</sub> "	18 <sup>3</sup> / <sub>10</sub> "	26.5 lb
Pyramid Swivel Chair with Casters, Cushion, and Upholstery	<b>VCBMAAPIRU</b>	19 <sup>9</sup> / <sub>10</sub> "	19 <sup>9</sup> / <sub>10</sub> "	32 <sup>3</sup> / <sub>10</sub> "	14 <sup>1</sup> / <sub>5</sub> "	18 <sup>1</sup> / <sub>10</sub> "	22.3 lb
<b>Caster Base Chairs</b>							
Chair with Casters	<b>VCBMAAPLBR</b>	22 <sup>2</sup> / <sub>5</sub> "	23 <sup>2</sup> / <sub>5</sub> "	30 <sup>7</sup> / <sub>10</sub> "–36"	14 <sup>1</sup> / <sub>5</sub> "	17"–21 <sup>1</sup> / <sub>2</sub> "	22.9 lb
Chair with Casters and Cushion	<b>VCBMAAPLBRC</b>	22 <sup>2</sup> / <sub>5</sub> "	23 <sup>2</sup> / <sub>5</sub> "	30 <sup>7</sup> / <sub>10</sub> "–36"	14 <sup>1</sup> / <sub>5</sub> "	17"–21 <sup>1</sup> / <sub>2</sub> "	22.9 lb
Chair with Casters, Cushion, and Upholstery	<b>VCBMAABR</b>	22 <sup>4</sup> / <sub>5</sub> "	23 <sup>2</sup> / <sub>5</sub> "	31"–35 <sup>4</sup> / <sub>5</sub> "	14 <sup>1</sup> / <sub>5</sub> "	17 <sup>1</sup> / <sub>10</sub> "–21 <sup>7</sup> / <sub>10</sub> "	22.6 lb
<b>Flat Swivel Base Chairs</b>							
Flat Swivel Chair	<b>VCBMAAPLPLA</b>	19 <sup>3</sup> / <sub>10</sub> "	18 <sup>7</sup> / <sub>10</sub> "	31 <sup>1</sup> / <sub>2</sub> "	14 <sup>1</sup> / <sub>5</sub> "	18 <sup>3</sup> / <sub>10</sub> "	20.7 lb
Flat Swivel Chair with Cushion	<b>VCBMAAPLPLAC</b>	19 <sup>3</sup> / <sub>10</sub> "	18 <sup>7</sup> / <sub>10</sub> "	31 <sup>1</sup> / <sub>2</sub> "	14 <sup>1</sup> / <sub>5</sub> "	18 <sup>1</sup> / <sub>2</sub> "	25.6 lb
Flat Swivel Chair with Upholstery	<b>VCBMAAPLA</b>	19 <sup>1</sup> / <sub>2</sub> "	18 <sup>9</sup> / <sub>10</sub> "	31 <sup>7</sup> / <sub>10</sub> "	14 <sup>1</sup> / <sub>5</sub> "	18 <sup>9</sup> / <sub>10</sub> "	21.4 lb
<b>Wooden Swivel Base Chairs</b>							
Wooden Swivel Chair	<b>VCBMAAPLM</b>	18 <sup>9</sup> / <sub>10</sub> "	18 <sup>1</sup> / <sub>2</sub> "	31 <sup>7</sup> / <sub>10</sub> "	14 <sup>1</sup> / <sub>5</sub> "	17 <sup>7</sup> / <sub>10</sub> "	21.8 lb
Wooden Swivel Chair with Cushion	<b>VCBMAAPLMC</b>	18 <sup>9</sup> / <sub>10</sub> "	18 <sup>1</sup> / <sub>2</sub> "	31 <sup>7</sup> / <sub>10</sub> "	14 <sup>1</sup> / <sub>5</sub> "	17 <sup>7</sup> / <sub>10</sub> "	26.7 lb
Wooden Swivel Chair with Upholstery	<b>VCBMAAM</b>	19 <sup>1</sup> / <sub>2</sub> "	18 <sup>9</sup> / <sub>10</sub> "	31 <sup>9</sup> / <sub>10</sub> "	14 <sup>1</sup> / <sub>5</sub> "	17 <sup>9</sup> / <sub>10</sub> "	22.5 lb
<b>Four Upholstered Leg Swivel Base Chairs</b>							
Four Upholstered Leg Swivel Chair	<b>VCBMAAPLPGT</b>	18 <sup>9</sup> / <sub>10</sub> "	18 <sup>1</sup> / <sub>2</sub> "	31 <sup>7</sup> / <sub>10</sub> "	14 <sup>1</sup> / <sub>5</sub> "	17 <sup>7</sup> / <sub>10</sub> "	21.8 lb
Four Upholstered Leg Swivel Chair with Cushion	<b>VCBMAAPLPGTC</b>	18 <sup>9</sup> / <sub>10</sub> "	18 <sup>1</sup> / <sub>2</sub> "	31 <sup>7</sup> / <sub>10</sub> "	14 <sup>1</sup> / <sub>5</sub> "	17 <sup>7</sup> / <sub>10</sub> "	21.8 lb
Four Upholstered Leg Swivel Chair with Upholstery	<b>VCBMAAPGT</b>	19 <sup>1</sup> / <sub>10</sub> "	18 <sup>9</sup> / <sub>10</sub> "	31 <sup>9</sup> / <sub>10</sub> "	14 <sup>1</sup> / <sub>5</sub> "	17 <sup>7</sup> / <sub>10</sub> "	26.7 lb

**Actual Dimensions, continued**

Description	Style Number	Depth	Width	Height	Seat Depth	Seat Width	Weight
<b>Four Upholstered Leg Base Chairs</b>							
Four Upholstered Leg Chair	<b>VCBMAAPL4PT</b>	19 <sup>3</sup> / <sub>10</sub> "	19 <sup>3</sup> / <sub>10</sub> "	32 <sup>1</sup> / <sub>10</sub> "	14 <sup>1</sup> / <sub>5</sub> "	17 <sup>9</sup> / <sub>10</sub> "	16.1 lb
Four Upholstered Leg Chair with Cushion	<b>VCBMAAPL4PTC</b>	19 <sup>3</sup> / <sub>10</sub> "	19 <sup>3</sup> / <sub>10</sub> "	32 <sup>1</sup> / <sub>10</sub> "	14 <sup>1</sup> / <sub>5</sub> "	18 <sup>3</sup> / <sub>10</sub> "	18.5 lb
Four Upholstered Leg Chair with Upholstery	<b>VCBMAA4PT</b>	19 <sup>1</sup> / <sub>2</sub> "	18 <sup>9</sup> / <sub>10</sub> "	31 <sup>3</sup> / <sub>10</sub> "	14 <sup>1</sup> / <sub>5</sub> "	17 <sup>1</sup> / <sub>2</sub> "	18.3 lb
<b>Sled Counter and Bar Stool Base Chairs with Low Backrest</b>							
Sled Counter Stool	<b>VCBMAAPLTPTCOB</b>	18 <sup>7</sup> / <sub>10</sub> "	20 <sup>1</sup> / <sub>10</sub> "	36"	14 <sup>1</sup> / <sub>5</sub> "	26 <sup>2</sup> / <sub>5</sub> "	15.9 lb
Sled Counter Stool with Upholstery	<b>VCBMAATPTCOB</b>	18 <sup>7</sup> / <sub>10</sub> "	20 <sup>1</sup> / <sub>10</sub> "	36"	14 <sup>1</sup> / <sub>5</sub> "	26 <sup>4</sup> / <sub>5</sub> "	16.8 lb
Sled Bar Stool	<b>VCBMAAPLTPTBARB</b>	19 <sup>7</sup> / <sub>10</sub> "	20 <sup>1</sup> / <sub>2</sub> "	40"	14 <sup>1</sup> / <sub>5</sub> "	29 <sup>9</sup> / <sub>10</sub> "	18.5 lb
Swivel Bar Stool with Upholstery	<b>VCBMAATPTBARB</b>	19 <sup>7</sup> / <sub>10</sub> "	20 <sup>1</sup> / <sub>2</sub> "	40 <sup>1</sup> / <sub>5</sub> "	14 <sup>1</sup> / <sub>5</sub> "	30 <sup>3</sup> / <sub>10</sub> "	20.0 lb
<b>Swivel Counter and Bar Stool Base Chairs with Low Backrest</b>							
Swivel Counter Stool	<b>VCBMAAPLCOB</b>	18 <sup>1</sup> / <sub>2</sub> "	18 <sup>1</sup> / <sub>2</sub> "	36"	14 <sup>1</sup> / <sub>5</sub> "	26"	18.5 lb
Swivel Counter Stool with Upholstery	<b>VCBMAATCOB</b>	18 <sup>1</sup> / <sub>2</sub> "	18 <sup>1</sup> / <sub>2</sub> "	36 <sup>1</sup> / <sub>5</sub> "	14 <sup>1</sup> / <sub>5</sub> "	26 <sup>2</sup> / <sub>5</sub> "	19.4 lb
Swivel Bar Stool	<b>VCBMAAPLBARB</b>	18 <sup>1</sup> / <sub>2</sub> "	18 <sup>1</sup> / <sub>2</sub> "	40"	14 <sup>1</sup> / <sub>5</sub> "	29 <sup>9</sup> / <sub>10</sub> "	19.4 lb
Swivel Bar Stool with Upholstery	<b>VCBMAATBARB</b>	18 <sup>1</sup> / <sub>2</sub> "	18 <sup>1</sup> / <sub>2</sub> "	40 <sup>1</sup> / <sub>5</sub> "	14 <sup>1</sup> / <sub>5</sub> "	30 <sup>3</sup> / <sub>10</sub> "	20.7 lb
<b>Four Wooden Leg Counter and Bar Stool Base Chairs with Low Backrest</b>							
Four Wooden Leg Counter Stool	<b>VCBMAAPLT4MCOB</b>	19 <sup>7</sup> / <sub>10</sub> "	17 <sup>3</sup> / <sub>10</sub> "	34 <sup>3</sup> / <sub>5</sub> "	14 <sup>1</sup> / <sub>5</sub> "	26"	19.0 lb
Four Wooden Leg Counter Stool with Upholstery	<b>VCBMAAT4MCOB</b>	19 <sup>7</sup> / <sub>10</sub> "	17 <sup>3</sup> / <sub>10</sub> "	34 <sup>4</sup> / <sub>5</sub> "	14 <sup>1</sup> / <sub>5</sub> "	26 <sup>2</sup> / <sub>5</sub> "	20.0 lb
Four Wooden Leg Bar Stool	<b>VCBMAAPLT4MBARB</b>	19 <sup>7</sup> / <sub>10</sub> "	17 <sup>9</sup> / <sub>10</sub> "	38 <sup>3</sup> / <sub>5</sub> "	14 <sup>1</sup> / <sub>5</sub> "	29 <sup>9</sup> / <sub>10</sub> "	20.0 lb
Four Wooden Leg Bar Stool with Upholstery	<b>VCBMAAT4MBARB</b>	18 <sup>7</sup> / <sub>10</sub> "	17 <sup>9</sup> / <sub>10</sub> "	38 <sup>4</sup> / <sub>5</sub> "	14 <sup>1</sup> / <sub>5</sub> "	30 <sup>3</sup> / <sub>10</sub> "	20.7 lb
<b>Swivel Counter and Bar Stool Base Chairs with High Backrest</b>							
Swivel Counter Stool	<b>VCBMAAPLCO</b>	18 <sup>1</sup> / <sub>2</sub> "	18 <sup>1</sup> / <sub>2</sub> "	40 <sup>3</sup> / <sub>5</sub> "	14 <sup>1</sup> / <sub>5</sub> "	26"	21.4 lb
Swivel Counter Stool with Cushion	<b>VCBMAAPLCOC</b>	18 <sup>1</sup> / <sub>2</sub> "	18 <sup>1</sup> / <sub>2</sub> "	40 <sup>3</sup> / <sub>5</sub> "	14 <sup>1</sup> / <sub>5</sub> "	26"	22.6 lb
Swivel Counter Stool with Upholstery	<b>VCBMAATCO</b>	18 <sup>7</sup> / <sub>10</sub> "	18 <sup>9</sup> / <sub>10</sub> "	40 <sup>7</sup> / <sub>10</sub> "	14 <sup>1</sup> / <sub>5</sub> "	26 <sup>2</sup> / <sub>5</sub> "	22.0 lb
Swivel Bar Stool	<b>VCBMAAPLBAR</b>	18 <sup>7</sup> / <sub>10</sub> "	18 <sup>1</sup> / <sub>2</sub> "	44 <sup>1</sup> / <sub>2</sub> "	14 <sup>1</sup> / <sub>5</sub> "	29 <sup>9</sup> / <sub>10</sub> "	24.5 lb
Swivel Bar Stool with Cushion	<b>VCBMAAPLBARC</b>	18 <sup>1</sup> / <sub>2</sub> "	18 <sup>1</sup> / <sub>2</sub> "	40 <sup>1</sup> / <sub>2</sub> "	14 <sup>1</sup> / <sub>5</sub> "	29 <sup>9</sup> / <sub>10</sub> "	29.3 lb
Swivel Bar Stool with Upholstery	<b>VCBMAATBAR</b>	18 <sup>7</sup> / <sub>10</sub> "	18 <sup>9</sup> / <sub>10</sub> "	44 <sup>7</sup> / <sub>10</sub> "	14 <sup>1</sup> / <sub>5</sub> "	30 <sup>3</sup> / <sub>10</sub> "	25.1 lb
<b>Auditorium Chair</b>							
Auditorium Chair with Upholstery	<b>VCBMAAAU</b>	14 <sup>1</sup> / <sub>5</sub> "	18 <sup>1</sup> / <sub>2</sub> "	14 <sup>1</sup> / <sub>5</sub> "	N.A.	N.A.	14.0 lb



# Noha

**Noha**, designed by Ludovica+Roberto Palomba, stands out for the sophisticated smooth lines of its backrest and its cleverly balanced seat that mimics a folded pillow. With or without armrests, with standard or executive backrest, the chair is a great addition to workspaces, meeting rooms, and lounge areas that seek friendlier shapes to make their teams feel comfortable and cared for.

► Specifying, pages 170–221

**Upholstery** available in fabric, vinyl, or leather.

**Five caster nylon base** available in black or white with soft casters for hard floors. Chair is height-adjustable.

**Flat swivel aluminum base** is powder coated in black or white paint. Glides are black or translucent with or without felt.

**Executive backrests** are available for all base types.

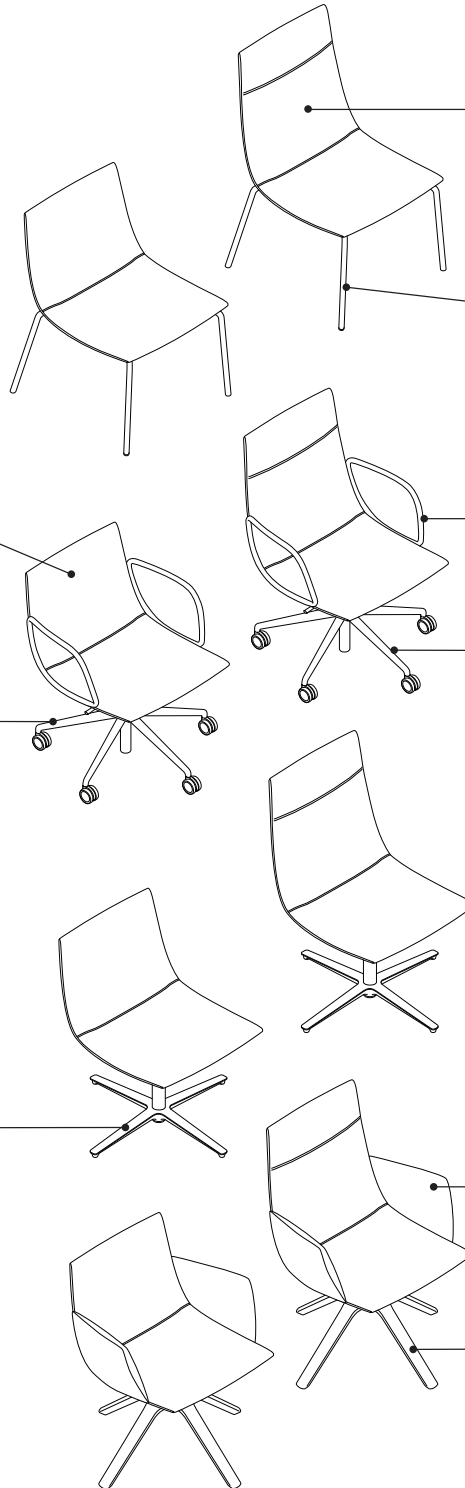
**Metal base** is powder coated in white, black, or taupe paint.

**Metal arms** available as an option on all base types.

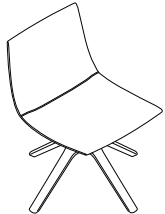
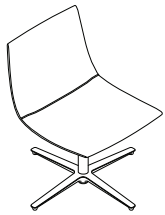
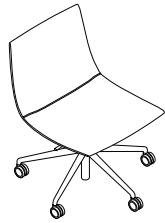
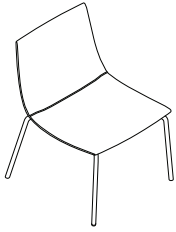
**Five caster aluminum base** is powder coated in white or black with soft casters for hard floors. Chair is height-adjustable.

**Upholstered arms** available as an option on all base types.

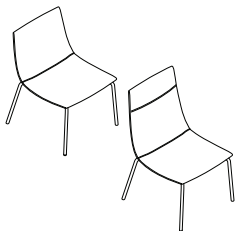
**Wooden swivel base** is available in stained beech wood. Glides are black or white with or without felt.



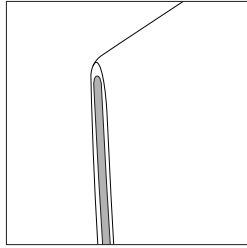
**Product Details**



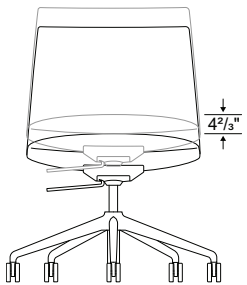
**Noha** is available with four different base types—four leg metal, five caster nylon or aluminum, flat swivel, or wooden swivel.



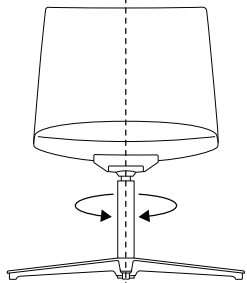
**Noha** is available with either a standard or executive backrest.



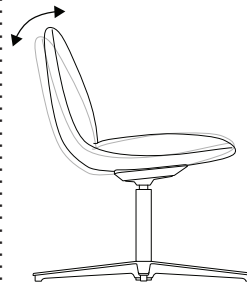
**Piping** available in five colors—anthracite, burgundy, forest green, linen, or white.



**Height adjustment system on five caster base** provides an adjustment range of 4 $\frac{2}{3}$ "H for both chair and executive chairs.



**Self-return system**, available as an option on the flat swivel and wooden swivel bases, brings the chair to its original position after use.



**Tilting mechanism** is available as an option for all bases except the four leg metal base. On the five-star caster base, the tilting mechanism can be locked by the user.

**Surface Materials**

**Upholstery**

- Fabric
- Vinyl
- Leather
- COM (Customer's Own Material)
- COL (Customer's Own Leather)

**Piping**

- Anthracite
- Burgundy
- Forest Green
- Linen
- White

**Metal base**

- 1019 Taupe RAL
- 9003 White RAL
- 9005 Black RAL

**Nylon/aluminum base**

- 9003 White RAL
- 9005 Black RAL

**Wooden swivel base—oak**

- Ash
- Bleached oak
- Cognac
- Matte oak
- Walnut oak

Noha, continued

**Actual Dimensions**

<b>Description</b>	<b>Style Number</b>	<b>Depth</b>	<b>Width</b>	<b>Height</b>	<b>Seat Depth</b>	<b>Seat Width</b>	<b>Seat Height</b>	<b>Weight</b>
Noha Standard Chair—Four Legs Metal Base	<b>VCBNOHEXSI4PME</b>	24 <sup>2</sup> / <sub>5</sub> "	23 <sup>3</sup> / <sub>5</sub> "	32 <sup>2</sup> / <sub>7</sub> "	17 <sup>2</sup> / <sub>3</sub> "	21 <sup>2</sup> / <sub>3</sub> "	18 <sup>1</sup> / <sub>9</sub> "	28.7 lb
Noha Executive Chair—Four Legs Metal Base	<b>VCBNOHEXSI4PME2</b>	24 <sup>2</sup> / <sub>5</sub> "	23 <sup>3</sup> / <sub>5</sub> "	38 <sup>1</sup> / <sub>2</sub> "	17 <sup>2</sup> / <sub>3</sub> "	21 <sup>2</sup> / <sub>3</sub> "	18 <sup>1</sup> / <sub>9</sub> "	32.2 lb
Noha Standard Chair—Five Casters Nylon Base	<b>VCBNOHEXSI5RPL</b>	27 <sup>3</sup> / <sub>5</sub> "	27 <sup>3</sup> / <sub>5</sub> "	30 <sup>2</sup> / <sub>3</sub> "–35 <sup>2</sup> / <sub>5</sub> "	17 <sup>2</sup> / <sub>3</sub> "	21 <sup>2</sup> / <sub>3</sub> "	16 <sup>8</sup> / <sub>9</sub> "–21 <sup>2</sup> / <sub>3</sub> "	29.5 lb
Noha Executive Chair—Five Casters Nylon Base	<b>VCBNOHEXSI5RPL2</b>	27 <sup>3</sup> / <sub>5</sub> "	27 <sup>3</sup> / <sub>5</sub> "	36 <sup>3</sup> / <sub>5</sub> "–41 <sup>2</sup> / <sub>7</sub> "	17 <sup>2</sup> / <sub>3</sub> "	21 <sup>2</sup> / <sub>3</sub> "	16 <sup>8</sup> / <sub>9</sub> "–21 <sup>2</sup> / <sub>3</sub> "	33.1 lb
Noha Standard Chair—Five Casters Aluminum Base	<b>VCBNOHEXSI5R</b>	27 <sup>3</sup> / <sub>5</sub> "	27 <sup>3</sup> / <sub>5</sub> "	30 <sup>2</sup> / <sub>3</sub> "–35 <sup>2</sup> / <sub>5</sub> "	17 <sup>2</sup> / <sub>3</sub> "	21 <sup>2</sup> / <sub>3</sub> "	16 <sup>8</sup> / <sub>9</sub> "–21 <sup>2</sup> / <sub>3</sub> "	31.1 lb
Noha Executive Chair—Five Casters Aluminum Base	<b>VCBNOHEXSI5R2</b>	27 <sup>3</sup> / <sub>5</sub> "	27 <sup>3</sup> / <sub>5</sub> "	36 <sup>3</sup> / <sub>5</sub> "–41 <sup>2</sup> / <sub>7</sub> "	17 <sup>2</sup> / <sub>3</sub> "	21 <sup>2</sup> / <sub>3</sub> "	16 <sup>8</sup> / <sub>9</sub> "–21 <sup>2</sup> / <sub>3</sub> "	34.6 lb
Noha Standard Chair—Flat Swivel Base	<b>VCBNOHEXSIGPL</b>	28 <sup>1</sup> / <sub>9</sub> "	28 <sup>1</sup> / <sub>9</sub> "	32 <sup>2</sup> / <sub>7</sub> "	17 <sup>2</sup> / <sub>3</sub> "	21 <sup>2</sup> / <sub>3</sub> "	18 <sup>1</sup> / <sub>9</sub> "	29.1 lb
Noha Executive Chair—Flat Swivel Base	<b>VCBNOHEXSIGPL2</b>	28 <sup>1</sup> / <sub>9</sub> "	28 <sup>1</sup> / <sub>9</sub> "	38 <sup>1</sup> / <sub>2</sub> "	17 <sup>2</sup> / <sub>3</sub> "	21 <sup>2</sup> / <sub>3</sub> "	18 <sup>1</sup> / <sub>9</sub> "	32.6 lb
Noha Standard Chair—Wooden Swivel Base	<b>VCBNOHEXSIGMA</b>	28 <sup>2</sup> / <sub>3</sub> "	28 <sup>2</sup> / <sub>3</sub> "	33 <sup>1</sup> / <sub>9</sub> "	17 <sup>2</sup> / <sub>3</sub> "	21 <sup>2</sup> / <sub>3</sub> "	18 <sup>1</sup> / <sub>9</sub> "	21.4 lb
Noha Executive Chair—Wooden Swivel Base	<b>VCBNOHEXSIGMA2</b>	28 <sup>2</sup> / <sub>3</sub> "	28 <sup>2</sup> / <sub>3</sub> "	34 <sup>2</sup> / <sub>5</sub> "	17 <sup>2</sup> / <sub>3</sub> "	21 <sup>2</sup> / <sub>3</sub> "	18 <sup>1</sup> / <sub>9</sub> "	30.4 lb

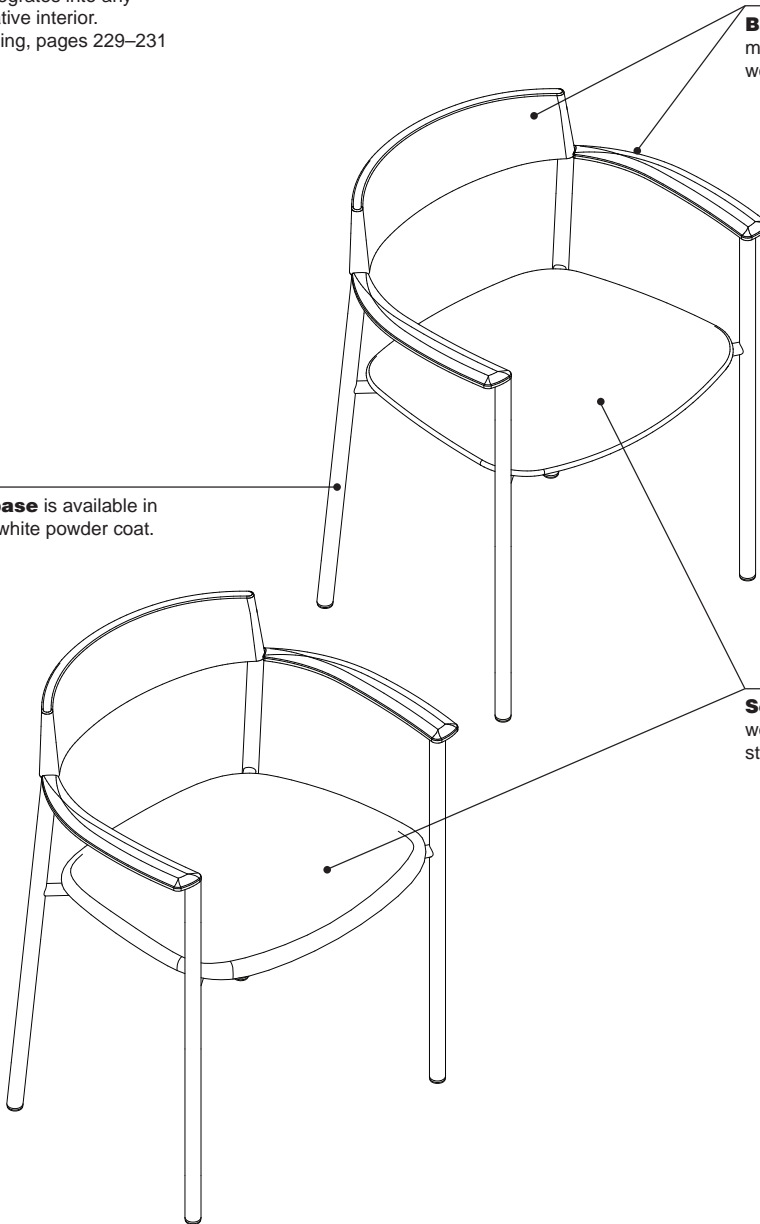
**Perxa**, designed by Piero Lissoni, embodies a refined wooden aesthetic that seamlessly integrates into any collaborative interior.

► Specifying, pages 229–231

**Metal base** is available in black or white powder coat.

**Backrest and armrest** made of stained solid ash wood.

**Seat** made of solid oak wood, available either stained or upholstered.



## Product Details

### Base

**Metal base** powder coated in black or white. Glides are with or without felt.

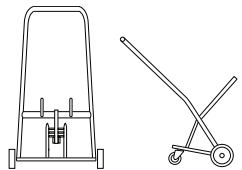
**Stackable chairs** are stackable up to four units.

### Seat and Back Types

**Backrest and armrest** is stained ash plywood available in five finishes.

**Seat** available in either stained oak or upholstered.

### Accessories



**Transportation trolley (VCBPERCT)** is available to transport up to four stackable chairs simultaneously. Trolley is available in black lacquer only.

## Surface Materials

### Wood Stains

- Ash
- Bleached
- Cognac
- Matt
- Walnut

### Upholstery

- Fabric
- Vinyl
- Leather
- COM (Customer's Own Material)
- COL (Customer's Own Leather)

### Base

- 9003 White RAL
- 9005 Black RAL

## Actual Dimensions

Description	Style Number	Depth	Width	Height	Seat Depth	Seat Width	Weight
Perxa Chair	<b>VCBPERSI4PMEZBR</b>	20 <sup>3</sup> / <sub>10</sub> "	25 <sup>1</sup> / <sub>10</sub> "	29 <sup>9</sup> / <sub>10</sub> "	18 <sup>1</sup> / <sub>2</sub> "	22"	15.43 lb
Perxa Stackable Chair	<b>VCBPERSI4PME4ZBR</b>	20 <sup>3</sup> / <sub>10</sub> "	25 <sup>1</sup> / <sub>10</sub> "	29 <sup>9</sup> / <sub>10</sub> "	18 <sup>1</sup> / <sub>2</sub> "	22"	15.43 lb
Perxa Chair with Upholstered Seat	<b>VCBPERSI4PMEYBR</b>	20 <sup>3</sup> / <sub>10</sub> "	25 <sup>1</sup> / <sub>10</sub> "	29 <sup>9</sup> / <sub>10</sub> "	18 <sup>1</sup> / <sub>2</sub> "	22"	15.43 lb
Perxa Stackable Chair with Upholstered Seat	<b>VCBPERSI4PME4YBR</b>	20 <sup>3</sup> / <sub>10</sub> "	25 <sup>1</sup> / <sub>10</sub> "	29 <sup>9</sup> / <sub>10</sub> "	18 <sup>1</sup> / <sub>2</sub> "	22"	15.43 lb

# Quadra

**Quadra chair** has a curved wooden seat and metal base designed by Mario Ferrarini. The Quadra chair is useful in projects that require resistant, versatile chairs with a timeless design such as educational centers, conference halls, restaurants, homes, or collaborative spaces.

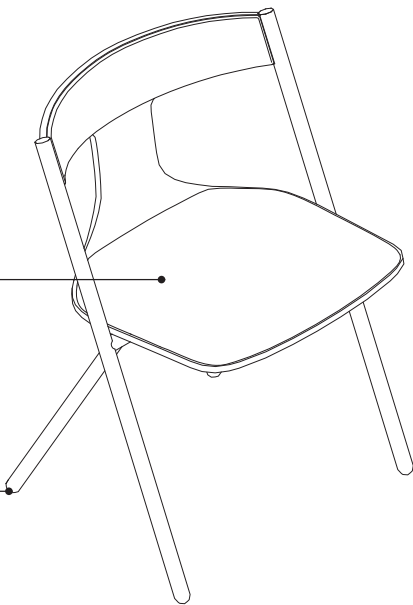
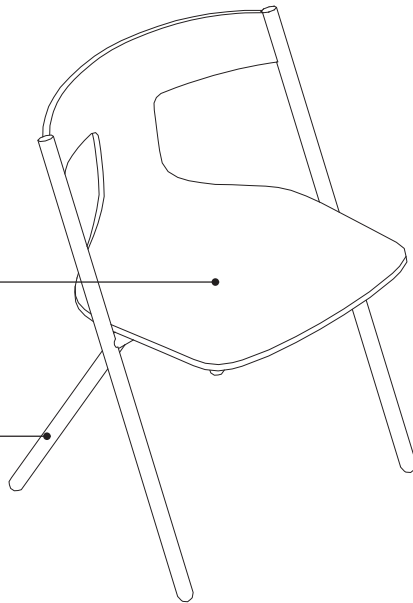
► Specifying, pages 232–236

**Seat** is stained oak plywood or white open pore. Seat also available with upholstered cushion or upholstered seat and back.

**Metal base** is available in black or white powder coat.

**Upholstered seat and back** available in contrasting fabric.

**Glides** are with or without felt.



## Product Details

### Base

**Four leg metal base chairs** are powder coated in black or white. Glides are with or without felt.

**Four leg metal base stackable chairs** are stackable up to 10 units.

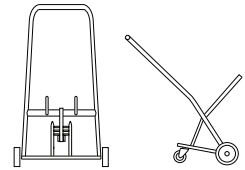
### Seat and Back Types

**Plywood shell** is stained oak plywood available in five finishes.

**Plywood seat and back with upholstered cushion** is available.

**Contrasting upholstered seat and back** is available. The highest price group will be applied if multiple price groups are selected.

### Accessories



**Transportation trolley (VCBQUACT)** is available to transport up to 10 stackable chairs simultaneously. Trolley is available in black lacquer only.

## Surface Materials

### Upholstery

- Fabric
- Vinyl
- Leather
- COM (Customer's Own Material)
- COL (Customer's Own Leather)

### Base

- 9003 White RAL
- 9005 Black RAL

## Actual Dimensions

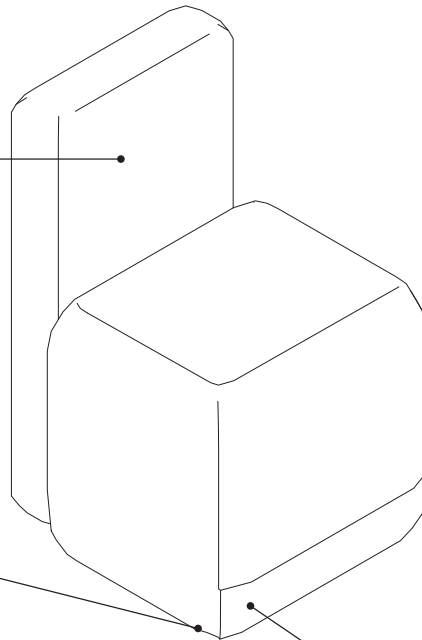
Description	Style Number	Depth	Width	Height	Seat Depth	Seat Height	Weight
Chair	<b>VCBQUARO</b>	19 <sup>7</sup> / <sub>10</sub> "	21 <sup>7</sup> / <sub>10</sub> "	30 <sup>7</sup> / <sub>10</sub> "	17 <sup>1</sup> / <sub>10</sub> "	18 <sup>1</sup> / <sub>10</sub> "	20.3 lb
Stackable Chair	<b>VCBQUAROA</b>	19 <sup>7</sup> / <sub>10</sub> "	21 <sup>7</sup> / <sub>10</sub> "	30 <sup>7</sup> / <sub>10</sub> "	17 <sup>1</sup> / <sub>10</sub> "	18 <sup>1</sup> / <sub>10</sub> "	20.3 lb
Chair with Cushion	<b>VCBQUAROC</b>	19 <sup>7</sup> / <sub>10</sub> "	21 <sup>7</sup> / <sub>10</sub> "	30 <sup>7</sup> / <sub>10</sub> "	17 <sup>1</sup> / <sub>10</sub> "	18 <sup>1</sup> / <sub>10</sub> "	20.3 lb
Chair with Cushion and Upholstered Backrest	<b>VCBQUAROCR</b>	19 <sup>7</sup> / <sub>10</sub> "	21 <sup>7</sup> / <sub>10</sub> "	30 <sup>7</sup> / <sub>10</sub> "	17 <sup>1</sup> / <sub>10</sub> "	18 <sup>1</sup> / <sub>10</sub> "	20.3 lb



Season chair has a unique geometric shape designed by Piero Lissoni. Season is surprisingly comfortable, ideal for use in offices and meeting rooms.  
 ▶ Specifying, page 237

**Upholstered seat and back** available in fabric or leather.

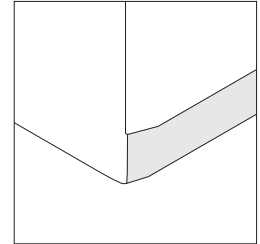
**Fixed legs or casters** are available.



**Upholstery protection** available in dark gray or light gray.

## Product Details

**Interior structure from solid wood**, covered with expanded polyurethane foam in different densities.



**A technical band at footrest height** is included, making it more durable and resistant to hard use. Available in dark grey or light grey.

## Surface Materials

### Upholstery

- Fabric
- Vinyl
- Leather
- COM (Customer's Own Material)
- COL (Customer's Own Leather)

## Actual Dimensions

Description	Style Number	Depth	Width	Height	Seat Height	Weight
Chair	<b>VCBSECH</b>	22"	20 <sup>7</sup> / <sub>10</sub> "	31 <sup>1</sup> / <sub>2</sub> "	19 <sup>3</sup> / <sub>10</sub> "	40 lb



---

# Specifying Chairs and Stools

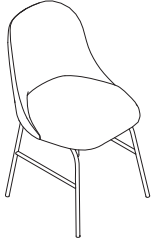
Standard Import Lead Time

## Specifying

Aleta	88
Aleta Executive	103
Copa	109
Ears	123
Funda	135
Klip	137
Last Minute	168
Maarten	170
Noha and Noha Executive	222
Perxa	229
Quadra	232
Season	237

# Chairs and Stools

## Aleta



*Tip: Unless contrasting option is selected, only one upholstery finish is required. If contrasting option is selected, both a seat and back finish is required. The highest price group will be applied if multiple price groups are selected.*

### Standard Includes

- Base: brass finish or powder coated paint in black, white, or taupe
- Upholstery: fabric price group 01
- Glides: plastic

### Options

Option	Options	Price
Contrasting Option	Contrasting	No cost
	Non Contrasting	No cost
Glides	Plastic	No cost
	Felt	+\$10
Back Finish	Fabric Price Grade 1	No cost
	Customer's Own Leather	Prices below
	Fabric Customer's Own Material	Prices below
	Fabric Price Grade 2	Prices below
	Fabric Price Grade 3	Prices below
	Fabric Price Grade 4	Prices below
	Fabric Price Grade 5	Prices below
Seat Finish	Leather Price Grade 5	Prices below
	Fabric Price Grade 1	No cost
	Customer's Own Leather	Prices below
	Fabric Customer's Own Material	Prices below
	Fabric Price Grade 2	Prices below
	Fabric Price Grade 3	Prices below
	Fabric Price Grade 4	Prices below
Fabric Price Grade 5	Prices below	
	Leather Price Grade 5	Prices below

### Specification Information

Dimensions			Style	Base Finish	Base Prices					
D	W	H	Number		Upholstery Grades:					
					1	2	3	4	5/Leather	COM/COL

#### Aleta Four Metal Legs Base Chair

21 1/2"	19 3/10"	32 3/10"	<b>VCBALSIME</b>	Paint	\$1231	\$1367	\$1530	\$1722	\$1914	\$1231
				Brass	\$2093	\$2229	\$2407	\$2597	\$2789	\$2093

Needed fabric for material 1.53 yd wide:

**Non-contrasting:** 1.53 yd

**Contrasting:** Seat 0.98 yd / back 1.42 yd



#### Aleta Four Metal Legs Base Chair with Arms

21 9/10"	20 9/10"	32 3/10"	<b>VCBALSIMEBR</b>	Paint	\$1477	\$1655	\$1860	\$2064	\$2324	\$1477
				Brass	\$2338	\$2503	\$2735	\$2940	\$3200	\$2338

Needed fabric for material 1.53 yd wide:

**Non-contrasting:** 1.64 yd

**Contrasting:** Seat 0.98 yd / back and arms 1.42 yd



# Chairs and Stools

## Aleta



*Tip: Unless contrasting option is selected, only one upholstery finish is required. If contrasting option is selected, both a seat and back finish is required. The highest price group will be applied if multiple price groups are selected.*

### Standard Includes

- Base: brass finish or powder coated paint in black, white, or taupe
- Upholstery: fabric price group 01
- Glides: plastic

### Options

Option	Option	Price
Contrasting Option	Contrasting	No cost
	Non Contrasting	No cost
Glides	Plastic	No cost
	Felt	+\$10
Back Finish	Fabric Price Grade 1	No cost
	Customer's Own Leather	Prices below
	Fabric Customer's Own Material	Prices below
	Fabric Price Grade 2	Prices below
	Fabric Price Grade 3	Prices below
	Fabric Price Grade 4	Prices below
	Fabric Price Grade 5	Prices below
Seat Finish	Leather Price Grade 5	Prices below
	Fabric Price Grade 1	No cost
	Customer's Own Leather	Prices below
	Fabric Customer's Own Material	Prices below
	Fabric Price Grade 2	Prices below
	Fabric Price Grade 3	Prices below
	Fabric Price Grade 4	Prices below
Fabric Price Grade 5	Prices below	
Leather Price Grade 5	Prices below	

Chairs and Stools

### Specification Information



Dimensions	Style	Base Prices							
		Upholstery Grades:							
D	W	H	Number	1	2	3	4	5/Leather	COM/COL

#### Aleta Swivel Base Chair

21 9/10" 19 3/10" 33 3/10" **VCBALSIG** \$1530 \$1682 \$1845 \$2024 \$2229 \$1530

Needed fabric for material 1.53 yd wide:

**Non-contrasting:** 1.53 yd

**Contrasting:** Seat 0.98 yd / back 1.42 yd



#### Aleta Swivel Base Chair with Arms

22 1/5" 20 9/10" 33 3/10" **VCBALSIGBR** \$1791 \$1955 \$2175 \$2379 \$2639 \$1791

Needed fabric for material 1.53 yd wide:

**Non-contrasting:** 1.64 yd

**Contrasting:** Seat 0.98 yd / back and arms 1.42 yd

# Chairs and Stools

## Aleta



*Tip: Unless contrasting option is selected, only one upholstery finish is required. If contrasting option is selected, both a seat and back finish is required. The highest price group will be applied if multiple price groups are selected.*

### Standard Includes

- Aluminum swivel base: powder coated paint in black or white
- Upholstery: fabric price group 01
- Glides: plastic

### Options

Contrasting Option	Contrasting	No cost
	Non Contrasting	No cost
Glides	Plastic	No cost
	Felt	+\$10
Back Finish	Fabric Price Grade 1	No cost
	Customer's Own Leather	Prices below
	Fabric Customer's Own Material	Prices below
	Fabric Price Grade 2	Prices below
	Fabric Price Grade 3	Prices below
	Fabric Price Grade 4	Prices below
	Fabric Price Grade 5	Prices below
Seat Finish	Leather Price Grade 5	Prices below
	Fabric Price Grade 1	No cost
	Customer's Own Leather	Prices below
	Fabric Customer's Own Material	Prices below
	Fabric Price Grade 2	Prices below
	Fabric Price Grade 3	Prices below
	Fabric Price Grade 4	Prices below
Fabric Price Grade 5	Prices below	
Leather Price Grade 5	Prices below	

### Specification Information

Dimensions			Style	Base Prices						
D	W	H	Number	Upholstery Grades:						
				1	2	3	4	5/Leather	COM/COL	

#### Aleta Pyramid Swivel Base Chair

21 9/10" 19 3/10" 31 7/10" **VCBALSIP1** \$1586 \$1736 \$1901 \$2093 \$2298 \$1586

Needed fabric for material 1.53 yd wide:

**Non-contrasting:** 1.53 yd

**Contrasting:** Seat 0.98 yd / back 1.42 yd



#### Aleta Pyramid Swivel Base Chair with Arms

22 1/5" 20 9/10" 31 7/10" **VCBALSIPBR** \$1845 \$2010 \$2229 \$2448 \$2693 \$1845

Needed fabric for material 1.53 yd wide:

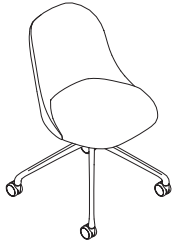
**Non-contrasting:** 1.64 yd

**Contrasting:** Seat 0.98 yd / back and arms 1.42 yd



# Chairs and Stools

## Aleta



*Tip: Unless contrasting option is selected, only one upholstery finish is required. If contrasting option is selected, both a seat and back finish is required. The highest price group will be applied if multiple price groups are selected.*

### Standard Includes

- Aluminum swivel base: powder coated paint in black or white
- Upholstery: fabric price group 01
- Soft casters for hard floors

### Options

Option	Description	Price
Contrasting Option	Contrasting	No cost
	Non Contrasting	No cost
Back Finish	Fabric Price Grade 1	No cost
	Customer's Own Leather	Prices below
	Fabric Customer's Own Material	Prices below
	Fabric Price Grade 2	Prices below
	Fabric Price Grade 3	Prices below
	Fabric Price Grade 4	Prices below
Seat Finish	Fabric Price Grade 5	Prices below
	Leather Price Grade 5	Prices below
	Fabric Price Grade 1	No cost
	Customer's Own Leather	Prices below
	Fabric Customer's Own Material	Prices below
	Fabric Price Grade 2	Prices below
	Fabric Price Grade 3	Prices below
	Fabric Price Grade 4	Prices below
	Fabric Price Grade 5	Prices below
	Leather Price Grade 5	Prices below

Chairs and Stools

### Specification Information



Dimensions			Style	Base Prices						
D	W	H	Number	Upholstery Grades:						
				1	2	3	4	5/Leather	COM/COL	

#### Aleta Pyramid Swivel Base Chair with Casters

21 9/10"	19 9/10"	32 1/10"	<b>VCBALSIPIRU</b>	\$1655	\$1791	\$1955	\$2146	\$2338	\$1655
Needed fabric for material 1.53 yd wide:									
<b>Non-contrasting:</b> 1.53 yd									
<b>Contrasting:</b> Seat 0.98 yd / back 1.42 yd									



#### Aleta Pyramid Swivel Base Chair with Casters and Arms

22 1/5"	20 9/10"	32 1/10"	<b>VCBALSIPIRUBR</b>	\$1888	\$2051	\$2282	\$2488	\$2748	\$1888
Needed fabric for material 1.53 yd wide:									
<b>Non-contrasting:</b> 1.64 yd									
<b>Contrasting:</b> Seat 0.98 yd / back and arms 1.42 yd									

# Chairs and Stools

## Aleta



*Tip: Unless contrasting option is selected, only one upholstery finish is required. If contrasting option is selected, both a seat and back finish is required. The highest price group will be applied if multiple price groups are selected.*

*Tip: When the base is white, the pneumatic cylinder is a chrome finish.*

### Standard Includes

- Aluminum swivel base: powder coated in high gloss black or white
- Upholstery: fabric price group 01
- Aluminum height adjustment system: black or white
- Soft casters for hard floors

### Options

Contrasting Option	Contrasting Non Contrasting	No cost No cost
Back Finish	Fabric Price Grade 1	No cost
	Customer's Own Leather	Prices below
	Fabric Customer's Own Material	Prices below
	Fabric Price Grade 2	Prices below
	Fabric Price Grade 3	Prices below
	Fabric Price Grade 4	Prices below
Seat Finish	Fabric Price Grade 5	Prices below
	Leather Price Grade 5	Prices below
	Fabric Price Grade 1	No cost
	Customer's Own Leather	Prices below
	Fabric Customer's Own Material	Prices below
	Fabric Price Grade 2	Prices below
	Fabric Price Grade 3	Prices below
	Fabric Price Grade 4	Prices below
	Fabric Price Grade 5	Prices below
	Leather Price Grade 5	Prices below

### Specification Information

Dimensions			Style	Base Prices					
D	W	H	Number	Upholstery Grades:					
				1	2	3	4	5/Leather	COM/COL

#### Aleta Five Caster Base Chair

23 2/5" 23 2/5" 30 1/2" - 36" **VCBALSIBR** \$1655 \$1791 \$1955 \$2146 \$2338 \$1655

Needed fabric for material 1.53 yd wide:

**Non-contrasting:** 1.53 yd

**Contrasting:** Seat 0.98 yd / back 1.42 yd



#### Aleta Five Caster Base Chair with Arms

23 4/5" 23 2/5" 30 1/2" - 36" **VCBALSIBRR** \$1888 \$2051 \$2282 \$2488 \$2748 \$1888

Needed fabric for material 1.53 yd wide:

**Non-contrasting:** 1.64 yd

**Contrasting:** Seat 0.98 yd / back and arms 1.42 yd





# Chairs and Stools

## Aleta



*Tip: Unless contrasting option is selected, only one upholstery finish is required. If contrasting option is selected, both a seat and back finish is required. The highest price group will be applied if multiple price groups are selected.*

### Standard Includes

- Aluminum swivel base: powder coated paint in black or white
- Upholstery: fabric price group 01
- Glides: plastic

### Options

Option	Option	Price
Contrasting Option	Contrasting	No cost
	Non Contrasting	No cost
Glides	Plastic	No cost
	Felt	+\$10
Back Finish	Fabric Price Grade 1	No cost
	Customer's Own Leather	Prices below
	Fabric Customer's Own Material	Prices below
	Fabric Price Grade 2	Prices below
	Fabric Price Grade 3	Prices below
	Fabric Price Grade 4	Prices below
	Fabric Price Grade 5	Prices below
Seat Finish	Leather Price Grade 5	Prices below
	Fabric Price Grade 1	No cost
	Customer's Own Leather	Prices below
	Fabric Customer's Own Material	Prices below
	Fabric Price Grade 2	Prices below
	Fabric Price Grade 3	Prices below
	Fabric Price Grade 4	Prices below
Fabric Price Grade 5	Prices below	
	Leather Price Grade 5	Prices below

Chairs and Stools

### Specification Information



Dimensions	Style	Base Prices							
		Upholstery Grades:							
D	W	H	Number	1	2	3	4	5/Leather	COM/COL

#### Aleta Flat Swivel Base Chair

21 9/10" 19 3/10" 31 7/10" **VCBALSIPLA** \$1709 \$1845 \$2010 \$2201 \$2407 \$1709

Needed fabric for material 1.53 yd wide:

**Non-contrasting:** 1.53 yd

**Contrasting:** Seat 0.98 yd / back 1.42 yd



#### Aleta Flat Swivel Base Chair with Arms

22 1/5" 20 9/10" 31 7/10" **VCBALSIPLABR** \$1955 \$2133 \$2338 \$2556 \$2803 \$1955

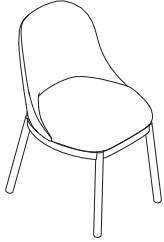
Needed fabric for material 1.53 yd wide:

**Non-contrasting:** 1.64 yd

**Contrasting:** Seat 0.98 yd / back and arms 1.42 yd

# Chairs and Stools

## Aleta



*Tip: Unless contrasting option is selected, only one upholstery finish is required. If contrasting option is selected, both a seat and back finish is required. The highest price group will be applied if multiple price groups are selected.*

### Standard Includes

- Base: wood stained solid oak
- Upholstery: fabric price group 01
- Glides: plastic

### Options

Contrasting Option	Contrasting	No cost
	Non Contrasting	No cost
Glides	Plastic	No cost
	Felt	+\$10
Back Finish	Fabric Price Grade 1	No cost
	Customer's Own Leather	Prices below
	Fabric Customer's Own Material	Prices below
	Fabric Price Grade 2	Prices below
	Fabric Price Grade 3	Prices below
	Fabric Price Grade 4	Prices below
	Fabric Price Grade 5	Prices below
Seat Finish	Leather Price Grade 5	Prices below
	Fabric Price Grade 1	No cost
	Customer's Own Leather	Prices below
	Fabric Customer's Own Material	Prices below
	Fabric Price Grade 2	Prices below
	Fabric Price Grade 3	Prices below
	Fabric Price Grade 4	Prices below
Fabric Price Grade 5	Prices below	
Leather Price Grade 5	Prices below	

### Specification Information

Dimensions			Style Number	Base Prices					
D	W	H		Upholstery Grades:					
				1	2	3	4	5/Leather	COM/COL

#### Aleta Four Wooden Legs Base

21 9/10" 19 3/10" 31 9/10" **VCBALSIMA** \$1709 \$1845 \$2010 \$2201 \$2407 \$1709

Needed fabric for material 1.53 yd wide:

**Non-contrasting:** 1.53 yd

**Contrasting:** Seat 0.98 yd / back 1.42 yd



#### Aleta Four Wooden Legs Base with Arms

22 1/5" 20 9/10" 31 9/10" **VCBALSIMABR** \$1955 \$2133 \$2338 \$2556 \$2803 \$1955

Needed fabric for material 1.53 yd wide:

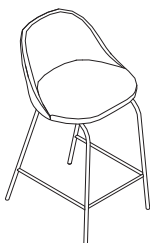
**Non-contrasting:** 1.64 yd

**Contrasting:** Seat 0.98 yd / back and arms 1.42 yd



# Chairs and Stools

## Aleta



*Tip: Unless contrasting option is selected, only one upholstery finish is required. If contrasting option is selected, both a seat and back finish is required. The highest price group will be applied if multiple price groups are selected.*

### Standard Includes

- Base: brass finish or powder coated paint in black, white, or taupe
- Upholstery: fabric price group 01
- Glides: plastic

### Options

Option	Option	Price
Contrasting Option	Contrasting	No cost
	Non Contrasting	No cost
Glides	Plastic	No cost
	Felt	+\$10
Back Finish	Fabric Price Grade 1	No cost
	Customer's Own Leather	Prices below
	Fabric Customer's Own Material	Prices below
	Fabric Price Grade 2	Prices below
	Fabric Price Grade 3	Prices below
	Fabric Price Grade 4	Prices below
	Fabric Price Grade 5	Prices below
Seat Finish	Leather Price Grade 5	Prices below
	Fabric Price Grade 1	No cost
	Customer's Own Leather	Prices below
	Fabric Customer's Own Material	Prices below
	Fabric Price Grade 2	Prices below
	Fabric Price Grade 3	Prices below
	Fabric Price Grade 4	Prices below
Fabric Price Grade 5	Prices below	
	Leather Price Grade 5	Prices below

Chairs and Stools

### Specification Information



Dimensions	Style	Base Prices							
		Base Finish	Upholstery Grades:						
D	W	H	Number	1	2	3	4	5/Leather	COM/COL

#### Aleta Fixed Metal Counter Stool

20 1/10"	16 1/10"	35 1/5"	<b>VCBALTAFC</b>	Paint	\$1325	\$1477	\$1655	\$1845	\$2051	\$1325
				Brass	\$2351	\$2503	\$2679	\$2885	\$3103	\$2351

Needed fabric for material 1.53 yd wide:

**Non-contrasting:** 1.31 yd

**Contrasting:** Seat 0.87 yd / back 1.2 yd



#### Aleta Fixed Metal Counter Stool - High Backrest

20 1/10"	16 1/10"	40 2/5"	<b>VCBALTAFC</b>	Paint	\$1354	\$1517	\$1722	\$1941	\$2188	\$1354
				Brass	\$2379	\$2556	\$2761	\$2967	\$3226	\$2379

Needed fabric for material 1.53 yd wide:

**Non-contrasting:** 1.42 yd

**Contrasting:** Seat 0.87 yd / back 1.42 yd

► **Product Information continued on next page**

# Chairs and Stools

## Aleta

► Product Information continued from previous page

### Specification Information

Dimensions			Style Number	Base Prices						
D	W	H		Base Finish	Upholstery Grades:					
				1	2	3	4	5/Leather	COM/COL	
<b>Aleta Fixed Metal Counter Stool - High Backrest with Arms</b>										
20 1/10"	21 1/10"	40 2/5"	<b>VCBALTAFCBHR</b>	Paint	\$1559	\$1764	\$1996	\$2269	\$2530	\$1559
				Brass	\$2612	\$2803	\$3035	\$3295	\$3582	\$2612



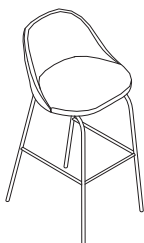
Needed fabric for material 1.53 yd wide:

**Non-contrasting:** 1.75 yd

**Contrasting:** Seat 0.87 yd / back and arms 1.42 yd

# Chairs and Stools

## Aleta



*Tip: Unless contrasting option is selected, only one upholstery finish is required. If contrasting option is selected, both a seat and back finish is required. The highest price group will be applied if multiple price groups are selected.*

### Standard Includes

- Base: brass finish or powder coated paint in black, white, or taupe
- Upholstery: fabric price group 01
- Glides: plastic

### Options

Contrasting Option	Contrasting	No cost
	Non Contrasting	No cost
Glides	Plastic	No cost
	Felt	+\$10
Back Finish	Fabric Price Grade 1	No cost
	Customer's Own Leather	Prices below
	Fabric Customer's Own Material	Prices below
	Fabric Price Grade 2	Prices below
	Fabric Price Grade 3	Prices below
	Fabric Price Grade 4	Prices below
	Fabric Price Grade 5	Prices below
Seat Finish	Leather Price Grade 5	Prices below
	Fabric Price Grade 1	No cost
	Customer's Own Leather	Prices below
	Fabric Customer's Own Material	Prices below
	Fabric Price Grade 2	Prices below
	Fabric Price Grade 3	Prices below
	Fabric Price Grade 4	Prices below
Fabric Price Grade 5	Prices below	
	Leather Price Grade 5	Prices below

Chairs and Stools

### Specification Information



Dimensions	Style	Base Prices							
		Base Finish	Upholstery Grades:						
D	W	H	Number	1	2	3	4	5/Leather	COM/COL

#### Aleta Fixed Metal Bar Stool

20 9/10"	16 1/10"	38 4/5"	<b>VCBALTA</b>	Paint	\$1325	\$1477	\$1655	\$1845	\$2051	\$1325
				Brass	\$2338	\$2488	\$2666	\$2871	\$3090	\$2338

Needed fabric for material 1.53 yd wide:

**Non-contrasting:** 1.31 yd

**Contrasting:** Seat 0.87 yd / back 1.2 yd



#### Aleta Fixed Metal Bar Stool - High Backrest

20 9/10"	16 1/10"	44 1/10"	<b>VCBALTAA</b>	Paint	\$1354	\$1517	\$1722	\$1941	\$2188	\$1354
				Brass	\$2366	\$2530	\$2748	\$2953	\$3213	\$2366

Needed fabric for material 1.53 yd wide:

**Non-contrasting:** 1.42 yd

**Contrasting:** Seat 0.87 yd / back 1.42 yd

▶ **Product Information continued on next page**

# Chairs and Stools

## Aleta

► Product Information continued from previous page

### Specification Information

Dimensions			Style Number	Base Prices						
D	W	H		Base Finish	Upholstery Grades:				5/Leather	COM/COL
				1	2	3	4			
<b>Aleta Fixed Metal Bar Stool - High Backrest with Arms</b>										
20 9/10"	22 1/10"	44 1/10"	<b>VCBALTAHBR</b>	Paint	\$1559	\$1764	\$1996	\$2269	\$2530	\$1559
				Brass	\$2597	\$2789	\$3021	\$3282	\$3569	\$2597



Needed fabric for material 1.53 yd wide:  
**Non-contrasting:** 1.75 yd  
**Contrasting:** Seat 0.87 yd / back and arms 1.42 yd

# Chairs and Stools

## Aleta



*Tip: Unless contrasting option is selected, only one upholstery finish is required. If contrasting option is selected, both a seat and back finish is required. The highest price group will be applied if multiple price groups are selected.*

### Standard Includes

- Base: brass finish or powder coated paint in black, white, or taupe
- Upholstery: fabric price group 01
- Glides: plastic

### Options

Option	Option	Price
Contrasting Option	Contrasting	No cost
	Non Contrasting	No cost
Glides	Plastic	No cost
	Felt	+\$10
Back Finish	Fabric Price Grade 1	No cost
	Customer's Own Leather	Prices below
	Fabric Customer's Own Material	Prices below
	Fabric Price Grade 2	Prices below
	Fabric Price Grade 3	Prices below
	Fabric Price Grade 4	Prices below
	Fabric Price Grade 5	Prices below
Seat Finish	Leather Price Grade 5	Prices below
	Fabric Price Grade 1	No cost
	Customer's Own Leather	Prices below
	Fabric Customer's Own Material	Prices below
	Fabric Price Grade 2	Prices below
	Fabric Price Grade 3	Prices below
	Fabric Price Grade 4	Prices below
Fabric Price Grade 5	Prices below	
	Leather Price Grade 5	Prices below

Chairs and Stools

### Specification Information



Dimensions	Style	Base Prices							
		Upholstery Grades:							
D	W	H	Number	1	2	3	4	5/Leather	COM/COL

#### Aleta Swivel Metal Counter Stool

19 7/10" 19 7/10" 35 1/5" **VCBALTACO** \$1682 \$1832 \$1996 \$2201 \$2420 \$1682

Needed fabric for material 1.53 yd wide:

**Non-contrasting:** 1.31 yd

**Contrasting:** Seat 0.87 yd / back 1.2 yd



#### Aleta Swivel Metal Counter Stool - High Backrest

20 1/10" 19 7/10" 40 2/5" **VCBALTACOH** \$1709 \$1873 \$2064 \$2298 \$2530 \$1709

Needed fabric for material 1.53 yd wide:

**Non-contrasting:** 1.42 yd

**Contrasting:** Seat 0.87 yd / back 1.42 yd

► **Product Information continued on next page**

# Chairs and Stools

## Aleta

► Product Information continued from previous page

### Specification Information



Dimensions			Style Number	Base Prices					
D	W	H		Upholstery Grades:					
				1	2	3	4	5/Leather	COM/COL
20 1/2"	21 1/10"	40 2/5"	<b>VCBALTACOHBR</b>	\$1914	\$2133	\$2351	\$2625	\$2898	\$1914

### Aleta Swivel Metal Counter Stool - High Backrest with Arms

20 1/2" 21 1/10" 40 2/5" **VCBALTACOHBR** \$1914 \$2133 \$2351 \$2625 \$2898 \$1914

Needed fabric for material 1.53 yd wide:

**Non-contrasting:** 1.75 yd

**Contrasting:** Seat 0.87 yd / back and arms 1.42 yd



# Chairs and Stools

## Aleta



*Tip: Unless contrasting option is selected, only one upholstery finish is required. If contrasting option is selected, both a seat and back finish is required. The highest price group will be applied if multiple price groups are selected.*

### Standard Includes

- Base: brass finish or powder coated paint in black, white, or taupe
- Upholstery: fabric price group 01
- Glides: plastic

### Options

Option	Option	Price
Contrasting Option	Contrasting	No cost
	Non Contrasting	No cost
Glides	Plastic	No cost
	Felt	+\$10
Back Finish	Fabric Price Grade 1	No cost
	Customer's Own Leather	Prices below
	Fabric Customer's Own Material	Prices below
	Fabric Price Grade 2	Prices below
	Fabric Price Grade 3	Prices below
	Fabric Price Grade 4	Prices below
Seat Finish	Fabric Price Grade 5	Prices below
	Leather Price Grade 5	Prices below
	Fabric Price Grade 1	No cost
	Customer's Own Leather	Prices below
	Fabric Customer's Own Material	Prices below
Seat Finish	Fabric Price Grade 2	Prices below
	Fabric Price Grade 3	Prices below
	Fabric Price Grade 4	Prices below
	Fabric Price Grade 5	Prices below
	Leather Price Grade 5	Prices below

Chairs and Stools

### Specification Information



Dimensions	Style	Base Prices							
		Upholstery Grades:							
D	W	H	Number	1	2	3	4	5/Leather	COM/COL

#### Aleta Swivel Metal Bar Stool

19 7/10" 19 7/10" 38 4/5" **VCBALTABAR** \$1682 \$1832 \$1996 \$2201 \$2420 \$1682

Needed fabric for material 1.53 yd wide:

**Non-contrasting:** 1.31 yd

**Contrasting:** Seat 0.87 yd / back 1.2 yd



#### Aleta Swivel Metal Bar Stool - High Backrest

20 1/10" 19 7/10" 44 1/10" **VCBALTABARH** \$1709 \$1873 \$2064 \$2298 \$2530 \$1709

Needed fabric for material 1.53 yd wide:

**Non-contrasting:** 1.42 yd

**Contrasting:** Seat 0.87 yd / back 1.42 yd

► **Product Information continued on next page**

# Chairs and Stools

## Aleta

► **Product Information continued from previous page**

### Specification Information



Dimensions			Style Number	Base Prices					
D	W	H		Upholstery Grades:					
				1	2	3	4	5/Leather	COM/COL
20 1/10"	21 3/5"	44 1/10"	<b>VCBALTABARHBR</b>	\$1914	\$2133	\$2351	\$2625	\$2898	\$1914

### Aleta Swivel Metal Bar Stool - High Backrest with Arms

20 1/10" 21 3/5" 44 1/10" **VCBALTABARHBR** \$1914 \$2133 \$2351 \$2625 \$2898 \$1914

Needed fabric for material 1.53 yd wide:

**Non-contrasting:** 1.75 yd

**Contrasting:** Seat 0.87 yd / back and arms 1.42 yd

# Chairs and Stools

## Aleta



### Standard Includes

- Nylon swivel base: black
- Upholstery: fabric price group 01
- Wooden outer backrest: wood stained solid oak, if selected
- Aluminum height adjustment system: black
- Soft casters for hard floors

### Options

Contrasting Option	Contrasting Back and Seat	No cost
	Contrasting with Wood Outer Back	No cost
	Non-Contrasting	No cost
	Non-Contrasting with Wood Outer Back	No cost
	Contrasting with Leather Outer Back	Eco Leather: +\$139 Leather: +\$462
	Non-Contrasting with Leather Outer Back	Eco Leather: +\$139 Leather: +\$462
Back Finish	Fabric Price Grade 1	No cost
	Stain Price Group 1	No cost
	Customer's Own Leather	Prices below
	Fabric Customer's Own Material	Prices below
	Fabric Price Grade 2	Prices below
	Fabric Price Grade 3	Prices below
	Fabric Price Grade 4	Prices below
	Fabric Price Grade 5	Prices below
	Leather Price Grade 5	Prices below
	Fabric Price Grade 2	Prices below
	Leather Price Grade 5	Prices below
Seat Finish	Fabric Price Grade 1	No cost
	Customer's Own Leather	Prices below
	Fabric Customer's Own Material	Prices below
	Fabric Price Grade 2	Prices below
	Fabric Price Grade 3	Prices below
	Fabric Price Grade 4	Prices below
	Fabric Price Grade 5	Prices below
	Leather Price Grade 5	Prices below
Tilt Option	Without Tilting	No cost
	With Tilting	+\$65

*Tip: Unless contrasting option is selected, only one upholstery finish is required. If contrasting option is selected, both a seat and back finish is required. The highest price group will be applied if multiple price groups are selected.*

Chairs and Stools

### Specification Information

Dimensions			Style Number	Base Prices						
Depth	Width	Height		1	2	3	4	5/Leather	COM/COL	
<b>Aleta Executive Chair - Fully Upholstered Five Casters Nylon Base</b>										
26 2/3"	26 2/3"	37 4/5" - 42 1/9"	<b>VCBALEXBRNY</b>	\$1804	\$1975	\$2150	\$2325	\$2475	\$1804	



► **Product Information continued on next page**

# Chairs and Stools

## Aleta

► **Product Information continued from previous page**

### Specification Information



Dimensions			Style Number	Base Prices					
Depth	Width	Height		1	2	3	4	5/Leather	COM/COL
<b>Aleta Executive Chair - Wooden Outer Back Five Casters Nylon Base</b>									
26 2/3"	26 2/3"	37 4/5" - 42 1/9"	<b>VCBALEXBRONY</b>	\$2300	\$2430	\$2600	\$2790	\$2980	\$2300

Needed fabric for material 1.56 yd wide:

**Non-contrasting:** Fabric 2.18 yd, Leather 5.79 yd

**Contrasting:** Fabric seat 1.09 yd / fabric back 1.74 yd, Leather seat 1.31 yd / leather back 4.48 yd

**Non-contrasting with leather outer back:** Fabric seat and front of back 1.74 yd, Eco-leather back 3.6 yd, Leather back 2.4 yd

**Contrasting with leather outer back:** Fabric seat 1.09 yd / fabric front of back 1.2 yd, Eco-leather back 1.2 yd, Leather back 2.4 yd

**Non-contrasting with wood outer back:** Fabric seat and front of back 1.74 yd, Leather seat and back front 3.71 yd

**Contrasting with wood outer back:** Fabric seat 1.09 yd / fabric front of back 1.2 yd, Leather seat 1.31 yd / leather front of back 2.4 yd

# Chairs and Stools

## Aleta



### Standard Includes

- Aluminum swivel base: powder coated paint in black or white
- Upholstery: fabric price group 01
- Wooden outer backrest: wood stained solid oak, if selected
- Aluminum height adjustment system: black or white
- Soft casters for hard floors

### Options

Contrasting Option	Contrasting Back and Seat	No cost
	Contrasting with Wood Outer Back	No cost
	Non-Contrasting	No cost
	Non-Contrasting with Wood Outer Back	No cost
	Contrasting with Leather Outer Back	Eco Leather: +\$139 Leather: +\$462
	Non-Contrasting with Leather Outer Back	Eco Leather: +\$139 Leather: +\$462
Back Finish	Fabric Price Grade 1	No cost
	Stain Price Group 1	No cost
	Customer's Own Leather	Prices below
	Fabric Customer's Own Material	Prices below
	Fabric Price Grade 2	Prices below
	Fabric Price Grade 3	Prices below
	Fabric Price Grade 4	Prices below
	Fabric Price Grade 5	Prices below
	Leather Price Grade 5	Prices below
	Fabric Price Grade 2	Prices below
Leather Price Grade 5	Prices below	
Seat Finish	Fabric Price Grade 1	No cost
	Customer's Own Leather	Prices below
	Fabric Customer's Own Material	Prices below
	Fabric Price Grade 2	Prices below
	Fabric Price Grade 3	Prices below
	Fabric Price Grade 4	Prices below
	Fabric Price Grade 5	Prices below
	Leather Price Grade 5	Prices below
Tilt Option	Without Tilting	No cost
	With Tilting	+\$65

*Tip: Unless contrasting option is selected, only one upholstery finish is required. If contrasting option is selected, both a seat and back finish is required. The highest price group will be applied if multiple price groups are selected.*

Chairs and Stools

### Specification Information

Dimensions			Style Number	Base Prices					
Depth	Width	Height		1	2	3	4	5/Leather	COM/COL
<b>Aleta Executive Chair - Fully Upholstered Five Casters Aluminum Base</b>									
26 2/3"	26 2/3"	37 4/5" - 42 1/9"	<b>VCBALEXBR</b>	\$2067	\$2190	\$2325	\$2520	\$2690	\$2067



► **Product Information continued on next page**

# Chairs and Stools

## Aleta

► **Product Information continued from previous page**

### Specification Information



Dimensions			Style Number	Base Prices					
Depth	Width	Height		1	2	3	4	5/Leather	COM/COL
<b>Aleta Executive Chair - Wooden Outer Back Five Casters Aluminum Base</b>									
26 2/3"	26 2/3"	37 4/5" - 42 1/9"	<b>VCBALEXBRRO</b>	\$2437	\$2550	\$2720	\$2895	\$3080	\$2437

Needed fabric for material 1.56 yd wide:

**Non-contrasting:** Fabric 2.18 yd, Leather 5.79 yd

**Contrasting:** Fabric seat 1.09 yd / fabric back 1.74 yd, Leather seat 1.31 yd / leather back 4.48 yd

**Non-contrasting with leather outer back:** Fabric seat and front of back 1.74 yd, Eco-leather back 3.6 yd, Leather back 2.4 yd

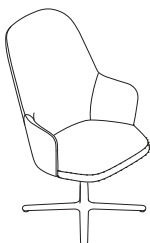
**Contrasting with leather outer back:** Fabric seat 1.09 yd / fabric front of back 1.2 yd, Eco-leather back 1.2 yd, Leather back 2.4 yd

**Non-contrasting with wood outer back:** Fabric seat and front of back 1.74 yd, Leather seat and back front 3.71 yd

**Contrasting with wood outer back:** Fabric seat 1.09 yd / fabric front of back 1.2 yd, Leather seat 1.31 yd / leather front of back 2.4 yd

# Chairs and Stools

## Aleta



### Standard Includes

- Upholstery: fabric price group 01
- Wooden outer backrest: wood stained solid oak, if selected
- Glides: plastic
- Aluminum swivel base: powder coated paint in black or white

### Options

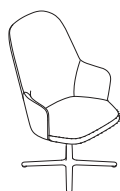
Contrasting Option	Contrasting Back and Seat	No cost
	Contrasting with Wood Outer Back	No cost
	Non-Contrasting	No cost
	Non-Contrasting with Wood Outer Back	No cost
	Contrasting with Leather Outer Back	Eco Leather: +\$139 Leather: +\$462
	Non-Contrasting with Leather Outer Back	Eco Leather: +\$139 Leather: +\$462
Back Finish	Fabric Price Grade 1	No cost
	Stain Price Group 1	No cost
	Customer's Own Leather	Prices below
	Fabric Customer's Own Material	Prices below
	Fabric Price Grade 2	Prices below
	Fabric Price Grade 3	Prices below
	Fabric Price Grade 4	Prices below
	Fabric Price Grade 5	Prices below
	Leather Price Grade 5	Prices below
	Fabric Price Grade 2	Prices below
Leather Price Grade 5	Prices below	
Seat Finish	Fabric Price Grade 1	No cost
	Customer's Own Leather	Prices below
	Fabric Customer's Own Material	Prices below
	Fabric Price Grade 2	Prices below
	Fabric Price Grade 3	Prices below
	Fabric Price Grade 4	Prices below
	Fabric Price Grade 5	Prices below
	Leather Price Grade 5	Prices below
Tilt Option	Without Tilting	No cost
	With Tilting	+\$65
Return Position	Without Self-Return Mechanism	No cost
	With Self-Return Mechanism	+\$127
Glides	Plastic	No cost
	Felt	+\$10

*Tip: Unless contrasting option is selected, only one upholstery finish is required. If contrasting option is selected, both a seat and back finish is required. The highest price group will be applied if multiple price groups are selected.*

Chairs and Stools

### Specification Information

Dimensions			Style Number	Base Prices					
Depth	Width	Height		1	2	3	4	5/Leather	COM/COL
<b>Aleta Executive Chair - Fully Upholstered Flat Swivel Base</b>									
28 2/3"	28 2/3"	39 1/5"	<b>VCBALEXPLA</b>	\$2067	\$2150	\$2300	\$2495	\$2650	\$2067



► **Product Information continued on next page**

# Chairs and Stools

## Aleta

► **Product Information continued from previous page**

### Specification Information



Dimensions			Style Number	Base Prices					
Depth	Width	Height		1	2	3	4	5/Leather	COM/COL
<b>Aleta Executive Chair - Wooden Outer Back Flat Swivel Base</b>									
28 2/3"	28 2/3"	39 1/5"	<b>VCBALEXPLARO</b>	\$2437	\$2550	\$2678	\$2890	\$2998	\$2437

Needed fabric for material 1.56 yd wide:

**Non-contrasting:** Fabric 2.18 yd, Leather 5.79 yd

**Contrasting:** Fabric seat 1.09 yd / fabric back 1.74 yd, Leather seat 1.31 yd / leather back 4.48 yd

**Non-contrasting with leather outer back:** Fabric seat and front of back 1.74 yd, Eco-leather back 3.6 yd, Leather back 2.4 yd

**Contrasting with leather outer back:** Fabric seat 1.09 yd / fabric front of back 1.2 yd, Eco-leather back 1.2 yd, Leather back 2.4 yd

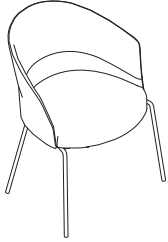
**Non-contrasting with wood outer back:** Fabric seat and front of back 1.74 yd, Leather seat and back front 3.71 yd

**Contrasting with wood outer back:** Fabric seat 1.09 yd / fabric front of back 1.2 yd, Leather seat 1.31 yd / Leather front of back 2.4 yd



# Chairs and Stools

## Copa



*Tip: Unless contrasting option is selected, only one upholstery finish is required. If contrasting option is selected, both a seat and back finish is required. The highest price group will be applied if multiple price groups are selected.*

*Tip: When contrasting backrest is selected, outer back is upholstered in leather.*

### Standard Includes

- Base: powder coated paint in black or white
- Upholstery: fabric price group 01
- Glides: plastic

### Options

Contrasting Option	Non Contrasting	No cost
	Contrasting Backrest	+\$244
Seat Back Finish	Fabric Price Grade 1	No cost
	Customer's Own Leather	Prices below
	Fabric Customer's Own Material	Prices below
	Fabric Price Grade 2	Prices below
	Fabric Price Grade 3	Prices below
	Fabric Price Grade 4	Prices below
Glides	Fabric Price Grade 5	Prices below
	Leather Price Grade 5	Prices below
	Plastic	No cost
	Felt	+\$10

### Specification Information



Dimensions		Style Number	Base Prices						
D	W		H	Upholstery Grades:					
			1	2	3	4	5/Leather	COM/COL	

### Copa Metal Chair with Smooth Upholstery

24 2/5" 24 4/5" 30 7/10" **VCBCOME** \$1162 \$1299 \$1449 \$1627 \$1832 \$1162

Needed fabric for material 1.53 yd wide:

**Non-contrasting:** Fabric 2.3 yd, Leather 2.6 yd

**Contrasting:** Fabric seat and front of back 1.8 yd, leather back 0.8 yd



### Copa Metal Chair with Soft Upholstery

24 2/5" 24 4/5" 30 7/10" **VCBCOME** \$1321 \$1410 \$1609 \$1794 \$1976 \$1321

Needed fabric for material 1.53 yd wide:

**Non-contrasting:** Fabric 2.3 yd, Leather 2.6 yd

**Contrasting:** Fabric seat and front of back 1.8 yd, leather back 0.8 yd

# Chairs and Stools

## Copa



*Tip: Unless contrasting option is selected, only one upholstery finish is required. If contrasting option is selected, both a seat and back finish is required. The highest price group will be applied if multiple price groups are selected.*

*Tip: When contrasting backrest is selected, outer back is upholstered in leather.*

### Standard Includes

- Aluminum swivel base: powder coated paint in black or white
- Upholstery: fabric price group 01
- Glides: plastic

### Options

Contrasting Option	Non Contrasting	No cost
	Contrasting Backrest	+\$244
Seat Back Finish	Fabric Price Grade 1	No cost
	Customer's Own Leather	Prices below
	Fabric Customer's Own Material	Prices below
	Fabric Price Grade 2	Prices below
	Fabric Price Grade 3	Prices below
	Fabric Price Grade 4	Prices below
Glides	Fabric Price Grade 5	Prices below
	Leather Price Grade 5	Prices below
	Plastic	No cost
	Felt	+\$10

### Specification Information



Dimensions			Style Number	Base Prices					
D	W	H		Upholstery Grades:					
				1	2	3	4	5/Leather	COM/COL

### Copa Pyramid Swivel Chair with Smooth Upholstery

24 2/5" 24 4/5" 30 9/10" **VCBCOPI** \$1530 \$1682 \$1832 \$1996 \$2201 \$1530

Needed fabric for material 1.53 yd wide:

**Non-contrasting:** Fabric 2.3 yd, Leather 2.6 yd

**Contrasting:** Fabric seat and front of back 1.8 yd, leather back 0.8 yd



### Copa Pyramid Swivel Chair with Soft Upholstery

24 2/5" 24 4/5" 30 9/10" **VCBCOPI** \$1636 \$1721 \$1902 \$2079 \$2265 \$1636

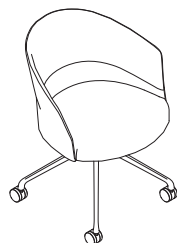
Needed fabric for material 1.53 yd wide:

**Non-contrasting:** Fabric 2.3 yd, Leather 2.6 yd

**Contrasting:** Fabric seat and front of back 1.8 yd, leather back 0.8 yd

# Chairs and Stools

## Copa



*Tip: Unless contrasting option is selected, only one upholstery finish is required. If contrasting option is selected, both a seat and back finish is required. The highest price group will be applied if multiple price groups are selected.*

*Tip: When contrasting backrest is selected, outer back is upholstered in leather.*

### Standard Includes

- Aluminum swivel base: powder coated paint in black or white
- Upholstery: fabric price group 01
- Soft casters for hard floors

### Options

Contrasting Option	Non Contrasting	No cost
	Contrasting Backrest	+\$244
Seat Back Finish	Fabric Price Grade 1	No cost
	Customer's Own Leather	Prices below
	Fabric Customer's Own Material	Prices below
	Fabric Price Grade 2	Prices below
	Fabric Price Grade 3	Prices below
	Fabric Price Grade 4	Prices below
Caster Opt	Fabric Price Grade 5	Prices below
	Leather Price Grade 5	Prices below
	Black	No cost
	White	No cost

Chairs and Stools

### Specification Information

Dimensions			Style	Base Prices						
D	W	H	Number	Upholstery Grades:						
				1	2	3	4	5/Leather	COM/COL	



#### Copa Pyramid Swivel Chair with Casters and Smooth Upholstery

24 2/5"	24 4/5"	31 1/10"	<b>VCBCOPIRU</b>	\$1573	\$1722	\$1873	\$2037	\$2256	\$1573
---------	---------	----------	------------------	--------	--------	--------	--------	--------	--------

Needed fabric for material 1.53 yd wide:

**Non-contrasting:** Fabric 2.3 yd, Leather 2.6 yd

**Contrasting:** Fabric seat and front of back 1.8 yd, leather back 0.8 yd



#### Copa Pyramid Swivel Chair with Casters and Soft Upholstery

24 2/5"	24 4/5"	31 1/10"	<b>VCBCOPIRU</b>	\$1676	\$1768	\$1936	\$2110	\$2310	\$1676
---------	---------	----------	------------------	--------	--------	--------	--------	--------	--------

Needed fabric for material 1.53 yd wide:

**Non-contrasting:** Fabric 2.3 yd, Leather 2.6 yd

**Contrasting:** Fabric seat and front of back 1.8 yd, leather back 0.8 yd

# Chairs and Stools

## Copa



*Tip: Unless contrasting option is selected, only one upholstery finish is required. If contrasting option is selected, both a seat and back finish is required. The highest price group will be applied if multiple price groups are selected.*

*Tip: When contrasting backrest is selected, outer back is upholstered in leather.*

### Standard Includes

- Aluminum swivel base: powder coated in high gloss black or white
- Aluminum height adjustment system: black or white
- Upholstery: fabric price group 01
- Soft casters for hard floors

### Options

Option	Option Description	Price
Contrasting Option	Non Contrasting	No cost
	Contrasting Backrest	+\$244
Seat Back Finish	Fabric Price Grade 1	No cost
	Customer's Own Leather	Prices below
	Fabric Customer's Own Material	Prices below
	Fabric Price Grade 2	Prices below
	Fabric Price Grade 3	Prices below
	Fabric Price Grade 4	Prices below
Caster Opt	Fabric Price Grade 5	Prices below
	Leather Price Grade 5	Prices below
Caster Opt	Black	No cost
	White	No cost

### Specification Information

Dimensions			Style	Base Prices						
D	W	H	Number	Upholstery Grades:						
				1	2	3	4	5/Leather	COM/COL	

#### Copa Five Caster Chair with Smooth Upholstery

24 2/5"    24 4/5"    30 9/10" - 35"    **VCBCOBR**    \$1573    \$1722    \$1873    \$2037    \$2256    \$1573

Needed fabric for material 1.53 yd wide:

**Non-contrasting:** Fabric 2.3 yd, Leather 2.6 yd

**Contrasting:** Fabric seat and front of back 1.8 yd, leather back 0.8 yd



#### Copa Five Caster Chair with Soft Upholstery

24 2/5"    24 4/5"    30 9/10" - 35"    **VCBCOBR**    \$1676    \$1768    \$1936    \$2110    \$2310    \$1676

Needed fabric for material 1.53 yd wide:

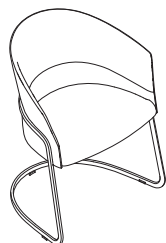
**Non-contrasting:** Fabric 2.3 yd, Leather 2.6 yd

**Contrasting:** Fabric seat and front of back 1.8 yd, leather back 0.8 yd



# Chairs and Stools

## Copa



*Tip: Unless contrasting option is selected, only one upholstery finish is required. If contrasting option is selected, both a seat and back finish is required. The highest price group will be applied if multiple price groups are selected.*

*Tip: When contrasting backrest is selected, outer back is upholstered in leather.*

### Standard Includes

- Base: powder coated paint in black or white
- Upholstery: fabric price group 01
- Glides: plastic

### Options

Option	Description	Price
Contrasting Option	Non Contrasting	No cost
	Contrasting Backrest	+\$244
Seat Back Finish	Fabric Price Grade 1	No cost
	Customer's Own Leather	Prices below
	Fabric Customer's Own Material	Prices below
	Fabric Price Grade 2	Prices below
	Fabric Price Grade 3	Prices below
	Fabric Price Grade 4	Prices below
Glides	Fabric Price Grade 5	Prices below
	Leather Price Grade 5	Prices below
Glides	Plastic	No cost
	Felt	+\$10

### Specification Information



Dimensions	Style	Base Prices							
		Upholstery Grades:							
D	W	H	Number	1	2	3	4	5/Leather	COM/COL

### Copa Cantilever Chair with Smooth Upholstery

20 1/10"	24 4/5"	31 1/10"	<b>VCBCOCL</b>	\$1627	\$1764	\$1914	\$2093	\$2298	\$1627
----------	---------	----------	----------------	--------	--------	--------	--------	--------	--------

Needed fabric for material 1.53 yd wide:

**Non-contrasting:** Fabric 2.3 yd, Leather 2.6 yd

**Contrasting:** Fabric seat and front of back 1.8 yd, leather back 0.8 yd



### Copa Cantilever Chair with Soft Upholstery

20 1/10"	24 4/5"	31 1/10"	<b>VCBCOCL</b>	\$1713	\$1813	\$1998	\$2178	\$2359	\$1713
----------	---------	----------	----------------	--------	--------	--------	--------	--------	--------

Needed fabric for material 1.53 yd wide:

**Non-contrasting:** Fabric 2.3 yd, Leather 2.6 yd

**Contrasting:** Fabric seat and front of back 1.8 yd, leather back 0.8 yd

# Chairs and Stools

## Copa



*Tip: Unless contrasting option is selected, only one upholstery finish is required. If contrasting option is selected, both a seat and back finish is required. The highest price group will be applied if multiple price groups are selected.*

*Tip: When contrasting backrest is selected, outer back is upholstered in leather.*

### Standard Includes

- Aluminum swivel base: powder coated paint in black or white
- Upholstery: fabric price group 01
- Glides: plastic

### Options

Contrasting Option	Non Contrasting Contrasting Backrest	No cost +\$244
Seat Back Finish	Fabric Price Grade 1	No cost
	Customer's Own Leather	Prices below
	Fabric Customer's Own Material	Prices below
	Fabric Price Grade 2	Prices below
	Fabric Price Grade 3	Prices below
	Fabric Price Grade 4	Prices below
Glides	Fabric Price Grade 5	Prices below
	Leather Price Grade 5	Prices below
	Plastic	No cost
	Felt	+\$10

### Specification Information

Dimensions			Style Number	Base Prices					
D	W	H		Upholstery Grades:					
				1	2	3	4	5/Leather	COM/COL

### Copa Flat Swivel Chair with Smooth Upholstery

24 2/5" 24 4/5" 29 9/10" **VCBCOPLA** \$1627 \$1764 \$1914 \$2093 \$2298 \$1627

Needed fabric for material 1.53 yd wide:

**Non-contrasting:** Fabric 2.3 yd, Leather 2.6 yd

**Contrasting:** Fabric seat and front of back 1.8 yd, leather back 0.8 yd



### Copa Flat Swivel Chair with Soft Upholstery

24 2/5" 24 4/5" 29 9/10" **VCBCOPLA** \$1713 \$1813 \$1998 \$2178 \$2359 \$1713

Needed fabric for material 1.53 yd wide:

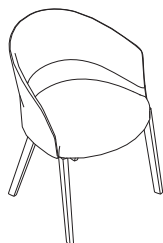
**Non-contrasting:** Fabric 2.3 yd, Leather 2.6 yd

**Contrasting:** Fabric seat and front of back 1.8 yd, leather back 0.8 yd



# Chairs and Stools

## Copa



*Tip: Unless contrasting option is selected, only one upholstery finish is required. If contrasting option is selected, both a seat and back finish is required. The highest price group will be applied if multiple price groups are selected.*

*Tip: When contrasting backrest is selected, outer back is upholstered in leather.*

### Standard Includes

- Base: wood stained solid oak
- Upholstery: fabric price group 01
- Glides: plastic

### Options

Contrasting Option	Non Contrasting Contrasting Backrest	No cost +\$244
Seat Back Finish	Fabric Price Grade 1	No cost
	Customer's Own Leather	Prices below
	Fabric Customer's Own Material	Prices below
	Fabric Price Grade 2	Prices below
	Fabric Price Grade 3	Prices below
	Fabric Price Grade 4	Prices below
Glides	Fabric Price Grade 5 Leather Price Grade 5	Prices below Prices below
	Plastic	No cost
	Felt	+\$10

### Specification Information



Dimensions		Style Number	Base Prices						
D	W		H	Upholstery Grades:					
			1	2	3	4	5/Leather	COM/COL	

### Copa Wooden Legs Chair with Smooth Upholstery

24 2/5" 24 4/5" 31 1/10" **VCBCOMA** \$1627 \$1764 \$1914 \$2093 \$2298 \$1627

Needed fabric for material 1.53 yd wide:

**Non-contrasting:** Fabric 2.3 yd, Leather 2.6 yd

**Contrasting:** Fabric seat and front of back 1.8 yd, leather back 0.8 yd



### Copa Wooden Legs Chair with Soft Upholstery

24 2/5" 24 4/5" 31 1/10" **VCBCOMA** \$1713 \$1813 \$1998 \$2178 \$2359 \$1713

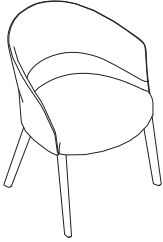
Needed fabric for material 1.53 yd wide:

**Non-contrasting:** Fabric 2.3 yd, Leather 2.6 yd

**Contrasting:** Fabric seat and front of back 1.8 yd, leather back 0.8 yd

# Chairs and Stools

## Copa



*Tip: Unless contrasting option is selected, only one upholstery finish is required. If contrasting option is selected, both a seat and back finish is required. The highest price group will be applied if multiple price groups are selected.*

*Tip: When contrasting backrest is selected, outer back is upholstered in leather.*

### Standard Includes

- Base: leather upholstered solid oak
- Upholstery: fabric price group 01
- Glides: plastic

### Options

Contrasting Option	Non Contrasting	No cost
	Contrasting Backrest	+\$244
Seat Back Finish	Fabric Price Grade 1	No cost
	Customer's Own Leather	Prices below
	Fabric Customer's Own Material	Prices below
	Fabric Price Grade 2	Prices below
	Fabric Price Grade 3	Prices below
	Fabric Price Grade 4	Prices below
Glides	Fabric Price Grade 5	Prices below
	Leather Price Grade 5	Prices below
	Plastic	No cost
	Felt	+\$10

### Specification Information



Dimensions		Style Number	Base Prices						
D	W		H	Upholstery Grades:					
			1	2	3	4	5/Leather	COM/COL	

### Copa Upholstered Wooden Legs Chair with Smooth Upholstery

24 2/5"    24 4/5"    31 1/10"    **VCBCOPTP**    \$2106    \$2242    \$2393    \$2571    \$2776    \$2106

Needed fabric for material 1.53 yd wide:

**Non-contrasting:** Fabric 2.3 yd, Leather 2.6 yd

**Contrasting:** Fabric seat and front of back 1.8 yd, leather back 0.8 yd



### Copa Upholstered Wooden Legs Chair with Soft Upholstery

24 2/5"    24 4/5"    31 1/10"    **VCBCOPTP**    \$2197    \$2337    \$2505    \$2675    \$2873    \$2197

Needed fabric for material 1.53 yd wide:

**Non-contrasting:** Fabric 2.3 yd, Leather 2.6 yd

**Contrasting:** Fabric seat and front of back 1.8 yd, leather back 0.8 yd



# Chairs and Stools

## Copa



*Tip: Unless contrasting option is selected, only one upholstery finish is required. If contrasting option is selected, both a seat and back finish is required. The highest price group will be applied if multiple price groups are selected.*

*Tip: When contrasting backrest is selected, outer back is upholstered in leather.*

### Standard Includes

- Base: powder coated paint in black or white
- Upholstery: fabric price group 01
- Footrest: powder coated to match base
- Glides: plastic

### Options

Contrasting Option	Non Contrasting	No cost
	Contrasting Backrest	+\$244
Seat Back Finish	Fabric Price Grade 1	No cost
	Customer's Own Leather	Prices below
	Fabric Customer's Own Material	Prices below
	Fabric Price Grade 2	Prices below
	Fabric Price Grade 3	Prices below
	Fabric Price Grade 4	Prices below
Glides	Fabric Price Grade 5	Prices below
	Leather Price Grade 5	Prices below
	Plastic	No cost
	Felt	+\$10

### Specification Information



Dimensions			Style Number	Base Prices					
D	W	H		Upholstery Grades:					
				1	2	3	4	5/Leather	COM/COL

#### Copa Fixed Counter Stool with Smooth Upholstery

19 3/10" 23 1/5" 34 3/10" **VCBCOT4MECO** \$1285 \$1367 \$1517 \$1682 \$1832 \$1285

Needed fabric for material 1.53 yd wide:

**Non-contrasting:** Fabric 1.9 yd, Leather 1.96 yd

**Contrasting:** Fabric seat and front of back 1.3 yd, leather back 0.66 yd



#### Copa Fixed Counter Stool with Soft Upholstery

19 3/10" 23 1/5" 34 3/10" **VCBCOT4MECO** \$1381 \$1475 \$1640 \$1804 \$1976 \$1381

Needed fabric for material 1.53 yd wide:

**Non-contrasting:** Fabric 1.9 yd, Leather 1.96 yd

**Contrasting:** Fabric seat and front of back 1.3 yd, leather back 0.66 yd

# Chairs and Stools

## Copa



*Tip: Unless contrasting option is selected, only one upholstery finish is required. If contrasting option is selected, both a seat and back finish is required. The highest price group will be applied if multiple price groups are selected.*

*Tip: When contrasting backrest is selected, outer back is upholstered in leather.*

### Standard Includes

- Base: powder coated paint in black or white
- Footrest: powder coated to match base
- Upholstery: fabric price group 01
- Glides: plastic

### Options

Contrasting Option	Non Contrasting	No cost
	Contrasting Backrest	+\$244
Seat Back Finish	Fabric Price Grade 1	No cost
	Customer's Own Leather	Prices below
	Fabric Customer's Own Material	Prices below
	Fabric Price Grade 2	Prices below
	Fabric Price Grade 3	Prices below
	Fabric Price Grade 4	Prices below
Glides	Fabric Price Grade 5	Prices below
	Leather Price Grade 5	Prices below
	Plastic	No cost
	Felt	+\$10

### Specification Information



Dimensions			Style Number	Base Prices						
D	W	H		Upholstery Grades:						
				1	2	3	4	5/Leather	COM/COL	

#### Copa Fixed Bar Stool with Smooth Upholstery

19 3/10" 23 1/5" 38 1/5" **VCBCOT4MEBAR** \$1285 \$1367 \$1517 \$1682 \$1832 \$1285

Needed fabric for material 1.53 yd wide:

**Non-contrasting:** Fabric 1.9 yd, Leather 1.96 yd

**Contrasting:** Fabric seat and front of back 1.3 yd, leather back 0.66 yd



#### Copa Fixed Bar Stool with Soft Upholstery

19 3/10" 23 1/5" 38 1/5" **VCBCOT4MEBAR** \$1381 \$1475 \$1640 \$1804 \$1976 \$1381

Needed fabric for material 1.53 yd wide:

**Non-contrasting:** Fabric 1.9 yd, Leather 1.96 yd

**Contrasting:** Fabric seat and front of back 1.3 yd, leather back 0.66 yd

# Chairs and Stools

## Copa



*Tip: Unless contrasting option is selected, only one upholstery finish is required. If contrasting option is selected, both a seat and back finish is required. The highest price group will be applied if multiple price groups are selected.*

*Tip: When contrasting backrest is selected, outer back is upholstered in leather.*

### Standard Includes

- Base: powder coated paint in black or white
- Upholstery: fabric price group 01
- Footrest: powder coated to match base
- Glides: plastic

### Options

Contrasting Option	Non Contrasting	No cost
	Contrasting Backrest	+\$244
Seat Back Finish	Fabric Price Grade 1	No cost
	Customer's Own Leather	Prices below
	Fabric Customer's Own Material	Prices below
	Fabric Price Grade 2	Prices below
	Fabric Price Grade 3	Prices below
	Fabric Price Grade 4	Prices below
Glides	Fabric Price Grade 5	Prices below
	Leather Price Grade 5	Prices below
	Plastic	No cost
	Felt	+\$10

### Specification Information



Dimensions			Style Number	Base Prices					
D	W	H		Upholstery Grades:					
				1	2	3	4	5/Leather	COM/COL

### Copa Swivel Counter Stool with Smooth Upholstery

19 3/10"	21 9/10"	36 3/5"	<b>VCBCOTGCO</b>	\$1559	\$1682	\$1832	\$1970	\$2133	\$1559
----------	----------	---------	------------------	--------	--------	--------	--------	--------	--------

Needed fabric for material 1.53 yd wide:

**Non-contrasting:** Fabric 1.9 yd, Leather 1.96 yd

**Contrasting:** Fabric seat and front of back 1.3 yd, leather back 0.66 yd

### Copa Swivel Counter Stool with Soft Upholstery

19 3/10"	21 9/10"	36 3/5"	<b>VCBCOTGCO</b>	\$1703	\$1800	\$1965	\$2119	\$2282	\$1703
----------	----------	---------	------------------	--------	--------	--------	--------	--------	--------

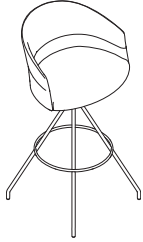
Needed fabric for material 1.53 yd wide:

**Non-contrasting:** Fabric 1.9 yd, Leather 1.96 yd

**Contrasting:** Fabric seat and front of back 1.3 yd, leather back 0.66 yd

# Chairs and Stools

## Copa



*Tip: Unless contrasting option is selected, only one upholstery finish is required. If contrasting option is selected, both a seat and back finish is required. The highest price group will be applied if multiple price groups are selected.*

*Tip: When contrasting backrest is selected, outer back is upholstered in leather.*

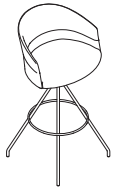
### Standard Includes

- Base: powder coated paint in black or white
- Upholstery: fabric price group 01
- Footrest: powder coated to match base
- Glides: plastic

### Options

Contrasting Option	Non Contrasting	No cost
	Contrasting Backrest	+\$244
Seat Back Finish	Fabric Price Grade 1	No cost
	Customer's Own Leather	Prices below
	Fabric Customer's Own Material	Prices below
	Fabric Price Grade 2	Prices below
	Fabric Price Grade 3	Prices below
	Fabric Price Grade 4	Prices below
Glides	Fabric Price Grade 5	Prices below
	Leather Price Grade 5	Prices below
	Plastic	No cost
	Felt	+\$10

### Specification Information



Dimensions			Style Number	Base Prices						
D	W	H		Upholstery Grades:						
				1	2	3	4	5/Leather	COM/COL	

### Copa Swivel Bar Stool with Smooth Upholstery

20 1/10" 22 1/5" 40 3/5" **VCBCOTGBAR** \$1559 \$1682 \$1832 \$1970 \$2133 \$1559

Needed fabric for material 1.53 yd wide:

**Non-contrasting:** Fabric 1.9 yd, Leather 1.96 yd

**Contrasting:** Fabric seat and front of back 1.3 yd, leather back 0.66 yd



### Copa Swivel Bar Stool with Soft Upholstery

20 1/10" 22 1/5" 40 3/5" **VCBCOTGBAR** \$1703 \$1800 \$1965 \$2119 \$2282 \$1703

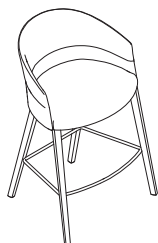
Needed fabric for material 1.53 yd wide:

**Non-contrasting:** Fabric 1.9 yd, Leather 1.96 yd

**Contrasting:** Fabric seat and front of back 1.3 yd, leather back 0.66 yd

# Chairs and Stools

## Copa



*Tip: Unless contrasting option is selected, only one upholstery finish is required. If contrasting option is selected, both a seat and back finish is required. The highest price group will be applied if multiple price groups are selected.*

*Tip: When contrasting backrest is selected, outer back is upholstered in leather.*

### Standard Includes

- Base: wood stained solid oak
- Upholstery: fabric price group 01
- Footrest: powder coated paint in black
- Glides: plastic

### Options

Contrasting Option	Non Contrasting	No cost
	Contrasting Backrest	+\$244
Seat Back Finish	Fabric Price Grade 1	No cost
	Customer's Own Leather	Prices below
	Fabric Customer's Own Material	Prices below
	Fabric Price Grade 2	Prices below
	Fabric Price Grade 3	Prices below
	Fabric Price Grade 4	Prices below
Glides	Fabric Price Grade 5	Prices below
	Leather Price Grade 5	Prices below
	Plastic	No cost
	Felt	+\$10

### Specification Information



Dimensions			Style Number	Base Prices						
D	W	H		Upholstery Grades:						
				1	2	3	4	5/Leather	COM/COL	

### Copa Fixed Wooden Legs Counter Stool with Smooth Upholstery

19 3/10" 22 2/5" 34 3/10" **VCBCOT4MACO** \$1845 \$1914 \$2051 \$2215 \$2366 \$1845

Needed fabric for material 1.53 yd wide:

**Non-contrasting:** Fabric 1.9 yd, Leather 1.96 yd

**Contrasting:** Fabric seat and front of back 1.3 yd, leather back 0.66 yd



### Copa Fixed Wooden Legs Counter Stool with Soft Upholstery

19 3/10" 22 2/5" 34 3/10" **VCBCOT4MACO** \$2001 \$2076 \$2240 \$2407 \$2560 \$2001

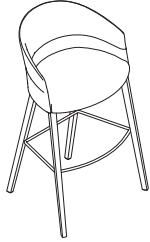
Needed fabric for material 1.53 yd wide:

**Non-contrasting:** Fabric 1.9 yd, Leather 1.96 yd

**Contrasting:** Fabric seat and front of back 1.3 yd, leather back 0.66 yd

# Chairs and Stools

## Copa



*Tip: Unless contrasting option is selected, only one upholstery finish is required. If contrasting option is selected, both a seat and back finish is required. The highest price group will be applied if multiple price groups are selected.*

*Tip: When contrasting backrest is selected, outer back is upholstered in leather.*

### Standard Includes

- Base: wood stained solid oak
- Upholstery: fabric price group 01
- Footrest: powder coated paint in black
- Glides: plastic

### Options

Contrasting Option	Non Contrasting	No cost
	Contrasting Backrest	+\$244
Seat Back Finish	Fabric Price Grade 1	No cost
	Customer's Own Leather	Prices below
	Fabric Customer's Own Material	Prices below
	Fabric Price Grade 2	Prices below
	Fabric Price Grade 3	Prices below
	Fabric Price Grade 4	Prices below
Glides	Fabric Price Grade 5	Prices below
	Plastic	No cost
	Felt	+\$10

### Specification Information



Dimensions			Style	Base Prices						
D	W	H	Number	Upholstery Grades:						
				1	2	3	4	5/Leather	COM/COL	

### Copa Fixed Wooden Legs Bar Stool with Smooth Upholstery

19 3/10" 22 4/5" 38 1/5" **VCBCOT4MABAR** \$1845 \$1914 \$2051 \$2215 \$2366 \$1845

Needed fabric for material 1.53 yd wide:

**Non-contrasting:** Fabric 1.9 yd, Leather 1.96 yd

**Contrasting:** Fabric seat and front of back 1.3 yd, leather back 0.66 yd



### Copa Fixed Wooden Legs Bar Stool with Soft Upholstery

19 3/10" 22 4/5" 38 1/5" **VCBCOT4MABAR** \$2001 \$2076 \$2240 \$2407 \$2560 \$2001

Needed fabric for material 1.53 yd wide:

**Non-contrasting:** Fabric 1.9 yd, Leather 1.96 yd

**Contrasting:** Fabric seat and front of back 1.3 yd, leather back 0.66 yd

# Chairs and Stools

## Ears



*Tip: Chairs are not stackable with arms.*

*Tip: Stackable up to ten chairs.*

*Tip: Side table is available on four leg metal base chairs only. Table is stained black.*

### Standard Includes

- Base: powder coated paint in black or white
- Seat and backrest: stained oak plywood
- Glides: plastic

### Options

Arms	No Arms	No cost
	With Metal Arms	+\$205
	With Metal and Wood Arms	+\$437
Glides	Plastic	No cost
	Felt	+\$10
Table	No Table	No cost
	With Table Left Side Facing	+\$232
	With Table Right Side Facing	+\$232

### Specification Information

Dimensions			Style	Base
D	W	H	Number	Price (each)

### Ears Four Leg Metal Base Chair

19 9/10"	19 1/2"	31 3/10"	<b>VCBEA4PRO</b>	\$711
----------	---------	----------	------------------	-------

# Chairs and Stools

## Ears



*Tip: Chairs are not stackable with arms.*

*Tip: Stackable up to ten chairs.*

*Tip: Side table is available on four leg metal base chairs only. Table is stained black.*

### Standard Includes

- Base: powder coated paint in black or white
- Backrest: stained oak plywood
- Seat cushion: fabric price group 01
- Glides: plastic

### Options

Arms	No Arms	No cost
	With Metal Arms	+\$218
	With Metal and Wood Arms	+\$458
Table	No Table	No cost
	With Table Left Side Facing	+\$232
	With Table Right Side Facing	+\$232
Glides	Plastic	No cost
	Felt	+\$10

### Specification Information

Dimensions				Style	Base Prices					
					Upholstery Grades:					
D	W	H	Number	1	2	3	4	5/Leather	COM/COL	
<b>Ears Four Leg Metal Base Chair with Cushion</b>										
19 9/10"	19 1/2"	31 3/10"	<b>VCBEA4PROC</b>	\$970	\$1012	\$1052	\$1107	\$1189	\$970	

Needed fabric for material 1.53 yd wide:

Cushion: 0.77 yd



# Chairs and Stools

Ears



*Tip: Side table is available on four leg metal base chairs only. Table is stained black.*

*Tip: Chairs are not stackable with arms.*

*Tip: Stackable up to four chairs.*

## Standard Includes

- Base: powder coated paint in black or white
- Upholstery: fabric price group 01
- Glides: plastic

## Options

Arms	No Arms	No cost
	With Metal Arms	+\$218
	With Metal and Wood Arms	+\$458
Table	No Table	No cost
	With Table Left Side Facing	+\$232
	With Table Right Side Facing	+\$232
Glides	Plastic	No cost
	Felt	+\$10

## Specification Information

Dimensions	Base Prices								
	W	H	Style Number	Upholstery Grades:					COM/COL
D				1	2	3	4	5/Leather	
<b>Ears Four Leg Metal Base Chair with Smooth Upholstery</b>									
19 9/10"	19 1/2"	31 1/2"	<b>VCBEA4PT</b>	\$1080	\$1189	\$1341	\$1477	\$1599	\$1080

Needed fabric for material 1.53 yd wide:

**Smooth Upholstery:** 1.37 yd

Chairs and Stools

# Chairs and Stools

## Ears



Tip: Wood base four leg chairs are not stackable.

### Standard Includes

- Base: stained oak plywood
- Seat and backrest: stained oak plywood
- Glides: plastic

### Options

Arms		
No Arms		No cost
With Metal Arms		+\$218
With Metal and Wood Arms		+\$458

### Specification Information

Dimensions			Style	Base
D	W	H	Number	Price

### Ears Four Leg Wooden Base Chair

20 1/10"	20 3/10"	31 3/10"	<b>VCBEA4PMRO</b>	\$984
----------	----------	----------	-------------------	-------

# Chairs and Stools

Ears



Tip: Chairs are not stackable with arms.

## Standard Includes

- Base: stained oak plywood
- Backrest: stained oak plywood
- Seat cushion: fabric price group 01
- Glides: plastic

## Options

Arms	No Arms	No cost
	With Metal Arms	+\$218
	With Metal and Wood Arms	+\$458

## Specification Information

Dimensions			Style Number	Base Prices					
D	W	H		Upholstery Grades:					
				1	2	3	4	5/Leather	COM/COL

### Ears Four Leg Wooden Base Chair with Cushion

20 1/10"	20 3/10"	31 3/10"	<b>VCBEA4PMROC</b>	\$1285	\$1325	\$1367	\$1422	\$1491	\$1285
----------	----------	----------	--------------------	--------	--------	--------	--------	--------	--------

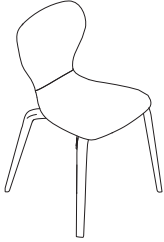
Needed fabric for material 1.53 yd wide:

Cushion: 0.77 yd

Chairs and Stools

# Chairs and Stools

## Ears



*Tip: Chairs are not stackable with arms.*

### Standard Includes

- Base: stained oak plywood
- Upholstery: fabric price group 01
- Glides: plastic

### Options

Arms	No Arms	No cost
	With Metal Arms	+\$218
	With Metal and Wood Arms	+\$458

### Specification Information

Dimensions			Style	Base Prices					
D	W	H	Number	Upholstery Grades:					
				1	2	3	4	5/Leather	COM/COL

### Ears Four Leg Wooden Base Chair with Smooth Upholstery

20 1/10"	20 3/10"	31 1/2"	<b>VCBEA4PMT</b>	\$1517	\$1586	\$1722	\$1832	\$1955	\$1517
----------	----------	---------	------------------	--------	--------	--------	--------	--------	--------

Needed fabric for material 1.53 yd wide:

**Smooth Upholstery:** 1.37 yd

# Chairs and Stools

## Ears



Tip: Stools are not stackable.

### Standard Includes

- Base: powder coated paint in black or white
- Seat and backrest: stained oak plywood
- Glides: plastic

### Options

Arms	No Arms	No cost
	With Metal Arms	+\$218
	With Metal and Wood Arms	+\$458
Glides	Plastic	No cost
	Felt	+\$10

### Specification Information

Dimensions			Style	Base
D	W	H	Number	Price

### Ears Fixed Bar Stool

20 9/10"	21 1/2"	42 1/2"	<b>VCBEATB4PRO</b>	\$916
----------	---------	---------	--------------------	-------

Chairs and Stools

# Chairs and Stools

## Ears



Tip: Stools are not stackable.

### Standard Includes

- Base: powder coated paint in black or white
- Backrest: stained oak plywood
- Seat cushion: fabric price group 01
- Glides: plastic

### Options

Arms	No Arms	No cost
	With Metal Arms	+\$218
	With Metal and Wood Arms	+\$458
Glides	Plastic	No cost
	Felt	+\$10

### Specification Information

Dimensions			Style Number	Base Prices						
D	W	H		Upholstery Grades:						
				1	2	3	4	5/Leather	COM/COL	

### Ears Fixed Bar Stool with Cushion

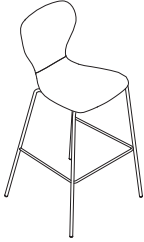
20 9/10"	21 1/2"	42 1/2"	<b>VCBEATB4PROC</b>	\$1218	\$1244	\$1285	\$1354	\$1408	\$1218
----------	---------	---------	---------------------	--------	--------	--------	--------	--------	--------

Needed fabric for material 1.53 yd wide:

**Cushion:** 0.77 yd

# Chairs and Stools

## Ears



Tip: Stools are not stackable.

### Standard Includes

- Base: powder coated paint in black or white
- Upholstery: fabric price group 01
- Glides: plastic

### Options

Arms	No Arms	No cost
	With Metal Arms	+\$218
	With Metal and Wood Arms	+\$458
Glides	Plastic	No cost
	Felt	+\$10

### Specification Information

Dimensions			Style Number	Base Prices					
D	W	H		Upholstery Grades:					
				1	2	3	4	5/Leather	COM/COL

#### Ears Fixed Bar Stool with Smooth Upholstery

20 9/10"	21 1/2"	42 1/2"	<b>VCBEATB4PT</b>	\$1258	\$1354	\$1491	\$1655	\$1791	\$1258
----------	---------	---------	-------------------	--------	--------	--------	--------	--------	--------

Needed fabric for material 1.53 yd wide:

**Smooth Upholstery:** 1.37 yd

Chairs and Stools

# Chairs and Stools

## Ears



Tip: Stools are not stackable.

### Standard Includes

- Base: powder coated paint in black or white
- Seat and backrest: stained oak plywood
- Glides: plastic

### Options

Arms	No Arms	No cost
	With Metal Arms	+\$218
	With Metal and Wood Arms	+\$458
Glides	Plastic	No cost
	Felt	+\$10

### Specification Information

Dimensions			Style	Base
D	W	H	Number	Price

### Ears Fixed Counter Stool

19 9/10"	20 1/2"	38 3/5"	<b>VCBEATC4PRO</b>	\$916
----------	---------	---------	--------------------	-------



# Chairs and Stools

Ears



Tip: Stools are not stackable.

## Standard Includes

- Base: powder coated paint in black or white
- Backrest: stained oak plywood
- Seat cushion: fabric price group 01
- Glides: plastic

## Options

Arms	No Arms	No cost
	With Metal Arms	+\$218
	With Metal and Wood Arms	+\$458
Glides	Plastic	No cost
	Felt	+\$10

## Specification Information

Dimensions			Style Number	Base Prices						
D	W	H		Upholstery Grades:						
				1	2	3	4	5/Leather	COM/COL	

### Ears Fixed Counter Stool with Cushion

19 9/10" 20 1/2" 38 3/5" **VCBEATC4PROC** \$1218 \$1244 \$1285 \$1354 \$1408 \$1218

Needed fabric for material 1.53 yd wide:

Cushion: 0.77 yd

Chairs and Stools

# Chairs and Stools

## Ears



Tip: Stools are not stackable.

### Standard Includes

- Base: powder coated paint in black or white
- Upholstery: fabric price group 01
- Glides: plastic

### Options

Arms	No Arms	No cost
	With Metal Arms	+\$218
	With Metal and Wood Arms	+\$458
Glides	Plastic	No cost
	Felt	+\$10

### Specification Information

Dimensions			Style	Base Prices					
D	W	H	Number	Upholstery Grades:					
				1	2	3	4	5/Leather	COM/COL

### Ears Fixed Counter Stool with Smooth Upholstery

19 9/10"	20 1/2"	38 3/5"	<b>VCBEATC4PT</b>	\$1258	\$1354	\$1491	\$1655	\$1791	\$1258
----------	---------	---------	-------------------	--------	--------	--------	--------	--------	--------

Needed fabric for material 1.53 yd wide:

Smooth Upholstery: 1.37 yd

# Chairs and Stools

## Funda



### Standard Includes

- Base: powder coated paint in black or white
- Upholstery: fabric price group 01
- Glides: plastic

### Specification Information

Dimensions			Style	Prices						
D	W	H	Number	Upholstery Grades:						
				1	2	3	4	5/Leather	COM/COL	

### Funda Chair

22"	23 4/5"	30 7/10"	<b>VCBFUS</b>	\$1422	\$1573	\$1778	\$1983	\$2215	\$1422
-----	---------	----------	---------------	--------	--------	--------	--------	--------	--------

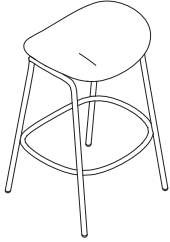
Needed fabric for material 1.64 yd wide:

**Upholstery:** 1.90 yd

Chairs and Stools

# Chairs and Stools

## Funda



### Standard Includes

- Base: powder coated paint in black or white
- Upholstery: fabric price group 01
- Glides: plastic

### Specification Information

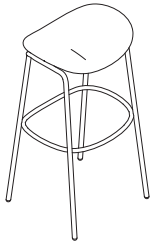
Dimensions			Style	Prices						
D	W	H	Number	Upholstery Grades:						
				1	2	3	4	5/Leather	COM/COL	

### Funda Fixed Counter Stool

14 2/5"	15 3/5"	28 3/10"	<b>VCBFUTC</b>	\$998	\$1052	\$1121	\$1162	\$1189	\$998
---------	---------	----------	----------------	-------	--------	--------	--------	--------	-------

Needed fabric for material 1.53 yd wide:

**Upholstery:** 0.77 yd



### Standard Includes

- Base: powder coated paint in black or white
- Upholstery: fabric price group 01
- Glides: plastic

### Specification Information

Dimensions			Style	Prices						
D	W	H	Number	Upholstery Grades:						
				1	2	3	4	5/Leather	COM/COL	

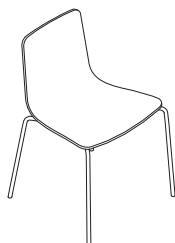
### Funda Fixed Bar Stool

15 1/5"	15 7/10"	32 3/10"	<b>VCBFUTB</b>	\$998	\$1052	\$1121	\$1162	\$1189	\$998
---------	----------	----------	----------------	-------	--------	--------	--------	--------	-------

Needed fabric for material 1.53 yd wide:

**Upholstery:** 0.77 yd

# Chairs and Stools

**Klip**


Tip: Stackable up to ten chairs.

Tip: Side table is available on four leg metal base chairs only. Table is stained black.

## Standard Includes

- Base: powder coated paint in black, white, or taupe
- Seat and backrest: stained oak plywood
- Glides: plastic

## Options

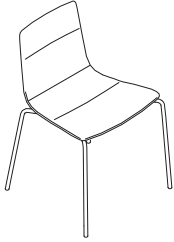
Arms	No Arms	No cost
	Metal Armrest	+\$205
	Upholstered Armrest	+\$328
Handle	No Handle Pull	No cost
	With Handle Pull	No cost
Glides	Plastic	No cost
	Felt	+\$10
Table	No Table	No cost
	With Table Left Side Facing	+\$232
	With Table Right Side Facing	+\$232

## Specification Information

Dimensions			Style	Seat and Backrest	Base Prices (each)
D	W	H	Number	Finish	
<b>Klip Four Metal Legs Base</b>					
20 1/2"	20 7/10"	31 1/2"	<b>VCBKL4PN</b>	Matte oak, cognac, ash, bleached oak, or walnut oak	\$533
				White or black	\$589
				Taupe, brick, ochre, olive green, dusty pink, or dusty green	\$629
				Bronze	\$670

# Chairs and Stools

## Klip



Tip: Chair with soft-lined upholstery shown.

Tip: Stackable up to four chairs.

Tip: Side table is available on four leg metal base chairs only. Table is stained black.

### Standard Includes

- Base: powder coated paint in black, white, or taupe
- Upholstery: fabric price group 01
- Glides: plastic

### Options

Arms	No Arms	No cost
	Metal Armrest	+\$205
	Upholstered Armrest	+\$328
Table	No Table	No cost
	With Table Left Side Facing	+\$232
	With Table Right Side Facing	+\$232
Glides	Plastic	No cost
	Felt	+\$10

### Specification Information

Dimensions			Style Number	Base Prices					
D	W	H		Upholstery Grades:					
				1	2	3	4	5/Leather	COM/COL

#### Klip Four Metal Legs Base Chair with Smooth Upholstery

20 7/10"	20 7/10"	31 7/10"	<b>VCBKL4PW</b>	\$739	\$807	\$888	\$970	\$1067	\$739
----------	----------	----------	-----------------	-------	-------	-------	-------	--------	-------

#### Klip Four Metal Legs Base Chair with Soft/Lined Upholstery

20 7/10"	20 7/10"	31 7/10"	<b>VCBKL4PW</b>	\$821	\$903	\$970	\$1067	\$1162	\$821
----------	----------	----------	-----------------	-------	-------	-------	--------	--------	-------

Needed fabric for material 1.53 yd wide:

Smooth/Soft/Lined Upholstery: 1.1 yd

# Chairs and Stools

**Klip**



Tip: Stackable up to four chairs.

Tip: Side table is available on four leg metal base chairs only. Table is stained black.

## Standard Includes

- Base: powder coated paint in black, white, or taupe
- Seat and backrest: stained oak plywood
- Seat cushion: fabric price group 01
- Glides: plastic

## Options

Arms	No Arms	No cost
	Metal Armrest	+\$205
	Upholstered Armrest	+\$328
Handle	No Handle Pull	No cost
	With Handle Pull	No cost
Glides	Plastic	No cost
	Felt	+\$10
Table	No Table	No cost
	With Table Left Side Facing	+\$232
	With Table Right Side Facing	+\$232

Chairs and Stools

## Specification Information

Dimensions			Style Number	Seat and Backrest Finish	Base Prices					
D	W	H			Upholstery Grades:					
					1	2	3	4	5/Leather	COM/COL
<b>Klip Four Metal Legs Base Cushion Chair</b>										
20 1/2"	20 7/10"	31 1/2"	<b>VCBKL4PC</b>	Matte oak, cognac, ash, bleached oak, or walnut oak	\$875	\$957	\$1052	\$1136	\$1244	\$875
				White or black	\$930	\$1026	\$1107	\$1218	\$1299	\$930
				Taupe, brick, ochre, olive green, dusty pink, or dusty green	\$970	\$1067	\$1162	\$1258	\$1354	\$970
				Bronze	\$1026	\$1107	\$1218	\$1299	\$1394	\$1026

Needed fabric for material 1.53 yd wide:

**Cushion:** 0.77 yd

# Chairs and Stools

## Klip



### Standard Includes

- Base: powder coated paint in black, white, or taupe
- Seat and backrest: stained oak plywood
- Glides: plastic

### Options

Arms	No Arms	No cost
	Metal Armrest	+\$205
	Upholstered Armrest	+\$328
Handle	No Handle Pull	No cost
	With Handle Pull	No cost
Glides	Plastic	No cost
	Felt	+\$10

### Specification Information

Dimensions			Style	Seat and Backrest	Base Prices
D	W	H	Number	Finish	

#### Klip Swivel Chair

19 3/10"	19 3/10"	31 1/2"	<b>VCBKLGN</b>	Matte oak, cognac, ash, bleached oak, or walnut oak	\$725
				White or black	\$765
				Taupe, brick, ochre, olive green, dusty pink, or dusty green	\$807
				Bronze	\$847



# Chairs and Stools

## Klip



Tip: Chair with soft/lined upholstery shown.

### Standard Includes

- Base: powder coated paint in black, white, or taupe
- Upholstery: fabric price group 01
- Glides: plastic

### Options

Arms	No Arms	No cost
	Metal Armrest	+\$205
	Upholstered Armrest	+\$328
Glides	Plastic	No cost
	Felt	+\$10

### Specification Information

Dimensions			Style Number	Base Prices					
D	W	H		Upholstery Grades:					
				1	2	3	4	5/Leather	COM/COL

#### Klip Swivel Chair with Smooth Upholstery

19 1/2"	19 9/10"	31 7/10"	<b>VCBKLGW</b>	\$930	\$1012	\$1080	\$1189	\$1272	\$930
---------	----------	----------	----------------	-------	--------	--------	--------	--------	-------

#### Klip Swivel Chair with Soft/Lined Upholstery

19 1/2"	19 9/10"	31 7/10"	<b>VCBKLGW</b>	\$1026	\$1094	\$1189	\$1272	\$1367	\$1026
---------	----------	----------	----------------	--------	--------	--------	--------	--------	--------

Needed fabric for material 1.53 yd wide:

**Smooth/Soft/Lined Upholstery:** 1.1 yd

Chairs and Stools

# Chairs and Stools

## Klip



### Standard Includes

- Base: powder coated paint in black, white, or taupe
- Seat and backrest: stained oak plywood
- Seat cushion: fabric price group 01
- Glides: plastic

### Options

Arms	No Arms	No cost
	Metal Armrest	+\$205
	Upholstered Armrest	+\$328
Handle	No Handle Pull	No cost
	With Handle Pull	No cost
Glides	Plastic	No cost
	Felt	+\$10

### Specification Information

Dimensions			Style Number	Seat and Backrest Finish	Base Prices					
D	W	H			Upholstery Grades:					
				1	2	3	4	5/Leather	COM/COL	
<b>Klip Swivel Cushion Chair</b>										
19 3/10"	19 3/10"	31 1/2"	<b>VCBKLG</b>	Matte oak, cognac, ash, bleached oak, or walnut oak	\$1067	\$1162	\$1258	\$1354	\$1436	\$1067
				White or black	\$1107	\$1218	\$1299	\$1394	\$1491	\$1107
				Taupe, brick, ochre, olive green, dusty pink, or dusty green	\$1162	\$1258	\$1354	\$1436	\$1530	\$1162
				Bronze	\$1218	\$1299	\$1394	\$1491	\$1573	\$1218

Needed fabric for material 1.53 yd wide:

**Cushion:** 0.77 yd

# Chairs and Stools

**Klip**



### Standard Includes

- Aluminum swivel base: powder coated paint in black or white
- Seat and backrest: stained oak plywood
- Glides: plastic

### Options

Arms	No Arms	No cost
	Metal Armrest	+\$205
	Upholstered Armrest	+\$328
Handle	No Handle Pull	No cost
	With Handle Pull	No cost
Glides	Plastic	No cost
	Felt	+\$10

### Specification Information

Dimensions			Style	Seat and Backrest	Base Prices
D	W	H	Number	Finish	
<b>Klip Pyramid Swivel Chair</b>					
19 3/10"	19 3/10"	31 3/10"	<b>VCBKLPIN</b>	Matte oak, cognac, ash, bleached oak, or walnut oak	\$807
				White or black	\$847
				Taupe, brick, ochre, olive green, dusty pink, or dusty green	\$888
				Bronze	\$930

Chairs and Stools

# Chairs and Stools

## Klip



Tip: Chair with soft/lined upholstery shown.

### Standard Includes

- Aluminum swivel base: powder coated paint in black or white
- Upholstery: fabric price group 01
- Glides: plastic

### Options

Arms	No Arms	No cost
	Metal Armrest	+\$205
	Upholstered Armrest	+\$328
Glides	Plastic	No cost
	Felt	+\$10

### Specification Information

Dimensions			Style Number	Base Prices					
D	W	H		Upholstery Grades:					
				1	2	3	4	5/Leather	COM/COL

#### Klip Pyramid Swivel Chair with Smooth Upholstery

19 1/2"	19 9/10"	31 1/2"	<b>VCBKLPW</b>	\$1026	\$1094	\$1189	\$1272	\$1367	\$1026
---------	----------	---------	----------------	--------	--------	--------	--------	--------	--------

#### Klip Pyramid Swivel Chair with Soft/Lined Upholstery

19 1/2"	19 9/10"	31 1/2"	<b>VCBKLPW</b>	\$1107	\$1203	\$1272	\$1367	\$1449	\$1107
---------	----------	---------	----------------	--------	--------	--------	--------	--------	--------

Needed fabric for material 1.53 yd wide:

Smooth/Soft/Lined Upholstery: 1.1 yd

# Chairs and Stools

**Klip**



### Standard Includes

- Aluminum swivel base: powder coated paint in black or white
- Seat and backrest: stained oak plywood
- Seat cushion: fabric price group 01
- Glides: plastic

### Options

Arms	No Arms	No cost
	Metal Armrest	+\$205
	Upholstered Armrest	+\$328
Handle	No Handle Pull	No cost
	With Handle Pull	No cost
Glides	Plastic	No cost
	Felt	+\$10

### Specification Information

Dimensions			Style Number	Seat and Backrest Finish	Base Prices					
D	W	H			Upholstery Grades:					
					1	2	3	4	5/Leather	COM/COL
<b>Klip Pyramid Swivel Cushion Chair</b>										
19 3/10"	19 9/10"	31 3/10"	<b>VCBKLPIC</b>	Matte oak, cognac, ash, bleached oak, or walnut oak	\$1162	\$1258	\$1354	\$1436	\$1530	\$1162
				White or black	\$1218	\$1299	\$1394	\$1491	\$1573	\$1218
				Taupe, brick, ochre, olive green, dusty pink, or dusty green	\$1258	\$1354	\$1436	\$1530	\$1627	\$1258
				Bronze	\$1299	\$1394	\$1491	\$1573	\$1682	\$1299

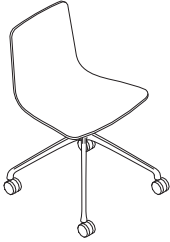
Needed fabric for material 1.53 yd wide:

**Cushion:** 0.77 yd

Chairs and Stools

# Chairs and Stools

## Klip



### Standard Includes

- Aluminum swivel base: powder coated paint in black or white
- Seat and backrest: stained oak plywood
- Soft casters for hard floors

### Options

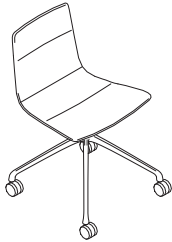
Arms	No Arms	No cost
	Metal Armrest	+\$205
	Upholstered Armrest	+\$328
Handle	No Handle Pull	No cost
	With Handle Pull	No cost

### Specification Information

Dimensions			Style	Seat and Backrest	Base Prices
D	W	H	Number	Finish	
<b>Klip Pyramid Swivel Chair with Casters</b>					
19 9/10"	19 9/10"	31 7/10"	<b>VCBKLP1RUR</b>	Matte oak, cognac, ash, bleached oak, or walnut oak	\$847
				White or black	\$888
				Taupe, brick, ochre, olive green, dusty pink, or dusty green	\$930
				Bronze	\$970

# Chairs and Stools

**Klip**



Tip: Chair with soft/lined upholstery shown.

### Standard Includes

- Aluminum swivel base: powder coated paint in black or white
- Upholstery: fabric price group 01
- Soft casters for hard floors

### Options

Arms	No Arms	No cost
	Metal Armrest	+\$205
	Upholstered Armrest	+\$328

### Specification Information

Dimensions			Style Number	Base Prices					
D	W	H		Upholstery Grades:					
				1	2	3	4	5/Leather	COM/COL

#### Klip Pyramid Swivel Cushion Chair with Casters and Smooth Upholstery

19 9/10"	19 9/10"	31 9/10"	<b>VCBKLP1RUW</b>	\$1067	\$1136	\$1231	\$1325	\$1408	\$1067
----------	----------	----------	-------------------	--------	--------	--------	--------	--------	--------

#### Klip Pyramid Swivel Cushion Chair with Casters and Soft/Lined Upholstery

19 9/10"	19 9/10"	31 9/10"	<b>VCBKLP1RUW</b>	\$1162	\$1244	\$1325	\$1408	\$1504	\$1162
----------	----------	----------	-------------------	--------	--------	--------	--------	--------	--------

Needed fabric for material 1.53 yd wide:

Smooth/Soft/Lined Upholstery: 1.1 yd

# Chairs and Stools

## Klip



### Standard Includes

- Aluminum swivel base: powder coated paint in black or white
- Seat and backrest: stained oak plywood
- Seat cushion: fabric price group 01
- Soft casters for hard floors

### Options

Arms	No Arms	No cost
	Metal Armrest	+\$205
	Upholstered Armrest	+\$328
Handle	No Handle Pull	No cost
	With Handle Pull	No cost

### Specification Information

Dimensions			Style Number	Seat and Backrest Finish	Base Prices					
D	W	H			Upholstery Grades:					
				1	2	3	4	5/Leather	COM/COL	
<b>Klip Pyramid Swivel Cushion Chair with Casters</b>										
19 9/10"	19 9/10"	31 7/10"	<b>VCBKLP1RUC</b>	Matte oak, cognac, ash, bleached oak, or walnut oak	\$1218	\$1299	\$1394	\$1491	\$1573	\$1218
				White or black	\$1258	\$1354	\$1436	\$1530	\$1627	\$1258
				Taupe, brick, ochre, olive green, dusty pink, or dusty green	\$1299	\$1394	\$1491	\$1573	\$1682	\$1299
				Bronze	\$1354	\$1436	\$1530	\$1627	\$1722	\$1354

Needed fabric for material 1.53 yd wide:

**Cushion:** 0.77 yd



# Chairs and Stools

## Klip



### Standard Includes

- Aluminum swivel base: powder coated in high gloss black or white
- Seat and backrest: stained oak plywood
- Soft casters for hard floors

### Options

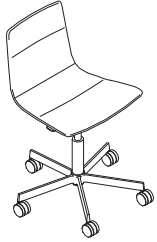
Arms	No Arms	No cost
	Metal Armrest	+\$205
	Upholstered Armrest	+\$328
Handle	No Handle Pull	No cost
	With Handle Pull	No cost

### Specification Information

Dimensions			Style	Seat and Backrest	Base Prices
D	W	H	Number	Finish	
<b>Klip Chair with Casters</b>					
22 2/5"	23 2/5"	28 7/10" - 34 1/10"	<b>VCBKLRN</b>	Matte oak, cognac, ash, bleached oak, or walnut oak	\$847
				White or black	\$888
				Taupe, brick, ochre, olive green, dusty pink, or dusty green	\$930
				Bronze	\$970

# Chairs and Stools

## Klip



Tip: Chair with soft/lined upholstery shown.

### Standard Includes

- Aluminum swivel base: powder coated in high gloss black or white
- Aluminum height adjustment system: black or white
- Upholstery: fabric price group 01
- Soft casters for hard floors

### Options

Arms	No Arms	No cost
	Metal Armrest	+\$205
	Upholstered Armrest	+\$328

### Specification Information

Dimensions			Style Number	Base Prices					
D	W	H		Upholstery Grades:					
				1	2	3	4	5/Leather	COM/COL

#### Klip Chair with Casters and Smooth Upholstery

22 2/5"	23 2/5"	28 9/10" - 34 3/10"	<b>VCBKLBRW</b>	\$1067	\$1136	\$1231	\$1325	\$1408	\$1067
---------	---------	---------------------	-----------------	--------	--------	--------	--------	--------	--------

#### Klip Chair with Casters and Soft/Lined Upholstery

22 2/5"	23 2/5"	28 9/10" - 34 3/10"	<b>VCBKLBRW</b>	\$1162	\$1244	\$1325	\$1408	\$1504	\$1162
---------	---------	---------------------	-----------------	--------	--------	--------	--------	--------	--------

Needed fabric for material 1.53 yd wide:

Smooth/Soft/Lined Upholstery: 1.1 yd

# Chairs and Stools

**Klip**



## Standard Includes

- Aluminum swivel base: powder coated in high gloss black or white
- Aluminum height adjustment system: black or white
- Seat and backrest: stained oak plywood
- Seat cushion: fabric price group 01
- Soft casters for hard floors

## Options

Arms	No Arms	No cost
	Metal Armrest	+\$205
	Upholstered Armrest	+\$328
Handle	No Handle Pull	No cost
	With Handle Pull	No cost

## Specification Information

Dimensions			Style Number	Seat and Backrest Finish	Base Prices					
D	W	H			Upholstery Grades:					
					1	2	3	4	5/Leather	COM/COL
<b>Klip Cushion Chair with Casters</b>										
22 2/5"	23 2/5"	28 7/10" - 34 1/10"	<b>VCBKLBR</b>	Matte oak, cognac, ash, bleached oak, or walnut oak	\$1218	\$1299	\$1394	\$1491	\$1573	\$1218
White or black					\$1258	\$1354	\$1436	\$1530	\$1627	\$1258
Taupe, brick, ochre, olive green, dusty pink, or dusty green					\$1299	\$1394	\$1491	\$1573	\$1682	\$1299
Bronze					\$1354	\$1436	\$1530	\$1627	\$1722	\$1354

Needed fabric for material 1.53 yd wide:

**Cushion:** 0.77 yd

Chairs and Stools

# Chairs and Stools

## Klip



### Standard Includes

- Aluminum swivel base: powder coated paint in black or white
- Seat and backrest: stained oak plywood
- Glides: plastic

### Options

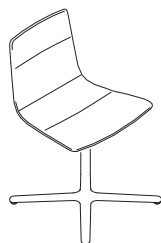
Arms	No Arms	No cost
	Metal Armrest	+\$205
	Upholstered Armrest	+\$328
Handle	No Handle Pull	No cost
	With Handle Pull	No cost
Glides	Plastic	No cost
	Felt	+\$10

### Specification Information

Dimensions			Style	Seat and Backrest	Base Prices
D	W	H	Number	Finish	
<b>Klip Flat Swivel Chair</b>					
18 9/10"	19 3/10"	31 1/2"	<b>VCBKLPAN</b>	Matte oak, cognac, ash, bleached oak, or walnut oak	\$903
				White or black	\$944
				Taupe, brick, ochre, olive green, dusty pink, or dusty green	\$984
				Bronze	\$1026

# Chairs and Stools

**Klip**



Tip: Chair with soft/lined upholstery shown.

## Standard Includes

- Aluminum swivel base: powder coated paint in black or white
- Upholstery: fabric price group 01
- Glides: plastic

## Options

Arms	No Arms	No cost
	Metal Armrest	+\$205
	Upholstered Armrest	+\$328
Glides	Plastic	No cost
	Felt	+\$10

## Specification Information

Dimensions			Style Number	Base Prices					
D	W	H		Upholstery Grades:					
				1	2	3	4	5/Leather	COM/COL

<b>Klip Flat Swivel Chair with Smooth Upholstery</b>									
19 1/10"	19 9/10"	31 7/10"	<b>VCBKLP</b>	\$1121	\$1218	\$1285	\$1381	\$1477	\$1121

<b>Klip Flat Swivel Chair with Soft/Lined Upholstery</b>									
19 1/10"	19 9/10"	31 7/10"	<b>VCBKLP</b>	\$1231	\$1299	\$1381	\$1477	\$1559	\$1231

Needed fabric for material 1.53 yd wide:

**Smooth/Soft/Lined Upholstery:** 1.1 yd

Chairs and Stools

# Chairs and Stools

## Klip



### Standard Includes

- Aluminum swivel base: powder coated paint in black or white
- Seat and backrest: stained oak plywood
- Seat cushion: fabric price group 01
- Glides: plastic

### Options

Arms	No Arms	No cost
	Metal Armrest	+\$205
	Upholstered Armrest	+\$328
Handle	No Handle Pull	No cost
	With Handle Pull	No cost
Glides	Plastic	No cost
	Felt	+\$10

### Specification Information

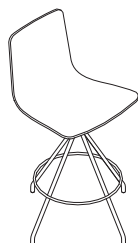
Dimensions				Style	Seat and Backrest	Base Prices					
						Upholstery Grades:					
D	W	H	Number	Finish	1	2	3	4	5/Leather	COM/COL	
<b>Klip Flat Swivel Cushion Chair</b>											
18 9/10"	19 3/10"	31 1/2"	<b>VCBKLPAC</b>	Matte oak, cognac, ash, bleached oak, or walnut oak	\$1272	\$1367	\$1449	\$1546	\$1655	\$1272	
				White or black	\$1325	\$1408	\$1504	\$1586	\$1696	\$1325	
				Taupe, brick, ochre, olive green, dusty pink, or dusty green	\$1367	\$1449	\$1546	\$1655	\$1736	\$1367	
				Bronze	\$1408	\$1504	\$1586	\$1696	\$1791	\$1408	

Needed fabric for material 1.53 yd wide:

**Cushion:** 0.77 yd

# Chairs and Stools

## Klip



### Standard Includes

- Base: powder coated paint in black, white, or taupe
- Seat and backrest: stained oak plywood
- Glides: plastic

### Options

Arms	No Arms	No cost
	Metal Armrest	+\$205
	Upholstered Armrest	+\$328
Handle	No Handle Pull	No cost
	With Handle Pull	No cost
Glides	Plastic	No cost
	Felt	+\$10

### Specification Information

Dimensions			Style	Seat and Backrest	Base Prices
D	W	H	Number	Finish	

### Klip Swivel Counter Stool

18 9/10"	19 3/10"	39 1/5"	<b>VCBKLT</b>	Matte oak, cognac, ash, bleached oak, or walnut oak	\$1026
				White or black	\$1080
				Taupe, brick, ochre, olive green, dusty pink, or dusty green	\$1121
				Bronze	\$1162

Chairs and Stools

# Chairs and Stools

## Klip



Tip: Chair with soft/lined upholstery shown.

### Standard Includes

- Base: powder coated paint in black, white, or taupe
- Upholstery: fabric price group 01
- Glides: plastic

### Options

Arms	No Arms	No cost
	Metal Armrest	+\$205
	Upholstered Armrest	+\$328
Glides	Plastic	No cost
	Felt	+\$10

### Specification Information

Dimensions			Style Number	Base Prices					
D	W	H		Upholstery Grades:					
				1	2	3	4	5/Leather	COM/COL

#### Klip Swivel Counter Stool with Smooth Upholstery

19 1/10"	19 9/10"	39 2/5"	<b>VCBKLTWC</b>	\$1121	\$1244	\$1367	\$1504	\$1668	\$1121
----------	----------	---------	-----------------	--------	--------	--------	--------	--------	--------

#### Klip Swivel Counter Stool with Soft/Lined Upholstery

19 1/10"	19 9/10"	39 2/5"	<b>VCBKLTWC</b>	\$1231	\$1341	\$1449	\$1586	\$1751	\$1231
----------	----------	---------	-----------------	--------	--------	--------	--------	--------	--------

Needed fabric for material 1.53 yd wide:

Smooth/Soft/Lined Upholstery: 1.1 yd



# Chairs and Stools

**Klip**



## Standard Includes

- Base: powder coated paint in black, white, or taupe
- Seat and backrest: stained oak plywood
- Seat cushion: fabric price group 01
- Glides: plastic

## Options

Arms	No Arms	No cost
	Metal Armrest	+\$205
	Upholstered Armrest	+\$328
Handle	No Handle Pull	No cost
	With Handle Pull	No cost
Glides	Plastic	No cost
	Felt	+\$10

## Specification Information

Dimensions			Style Number	Seat and Backrest Finish	Base Prices					
D	W	H			Upholstery Grades:					
				1	2	3	4	5/Leather	COM/COL	

### Klip Swivel Cushion Counter Stool

19 1/10"	19 9/10"	39 1/5"	<b>VCBKLTC</b>	Matte oak, cognac, ash, bleached oak, or walnut oak	\$1408	\$1504	\$1586	\$1696	\$1791	\$1408
				White or black	\$1477	\$1559	\$1668	\$1751	\$1845	\$1477
				Taupe, brick, ochre, olive green, dusty pink, or dusty green	\$1517	\$1599	\$1709	\$1804	\$1888	\$1517
				Bronze	\$1559	\$1668	\$1751	\$1845	\$1941	\$1559

Needed fabric for material 1.53 yd wide:

**Cushion:** 0.77 yd

Chairs and Stools

# Chairs and Stools

## Klip



### Standard Includes

- Base: powder coated paint in black, white, or taupe
- Seat and backrest: stained oak plywood
- Glides: plastic

### Options

Arms	No Arms	No cost
	Metal Armrest	+\$205
	Upholstered Armrest	+\$328
Handle	No Handle Pull	No cost
	With Handle Pull	No cost
Glides	Plastic	No cost
	Felt	+\$10

### Specification Information

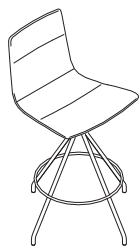
Dimensions			Style	Seat and Backrest	Base Prices
D	W	H	Number	Finish	

### Klip Swivel Bar Stool

18 9/10"	19 3/10"	43 1/10"	<b>VCBKLTBN</b>	Matte oak, cognac, ash, bleached oak, or walnut oak	\$1026
				White or black	\$1080
				Taupe, brick, ochre, olive green, dusty pink, or dusty green	\$1121
				Bronze	\$1162

# Chairs and Stools

## Klip



Tip: Chair with soft/lined upholstery shown.

### Standard Includes

- Base: powder coated paint in black, white, or taupe
- Upholstery: fabric price group 01
- Glides: plastic

### Options

Arms	No Arms	No cost
	Metal Armrest	+\$205
	Upholstered Armrest	+\$328
Glides	Plastic	No cost
	Felt	+\$10

### Specification Information

Dimensions			Style Number	Base Prices					
D	W	H		Upholstery Grades:					
				1	2	3	4	5/Leather	COM/COL

<b>Klip Swivel Bar Stool with Smooth Upholstery</b>									
19 1/10"	19 9/10"	43 3/10"	<b>VCBKLTBW</b>	\$1121	\$1244	\$1367	\$1504	\$1668	\$1121

<b>Klip Swivel Bar Stool with Soft/Lined Upholstery</b>									
19 1/10"	19 9/10"	43 3/10"	<b>VCBKLTBW</b>	\$1231	\$1341	\$1449	\$1586	\$1751	\$1231

Needed fabric for material 1.53 yd wide:

**Smooth/Soft/Lined Upholstery:** 1.1 yd

Chairs and Stools

# Chairs and Stools

## Klip



### Standard Includes

- Base: powder coated paint in black, white, or taupe
- Seat and backrest: stained oak plywood
- Seat cushion: fabric price group 01
- Glides: plastic

### Options

Arms	No Arms	No cost
	Metal Armrest	+\$205
	Upholstered Armrest	+\$328
Handle	No Handle Pull	No cost
	With Handle Pull	No cost
Glides	Plastic	No cost
	Felt	+\$10

### Specification Information

Dimensions			Style Number	Seat and Backrest Finish	Base Prices					
D	W	H			Upholstery Grades:					
				1	2	3	4	5/Leather	COM/COL	
<b>Klip Swivel Cushion Bar Stool</b>										
18 9/10"	19 3/10"	43 1/10"	<b>VCBKLTBC</b>	Matte oak, cognac, ash, bleached oak, or walnut oak	\$1408	\$1504	\$1586	\$1696	\$1791	\$1408
				White or black	\$1477	\$1559	\$1668	\$1751	\$1845	\$1477
				Taupe, brick, ochre, olive green, dusty pink, or dusty green	\$1517	\$1599	\$1709	\$1804	\$1888	\$1517
				Bronze	\$1559	\$1668	\$1751	\$1845	\$1941	\$1559

Needed fabric for material 1.53 yd wide:

**Cushion:** 0.77 yd

# Chairs and Stools

## Klip



### Standard Includes

- Base: powder coated paint in black, white, or taupe
- Seat and backrest: stained oak plywood
- Glides: plastic

### Options

Arms	No Arms	No cost
	Metal Armrest	+\$205
	Upholstered Armrest	+\$328
Handle	No Handle Pull	No cost
	With Handle Pull	No cost
Glides	Plastic	No cost
	Felt	+\$10

### Specification Information

Dimensions			Style	Seat and Backrest	Base Prices
D	W	H	Number	Finish	
<b>Klip Fixed Counter Stool</b>					
18 9/10"	19 3/10"	39 4/5"	<b>VCBKLTFCON</b>	Matte oak, cognac, ash, bleached oak, or walnut oak	\$752
				White or black	\$834
				Taupe, brick, ochre, olive green, dusty pink, or dusty green	\$875
				Bronze	\$903

# Chairs and Stools

## Klip



Tip: Stool with soft/lined upholstery shown.

### Standard Includes

- Base: powder coated paint in black or white
- Upholstery: fabric price group 01
- Glides: plastic

### Options

Arms	No Arms	No cost
	Metal Armrest	+\$205
	Upholstered Armrest	+\$328
Glides	Plastic	No cost
	Felt	+\$10

### Specification Information

Dimensions				Base Prices						
D	W	H	Style Number	Upholstery Grades:						
				1	2	3	4	5/Leather	COM/COL	

#### Klip Fixed Cushion Counter Stool with Smooth Upholstery

19 1/10"	19 3/10"	40"	<b>VCBKLTFCOW</b>	\$957	\$1026	\$1121	\$1244	\$1354	\$957
----------	----------	-----	-------------------	-------	--------	--------	--------	--------	-------

#### Klip Fixed Cushion Counter Stool with Soft/Lined Upholstery

19 1/10"	19 3/10"	40"	<b>VCBKLTFCOW</b>	\$1052	\$1107	\$1218	\$1341	\$1436	\$1052
----------	----------	-----	-------------------	--------	--------	--------	--------	--------	--------

Needed fabric for material 1.53 yd wide:

Smooth/Soft/Lined Upholstery: 1.1 yd

# Chairs and Stools

## Klip



### Standard Includes

- Base: powder coated paint in black or white
- Seat and backrest: stained oak plywood
- Seat cushion: fabric price group 01
- Glides: plastic

### Options

Arms	No Arms	No cost
	Metal Armrest	+\$205
	Upholstered Armrest	+\$328
Handle	No Handle Pull	No cost
	With Handle Pull	No cost
Glides	Plastic	No cost
	Felt	+\$10

### Specification Information

Dimensions			Style Number	Seat and Backrest Finish	Base Prices						
D	W	H			Upholstery Grades:						
				1	2	3	4	5/Leather	COM/COL		
<b>Klip Fixed Cushion Counter Stool</b>											
18 9/10"	19 3/10"	39 4/5"	<b>VCBKLTFCOC</b>	Matte oak, cognac, ash, bleached oak, or walnut oak	\$1408	\$1504	\$1586	\$1696	\$1791	\$1408	
				White or black	\$1477	\$1559	\$1668	\$1751	\$1845	\$1477	
				Taupe, brick, ochre, olive green, dusty pink, or dusty green	\$1517	\$1599	\$1709	\$1804	\$1888	\$1517	
				Bronze	\$1559	\$1668	\$1751	\$1845	\$1941	\$1559	

Needed fabric for material 1.53 yd wide:

**Cushion:** 0.77 yd

Chairs and Stools

# Chairs and Stools

## Klip



### Standard Includes

- Base: powder coated paint in black or white
- Seat and backrest: stained oak plywood
- Glides: plastic

### Options

Arms	No Arms	No cost
	Metal Armrest	+\$205
	Upholstered Armrest	+\$328
Handle	No Handle Pull	No cost
	With Handle Pull	No cost
Glides	Plastic	No cost
	Felt	+\$10

### Specification Information

Dimensions			Style	Seat and Backrest	Base Prices
D	W	H	Number	Finish	
<b>Klip Fixed Bar Stool</b>					
19 1/10"	19 9/10"	43 3/10"	<b>VCBKLTFBARN</b>	Matte oak, cognac, ash, bleached oak, or walnut oak	\$752
				White or black	\$834
				Taupe, brick, ochre, olive green, dusty pink, or dusty green	\$875
				Bronze	\$903



# Chairs and Stools

## Klip



Tip: Chair with soft/lined upholstery shown.

### Standard Includes

- Base: powder coated paint in black, white, or taupe
- Upholstery: fabric price group 01
- Glides: plastic

### Options

Arms	No Arms	No cost
	Metal Armrest	+\$205
	Upholstered Armrest	+\$328
Glides	Plastic	No cost
	Felt	+\$10

### Specification Information

Dimensions			Style Number	Base Prices					
D	W	H		Upholstery Grades:					
				1	2	3	4	5/Leather	COM/COL

#### Klip Fixed Bar Stool with Smooth Upholstery

19 1/10"	19 9/10"	43 1/2"	<b>VCBKLTFBARW</b>	\$957	\$1026	\$1121	\$1244	\$1354	\$957
----------	----------	---------	--------------------	-------	--------	--------	--------	--------	-------

#### Klip Fixed Bar Stool with Soft/Lined Upholstery

19 1/10"	19 9/10"	43 1/2"	<b>VCBKLTFBARW</b>	\$1052	\$1107	\$1218	\$1341	\$1436	\$1052
----------	----------	---------	--------------------	--------	--------	--------	--------	--------	--------

Needed fabric for material 1.53 yd wide:

Smooth/Soft/Lined Upholstery: 1.1 yd

Chairs and Stools

# Chairs and Stools

## Klip



### Standard Includes

- Base: powder coated paint in black or white
- Seat and backrest: stained oak plywood
- Seat cushion: fabric price group 01
- Glides: plastic

### Options

Arms	No Arms	No cost
	Metal Armrest	+\$205
	Upholstered Armrest	+\$328
Handle	No Handle Pull	No cost
	With Handle Pull	No cost
Glides	Plastic	No cost
	Felt	+\$10

### Specification Information

Dimensions			Style Number	Seat and Backrest Finish	Base Prices					
D	W	H			Upholstery Grades:					
				1	2	3	4	5/Leather	COM/COL	
<b>Klip Fixed Cushion Bar Stool</b>										
19 1/10"	19 9/10"	43 3/10"	<b>VCBKLTFBARC</b>	Matte oak, cognac, ash, bleached oak, or walnut oak	\$1408	\$1504	\$1586	\$1696	\$1791	\$1408
				White or black	\$1477	\$1559	\$1668	\$1751	\$1845	\$1477
				Taupe, brick, ochre, olive green, dusty pink, or dusty green	\$1517	\$1599	\$1709	\$1804	\$1888	\$1517
				Bronze	\$1559	\$1668	\$1751	\$1845	\$1941	\$1559

Needed fabric for material 1.53 yd wide:

**Cushion:** 0.77 yd

# Chairs and Stools

**Klip**

*Tip: Four leg metal chairs with upholstery are stackable up to four units.*

*Tip: Order a quantity of one for every chair.*

## Standard Includes

- Stacking protection pad

## Specification Information

Style

Number	Price
--------	-------

### Klip Pad

<b>VCBKLC0</b>	\$55
----------------	------

*Tip: Link is for use with four leg metal base chairs only.*

*Tip: One linking device connects two chairs to each other.*

## Standard Includes

- Linking device: black

## Specification Information

Style

Number	Price
--------	-------

### Klip Link

<b>VCBKLUN</b>	\$82
----------------	------

*Tip: Transport is a maximum of 10 chairs simultaneously for models of plywood oak stained or lacquered and four chairs for upholstered models.*

## Standard Includes

- Trolley: lacquered in black

## Specification Information

Style

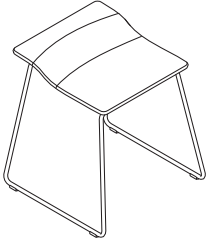
Number	Price
--------	-------

### Klip Trolley

<b>VCBKLCT</b>	\$984
----------------	-------

# Chairs and Stools

## Last Minute



Tip: If plastic seat is selected, color will match the base structure color selected.

### Standard Includes

- Base: powder coated paint in black or white
- Seat: molded plastic in black or white
- Upholstered seat cushion, if selected: fabric or leather
- Glides: plastic

### Options

Glides	Plastic	No cost
	Felt	+\$10

### Specification Information

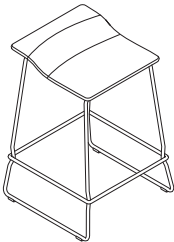
Dimensions			Style	Base Prices						
D	W	H	Number	Plastic Black/White	Upholstery Grades:					
					1	2	3	4	5/Leather	COM/COL

### Last Minute Stool - Low Height

17 1/10"	17 7/10"	19 3/10"	<b>VCBLMB</b>	\$615	\$862	\$888	\$930	\$984	\$1026	\$862
----------	----------	----------	---------------	-------	-------	-------	-------	-------	--------	-------

Needed fabric for material 1.53 yd wide:

**Upholstery:** 0.82 yd



Tip: If plastic seat is selected, color will match the base structure color selected.

### Standard Includes

- Base: powder coated paint in black or white
- Seat: molded plastic in black or white
- Upholstered seat cushion, if selected: fabric or leather
- Footrest: stainless steel
- Glides: plastic

### Options

Glides	Plastic	No cost
	Felt	+\$10

### Specification Information

Dimensions			Style	Base Prices							
D	W	H	Number	Plastic Black/White	Taupe	Upholstery Grades:					
						1	2	3	4	5/Leather	COM/COL

### Last Minute Stool - Medium Height

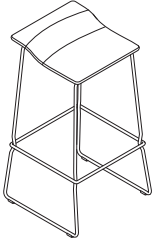
17 1/10"	17 7/10"	25 2/5"	<b>VCBLMM</b>	\$739	\$847	\$984	\$998	\$1039	\$1094	\$1136	\$984
----------	----------	---------	---------------	-------	-------	-------	-------	--------	--------	--------	-------

Needed fabric for material 1.53 yd wide:

**Upholstery:** 0.82 yd

# Chairs and Stools

## Last Minute



Tip: If plastic seat is selected, color will match the base structure color selected.

### Standard Includes

- Base: powder coated paint in black or white
- Seat: molded plastic in black or white
- Upholstered seat cushion, if selected: fabric or leather
- Footrest: stainless steel
- Glides: plastic

### Options

Glides	Plastic	No cost
	Felt	+\$10

### Specification Information

Dimensions			Style Number	Base Prices						
D	W	H		Plastic Black/White	Upholstery Grades:				5/Leather	COM/COL
				Taupe	1	2	3	4		

#### Last Minute Stool - High Height

17 1/10"	17 7/10"	31 3/10"	<b>VCBLMA</b>	\$779	\$862	\$1026	\$1052	\$1107	\$1136	\$1189	\$1026
----------	----------	----------	---------------	-------	-------	--------	--------	--------	--------	--------	--------

Needed fabric for material 1.53 yd wide:

**Upholstery:** 0.82 yd

Chairs and Stools

# Chairs and Stools

## Maarten



*Tip: Chairs can be stacked up to ten high.*

*Tip: Side table is available on four leg metal base and sled base chairs only. Table is stained black.*

### Standard Includes

- Base: powder coated paint in black, white, or taupe
- Shell: plastic
- Glides: plastic

### Options

Arms	No Arms	No cost
	With Metal Arms	+\$218
	Upholstered Armrest	+\$342
	With Metal Arms and Wood Armrests	+\$458
Glides	Plastic	No cost
	Felt	+\$10
Table	No Table	No cost
	With Table Left Side Facing	+\$246
	With Table Right Side Facing	+\$246

### Specification Information

Dimensions			Style	Base	Base
D	W	H	Number	Finish Group	Prices (each)
<b>Maarten Four Leg Chair</b>					
19 9/10"	23 1/5"	31 9/10"	<b>VCBMAAPL4P</b>	Paint PG1	\$376
				Paint PG2	\$458

# Chairs and Stools

## Maarten



Tip: Chairs with cushion or upholstery can be stacked up to four high.

Tip: Side table is available on four leg metal base and sled base chairs only. Table is stained black.

### Standard Includes

- Base: powder coated paint in black, white, or taupe
- Shell: plastic
- Cushion: fabric price group 01
- Glides: plastic

### Options

Arms	No Arms	No cost
	With Metal Arms	+\$218
	Upholstered Armrest	+\$342
	With Metal Arms and Wood Armrests	+\$458
Table	No Table	No cost
	With Table Left Side Facing	+\$246
	With Table Right Side Facing	+\$246
Glides	Plastic	No cost
	Felt	+\$10

### Specification Information

Dimensions			Style Number	Base Finish Group	Base Prices					
D	W	H			Upholstery Grades:					
19 9/10"	23 1/5"	31 9/10"	<b>VCBMAAPL4C</b>	Paint PG1	\$573	\$602	\$650	\$718	\$794	\$573
				Paint PG2	\$602	\$663	\$691	\$744	\$807	\$602

Needed fabric for material 1.53 yd wide:

**Cushion:** 0.77 yd

Chairs and Stools

# Chairs and Stools

## Maarten



Tip: Chairs with cushion or upholstery can be stacked up to four high.

Tip: Side table is available on four leg metal base and sled base chairs only. Table is stained black.

### Standard Includes

- Base: powder coated paint in black, white, or taupe
- Upholstery: fabric price group 01
- Glides: plastic

### Options

Arms	No Arms	No cost
	With Metal Arms	+\$218
	Upholstered Armrest	+\$342
	With Metal Arms and Wood Armrests	+\$458
Upholstery Version	Smooth Upholstery	Prices below
	Soft Upholstery	Prices below
Table	No Table	No cost
	With Table Left Side Facing	+\$246
	With Table Right Side Facing	+\$246
Glides	Plastic	No cost
	Felt	+\$10

### Specification Information

Dimensions			Style Number	Base Finish Group	Base Prices					
D	W	H			Upholstery Grades:					

#### Maarten Four Leg Chair with Smooth Upholstery

20 1/10"	23 1/5"	32 1/10"	<b>VCBMAA4P</b>	Paint PG1	\$807	\$875	\$965	\$1059	\$1162	\$807
				Paint PG2	\$1018	\$1107	\$1176	\$1292	\$1408	\$1018



#### Maarten Four Leg Chair with Soft Upholstery

20 1/10"	23 1/5"	32 1/10"	<b>VCBMAA4P</b>	Paint PG1	\$916	\$1005	\$1107	\$1223	\$1346	\$916
				Paint PG2	\$1136	\$1251	\$1333	\$1449	\$1579	\$1136



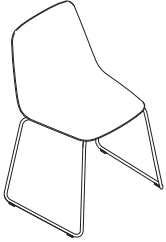
Needed fabric for material 1.53 yd wide:

**Smooth/Soft:** 1.2 yd



# Chairs and Stools

**Maarten**



*Tip: Chairs can be stacked up to ten high.*

*Tip: Minimum order quantity of two units.*

## Standard Includes

- Base: powder coated paint in black or white
- Shell: plastic
- Glides: plastic

## Options

Arms	No Arms	No cost
	With Metal Arms	+\$218
	Upholstered Armrest	+\$342
	With Metal Arms and Wood Armrests	+\$458
Glides	Plastic	No cost
	Felt	+\$10

## Specification Information

Dimensions			Style	Base
D	W	H	Number	Price (each)

### Maarten Sled Chair

19 3/10" 22" 32 3/10" **VCBMAAPLPT** \$417

Chairs and Stools

# Chairs and Stools

## Maarten



*Tip: Chairs with cushion or upholstery can be stacked up to four high.*

### Standard Includes

- Base: powder coated paint in black or white
- Upholstery: fabric price group 01
- Shell: plastic
- Glides: plastic

### Options

Arms	No Arms	No cost
	With Metal Arms	+\$218
	Upholstered Armrest	+\$342
	With Metal Arms and Wood Armrests	+\$458
Glides	Plastic	No cost
	Felt	+\$10

### Specification Information

Dimensions			Style Number	Base Prices						
				Upholstery Grades:						
D	W	H		1	2	3	4	5/Leather	COM/COL	

### Maarten Sled Chair with Cushion

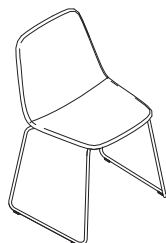
19 3/10"	22"	32 3/10"	<b>VCBMAAPLPTC</b>	\$615	\$650	\$691	\$760	\$821	\$615
----------	-----	----------	--------------------	-------	-------	-------	-------	-------	-------

Needed fabric for material 1.53 yd wide:

**Cushion:** 0.77 yd

# Chairs and Stools

Maarten



Tip: Chairs with cushion or upholstery can be stacked up to four high.

## Standard Includes

- Base: powder coated paint in black or white
- Upholstery: fabric price group 01
- Glides: plastic

## Options

Upholstery Version	Smooth Upholstery	Prices below
	Soft Upholstery	Prices below
Arms	No Arms	No cost
	With Metal Arms	+\$218
	Upholstered Armrest	+\$342
	With Metal Arms and Wood Armrests	+\$458
Glides	Plastic	No cost
	Felt	+\$10

## Specification Information

Dimensions			Style Number	Base Prices						
D	W	H		Upholstery Grades:						
				1	2	3	4	5/Leather	COM/COL	



### Maarten Sled Chair with Smooth Upholstery

19 1/2"	22"	32 1/2"	<b>VCBMAAPT</b>	\$875	\$965	\$1033	\$1136	\$1264	\$875
---------	-----	---------	-----------------	-------	-------	--------	--------	--------	-------



### Maarten Sled Chair with Soft Upholstery

19 1/2"	22"	32 1/2"	<b>VCBMAAPT</b>	\$991	\$1094	\$1176	\$1306	\$1436	\$991
---------	-----	---------	-----------------	-------	--------	--------	--------	--------	-------

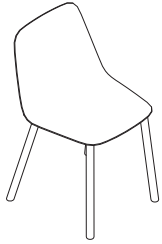
Needed fabric for material 1.53 yd wide:

Smooth/Soft: 1.2 yd

Chairs and Stools

# Chairs and Stools

## Maarten



### Standard Includes

- Base: wood stained solid oak
- Shell: plastic
- Glides: plastic

### Options

Arms	No Arms	No cost
	With Metal Arms	+\$218
	Upholstered Armrest	+\$342
	With Metal Arms and Wood Armrests	+\$458
Glides	Plastic	No cost
	Felt	+\$10

### Specification Information

Dimensions			Style	Base
D	W	H	Number	Price

### Maarten Four Wooden Leg Chair

19 3/10" 19 3/10" 32 1/10" **VCBMAAPL4PM** \$718

# Chairs and Stools

**Maarten**



### Standard Includes

- Base: wood stained solid oak
- Cushion: fabric price group 01
- Shell: plastic
- Glides: plastic

### Options

Arms	No Arms	No cost
	With Metal Arms	+\$218
	Upholstered Armrest	+\$342
	With Metal Arms and Wood Armrests	+\$458
Glides	Plastic	No cost
	Felt	+\$10

### Specification Information

Dimensions			Style Number	Base Prices						
D	W	H		Upholstery Grades:						
				1	2	3	4	5/Leather	COM/COL	

### Maarten Four Wooden Leg Chair with Cushion

19 3/10"	19 3/10"	31 1/10"	<b>VCBMAAPL4PMC</b>	\$1005	\$1033	\$1094	\$1149	\$1223	\$1005
----------	----------	----------	---------------------	--------	--------	--------	--------	--------	--------

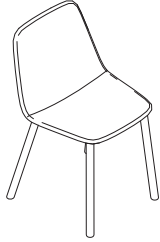
Needed fabric for material 1.53 yd wide:

**Cushion:** 0.77 yd

Chairs and Stools

# Chairs and Stools

## Maarten



### Standard Includes

- Base: wood stained solid oak
- Upholstery: fabric price group 01
- Glides: plastic

### Options

Upholstery Version	Smooth Upholstery	Prices below
	Soft Upholstery	Prices below
Arms	No Arms	No cost
	With Metal Arms	+\$218
	Upholstered Armrest	+\$342
	With Metal Arms and Wood Armrests	+\$458
Glides	Plastic	No cost
	Felt	+\$10

### Specification Information

Dimensions			Style Number	Base Prices						
D	W	H		Upholstery Grades:						
				1	2	3	4	5/Leather	COM/COL	

### Maarten Four Wooden Leg Chair with Smooth Upholstery

19 1/2"	18 9/10"	31 3/10"	<b>VCBMAA4PM</b>	\$1149	\$1189	\$1306	\$1422	\$1525	\$1149
---------	----------	----------	------------------	--------	--------	--------	--------	--------	--------



### Maarten Four Wooden Leg Chair with Soft Upholstery

19 1/2"	18 9/10"	31 3/10"	<b>VCBMAA4PM</b>	\$1320	\$1394	\$1491	\$1607	\$1751	\$1320
---------	----------	----------	------------------	--------	--------	--------	--------	--------	--------

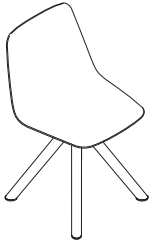
Needed fabric for material 1.53 yd wide:

**Smooth/Soft:** 1.2 yd



# Chairs and Stools

## Maarten



### Standard Includes

- Base: powder coated paint in black, white, or taupe
- Shell: plastic
- Glides: plastic

### Options

Arms	No Arms	No cost
	With Metal Arms	+\$218
	Upholstered Armrest	+\$342
	With Metal Arms and Wood Armrests	+\$458

### Specification Information

Dimensions			Style	Base	Base
D	W	H	Number	Finish Group	Prices

### Maarten Swivel Chair

18 9/10"	18 1/2"	31 7/10"	<b>VCBMAAPL</b>	Paint PG1	\$744
				Paint PG2	\$936

# Chairs and Stools

## Maarten



### Standard Includes

- Aluminum swivel base: powder coated paint in black, white, or taupe
- Cushion: fabric price group 01
- Shell: plastic
- Glides: plastic

### Options

Arms	No Arms	No cost
	With Metal Arms	+\$218
	Upholstered Armrest	+\$342
	With Metal Arms and Wood Armrests	+\$458

### Specification Information

Dimensions			Style Number	Base Finish Group	Base Prices					
D	W	H			Upholstery Grades:					
					1	2	3	4	5/Leather	COM/COL

### Maarten Swivel Chair with Cushion

18 9/10"	18 1/2"	31 7/10"	<b>VCBMAAPLC</b>	Paint PG1	\$949	\$978	\$1018	\$1080	\$1136	\$949
					Paint PG2	\$978	\$1136	\$1162	\$1203	\$978

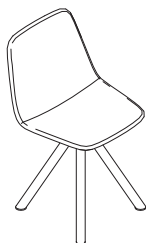
Needed fabric for material 1.53 yd wide:

**Cushion:** 0.77 yd



# Chairs and Stools

## Maarten



### Standard Includes

- Aluminum swivel base: powder coated paint in black, white, or taupe
- Upholstery: fabric price group 01
- Glides: plastic

### Options

Upholstery Version	Smooth Upholstery	Prices below
	Soft Upholstery	Prices below
Arms	No Arms	No cost
	With Metal Arms	+\$218
	Upholstered Armrest	+\$342
	With Metal Arms and Wood Armrests	+\$458

### Specification Information



Dimensions			Style Number	Base Finish Group	Base Prices						
D	W	H			Upholstery Grades:						
					1	2	3	4	5/Leather	COM/COL	
<b>Maarten Swivel Chair with Smooth Upholstery</b>											
19 1/10"	18 9/10"	31 9/10"	<b>VCBMAA</b>	Paint PG1	\$1292	\$1367	\$1449	\$1552	\$1655	\$1292	
				Paint PG2	\$1607	\$1682	\$1778	\$1880	\$1983	\$1607	



<b>Maarten Swivel Chair with Soft Upholstery</b>											
D	W	H	Style Number	Base Finish Group	1	2	3	4	5/Leather	COM/COL	
19 1/10"	18 9/10"	31 9/10"	<b>VCBMAA</b>	Paint PG1	\$1408	\$1491	\$1594	\$1709	\$1839	\$1408	
				Paint PG2	\$1736	\$1825	\$1922	\$2037	\$2154	\$1736	

Needed fabric for material 1.53 yd wide:

**Smooth/Soft:** 1.2 yd

Chairs and Stools

# Chairs and Stools

## Maarten



### Standard Includes

- Aluminum swivel base: powder coated paint in black or white
- Shell: plastic
- Glides: plastic

### Options

Arms	No Arms	No cost
	With Metal Arms	+\$218
	Upholstered Armrest	+\$342
	With Metal Arms and Wood Armrests	+\$458
Glides	Plastic	No cost
	Felt	+\$10

### Specification Information

Dimensions			Style	Base
D	W	H	Number	Price

### Maarten Pyramid Swivel Chair

19 3/10"   18 9/10"   31 1/10"   **VCBMAAPLPI**   \$807

# Chairs and Stools

Maarten



### Standard Includes

- Aluminum swivel base: powder coated paint in black or white
- Cushion: fabric price group 01
- Shell: plastic
- Glides: plastic

### Options

Arms	No Arms	No cost
	With Metal Arms	+\$218
	Upholstered Armrest	+\$342
	With Metal Arms and Wood Armrests	+\$458
Glides	Plastic	No cost
	Felt	+\$10

### Specification Information

Dimensions			Style Number	Base Prices						
D	W	H		Upholstery Grades:						
				1	2	3	4	5/Leather	COM/COL	

### Maarten Pyramid Swivel Chair with Cushion

19 3/10"	18 9/10"	31 1/10"	<b>VCBMAAPLIC</b>	\$1005	\$1033	\$1080	\$1136	\$1189	\$1005
----------	----------	----------	-------------------	--------	--------	--------	--------	--------	--------

Needed fabric for material 1.53 yd wide:

**Cushion:** 0.77 yd

# Chairs and Stools

## Maarten



### Standard Includes

- Aluminum swivel base: powder coated paint in black or white
- Upholstery: fabric price group 01
- Glides: plastic

### Options

Upholstery Version	Smooth Upholstery	Prices below
	Soft Upholstery	Prices below
Arms	No Arms	No cost
	With Metal Arms	+\$218
	Upholstered Armrest	+\$342
	With Metal Arms and Wood Armrests	+\$458
Glides	Plastic	No cost
	Felt	+\$10

### Specification Information

Dimensions			Style Number	Base Prices					
D	W	H		Upholstery Grades:					
				1	2	3	4	5/Leather	COM/COL

### Maarten Pyramid Swivel Chair with Smooth Upholstery

19 1/2"	18 9/10"	31 3/10"	<b>VCBMAAPI</b>	\$1408	\$1477	\$1565	\$1655	\$1778	\$1408
---------	----------	----------	-----------------	--------	--------	--------	--------	--------	--------



### Maarten Pyramid Swivel Chair with Soft Upholstery

19 1/2"	18 9/10"	31 3/10"	<b>VCBMAAPI</b>	\$1512	\$1607	\$1709	\$1825	\$1955	\$1512
---------	----------	----------	-----------------	--------	--------	--------	--------	--------	--------

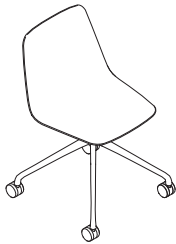
Needed fabric for material 1.53 yd wide:

**Smooth/Soft:** 1.2 yd



# Chairs and Stools

Maarten



### Standard Includes

- Aluminum swivel base: powder coated paint in black or white
- Shell: plastic
- Soft casters for hard floors

### Options

Arms	No Arms	No cost
	With Metal Arms	+\$218
	Upholstered Armrest	+\$342
	With Metal Arms and Wood Armrests	+\$458

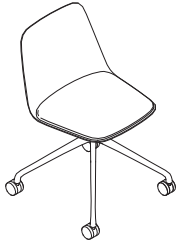
### Specification Information

Dimensions			Style	Base
D	W	H	Number	Price
<b>Maarten Pyramid Swivel Chair with Casters</b>				
19 9/10"	19 9/10"	32 1/10"	<b>VCBMAAPLPIRU</b>	\$847

Chairs and Stools

# Chairs and Stools

## Maarten



### Standard Includes

- Aluminum swivel base: powder coated paint in black or white
- Cushion: fabric price group 01
- Shell: plastic
- Soft casters for hard floors

### Options

Arms	No Arms	No cost
	With Metal Arms	+\$218
	Upholstered Armrest	+\$342
	With Metal Arms and Wood Armrests	+\$458

### Specification Information

Dimensions			Style	Base Prices						
D	W	H	Number	Upholstery Grades:						
				1	2	3	4	5/Leather	COM/COL	

### Maarten Pyramid Swivel Chair with Casters and Cushion

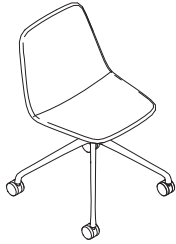
19 9/10"	19 9/10"	32 1/10"	<b>VCBMAAPLPIRUC</b>	\$1046	\$1080	\$1121	\$1176	\$1251	\$1046
----------	----------	----------	----------------------	--------	--------	--------	--------	--------	--------

Needed fabric for material 1.53 yd wide:

**Cushion:** 0.77 yd

# Chairs and Stools

Maarten



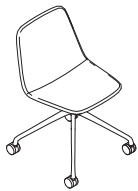
### Standard Includes

- Aluminum swivel base: powder coated paint in black or white
- Upholstery: fabric price group 01
- Soft casters for hard floors

### Options

Upholstery Version	Smooth Upholstery	Prices below
	Soft Upholstery	Prices below
Arms	No Arms	No cost
	With Metal Arms	+\$218
	Upholstered Armrest	+\$342
	With Metal Arms and Wood Armrests	+\$458

### Specification Information



Dimensions			Style Number	Base Prices						
D	W	H		Upholstery Grades:						
				1	2	3	4	5/Leather	COM/COL	
<b>Maarten Pyramid Swivel Chair with Casters and Smooth Upholstery</b>										
19 9/10"	19 9/10"	32 3/10"	<b>VCBMAAPIRU</b>	\$1449	\$1525	\$1607	\$1709	\$1825	\$1449	

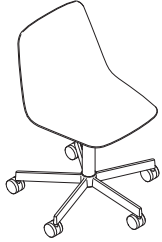


<b>Maarten Pyramid Swivel Chair with Casters and Soft Upholstery</b>									
D	W	H	Style Number	1	2	3	4	5/Leather	COM/COL
19 9/10"	19 9/10"	32 3/10"	<b>VCBMAAPIRU</b>	\$1565	\$1655	\$1764	\$1880	\$1996	\$1565
Needed fabric for material 1.53 yd wide:									
<b>Smooth/Soft:</b> 1.2 yd									

Chairs and Stools

# Chairs and Stools

## Maarten



*Tip: When the base is white, the gas lift tube is chrome finished.*

### Standard Includes

- Aluminum swivel base: powder coated in high gloss black or white
- Aluminum height adjustment system: black or white
- Shell: plastic
- Soft casters for hard floors

### Options

Arms	No Arms	No cost
	With Metal Arms	+\$218
	Upholstered Armrest	+\$342
	With Metal Arms and Wood Armrests	+\$458

### Specification Information

Dimensions			Style	Base
D	W	H	Number	Price
<b>Maarten Five Caster Chair</b>				
22 2/5"	23 2/5"	30 7/10" - 36"	<b>VCBMAAPLBR</b>	\$847



# Chairs and Stools

## Maarten



Tip: When the base is white, the gas lift tube is chrome finished.

### Standard Includes

- Aluminum swivel base: powder coated in high gloss black or white
- Aluminum height adjustment system: black or white
- Cushion: fabric price group 01
- Shell: plastic
- Soft casters for hard floors

### Options

Arms		
No Arms		No cost
With Metal Arms		+\$218
Upholstered Armrest		+\$342
With Metal Arms and Wood Armrests		+\$458

### Specification Information

Dimensions			Style Number	Base Prices						
D	W	H		Upholstery Grades:						
				1	2	3	4	5/Leather	COM/COL	

#### Maarten Five Caster Chair with Cushion

22 2/5"	23 2/5"	30 7/10" - 36"	<b>VCBMAAPLBRC</b>	\$1046	\$1080	\$1121	\$1176	\$1251	\$1046
---------	---------	----------------	--------------------	--------	--------	--------	--------	--------	--------

Needed fabric for material 1.53 yd wide:

Cushion: 0.77 yd

Chairs and Stools

# Chairs and Stools

## Maarten



Tip: When the base is white, the gas lift tube is chrome finished.

### Standard Includes

- Aluminum swivel base: powder coated in high gloss black or white
- Aluminum height adjustment system: black or white
- Upholstery: fabric price group 01
- Soft casters for hard floors

### Options

Upholstery Version	Smooth Upholstery	Prices below
	Soft Upholstery	Prices below
Arms	No Arms	No cost
	With Metal Arms	+\$218
	Upholstered Armrest	+\$342
	With Metal Arms and Wood Armrests	+\$458

### Specification Information

Dimensions			Style Number	Base Prices					
D	W	H		Upholstery Grades:					
				1	2	3	4	5/Leather	COM/COL

#### Maarten Five Caster Chair with Smooth Upholstery

22 4/5"	23 2/5"	31" - 35 4/5"	<b>VCBMAABR</b>	\$1449	\$1525	\$1607	\$1709	\$1825	\$1449
---------	---------	---------------	-----------------	--------	--------	--------	--------	--------	--------



#### Maarten Five Caster Chair with Soft Upholstery

22 4/5"	23 2/5"	31" - 35 4/5"	<b>VCBMAABR</b>	\$1565	\$1655	\$1764	\$1880	\$1996	\$1565
---------	---------	---------------	-----------------	--------	--------	--------	--------	--------	--------

Needed fabric for material 1.53 yd wide:

**Smooth/Soft:** 1.2 yd



# Chairs and Stools

## Maarten



### Standard Includes

- Aluminum swivel base: powder coated paint in black or white
- Shell: plastic
- Glides: plastic

### Options

Arms	No Arms	No cost
	With Metal Arms	+\$218
	Upholstered Armrest	+\$342
	With Metal Arms and Wood Armrests	+\$458
Glides	Plastic	No cost
	Felt	+\$10

### Specification Information

Dimensions			Style	Base
D	W	H	Number	Price

### Maarten Flat Swivel Chair

19 3/10"	18 7/10"	31 1/2"	<b>VCBMAAPLPLA</b>	\$903
----------	----------	---------	--------------------	-------

# Chairs and Stools

## Maarten



### Standard Includes

- Aluminum swivel base: powder coated paint in black or white
- Cushion: fabric price group 01
- Shell: plastic
- Glides: plastic

### Options

Arms	No Arms	No cost
	With Metal Arms	+\$218
	Upholstered Armrest	+\$342
	With Metal Arms and Wood Armrests	+\$458
Glides	Plastic	No cost
	Felt	+\$10

### Specification Information

Dimensions			Style Number	Base Prices						
D	W	H		Upholstery Grades:						
				1	2	3	4	5/Leather	COM/COL	

### Maarten Flat Swivel Chair with Cushion

19 3/10"	18 7/10"	31 1/2"	<b>VCBMAAPLPLAC</b>	\$1107	\$1136	\$1176	\$1251	\$1306	\$1107
----------	----------	---------	---------------------	--------	--------	--------	--------	--------	--------

Needed fabric for material 1.53 yd wide:

**Cushion:** 0.77 yd

# Chairs and Stools

Maarten



### Standard Includes

- Aluminum swivel base: powder coated paint in black or white
- Upholstery: fabric price group 01
- Glides: plastic

### Options

Upholstery Version	Smooth Upholstery	Prices below
	Soft Upholstery	Prices below
Arms	No Arms	No cost
	With Metal Arms	+\$218
	Upholstered Armrest	+\$342
	With Metal Arms and Wood Armrests	+\$458
Glides	Plastic	No cost
	Felt	+\$10

### Specification Information



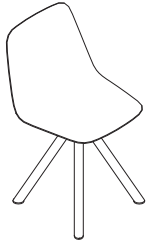
Dimensions			Style Number	Base Prices						
D	W	H		Upholstery Grades:						
				1	2	3	4	5/Leather	COM/COL	
<b>Maarten Flat Swivel Chair with Smooth Upholstery</b>										
19 1/2"	18 9/10"	31 7/10"	<b>VCBMAAPLA</b>	\$1552	\$1620	\$1709	\$1812	\$1922	\$1552	



<b>Maarten Flat Swivel Chair with Soft Upholstery</b>										
				1	2	3	4	5/Leather	COM/COL	
19 1/2"	18 9/10"	31 7/10"	<b>VCBMAAPLA</b>	\$1655	\$1764	\$1853	\$1970	\$2098	\$1655	
Needed fabric for material 1.53 yd wide:										
<b>Smooth/Soft:</b> 1.2 yd										

# Chairs and Stools

## Maarten



### Standard Includes

- Swivel base: steel with stained oak veneer
- Shell: plastic
- Glides: plastic

### Options

Arms	No Arms	No cost
	With Metal Arms	+\$218
	Upholstered Armrest	+\$342
	With Metal Arms and Wood Armrests	+\$458
Glides	Plastic	No cost
	Felt	+\$10

### Specification Information

Dimensions			Style	Base
D	W	H	Number	Price

### Maarten Wooden Swivel Chair

18 9/10"	18 1/2"	31 7/10"	<b>VCBMAAPLM</b>	\$1346
----------	---------	----------	------------------	--------

# Chairs and Stools

**Maarten**



## Standard Includes

- Swivel base: steel with stained oak veneer
- Shell: plastic
- Cushion: fabric price group 01
- Glides: plastic

## Options

Arms	No Arms	No cost
	With Metal Arms	+\$218
	Upholstered Armrest	+\$342
	With Metal Arms and Wood Armrests	+\$458
Glides	Plastic	No cost
	Felt	+\$10

## Specification Information

Dimensions			Style Number	Base Prices						
D	W	H		Upholstery Grades:						
				1	2	3	4	5/Leather	COM/COL	

### Maarten Wooden Swivel Chair with Cushion

18 9/10"	18 1/2"	31 7/10"	<b>VCBMAAPLMC</b>	\$1552	\$1579	\$1620	\$1682	\$1751	\$1552
----------	---------	----------	-------------------	--------	--------	--------	--------	--------	--------

Needed fabric for material 1.53 yd wide:

**Cushion:** 0.77 yd

Chairs and Stools

# Chairs and Stools

## Maarten



### Standard Includes

- Swivel base: steel with stained oak veneer
- Upholstery: fabric price group 01
- Glides: plastic

### Options

Upholstery Version	Smooth Upholstery	Prices below
	Soft Upholstery	Prices below
Arms	No Arms	No cost
	With Metal Arms	+\$218
	Upholstered Armrest	+\$342
	With Metal Arms and Wood Armrests	+\$458
Glides	Plastic	No cost
	Felt	+\$10

### Specification Information



Dimensions			Style Number	Base Prices					
D	W	H		Upholstery Grades:					
				1	2	3	4	5/Leather	COM/COL
<b>Maarten Wooden Swivel Chair with Smooth Upholstery</b>									
19 1/2"	18 9/10"	31 9/10"	<b>VCBMAAM</b>	\$1941	\$2010	\$2098	\$2195	\$2311	\$1941

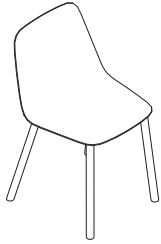


<b>Maarten Wooden Swivel Chair with Smooth Upholstery</b>									
D	W	H	Style Number	1	2	3	4	5/Leather	COM/COL
19 1/2"	18 9/10"	31 9/10"	<b>VCBMAAM</b>	\$2051	\$2140	\$2256	\$2372	\$2482	\$2051
Needed fabric for material 1.53 yd wide:									
<b>Smooth/Soft: 1.2 yd</b>									



# Chairs and Stools

## Maarten



### Standard Includes

- Base: leather upholstered solid oak
- Shell: plastic
- Glides: plastic

### Options

Arms		
No Arms		No cost
With Metal Arms		+\$218
Upholstered Armrest		+\$342
With Metal Arms and Wood Armrests		+\$458

### Specification Information

Dimensions			Style	Base
D	W	H	Number	Price

### Maarten Four Upholstered Leg Chair

19 3/10"	19 3/10"	32 1/10"	<b>VCBMAAPL4PT</b>	\$1238
----------	----------	----------	--------------------	--------

# Chairs and Stools

## Maarten



### Standard Includes

- Base: leather upholstered solid oak
- Cushion: fabric price group 01
- Shell: plastic
- Glides: plastic

### Options

Arms	No Arms	No cost
	With Metal Arms	+\$218
	Upholstered Armrest	+\$342
	With Metal Arms and Wood Armrests	+\$458

### Specification Information

Dimensions			Style Number	Base Prices						
D	W	H		Upholstery Grades:						
				1	2	3	4	5/Leather	COM/COL	

### Maarten Four Upholstered Leg Chair with Cushion

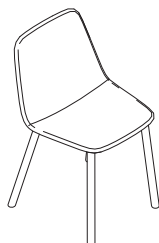
19 3/10"	19 3/10"	32 1/10"	<b>VCBMAAPL4PTC</b>	\$1525	\$1552	\$1607	\$1668	\$1736	\$1525
----------	----------	----------	---------------------	--------	--------	--------	--------	--------	--------

Needed fabric for material 1.53 yd wide:

**Cushion:** 0.77 yd

# Chairs and Stools

Maarten



### Standard Includes

- Base: leather upholstered solid oak
- Upholstery: fabric price group 01
- Shell: plastic
- Glides: plastic

### Options

Upholstery Version	Smooth Upholstery	Prices below
	Soft Upholstery	Prices below
Arms	No Arms	No cost
	With Metal Arms	+\$218
	Upholstered Armrest	+\$342
	With Metal Arms and Wood Armrests	+\$458

### Specification Information



Dimensions			Style Number	Base Prices						
D	W	H		Upholstery Grades:						
				1	2	3	4	5/Leather	COM/COL	
<b>Maarten Four Upholstered Leg Chair with Smooth Upholstery</b>										
19 1/2"	18 9/10"	31 3/10"	<b>VCBMAA4PT</b>	\$1668	\$1709	\$1825	\$1941	\$2037	\$1668	

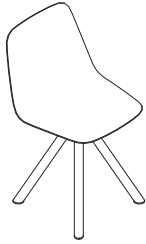


<b>Maarten Four Upholstered Leg Chair with Soft Upholstery</b>									
D	W	H	Style Number	1	2	3	4	5/Leather	COM/COL
19 1/2"	18 9/10"	31 3/10"	<b>VCBMAA4PT</b>	\$1839	\$1906	\$2010	\$2127	\$2269	\$1839
Needed fabric for material 1.53 yd wide:									
<b>Smooth/Soft:</b> 1.2 yd									

Chairs and Stools

# Chairs and Stools

## Maarten



### Standard Includes

- Base: leather upholstered steel
- Shell: plastic
- Glides: plastic

### Options

Options		
Arms	No Arms	No cost
	With Metal Arms	+\$218
	Upholstered Armrest	+\$342
	With Metal Arms and Wood Armrests	+\$458

### Specification Information

Dimensions			Style	Base
D	W	H	Number	Price

### Maarten Upholstered Leg Swivel Chair

18 9/10"   18 1/2"   31 7/10"   **VCBMAAPLPGT**   \$1346

# Chairs and Stools

## Maarten



### Standard Includes

- Base: leather upholstered steel
- Shell: plastic
- Cushion: fabric price group 01
- Glides: plastic

### Options

Arms	No Arms	No cost
	With Metal Arms	+\$218
	Upholstered Armrest	+\$342
	With Metal Arms and Wood Armrests	+\$458

### Specification Information

Dimensions			Style Number	Base Prices					
D	W	H		Upholstery Grades:					
				1	2	3	4	5/Leather	COM/COL

### Maarten Upholstered Leg Swivel Chair with Cushion

18 9/10"	18 1/2"	31 7/10"	<b>VCBMAAPLPGTC</b>	\$1552	\$1579	\$1620	\$1682	\$1736	\$1552
----------	---------	----------	---------------------	--------	--------	--------	--------	--------	--------

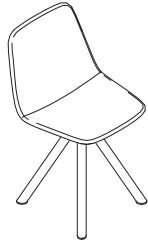
Needed fabric for material 1.53 yd wide:

**Cushion:** 0.77 yd

Chairs and Stools

# Chairs and Stools

## Maarten



### Standard Includes

- Base: leather upholstered steel
- Upholstery: fabric price group 01
- Glides: plastic

### Options

Upholstery Version	Smooth Upholstery	Prices below
	Soft Upholstery	Prices below
Arms	No Arms	No cost
	With Metal Arms	+\$218
	Upholstered Armrest	+\$342
	With Metal Arms and Wood Armrests	+\$458

### Specification Information



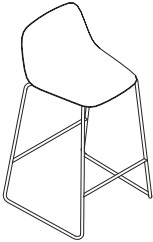
Dimensions			Style Number	Base Prices					
D	W	H		Upholstery Grades:					
				1	2	3	4	5/Leather	COM/COL
<b>Maarten Upholstered Leg Swivel Chair with Smooth Upholstery</b>									
19 1/10"	18 9/10"	31 9/10"	<b>VCBMAAPGT</b>	\$1893	\$1970	\$2051	\$2154	\$2256	\$1893



<b>Maarten Upholstered Leg Swivel Chair with Soft Upholstery</b>									
D	W	H	Style Number	1	2	3	4	5/Leather	COM/COL
19 1/10"	18 9/10"	31 9/10"	<b>VCBMAAPGT</b>	\$2010	\$2098	\$2195	\$2311	\$2441	\$2010
Needed fabric for material 1.53 yd wide:									
<b>Smooth/Soft:</b> 1.2 yd									

# Chairs and Stools

Maarten



Tip: Plastic stools can be stacked up to four high.

## Standard Includes

- Base: powder coated paint in black or white
- Shell: plastic
- Glides: plastic

## Options

Glides	Plastic	No cost
	Felt	+\$10

## Specification Information

Dimensions			Style	Base
D	W	H	Number	Price

### Maarten Sled Counter Stool with Low Backrest

18 7/10"	20 1/10"	36"	<b>VCBMAAPLTPTCOB</b>	\$560
----------	----------	-----	-----------------------	-------

Chairs and Stools

# Chairs and Stools

## Maarten



Tip: Stools with cushion or upholstery can be stacked up to four high.

### Standard Includes

- Base: powder coated paint in black or white
- Upholstery: fabric price group 01
- Glides: plastic

### Options

Upholstery Version	Smooth Upholstery	Prices below
	Soft Upholstery	Prices below
Glides	Plastic	No cost
	Felt	+\$10

### Specification Information

Dimensions			Style Number	Base Prices						
D	W	H		Upholstery Grades:						
				1	2	3	4	5/Leather	COM/COL	

#### Maarten Sled Counter Stool with Low Backrest and Smooth Upholstery

18 7/10"	20 1/10"	36"	<b>VCBMAATPTCOB</b>	\$965	\$991	\$1094	\$1162	\$1264	\$965
----------	----------	-----	---------------------	-------	-------	--------	--------	--------	-------



#### Maarten Sled Counter Stool with Low Backrest and Soft Upholstery

18 7/10"	20 1/10"	36 1/5"	<b>VCBMAATPTCOB</b>	\$1080	\$1121	\$1223	\$1320	\$1422	\$1080
----------	----------	---------	---------------------	--------	--------	--------	--------	--------	--------

Needed fabric for material 1.53 yd wide:

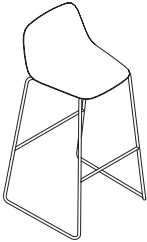
Smooth/Soft: 1.1 yd





# Chairs and Stools

Maarten



Tip: Plastic stools can be stacked up to four high.

## Standard Includes

- Base: powder coated paint in black or white
- Shell: plastic
- Glides: plastic

## Options

Glides	Plastic	No cost
	Felt	+\$10

## Specification Information

Dimensions			Style	Base
D	W	H	Number	Price

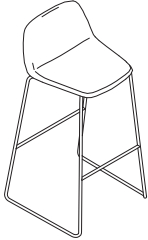
### Maarten Sled Bar Stool with Low Backrest

19 7/10"	20 1/2"	40"	<b>VCBMAAPLPTBARB</b>	\$560
----------	---------	-----	-----------------------	-------

Chairs and Stools

# Chairs and Stools

## Maarten



Tip: Stools with cushion or upholstery can be stacked up to four high.

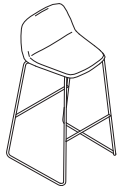
### Standard Includes

- Base: powder coated paint in black or white
- Upholstery: fabric price group 01
- Glides: plastic

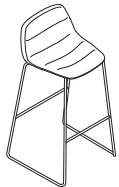
### Options

Upholstery Version	Smooth Upholstery	Prices below
	Soft Upholstery	Prices below
Glides	Plastic	No cost
	Felt	+\$10

### Specification Information



Dimensions			Style Number	Base Prices					
D	W	H		Upholstery Grades:					
				1	2	3	4	5/Leather	COM/COL
<b>Maarten Sled Bar Stool with Low Backrest and Smooth Upholstery</b>									
19 7/10"	20 1/2"	40 1/5"	<b>VCBMAATPTBARB</b>	\$965	\$991	\$1094	\$1162	\$1264	\$965



<b>Maarten Sled Bar Stool with Low Backrest and Soft Upholstery</b>									
19 7/10"	20 1/2"	40 1/5"	<b>VCBMAATPTBARB</b>	\$1080	\$1121	\$1223	\$1320	\$1422	\$1080
Needed fabric for material 1.53 yd wide:									
<b>Smooth/Soft:</b> 1.1 yd									

# Chairs and Stools

Maarten



### Standard Includes

- Aluminum swivel base: powder coated paint in black or white
- Shell: plastic
- Footrest: powder coated paint in black
- Glides: plastic

### Options

Glides	Plastic	No cost
	Felt	+\$10

### Specification Information

Dimensions			Style	Base
D	W	H	Number	Price

### Maarten Swivel Counter Stool with Low Backrest

18 1/2"	18 1/2"	36"	<b>VCBMAAPLCOB</b>	\$704
---------	---------	-----	--------------------	-------

Chairs and Stools

# Chairs and Stools

## Maarten



### Standard Includes

- Aluminum swivel base: powder coated paint in black or white
- Upholstery: fabric price group 01
- Glides: plastic

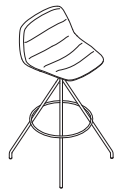
### Options

Upholstery Version	Smooth Upholstery	Prices below
	Soft Upholstery	Prices below
Glides	Plastic	No cost
	Felt	+\$10

### Specification Information



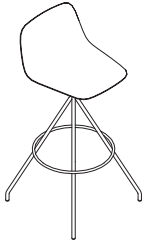
Dimensions			Style Number	Base Prices						
D	W	H		Upholstery Grades:						
				1	2	3	4	5/Leather	COM/COL	
<b>Maarten Swivel Counter Stool with Low Backrest and Smooth Upholstery</b>										
18 1/2"	18 1/2"	36 1/5"	<b>VCBMAATCOB</b>	\$1176	\$1251	\$1320	\$1422	\$1512	\$1176	



Dimensions			Style Number	Base Prices						
D	W	H		Upholstery Grades:						
				1	2	3	4	5/Leather	COM/COL	
<b>Maarten Swivel Counter Stool with Low Backrest and Soft Upholstery</b>										
18 1/2"	18 1/2"	36 1/5"	<b>VCBMAATCOB</b>	\$1251	\$1292	\$1367	\$1463	\$1565	\$1251	
Needed fabric for material 1.53 yd wide:										
<b>Smooth/Soft:</b> 1.1 yd										

# Chairs and Stools

Maarten



### Standard Includes

- Aluminum swivel base: powder coated paint in black or white
- Shell: plastic
- Glides: plastic

### Options

Glides	Plastic	No cost
	Felt	+\$10

### Specification Information

Dimensions		Style		Base
D	W	H	Number	Price

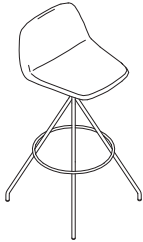
### Maarten Swivel Bar Stool with Low Backrest

18 1/2"	18 1/2"	40"	<b>VCBMAAPLBARB</b>	\$704
---------	---------	-----	---------------------	-------

Chairs and Stools

# Chairs and Stools

## Maarten



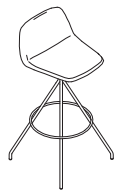
### Standard Includes

- Aluminum swivel base: powder coated paint in black or white
- Upholstery: fabric price group 01
- Glides: plastic

### Options

Upholstery Version	Smooth Upholstery	Prices below
	Soft Upholstery	Prices below
Glides	Plastic	No cost
	Felt	+\$10

### Specification Information



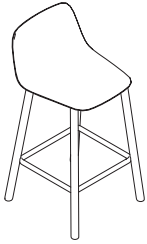
Dimensions			Style Number	Base Prices						
D	W	H		Upholstery Grades:						
				1	2	3	4	5/Leather	COM/COL	
<b>Maarten Swivel Bar Stool with Low Backrest and Smooth Upholstery</b>										
18 1/2"	18 1/2"	40 1/5"	<b>VCBMAATBARB</b>	\$1176	\$1251	\$1320	\$1422	\$1512	\$1176	



Dimensions			Style Number	Base Prices						
D	W	H		Upholstery Grades:						
				1	2	3	4	5/Leather	COM/COL	
<b>Maarten Swivel Bar Stool with Low Backrest and Soft Upholstery</b>										
18 1/2"	18 1/2"	40 1/5"	<b>VCBMAATBARB</b>	\$1251	\$1292	\$1367	\$1463	\$1565	\$1251	
Needed fabric for material 1.53 yd wide:										
<b>Smooth/Soft:</b> 1.1 yd										

# Chairs and Stools

Maarten



## Standard Includes

- Base: wood stained solid oak
- Shell: plastic
- Footrest: powder coated paint in black
- Glides: plastic

## Options

Glides	Plastic	No cost
	Felt	+\$10

## Specification Information

Dimensions			Style	Base
D	W	H	Number	Price

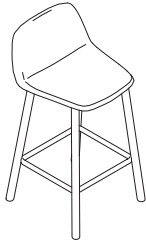
### Maarten Four Wooden Leg Counter Stool with Low Backrest

19 7/10"	17 3/10"	34 3/5"	<b>VCBMAAPLT4MCOB</b>	\$991
----------	----------	---------	-----------------------	-------

Chairs and Stools

# Chairs and Stools

## Maarten



### Standard Includes

- Base: wood stained solid oak
- Upholstery: fabric price group 01
- Footrest: powder coated paint in black
- Glides: plastic

### Options

Upholstery Version	Smooth Upholstery	Prices below
	Soft Upholstery	Prices below
Glides	Plastic	No cost
	Felt	+\$10

### Specification Information



Dimensions				Style Number	Base Prices					
					Upholstery Grades:					
D	W	H		1	2	3	4	5/Leather		
<b>Maarten Four Wooden Leg Counter Stool with Low Backrest and Smooth Upholstery</b>										
19 7/10"	17 3/10"	34 4/5"	<b>VCBMAAT4MCOB</b>	\$1491	\$1552	\$1634	\$1736	\$1812	\$1491	

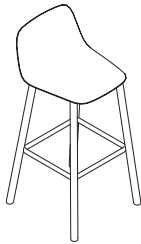


<b>Maarten Four Wooden Leg Counter Stool with Low Backrest and Soft Upholstery</b>									
19 7/10"	17 3/10"	34 4/5"	<b>VCBMAAT4MCOB</b>	\$1552	\$1607	\$1709	\$1799	\$1893	\$1552
Needed fabric for material 1.53 yd wide:									
<b>Smooth/Soft:</b> 1.1 yd									



# Chairs and Stools

Maarten



### Standard Includes

- Base: wood stained solid oak
- Shell: plastic
- Footrest: powder coated paint in black
- Glides: plastic

### Options

Glides	Plastic	No cost
	Felt	+\$10

### Specification Information

Dimensions			Style	Base
D	W	H	Number	Price

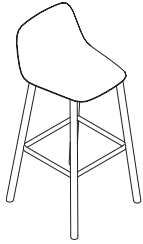
### Maarten Four Wooden Leg Bar Stool with Low Backrest

19 7/10"	17 9/10"	38 3/5"	<b>VCBMAAPLT4MBARB</b>	\$991
----------	----------	---------	------------------------	-------

Chairs and Stools

# Chairs and Stools

## Maarten



### Standard Includes

- Base: wood stained solid oak
- Upholstery: fabric price group 01
- Footrest: powder coated paint in black
- Glides: plastic

### Options

Upholstery Version	Smooth Upholstery	Prices below
	Soft Upholstery	Prices below
Glides	Plastic	No cost
	Felt	+\$10

### Specification Information



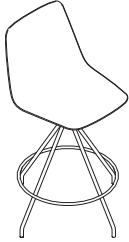
Dimensions			Style Number	Base Prices					
D	W	H		Upholstery Grades:					
				1	2	3	4	5/Leather	COM/COL
<b>Maarten Four Wooden Leg Bar Stool with Low Backrest and Smooth Upholstery</b>									
18 7/10"	17 9/10"	38 4/5"	<b>VCBMAAT4MBARB</b>	\$1491	\$1552	\$1634	\$1736	\$1812	\$1491



<b>Maarten Four Wooden Leg Bar Stool with Low Backrest and Soft Upholstery</b>									
18 7/10"	17 9/10"	38 4/5"	<b>VCBMAAT4MBARB</b>	\$1552	\$1607	\$1709	\$1799	\$1893	\$1552
Needed fabric for material 1.53 yd wide:									
<b>Smooth/Soft:</b> 1.1 yd									

# Chairs and Stools

## Maarten



### Standard Includes

- Aluminum swivel base: powder coated paint in black, white, or taupe
- Shell: plastic
- Glides: plastic

### Options

Arms	No Arms	No cost
	With Metal Arms	+\$218
	Upholstered Armrest	+\$342
	With Metal Arms and Wood Armrests	+\$458
Glides	Plastic	No cost
	Felt	+\$10

### Specification Information

Dimensions			Style	Base	Base
D	W	H	Number	Finish Group	Prices

### Maarten Swivel Counter Stool with High Backrest

18 1/2"	18 1/2"	40 3/5"	<b>VCBMAAPLCO</b>	Paint PG1	\$773
				Paint PG2	\$965

Chairs and Stools

# Chairs and Stools

## Maarten



### Standard Includes

- Aluminum swivel base: powder coated paint in black, white, or taupe
- Shell: plastic
- Cushion: fabric price group 01
- Glides: plastic

### Options

Arms	No Arms	No cost
	With Metal Arms	+\$218
	Upholstered Armrest	+\$342
	With Metal Arms and Wood Armrests	+\$458
Glides	Plastic	No cost
	Felt	+\$10

### Specification Information

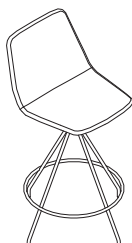
Dimensions			Style Number	Structure Finish Group	Base Prices						
D	W	H			Upholstery Grades:						
						1	2	3	4	5/Leather	COM/COL
<b>Maarten Swivel Counter Stool with High Backrest and Cushion</b>											
18 1/2"	18 1/2"	40 3/5"	<b>VCBMAAPLCOC</b>	Paint PG1	\$978	\$1005	\$1046	\$1107	\$1162	\$978	
				Paint PG2	\$1005	\$1162	\$1189	\$1251	\$1306	\$1005	

Needed fabric for material 1.53 yd wide:

**Cushion:** 0.77 yd

# Chairs and Stools

Maarten



### Standard Includes

- Aluminum swivel base: powder coated paint in black, white, or taupe
- Upholstery: fabric price group 01
- Glides: plastic

### Options

Upholstery Version	Smooth Upholstery	Soft Upholstery	Prices below
			Prices below
Arms	No Arms		No cost
	With Metal Arms		+\$218
	Upholstered Armrest		+\$342
	With Metal Arms and Wood Armrests		+\$458
Glides	Plastic		No cost
	Felt		+\$10

### Specification Information



Dimensions				Style Number	Base Finish Group	Base Prices					COM/COL
D	W	H	Upholstery Grades:			1	2	3	4	5/Leather	
18 7/10"	18 9/10"	40 7/10"	<b>VCBMAATCO</b>	Paint PG1	\$1491	\$1634	\$1812	\$1983	\$2167	\$1491	
				Paint PG2	\$1955	\$2098	\$2269	\$2441	\$2625	\$1955	

### Maarten Swivel Counter Stool with High Backrest and Smooth Upholstery



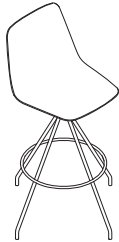
Dimensions				Style Number	Base Finish Group	Base Prices					COM/COL
D	W	H	Upholstery Grades:			1	2	3	4	5/Leather	
18 7/10"	18 9/10"	40 7/10"	<b>VCBMAATCO</b>	Paint PG1	\$1607	\$1764	\$1922	\$2098	\$2298	\$1607	
				Paint PG2	\$2064	\$2229	\$2385	\$2556	\$2756	\$2064	

Needed fabric for material 1.53 yd wide:  
**Smooth/Soft:** 1.2 yd

Chairs and Stools

# Chairs and Stools

## Maarten



### Standard Includes

- Aluminum swivel base: powder coated paint in black, white, or taupe
- Shell: plastic
- Glides: plastic

### Options

Arms	No Arms	No cost
	With Metal Arms	+\$218
	Upholstered Armrest	+\$342
	With Metal Arms and Wood Armrests	+\$458
Glides	Plastic	No cost
	Felt	+\$10

### Specification Information

Dimensions			Style	Base	Base
D	W	H	Number	Finish Group	Prices

### Maarten Swivel Bar Stool with High Backrest

18 7/10"	18 1/2"	44 1/2"	<b>VCBMAAPLBAR</b>	Paint PG1	\$773
				Paint PG2	\$965

# Chairs and Stools

Maarten



## Standard Includes

- Aluminum swivel base: powder coated paint in black, white, or taupe
- Shell: plastic
- Cushion: fabric price group 01
- Glides: plastic

## Options

Arms	No Arms	No cost
	With Metal Arms	+\$218
	Upholstered Armrest	+\$342
	With Metal Arms and Wood Armrests	+\$458
Glides	Plastic	No cost
	Felt	+\$10

## Specification Information

Dimensions			Style Number	Base Finish Group	Base Prices					
D	W	H			Upholstery Grades:					
					1	2	3	4	5/Leather	COM/COL

### Maarten Swivel Bar Stool with High Backrest and Cushion

18 1/2"	18 1/2"	40 1/2"	<b>VCBMAAPLBARC</b>	Paint PG1	\$978	\$1005	\$1046	\$1107	\$1162	\$978
				Paint PG2	\$1005	\$1162	\$1189	\$1251	\$1306	\$1005

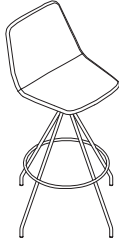
Needed fabric for material 1.53 yd wide:

**Cushion:** 0.77 yd

Chairs and Stools

# Chairs and Stools

## Maarten



### Standard Includes

- Aluminum swivel base: powder coated paint in black, white, or taupe
- Upholstery: fabric price group 01
- Glides: plastic

### Options

Upholstery Version	Smooth Upholstery	Prices below
	Soft Upholstery	Prices below
Arms	No Arms	No cost
	With Metal Arms	+\$218
	Upholstered Armrest	+\$342
	With Metal Arms and Wood Armrests	+\$458
Glides	Plastic	No cost
	Felt	+\$10

### Specification Information



Dimensions			Style Number	Base Finish Group	Base Prices					
D	W	H			Upholstery Grades:					
					1	2	3	4	5/Leather	COM/COL
<b>Maarten Swivel Bar Stool with High Backrest and Smooth Upholstery</b>										
18 7/10"	18 9/10"	44 7/10"	<b>VCBMAATBAR</b>	Paint PG1	\$1491	\$1634	\$1812	\$1983	\$2167	\$1491
				Paint PG2	\$1955	\$2098	\$2269	\$2441	\$2625	\$1955

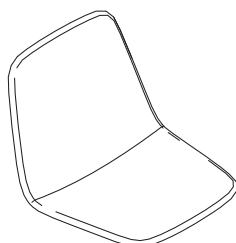


<b>Maarten Swivel Bar Stool with High Backrest and Soft Upholstery</b>										
18 7/10"	18 9/10"	44 7/10"	<b>VCBMAATBAR</b>	Paint PG1	\$1607	\$1764	\$1922	\$2098	\$2298	\$1607
				Paint PG2	\$2064	\$2229	\$2385	\$2556	\$2756	\$2064
Needed fabric for material 1.53 yd wide:										
<b>Smooth/Soft:</b> 1.2 yd										



# Chairs and Stools

Maarten



Tip: Minimum order quantity of two units.

Tip: Screws or anchoring system not included.

## Standard Includes

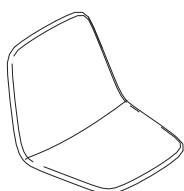
- Shell: plastic
- Upholstery: fabric price group 01

## Options

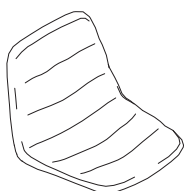
Upholstery Version	Smooth Upholstery	Prices below
	Soft Upholstery	Prices below

## Specification Information

Dimensions			Style Number	Base Prices (each)					
D	W	H		Upholstery Grades:					
				1	2	3	4	5/Leather	COM/COL
<b>Maarten Auditorium Chair with Smooth Upholstery</b>									
14 1/5"	18 1/2"	14 1/5"	<b>VCBMAAAU</b>	\$744	\$834	\$949	\$1080	\$1223	\$744



<b>Maarten Auditorium Chair with Soft Upholstery</b>									
14 1/5"	18 1/2"	14 1/5"	<b>VCBMAAAU</b>	\$847	\$949	\$1059	\$1176	\$1333	\$847
Needed fabric for material 1.53 yd wide:									
Smooth/Soft: 1.2 yd									



Tip: Link is for use with four leg metal base chairs only.

Tip: One linking device connects two chairs to each other.

## Standard Includes

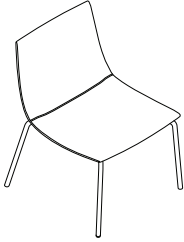
- Linking device: black

## Specification Information

Style Number	Price
<b>Maarten Link</b>	
<b>VCBMAAUN</b>	\$82

# Chairs and Stools

## Noha



### Standard Includes

- Base: powder coated paint in black, white, or taupe
- Upholstery: fabric price group 01
- Piping: anthracite, burgundy, forest green, linen, white
- Glides: plastic

### Options

Upholstery Finish	Customer's Own Leather	See below
	Fabric Customer's Own Material	See below
	Fabric Price Grade 1	See below
	Fabric Price Grade 2	See below
	Fabric Price Grade 3	See below
	Fabric Price Grade 4	See below
	Fabric Price Grade 5	See below
Arms	Leather Price Grade 5	See below
	No Arms	No cost
	With Metal Arms	+\$390
	Upholstered Arms	+\$607
Arms Finish	Customer's Own Leather	No cost
	Fabric Customer's Own Material	No cost
	Fabric Price Grade 1	No cost
	Fabric Price Grade 2	+\$112
	Fabric Price Grade 3	+\$336
	Fabric Price Grade 4	+\$560
	Fabric Price Grade 5	+\$784
Glides	Leather Price Grade 5	+\$784
	Plastic	No cost
	Felt	+\$10

### Specification Information

Dimensions			Style Number	Base Prices					
D	W	H		Upholstery Grades:					
				1	2	3	4	5/Leather	COM/COL

#### Noha Standard Chair - Four Metal Legs Base

24 2/5"	23 3/5"	32 2/7"	<b>VCBNOHEXSI4PME</b>	\$1092	\$1154	\$1277	\$1400	\$1523	\$1092
---------	---------	---------	-----------------------	--------	--------	--------	--------	--------	--------



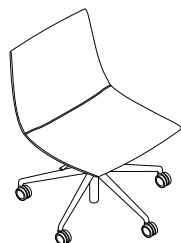
#### Noha Executive Chair - Four Metal Legs Base

24 2/5"	23 3/5"	38 1/2"	<b>VCBNOHEXSI4PME2</b>	\$1232	\$1318	\$1492	\$1666	\$1839	\$1232
---------	---------	---------	------------------------	--------	--------	--------	--------	--------	--------



# Chairs and Stools

## Noha



### Standard Includes

- Nylon swivel base: black or white
- Upholstery: fabric price group 01
- Piping: anthracite, burgundy, forest green, linen, white
- Aluminum height adjustment system: black or white
- Soft casters for hard floors

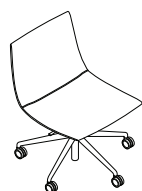
### Options

Upholstery Finish	Customer's Own Leather	See below
	Fabric Customer's Own Material	See below
	Fabric Price Grade 1	See below
	Fabric Price Grade 2	See below
	Fabric Price Grade 3	See below
	Fabric Price Grade 4	See below
	Fabric Price Grade 5	See below
Arms	Leather Price Grade 5	See below
	No Arms	No cost
	With Metal Arms	+\$390
	Upholstered Arms	+\$607
Arms Finish	Customer's Own Leather	No cost
	Fabric Customer's Own Material	No cost
	Fabric Price Grade 1	No cost
	Fabric Price Grade 2	+\$112
	Fabric Price Grade 3	+\$336
	Fabric Price Grade 4	+\$560
	Fabric Price Grade 5	+\$784
Tilt Option	Leather Price Grade 5	+\$784
	Without Tilting	No cost
	With Tilting	+\$65

Chairs and Stools

### Specification Information

Dimensions			Style Number	Base Prices					
D	W	H		Upholstery Grades:					
				1	2	3	4	5/Leather	COM/COL



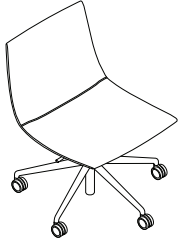
<b>Noha Standard Chair - Five Casters Nylon Base</b>									
27 3/5"	27 3/5"	30 2/3" - 35 2/5"	<b>VCBNOHEXSI5RPL</b>	\$1354	\$1416	\$1539	\$1662	\$1785	\$1354



<b>Noha Executive Chair - Five Casters Nylon Base</b>									
27 3/5"	27 3/5"	36 3/5" - 41 2/7"	<b>VCBNOHEXSI5RPL2</b>	\$1494	\$1580	\$1754	\$1928	\$2101	\$1494

# Chairs and Stools

## Noha



### Standard Includes

- Aluminum swivel base: powder coated paint in black or white
- Upholstery: fabric price group 01
- Piping: anthracite, burgundy, forest green, linen, white
- Aluminum height adjustment system: black or white
- Soft casters for hard floors

### Options

Upholstery Finish	Customer's Own Leather	See below
	Fabric Customer's Own Material	See below
	Fabric Price Grade 1	See below
	Fabric Price Grade 2	See below
	Fabric Price Grade 3	See below
	Fabric Price Grade 4	See below
	Fabric Price Grade 5	See below
Leather Price Grade 5		See below
		See below
Arms	No Arms	No cost
	With Metal Arms	+\$390
	Upholstered Arms	+\$607
Arms Finish	Customer's Own Leather	No cost
	Fabric Customer's Own Material	No cost
	Fabric Price Grade 1	No cost
	Fabric Price Grade 2	+\$112
	Fabric Price Grade 3	+\$336
	Fabric Price Grade 4	+\$560
	Fabric Price Grade 5	+\$784
Leather Price Grade 5	+\$784	
Tilt Option	Without Tilting	No cost
	With Tilting	+\$65

### Specification Information

Dimensions			Style Number	Base Prices					
D	W	H		Upholstery Grades:					
				1	2	3	4	5/Leather	COM/COL

#### Noha Standard Chair - Five Casters Aluminum Base

27 3/5"	27 3/5"	30 2/3" - 35 2/5"	<b>VCBNOHEXS15R</b>	\$1556	\$1618	\$1741	\$1864	\$1987	\$1556
---------	---------	-------------------	---------------------	--------	--------	--------	--------	--------	--------



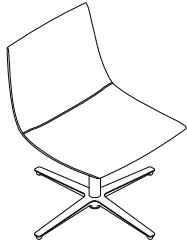
#### Noha Executive Chair - Five Casters Aluminum Base

27 3/5"	27 3/5"	36 3/5" - 41 2/7"	<b>VCBNOHEXS15R2</b>	\$1696	\$1782	\$1956	\$2130	\$2303	\$1696
---------	---------	-------------------	----------------------	--------	--------	--------	--------	--------	--------



# Chairs and Stools

## Noha



### Standard Includes

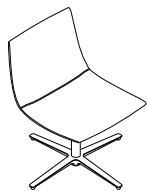
- Aluminum swivel base: powder coated paint in black or white
- Upholstery: fabric price group 01
- Piping: anthracite, burgundy, forest green, linen, white
- Glides: plastic

### Options

Upholstery Finish	Customer's Own Leather	See below
	Fabric Customer's Own Material	See below
	Fabric Price Grade 1	See below
	Fabric Price Grade 2	See below
	Fabric Price Grade 3	See below
	Fabric Price Grade 4	See below
	Fabric Price Grade 5	See below
Arms	Leather Price Grade 5	See below
	No Arms	No cost
	With Metal Arms	+\$390
	Upholstered Arms	+\$607
Arms Finish	Customer's Own Leather	No cost
	Fabric Customer's Own Material	No cost
	Fabric Price Grade 1	No cost
	Fabric Price Grade 2	+\$112
	Fabric Price Grade 3	+\$336
	Fabric Price Grade 4	+\$560
	Fabric Price Grade 5	+\$784
Tilt Option	Leather Price Grade 5	+\$784
	Without Tilting	No cost
Return Position	With Tilting	+\$65
	Without Self-Return Mechanism	No cost
Glides	With Self-Return Mechanism	+\$127
	Plastic	No cost
	Felt	+\$10

Chairs and Stools

### Specification Information



Dimensions				Style Number	Base Prices					
					Upholstery Grades:					
D	W	H			1	2	3	4	5/Leather	COM/COL
<b>Noha Standard Chair - Flat Swivel Base</b>										
28 1/9"	28 1/9"	32 2/7"	<b>VCBNOHEXSIGPL</b>		\$1511	\$1573	\$1696	\$1819	\$1942	\$1511

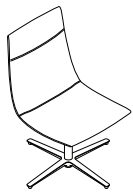
► **Product Information continued on next page**

# Chairs and Stools

## Noha

► Product Information continued from previous page

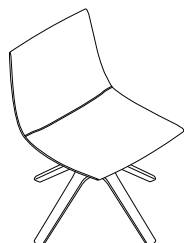
### Specification Information



Dimensions			Style Number	Base Prices						
D	W	H		Upholstery Grades:						
				1	2	3	4	5/Leather	COM/COL	
<b>Noha Executive Chair - Flat Swivel Base</b>										
28 1/9"	28 1/9"	38 1/2"	<b>VCBNOHEXSIGPL2</b>	\$1651	\$1737	\$1911	\$2085	\$2258	\$1651	

# Chairs and Stools

## Noha



### Standard Includes

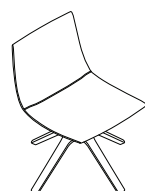
- Wooden swivel base: wood stained solid beech
- Upholstery: fabric price group 01
- Piping: anthracite, burgundy, forest green, linen, white
- Glides: plastic

### Options

Upholstery Finish	Customer's Own Leather	See below
	Fabric Customer's Own Material	See below
	Fabric Price Grade 1	See below
	Fabric Price Grade 2	See below
	Fabric Price Grade 3	See below
	Fabric Price Grade 4	See below
	Fabric Price Grade 5	See below
Arms	Leather Price Grade 5	See below
	No Arms	No cost
	With Metal Arms	+\$390
	Upholstered Arms	+\$607
Arms Finish	Customer's Own Leather	No cost
	Fabric Customer's Own Material	No cost
	Fabric Price Grade 1	No cost
	Fabric Price Grade 2	+\$112
	Fabric Price Grade 3	+\$336
	Fabric Price Grade 4	+\$560
	Fabric Price Grade 5	+\$784
Tilt Option	Leather Price Grade 5	+\$784
	Without Tilting	No cost
Return Position	With Tilting	+\$65
	Without Self-Return Mechanism	No cost
Glides	With Self-Return Mechanism	+\$127
	Plastic	No cost
	Felt	+\$10

Chairs and Stools

### Specification Information



				Base Prices						
Dimensions			Style	Upholstery Grades:						
D	W	H	Number	1	2	3	4	5/Leather	COM/COL	
<b>Noha Standard Chair - Wooden Swivel Base</b>										
28 2/3"	28 2/3"	33 1/9"	<b>VCBNOHEXSIGMA</b>	\$2167	\$2229	\$2352	\$2475	\$2598	\$2167	

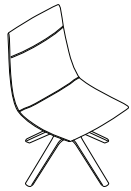
► Product Information continued on next page

# Chairs and Stools

## Noha

► Product Information continued from previous page

### Specification Information



Dimensions			Style Number	Base Prices						
D	W	H		Upholstery Grades:						
				1	2	3	4	5/Leather	COM/COL	
<b>Noha Executive Chair - Wooden Swivel Base</b>										
28 2/3"	28 2/3"	34 2/5"	<b>VCBNOHEXSIGMA2</b>	\$2307	\$2393	\$2567	\$2741	\$2914	\$2307	



# Chairs and Stools

## Perxa



### Standard Includes

- Base: powder coated paint in black or white
- Seat and backrest: stained solid ash wood
- Glides: plastic

### Options

Glides	Plastic	No cost
	Felt	+\$10

### Specification Information

Dimensions			Style	Seat and Backrest Finish	Base Price
D	W	H	Number		
<b>Perxa Chair</b>					
20 3/10"	25 1/10"	29 9/10"	<b>VCBPERSI4PMEZBR</b>	Ash, bleached oak, cognac, matte oak, or walnut oak	\$1252

### Perxa Stackable Chair

20 3/10"	25 1/10"	29 9/10"	<b>VCBPERSI4PME4ZBR</b>	Ash, bleached oak, cognac, matte oak, or walnut oak	\$1252
----------	----------	----------	-------------------------	---	--------

# Chairs and Stools

## Perxa



### Standard Includes

- Base: powder coated paint in black or white
- Seat and backrest: stained solid ash wood
- Seat cushion: fabric price group 1
- Glides: plastic

### Options

Glides	Plastic	No cost
	Felt	+\$10
Upholstery Finish	Fabric Price Grade 1	No cost
	Customer's Own Leather	Prices below
	Fabric Customer's Own Material	Prices below
	Fabric Price Grade 2	Prices below
	Fabric Price Grade 3	Prices below
	Fabric Price Grade 4	Prices below
	Fabric Price Grade 5	Prices below
	Leather Price Grade 5	Prices below

### Specification Information

Dimensions			Style Number	Seat and Backrest Finish	Base Prices					
D	W	H			Upholstery Grades:					
				1	2	3	4	5/Leather	COM/COL	

#### Perxa Chair with Upholstered Seat

20 3/10"	25 1/10"	29 9/10"	<b>VCBPERSI4PMEYBR</b>	Ash, bleached oak, cognac, matte oak, or walnut oak	\$1330	\$1392	\$1455	\$1517	\$1580	\$1330
----------	----------	----------	------------------------	---	--------	--------	--------	--------	--------	--------

Needed fabric for material 1.53 yd wide:

Seat: 0.77 yd

#### Perxa Stackable Chair with Upholstered Seat

20 3/10"	25 1/10"	29 9/10"	<b>VCBPERSI4PME4YBR</b>	Ash, bleached oak, cognac, matte oak, or walnut oak	\$1330	\$1392	\$1455	\$1517	\$1580	\$1330
----------	----------	----------	-------------------------	---	--------	--------	--------	--------	--------	--------

Needed fabric for material 1.53 yd wide:

Seat: 0.77 yd

# Chairs and Stools

**Perxa**

*Tip: Trolley can only be used with stacking Perxa chairs. It holds a maximum of four chairs.*

## Standard Includes

- Trolley: Lacquered in black

## Specification Information

Style

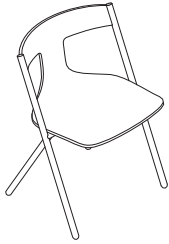
Number      Price

### Perxa Trolley

**VCBPERCT**    \$984

# Chairs and Stools

## Quadra



Tip: Style VCBQUARO is not stackable.

### Standard Includes

- Base: powder coated paint in black or white
- Seat and backrest: stained oak plywood
- Glides: plastic

### Options

Glides	Plastic	No cost
	Felt	+\$10

### Specification Information

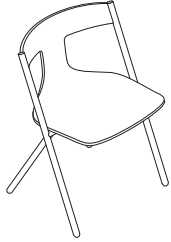
Dimensions			Style	Seat and Backrest	Base Price
D	W	H	Number	Finish	

### Quadra Chair

19 7/10"	21 7/10"	30 7/10"	<b>VCBQUARO</b>	Matte oak, cognac, ash, bleached oak, walnut oak, or white open pore	\$821
----------	----------	----------	-----------------	--	-------

# Chairs and Stools

## Quadra



Tip: Chairs can be stacked up to ten high.

### Standard Includes

- Base: powder coated paint in black or white
- Seat and backrest: stained oak plywood
- Glides: plastic

### Options

Glides	Plastic	No cost
	Felt	+\$10

### Specification Information

Dimensions			Style	Seat and Backrest	Base Price (each)
D	W	H	Number	Finish	

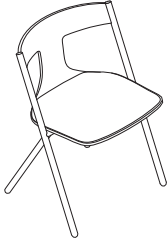
### Quadra Stackable Chair

19 7/10"	21 7/10"	30 7/10"	<b>VCBQUAROA</b>	Matte oak, cognac, ash, bleached oak, walnut oak, or white open pore	\$821
----------	----------	----------	------------------	--	-------

Chairs and Stools

# Chairs and Stools

## Quadra



### Standard Includes

- Base: powder coated paint in black or white
- Seat and backrest: stained oak plywood
- Seat cushion: fabric price group 01
- Glides: plastic

### Options

Glides	Plastic	No cost
	Felt	+\$10

### Specification Information

Dimensions			Style Number	Seat and Backrest Finish	Base Prices					
D	W	H			Upholstery Grades:					
				1	2	3	4	5/Leather	COM/COL	

### Quadra Chair with Cushion

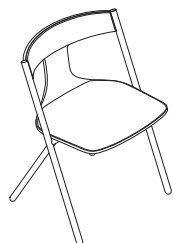
19 7/10"	21 7/10"	30 7/10"	<b>VCBQUAROC</b>	Matte oak, cognac, ash, bleached oak, walnut oak, or white open pore	\$1121	\$1244	\$1367	\$1504	\$1668	\$1121
----------	----------	----------	------------------	--	--------	--------	--------	--------	--------	--------

Needed fabric for material 1.53 yd wide:

**Cushion:** 0.77 yd

# Chairs and Stools

## Quadra



*Tip: Only one upholstery finish is required unless the contrasting option is selected, then two upholstery finishes must be entered. The highest price group will be applied if multiple price groups are selected.*

### Standard Includes

- Base: powder coated paint in black or white
- Seat and backrest: stained oak plywood
- Upholstery: fabric price group 01
- Glides: plastic

### Options

Contrasting Option	Contrasting Non Contrasting	No cost No cost
Cushion Finish	Customer's Own Leather	Prices below
	Fabric Customer's Own Material	Prices below
	Fabric Price Grade 1	Prices below
	Fabric Price Grade 2	Prices below
	Fabric Price Grade 3	Prices below
	Fabric Price Grade 4	Prices below
Back Cushion Finish	Fabric Price Grade 5	Prices below
	Leather Price Grade 5	Prices below
	Customer's Own Leather	Prices below
	Fabric Customer's Own Material	Prices below
	Fabric Price Grade 1	Prices below
	Fabric Price Grade 2	Prices below
	Fabric Price Grade 3	Prices below
	Fabric Price Grade 4	Prices below
	Fabric Price Grade 5	Prices below
	Leather Price Grade 5	Prices below
	Glides	Plastic Felt

Chairs and Stools

### Specification Information

Dimensions			Style Number	Seat and Backrest Finish	Base Prices					
D	W	H			Upholstery Grades:					
				1	2	3	4	5/Leather	COM/COL	

### Quadra Chair with Cushion and Upholstered Backrest

19 7/10"	21 7/10"	30 7/10"	<b>VCBQUAROCR</b>	Matte oak, cognac, ash, bleached oak, walnut oak, or white open pore	\$1285	\$1408	\$1530	\$1668	\$1832	\$1285
----------	----------	----------	-------------------	--	--------	--------	--------	--------	--------	--------

Needed fabric for material 1.53 yd wide:

**Backrest:** 0.44 yd

**Cushion:** 0.77 yd

# Chairs and Stools

## Quadra

*Tip: Trolley can only be used with stacking Quadra chairs VCBQUAROA. It holds a maximum of ten chairs.*

### Standard Includes

- Trolley: lacquered in black

### Specification Information

Dimensions		Style	Price
W	H	Number	

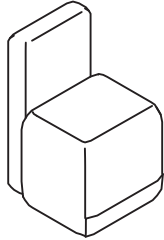
### Quadra Trolley

25 4/5"	44 1/10"	<b>VCBQUACT</b>	\$984
---------	----------	-----------------	-------



# Chairs and Stools

Season



### Standard Includes

- Upholstery: fabric price group 01
- Upholstery protection: dark or light grey technical fabric
- Fixed legs or casters

### Options

Upholstery Protection	Dark Grey	No cost
	Light Grey	No cost
Caster Opt	Fixed	See below
	With Casters	See below

### Specification Information

Dimensions			Style Number	Prices					
				Upholstery Grades:					
D	W	H		1	2	3	4	5/Leather	COM/COL

#### Season Chair with Fixed Legs

22"	20 7/10"	31 1/2"	<b>VCBSECH</b>	\$1449	\$1682	\$2119	\$2653	\$3103	\$1449
-----	----------	---------	----------------	--------	--------	--------	--------	--------	--------

#### Season Chair with Casters

22"	20 7/10"	31 1/2"	<b>VCBSECH</b>	\$1517	\$1736	\$2160	\$2721	\$3158	\$1517
-----	----------	---------	----------------	--------	--------	--------	--------	--------	--------

Needed fabric for material 1.53 yd wide:

**Upholstery:** 2.62 yd



---

# Understanding Lounge Chairs

Standard Import Lead Time

---

**Statement of Line** **240**

**Understanding**

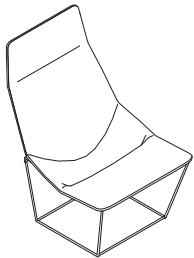
Ace	<b>244</b>
Aleta Lounge	<b>246</b>
Aleta Executive Lounge	<b>248</b>
Brix	<b>250</b>
Colubi	<b>252</b>
Copa Lounge	<b>254</b>
Fedele	<b>256</b>
Funda Lounge and Funda Bold	<b>258</b>
Maarten Lounge	<b>260</b>
Nagi	<b>262</b>
Noha and Noha Executive Lounge	<b>264</b>
Penta	<b>266</b>
Zoco	<b>267</b>

# Statement of Line

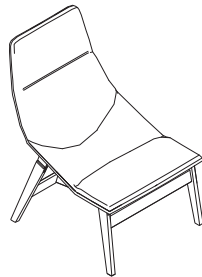
## Lounge Chairs

### Ace

Understanding  
▶ Page 244  
Specifying  
▶ Pages 270–272



**Metal Lounge Chair**



**Wood Lounge Chair without Arms**



**Wood Lounge Chair with Arms**



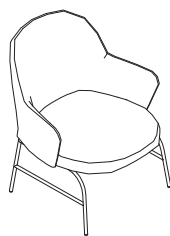
**Headrest**

### Aleta Lounge

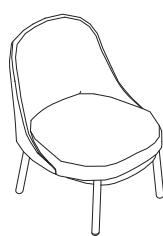
Understanding  
▶ Page 246  
Specifying  
▶ Pages 273–274



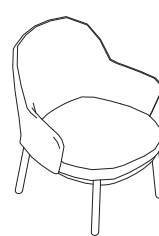
**Metal Base Lounge Chair**



**Metal Base Lounge Chair with Arms**



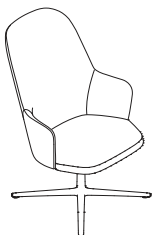
**Wood Base Lounge Chair**



**Wood Base Lounge Chair with Arms**

### Aleta Executive Lounge

Understanding  
▶ Page 248  
Specifying  
▶ Pages 275–274

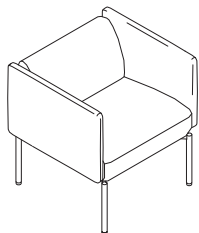


**Fully Upholstered Swivel Base Executive Lounge**



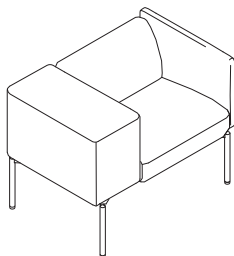
**Wooden Outer Back Swivel Base Executive Lounge**

**Brix**



**Narrow Arm Lounge Chair**

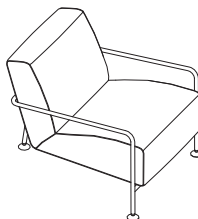
Understanding  
 ▶ Page 250  
 Specifying  
 ▶ Page 277



**Wide Arm Lounge Chair**

Understanding  
 ▶ Page 250  
 Specifying  
 ▶ Page 277

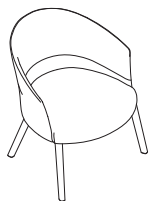
**Colubi**



**Lounge Chair**

Understanding  
 ▶ Page 252  
 Specifying  
 ▶ Page 278

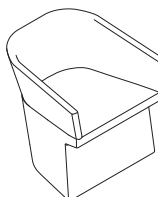
**Copa Lounge**



**Wooden Legs Lounge Chair with Upholstery**

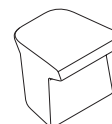
Understanding  
 ▶ Page 254  
 Specifying  
 ▶ Page 279

**Fedele**



**Lounge Chair**

Understanding  
 ▶ Page 256  
 Specifying  
 ▶ Page 280

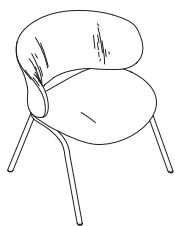


**Pouf**

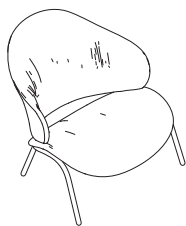
Understanding  
 ▶ Page 256  
 Specifying  
 ▶ Page 280

**Funda Lounge and Funda Bold**

Understanding  
 ▶ Page 258  
 Specifying  
 ▶ Pages 281–283



**Lounge**



**Bold Lounge**

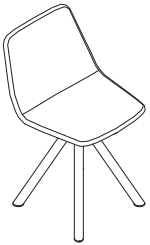


**Ottoman**

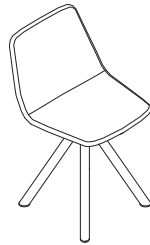
---

## Marteen Lounge

Understanding  
▶ Page 260  
Specifying  
▶ Pages 284-285



**Metal Swivel Lounge  
with Upholstery**

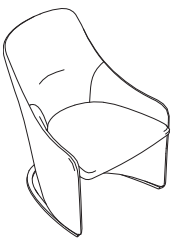


**Wooden Swivel Lounge  
with Upholstery**

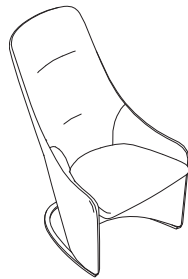
---

## Nagi

Understanding  
▶ Page 262  
Specifying  
▶ Pages 286-288



**Fixed or Rocking Low  
Back Lounge Chair  
with Upholstery**



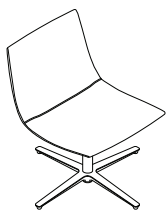
**Fixed or Rocking High  
Back Lounge Chair  
with Upholstery**



**Lounge Chair Headrest**

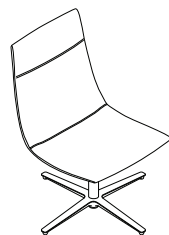
---

## Noha Lounge



**Swivel Base Standard  
Lounge**

Understanding  
▶ Page 264  
Specifying  
▶ Page 289

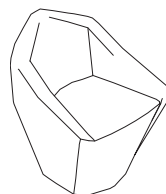


**Swivel Base Executive  
Lounge**

Understanding  
▶ Page 264  
Specifying  
▶ Page 268

---

## Penta

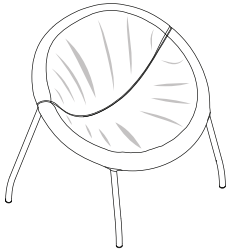


**Fixed or Swivel  
Lounge Chair**

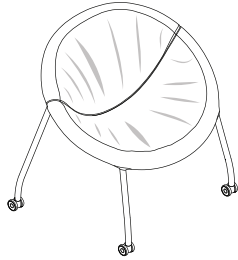
Understanding  
▶ Page 266  
Specifying  
▶ Page 291

**Zoco**

- Understanding
- ▶ Page 267
- Specifying
- ▶ Page 292



**Fixed Armchair**



**Armchair on Casters**

# Ace

**Ace**, designed by Jean-Marie Massaud, is an elegant and modern high back armchair with a relaxed design.

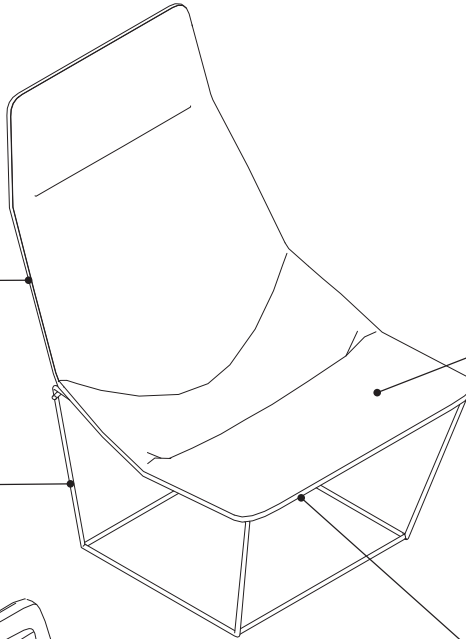
► Specifying, pages 270–270

**Back** angled for relaxed posture.

**Base** is available in metal or wood. Metal base available in powder coated steel in black or white. Wooden base available in solid oak stained or lacquered beech.

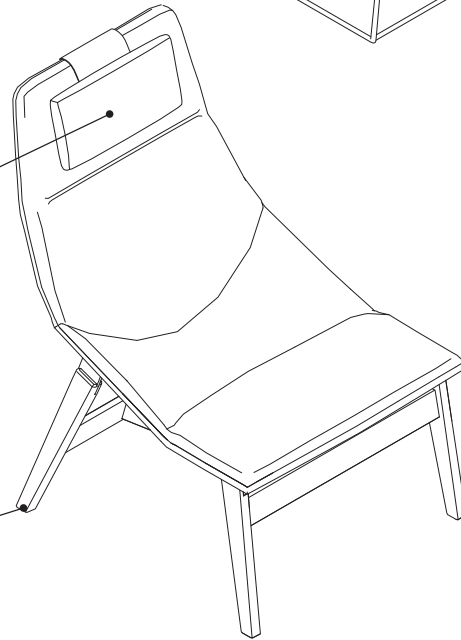
**Headrest optional accessory** adapts to the shape of the lounge chair and the height of the user. Headrest is not attached to chair and can be adjusted by the user.

**Plastic glides** are available with or without felt.



**Upholstered seat and back** available in fabric or leather.

**Zipper** specifiable in five accent colors.



## Actual Dimensions

Description	Style Number	Depth	Width	Height	Seat Depth	Seat Height	Arms Height	Weight
Metal Base	<b>VCBACA</b>	29½"	26"	38½"	19¾"	16¼"	N.A.	34.2 lbs
Wooden Base	<b>VCBACAM</b>	31¼"	25¾"	38½"	18¾"	15⅞"	N.A.	37.0 lbs
Wooden Base with Arms	<b>VCBACAM</b>	31¾"	30¾"	38½"	18¾"	15⅞"	22¾"	44.1 lbs
Headrest	<b>VCBACARE</b>	N.A.	13¾"	6¾"	N.A.	N.A.	N.A.	1.8 lbs

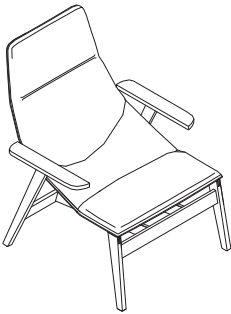


## Product Details

**Ace lounge chair** utilizes a metal or wooden structure with or without armrests to create a versatile and comfortable chair.

**Metal base** is available in powder coated paint.

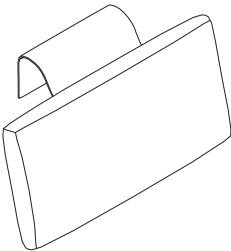
**Wooden base** will be solid oak stained.



**Wood armrests** are available on wooden base version only and will match base finish specified.

**Contrasting upholstery option** is available so the outer back varies in upholstery from the inner back and seat.

*Tip: If contrasting upholstery is specified, seat finish group and outer back finish group will be specified separately and pricing will be based on highest finish group selected.*



**Headrest accessory** adapts to the shape of the lounge and is adjustable for the height of the user. Headrest requires no additional installation and is retrofitable to all Ace lounge styles.

**Zipper** is not removable.

## Surface Materials

### Upholstery

- Fabric
- Vinyl
- Leather
- COM (Customer's Own Material)
- COL (Customer's Own Leather)

### Metal base

- 9003 White RAL
- 9005 Black RAL

### Wooden base

- Ash
- Bleached oak
- Cognac
- Matte oak
- Walnut oak

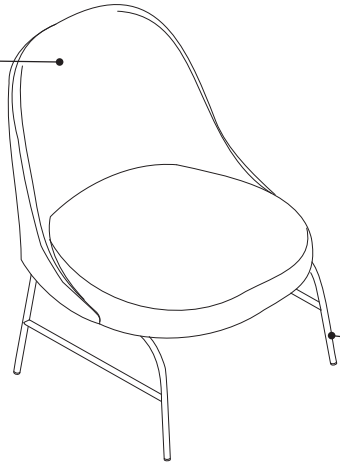
### Zipper

- Black
- Blue
- Green
- Red
- Yellow

# Aleta Lounge

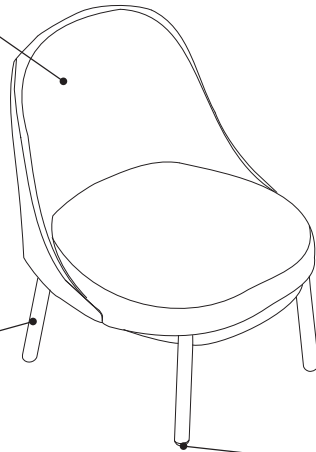
**Aleta seating** is designed by Jaime Hayon and inspired by the physiognomy and movement of sharks.  
▶ Specifying, pages 273–274

**Upholstered backrest** available in fabric, leather, or vinyl.



**Metal base** is available in brass finish or powder coated paint in black, white, or taupe.

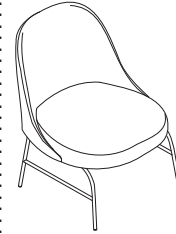
**Chairs** are available with a highback rest as well as with and without arms. Armrests are fully integrated into the seat shell.



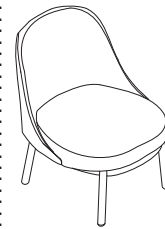
**Solid oak stained wood base** available.

**Plastic glides** without or without felt.

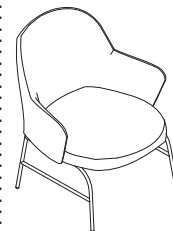
## Product Details



**Four leg metal base chairs** are available in brass finish or powder coated paint in black, white, or taupe. Legs have plastic glides with or without felt.



**Wood leg base chairs** are solid oak wood stained. Legs have plastic glides with or without felt.



**Seats** are available with or without arms.

**Contrasting fabric** is available for seat and back. *Tip: If contrasting upholstery is specified, seat finish group and back finish group will be specified separately, and pricing will be based on highest finish group selected.*

**Surface Materials****Upholstery**

- Fabric
- Vinyl
- Leather
- COM (Customer's Own Material)
- COL (Customer's Own Leather)

**Metal base**

- 1019 Taupe RAL
- 9003 White RAL
- 9005 Black RAL
- Brass finish

**Wood base**

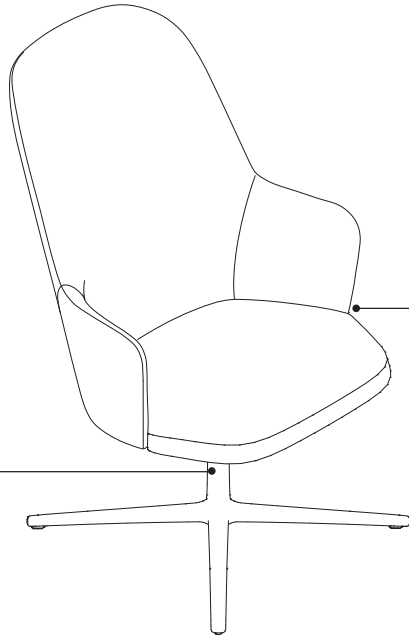
- Ash
- Bleached oak
- Cognac
- Matte oak
- Walnut oak

**Actual Dimensions**

Description	Style Number	Depth	Width	Height	Seat Depth	Seat Height	Arm Height from Floor	Weight
<b>Metal Base Lounge Chairs</b>								
Chair	<b>VCBALBUME</b>	28½"	26½"	32¼"	21¾"	16⅞"	N.A.	33.7 lb
Chair with Arms	<b>VCBALBUME BR</b>	28½"	26½"	32¼"	21¾"	16⅞"	24¾"	36.8 lb
<b>Wood Base Lounge Chairs</b>								
Chair	<b>VCBALBUMA</b>	28¾"	26"	32½"	21¾"	16⅞"	N.A.	36.2 lb
Chair with Arms	<b>VCBALBUMA BR</b>	28¾"	26"	32½"	21¾"	16⅞"	24¾"	39.2 lb

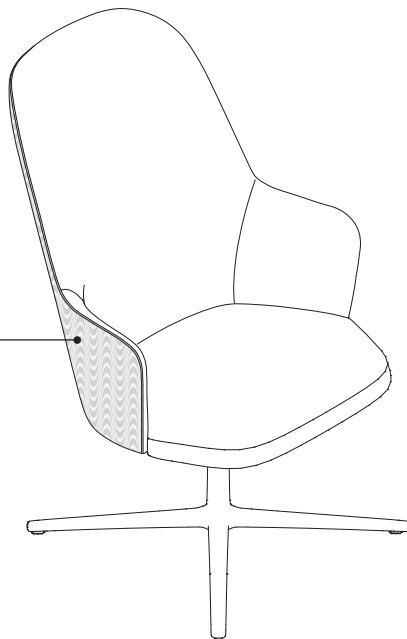
# Aleta Executive Lounge

**Aleta Executive**, designed by Jaime Hayon, is an elegant designer lounge with multiple possibilities that will keep users well seated and focused for as long as they require. An expansion of the Aleta collection, the executive lounge features a distinctive back that can be specified in eco-leather, leather, or wood. ▶ Specifying, pages 286–288



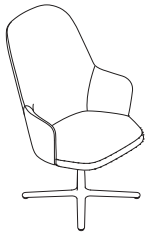
**Fully upholstered seat shell** made of plywood covered with non-deformable expanded polyurethane.

**Flat swivel aluminum base** is powder coated in black or white paint. Glides are black or translucent with or without felt.

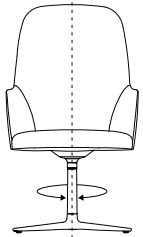


**Outer back** can be specified in eco-leather, leather, or wood.

**Product Details**



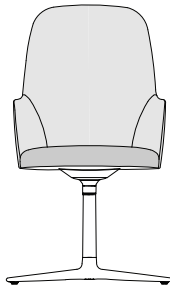
**Flat swivel base** is powder coated in black or white paint. Glides are black or translucent with or without felt.



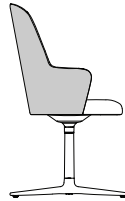
**Self-return system** is available as an option only on the flat swivel base that brings the chair to its original position after use.



**Tilting mechanism** is available as an option for all bases. On the five-star caster base, the tilting mechanism can be locked by the user.



**Contrasting fabric** is available for seat and inner back.  
*Tip: If contrasting upholstery is specified, seat finish group and back finish group will be specified separately, and pricing will be based on highest finish group selected.*



**Outer back** available in three different options:

- Standard back—outer back upholstered in the same finish as the rest of the chair
- Eco-leather/leather outer back—outer back upholstered in eco-leather or leather
- Wood outer back—outer back in polished oak veneer

**Surface Materials**

**Upholstery**

- Fabric
- Eco-Leather
- Leather
- COM (Customer's Own Material)
- COL (Customer's Own Leather)

**Wood outer back—oak**

- Ash
- Bleached oak
- Cognac
- Matte oak
- Walnut oak

**Nylon/aluminum base**

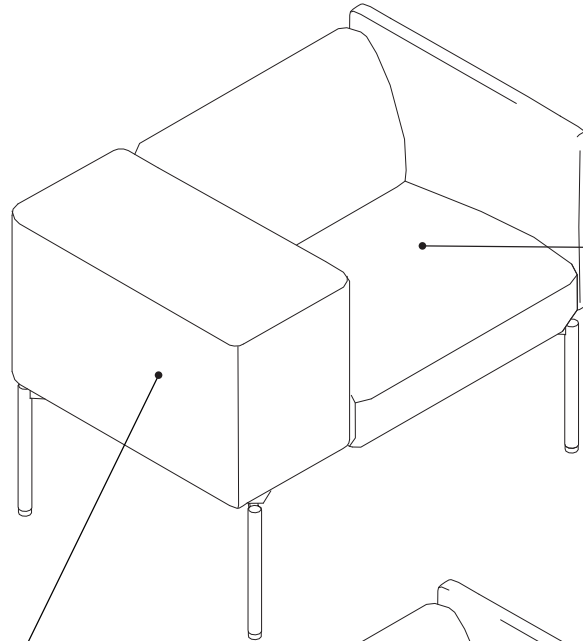
- 9003 White RAL
- 9005 Black RAL

**Actual Dimensions**

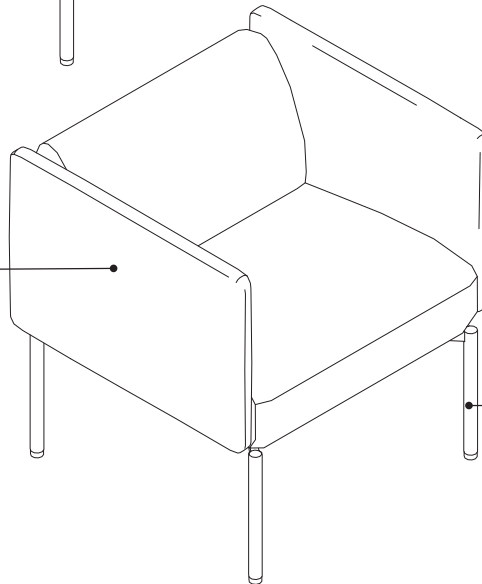
Description	Style Number	Depth	Width	Height	Seat Depth	Seat Height	Weight
Aleta Executive Lounge Chair—Fully Upholstered Flat Swivel Base	<b>VCBALEXBUPLA</b>	28 <sup>2</sup> / <sub>3</sub> "	23 <sup>1</sup> / <sub>5</sub> "	39 <sup>1</sup> / <sub>5</sub> "	18 <sup>1</sup> / <sub>9</sub> "	16 <sup>1</sup> / <sub>2</sub> "	38.58 lb
Aleta Executive Lounge Chair—Wooden Outer Back Flat Swivel Base	<b>VCBALEXBUPLARO</b>	28 <sup>2</sup> / <sub>3</sub> "	23 <sup>1</sup> / <sub>5</sub> "	39 <sup>1</sup> / <sub>5</sub> "	18 <sup>1</sup> / <sub>9</sub> "	16 <sup>1</sup> / <sub>2</sub> "	41.88 lb

# Brix

**Brix**, designed by Kenasku Oshiro, is a multipurpose lounge chair with a unique arms that can be used as a worksurface.  
 ▶ Specifying, page 277



**Upholstered seat and back.**



**Arms** available in narrow and wide styles.

**Metal base** powder coated in black or white.

## Actual Dimensions

Description	Style Number	Depth	Width	Height	Seat Height	Seat Width	Seat Depth	Weight
Narrow Arms Lounge	<b>VCBBRIXE</b>	24"	26 <sup>2</sup> / <sub>5</sub> "	27 <sup>1</sup> / <sub>5</sub> "	17 <sup>3</sup> / <sub>10</sub> "	22"	16 <sup>9</sup> / <sub>10</sub> "	51.4 lb
Wide Arms Lounge	<b>VCBBRIX</b>	24"	36 <sup>1</sup> / <sub>5</sub> "	27 <sup>1</sup> / <sub>5</sub> "	17 <sup>3</sup> / <sub>10</sub> "	22"	16 <sup>9</sup> / <sub>10</sub> "	56.9 lb

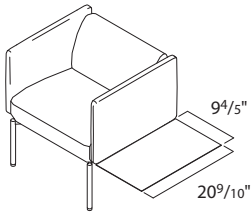
### Product Details

**Four leg metal base** is powder coated in black or white with plastic glides.

**Upholstered seat and back** available in fabric or leather.

**Arms** available in narrow and wide styles. Narrow arms are 2 $\frac{2}{5}$ "W and wide arms are 11 $\frac{1}{5}$ "W.

*Tip: Wide arm can be specified on the left or right. Left and right determined when facing the unit.*



**Side table** available as an option for both arm styles in left and right configurations. Available with lacquered MDF top.

**Side table** is approximately 11" from the floor and measures 20 $\frac{9}{10}$ "D x 9 $\frac{4}{5}$ "W.

**Plastic glides** are standard.

### Surface Materials

#### Upholstery

- Fabric
- Vinyl
- Leather
- COM (Customer's Own Material)
- COL (Customer's Own Leather)

#### Base

- 9003 White RAL
- 9005 Black RAL

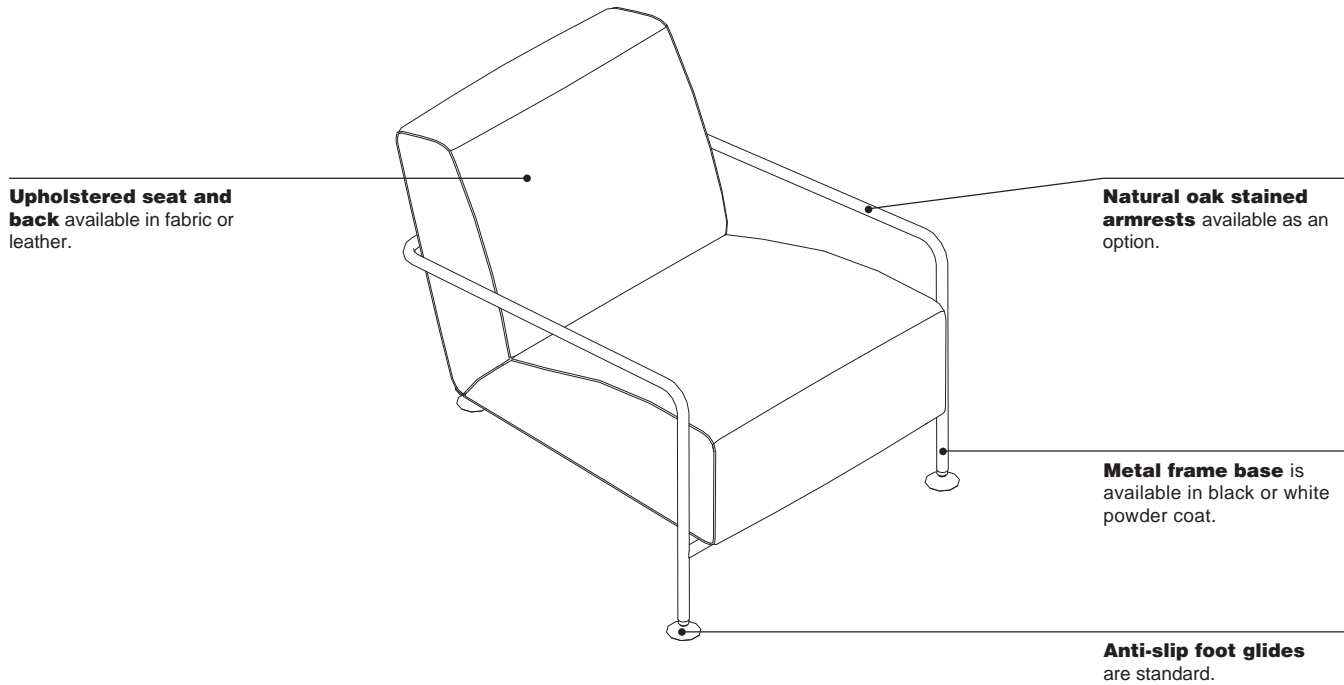
#### Side table

- 050 50 30 Brick RAL
- 060 70 20 Dusty Pink RAL
- 090 40 30 Olive Green RAL
- 1011 Ochre RAL
- 1019 Taupe RAL
- 7034 Dusty Green RAL
- 9003 White RAL
- 9005 Black RAL
- Bronze

*Tip: Lacquered finishes are smooth with the exception of black which has a microtextured finish.*

# Colubi

**Colubi**, designed by RT Design, is an upholstered armchair which displays an elegant exterior, while also ensuring high comfort.  
 ▶ Specifying, page 278



## Actual Dimensions

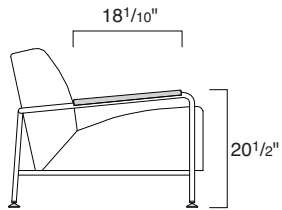
Description	Style Number	Depth	Width	Height	Seat Depth	Seat Height	Weight
Lounge Chair	<b>VCBTA04</b>	33 <sup>1</sup> / <sub>2</sub> "	26 <sup>2</sup> / <sub>5</sub> "	28"	20 <sup>9</sup> / <sub>10</sub> "	16 <sup>1</sup> / <sub>2</sub> "	41.2 lb



### Product Details

**Base** available in black or white powder coat with a thermoreinforce polyester coating.

**Seat and back** are upholstered and can be specified in fabric or leather finishes.



**Wood armrests** are stained natural oak.

### Surface Materials

#### Upholstery

- Fabric
- Vinyl
- Leather
- COM (Customer's Own Material)
- COL (Customer's Own Leather)

#### Metal base

- 9003 White RAL
- 9005 Black RAL

#### Wood armrests

- Ash
- Bleached oak
- Cognac
- Matte oak
- Walnut oak

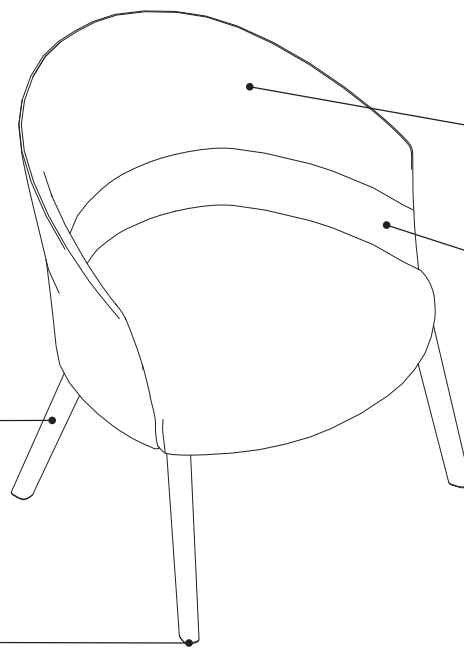
*Tip: Due to the fact the wood used is natural, the finish may vary.*

# Copa Lounge

**Copa**, designed by Ramos and Bassols, is an upholstered seating collection inspired by an elegant crystal glass. Its generous seat and enveloping design bring comfort making users feel at ease.

**Copa** has a fully upholstered shell. The outer back has an indented sewn line to provide visual interest. Thread used is defaulted to the fabric used. The upholstered shell is available in a smooth upholstery application which has a matching sew in line on the inner back. The soft upholstery provides additional visual and physical comfort. The inner back has built in comfort wrinkles.

► Specifying, page 279



**Upholstered seat and back** available in fabric or leather.

**Soft upholstery** available on the backrest.

**Solid oak wood leg base** available in stained finishes.

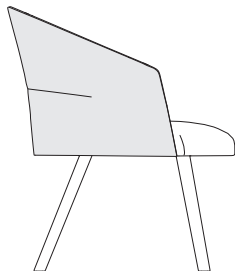
**Glides** are with or without felt.

## Actual Dimensions

Description	Style Number	Depth	Width	Height	Seat Height	Seat Depth	Weight
Wooden Legs Lounge Chair	<b>VCBCOBUMA</b>	24 <sup>2</sup> / <sub>5</sub> "	24 <sup>4</sup> / <sub>5</sub> "	27 <sup>4</sup> / <sub>5</sub> "	15 <sup>9</sup> / <sub>10</sub> "	18 <sup>9</sup> / <sub>10</sub> "	22.3 lb

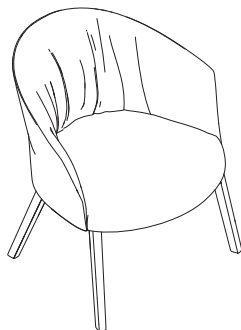
### Product Details

**Wooden base** is stained solid oak.



**Contrasting outer backrest in leather** is available when the contrasting option is selected. If contrasting is not specified, the backrest will be upholstered with the same fabric as the seat.

**Plastic glides** are available, with or without felt.



**Soft upholstery**, available on the backrest, adds comfort wrinkles providing a warm, cozy environment.

### Surface Materials

#### Upholstery

- Fabric
- Vinyl
- Leather
- COM (Customer's Own Material)
- COL (Customer's Own Leather)

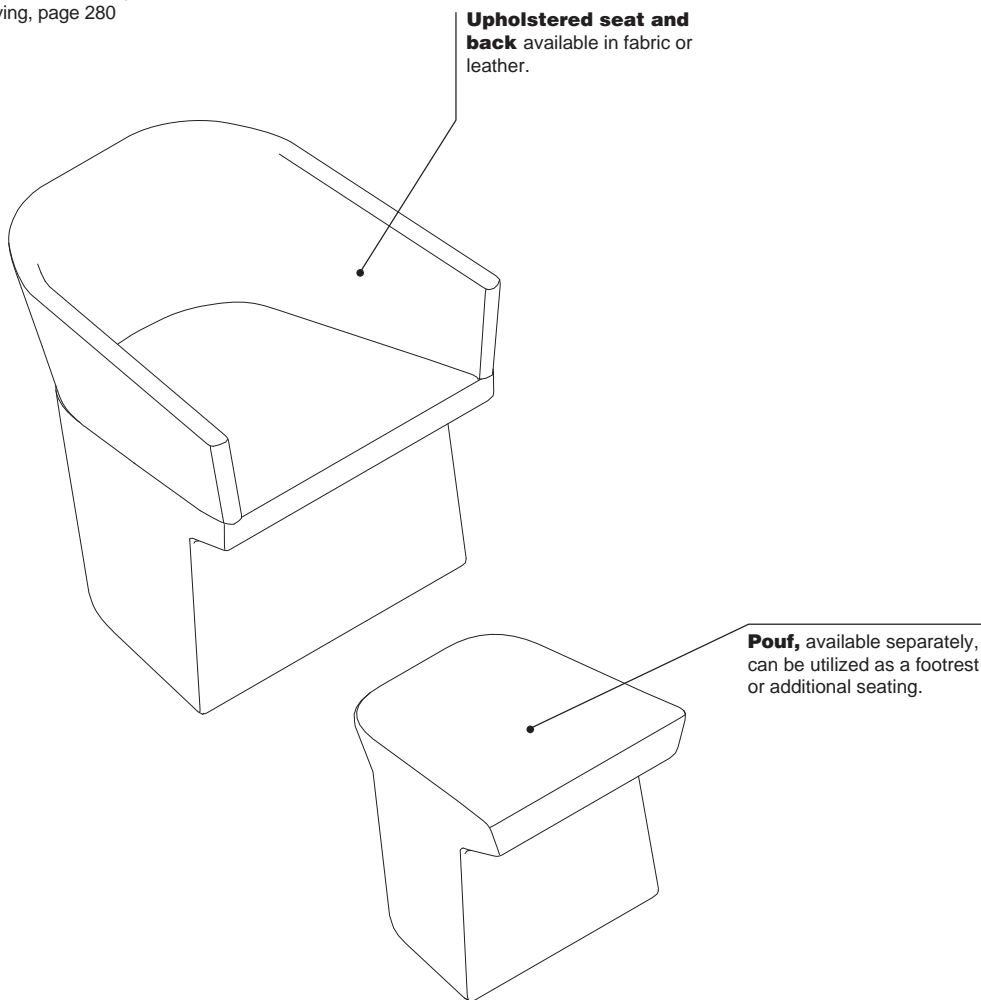
#### Wood base

- Ash
- Bleached oak
- Cognac
- Matte oak
- Walnut oak

# Fedele

**Fedele**, designed by Victor Carrasco, is an upholstered seating collection - armchair and matching pouf. Thanks to its balanced proportions, this makes it a perfect option for lounge and social settings.

► Specifying, page 280



## Product Details

**Seat and back** are upholstered and can be specified in fabric or leather finishes.

## Surface Materials

### Upholstery

- Fabric
- Leather
- COM (Customer's Own Material)
- COL (Customer's Own Leather)

## Actual Dimensions

Description	Style Number	Depth	Width	Height	Seat Height	Weight
Lounge Chair	<b>VCBFE</b>	26"	28"	27 <sup>1</sup> / <sub>5</sub> "	15 <sup>2</sup> / <sub>5</sub> "	36.4 lb
Pouf	<b>VCBFEP</b>	16 <sup>9</sup> / <sub>10</sub> "	18 <sup>3</sup> / <sub>10</sub> "	16 <sup>1</sup> / <sub>10</sub> "	N.A.	17.9 lb

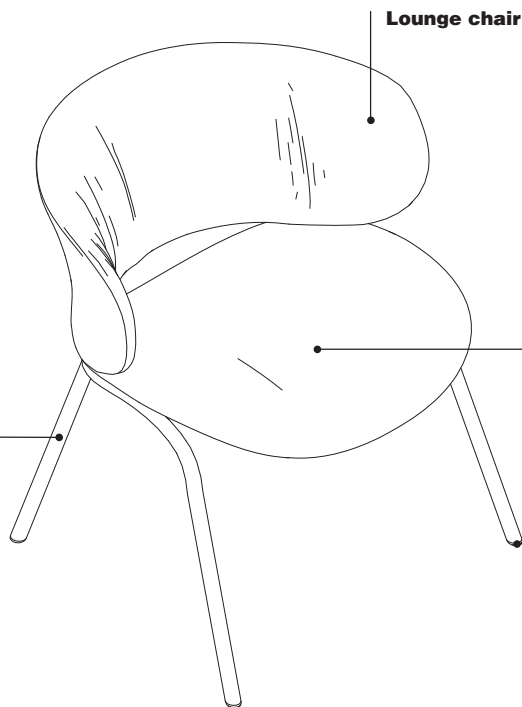


# Funda Lounge and Funda Bold

**Funda** is an upholstered seating collection designed by Stefan Diez with a commitment to maximum sustainability and comfort through an innovative and light chair. The chair is made of two different pieces: a metal structure that works as a skeleton and a wrinkled upholstered seat that shapes and brings comfort.

► Specifying, page 281

**Base** is powder coated in black or white.

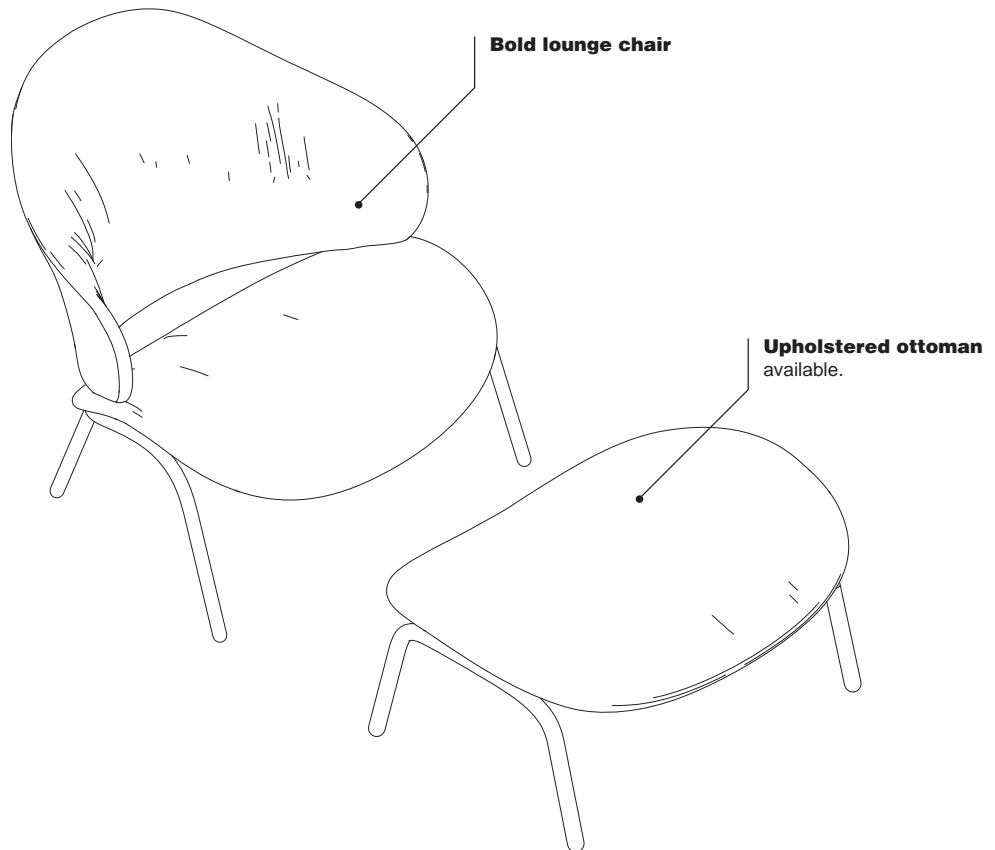


**Upholstered seat and back** can be separated from the structure for easy recycling.

**Plastic glides** are suitable for all surfaces.

**Funda Bold** is extremely comfortable with an oversize seat. Funda Bold's large silhouette and comfortable proportions are created for promoting a relaxed posture in ancillary spaces. This design represents the new era of comfort. The Funda Bold armchair promises to be roomy without losing an ounce of lightness. Its construction system is formed by a single steel tube that makes the chair light and allows it to be easily transported.

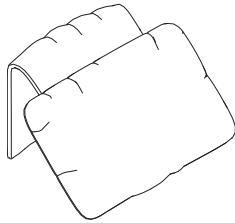
► Specifying, pages 286-261



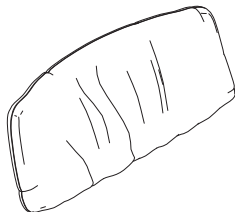
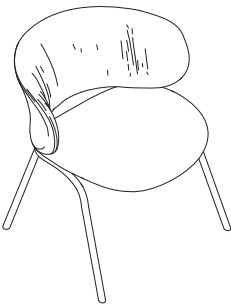
### Product Details



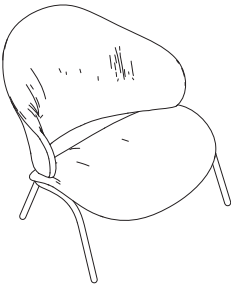
**Soft upholstery** creates a comfortable, inviting silhouette that is standard on all styles.



**Upholstered headrest** adapts to the shape of the chair and the height of the user. Headrest requires no installation.



**Upholstered cushion** is made from high performance microfiber. Cushion is designed for use with Funda Bold.



### Surface Materials

#### Upholstery

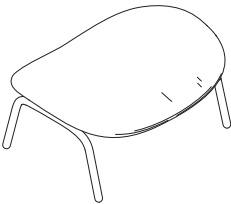
- Fabric
- Leather
- COM (Customer's Own Material)
- COL (Customer's Own Leather)

#### Metal base

- 9003 White RAL
- 9005 Black RAL

**Chairs** are powder coated in white or black with plastic glides.

**Funda seating** is not stackable.



**Ottoman** is powder coated in black or white with glides.

### Actual Dimensions

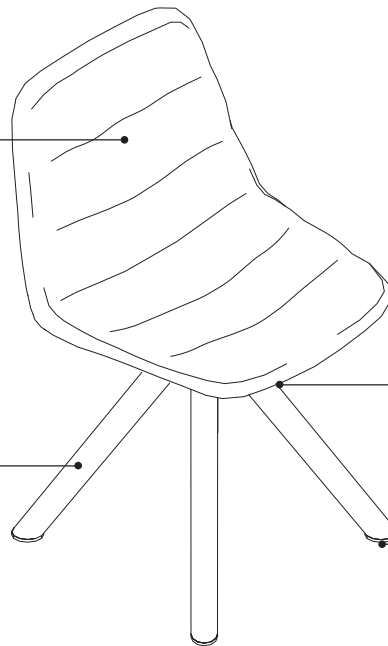
Description	Style Number	Depth	Width	Height	Seat Height	Weight
Lounge	<b>VCBFUB</b>	26"	28"	29 <sup>1</sup> / <sub>10</sub> "	14 <sup>3</sup> / <sub>5</sub> "	22.0 lb
Bold Lounge	<b>VCBFUBO</b>	37 <sup>4</sup> / <sub>5</sub> "	37 <sup>2</sup> / <sub>5</sub> "	36 <sup>3</sup> / <sub>5</sub> "	13 <sup>4</sup> / <sub>5</sub> "	44.8 lb
Ottoman	<b>VCBFUBOT</b>	26"	33 <sup>1</sup> / <sub>2</sub> "	15"	13 <sup>4</sup> / <sub>5</sub> "	21.8 lb
Cushion	<b>VCBFUBOAL</b>	N.A.	23 <sup>3</sup> / <sub>5</sub> "	11"	N.A.	2.2 lb
Headrest	<b>VCBFUBORE</b>	N.A.	13"	8 <sup>3</sup> / <sub>10</sub> "	N.A.	1.8 lb

# Maarten Lounge

**Maarten lounge**, designed by Victor Carrasco, is a versatile lounge chair available in a wide range of shell and base options. It is available with a plastic shell, plastic shell with seat cushion, smooth upholstered seat and back, and soft upholstered seat and back.  
 ▶ Specifying, pages 284–285

**Upholstered seat and back** available in smooth and soft upholstery (soft shown).

**Metal swivel base** is powder coated in black, white, or taupe.

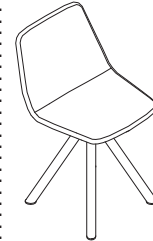


**Wood swivel base in stained solid oak.**

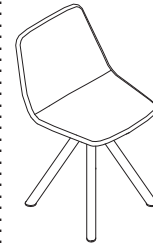
**Clear plastic glides**

## Product Details

### Base Types

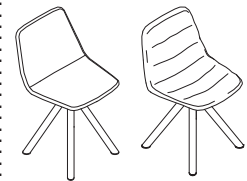


**Metal swivel base chairs** are powder coated in black, white, or taupe. Glides are clear.



**Wooden swivel base** is steel internal structure, finished with oak veneer in stained finishes. Glides are clear.

### Seat and Back Types



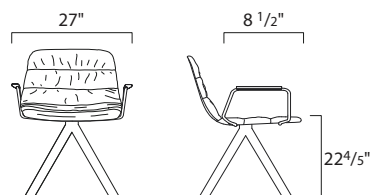
**Upholstered seat and back** available in smooth or soft.

*Tip: Soft upholstery includes intentional wrinkles that vary by chair.*

## Actual Dimensions

Description	Style Number	Depth	Width	Height	Seat Height	Seat Depth	Weight
Metal Swivel Lounge with Upholstery	<b>VCBMAAB</b>	21 <sup>3</sup> / <sub>10</sub> "	24"	30 <sup>9</sup> / <sub>10</sub> "	16 <sup>6</sup> / <sub>10</sub> "	15 <sup>7</sup> / <sub>10</sub> "	35.3 lb
Wooden Swivel Lounge with Upholstery	<b>VCBMAABM</b>	21 <sup>3</sup> / <sub>10</sub> "	24"	30 <sup>9</sup> / <sub>10</sub> "	16 <sup>6</sup> / <sub>10</sub> "	15 <sup>7</sup> / <sub>10</sub> "	35.3 lb



**Optional Accessories**

**Metal arms** are powder coated in black, white, or taupe with stained oak armrests.

**Surface Materials****Upholstery**

- Fabric
- Vinyl
- Leather
- COM (Customer's Own Material)
- COL (Customer's Own Leather)

**Metal base and arms**

- 9003 White RAL
- 9005 Black RAL
- 1019 Taupe RAL

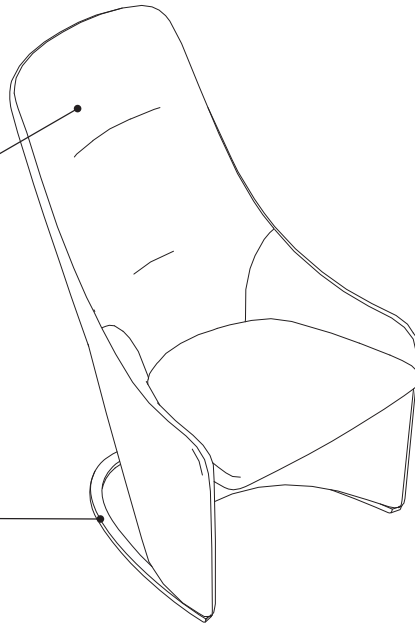
**Wood base and wood armrests**

- Ash
- Bleached oak
- Cognac
- Matte oak
- Walnut oak

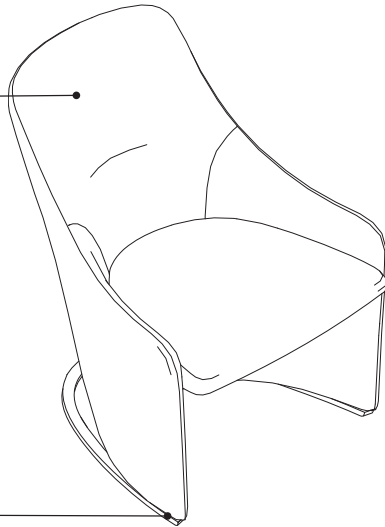
# Nagi

**Nagi**, designed by Tomoya Tabuchi, is a fixed or rocking lounge chair which offers extra comfort for collaborative work-spaces.  
 ▶ Specifying, pages 286–288

**Backrest** is available in low or high.



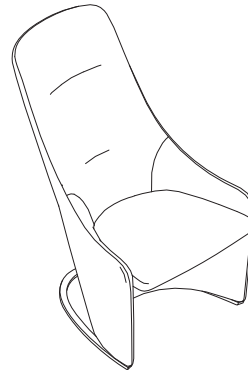
**Fixed or rocking base** available in brass finish or powder coated in black or white.



**Upholstered seat and back** available in fabric or leather. Available in both smooth and soft upholstery options. The soft upholstery adds visual comfort and interest. Comfort wrinkles are unique on each chair.

**Nylon glides**

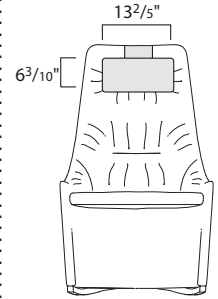
## Product Details



**Seat and back** are upholstered and can be specified in fabric or leather finishes.

**Fixed or rocking base** available in brass finish or powder coated in black or white.

**Nagi** is available in both smooth and soft upholstery options. The soft upholstery adds visual comfort and interest. Comfort wrinkles are unique on each chair.



**Upholstered headrest** is available and measures 13<sup>2/5</sup>"W x 6<sup>3/10</sup>"H and requires no installation. The headrest adapts to the shape of the chair and can be adjusted to various heights.

## Surface Materials

### Upholstery

- Fabric
- Vinyl
- Leather
- COM (Customer's Own Material)
- COL (Customer's Own Leather)

### Base

- 9003 White RAL
- 9005 Black RAL
- Brass finish

## Actual Dimensions

Description	Style Number	Depth	Width	Height	Seat Depth	Seat Height	Integrated Arm Height	Weight
Low Backrest	<b>VCBNAGIB</b>	28 <sup>3/10</sup> "	26 <sup>4/5</sup> "	31 <sup>1/2</sup> "	18 <sup>1/2</sup> "	16 <sup>3/10</sup> "	20 <sup>1/10</sup> "	47.0 lb
High Backrest	<b>VCBNAGI</b>	36 <sup>1/5</sup> "	26 <sup>4/5</sup> "	39 <sup>2/5</sup> "	18 <sup>1/2</sup> "	16 <sup>3/10</sup> "	20 <sup>1/10</sup> "	56.0 lb



# Noha

**Noha**, designed by Ludovica+Roberto Palomba, stands out for the sophisticated smooth lines of its backrest and its cleverly balanced seat that mimics a folded pillow. With or without armrests, with standard or executive backrest, Noha is a great addition to lounge areas that seek friendlier shapes to make their teams feel comfortable and cared for.

► Specifying, page 286



**Executive backrest** is available for the lounge.

**Upholstery** available in fabric, vinyl, or leather.

**Flat swivel aluminum base** is powder coated in black or white paint. Glides are black or translucent with or without felt.

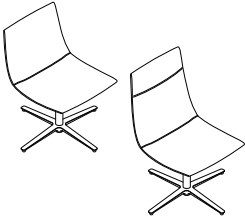
**Upholstered arms** available as an option.

**Metal arms** available as an option.

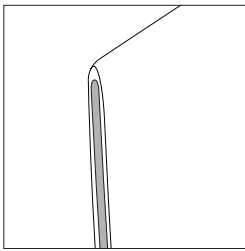
## Actual Dimensions

Description	Style Number	Depth	Width	Height	Seat Depth	Seat Height	Weight
Noha Standard Chair—Flat Swivel Base	<b>VCBNOHEXBUGPL</b>	28 <sup>1</sup> / <sub>9</sub> "	28 <sup>1</sup> / <sub>9</sub> "	30 <sup>1</sup> / <sub>2</sub> "	17 <sup>2</sup> / <sub>3</sub> "	16 <sup>1</sup> / <sub>3</sub> "	29.1 lb
Noha Executive Chair—Flat Swivel Base	<b>VCBNOHEXBUGPL2</b>	28 <sup>1</sup> / <sub>9</sub> "	28 <sup>1</sup> / <sub>9</sub> "	36 <sup>5</sup> / <sub>7</sub> "	17 <sup>2</sup> / <sub>3</sub> "	16 <sup>1</sup> / <sub>3</sub> "	32.6 lb

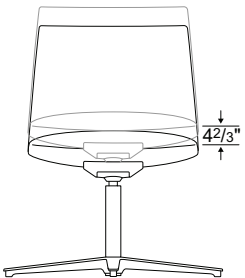
**Product Details**



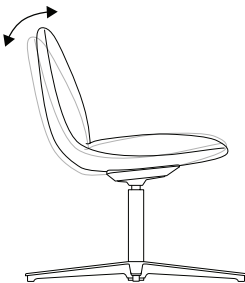
**Noha** is available with either a standard or executive backrest.



**Piping** available in five colors—anthracite, burgundy, forest green, linen, or white.



**Self-return system**, available as an option on the flat swivel and wooden swivel bases, brings the chair to its original position after use.



**Tilting mechanism** is available as an option.

**Surface Materials**

**Upholstery**

- Fabric
- Vinyl
- Leather
- COM (Customer's Own Material)
- COL (Customer's Own Leather)

**Piping**

- Anthracite
- Burgundy
- Forest Green
- Linen
- White

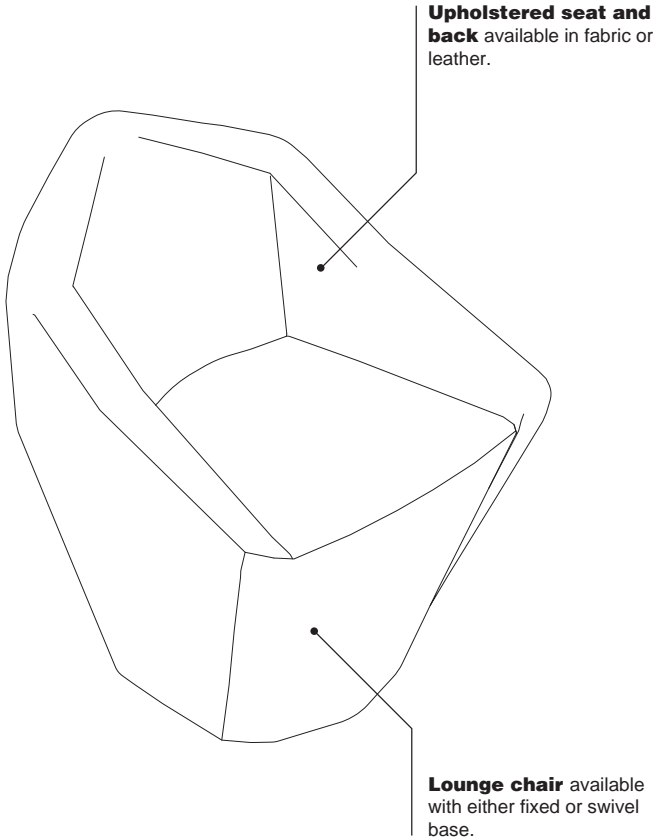
**Flat swivel aluminum base**

- 9003 White RAL
- 9005 Black RAL

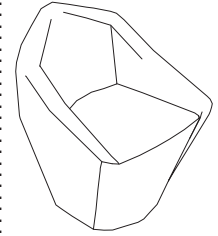
# Penta

**Penta**, designed by Toan Nguyen, makes the perfect lounge chair, with the right amount of comfort. This modern lounge chair adds flexibility and a distinct aesthetic to collaborative spaces.

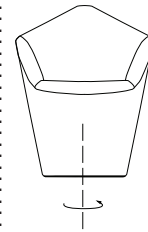
► Specifying, page 291



## Product Details



**Seat and back** are upholstered and can be specified in fabric or leather finishes.



**Penta** is available with either fixed or swivel base option, which is hidden under the chair.

## Surface Materials

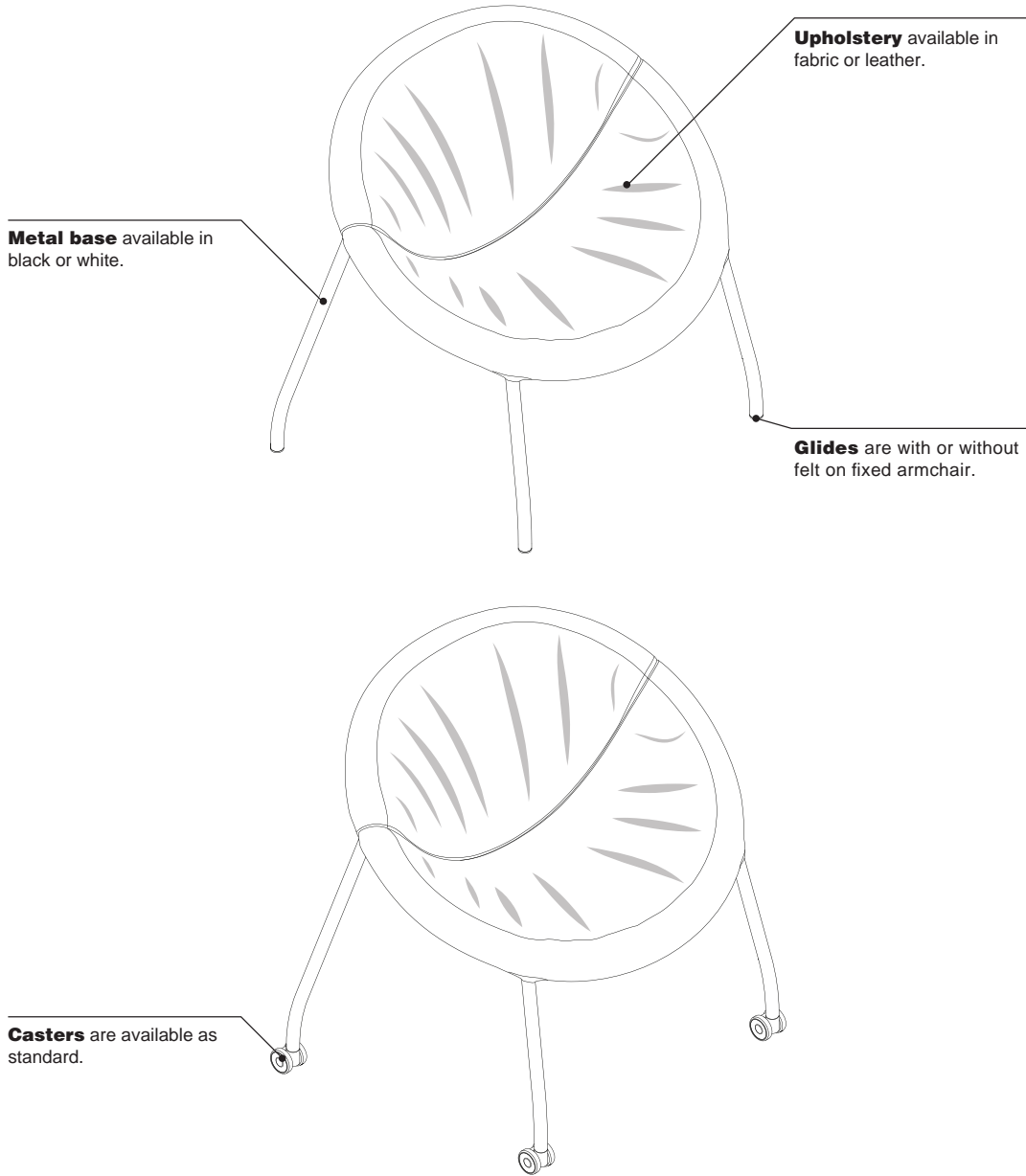
### Upholstery

- Fabric
- Leather
- COM (Customer's Own Material)
- COL (Customer's Own Leather)

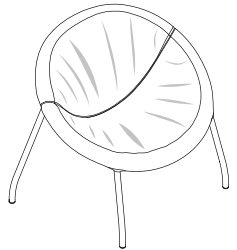
## Actual Dimensions

Description	Style Number	Depth	Width	Height	Seat Height	Weight
Fixed Lounge Chair	<b>VCBPE</b>	26 <sup>2</sup> / <sub>5</sub> "	25 <sup>3</sup> / <sub>5</sub> "	31 <sup>1</sup> / <sub>2</sub> "	17 <sup>9</sup> / <sub>10</sub> "	57.5 lb
Swivel Lounge Chair	<b>VCBPE</b>	26 <sup>2</sup> / <sub>5</sub> "	25 <sup>3</sup> / <sub>5</sub> "	31 <sup>1</sup> / <sub>2</sub> "	17 <sup>9</sup> / <sub>10</sub> "	62.8 lb

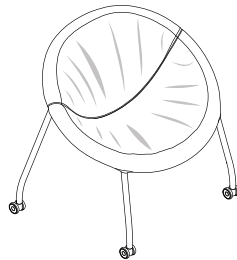
**Zoco**, designed by Victor Carrasco, is a modern lounge chair with a comfortable, well-balanced rounded silhouette.  
 ▶ Specifying, page 292



**Product Details**



**Fixed armchair metal base** is powder coated in black or white and upholstered in fabric or leather. Glides are with or without felt.



**Armchair on casters metal base** is powder coated in black or white and upholstered in fabric or leather. Casters come standard.

**Surface Materials**

- Upholstery**
- Fabric
  - Leather
  - COM (Customer's Own Material)
  - COL (Customer's Own Leather)

- Metal base**
- 9003 White RAL
  - 9005 Black RAL

Lounge Chairs

**Actual Dimensions**

Description	Style Number	Depth	Width	Height	Seat Depth	Weight
Fixed armchair		26"	33 <sup>3</sup> / <sub>10</sub> "	29 <sup>1</sup> / <sub>10</sub> "	18 <sup>1</sup> / <sub>10</sub> "	44.7 lb
Armchair on casters	<b>VCBZOR</b>	26"	33 <sup>3</sup> / <sub>10</sub> "	31 <sup>1</sup> / <sub>10</sub> "	18 <sup>1</sup> / <sub>10</sub> "	44.7 lb





---

# Specifying Lounge Chairs

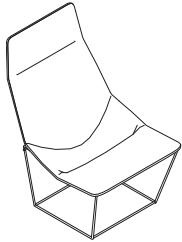
Standard Import Lead Time

## Specifying

Ace	270
Aleta Lounge	273
Aleta Executive Lounge	275
Brix	277
Colubi	278
Copa Lounge	279
Fedele	280
Funda Lounge	281
Maarten Lounge	284
Nagi	286
Noha and Noha Executive Lounge	289
Penta	291
Zoco	292

# Lounge Chairs

## Ace



Tip: Ace headrest is available separately **VCBACARE**.

Tip: Unless contrasting option is selected, only one upholstery finish is required. If contrasting option is selected, both a seat and back finish is required. The highest price group will be applied if multiple price groups are selected.

### Standard Includes

- Base: powder coated paint in black or white
- Upholstery: fabric price group 01
- Zip-around closure: black, blue, green, red, or yellow
- Glides: plastic

### Options

Contrasting Option	Contrasting	No cost
	Non Contrasting	No cost
Back Finish	Fabric Price Grade 1	No cost
	Customer's Own Leather	Prices below
	Fabric Customer's Own Material	Prices below
	Fabric Price Grade 2	Prices below
	Fabric Price Grade 3	Prices below
	Fabric Price Grade 4	Prices below
Seat Finish	Fabric Price Grade 5	Prices below
	Leather Price Grade 5	Prices below
	Fabric Price Grade 1	No cost
	Customer's Own Leather	Prices below
	Fabric Customer's Own Material	Prices below
	Fabric Price Grade 2	Prices below
Glides	Fabric Price Grade 3	Prices below
	Fabric Price Grade 4	Prices below
	Fabric Price Grade 5	Prices below
	Leather Price Grade 5	Prices below
	Plastic	No cost
	Felt	+\$10

### Specification Information

Dimensions			Style Number	Base Prices					
				Upholstery Grades:					
D	W	H		1	2	3	4	5/Leather	COM/COL

### Ace Metal Lounge Chair

29 1/2"    26"    38 1/5"    **VCBACA**    \$2776    \$3035    \$3569    \$4129    \$4636    \$2776

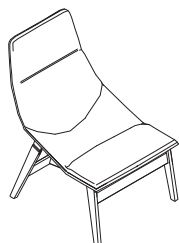
Needed fabric for material 1.53 yd wide:

**Non-Contrasting:** 2.73 yd

**Contrasting:** Front 1.15 yd / back 1.59 yd

# Lounge Chairs

**Ace**



Tip: Ace headrest is available separately **VCBACARE**.

Tip: Unless contrasting option is selected, only one upholstery finish is required. If contrasting option is selected, both a seat and back finish is required. The highest price group will be applied if multiple price groups are selected.

## Standard Includes

- Base: wood stained solid oak
- Upholstery: fabric price group 01
- Zip-around closure: black, blue, green, red, or yellow
- Glides: plastic

## Options

Contrasting Option	Contrasting	No cost
	Non Contrasting	No cost
Back Finish	Fabric Price Grade 1	No cost
	Customer's Own Leather	Prices below
	Fabric Customer's Own Material	Prices below
	Fabric Price Grade 2	Prices below
	Fabric Price Grade 3	Prices below
	Fabric Price Grade 4	Prices below
Seat Finish	Fabric Price Grade 5	Prices below
	Leather Price Grade 5	Prices below
	Fabric Price Grade 1	No cost
	Customer's Own Leather	Prices below
	Fabric Customer's Own Material	Prices below
	Fabric Price Grade 2	Prices below
Glides	Fabric Price Grade 3	Prices below
	Fabric Price Grade 4	Prices below
	Fabric Price Grade 5	Prices below
	Leather Price Grade 5	Prices below
	Felt	No cost
	Plastic	No cost

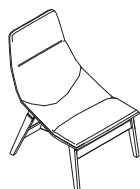
Lounge Chairs

## Specification Information

Dimensions			Style Number	Base Prices					
D	W	H		Upholstery Grades:					
				1	2	3	4	5/Leather	COM/COL

### Ace Wood Lounge Chair without Arms

31 1/10"	25 3/5"	38 4/5"	<b>VCBACAM</b>	\$4212	\$4594	\$5319	\$6097	\$6795	\$4212
----------	---------	---------	----------------	--------	--------	--------	--------	--------	--------



### Ace Wood Lounge Chair with Arms

31 9/10"	30 3/10"	38 1/5"	<b>VCBACAM</b>	\$4854	\$5278	\$6139	\$7028	\$7835	\$4854
----------	----------	---------	----------------	--------	--------	--------	--------	--------	--------



Needed fabric for material 1.53 yd wide:

**Non-Contrasting:** 2.73 yd

**Contrasting:** Front 1.15 yd / back 1.59 yd

# Lounge Chairs

## Ace



*Tip: Ace headrest is not attached to Ace lounge and can be added to any Ace lounge chair.*

### Standard Includes

- Upholstery: fabric price group 01

### Specification Information

Dimensions		Style	Prices					COM/COL
W	H	Number	Upholstery Grades:					
			1	2	3	4	5/Leather	

### Ace Headrest

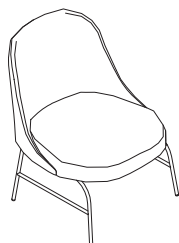
13 2/5"	6 3/10"	<b>VCBACARE</b>	\$274	\$287	\$368	\$437	\$506	\$274
---------	---------	-----------------	-------	-------	-------	-------	-------	-------

Needed fabric for material 1.53 yd wide:

**Headrest:** 0.77 yd

# Lounge Chairs

## Aleta Lounge



*Tip: Unless contrasting option is selected, only one upholstery finish is required. If contrasting option is selected, both a seat and back finish is required. The highest price group will be applied if multiple price groups are selected.*

### Standard Includes

- Base: brass finish or powder coated paint in black, white, or taupe
- Upholstery: fabric price group 01
- Glides: plastic

### Options

Option	Options	Price
Contrasting Option	Contrasting	No cost
	Non Contrasting	No cost
Glides	Plastic	No cost
	Felt	+\$10
Back Finish	Fabric Price Grade 1	No cost
	Customer's Own Leather	Prices below
	Fabric Customer's Own Material	Prices below
	Fabric Price Grade 2	Prices below
	Fabric Price Grade 3	Prices below
	Fabric Price Grade 4	Prices below
Seat Finish	Fabric Price Grade 5	Prices below
	Leather Price Grade 5	Prices below
	Fabric Price Grade 1	No cost
	Customer's Own Leather	Prices below
	Fabric Customer's Own Material	Prices below
Seat Finish	Fabric Price Grade 2	Prices below
	Fabric Price Grade 3	Prices below
	Fabric Price Grade 4	Prices below
	Fabric Price Grade 5	Prices below
	Leather Price Grade 5	Prices below

Lounge Chairs

### Specification Information



Dimensions			Style Number	Base Finish Group	Base Prices						
D	W	H			Upholstery Grades:						
28 1/2"	26 1/5"	32 1/10"	<b>VCBALBUME</b>	Paint	\$2756	\$3055	\$3623	\$4012	\$4375	\$2756	
				Brass	\$3699	\$3986	\$4574	\$4949	\$5312	\$3699	

Needed fabric for material 1.53 yd wide:  
**Non-Contrasting:** 2.62 yd  
**Contrasting:** Seat 1.53 yd / back 1.57 yd

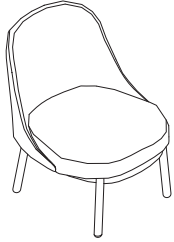


Dimensions			Style Number	Base Finish Group	Base Prices						
D	W	H			Upholstery Grades:						
28 1/2"	26 1/5"	32 1/10"	<b>VCBALBUME BR</b>	Paint	\$3548	\$3807	\$4375	\$4751	\$5127	\$3548	
				Brass	\$4485	\$4751	\$5312	\$5688	\$6077	\$4485	

Needed fabric for material 1.53 yd wide:  
**Non-Contrasting:** 2.73 yd  
**Contrasting:** Seat 1.53 yd / back and arms 1.70 yd

# Lounge Chairs

## Aleta Lounge



*Tip: Unless contrasting option is selected, only one upholstery finish is required. If contrasting option is selected, both a seat and back finish is required. The highest price group will be applied if multiple price groups are selected.*

### Standard Includes

- Base: wood stained solid oak
- Upholstery: fabric price group 01
- Glides: plastic

### Options

Option	Options	Price
Contrasting Option	Contrasting	No cost
	Non Contrasting	No cost
Glides	Felt	No cost
	Plastic	No cost
Back Finish	Fabric Price Grade 1	No cost
	Customer's Own Leather	Prices below
	Fabric Customer's Own Material	Prices below
	Fabric Price Grade 2	Prices below
	Fabric Price Grade 3	Prices below
	Fabric Price Grade 4	Prices below
	Fabric Price Grade 5	Prices below
Seat Finish	Leather Price Grade 5	Prices below
	Fabric Price Grade 1	No cost
	Customer's Own Leather	Prices below
	Fabric Customer's Own Material	Prices below
	Fabric Price Grade 2	Prices below
	Fabric Price Grade 3	Prices below
	Fabric Price Grade 4	Prices below
Fabric Price Grade 5	Prices below	
	Leather Price Grade 5	Prices below

### Specification Information

Dimensions	Style	Base Prices							
		Upholstery Grades:							
D	W	H	Number	1	2	3	4	5/Leather	COM/COL

#### Aleta Wood Base Lounge Chair

28 3/10" 26" 32 1/2" **VCBALBUMA** \$3562 \$3733 \$4089 \$4949 \$5312 \$3562

Needed fabric for material 1.53 yd wide:

**Non-Contrasting:** 2.62 yd

**Contrasting:** Seat 1.53 yd / back 1.57 yd



#### Aleta Wood Base Lounge Chair with Arms

28 3/10" 26" 32 1/2" **VCBALBUMABR** \$4375 \$4539 \$4827 \$5688 \$6077 \$4375

Needed fabric for material 1.53 yd wide:

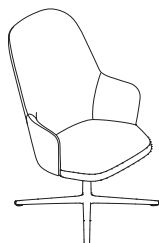
**Non-Contrasting:** 2.73 yd

**Contrasting:** Seat 1.53 yd / back and arms 1.70 yd



# Lounge Chairs

## Aleta Lounge



### Standard Includes

- Aluminum swivel base: powder coated paint in black or white
- Upholstery: fabric price group 01
- Wooden outer backrest: wood stained solid oak, if selected
- Glides: plastic

### Options

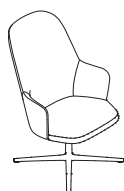
Contrasting Option	Contrasting Back and Seat	No cost
	Contrasting with Wood Outer Back	No cost
	Non-Contrasting	No cost
	Non-Contrasting with Wood Outer Back	No cost
	Contrasting with Leather Outer Back	Eco Leather: +\$139 Leather: +\$462
	Non-Contrasting with Leather Outer Back	Eco Leather: +\$139 Leather: +\$462
Back Finish	Fabric Price Grade 1	No cost
	Stain Price Group 1	No cost
	Customer's Own Leather	Prices below
	Fabric Customer's Own Material	Prices below
	Fabric Price Grade 2	Prices below
	Fabric Price Grade 3	Prices below
	Fabric Price Grade 4	Prices below
	Fabric Price Grade 5	Prices below
	Leather Price Grade 5	Prices below
	Fabric Price Grade 2	Prices below
Leather Price Grade 5	Prices below	
Seat Finish	Fabric Price Grade 1	No cost
	Customer's Own Leather	Prices below
	Fabric Customer's Own Material	Prices below
	Fabric Price Grade 2	Prices below
	Fabric Price Grade 3	Prices below
	Fabric Price Grade 4	Prices below
	Fabric Price Grade 5	Prices below
	Leather Price Grade 5	Prices below
Tilt Option	Without Tilting	No cost
	With Tilting	+\$65
Return Position	Without Self-Return Mechanism	No cost
	With Self-Return Mechanism	+\$127
Glides	Plastic	No cost
	Felt	+\$10

*Tip: Unless contrasting option is selected, only one upholstery finish is required. If contrasting option is selected, both a seat and back finish is required. The highest price group will be applied if multiple price groups are selected.*

Lounge Chairs

### Specification Information

Dimensions			Style Number	Base Prices					
Depth	Width	Height		1	2	3	4	5/Leather	COM/COL
<b>Aleta Executive Lounge Chair - Fully Upholstered Flat Swivel Base</b>									
28 2/3"	28 2/3"	39 1/5"	<b>VCBALEXBUPLA</b>	\$2541	\$2680	\$2850	\$3050	\$3256	\$2541



► **Product Information continued on next page**

# Lounge Chairs

## Aleta Lounge

► Product Information continued from previous page

### Specification Information



Dimensions			Style Number	Base Prices					
Depth	Width	Height		1	2	3	4	5/Leather	COM/COL
<b>Aleta Executive Lounge Chair - Wooden Outer Back Flat Swivel Base</b>									
28 2/3"	28 2/3"	39 1/5"	<b>VCBALEXBUPLARO</b>	\$2911	\$3067	\$3230	\$3434	\$3633	\$2911

Needed fabric for material 1.56 yd wide:

**Non-Contrasting:** Fabric 2.18 yd / Leather 5.79 yd

**Contrasting:** Fabric 1.09 yd / fabric back 1.74 yd, Leather seat 1.31 yd / Leather back 4.48 yd

**Non-Contrasting with leather outer back:** Fabric seat and front of back 1.74 yd, Eco-leather back 3.6 yd, Leather back 2.4 yd

**Contrasting with leather outer back:** Fabric seat 1.09 yd / fabric front of back 1.2 yd, Eco-leather back 1.2 yd, Leather back 2.4 yd

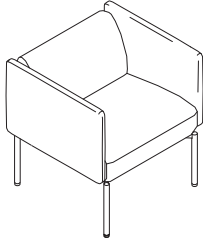
**Non-Contrasting with wood outer back:** Fabric seat and front of back 1.74 yd, Leather seat and back front 3.71 yd

**Contrasting with wood outer back:** Fabric seat 1.09 yd / fabric front of back 1.2 yd, Leather seat 1.31 yd / Leather front of back 2.4 yd



# Lounge Chairs

**Brix**



Tip: Wide arm position selection available on VCBBRIX only.

## Standard Includes

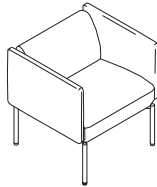
- Internal frame: wood
- Expanded polyurethane foam
- Upholstery: fabric price group 01
- Calibrated steel structure: powder coated paint in black or white
- Glides: plastic

## Options

Table	No Table	No cost
	With Table Left Side Facing	+\$397
	With Table Right Side Facing	+\$397
Table Finish	Lacquers MDF Microtexture PG1 (Black)	No cost
	Lacquers on MDF PG1	No cost
	Lacquers on MDF PG2	+\$27
	Lacquers on MDF PG3	+\$40
Wide Arm Position	Wide Arm Left Side Facing	No cost
	Wide Arm Right Side Facing	No cost

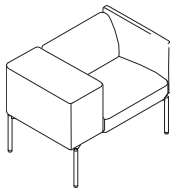
## Specification Information

Dimensions			Style	Base Prices					
				Upholstery Grades:					
D	W	H	Number	1	2	3	4	5/Leather	COM/COL



### Brix Narrow Arm Lounge Chair

24"	26 2/5"	27 1/5"	<b>VCBBRIXE</b>	\$2612	\$2817	\$3268	\$3802	\$4444	\$2612
Needed fabric for material 1.53 yd wide: Upholstery: 2.52 yd									



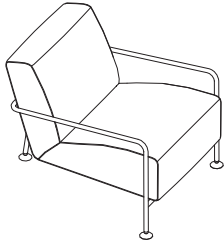
### Brix Wide Arm Lounge Chair

24"	36 1/5"	27 1/5"	<b>VCBBRIX</b>	\$2735	\$2953	\$3418	\$4007	\$4676	\$2735
Needed fabric for material 1.53 yd wide: Upholstery: 2.84 yd									

Lounge Chairs

# Lounge Chairs

## Colubi



### Standard Includes

- Base: powder coated paint in black or white
- Upholstery: fabric price group 01
- Armrests: stained natural oak, if selected
- Glides: plastic

### Options

Upholstery Finish	Fabric Price Grade 1	No cost
	Customer's Own Leather	Prices below
	Fabric Customer's Own Material	Prices below
	Fabric Price Grade 2	Prices below
	Fabric Price Grade 3	Prices below
	Fabric Price Grade 4	Prices below
	Fabric Price Grade 5	Prices below
Arm Rest Option	No Arm Rests	No cost
	With Arm Rests	No cost

### Specification Information

Dimensions			Style Number	Base Prices					
D	W	H		Upholstery Grades:					
				1	2	3	4	5/Leather	COM/COL

### Colubi Lounge Chair

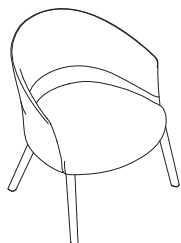
33 1/2"    26 2/5"    28"    **VCBTA04**    No cost    No cost    No cost    No cost    No cost    No cost

Needed fabric for material 1.53 yd wide:

**Upholstery:** 2.19 yd

# Lounge Chairs

## Copa Lounge



*Tip: Unless contrasting option is selected, only one upholstery finish is required. If contrasting option is selected, both a seat and back finish is required. The highest price group will be applied if multiple price groups are selected.*

*Tip: When contrasting backrest is selected, outer back is upholstered in leather.*

### Standard Includes

- Base: wood stained solid oak
- Upholstery: fabric price group 01
- Glides: plastic

### Options

Upholstery Version	Smooth Upholstery Soft Upholstery	Prices below Prices below
Contrasting Option	Non Contrasting Contrasting Backrest	No cost +\$244
Seat Back Finish	Fabric Price Grade 1 Customer's Own Leather Fabric Customer's Own Material Fabric Price Grade 2 Fabric Price Grade 3 Fabric Price Grade 4 Fabric Price Grade 5 Leather Price Grade 5	No cost Prices below Prices below Prices below Prices below Prices below Prices below
Glides	Plastic Felt	No cost +\$10

### Specification Information



Dimensions			Style	Base Prices						
D	W	H	Number	Upholstery Grades:						
				1	2	3	4	5/Leather	COM/COL	

### Copa Wooden Legs Lounge Chair with Smooth Upholstery

24 2/5" 24 4/5" 27 4/5" **VCBCOBUMA** \$1627 \$1764 \$1914 \$2093 \$2298 \$1627

Needed fabric for material 1.53 yd wide:

**Non-Contrasting:** Fabric 2.3 yd, Leather 2.6 yd

**Contrasting:** Fabric seat and front of back 1.8 yd, leather back 0.8 yd



### Copa Wooden Legs Lounge Chair with Soft Upholstery

24 2/5" 24 4/5" 27 4/5" **VCBCOBUMA** \$1741 \$1813 \$1963 \$2144 \$2359 \$1741

Needed fabric for material 1.53 yd wide:

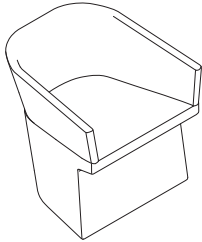
**Non-Contrasting:** Fabric 2.3 yd, Leather 2.6 yd

**Contrasting:** Fabric seat and front of back 1.8 yd, leather back 0.8 yd

Lounge Chairs

# Lounge Chairs

## Fedele



### Standard Includes

- Upholstery: fabric price group 01

### Specification Information

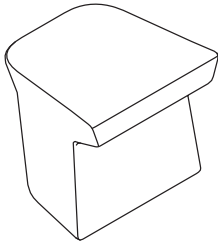
Dimensions			Style	Prices					
D	W	H	Number	Upholstery Grades:					
				1	2	3	4	5/Leather	COM/COL

### Fedele Lounge Chair

26" 28" 27 1/5" **VCBFE** \$2160 \$2420 \$2721 \$3035 \$3405 \$2160

Needed fabric for material 1.53 yd wide:

**Upholstery:** 3.17 yd



### Standard Includes

- Upholstery: fabric price group 01

### Specification Information

Dimensions			Style	Prices					
D	W	H	Number	Upholstery Grades:					
				1	2	3	4	5/Leather	COM/COL

### Fedele Pouf

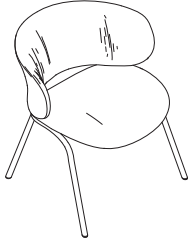
16 9/10" 18 3/10" 16 1/10" **VCBFEP** \$1231 \$1367 \$1530 \$1722 \$1914 \$1231

Needed fabric for material 1.53 yd wide:

**Upholstery:** 1.42 yd

# Lounge Chairs

## Funda Lounge



### Standard Includes

- Base: powder coated paint in black or white
- Upholstery: fabric price group 01
- Glides: plastic

### Specification Information

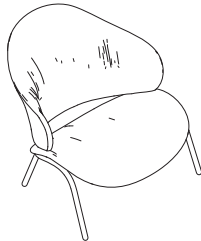
Dimensions			Style	Prices						
D	W	H	Number	Upholstery Grades:						
				1	2	3	4	5/Leather	COM/COL	

#### Funda Lounge Chair

26" 28" 29 1/10" **VCBFUB** \$1955 \$2146 \$2324 \$2543 \$2735 \$1955

Needed fabric for material 1.53 yd wide:

**Upholstery:** 1.91 yd



### Standard Includes

- Base: powder coated paint in black or white
- Upholstery: fabric price group 01
- Glides: plastic

### Specification Information

Dimensions			Style	Prices						
D	W	H	Number	Upholstery Grades:						
				1	2	3	4	5/Leather	COM/COL	

#### Funda Bold Lounge Chair

37 4/5" 37 2/5" 36 3/5" **VCBFUBO** \$3652 \$3865 \$4292 \$4721 \$5148 \$3652

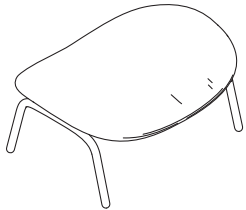
Needed fabric for material 1.53 yd wide:

**Upholstery:** 4.2 yd

Lounge Chairs

# Lounge Chairs

## Funda Lounge



### Standard Includes

- Base: powder coated paint in black or white
- Upholstery: fabric price group 01
- Glides: plastic

### Specification Information

Dimensions			Style	Prices					
D	W	H	Number	Upholstery Grades:					
				1	2	3	4	5/Leather	COM/COL

### Funda Bold Ottoman

26" 33 1/2" 15" **VCBFUBOT** \$1525 \$1718 \$2103 \$2488 \$2873 \$1525

Needed fabric for material 1.53 yd wide:

**Upholstery:** 2.1 yd

# Lounge Chairs

## Funda Lounge



Tip: Cushion is packed with the armchair and is designed for use for Funda Bold.

### Standard Includes

- Upholstery: fabric price group 01

### Specification Information

Dimensions		Style Number	Prices					
W	H		Upholstery Grades:					
			1	2	3	4	5/Leather	COM/COL

#### Funda Bold Cushion

23 3/5"	11"	<b>VCBFUBOAL</b>	\$118	\$144	\$200	\$326	\$398	\$118
---------	-----	------------------	-------	-------	-------	-------	-------	-------

Needed fabric for material 1.53 yd wide:

**Upholstery:** 1.1 yd



Tip: Headrest is packed with the armchair.

### Standard Includes

- Upholstery: fabric price group 01

### Specification Information

Dimensions		Style Number	Prices					
W	H		Upholstery Grades:					
			1	2	3	4	5/Leather	COM/COL

#### Funda Bold Headrest

13"	8 3/10"	<b>VCBFUBORE</b>	\$310	\$328	\$420	\$496	\$576	\$310
-----	---------	------------------	-------	-------	-------	-------	-------	-------

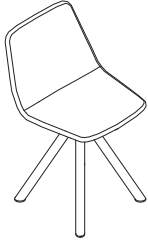
Needed fabric for material 1.53 yd wide:

**Upholstery:** 0.82 yd

Lounge Chairs

# Lounge Chairs

## Maarten Lounge



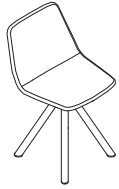
### Standard Includes

- Aluminum swivel base: powder coated paint in black, white, or taupe
- Upholstery: fabric price group 01
- Glides: plastic

### Options

Upholstery Version	Smooth Upholstery	Prices below
	Soft Upholstery	Prices below
Arms	No Arms	No cost
	With Arms	+\$437

### Specification Information



Dimensions			Style Number	Base Prices					
D	W	H		Upholstery Grades:					
				1	2	3	4	5/Leather	COM/COL
<b>Maarten Metal Swivel Lounge Chair with Smooth Upholstery</b>									
21 3/10"	24"	30 9/10"	<b>VCBMAAB</b>	\$1599	\$1764	\$1941	\$2146	\$2351	\$1599

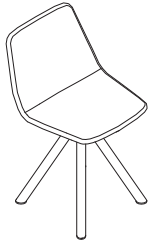


<b>Maarten Metal Swivel Lounge Chair with Soft Upholstery</b>									
21 3/10"	24"	30 9/10"	<b>VCBMAAB</b>	\$1722	\$1873	\$2037	\$2256	\$2461	\$1722
Needed fabric for material 1.53 yd wide:									
<b>Smooth/Soft:</b> 1.2 yd									



# Lounge Chairs

## Maarten Lounge



### Standard Includes

- Swivel base: steel with stained oak veneer
- Upholstery: fabric price group 01
- Glides: plastic

### Options

Upholstery Version	Smooth Upholstery	Prices below
	Soft Upholstery	Prices below
Arms	No Arms	No cost
	With Arms	+\$437

### Specification Information

Dimensions			Style Number	Base Prices					
D	W	H		Upholstery Grades:					
				1	2	3	4	5/Leather	COM/COL

### Maarten Wooden Swivel Lounge Chair with Smooth Upholstery

21 3/10"	24"	30 9/10"	<b>VCBMAABM</b>	\$2311	\$2461	\$2639	\$2830	\$3063	\$2311
----------	-----	----------	-----------------	--------	--------	--------	--------	--------	--------

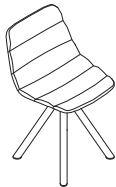


### Maarten Wooden Swivel Lounge Chair with Soft Upholstery

21 3/10"	24"	30 9/10"	<b>VCBMAABM</b>	\$2420	\$2571	\$2748	\$2940	\$3158	\$2420
----------	-----	----------	-----------------	--------	--------	--------	--------	--------	--------

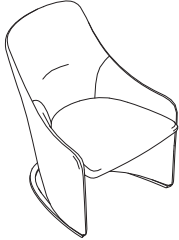
Needed fabric for material 1.53 yd wide:

Smooth/Soft: 1.2 yd



# Lounge Chairs

## Nagi



### Standard Includes

- Upholstery: fabric price group 01
- Base: brass finish or powder coated paint in black, or white
- Headrest: fabric or leather, if selected
- Glides: plastic

### Options

Upholstery Version	Smooth Upholstery	Prices below
	Soft Upholstery	Prices below
Base Type	Fixed Base	No cost
	Rocking Base	No cost
Headrest Finish	Customer's Own Leather	+\$274
	Fabric Customer's Own Material	+\$274
	Fabric Price Grade 1	+\$274
	Fabric Price Grade 2	+\$287
	Fabric Price Grade 3	+\$368
	Fabric Price Grade 4	+\$437
	Fabric Price Grade 5	+\$506
	Leather Price Grade 5	+\$506

### Specification Information

Dimensions			Style Number	Base Finish Group	Base Prices					
D	W	H			Upholstery Grades:					
					1	2	3	4	5/Leather	COM/COL

#### Nagi Fixed or Rocking Low Backrest Lounge Chair with Smooth Upholstery

28 3/10"	26 4/5"	31 1/2"	<b>VCBNAGIB</b>	Paint	\$2761	\$3076	\$3405	\$3787	\$4212	\$2761
				Brass	\$3323	\$3636	\$3965	\$4348	\$4772	\$3323

#### Nagi Fixed or Rocking Low Backrest Lounge Chair with Soft Upholstery

28 3/10"	26 4/5"	31 1/2"	<b>VCBNAGIB</b>	Paint	\$3035	\$3350	\$3692	\$4076	\$4498	\$3035
				Brass	\$3610	\$3910	\$4252	\$4636	\$5059	\$3610

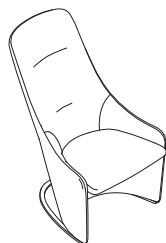
Needed fabric for material 1.53 yd wide:

**Smooth upholstery:** 3.94 yd

**Soft upholstery:** 4.27 yd

# Lounge Chairs

**Nagi**



## Standard Includes

- Upholstery: fabric price group 01
- Base: brass finish or powder coated paint in black, or white
- Headrest: fabric or leather, if selected
- Glides: plastic

## Options

Upholstery Version	Smooth Upholstery	Prices below
	Soft Upholstery	Prices below
Base Type	Fixed Base	No cost
	Rocking Base	No cost
Headrest Finish	Customer's Own Leather	+\$274
	Fabric Customer's Own Material	+\$274
	Fabric Price Grade 1	+\$274
	Fabric Price Grade 2	+\$287
	Fabric Price Grade 3	+\$368
	Fabric Price Grade 4	+\$437
	Fabric Price Grade 5	+\$506
	Leather Price Grade 5	+\$506

## Specification Information

Dimensions			Style Number	Base Finish Group	Base Prices					
D	W	H			Upholstery Grades:					
					1	2	3	4	5/Leather	COM/COL

### Nagi Fixed or Rocking High Backrest Lounge Chair with Smooth Upholstery

36 1/5"	26 4/5"	39 2/5"	<b>VCBNAGI</b>	Paint	\$2803	\$3117	\$3445	\$3828	\$4252	\$2803
				Brass	\$3364	\$3679	\$4020	\$4388	\$4812	\$3364

### Nagi Fixed or Rocking High Backrest Lounge with Soft Upholstery

36 1/5"	26 4/5"	39 2/5"	<b>VCBNAGI</b>	Paint	\$3090	\$3418	\$3761	\$4143	\$4567	\$3090
				Brass	\$3650	\$3979	\$4321	\$4703	\$5127	\$3650

Needed fabric for material 1.53 yd wide:

**Smooth upholstery:** 3.94 yd

**Soft upholstery:** 4.27 yd

Lounge Chairs

# Lounge Chairs

## Nagi



*Tip: Nagi headrest can be optioned on or ordered separately. It is movable and sits on the chair back.*

### Standard Includes

- Upholstery: fabric price group 01

### Specification Information

Dimensions		Style Number	Prices					
W	H		Upholstery Grades:					
			1	2	3	4	5/Leather	COM/COL

### Nagi Lounge Chair Headrest

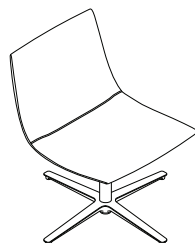
13 2/5"	6 3/10"	<b>VCBNAGIRE</b>	\$274	\$287	\$368	\$437	\$506	\$274
---------	---------	------------------	-------	-------	-------	-------	-------	-------

Needed fabric for material 1.53 yd wide:

**Upholstery:** 0.77 yd

# Lounge Chairs

## Noha



### Standard Includes

- Aluminum swivel base: powder coated paint in black or white
- Upholstery: fabric price group 01
- Piping: anthracite, burgundy, forest green, linen, white
- Glides: plastic

### Options

Upholstery Finish	Customer's Own Leather	See below
	Fabric Customer's Own Material	See below
	Fabric Price Grade 1	See below
	Fabric Price Grade 2	See below
	Fabric Price Grade 3	See below
	Fabric Price Grade 4	See below
	Fabric Price Grade 5	See below
Arms	Leather Price Grade 5	See below
	No Arms	No cost
	With Metal Arms	+\$390
	Upholstered Arms	+\$607
Arms Finish	Customer's Own Leather	No cost
	Fabric Customer's Own Material	No cost
	Fabric Price Grade 1	No cost
	Fabric Price Grade 2	+\$112
	Fabric Price Grade 3	+\$336
	Fabric Price Grade 4	+\$560
	Fabric Price Grade 5	+\$784
Tilt Option	Leather Price Grade 5	+\$784
	Without Tilting	No cost
Return Position	With Tilting	+\$65
	Without Self-Return Mechanism	No cost
Glides	With Self-Return Mechanism	+\$127
	Plastic	No cost
	Felt	+\$10

Lounge Chairs

### Specification Information



				Base Prices						
Dimensions			Style	Upholstery Grades:						
D	W	H	Number	1	2	3	4	5/Leather	COM/COL	
<b>Noha Standard Lounge Chair - Flat Swivel Base</b>										
28 1/9"	28 1/9"	30 1/2"	<b>VCBNOHEXBUGPL</b>	\$1643	\$1705	\$1828	\$1951	\$2074	\$1643	

► Product Information continued on next page

# Lounge Chairs

## Noha

▶ **Product Information continued from previous page**

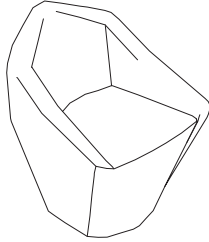
### Specification Information



Dimensions			Style Number	Base Prices						
D	W	H		Upholstery Grades:						
				1	2	3	4	5/Leather	COM/COL	
<b>Noha Executive Lounge Chair - Flat Swivel Base</b>										
28 1/9"	28 1/9"	36 5/7"	<b>VCBNOHEXBUGPL2</b>	\$1783	\$1869	\$2043	\$2217	\$2390	\$1783	

# Lounge Chairs

## Penta



### Standard Includes

- Upholstery: fabric price group 01
- Fixed or swivel base

### Specification Information

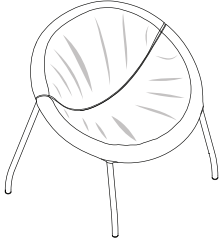
Dimensions			Style Number	Base Prices					
D	W	H		Upholstery Grades:					
				1	2	3	4	5/Leather	COM/COL
<b>Penta Fixed Lounge Chair</b>									
26 2/5"	25 3/5"	31 1/2"	<b>VCBPE</b>	\$1955	\$2201	\$2461	\$2761	\$3103	\$1955
<b>Penta Swivel Lounge Chair</b>									
26 2/5"	25 3/5"	31 1/2"	<b>VCBPE</b>	\$2488	\$2789	\$3132	\$3500	\$3924	\$2488

Needed fabric for material 1.53 yd wide:

**Upholstery:** 2.51 yd

# Lounge Chairs

## Zoco



### Standard Includes

- Base: powder coated paint in black or white
- Upholstery: fabric price group 01
- Glides: plastic

### Specification Information

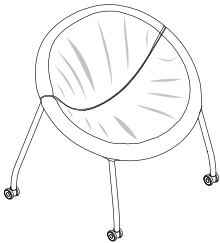
Dimensions			Style	Prices					
D	W	H	Number	Upholstery Grades:					
26"	33 3/10"	29 1/10"	<b>VCBZO</b>	1	2	3	4	5/Leather	COM/COL

### Fixed Armchair

26" 33 3/10" 29 1/10" **VCBZO** \$1160 \$1230 \$1410 \$1620 \$1780 \$1160

Needed fabric for material 1.53 yd wide:

**Upholstery:** 2.6 yd



### Standard Includes

- Base: powder coated paint in black or white
- Upholstery: fabric price group 01
- Castors

### Specification Information

Dimensions			Style	Prices					
D	W	H	Number	Upholstery Grades:					
26"	33 3/10"	31 1/10"	<b>VCBZOR</b>	1	2	3	4	5/Leather	COM/COL

### Armchair on Casters

26" 33 3/10" 31 1/10" **VCBZOR** \$1184 \$1254 \$1434 \$1644 \$1804 \$1184

Needed fabric for material 1.53 yd wide:

**Upholstery:** 2.6 yd



---

# Understanding Sofas

Standard Import Lead Time

---

## Statement of Line 294

### Understanding

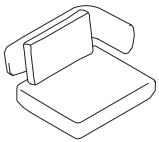
Levitt	<b>296</b>
Savina	<b>298</b>
Season Sofa	<b>320</b>
Season Pouf	<b>330</b>
Step	<b>332</b>

# Statement of Line

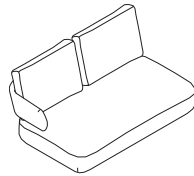
## Sofas

### Levitt

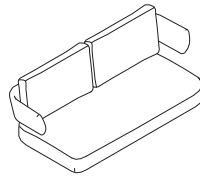
Understanding  
▶ Page 296  
Specifying  
▶ Pages 350–354



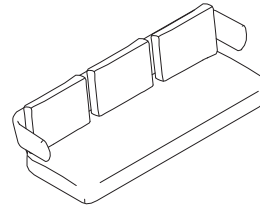
**Armchair**



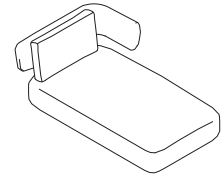
**Small Sofa**



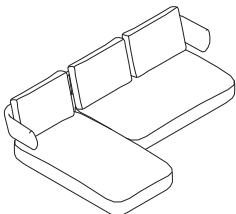
**Medium Sofa**



**Large Sofa**



**Chaise**



**Sofa Composition L1**



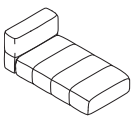
**Square Cushion**



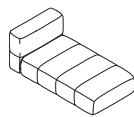
**Rectangular Cushion**

### Savina

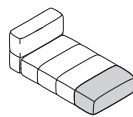
Understanding  
▶ Page 298  
Specifying  
▶ Pages 355–361



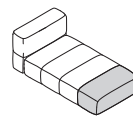
**Chaise**



**Chaise with Casters**



**Chaise with Upholstery Protection**



**Chaise with Casters and Upholstery Protection**



**Backless Sofa Module**



**Backless Sofa Module with Casters**



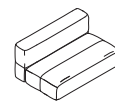
**Pouf**



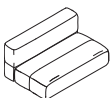
**Sofa Module with Back**



**Sofa Module with Back and Casters**



**Double Sofa with Back**



**Double Sofa with Back and Casters**



**Corner Sofa Module**



**Corner Sofa Module with Casters**



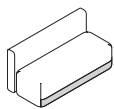
**Square Cushion**



**Rectangular Cushion**

## Season Sofa

Understanding  
 ▶ Page 320  
 Specifying  
 ▶ Pages 362–365



**Straight Module**



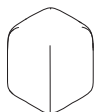
**Closed Module**



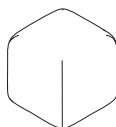
**Open Module**

## Season Pouf

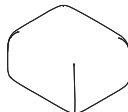
Understanding  
 ▶ Page 330  
 Specifying  
 ▶ Pages 364–366



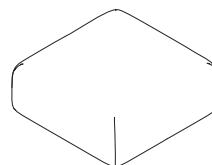
**Pouf—15<sup>7</sup>/<sub>20</sub>"W**



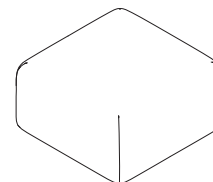
**Pouf—19<sup>7</sup>/<sub>10</sub>"W**



**Pouf—23<sup>3</sup>/<sub>5</sub>"W**



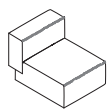
**Pouf—35<sup>2</sup>/<sub>5</sub>"W x 14<sup>1</sup>/<sub>5</sub>"H**



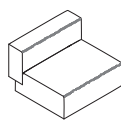
**Pouf—35<sup>2</sup>/<sub>5</sub>"W x 19<sup>3</sup>/<sub>10</sub>"H**

## Step

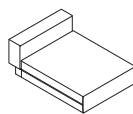
Understanding  
 ▶ Page 332  
 Specifying  
 ▶ Pages 367–371



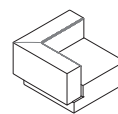
**Module 27<sup>3</sup>/<sub>5</sub>"**



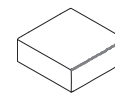
**Module 35<sup>2</sup>/<sub>5</sub>"**



**Chaise**



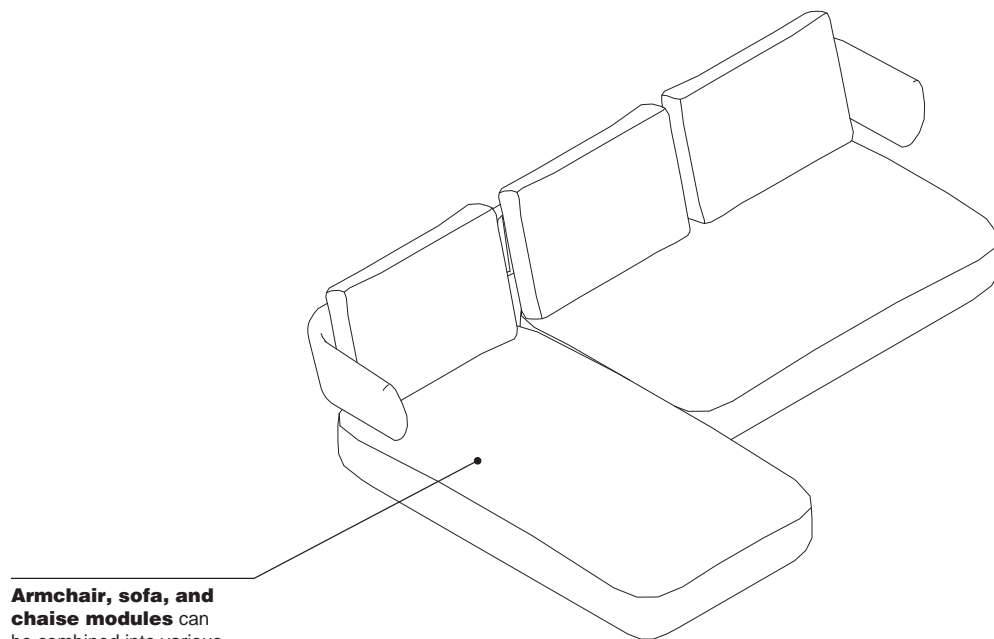
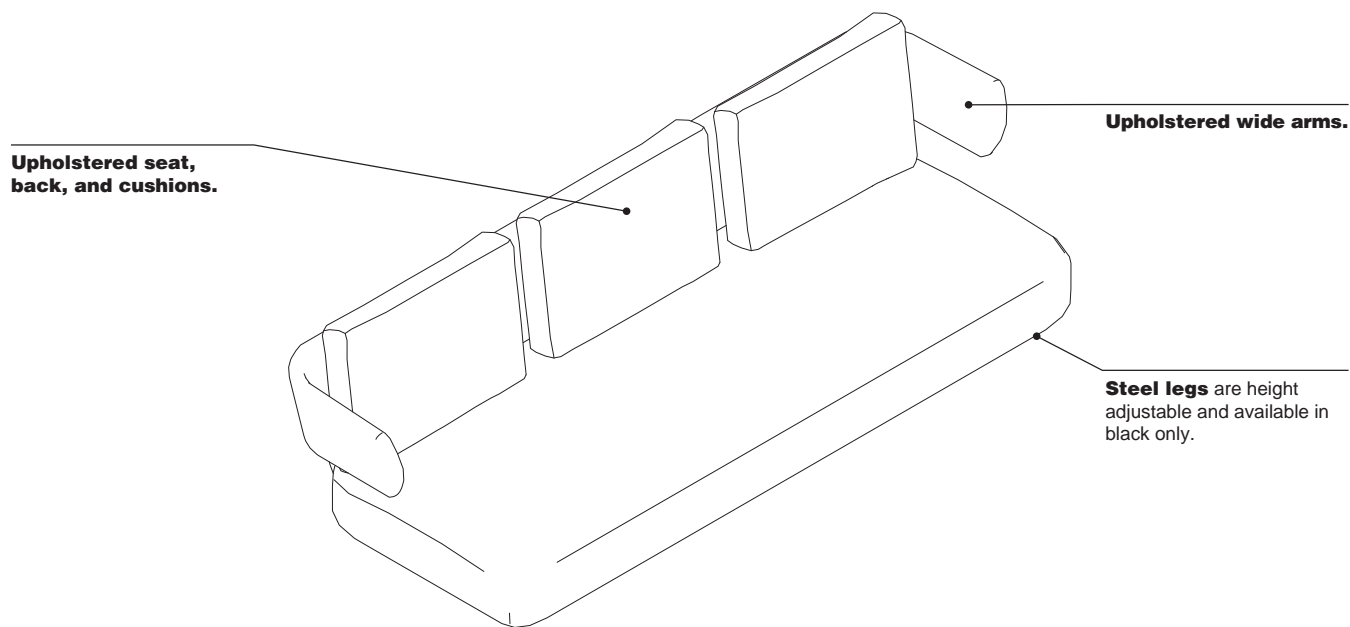
**Corner**



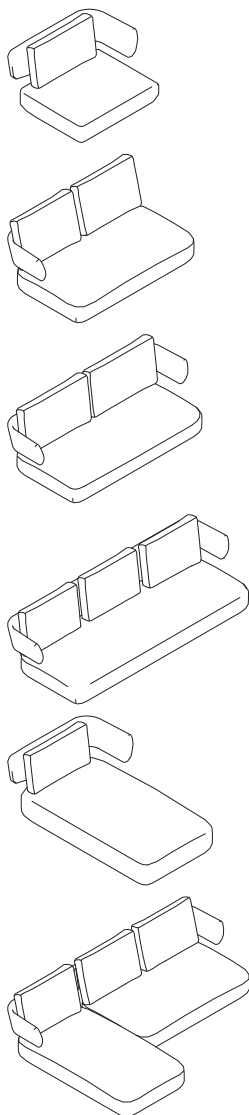
**Pouf**

# Levitt

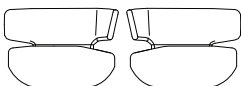
**Levitt**, designed by Ludovica and Roberto Palomba, is a collection of modular sofas and armchairs.  
▶ Specifying, pages 350–354



**Product Details**



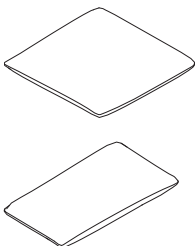
Levitt is available in an armchair, small sofa, medium sofa, large sofa, chaise, and a composition L1 sofa.



**Right** **Left**  
**Armchair** comes standard with a wide right arm (front-on-view). Left wide arm is available. All other Levitt modules come supplied as shown.

**Steel legs** are height adjustable and available in black only.

**Backrest cushions** come standard. Each lounge comes with the number of back cushions equal to the number of seats. Additional cushions are available to order.



**Decorative upholstered cushions** are available microfiber filled.

**Surface Materials**

**Upholstery**

- Fabric
- Leather
- COM (Customer's Own Material)
- COL (Customer's Own Leather)

**Actual Dimensions**

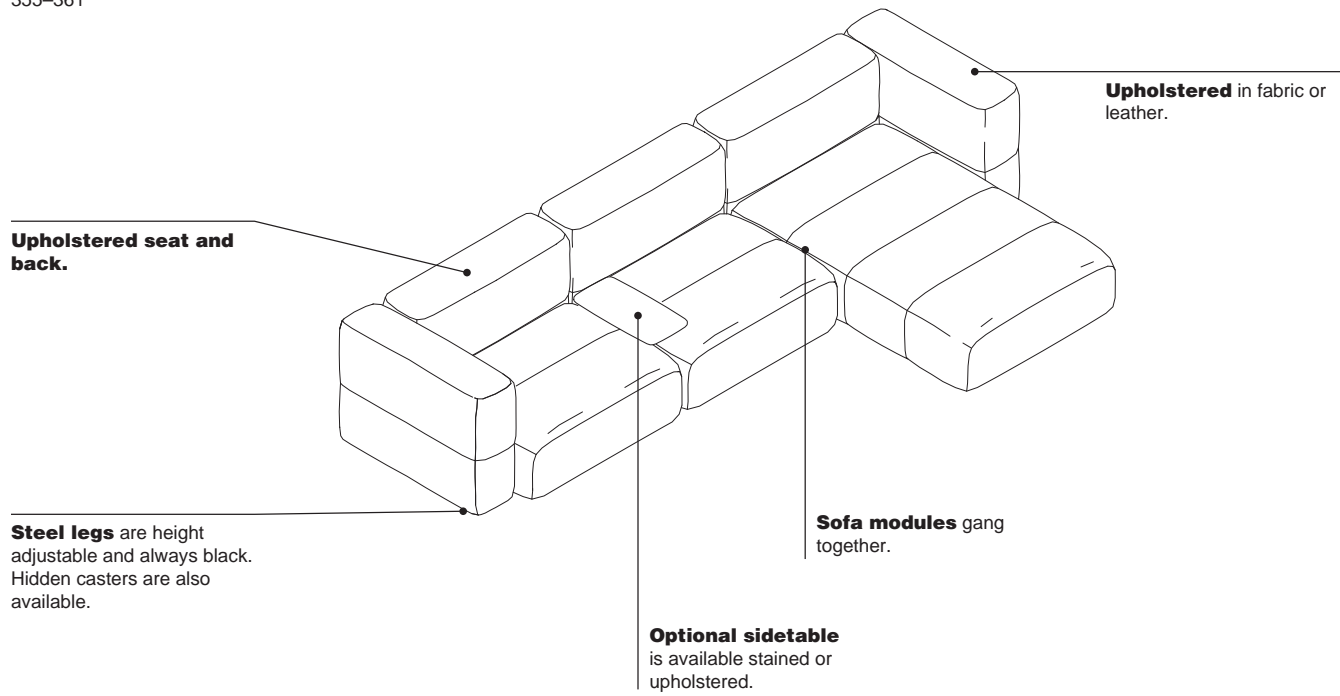
Description	Style Number	Depth	Width	Height	Seat Depth*	Seat Height	Weight
Armchair	<b>VCBBUTACA</b>	27 <sup>3</sup> / <sub>8</sub> "	36 <sup>1</sup> / <sub>8</sub> "	31 <sup>1</sup> / <sub>2</sub> "	31 <sup>1</sup> / <sub>2</sub> "	13 <sup>3</sup> / <sub>8</sub> "	75.0 lb
Small Sofa	<b>VCBSOFA152</b>	35 <sup>2</sup> / <sub>8</sub> "	59 <sup>4</sup> / <sub>8</sub> "	31 <sup>1</sup> / <sub>2</sub> "	31 <sup>1</sup> / <sub>2</sub> "	13 <sup>3</sup> / <sub>8</sub> "	179.0 lb
Medium Sofa	<b>VCBSOFA184</b>	35 <sup>2</sup> / <sub>8</sub> "	72 <sup>2</sup> / <sub>8</sub> "	31 <sup>1</sup> / <sub>2</sub> "	31 <sup>1</sup> / <sub>2</sub> "	13 <sup>3</sup> / <sub>8</sub> "	179.7 lb
Large Sofa	<b>VCBSOFA244</b>	35 <sup>2</sup> / <sub>8</sub> "	96 <sup>1</sup> / <sub>10</sub> "	31 <sup>1</sup> / <sub>2</sub> "	31 <sup>1</sup> / <sub>2</sub> "	13 <sup>3</sup> / <sub>8</sub> "	219.4 lb
Chaise	<b>VCBCHAISE</b>	123 <sup>3</sup> / <sub>8</sub> "	36 <sup>1</sup> / <sub>8</sub> "	31 <sup>1</sup> / <sub>2</sub> "	31 <sup>1</sup> / <sub>2</sub> "	13 <sup>3</sup> / <sub>8</sub> "	103.6 lb
Composition L1 Sofa	<b>VCBSOFACOMPL1</b>	123 <sup>3</sup> / <sub>10</sub> "	96 <sup>1</sup> / <sub>10</sub> "	31 <sup>1</sup> / <sub>2</sub> "	35 <sup>2</sup> / <sub>8</sub> "	13 <sup>4</sup> / <sub>10</sub> "	162.2 lb
Square	<b>VCBLEAL50</b>	19 <sup>7</sup> / <sub>10</sub> "	19 <sup>7</sup> / <sub>10</sub> "	N.A.	N.A.	N.A.	N.A.
Rectangle	<b>VCBLEAL30</b>	11 <sup>4</sup> / <sub>8</sub> "	23 <sup>3</sup> / <sub>8</sub> "	N.A.	N.A.	N.A.	N.A.

\*Tip: Seat depth is without cushions.

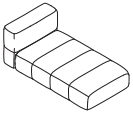
# Savina

Savina enhances soft collaboration. An innovative modular cloud sofa that presents a new universe of comfortable working solutions for social and collaborative applications.

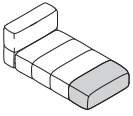
► Specifying, pages 355–361



**Product Details**



Chaise



Chaise with Upholstery Protection



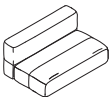
Backless Sofa



Pouf



Sofa with Back

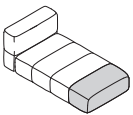


Double Sofa with Back

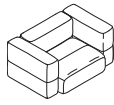


Corner

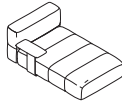
**Savina individual module components** are available in backless or back sofa, chaise, and corner to create custom compositions.



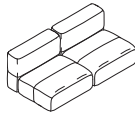
**Chaise lounge** is available with upholstery protection to protect from shoes when lying. Technical fabric is available in light gray or dark gray.



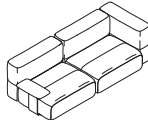
Composition 1



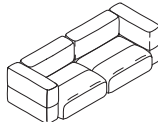
Composition 2



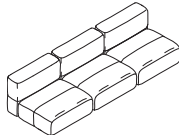
Composition 3



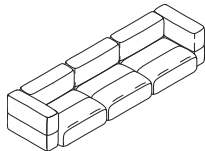
Composition 4



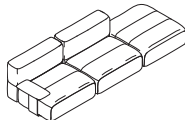
Composition 5



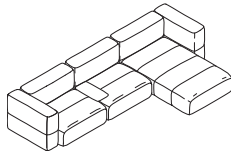
Composition 6



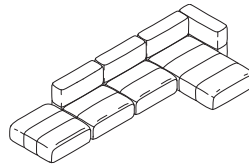
Composition 7



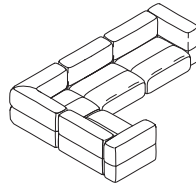
Composition 8



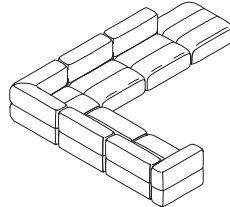
Composition 9



Composition 10



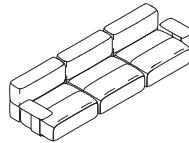
Composition 11



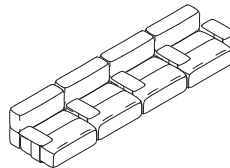
Composition 12



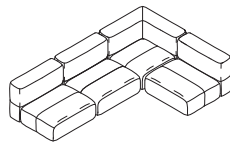
Composition 13



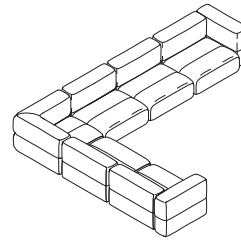
Composition 14



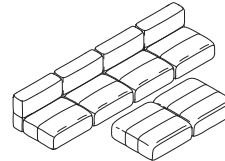
Composition 15



Composition 16



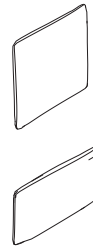
Composition 17



Composition 18

**Savina compositions** can be created by ordering individual module components.

▶ See *Thought Starters*, pages 302–319



**Decorative upholstered cushions** are available and are microfiber filled.

**Right and left end configuration options** help determine sofa layout.

**Right and left** are understood from the perspective of the person looking at the object from the front.

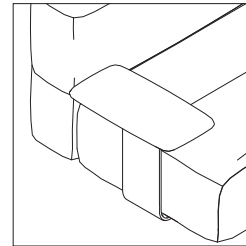
**Surface Materials**

**Upholstery**

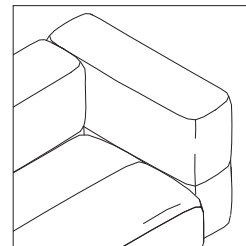
- Fabric
- Leather
- COM (Customer's Own Material)
- COL (Customer's Own Leather)

**Side table stains**

- Matte oak
- Cognac
- Ash
- Wenge



**Side tables** are available and can be attached to the ends of a lounge or in between individual sofa modules. Side tables can be stained or upholstered.



**Upholstered high armrest** available in fabric or leather. Armrests shipped installed.

Savina, continued

<b>Actual Dimensions</b>							
<b>Description</b>	<b>Style Number</b>	<b>Depth</b>	<b>Width</b>	<b>Height</b>	<b>Seat Depth</b>	<b>Seat Height</b>	<b>Weight</b>
Backless Sofa Module	<b>VCBSAVISR</b>	39 <sup>2</sup> / <sub>5</sub> "	36 <sup>1</sup> / <sub>5</sub> "	14 <sup>3</sup> / <sub>5</sub> "	27 <sup>3</sup> / <sub>5</sub> "	14 <sup>3</sup> / <sub>5</sub> "	63.9 lb
Backless Sofa Module with Casters	<b>VCBSAVISRR</b>	39 <sup>2</sup> / <sub>5</sub> "	36 <sup>1</sup> / <sub>5</sub> "	14 <sup>3</sup> / <sub>5</sub> "	27 <sup>3</sup> / <sub>5</sub> "	14 <sup>3</sup> / <sub>5</sub> "	63.9 lb
Pouf	<b>VCBSAVIPO</b>	39 <sup>2</sup> / <sub>5</sub> "	36 <sup>1</sup> / <sub>5</sub> "	14 <sup>3</sup> / <sub>5</sub> "	27 <sup>3</sup> / <sub>5</sub> "	14 <sup>3</sup> / <sub>5</sub> "	63.9 lb
Pouf with Casters	<b>VCBSAVIPO</b>	39 <sup>2</sup> / <sub>5</sub> "	36 <sup>1</sup> / <sub>5</sub> "	14 <sup>3</sup> / <sub>5</sub> "	27 <sup>3</sup> / <sub>5</sub> "	14 <sup>3</sup> / <sub>5</sub> "	63.9 lb
Sofa Module with Back	<b>VCBSAVIM</b>	39 <sup>2</sup> / <sub>5</sub> "	36 <sup>1</sup> / <sub>5</sub> "	27"	27 <sup>3</sup> / <sub>5</sub> "	14 <sup>3</sup> / <sub>5</sub> "	105.8 lb
Sofa Module with Back and Casters	<b>VCBSAVIMR</b>	39 <sup>2</sup> / <sub>5</sub> "	36 <sup>1</sup> / <sub>5</sub> "	27"	27 <sup>3</sup> / <sub>5</sub> "	14 <sup>3</sup> / <sub>5</sub> "	105.8 lb
Double Sofa Module	<b>VCBSAVIMA</b>	39 <sup>2</sup> / <sub>5</sub> "	55 <sup>1</sup> / <sub>10</sub> "	27"	27 <sup>3</sup> / <sub>5</sub> "	14 <sup>3</sup> / <sub>5</sub> "	144.4 lb
Double Sofa Module with Casters	<b>VCBSAVIMA</b>	39 <sup>2</sup> / <sub>5</sub> "	55 <sup>1</sup> / <sub>10</sub> "	27"	27 <sup>3</sup> / <sub>5</sub> "	14 <sup>3</sup> / <sub>5</sub> "	144.4 lb
Corner Sofa Module	<b>VCBSAVIRI</b>	39 <sup>2</sup> / <sub>5</sub> "	39 <sup>2</sup> / <sub>5</sub> "	27"	27 <sup>3</sup> / <sub>5</sub> "	14 <sup>3</sup> / <sub>5</sub> "	143.3 lb
Corner Sofa Module with Casters	<b>VCBSAVIRIR</b>	39 <sup>2</sup> / <sub>5</sub> "	39 <sup>2</sup> / <sub>5</sub> "	27"	27 <sup>3</sup> / <sub>5</sub> "	14 <sup>3</sup> / <sub>5</sub> "	143.3 lb
Chaise	<b>VCBSAVICH</b>	68 <sup>9</sup> / <sub>10</sub> "	36 <sup>1</sup> / <sub>5</sub> "	27"	55 <sup>1</sup> / <sub>5</sub> "	14 <sup>3</sup> / <sub>5</sub> "	150.0 lb
Chaise with Casters	<b>VCBSAVICHR</b>	68 <sup>9</sup> / <sub>10</sub> "	36 <sup>1</sup> / <sub>5</sub> "	27"	55 <sup>1</sup> / <sub>5</sub> "	14 <sup>3</sup> / <sub>5</sub> "	150.0 lb
Chaise with Upholstery Protection	<b>VCBSAVICHHP</b>	68 <sup>9</sup> / <sub>10</sub> "	36 <sup>1</sup> / <sub>5</sub> "	27"	55 <sup>1</sup> / <sub>5</sub> "	14 <sup>3</sup> / <sub>5</sub> "	150.0 lb
Chaise with Casters and Upholstery Protection	<b>VCBSAVICHPR</b>	68 <sup>9</sup> / <sub>10</sub> "	36 <sup>1</sup> / <sub>5</sub> "	27"	55 <sup>1</sup> / <sub>5</sub> "	14 <sup>3</sup> / <sub>5</sub> "	150.0 lb
Square Cushion	<b>VCBSAVIAL50</b>	N.A.	19 <sup>7</sup> / <sub>10</sub> "	19 <sup>7</sup> / <sub>10</sub> "	N.A.	N.A.	N.A.
Rectangular Cushion	<b>VCBSAVIAL30</b>	N.A.	23 <sup>3</sup> / <sub>5</sub> "	11 <sup>4</sup> / <sub>5</sub> "	N.A.	N.A.	N.A.

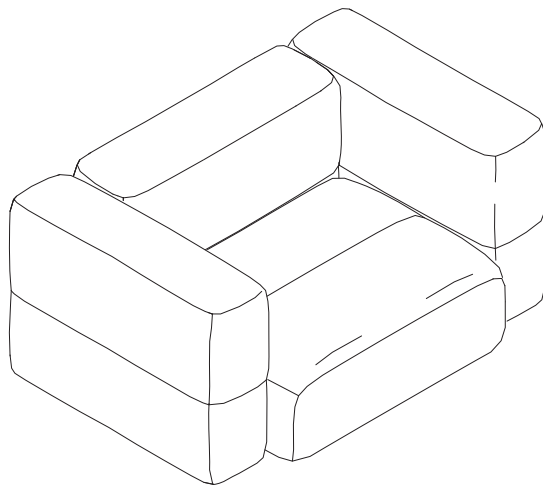




# Thought Starters

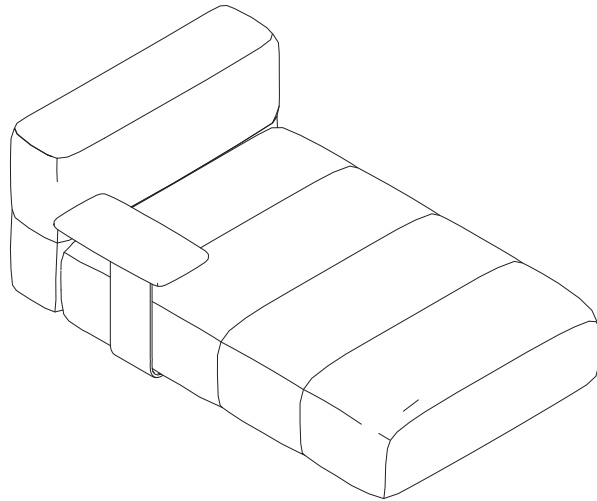
Savina Sofa Compositions

## Composition 1



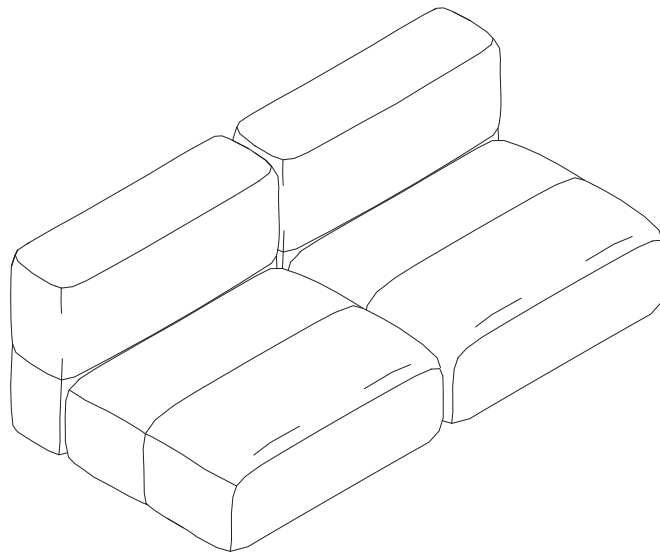
39 $\frac{5}{8}$ "D x 60"W x 27"H

Quantity	Style Number	Description	Page for Ordering
1	VCBSAVIM	Savina sofa module with back and two upholstered armrests	358

**Composition 2**68<sup>1</sup>/<sub>10</sub>"D x 46"W x 27"H

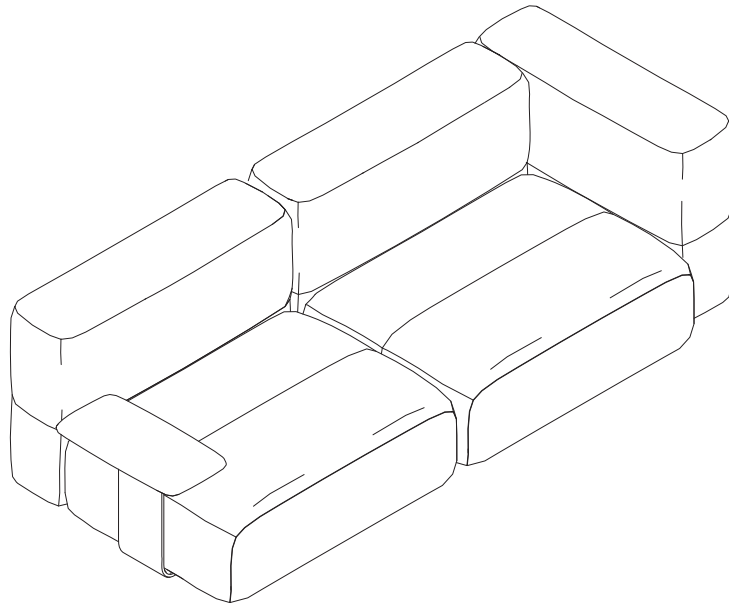
Quantity	Style Number	Description	Page for Ordering
1	VCBSAVICH	Savina chaise with table left side facing	355

**Composition 3**



39<sup>2</sup>/<sub>5</sub>"D x 72<sup>2</sup>/<sub>6</sub>"W x 27"H

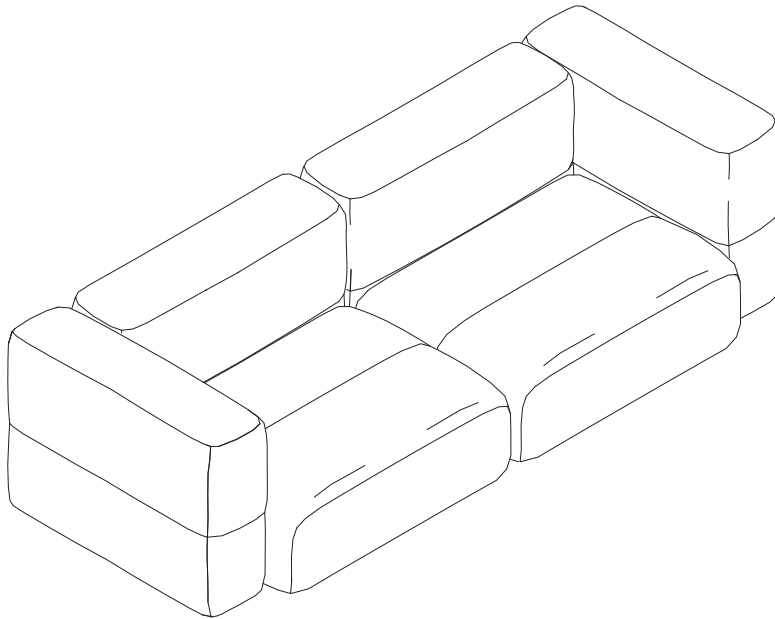
Quantity	Style Number	Description	Page for Ordering
2	VCBSAVIM	Savina sofa module with back	358

**Composition 4**

39 $\frac{2}{5}$ "D x 94 $\frac{1}{10}$ "W x 27"H

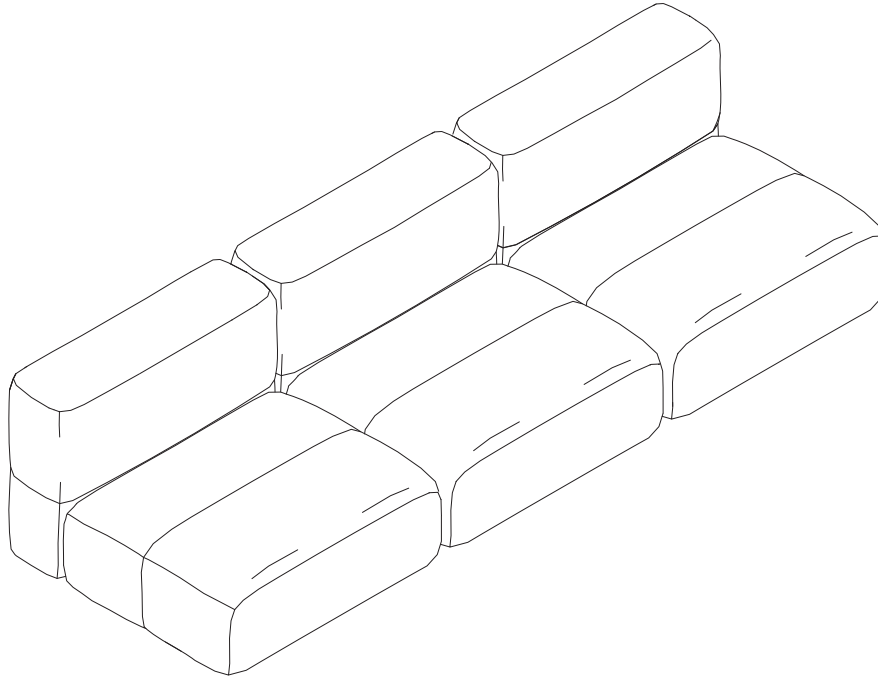
Quantity	Style Number	Description	Page for Ordering
1	<b>VCBSAVIM</b>	Savina sofa module with back and one arm right side facing	<b>358</b>
1	<b>VCBSAVIM</b>	Savina sofa module with back and table left side facing	<b>358</b>

**Composition 5**



39<sup>2</sup>/<sub>5</sub>"D x 96"W x 27"H

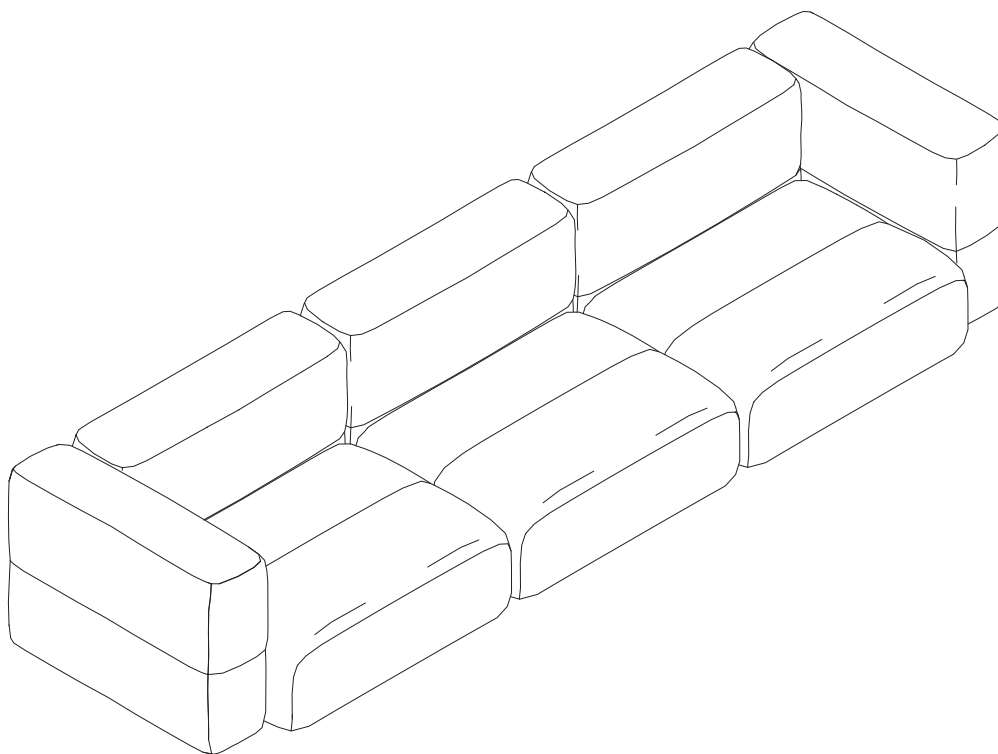
Quantity	Style Number	Description	Page for Ordering
1	<b>VCBSAVIM</b>	Savina sofa module with back and one arm right side facing	<b>358</b>
1	<b>VCBSAVIM</b>	Savina sofa module with back and one arm left side facing	<b>358</b>

**Composition 6**

39<sup>2</sup>/<sub>6</sub>"D x 108<sup>7</sup>/<sub>10</sub>"W x 27"H

Quantity	Style Number	Description	Page for Ordering
3	VCBSAVIM	Savina sofa module with back	358

**Composition 7**

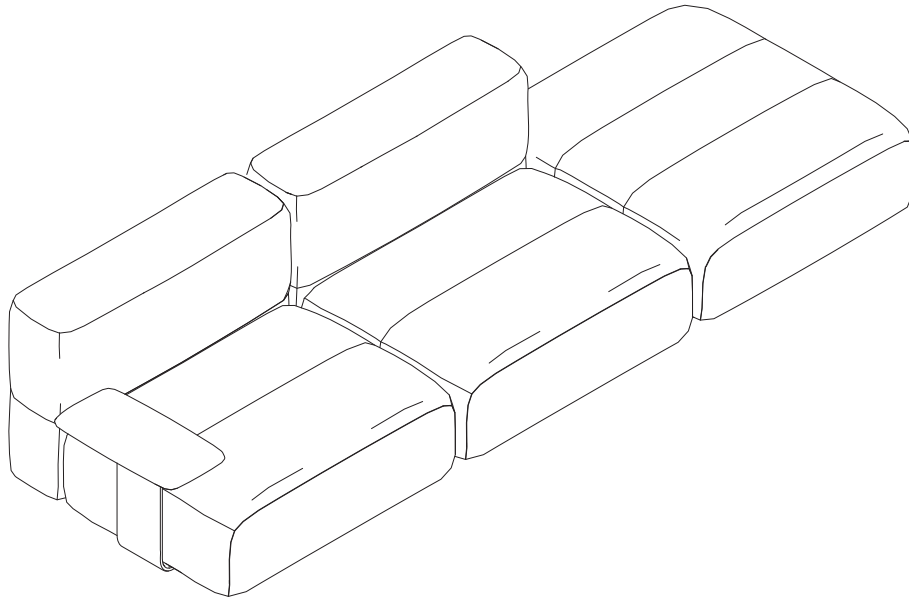


39<sup>5</sup>/<sub>16</sub>"D x 132<sup>3</sup>/<sub>10</sub>"W x 27"H

Quantity	Style Number	Description	Page for Ordering
1	<b>VCBSAVIM</b>	Savina sofa module with back and one arm right side facing	<b>358</b>
1	<b>VCBSAVIM</b>	Savina sofa module with back	<b>358</b>
1	<b>VCBSAVIM</b>	Savina sofa module with back and one arm left side facing	<b>358</b>



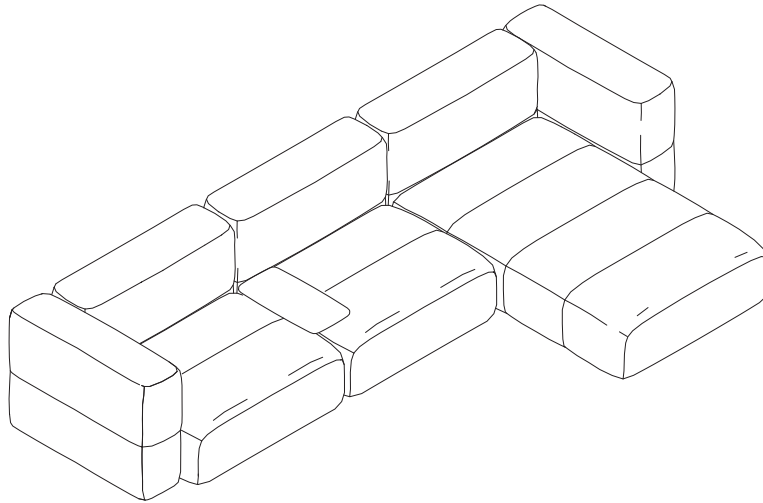
## Composition 8



39 $\frac{2}{5}$ "D x 118 $\frac{1}{2}$ "W x 27"H

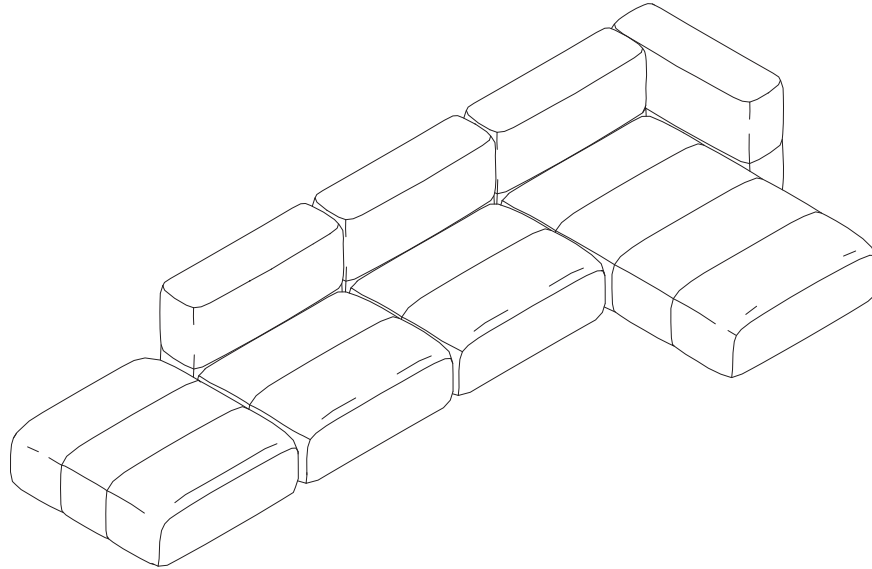
Quantity	Style Number	Description	Page for Ordering
1	<b>VCBSAVISR</b>	Savina backless sofa module	<b>357</b>
1	<b>VCBSAVIM</b>	Savina sofa module with back	<b>358</b>
1	<b>VCBSAVIM</b>	Savina sofa module with back and table left side sacing	<b>358</b>

**Composition 9**



68<sup>9</sup>/<sub>10</sub>"D x 132<sup>1</sup>/<sub>8</sub>"W x 27"H

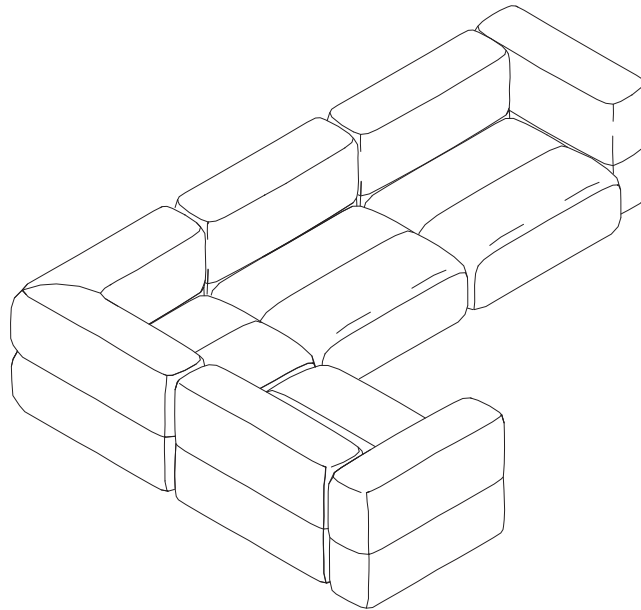
Quantity	Style Number	Description	Page for Ordering
1	<b>VCBSAVICH</b>	Savina chaise with one arm right side facing	<b>355</b>
1	<b>VCBSAVIM</b>	Savina sofa module with back and table left side facing	<b>358</b>
1	<b>VCBSAVIM</b>	Savina sofa module with back and one arm left side facing	<b>358</b>

**Composition 10**

68<sup>9</sup>/<sub>10</sub>"D x 156<sup>7</sup>/<sub>10</sub>"W x 27"H

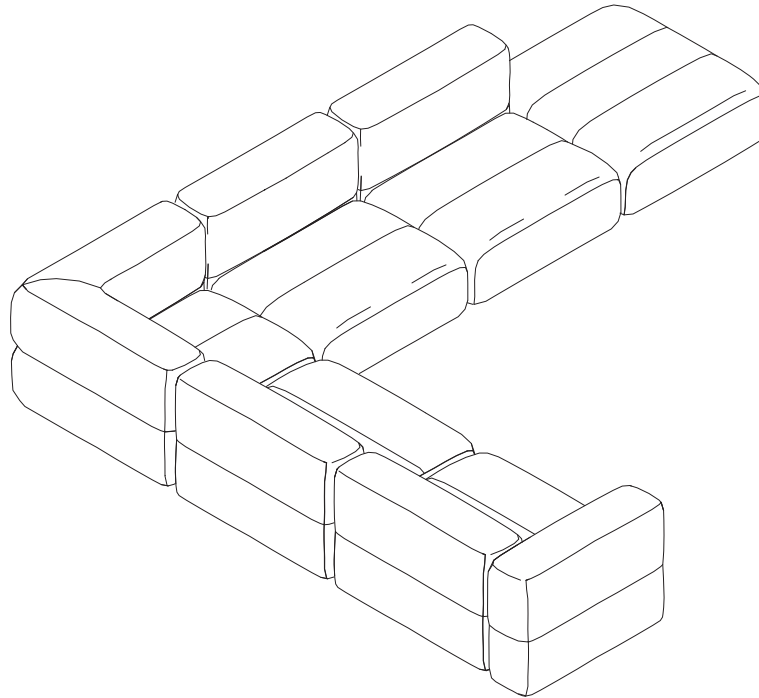
Quantity	Style Number	Description	Page for Ordering
1	<b>VCBSAVICH</b>	Savina chaise with one arm right side facing	<b>355</b>
2	<b>VCBSAVIM</b>	Savina sofa module with back	<b>358</b>
1	<b>VCBSAVISR</b>	Savina backless sofa module	<b>357</b>

**Composition 11**



87<sup>2</sup>/<sub>6</sub>"D x 159<sup>4</sup>/<sub>6</sub>"W x 27"H

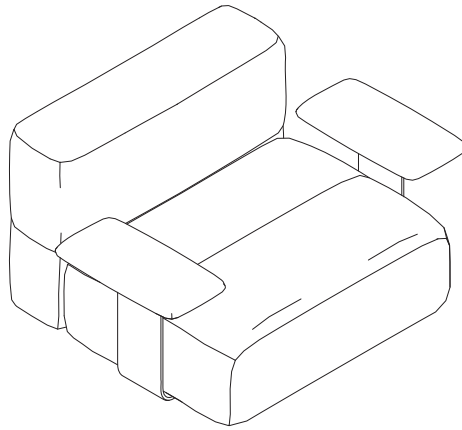
Quantity	Style Number	Description	Page for Ordering
1	<b>VCBSAVIM</b>	Savina sofa module with back and one arm right side facing	<b>358</b>
1	<b>VCBSAVIM</b>	Savina sofa module with back	<b>358</b>
1	<b>VCBSAVIRI</b>	Savina corner sofa module	<b>360</b>
1	<b>VCBSAVIM</b>	Savina sofa module with back and one arm left side facing	<b>358</b>

**Composition 12**

146½"D x 123¾"W x 27"H

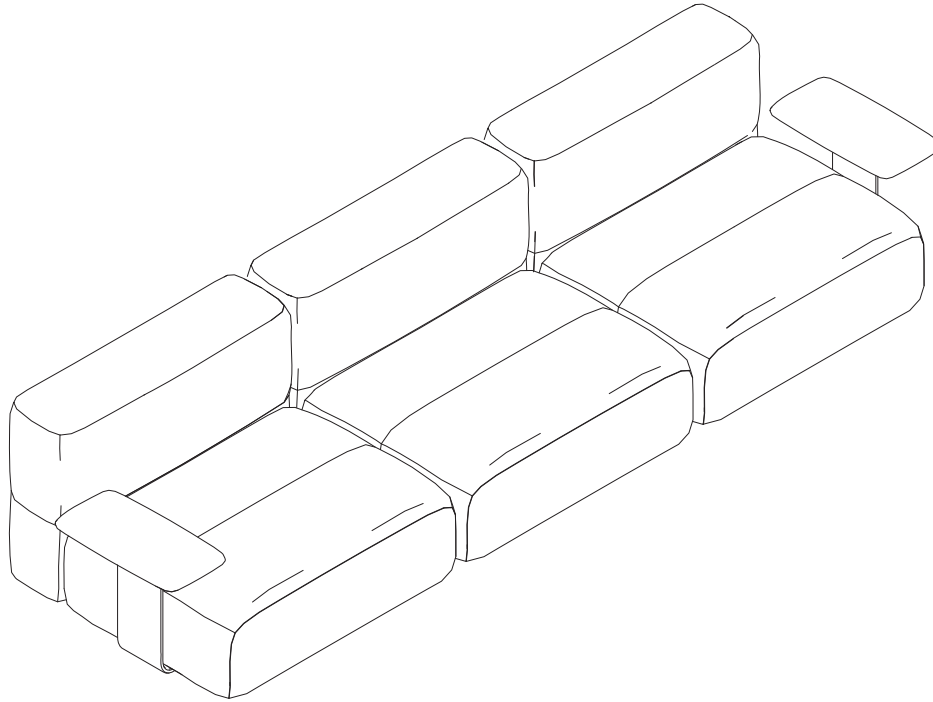
Quantity	Style Number	Description	Page for Ordering
1	<b>VCBSAVISR</b>	Savina backless sofa module	<b>357</b>
3	<b>VCBSAVIM</b>	Savina sofa module with back	<b>358</b>
1	<b>VCBSAVIRI</b>	Savina corner sofa module	<b>360</b>
1	<b>VCBSAVIM</b>	Savina sofa module with back and one arm left side facing	<b>358</b>

**Composition 13**



39<sup>2</sup>/<sub>5</sub>"D x 55<sup>9</sup>/<sub>10</sub>"W x 27"H

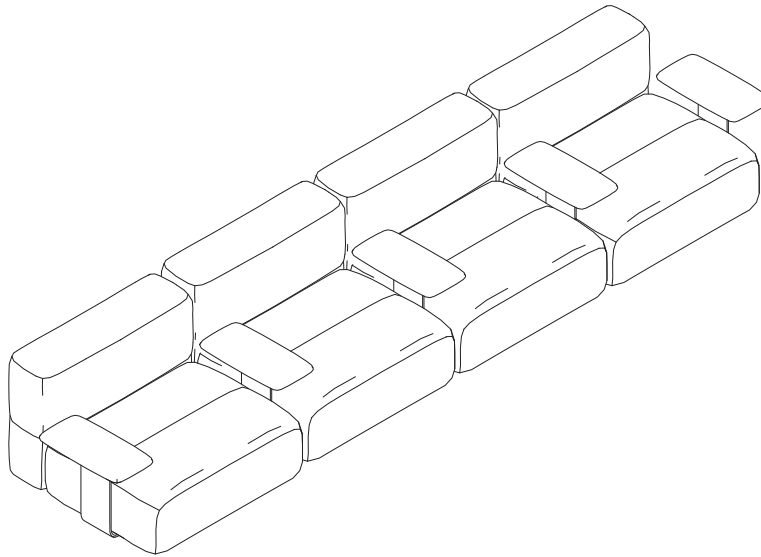
Quantity	Style Number	Description	Page for Ordering
1	VCBSAVIM	Savina sofa module with back and table left side and right facing	358

**Composition 14**

39 $\frac{2}{5}$ "D x 128 $\frac{3}{10}$ "W x 27"H

Quantity	Style Number	Description	Page for Ordering
1	<b>VCBSAVIM</b>	Savina sofa module with back and table right side facing	<b>358</b>
1	<b>VCBSAVIM</b>	Savina sofa module with back	<b>358</b>
1	<b>VCBSAVIM</b>	Savina sofa module with back and table left side facing	<b>358</b>

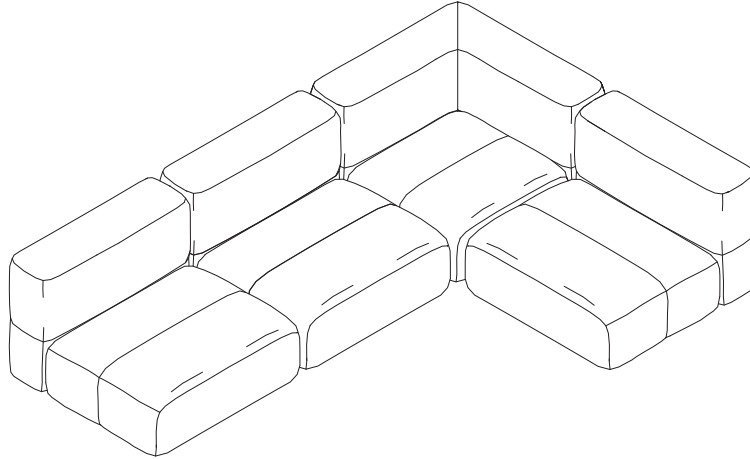
**Composition 15**



39<sup>2</sup>/<sub>5</sub>"D x 164<sup>3</sup>/<sub>5</sub>"W x 27"H

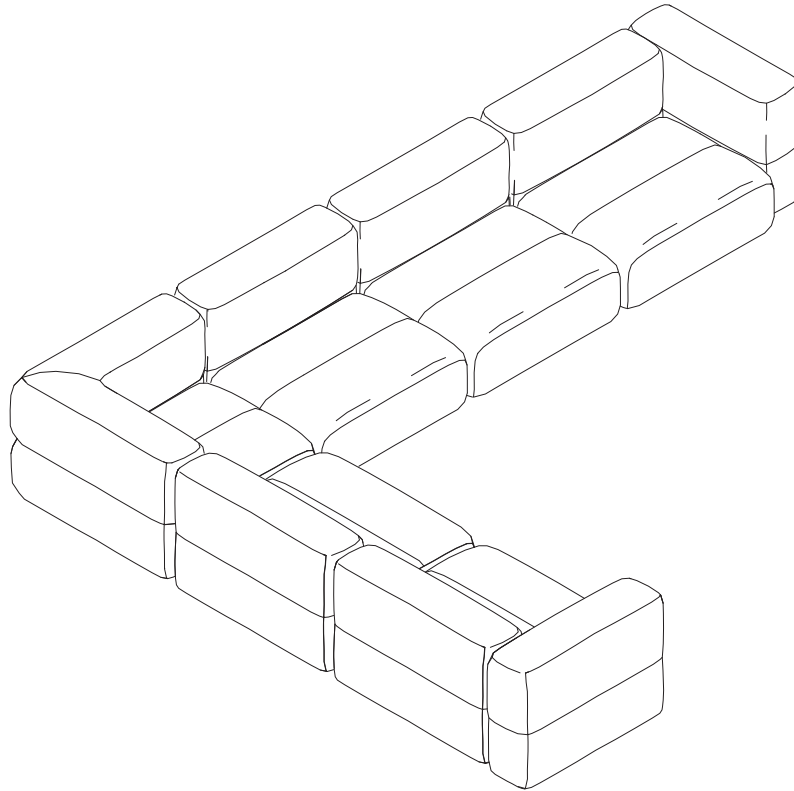
Quantity	Style Number	Description	Page for Ordering
3	VCBSAVIM	Savina sofa module with back and table right side facing	358
1	VCBSAVIM	Savina sofa module with back and tables left side and right side facing	358



**Composition 16**75 $\frac{3}{8}$ "D x 111 $\frac{4}{5}$ "W x 27"H

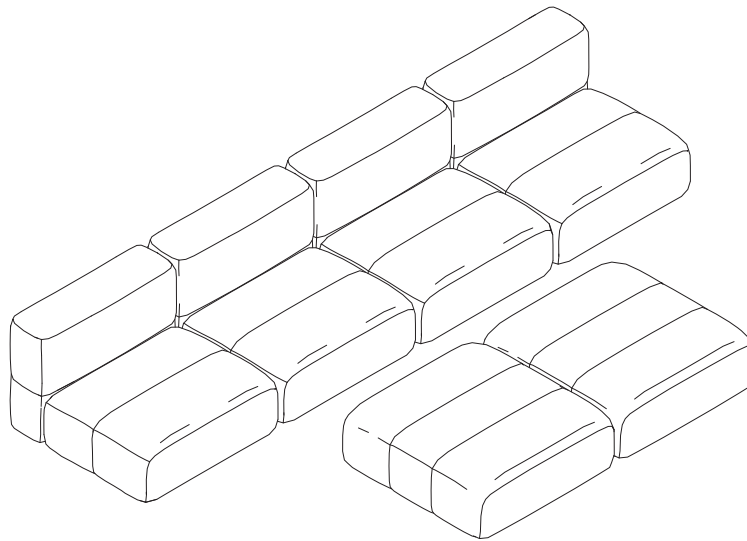
Quantity	Style Number	Description	Page for Ordering
3	VCBSAVIM	Savina sofa module with back	358
1	VCBSAVIRI	Savina corner sofa module	360

**Composition 17**



157<sup>9</sup>/<sub>10</sub>"D x 157<sup>9</sup>/<sub>10</sub>"W x 27"H

Quantity	Style Number	Description	Page for Ordering
1	<b>VCBSAVIM</b>	Savina sofa module with back and one arm right side facing	<b>358</b>
3	<b>VCBSAVIM</b>	Savina sofa module with back	<b>358</b>
1	<b>VCBSAVIRI</b>	Savina corner sofa module	<b>360</b>
1	<b>VCBSAVIM</b>	Savina sofa module with back and one arm left side facing	<b>358</b>

**Composition 18**

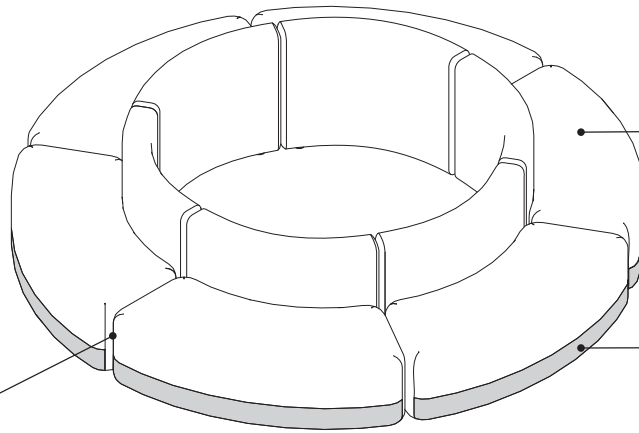
78½"D x 144½"W x 27"H

Quantity	Style Number	Description	Page for Ordering
4	<b>VCBSAVIM</b>	Savina sofa module with back	<b>358</b>
2	<b>VCBSAVISR</b>	Savina backless sofa module	<b>357</b>

# Season Sofa

**Season** is a simple and elegant upholstered modular sofa. The collection is composed by different modules, which makes it very easy to create different compositions for waiting areas and living rooms.

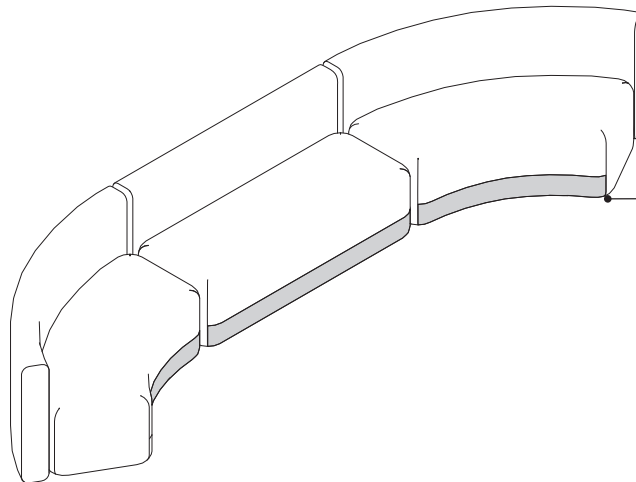
► Specifying, pages 362–363



**Upholstered in fabric or leather.**

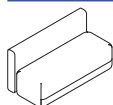
**Base of the sofa** has a grey protection of washable technical fabric, available in two color options.

**Sofa modules** gang together, allowing a wide variety of compositions.



**Height equalising legs** with a  $\frac{3}{4}$ " adjustment range.

**Product Details**



Straight Module

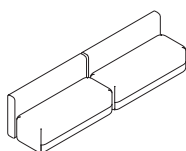


Closed Module

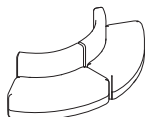


Open Module

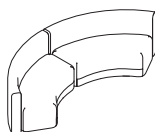
**Season sofa individual module components** are available in straight, closed, and open to create custom compositions.



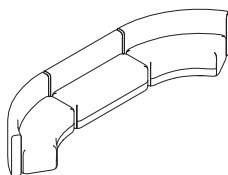
Composition 1



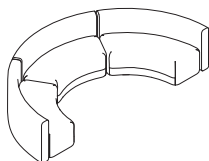
Composition 2



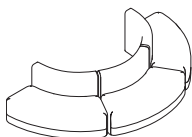
Composition 3



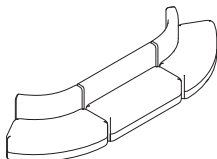
Composition 4



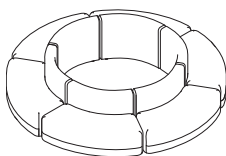
Composition 5



Composition 6



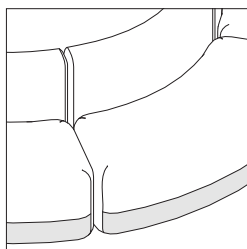
Composition 7



Composition 8

**Season sofa** compositions can be created by ordering individual module components.

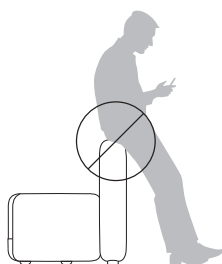
▶ See *Thought Starters*, pages 322–329



**Includes** a technical band at footrest height, making it more durable and resistant to hard use. Available in light gray or dark gray.

**Right and left end configuration options** help determine sofa layout.

**Right and left** are understood from the perspective of the person looking at the object from the front.



**Season backrest** is not intended for perching as an alternative seating method on the sofa.

**Surface Materials**

**Upholstery**

- Fabric
- Vinyl
- Leather
- COM (Customer's Own Material)
- COL (Customer's Own Leather)

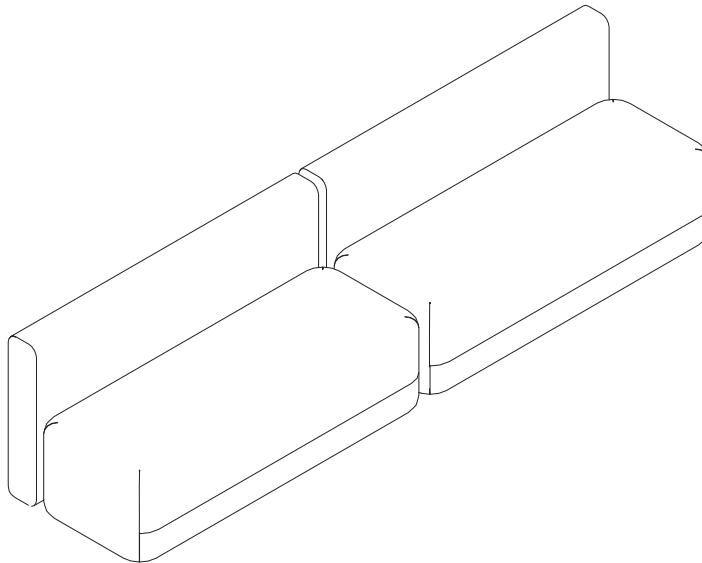
**Actual Dimensions**

Description	Style Number	Depth	Width	Height	Seat Depth	Seat Height	Weight
Straight Module	<b>VCBSESAS</b>	27 <sup>3</sup> / <sub>5</sub> "	59 <sup>1</sup> / <sub>10</sub> "	29 <sup>1</sup> / <sub>10</sub> "	21 <sup>3</sup> / <sub>10</sub> "	16 <sup>1</sup> / <sub>2</sub> "	109.3 lb
Closed Module	<b>VCBSESBS</b>	27 <sup>3</sup> / <sub>5</sub> "	67 <sup>7</sup> / <sub>10</sub> "	29 <sup>1</sup> / <sub>10</sub> "	21 <sup>3</sup> / <sub>10</sub> "	16 <sup>1</sup> / <sub>2</sub> "	110.7 lb
Open Module	<b>VCBSESCS</b>	27 <sup>3</sup> / <sub>5</sub> "	59 <sup>1</sup> / <sub>10</sub> "	29 <sup>1</sup> / <sub>10</sub> "	21 <sup>3</sup> / <sub>10</sub> "	16 <sup>1</sup> / <sub>2</sub> "	92.6 lb

# Thought Starters

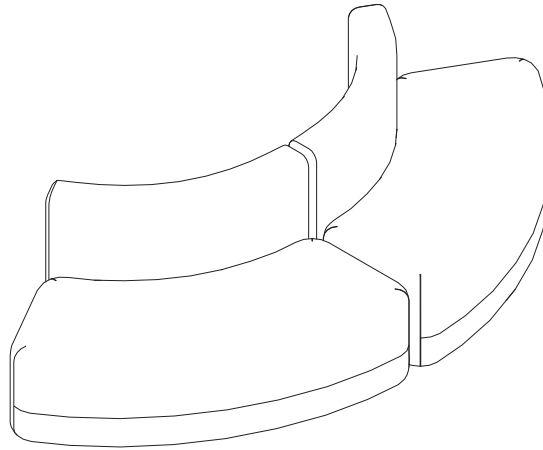
Season Sofa Compositions

## Composition 1



27<sup>3</sup>/<sub>8</sub>"D x 118<sup>1</sup>/<sub>10</sub>"W x 29<sup>1</sup>/<sub>10</sub>"H  
218.6 lb

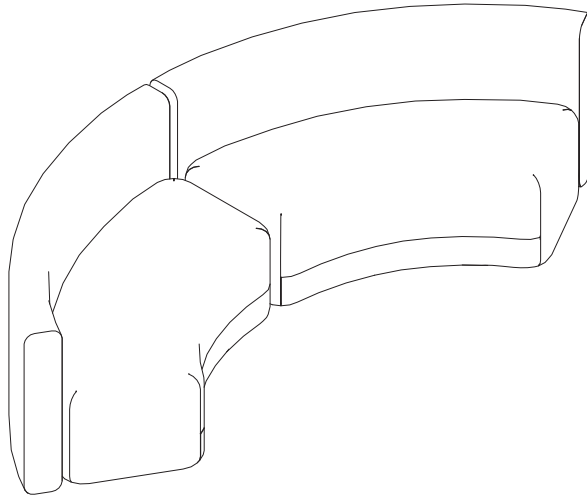
Quantity	Style Number	Description	Page for Ordering
2	VCBSESAS	Season straight module	362

**Composition 2**

104<sup>3</sup>/<sub>10</sub>"W x 29<sup>1</sup>/<sub>10</sub>"H  
185.2 lb

Quantity	Style Number	Description	Page for Ordering
2	VCBSESCS	Season open module	363

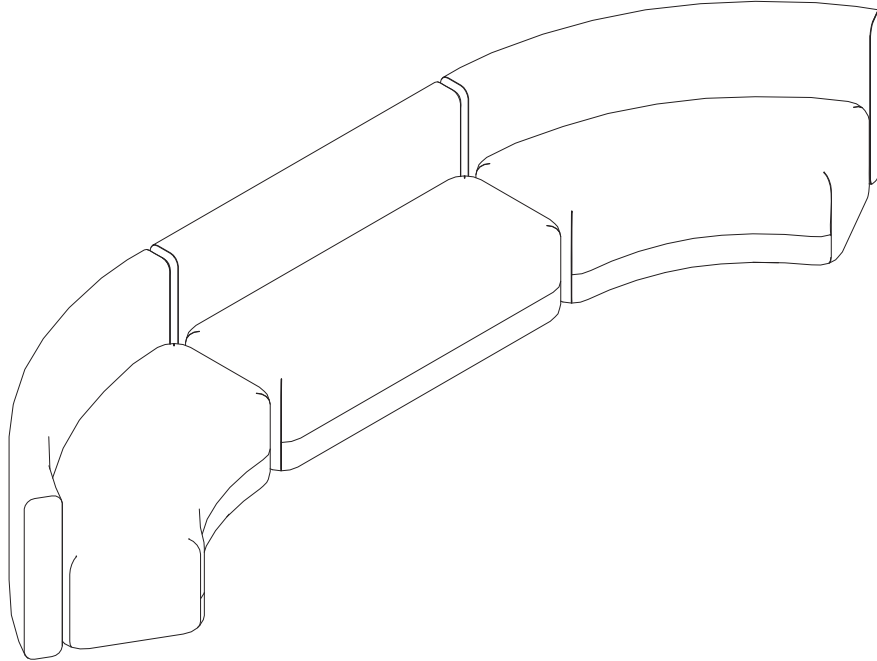
**Composition 3**



118<sup>1</sup>/<sub>10</sub>"W x 29<sup>1</sup>/<sub>10</sub>"H  
221.4 lb

Quantity	Style Number	Description	Page for Ordering
2	VCBSESBS	Season closed module	362

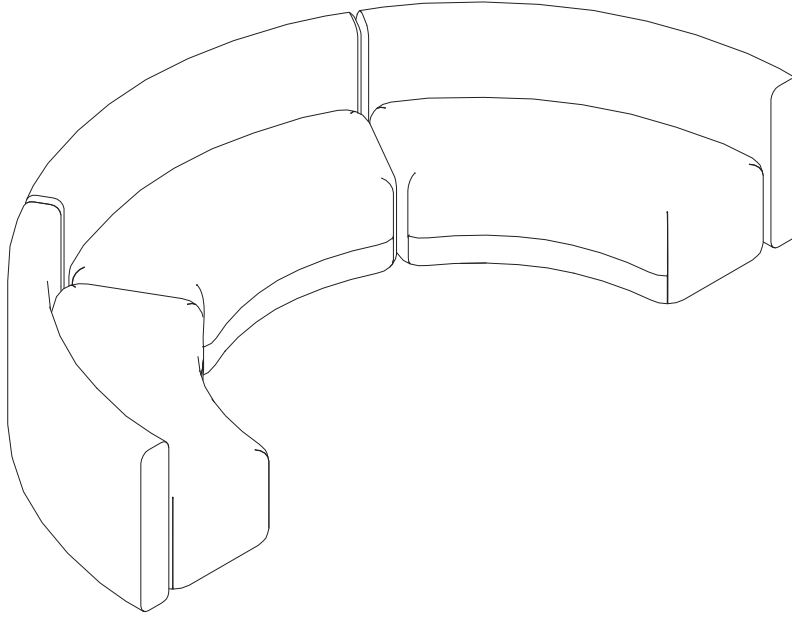


**Composition 4**

177<sup>1</sup>/<sub>8</sub>"W x 29<sup>1</sup>/<sub>10</sub>"H  
330.7 lb

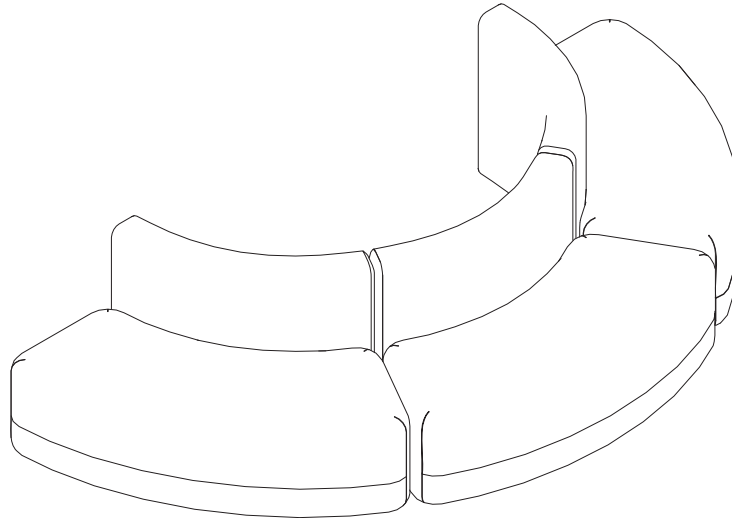
Quantity	Style Number	Description	Page for Ordering
2	<b>VCBSESBS</b>	Season closed module	<b>362</b>
1	<b>VCBSESAS</b>	Season straight module	<b>362</b>

**Composition 5**



137<sup>4</sup>/<sub>8</sub>"W x 29<sup>1</sup>/<sub>10</sub>"H  
332.1 lb

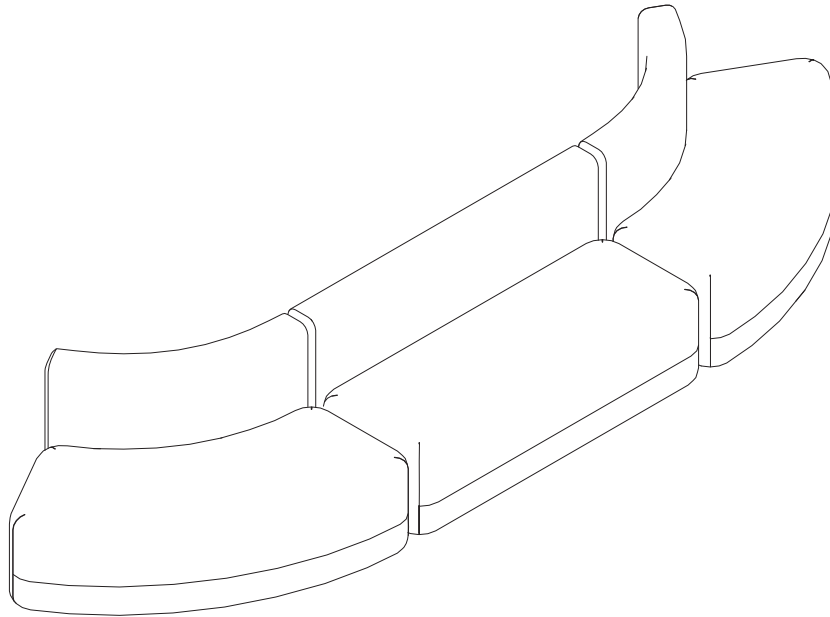
Quantity	Style Number	Description	Page for Ordering
3	VCBSESBS	Season closed module	362

**Composition 6**

124"W x 29<sup>1</sup>/<sub>10</sub>"H  
277.8 lb

Quantity	Style Number	Description	Page for Ordering
3	VCBSECS	Season open module	363

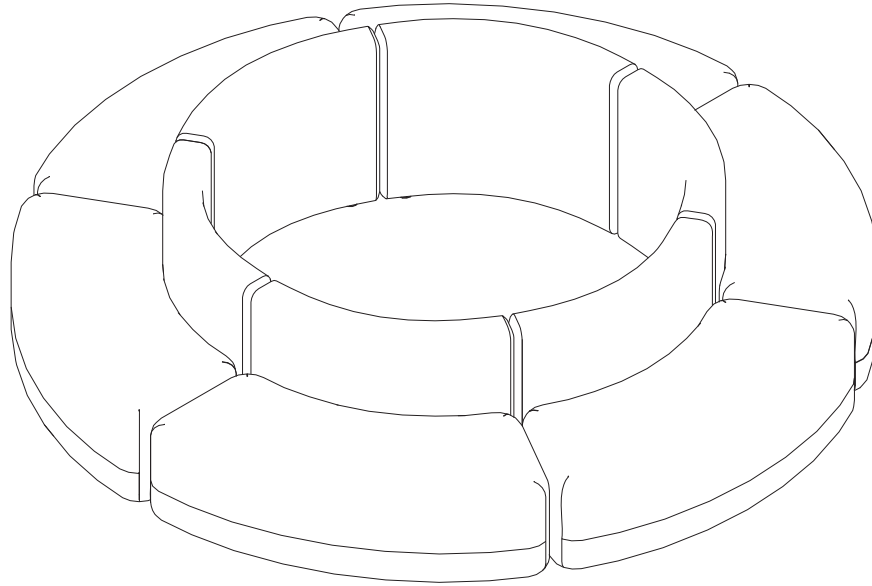
**Composition 7**



163<sup>1</sup>/<sub>2</sub>"W x 29<sup>1</sup>/<sub>10</sub>"H  
294.5 lb

Quantity	Style Number	Description	Page for Ordering
2	<b>VCBSESCS</b>	Season open module	<b>363</b>
1	<b>VCBSESAS</b>	Season straight module	<b>362</b>

### Composition 8



124"W x 29<sup>1</sup>/<sub>10</sub>"H  
555.6 lb

Quantity	Style Number	Description	Page for Ordering
6	VCBSECS	Season open module	363

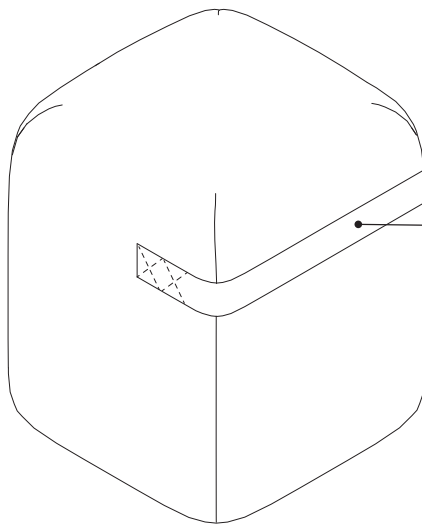
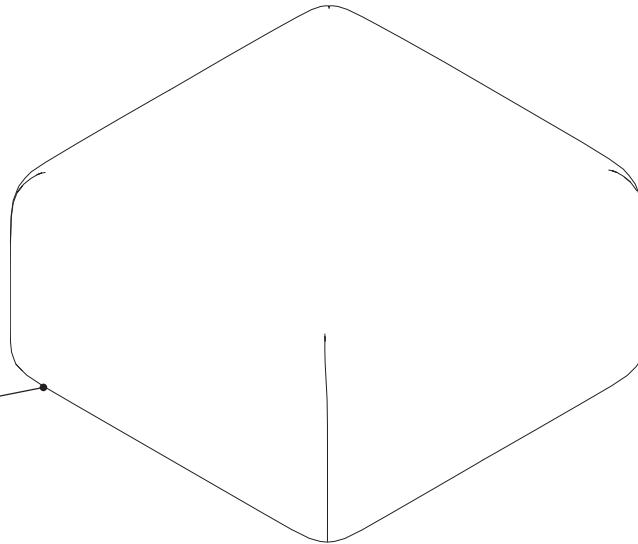
# Season Pouf

**Season Pouf**, designed by Piero Lissoni, is a collection of soft seating best used as a footrest or independent guest seat. The pouf can include hidden casters and a strap which facilitates its transportation.

► Specifying, pages 364–365

**Height adjustable legs** are suitable for all surfaces.

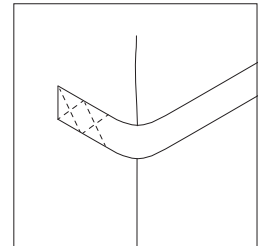
**Hidden casters** provide easy maneuverability and low profile.



**Strap** is optional and made of polypropylene. The strap provides visual interest as well as an easy way to move poufs.

## Product Details

**Season Pouf** is fully upholstered and has a relaxed appearance. Poufs may show soft comfort wrinkles upon use.



**Strap** is sewn on the side of the pouf and is available in three colors. The strap has detailed stitching that is matched to the upholstery. The strap is sewn with clear mono-filament.

## Surface Materials

### Upholstery

- Fabric
- Vinyl
- Leather
- COM (Customer's Own Material)
- COL (Customer's Own Leather)

### Strap

- Black
- Grey
- Red

## Actual Dimensions

Description	Style Number	Depth	Width	Height	Weight
Season Pouf—15 <sup>7</sup> / <sub>10</sub> "	<b>VCBSEM40</b> <b>VCBSEMR40</b>	15 <sup>7</sup> / <sub>10</sub> "	15 <sup>7</sup> / <sub>10</sub> "	19 <sup>3</sup> / <sub>10</sub> "	22.5 lb
Season Pouf—19 <sup>7</sup> / <sub>10</sub> "	<b>VCBSEM50</b> <b>VCBSEMR50</b>	19 <sup>7</sup> / <sub>10</sub> "	19 <sup>7</sup> / <sub>10</sub> "	19 <sup>3</sup> / <sub>10</sub> "	26.2 lb
Season Pouf—23 <sup>3</sup> / <sub>5</sub> "	<b>VCBSEM60</b> <b>VCBSEMR60</b>	19 <sup>7</sup> / <sub>10</sub> "	23 <sup>3</sup> / <sub>5</sub> "	14 <sup>1</sup> / <sub>5</sub> "	25.1 lb
Season Pouf—35 <sup>2</sup> / <sub>5</sub> " x 14 <sup>1</sup> / <sub>5</sub> "	<b>VCBSEM90</b> <b>VCBSEMR90</b>	35 <sup>2</sup> / <sub>5</sub> "	35 <sup>2</sup> / <sub>5</sub> "	14 <sup>1</sup> / <sub>5</sub> "	58.4 lb
Season Pouf—35 <sup>2</sup> / <sub>5</sub> " x 19 <sup>3</sup> / <sub>10</sub> "	<b>VCBSEM90H</b> <b>VCBSEMR90H</b>	35 <sup>2</sup> / <sub>5</sub> "	35 <sup>2</sup> / <sub>5</sub> "	19 <sup>3</sup> / <sub>10</sub> "	66.8 lb

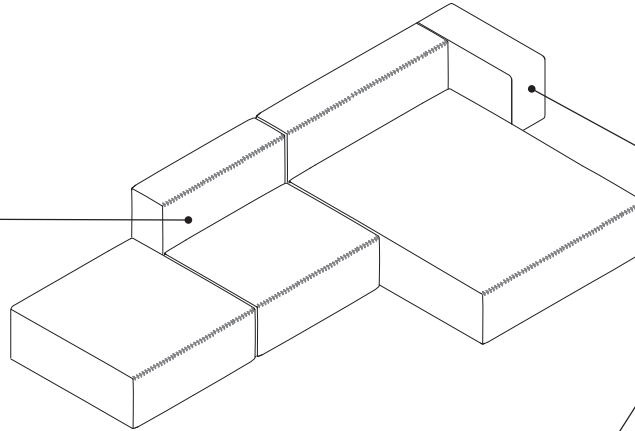


# Step

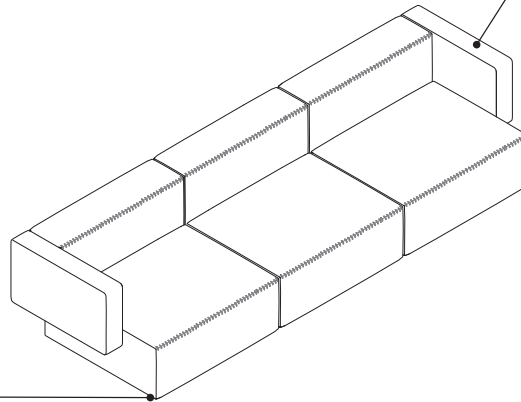
**Step**, designed by Vincent Van Duysen, is a collection of seating modules that allows a wide variety of compositions by combining elements of different dimensions.

► Specifying, pages 367–371

**Upholstered seat and back**



**Upholstered arms** are available in narrow and wide.



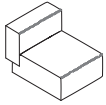
**Height-adjustable legs** have a 3/4" adjustment range.

## Actual Dimensions

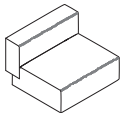
Description	Style Number	Depth	Width	Height	Seat Depth	Seat Height	Weight
Module 27 <sup>3</sup> / <sub>5</sub> " (Small)	<b>VCBST70</b>	37 <sup>2</sup> / <sub>5</sub> "	27 <sup>3</sup> / <sub>5</sub> "	25 <sup>3</sup> / <sub>5</sub> "	27 <sup>3</sup> / <sub>5</sub> "	14 <sup>1</sup> / <sub>5</sub> "	58.9 lb
Module 35 <sup>2</sup> / <sub>5</sub> " (Large)	<b>VCBST90</b>	37 <sup>2</sup> / <sub>5</sub> "	35 <sup>2</sup> / <sub>5</sub> "	25 <sup>3</sup> / <sub>5</sub> "	27 <sup>3</sup> / <sub>5</sub> "	14 <sup>1</sup> / <sub>5</sub> "	80.5 lb
Chaise	<b>VCBSTCH</b>	62"	35 <sup>2</sup> / <sub>5</sub> "	25 <sup>3</sup> / <sub>5</sub> "	27 <sup>3</sup> / <sub>5</sub> "	14 <sup>1</sup> / <sub>5</sub> "	135.4 lb
Corner	<b>VCBSTRI</b>	37 <sup>2</sup> / <sub>5</sub> "	35 <sup>2</sup> / <sub>5</sub> "	25 <sup>3</sup> / <sub>5</sub> "	27 <sup>3</sup> / <sub>5</sub> "	14 <sup>1</sup> / <sub>5</sub> "	90.2 lb
Pouf	<b>VCBSTPO</b>	37 <sup>2</sup> / <sub>5</sub> "	35 <sup>2</sup> / <sub>5</sub> "	14 <sup>1</sup> / <sub>5</sub> "	27 <sup>3</sup> / <sub>5</sub> "	14 <sup>1</sup> / <sub>5</sub> "	60.2 lb
Square Cushion	<b>VCBSTAL25</b>	19 <sup>7</sup> / <sub>10</sub> "	19 <sup>7</sup> / <sub>10</sub> "	N.A.	N.A.	N.A.	N.A.
Rectangle Cushion	<b>VCBSTAL50</b>	23 <sup>3</sup> / <sub>5</sub> "	11 <sup>1</sup> / <sub>5</sub> "	N.A.	N.A.	N.A.	N.A.



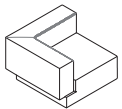
**Product Details**



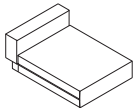
Module 27<sup>3</sup>/<sub>8</sub>"



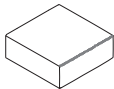
Module 35<sup>3</sup>/<sub>8</sub>"



Corner



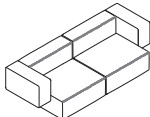
Chaise



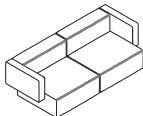
Pouf

**Step individual module components** are available in small and large module, chaise, corner, and pouf to create custom compositions.

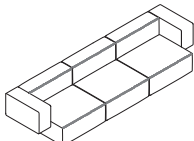
**Sofa Compositions**



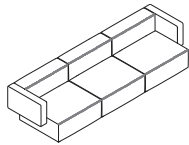
Composition 1



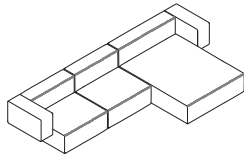
Composition 2



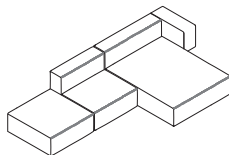
Composition 3



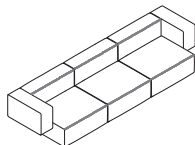
Composition 4



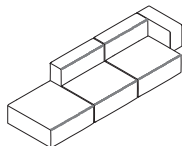
Composition 5



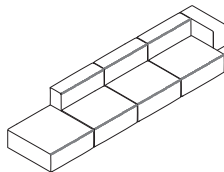
Composition 6



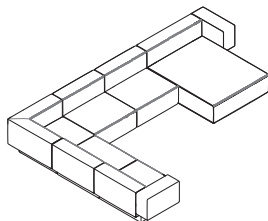
Composition 7



Composition 8

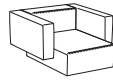


Composition 9

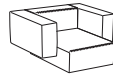


Composition 10

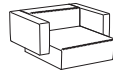
**Armchair Compositions**



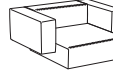
Composition 1



Composition 2

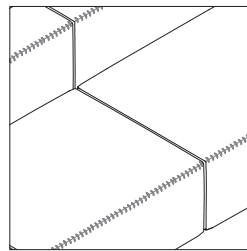


Composition 3

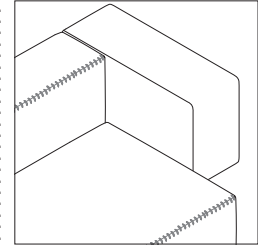
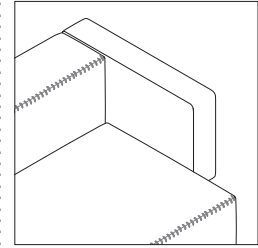


Composition 4

**Step compositions** can be created by ordering individual module components  
 ▶ See *Thought Starters*, pages 334–347.



**Decorative seams** are optional and are handmade, available in several colors.



**Armrests** are available narrow and wide. Armrests are 27<sup>3</sup>/<sub>8</sub>"D x 18<sup>9</sup>/<sub>10</sub>"H. They are installed so the armrest is at an overall height of 25<sup>3</sup>/<sub>8</sub>"H. The narrow armrests are 4<sup>9</sup>/<sub>10</sub>"W and the wide armrest are 9<sup>4</sup>/<sub>5</sub>"W.  
 Tip: *Narrow and wide armrests may be combined in the same composition.*

**Right and left end configuration options** help determine sofa layout.

**Right and left** are understood from the perspective of the person looking at the object from the front.

**Surface Materials**

**Upholstery**

- Fabric
- COM (Customer's Own Material)

Tip: *Step sofas are not available in leather.*

**Seam**

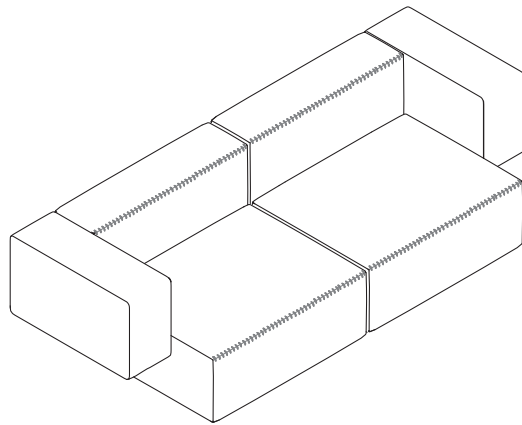
- White
- Black
- Red
- Sky Blue
- Light Grey
- Dark Grey
- Green
- Cream
- Deep Blue
- Caramel
- Wine

# Thought Starters

## Step Sofa Compositions

### Composition 1

#### Sofa Compositions

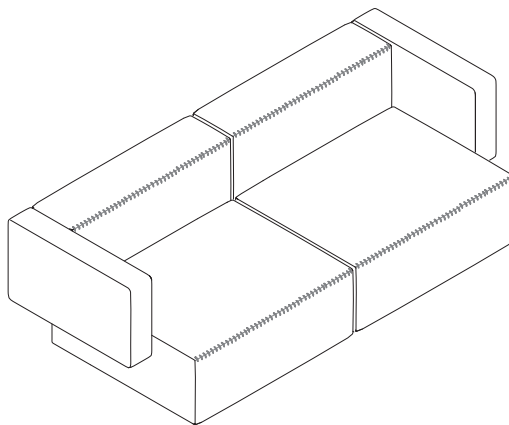


37<sup>2</sup>/<sub>5</sub>"D x 90<sup>2</sup>/<sub>5</sub>"W x 25<sup>3</sup>/<sub>5</sub>"H

Quantity	Style Number	Description	Page for Ordering
1	<b>VCBST90</b>	Step 35 <sup>2</sup> / <sub>5</sub> "W module with one wide arm right side facing	<b>367</b>
1	<b>VCBST90</b>	Step 35 <sup>2</sup> / <sub>5</sub> "W module with one wide arm left side facing	<b>367</b>

## Composition 2

Sofa Compositions

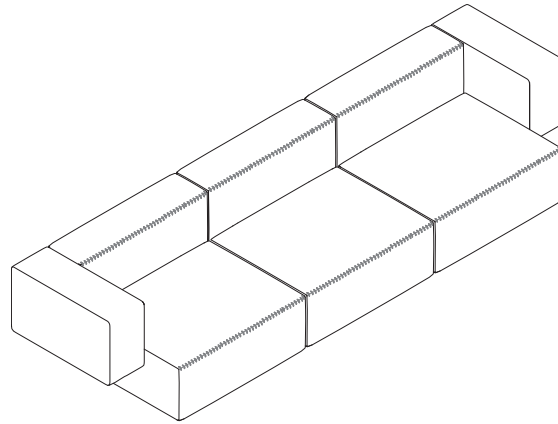


37 $\frac{2}{8}$ "D x 80 $\frac{3}{8}$ "W x 25 $\frac{3}{8}$ "H

Quantity	Style Number	Description	Page for Ordering
1	<b>VCBST90</b>	Step 35 $\frac{1}{2}$ "W module with one narrow arm right side facing	<b>367</b>
1	<b>VCBST90</b>	Step 35 $\frac{1}{2}$ "W module with one narrow arm left side facing	<b>367</b>

**Composition 3**

Sofa Compositions

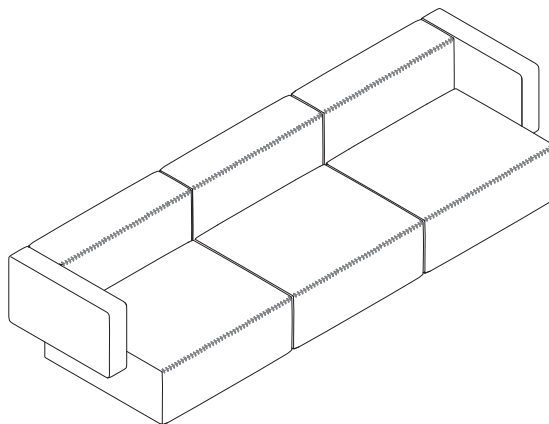


37<sup>2</sup>/<sub>5</sub>"D x 125<sup>4</sup>/<sub>5</sub>"W x 25<sup>3</sup>/<sub>5</sub>"H

Quantity	Style Number	Description	Page for Ordering
1	<b>VCBST90</b>	Step 35 <sup>2</sup> / <sub>5</sub> "W module with one wide arm right side facing	<b>367</b>
1	<b>VCBST90</b>	Step 35 <sup>2</sup> / <sub>5</sub> "W module	<b>367</b>
1	<b>VCBST90</b>	Step 35 <sup>2</sup> / <sub>5</sub> "W module with one wide arm left side facing	<b>367</b>

## Composition 4

Sofa Compositions

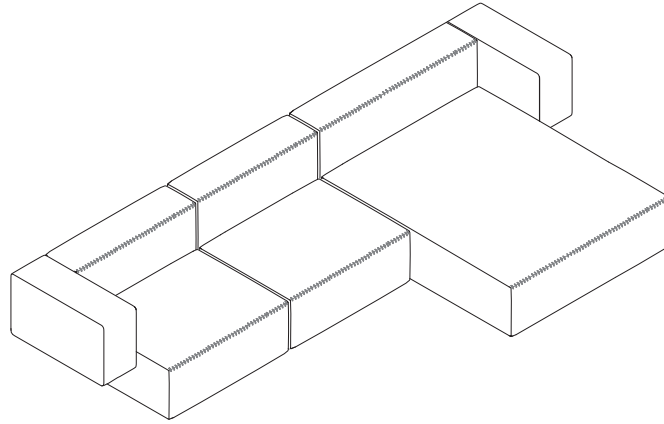


37 $\frac{2}{5}$ "D x 116"W x 25 $\frac{3}{5}$ "H

Quantity	Style Number	Description	Page for Ordering
1	<b>VCBST90</b>	Step 35 $\frac{2}{5}$ "W module with one narrow arm right side facing	<b>367</b>
1	<b>VCBST90</b>	Step 35 $\frac{2}{5}$ "W module	<b>367</b>
1	<b>VCBST90</b>	Step 35 $\frac{2}{5}$ "W module with one narrow arm left side facing	<b>367</b>

**Composition 5**

Sofa Compositions

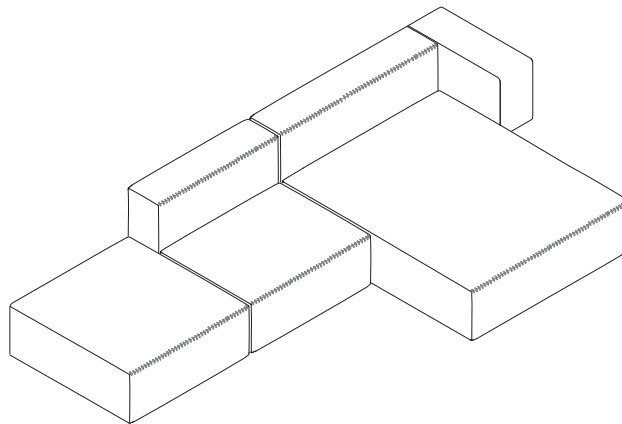


62"D x 125 1/8"W x 25 3/8"H

Quantity	Style Number	Description	Page for Ordering
1	<b>VCBSTCH</b>	Step chaise with one wide arm right side facing	<b>369</b>
1	<b>VCBST90</b>	Step 35 1/2"W module	<b>367</b>
1	<b>VCBST90</b>	Step 35 1/2"W module with one wide arm left side facing	<b>367</b>

## Composition 6

Sofa Compositions

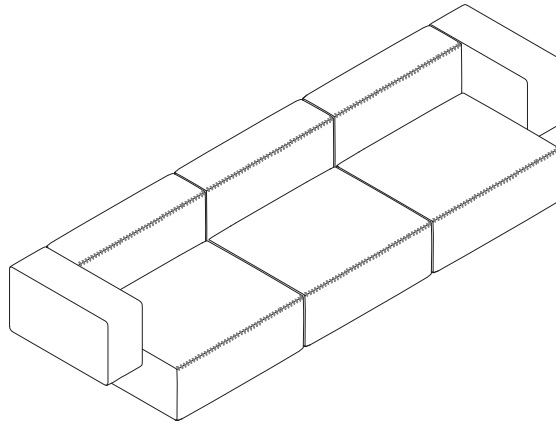


*37 $\frac{2}{5}$ "D x 128"W x 25 $\frac{3}{5}$ "H*

Quantity	Style Number	Description	Page for Ordering
1	<b>VCBSTCH</b>	Step chaise with one wide arm right side facing	<b>369</b>
1	<b>VCBST90</b>	Step 35 $\frac{2}{5}$ "W module	<b>367</b>
1	<b>VCBSTPO</b>	Step pouf	<b>370</b>

**Composition 7**

Sofa Compositions



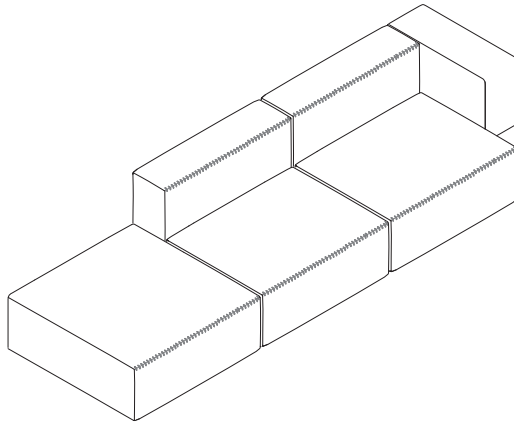
37<sup>2</sup>/<sub>8</sub>"D x 102<sup>2</sup>/<sub>8</sub>"W x 25<sup>3</sup>/<sub>8</sub>"H

Quantity	Style Number	Description	Page for Ordering
1	<b>VCBST70</b>	Step 27 <sup>3</sup> / <sub>8</sub> "W module with one wide arm right side facing	<b>367</b>
1	<b>VCBST70</b>	Step 27 <sup>3</sup> / <sub>8</sub> "W module	<b>367</b>
1	<b>VCBST70</b>	Step 27 <sup>3</sup> / <sub>8</sub> "W module with one wide arm left side facing	<b>367</b>



## Composition 8

Sofa Compositions

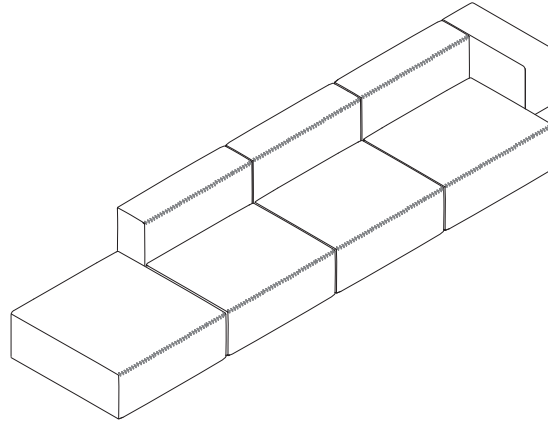


37 $\frac{2}{5}$ "D x 116"W x 25 $\frac{3}{8}$ "H

Quantity	Style Number	Description	Page for Ordering
1	<b>VCBST90</b>	Step 35 $\frac{2}{5}$ "W module with one wide arm right side facing	<b>367</b>
1	<b>VCBST90</b>	Step 35 $\frac{2}{5}$ "W module	<b>367</b>
1	<b>VCBSTPO</b>	Step pouf	<b>370</b>

**Composition 9**

Sofa Compositions

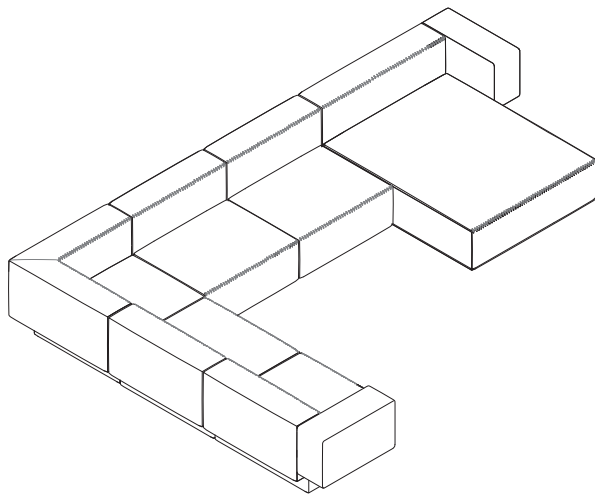


37 $\frac{1}{2}$ "D x 151 $\frac{3}{8}$ "W x 25 $\frac{3}{8}$ "H

Quantity	Style Number	Description	Page for Ordering
1	<b>VCBST90</b>	Step 35 $\frac{7}{8}$ "W module with one wide arm right side facing	<b>367</b>
2	<b>VCBST90</b>	Step 35 $\frac{7}{8}$ "W module	<b>367</b>
1	<b>VCBSTPO</b>	Step pouf	<b>370</b>

**Composition 10**

## Sofa Compositions



118 $\frac{1}{10}$ "D x 151 $\frac{2}{5}$ "W x 25 $\frac{3}{8}$ "H

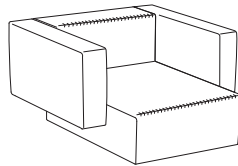
Quantity	Style Number	Description	Page for Ordering
1	<b>VCBSTCH</b>	Step chaise with one wide arm right side facing	<b>369</b>
3	<b>VCBST90</b>	Step 35 $\frac{2}{5}$ "W module	<b>367</b>
1	<b>VCBSTRI</b>	Step corner module	<b>370</b>
1	<b>VCBST90</b>	Step 35 $\frac{2}{5}$ "W module with one wide arm left side facing	<b>367</b>

# Thought Starters

Step Armchair Compositions

## Composition 1

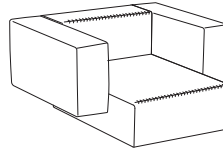
Armchair Compositions



37<sup>7</sup>/<sub>8</sub>"D x 37<sup>7</sup>/<sub>8</sub>"W x 25<sup>3</sup>/<sub>8</sub>"H

Quantity	Style Number	Description	Page for Ordering
1	VCBST70	Step 27 <sup>3</sup> / <sub>8</sub> "W module with two narrow arms, right and left facing	367

**Composition 2**  
Armchair Compositions

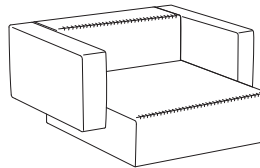


37<sup>2</sup>/<sub>6</sub>"D x 47<sup>3</sup>/<sub>6</sub>"W x 25<sup>3</sup>/<sub>6</sub>"H

Quantity	Style Number	Description	Page for Ordering
1	<b>VCBST70</b>	Step 27 <sup>3</sup> / <sub>6</sub> "W module with two wide arms, right and left facing	<b>367</b>

**Composition 3**

Armchair Compositions

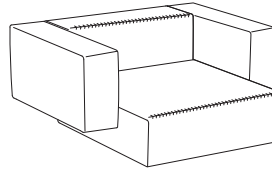


37 $\frac{1}{2}$ "D x 45 $\frac{1}{2}$ "W x 25 $\frac{3}{8}$ "H

Quantity	Style Number	Description	Page for Ordering
1	<b>VCBST90</b>	Step 35 $\frac{1}{2}$ "W module with two narrow arms, right and left facing	<b>367</b>

**Composition 4**

## Armchair Compositions



*37<sup>2</sup>/<sub>5</sub>"D x 55<sup>1</sup>/<sub>10</sub>"W x 25<sup>3</sup>/<sub>8</sub>"H*

Quantity	Style Number	Description	Page for Ordering
1	<b>VCBST90</b>	Step 35 <sup>2</sup> / <sub>5</sub> "W module with two wide arms, right and left facing	<b>367</b>





---

# Specifying Sofas

Standard Import Lead Time

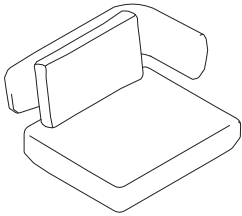
---

## Specifying

Levitt	<b>350</b>
Savina	<b>355</b>
Season Sofa	<b>362</b>
Season Pouf	<b>364</b>
Step	<b>367</b>

# Sofas

## Levitt



*Tip: The armchair is standard with a wide right side facing arm, shown above.*

### Standard Includes

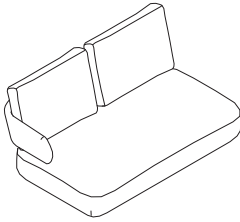
- Upholstery: fabric price group 01
- Legs: black high-density polyurethane resin

### Options

Wide Arm Position	Wide Arm Left Side Facing	No cost
	Wide Arm Right Side Facing	No cost

### Specification Information

Dimensions			Style Number	Prices					
D	W	H		Upholstery Grades:					
				1	2	3	4	5/Leather	COM/COL
<b>Levitt Armchair</b>									
27 3/5"	36 1/5"	31 1/2"	<b>VCBBUTACA</b>	\$3239	\$3418	\$3774	\$4321	\$5222	\$3239



**Standard Includes**

- Upholstery: fabric price group 01
- Legs: black high-density polyurethane resin

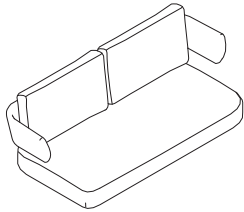
**Specification Information**

Dimensions			Style Number	Prices					
D	W	H		Upholstery Grades:					
				1	2	3	4	5/Leather	COM/COL
<b>Levitt Small Sofa</b>									
35 2/5"	59 4/5"	31 1/2"	<b>VCBSOFA152</b>	\$4703	\$4964	\$5511	\$6371	\$7712	\$4703



# Sofas

## Levitt

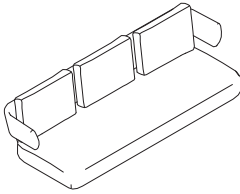


### Standard Includes

- Upholstery: fabric price group 01
- Legs: black high-density polyurethane resin

### Specification Information

Dimensions				Style Number	Prices					
D	W	H	Upholstery Grades:							
					1	2	3	4	5/Leather	COM/COL
<b>Levitt Medium Sofa</b>										
35 2/5"	72 2/5"	31 1/2"	<b>VCBSOFA184</b>	\$6317	\$6632	\$7288	\$9845	\$11,391	\$6317	



**Standard Includes**

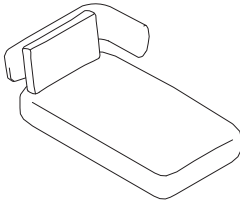
- Upholstery: fabric price group 01
- Legs: black high-density polyurethane resin

**Specification Information**

Dimensions			Style Number	Prices						
D	W	H		Upholstery Grades:						
				1	2	3	4	5/Leather	COM/COL	

**Levitt Large Sofa**

35 2/5"	96 1/10"	31 1/2"	<b>VCBSOFA244</b>	\$7957	\$8395	\$9270	\$10,828	\$13,100	\$7957
---------	----------	---------	-------------------	--------	--------	--------	----------	----------	--------



**Standard Includes**

- Upholstery: fabric price group 01
- Legs: black high-density polyurethane resin

**Specification Information**

Dimensions			Style Number	Prices						
D	W	H		Upholstery Grades:						
				1	2	3	4	5/Leather	COM/COL	

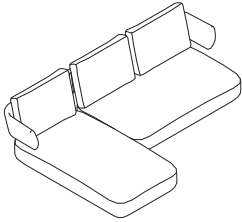
**Levitt Chaise**

123 3/5"	36 1/5"	31 1/2"	<b>VCBCHAISE</b>	\$3924	\$4157	\$4594	\$5209	\$6276	\$3924
----------	---------	---------	------------------	--------	--------	--------	--------	--------	--------



# Sofas

## Levitt



### Standard Includes

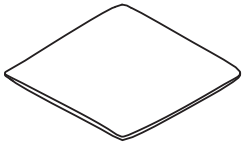
- Upholstery: fabric price group 01
- Legs: black high-density polyurethane resin

### Specification Information

Dimensions			Style Number	Prices					
D	W	H		Upholstery Grades:					
				1	2	3	4	5/Leather	COM/COL

### Levitt Sofa Composition L1

123 3/10"	96 1/10"	31 1/2"	<b>VCBSOFACOMPL1</b>	\$8627	\$9119	\$10,104	\$11,580	\$13,988	\$8627
-----------	----------	---------	----------------------	--------	--------	----------	----------	----------	--------



### Standard Includes

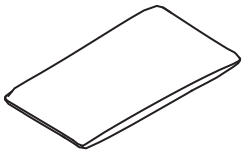
- Upholstered cushion

### Specification Information

Dimensions		Style Number	Prices					
D	W		Upholstery Grades:					
			1	2	3	4	5/Leather	COM/COL

### Levitt Square Cushion

19 7/10"	19 7/10"	<b>VCBLEAL50</b>	\$164	\$205	\$301	\$451	\$520	\$164
----------	----------	------------------	-------	-------	-------	-------	-------	-------



### Standard Includes

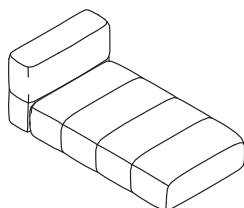
- Upholstered cushion

### Specification Information

Dimensions		Style Number	Prices					
D	W		Upholstery Grades:					
			1	2	3	4	5/Leather	COM/COL

### Levitt Rectangular Cushion

11 4/5"	23 3/5"	<b>VCBLEAL30</b>	\$274	\$287	\$368	\$437	\$506	\$274
---------	---------	------------------	-------	-------	-------	-------	-------	-------



Tip: Arms must be specified in the same fabric group as sofa module.

**Standard Includes**

- Upholstery: fabric price group 01
- Legs: Height-adjustable legs or hidden casters, if selected
- Side table: solid oak wood, if selected

**Options**

Table	No Table	No cost
	With Table Left Side Facing	+\$622
	With Table Right Side Facing	+\$622
Arms	No Arm Rests	No cost
	1 Arm Left Side Facing	Prices below
	1 Arm Right Side Facing	Prices below
	2 Arms Left and Right	Prices below
Right End Configuration	Connect Another	No cost
	End Run	No cost
Left End Configuration	Connect Another	No cost
	End Run	No cost

**Specification Information**

	Arm Upcharges					
	Upholstery Grades:					
	1	2	3	4	5/Leather	COM/COL
One Arm Left or Right Side Facing - Upholstered Sidearm	+\$901	+\$974	+\$1103	+\$1233	+\$1392	+\$901
One Arm Left or Right Side Facing - Upholstered High Arm	+\$1036	+\$1155	+\$1377	+\$1609	+\$1851	+\$1036
Two Arms Left and Right - Two Upholstered Sidearms	+\$1802	+\$1948	+\$2206	+\$2466	+\$2784	+\$1802
Two Arms Left and Right - One Upholstered Sidearm and One Upholstered High Arm	+\$1937	+\$2129	+\$2480	+\$2842	+\$3243	+\$1937
Two Arms Left and Right - Two Upholstered High Arms	+\$2072	+\$2310	+\$2754	+\$3218	+\$3702	+\$2072

► **Product Information continued on next page**

Sofas

# Sofas

## Savina

► **Product Information continued from previous page**

### Specification Information

				Base Prices					
Dimensions			Style	Upholstery Grades:					
D	W	H	Number	1	2	3	4	5/Leather	COM/COL
<b>Savina Chaise</b>									
68 9/10"	36 1/5"	27"	<b>VCBSAVICH</b>	\$4259	\$4727	\$5513	\$6338	\$7198	\$4259
<b>Savina Chaise with Upholstery Protection</b>									
68 9/10"	36 1/5"	27"	<b>VCBSAVICHPR</b>	\$4344	\$4812	\$5598	\$6423	\$7283	\$4344
<b>Savina Chaise with Casters</b>									
68 9/10"	36 1/5"	27"	<b>VCBSAVICHCR</b>	\$4368	\$4836	\$5623	\$6448	\$7307	\$4368
<b>Savina Chaise with Casters and Upholstery Protection</b>									
68 9/10"	36 1/5"	27"	<b>VCBSAVICHPCR</b>	\$4454	\$4922	\$5708	\$6533	\$7393	\$4454

Needed fabric for material 1.53 yd wide:

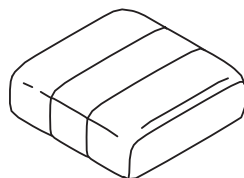
**Chaise:** 5.57 yd

**Chaise with protection:** 4.54 yd

**High arm:** 2.4 yd

**Sidearm:** 0.55 yd





Tip: Arms must be specified in the same fabric group as sofa module.

Tip: Savina pouf is independent of sofa configuration and can be added as a complement to a layout. Arms are not specifiable on pouf.

Tip: Table not available on Savina pouf.

**Standard Includes**

- Upholstery: fabric price group 01
- Legs: fixed or with hidden casters
- Side table: solid oak wood, if selected

**Options**

Table	No Table	No cost
	With Table Left Side Facing	+\$622
	With Table Right Side Facing	+\$622
Arms	No Arm Rests	No cost
	1 Arm Left Side Facing	Prices below
	1 Arm Right Side Facing	Prices below
	2 Arms Left and Right	Prices below
Right End Configuration	Connect Another	No cost
	End Run	No cost
Left End Configuration	Connect Another	No cost
	End Run	No cost

**Specification Information**

	Arm Upcharges					
	Upholstery Grades:					
	1	2	3	4	5/Leather	COM/COL
One Arm Left or Right Side Facing - Upholstered Sidearm	+\$901	+\$974	+\$1103	+\$1233	+\$1392	+\$901
Two Arms Left and Right - Two Upholstered Sidearms	+\$1802	+\$1948	+\$2206	+\$2466	+\$2784	+\$1802

Dimensions	Style	Base Prices							
		Upholstery Grades:							
D	W	H	Number	1	2	3	4	5/Leather	COM/COL

**Savina Backless Sofa Module**

39 2/5"	36 1/5"	14 3/5"	<b>VCBSAVISR</b>	\$2075	\$2317	\$2736	\$3174	\$3634	\$2075
---------	---------	---------	------------------	--------	--------	--------	--------	--------	--------

**Savina Backless Sofa Module with Casters**

39 2/5"	36 1/5"	14 3/5"	<b>VCBSAVISRR</b>	\$2173	\$2415	\$2834	\$3272	\$3732	\$2173
---------	---------	---------	-------------------	--------	--------	--------	--------	--------	--------

**Savina Pouf**

39 2/5"	36 1/5"	14 3/5"	<b>VCBSAUIPO</b>	\$2075	\$2317	\$2736	\$3174	\$3634	\$2075
---------	---------	---------	------------------	--------	--------	--------	--------	--------	--------

**Savina Pouf with Casters**

39 2/5"	36 1/5"	14 3/5"	<b>VCBSAUIPOR</b>	\$2173	\$2415	\$2834	\$3272	\$3732	\$2173
---------	---------	---------	-------------------	--------	--------	--------	--------	--------	--------

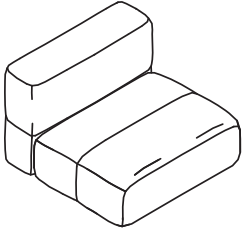
Needed fabric for material 1.53 yd wide:

**Backless:** 3.4 yd

**Sidearm:** 0.55 yd

# Sofas

## Savina



Tip: Arms must be specified in the same fabric group as sofa module.

### Standard Includes

- Upholstery: fabric price group 01
- Legs: fixed or with hidden casters
- Side table: solid oak wood, if selected

### Options

Table	No Table	No cost
	With Table Left Side Facing	+\$622
	With Table Right Side Facing	+\$622
Arms	No Arm Rests	No cost
	1 Arm Left Side Facing	Prices below
	1 Arm Right Side Facing	Prices below
	2 Arms Left and Right	Prices below
Right End Configuration	Connect Another	No cost
	End Run	No cost
Left End Configuration	Connect Another	No cost
	End Run	No cost

### Specification Information

#### Arm Upcharges

#### Upholstery Grades:

	1	2	3	4	5/Leather	COM/COL
One Arm Left or Right Side Facing - Upholstered Sidearm	+\$901	+\$974	+\$1103	+\$1233	+\$1392	+\$901
Two Arms Left and Right - Two Upholstered Sidearms	+\$1802	+\$1948	+\$2206	+\$2466	+\$2784	+\$1802

#### Base Prices

Dimensions			Style Number	Upholstery Grades:					
D	W	H		1	2	3	4	5/Leather	COM/COL

### Savina Sofa Module with Back

39 2/5"	36 1/5"	27"	<b>VCBSAVIM</b>	\$2981	\$3286	\$3843	\$4422	\$5025	\$2981
---------	---------	-----	-----------------	--------	--------	--------	--------	--------	--------

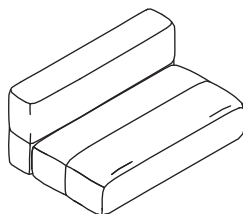
### Savina Sofa Module with Back and Casters

39 2/5"	36 1/5"	27"	<b>VCBSAVIMR</b>	\$3091	\$3396	\$3953	\$4531	\$5135	\$3091
---------	---------	-----	------------------	--------	--------	--------	--------	--------	--------

Needed fabric for material 1.53 yd wide:

**With back:** 4.48 yd

**Sidearm:** 0.55 yd



Tip: Arms must be specified in the same fabric group as sofa module.

**Standard Includes**

- Upholstery: fabric price group 01
- Legs: fixed or with hidden casters
- Side table: solid oak wood, if selected

**Options**

Table	No Table	No cost
	With Table Left Side Facing	+\$622
	With Table Right Side Facing	+\$622
Arms	No Arm Rests	No cost
	1 Arm Left Side Facing	Prices below
	1 Arm Right Side Facing	Prices below
	2 Arms Left and Right	Prices below
Right End Configuration	Connect Another	No cost
	End Run	No cost
Left End Configuration	Connect Another	No cost
	End Run	No cost

**Specification Information**

	Arm Upcharges					
	Upholstery Grades:					
	1	2	3	4	5/Leather	COM/COL
One Arm Left or Right Side Facing - Upholstered Sidearm	+\$901	+\$974	+\$1103	+\$1233	+\$1392	+\$901
Two Arms Left and Right - Two Upholstered Sidearms	+\$1802	+\$1948	+\$2206	+\$2466	+\$2784	+\$1802

Dimensions	Style	Base Prices							
		D	W	H	Number	Upholstery Grades:			COM/COL
						1	2	3	

<b>Savina Double Sofa Module with Back</b>									
39 2/5"	55 1/10"	27"	<b>VCBSAVIMA</b>	\$3370	\$3710	\$4336	\$4988	\$5672	\$3370

<b>Savina Double Sofa Module with Back and Casters</b>									
39 2/5"	55 1/10"	27"	<b>VCBSAVIMAR</b>	\$3415	\$3755	\$4381	\$5033	\$5717	\$3415

Needed fabric for material 1.53 yd wide:

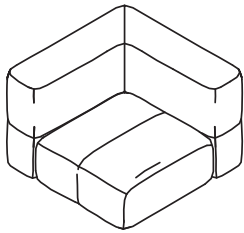
**With back:** 5.4 yd

**Sidearm:** 0.55 yd



# Sofas

## Savina



### Standard Includes

- Upholstery: fabric price group 01
- Legs: fixed or with hidden casters

### Options

Right End Configuration	Connect Another	No cost
	End Run	No cost
Left End Configuration	Connect Another	No cost
	End Run	No cost

### Specification Information

Dimensions			Style	Prices					
D	W	H	Number	Upholstery Grades:					
				1	2	3	4	5/Leather	COM/COL

#### Savina Corner Sofa Module

39 2/5"	39 2/5"	27"	<b>VCBSAVIRI</b>	\$3761	\$4109	\$4680	\$5279	\$5935	\$3761
---------	---------	-----	------------------	--------	--------	--------	--------	--------	--------

#### Savina Corner Sofa Module with Casters

39 2/5"	39 2/5"	27"	<b>VCBSAVIRIR</b>	\$3870	\$4219	\$4791	\$5389	\$6045	\$3870
---------	---------	-----	-------------------	--------	--------	--------	--------	--------	--------

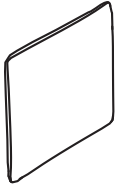
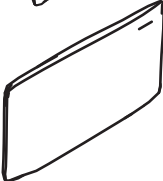
Needed fabric for material 1.53 yd wide:

With back: 5 yd

**Standard Includes**

- Upholstered cushion
- Upholstery: fabric price group 01

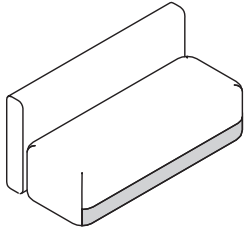
**Specification Information**

Dimensions		Style Number	Prices					
W	H		Upholstery Grades:					COM/COL
			1	2	3	4	5/Leather	
		<b>Savina Square Cushion</b>						
19 7/10"	19 7/10"	<b>VCBSAVIAL50</b>	\$130	\$166	\$256	\$398	\$461	\$130
		<b>Savina Rectangular Cushion</b>						
23 3/5"	11 4/5"	<b>VCBSAVIAL30</b>	\$102	\$130	\$181	\$295	\$359	\$102



# Sofas

## Season Sofa



### Standard Includes

- Upholstery: fabric price group 01
- Upholstery protection: technical fabric in light or dark grey
- Legs

### Options

Upholstery Protection	Dark Grey	No cost
	Light Grey	No cost
Right End Configuration	Connect Another	No cost
	End Run	No cost
Left End Configuration	Connect Another	No cost
	End Run	No cost

### Specification Information

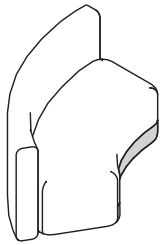
Dimensions			Style Number	Prices					
D	W	H		Upholstery Grades:					
				1	2	3	4	5/Leather	COM/COL

#### Season Straight Module

27 3/5" 59 1/10" 29 1/10" **VCBSESAS** \$3076 \$3582 \$4170 \$4867 \$5688 \$3076

Needed fabric for material 1.53 yd wide:

**Upholstery:** 6.07 yd



### Standard Includes

- Upholstery: fabric price group 01
- Upholstery protection: technical fabric in light or dark grey
- Legs

### Options

Upholstery Protection	Dark Grey	No cost
	Light Grey	No cost
Right End Configuration	Connect Another	No cost
	End Run	No cost
Left End Configuration	Connect Another	No cost
	End Run	No cost

### Specification Information

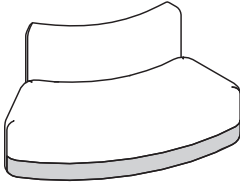
Dimensions			Style Number	Prices					
D	W	H		Upholstery Grades:					
				1	2	3	4	5/Leather	COM/COL

#### Season Closed Module

27 3/5" 67 7/10" 29 1/10" **VCBSESBS** \$3636 \$4239 \$4964 \$5785 \$6782 \$3636

Needed fabric for material 1.53 yd wide:

**Upholstery:** 6.23 yd



**Standard Includes**

- Upholstery: fabric price group 01
- Upholstery protection: technical fabric in light or dark grey
- Legs

**Options**

Upholstery Protection	Dark Grey	No cost
	Light Grey	No cost
Right End Configuration	Connect Another	No cost
	End Run	No cost
Left End Configuration	Connect Another	No cost
	End Run	No cost

**Specification Information**

Dimensions			Style Number	Prices					
D	W	H		Upholstery Grades:					
				1	2	3	4	5/Leather	COM/COL

**Season Open Module**

27 3/5"    59 1/10"    29 1/10"    **VCBSESCS**    \$3487    \$4076    \$4759    \$5564    \$6508    \$3487

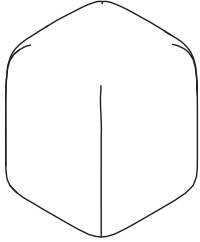
Needed fabric for material 1.53 yd wide:

**Upholstery:** 5.91 yd



# Sofas

## Season Pouf



### Standard Includes

- Upholstery: fabric price group 01
- Strap in high-resistance technical fabric black, grey, or red, if selected
- Height-adjustable legs or hidden casters, if selected

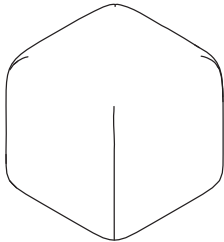
### Options

Strap Option	No Strap	No cost
	With Strap	No cost

### Specification Information

Dimensions			Style Number	Prices					
D	W	H		Upholstery Grades:					
				1	2	3	4	5/Leather	COM/COL
<b>Season Pouf - 15 7/10"W</b>									
15 7/10"	15 7/10"	19 3/10"	<b>VCBSEM40</b>	\$916	\$1026	\$1203	\$1367	\$1530	\$916

<b>Season Pouf with Casters - 15 7/10"W</b>									
15 7/10"	15 7/10"	19 3/10"	<b>VCBSEMR40</b>	\$970	\$1080	\$1258	\$1422	\$1586	\$970
Needed fabric for material 1.53 yd wide:									
<b>Upholstery:</b> 1.6 yd									



### Standard Includes

- Upholstery: fabric price group 01
- Strap in high-resistance technical fabric black, grey, or red, if selected
- Height-adjustable legs or hidden casters, if selected

### Options

Strap Option	No Strap	No cost
	With Strap	No cost

### Specification Information

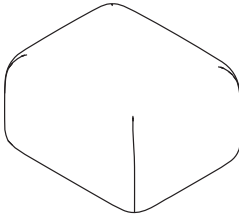
Dimensions			Style Number	Prices					
D	W	H		Upholstery Grades:					
				1	2	3	4	5/Leather	COM/COL
<b>Season Pouf - 19 7/10"W</b>									
19 7/10"	19 7/10"	19 3/10"	<b>VCBSEM50</b>	\$1121	\$1272	\$1422	\$1586	\$1791	\$1121

<b>Season Pouf with Casters - 19 7/10"W</b>									
19 7/10"	19 7/10"	19 3/10"	<b>VCBSEMR50</b>	\$1203	\$1341	\$1491	\$1668	\$1845	\$1203
Needed fabric for material 1.53 yd wide:									
<b>Upholstery:</b> 1.9 yd									



# Sofas

## Season Pouf



### Standard Includes

- Upholstery: fabric price group 01
- Strap in high-resistance technical fabric black, grey, or red, if selected
- Height-adjustable legs or hidden casters, if selected

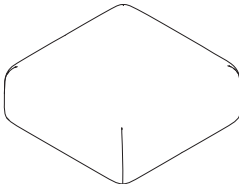
### Options

Strap Option	No Strap	No cost
	With Strap	No cost

### Specification Information

Dimensions			Style Number	Prices					
D	W	H		Upholstery Grades:					
				1	2	3	4	5/Leather	COM/COL
<b>Season Pouf - 23 3/5"W</b>									
19 7/10"	23 3/5"	14 1/5"	<b>VCBSEM60</b>	\$1121	\$1272	\$1422	\$1586	\$1791	\$1121

<b>Season Pouf with Casters - 23 3/5"W</b>									
19 7/10"	23 3/5"	14 1/5"	<b>VCBSEMR60</b>	\$1203	\$1341	\$1491	\$1668	\$1845	\$1203
Needed fabric for material 1.53 yd wide:									
<b>Upholstery:</b> 1.7 yd									



Tip: Straps are not available on this size Season Pouf.

### Standard Includes

- Upholstery: fabric price group 01
- Height-adjustable legs or hidden casters, if selected

### Specification Information

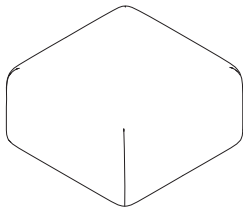
Dimensions			Style Number	Prices					
D	W	H		Upholstery Grades:					
				1	2	3	4	5/Leather	COM/COL
<b>Season Pouf - 35 2/5"W</b>									
35 2/5"	35 2/5"	14 1/5"	<b>VCBSEM90</b>	\$1491	\$1751	\$2051	\$2298	\$2407	\$1491

<b>Season Pouf with Casters - 35 2/5"W</b>									
35 2/5"	35 2/5"	14 1/5"	<b>VCBSEMR90</b>	\$1546	\$1819	\$2133	\$2351	\$2461	\$1546
Needed fabric for material 1.53 yd wide:									
<b>Upholstery:</b> 3.8 yd									

Sofas

# Sofas

## Season Pouf



Tip: Straps are not available on this size Season Pouf.

### Standard Includes

- Upholstery: fabric price group 01
- Height-adjustable legs or hidden casters, if selected

### Specification Information

Dimensions			Style Number	Prices					
D	W	H		Upholstery Grades:					
				1	2	3	4	5/Leather	COM/COL

#### Season Pouf - 35 2/5"W x 19 3/10"H

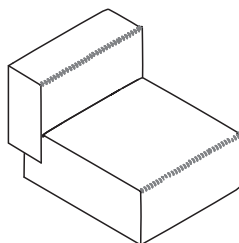
35 2/5"	35 2/5"	19 3/10"	<b>VCBSEM90H</b>	\$1546	\$1819	\$2133	\$2351	\$2461	\$1546
---------	---------	----------	------------------	--------	--------	--------	--------	--------	--------

#### Season Pouf with Casters - 35 2/5"W x 19 3/10"H

35 2/5"	35 2/5"	19 3/10"	<b>VCBSEMR90H</b>	\$1599	\$1873	\$2188	\$2434	\$2488	\$1599
---------	---------	----------	-------------------	--------	--------	--------	--------	--------	--------

Needed fabric for material 1.53 yd wide:

**Upholstery:** 4.2 yd



**Standard Includes**

- Upholstery: fabric
- Height-adjustable legs

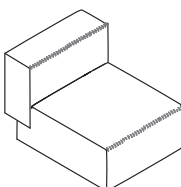
**Options**

Arms	No Arms	No cost
	1 Narrow Arm Left Side Facing	Prices below
	1 Narrow Arm Right Side Facing	Prices below
	1 Narrowarm Lsf, 1 Widearm Rsf	Prices below
	1 Wide Arm Left Side Facing	Prices below
	1 Wide Arm Right Side Facing	Prices below
	1 Widearm Lsf, 1 Narrowarm Rsf	Prices below
	2 Narrow Arms Left and Right	Prices below
	2 Wide Arm Left and Right	Prices below
Seam	No Seam	No cost
	With Seam	Prices below
Right End Configuration	Connect Another	No cost
	End Run	No cost
Left End Configuration	Connect Another	No cost
	End Run	No cost

**Specification Information**

	Arm Upcharges					
	Upholstery Grades:					
	1	2	3	4	5/Leather	COM
One Narrow Arm	+\$589	+\$650	+\$807	+\$936	+\$1080	+\$589
One Wide Arm	+\$663	+\$663	+\$834	+\$978	+\$1121	+\$663
Two Narrow Arms	+\$1178	+\$1300	+\$1614	+\$1872	+\$2160	+\$1178
One Narrow Arm and One Wide Arm	+\$1252	+\$1313	+\$1641	+\$1914	+\$2201	+\$1252
Two Wide Arms	+\$1326	+\$1326	+\$1668	+\$1956	+\$2242	+\$1326

Dimensions	Style Number	Base Prices							
		Upholstery Grades:							
		1	2	3	4	5/Leather	COM		



**Step 27 3/5"W Module - No Seam**

37 2/5"	27 3/5"	25 3/5"	<b>VCBST70</b>	\$2351	\$2482	\$2769	\$3460	\$4163	\$2351
---------	---------	---------	----------------	--------	--------	--------	--------	--------	--------

**Step 27 3/5"W Module - With Seam**

37 2/5"	27 3/5"	25 3/5"	<b>VCBST70</b>	\$2584	\$2742	\$3042	\$3807	\$4580	\$2584
---------	---------	---------	----------------	--------	--------	--------	--------	--------	--------

Needed fabric for material 1.53 yd wide:

**Step module 27 3/5"**: 3.72 yd

**Narrow armrest**: 1.31 yd

**Wide armrest**: 1.31 yd

► **Product Information continued on next page**

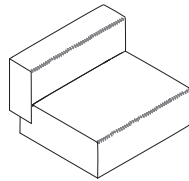
Sofas

# Sofas

## Step

► **Product Information continued from previous page**

### Specification Information



Dimensions			Style Number	Base Prices					
D	W	H		Upholstery Grades:					
				1	2	3	4	5/Leather	COM
<b>Step 35 2/5"W Module - No Seam</b>									
37 2/5"	35 2/5"	25 3/5"	<b>VCBST90</b>	\$2830	\$2988	\$3329	\$4137	\$5012	\$2830

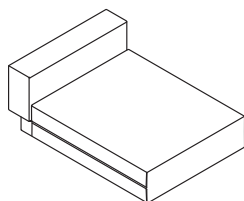
<b>Step 35 2/5"W Module - With Seam</b>									
37 2/5"	35 2/5"	25 3/5"	<b>VCBST90</b>	\$3103	\$3289	\$3665	\$4554	\$5511	\$3103

Needed fabric for material 1.53 yd wide:

**Step module 35 2/5"**: 3.72 yd

**Narrow armrest**: 1.31 yd

**Wide armrest**: 1.31 yd



**Standard Includes**

- Upholstery: fabric
- Height-adjustable legs

**Options**

Arms	No Arms	No cost
	1 Narrow Arm Left Side Facing	Prices below
	1 Narrow Arm Right Side Facing	Prices below
	1 Narrowarm Lsf, 1 Widearm Rsf	Prices below
	1 Wide Arm Left Side Facing	Prices below
	1 Wide Arm Right Side Facing	Prices below
	1 Widearm Lsf, 1 Narrowarm Rsf	Prices below
	2 Narrow Arms Left and Right	Prices below
	2 Wide Arm Left and Right	Prices below
Seam	No Seam	No cost
	With Seam	Prices below
Right End Configuration	Connect Another	No cost
	End Run	No cost
Left End Configuration	Connect Another	No cost
	End Run	No cost

**Specification Information**

	Arm Upcharges					
	Upholstery Grades:					
	1	2	3	4	5/Leather	COM
One Narrow Arm	+\$589	+\$650	+\$807	+\$936	+\$1080	+\$589
One Wide Arm	+\$663	+\$663	+\$834	+\$978	+\$1121	+\$663
Two Narrow Arms	+\$1178	+\$1300	+\$1614	+\$1872	+\$2160	+\$1178
One Narrow Arm and One Wide Arm	+\$1252	+\$1313	+\$1641	+\$1914	+\$2201	+\$1252
Two Wide Arms	+\$1326	+\$1326	+\$1668	+\$1956	+\$2242	+\$1326

Dimensions	Style	Base Prices							
		D	W	H	Number	Upholstery Grades:			
						1	2	3	4

**Step Chaise - No Seam**

62"	35 2/5"	25 3/5"	<b>VCBSTCH</b>	\$4265	\$4505	\$5025	\$6263	\$7568	\$4265
-----	---------	---------	----------------	--------	--------	--------	--------	--------	--------

**Step Chaise - With Seam**

62"	35 2/5"	25 3/5"	<b>VCBSTCH</b>	\$4697	\$4970	\$5531	\$6878	\$8328	\$4697
-----	---------	---------	----------------	--------	--------	--------	--------	--------	--------

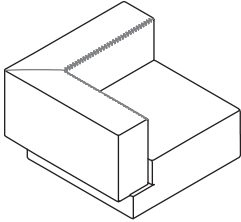
Needed fabric for material 1.53 yd wide:

- Step chaise:** 6.23 yd
- Narrow armrest:** 1.31 yd
- Wide armrest:** 1.31 yd



# Sofas

## Step



### Standard Includes

- Upholstery: fabric
- Height-adjustable legs

### Options

Seam	No Seam	No cost
	With Seam	Prices below
Right End Configuration	Connect Another	No cost
	End Run	No cost
Left End Configuration	Connect Another	No cost
	End Run	No cost

### Specification Information

Dimensions			Style Number	Base Prices					
D	W	H		Upholstery Grades:					
				1	2	3	4	5/Leather	COM

#### Step Corner - No Seam

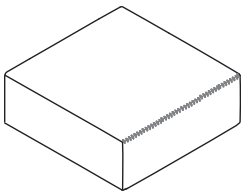
37 2/5"	37 2/5"	25 3/5"	<b>VCBSTRI</b>	\$3746	\$3965	\$4409	\$5496	\$6658	\$3746
---------	---------	---------	----------------	--------	--------	--------	--------	--------	--------

#### Step Corner - With Seam

37 2/5"	37 2/5"	25 3/5"	<b>VCBSTRI</b>	\$4109	\$4362	\$4854	\$6043	\$7323	\$4109
---------	---------	---------	----------------	--------	--------	--------	--------	--------	--------

Needed fabric for material 1.53 yd wide:

**Upholstery:** 5.35 yd



### Standard Includes

- Upholstery: fabric
- Height-adjustable legs

### Options

Seam	No Seam	No cost
	With Seam	Prices below

### Specification Information

Dimensions			Style Number	Prices					
D	W	H		Upholstery Grades:					
				1	2	3	4	5/Leather	COM

#### Step Pouf - No Seam

37 2/5"	35 2/5"	14 1/5"	<b>VCBSTPO</b>	\$1655	\$1751	\$1941	\$2427	\$2927	\$1655
---------	---------	---------	----------------	--------	--------	--------	--------	--------	--------

#### Step Pouf - With Seam

37 2/5"	35 2/5"	14 1/5"	<b>VCBSTPO</b>	\$1825	\$1922	\$2127	\$2659	\$3234	\$1825
---------	---------	---------	----------------	--------	--------	--------	--------	--------	--------

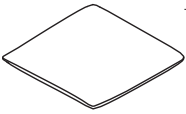
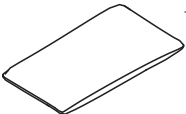
Needed fabric for material 1.53 yd wide:

**Upholstery:** 2.13 yd

**Standard Includes**

- Upholstery: fabric

**Specification Information**

Dimensions			Style Number	Prices					
D	W			Upholstery Grades:					
				1	2	3	4	5/Leather	COM
<b>Step Square Cushion</b>									
	19 7/10"	19 7/10"	<b>VCBSTAL25</b>	\$116	\$144	\$197	\$328	\$403	\$116
<b>Step Rectangular Cushion</b>									
	11 4/5"	23 3/5"	<b>VCBSTAL50</b>	\$144	\$184	\$287	\$431	\$520	\$144





---

# Understanding Benches

Standard Import Lead Time

  
**Statement of Line** **374**

  
**Understanding**

Season	<b>376</b>
Torii	<b>378</b>

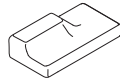
# Statement of Line

Benches

## Season

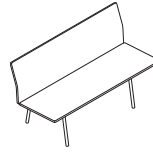


**Bench**  
Understanding  
▶ Page 376  
Specifying  
▶ Page 382

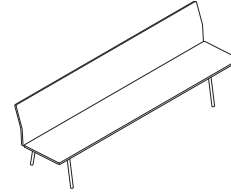


**Large Bench**  
Understanding  
▶ Page 376  
Specifying  
▶ Page 383

## Torii



**Bench**  
Understanding  
▶ Page 378  
Specifying  
▶ Page 384

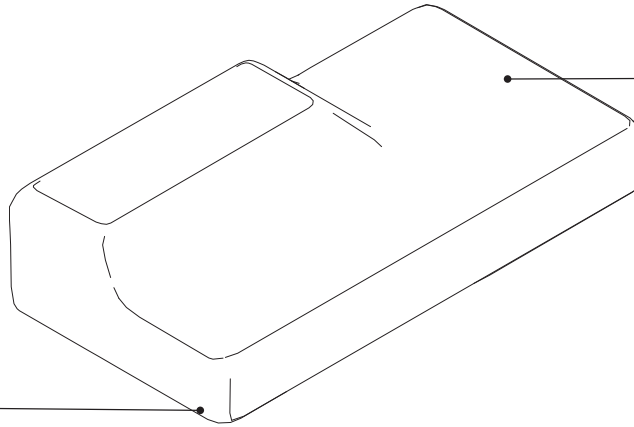


**Large Bench**  
Understanding  
▶ Page 378  
Specifying  
▶ Page 386



# Season Bench

**Season bench,**  
designed by Piero Lissoni,  
is a collection that stands  
out through its simple yet  
elegant design. It comes  
in two sizes, both specified  
with a raised back on one  
side of the bench.  
► Specifying, pages  
382–383



**Upholstered seat and back** available in fabric or leather.

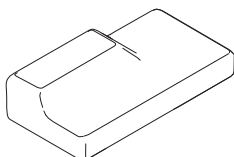
**Height adjustable glides** have an adjustment height of  $\frac{3}{4}$ " and are suitable for all surfaces.

**Product Details**

**Seat and back** are upholstered and can be specified in fabric or leather.

*Tip: Leather and some technical upholstery are manufactured with different seams.*

**Glides** are standard with an adjustable height.



**Raised back** can be specified on the right or left side of the bench and is understood from the perspective of the person looking at the object from the front. Its size differs based on the bench size.

**Surface Materials**

**Upholstery**

- Fabric
- Vinyl
- Leather
- COM (Customer's Own Material)
- COL (Customer's Own Leather)

**Actual Dimensions**

Description	Style Number	Depth	Width	Height	Seat Depth	Seat Height	Weight
Bench 74 <sup>1</sup> / <sub>5</sub> "	<b>VCBSE190</b>	33 <sup>1</sup> / <sub>2</sub> "	74 <sup>4</sup> / <sub>5</sub> "	23 <sup>3</sup> / <sub>5</sub> "	15 <sup>7</sup> / <sub>10</sub> "	14 <sup>1</sup> / <sub>5</sub> "	122.0 lb
Bench 98 <sup>2</sup> / <sub>5</sub> "	<b>VCBSE250</b>	51 <sup>1</sup> / <sub>5</sub> "	98 <sup>2</sup> / <sub>5</sub> "	23 <sup>3</sup> / <sub>5</sub> "	23 <sup>3</sup> / <sub>5</sub> "	14 <sup>1</sup> / <sub>5</sub> "	220.0 lb

# Torii

**Torii**, designed by Ludovica and Roberto Palomba, is distinguished by its multifunctionality and use, as it is typically placed in collaborative spaces and is available in two lengths and multiple cushion locations.

**Torii benches** come in four different options: stained seat and backrest, upholstered seat and stained backrest, upholstered seat and backrest, and upholstered seat and backrest with cushions.

► Specifying, pages 384–386

**Seat and back** are stained natural oak plywood.

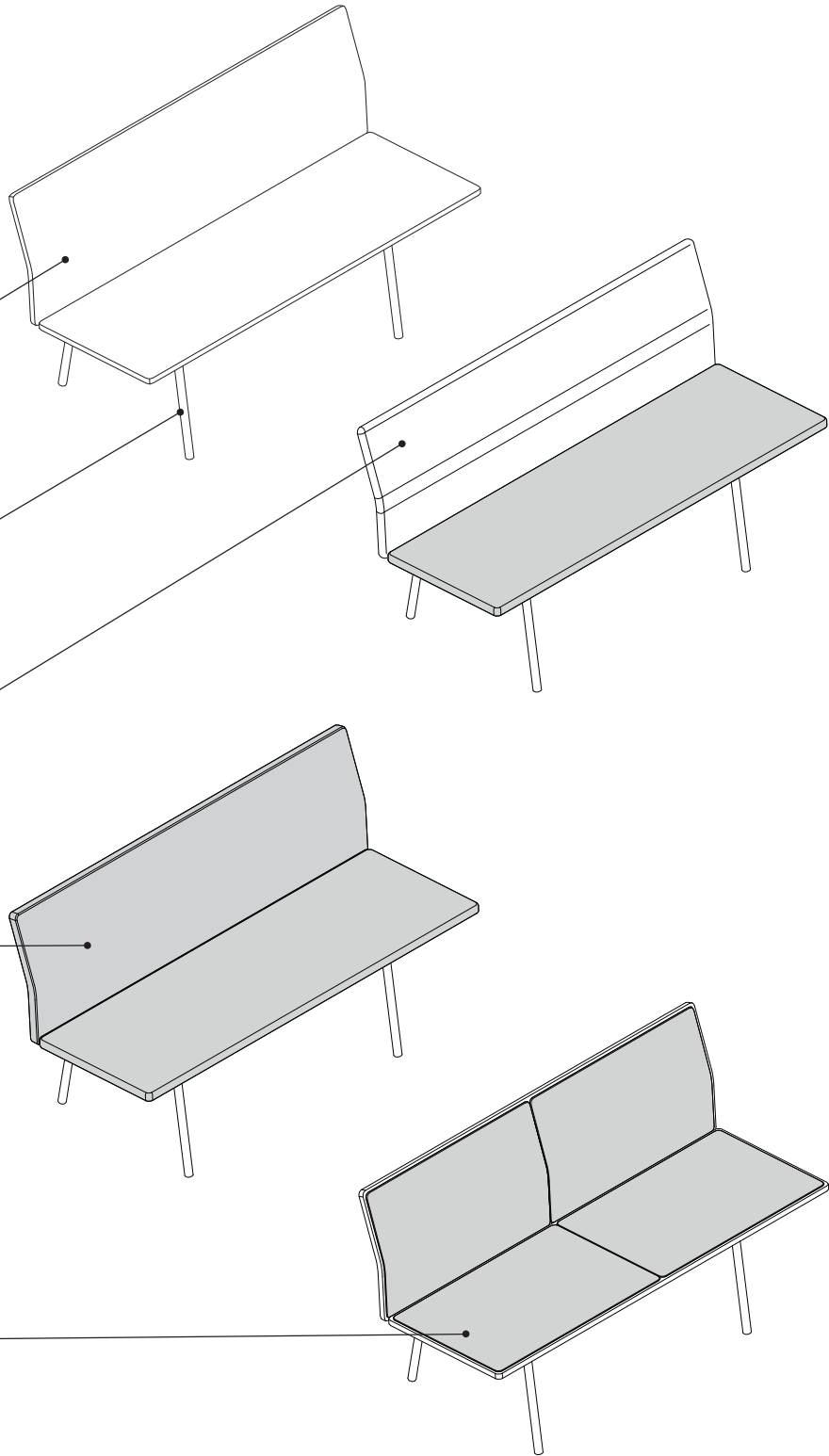
**Frame** is powdered coated paint with plastic glides.

**Upholstered seat with stained plywood back.**

**Upholstered seat and back.**

**Seat and back** are stained natural oak plywood and upholstered cushions.

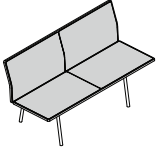
*Tip: Cushions available in two widths based on pre-determined configurations.*



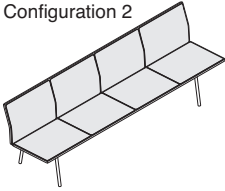
**Product Details**

**Seat height** is 18.5" without cushion and 18.9" with cushion. Seat depth is 18.9".

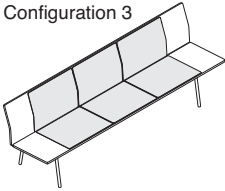
Configuration 1



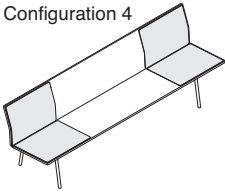
Configuration 2



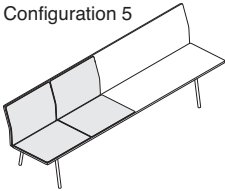
Configuration 3



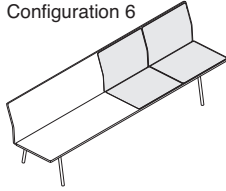
Configuration 4



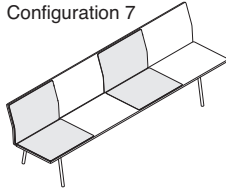
Configuration 5



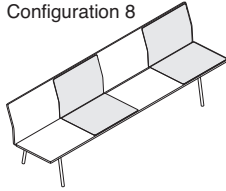
Configuration 6



Configuration 7



Configuration 8



**Torii bench** is available with eight pre-configured compositions. Sections showing as white in the images above are stained plywood without cushions.

**When selecting the cushion options,** if both the seat and backrest cushions are selected, its possible to select different fabrics for the seat and backrest. Always calculate the price based on the highest price group selected.

**Surface Materials**

**Upholstery**

- Fabric
- Vinyl
- Leather
- COM (Customer's Own Material)
- COL (Customer's Own Leather)

**Seat and back**

- Ash
- Bleached oak
- Cognac
- Matte oak
- Walnut oak

**Frame**

- 9003 White RAL
- 9005 Black RAL

Actual Dimensions							
Description	Style Number	Depth	Width	Height	Cushion Widths	Cushion Quantity	Weight
<b>55 1/10" W Bench</b>							
Stained Seat and Backrest Bench	<b>VCBTO140</b>	25 1/5"	55 1/10"	33 1/10"	N.A.	N.A.	64.8 lb
Upholstered Seat and Stained Backrest Bench	<b>VCBTO140</b>	25 1/5"	55 1/10"	33 1/10"	N.A.	N.A.	69.4 lb
Upholstered Seat and Backrest Bench	<b>VCBTO140</b>	25 1/5"	55 1/10"	33 1/10"	N.A.	N.A.	71.9 lb
Stained Seat and Backrest Bench with Cushions	<b>VCBTO140</b>	25 1/5"	55 1/10"	33 1/10"	27 1/5"	2	71.9 lb
<b>94 1/2" W Bench</b>							
Stained Seat and Backrest Bench	<b>VCBTO240</b>	25 1/5"	94 1/2"	33 1/10"	N.A.	N.A.	119.0 lb
Upholstered Seat and Stained Backrest Bench	<b>VCBTO240</b>	25 1/5"	94 1/2"	33 1/10"	N.A.	N.A.	120.8 lb
Upholstered Seat and Backrest Bench	<b>VCBTO240</b>	25 1/5"	94 1/2"	33 1/10"	N.A.	N.A.	122.1 lb
Stained Seat and Backrest Bench with Cushions Configuration 1	<b>VCBTO240</b>	25 1/5"	94 1/2"	33 1/10"	23 1/5"	2	122.1 lb
Stained Seat and Backrest Bench with Cushions Configuration 2	<b>VCBTO240</b>	25 1/5"	94 1/2"	33 1/10"	23 1/5"	4	122.1 lb
Stained Seat and Backrest Bench with Cushions Configuration 3	<b>VCBTO240</b>	25 1/5"	94 1/2"	33 1/10"	23 1/5"	3	122.1 lb
Stained Seat and Backrest Bench with Cushions Configuration 4	<b>s</b>	25 1/5"	94 1/2"	33 1/10"	23 1/5"	2	122.1 lb
Stained Seat and Backrest Bench with Cushions Configuration 5	<b>VCBTO240</b>	25 1/5"	94 1/2"	33 1/10"	23 1/5"	2	122.1 lb
Stained Seat and Backrest Bench with Cushions Configuration 6	<b>VCBTO240</b>	25 1/5"	94 1/2"	33 1/10"	23 1/5"	2	122.1 lb
Stained Seat and Backrest Bench with Cushions Configuration 7	<b>VCBTO240</b>	25 1/5"	94 1/2"	33 1/10"	23 1/5"	2	122.1 lb
Stained Seat and Backrest Bench with Cushions Configuration 8	<b>VCBTO240</b>	25 1/5"	94 1/2"	33 1/10"	23 1/5"	2	122.1 lb



---

# Specifying Benches

Standard Import Lead Time

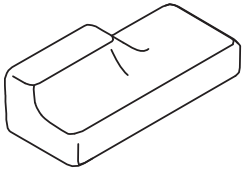
---

## Specifying

Season	<b>382</b>
Torii	<b>384</b>

# Benches

## Season Bench



Tip: Art presented is raised left side facing.

### Standard Includes

- Upholstery: fabric price group 01
- Adjustable glides

### Options

Raised Position	Raised Left Side Facing	No cost
	Raised Right Side Facing	No cost

### Specification Information

Dimensions			Style	Prices						
D	W	H	Number	Upholstery Grades:						
				1	2	3	4	5/Leather	COM/COL	

### Season Bench

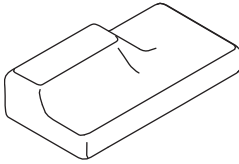
33 1/2"	74 4/5"	23 3/5"	<b>VCBSE190</b>	\$4602	\$4833	\$5320	\$6397	\$7024	\$4602
---------	---------	---------	-----------------	--------	--------	--------	--------	--------	--------

Needed fabric for material 1.53 yd wide:

**Upholstery:** 5.90 yd

# Benches

## Season Bench



Tip: Art presented is raised left side facing.

### Standard Includes

- Upholstery: fabric price group 01
- Adjustable glides

### Options

Raised Position	Raised Left Side Facing	No cost
	Raised Right Side Facing	No cost

### Specification Information

Dimensions			Style	Prices						
D	W	H	Number	Upholstery Grades:						
				1	2	3	4	5/Leather	COM/COL	

### Season Large Bench

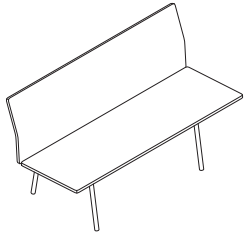
51 1/5"    98 2/5"    23 3/5"    **VCBSE250**    \$6084    \$6399    \$7028    \$8451    \$9298    \$6084

Needed fabric for material 1.53 yd wide:

**Upholstery:** 8.0 yd

# Benches

## Torii



Tip: When selecting both the upholstered seat and backrest, it's possible to select different fabrics on the seat and backrest. Calculate the price based on the highest price group selected.

Tip: When with cushion is selected, cushion quantity will be two. The cushions are 27 1/5" wide and installed on the bench (non-removable).

### Standard Includes

- Frame: powder coated paint in black or white
- Seat and backrest: stained oak plywood
- Cushion or upholstered, if selected: fabric
- Glides: plastic

### Options

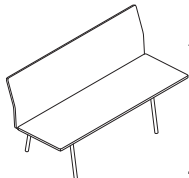
Upholstery Finish	Fabric Price Grade 1	No cost
	Customer's Own Leather	Prices below
	Fabric Customer's Own Material	Prices below
	Fabric Price Grade 2	Prices below
	Fabric Price Grade 3	Prices below
	Fabric Price Grade 4	Prices below
Cushion Option	Fabric Price Grade 5	Prices below
	Leather Price Grade 5	Prices below
Cushion Option	Configuration 1	Prices below
Cushion Finish	Fabric Price Grade 1	No cost
	Customer's Own Leather	Prices below
	Fabric Customer's Own Material	Prices below
	Fabric Price Grade 2	Prices below
	Fabric Price Grade 3	Prices below
	Fabric Price Grade 4	Prices below
	Fabric Price Grade 5	Prices below
	Leather Price Grade 5	Prices below

### Specification Information

Dimensions			Style	Prices						
D	W	H	Number	Stain Group 1	Upholstery Grades:				5/Leather	COM/COL
					1	2	3	4		

#### Torii Stained Seat and Backrest Bench

25 1/5"	55 1/10"	33 1/10"	<b>VCBTO140</b>	\$2803	N.A.	N.A.	N.A.	N.A.	N.A.	N.A.
---------	----------	----------	-----------------	--------	------	------	------	------	------	------

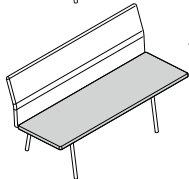


#### Torii Upholstered Seat and Stained Backrest Bench

25 1/5"	55 1/10"	33 1/10"	<b>VCBTO140</b>	N.A.	\$2927	\$3282	\$3679	\$4116	\$4607	\$2927
---------	----------	----------	-----------------	------	--------	--------	--------	--------	--------	--------

Needed fabric for material 1.53 yd wide:

**Upholstery:** Fabric 1.91 yd, leather 5.5 yd

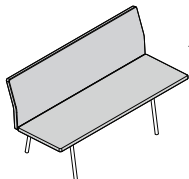


#### Torii Upholstered Seat and Backrest Bench

25 1/5"	55 1/10"	33 1/10"	<b>VCBTO140</b>	N.A.	\$2748	\$3076	\$3431	\$3842	\$4307	\$2748
---------	----------	----------	-----------------	------	--------	--------	--------	--------	--------	--------

Needed fabric for material 1.53 yd wide:

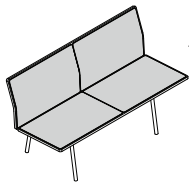
**Upholstery:** Fabric 4.1 yd, leather 10.9 yd



▶ **Product Information continued on next page**

► Product Information continued from previous page

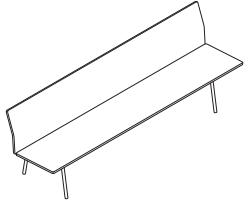
## Specification Information



Dimensions			Style Number	Prices						
D	W	H		Stain Group 1	Upholstery Grades:				5/Leather	COM/COL
				<b>Torii Bench Configuration 1</b>						
25 1/5"	55 1/10"	33 1/10"	<b>VCBTO140</b>	N.A.	\$4007	\$4252	\$4662	\$5073	\$5537	\$4007

# Benches

## Torii



*Tip: When selecting both the upholstered seat and backrest, its possible to select different fabrics on the seat and backrest. Calculate the price based on the highest price group selected.*

*Tip: When with cushion is selected, cushion quantity will vary. The cushions are 23 1/5" wide and installed on the bench (non-removable).*

### Standard Includes

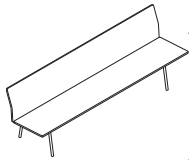
- Frame: powder coated paint in black or white
- Seat and backrest: stained oak plywood
- Cushion or upholstered, if selected: fabric
- Glides: plastic

### Options

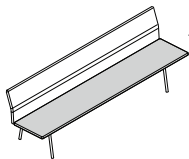
Option	Option Description	Price
Upholstery Finish	Fabric Price Grade 1	No cost
	Customer's Own Leather	Prices below
	Fabric Customer's Own Material	Prices below
	Fabric Price Grade 2	Prices below
	Fabric Price Grade 3	Prices below
	Fabric Price Grade 4	Prices below
	Fabric Price Grade 5	Prices below
Cushion Option	Leather Price Grade 5	Prices below
	Configuration 2	Prices below
	Configuration 3	Prices below
	Configuration 4	Prices below
	Configuration 5	Prices below
	Configuration 6	Prices below
	Configuration 7	Prices below
	Configuration 8	Prices below
Cushion Finish	Fabric Price Grade 1	No cost
	Customer's Own Leather	Prices below
	Fabric Customer's Own Material	Prices below
	Fabric Price Grade 2	Prices below
	Fabric Price Grade 3	Prices below
	Fabric Price Grade 4	Prices below
	Fabric Price Grade 5	Prices below
	Leather Price Grade 5	Prices below

### Specification Information

Dimensions			Style Number	Prices						
D	W	H		Stain Group 1	Upholstery Grades:				5/Leather	COM/COL
<b>Torii Stained Seat and Backrest Bench</b>										
25 1/5"	94 1/2"	33 1/10"	<b>VCBTO240</b>	\$4116	N.A.	N.A.	N.A.	N.A.	N.A.	N.A.



<b>Torii Upholstered Seat and Stained Backrest Bench</b>										
25 1/5"	94 1/2"	33 1/10"	<b>VCBTO240</b>	N.A.	\$4212	\$4718	\$5278	\$5921	\$6632	\$4212
Needed fabric for material 1.53 yd wide:										
Upholstery: Fabric 3.01 yd, leather 10.9 yd										



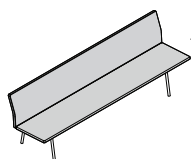
► Product Information continued on next page

► Product Information continued from previous page

### Specification Information

Dimensions			Style Number	Prices						
D	W	H		Stain Group 1	Upholstery Grades:				COM/COL	
				1	2	3	4	5/Leather		

#### Torii Upholstered Seat and Backrest Bench

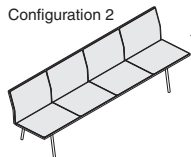


25 1/5"	94 1/2"	33 1/10"	<b>VCBTO240</b>	N.A.	\$3897	\$4362	\$4895	\$5483	\$6139	\$3897
---------	---------	----------	-----------------	------	--------	--------	--------	--------	--------	--------

Needed fabric for material 1.53 yd wide:

**Upholstery:** Fabric 5.5 yd, leather 21.9 yd

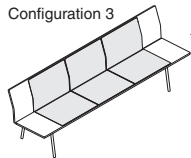
Configuration 2



#### Torii Bench Configuration 2

25 1/5"	94 1/2"	33 1/10"	<b>VCBTO240</b>	N.A.	\$6521	\$7015	\$7835	\$8656	\$9584	\$6521
---------	---------	----------	-----------------	------	--------	--------	--------	--------	--------	--------

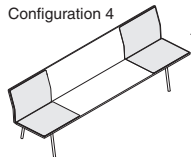
Configuration 3



#### Torii Bench Configuration 3

25 1/5"	94 1/2"	33 1/10"	<b>VCBTO240</b>	N.A.	\$5921	\$6289	\$6905	\$7520	\$8218	\$5921
---------	---------	----------	-----------------	------	--------	--------	--------	--------	--------	--------

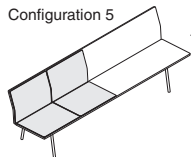
Configuration 4



#### Torii Bench Configuration 4

25 1/5"	94 1/2"	33 1/10"	<b>VCBTO240</b>	N.A.	\$5319	\$5564	\$5974	\$6385	\$6850	\$5319
---------	---------	----------	-----------------	------	--------	--------	--------	--------	--------	--------

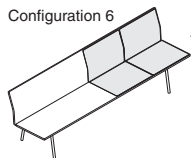
Configuration 5



#### Torii Bench Configuration 5

25 1/5"	94 1/2"	33 1/10"	<b>VCBTO240</b>	N.A.	\$5319	\$5564	\$5974	\$6385	\$6850	\$5319
---------	---------	----------	-----------------	------	--------	--------	--------	--------	--------	--------

Configuration 6



#### Torii Bench Configuration 6

25 1/5"	94 1/2"	33 1/10"	<b>VCBTO240</b>	N.A.	\$5319	\$5564	\$5974	\$6385	\$6850	\$5319
---------	---------	----------	-----------------	------	--------	--------	--------	--------	--------	--------

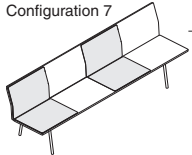
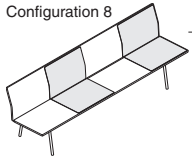
► Product Information continued on next page

# Benches

## Torii

► Product Information continued from previous page

### Specification Information

	Dimensions			Style Number	Prices							
	D	W	H		Stain Group 1	Upholstery Grades:					COM/COL	
						1	2	3	4	5/Leather		
 <p>Configuration 7</p>	<b>Torii Bench Configuration 7</b>											
	25 1/5"	94 1/2"	33 1/10"	<b>VCBTO240</b>	N.A.	\$5319	\$5564	\$5974	\$6385	\$6850	\$5319	
 <p>Configuration 8</p>	<b>Torii Bench Configuration 8</b>											
	25 1/5"	94 1/2"	33 1/10"	<b>VCBTO240</b>	N.A.	\$5319	\$5564	\$5974	\$6385	\$6850	\$5319	



---

# Understanding Tables

Standard Import Lead Time

  
**Statement of Line** **390**

  
**Understanding**

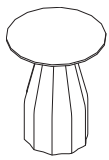
Burin	<b>398</b>
Cambio	<b>404</b>
Common	<b>410</b>
Foro	<b>412</b>
Fuste	<b>414</b>
Maarten	<b>416</b>
Solar	<b>420</b>
Trivio	<b>422</b>

# Statement of Line

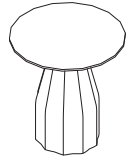
## Tables

### Burin

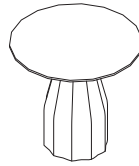
Understanding  
 ▶ Page 398  
 Specifying  
 ▶ Pages 424–445



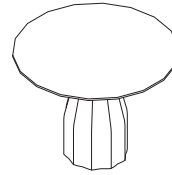
**Round Table 23<sup>3</sup>/<sub>5</sub>"Dia.  
 X 29<sup>1</sup>/<sub>10</sub>"H**



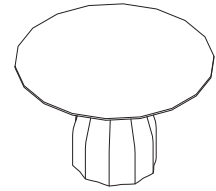
**Round Table 27<sup>3</sup>/<sub>5</sub>"Dia.  
 X 29<sup>1</sup>/<sub>10</sub>"H**



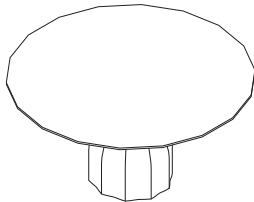
**Round Table 31<sup>1</sup>/<sub>2</sub>"Dia.  
 X 29<sup>1</sup>/<sub>10</sub>"H**



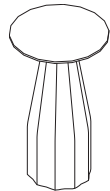
**Round Table 39<sup>2</sup>/<sub>5</sub>"Dia.  
 X 29<sup>1</sup>/<sub>10</sub>"H**



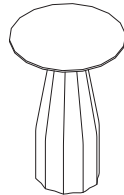
**Round Table  
 47<sup>1</sup>/<sub>5</sub>"Dia. X 29<sup>1</sup>/<sub>10</sub>"H**



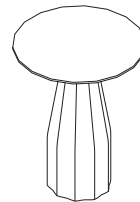
**Round Table 59<sup>1</sup>/<sub>10</sub>"Dia.  
 X 29<sup>1</sup>/<sub>10</sub>"H**



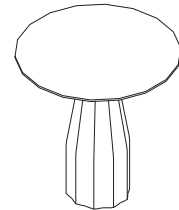
**Round Table 23<sup>3</sup>/<sub>5</sub>"Dia.  
 X 40<sup>1</sup>/<sub>5</sub>"H**



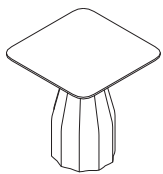
**Round Table 27<sup>3</sup>/<sub>5</sub>"Dia.  
 X 40<sup>1</sup>/<sub>5</sub>"H**



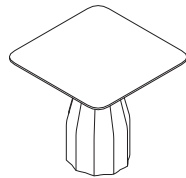
**Round Table 31<sup>1</sup>/<sub>2</sub>"Dia.  
 X 40<sup>1</sup>/<sub>5</sub>"H**



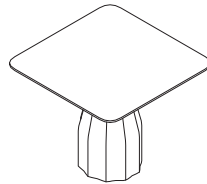
**Round Table  
 39<sup>1</sup>/<sub>5</sub>"Dia. X 40<sup>1</sup>/<sub>5</sub>"H**



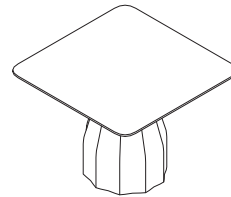
**Square Table 27<sup>3</sup>/<sub>5</sub>"D/W  
 X 29<sup>1</sup>/<sub>10</sub>"H**



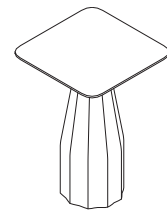
**Square Table 31<sup>1</sup>/<sub>2</sub>"D/W  
 X 29<sup>1</sup>/<sub>10</sub>"H**



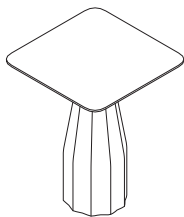
**Square Table 35<sup>2</sup>/<sub>5</sub>"D/W  
 X 29<sup>1</sup>/<sub>10</sub>"H**



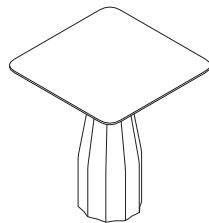
**Square Table 39<sup>2</sup>/<sub>5</sub>"D/W  
 X 29<sup>1</sup>/<sub>10</sub>"H**



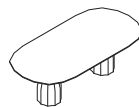
**Square Table  
 27<sup>3</sup>/<sub>5</sub>"D/W X 40<sup>1</sup>/<sub>5</sub>"H**



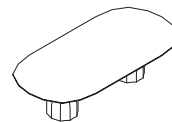
**Square Table 31<sup>1</sup>/<sub>2</sub>"D/W  
 X 40<sup>1</sup>/<sub>5</sub>"H**



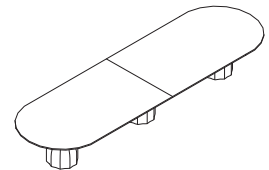
**Square Table 35<sup>2</sup>/<sub>5</sub>"D/W  
 X 40<sup>1</sup>/<sub>5</sub>"H**



**Oval Table  
 47<sup>1</sup>/<sub>5</sub>"D X 94<sup>2</sup>/<sub>5</sub>"W x  
 29<sup>1</sup>/<sub>10</sub>"H**



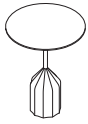
**Oval Table  
 59<sup>1</sup>/<sub>10</sub>"D X 118<sup>1</sup>/<sub>10</sub>"W X  
 29<sup>2</sup>/<sub>5</sub>"H**



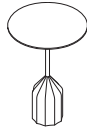
**Oval Table  
 59<sup>1</sup>/<sub>10</sub>"D X 196<sup>1</sup>/<sub>10</sub>"W X  
 29<sup>1</sup>/<sub>10</sub>"H**

**Burin, continued**

Understanding  
 ▶ Page 398  
 Specifying  
 ▶ Pages 424–445



**Mini Table**  
 14<sup>1</sup>/<sub>5</sub>"Dia. X 19<sup>7</sup>/<sub>10</sub>"H



**Mini Table**  
 14<sup>1</sup>/<sub>5</sub>"Dia. X 21<sup>7</sup>/<sub>10</sub>"H

**Cambio**

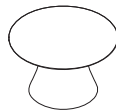
Understanding  
 ▶ Page 404  
 Specifying  
 ▶ Pages 446–462



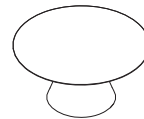
**Round Table** 23<sup>3</sup>/<sub>5</sub>"Dia.  
 X 18<sup>9</sup>/<sub>10</sub>"H



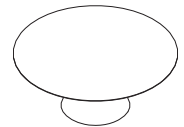
**Round Table** 27<sup>3</sup>/<sub>5</sub>"Dia.  
 X 18<sup>9</sup>/<sub>10</sub>"H



**Round Table** 31<sup>1</sup>/<sub>2</sub>"Dia.  
 X 18<sup>9</sup>/<sub>10</sub>"H



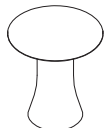
**Round Table** 39<sup>2</sup>/<sub>5</sub>"Dia.  
 X 18<sup>9</sup>/<sub>10</sub>"H



**Round Table** 47<sup>1</sup>/<sub>5</sub>"Dia. X 18<sup>9</sup>/<sub>10</sub>"H



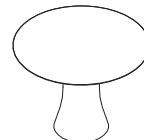
**Round Table** 23<sup>3</sup>/<sub>5</sub>"Dia.  
 X 29<sup>1</sup>/<sub>10</sub>"H



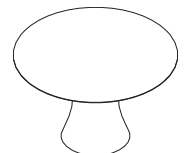
**Round Table** 27<sup>3</sup>/<sub>5</sub>"Dia. X 29<sup>1</sup>/<sub>10</sub>"H



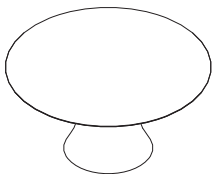
**Round Table** 31<sup>1</sup>/<sub>2</sub>"Dia. X 29<sup>1</sup>/<sub>10</sub>"H



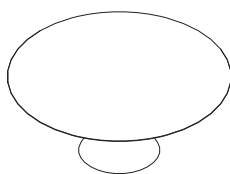
**Round Table** 39<sup>2</sup>/<sub>5</sub>"Dia. X 29<sup>1</sup>/<sub>10</sub>"H



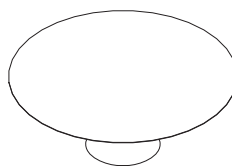
**Round Table** 47<sup>1</sup>/<sub>5</sub>"Dia. X 29<sup>1</sup>/<sub>10</sub>"H



**Round Table** 59"Dia. X 29<sup>1</sup>/<sub>10</sub>"H



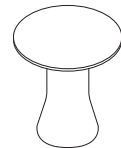
**Round Table** 71"Dia. X 29<sup>1</sup>/<sub>10</sub>"H



**Round Table** 78<sup>7</sup>/<sub>10</sub>"Dia. X 29<sup>1</sup>/<sub>10</sub>"H



**Round Table** 23<sup>3</sup>/<sub>5</sub>"Dia. X 41<sup>2</sup>/<sub>7</sub>"H



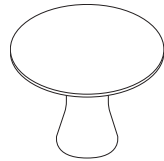
**Round Table** 27<sup>3</sup>/<sub>5</sub>"Dia. X 41<sup>2</sup>/<sub>7</sub>"H

**Cambio, continued**

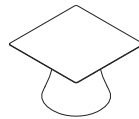
Understanding  
 ▶ Page 404  
 Specifying  
 ▶ Pages 446–462



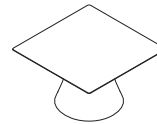
**Round Table**  
 31½"Dia. X 41⅔"H



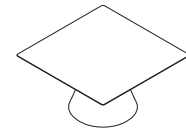
**Round Table**  
 39⅔"Dia. X 41⅔"H



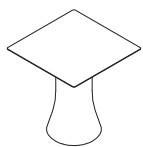
**Square Table**  
 27⅔"D/W X 18⅑"H



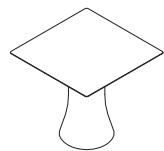
**Square Table**  
 31½"D/W X 18⅑"H



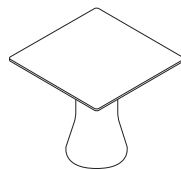
**Square Table**  
 35⅔"D/W X 18⅑"H



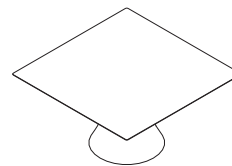
**Square Table**  
 27⅔"D/W X 29⅑"H



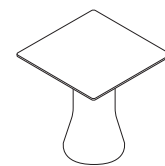
**Square Table**  
 31½"D/W X 29⅑"H



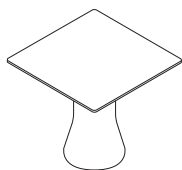
**Square Table**  
 35⅔"D/W X 29⅑"H



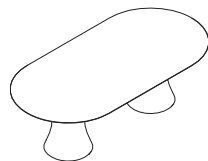
**Square Table**  
 55¼"D/W X 29⅑"H



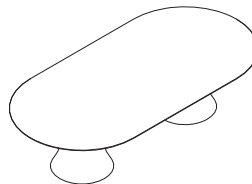
**Square Table**  
 27⅔"D/W X 41⅔"H



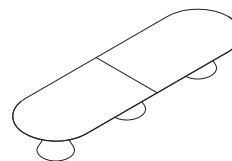
**Square Table**  
 31½"D/W X 41⅔"H



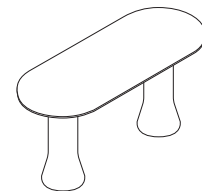
**Oval Table**  
 47⅑"D x 94½"W X  
 29⅑"H



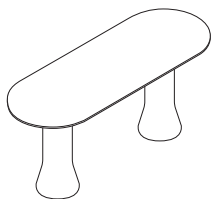
**Oval Table**  
 59"D x 118"W X  
 29⅑"H



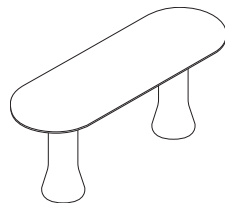
**Oval Table**  
 59"D x 197"W X  
 29⅑"H



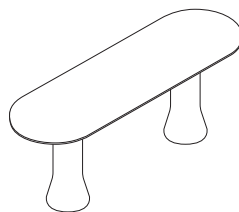
**Oval Table**  
 86⅔"D x 35⅔"W X  
 41⅔"H



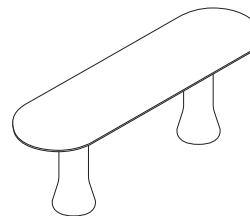
**Oval Table**  
 94½"D x 35⅔"W X  
 41⅔"H



**Oval Table**  
 102⅔"D x 35⅔"W X  
 41⅔"H



**Oval Table**  
 110⅑"D x 35⅔"W X  
 41⅔"H



**Oval Table**  
 118¼"D x 35⅔"W X  
 41⅔"H

**Common**

Understanding  
 ▶ Page 410  
 Specifying  
 ▶ Page 472



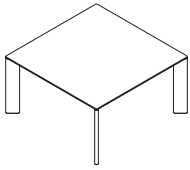
**High Table**



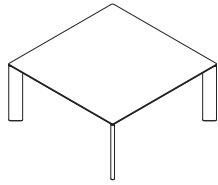
**Low Table**

**Foro**

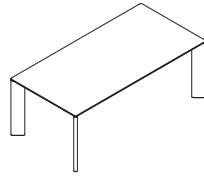
Understanding  
 ▶ Page 412  
 Specifying  
 ▶ Page 473



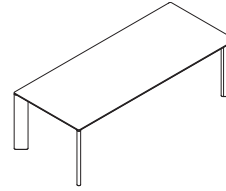
**Table—55<sup>1</sup>/<sub>10</sub>"D X 55<sup>1</sup>/<sub>10</sub>"W**



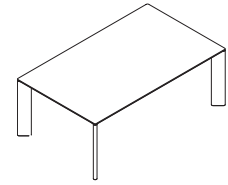
**Table—63"D X 63"W**



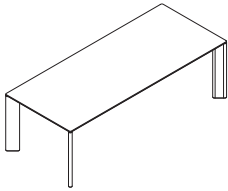
**Table—78<sup>7</sup>/<sub>10</sub>"D X 39<sup>4</sup>/<sub>10</sub>"W**



**Table—94<sup>1</sup>/<sub>2</sub>"D X 39<sup>4</sup>/<sub>10</sub>"W**



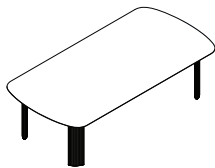
**Table—78<sup>7</sup>/<sub>10</sub>"D X 47<sup>1</sup>/<sub>5</sub>"W**



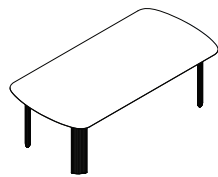
**Table—94<sup>1</sup>/<sub>2</sub>"D X 47<sup>1</sup>/<sub>5</sub>"W**

**Fuste**

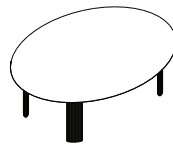
Understanding  
 ▶ Page 414  
 Specifying  
 ▶ Page 475



**Table—Soft Rectangle, 25<sup>3</sup>/<sub>5</sub>"H**



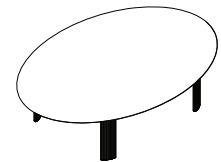
**Table—Soft Rectangle, 29<sup>1</sup>/<sub>10</sub>"H**



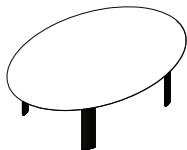
**Table—Oval, 82<sup>7</sup>/<sub>10</sub>"W X 25<sup>3</sup>/<sub>5</sub>"H**



**Table—Oval, 82<sup>7</sup>/<sub>10</sub>"W X 29<sup>1</sup>/<sub>10</sub>"H**



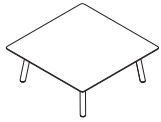
**Table—Oval, 102<sup>2</sup>/<sub>5</sub>"W X 25<sup>3</sup>/<sub>5</sub>"H**



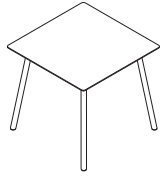
**Table—Oval, 102<sup>2</sup>/<sub>5</sub>"W X 29<sup>1</sup>/<sub>10</sub>"H**

**Maarten Tables with Glides**

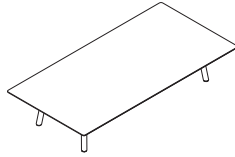
Understanding  
 ▶ Page 416  
 Specifying  
 ▶ Pages 477–485



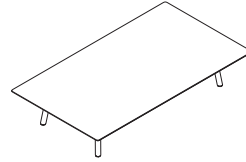
**31 1/2" Low Square Table**



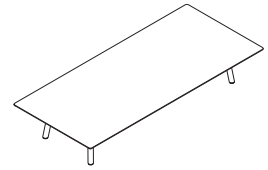
**31 1/2" High Square Table**



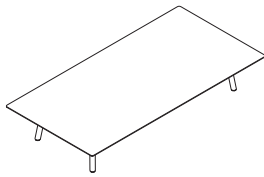
**63" X 31 1/2" Low Rectangle Table**



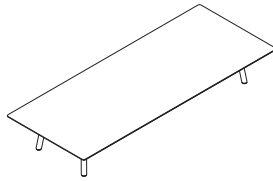
**63" X 35 2/5" Low Rectangle Table**



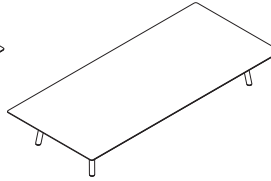
**70 9/10" X 31 1/2" Low Rectangle Table**



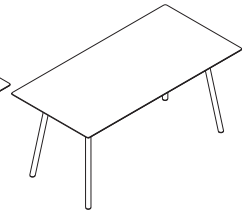
**70 9/10" X 35 2/5" Low Rectangle Table**



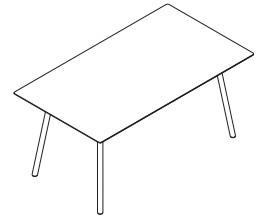
**78 7/10" X 31 1/2" Low Rectangle Table**



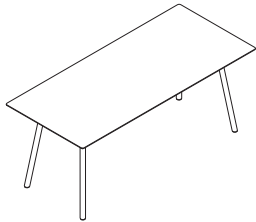
**78 7/10" X 35 2/5" Low Rectangle Table**



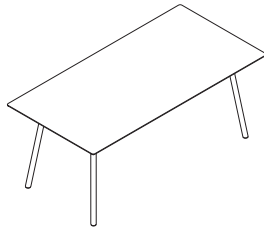
**63" X 31 1/2" High Rectangle Table**



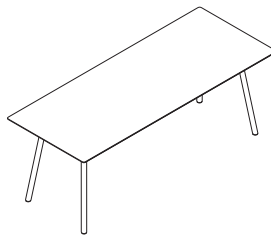
**63" X 35 2/5" High Rectangle Table**



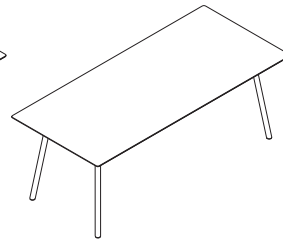
**70 9/10" X 31 1/2" High Rectangle Table**



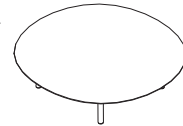
**70 9/10" X 35 2/5" High Rectangle Table**



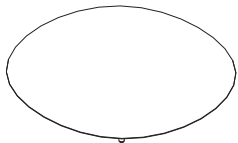
**78 7/10" X 31 1/2" High Rectangle Table**



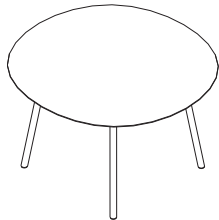
**78 7/10" X 35 2/5" High Rectangle Table**



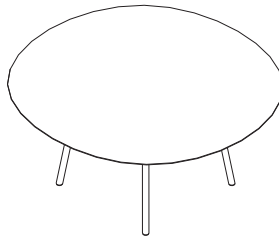
**47 1/5" Low Oval Table**



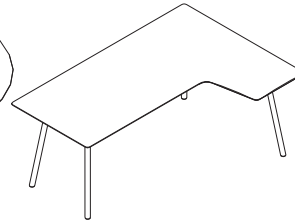
**63" Low Oval Table**



**47 1/5" High Oval Table**



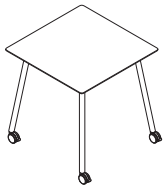
**63" High Oval Table**



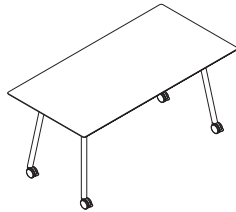
**47 1/5" D X 70 9/10" W High Return Table**

## Maarten Tables with Casters

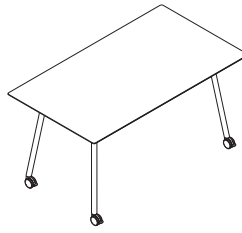
Understanding  
 ▶ Page 416  
 Specifying  
 ▶ Pages 486–490



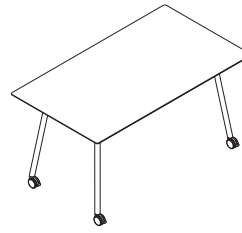
**31½" High Square Table with Casters**



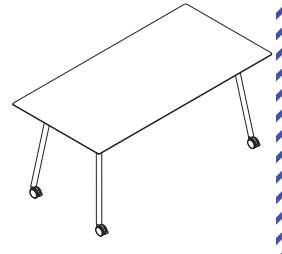
**63"D x 31½"W High Rectangle Table with Casters**



**63"D x 35⅝"W High Rectangle Table with Casters**



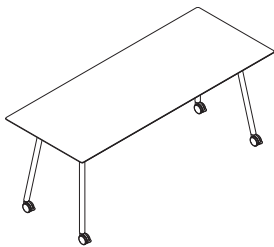
**70⅞"D x 31½"W High Rectangle Table with Casters**



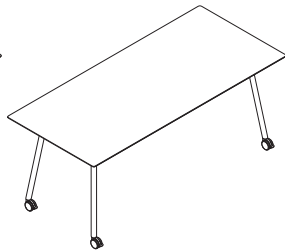
**70⅞"D x 35⅝"W High Rectangle Table with Casters**

## Maarten Tables with Casters

Understanding  
 ▶ Page 416  
 Specifying  
 ▶ Pages 486–490



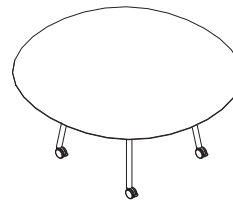
**78⅞"D X 31½"W High Rectangle Table with Casters**



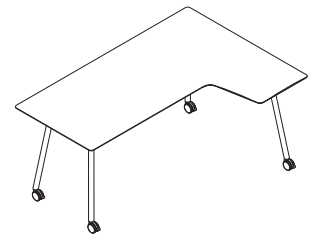
**78⅞"D X 35⅝"W High Rectangle Table with Casters**



**47⅞" High Oval Table with Casters**



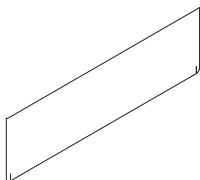
**63" High Oval Table with Casters**



**47⅞"D X 70⅞"W High Rectangle Table with Casters**

---

## Maarten Accessories

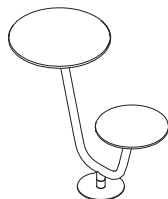


### Modesty Screens

Specifying  
▶ Page 491

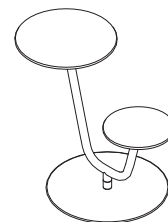
---

## Solar



### Anchored Compact Table

Understanding  
▶ Page 420  
Specifying  
▶ Page 492

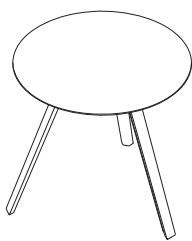


### Free Base Compact Table

Understanding  
▶ Page 420  
Specifying  
▶ Page 495

---

## Trivio



Understanding

▶ Page 422  
Specifying  
▶ Page 496

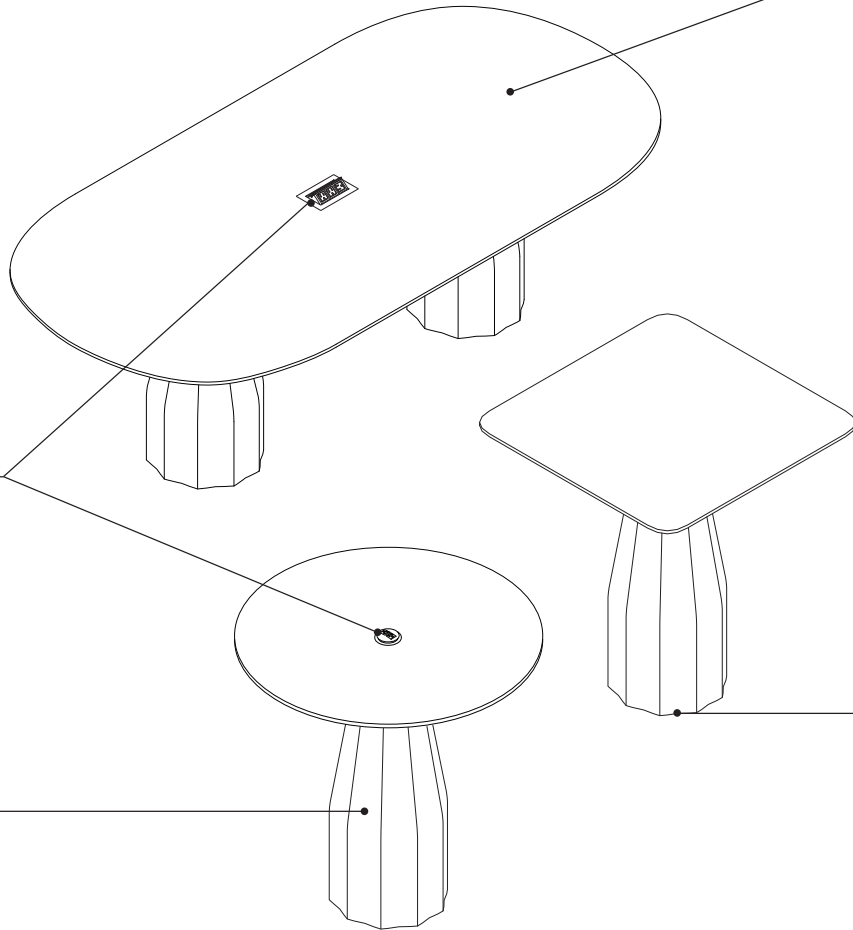




# Burin Tables

**Burin tables**, designed by Patricia Urquiola, are a collection of sculptural designer tables with a silhouette that pays tribute to traditional wood carving tools.

► Specifying, pages 424–445



**Top** is available in Low-Pressure Laminate, High-Pressure Laminate, compact laminate, or lacquered or stained MDF.

**Top** is scratch resistant materials available in three edge profiles.

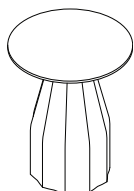
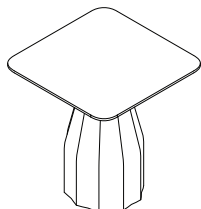
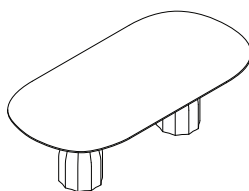
**Power** is available as an option.

► See *Power, Wiring, and Cabling*.

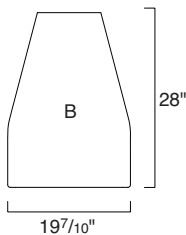
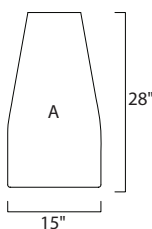
**22 pound counterweight** included.

**Base** is powder coated paint.

**Product Details**



**Bases** must be installed with recommended counterweight.



**Base width** varies based on top size specified.

- A: 23<sup>3</sup>/<sub>5</sub>"–39<sup>2</sup>/<sub>5</sub>"
- B: 47<sup>1</sup>/<sub>5</sub>"–59<sup>1</sup>/<sub>10</sub>"
- C: 23<sup>3</sup>/<sub>5</sub>"–39<sup>2</sup>/<sub>5</sub>"

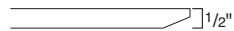
MDF (stained/lacquered)  
High-Pressure Laminate



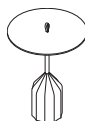
Low-Pressure Laminate



Compact



**Table tops** available in Low-Pressure Laminate, High-Pressure Laminate, compact laminate, lacquered MDF, or stained MDF.

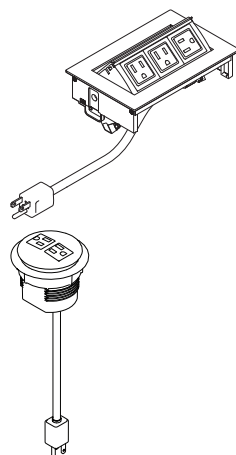


**Mini table** is available in 19<sup>7</sup>/<sub>10</sub>" and 21<sup>7</sup>/<sub>10</sub>" heights.

**Mini table base** is powder coated paint and includes a 22 pound counterweight.

**Optional handle on mini table** made from high resistance technical fabric.

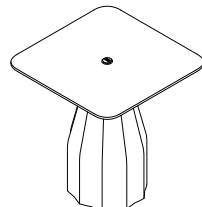
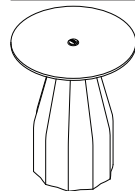
**Power, Wiring, and Cabling**



**Surface power** available as an option.

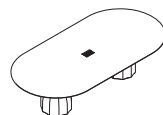
**On single base tables, round power module** will be specifiable, and on double and triple base tables, square module(s) will be specifiable.

**Power Locations**



**Single base Burin tables:**

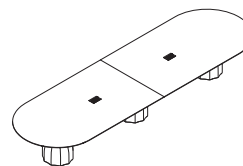
- One centered round power module



**Double base Burin tables:**

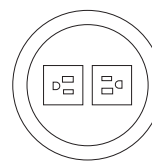
- One centered square power module

*Tip: Power is not available on the 94<sup>1</sup>/<sub>2</sub>"W Burin oval table with a compact laminate top.*

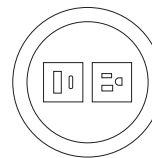


**Triple base Burin tables:**

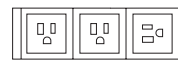
- Two centered square power modules, one direction
- Two centered square power modules, two directions



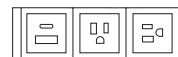
Power, Power



USB-A, USB-C, Power



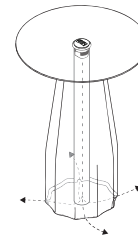
Power, Power, Power



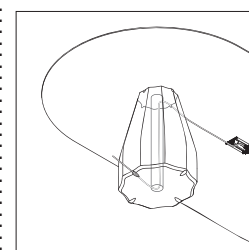
USB-C, USB-A, Power, Power

**Surface power** available in two configurations for both power modules.

**Power infeed** is cord and plug. Both round and square modules have 57" of cord on 29<sup>1</sup>/<sub>10</sub>"H tables and 45" of cord on 40<sup>1</sup>/<sub>5</sub>"H tables. When there are multiple square power modules, they are chained together and have one plug.



**For single base Burin tables,** cables are managed through the center of the base and out the bottom of the base.



**For double and triple base Burin tables,** cables are managed under the table top to a base, and then out the bottom of the base.

**Wire management kit** included when a square power module is specified. Kit includes clips, screws, and velcro straps to route cord under the table top and down the base.

**Power** is field-installed.

**Surface Materials**

**Base**

- 1019 Taupe RAL
- 9003 White RAL
- 9005 Black RAL

**Top**

**Low-Pressure Laminate**

- Black top/black edge
- White top/white edge

**High-Pressure Laminate**

- Black Soft Touch by Fenix top/stained edge
- White top/stained edge

**Compact Laminate**

- White top/black edge
- Black top/black edge
- White top/white edge

**Lacquered MDF**

- 050 50 30 Brick RAL
- 060 70 20 Dusty Pink RAL
- 090 40 30 Olive Green RAL
- 1011 Ochre RAL
- 1019 Taupe RAL
- 7034 Dusty Green RAL
- 9003 White RAL
- 9005 Black RAL
- Bronze

**Stained MDF**

- Ash
- Bleached oak
- Cognac
- Matte oak
- Walnut oak

*Tip: The range of lacquered colors have a smooth finish except for black, which has a lacquered microtextured finish.*

*Tip: Not all top finishes available on all styles.*

**Square MhoB power module**

- 4242 Milk Matte
- 4710 Black
- 4799 Platinum Metallic

**Round Node power module**

- 4013 Silver/Black
- 4180 Graphite Matte
- 4242 Milk Matte
- 4710 Black

**Mini table handle**

- Black
- Blue
- Brown
- Green
- Red
- White

**Actual Dimensions**

Description	Style Number	Top Depth/ Diameter	Base Diameter	Height	Weight
<b>Low-Pressure Laminate</b>					
<b>Round Tables</b>					
Round Table 23 <sup>3</sup> / <sub>5</sub> "	<b>VCBBUD6075HM</b>	23 <sup>3</sup> / <sub>5</sub> "	15"	29 <sup>1</sup> / <sub>10</sub> "	126.1 lb
Round Table 27 <sup>3</sup> / <sub>5</sub> "	<b>VCBBUD7075HM</b>	27 <sup>3</sup> / <sub>5</sub> "	15"	29 <sup>1</sup> / <sub>10</sub> "	120.4 lb
Round Table 31 <sup>1</sup> / <sub>2</sub> "	<b>VCBBUD8075HM</b>	31 <sup>1</sup> / <sub>2</sub> "	15"	29 <sup>1</sup> / <sub>10</sub> "	132.9 lb
Round Table 39 <sup>2</sup> / <sub>5</sub> "	<b>VCBBUD10075HM</b>	39 <sup>2</sup> / <sub>5</sub> "	15"	29 <sup>1</sup> / <sub>10</sub> "	148.6 lb
Round Table 47 <sup>1</sup> / <sub>5</sub> "	<b>VCBBUD12075HM</b>	47 <sup>1</sup> / <sub>5</sub> "	19 <sup>7</sup> / <sub>10</sub> "	29 <sup>1</sup> / <sub>10</sub> "	212.9 lb
Round Table 59 <sup>1</sup> / <sub>10</sub> "	<b>VCBBUD15075HM</b>	59 <sup>1</sup> / <sub>10</sub> "	19 <sup>7</sup> / <sub>10</sub> "	29 <sup>1</sup> / <sub>10</sub> "	240.3 lb
<b>Square Tables</b>					
Square Table 27 <sup>3</sup> / <sub>5</sub> "	<b>VCBBUC7075HM</b>	27 <sup>3</sup> / <sub>5</sub> "	15"	29 <sup>1</sup> / <sub>10</sub> "	131.8 lb
Square Table 31 <sup>1</sup> / <sub>2</sub> "	<b>VCBBUC8075HM</b>	31 <sup>1</sup> / <sub>2</sub> "	15"	29 <sup>1</sup> / <sub>10</sub> "	138.5 lb
Square Table 35 <sup>2</sup> / <sub>5</sub> "	<b>VCBBUC9075HM</b>	35 <sup>2</sup> / <sub>5</sub> "	19 <sup>7</sup> / <sub>10</sub> "	29 <sup>1</sup> / <sub>10</sub> "	155.0 lb
Square Table 39 <sup>2</sup> / <sub>5</sub> "	<b>VCBBUC10075HM</b>	39 <sup>2</sup> / <sub>5</sub> "	19 <sup>7</sup> / <sub>10</sub> "	29 <sup>1</sup> / <sub>10</sub> "	211.0 lb
<b>High Round Tables</b>					
Round Table 23 <sup>3</sup> / <sub>5</sub> "	<b>VCBBUD60H75HM</b>	23 <sup>3</sup> / <sub>5</sub> "	15"	40 <sup>1</sup> / <sub>5</sub> "	82.0 lb
Round Table 27 <sup>3</sup> / <sub>5</sub> "	<b>VCBBUD70H75HM</b>	27 <sup>3</sup> / <sub>5</sub> "	15"	40 <sup>1</sup> / <sub>5</sub> "	80.2 lb
Round Table 31 <sup>1</sup> / <sub>2</sub> "	<b>VCBBUD80H75HM</b>	31 <sup>1</sup> / <sub>2</sub> "	15"	40 <sup>1</sup> / <sub>5</sub> "	92.8 lb
Round Table 39 <sup>2</sup> / <sub>5</sub> "	<b>VCBBUD100H75HM</b>	39 <sup>2</sup> / <sub>5</sub> "	15"	40 <sup>1</sup> / <sub>5</sub> "	108.5 lb
<b>High Square Tables</b>					
Square Table 27 <sup>3</sup> / <sub>5</sub> "	<b>VCBBUC70H75HM</b>	27 <sup>3</sup> / <sub>5</sub> "	15"	40 <sup>1</sup> / <sub>5</sub> "	91.7 lb
Square Table 31 <sup>1</sup> / <sub>2</sub> "	<b>VCBBUC80H75HM</b>	31 <sup>1</sup> / <sub>2</sub> "	15"	40 <sup>1</sup> / <sub>5</sub> "	98.3 lb
<b>High-Pressure Laminate</b>					
<b>Round Tables</b>					
Round Table 23 <sup>3</sup> / <sub>5</sub> "	<b>VCBBUD6075HPL</b>	23 <sup>3</sup> / <sub>5</sub> "	15"	29 <sup>1</sup> / <sub>10</sub> "	126.1 lb
Round Table 27 <sup>3</sup> / <sub>5</sub> "	<b>VCBBUD7075HPL</b>	27 <sup>3</sup> / <sub>5</sub> "	15"	29 <sup>1</sup> / <sub>10</sub> "	120.4 lb
Round Table 31 <sup>1</sup> / <sub>2</sub> "	<b>VCBBUD8075HPL</b>	31 <sup>1</sup> / <sub>2</sub> "	15"	29 <sup>1</sup> / <sub>10</sub> "	132.9 lb
Round Table 39 <sup>2</sup> / <sub>5</sub> "	<b>VCBBUD10075HPL</b>	39 <sup>2</sup> / <sub>5</sub> "	15"	29 <sup>1</sup> / <sub>10</sub> "	148.6 lb
Round Table 47 <sup>1</sup> / <sub>5</sub> "	<b>VCBBUD12075HPL</b>	47 <sup>1</sup> / <sub>5</sub> "	19 <sup>7</sup> / <sub>10</sub> "	29 <sup>1</sup> / <sub>10</sub> "	212.9 lb
<b>Square Tables</b>					
Square Table 27 <sup>3</sup> / <sub>5</sub> "	<b>VCBBUC7075HPL</b>	27 <sup>3</sup> / <sub>5</sub> "	15"	29 <sup>1</sup> / <sub>10</sub> "	131.8 lb
Square Table 31 <sup>1</sup> / <sub>2</sub> "	<b>VCBBUC8075HPL</b>	31 <sup>1</sup> / <sub>2</sub> "	15"	29 <sup>1</sup> / <sub>10</sub> "	138.5 lb
Square Table 35 <sup>2</sup> / <sub>5</sub> "	<b>VCBBUC9075HPL</b>	35 <sup>2</sup> / <sub>5</sub> "	19 <sup>7</sup> / <sub>10</sub> "	29 <sup>1</sup> / <sub>10</sub> "	155.0 lb
Square Table 39 <sup>2</sup> / <sub>5</sub> "	<b>VCBBUC10075HPL</b>	39 <sup>2</sup> / <sub>5</sub> "	19 <sup>7</sup> / <sub>10</sub> "	29 <sup>1</sup> / <sub>10</sub> "	211.0 lb
<b>High Round Tables</b>					
Round Table 23 <sup>3</sup> / <sub>5</sub> "	<b>VCBBUD60H75HPL</b>	23 <sup>3</sup> / <sub>5</sub> "	15"	40 <sup>1</sup> / <sub>5</sub> "	82.0 lb
Round Table 27 <sup>3</sup> / <sub>5</sub> "	<b>VCBBUD70H75HPL</b>	27 <sup>3</sup> / <sub>5</sub> "	15"	40 <sup>1</sup> / <sub>5</sub> "	80.2 lb
Round Table 31 <sup>1</sup> / <sub>2</sub> "	<b>VCBBUD80H75HPL</b>	31 <sup>1</sup> / <sub>2</sub> "	15"	40 <sup>1</sup> / <sub>5</sub> "	92.8 lb
Round Table 39 <sup>2</sup> / <sub>5</sub> "	<b>VCBBUD100H75HPL</b>	39 <sup>2</sup> / <sub>5</sub> "	15"	40 <sup>1</sup> / <sub>5</sub> "	108.5 lb
<b>High Square Tables</b>					
Square Table 27 <sup>3</sup> / <sub>5</sub> "	<b>VCBBUC70H75HPL</b>	27 <sup>3</sup> / <sub>5</sub> "	15"	40 <sup>1</sup> / <sub>5</sub> "	91.7 lb
Square Table 31 <sup>1</sup> / <sub>2</sub> "	<b>VCBBUC80H75HPL</b>	31 <sup>1</sup> / <sub>2</sub> "	15"	40 <sup>1</sup> / <sub>5</sub> "	98.3 lb

Burin Tables, continued

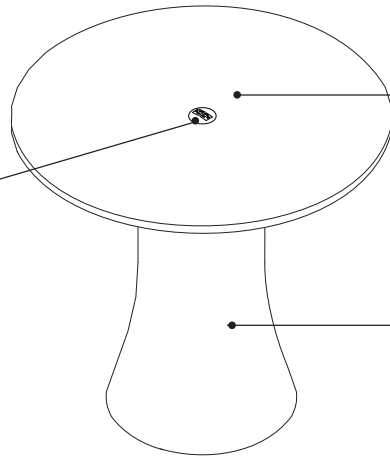
<b>Actual Dimensions</b>					
<b>Description</b>	<b>Style Number</b>	<b>Top Depth/ Diameter</b>	<b>Base Diameter</b>	<b>Height</b>	<b>Weight</b>
<b>Compact Laminate</b>					
<b>Round Tables</b>					
Round Table 23 <sup>3</sup> / <sub>5</sub> "	<b>VCBBUD6047</b>	23 <sup>3</sup> / <sub>5</sub> "	15"	29 <sup>1</sup> / <sub>10</sub> "	126.1 lb
Round Table 27 <sup>3</sup> / <sub>5</sub> "	<b>VCBBUD7047</b>	27 <sup>3</sup> / <sub>5</sub> "	15"	29 <sup>1</sup> / <sub>10</sub> "	120.4 lb
Round Table 31 <sup>1</sup> / <sub>2</sub> "	<b>VCBBUD8047</b>	31 <sup>1</sup> / <sub>2</sub> "	15"	29 <sup>1</sup> / <sub>10</sub> "	132.9 lb
Round Table 39 <sup>2</sup> / <sub>5</sub> "	<b>VCBBUD10047</b>	39 <sup>2</sup> / <sub>5</sub> "	15"	29 <sup>1</sup> / <sub>10</sub> "	148.6 lb
Round Table 47 <sup>1</sup> / <sub>5</sub> "	<b>VCBBUD12047</b>	47 <sup>1</sup> / <sub>5</sub> "	19 <sup>7</sup> / <sub>10</sub> "	29 <sup>1</sup> / <sub>10</sub> "	212.9 lb
Round Table 59 <sup>1</sup> / <sub>10</sub> "	<b>VCBBUD15047</b>	59 <sup>1</sup> / <sub>10</sub> "	19 <sup>7</sup> / <sub>10</sub> "	29 <sup>1</sup> / <sub>10</sub> "	240.3 lb
<b>Square Tables</b>					
Square Table 27 <sup>3</sup> / <sub>5</sub> "	<b>VCBBUC7047</b>	27 <sup>3</sup> / <sub>5</sub> "	15"	29 <sup>1</sup> / <sub>10</sub> "	131.8 lb
Square Table 31 <sup>1</sup> / <sub>2</sub> "	<b>VCBBUC8047</b>	31 <sup>1</sup> / <sub>2</sub> "	15"	29 <sup>1</sup> / <sub>10</sub> "	138.5 lb
Square Table 35 <sup>5</sup> / <sub>8</sub> "	<b>VCBBUC9047</b>	35 <sup>5</sup> / <sub>8</sub> "	19 <sup>7</sup> / <sub>10</sub> "	29 <sup>1</sup> / <sub>10</sub> "	155.0 lb
Square Table 39 <sup>2</sup> / <sub>5</sub> "	<b>VCBBUC10047</b>	39 <sup>2</sup> / <sub>5</sub> "	19 <sup>7</sup> / <sub>10</sub> "	29 <sup>1</sup> / <sub>10</sub> "	211.0 lb
<b>High Round Tables</b>					
Round Table 23 <sup>3</sup> / <sub>5</sub> "	<b>VCBBUD60H47</b>	23 <sup>3</sup> / <sub>5</sub> "	15"	40 <sup>1</sup> / <sub>5</sub> "	82.0 lb
Round Table 27 <sup>3</sup> / <sub>5</sub> "	<b>VCBBUD70H47</b>	27 <sup>3</sup> / <sub>5</sub> "	15"	40 <sup>1</sup> / <sub>5</sub> "	80.2 lb
Round Table 31 <sup>1</sup> / <sub>2</sub> "	<b>VCBBUD80H47</b>	31 <sup>1</sup> / <sub>2</sub> "	15"	40 <sup>1</sup> / <sub>5</sub> "	92.8 lb
Round Table 39 <sup>2</sup> / <sub>5</sub> "	<b>VCBBUD100H47</b>	39 <sup>2</sup> / <sub>5</sub> "	15"	40 <sup>1</sup> / <sub>5</sub> "	108.5 lb
<b>High Square Tables</b>					
Square Table 27 <sup>3</sup> / <sub>5</sub> "	<b>VCBBUC70H47</b>	27 <sup>3</sup> / <sub>5</sub> "	15"	40 <sup>1</sup> / <sub>5</sub> "	91.7 lb
Square Table 31 <sup>1</sup> / <sub>2</sub> "	<b>VCBBUC80H47</b>	31 <sup>1</sup> / <sub>2</sub> "	15"	40 <sup>1</sup> / <sub>5</sub> "	98.3 lb
<b>Oval Table</b>					
Oval Table 47 <sup>1</sup> / <sub>5</sub> "	<b>VCBBUC24047</b>	94 <sup>2</sup> / <sub>5</sub> "	19 <sup>7</sup> / <sub>10</sub> "	29 <sup>1</sup> / <sub>10</sub> "	454.2 lb
<b>Lacquered or Stained MDF</b>					
<b>Round Tables</b>					
Round Table 23 <sup>3</sup> / <sub>5</sub> "	<b>VCBBUD6087</b>	23 <sup>3</sup> / <sub>5</sub> "	15"	29 <sup>1</sup> / <sub>10</sub> "	126.1 lb
Round Table 27 <sup>3</sup> / <sub>5</sub> "	<b>VCBBUD7087</b>	27 <sup>3</sup> / <sub>5</sub> "	15"	29 <sup>1</sup> / <sub>10</sub> "	120.4 lb
Round Table 31 <sup>1</sup> / <sub>2</sub> "	<b>VCBBUD8087</b>	31 <sup>1</sup> / <sub>2</sub> "	15"	29 <sup>1</sup> / <sub>10</sub> "	132.9 lb
Round Table 39 <sup>2</sup> / <sub>5</sub> "	<b>VCBBUD10087</b>	39 <sup>2</sup> / <sub>5</sub> "	15"	29 <sup>1</sup> / <sub>10</sub> "	148.6 lb
Round Table 47 <sup>1</sup> / <sub>5</sub> "	<b>VCBBUD12087</b>	47 <sup>1</sup> / <sub>5</sub> "	19 <sup>7</sup> / <sub>10</sub> "	29 <sup>1</sup> / <sub>10</sub> "	212.9 lb
Round Table 59 <sup>1</sup> / <sub>10</sub> "	<b>VCBBUD15087</b>	59 <sup>1</sup> / <sub>10</sub> "	19 <sup>7</sup> / <sub>10</sub> "	29 <sup>1</sup> / <sub>10</sub> "	240.3 lb
<b>Square Tables</b>					
Square Table 27 <sup>3</sup> / <sub>5</sub> "	<b>VCBBUC7087</b>	27 <sup>3</sup> / <sub>5</sub> "	15"	29 <sup>1</sup> / <sub>10</sub> "	131.8 lb
Square Table 31 <sup>1</sup> / <sub>2</sub> "	<b>VCBBUC8087</b>	31 <sup>1</sup> / <sub>2</sub> "	15"	29 <sup>1</sup> / <sub>10</sub> "	138.5 lb
Square Table 35 <sup>5</sup> / <sub>8</sub> "	<b>VCBBUC9087</b>	35 <sup>5</sup> / <sub>8</sub> "	19 <sup>7</sup> / <sub>10</sub> "	29 <sup>1</sup> / <sub>10</sub> "	155.0 lb
Square Table 39 <sup>2</sup> / <sub>5</sub> "	<b>VCBBUC10087</b>	39 <sup>2</sup> / <sub>5</sub> "	19 <sup>7</sup> / <sub>10</sub> "	29 <sup>1</sup> / <sub>10</sub> "	211.0 lb
<b>High Round Table</b>					
Round Table 23 <sup>3</sup> / <sub>5</sub> "	<b>VCBBUD60H87</b>	23 <sup>3</sup> / <sub>5</sub> "	15"	40 <sup>1</sup> / <sub>5</sub> "	82.0 lb

<b>Actual Dimensions</b>					
<b>Description</b>	<b>Style Number</b>	<b>Top Depth/ Diameter</b>	<b>Base Diameter</b>	<b>Height</b>	<b>Weight</b>
<b>Lacquered or Stained MDF, continued</b>					
Round Table 27 <sup>3</sup> / <sub>5</sub> "	<b>VCBBUD70H87</b>	27 <sup>3</sup> / <sub>5</sub> "	15"	40 <sup>1</sup> / <sub>5</sub> "	80.2 lb
Round Table 31 <sup>1</sup> / <sub>2</sub> "	<b>VCBBUD80H87</b>	31 <sup>1</sup> / <sub>2</sub> "	15"	40 <sup>1</sup> / <sub>5</sub> "	92.8 lb
Round Table 39 <sup>2</sup> / <sub>5</sub> "	<b>VCBBUD100H87</b>	39 <sup>2</sup> / <sub>5</sub> "	15"	40 <sup>1</sup> / <sub>5</sub> "	108.5 lb
<b>High Square Tables</b>					
Square Table 27 <sup>3</sup> / <sub>5</sub> "	<b>VCBBUC70H87</b>	27 <sup>3</sup> / <sub>5</sub> "	15"	40 <sup>1</sup> / <sub>5</sub> "	91.7 lb
Square Table 31 <sup>1</sup> / <sub>2</sub> "	<b>VCBBUC80H87</b>	31 <sup>1</sup> / <sub>2</sub> "	15"	40 <sup>1</sup> / <sub>5</sub> "	98.3 lb
<b>Oval Tables</b>					
Oval Table 47 <sup>1</sup> / <sub>5</sub> "	<b>VCBBUC24087</b>	94 <sup>1</sup> / <sub>2</sub> "	19 <sup>7</sup> / <sub>10</sub> "	29 <sup>1</sup> / <sub>10</sub> "	454.2 lb
Oval Table 59 <sup>1</sup> / <sub>10</sub> "	<b>VCBBUC30087</b>	118 <sup>1</sup> / <sub>10</sub> "	19 <sup>7</sup> / <sub>10</sub> "	29 <sup>1</sup> / <sub>10</sub> "	541.9 lb
Oval Table 59 <sup>1</sup> / <sub>10</sub> "	<b>VCBBUC50087</b>	196 <sup>9</sup> / <sub>10</sub> "	19 <sup>7</sup> / <sub>10</sub> "	29 <sup>1</sup> / <sub>10</sub> "	875.2 lb
<b>Mini Tables</b>					
Mini Low Table	<b>VCBBU50</b>	14 <sup>1</sup> / <sub>5</sub> "	N.A.	19 <sup>7</sup> / <sub>10</sub> "	28.9 lb
Mini High Table	<b>VCBBU55</b>	14 <sup>1</sup> / <sub>5</sub> "	N.A.	21 <sup>7</sup> / <sub>10</sub> "	28.9 lb

# Cambio Tables

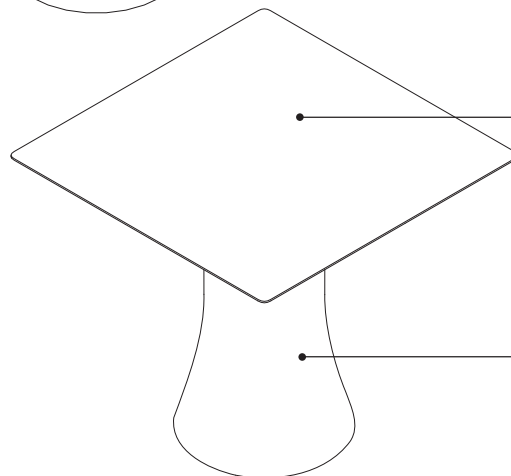
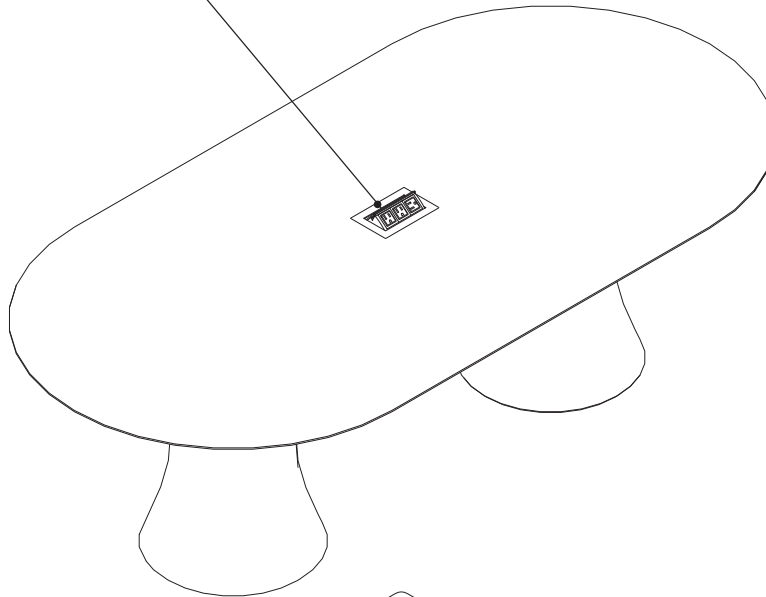
**Cambio tables**, designed by Victor Carrasco, displays a singular central base with a seamless silhouette. A modern collection that allows for infinite compositions to be created and accommodates multiple guests.  
▶ Specifying, pages 446–462

**Power** is available as an option.  
▶ See *Power, Wiring, and Cabling*.



**Top** is available in Low-Pressure Laminate, High-Pressure Laminate, compact laminate, or lacquered or stained MDF.

**Base** is powder coated paint.



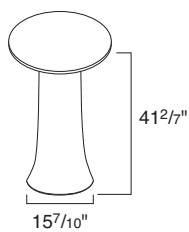
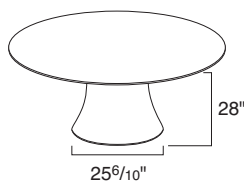
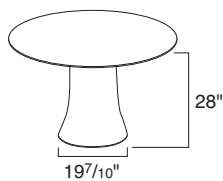
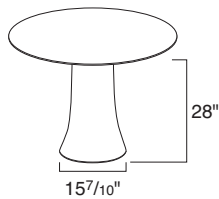
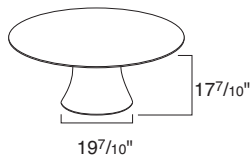
**Top** is 1 1/8" thick scratch resistant materials available in three edge profiles.

**22 pound counter-weight** included.



**Product Details**

**Bases** must be installed with recommended counterweight.

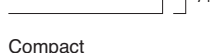


**Base width** varies based on top size specified.

MDF (stained/lacquered) or HPL with MDF



Melamine

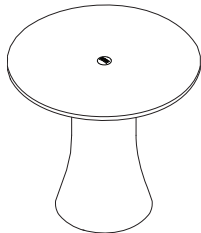


Compact

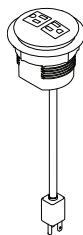
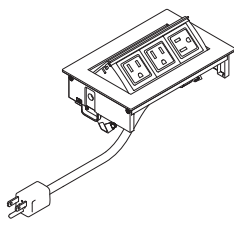


**Table tops** available in veneer, lacquered MDF, High-Pressure Laminate, melamine, and compact laminate.

**Power, Wiring, and Cabling**

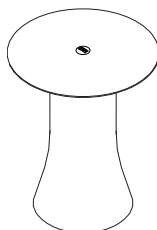


**Surface power** available as an option on 29 1/10"H Cambio tables.



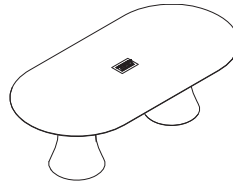
**On single base tables, round power module** will be specifiable, and on double and triple base tables, square module(s) will be specifiable.

**Power Locations**



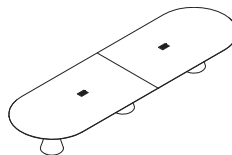
**Single base Cambio tables:**

- One centered round power module



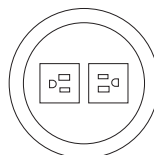
**Double base Cambio tables:**

- One centered square power module  
*Tip: Power is not available on the 94 1/2"W Cambio oval table with a compact laminate top.*

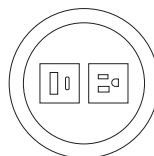


**Triple base Cambio tables:**

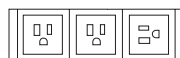
- Two centered square power modules, one direction
- Two centered square power modules, two directions



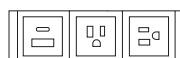
Power, Power



USB-A, USB-C, Power



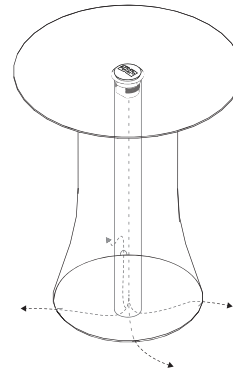
Power, Power, Power



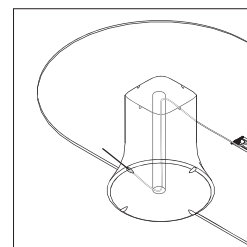
USB-C, USB-A, Power, Power

**Surface power** available in two configurations for both power modules.

**Power infeed** is cord and plug. Both round and square modules have 57" of cord on 29 1/10"H tables and 44" of cord on 41 2/7"H tables. When there are multiple square power modules, they are chained together and have one plug.



**For single base Cambio tables,** cables are managed through the center of the base and out the bottom of the base.



**For double and triple base Cambio tables,** cables are managed under the table top to a base, and then out the bottom of the base.

**Wire management kit** included when a square power module is specified. Kit includes clips, screws, and velcro straps to route cord under the table top and down the base.

**Power** is field-installed.

**Surface Materials**

**Base**

- 1019 Taupe RAL
- 9003 White RAL
- 9005 Black RAL

**Top Low-Pressure Laminate**

- Black top/black edge
- White top/white edge

**High-Pressure Laminate**

- Black Soft Touch by Fenix top/stained edge
- White top/stained edge

**Compact Laminate**

- White top/black edge
- Black top/black edge
- White top/white edge

**Lacquered MDF**

- 050 50 30 Brick RAL
- 060 70 20 Dusty Pink RAL
- 090 40 30 Olive Green RAL
- 1011 Ochre RAL
- 1019 Taupe RAL
- 7034 Dusty Green RAL
- 9003 White RAL
- 9005 Black RAL

**Stained MDF**

- Ash
- Bleached oak
- Cognac
- Matte oak
- Walnut oak

*Tip: The range of lacquered colors have a smooth finish except for black, which has a lacquered microtextured finish.*

*Tip: Not all top finishes available on all styles.*

**Square MhoB power module**

- 4242 Milk Matte
- 4710 Black
- 4799 Platinum Metallic

**Round node power module**

- 4013 Silver/Black
- 4180 Graphite Matte
- 4242 Milk Matte
- 4710 Black

Cambio Tables, continued

<b>Actual Dimensions</b>				
<b>Description</b>	<b>Style Number</b>	<b>Top Depth/ Diameter</b>	<b>Base Diameter</b>	<b>Height</b>
<b>Compact Laminate</b>				
<b>Round Tables</b>				
Low Round Table 23 <sup>3</sup> / <sub>8</sub> "	<b>VCBCAD60BL</b>	23 <sup>3</sup> / <sub>8</sub> "	19 <sup>7</sup> / <sub>10</sub> "	18 <sup>9</sup> / <sub>10</sub> "
Low Round Table 27 <sup>3</sup> / <sub>8</sub> "	<b>VCBCAD70BL</b>	27 <sup>3</sup> / <sub>8</sub> "	19 <sup>7</sup> / <sub>10</sub> "	18 <sup>9</sup> / <sub>10</sub> "
Low Round Table 31 <sup>1</sup> / <sub>2</sub> "	<b>VCBCAD80BL</b>	31 <sup>1</sup> / <sub>2</sub> "	19 <sup>7</sup> / <sub>10</sub> "	18 <sup>9</sup> / <sub>10</sub> "
Low Round Table 39 <sup>3</sup> / <sub>8</sub> "	<b>VCBCAD100BL</b>	39 <sup>3</sup> / <sub>8</sub> "	19 <sup>7</sup> / <sub>10</sub> "	18 <sup>9</sup> / <sub>10</sub> "
Low Round Table 47 <sup>1</sup> / <sub>8</sub> "	<b>VCBCAD120BL</b>	47 <sup>1</sup> / <sub>8</sub> "	19 <sup>7</sup> / <sub>10</sub> "	18 <sup>9</sup> / <sub>10</sub> "
<b>Square Tables</b>				
Low Square Table 23 <sup>3</sup> / <sub>8</sub> "	<b>VCBCAC70BL</b>	23 <sup>3</sup> / <sub>8</sub> "	19 <sup>7</sup> / <sub>10</sub> "	18 <sup>9</sup> / <sub>10</sub> "
Low Square Table 27 <sup>3</sup> / <sub>8</sub> "	<b>VCBCAC80BL</b>	27 <sup>3</sup> / <sub>8</sub> "	19 <sup>7</sup> / <sub>10</sub> "	18 <sup>9</sup> / <sub>10</sub> "
Low Square Table 31 <sup>1</sup> / <sub>2</sub> "	<b>VCBCAC90BL</b>	31 <sup>1</sup> / <sub>2</sub> "	19 <sup>7</sup> / <sub>10</sub> "	18 <sup>9</sup> / <sub>10</sub> "
Low Square Table 39 <sup>3</sup> / <sub>8</sub> "	<b>VCBCAD100BL</b>	39 <sup>3</sup> / <sub>8</sub> "	19 <sup>7</sup> / <sub>10</sub> "	18 <sup>9</sup> / <sub>10</sub> "
Low Square Table 47 <sup>1</sup> / <sub>8</sub> "	<b>VCBCAD120BL</b>	47 <sup>1</sup> / <sub>8</sub> "	19 <sup>7</sup> / <sub>10</sub> "	18 <sup>9</sup> / <sub>10</sub> "
<b>Seated Round Tables</b>				
Seated Round Table 23 <sup>3</sup> / <sub>8</sub> "	<b>VCBCAD60L</b>	23 <sup>3</sup> / <sub>8</sub> "	15 <sup>7</sup> / <sub>10</sub> "	29 <sup>1</sup> / <sub>10</sub> "
Seated Round Table 27 <sup>3</sup> / <sub>8</sub> "	<b>VCBCAD70L</b>	27 <sup>3</sup> / <sub>8</sub> "	15 <sup>7</sup> / <sub>10</sub> "	29 <sup>1</sup> / <sub>10</sub> "
Seated Round Table 31 <sup>1</sup> / <sub>2</sub> "	<b>VCBCAD80L</b>	31 <sup>1</sup> / <sub>2</sub> "	15 <sup>7</sup> / <sub>10</sub> "	29 <sup>1</sup> / <sub>10</sub> "
Seated Round Table 39 <sup>3</sup> / <sub>8</sub> "	<b>VCBCAD100L</b>	39 <sup>3</sup> / <sub>8</sub> "	15 <sup>7</sup> / <sub>10</sub> "	29 <sup>1</sup> / <sub>10</sub> "
Seated Round Table 47 <sup>1</sup> / <sub>8</sub> "	<b>VCBCAD120L</b>	47 <sup>1</sup> / <sub>8</sub> "	19 <sup>7</sup> / <sub>10</sub> "	29 <sup>1</sup> / <sub>10</sub> "
Seated Round Table 59"	<b>VCBCAD150L</b>	59"	25 <sup>3</sup> / <sub>8</sub> "	29 <sup>1</sup> / <sub>10</sub> "
Seated Round Table 71"	<b>VCBCAD180L</b>	71"	25 <sup>3</sup> / <sub>8</sub> "	29 <sup>1</sup> / <sub>10</sub> "
Seated Round Table 78 <sup>7</sup> / <sub>10</sub> "	<b>VCBCAD200L</b>	78 <sup>7</sup> / <sub>10</sub> "	25 <sup>3</sup> / <sub>8</sub> "	29 <sup>1</sup> / <sub>10</sub> "
<b>Oval Table</b>				
Oval Table 47 <sup>1</sup> / <sub>8</sub> "	<b>VCBCAC240L</b>	47 <sup>1</sup> / <sub>8</sub> "	19 <sup>7</sup> / <sub>10</sub> "	29 <sup>1</sup> / <sub>10</sub> "
<b>Seated Square Tables</b>				
Seated Square Table 27 <sup>3</sup> / <sub>8</sub> "	<b>VCBCAC70L</b>	27 <sup>3</sup> / <sub>8</sub> "	15 <sup>7</sup> / <sub>10</sub> "	29 <sup>1</sup> / <sub>10</sub> "
Seated Square Table 31 <sup>1</sup> / <sub>2</sub> "	<b>VCBCAC80L</b>	31 <sup>1</sup> / <sub>2</sub> "	15 <sup>7</sup> / <sub>10</sub> "	29 <sup>1</sup> / <sub>10</sub> "
Seated Square Table 35 <sup>3</sup> / <sub>8</sub> "	<b>VCBCAC90L</b>	35 <sup>3</sup> / <sub>8</sub> "	19 <sup>7</sup> / <sub>10</sub> "	29 <sup>1</sup> / <sub>10</sub> "
Seated Square Table 55 <sup>1</sup> / <sub>10</sub> "	<b>VCBCAC140L</b>	55 <sup>1</sup> / <sub>10</sub> "	25 <sup>3</sup> / <sub>8</sub> "	29 <sup>1</sup> / <sub>10</sub> "
<b>High Round Tables</b>				
High Round Table 23 <sup>3</sup> / <sub>8</sub> "	<b>VCBCAD60H</b>	23 <sup>3</sup> / <sub>8</sub> "	15 <sup>7</sup> / <sub>10</sub> "	41 <sup>2</sup> / <sub>7</sub> "
High Round Table 27 <sup>3</sup> / <sub>8</sub> "	<b>VCBCAD70H</b>	27 <sup>3</sup> / <sub>8</sub> "	15 <sup>7</sup> / <sub>10</sub> "	41 <sup>2</sup> / <sub>7</sub> "
High Round Table 31 <sup>1</sup> / <sub>2</sub> "	<b>VCBCAD80H</b>	31 <sup>1</sup> / <sub>2</sub> "	15 <sup>7</sup> / <sub>10</sub> "	41 <sup>2</sup> / <sub>7</sub> "
High Round Table 39 <sup>3</sup> / <sub>8</sub> "	<b>VCBCAD100H</b>	39 <sup>3</sup> / <sub>8</sub> "	15 <sup>7</sup> / <sub>10</sub> "	41 <sup>2</sup> / <sub>7</sub> "
<b>High Oval Tables</b>				
High Oval Table 86 <sup>3</sup> / <sub>8</sub> "D X 35 <sup>3</sup> / <sub>8</sub> "W	<b>VCBCAC220H</b>	86 <sup>3</sup> / <sub>8</sub> "	15 <sup>7</sup> / <sub>10</sub> "	41 <sup>2</sup> / <sub>7</sub> "
High Oval Table 94 <sup>1</sup> / <sub>2</sub> "D X 35 <sup>3</sup> / <sub>8</sub> "W	<b>VCBCAC240H</b>	94 <sup>1</sup> / <sub>2</sub> "	15 <sup>7</sup> / <sub>10</sub> "	41 <sup>2</sup> / <sub>7</sub> "
High Oval Table 102 <sup>3</sup> / <sub>8</sub> "D X 35 <sup>3</sup> / <sub>8</sub> "W	<b>VCBCAC260H</b>	102 <sup>3</sup> / <sub>8</sub> "	15 <sup>7</sup> / <sub>10</sub> "	41 <sup>2</sup> / <sub>7</sub> "
High Oval Table 110 <sup>1</sup> / <sub>8</sub> "D X 35 <sup>3</sup> / <sub>8</sub> "W	<b>VCBCAC280H</b>	110 <sup>1</sup> / <sub>8</sub> "	15 <sup>7</sup> / <sub>10</sub> "	41 <sup>2</sup> / <sub>7</sub> "
High Oval Table 118 <sup>1</sup> / <sub>10</sub> "D X 35 <sup>3</sup> / <sub>8</sub> "W	<b>VCBCAC300H</b>	118 <sup>1</sup> / <sub>10</sub> "	15 <sup>7</sup> / <sub>10</sub> "	41 <sup>2</sup> / <sub>7</sub> "
<b>High Square Tables</b>				
High Square Table 27 <sup>3</sup> / <sub>8</sub> "	<b>VCBCAC70H</b>	27 <sup>3</sup> / <sub>8</sub> "	15 <sup>7</sup> / <sub>10</sub> "	41 <sup>2</sup> / <sub>7</sub> "
High Square Table 31 <sup>1</sup> / <sub>2</sub> "	<b>VCBCAC80H</b>	31 <sup>1</sup> / <sub>2</sub> "	15 <sup>7</sup> / <sub>10</sub> "	41 <sup>2</sup> / <sub>7</sub> "

**Actual Dimensions**

Description	Style Number	Top Depth/ Diameter	Base Diameter	Height
<b>Lacquered or Stained MDF</b>				
<b>Round Tables</b>				
Low Round Table 23 <sup>3</sup> / <sub>5</sub> "	<b>VCBCAD60B</b>	23 <sup>3</sup> / <sub>5</sub> "	19 <sup>7</sup> / <sub>10</sub> "	18 <sup>9</sup> / <sub>10</sub> "
Low Round Table 27 <sup>3</sup> / <sub>5</sub> "	<b>VCBCAD70B</b>	27 <sup>3</sup> / <sub>5</sub> "	19 <sup>7</sup> / <sub>10</sub> "	18 <sup>9</sup> / <sub>10</sub> "
Low Round Table 31 <sup>1</sup> / <sub>2</sub> "	<b>VCBCAD80B</b>	31 <sup>1</sup> / <sub>2</sub> "	19 <sup>7</sup> / <sub>10</sub> "	18 <sup>9</sup> / <sub>10</sub> "
Low Round Table 39 <sup>2</sup> / <sub>5</sub> "	<b>VCBCAD100B</b>	39 <sup>2</sup> / <sub>5</sub> "	19 <sup>7</sup> / <sub>10</sub> "	18 <sup>9</sup> / <sub>10</sub> "
Low Round Table 47 <sup>1</sup> / <sub>5</sub> "	<b>VCBCAD120B</b>	47 <sup>1</sup> / <sub>5</sub> "	19 <sup>7</sup> / <sub>10</sub> "	18 <sup>9</sup> / <sub>10</sub> "
<b>Square Tables</b>				
Low Square Table 23 <sup>3</sup> / <sub>5</sub> "	<b>VCBCAC70B</b>	27 <sup>3</sup> / <sub>5</sub> "	19 <sup>7</sup> / <sub>10</sub> "	18 <sup>9</sup> / <sub>10</sub> "
Low Square Table 31 <sup>1</sup> / <sub>2</sub> "	<b>VCBCAC80B</b>	31 <sup>1</sup> / <sub>2</sub> "	19 <sup>7</sup> / <sub>10</sub> "	18 <sup>9</sup> / <sub>10</sub> "
Low Square Table 35 <sup>2</sup> / <sub>5</sub> "	<b>VCBCAC90B</b>	35 <sup>2</sup> / <sub>5</sub> "	19 <sup>7</sup> / <sub>10</sub> "	18 <sup>9</sup> / <sub>10</sub> "
<b>Seated Round Tables</b>				
Seated Round Table 23 <sup>3</sup> / <sub>5</sub> "	<b>VCBCAD60</b>	23 <sup>3</sup> / <sub>5</sub> "	15 <sup>7</sup> / <sub>10</sub> "	29 <sup>1</sup> / <sub>10</sub> "
Seated Round Table 27 <sup>3</sup> / <sub>5</sub> "	<b>VCBCAD70</b>	27 <sup>3</sup> / <sub>5</sub> "	15 <sup>7</sup> / <sub>10</sub> "	29 <sup>1</sup> / <sub>10</sub> "
Seated Round Table 31 <sup>1</sup> / <sub>2</sub> "	<b>VCBCAD80</b>	31 <sup>1</sup> / <sub>2</sub> "	15 <sup>7</sup> / <sub>10</sub> "	29 <sup>1</sup> / <sub>10</sub> "
Seated Round Table 39 <sup>2</sup> / <sub>5</sub> "	<b>VCBCAD100</b>	39 <sup>2</sup> / <sub>5</sub> "	15 <sup>7</sup> / <sub>10</sub> "	29 <sup>1</sup> / <sub>10</sub> "
Seated Round Table 47 <sup>1</sup> / <sub>5</sub> "	<b>VCBCAD120</b>	47 <sup>1</sup> / <sub>5</sub> "	19 <sup>7</sup> / <sub>10</sub> "	29 <sup>1</sup> / <sub>10</sub> "
Seated Round Table 59"	<b>VCBCAD150</b>	59"	25 <sup>3</sup> / <sub>5</sub> "	29 <sup>1</sup> / <sub>10</sub> "
Seated Round Table 71"	<b>VCBCAD180</b>	71"	25 <sup>3</sup> / <sub>5</sub> "	29 <sup>1</sup> / <sub>10</sub> "
Seated Round Table 78 <sup>7</sup> / <sub>10</sub> "	<b>VCBCAD200</b>	78 <sup>7</sup> / <sub>10</sub> "	25 <sup>3</sup> / <sub>5</sub> "	29 <sup>1</sup> / <sub>10</sub> "
<b>Oval Tables</b>				
Oval Table 94 <sup>1</sup> / <sub>2</sub> "	<b>VCBCAC240</b>	94 <sup>1</sup> / <sub>2</sub> "	19 <sup>7</sup> / <sub>10</sub> "	29 <sup>1</sup> / <sub>10</sub> "
Oval Table 118"	<b>VCBCAC300</b>	118"	25 <sup>3</sup> / <sub>5</sub> "	29 <sup>1</sup> / <sub>10</sub> "
Oval Table 197"	<b>VCBCAC500</b>	197"	25 <sup>3</sup> / <sub>5</sub> "	29 <sup>1</sup> / <sub>10</sub> "
<b>Seated Square Tables</b>				
Seated Square Table 27 <sup>3</sup> / <sub>5</sub> "	<b>VCBCAC70</b>	27 <sup>3</sup> / <sub>5</sub> "	15 <sup>7</sup> / <sub>10</sub> "	29 <sup>1</sup> / <sub>10</sub> "
Seated Square Table 31 <sup>1</sup> / <sub>2</sub> "	<b>VCBCAC80</b>	31 <sup>1</sup> / <sub>2</sub> "	15 <sup>7</sup> / <sub>10</sub> "	29 <sup>1</sup> / <sub>10</sub> "
Seated Square Table 35 <sup>2</sup> / <sub>5</sub> "	<b>VCBCAC90</b>	35 <sup>2</sup> / <sub>5</sub> "	19 <sup>7</sup> / <sub>10</sub> "	29 <sup>1</sup> / <sub>10</sub> "
Seated Square Table 55 <sup>1</sup> / <sub>10</sub> "	<b>VCBCAC140</b>	55 <sup>1</sup> / <sub>10</sub> "	25 <sup>3</sup> / <sub>5</sub> "	29 <sup>1</sup> / <sub>10</sub> "
<b>High Round Tables</b>				
High Round Table 23 <sup>3</sup> / <sub>5</sub> "	<b>VCBCAD60H</b>	23 <sup>3</sup> / <sub>5</sub> "	15 <sup>7</sup> / <sub>10</sub> "	41 <sup>2</sup> / <sub>7</sub> "
High Round Table 27 <sup>3</sup> / <sub>5</sub> "	<b>VCBCAD70H</b>	27 <sup>3</sup> / <sub>5</sub> "	15 <sup>7</sup> / <sub>10</sub> "	41 <sup>2</sup> / <sub>7</sub> "
High Round Table 31 <sup>1</sup> / <sub>2</sub> "	<b>VCBCAD80H</b>	31 <sup>1</sup> / <sub>2</sub> "	15 <sup>7</sup> / <sub>10</sub> "	41 <sup>2</sup> / <sub>7</sub> "
High Round Table 39 <sup>2</sup> / <sub>5</sub> "	<b>VCBCAD100H</b>	39 <sup>2</sup> / <sub>5</sub> "	15 <sup>7</sup> / <sub>10</sub> "	41 <sup>2</sup> / <sub>7</sub> "
<b>High Square Tables</b>				
High Square Table 27 <sup>3</sup> / <sub>5</sub> "	<b>VCBCAC70H</b>	27 <sup>3</sup> / <sub>5</sub> "	15 <sup>7</sup> / <sub>10</sub> "	41 <sup>2</sup> / <sub>7</sub> "
High Square Table 31 <sup>1</sup> / <sub>2</sub> "	<b>VCBCAC80H</b>	31 <sup>1</sup> / <sub>2</sub> "	15 <sup>7</sup> / <sub>10</sub> "	41 <sup>2</sup> / <sub>7</sub> "

Actual Dimensions				
Description	Style Number	Top Depth/ Diameter	Base Diameter	Height
<b>Low-Pressure Laminate</b>				
<b>Round Tables</b>				
Low Round Table 23 <sup>3</sup> / <sub>8</sub> "	<b>VCBCAD60BM</b>	23 <sup>3</sup> / <sub>8</sub> "	19 <sup>7</sup> / <sub>10</sub> "	18 <sup>9</sup> / <sub>10</sub> "
Low Round Table 27 <sup>3</sup> / <sub>8</sub> "	<b>VCBCAD70BM</b>	27 <sup>3</sup> / <sub>8</sub> "	19 <sup>7</sup> / <sub>10</sub> "	18 <sup>9</sup> / <sub>10</sub> "
Low Round Table 31 <sup>1</sup> / <sub>2</sub> "	<b>VCBCAD80BM</b>	31 <sup>1</sup> / <sub>2</sub> "	19 <sup>7</sup> / <sub>10</sub> "	18 <sup>9</sup> / <sub>10</sub> "
Low Round Table 39 <sup>3</sup> / <sub>8</sub> "	<b>VCBCAD100BM</b>	39 <sup>3</sup> / <sub>8</sub> "	19 <sup>7</sup> / <sub>10</sub> "	18 <sup>9</sup> / <sub>10</sub> "
Low Round Table 47 <sup>1</sup> / <sub>8</sub> "	<b>VCBCAD120BM</b>	47 <sup>1</sup> / <sub>8</sub> "	19 <sup>7</sup> / <sub>10</sub> "	18 <sup>9</sup> / <sub>10</sub> "
<b>Square Tables</b>				
Low Square Table 23 <sup>3</sup> / <sub>8</sub> "	<b>VCBCAC70BM</b>	27 <sup>3</sup> / <sub>8</sub> "	19 <sup>7</sup> / <sub>10</sub> "	18 <sup>9</sup> / <sub>10</sub> "
Low Square Table 31 <sup>1</sup> / <sub>2</sub> "	<b>VCBCAC80BM</b>	31 <sup>1</sup> / <sub>2</sub> "	19 <sup>7</sup> / <sub>10</sub> "	18 <sup>9</sup> / <sub>10</sub> "
Low Square Table 35 <sup>3</sup> / <sub>8</sub> "	<b>VCBCAC90BM</b>	35 <sup>3</sup> / <sub>8</sub> "	19 <sup>7</sup> / <sub>10</sub> "	18 <sup>9</sup> / <sub>10</sub> "
<b>Seated Round Tables</b>				
Seated Round Table 23 <sup>3</sup> / <sub>8</sub> "	<b>VCBCAD60M</b>	23 <sup>3</sup> / <sub>8</sub> "	15 <sup>7</sup> / <sub>10</sub> "	29 <sup>1</sup> / <sub>10</sub> "
Seated Round Table 27 <sup>3</sup> / <sub>8</sub> "	<b>VCBCAD70M</b>	27 <sup>3</sup> / <sub>8</sub> "	15 <sup>7</sup> / <sub>10</sub> "	29 <sup>1</sup> / <sub>10</sub> "
Seated Round Table 31 <sup>1</sup> / <sub>2</sub> "	<b>VCBCAD80M</b>	31 <sup>1</sup> / <sub>2</sub> "	15 <sup>7</sup> / <sub>10</sub> "	29 <sup>1</sup> / <sub>10</sub> "
Seated Round Table 39 <sup>3</sup> / <sub>8</sub> "	<b>VCBCAD100M</b>	39 <sup>3</sup> / <sub>8</sub> "	15 <sup>7</sup> / <sub>10</sub> "	29 <sup>1</sup> / <sub>10</sub> "
Seated Round Table 47 <sup>1</sup> / <sub>8</sub> "	<b>VCBCAD120M</b>	47 <sup>1</sup> / <sub>8</sub> "	19 <sup>7</sup> / <sub>10</sub> "	29 <sup>1</sup> / <sub>10</sub> "
Seated Round Table 59"	<b>VCBCAD150M</b>	59"	25 <sup>3</sup> / <sub>8</sub> "	29 <sup>1</sup> / <sub>10</sub> "
Seated Round Table 71"	<b>VCBCAD180M</b>	71"	25 <sup>3</sup> / <sub>8</sub> "	29 <sup>1</sup> / <sub>10</sub> "
<b>Seated Square Tables</b>				
Seated Square Table 27 <sup>3</sup> / <sub>8</sub> "	<b>VCBCAC70M</b>	27 <sup>3</sup> / <sub>8</sub> "	15 <sup>7</sup> / <sub>10</sub> "	29 <sup>1</sup> / <sub>10</sub> "
Seated Square Table 31 <sup>1</sup> / <sub>2</sub> "	<b>VCBCAC80M</b>	31 <sup>1</sup> / <sub>2</sub> "	15 <sup>7</sup> / <sub>10</sub> "	29 <sup>1</sup> / <sub>10</sub> "
Seated Square Table 35 <sup>3</sup> / <sub>8</sub> "	<b>VCBCAC90M</b>	35 <sup>3</sup> / <sub>8</sub> "	19 <sup>7</sup> / <sub>10</sub> "	29 <sup>1</sup> / <sub>10</sub> "
Seated Square Table 55 <sup>1</sup> / <sub>10</sub> "	<b>VCBCAC140M</b>	55 <sup>1</sup> / <sub>10</sub> "	25 <sup>3</sup> / <sub>8</sub> "	29 <sup>1</sup> / <sub>10</sub> "
<b>High Round Tables</b>				
High Round Table 23 <sup>3</sup> / <sub>8</sub> "	<b>VCBCAD60H</b>	23 <sup>3</sup> / <sub>8</sub> "	15 <sup>7</sup> / <sub>10</sub> "	41 <sup>2</sup> / <sub>7</sub> "
High Round Table 27 <sup>3</sup> / <sub>8</sub> "	<b>VCBCAD70H</b>	27 <sup>3</sup> / <sub>8</sub> "	15 <sup>7</sup> / <sub>10</sub> "	41 <sup>2</sup> / <sub>7</sub> "
High Round Table 31 <sup>1</sup> / <sub>2</sub> "	<b>VCBCAD80H</b>	31 <sup>1</sup> / <sub>2</sub> "	15 <sup>7</sup> / <sub>10</sub> "	41 <sup>2</sup> / <sub>7</sub> "
High Round Table 39 <sup>3</sup> / <sub>8</sub> "	<b>VCBCAD100H</b>	39 <sup>3</sup> / <sub>8</sub> "	15 <sup>7</sup> / <sub>10</sub> "	41 <sup>2</sup> / <sub>7</sub> "
<b>High Oval Tables</b>				
High Oval Table 86 <sup>3</sup> / <sub>8</sub> "D X 35 <sup>3</sup> / <sub>8</sub> "W	<b>VCBCAC220H</b>	86 <sup>3</sup> / <sub>8</sub> "	15 <sup>7</sup> / <sub>10</sub> "	41 <sup>2</sup> / <sub>7</sub> "
High Oval Table 94 <sup>1</sup> / <sub>2</sub> "D X 35 <sup>3</sup> / <sub>8</sub> "W	<b>VCBCAC240H</b>	94 <sup>1</sup> / <sub>2</sub> "	15 <sup>7</sup> / <sub>10</sub> "	41 <sup>2</sup> / <sub>7</sub> "
High Oval Table 102 <sup>2</sup> / <sub>8</sub> "D X 35 <sup>3</sup> / <sub>8</sub> "W	<b>VCBCAC260H</b>	102 <sup>2</sup> / <sub>8</sub> "	15 <sup>7</sup> / <sub>10</sub> "	41 <sup>2</sup> / <sub>7</sub> "
High Oval Table 110 <sup>1</sup> / <sub>8</sub> "D X 35 <sup>3</sup> / <sub>8</sub> "W	<b>VCBCAC280H</b>	110 <sup>1</sup> / <sub>8</sub> "	15 <sup>7</sup> / <sub>10</sub> "	41 <sup>2</sup> / <sub>7</sub> "
High Oval Table 118 <sup>1</sup> / <sub>10</sub> "D X 35 <sup>3</sup> / <sub>8</sub> "W	<b>VCBCAC300H</b>	118 <sup>1</sup> / <sub>10</sub> "	15 <sup>7</sup> / <sub>10</sub> "	41 <sup>2</sup> / <sub>7</sub> "
<b>High Square Tables</b>				
High Square Table 27 <sup>3</sup> / <sub>8</sub> "	<b>VCBCAC70H</b>	27 <sup>3</sup> / <sub>8</sub> "	15 <sup>7</sup> / <sub>10</sub> "	41 <sup>2</sup> / <sub>7</sub> "
High Square Table 31 <sup>1</sup> / <sub>2</sub> "	<b>VCBCAC80H</b>	31 <sup>1</sup> / <sub>2</sub> "	15 <sup>7</sup> / <sub>10</sub> "	41 <sup>2</sup> / <sub>7</sub> "

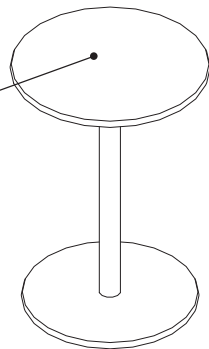
**Actual Dimensions**

<b>Description</b>	<b>Style Number</b>	<b>Top Depth/ Diameter</b>	<b>Base Diameter</b>	<b>Height</b>
<b>High-Pressure Laminate</b>				
<b>Round Tables</b>				
Low Round Table 23 <sup>3</sup> / <sub>8</sub> "	<b>VCBCAD60BHPL</b>	23 <sup>3</sup> / <sub>8</sub> "	19 <sup>7</sup> / <sub>10</sub> "	18 <sup>9</sup> / <sub>10</sub> "
Low Round Table 27 <sup>3</sup> / <sub>8</sub> "	<b>VCBCAD70BHPL</b>	27 <sup>3</sup> / <sub>8</sub> "	19 <sup>7</sup> / <sub>10</sub> "	18 <sup>9</sup> / <sub>10</sub> "
Low Round Table 31 <sup>1</sup> / <sub>2</sub> "	<b>VCBCAD80BHPL</b>	31 <sup>1</sup> / <sub>2</sub> "	19 <sup>7</sup> / <sub>10</sub> "	18 <sup>9</sup> / <sub>10</sub> "
Low Round Table 39 <sup>2</sup> / <sub>8</sub> "	<b>VCBCAD100BHPL</b>	39 <sup>2</sup> / <sub>8</sub> "	19 <sup>7</sup> / <sub>10</sub> "	18 <sup>9</sup> / <sub>10</sub> "
Low Round Table 47 <sup>1</sup> / <sub>8</sub> "	<b>VCBCAD120BHPL</b>	47 <sup>1</sup> / <sub>8</sub> "	19 <sup>7</sup> / <sub>10</sub> "	18 <sup>9</sup> / <sub>10</sub> "
<b>Square Tables</b>				
Low Square Table 23 <sup>3</sup> / <sub>8</sub> "	<b>VCBCAC70BHPL</b>	27 <sup>3</sup> / <sub>8</sub> "	19 <sup>7</sup> / <sub>10</sub> "	18 <sup>9</sup> / <sub>10</sub> "
Low Square Table 31 <sup>1</sup> / <sub>2</sub> "	<b>VCBCAC80BHPL</b>	31 <sup>1</sup> / <sub>2</sub> "	19 <sup>7</sup> / <sub>10</sub> "	18 <sup>9</sup> / <sub>10</sub> "
Low Square Table 35 <sup>2</sup> / <sub>8</sub> "	<b>VCBCAC90BHPL</b>	35 <sup>2</sup> / <sub>8</sub> "	19 <sup>7</sup> / <sub>10</sub> "	18 <sup>9</sup> / <sub>10</sub> "
<b>Seated Round Tables</b>				
Seated Round Table 23 <sup>3</sup> / <sub>8</sub> "	<b>VCBCAD60HPL</b>	23 <sup>3</sup> / <sub>8</sub> "	15 <sup>7</sup> / <sub>10</sub> "	29 <sup>1</sup> / <sub>10</sub> "
Seated Round Table 27 <sup>3</sup> / <sub>8</sub> "	<b>VCBCAD70HPL</b>	27 <sup>3</sup> / <sub>8</sub> "	15 <sup>7</sup> / <sub>10</sub> "	29 <sup>1</sup> / <sub>10</sub> "
Seated Round Table 31 <sup>1</sup> / <sub>2</sub> "	<b>VCBCAD80HPL</b>	31 <sup>1</sup> / <sub>2</sub> "	15 <sup>7</sup> / <sub>10</sub> "	29 <sup>1</sup> / <sub>10</sub> "
Seated Round Table 39 <sup>2</sup> / <sub>8</sub> "	<b>VCBCAD100HPL</b>	39 <sup>2</sup> / <sub>8</sub> "	15 <sup>7</sup> / <sub>10</sub> "	29 <sup>1</sup> / <sub>10</sub> "
Seated Round Table 47 <sup>1</sup> / <sub>8</sub> "	<b>VCBCAD120HPL</b>	47 <sup>1</sup> / <sub>8</sub> "	19 <sup>7</sup> / <sub>10</sub> "	29 <sup>1</sup> / <sub>10</sub> "
<b>Seated Square Tables</b>				
Seated Square Table 27 <sup>3</sup> / <sub>8</sub> "	<b>VCBCAC70HPL</b>	27 <sup>3</sup> / <sub>8</sub> "	15 <sup>7</sup> / <sub>10</sub> "	29 <sup>1</sup> / <sub>10</sub> "
Seated Square Table 31 <sup>1</sup> / <sub>2</sub> "	<b>VCBCAC80HPL</b>	31 <sup>1</sup> / <sub>2</sub> "	15 <sup>7</sup> / <sub>10</sub> "	29 <sup>1</sup> / <sub>10</sub> "
Seated Square Table 35 <sup>2</sup> / <sub>8</sub> "	<b>VCBCAC90HPL</b>	35 <sup>2</sup> / <sub>8</sub> "	19 <sup>7</sup> / <sub>10</sub> "	29 <sup>1</sup> / <sub>10</sub> "
<b>High Round Tables</b>				
High Round Table 23 <sup>3</sup> / <sub>8</sub> "	<b>VCBCAD60H</b>	23 <sup>3</sup> / <sub>8</sub> "	15 <sup>7</sup> / <sub>10</sub> "	41 <sup>2</sup> / <sub>8</sub> "
High Round Table 27 <sup>3</sup> / <sub>8</sub> "	<b>VCBCAD70H</b>	27 <sup>3</sup> / <sub>8</sub> "	15 <sup>7</sup> / <sub>10</sub> "	41 <sup>2</sup> / <sub>8</sub> "
High Round Table 31 <sup>1</sup> / <sub>2</sub> "	<b>VCBCAD80H</b>	31 <sup>1</sup> / <sub>2</sub> "	15 <sup>7</sup> / <sub>10</sub> "	41 <sup>2</sup> / <sub>8</sub> "
High Round Table 39 <sup>2</sup> / <sub>8</sub> "	<b>VCBCAD100H</b>	39 <sup>2</sup> / <sub>8</sub> "	15 <sup>7</sup> / <sub>10</sub> "	41 <sup>2</sup> / <sub>8</sub> "
<b>High Oval Tables</b>				
High Oval Table 86 <sup>3</sup> / <sub>8</sub> "D X 35 <sup>2</sup> / <sub>8</sub> "W	<b>VCBCAC220H</b>	86 <sup>3</sup> / <sub>8</sub> "	15 <sup>7</sup> / <sub>10</sub> "	41 <sup>2</sup> / <sub>8</sub> "
High Oval Table 94 <sup>1</sup> / <sub>2</sub> "D X 35 <sup>2</sup> / <sub>8</sub> "W	<b>VCBCAC240H</b>	94 <sup>1</sup> / <sub>2</sub> "	15 <sup>7</sup> / <sub>10</sub> "	41 <sup>2</sup> / <sub>8</sub> "
High Oval Table 102 <sup>2</sup> / <sub>8</sub> "D X 35 <sup>2</sup> / <sub>8</sub> "W	<b>VCBCAC260H</b>	102 <sup>2</sup> / <sub>8</sub> "	15 <sup>7</sup> / <sub>10</sub> "	41 <sup>2</sup> / <sub>8</sub> "
High Oval Table 110 <sup>1</sup> / <sub>8</sub> "D X 35 <sup>2</sup> / <sub>8</sub> "W	<b>VCBCAC280H</b>	110 <sup>1</sup> / <sub>8</sub> "	15 <sup>7</sup> / <sub>10</sub> "	41 <sup>2</sup> / <sub>8</sub> "
High Oval Table 118 <sup>1</sup> / <sub>10</sub> "D X 35 <sup>2</sup> / <sub>8</sub> "W	<b>VCBCAC300H</b>	118 <sup>1</sup> / <sub>10</sub> "	15 <sup>7</sup> / <sub>10</sub> "	41 <sup>2</sup> / <sub>8</sub> "
<b>High Square Tables</b>				
High Square Table 27 <sup>3</sup> / <sub>8</sub> "	<b>VCBCAC70H</b>	27 <sup>3</sup> / <sub>8</sub> "	15 <sup>7</sup> / <sub>10</sub> "	41 <sup>2</sup> / <sub>8</sub> "
High Square Table 31 <sup>1</sup> / <sub>2</sub> "	<b>VCBCAC80H</b>	31 <sup>1</sup> / <sub>2</sub> "	15 <sup>7</sup> / <sub>10</sub> "	41 <sup>2</sup> / <sub>8</sub> "

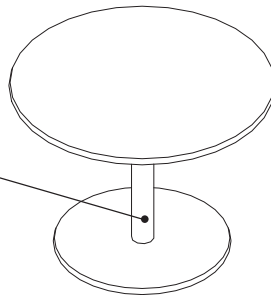
# Common Tables

**Common table**, designed by Naoto Fukasawa, is an auxiliary table inspired by the Japanese classics. Available in two heights, pair with common bench or specify on its own.  
 ▶ Specifying, page 472

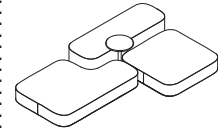
**Top** is available in lacquered MDF.



**Column** constructed from steel, finished in matte beech veneer.



## Product Details



**Common tables** are designed to pair with Common benches.  
 ▶ See page 41

**Column** constructed from steel powder coated in thermo-reinforced polyester, finished in beech veneer with a matte stain.

**Base and top** in lacquered MDF.

## Surface Materials

### Base and top finish

- 050 50 30 Brick RAL
- 060 70 20 Dusty Pink RAL
- 090 40 30 Olive Green RAL
- 1011 Ochre RAL
- 1019 Taupe RAL
- 7034 Dusty Green RAL
- 9003 White RAL
- 9005 Black RAL
- Bronze

### Column

- Matte Beech

*Tip: All top colors have a smooth lacquered finish except black which has the lacquered microtextured finish.*

## Actual Dimensions

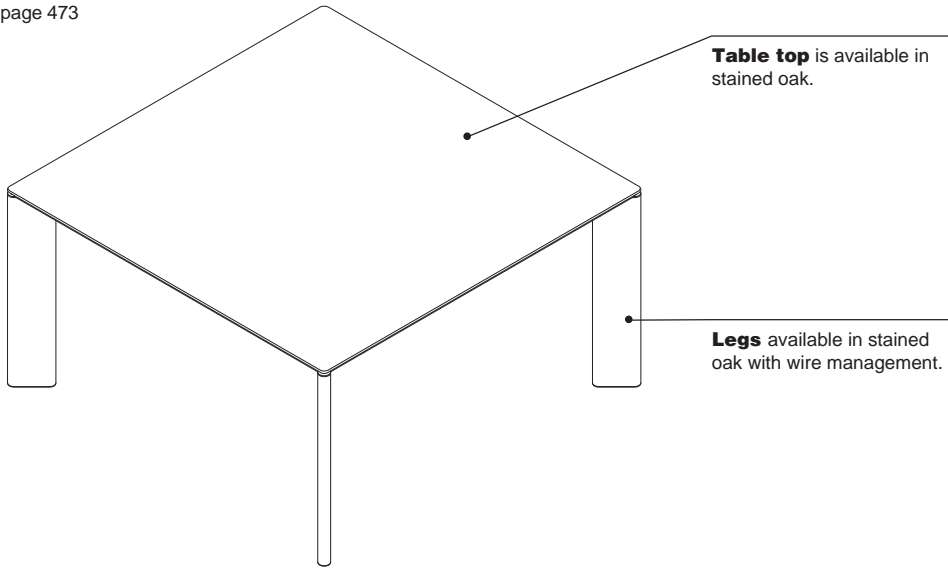
Description	Style Number	Base Diameter	Top Diameter	Height	Weight
High Table	<b>VCBCOD45H65</b>	15 <sup>7</sup> / <sub>10</sub> "	17 <sup>7</sup> / <sub>10</sub> "	25 <sup>3</sup> / <sub>5</sub> "	19.8 lb
Low Table	<b>VCBCOD60H45</b>	15 <sup>7</sup> / <sub>10</sub> "	23 <sup>7</sup> / <sub>10</sub> "	17 <sup>7</sup> / <sub>10</sub> "	15.4 lb



# Foro

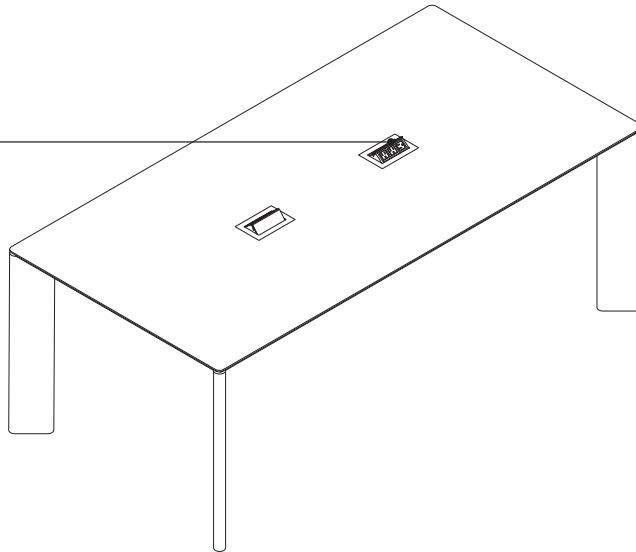
**Foro** is a collection of tables designed by John Pawson, conveying richness, warmth, and depth to any atmosphere.

► Specifying, page 473



**Power** is available as an option.

► See *Power, Wiring, and Cabling*.



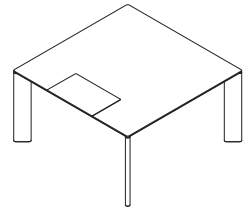
## Product Details



**Edge profile** is tapered knife edge as standard.

**Table tops** are available in stained oak.

**Legs** are made from solid oak, stained to match table top.



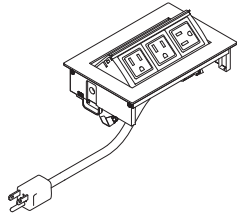
**Table top protector** is available as an option.

## Actual Dimensions

Description	Style Number	Depth	Width	Height	Cord Lengths (if power is specified)
Table—55 <sup>1</sup> / <sub>10</sub> " x 55 <sup>1</sup> / <sub>10</sub> "	<b>VCBFO140RO</b>	55 <sup>1</sup> / <sub>10</sub> "	55 <sup>1</sup> / <sub>10</sub> "	29 <sup>1</sup> / <sub>10</sub> "	43"
Table—63" x 63"	<b>VCBFO160RO</b>	63"	63"	29 <sup>1</sup> / <sub>10</sub> "	37"
Table—39 <sup>4</sup> / <sub>10</sub> " x 78 <sup>7</sup> / <sub>10</sub> "	<b>VCBFO200RO</b>	39 <sup>4</sup> / <sub>10</sub> "	78 <sup>7</sup> / <sub>10</sub> "	29 <sup>1</sup> / <sub>10</sub> "	41"
Table—39 <sup>4</sup> / <sub>10</sub> " x 94 <sup>1</sup> / <sub>2</sub> "	<b>VCBFO240RO</b>	39 <sup>4</sup> / <sub>10</sub> "	94 <sup>1</sup> / <sub>2</sub> "	29 <sup>1</sup> / <sub>10</sub> "	33"
Table—47 <sup>1</sup> / <sub>5</sub> " x 78 <sup>7</sup> / <sub>10</sub> "	<b>VCBFO200ARO</b>	47 <sup>1</sup> / <sub>5</sub> "	78 <sup>7</sup> / <sub>10</sub> "	29 <sup>1</sup> / <sub>10</sub> "	37"
Table—47 <sup>1</sup> / <sub>5</sub> " x 94 <sup>1</sup> / <sub>2</sub> "	<b>VCBFO240ARO</b>	47 <sup>1</sup> / <sub>5</sub> "	94 <sup>1</sup> / <sub>2</sub> "	29 <sup>1</sup> / <sub>10</sub> "	30"

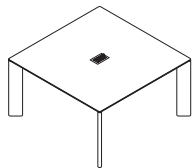


**Power, Wiring, and Cabling**



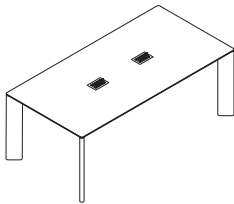
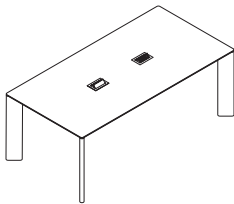
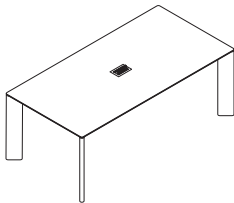
**Surface power** available as an option on Foro tables.

**Power Locations**



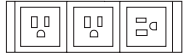
**Square Foro tables:**

- One centered square power module

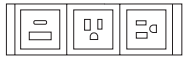


**Rectangle Foro tables:**

- One centered square power module
- Two centered square power modules, two directions
- Two centered square power modules, one direction



Power, Power, Power

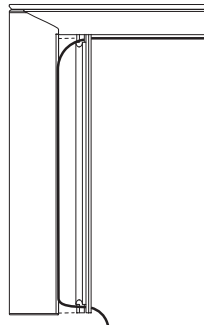


USB-C, USB-A, Power, Power

**Surface power** available in two configurations.

**Power infeed** is cord and plug. When there are multiple square power modules, they are chained together and have one plug.

▶ See *Actual Dimensions* for cord lengths per style number.



**If wire management leg is specified**, cables are managed under the table top to a leg, and then down the leg toward the floor.

**Wire management kit** included when power is specified. Kit includes clips, screws, and velcro straps to route cord under the table top and down the leg.

*Tip: Velcro straps are only needed if wire management leg is not specified.*

**Power** is field-installed.

**Surface Materials**

**Top and legs**

**Stained Oak**

- Ash
- Bleached oak
- Cognac
- Matte oak
- Walnut oak

**Table top protector**

- Ecoleather

**Square MhoB power module**

- 4242 Milk Matte
- 4710 Black
- 4799 Platinum Metallic

# Fuste

**Fuste** is a collection of tables designed by Victor Carrasco. An oak table with organic lines, it takes its name from the point of union between a column's base and capital, the shaft, (Fuste in Spanish) an architectural element since the times of classical Greece.

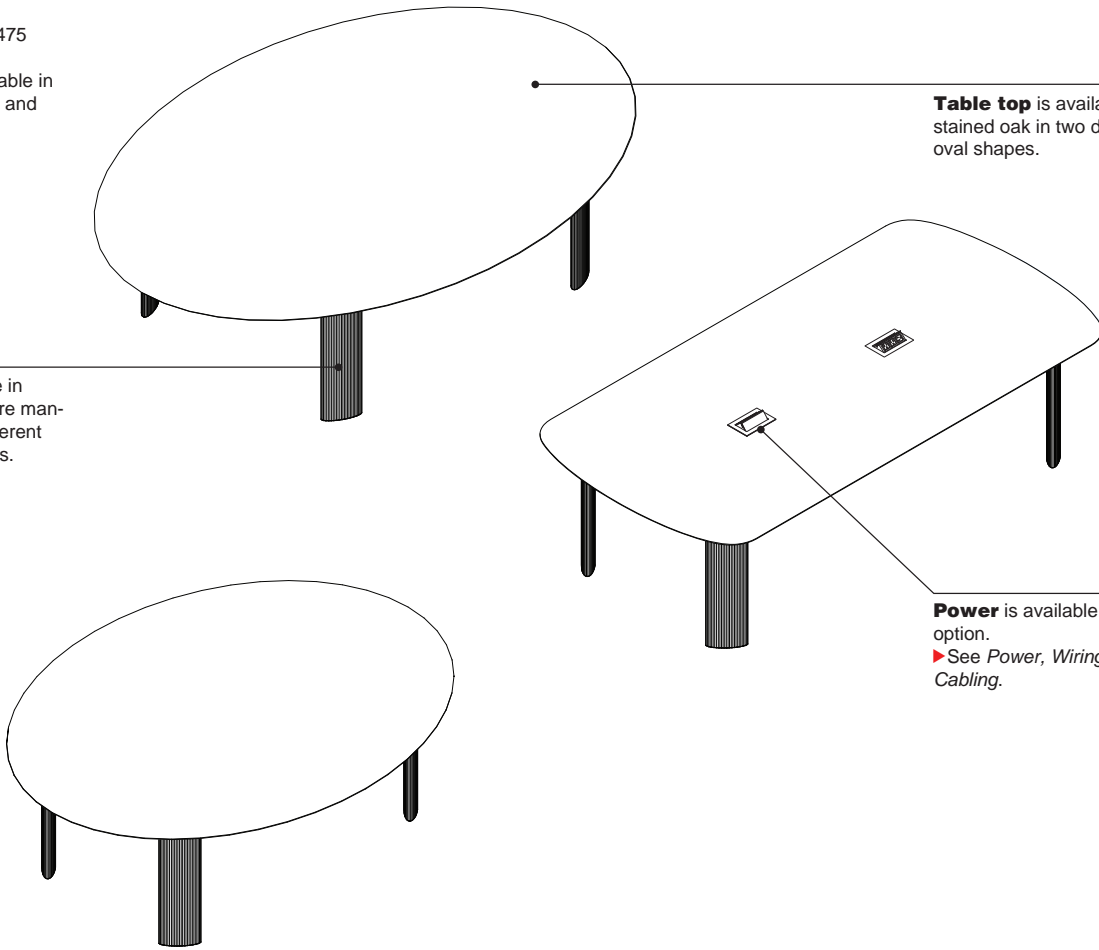
► Specifying, page 475

**Heights** are available in two options—25<sup>3</sup>/<sub>8</sub>" and 29<sup>1</sup>/<sub>10</sub>".

**Legs** are available in stained oak with wire management in two different specifiable positions.

**Table top** is available in stained oak in two different oval shapes.

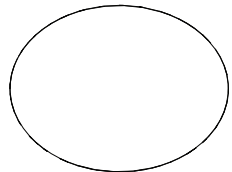
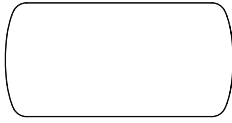
**Power** is available as an option.  
► See *Power, Wiring, and Cabling*.



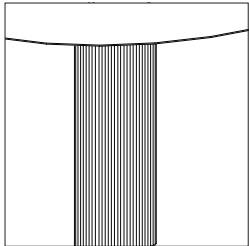
## Actual Dimensions

Description	Style Number	Depth	Width	Height	Cord Lengths (if power is specified)
Table—Soft Rectangle, 25 <sup>3</sup> / <sub>8</sub> "H	<b>VCBFUS240ROH</b>	47 <sup>1</sup> / <sub>8</sub> "	94 <sup>1</sup> / <sub>2</sub> "	25 <sup>3</sup> / <sub>8</sub> "	57"
Table—Soft Rectangle, 29 <sup>1</sup> / <sub>10</sub> "H	<b>VCBFUS240RO</b>	47 <sup>1</sup> / <sub>8</sub> "	94 <sup>1</sup> / <sub>2</sub> "	29 <sup>1</sup> / <sub>10</sub> "	53 <sup>1</sup> / <sub>2</sub> "
Table—Oval, 25 <sup>3</sup> / <sub>8</sub> "H	<b>VCBFUS210ROH</b>	63"	82 <sup>7</sup> / <sub>10</sub> "	25 <sup>3</sup> / <sub>8</sub> "	69"
Table—Oval, 29 <sup>1</sup> / <sub>10</sub> "H	<b>VCBFUS210RO</b>	63"	82 <sup>7</sup> / <sub>10</sub> "	29 <sup>1</sup> / <sub>10</sub> "	65 <sup>1</sup> / <sub>2</sub> "
Table—Oval, 25 <sup>3</sup> / <sub>8</sub> "H	<b>VCBFUS260ROH</b>	70 <sup>9</sup> / <sub>10</sub> "	102 <sup>2</sup> / <sub>8</sub> "	25 <sup>3</sup> / <sub>8</sub> "	65 <sup>5</sup> / <sub>8</sub> "
Table—Oval, 29 <sup>1</sup> / <sub>10</sub> "H	<b>VCBFUS260RO</b>	70 <sup>9</sup> / <sub>10</sub> "	102 <sup>2</sup> / <sub>8</sub> "	29 <sup>1</sup> / <sub>10</sub> "	60 <sup>1</sup> / <sub>8</sub> "

**Product Details**

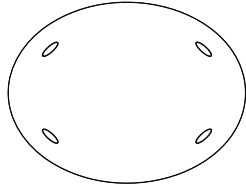
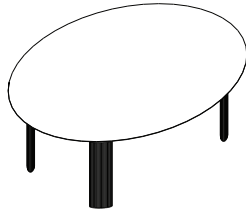


**Table tops** are available in stained oak.

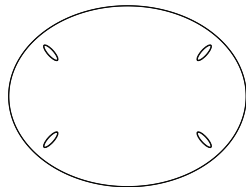
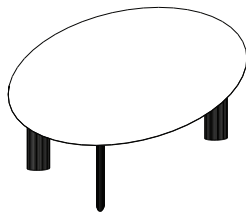


**Legs** are made from solid oak stained to match table top.

**Position A**



**Position B**

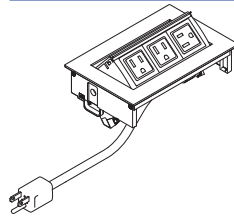


**Legs** are available in two different positions.



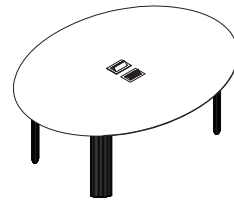
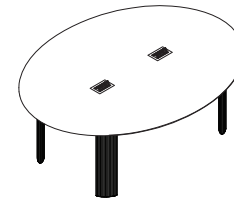
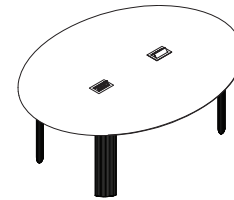
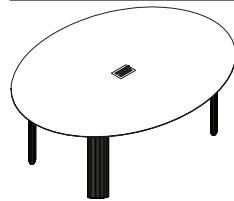
**Edge profile** is tapered knife edge as standard.

**Power, Wiring, and Cabling**



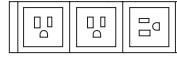
**Surface power** available as an option on Fuste tables.

**Power Locations**

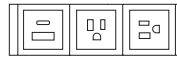


**Both Fuste table top oval shapes** have the same power locations options:

- One centered square power module
- Two centered square power modules, stacked
- Two centered square power modules, two directions
- Two centered square power modules, one direction



Power, Power, Power

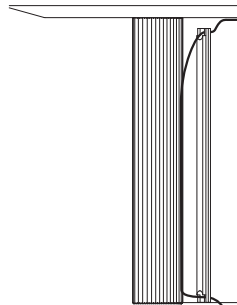


USB-C, USB-A, Power, Power

**Surface power** available in two configurations.

**Power infeed** is cord and plug. When there are multiple square power modules, they are chained together and have one plug.

▶ See *Actual Dimensions* for cord lengths per style number.



**If wire management leg is specified**, cables are managed under the table top to a leg, and then down the leg toward the floor.

**Wire management kit** included when power is specified. Kit includes clips, screws, and velcro straps to route cord under the table top and down the leg.

*Tip: Velcro straps are only needed if wire management leg is not specified.*

**Power** is field-installed.

**Surface Materials**

**Top and legs**

**Stained Oak**

- Ash
- Bleached oak
- Cognac
- Matte oak
- Walnut oak

**Square MhoB power module**

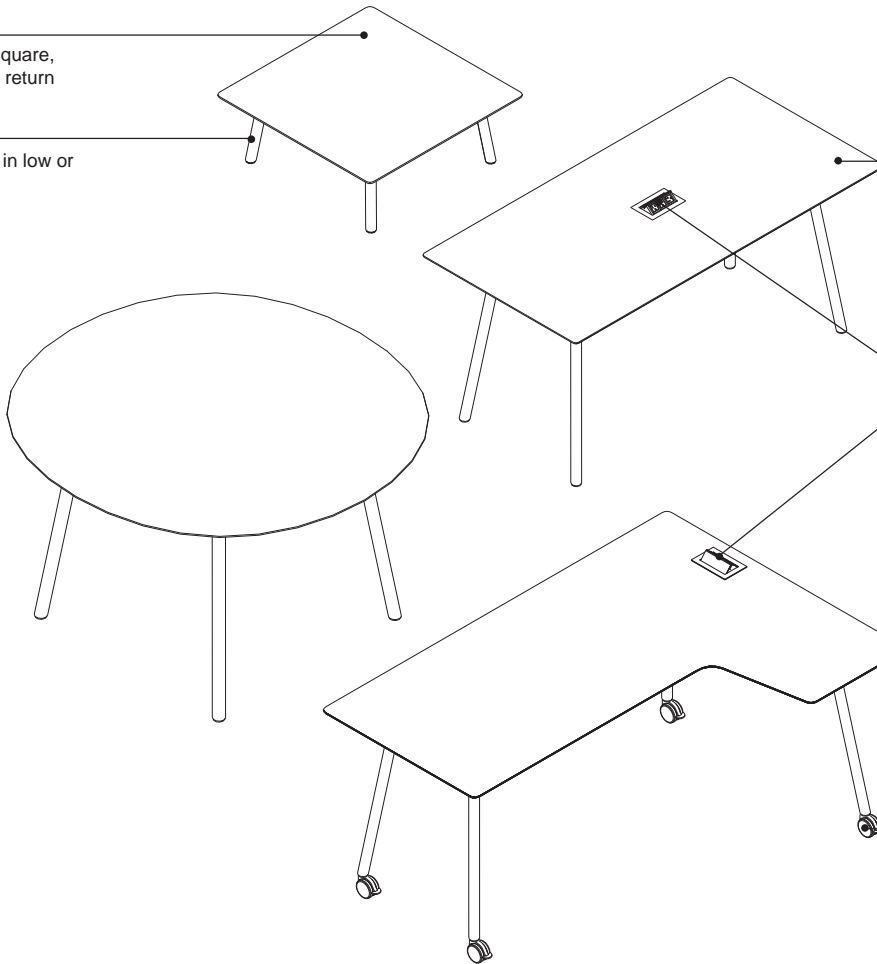
- 4242 Milk Matte
- 4710 Black
- 4799 Platinum Metallic

# Maarten Tables

**Maarten tables,** designed by Victor Carrasco, are a collection of café and occasional use tables based on a technical minimalistic leg solution that can be attached directly to the tabletop. Specify on its own or pair together with Maarten seating.  
▶ Specifying, pages 477–491

**Tops** available in square, rectangle, oval, and return shapes.

**Legs** are available in low or high heights.



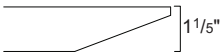
**Top** is available in High-Pressure Laminate and lacquered or stained MDF.

**Power** is available as an option.  
▶ See *Power, Wiring, and Cabling*.

**Worksurface** available with tapered knife edge as standard.

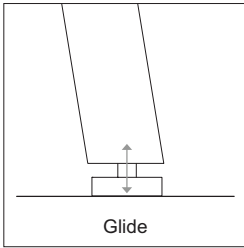
**Tables** available with glides and casters.

**Product Details**

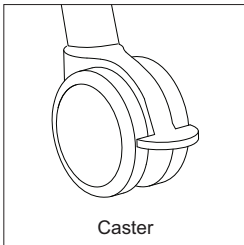


**Edge profile** is tapered knife edge as standard.

**Table height** available in 11 1/5"H or 29 1/10"H.



Glide



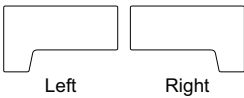
Caster

**Tables** are available with glides or casters. Tables with casters are only available on 29 1/10"H tables.

**Contrasting metal legs** are available allowing for up to three different colored legs.

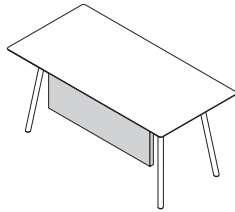
**Legs** made from calibrated steel available in painted or stained oak veneer finishes on styles with glides only.

**Worksurface** is 1 1/5" thick microtextured MDF in lacquered, HPL, or oak veneer finishes.



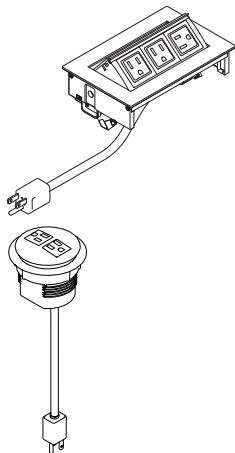
Left Right

**Return position** is determined from the seated user position.



**Modesty panels** can be ordered separately.

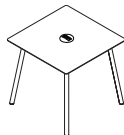
**Power, Wiring, and Cabling**



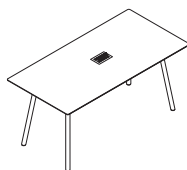
**Surface power** available as an option on high Maarten tables, with or without casters.

**On square tables, round power module** is specifiable, and on rectangle, oval, and return tables, square module is specifiable.

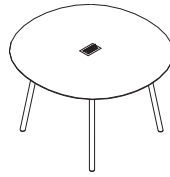
**Power Locations**



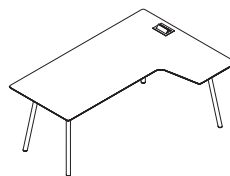
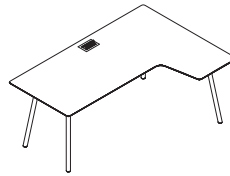
**Square tables:**  
• One centered round power module



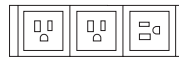
**Rectangle tables:**  
• One centered square power module



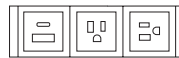
**Oval tables:**  
• One centered square power module



**Return tables:**  
• One square power module on edge  
• One square power module on return



Power, Power, Power



USB-C, USB-A, Power, Power

**Surface power** available in two configurations for both power modules.

**Power infeed** is cord and plug. When there are multiple square power modules, they are chained together and have one plug.  
▶ See *Actual Dimensions* for cord lengths per style number.

**Wire management kit** included when a square power module is specified. Kit includes clips, screws, and velcro straps to route cord under the table top and down the base.

**Power** is field-installed.

**Surface Materials**

**Top High-Pressure Laminate**

- Black Soft Touch by Fenix
- White

**Lacquered MDF**

- 050 50 30 Brick RAL
- 060 70 20 Dusty Pink RAL
- 090 40 30 Olive Green RAL
- 1011 Ochre RAL
- 1019 Taupe RAL
- 7034 Dusty Green RAL
- 9003 White RAL
- 9005 Black RAL

**Stained MDF**

- Ash
- Bleached oak
- Cognac
- Matte oak
- Walnut oak

**Metal legs**

- 1019 Taupe RAL
- 9003 White RAL
- 9005 Black RAL

**Wood legs**

- Ash
- Bleached oak
- Cognac
- Matte oak
- Walnut oak

*Tip: The range of lacquered colors have a smooth finish except for black, which has a lacquered microtextured finish.*

*Tip: Not all top finishes available on all styles.*

**Square MhoB power module**

- 4242 Milk Matte
- 4710 Black
- 4799 Platinum Metallic

**Round node power module**

- 4013 Silver/Black
- 4180 Graphite Matte
- 4242 Milk Matte
- 4710 Black

Actual Dimensions						
Description	Style Number	Depth	Width	Height	Weight	Cord Lengths (if power is specified)
<b>With Glides</b>						
<b>Square Low Table</b>						
Low Square Table	<b>VCBMAAB80</b>	31½"	31½"	11¼"	61.9 lb	N.A.
<b>Square High Table</b>						
High Square Table	<b>VCBMAA80</b>	31½"	31½"	29¼"	71.7 lb	52½"
<b>Rectangle Low Tables</b>						
Low Rectangle Table	<b>VCBMAAB160</b>	31½"	63"	11¼"	89.9 lb	N.A.
Low Rectangle Table	<b>VCBMAAB16090</b>	35¾"	63"	11¼"	102.1 lb	N.A.
Low Rectangle Table	<b>VCBMAAB180</b>	31½"	70¾"	11¼"	93 lb	N.A.
Low Rectangle Table	<b>VCBMAAB18090</b>	35¾"	70¾"	11¼"	97.4 lb	N.A.
Low Rectangle Table	<b>VCBMAAB200</b>	31½"	78⅞"	11¼"	95.2 lb	N.A.
Low Rectangle Table	<b>VCBMAAB20090</b>	35¾"	78⅞"	11¼"	119.3 lb	N.A.
<b>Rectangle High Tables</b>						
High Rectangle Table	<b>VCBMAA160</b>	31½"	63"	29¼"	99.6 lb	50"
High Rectangle Table	<b>VCBMAA16090</b>	35¾"	63"	29¼"	111.8 lb	48"
High Rectangle Table	<b>VCBMAA180</b>	31½"	70¾"	29¼"	103.2 lb	46"
High Rectangle Table	<b>VCBMAA18090</b>	35¾"	70¾"	29¼"	107.6 lb	44"
High Rectangle Table	<b>VCBMAA200</b>	31½"	78⅞"	29¼"	104.9 lb	43"
High Rectangle Table	<b>VCBMAA20090</b>	35¾"	78⅞"	29¼"	129 lb	41"
<b>Oval Low Tables</b>						
Low Oval Table	<b>VCBMAABD120</b>	47⅞"	49"	11¼"	92.2 lb	N.A.
Low Oval Table	<b>VCBMAABD160</b>	63"	65¾"	11¼"	136.2 lb	N.A.
<b>Oval High Tables</b>						
High Oval Table	<b>VCBMAAD120</b>	47⅞"	49"	29¼"	101.9 lb	74"
High Oval Table	<b>VCBMAAD160</b>	63"	65¾"	29¼"	145.9 lb	74"
<b>Return High Table</b>						
High Return Table	<b>VCBMAAA180</b>	47⅞"	70¾"	29¼"	97.4 lb	83"
<b>With Casters</b>						
<b>Square High Table</b>						
High Square Table	<b>VCBMAA80R</b>	31½"	31½"	29¼"	61.9 lb	52½"
<b>Rectangle High Tables</b>						
High Rectangle Table	<b>VCBMAA160R</b>	31½"	63"	29¼"	89.9 lb	50"
High Rectangle Table	<b>VCBMAA16090R</b>	35¾"	63"	29¼"	102.1 lb	48"
High Rectangle Table	<b>VCBMAA180R</b>	31½"	70¾"	29¼"	97.4 lb	46"
High Rectangle Table	<b>VCBMAA18090R</b>	35¾"	70¾"	29¼"	107.6 lb	44"
High Rectangle Table	<b>VCBMAA200R</b>	31½"	78⅞"	29¼"	104.5 lb	43"
High Rectangle Table	<b>VCBMAA20090R</b>	35¾"	78⅞"	29¼"	119.3 lb	41"
<b>Oval High Tables</b>						
High Oval Table	<b>VCBMAAD120R</b>	47⅞"	49"	29¼"	92.2 lb	74"
High Oval Table	<b>VCBMAAD160R</b>	63"	65¾"	29¼"	136.2 lb	74"
<b>Return High Table</b>						
High Return Table	<b>VCBMAAA180R</b>	47⅞"	70¾"	29¼"	85.5 lb	83"

**Actual Dimensions**

Description	Style Number	Depth	Width	Height	Weight
-------------	--------------	-------	-------	--------	--------

**Accessories**

**Modesty Panels**

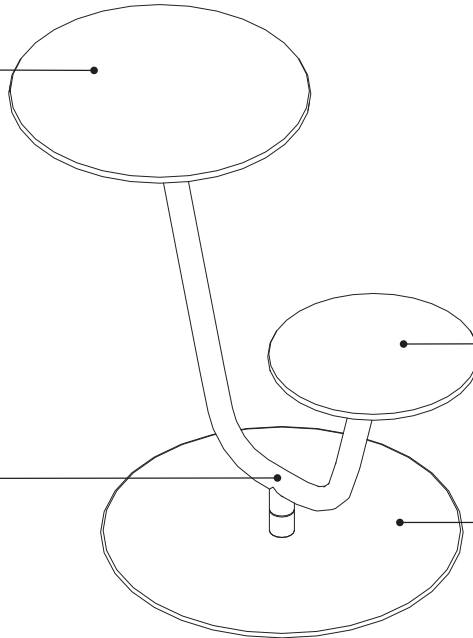
Modesty Screen 63"	<b>VCBMAAF160</b>	N.A.	44 <sup>9</sup> / <sub>10</sub> "	13"	–
Modesty Screen 70 <sup>9</sup> / <sub>10</sub> "	<b>VCBMAAF180</b>	N.A.	52 <sup>4</sup> / <sub>5</sub> "	13"	–
Modesty Screen 78 <sup>7</sup> / <sub>10</sub> "	<b>VCBMAAF200</b>	N.A.	52 <sup>4</sup> / <sub>5</sub> "	13"	–

# Solar

**Solar** is a disruptive table concept designed by Marc Krusin, which opens up new ways of working and collaborating.  
 ▶ Specifying, pages 492–495

**Top** available in stained MDF or compact laminate with matching lacquered MDF edge.

**Solar** consists of a table with an integrated seat and table which rotate to improve collaboration and privacy.



**Seat** available in compact laminate with matching lacquered MDF edge or upholstered.

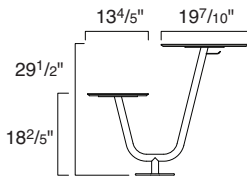
**Base** can be either anchored to the floor or freestanding base. (Freestanding base shown.)

## Actual Dimensions

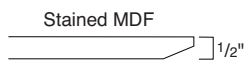
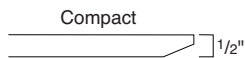
Description	Style Number	Depth	Width	Seat Height	Height	Seat Depth	Table Depth	Weight
Anchored Base, Compact Seat	<b>VCBSOLAN</b>	19 <sup>7</sup> / <sub>10</sub> "	36 <sup>2</sup> / <sub>5</sub> "	18 <sup>2</sup> / <sub>5</sub> "	29 <sup>1</sup> / <sub>2</sub> "	13 <sup>4</sup> / <sub>5</sub> "	19 <sup>7</sup> / <sub>10</sub> "	42.5 lb
Anchored Base, Upholstery Seat	<b>VCBSOLANT</b>	19 <sup>7</sup> / <sub>10</sub> "	36 <sup>2</sup> / <sub>5</sub> "	19 <sup>2</sup> / <sub>5</sub> "	29 <sup>1</sup> / <sub>2</sub> "	13 <sup>4</sup> / <sub>5</sub> "	19 <sup>7</sup> / <sub>10</sub> "	43.0 lb
Free Base, Compact Seat	<b>VCBSOL</b>	23 <sup>3</sup> / <sub>5</sub> "	36 <sup>2</sup> / <sub>5</sub> "	18 <sup>2</sup> / <sub>5</sub> "	29 <sup>1</sup> / <sub>2</sub> "	13 <sup>4</sup> / <sub>5</sub> "	19 <sup>7</sup> / <sub>10</sub> "	74.5 lb
Free Base, Upholstery Seat	<b>VCBSOLT</b>	23 <sup>3</sup> / <sub>5</sub> "	36 <sup>2</sup> / <sub>5</sub> "	19 <sup>2</sup> / <sub>5</sub> "	29 <sup>1</sup> / <sub>2</sub> "	13 <sup>4</sup> / <sub>5</sub> "	19 <sup>7</sup> / <sub>10</sub> "	75.0 lb



## Product Details

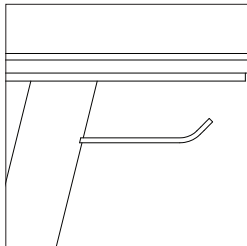


**Base** is powder coated in black or white (anchored base shown).

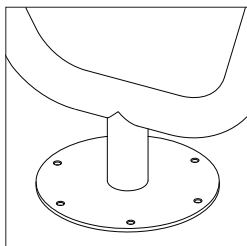


**Table top** is compact laminate or MDF with oak veneer.

**Seat** is compact laminate or upholstered.



**Solar tables** include a small hook, located under the tabletop.



**Anchored base** to floor is available.

## Surface Materials

### Base

- 9003 White RAL
- 9005 Black RAL

### Top

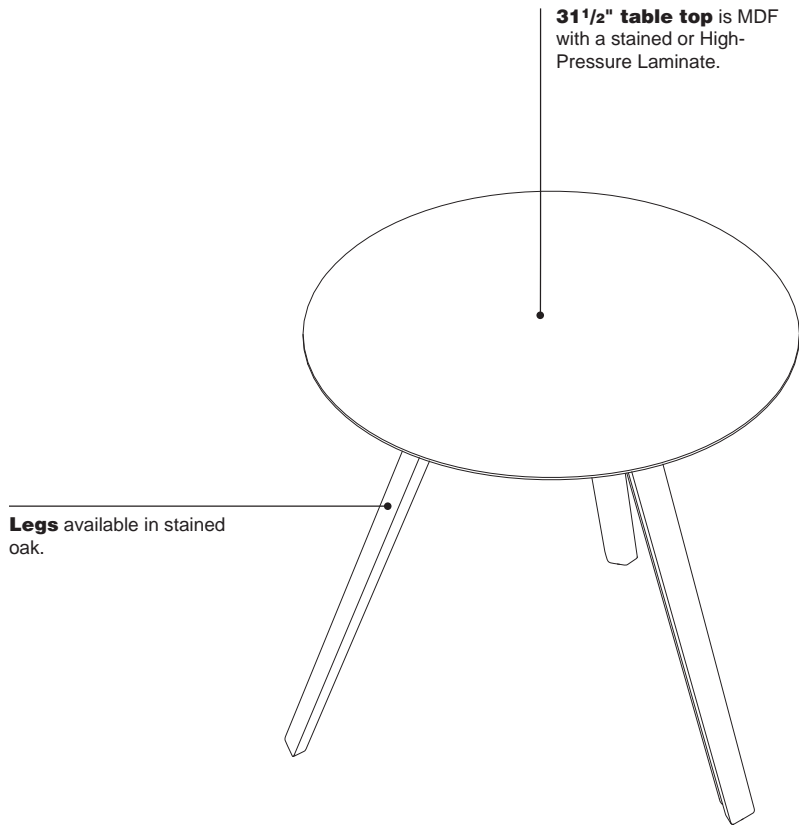
- Ash
- Bleached oak
- Cognac
- Matte oak
- Walnut oak
- Compact Laminate White/Black
- Compact Laminate White/White
- Compact Laminate Black/Black

### Seat

- Compact Laminate White/Black
- Compact Laminate White/White
- Compact Laminate Black/Black
- Upholstery

# Trivio

**Trivio bistro style table**, designed by Jasper Morrison, joins all elements together for an easy assembly.  
 ▶ Specifying, page 496



## Product Details



**Edge profile** is tapered knife edge as standard.

**Table top** is MDF with a stained or High-Pressure Laminate.

**Legs** available in stained oak.

**Optional wire holder** is made of powder coated metal and mounted on the leg.

## Surface Materials

### Top

#### High-Pressure Laminate

- Black Soft Touch by Fenix
- White

#### Stained MDF

- 050 50 30 Brick RAL
- 060 70 20 Dusty Pink RAL
- 090 40 30 Olive Green RAL
- 1011 Ochre RAL
- 1019 Taupe RAL
- 7034 Dusty Green RAL
- 9003 White RAL
- 9005 Black RAL
- Bronze
- White

#### Stained Oak

- Ash
- Bleached oak
- Cognac
- Matte oak
- Walnut oak

### Legs

#### Stained Oak

- Ash
- Bleached Oak
- Cognac
- Matte Oak
- Walnut Oak

#### Join piece

- 1019 Taupe RAL
- 2005 Fluorescent Orange RAL
- 9003 White RAL
- 9005 Black RAL

#### Wire holder

- Black
- White

## Actual Dimensions

Description	Style Number	Height	Width	Dia.	Weight
Table	<b>VCBTRI80RO</b>	31 1/2"	29 3/10"	29 1/10"	48.5 lb

---

# Specifying Tables

## Standard Import Lead Time

---

### Specifying

Burin	<b>424</b>
Cambio	<b>446</b>
Common	<b>472</b>
Foro	<b>473</b>
Fuste	<b>475</b>
Maarten	<b>477</b>
Solar	<b>492</b>
Trivio	<b>496</b>

# Tables

## Burin

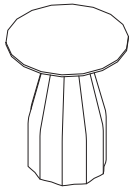
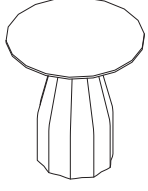
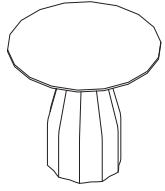
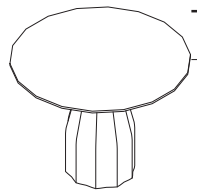
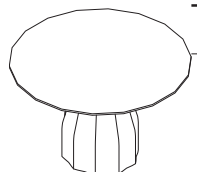
### Standard Includes

- Top: Low-Pressure Laminate price group 01
- Base: black, white, or taupe

### Options

Power Option	No Power	No cost
	With U.S. Power	Price below
Power Location	1 Centered	+\$444
Power Finish	Paint Price Group 01	No cost
Power Configuration	2 Power	No cost
	1 Power 1 USB A 1 USB C	+\$88

### Specification Information

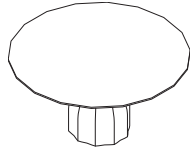
	Dimensions		Style	Price
	Dia.	H	Number	
	<b>Burin Low 23 3/5" LPL Round Table</b>			
	23 3/5"	29 1/10"	<b>VCBBUD6075HM</b>	\$855
	<b>Burin Low 27 3/5" LPL Round Table</b>			
	27 3/5"	29 1/10"	<b>VCBBUD7075HM</b>	\$879
	<b>Burin Low 31 1/2" LPL Round Table</b>			
	31 1/2"	29 1/10"	<b>VCBBUD8075HM</b>	\$1026
	<b>Burin Low 39 2/5" LPL Round Table</b>			
	39 2/5"	29 1/10"	<b>VCBBUD10075HM</b>	\$1184
	<b>Burin Low 47 1/5" LPL Round Table</b>			
	47 1/5"	29 1/10"	<b>VCBBUD12075HM</b>	\$1453

► Product Information continued on next page

► **Product Information continued from previous page**

**Specification Information**

Dimensions		Style	Price
Dia.	H	Number	
<b>Burin Low 59 1/10" LPL Round Table</b>			
59 1/10"	29 1/10"	<b>VCBBUD15075HM</b>	\$1831



# Tables

## Burin

### Standard Includes

- Top: Low-Pressure Laminate price group 01
- Base: black, white, or taupe

### Options

Power Option	No Power	No cost
	With U.S. Power	Price below
Power Location	1 Centered	+\$444
Power Finish	Paint Price Group 01	No cost
Power Configuration	2 Power	No cost
	1 Power 1 USB A 1 USB C	+\$88

### Specification Information

	Dimensions		Style	Price
	Dia.	H	Number	
	<b>Burin High 23 3/5" LPL Round Table</b>			
	23 3/5"	40 1/5"	<b>VCBBUD60H75HM</b>	\$1062
	<b>Burin High 27 3/5" LPL Round Table</b>			
	27 3/5"	40 1/5"	<b>VCBBUD70H75HM</b>	\$1087
	<b>Burin High 31 1/2" LPL Round Table</b>			
	31 1/2"	40 1/5"	<b>VCBBUD80H75HM</b>	\$1221
	<b>Burin High 39 2/5" LPL Round Table</b>			
	39 2/5"	40 1/5"	<b>VCBBUD100H75HM</b>	\$1477

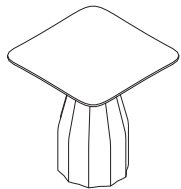
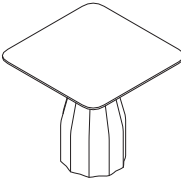
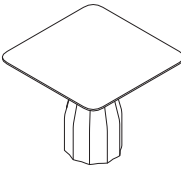
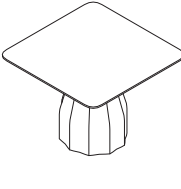
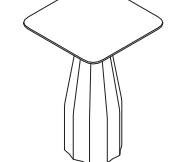
### Standard Includes

- Top: Low-Pressure Laminate price group 01
- Base: black, white, or taupe

### Options

Power Option	No Power	No cost
	With U.S. Power	Price below
Power Location	1 Centered	+\$444
Power Finish	Paint Price Group 01	No cost
Power Configuration	2 Power	No cost
	1 Power 1 USB A 1 USB C	+\$88

### Specification Information

	Dimensions			Style	Price
	D	W	H	Number	
	<b>Burin Low 27 3/5\" LPL Square Table</b>				
	27 3/5"	15"	29 1/10"	<b>VCBBUC7075HM</b>	\$940
	<b>Burin Low 31 1/2\" LPL Square Table</b>				
	31 1/2"	15"	29 1/10"	<b>VCBBUC8075HM</b>	\$1026
	<b>Burin Low 35 2/5\" LPL Square Table</b>				
	35 2/5"	15"	29 1/10"	<b>VCBBUC9075HM</b>	\$1087
	<b>Burin Low 39 2/5\" LPL Square Table</b>				
	39 2/5"	19 7/10"	29 1/10"	<b>VCBBUC10075HM</b>	\$1184
	<b>Burin High 27 3/5\" LPL Square Table</b>				
	27 3/5"	15"	40 1/5"	<b>VCBBUC70H75HM</b>	\$1087

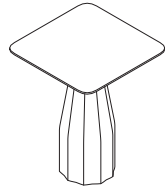
► Product Information continued on next page

# Tables

## Burin

► Product Information continued from previous page

### Specification Information



Dimensions			Style	Price
D	W	H	Number	
<b>Burin High 31 1/2" LPL Square Table</b>				
31 1/2"	15"	40 1/5"	<b>VCBBUC80H75HM</b>	\$1221



# Tables

## Burin

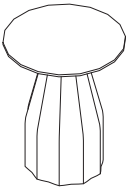
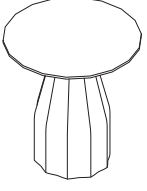
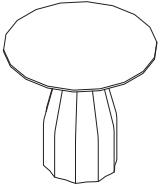
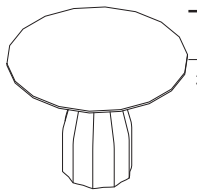
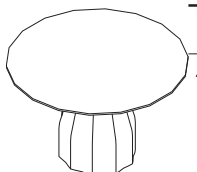
### Standard Includes

- Top: High-Pressure Laminate price group 1 with exposed knife edge
- Base: black, white, or taupe

### Options

Power Option	No Power	No cost
	With U.S. Power	Price below
Power Location	1 Centered	+\$444
Power Finish	Paint Price Group 01	No cost
Power Configuration	2 Power	No cost
	1 Power 1 USB A 1 USB C	+\$88

### Specification Information

	Dimensions		Style	Price
	Dia.	H	Number	
	<b>Burin Low 23 3/5\" HPL Round Table</b>			
	23 3/5"	29 1/10"	<b>VCBBUD6075HPL</b>	\$1099
	<b>Burin Low 27 3/5\" HPL Round Table</b>			
	27 3/5"	29 1/10"	<b>VCBBUD7075HPL</b>	\$1148
	<b>Burin Low 31 1/2\" HPL Round Table</b>			
	31 1/2"	29 1/10"	<b>VCBBUD8075HPL</b>	\$1416
	<b>Burin Low 39 2/5\" HPL Round Table</b>			
	39 2/5"	29 1/10"	<b>VCBBUD10075HPL</b>	\$1758
	<b>Burin Low 47 1/5\" HPL Round Table</b>			
	47 1/5"	29 1/10"	<b>VCBBUD12075HPL</b>	\$2099

► Product Information continued on next page

Tables

# Tables

## Burin

► **Product Information continued from previous page**

### Specification Information

	Dimensions		Style	Price
	Dia.	H	Number	
	<b>Burin High 23 3/5" HPL Round Table</b>			
	23 3/5"	40 1/5"	<b>VCBBUD60H75HPL</b>	\$1319
	<b>Burin High 27 3/5" HPL Round Table</b>			
	27 3/5"	40 1/5"	<b>VCBBUD70H75HPL</b>	\$1343
	<b>Burin High 31 1/2" HPL Round Table</b>			
	31 1/2"	40 1/5"	<b>VCBBUD80H75HPL</b>	\$1636
	<b>Burin High 39 2/5" HPL Round Table</b>			
	39 2/5"	40 1/5"	<b>VCBBUD100H75HPL</b>	\$1892

# Tables

## Burin

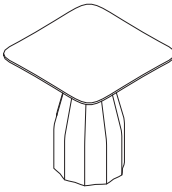
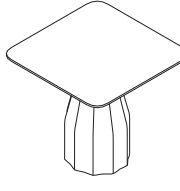
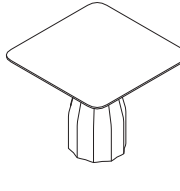
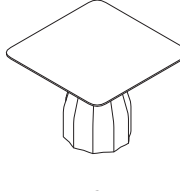
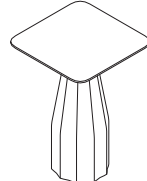
### Standard Includes

- Top: High-Pressure Laminate price group 1 with exposed knife edge
- Base: black, white, or taupe

### Options

Power Option	No Power With U.S. Power	No cost Price below
Power Location	1 Centered	+\$444
Power Finish	Paint Price Group 01	No cost
Power Configuration	2 Power 1 Power 1 USB A 1 USB C	No cost +\$88

### Specification Information

	Dimensions			Style	Price
	D	W	H	Number	
	<b>Burin Low 27 3/5\" HPL Square Table</b>				
	27 3/5"	15"	29 1/10"	<b>VCBBUC7075HPL</b>	\$1148
	<b>Burin Low 31 1/2\" HPL Square Table</b>				
	31 1/2"	15"	29 1/10"	<b>VCBBUC8075HPL</b>	\$1416
	<b>Burin Low 35 2/5\" HPL Square Table</b>				
	35 2/5"	15"	29 1/10"	<b>VCBBUC9075HPL</b>	\$1587
	<b>Burin Low 39 2/5\" HPL Square Table</b>				
	39 2/5"	19 7/10"	29 1/10"	<b>VCBBUC10075HPL</b>	\$1758
	<b>Burin High 27 3/5\" HPL Square Table</b>				
	27 3/5"	15"	40 1/5"	<b>VCBBUC70H75HPL</b>	\$1343

► Product Information continued on next page

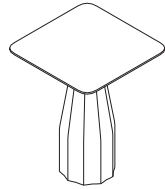
Tables

# Tables

## Burin

► **Product Information continued from previous page**

### Specification Information



Dimensions			Style	Price
D	W	H	Number	
<b>Burin High 31 1/2" HPL Square Table</b>				
31 1/2"	15"	40 1/5"	<b>VCBBUC80H75HPL</b>	\$1636

# Tables

## Burin

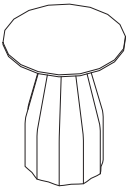
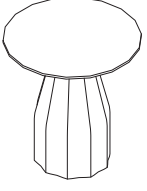
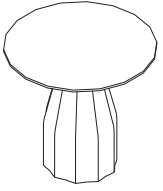
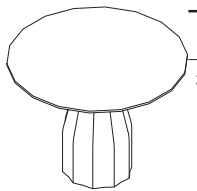
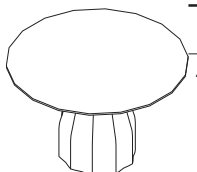
### Standard Includes

- Top: compact laminate
- Base: black, white, or taupe

### Options

Power Option	No Power	No cost
	With U.S. Power	Price below
Power Location	1 Centered	+\$444
Power Finish	Paint Price Group 01	No cost
Power Configuration	2 Power	No cost
	1 Power 1 USB A 1 USB C	+\$88

### Specification Information

	Dimensions		Style	Price
	Dia.	H	Number	
	<b>Burin Low 23 3/5" Compact Laminate Round Table</b>			
	23 3/5"	29 1/10"	<b>VCBBUD6047</b>	\$1231
	<b>Burin Low 27 3/5" Compact Laminate Round Table</b>			
	27 3/5"	29 1/10"	<b>VCBBUD7047</b>	\$1285
	<b>Burin Low 31 1/2" Compact Laminate Round Table</b>			
	31 1/2"	29 1/10"	<b>VCBBUD8047</b>	\$1586
	<b>Burin Low 39 2/5" Compact Laminate Round Table</b>			
	39 2/5"	29 1/10"	<b>VCBBUD10047</b>	\$1970
	<b>Burin Low 47 1/5" Compact Laminate Round Table</b>			
	47 1/5"	29 1/10"	<b>VCBBUD12047</b>	\$2351

► Product Information continued on next page

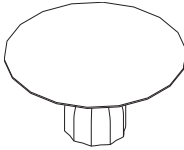
# Tables

## Burin

► **Product Information continued from previous page**

### Specification Information

Dimensions		Style	Price
Dia.	H	Number	
<b>Burin Low 59 1/10" Compact Laminate Round Table</b>			
59 1/10"	29 1/10"	<b>VCBBUD15047</b>	\$2981



# Tables

## Burin

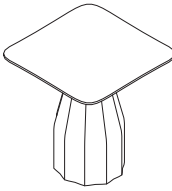
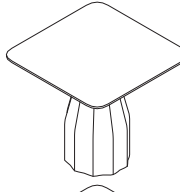
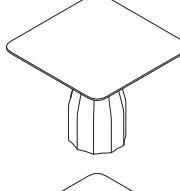
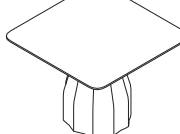
### Standard Includes

- Top: compact laminate
- Base: black, white, or taupe

### Options

Power Option	No Power	No cost
	With U.S. Power	Price below
Power Location	1 Centered	+\$444
Power Finish	Paint Price Group 01	No cost
Power Configuration	2 Power	No cost
	1 Power 1 USB A 1 USB C	+\$88

### Specification Information

	Dimensions			Style	Price
	D	W	H	Number	
	<b>Burin Low 27 3/5" Compact Laminate Square Table</b>				
	27 3/5"	15"	29 1/10"	<b>VCBBUC7047</b>	\$1285
	<b>Burin Low 31 1/2" Compact Laminate Square Table</b>				
	31 1/2"	15"	29 1/10"	<b>VCBBUC8047</b>	\$1586
	<b>Burin Low 35 2/5" Compact Laminate Square Table</b>				
	35 2/5"	15"	29 1/10"	<b>VCBBUC9047</b>	\$1778
	<b>Burin Low 39 2/5" Compact Laminate Square Table</b>				
	39 2/5"	19 7/10"	29 1/10"	<b>VCBBUC10047</b>	\$1970

# Tables

## Burin

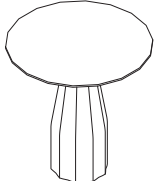
### Standard Includes

- Top: compact laminate
- Base: black, white, or taupe

### Options

Power Option	No Power	No cost
	With U.S. Power	Price below
Power Location	1 Centered	+\$444
Power Finish	Paint Price Group 01	No cost
Power Configuration	2 Power	No cost
	1 Power 1 USB A 1 USB C	+\$88

### Specification Information

	Dimensions		Style	Price
	Dia.	H	Number	
	<b>Burin High 23 3/5" Compact Laminate Round Table</b>			
	23 3/5"	40 1/5"	<b>VCBBUD60H47</b>	\$1477
	<b>Burin High 27 3/5" Compact Laminate Round Table</b>			
	27 3/5"	40 1/5"	<b>VCBBUD70H47</b>	\$1504
	<b>Burin High 31 1/2" Compact Laminate Round Table</b>			
	31 1/2"	40 1/5"	<b>VCBBUD80H47</b>	\$1832
	<b>Burin High 39 2/5" Compact Laminate Round Table</b>			
	39 2/5"	40 1/5"	<b>VCBBUD100H47</b>	\$2119



# Tables

## Burin

### Standard Includes

- Top: compact laminate
- Base: black, white, or taupe

### Options

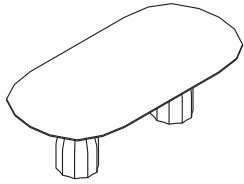
Power Option	No Power	No cost
	With U.S. Power	Price below
Power Location	1 Centered	+\$444
Power Finish	Paint Price Group 01	No cost
Power Configuration	2 Power	No cost
	1 Power 1 USB A 1 USB C	+\$88

### Specification Information

	Dimensions			Style	Price
	D	W	H	Number	
	<b>Burin High 27 3/5" Compact Laminate Square Table</b>				
	27 3/5"	15"	40 1/5"	<b>VCBBUC70H47</b>	\$1504
	<b>Burin High 31 1/2" Compact Laminate Square Table</b>				
	31 1/2"	15"	40 1/5"	<b>VCBBUC80H47</b>	\$1832

# Tables

## Burin



*Tip: Power is not available on VCBUC24047 due to the compact laminate top material.*

### Standard Includes

- Top: compact laminate
- Base: black, white, or taupe

### Specification Information

Dimensions			Style	Price
D	W	H	Number	

### Burin 47 1/5" x 94 2/5" Compact Laminate Oval Table

47 1/5"	94 2/5"	29 1/10"	<b>VCBUC24047</b>	\$3364
---------	---------	----------	-------------------	--------

# Tables

## Burin

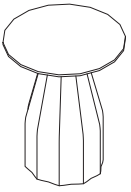
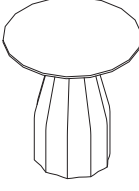
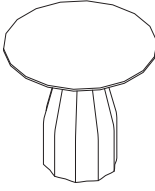
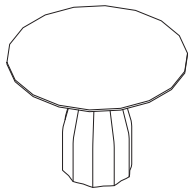
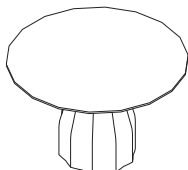
### Standard Includes

- Top: stained oak veneer or lacquered MDF
- Base: black, white, or taupe

### Options

Power Option	No Power	No cost
	With U.S. Power	Price below
Power Location	1 Centered	+\$444
Power Finish	Paint Price Group 01	No cost
Power Configuration	2 Power	No cost
	1 Power 1 USB A 1 USB C	+\$88

### Specification Information

	Dimensions		Style	Top	Price
	Dia.	H	Number	Finish Group	
	<b>Burin Low 23 3/5" MDF Round Table</b>				
	23 3/5"	29 1/10"	<b>VCBBUD6087</b>	Stain PG1	\$1107
				Lacquers on Wood PG1	\$1121
				Lacquers on Wood PG2	\$1149
	<b>Burin Low 27 3/5" MDF Round Table</b>				
	27 3/5"	29 1/10"	<b>VCBBUD7087</b>	Stain PG1	\$1149
				Lacquers on Wood PG1	\$1189
				Lacquers on Wood PG2	\$1218
	<b>Burin Low 31 1/2" MDF Round Table</b>				
	31 1/2"	29 1/10"	<b>VCBBUD8087</b>	Stain PG1	\$1325
				Lacquers on Wood PG1	\$1491
				Lacquers on Wood PG2	\$1517
	<b>Burin Low 39 2/5" MDF Round Table</b>				
	39 2/5"	29 1/10"	<b>VCBBUD10087</b>	Stain PG1	\$1504
				Lacquers on Wood PG1	\$1860
				Lacquers on Wood PG2	\$1888
	<b>Burin Low 47 1/5" MDF Round Table</b>				
	47 1/5"	29 1/10"	<b>VCBBUD12087</b>	Stain PG1	\$1832
				Lacquers on Wood PG1	\$2229
				Lacquers on Wood PG2	\$2256

► Product Information continued on next page

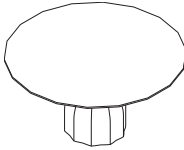
Tables

# Tables

## Burin

► **Product Information continued from previous page**

### Specification Information

Dimensions		Style	Top	Price
Dia.	H	Number	Finish Group	
<b>Burin Low 59 1/10" MDF Round Table</b>				
	59 1/10"	29 1/10"	<b>VCBBUD15087</b>	Stain PG1 \$2282
				Lacquers on Wood PG1 \$2845
				Lacquers on Wood PG2 \$2871

# Tables

## Burin

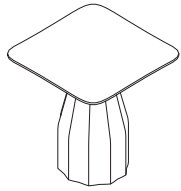
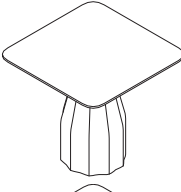
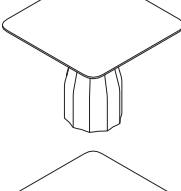
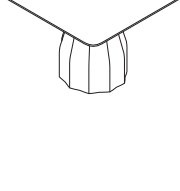
### Standard Includes

- Top: stained oak veneer or lacquered MDF
- Base: black, white, or taupe

### Options

Power Option	No Power With U.S. Power	No cost Price below
Power Location	1 Centered	+\$444
Power Finish	Paint Price Group 01	No cost
Power Configuration	2 Power 1 Power 1 USB A 1 USB C	No cost +\$88

### Specification Information

	Dimensions			Style Number	Top Finish Group	Price
	D	W	H			
	<b>Burin Low 27 3/5" MDF Square Table</b>					
	27 3/5"	15"	29 1/10"	<b>VCBBUC7087</b>	Stain PG1	\$1149
					Lacquers on Wood PG1	\$1189
					Lacquers on Wood PG2	\$1218
	<b>Burin Low 31 1/2" MDF Square Table</b>					
	31 1/2"	15"	29 1/10"	<b>VCBBUC8087</b>	Stain PG1	\$1325
					Lacquers on Wood PG1	\$1491
					Lacquers on Wood PG2	\$1517
	<b>Burin Low 35 2/5" MDF Square Table</b>					
	35 2/5"	15"	29 1/10"	<b>VCBBUC9087</b>	Stain PG1	\$1408
					Lacquers on Wood PG1	\$1696
					Lacquers on Wood PG2	\$1709
	<b>Burin Low 39 2/5" MDF Square Table</b>					
	39 2/5"	19 7/10"	29 1/10"	<b>VCBBUC10087</b>	Stain PG1	\$1504
					Lacquers on Wood PG1	\$1860
					Lacquers on Wood PG2	\$1888

# Tables

## Burin

### Standard Includes

- Top: stained oak veneer or lacquered MDF
- Base: black, white, or taupe

### Options

Power Option	No Power With U.S. Power	No cost Price below
Power Location	1 Centered	+\$444
Power Finish	Paint Price Group 01	No cost
Power Configuration	2 Power 1 Power 1 USB A 1 USB C	No cost +\$88

### Specification Information

	Dimensions		Style Number	Top Finish Group	Price
	Dia.	H			
	<b>Burin High 23 3/5" MDF Round Table</b>				
	23 3/5"	40 1/5"	<b>VCBBUD60H87</b>	Stain PG1	\$1354
				Lacquers on Wood PG1	\$1354
				Lacquers on Wood PG2	\$1381
	<b>Burin High 27 3/5" MDF Round Table</b>				
	27 3/5"	40 1/5"	<b>VCBBUD70H87</b>	Stain PG1	\$1381
				Lacquers on Wood PG1	\$1408
				Lacquers on Wood PG2	\$1436
	<b>Burin High 31 1/2" MDF Round Table</b>				
	31 1/2"	40 1/5"	<b>VCBBUD80H87</b>	Stain PG1	\$1546
				Lacquers on Wood PG1	\$1722
				Lacquers on Wood PG2	\$1751
	<b>Burin High 39 2/5" MDF Round Table</b>				
	39 2/5"	40 1/5"	<b>VCBBUD100H87</b>	Stain PG1	\$1845
				Lacquers on Wood PG1	\$2024
				Lacquers on Wood PG2	\$2024

# Tables

## Burin

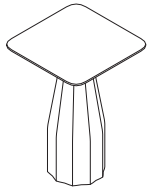
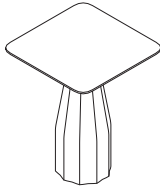
### Standard Includes

- Top: stained oak veneer or lacquered MDF
- Base: black, white, or taupe

### Options

Power Option	No Power	No cost
	With U.S. Power	Price below
Power Location	1 Centered	+\$444
Power Finish	Paint Price Group 01	No cost
Power Configuration	2 Power	No cost
	1 Power 1 USB A 1 USB C	+\$88

### Specification Information

	Dimensions			Style Number	Top Finish Group	Price
	D	W	H			
	<b>Burin High 27 3/5" MDF Square Table</b>					
	27 3/5"	15"	40 1/5"	<b>VCBBUC70H87</b>	Stain PG1	\$1381
					Lacquers on Wood PG1	\$1408
					Lacquers on Wood PG2	\$1436
	<b>Burin High 31 1/2" MDF Square Table</b>					
	31 1/2"	15"	40 1/5"	<b>VCBBUC80H87</b>	Stain PG1	\$1546
					Lacquers on Wood PG1	\$1722
					Lacquers on Wood PG2	\$1751

# Tables

## Burin

Tip: "1 centered power" available for two base tables. "2 centered power" available on three base tables.

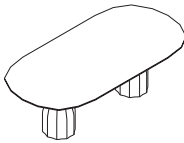
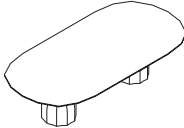
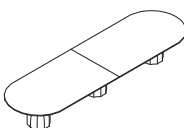
### Standard Includes

- Top: stained oak veneer or lacquered MDF
- Base: black, white, or taupe

### Options

Power Option	No Power	No cost
	With U.S. Power	Prices below
Power Location	240 - Power A - 1 Centered	+\$523
	300 - Power A - 1 Centered	+\$523
	500-Pwr A-2 Center,1 Direction	+\$901
	500-Pwr G-2 Center,2 Directions	+\$901
Power Finish	Paint Price Group 01	No cost
	Paint Price Group 02	No cost
Power Configuration	3 Power	No cost
	2 Power + 1 USB A+C	One unit: +\$96 Two unit: +\$216

### Specification Information

	Dimensions			Style Number	Top Finish Group	Price
	D	W	H			
	<b>Burin 94 2/5" x 47 1/5" MDF Oval Table</b>					
	47 1/5"	94 2/5"	29 1/10"	<b>VCBBUC24087</b>	Lacquers on Wood PG1	\$3213
					Lacquers on Wood PG2	\$3239
					Stain PG1	\$4102
	<b>Burin 118 1/10" x 59 1/10" MDF Oval Table</b>					
	59 1/10"	118 1/10"	29 1/10"	<b>VCBBUC30087</b>	Lacquers on Wood PG1	\$4964
					Lacquers on Wood PG2	\$4991
					Stain PG1	\$6782
	<b>Burin 196 9/10" x 59 1/10" MDF Oval Table</b>					
	59 1/10"	196 9/10"	29 1/10"	<b>VCBBUC50087</b>	Lacquers on Wood PG1	\$7862
					Lacquers on Wood PG2	\$7888
					Stain PG1	\$9325



# Tables

## Burin

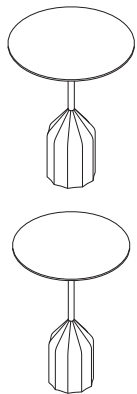
### Standard Includes

- Top: stained oak veneer or lacquered MDF
- Polyurethane foam base with 22 lb interior counterweight
- Handle: high resistance technical fabric

### Options

Handle	No Handle Pull With Handle Pull	No cost See below
--------	------------------------------------	----------------------

### Specification Information



Dimensions			Style Number	Top Finish Group	Base Price	Option
Diameter	W	H				(Add \$ to Base Price) Handle
<b>Burin Mini Table 19 7/10”H</b>						
14 1/5”	14 1/5”	19 7/10”	<b>VCBBU50</b>	Lacquers on MDF PG1	\$1067	+\$82
				Lacquers on MDF PG2	\$1107	+\$96
				Lacquers on MDF PG3	\$1162	+\$96
<b>Burin Mini Table 21 7/10”H</b>						
14 1/5”	14 1/5”	21 7/10”	<b>VCBBU55</b>	Lacquers on MDF PG1	\$1067	+\$82
				Lacquers on MDF PG2	\$1107	+\$96
				Lacquers on MDF PG3	\$1162	+\$96

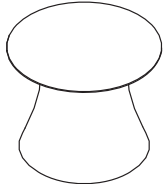
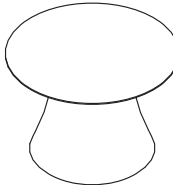
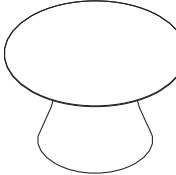
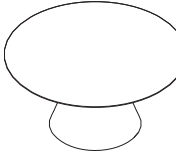
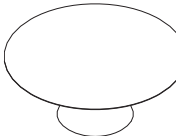
# Tables

## Cambio

### Standard Includes

- Top: compact laminate
- Base: black, white, or taupe

### Specification Information

	Dimensions		Style Number	Edge Finish	Prices
	Dia.	H			
	<b>Cambio Low 23 3/5" Compact Laminate Round Table</b>				
	23 3/5"	18 9/10"	<b>VCBCAD60BL</b>	Compact Laminate Black	\$904
				Compact Laminate White	\$1050
	<b>Cambio Low 27 3/5" Compact Laminate Round Table</b>				
	27 3/5"	18 9/10"	<b>VCBCAD70BL</b>	Compact Laminate Black	\$953
				Compact Laminate White	\$1148
	<b>Cambio Low 31 1/2" Compact Laminate Round Table</b>				
	31 1/2"	18 9/10"	<b>VCBCAD80BL</b>	Compact Laminate Black	\$1001
				Compact Laminate White	\$1245
	<b>Cambio Low 39 2/5" Compact Laminate Round Table</b>				
	39 2/5"	18 9/10"	<b>VCBCAD100BL</b>	Compact Laminate Black	\$1221
				Compact Laminate White	\$1648
	<b>Cambio Low 47 1/5" Compact Laminate Round Table</b>				
	47 1/5"	18 9/10"	<b>VCBCAD120BL</b>	Compact Laminate Black	\$1733
				Compact Laminate White	\$2320

**Standard Includes**

- Top: compact laminate
- Base: black, white, or taupe

**Specification Information**

Dimensions		Style	Edge	Prices
D/W	H	Number	Finish	
<b>Cambio Low 27 3/5" Compact Laminate Square Table</b>				
	27 3/5"	18 9/10"	<b>VCBCAC70BL</b>	Compact Laminate Black \$1087
				Compact Laminate White \$1207
<b>Cambio Low 31 1/2" Compact Laminate Square Table</b>				
	31 1/2"	18 9/10"	<b>VCBCAC80BL</b>	Compact Laminate Black \$1172
				Compact Laminate White \$1487
<b>Cambio Low 35 2/5" Compact Laminate Square Table</b>				
	35 2/5"	18 9/10"	<b>VCBCAC90BL</b>	Compact Laminate Black \$1367
				Compact Laminate White \$1668

# Tables

## Cambio

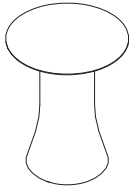
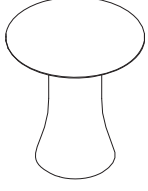
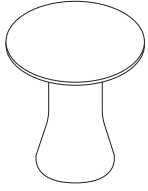
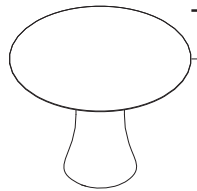
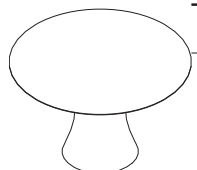
### Standard Includes

- Top: compact laminate
- Base: black, white, or taupe

### Options

Power Option	No Power With U.S. Power	No cost Price below
Power Location	1 Centered	+\$444
Power Finish	Paint Price Group 01	No cost
Power Configuration	2 Power 1 Power 1 USB A 1 USB C	No cost +\$88

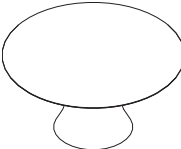
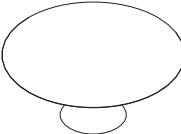
### Specification Information

	Dimensions		Style Number	Edge Finish	Prices
	Dia.	H			
	<b>Cambio High 23 3/5" Compact Laminate Round Table</b>				
	23 3/5"	29 1/10"	<b>VCBCAD60L</b>	Compact Laminate Black	\$916
				Compact Laminate White	\$1062
	<b>Cambio High 27 3/5" Compact Laminate Round Table</b>				
	27 3/5"	29 1/10"	<b>VCBCAD70L</b>	Compact Laminate Black	\$1001
				Compact Laminate White	\$1197
	<b>Cambio High 31 1/2" Compact Laminate Round Table</b>				
	31 1/2"	29 1/10"	<b>VCBCAD80L</b>	Compact Laminate Black	\$1075
				Compact Laminate White	\$1270
	<b>Cambio High 39 2/5" Compact Laminate Round Table</b>				
	39 2/5"	29 1/10"	<b>VCBCAD100L</b>	Compact Laminate Black	\$1270
				Compact Laminate White	\$1514
	<b>Cambio High 47 1/5" Compact Laminate Round Table</b>				
	47 1/5"	29 1/10"	<b>VCBCAD120L</b>	Compact Laminate Black	\$1685
				Compact Laminate White	\$1977

► Product Information continued on next page

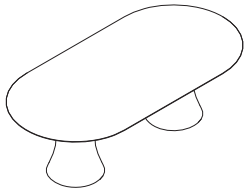
► **Product Information continued from previous page**

**Specification Information**

Dimensions		Style	Edge	Prices
Dia.	H	Number	Finish	
<b>Cambio High 59" Compact Laminate Round Table</b>				
	59"	29 1/10"	<b>VCBCAD150L</b>	Compact Laminate Black \$2662
				Compact Laminate White \$3028
<b>Cambio High 71" Compact Laminate Round Table</b>				
	71"	29 1/10"	<b>VCBCAD180L</b>	Compact Laminate Black \$3784
				Compact Laminate White \$5738

# Tables

## Cambio



*Tip: Power is not available on VCBCAC240L due to the compact laminate top material.*

### Standard Includes

- Top: compact laminate
- Base: black, white, or taupe

### Specification Information

Dimensions			Style	Edge	Prices
D	W	H	Number	Finish Group	
<b>Cambio 47 1/5" x 94 1/2" x 29 1/10" Laminate Oval Table</b>					
47 1/5"	94 1/2"	29 1/10"	<b>VCBCAC240L</b>	Compact Laminate Black	\$4029
				Compact Laminate White	\$5823

# Tables

## Cambio

### Standard Includes

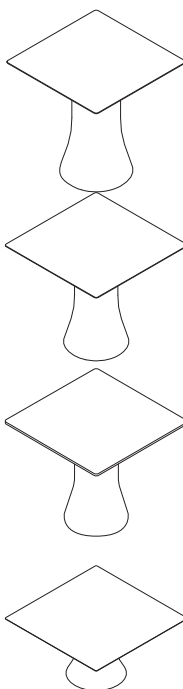
- Top: compact laminate
- Base: black, white, or taupe

### Options

Power Option	No Power	No cost
	With U.S. Power	Price below
Power Location	1 Centered	+\$444
Power Finish	Paint Price Group 01	No cost
Power Configuration	2 Power	No cost
	1 Power 1 USB A 1 USB C	+\$88

### Specification Information

Dimensions		Style	Edge	Prices
D/W	H	Number	Finish	
<b>Cambio High 27 3/5" Compact Laminate Square Table</b>				
27 3/5"	29 1/10"	<b>VCBCAC70L</b>	Compact Laminate Black	\$1001
			Compact Laminate White	\$1172
<b>Cambio High 31 1/2" Compact Laminate Square Table</b>				
31 1/2"	29 1/10"	<b>VCBCAC80L</b>	Compact Laminate Black	\$1062
			Compact Laminate White	\$1258
<b>Cambio High 35 2/5" Compact Laminate Square Table</b>				
35 2/5"	29 1/10"	<b>VCBCAC90L</b>	Compact Laminate Black	\$1209
			Compact Laminate White	\$1526
<b>Cambio High 55 1/10" Compact Laminate Square Table</b>				
55 1/10"	29 1/10"	<b>VCBCAC140L</b>	Compact Laminate Black	\$2466
			Compact Laminate White	\$3784



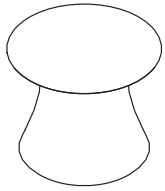
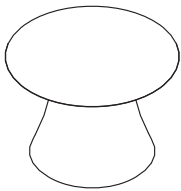
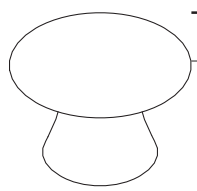
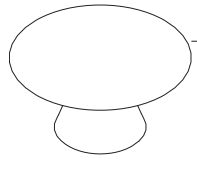
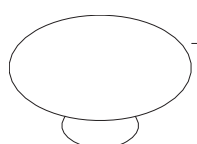
# Tables

## Cambio

### Standard Includes

- Top: lacquered MDF
- Base: black, white, or taupe

### Specification Information

	Dimensions		Style Number	Top Finish Group	Prices
	Dia.	H			
	<b>Cambio Low 23 3/5" MDF Round Table</b>				
	23 3/5"	18 9/10"	<b>VCBCAD60B</b>	Lacquers on Wood PG1	\$1014
				Lacquers on Wood PG2	\$1038
				Stain PG1	\$1026
	<b>Cambio Low 27 3/5" MDF Round Table</b>				
	27 3/5"	18 9/10"	<b>VCBCAD70B</b>	Lacquers on Wood PG1	\$1026
				Lacquers on Wood PG2	\$1050
				Stain PG1	\$1099
	<b>Cambio Low 31 1/2" MDF Round Table</b>				
	31 1/2"	18 9/10"	<b>VCBCAD80B</b>	Lacquers on Wood PG1	\$1111
				Lacquers on Wood PG2	\$1136
				Stain PG1	\$1160
	<b>Cambio Low 39 2/5" MDF Round Table</b>				
	39 2/5"	18 9/10"	<b>VCBCAD100B</b>	Lacquers on Wood PG1	\$1380
				Lacquers on Wood PG2	\$1406
				Stain PG1	\$1550
	<b>Cambio Low 47 1/5" MDF Round Table</b>				
	47 1/5"	18 9/10"	<b>VCBCAD120B</b>	Lacquers on Wood PG1	\$1831
				Lacquers on Wood PG2	\$1855
				Stain PG1	\$1977



### Standard Includes

- Top: lacquered MDF
- Base: black, white, or taupe

### Specification Information

	Dimensions		Style Number	Top Finish Group	Prices
	D/W	H			
	<b>Cambio Low 27 3/5" MDF Square Table</b>				
	27 3/5"	18 9/10"	<b>VCBCAC70B</b>	Lacquers on Wood PG1	\$1184
				Lacquers on Wood PG2	\$1209
				Stain PG1	\$1209
	<b>Cambio Low 31 1/2" MDF Square Table</b>				
	31 1/2"	18 9/10"	<b>VCBCAC80B</b>	Lacquers on Wood PG1	\$1331
				Lacquers on Wood PG2	\$1355
				Stain PG1	\$1380
	<b>Cambio Low 35 2/5" MDF Square Table</b>				
	35 2/5"	18 9/10"	<b>VCBCAC90B</b>	Lacquers on Wood PG1	\$1575
				Lacquers on Wood PG2	\$1599
				Stain PG1	\$1587

# Tables

## Cambio

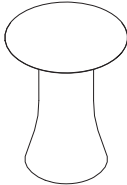
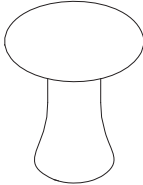
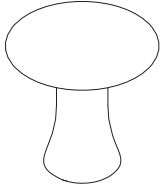
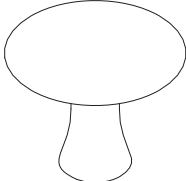
### Standard Includes

- Top: lacquered MDF
- Base: black, white, or taupe

### Options

Power Option	No Power With U.S. Power	No cost Price below
Power Location	1 Centered	+\$444
Power Finish	Paint Price Group 01	No cost
Power Configuration	2 Power 1 Power 1 USB A 1 USB C	No cost +\$88

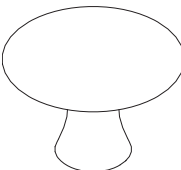
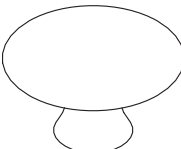
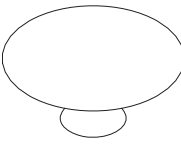
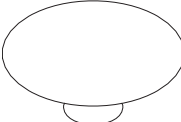
### Specification Information

	Dimensions		Style Number	Top Finish Group	Prices
	Dia.	H			
	<b>Cambio High 23 3/5" MDF Round Table</b>				
	23 3/5"	29 1/10"	<b>VCBCAD60</b>	Lacquers on Wood PG1	\$1026
				Lacquers on Wood PG2	\$1050
				Stain PG1	\$1014
	<b>Cambio High 27 3/5" MDF Round Table</b>				
	27 3/5"	29 1/10"	<b>VCBCAD70</b>	Lacquers on Wood PG1	\$1099
				Lacquers on Wood PG2	\$1123
				Stain PG1	\$1123
	<b>Cambio High 31 1/2" MDF Round Table</b>				
	31 1/2"	29 1/10"	<b>VCBCAD80</b>	Lacquers on Wood PG1	\$1172
				Lacquers on Wood PG2	\$1197
				Stain PG1	\$1245
	<b>Cambio High 39 2/5" MDF Round Table</b>				
	39 2/5"	29 1/10"	<b>VCBCAD100</b>	Lacquers on Wood PG1	\$1441
				Lacquers on Wood PG2	\$1465
				Stain PG1	\$1514

► Product Information continued on next page

► **Product Information continued from previous page**

### Specification Information

	Dimensions		Style Number	Top Finish Group	Prices
	Dia.	H			
	<b>Cambio High 47 1/5" MDF Round Table</b>				
	47 1/5"	29 1/10"	<b>VCBCAD120</b>	Lacquers on Wood PG1	\$1611
				Lacquers on Wood PG2	\$1636
				Stain PG1	\$2014
	<b>Cambio High 59" MDF Round Table</b>				
	59"	29 1/10"	<b>VCBCAD150</b>	Lacquers on Wood PG1	\$2686
				Lacquers on Wood PG2	\$2710
				Stain PG1	\$2906
	<b>Cambio High 71" MDF Round Table</b>				
	71"	29 1/10"	<b>VCBCAD180</b>	Lacquers on Wood PG1	\$3491
				Lacquers on Wood PG2	\$3516
				Stain PG1	\$3834
	<b>Cambio High 78 7/10" MDF Round Table</b>				
	78 7/10"	29 1/10"	<b>VCBCAD200</b>	Lacquers on Wood PG1	\$3761
				Lacquers on Wood PG2	\$3784
				Stain PG1	\$4810

# Tables

## Cambio

### Standard Includes

- Top: lacquered MDF
- Base: black, white, or taupe

### Options

Power Option	No Power	No cost
	With U.S. Power	Prices below
Power Location	240 - Power A -1 Centered	+\$523
	300 - Power A -1 Centered	+\$523
	500 - Power C-2 Centered, 1 Direction	+\$901
	500 - Power D-2 Centered, 2 Directions	+\$901
Power Finish	Paint Price Group 01	No cost
	Paint Price Group 02	No cost
Power Configuration	3 Power	No cost
	2 Power + 1 USB A+C	One unit: +\$96 Two unit: +\$216

Tip: "1 centered power" available for two base tables. "2 centered power" available on three base tables.

### Specification Information

	Dimensions			Style Number	Top Finish Group	Prices
	D	W	H			
	<b>Cambio 47 1/5" x 94 1/2" x 29 1/10" MDF Oval Table</b>					
	47 1/5"	94 1/2"	29 1/10"	<b>VCBCAC240</b>	Lacquers on Wood PG1	\$3711
					Lacquers on Wood PG2	\$3735
					Stain PG1	\$4041
	<b>Cambio 59" x 118" x 29 1/10" MDF Oval Table</b>					
	59"	118"	29 1/10"	<b>VCBCAC300</b>	Lacquers on Wood PG1	\$6397
					Lacquers on Wood PG2	\$6421
					Stain PG1	\$6555
	<b>Cambio 59" x 197" x 29 1/10" MDF Oval Table</b>					
	59"	197"	29 1/10"	<b>VCBCAC500</b>	Lacquers on Wood PG1	\$10,792
					Lacquers on Wood PG2	\$10,816
					Stain PG1	\$10,706

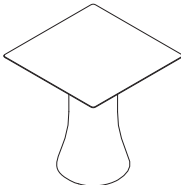
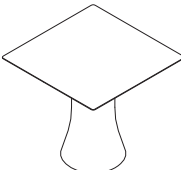
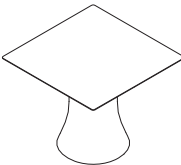
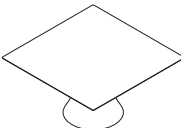
### Standard Includes

- Top: lacquered MDF
- Base: black, white, or taupe

### Options

Power Option	No Power With U.S. Power	No cost Price below
Power Location	1 Centered	+\$444
Power Finish	Paint Price Group 01	No cost
Power Configuration	2 Power 1 Power 1 USB A 1 USB C	No cost +\$88

### Specification Information

	Dimensions		Style Number	Top Finish Group	Prices
	D/W	H			
	<b>Cambio High 27 3/5" MDF Square Table</b>				
	27 3/5"	29 1/10"	<b>VCBCAC70</b>	Lacquers on Wood PG1	\$1099
				Lacquers on Wood PG2	\$1123
				Stain PG1	\$1148
	<b>Cambio High 31 1/2" MDF Square Table</b>				
	31 1/2"	29 1/10"	<b>VCBCAC80</b>	Lacquers on Wood PG1	\$1184
				Lacquers on Wood PG2	\$1209
				Stain PG1	\$1216
	<b>Cambio High 35 2/5" MDF Square Table</b>				
	35 2/5"	29 1/10"	<b>VCBCAC90</b>	Lacquers on Wood PG1	\$1294
				Lacquers on Wood PG2	\$1319
				Stain PG1	\$1489
	<b>Cambio High 55 1/10" MDF Square Table</b>				
	55 1/10"	29 1/10"	<b>VCBCAC140</b>	Lacquers on Wood PG1	\$2564
				Lacquers on Wood PG2	\$2588
				Stain PG1	\$2735

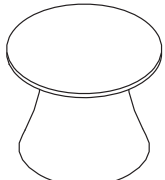

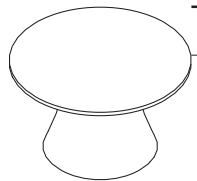
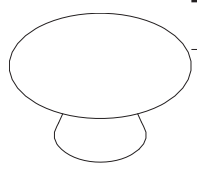
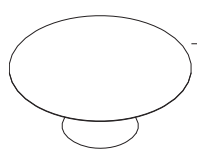
# Tables

## Cambio

### Standard Includes

- Top: Low-Pressure Laminate price group 01
- Base: black, white, or taupe

### Specification Information

	Dimensions		Style	Price
	Dia.	H	Number	
	<b>Cambio Low 23 3/5" LPL Round Table</b>			
	23 3/5"	18 9/10"	<b>VCBCAD60BM</b>	\$756
	<b>Cambio Low 27 3/5" LPL Round Table</b>			
	27 3/5"	18 9/10"	<b>VCBCAD70BM</b>	\$782
	<b>Cambio Low 31 1/2" LPL Round Table</b>			
	31 1/2"	18 9/10"	<b>VCBCAD80BM</b>	\$818
	<b>Cambio Low 39 2/5" LPL Round Table</b>			
	39 2/5"	18 9/10"	<b>VCBCAD100BM</b>	\$928
	<b>Cambio Low 47 1/5" LPL Round Table</b>			
	47 1/5"	18 9/10"	<b>VCBCAD120BM</b>	\$1014

**Standard Includes**

- Top: Low-Pressure Laminate price group 01
- Base: black, white, or taupe

**Specification Information**

	Dimensions		Style	Price
	D/W	H	Number	
	<b>Cambio Low 27 3/5\" LPL Square Table</b>			
	27 3/5"	18 9/10"	<b>VCBCAC70BM</b>	\$770
	<b>Cambio Low 31 1/2\" LPL Square Table</b>			
	31 1/2"	18 9/10"	<b>VCBCAC80BM</b>	\$818
	<b>Cambio Low 35 2/5\" LPL Square Table</b>			
	35 2/5"	18 9/10"	<b>VCBCAC90BM</b>	\$879

# Tables

## Cambio

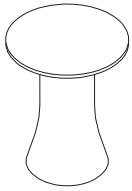
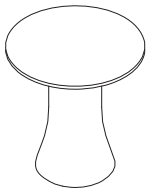
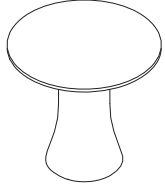
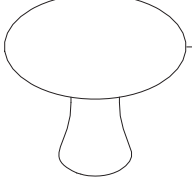
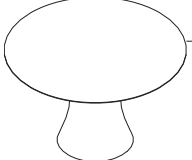
### Standard Includes

- Top: Low-Pressure Laminate price group 01
- Base: black, white, or taupe

### Options

Power Option	No Power	No cost
	With U.S. Power	Price below
Power Location	1 Centered	+\$444
Power Finish	Paint Price Group 01	No cost
Power Configuration	2 Power	No cost
	1 Power 1 USB A 1 USB C	+\$88

### Specification Information

	Dimensions		Style	Price
	Dia.	H	Number	
	<b>Cambio High 23 3/5" LPL Round Table</b>			
	23 3/5"	29 1/10"	<b>VCBCAD60M</b>	\$770
	<b>Cambio High 27 3/5" LPL Round Table</b>			
	27 3/5"	29 1/10"	<b>VCBCAD70M</b>	\$806
	<b>Cambio High 31 1/2" LPL Round Table</b>			
	31 1/2"	29 1/10"	<b>VCBCAD80M</b>	\$855
	<b>Cambio High 39 2/5" LPL Round Table</b>			
	39 2/5"	29 1/10"	<b>VCBCAD100M</b>	\$1014
	<b>Cambio High 47 1/5" LPL Round Table</b>			
	47 1/5"	29 1/10"	<b>VCBCAD120M</b>	\$1026

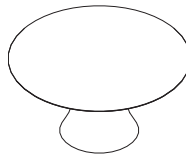
► **Product Information continued on next page**



► **Product Information continued from previous page**

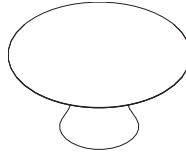
**Specification Information**

Dimensions		Style	Price
Dia.	H	Number	



**Cambio High 59" LPL Round Table**

59"	29 1/10"	<b>VCBCAD150M</b>	\$1831
-----	----------	-------------------	--------



**Cambio High 71" LPL Round Table**

71"	29 1/10"	<b>VCBCAD180M</b>	\$2148
-----	----------	-------------------	--------

# Tables

## Cambio

### Standard Includes

- Top: Low-Pressure Laminate price group 01
- Base: black, white, or taupe

### Options

Power Option	No Power	No cost
	With U.S. Power	Price below
Power Location	1 Centered	+\$444
Power Finish	Paint Price Group 01	No cost
Power Configuration	2 Power	No cost
	1 Power 1 USB A 1 USB C	+\$88

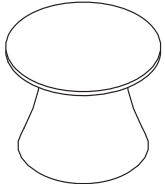
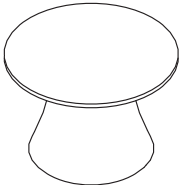
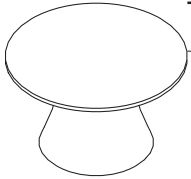
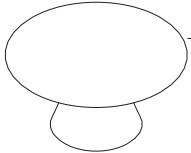
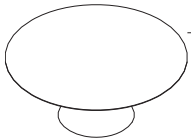
### Specification Information

	Dimensions		Style Number	Price
	D/W	H		
	<b>Cambio High 27 3/5" LPL Square Table</b>			
	27 3/5"	29 1/10"	<b>VCBCAC70M</b>	\$818
	<b>Cambio High 31 1/2" LPL Square Table</b>			
	31 1/2"	29 1/10"	<b>VCBCAC80M</b>	\$843
	<b>Cambio High 35 2/5" LPL Square Table</b>			
	35 2/5"	29 1/10"	<b>VCBCAC90M</b>	\$892
	<b>Cambio High 55 1/10" LPL Square Table</b>			
	55 1/10"	29 1/10"	<b>VCBCAC140M</b>	\$1831

**Standard Includes**

- Top: High-Pressure Laminate price group 01
- Base: black, white, or taupe

**Specification Information**

	Dimensions		Style	Price
	Dia.	H	Number	
	<b>Cambio Low 23 3/5" HPL Round Table</b>			
	23 3/5"	18 9/10"	<b>VCBCAD60BHPL</b>	\$998
	<b>Cambio Low 27 3/5" HPL Round Table</b>			
	27 3/5"	18 9/10"	<b>VCBCAD70BHPL</b>	\$1091
	<b>Cambio Low 31 1/2" HPL Round Table</b>			
	31 1/2"	18 9/10"	<b>VCBCAD80BHPL</b>	\$1183
	<b>Cambio Low 39 2/5" HPL Round Table</b>			
	39 2/5"	18 9/10"	<b>VCBCAD100BHPL</b>	\$1566
	<b>Cambio Low 47 1/5" HPL Round Table</b>			
	47 1/5"	18 9/10"	<b>VCBCAD120BHPL</b>	\$2204

# Tables

## Cambio

### Standard Includes

- Top: High-Pressure Laminate price group 01
- Base: black, white, or taupe

### Specification Information

	Dimensions		Style	Price
	D/W	H	Number	
	<b>Cambio Low 27 3/5" HPL Square Table</b>			
	27 3/5"	18 9/10"	<b>VCBCAC70BHPL</b>	\$1147
	<b>Cambio Low 31 1/2" HPL Square Table</b>			
	31 1/2"	18 9/10"	<b>VCBCAC80BHPL</b>	\$1413
	<b>Cambio Low 35 2/5" HPL Square Table</b>			
	35 2/5"	18 9/10"	<b>VCBCAC90BHPL</b>	\$1585

# Tables

## Cambio

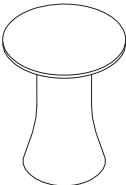
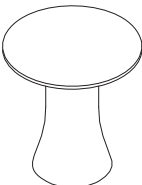
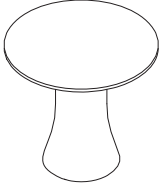
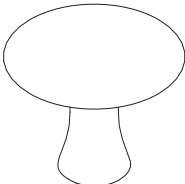
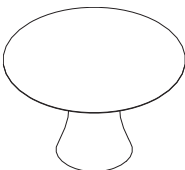
### Standard Includes

- Top: High-Pressure Laminate price group 01
- Base: black, white, or taupe

### Options

Power Option	No Power	No cost
	With U.S. Power	Price below
Power Location	1 Centered	+\$444
Power Finish	Paint Price Group 01	No cost
Power Configuration	2 Power	No cost
	1 Power 1 USB A 1 USB C	+\$88

### Specification Information

	Dimensions		Style	Price
	Dia.	H	Number	
	<b>Cambio High 23 3/5" HPL Round Table</b>			
	23 3/5"	29 1/10"	<b>VCBCAD60HPL</b>	\$1009
	<b>Cambio High 27 3/5" HPL Round Table</b>			
	27 3/5"	29 1/10"	<b>VCBCAD70HPL</b>	\$1137
	<b>Cambio High 31 1/2" HPL Round Table</b>			
	31 1/2"	29 1/10"	<b>VCBCAD80HPL</b>	\$1207
	<b>Cambio High 39 2/5" HPL Round Table</b>			
	39 2/5"	29 1/10"	<b>VCBCAD100HPL</b>	\$1438
	<b>Cambio High 47 1/5" HPL Round Table</b>			
	47 1/5"	29 1/10"	<b>VCBCAD120HPL</b>	\$1878

# Tables

## Cambio

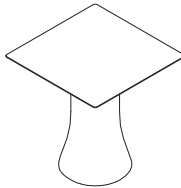
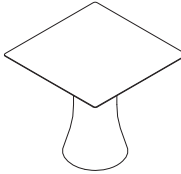
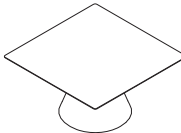
### Standard Includes

- Top: High-Pressure Laminate price group 01
- Base: black, white, or taupe

### Options

Power Option	No Power	No cost
	With U.S. Power	Price below
Power Location	1 Centered	+\$444
Power Finish	Paint Price Group 01	No cost
Power Configuration	2 Power	No cost
	1 Power 1 USB A 1 USB C	+\$88

### Specification Information

	Dimensions		Style Number	Price
	D/W	H		
	<b>Cambio High 27 3/5" HPL Square Table</b>			
	27 3/5"	29 1/10"	<b>VCBCAC70HPL</b>	\$1113
	<b>Cambio High 31 1/2" HPL Square Table</b>			
	31 1/2"	29 1/10"	<b>VCBCAC80HPL</b>	\$1195
	<b>Cambio High 35 2/5" HPL Square Table</b>			
	35 2/5"	29 1/10"	<b>VCBCAC90HPL</b>	\$1450

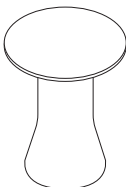
### Standard Includes

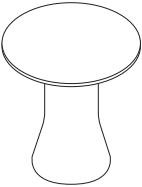
- Top: Low-Pressure Laminate price group 01
- Base: black, white, or taupe

### Options

Base Finish	Polyethylene Group 1	No cost
Top Finish	Low Pressure Laminate PG1	No cost
	Compact Laminate PG1	Price below
	High Pressure Laminate PG1	Price below
	Lacquers on Wood PG1	Price below
	Lacquers on Wood PG2	Price below
Power Option	No Power	No cost
	With U.S. Power	Price below
Power Location	1 Centered	+\$444
Power Finish	Paint Price Group 01	No cost
Power Configuration	2 Power	No cost
	1 Power 1 USB A 1 USB C	+\$88
Top Edge Finish	Compact Laminate PG1	No cost

### Specification Information

Dimensions	Style	Top	Prices		
				Dia.	H
<b>Cambio High 23 3/5" LPL Round Table</b>					
	23 3/5"	41 2/7"	<b>VCBCAD60H</b>	LPL PG1	\$930
				Compact Laminate PG1	\$950
				Lacquers on Wood PG1	\$1122
				Lacquers on Wood PG2	\$1150
				HPL PG1	\$1174
				Stain PG1	\$1128

<b>Cambio High 27 3/5" LPL Round Table</b>					
	27 3/5"	41 2/7"	<b>VCBCAD70H</b>	LPL PG1	\$952
				Compact Laminate PG1	\$1086
				Lacquers on Wood PG1	\$1176
				Lacquers on Wood PG2	\$1200
				HPL PG1	\$1198
				Stain PG1	\$1150

► **Product Information continued on next page**

# Tables

## Cambio

► Product Information continued from previous page

### Specification Information

Dimensions	Style	Top	Prices
<b>Cambio High 31 1/2" LPL Round Table</b>			
31 1/2"	41 2/7"	<b>VCBCAD80H</b>	LPL PG1 \$1080
			Compact Laminate PG1 \$1296
			Lacquers on Wood PG1 \$1458
			Lacquers on Wood PG2 \$1482
			HPL PG1 \$1478
			Stain PG1 \$1296

<b>Cambio High 39 2/5" LPL Round Table</b>			
39 2/5"	41 2/7"	<b>VCBCAD100H</b>	LPL PG1 \$1324
			Compact Laminate PG1 \$1486
			Lacquers on Wood PG1 \$1726
			Lacquers on Wood PG2 \$1754
			HPL PG1 \$1722
			Stain PG1 \$1568



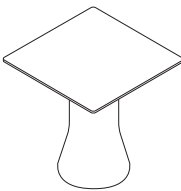
### Standard Includes

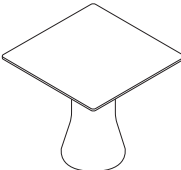
- Top: Low-Pressure Laminate price group 01
- Base: black, white, or taupe

### Options

Base Finish	Polyethylene Group 1	No cost
Top Finish	Low Pressure Laminate PG1	No cost
	Compact Laminate PG1	Price below
	High Pressure Laminate PG1	Price below
	Lacquers on Wood PG1	Price below
	Lacquers on Wood PG2	Price below
Power Option	No Power	No cost
	With U.S. Power	Price below
Power Location	1 Centered	+\$444
Power Finish	Paint Price Group 01	No cost
Power Configuration	2 Power	No cost
	1 Power 1 USB A 1 USB C	+\$88
Top Edge Finish	Compact Laminate PG1	No cost

### Specification Information

	Dimensions		Style Number	Top Finish Group	Prices
	D/W	H			
	<b>Cambio High 23 3/5" LPL Square Table</b>				
	23 3/5"	41 2/7"	<b>VCBCAC70H</b>	LPL PG1	\$952
				Compact Laminate PG1	\$1086
				Lacquers on Wood PG1	\$1176
				Lacquers on Wood PG2	\$1200
				HPL PG1	\$1198
			Stain PG1	\$1150	

	<b>Cambio High 31 1/2" LPL Square Table</b>				
	31 1/2"	41 2/7"	<b>VCBCAC80H</b>	LPL PG1	\$1080
				Compact Laminate PG1	\$1296
				Lacquers on Wood PG1	\$1458
				Lacquers on Wood PG2	\$1482
				HPL PG1	\$1478
			Stain PG1	\$1296	

# Tables

## Cambio

Tip: Power is not available when compact laminate top is specified.

### Standard Includes

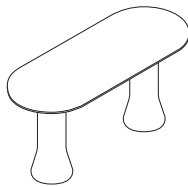
- Top: compact laminate
- Base: black, white, or taupe

### Options

Base Finish	Polyethylene Group 1	No cost
Top Finish	Compact Laminate PG1	No cost
	High Pressure Laminate PG1	Price below
	Lacquers on Wood PG1	Price below
	Lacquers on Wood PG2	Price below
	Stain Price Group 1	Price below
Power Option	No Power	No cost
	With U.S. Power	Price below
Power Location	220 - Power Ha - 1 Centered	+\$523
	240 - Power Ha - 1 Centered	+\$523
	260 - Power Ha - 1 Centered	+\$523
	280 - Power Ha - 1 Centered	+\$523
	300-Power Ha-2 Centered, 2 Dir	+\$901
	300-Power Ha-2 Centered, 1 Dir	+\$901
Power Finish	Paint Price Group 01	No cost
	Paint Price Group 02	No cost
Power Configuration	3 Power	No cost
	2 Power + 1 USB A+C	+\$96
Top Edge Finish	Compact Laminate PG1	No cost

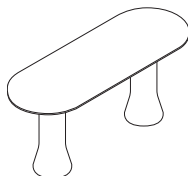
### Specification Information

Dimensions			Style Number	Top Finish Group	Prices
D	W	H			



#### Cambio 86 3/5" x 35 2/5" x 41 2/7" Compact Laminate Oval Table

86 3/5"	35 2/5"	41 2/7"	<b>VCBCAC220H</b>	Compact Laminate PG1	\$3278
				Lacquers on Wood PG1	\$3352
				Lacquers on Wood PG2	\$3360
				HPL PG1	\$3500
				Stain PG1	\$2842



#### Cambio 94 1/2" x 35 2/5" x 41 2/7" Compact Laminate Oval Table

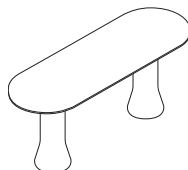
94 1/2"	35 2/5"	41 2/7"	<b>VCBCAC240H</b>	Compact Laminate PG1	\$3478
				Lacquers on Wood PG1	\$3478
				Lacquers on Wood PG2	\$3504
				HPL PG1	\$3518
				Stain PG1	\$2860

▶ Product Information continued on next page

► **Product Information continued from previous page**

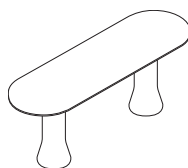
**Specification Information**

Dimensions			Style	Top	Prices
D	W	H	Number	Finish Group	



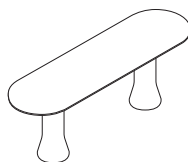
**Cambio 102 2/5" x 35 2/5" x 41 2/7" Compact Laminate Oval Table**

102 2/5"	35 2/5"	41 2/7"	<b>VCBCAC260H</b>	Compact Laminate PG1	\$3678
				Lacquers on Wood PG1	\$3620
				Lacquers on Wood PG2	\$3646
				HPL PG1	\$3534
				Stain PG1	\$3032



**Cambio 110 1/5" x 35 2/5" x 41 2/7" Compact Laminate Oval Table**

110 1/5"	35 2/5"	41 2/7"	<b>VCBCAC280H</b>	Compact Laminate PG1	\$5282
				Lacquers on Wood PG1	\$5448
				Lacquers on Wood PG2	\$5478
				HPL PG1	\$6104
				Stain PG1	\$4138

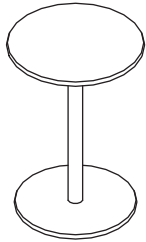


**Cambio 118 1/10" x 35 2/5" x 41 2/7" Compact Laminate Oval Table**

118 1/10"	35 2/5"	41 2/7"	<b>VCBCAC300H</b>	Compact Laminate PG1	\$5682
				Lacquers on Wood PG1	\$5582
				Lacquers on Wood PG2	\$5610
				HPL PG1	\$6122
				Stain PG1	\$4234

# Tables

## Common



### Standard Includes

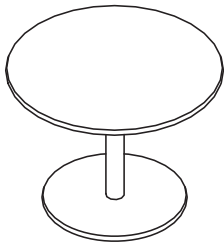
- Base and top: lacquered MDF
- Column: matte varnished natural beech

### Specification Information

Dimensions	Style	Table	Prices
Diameter H	Number	Finish Group	

### Common High Table

17 7/10"	25 3/5"	<b>VCBCOD45H65</b>	Lacquers on MDF PG1	\$991
			Lacquers on MDF PG2	\$1046
			Lacquers on MDF PG3	\$1094



### Standard Includes

- Base and top: lacquered MDF
- Column: matte varnished natural beech

### Specification Information

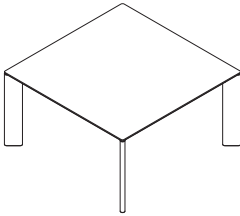
Dimensions	Style	Table	Prices
Diameter H	Number	Finish Group	

### Common Low Table

23 3/5"	17 7/10"	<b>VCBCOD60H45</b>	Lacquers on MDF PG1	\$991
			Lacquers on MDF PG2	\$1046
			Lacquers on MDF PG3	\$1094

# Tables

Foro



### Standard Includes

- Frame: solid oak wood
- Top: lacquered MDF
- Legs: solid oak wood

### Options

Leg Type	All Standard Legs	No cost
	1 Wire Management Leg	+\$390
	2 Wire Management Leg	+\$780
	3 Wire Management Leg	+\$1170
	4 Wire Management Leg	+\$1560
Table Protection Option	No Table Protection	No cost
	Ecoleather Table Top Protector	+\$587
Power Option	No Power	No cost
	With U.S. Power	Prices below
Power Location	140-Power A-1 Centered	+\$523
	160-Power A-1 Centered	+\$523
	200-Power A-1 Centered	+\$523
	240-Power A-1 Center	+\$523
	200-Power B-2 Sides, 2 Directions	+\$901
	200-Power C-2 Sides, 1 Direction	+\$901
	240-Power B-2 Sides, 2 Directions	+\$901
	240-Power C-2 Sides, 1 Direction	+\$901
Power Finish	Paint Price Group 01	No cost
	Paint Price Group 02	No cost
Power Configuration	3 Power	No cost
	2 Power + 1 USB A+C	One unit: +\$96 Two unit: +\$216

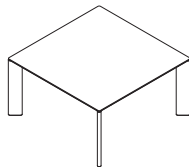
Tip: "1 centered power" available on square and rectangle tables. "2 centered power" available only on rectangle tables.

### Specification Information

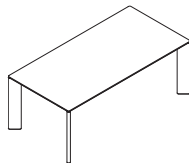
Dimensions			Style	Base
D	W	H	Number	Prices

#### Foro Tables

55 1/10"	55 1/10"	29 1/10"	<b>VCBFO140RO</b>	\$5220
----------	----------	----------	-------------------	--------



39 4/10"	78 7/10"	29 1/10"	<b>VCBFO200RO</b>	\$5360
----------	----------	----------	-------------------	--------



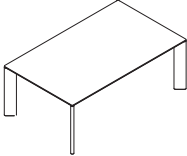
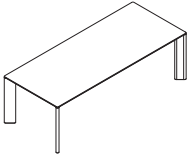
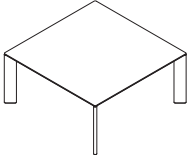
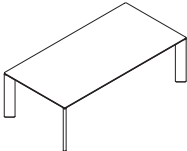
► Product Information continued on next page

# Tables

## Foro

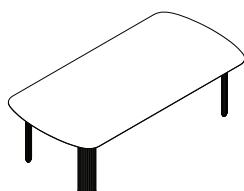
► **Product Information continued from previous page**

**Specification Information**

	Dimensions			Style Number	Base Prices
	D	W	H		
	47 1/5"	78 7/10"	29 1/10"	<b>VCBFO200ARO</b>	\$5780
	39 4/10"	94 1/2"	29 1/10"	<b>VCBFO240RO</b>	\$5920
	63"	63"	29 1/10"	<b>VCBFO160RO</b>	\$5960
	47 1/5"	94 1/2"	29 1/10"	<b>VCBFO240ARO</b>	\$6380

# Tables

## Fuste



### Standard Includes

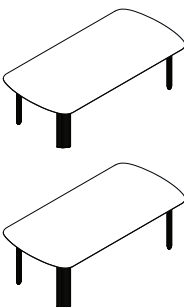
- Frame: solid oak wood
- Top: lacquered MDF
- Legs: solid oak wood

### Options

Leg Type	All Standard Legs	No cost
	Fuste 1 Wire Management Leg	+\$390
	Fuste 2 Wire Management Leg	+\$780
	Fuste 3 Wire Management Leg	+\$1170
	Fuste 4 Wire Management Leg	+\$1560
Leg Position	Leg Position A	No cost
	Leg Position B	No cost
Power Option	No Power	No cost
	With U.S. Power	Prices below
Power Location	210-Power A-1 Centered	+\$523
	240-Power A-1 Centered	+\$523
	210-Power B-2 Sides, 2 Directions	+\$901
	210-Power C-2 Sides, 1 Direction	+\$901
	210-Power D-2 Centered	+\$901
	240-Power B-2 Sides, 2 Directions	+\$901
	240-Power C-2 Sides, 1 Direction	+\$901
	240-Power D-2 Centered	+\$901
Power Finish	Paint Price Group 01	No cost
	Paint Price Group 02	No cost
Power Configuration	3 Power	No cost
	2 Power + 1 USB A+C	One unit: +\$96 Two unit: +\$216

### Specification Information

Dimensions			Style Number	Base Prices
D	W	H		
<b>Fuste Tables</b>				
47 1/5"	94 1/2"	25 3/10"	<b>VCBFUS240ROH</b>	\$5760
47 1/5"	94 1/2"	29 1/10"	<b>VCBFUS240RO</b>	\$5900
63"	82 7/10"	25 3/10"	<b>VCBFUS210ROH</b>	\$6460



► Product Information continued on next page

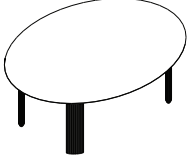
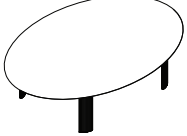


# Tables

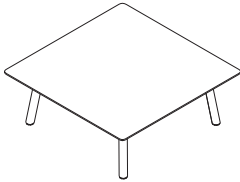
## Fuste

► Product Information continued from previous page

### Specification Information

	Dimensions			Style Number	Base Prices
	D	W	H		
	63"	82 7/10"	29 1/10"	<b>VCBFUS210RO</b>	\$6540
	70 9/10"	102 2/5"	25 3/10"	<b>VCBFUS260ROH</b>	\$6930
	70 9/10"	102 2/5"	29 1/10"	<b>VCBFUS260RO</b>	\$7020





Tip: Contrasting option is available for metal legs only.

**Standard Includes**

- Top: stained natural oak
- Legs: paint price group 1 or stained oak veneer, if selected

**Options**

Leg Type	Metal Legs	Prices below
	Wood Legs	Prices below
Contrasting Option	Contrasting	No cost
	Non Contrasting	No cost

**Specification Information**

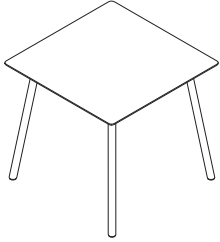
Dimensions			Style Number	Top Finish Group	Prices	
D	W	H			Leg Type: Metal	Wood

**Maarten 31 1/2" Low Square Table**

31 1/2"	31 1/2"	11 4/5"	<b>VCBMAAB80</b>	Stain Price Group 1	\$1231	\$1668
				Stain Price Group 2	\$1325	\$1914
				Lacquers MDF Microtexture PG1	\$1285	\$1845
				Lacquers MDF Microtexture PG2	\$1325	\$1914
				High-Pressure Laminate PG1	\$1453	\$1892

# Tables

## Maarten



Tip: Contrasting option is available for metal legs only.

### Standard Includes

- Top: stained natural oak
- Legs: paint price group 1 or stained oak veneer, if selected

### Options

Leg Type	Metal Legs	Prices below
	Wood Legs	Prices below
Contrasting Option	Contrasting	No cost
	Non Contrasting	No cost
Power Option	No Power	No cost
	With U.S. Power	Prices below
Power Location	1 Centered	+\$444
Power Finish	Paint Price Group 01	No cost
Power Configuration	2 Power	No cost
	1 Power 1 USB A 1 USB C	+\$88

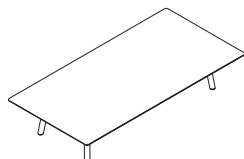
### Specification Information

Dimensions					Prices	
D	W	H	Style Number	Top Finish Group	Leg Type:	
					Metal	Wood

<b>Maarten 31 1/2" High Square Table</b>						
31 1/2"	31 1/2"	29 1/10"	<b>VCBMAA80</b>	Stain Price Group 1	\$1367	\$1845
				Stain Price Group 2	\$1463	\$2133
				Lacquers MDF Microtexture PG1	\$1422	\$2037
				Lacquers MDF Microtexture PG2	\$1463	\$2133
				High-Pressure Laminate PG1	\$1611	\$2099

# Tables

## Maarten



Tip: Contrasting option is available for metal legs only.

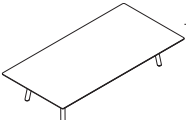
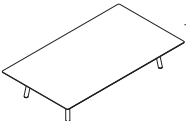
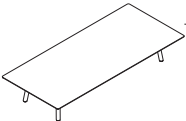
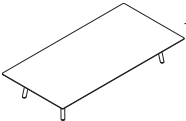
### Standard Includes

- Top: lacquered MDF
- Top: stained natural oak
- Calibrated steel legs powder coated in thermoreinforced polyester: black, white, or stained oak veneer
- Legs: paint price group 1 or stained oak veneer, if selected

### Options

Leg Type	Metal Legs	Prices below
	Wood Legs	Prices below
Contrasting Option	Contrasting	No cost
	Non Contrasting	No cost

### Specification Information

Dimensions	Style Number	Top Finish Group	Prices				
			Leg Type: Metal	Wood			
<b>Maarten 31 1/2" x 63" Low Rectangle Table</b>							
	31 1/2"	63"	11 4/5"	<b>VCBMAAB160</b>	Stain Price Group 1	\$1449	\$1955
					Stain Price Group 2	\$1559	\$2269
					Lacquers MDF Microtexture PG1	\$1491	\$2188
					Lacquers MDF Microtexture PG2	\$1559	\$2269
					High-Pressure Laminate PG1	\$1892	\$2466
<b>Maarten 35 2/5" x 63" Low Rectangle Table</b>							
	35 2/5"	63"	11 4/5"	<b>VCBMAAB16090</b>	Stain Price Group 1	\$1614	\$2201
					Stain Price Group 2	\$1764	\$2543
					Lacquers MDF Microtexture PG1	\$1668	\$2434
					Lacquers MDF Microtexture PG2	\$1764	\$2543
					High-Pressure Laminate PG1	\$2112	\$2747
<b>Maarten 31 1/2" x 70 9/10" Low Rectangle Table</b>							
	31 1/2"	70 9/10"	11 4/5"	<b>VCBMAAB180</b>	Stain Price Group 1	\$1546	\$2093
					Stain Price Group 2	\$1709	\$2461
					Lacquers MDF Microtexture PG1	\$1599	\$2366
					Lacquers MDF Microtexture PG2	\$1709	\$2461
					High-Pressure Laminate PG1	\$2148	\$2784
<b>Maarten 35 2/5" x 70 9/10" Low Rectangle Table</b>							
	35 2/5"	70 9/10"	11 4/5"	<b>VCBMAAB18090</b>	Stain Price Group 1	\$1751	\$2351
					Stain Price Group 2	\$1901	\$2761
					Lacquers MDF Microtexture PG1	\$1804	\$2653
					Lacquers MDF Microtexture PG2	\$1901	\$2761
					High-Pressure Laminate PG1	\$2209	\$2881

► Product Information continued on next page

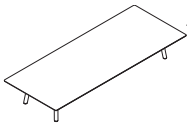
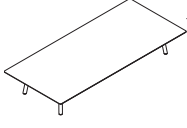
Tables

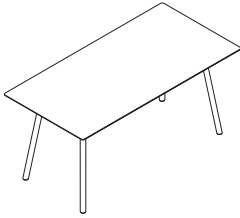
# Tables

## Maarten

► Product Information continued from previous page

### Specification Information

					Prices	
Dimensions			Style Number	Top Finish Group	Leg Type:	
D	W	H			Metal	Wood
<b>Maarten 31 1/2" x 78 7/10" Low Rectangle Table</b>						
	31 1/2"	78 7/10"	11 4/5"	<b>VCBMAAB200</b>	Stain Price Group 1	\$1559 \$2119
					Stain Price Group 2	\$1832 \$2653
					Lacquers MDF Microtexture PG1	\$1722 \$2543
					Lacquers MDF Microtexture PG2	\$1832 \$2653
					High-Pressure Laminate PG1	\$2405 \$3125
<b>Maarten 35 2/5" x 78 7/10" Low Rectangle Table</b>						
	35 2/5"	78 7/10"	11 4/5"	<b>VCBMAAB20090</b>	Stain Price Group 1	\$1764 \$2366
					Stain Price Group 2	\$2037 \$2967
					Lacquers MDF Microtexture PG1	\$1927 \$2858
					Lacquers MDF Microtexture PG2	\$2037 \$2967
					High-Pressure Laminate PG1	\$2527 \$3296



*Tip: Contrasting option is available for metal legs only.*

**Standard Includes**

- Top: stained natural oak
- Legs: paint price group 1 or stained oak veneer, if selected

**Options**

Leg Type	Metal Legs	Prices below
	Wood Legs	Prices below
Contrasting Option	Contrasting	No cost
	Non Contrasting	No cost
Power Option	No Power	No cost
	With U.S. Power	Prices below
Power Location	160 - Power A - 1 Centered	+\$523
	160 - Power B - 1 Edge	+\$523
	180 - Power A - 1 Centered	+\$523
	180 - Power B - 1 Edge	+\$523
	200 - Power B - 1 Centered	+\$523
	200 - Power C - 1 Edge	+\$523
Power Finish	Paint Price Group 01	No cost
	Paint Price Group 02	No cost
Power Configuration	3 Power	No cost
	2 Power + 1 USB A+C	+\$96

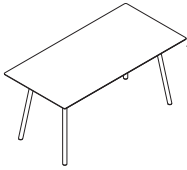
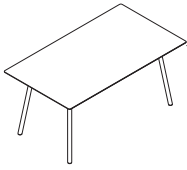
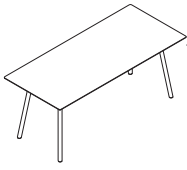
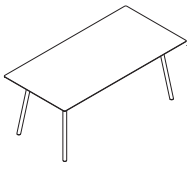
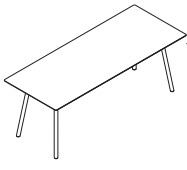
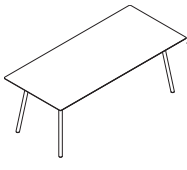
► **Product Information continued on next page**

# Tables

## Maarten

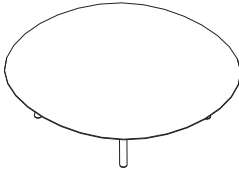
► **Product Information continued from previous page**

### Specification Information

					Prices	
Dimensions			Style Number	Top Finish Group	Leg Type:	
D	W	H			Metal	Wood
						
<b>Maarten 31 1/2" x 63" High Rectangle Table</b>						
31 1/2"	63"	29 1/10"	<b>VCBMAA160</b>	Stain Price Group 1	\$1599	\$2175
				Stain Price Group 2	\$1751	\$2516
				Lacquers MDF Microtexture PG1	\$1668	\$2420
				Lacquers MDF Microtexture PG2	\$1751	\$2516
				High-Pressure Laminate PG1	\$2112	\$2747
						
<b>Maarten 35 2/5" x 63" High Rectangle Table</b>						
35 2/5"	63"	29 1/10"	<b>VCBMAA16090</b>	Stain Price Group 1	\$1804	\$2434
				Stain Price Group 2	\$1941	\$2830
				Lacquers MDF Microtexture PG1	\$1860	\$2721
				Lacquers MDF Microtexture PG2	\$1941	\$2830
				High-Pressure Laminate PG1	\$2344	\$3052
						
<b>Maarten 31 1/2" x 70 9/10" High Rectangle Table</b>						
31 1/2"	70 9/10"	29 1/10"	<b>VCBMAA180</b>	Stain Price Group 1	\$1709	\$2338
				Stain Price Group 2	\$1888	\$2735
				Lacquers MDF Microtexture PG1	\$1791	\$2242
				Lacquers MDF Microtexture PG2	\$1888	\$2338
				High-Pressure Laminate PG1	\$2381	\$3089
						
<b>Maarten 35 2/5" x 70 9/10" High Rectangle Table</b>						
35 2/5"	70 9/10"	29 1/10"	<b>VCBMAA18090</b>	Stain Price Group 1	\$1927	\$2612
				Stain Price Group 2	\$2119	\$3076
				Lacquers MDF Microtexture PG1	\$1996	\$2940
				Lacquers MDF Microtexture PG2	\$2119	\$3076
				High-Pressure Laminate PG1	\$2466	\$3211
						
<b>Maarten 31 1/2" x 78 7/10" High Rectangle Table</b>						
31 1/2"	78 7/10"	29 1/10"	<b>VCBMAA200</b>	Stain Price Group 1	\$1751	\$2351
				Stain Price Group 2	\$2024	\$2940
				Lacquers MDF Microtexture PG1	\$1914	\$2830
				Lacquers MDF Microtexture PG2	\$2024	\$2940
				High-Pressure Laminate PG1	\$2674	\$3467
						
<b>Maarten 35 2/5" x 78 7/10" High Rectangle Table</b>						
35 2/5"	78 7/10"	29 1/10"	<b>VCBMAA20090</b>	Stain Price Group 1	\$1941	\$2639
				Stain Price Group 2	\$2282	\$3295
				Lacquers MDF Microtexture PG1	\$2146	\$3172
				Lacquers MDF Microtexture PG2	\$2282	\$3295
				High-Pressure Laminate PG1	\$2808	\$3662

# Tables

## Maarten



Tip: Contrasting option is available for metal legs only.

### Standard Includes

- Top: stained natural oak
- Legs: paint price group 1 or stained oak veneer, if selected

### Options

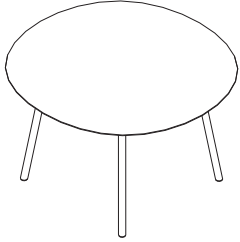
Leg Type	Metal Legs	Prices below
	Wood Legs	Prices below
Contrasting Option	Contrasting	No cost
	Non Contrasting	No cost

### Specification Information

					Prices	
Dimensions			Style	Top	Leg Type:	
D	W	H	Number	Finish Group	Metal	Wood
<b>Maarten 47 1/5" Low Oval Table</b>						
	47 1/5"	49"	11 4/5"	<b>VCBMAABD120</b>	Stain Price Group 1	\$1722 \$2024
					Stain Price Group 2	\$1860 \$2351
					Lacquers MDF Microtexture PG1	\$1764 \$2269
					Lacquers MDF Microtexture PG2	\$1860 \$2351
					High-Pressure Laminate PG1	\$2124 \$2771
<b>Maarten 63" Low Oval Table</b>						
	63"	65 2/5"	11 4/5"	<b>VCBMAABD160</b>	Stain Price Group 1	\$2269 \$2679
					Stain Price Group 2	\$2461 \$3145
					Lacquers MDF Microtexture PG1	\$2338 \$3008
					Lacquers MDF Microtexture PG2	\$2461 \$3145
					High-Pressure Laminate PG1	\$4193 \$5531

# Tables

## Maarten



Tip: Contrasting option is available for metal legs only.

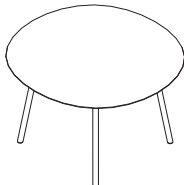
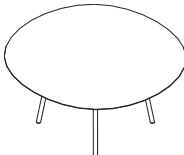
### Standard Includes

- Top: stained natural oak
- Legs: paint price group 1 or stained oak veneer, if selected

### Options

Leg Type	Metal Legs	Prices below
	Wood Legs	Prices below
Contrasting Option	Contrasting	No cost
	Non Contrasting	No cost
Power Option	No Power	No cost
	With U.S. Power	Prices below
Power Location	120 - Power OA - 1 Centered	+\$523
	160 - Power OA - 1 Centered	+\$523
Power Finish	Paint Price Group 01	No cost
	Paint Price Group 02	No cost
Power Configuration	3 Power	No cost
	2 Power + 1 USB A+C	+\$96

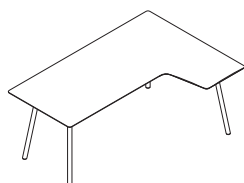
### Specification Information

Dimensions	Style	Top	Prices			
			Leg Type:			
D	W	H	Number	Finish Group	Metal	Wood
<b>Maarten 47 1/5" High Oval Table</b>						
	47 1/5"	49"	29 1/10"	<b>VCBMAAD120</b>	Stain Price Group 1	\$1901 \$2242
					Stain Price Group 2	\$2064 \$2625
					Lacquers MDF Microtexture PG1	\$1941 \$2516
					Lacquers MDF Microtexture PG2	\$2064 \$2625
					High-Pressure Laminate PG1	\$2369 \$3076
<b>Maarten 63" High Oval Table</b>						
	63"	65 2/5"	29 1/10"	<b>VCBMAAD160</b>	Stain Price Group 1	\$2516 \$2967
					Stain Price Group 2	\$2748 \$3473
					Lacquers MDF Microtexture PG1	\$2597 \$3350
					Lacquers MDF Microtexture PG2	\$2748 \$3487
					High-Pressure Laminate PG1	\$4731 \$6145



# Tables

## Maarten



Tip: Contrasting option is available for metal legs only.

Tip: Return position is determined from the seated user position. Return right side facing is shown.

### Standard Includes

- Top: stained natural oak
- Legs: paint price group 1 or stained oak veneer, if selected

### Options

Leg Type	Metal Legs Wood Legs	Prices below Prices below
Contrasting Option	Contrasting Non Contrasting	No cost No cost
Return Position	Return Left Side Facing Return Right Side Facing	No cost No cost
Power Option	No Power With U.S. Power	No cost Prices below
Power Location	180 - Power DA - 1 Edge 180 - Power DB - 1 Return	+\$523 +\$523
Power Finish	Paint Price Group 01 Paint Price Group 02	No cost No cost
Power Configuration	3 Power 2 Power + 1 USB A+C	No cost +\$96

### Specification Information

Dimensions				Style Number	Top Finish Group	Prices	
D	W	H	Metal			Wood	

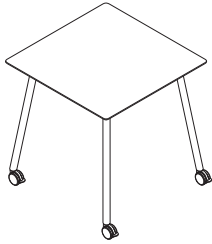
### Maarten 47 1/5" x 70 9/10" High Return Table

47 1/5"	70 9/10"	29 1/10"	<b>VCBMAAA180</b>	Stain Price Group 1	\$2242	\$3008
				Stain Price Group 2	\$2448	\$3569
				Lacquers MDF Microtexture PG1	\$2311	\$3418
				Lacquers MDF Microtexture PG2	\$2448	\$3569
				High-Pressure Laminate PG1	\$3223	\$4188



# Tables

## Maarten



### Standard Includes

- Top: stained natural oak
- Legs: paint price group 01
- Castors

### Options

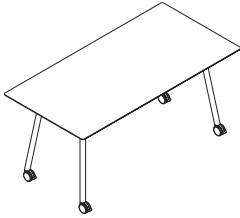
Contrasting Option	Contrasting	No cost
	Non Contrasting	No cost
Caster Opt	Black	No cost
	White	No cost
Power Option	No Power	No cost
	With U.S. Power	Prices below
Power Location	1 Centered	+\$444
Power Finish	Paint Price Group 01	No cost
Power Configuration	2 Power	No cost
	1 Power 1 USB A 1 USB C	+\$88

### Specification Information

Dimensions			Style	Top	Prices
D	W	H	Number	Finish Group	
<b>Maarten 31 1/2" High Square Table with Casters</b>					
31 1/2"	31 1/2"	29 1/10"	<b>VCBMAA80R</b>	Stain Price Group 1	\$1530
				Stain Price Group 2	\$1627
				Lacquers MDF Microtexture PG1	\$1586
				Lacquers MDF Microtexture PG2	\$1627
				High-Pressure Laminate PG1	\$2527

# Tables

## Maarten



### Standard Includes

- Top: stained natural oak
- Legs: paint price group 01
- Castors

### Options

Contrasting Option	Contrasting	No cost
	Non Contrasting	No cost
Leg Type	Metal Legs	No cost
Caster Opt	Black	No cost
	White	No cost
Power Option	No Power	No cost
	With U.S. Power	Prices below
Power Location	160 - Power A - 1 Centered	+\$523
	160 - Power B - 1 Edge	+\$523
	180 - Power A - 1 Centered	+\$523
	180 - Power B - 1 Edge	+\$523
	200 - Power B - 1 Centered	+\$523
	200 - Power C - 1 Edge	+\$523
Power Finish	Paint Price Group 01	No cost
	Paint Price Group 02	No cost
Power Configuration	3 Power	No cost
	2 Power + 1 USB A+C	+\$96

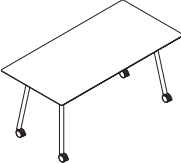
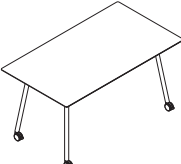
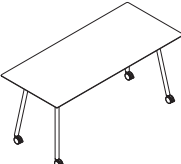
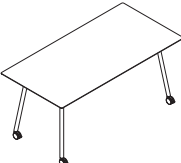
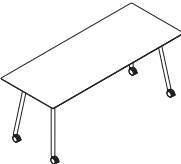
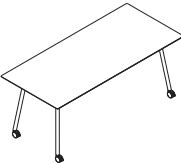
► **Product Information continued on next page**

# Tables

## Maarten

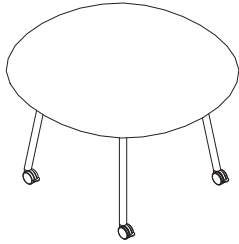
► Product Information continued from previous page

### Specification Information

	Dimensions			Style Number	Top Finish Group	Prices
	D	W	H			
	<b>Maarten 31 1/2" x 63" High Rectangle Table with Casters</b>					
	31 1/2"	63"	29 1/10"	<b>VCBMAA160R</b>	Stain Price Group 1	\$1778
					Stain Price Group 2	\$1914
					Lacquers MDF Microtexture PG1	\$1832
					Lacquers MDF Microtexture PG2	\$1914
				High-Pressure Laminate PG1	\$3259	
	<b>Maarten 35 2/5" x 63" High Rectangle Table with Casters</b>					
	35 2/5"	63"	29 1/10"	<b>VCBMAA16090R</b>	Stain Price Group 1	\$1970
					Stain Price Group 2	\$2119
					Lacquers MDF Microtexture PG1	\$2024
					Lacquers MDF Microtexture PG2	\$2119
				High-Pressure Laminate PG1	\$3601	
	<b>Maarten 31 1/2" x 70 9/10" High Rectangle Table with Casters</b>					
	31 1/2"	70 9/10"	29 1/10"	<b>VCBMAA180R</b>	Stain Price Group 1	\$1873
					Stain Price Group 2	\$2051
					Lacquers MDF Microtexture PG1	\$1955
					Lacquers MDF Microtexture PG2	\$2051
				High-Pressure Laminate PG1	\$3662	
	<b>Maarten 35 2/5" x 70 9/10" High Rectangle Table with Casters</b>					
	35 2/5"	70 9/10"	29 1/10"	<b>VCBMAA18090R</b>	Stain Price Group 1	\$2093
					Stain Price Group 2	\$2282
					Lacquers MDF Microtexture PG1	\$2175
					Lacquers MDF Microtexture PG2	\$2282
				High-Pressure Laminate PG1	\$3772	
	<b>Maarten 31 1/2" x 78 7/10" High Rectangle Table with Casters</b>					
	31 1/2"	78 7/10"	29 1/10"	<b>VCBMAA200R</b>	Stain Price Group 1	\$1914
					Stain Price Group 2	\$2201
					Lacquers MDF Microtexture PG1	\$2078
					Lacquers MDF Microtexture PG2	\$2201
				High-Pressure Laminate PG1	\$4090	
	<b>Maarten 35 2/5" x 78 7/10" High Rectangle Table with Casters</b>					
	35 2/5"	78 7/10"	29 1/10"	<b>VCBMAA20090R</b>	Stain Price Group 1	\$2119
					Stain Price Group 2	\$2448
					Lacquers MDF Microtexture PG1	\$2311
					Lacquers MDF Microtexture PG2	\$2448
				High-Pressure Laminate PG1	\$4285	

# Tables

## Maarten



### Standard Includes

- Top: stained natural oak
- Legs: paint price group 01
- Castors

### Options

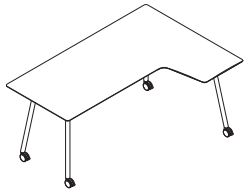
Contrasting Option	Contrasting	No cost
	Non Contrasting	No cost
Caster Opt	Black	No cost
	White	No cost
Power Option	No Power	No cost
	With U.S. Power	Prices below
Power Location	120 - Power OA - 1 Centered	+\$523
	160 - Power OA - 1 Centered	+\$523
Power Finish	Paint Price Group 01	No cost
	Paint Price Group 02	No cost
Power Configuration	3 Power	No cost
	2 Power + 1 USB A+C	+\$96

### Specification Information

	Dimensions			Style Number	Top Finish Group	Prices
	D	W	H			
	<b>Maarten 47 1/5" High Oval Table with Casters</b>					
	47 1/5"	49"	29 1/10"	<b>VCBMAAD120R</b>	Stain Price Group 1	\$2064
					Stain Price Group 2	\$2242
					Lacquers MDF Microtexture PG1	\$2119
					Lacquers MDF Microtexture PG2	\$2242
	<b>Maarten 63" High Oval Table with Casters</b>					
	63"	65 2/5"	29 1/10"	<b>VCBMAAD160R</b>	Stain Price Group 1	\$2693
					Stain Price Group 2	\$2912
					Lacquers MDF Microtexture PG1	\$2761
					Lacquers MDF Microtexture PG2	\$2912

# Tables

## Maarten



Tip: Return position is determined from the seated user position. Return right side facing is shown.

### Standard Includes

- Top: stained natural oak
- Legs: paint price group 01
- Castors

### Options

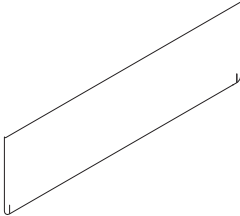
Contrasting Option	Contrasting	No cost
	Non Contrasting	No cost
Return Position	Return Left Side Facing	No cost
	Return Right Side Facing	No cost
Caster Opt	Black	No cost
	White	No cost
Power Option	No Power	No cost
	With U.S. Power	Prices below
Power Location	180 - Power DA - 1 Edge	+\$523
	180 - Power DB - 1 Return	+\$523
Power Finish	Paint Price Group 01	No cost
	Paint Price Group 02	No cost
Power Configuration	3 Power	No cost
	2 Power + 1 USB A+C	+\$96

### Specification Information

Dimensions			Style	Top	Prices
D	W	H	Number	Finish Group	

### Maarten 47 1/5" x 70 9/10" High Return Table with Casters

47 1/5"	70 9/10"	29 1/10"	<b>VCBMAAA180R</b>	Stain Price Group 1	\$2407
				Stain Price Group 2	\$2625
				Lacquers MDF Microtexture PG1	\$2474
				Lacquers MDF Microtexture PG2	\$2625
				High-Pressure Laminate PG1	\$4895

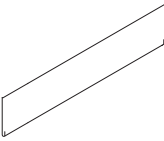
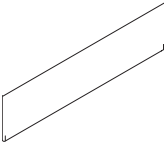
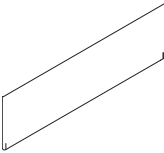


**Standard Includes**

- Screen: solid oak wood

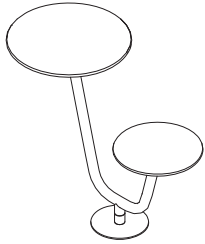
**Specification Information**

Dimensions		Style	Screen	
W	H	Number	Finish Group	Prices
<b>Maarten Modesty Screen for 63"W Table</b>				
44 9/10"	13"	<b>VCBMAAF160</b>	Stain Price Group 1	\$368
			Lacquers on Wood Price Group 1	\$384
			Lacquers on Wood Price Group 2	\$397
			Lacquers on Wood Price Group 3	\$424
<b>Maarten Modesty Screen for 70 9/10"W Table</b>				
52 4/5"	13"	<b>VCBMAAF180</b>	Stain Price Group 1	\$368
			Lacquers on Wood Price Group 1	\$384
			Lacquers on Wood Price Group 2	\$397
			Lacquers on Wood Price Group 3	\$424
<b>Maarten Modesty Screen for 78 7/10"W Table</b>				
52 4/5"	13"	<b>VCBMAAF200</b>	Stain Price Group 1	\$368
			Lacquers on Wood Price Group 1	\$384
			Lacquers on Wood Price Group 2	\$397
			Lacquers on Wood Price Group 3	\$424



# Tables

## Solar



Tip: Stained tops will have a matching stained edge.

### Standard Includes

- Base: powder coated paint in black or white
- Top: compact laminate
- Seat: compact laminate

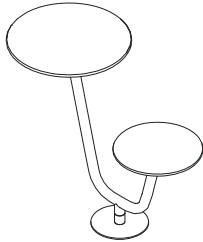
### Specification Information

Dimensions			Style	Top Finish	Seat Finish	Edge	Prices
D	W	H	Number			Finish	
<b>Solar Compact Table with Anchored Base</b>							
19 7/10"	36 2/5"	29 1/2"	<b>VCBSOLAN</b>	Ash, Bleached Oak, Cognac, Matte Oak, or Walnut Oak	Black or White Compact Laminate	Black	\$1404
				Ash, Bleached Oak, Cognac, Matte Oak, or Walnut Oak	White Compact Laminate	White	\$1526
				Black or White Compact Laminate	Black or White Compact Laminate	Black	\$1404
				White Compact Laminate	White Compact Laminate	White	\$1648



# Tables

## Solar



### Standard Includes

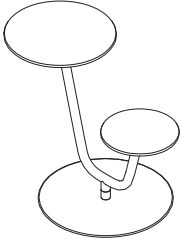
- Base: powder coated paint in black or white
- Top: compact laminate
- Seat cushion: fabric price group 01

### Specification Information

Dimensions			Style Number	Top Finish	Edge Finish	Prices					Leather Grades:	
D	W	H				Fabric Grades:	COM	COL	2			
					1	2	3	4	5			
<b>Solar Compact Table with Anchored Base and Upholstered Seat</b>												
19 7/10"	36 2/5"	29 1/2"	<b>VCBSOLANT</b>	Ash, Bleached Oak, Cognac, Matte Oak, or Walnut Oak	N.A.	\$1585	\$1651	\$1719	\$1787	\$1853	\$1585	\$1853
				Black or White								
				Compact Laminate	Black	\$1611	\$1679	\$1746	\$1813	\$1880	\$1611	\$1880
				White Compact Laminate	White	\$1880	\$1947	\$2014	\$2082	\$2148	\$1880	\$2148

# Tables

## Solar



Tip: Stained tops will have a matching stained edge.

### Standard Includes

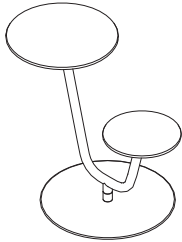
- Base: powder coated paint in black or white
- Top: compact laminate
- Seat: compact laminate

### Specification Information

Dimensions			Style	Top Finish	Seat Finish	Edge	Prices
D	W	H	Number			Finish	

### Solar Compact Table with Freestanding Base

23 3/5"	36 2/5"	29 1/2"	<b>VCBSOL</b>	Ash, Bleached Oak, Cognac, Matte Oak, or Walnut Oak	Black or White Compact Laminate	Black	\$2075
				Ash, Bleached Oak, Cognac, Matte Oak, or Walnut Oak	White Compact Laminate	White	\$2160
				Black or White Compact Laminate	Black or White Compact Laminate	Black	\$2075
				White Compact Laminate	White Compact Laminate	White	\$2344



**Standard Includes**

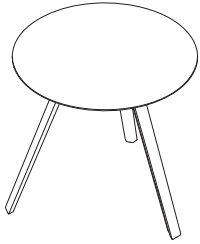
- Base: powder coated paint in black or white
- Top: compact laminate
- Seat cushion: fabric price group 01

**Specification Information**

Dimensions			Style Number	Top Finish	Edge Finish	Prices					Leather Grades:		
D	W	H				Fabric Grades:	COM	COL	2				
<b>Solar Compact Table with Freestanding Base and Upholstered Seat</b>													
23 3/5"	36 2/5"	29 1/2"	<b>VCBSOLT</b>	Ash, Bleached Oak, Cognac, Matte Oak, or Walnut Oak	N.A.	\$2148	\$2216	\$2282	\$2350	\$2418	\$2148	\$2148	\$2418
				Black or White Compact Laminate	Black	\$2176	\$2242	\$2310	\$2377	\$2444	\$2176	\$2176	\$2444
				White Compact Laminate	White	\$2444	\$2511	\$2578	\$2645	\$2713	\$2444	\$2444	\$2713

# Tables

## Trivio



### Standard Includes

- Top: lacquered MDF
- Legs: solid oak
- Join piece: powder coated paint in black, white, or taupe
- Wire holder: black or white

### Options

Wire Holder Option	No Wire Holder	No cost
	With Wire Holder	+\$40
Wireway Finish	Textile	No cost
Glides	Plastic	No cost
	Felt	+\$10

### Specification Information

Dimensions			Style	Top	Base Prices
Dia.	W	H	Number	Finish Group	

#### Trivio Table

31 1/2"	29 3/10"	29 1/10"	<b>VCBTRIBORO</b>	Lacquered MDF	\$1584
				Stained Ash, Bleached, Cognac, Matte, or Walnut Oak	\$1590
				Black or White High-Pressure Laminate	\$1978

---

# Understanding Low Tables

Standard Import Lead Time

---

**Statement of Line** **498**

**Understanding**

Aleta	<b>500</b>
Bamba	<b>501</b>
Giro	<b>502</b>
Ryutaro	<b>503</b>
Shape	<b>504</b>
Tiers	<b>505</b>
Trino	<b>506</b>

# Statement of Line

## Low Tables

### Aleta



#### Aleta Low Table

Understanding  
▶ Page 500  
Specifying  
▶ Page 508

### Bamba



#### Sculpture Table

Understanding  
▶ Page 501  
Specifying  
▶ Page 509

### Giro



#### Sculpture Table

Understanding  
▶ Page 502  
Specifying  
▶ Page 510

### Ryutaro



#### Low Table 19<sup>7</sup>/<sub>10</sub>" Dia.

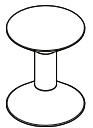
Understanding  
▶ Page 503  
Specifying  
▶ Page 511



#### Medium Table 23<sup>3</sup>/<sub>5</sub>" Dia.

Understanding  
▶ Page 503  
Specifying  
▶ Page 511

### Shape



#### Model H Table

Understanding  
▶ Page 504  
Specifying  
▶ Page 512



#### Model O Table

Understanding  
▶ Page 504  
Specifying  
▶ Page 512

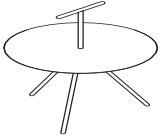


#### Model A Low Table

Understanding  
▶ Page 505  
Specifying  
▶ Page 513

### Tiers

## Trino



### **T Model Table**

Understanding

▶ Page 506

Specifying

▶ Page 514



### **Trino Sphere Model Table**

Understanding

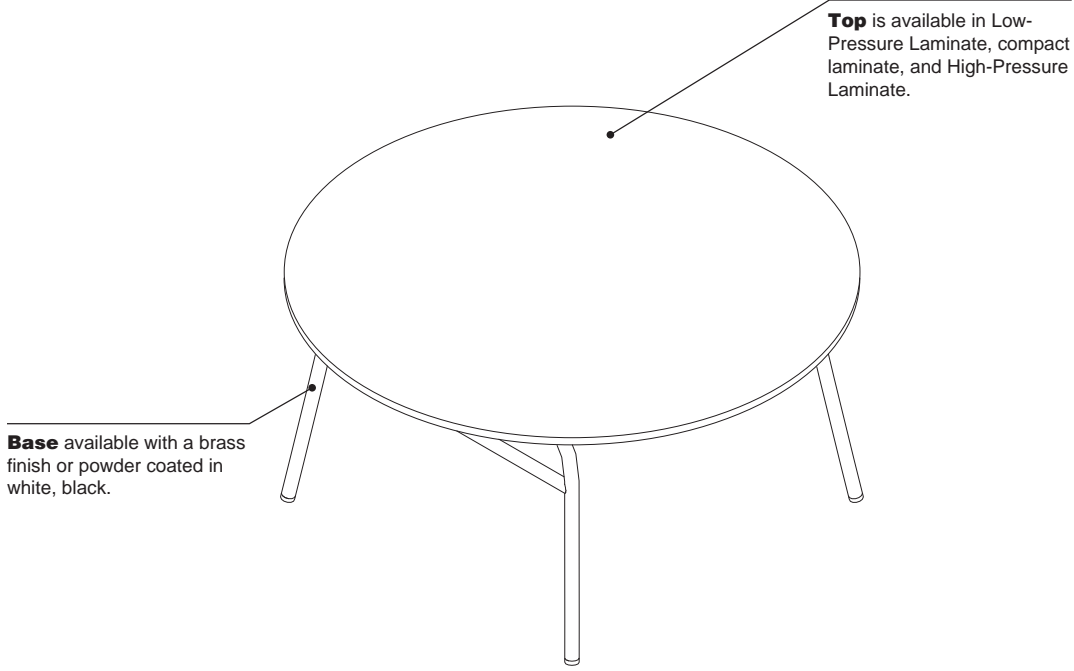
▶ Page 506

Specifying

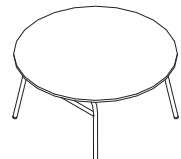
▶ Page 514

# Aleta

**Aleta low table**, designed by Jaime Hayon, adds a touch of elegance as a coffee table or laptop support in casual meetings or video calls. It's available in different finishes with metal legs.  
 ▶ Specifying, page 508



## Product Details



**Aleta table** is available in three top thicknesses.

**Low-Pressure Laminate (LPL) thickness** is 3/4", in black or white with matching white or black edge.

**High-Pressure Laminate (HPL) thickness** is 3/4", in black or white with a stained edge.

**Compact laminate thickness** is 1/2", in white with black or white edge or black with black edge only.

## Surface Materials

- Base**
- 9003 White RAL
  - 9005 Black RAL
  - Brass

- Top**
- Low-Pressure Laminate:
- Black top/black edge
  - White top/white edge

- High-Pressure Laminate:
- Black top/stained edge
  - White top/stained edge

- Compact Laminate:
- White top/black edge
  - Black top/black edge
  - White top/white edge

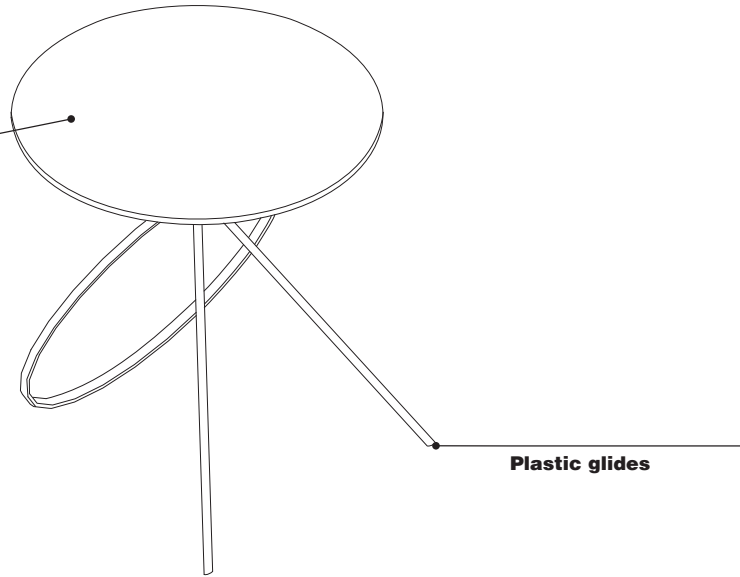
## Actual Dimensions

Description	Style Number	Diameter	Height	Weight
Low Table – Compact Laminate	<b>VCBALMEB8047</b>	31 1/2"	15 7/10"	40.0 lb
Low Table – Low-Pressure Laminate	<b>VCBALMEB8075</b>	31 1/2"	15 7/10"	40.0 lb
Low Table – High-Pressure Laminate	<b>VCBALMEB8075</b>	31 1/2"	15 7/10"	40.0 lb



**Bamba low tables** represent the symbiosis of sculpture and balance. Composed of a metal tabletop and a base comprised of a circle and two metal rods that evoke the "slashed O", the emblem of Brazilian designer Pedro Paulo-Venzon.  
 ▶ Specifying, page 509

**Table top and base** are steel and available in black or white paint.



### Product Details

**Bamba** is one piece steel construction powder coated in black or white with plastic glides.

### Surface Materials

- Table**
- 9003 White RAL
  - 9005 Black RAL

### Actual Dimensions

Description	Style Number	Base Depth	Base Width	Table Top Diameter	Height	Weight
Sculpture Table	VCBBAMBA	21 <sup>7</sup> / <sub>10</sub> "	21 <sup>3</sup> / <sub>10</sub> "	21 <sup>7</sup> / <sub>10</sub> "	20 <sup>1</sup> / <sub>2</sub> "	32.8 lb

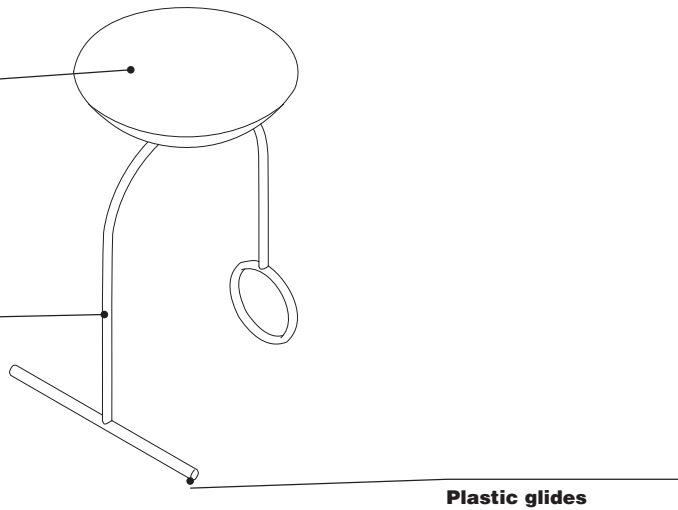
# Giro

**Giro**, designed by Pedro Paulo-Venzon, is a minimalist, geometric side table. The artistic yet functional side table combines a steel frame with a matte oak table top, creating a sculptural design that represents the perfect balance between art and furniture.

► Specifying, page 510

**Table top** is solid oak.

**Base** is available in black, white, or brass.



## Product Details

**Table top** is a 12" diameter stained natural oak table top. Base is available in black, white, or brass.

## Surface Materials

### Base

- 9003 White RAL
- 9005 Black RAL
- Brass

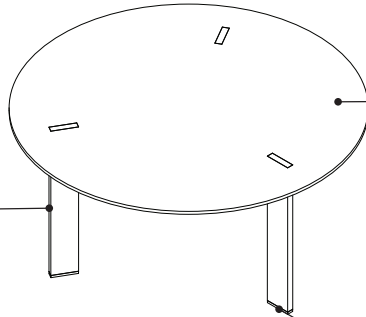
### Top

- 9003 White RAL
- 9005 Black RAL
- Ash
- Bleached oak
- Cognac
- Matte oak
- Walnut oak

## Actual Dimensions

Description	Style Number	Width	Height	Table Top Diameter	Frame Depth	Weight
Sculpture Table	<b>VCBGIRO</b>	13"	21 <sup>7</sup> / <sub>10</sub> "	12"	14 <sup>1</sup> / <sub>5</sub> "	11.9 lb

**Ryutaro**, designed by Victor Carrasco, is a low table style for any living room or waiting area. The steel legs are mortised through the top, creating a singular look.  
 ▶ Specifying, page 511



**Base** is available in black or white paint.

**Top** is available painted MDF or oak veneer.

**Plastic glides**

### Product Details

**Ryutaro low tables** are available in three sizes. Table top is available in painted MDF or oak veneer. Base is powder coated in black or white.

### Surface Materials

#### Base

- 9003 White RAL
- 9005 Black RAL

#### Top

##### Lacquered MDF

- 050 50 30 Brick RAL
- 060 70 20 Dusty Pink RAL
- 090 40 30 Olive Green RAL
- 1011 Ochre RAL
- 1019 Taupe RAL
- 7034 Dusty Green RAL
- 9003 White RAL
- 9005 Black RAL
- Bronze

##### Stained

- Ash
- Bleached oak
- Cognac
- Matte oak
- Walnut oak

*Tip: The range of lacquered colors have a smooth finish except for black, which has a lacquered microtextured finish.*

### Actual Dimensions

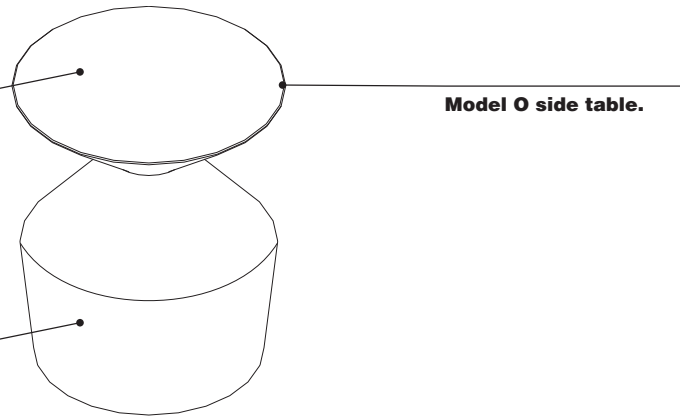
Description	Style Number	Diameter	Height	Weight
Low Table—19 <sup>7</sup> / <sub>10</sub> " Dia.	<b>VCBRYD50H25</b>	19 <sup>7</sup> / <sub>10</sub> "	9 <sup>4</sup> / <sub>5</sub> "	11.5 lb
Medium Table—23 <sup>3</sup> / <sub>5</sub> " Dia.	<b>VCBRYD60H30</b>	23 <sup>3</sup> / <sub>5</sub> "	11 <sup>4</sup> / <sub>5</sub> "	14.8 lb

# Shape

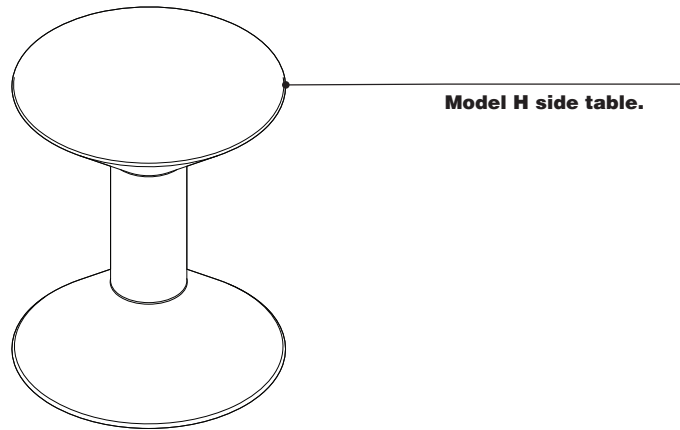
**Shape** is a decorative table, designed by Jorge Pensi, that adds a special touch to the decoration and design element to every space where it's used.  
 ▶ Specifying, page 512

**Table** available in lacquered MDF.

**Base** is powder coated paint.



**Model O side table.**



**Model H side table.**

## Product Details

**Shape side tables** are manufactured in MDF and painted.

**Shape side tables** are available in a model H and a model O.

## Surface Materials

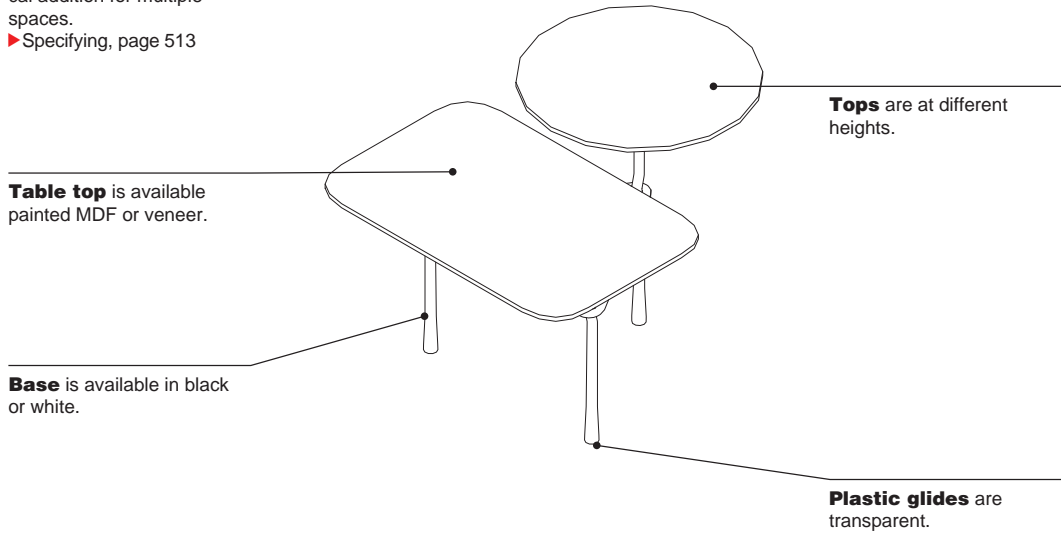
### Base and top Lacquered MDF

- 050 50 30 Brick RAL
- 060 70 20 Dusty Pink RAL
- 090 40 30 Olive Green RAL
- 1011 Ochre RAL
- 2019 Taupe RAL
- 7034 Dusty Green RAL
- 9003 White Matte RAL
- 9005 Black Matte RAL
- Bronze Matte

## Actual Dimensions

Description	Style Number	Top Diameter	Height	Weight
Table — Model H	<b>VCBSHH</b>	15"	17 <sup>7</sup> / <sub>10</sub> "	33.1 lb
Table — Model O	<b>VCBSHO</b>	15"	17 <sup>7</sup> / <sub>10</sub> "	33.7 lb

**Tiers low table** is a design by Patricia Urquiola and is composed of two tabletops attached in different heights. Its carefully thought out details make this low table a practical addition for multiple spaces.  
 ▶ Specifying, page 513



### Product Details

**Tiers** is composed of a base and two table tops: a rectangular top and a 14<sup>1</sup>/<sub>5</sub>" round top at different heights.

### Surface Materials

#### Base

- 9003 White RAL
- 9005 Black RAL

#### Top Lacquered MDF

- 050 50 30 Brick RAL
- 060 70 20 Dusty Pink RAL
- 090 40 30 Olive Green RAL
- 1011 Ochre RAL
- 1019 Taupe RAL
- 7034 Dusty Green RAL
- 9003 White RAL
- 9005 Black RAL
- Bronze

#### Stained

- Ash
- Bleached oak
- Cognac
- Matte oak
- Walnut oak

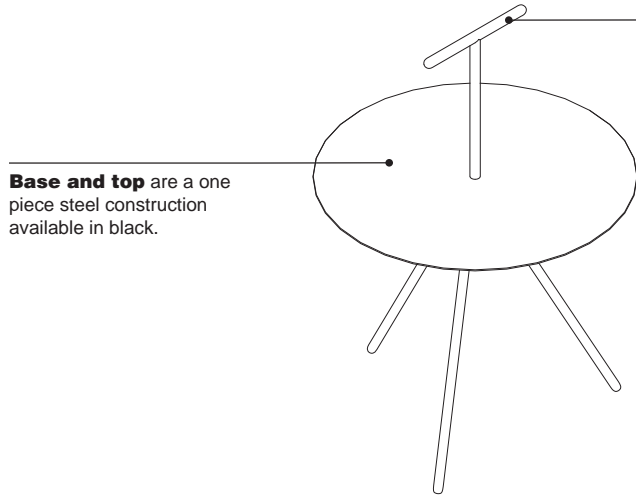
*Tip: The range of lacquered colors have a smooth finish except for black, which has a lacquered microtextured finish.*

### Actual Dimensions

Description	Style Number	Depth	Width	Height	Weight
Table	<b>VCBT1AB</b>	19 <sup>1</sup> / <sub>10</sub> "	22 <sup>4</sup> / <sub>5</sub> "	16 <sup>3</sup> / <sub>10</sub> "	16.5 lb

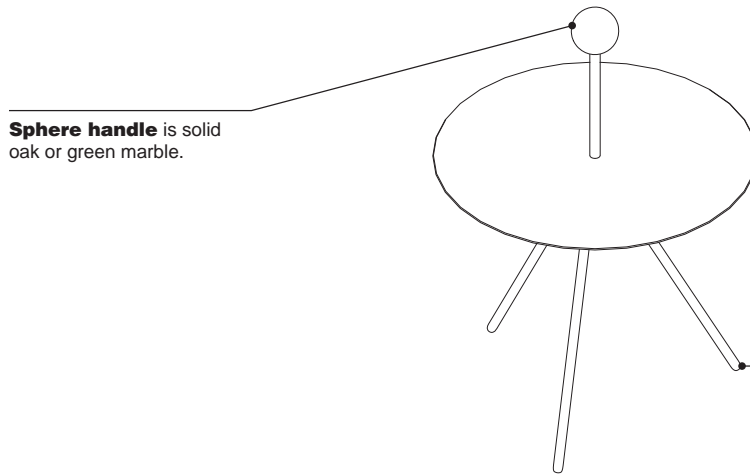
# Trino

**Trino low tables**, designed by Elisa Ossino, are elegant and easy to move tables with a handle.  
 ▶ Specifying, page 514



**Base and top** are a one piece steel construction available in black.

**Two handle models** available to allow easy movement of table. T model table shown to left.



**Sphere handle** is solid oak or green marble.

**Plastic glides**

## Product Details

**Trino low tables** are available in a T model and two different sphere models, one with a matte oak sphere and one with a green marble sphere.

**The sphere handle on the sphere model table** is 2 1/2" in diameter. The Trino T model table's handle is 7" in length.

## Surface Materials

- Table**
- 9005 Black RAL

## Actual Dimensions

Description	Style Number	Width	Depth	Height	Table Height	Weight
T Model	<b>VCBTRIR</b>	17 <sup>7</sup> / <sub>10</sub> "	17 <sup>7</sup> / <sub>10</sub> "	25 <sup>2</sup> / <sub>5</sub> "	15 <sup>7</sup> / <sub>10</sub> "	15.0 lb
Oak Sphere Model	<b>VCBTRIRO</b>	17 <sup>7</sup> / <sub>10</sub> "	17 <sup>7</sup> / <sub>10</sub> "	25 <sup>2</sup> / <sub>5</sub> "	15 <sup>7</sup> / <sub>10</sub> "	14.8 lb
Green Marble Sphere Model	<b>VCBTRIM</b>	17 <sup>7</sup> / <sub>10</sub> "	17 <sup>7</sup> / <sub>10</sub> "	25 <sup>2</sup> / <sub>5</sub> "	15 <sup>7</sup> / <sub>10</sub> "	15.7 lb

---

# Specifying Low Tables

Standard Import Lead Time

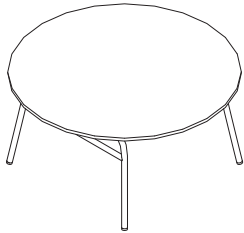
---

## Specifying

Aleta	<b>508</b>
Bamba	<b>509</b>
Giro	<b>510</b>
Ryutaro	<b>511</b>
Shape	<b>512</b>
Tiers	<b>513</b>
Trino	<b>514</b>

# Low Tables

## Aleta



*Tip: VCBALMEB8047 can have a black edge with a black or white top. A white edge with a white top is also available.*

*Tip: VCBALMEB8075 can have a black top with a black edge and a white top with a white edge.*

### Standard Includes

- Top: Low-Pressure Laminate price group 01
- Base: brass finish or powder coated paint in black or white

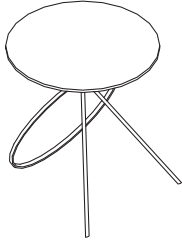
### Specification Information

Dimensions				Style Number	Base Finish Group	Prices	
Di.	H	Top Thickness	Edge Finish: Black Edge			White Edge	
<b>Aleta Low Table - Low-Pressure Laminate</b>							
31 1/2"	15 7/10"	3/4"	<b>VCBALMEB8075</b>	Black or White	\$1251	\$1251	
				Brass	\$1791	\$1791	
<b>Aleta Low Table - Compact Laminate</b>							
31 1/2"	15 7/10"	1/2"	<b>VCBALMEB8047</b>	Black or White	\$1627	\$2180	
				Brass	\$2093	\$2796	



# Low Tables

## Bamba



*Tip: Table top diameter is 21 7/10" and overhangs the frame slightly.*

### Standard Includes

- Top and base: powder coated paint in black or white
- Glides: plastic

### Specification Information

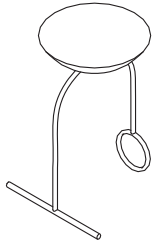
Dimensions		Style	Base	Price
Dia.	H	Number	Finish Group	

### Bamba Sculpture Table

21 7/10"	20 1/2"	<b>VCBBAMBA</b>	Black or White	\$1094
----------	---------	-----------------	----------------	--------

# Low Tables

## Giro



### Standard Includes

- Top: stained natural oak
- Base: brass finish or powder coated paint in black or white
- Glides: plastic

### Specification Information

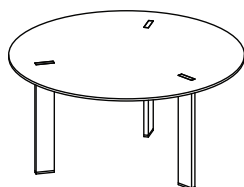
Dimensions			Style	Base	Price
D	W	H	Number	Finish Group	

### Giro Sculpture Table

14 1/5"	13"	21 7/10"	<b>VCBGIRO</b>	Black or White	\$1394
				Brass	\$1751

# Low Tables

## Ryutaro



### Standard Includes

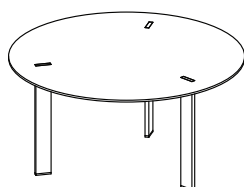
- Top: stained oak veneer or lacquered MDF
- Base: powder coated paint in black or white

### Specification Information

Dimensions		Style	Top	Price
Dia.	H	Number	Finish Group	

### Ryutaro 19 7/10" Low Table

19 7/10"	9 4/5"	<b>VCBRYD50H25</b>	Stained Matte Oak	\$657
			Lacquered MDF Black or White	\$683
			Stained Ash, Cognac, Bleached Oak, or Walnut Oak	\$725
			Lacquered MDF Brick, Dusty Green, Dusty Pink, Olive Green, Ochre, or Taupe	\$725
			Lacquered MDF Bronze	\$752



### Standard Includes

- Top: stained oak veneer or lacquered MDF
- Base: powder coated paint in black or white

### Specification Information

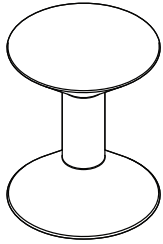
Dimensions		Style	Top	Price
Dia.	H	Number	Finish Group	

### Ryutaro 23 3/5" Medium Table

23 3/5"	11 4/5"	<b>VCBRYD60H30</b>	Stained Matte Oak	\$739
			Lacquered MDF Black or White	\$779
			Stained Ash, Cognac, Bleached Oak, or Walnut Oak	\$807
			Lacquered MDF Brick, Dusty Green, Dusty Pink, Olive Green, Ochre, or Taupe	\$807
			Lacquered MDF Bronze	\$834

# Low Tables

## Shape



### Standard Includes

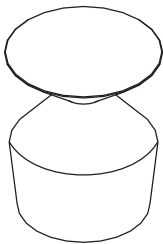
- Table: lacquered MDF

### Specification Information

Dimensions			Style	Base and Top	Price
D	W	H	Number	Finish Group	

### Shape Model H Table

15"	15"	17 7/10"	<b>VCBSHH</b>	White, Black, Taupe, Brick, Ochre, Dusty Pink, Dusty Green, or Olive Green	\$1354
				Lacquered Bronze	\$1422



### Standard Includes

- Table: lacquered MDF

### Specification Information

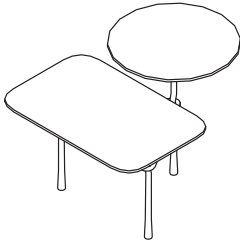
Dimensions			Style	Base and Top	Price
D	W	H	Number	Finish Group	

### Shape Model O Table

15"	15"	17 7/10"	<b>VCBSHO</b>	White, Black, Taupe, Brick, Ochre, Dusty Pink, Dusty Green, or Olive Green	\$1688
				Lacquered Bronze	\$1764

# Low Tables

## Tiers



### Standard Includes

- Top: stained oak veneer or lacquered MDF
- Base: powder coated paint in black or white
- Glides: plastic

### Specification Information

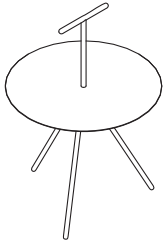
Dimensions			Style	Top	Price
D	W	H	Number	Finish Group	

### Tiers Model A Low Table

19 1/10"	22 4/5"	16 3/10"	<b>VCBT1AB</b>	Stained Matte Oak	\$1052
				Lacquered MDF Black or White	\$1052
				Stained Ash, Cognac, Bleached Oak, or Walnut Oak	\$1094
				Lacquered MDF Brick, Dusty Green, Dusty Pink, Olive Green, Ochre, or Taupe	\$1094
				Lacquered MDF Bronze	\$1136

# Low Tables

## Trino



### Standard Includes

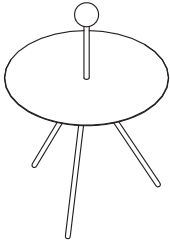
- Base: powder coated paint in black

### Specification Information

Dimensions		Style	Structure	Price
W	H	Number	Finish Group	

### Trino T Model Table

17 7/10"	25 2/5"	<b>VCBTRIR</b>	Black	\$629
----------	---------	----------------	-------	-------



### Standard Includes

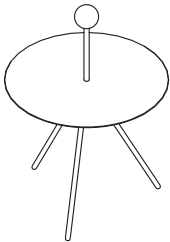
- Base: powder coated paint in black
- Solid oak sphere handle: natural oak

### Specification Information

Dimensions		Style	Price
W	H	Number	

### Trino Oak Sphere Model Table

17 7/10"	25 2/5"	<b>VCBTRIRO</b>	\$725
----------	---------	-----------------	-------



### Standard Includes

- Base: powder coated paint in black
- Marble sphere handle: green

### Specification Information

Dimensions		Style	Price
W	H	Number	

### Trino Green Marble Sphere Model Table

17 7/10"	25 2/5"	<b>VCBTRIM</b>	\$1107
----------	---------	----------------	--------

---

# Understanding Accessories

Standard Import Lead Time

  
**Statement of Line** **516**

  
**Understanding**  
Window **518**

---

# Statement of Line

Accessories

---

## Window



### **Freestanding Coat Hanger**

Understanding  
▶ Page 518  
Specifying  
▶ Page 520



### **Wall Coat Hanger**

Understanding  
▶ Page 518  
Specifying  
▶ Page 520



### **Umbrella Stand**

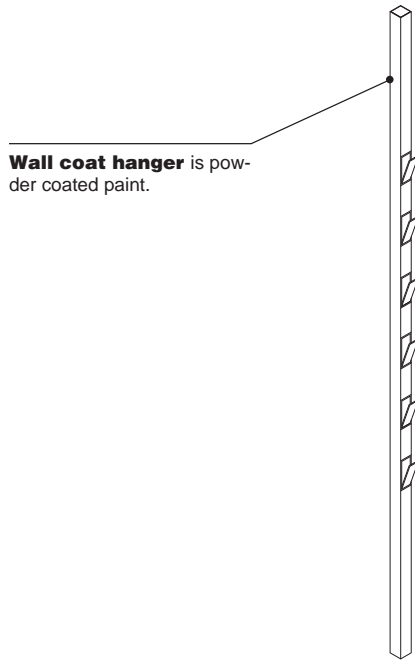
Understanding  
▶ Page 518  
Specifying  
▶ Page 520



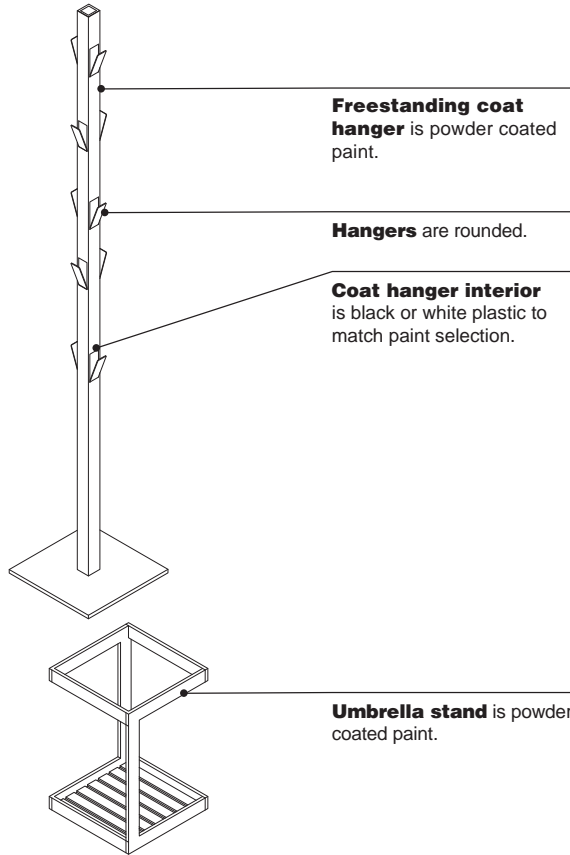


# Window

**Window coat hangers and umbrella stand,** designed by the architect Vincent Van Duysen, are for storing clothes and umbrellas.  
 ▶ Specifying, page 520



**Wall coat hanger** is powder coated paint.



**Freestanding coat hanger** is powder coated paint.

**Hangers** are rounded.

**Coat hanger interior** is black or white plastic to match paint selection.

**Umbrella stand** is powder coated paint.

## Product Details

**Powder coated steel tube in black or white.**

**Polyethylene mousse interior in black or white.**

## Surface Materials

**Coat hanger and umbrella stand**

- 9003 White RAL
- 9005 Black RAL

**Coat hanger interior**

- Black or white plastic

## Actual Dimensions

Description	Style Number	Depth	Width	Height	Weight
Freestanding coat hanger	<b>VCBWIPI</b>	11 <sup>4</sup> / <sub>5</sub> "	11 <sup>4</sup> / <sub>5</sub> "	74 <sup>4</sup> / <sub>5</sub> "	32.8 lb
Wall coat hanger	<b>VCBWIPA</b>	3 <sup>1</sup> / <sub>10</sub> "	1 <sup>3</sup> / <sub>5</sub> "	86 <sup>3</sup> / <sub>5</sub> "	19.6 lb
Umbrella stand	<b>VCBWIPR</b>	11 <sup>4</sup> / <sub>5</sub> "	11 <sup>4</sup> / <sub>5</sub> "	19 <sup>7</sup> / <sub>10</sub> "	13.2 lb

---

# Specifying Accessories

Standard Import Lead Time

---

## Specifying

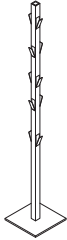
Window

520

Accessories

# Accessories

## Window



### Standard Includes

- Coat hanger: black or white
- Rounded hangers
- Plastic interior: black or white

### Specification Information

Dimensions			Style	Price
D	W	H	Number	

### Window Freestanding Coat Hanger

11 4/5"	11 4/5"	74 4/5"	<b>VCBWIPI</b>	\$739
---------	---------	---------	----------------	-------



### Standard Includes

- Coat hanger: black or white
- Rounded hangers
- Plastic interior: black or white

### Specification Information

Dimensions			Style	Price
D	W	H	Number	

### Window Wall Coat Hanger

3 1/10"	1 3/5"	86 3/5"	<b>VCBWIPA</b>	\$533
---------	--------	---------	----------------	-------



### Standard Includes

- Umbrella stand: black or white

### Specification Information

Dimensions			Style	Price
D	W	H	Number	

### Window Umbrella Stand

11 4/5"	11 4/5"	19 7/10"	<b>VCBWIPR</b>	\$739
---------	---------	----------	----------------	-------

---

# Surface Materials

**Surface Materials**

**522**

Surface Materials

# Surface Materials

**This listing** includes all the surface material choices that are available for the products in this specification guide.

## Standard 4–6 Week Lead Time Surface Materials

### Paint

#### Price Group 1

##### Smooth Paint

- 4242 Milk
- 4710 Low Gloss Black

##### Textured Paint

- 7207 Black
- 7225 Sand
- 7237 Slate
- 7238 Fieldstone
- 7239 Midnight
- 7241 Arctic White
- 7243 Seagull
- 7250 Sterling Dark Solid
- 7278 Dark Bronze
- 7360 Merle

#### Price Group 2

##### Smooth Metallic Paint

- 4728 Nickel Metallic
- 4743 Mineral Metallic
- 4750 Champagne Metallic
- 4798 Sterling Metallic
- 4799 Platinum Metallic
- 4803 Near Black Metallic

##### Smooth Paint

- 4700 Warm White

##### Textured Metallic Paint

- 7245 Carbon Metallic
- 7246 Midnight Metallic

#### Price Group 3

##### Coatings

- 1ATT Cast Shadow

##### Lux Coatings

- 4B20 Obsidian
- 4B22 Matte Brass
- 4B23 Burnished Bronze
- 4B24 Night Bronze
- 4B25 Matte Copper
- 4B26 Smoked Mica
- 4B29 Cast Iron

#### Accent Paint

- 1ATG Rose Quartz
- 4AV3 Blue Jay
- 4AV4 Baltic
- 4AX1 Citron
- 4AY2 Chili
- 4AZ5 Marlin
- 4CL1 Dark Olivine
- 4CL2 Ice Blue
- 4CL3 Aura
- 4CL4 Sea Glass
- 4CL5 Light Matcha
- 4CL6 Terra
- 4CL7 Sandstone
- 4CL8 Smokey Plum
- 4CZ5 Honey
- 4CZ6 Lagoon

#### Price Group 3

##### PerfectMatch

PerfectMatch is a service that allows you to create your own paint color. Refer to the Concierge team for more information about this program.

### Accessory Paint

- 4140 Arctic White Gloss
- 4144 Black Gloss

### Laminate

#### Solid Laminate

- 2722 Cream
- 2730 Arctic White
- 2746 Black
- 2759 Warm White
- 2811 Mist
- 2883 Seagull
- 2884 Milk
- 2885 Dune

#### High-Pressure Laminate

#### Price Group 1

##### Fiber Laminate

- 2850 Vanadium Fiber
- 2852 Tungsten Fiber
- 2854 Vellum Fiber
- 2860 Granite Fiber
- 2862 Stucco Fiber

##### Micro Laminate

- 2920 Marl Micro
- 2921 Gypsum Micro
- 2922 Clay Micro

##### Patina Laminate

- 2870 Blonde Bronze Patina
- 2873 Instant Iron Patina

#### Solid Laminate

- 2722 Cream
- 2730 Arctic White
- 2746 Black
- 2811 Mist
- 2883 Seagull
- 2884 Milk
- 2885 Dune
- 2HAA Persian Salt
- 2HAB Rose
- 2HAC Indigo
- 2HAD Green Citrine
- 2HAE Dark Olivine
- 2HAF Cloudy
- 2HMG Merle

#### Speckle Laminate

- 2820 Coffee Speckle
- 2823 Driftwood Speckle
- 2824 Smoke Speckle
- 2825 Vanadium Speckle

*Tip: Some wood veneer finishes and woodgrain laminates share the same name. Because of the difference in materials, veneers and laminates of the same name are not an exact match but do coordinate with each other.*

#### Woodgrain Laminate

- 2406 Clear Cherry
- 2409 Clear Maple
- 2410 Graphite Walnut
- 2412 Natural Cherry
- 2422 Medium Cherry
- 2511 Winter on Maple
- 2535 Virginia Walnut
- 2536 Blackwood
- 2538 Clear Walnut
- 2592 Blonde on Maple
- 2714 Natural Walnut
- 2HAK Clear Oak
- 2HAN Ash Noce
- 2HAT Acacia
- 2HAW Ash Wenge
- 2HBN Bisque Noce
- 2HBW Bisque Wenge
- 2HCN Clay Noce
- 2HCW Clay Wenge
- 2HSN Storm Noce
- 2HSW Storm Wenge
- 2HWA Grey Kingswood
- 2HWB Planked Walnut
- 2HWD Resolute Walnut
- 2HWE Natural Recon
- 2HWF Smoked Walnut

### Wood

Viccarbe carefully selects veneer and solid wood for consistent color and grain structure. Wood is a natural material and variations will occur in color, grain and texture. These variations are part of the inherent natural beauty of wood and are not considered defects.

All wood products will darken with age and exposure to ultraviolet light. This is especially apparent with cherry and maple veneer. We recommend that desk accessories be rearranged periodically to ensure even aging of wood surfaces.

When storing your wood furniture, please follow the following guidelines:

- Do not store products in trailers
- Store products in areas that simulate office temperatures (60°F to 90°F)
- Store products in areas that maintain constant, office-like humidity levels
- Keep product away from light. Cover products to make sure they are not exposed to light.

**Veneers** are matched for proper balance and consistency. Veneers are available flat cut or quarter cut, except for Oak, which is rift cut. Refer to the Concierge team for descriptions of each cut.

**Open-pore finish** is a medium gloss finish that leaves the wood grain texture visible to the eye and distinguishable to the touch.

### Veneer

#### Wood Group 1

##### Rift-Cut Open-Pore

- 3602 RC/OP Desert Oak

##### Rift-Cut Full-Fill, Natural Veneer

- 36A2 RC/OP Volcanic Oak

##### Open-Pore Planked Veneer

- 3VFX RC/OP Unmarked Oak

*Tip: Known for its uniqueness, planked veneer has intentional and natural variations that include, but are not limited to: character marks, grain pattern, color, and natural color aging.*

##### Rift-Cut – Low Sheen

- V3AK RC/LS Natural (Raw) Oak

##### Rift-Cut Open-Pore Low Sheen

- 3027 Low Sheen Oak
- 3028 Low Sheen Cognac
- 3029 Low Sheen Ash
- 3030 Low Sheen Light Oak
- 3031 Low Sheen Walnut Oak

**Custom Surfaces**

**Customiz stain** is a service that allows you to create your own stain colors and finishes on standard veneer. Customiz stain color is available on all product lines that offer wood veneer.

A \$500 stain-matching fee applies on CUSTOMIZ requests (Exception: The \$500 fee does not apply on matches to Viccarbe standard finishes or for a low-gloss finish request on a standard color). The \$500 fee covers the cost of formulating the Customiz color finish and applies regardless of whether or not an order for product is placed.

In addition, an approval form must be signed to indicate customer acceptance of Customiz match. A \$1,500 initiation fee will be charged prior to first order entry. This initiation fee activates the finish for unlimited use on any standard 4-6 week lead time Viccarbe product for an 18 month time period. After the 18 month time period has lapsed, the Customiz finish may be reactivated for another 18 months for a \$1,000 fee at any point within five years after the \$1,500 initiation fee was paid. If the finish is not reactivated within five years after the \$1,500 initiation fee was paid, the finish will be culled and the customer will need to pay the \$1,500 initiation fee again. All style number related Customiz charges products are no cost as of April 2014. The matching and initiation fees are not discountable.

Customiz stain takes 10 days to formulate. Consult the Concierge team for more information. Custom veneers are also available and must be quoted by the Concierge team. Customiz stain on custom veneers takes 2 to 4 weeks to formulate.

**Vertical Upholstery****Price Group 1****Buzz2**

5F03	Tomato
5F04	Red
5F05	Burgundy
5F06	Sky
5F07	Blue
5F08	Navy
5F15	Stone
5F16	Grey
5F17	Black
5G50	Dunegrass
5G51	Sable
5G55	Pumpkin
5G57	Rouge
5G59	Meadow
5G61	Cyan
5G62	Atlantic
5G63	Crocus
5G64	Alpine
5G65	Tornado

**Era**

5ER0	Cobalt
5ER1	Harbor
5ER2	Blue Nickel
5ER3	Pistachio
5ER4	Canary
5ER5	Comet
5ER6	Truffle
5ER7	Saffron
5ER8	Pink Lemonade
5ER9	Onyx
5ES0	Scarlet
5ES1	Lentil
5ES2	Oatmeal
5ES3	Persimmon
5ES4	Sprout
5ES5	Blue Mint
5ES6	Royal Blue
5ES7	Night Owl
5ET1	Rose Quartz
5ET3	Olivine
5EU2	Electric Indigo
5EU3	Green Citrine
5EU4	Storm Cloud

**Jacks**

5B61	Taupe
5B63	Camel
5B64	Pewter
5B70	Midnight

**Link**

5A24	Blue
5A25	Navy
5A27	Black

**New Black**

5J10	New Black: Bruce
5J11	New Black: Henry

*Tip: New Black upholstery has color numbers in both price group 1 and price group 2.*

**Price Group 2****Chainmail**

5551	Space
5552	Silver Dollar
5553	Volcano
5555	Tricycle
5559	Lagoon

**Cogent: Connect**

5S15	Coconut
5S16	Turmeric/Honey
5S17	Tangerine
5S18	Scarlet
5S19	Concord
5S21	Blue Jay
5S23	Wasabi
5S24	Nickel
5S25	Graphite
5S26	Licorice
5S27	Malt
5S28	Root Beer
5S93	Indigo/Blueprint
5S94	Lizard/Jungle
5S95	Sailor
5S96	Quicksilver
5S99	Lipstick/Merlot
5SD0	Royal Blue
5SD1	Aubergine
5SD2	Peacock
5SD3	Lagoon
5SD4	Saffron
5SD5	Citrine
5SD6	Rose Quartz
5SD7	Sea Salt
5SF3	Storm Cloud
5SF4	Olivine

**Dovetail by Designtex**

5H39	Light Mocha
5H40	Pebble
5H41	Warm White
5H42	Sandstone
5H43	Honeycomb
5H44	Terra
5H45	Honeydew
5H46	Denim
5H47	Storm
5H48	Ice Blue
5H49	Aura
5H50	Darkest Grey

**Foundation**

5875	Black
5876	Navy
5877	Foggy Night
5878	Sailor
5879	Ivory
5880	Seal
5881	Peat
5882	New Sand
5883	Cranberry
5884	Spring
5885	Honey
5886	Folkstone
5887	Pebble
5888	Oregano

**New Black**

5J08	New Black: Jack
5J09	New Black: James
5J12	New Black: Harley

*Tip: New Black upholstery has color numbers in both price group 1 and price group 2.*

**Nitelights**

5F66	Stone
5F67	Moon

**SoftNext**

5H27	Obsidian
5H28	Foggy Night
5H29	Greystone
5H30	Mocha
5H31	Clay
5H32	Sandstone
5H33	Chalk
5H34	Midnight
5H35	Blue Mica
5H36	Jade
5H37	Burnt Umber
5H38	Cinnabar

**Stand In**

5621	Sleet
5622	Lunar
5623	Cyclone
5624	Eclipse
5625	Powder
5626	Chardonnay
5627	Graham
5628	Sediment
5629	Allspice
5630	Apple
5631	Lava
5632	Cayenne
5633	Plantain
5634	Parsley
5635	Scallion
5636	Atlantis
5691	Orca
5740	Burlap
5741	Porter
5742	Tusk
5743	Putty
5744	Blueberry
5745	Chartreuse
5746	Mango
5747	Sedona
5748	Juniper
5749	Peanut

**Price Group 3****Billiard Multi-Use by Designtex**

5H11	Poppy
5H12	Tangelo
5H13	Citrine/Citron
5H14	Avocado
5H16	Indigo
5H17	Mallard
5H18	Teak
5H19	Cumulus
5H20	Pewter
5H21	Gunmetal
5H22	Ink
5H23	Rose Quartz
5H24	Sea Salt
5H25	Storm Cloud
5H26	Olivine

**Gaja**

5W40	Black
5W41	Pepper
5W42	Pearl Grey
5W43	Crimson
5W44	Ink
5W45	Night Blue
5W48	Sepia
5W51	Camellia Red
5W52	Emerald
5W53	Snow Pea
5W54	Olive
5W56	Maroon
5W57	Black Raspberry
5W58	Spruce
5W60	Deep Blue
5W61	Chili Pepper

**Redeem**

TM50	Brick
TM52	Cinnamon
TM55	Water
TM58	Mallard
TM60	Greyhound
TM62	Iceberg
TM63	Chestnut
TM64	Granite
TM66	Barnwood

**Retrieve**

TM31	Lake
TM32	Gala
TM37	Submarine
TM40	Quarry
TM42	Shadow
TM43	Seal

**Price Group 5****Bo Peep**

5G67	Bone
5G72	Honey Mustard
5G73	Marmalade
5G74	Picnic
5G75	Pinot
5G76	Bloom
5G77	Grapevine
5G79	Artichoke
5G80	Serpent
5G81	Carolina
5G82	Blue Bonnet
5G83	Nautical
5G84	Gravel
5G85	Sharkskin
5G86	Kohl

**Remix**

- RE01 Rust
- RE03 Pebble
- RE04 Dark Chocolate
- RE06 Linen Beige
- RE08 Concrete Grey
- RE09 Sky Blue
- RE10 Blue Jean
- RE11 Ivy Green
- RE13 Night Blue

**Silk**

- 5L31 Dijon
- 5L32 Seaweed
- 5L33 Boysenberry
- 5L35 Marina
- 5L36 Heather Blue
- 5L37 Blue Raspberry
- 5L38 Cauldron
- 5L39 Flaxen

**Price Group 6**

**Brisa**

- BR01 Black Onyx
- BR04 Truffle
- BR06 Ash
- BR07 Sage
- BR08 Celery
- BR09 Sterling Blue
- BR10 Night Navy
- BR11 Cambridge Blue
- BR12 Abyss
- BR14 Pompeian Red
- BR16 Cinnabar
- BR18 New Sand
- BR20 White
- BR21 Moccasin
- BR22 Buckskin
- BR24 Mineral
- BR25 Skyway
- BR26 Iron
- BR27 Stormy
- BR28 Esmeralda
- BR29 Seaweed
- BR30 Bone
- BR31 Caramel
- BR32 Bridle
- BR33 Moon

**Fusion**

- CL60 Fusion Caviar
- CL62 Fusion Graphite
- CL64 Fusion Steam
- CL80 Terracotta
- CL81 Copper
- CL82 Sage
- CL83 Blue Ink
- CL84 Blue steel

*Tip: Fusion only available on Maarten chairs.*

**Price Group 7**

**Steelcut Trio**

- TR01 Mist Grey
- TR02 Stone Grey
- TR03 Cassonade Beige
- TR04 Nutmeg Beige
- TR06 Licorice Black
- TR11 Ice Blue
- TR15 Brown Frost
- TR18 Coastal Oasis
- TR19 Deep Sea

**Leather Price Group**

**Steelcase Leather**

- L207 Mahogany
- L220 Soapstone
- L221 Rocky

*Tip: Steelcase leather only available on Trestle bench.*

**Elmosoft Leather Price Group**

**Elmosoft Leather**

- L110 Maritime Blue
- L111 Midnight Blue
- L112 Ebony
- L113 Gunmetal
- L114 Mica
- L115 Dove Grey
- L116 Plum Pleasure
- L122 Truffle
- L128 Red Birch
- L133 Espresso
- L134 Ruby
- L135 Scarlet
- L138 Bourbon
- L139 Cinder
- L140 Garnet
- L143 Pecan
- L144 Chamois
- L146 Russet
- L147 Saddle
- L151 White
- L709 Sugar
- L711 Parchment
- L717 Cameo
- L723 Storm
- L730 Hunter
- L743 Forest Green
- L747 Cigar
- L749 Beaver
- L750 Bluffstone
- L752 Oxblood
- L755 Peanut Butter
- L758 Mustard
- L762 Canvas
- L763 Macadamia
- L768 Tropical
- L769 Mauve
- L770 Cadet
- L772 Timberwolf
- L773 Chalice
- L774 Oil
- L775 Coyote

*Tip: Elmosoft leather only available on Trestle bench.*

**Custom Surfaces**

**Price Group COM (Customer's Own Material)**

**Fabric Approval and Yardage**

To confirm whether a particular COM material has already been tested for use on a specific Viccarbe product or to determine actual yardage requirements, please contact the Concierge team.

**Standard Import Lead Time Surface Materials**

**Lacquered Woods**

**Price Group 1**

- 9003 White RAL
- 9005 Black RAL

**Price Group 2**

- 1019 Taupe RAL
- 050 50 30 Brick RAL
- 1011 Ochre RAL
- 090 40 30 Olive Green RAL
- 060 70 20 Dusty Pink RAL
- 7034 Dusty Green RAL

**Price Group 3**

- 2005 Bronze
- Fluorescent
- Orange RAL

**Lacquered Metal**

**Price Group 1**

- 9003 White RAL
- 9005 Black RAL
- 1019 Taupe RAL
- 2005 Fluorescent Orange Brass RAL

**Polypropylene**

**Price Group 1**

- 9003 White RAL
- 9005 Black RAL
- 1019 Taupe RAL
- 050 50 30 Brick RAL
- 1011 Ochre RAL
- 7034 Dusty Green RAL

**Polyethylene**

**Price Group 1**

- 9003 White RAL
- 9005 Black RAL
- 1019 Taupe RAL

**Stained Wood**

**Price Group 1**

- Ash
- Bleached oak
- Cognac
- Matte oak
- Walnut oak
- White

**Custom Surfaces**

**Customiz stain** is a service that allows you to create your own stain colors and finishes on standard veneer. Customiz stain color is available on all product lines that offer wood veneer. A \$500 stain-matching fee applies on CUSTOMIZ requests. The \$500 fee covers the cost of formulating the Customiz color finish and applies regardless of whether or not an order for product is placed.

In addition, an approval form must be signed to indicate customer acceptance of Customiz match. A \$1,500 initiation fee will be charged prior to first order entry. This initiation fee activates the finish for unlimited use on any standard Viccarbe imported lead time product for an 18 month time period. After the 18 month time period has lapsed, the Customiz finish may be reactivated for another 18 months for a \$1,000 fee at any point within five years after the \$1,500 initiation fee was paid. If the finish is not reactivated within five years after the \$1,500 initiation fee was paid, the finish will be culled and the customer will need to pay the \$1,500 initiation fee again. The matching and initiation fees are not discountable. Customiz stain takes 10 days to formulate. Consult the Concierge team for more information. Custom veneers are also available and must be quoted by the Concierge team specials group. Customiz stain on custom veneers takes 2 to 4 weeks to formulate.

**Piping**

- Anthracite
- Burgundy
- Forest Green
- Linen
- White

**Technical Fabric**

**Price Group 1**

- Dark grey
- Light grey

**Marble**

**Price Group 1**

- Green

**Top Surface**

- Compact laminate, white top with black core
- Compact laminate, black top with black core
- Compact laminate, white top with white core
- Low-Pressure Laminate, black core
- Low-Pressure Laminate, white core
- MDF with High-Pressure Laminate, stained core
- MDF, matte oak top with stained core
- MDF, ash top with stained core
- MDF, cognac top with stained core
- Lacquered wood

**Plastic**

**Price Group 1**

- Black
- White

**Price Group 2**

- Brick
- Dusty green
- Taupe
- Yellow ochre

**Fabric**

**Designtex Coveted Collection**

**Price Group 2**

- Gamut**
- Chalk 101
- Deep ocean 405
- Pebble 803
- Pewter 808
- Cobblestone 811

**Price Group 3**

**Brushed Flannel**

- Crème 101
- Blue 403
- Light grey 801
- Charcoal 803



<b>Billiard</b>	<b>Price Group 1</b>	<b>Cura</b>	<b>Duo</b>	<b>Era</b>
Indigo 402	<b>Atlantic</b>	60000 Cura	1 Duo	CSE01 Futurist
Cumulus 803	60011 Atlantic	60019 Cura	2 Duo	CSE02 Generation
Pewter 804	60025 Atlantic	60109 Cura	4 Duo	CSE03 Lifetime
Ink 806	60061 Atlantic	60110 Cura	5 Duo	CSE05 Span
<b>Rocket</b>	60063 Atlantic	60111 Cura	7 Duo	CSE06 Cycle
Graphite 801	60095 Atlantic	60112 Cura	8 Duo	CSE07 Period
Ink 802	60141 Atlantic	60327 Cura	10 Duo	CSE08 Chapter
Osprey 804	60142 Atlantic	60999 Cura	11 Duo	CSE09 Prime
<b>Woolish</b>	60143 Atlantic	61168 Cura	13 Duo	CSE10 Everlasting
Sea 407	60333 Atlantic	61169 Cura	16 Duo	CSE11 Forecast
Mica 803	60334 Atlantic	61232 Cura	17 Duo	CSE12 Perennial
Osprey 804	60999 Atlantic	61233 Cura	18 Duo	CSE13 Present
<b>Price Group 4</b>	61078 Atlantic	61257 Cura	21 Duo	CSE14 Forward
<b>Everywhere Texture</b>	61110 Atlantic	61258 Cura	26 Duo	CSE15 Stage
Shell 102	61128 Atlantic	61259 Cura	30 Duo	CSE16 Timelapse
Light blue 401	61163 Atlantic	61260 Cura	33 Duo	CSE17 Phase
Smoke 804	61164 Atlantic	62082 Cura	34 Duo	CSE18 Event
Ash 805	61165 Atlantic	62083 Cura	40 Duo	CSE19 Calendar
<b>Mateo</b>	61166 Atlantic	62084 Cura	42 Duo	CSE20 Aeon
Plaster 801	61269 Atlantic	62125 Cura	43 Duo	CSE21 History
<b>Pause</b>	61270 Atlantic	62126 Cura	50 Duo	CSE23 Occurrence
Canvas 101	61271 Atlantic	63012 Cura	51 Duo	CSE24 Date
Greige 102	61272 Atlantic	63078 Cura	52 Duo	CSE25 Sequence
Glow 201	62048 Atlantic	64013 Cura	53 Duo	CSE26 Turn
<b>Price Group 5</b>	63033 Atlantic	64194 Cura	54 Duo	CSE27 Measure
<b>Bixby</b>	63034 Atlantic	64195 Cura	55 Duo	CSE28 Extent
Nite 402	63055 Atlantic	64196 Cura	59 Duo	CSE29 Experience
<b>Dapple</b>	63057 Atlantic	64197 Cura	61 Duo	CSE30 Transition
Shoji 103	64089 Atlantic	64240 Cura	64 Duo	CSE31 Splitsecond
Indigo 405	64092 Atlantic	64252 Cura	66 Duo	CSE32 Occasion
Travertine 801	64093 Atlantic	65105 Cura	70 Duo	CSE33 Analogue
<b>Heather</b>	64105 Atlantic	65137 Cura	71 Duo	CSE34 Endurance
Stone 802	64117 Atlantic	66165 Cura	80 Duo	CSE35 Signature
Slate 803	64255 Atlantic	66166 Cura	83 Duo	CSE36 Notation
	65037 Atlantic	66167 Cura		CSE37 Rest
	65142 Atlantic	66169 Cura		CSE38 Allowance
	66041 Atlantic	66170 Cura		CSE39 Youth
	66057 Atlantic	66239 Cura		CSE40 Maturity
	66062 Atlantic	66240 Cura		CSE41 Quota
	66063 Atlantic	67084 Cura		CSE42 Range
	66064 Atlantic	68180 Cura		CSE43 Late
	66086 Atlantic	68180 Cura		CSE44 Elapse
	66095 Atlantic	68181 Cura		CSE45 Prompt
	66123 Atlantic	68182 Cura		CSE46 Memo
	66125 Atlantic	68183 Cura		
	66140 Atlantic	68186 Cura		
	66249 Atlantic	68187 Cura		
	66250 Atlantic	68261 Cura		
	67030 Atlantic	68262 Cura		
	67043 Atlantic	68263 Cura		
	67128 Atlantic	68264 Cura		
	68054 Atlantic			
	68110 Atlantic			
	68274 Atlantic			
	68275 Atlantic			
	68276 Atlantic			
	68277 Atlantic			

Surface Materials, continued

<p><b>Libra</b></p> <p>05 Libra 07 Libra 08 Libra 10 Libra 11 Libra 12 Libra 18 Libra 20 Libra 22 Libra 23 Libra 29 Libra 30 Libra 34 Libra 37 Libra 39 Libra 40 Libra 41 Libra 42 Libra 45 Libra 47 Libra 49 Libra 50 Libra 51 Libra 52 Libra 53 Libra 59 Libra 60 Libra 61 Libra 62 Libra 64 Libra 67 Libra</p> <p><b>Felicity</b></p> <p>60105 Felicity 60106 Felicity 60107 Felicity 60108 Felicity 60999 Felicity 61163 Felicity 61164 Felicity 61165 Felicity 61166 Felicity 61167 Felicity 62080 Felicity 62081 Felicity 63087 Felicity 63088 Felicity 63089 Felicity 64189 Felicity 64190 Felicity 64191 Felicity 65102 Felicity 65103 Felicity 66161 Felicity 66162 Felicity 66163 Felicity 66164 Felicity 67079 Felicity 67080 Felicity 67081 Felicity 67082 Felicity 67083 Felicity 68178 Felicity 68179 Felicity</p>	<p><b>Tonal</b></p> <p>2490-60122 Tonal 2490-60123 Tonal 2490-60124 Tonal 2490-60999 Tonal 2490-61179 Tonal 2490-61180 Tonal 2490-61181 Tonal 2490-61182 Tonal 2490-62057 Tonal 2490-62092 Tonal 2490-63097 Tonal 2490-63098 Tonal 2490-64207 Tonal 2490-64208 Tonal 2490-64209 Tonal 2490-64210 Tonal 2490-64211 Tonal 2490-66181 Tonal 2490-66182 Tonal 2490-66183 Tonal 2490-66184 Tonal 2490-66185 Tonal 2490-66186 Tonal 2490-67088 Tonal 2490-67089 Tonal 2490-67090 Tonal 2490-68204 Tonal 2490-68205 Tonal 2490-68206 Tonal 2490-68207 Tonal</p> <p><b>Urus</b></p> <p>08 Urus 42 Urus 51 Urus 53 Urus 55 Urus</p>	<p><b>Price Group 2</b></p> <p><b>Canvas 2</b></p> <p>114 Canvas 124 Canvas 134 Canvas 154 Canvas 174 Canvas 216 Canvas 224 Canvas 244 Canvas 254 Canvas 264 Canvas 356 Canvas 364 Canvas 374 Canvas 414 Canvas 424 Canvas 446 Canvas 454 Canvas 546 Canvas 556 Canvas 566 Canvas 576 Canvas 614 Canvas 644 Canvas 654 Canvas 666 Canvas 674 Canvas 684 Canvas 694 Canvas 716 Canvas 726 Canvas 734 Canvas 746 Canvas 764 Canvas 786 Canvas 794 Canvas 836 Canvas 854 Canvas 926 Canvas 936 Canvas 946 Canvas 954 Canvas 964 Canvas 974 Canvas 984 Canvas 996 Canvas</p> <p><b>Gamut</b></p> <p>202 Gamut 304 Gamut 403 Gamut 404 Gamut 405 Gamut 406 Gamut 407 Gamut 408 Gamut 503 Gamut 604 Gamut 701 Gamut 805 Gamut 806 Gamut 808 Gamut 810 Gamut 811 Gamut 812 Gamut 138 Fusion</p>	<p><b>Gaudi</b></p> <p>02 Gaudi 05 Gaudi 10 Gaudi 11 Gaudi 12 Gaudi 14 Gaudi 29 Gaudi 30 Gaudi 43 Gaudi 45 Gaudi 46 Gaudi 48 Gaudi 51 Gaudi 52 Gaudi 53 Gaudi 60 Gaudi</p> <p><b>Fusion</b></p> <p>05 Fusion 07 Fusion 08 Fusion 11 Fusion 13 Fusion 20 Fusion 24 Fusion 36 Fusion 40 Fusion 41 Fusion 42 Fusion 43 Fusion 45 Fusion 51 Fusion 53 Fusion 54 Fusion 60 Fusion 62 Fusion 80 Fusion 91 Fusion 95 Fusion 122 Fusion 125 Fusion 126 Fusion 138 Fusion 139 Fusion 143 Fusion 149 Fusion 155 Fusion 159 Fusion 171 Fusion</p>	<p><b>Main Line Flax</b></p> <p>01 Main Line Flax 02 Main Line Flax 03 Main Line Flax 05 Main Line Flax 06 Main Line Flax 07 Main Line Flax 08 Main Line Flax 09 Main Line Flax 10 Main Line Flax 12 Main Line Flax 13 Main Line Flax 14 Main Line Flax 15 Main Line Flax 16 Main Line Flax 17 Main Line Flax 18 Main Line Flax 19 Main Line Flax 20 Main Line Flax 21 Main Line Flax 22 Main Line Flax 23 Main Line Flax 24 Main Line Flax 25 Main Line Flax 26 Main Line Flax 28 Main Line Flax 29 Main Line Flax 31 Main Line Flax 32 Main Line Flax 34 Main Line Flax 35 Main Line Flax 36 Main Line Flax 37 Main Line Flax 40 Main Line Flax 43 Main Line Flax 44 Main Line Flax 45 Main Line Flax 46 Main Line Flax 47 Main Line Flax 48 Main Line Flax 49 Main Line Flax 50 Main Line Flax 51 Main Line Flax 52 Main Line Flax 53 Main Line Flax 54 Main Line Flax 55 Main Line Flax 56 Main Line Flax 57 Main Line Flax 59 Main Line Flax 60 Main Line Flax 61 Main Line Flax 62 Main Line Flax 63 Main Line Flax 64 Main Line Flax 65 Main Line Flax 66 Main Line Flax 67 Main Line Flax</p>
--	--	--	--	---

<b>Matiss</b>	<b>Messenger 5</b>	<b>Remix 3</b>	<b>Seven</b>	<b>Price Group 3</b>
05 Matiss	007 Messenger	113 Remix 3	05 Seven Beige	<b>Arc</b>
07 Matiss	008 Messenger	123 Remix 3	10 Seven Liver	005 Arc
08 Matiss	024 Messenger	126 Remix 3	11 Seven Capuccino	007 Arc
10 Matiss	025 Messenger	133 Remix 3	18 Seven Darkbrown	011 Arc
12 Matiss	029 Messenger	136 Remix 3	23 Seven Ocre	024 Arc
16 Matiss	031 Messenger	143 Remix 3	28 Seven Cognac	036 Arc
22 Matiss	038 Messenger	152 Remix 3	39 Seven Winered	041 Arc
30 Matiss	040 Messenger	163 Remix 3	44 Seven Turquoise	045 Arc
31 Matiss	041 Messenger	173 Remix 3	45 Seven Blue	051 Arc
37 Matiss	045 Messenger	183 Remix 3	46 Seven Carmine	053 Arc
39 Matiss	046 Messenger	196 Remix 3	48 Seven Dark Blue	054 Arc
45 Matiss	048 Messenger	223 Remix 3	49 Seven Navy	060 Arc
49 Matiss	050 Messenger	233 Remix 3	50 Seven Mint	080 Arc
52 Matiss	051 Messenger	242 Remix 3	56 Seven Petrol	091 Arc
53 Matiss	053 Messenger	252 Remix 3	59 Seven Moss	122 Arc
54 Matiss	054 Messenger	266 Remix 3	65 Seven Grey	125 Arc
60 Matiss	058 Messenger	276 Remix 3	67 Seven Anthracite	138 Arc
61 Matiss	060 Messenger	286 Remix 3	70 Seven Lilac	143 Arc
64 Matiss	061 Messenger	296 Remix 3	71 Seven Lavender	155 Arc
95 Matiss	062 Messenger	326 Remix 3	88 Seven Turtle	159 Arc
	063 Messenger	346 Remix 3	94 Seven Cinnamon	
<b>Medley</b>	066 Messenger	356 Remix 3	101 Seven Ivory	
60003 Medley	067 Messenger	362 Remix 3	123 Seven Espresso	
60004 Medley	069 Messenger	373 Remix 3	124 Seven Shitake	
60167 Medley	070 Messenger	383 Remix 3	126 Seven Copper	
60999 Medley	071 Messenger	393 Remix 3	141 Seven Scarlet	
61002 Medley	072 Messenger	406 Remix 3	142 Seven Sky	
61003 Medley	076 Messenger	412 Remix 3	149 Seven Steel	
61004 Medley	077 Messenger	422 Remix 3	153 Seven Denim	
61189 Medley	078 Messenger	433 Remix 3	156 Seven Hunter	
62002 Medley	079 Messenger	443 Remix 3	158 Seven Niagara	
62054 Medley	080 Messenger	452 Remix 3	160 Seven Magnolia	
63013 Medley	081 Messenger	516 Remix 3	162 Seven Forest	
63016 Medley	083 Messenger	536 Remix 3	166 Seven Blossom	
63017 Medley	084 Messenger	543 Remix 3	168 Seven Plumb	
63063 Medley	085 Messenger	566 Remix 3	169 Seven Onyx	
63064 Medley	086 Messenger	606 Remix 3	177 Seven Blackberry	
64019 Medley	087 Messenger	612 Remix 3	178 Seven Nightshade	
64123 Medley	089 Messenger	632 Remix 3	180 Seven Dolphin	
64124 Medley	090 Messenger	643 Remix 3	183 Seven Saffron	
64125 Medley	091 Messenger	653 Remix 3	184 Seven Emerald	
65011 Medley	092 Messenger	662 Remix 3	193 Seven Eucalyptus	
65012 Medley	093 Messenger	672 Remix 3	198 Seven Teal	
65086 Medley	094 Messenger	682 Remix 3	202 Seven Honey	
66007 Medley	095 Messenger	686 Remix 3		
66008 Medley	096 Messenger	692 Remix 3		
66009 Medley	097 Messenger	716 Remix 3		
66010 Medley	098 Messenger	722 Remix 3		
66144 Medley		733 Remix 3		
66145 Medley		743 Remix 3		
67002 Medley		753 Remix 3		
67006 Medley		762 Remix 3		
67052 Medley		773 Remix 3		
67053 Medley		783 Remix 3		
67054 Medley		796 Remix 3		
68002 Medley		816 Remix 3		
68005 Medley		823 Remix 3		
68114 Medley		836 Remix 3		
68115 Medley		842 Remix 3		
		852 Remix 3		
		866 Remix 3		
		873 Remix 3		
		906 Remix 3		
		912 Remix 3		
		923 Remix 3		
		933 Remix 3		
		942 Remix 3		
		954 Remix 3		
		962 Remix 3		
		973 Remix 3		
		982 Remix 3		
		996 Remix 3		

Surface Materials



<b>Capture</b>	<b>Crisp</b>	<b>Fiord 2</b>	<b>Hero 2</b>	<b>Steelcut Trio 3</b>
2701 Capture	4011 Crisp	101 Fiord 2	102 Hero	105 Steelcut Trio 3
2801 Capture	4013 Crisp	121 Fiord 2	152 Hero	113 Steelcut Trio 3
2901 Capture	4021 Crisp	151 Fiord 2	162 Hero	124 Steelcut Trio 3
3001 Capture	4022 Crisp	171 Fiord 2	182 Hero	133 Steelcut Trio 3
3002 Capture	4031 Crisp	191 Fiord 2	192 Hero	153 Steelcut Trio 3
3101 Capture	4032 Crisp	201 Fiord 2	202 Hero	176 Steelcut Trio 3
3201 Capture	4033 Crisp	251 Fiord 2	212 Hero	195 Steelcut Trio 3
3202 Capture	4034 Crisp	262 Fiord 2	232 Hero	205 Steelcut Trio 3
3301 Capture	4115 Crisp	271 Fiord 2	312 Hero	213 Steelcut Trio 3
3302 Capture	4117 Crisp	322 Fiord 2	352 Hero	226 Steelcut Trio 3
3303 Capture	4122 Crisp	351 Fiord 2	372 Hero	236 Steelcut Trio 3
3304 Capture	4123 Crisp	371 Fiord 2	392 Hero	246 Steelcut Trio 3
3305 Capture	4125 Crisp	382 Fiord 2	422 Hero	253 Steelcut Trio 3
3306 Capture	4201 Crisp	391 Fiord 2	432 Hero	266 Steelcut Trio 3
3401 Capture	4203 Crisp	422 Fiord 2	512 Hero	276 Steelcut Trio 3
3402 Capture	4211 Crisp	442 Fiord 2	542 Hero	283 Steelcut Trio 3
3501 Capture	4301 Crisp	451 Fiord 2	552 Hero	336 Steelcut Trio 3
3601 Capture	4302 Crisp	521 Fiord 2	582 Hero	376 Steelcut Trio 3
3701 Capture	4411 Crisp	551 Fiord 2	622 Hero	383 Steelcut Trio 3
3801 Capture	4430 Crisp	562 Fiord 2	652 Hero	416 Steelcut Trio 3
3901 Capture	4431 Crisp	571 Fiord 2	662 Hero	426 Steelcut Trio 3
4001 Capture	4432 Crisp	581 Fiord 2	672 Hero	436 Steelcut Trio 3
4101 Capture	4601 Crisp	591 Fiord 2	732 Hero	446 Steelcut Trio 3
4102 Capture	4602 Crisp	642 Fiord 2	742 Hero	453 Steelcut Trio 3
4201 Capture	4603 Crisp	662 Fiord 2	752 Hero	466 Steelcut Trio 3
4301 Capture	4604 Crisp	672 Fiord 2	772 Hero	476 Steelcut Trio 3
4401 Capture	4605 Crisp	271 Fiord 2	782 Hero	506 Steelcut Trio 3
4501 Capture	4701 Crisp	751 Fiord 2	862 Hero	515 Steelcut Trio 3
4601 Capture	4702 Crisp	762 Fiord 2	882 Hero	526 Steelcut Trio 3
4702 Capture	4711 Crisp	771 Fiord 2	912 Hero	533 Steelcut Trio 3
4801 Capture	4712 Crisp	782 Fiord 2	932 Hero	553 Steelcut Trio 3
4802 Capture	4721 Crisp	791 Fiord 2	942 Hero	576 Steelcut Trio 3
4803 Capture	4722 Crisp	821 Fiord 2	962 Hero	616 Steelcut Trio 3
4901 Capture	4723 Crisp	862 Fiord 2		636 Steelcut Trio 3
4902 Capture	4731 Crisp	951 Fiord 2	<b>Melange Nap</b>	645 Steelcut Trio 3
5001 Capture	4741 Crisp	961 Fiord 2	111 Melange Nap	666 Steelcut Trio 3
5002 Capture	4751 Crisp	971 Fiord 2	171 Melange Nap	686 Steelcut Trio 3
5101 Capture	4752 Crisp	981 Fiord 2	191 Melange Nap	713 Steelcut Trio 3
5102 Capture	4761 Crisp	991 Fiord 2	211 Melange Nap	716 Steelcut Trio 3
5103 Capture	4771 Crisp		221 Melange Nap	746 Steelcut Trio 3
5201 Capture			241 Melange Nap	756 Steelcut Trio 3
5301 Capture	<b>Famehybrid</b>		271 Melange Nap	776 Steelcut Trio 3
5401 Capture	1101 Fame Hybrid		321 Melange Nap	796 Steelcut Trio 3
5402 Capture	1201 Fame Hybrid		351 Melange Nap	806 Steelcut Trio 3
5501 Capture	1301 Fame Hybrid		371 Melange Nap	865 Steelcut Trio 3
6001 Capture	1401 Fame Hybrid		411 Melange Nap	883 Steelcut Trio 3
6101 Capture	1501 Fame Hybrid		441 Melange Nap	906 Steelcut Trio 3
6201 Capture	1601 Fame Hybrid		461 Melange Nap	916 Steelcut Trio 3
6301 Capture	1701 Fame Hybrid		491 Melange Nap	946 Steelcut Trio 3
6401 Capture	1801 Fame Hybrid		521 Melange Nap	953 Steelcut Trio 3
6501 Capture	1901 Fame Hybrid		551 Melange Nap	966 Steelcut Trio 3
6601 Capture	2001 Fame Hybrid		651 Melange Nap	976 Steelcut Trio 3
6602 Capture	2101 Fame Hybrid		691 Melange Nap	983 Steelcut Trio 3
6801 Capture	2201 Fame Hybrid		711 Melange Nap	996 Steelcut Trio 3
6901 Capture	2301 Fame Hybrid		751 Melange Nap	
7101 Capture	2401 Fame Hybrid		771 Melange Nap	
7201 Capture	2501 Fame Hybrid		791 Melange Nap	
7301 Capture	2601 Fame Hybrid		871 Melange Nap	
7401 Capture	2701 Fame Hybrid		911 Melange Nap	
	2801 Fame Hybrid		951 Melange Nap	
	2901 Fame Hybrid		991 Melange Nap	

Surface Materials

**Price Group 5**

**Divina MD**

- 193 Divina MD
- 203 Divina MD
- 213 Divina MD
- 293 Divina MD
- 343 Divina MD
- 353 Divina MD
- 363 Divina MD
- 413 Divina MD
- 433 Divina MD
- 453 Divina MD
- 613 Divina MD
- 633 Divina MD
- 653 Divina MD
- 673 Divina MD
- 683 Divina MD
- 713 Divina MD
- 733 Divina MD
- 743 Divina MD
- 753 Divina MD
- 773 Divina MD
- 783 Divina MD
- 813 Divina MD
- 843 Divina MD
- 873 Divina MD
- 913 Divina MD
- 943 Divina MD
- 973 Divina MD

**Divina Melange**

- 120 Divina Melange
- 147 Divina Melange
- 170 Divina Melange
- 180 Divina Melange
- 227 Divina Melange
- 237 Divina Melange
- 260 Divina Melange
- 277 Divina Melange
- 280 Divina Melange
- 367 Divina Melange
- 427 Divina Melange
- 457 Divina Melange
- 467 Divina Melange
- 471 Divina Melange
- 517 Divina Melange
- 527 Divina Melange
- 547 Divina Melange
- 557 Divina Melange
- 567 Divina Melange
- 571 Divina Melange
- 581 Divina Melange
- 597 Divina Melange
- 617 Divina Melange
- 620 Divina Melange
- 647 Divina Melange
- 677 Divina Melange
- 687 Divina Melange
- 731 Divina Melange
- 747 Divina Melange
- 757 Divina Melange
- 777 Divina Melange
- 787 Divina Melange
- 821 Divina Melange
- 871 Divina Melange
- 917 Divina Melange
- 937 Divina Melange
- 967 Divina Melange
- 977 Divina Melange

**Hallingdal 65**

- 100 Hallingdal 65
- 103 Hallingdal 65
- 110 Hallingdal 65
- 113 Hallingdal 65
- 116 Hallingdal 65
- 123 Hallingdal 65
- 126 Hallingdal 65
- 130 Hallingdal 65
- 143 Hallingdal 65
- 153 Hallingdal 65
- 166 Hallingdal 65
- 173 Hallingdal 65
- 180 Hallingdal 65
- 190 Hallingdal 65
- 200 Hallingdal 65
- 220 Hallingdal 65
- 224 Hallingdal 65
- 227 Hallingdal 65
- 270 Hallingdal 65
- 350 Hallingdal 65
- 368 Hallingdal 65
- 370 Hallingdal 65
- 376 Hallingdal 65
- 390 Hallingdal 65
- 407 Hallingdal 65
- 420 Hallingdal 65
- 457 Hallingdal 65
- 526 Hallingdal 65
- 547 Hallingdal 65
- 563 Hallingdal 65
- 573 Hallingdal 65
- 590 Hallingdal 65
- 596 Hallingdal 65
- 600 Hallingdal 65
- 657 Hallingdal 65
- 660 Hallingdal 65
- 674 Hallingdal 65
- 680 Hallingdal 65
- 687 Hallingdal 65
- 694 Hallingdal 65
- 702 Hallingdal 65
- 723 Hallingdal 65
- 733 Hallingdal 65
- 750 Hallingdal 65
- 753 Hallingdal 65
- 754 Hallingdal 65
- 763 Hallingdal 65
- 764 Hallingdal 65
- 773 Hallingdal 65
- 810 Hallingdal 65
- 840 Hallingdal 65
- 850 Hallingdal 65
- 890 Hallingdal 65
- 907 Hallingdal 65
- 944 Hallingdal 65
- 960 Hallingdal 65
- 968 Hallingdal 65
- 980 Hallingdal 65

**Leather**

**Price Group 2**

**Leather 5**

- 101 Leather
- 102 Leather
- 103 Leather
- 109 Leather
- 111 Leather
- 113 Leather
- 114 Leather
- 115 Leather
- 116 Leather
- 117 Leather
- 121 Leather
- 122 Leather
- 123 Leather
- 125 Leather
- 126 Leather
- 127 Leather
- 128 Leather
- 129 Leather
- 131 Leather
- 133 Leather
- 136 Leather
- 137 Leather
- 139 Leather
- 141 Leather
- 142 Leather
- 145 Leather
- 147 Leather
- 148 Leather
- 149 Leather
- 160 Leather
- 179 Leather
- 197 Leather



---

# Resources

**Style Number Index**

**532**

# Style Number Index

Style Number	Page	Description
<b>VCBACA</b>	270	Ace Lounge Chair
<b>VCBACAM</b>	271	Ace Lounge Chair
<b>VCBACARE</b>	272	Ace Headrest
<b>VCBALBUMA</b>	274	Aleta Lounge Chair
<b>VCBALBUMABR</b>	274	Aleta Lounge Chair
<b>VCBALBUME</b>	273	Aleta Lounge Chair
<b>VCBALBUMEBR</b>	273	Aleta Lounge Chair
<b>VCBALEXBR</b>	105	Aleta Executive Chair
<b>VCBALEXBRNY</b>	103	Aleta Executive Chair
<b>VCBALEXBRRO</b>	106	Aleta Executive Chair
<b>VCBALEXBRRONY</b>	104	Aleta Executive Chair
<b>VCBALEXBUPLA</b>	275	Aleta Executive Chair
<b>VCBALEXBUPLARO</b>	276	Aleta Executive Chair
<b>VCBALEXPLA</b>	107	Aleta Executive Chair
<b>VCBALEXPLARO</b>	108	Aleta Executive Chair
<b>VCBALMEB8047</b>	508	Aleta Low Table
<b>VCBALMEB8075</b>	508	Aleta Low Table
<b>VCBALSIBR</b>	92	Aleta Chair
<b>VCBALSIBRBR</b>	92	Aleta Chair
<b>VCBALSIG</b>	89	Aleta Chair
<b>VCBALSIGBR</b>	89	Aleta Chair
<b>VCBALSIMA</b>	94	Aleta Chair
<b>VCBALSIMABR</b>	94	Aleta Chair
<b>VCBALSIME</b>	88	Aleta Chair
<b>VCBALSIMEBR</b>	88	Aleta Chair
<b>VCBALSIFI</b>	90	Aleta Chair
<b>VCBALSIFIPI</b>	90	Aleta Chair
<b>VCBALSIFIRU</b>	91	Aleta Chair
<b>VCBALSIFIRUBR</b>	91	Aleta Chair
<b>VCBALSIIPLA</b>	93	Aleta Chair
<b>VCBALSIIPLABR</b>	93	Aleta Chair
<b>VCBALTA</b>	97	Aleta Stool
<b>VCBALTAA</b>	97	Aleta Stool
<b>VCBALTABAR</b>	101	Aleta Stool
<b>VCBALTABARH</b>	101	Aleta Stool
<b>VCBALTABARHBR</b>	102	Aleta Stool
<b>VCBALTACO</b>	99	Aleta Stool
<b>VCBALTACOH</b>	99	Aleta Stool
<b>VCBALTACOHBR</b>	100	Aleta Stool
<b>VCBALTAFC</b>	95	Aleta Stool
<b>VCBALTAFCFCH</b>	95	Aleta Stool
<b>VCBALTAFCFCHBR</b>	96	Aleta Stool
<b>VCBALTAHBR</b>	98	Aleta Stool
<b>VCBBAMBA</b>	509	Bamba Low Table
<b>VCBBRIX</b>	277	Brix Lounge Chair
<b>VCBBRIXE</b>	277	Brix Lounge Chair
<b>VCBBU50</b>	445	Burin Table
<b>VCBBU55</b>	445	Burin Table
<b>VCBBUC10047</b>	435	Burin Table
<b>VCBBUC10075HM</b>	427	Burin Table
<b>VCBBUC10075HPL</b>	431	Burin Table
<b>VCBBUC10087</b>	441	Burin Table
<b>VCBBUC24047</b>	438	Burin Table
<b>VCBBUC24087</b>	444	Burin Table
<b>VCBBUC30087</b>	444	Burin Table

Style Number	Page	Description
<b>VCBBUC50087</b>	444	Burin Table
<b>VCBBUC7047</b>	435	Burin Table
<b>VCBBUC7075HM</b>	427	Burin Table
<b>VCBBUC7075HPL</b>	431	Burin Table
<b>VCBBUC7087</b>	441	Burin Table
<b>VCBBUC70H47</b>	437	Burin Table
<b>VCBBUC70H75HM</b>	427	Burin Table
<b>VCBBUC70H75HPL</b>	431	Burin Table
<b>VCBBUC70H87</b>	443	Burin Table
<b>VCBBUC8047</b>	435	Burin Table
<b>VCBBUC8075HM</b>	427	Burin Table
<b>VCBBUC8075HPL</b>	431	Burin Table
<b>VCBBUC8087</b>	441	Burin Table
<b>VCBBUC80H47</b>	437	Burin Table
<b>VCBBUC80H75HM</b>	428	Burin Table
<b>VCBBUC80H75HPL</b>	432	Burin Table
<b>VCBBUC80H87</b>	443	Burin Table
<b>VCBBUC9047</b>	435	Burin Table
<b>VCBBUC9075HM</b>	427	Burin Table
<b>VCBBUC9075HPL</b>	431	Burin Table
<b>VCBBUC9087</b>	441	Burin Table
<b>VCBBUD10047</b>	433	Burin Table
<b>VCBBUD10075HM</b>	424	Burin Table
<b>VCBBUD10075HPL</b>	429	Burin Table
<b>VCBBUD10087</b>	439	Burin Table
<b>VCBBUD100H47</b>	436	Burin Table
<b>VCBBUD100H75HM</b>	426	Burin Table
<b>VCBBUD100H75HPL</b>	430	Burin Table
<b>VCBBUD100H87</b>	442	Burin Table
<b>VCBBUD12047</b>	433	Burin Table
<b>VCBBUD12075HM</b>	424	Burin Table
<b>VCBBUD12075HPL</b>	429	Burin Table
<b>VCBBUD12087</b>	439	Burin Table
<b>VCBBUD15047</b>	434	Burin Table
<b>VCBBUD15075HM</b>	425	Burin Table
<b>VCBBUD15087</b>	440	Burin Table
<b>VCBBUD6047</b>	433	Burin Table
<b>VCBBUD6075HM</b>	424	Burin Table
<b>VCBBUD6075HPL</b>	429	Burin Table
<b>VCBBUD6087</b>	439	Burin Table
<b>VCBBUD60H47</b>	436	Burin Table
<b>VCBBUD60H75HM</b>	426	Burin Table
<b>VCBBUD60H75HPL</b>	430	Burin Table
<b>VCBBUD60H87</b>	442	Burin Table
<b>VCBBUD7047</b>	433	Burin Table
<b>VCBBUD7075HM</b>	424	Burin Table
<b>VCBBUD7075HPL</b>	429	Burin Table
<b>VCBBUD7087</b>	439	Burin Table
<b>VCBBUD70H47</b>	436	Burin Table
<b>VCBBUD70H75HM</b>	426	Burin Table
<b>VCBBUD70H75HPL</b>	430	Burin Table
<b>VCBBUD70H87</b>	442	Burin Table
<b>VCBBUD8047</b>	433	Burin Table
<b>VCBBUD8075HM</b>	424	Burin Table
<b>VCBBUD8075HPL</b>	429	Burin Table



Style Number	Page	Description
<b>VCBBUD8087</b>	439	Burin Table
<b>VCBBUD80H47</b>	436	Burin Table
<b>VCBBUD80H75HM</b>	426	Burin Table
<b>VCBBUD80H75HPL</b>	430	Burin Table
<b>VCBBUD80H87</b>	442	Burin Table
<b>VCBBUTACA</b>	350	Burin Table
<b>VCBCAC140</b>	457	Cambio Table
<b>VCBCAC140L</b>	451	Cambio Table
<b>VCBCAC140M</b>	462	Cambio Table
<b>VCBCAC220H</b>	470	Cambio Table
<b>VCBCAC240</b>	456	Cambio Table
<b>VCBCAC240H</b>	470	Cambio Table
<b>VCBCAC240L</b>	450	Cambio Table
<b>VCBCAC260H</b>	471	Cambio Table
<b>VCBCAC280H</b>	471	Cambio Table
<b>VCBCAC300</b>	456	Cambio Table
<b>VCBCAC300H</b>	471	Cambio Table
<b>VCBCAC500</b>	456	Cambio Table
<b>VCBCAC70</b>	457	Cambio Table
<b>VCBCAC70B</b>	453	Cambio Table
<b>VCBCAC70BHPL</b>	464	Cambio Table
<b>VCBCAC70BL</b>	447	Cambio Table
<b>VCBCAC70BM</b>	459	Cambio Table
<b>VCBCAC70H</b>	469	Cambio Table
<b>VCBCAC70HPL</b>	466	Cambio Table
<b>VCBCAC70L</b>	451	Cambio Table
<b>VCBCAC70M</b>	462	Cambio Table
<b>VCBCAC80</b>	457	Cambio Table
<b>VCBCAC80B</b>	453	Cambio Table
<b>VCBCAC80BHPL</b>	464	Cambio Table
<b>VCBCAC80BL</b>	447	Cambio Table
<b>VCBCAC80BM</b>	459	Cambio Table
<b>VCBCAC80H</b>	469	Cambio Table
<b>VCBCAC80HPL</b>	466	Cambio Table
<b>VCBCAC80L</b>	451	Cambio Table
<b>VCBCAC80M</b>	462	Cambio Table
<b>VCBCAC90</b>	457	Cambio Table
<b>VCBCAC90B</b>	453	Cambio Table
<b>VCBCAC90BHPL</b>	464	Cambio Table
<b>VCBCAC90BL</b>	447	Cambio Table
<b>VCBCAC90BM</b>	459	Cambio Table
<b>VCBCAC90HPL</b>	466	Cambio Table
<b>VCBCAC90L</b>	451	Cambio Table
<b>VCBCAC90M</b>	462	Cambio Table
<b>VCBCAD100</b>	454	Cambio Table
<b>VCBCAD100B</b>	452	Cambio Table
<b>VCBCAD100BHPL</b>	463	Cambio Table
<b>VCBCAD100BL</b>	446	Cambio Table
<b>VCBCAD100BM</b>	458	Cambio Table
<b>VCBCAD100H</b>	468	Cambio Table
<b>VCBCAD100HPL</b>	465	Cambio Table
<b>VCBCAD100L</b>	448	Cambio Table
<b>VCBCAD100M</b>	460	Cambio Table
<b>VCBCAD120</b>	455	Cambio Table
<b>VCBCAD120B</b>	452	Cambio Table

Style Number	Page	Description
<b>VCBCAD120BHPL</b>	463	Cambio Table
<b>VCBCAD120BL</b>	446	Cambio Table
<b>VCBCAD120BM</b>	458	Cambio Table
<b>VCBCAD120HPL</b>	465	Cambio Table
<b>VCBCAD120L</b>	448	Cambio Table
<b>VCBCAD120M</b>	460	Cambio Table
<b>VCBCAD150</b>	455	Cambio Table
<b>VCBCAD150L</b>	449	Cambio Table
<b>VCBCAD150M</b>	461	Cambio Table
<b>VCBCAD180</b>	455	Cambio Table
<b>VCBCAD180L</b>	449	Cambio Table
<b>VCBCAD180M</b>	461	Cambio Table
<b>VCBCAD200</b>	455	Cambio Table
<b>VCBCAD60</b>	454	Cambio Table
<b>VCBCAD60B</b>	452	Cambio Table
<b>VCBCAD60BHPL</b>	463	Cambio Table
<b>VCBCAD60BL</b>	446	Cambio Table
<b>VCBCAD60BM</b>	458	Cambio Table
<b>VCBCAD60H</b>	467	Cambio Table
<b>VCBCAD60HPL</b>	465	Cambio Table
<b>VCBCAD60L</b>	448	Cambio Table
<b>VCBCAD60M</b>	460	Cambio Table
<b>VCBCAD70</b>	454	Cambio Table
<b>VCBCAD70B</b>	452	Cambio Table
<b>VCBCAD70BHPL</b>	463	Cambio Table
<b>VCBCAD70BL</b>	446	Cambio Table
<b>VCBCAD70BM</b>	458	Cambio Table
<b>VCBCAD70H</b>	467	Cambio Table
<b>VCBCAD70HPL</b>	465	Cambio Table
<b>VCBCAD70L</b>	448	Cambio Table
<b>VCBCAD70M</b>	460	Cambio Table
<b>VCBCAD80</b>	454	Cambio Table
<b>VCBCAD80B</b>	452	Cambio Table
<b>VCBCAD80BHPL</b>	463	Cambio Table
<b>VCBCAD80BL</b>	446	Cambio Table
<b>VCBCAD80BM</b>	458	Cambio Table
<b>VCBCAD80H</b>	468	Cambio Table
<b>VCBCAD80HPL</b>	465	Cambio Table
<b>VCBCAD80L</b>	448	Cambio Table
<b>VCBCAD80M</b>	460	Cambio Table
<b>VCBCB4724H</b>	41	Common Benches
<b>VCBCB4724L</b>	41	Common Benches
<b>VCBCB4724M</b>	41	Common Benches
<b>VCBCB4747L</b>	41	Common Benches
<b>VCBCB7124H</b>	42	Common Benches
<b>VCBCB7124L</b>	42	Common Benches
<b>VCBCB7124M</b>	42	Common Benches
<b>VCBCB7147CIL</b>	42	Common Benches
<b>VCBCB7147L</b>	42	Common Benches
<b>VCBCB9447CIL</b>	42	Common Benches
<b>VCBCHAISE</b>	353	Levitt Sofa
<b>VCBCOBR</b>	112	Copa Chair
<b>VCBCOBUMA</b>	279	Copa Lounge Chair
<b>VCBCOCL</b>	113	Copa Chair
<b>VCBCOD45H65</b>	472	Common Table

Style Number Index, continued

Style Number	Page	Description
<b>VCBCOD60H45</b>	472	Common Table
<b>VCBCOMA</b>	115	Copa Chair
<b>VCBCOME</b>	109	Copa Chair
<b>VCBCOPI</b>	110	Copa Chair
<b>VCBCOPIRU</b>	111	Copa Chair
<b>VCBCOPLA</b>	114	Copa Chair
<b>VCBCOPTP</b>	116	Copa Chair
<b>VCBCOT4MABAR</b>	122	Copa Stool
<b>VCBCOT4MACO</b>	121	Copa Stool
<b>VCBCOT4MEBAR</b>	118	Copa Stool
<b>VCBCOT4MECO</b>	117	Copa Stool
<b>VCBCOTGBAR</b>	120	Copa Stool
<b>VCBCOTGCO</b>	119	Copa Stool
<b>VCBEA4PMRO</b>	126	Ears Chair
<b>VCBEA4PMROC</b>	127	Ears Chair
<b>VCBEA4PMT</b>	128	Ears Chair
<b>VCBEA4PRO</b>	123	Ears Chair
<b>VCBEA4PROC</b>	124	Ears Chair
<b>VCBEA4PT</b>	125	Ears Chair
<b>VCBEATB4PRO</b>	129	Ears Stool
<b>VCBEATB4PROC</b>	130	Ears Stool
<b>VCBEATB4PT</b>	131	Ears Stool
<b>VCBEATC4PRO</b>	132	Ears Stool
<b>VCBEATC4PROC</b>	133	Ears Stool
<b>VCBEATC4PT</b>	134	Ears Stool
<b>VCBFE</b>	280	Fedele Lounge Chair
<b>VCBFEP</b>	280	Fedele Pouf
<b>VCBFO140RO</b>	473	Foro Table
<b>VCBFO160RO</b>	474	Foro Table
<b>VCBFO200ARO</b>	474	Foro Table
<b>VCBFO200RO</b>	473	Foro Table
<b>VCBFO240ARO</b>	474	Foro Table
<b>VCBFO240RO</b>	474	Foro Table
<b>VCBFUB</b>	281	Funda Lounge Chair
<b>VCBFUBO</b>	281	Funda Lounge Chair
<b>VCBFUBOAL</b>	283	Funda Cushion
<b>VCBFUBORE</b>	283	Fund Headrest
<b>VCBFUBOT</b>	282	Funda Ottoman
<b>VCBFUS</b>	135	Funda Chair
<b>VCBFUS210RO</b>	476	Fuste Table
<b>VCBFUS210ROH</b>	475	Fuste Table
<b>VCBFUS240RO</b>	475	Fuste Table
<b>VCBFUS240ROH</b>	475	Fuste Table
<b>VCBFUS260RO</b>	476	Fuste Table
<b>VCBFUS260ROH</b>	476	Fuste Table
<b>VCBFUTB</b>	136	Funda Stool
<b>VCBFUTC</b>	136	Funda Stool
<b>VCBGIRO</b>	510	Giro Low Table
<b>VCBKL4PC</b>	139	Klip Chair
<b>VCBKL4PN</b>	137	Klip Chair
<b>VCBKL4PW</b>	138	Klip Chair
<b>VCBKLBRC</b>	151	Klip Chair
<b>VCBKLB RN</b>	149	Klip Chair
<b>VCBKLB RW</b>	150	Klip Chair
<b>VCBKLCO</b>	167	Klip Stool

Style Number	Page	Description
<b>VCBKLC T</b>	167	Klip Stool
<b>VCBKLG C</b>	142	Klip Chair
<b>VCBKLG N</b>	140	Klip Chair
<b>VCBKLG W</b>	141	Klip Chair
<b>VCBKLPAC</b>	154	Klip Chair
<b>VCBKLPAN</b>	152	Klip Chair
<b>VCBKLP AW</b>	153	Klip Chair
<b>VCBKLPIC</b>	145	Klip Chair
<b>VCBKLPIN</b>	143	Klip Chair
<b>VCBKLP IRUC</b>	148	Klip Chair
<b>VCBKLP IRUN</b>	146	Klip Chair
<b>VCBKLP IRUW</b>	147	Klip Chair
<b>VCBKLP IW</b>	144	Klip Chair
<b>VCBKLTBC</b>	160	Klip Stool
<b>VCBKLTBN</b>	158	Klip Stool
<b>VCBKLTBW</b>	159	Klip Stool
<b>VCBKLTCC</b>	157	Klip Stool
<b>VCBKLT CN</b>	155	Klip Stool
<b>VCBKLT CW</b>	156	Klip Stool
<b>VCBKLT FBARC</b>	166	Klip Stool
<b>VCBKLT FBARN</b>	164	Klip Stool
<b>VCBKLT FBARW</b>	165	Klip Stool
<b>VCBKLT FCOC</b>	163	Klip Stool
<b>VCBKLT FC ON</b>	161	Klip Stool
<b>VCBKLT FC OW</b>	162	Klip Stool
<b>VCBK LUN</b>	167	Klip Link
<b>VCBLEAL30</b>	354	Levitt Cushion
<b>VCBLEAL50</b>	354	Levitt Cushion
<b>VCBLMA</b>	169	Last Minute Stool
<b>VCBLMB</b>	168	Last Minute Stool
<b>VCBLMM</b>	168	Last Minute Stool
<b>VCBMAA</b>	181	Maarten Chair
<b>VCBMAA160</b>	482	Maarten Table
<b>VCBMAA16090</b>	482	Maarten Table
<b>VCBMAA16090R</b>	488	Maarten Table
<b>VCBMAA160R</b>	488	Maarten Table
<b>VCBMAA180</b>	482	Maarten Table
<b>VCBMAA18090</b>	482	Maarten Table
<b>VCBMAA18090R</b>	488	Maarten Table
<b>VCBMAA180R</b>	488	Maarten Table
<b>VCBMAA200</b>	418, 482	Maarten Table
<b>VCBMAA20090</b>	482	Maarten Table
<b>VCBMAA20090R</b>	488	Maarten Table
<b>VCBMAA200R</b>	488	Maarten Table
<b>VCBMAA4P</b>	172	Maarten Chair
<b>VCBMAA4PM</b>	178	Maarten Chair
<b>VCBMAA4PT</b>	199	Maarten Chair
<b>VCBMAA80</b>	478	Maarten Table
<b>VCBMAA80R</b>	486	Maarten Table
<b>VCBMAAA180</b>	485	Maarten Table
<b>VCBMAAA180R</b>	490	Maarten Table
<b>VCBMAAAU</b>	221	Quadra Chair
<b>VCBMAAB</b>	284	Maarten Chair
<b>VCBMAAB160</b>	479	Maarten Table
<b>VCBMAAB16090</b>	479	Maarten Table

Style Number	Page	Description	Style Number	Page	Description
<b>VCBMAAB180</b>	479	Maarten Table	<b>VCBMAAT4MCOB</b>	212	Maarten Stool
<b>VCBMAAB18090</b>	479	Maarten Table	<b>VCBMAATBAR</b>	220	Maarten Stool
<b>VCBMAAB200</b>	480	Maarten Table	<b>VCBMAATBARB</b>	210	Maarten Stool
<b>VCBMAAB20090</b>	480	Maarten Table	<b>VCBMAATCO</b>	217	Maarten Stool
<b>VCBMAAB80</b>	477	Maarten Table	<b>VCBMAATCOB</b>	208	Maarten Stool
<b>VCBMAABD120</b>	483	Maarten Table	<b>VCBMAATPTBARB</b>	206	Maarten Stool
<b>VCBMAABD160</b>	483	Maarten Table	<b>VCBMAATPTCOB</b>	204	Maarten Stool
<b>VCBMAABM</b>	285	Maarten Chair	<b>VCBMAAUN</b>	221	Maarten Link
<b>VCBMAABR</b>	190	Maarten Chair	<b>VCBMAMCP</b>	12	Maarten Chair
<b>VCBMAAD120</b>	484	Maarten Table	<b>VCBMAMCU</b>	13	Maarten Chair
<b>VCBMAAD120R</b>	489	Maarten Table	<b>VCBMAMSCP</b>	14	Maarten Chair
<b>VCBMAAD160</b>	484	Maarten Table	<b>VCBMAMSCU</b>	15	Maarten Chair
<b>VCBMAAD160R</b>	489	Maarten Table	<b>VCBMASBSP</b>	18	Maarten Chair
<b>VCBMAAF160</b>	491	Maarten Table	<b>VCBMASBSU</b>	19	Maarten Chair
<b>VCBMAAF180</b>	491	Maarten Table	<b>VCBMASCS</b>	16	Maarten Chair
<b>VCBMAAF200</b>	491	Maarten Table	<b>VCBMASCSU</b>	17	Maarten Chair
<b>VCBMAAM</b>	196	Maarten Chair	<b>VCBNAGI</b>	287	Nagi Lounge Chair
<b>VCBMAAPGT</b>	202	Maarten Chair	<b>VCBNAGIB</b>	286	Nagi Lounge Chair
<b>VCBMAAPI</b>	184	Maarten Chair	<b>VCBNAGIRE</b>	288	Nagi Headrest
<b>VCBMAAPIRU</b>	187	Maarten Chair	<b>VCBNOHEXBUGPL</b>	289	Noha Lounge Chair
<b>VCBMAAPL</b>	179	Maarten Chair	<b>VCBNOHEXBUGPL2</b>	290	Noha Lounge Chair
<b>VCBMAAPL4C</b>	171	Maarten Chair	<b>VCBNOHEXSI4PME</b>	222	Noha Standard Chair
<b>VCBMAAPL4P</b>	170	Maarten Chair	<b>VCBNOHEXSI4PME2</b>	222	Noha Executive Chair
<b>VCBMAAPL4PM</b>	176	Maarten Chair	<b>VCBNOHEXSI5R</b>	224	Noha Standard Chair
<b>VCBMAAPL4PMC</b>	177	Maarten Chair	<b>VCBNOHEXSI5R2</b>	224	Noha Executive Chair
<b>VCBMAAPL4PT</b>	197	Maarten Chair	<b>VCBNOHEXSI5RPL</b>	223	Noha Standard Chair
<b>VCBMAAPL4PTC</b>	198	Maarten Chair	<b>VCBNOHEXSI5RPL2</b>	223	Noha Executive Chair
<b>VCBMAAPLA</b>	193	Maarten Chair	<b>VCBNOHEXSIGMA</b>	227	Noha Standard Chair
<b>VCBMAAPLBAR</b>	218	Maarten Stool	<b>VCBNOHEXSIGMA2</b>	228	Noha Executive Chair
<b>VCBMAAPLBARB</b>	209	Maarten Stool	<b>VCBNOHEXSIGPL</b>	225	Noha Standard Chair
<b>VCBMAAPLBARC</b>	219	Maarten Stool	<b>VCBNOHEXSIGPL2</b>	226	Noha Executive Chair
<b>VCBMAAPLBR</b>	188	Maarten Chair	<b>VCBPE</b>	291	Penta Lounge Chair
<b>VCBMAAPLBRC</b>	189	Maarten Chair	<b>VCBPERCT</b>	231	Perxa Trolley
<b>VCBMAAPLC</b>	180	Maarten Chair	<b>VCBPERSI4PME4YBR</b>	230	Perxa Stackable Chair with Uphs Seat
<b>VCBMAAPLCO</b>	215	Maarten Stool	<b>VCBPERSI4PME4ZBR</b>	229	Perxa Stackable Chair
<b>VCBMAAPLCOB</b>	207	Maarten Stool	<b>VCBPERSI4PMEYBR</b>	230	Perxa Chair with Uphs Seat
<b>VCBMAAPLCOC</b>	216	Maarten Stool	<b>VCBPERSI4PMEZBR</b>	229	Perxa Chair
<b>VCBMAAPLM</b>	194	Maarten Chair	<b>VCBQUACT</b>	236	Quadra Trolley
<b>VCBMAAPLMC</b>	195	Maarten Chair	<b>VCBQUARO</b>	232	Quadra Chair
<b>VCBMAAPLPGT</b>	200	Maarten Chair	<b>VCBQUAROA</b>	233	Quadra Chair
<b>VCBMAAPLPGTC</b>	201	Maarten Chair	<b>VCBQUAROC</b>	234	Quadra Chair
<b>VCBMAAPLPI</b>	182	Maarten Chair	<b>VCBQUAROCR</b>	235	Quadra Chair
<b>VCBMAAPLPIC</b>	183	Maarten Chair	<b>VCBRYD50H25</b>	511	Ryutaro Low Table
<b>VCBMAAPLPIRU</b>	185	Maarten Chair	<b>VCBRYD60H30</b>	511	Ryutaro Low Table
<b>VCBMAAPLPIRUC</b>	186	Maarten Chair	<b>VCBSAVIAL30</b>	361	Savina Cushion
<b>VCBMAAPLPLA</b>	191	Maarten Chair	<b>VCBSAVIAL50</b>	361	Savina Cushion
<b>VCBMAAPLPLAC</b>	192	Maarten Chair	<b>VCBSAVICH</b>	356	Savina Chaise
<b>VCBMAAPLPT</b>	173	Maarten Chair	<b>VCBSAVICHP</b>	356	Savina Chaise
<b>VCBMAAPLPTC</b>	174	Maarten Chair	<b>VCBSAVICHPR</b>	356	Savina Chaise
<b>VCBMAAPLT4MBARB</b>	213	Maarten Stool	<b>VCBSAVICHR</b>	356	Savina Chaise
<b>VCBMAAPLT4MCOB</b>	211	Maarten Stool	<b>VCBSAVIM</b>	358	Savina Sofa
<b>VCBMAAPLTPTBARB</b>	205	Maarten Stool	<b>VCBSAVIMA</b>	359	Savina Double Sofa
<b>VCBMAAPLTPTCOB</b>	203	Maarten Stool	<b>VCBSAVIMAR</b>	359	Savina Double Sofa
<b>VCBMAAPT</b>	175	Maarten Chair	<b>VCBSAVIMR</b>	358	Savina Sofa
<b>VCBMAAT4MBARB</b>	214	Maarten Stool	<b>VCBSAVIPO</b>	357	Savina Pouf

Style Number Index, continued

Style Number	Page	Description
<b>VCBSAVIRI</b>	360	Savina Sofa
<b>VCBSAVIRIR</b>	360	Savina Sofa
<b>VCBSAVISR</b>	357	Savina Module
<b>VCBSAVISRR</b>	357	Savina Module
<b>VCBSE190</b>	382	Season Bench
<b>VCBSE250</b>	383	Season Bench
<b>VCBSECH</b>	237	Season Chair
<b>VCBSEM40</b>	364	Season Pouf
<b>VCBSEM50</b>	364	Season Pouf
<b>VCBSEM60</b>	365	Season Pouf
<b>VCBSEM90</b>	365	Season Pouf
<b>VCBSEM90H</b>	366	Season Pouf
<b>VCBSEMR40</b>	364	Season Pouf
<b>VCBSEMR50</b>	364	Season Pouf
<b>VCBSEMR60</b>	365	Season Pouf
<b>VCBSEMR90</b>	365	Season Pouf
<b>VCBSEMR90H</b>	366	Season Pouf
<b>VCBSESAS</b>	362	Season Sofa
<b>VCBSESEBS</b>	362	Season Sofa
<b>VCBSESCS</b>	363	Season Sofa
<b>VCBSHH</b>	512	Shape Low Table
<b>VCBSHO</b>	512	Shape Low Table
<b>VCBSOFA152</b>	351	Levitt Sofa
<b>VCBSOFA184</b>	352	Levitt Sofa
<b>VCBSOFA244</b>	353	Levitt Sofa
<b>VCBSOFACOMPL1</b>	354	Levitt Sofa
<b>VCBSOL</b>	494	Solar Table
<b>VCBSOLAN</b>	492	Solar Table
<b>VCBSOLANT</b>	493	Solar Table
<b>VCBSOLT</b>	495	Solar Table
<b>VCBST70</b>	367	Step Module
<b>VCBST90</b>	368	Step Module
<b>VCBSTAL25</b>	371	Step Cushion
<b>VCBSTAL50</b>	371	Step Cushion
<b>VCBSTCH</b>	369	Step Chaise
<b>VCBSTPO</b>	370	Step Pouf
<b>VCBSTRI</b>	370	Step Sofa
<b>VCBT1AB</b>	513	Tier Low Table
<b>VCBTA04</b>	278	Colubi Lounge Chair
<b>VCBTO140</b>	384-385	Torii Bench
<b>VCBTO240</b>	386-388	Torii Bench
<b>VCBTR</b>	37	Vicarbe Table
<b>VCBTRCB</b>	34	Trestle Bench
<b>VCBTRCC</b>	39	Trestle Leg Cable Cover
<b>VCBTRDB</b>	33	Trestle Bench
<b>VCBTREB</b>	35	Trestle Bench
<b>VCBTRI80RO</b>	496	Trivio Table
<b>VCBTRIM</b>	514	Trino low Table
<b>VCBTRIR</b>	514	Trino low Table
<b>VCBTRIRO</b>	514	Trino low Table
<b>VCBTRPWR</b>	40	Trestle Power Kit
<b>VCBTRSB</b>	32	Trestle Bench
<b>VCBTRST</b>	38	Trestle Table
<b>VCBTRWMT</b>	39	Trestle Wire Management Tray
<b>VCBWIPA</b>	520	Window Wall Coat Hanger

Style Number	Page	Description
<b>VCBWIPI</b>	520	Window Freestanding Coat Hanger
<b>VCBWIPR</b>	520	Window Umbrella Stand
<b>VCBZO</b>	292	Zoco Lounge Chair
<b>VCBZOR</b>	292	Zoco Lounge Chair

