

Turnstone Campfire Seating

Lounge Seating

Tip: To see the rest of the Campfire Collection including Big Table, Slim Table, Big Lamp, and Power Accessories, please refer to the Conference and Collaborative Tables Specification Guide.

Product Details

Thought Starters	530
Big Lounge, Half Lounge, Corner Lounge, Ottoman, Pouf, and Wedge	534
Screen and Footrest	537

Lounge

Lounges	538
Ganging Brackets	551
Ottoman	552
Pouf	553
Wedge	554

Accessories

Footrest	555
Screens	555

Surface Materials

634

Thought Starters

Islands

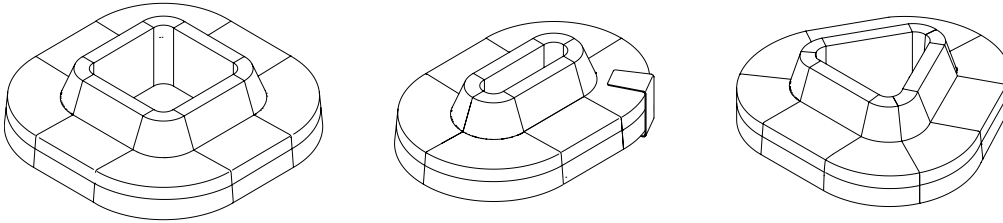

Quantity	Style Number	Description	Page for Ordering
Square Island			
4	TS3HLW	Campfire Half Lounge—Waterfall	543
4	TS3CROUT90W	Campfire 90° Corner Lounges—Waterfall	546
Oval Island			
2	TS3HLW	Campfire Half Lounge—Waterfall	543
4	TS3CROUT90W	Campfire 90° Corner Lounges—Waterfall	546
1	TS4TWP	Personal Table	▶ See <i>Conference and Collaborative Tables Specification Guide</i> .
Triangle Island			
3	TS3HLW	Campfire Half Lounge—Waterfall	543
6	TS3CROUT60W	Campfire 60° Corner Lounges—Waterfall	546

Tip: Island configurations create an open space in the middle due to the rounded backs of the corner lounges.

Collaborative Sharing

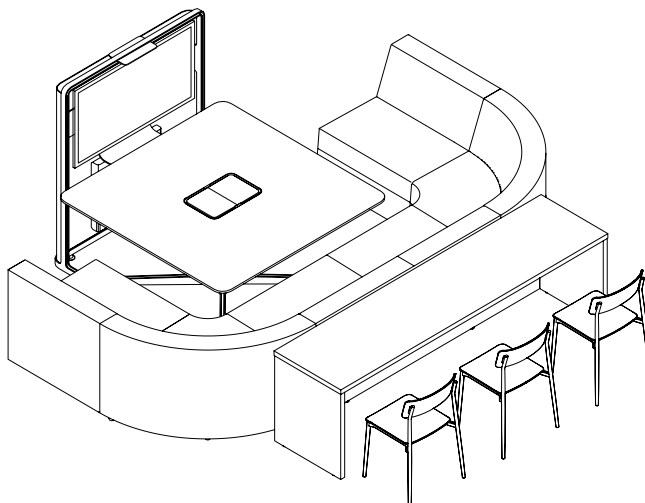

Quantity	Style Number	Description	Page for Ordering
1	TS3BCS	Campfire Big Lounge – Seam	539
2	TS3HLS	Campfire Half Lounge – Seam	542
2	TS3CRIN90S	Campfire 90° Corner Lounges – Seam	544
1	TS4TLH28	Campfire Big Table – Half Depth	▶ See <i>Conference and Collaborative Tables Specification Guide</i> .
3	TSAVNCH	Simple Chair	380
1	MT03DS6060T	media:scape Square Desk-Height Table	▶ See <i>Conference and Collaborative Tables Specification Guide</i> .

Serpentine

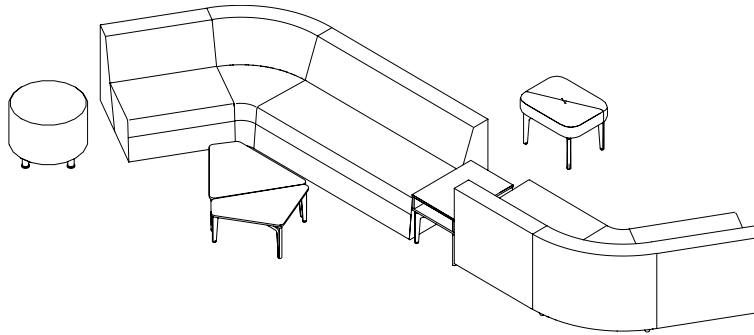

Quantity	Style Number	Description	Page for Ordering
1	TS3BCW	Campfire Big Lounge – Waterfall	540
3	TS3HLW	Campfire Half Lounge – Waterfall	543
2	TS3CRIN60W	Campfire 60° Corner Lounges – Waterfall	550
1	TSBLNT3LEGS	Bassline Small Asymmetrical Table	▶ See <i>Conference and Collaborative Tables Specification Guide</i> .
1	TSBLNT3LEGM	Bassline Medium Asymmetrical Table	▶ See <i>Conference and Collaborative Tables Specification Guide</i> .
1	TSBLNTBX	Bassline 30"D x 18"H Box Top Table	▶ See <i>Conference and Collaborative Tables Specification Guide</i> .
1	TSBLNS1	Bassline One Seat Bench	▶ See <i>Conference and Collaborative Tables Specification Guide</i> .
1	TS34401	Alight round	631

Big Lounge, Half Lounge, Corner Lounge, Ottoman, Pouf, and Wedge

Big Lounge, Half Lounge, and Corner Lounges come standard armless with black plastic feet. Available options include single, multiple, or waterfall upholstery. ▶ Specifying, pages 538–554

Campfire Lounge products are fully upholstered and have a relaxed appearance. They may show soft comfort wrinkles upon use.

Half Lounge is a generous seat for one at 33"W. When paired with other lounges use ganging brackets (ordered separately) to create a wide range of applications.

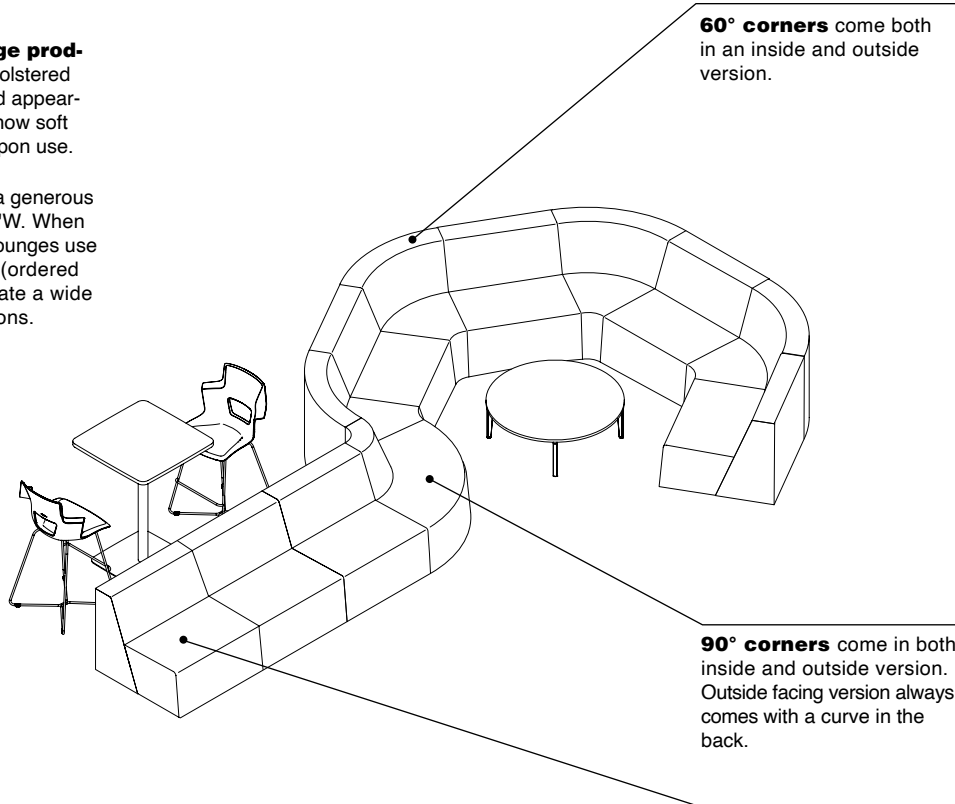

60° corners come both in an inside and outside version.

90° corners come both in inside and outside version. Outside facing version always comes with a curve in the back.

Big Lounge is 66"W and provides a comfortable seat for two. Pair with other lounges using ganging brackets (ordered separately) to create a wide range of applications.

Product Details

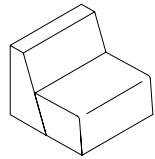
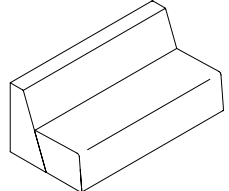

Straight seating available in Big Lounge or Half Lounge.

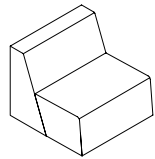

Big and Half Lounges with seams are available as standard styles. (TS3BCS and TS3HLS) Seams come standard on 90° and 60° Corner Lounges. Order Half and Big Lounges with seams when specifying with the corner lounges for a cohesive design aesthetic.

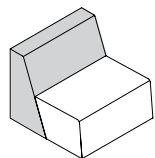

Styles with the "S" suffix, noting they have a seam, can also be ordered in multiple fabric combinations.

Actual Dimensions

	Big Lounge	Half Lounge	90° Inside Corner Lounge	90° Outside Corner Lounge	60° Inside Corner Lounge	60° Outside Corner Lounge	Ottoman	Pouf	Wedge
Depth	32"	32"	32"	32"	32"	32"		15"	17 ⁷ / ₈ "
Width	66"	33"	54 ¹ / ₂ "	55 ¹ / ₄ "	38 ¹ / ₂ "	39 ¹ / ₄ "	24"	15"	33"
Height	29"	29"	29"	29"	29"	29"	16"	18"	29"
Seat Depth	22"	22"	22"	22"	22"	22"			
Floor to Seat Height	16"	16"	16"	16"	16"	16"			

*Tip: Specify Ottoman with low profile glides to achieve 16"H.

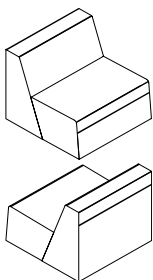

Waterfall option on lounges features upholstery that wraps around the top of the back and cascades over the front edge of the seat.

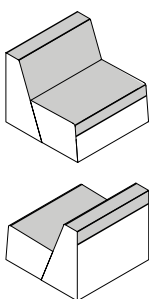

Styles with the "W" suffix, noting they have waterfall upholstery, can also be ordered in a multiple fabric combinations.

When ordering multi-fabric, note "upholstery" refers to the fabric selection for the lower section and "waterfall" refers to the fabric selection across the top.

On waterfall lounges with multiple fabrics, only one thread color is used. The thread color that coordinates with the waterfall upholstery will be used on the entire unit.

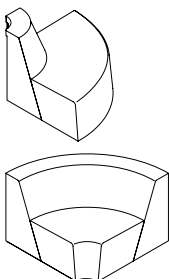

90° Lounges are available outside or inside facing.

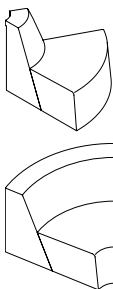

60° Lounges are available outside or inside facing.

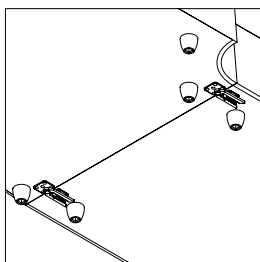

Corner Lounges connected to other lounges require the ganging brackets (TS3GANGING) ordered separately.

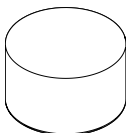

Ottoman ships fully assembled.

Ottoman is the same as Aight Round Ottoman. The Aight Round Ottoman with the low-profile glide option decreases the seat height from 19" down to 16". It is often shown with Campfire and referred to as Campfire Ottoman. It is being included in the Campfire lounge specifying section for easy reference.

► Specifying, page 552

Ottoman supports up to 225 pounds.

Pouf is designed for quick sits; and its lightweight construction of under eight pounds allows it to be easily moved. Pouf includes a nylon handle for easy carrying and a foam core with a top layer of softer foam for comfortable seating.

► Specifying, page 553

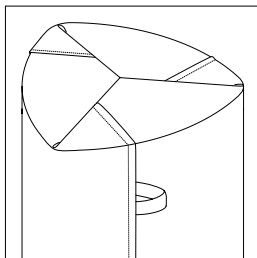

Pouf has a unique design feature that extends down all three sides.

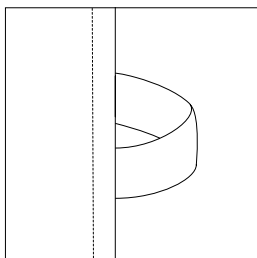

Handle is sewn on the side of the Pouf and is available in multiple colors.

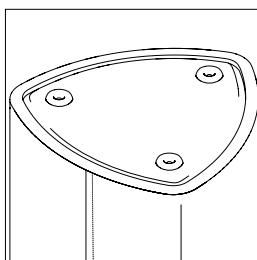

Glides on the bottom of the Pouf are part of a plastic molded base.

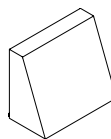

Wedge comes standard with black plastic feet and stability brackets. Independent Wedges and Half Lounges may be positioned into any configuration without moving or removing the stability brackets.

► Specifying, page 554

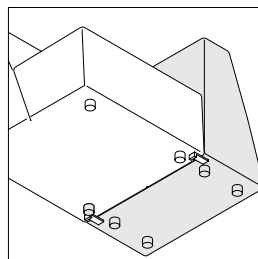

Wedges connected to the side of a Half Lounge would use the stability brackets facing towards the back as they come standard.

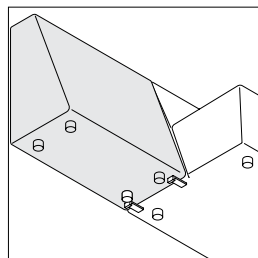

Wedges connected to the back of a Half Lounge or in-line with another Wedge would require moving the stability brackets to the side.

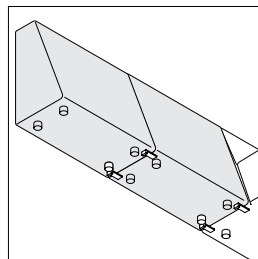

No more than two Wedges can be attached to a single lounge. Wedges can be freestanding, either alone or next to the Big Lounges or Half Lounges.

Surface Materials

Big Lounge, Half Lounge, and Wedge

- Fabric price groups 1-10
- COM

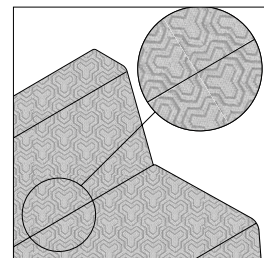

Solid, non-repeat fabrics are recommended for Campfire Lounge settings. Steelcase will not pattern match fabrics which have a distinct repeating pattern. It is recommended to use one of the standard fabrics or patterned COM.

Comfort wrinkles are intended to occur over the time to increase the comfort of Campfire Lounge. Very little maintenance is required to reduce the definition: smooth the cushion fabric with a spreading/wiping motion.

Pouf

- Body
- Fabric

Base

- Black plastic

Handle

- Nylon Contrasting Thread
- UB01 Charcoal
- UB02 Ash
- UB03 Powder Blue
- UB04 Evergreen
- UB05 Bright Red

Tip: Contrasting stitching is optional for Pouf and must be specified.

Surface Materials, continued

Big Lounges and Half Lounges

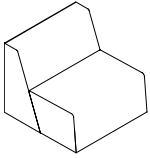

No Seam

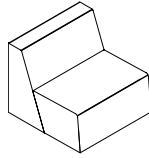

Seam

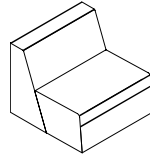

Waterfall (front)

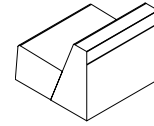

Waterfall (back)

Corner Lounges

NOT AVAILABLE

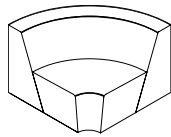

Seam

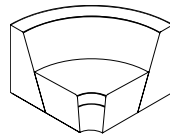

Waterfall (front)

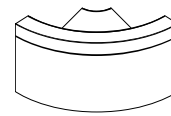

Waterfall (back)

Screen and Footrest

Product Details

16¹/₄"D 16⁵/₈"H
11"W



Footrest supports feet and legs and is designed to be used in multiple orientations to encourage active movement when in a lounge posture.

► Specifying, page 555

Footrest is grey expanded polypropylene with a plastic band available in five finishes.

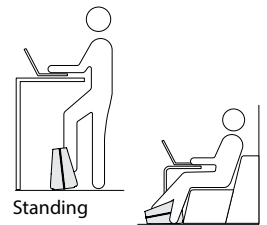

Guest

Footrest can be used when in a lounge posture, seated, or standing height. It can also be used as a guest chair.

Surface Materials

Footrest band

- 6009 Arctic White
- 6333 Picasso
- 6335 Wasabi
- 6338 Chili
- 6527 Merle

Screen

- Mesh:
 - T615 Sultry Smoke
 - T620 Arctic Ermine
 - T625 Marina Blue

Big Lamp can be found in *Conference and Collaborative Tables Specification Guide*.

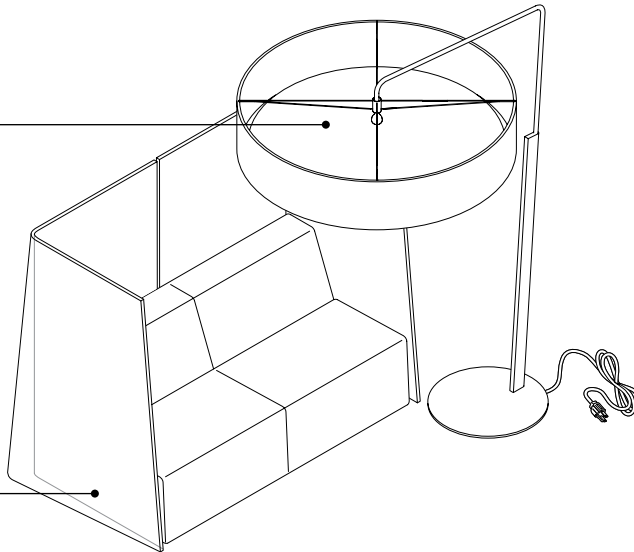

Screens are constructed with a steel frame and a mesh sock. Screens are handed. Right-hand and left-hand versions are available.

► Specifying, page 555

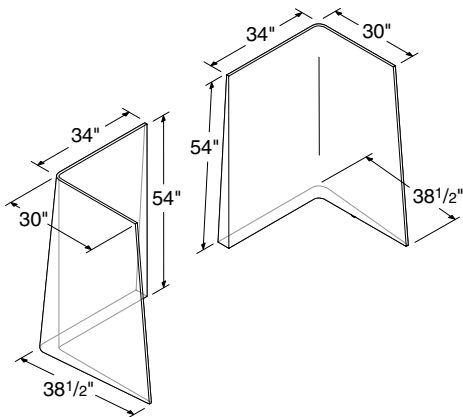

Lounges

Big Lounge

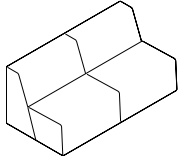

Standard Includes	Required to Specify
-------------------	---------------------

- | | | |
|------------------------------------------------------------------------------------------|---------------------------------------------------------------------------------------------------------------------------------------------------------------------------------------------------------------------|---------------------------------------------------------------------------------------------------------------------------------------------------------------------------------------------------------------|
| <ul style="list-style-type: none"> ▶ Need help? Product details, page 534 | <ul style="list-style-type: none"> • Fully upholstered armless lounge: fabric price group 1 • Foot: black plastic • Shipped fully assembled • Meets Cal. 117 requirements | <ul style="list-style-type: none"> 1 Style number 2 Fabric color number for upholstery 3 Options, if selected (see below) ▶ See <i>Surface Materials</i>, page 634. |
|------------------------------------------------------------------------------------------|---------------------------------------------------------------------------------------------------------------------------------------------------------------------------------------------------------------------|---------------------------------------------------------------------------------------------------------------------------------------------------------------------------------------------------------------|

Options	U.S. Price	Required to Specify
---------	------------	---------------------

Surface Materials	Single upholstery fabric	Required to Specify
	<ul style="list-style-type: none"> • Fabric price group 1 No cost • Fabric price group 2 +\$ 57 • Fabric price group 3 +\$ 222 • Fabric price group 4 +\$ 393 • Fabric price group 5 +\$ 705 • Fabric price group 6 +\$ 739 • Fabric price group 7 +\$ 850 • Fabric price group 8 +\$1210 • Fabric price group 9 +\$1480 • Fabric price group 10 +\$1548 • Customer's Own Material (COM) +\$ 56 	<ul style="list-style-type: none"> Specify fabric color number. Specify fabric color number. Specify fabric color number. Specify fabric color number. Specify fabric color number. Specify fabric color number. Specify fabric color number. Specify fabric color number. Specify fabric color number. Specify fabric color number. ▶ See <i>Understanding Customer's Own Material (COM)</i>, page 642.

Tip: Campfire Lounges can be ordered as a single or multi-fabric upholstery.

Tip: When specifying multiple COM fabrics, indicate all surfaces where COM applies. Example: TS3BCM with Designtex 1234 on seat and Designtex 5678 on back.

Options	U.S. Price	Required to Specify
Multiple upholstery fabric <ul style="list-style-type: none"> • Different fabric on seat and back +\$ 93 	<ul style="list-style-type: none"> + \$ 93 	<ul style="list-style-type: none"> Add suffix M to Big Lounge chair style number and select fabric color number for: 1 Seat, 2 Back
① Fabric on seat <ul style="list-style-type: none"> • Fabric price group 1 No cost • Fabric price group 2 +\$ 23 • Fabric price group 3 +\$ 97 • Fabric price group 4 +\$ 169 • Fabric price group 5 +\$ 305 • Fabric price group 6 +\$ 316 • Fabric price group 7 +\$ 363 • Fabric price group 8 +\$ 517 • Fabric price group 9 +\$ 633 • Fabric price group 10 +\$ 665 • Customer's Own Material (COM) +\$ 27 	<ul style="list-style-type: none"> No cost + \$ 23 + \$ 97 + \$ 169 + \$ 305 + \$ 316 + \$ 363 + \$ 517 + \$ 633 + \$ 665 + \$ 27 	<ul style="list-style-type: none"> Specify fabric color number. Specify fabric color number. Specify fabric color number. Specify fabric color number. Specify fabric color number. Specify fabric color number. Specify fabric color number. Specify fabric color number. Specify fabric color number. Specify fabric color number. ▶ See <i>Understanding Customer's Own Material (COM)</i>, page 642.
② Fabric on back <ul style="list-style-type: none"> • Fabric price group 1 No cost • Fabric price group 2 +\$ 37 • Fabric price group 3 +\$ 152 • Fabric price group 4 +\$ 277 • Fabric price group 5 +\$ 500 • Fabric price group 6 +\$ 523 • Fabric price group 7 +\$ 603 • Fabric price group 8 +\$ 862 • Fabric price group 9 +\$1054 • Fabric price group 10 +\$1102 • Customer's Own Material (COM) +\$ 27 	<ul style="list-style-type: none"> No cost + \$ 37 + \$ 152 + \$ 277 + \$ 500 + \$ 523 + \$ 603 + \$ 862 + \$1054 + \$1102 + \$ 27 	<ul style="list-style-type: none"> Specify fabric color number. Specify fabric color number. Specify fabric color number. Specify fabric color number. Specify fabric color number. Specify fabric color number. Specify fabric color number. Specify fabric color number. Specify fabric color number. Specify fabric color number. ▶ See <i>Understanding Customer's Own Material (COM)</i>, page 642.

Related Products	• Ottoman	▶ Page 552
-------------------------	-----------	------------

Specification Information				
---------------------------	--	--	--	--

Dimensions	Style Number	U.S. Base Price
D W H		
32" 66" 29"	TS3BC	\$3977

For Canadian Pricing
 Multiply U.S. Price by the Canadian price factor.
 ▶ See page 1 for details.

Big Lounge—Seam

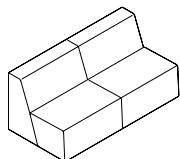

Tip: Seams are located at the top of the back and the front edge of the seat to match seams on Corner Lounges. Corner Lounges come standard with seams. Specify Big and Half Lounges with seams when creating an application with Corner Lounges to create a cohesive design aesthetic.

Tip: Campfire Lounges with seams can be ordered as a single or multi-fabric upholstery.

Tip: When specifying multiple COM fabrics, indicate all surfaces where COM applies. Example: TS3BCM with Designtex 1234 on seat and Designtex 5678 on back.

Tip: Order ganging brackets TS3GANGING to gang units together for more stable applications.

Standard Includes	Required to Specify
<ul style="list-style-type: none"> ▶ Need help? Product details, page 534 Fully upholstered armless lounge: fabric price group 1 Foot: black plastic Shipped fully assembled Meets Cal. 117 requirements 	<ul style="list-style-type: none"> 1 Style number 2 Fabric color number for upholstery 3 Options, if selected (see below) ▶ See <i>Surface Materials</i>, page 634.

Options	U.S. Price	Required to Specify
Surface Materials		
Single upholstery fabric		
• Fabric price group 1	No cost	Specify fabric color number.
• Fabric price group 2	+\$ 57	Specify fabric color number.
• Fabric price group 3	+\$ 222	Specify fabric color number.
• Fabric price group 4	+\$ 393	Specify fabric color number.
• Fabric price group 5	+\$ 705	Specify fabric color number.
• Fabric price group 6	+\$ 739	Specify fabric color number.
• Fabric price group 7	+\$ 850	Specify fabric color number.
• Fabric price group 8	+\$1210	Specify fabric color number.
• Fabric price group 9	+\$1480	Specify fabric color number.
• Fabric price group 10	+\$1548	Specify fabric color number.
• Customer's Own Material (COM)	+\$ 56	▶ See <i>Understanding Customer's Own Material (COM)</i> , page 642.
Multiple upholstery fabric		
• Different fabric on seat and back	+\$ 93	Add suffix M to Big Lounge chair style number and select fabric color number for: 1 Seat, 2 Back
① Fabric on seat		
• Fabric price group 1	No cost	Specify fabric color number.
• Fabric price group 2	+\$ 23	Specify fabric color number.
• Fabric price group 3	+\$ 97	Specify fabric color number.
• Fabric price group 4	+\$ 169	Specify fabric color number.
• Fabric price group 5	+\$ 305	Specify fabric color number.
• Fabric price group 6	+\$ 316	Specify fabric color number.
• Fabric price group 7	+\$ 363	Specify fabric color number.
• Fabric price group 8	+\$ 517	Specify fabric color number.
• Fabric price group 9	+\$ 633	Specify fabric color number.
• Fabric price group 10	+\$ 665	Specify fabric color number.
• Customer's Own Material (COM)	+\$ 27	▶ See <i>Understanding Customer's Own Material (COM)</i> , page 642.
② Fabric on back		
• Fabric price group 1	No cost	Specify fabric color number.
• Fabric price group 2	+\$ 37	Specify fabric color number.
• Fabric price group 3	+\$ 152	Specify fabric color number.
• Fabric price group 4	+\$ 277	Specify fabric color number.
• Fabric price group 5	+\$ 500	Specify fabric color number.
• Fabric price group 6	+\$ 523	Specify fabric color number.
• Fabric price group 7	+\$ 603	Specify fabric color number.
• Fabric price group 8	+\$ 862	Specify fabric color number.
• Fabric price group 9	+\$1054	Specify fabric color number.
• Fabric price group 10	+\$1102	Specify fabric color number.
• Customer's Own Material (COM)	+\$ 27	▶ See <i>Understanding Customer's Own Material (COM)</i> , page 642.

Related Products	• Ottoman	▶ Page 552
-------------------------	-----------	------------

Specification Information

• Dimensions			• Style	• U.S.
D	W	H	Number	Base Price
32"	66"	29"	TS3BCS	\$4004

For Canadian Pricing
Multiply U.S. Price by the Canadian price factor.
▶ See page 1 for details.

Big Lounge—Waterfall

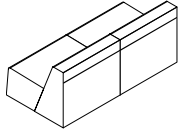
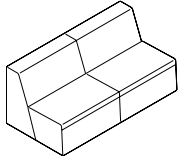

Tip: Waterfall seams are located at the top of the back, the front edge of the seat, 3½" below the front edge seam and 3½" below the top edge seam on the back of the lounge.

Tip: Campfire Lounges with waterfall upholstery can be ordered as a single or multi-fabric upholstery.

Tip: When specifying multiple COM fabrics, indicate all surfaces where COM applies. Example: TS3BCM with Designtex 1234 on seat and Designtex 5678 on back.

Tip: One thread color is used on waterfall lounges with multiple fabrics. The thread color used on the waterfall upholstery will be used on the entire unit.

Tip: Order ganging brackets TS3GANGING to gang units together for more stable applications.

Standard Includes	Required to Specify
-------------------	---------------------

- | | | |
|------------------------------------------------------------------------------------------|-------------------------------------------------------------------------------------------------------------------------------------------------------------------------------------------------------------|---------------------------------------------------------------------------------------------------------------------------------------------------------------------------------------------------------------|
| <ul style="list-style-type: none"> ▶ Need help? Product details, page 534 | <ul style="list-style-type: none"> Fully upholstered armless lounge: fabric price group 1 Foot: black plastic Shipped fully assembled Meets Cal. 117 requirements | <ul style="list-style-type: none"> 1 Style number 2 Fabric color number for upholstery 3 Options, if selected (see below) ▶ See <i>Surface Materials</i>, page 634. |
|------------------------------------------------------------------------------------------|-------------------------------------------------------------------------------------------------------------------------------------------------------------------------------------------------------------|---------------------------------------------------------------------------------------------------------------------------------------------------------------------------------------------------------------|

Surface Materials	Options	U.S. Price	Required to Specify
-------------------	---------	------------	---------------------

Surface Materials	Single upholstery fabric		Specify fabric color number. Specify fabric color number. Specify fabric color number. Specify fabric color number. Specify fabric color number. Specify fabric color number. Specify fabric color number. Specify fabric color number. Specify fabric color number. Specify fabric color number. Specify fabric color number. ▶ See <i>Understanding Customer's Own Material (COM)</i> , page 642.
	• Fabric price group 1	No cost	
	• Fabric price group 2	+\$ 57	
	• Fabric price group 3	+\$ 222	
	• Fabric price group 4	+\$ 393	
	• Fabric price group 5	+\$ 705	
	• Fabric price group 6	+\$ 739	
	• Fabric price group 7	+\$ 850	
	• Fabric price group 8	+\$1210	
	• Fabric price group 9	+\$1480	
	• Fabric price group 10	+\$1548	
• Customer's Own Material (COM)	+\$ 56		

Options	U.S. Price	Required to Specify
---------	------------	---------------------

Multiple upholstery fabric		Add suffix M to Big Lounge chair style number and select fabric color number for: 1 Seat, 2 Back
• Different fabric on seat and back	+\$ 93	
① Fabric on seat		Specify fabric color number. Specify fabric color number. Specify fabric color number. Specify fabric color number. Specify fabric color number. Specify fabric color number. Specify fabric color number. Specify fabric color number. Specify fabric color number. Specify fabric color number. Specify fabric color number. ▶ See <i>Understanding Customer's Own Material (COM)</i> , page 642.
• Fabric price group 1	No cost	
• Fabric price group 2	+\$ 28	
• Fabric price group 3	+\$ 119	
• Fabric price group 4	+\$ 215	
• Fabric price group 5	+\$ 386	
• Fabric price group 6	+\$ 404	
• Fabric price group 7	+\$ 465	
• Fabric price group 8	+\$ 665	
• Fabric price group 9	+\$ 813	
• Fabric price group 10	+\$ 848	
• Customer's Own Material (COM)	+\$ 27	
② Fabric on back		Specify fabric color number. Specify fabric color number. Specify fabric color number. Specify fabric color number. Specify fabric color number. Specify fabric color number. Specify fabric color number. Specify fabric color number. Specify fabric color number. Specify fabric color number. Specify fabric color number. ▶ See <i>Understanding Customer's Own Material (COM)</i> , page 642.
• Fabric price group 1	No cost	
• Fabric price group 2	+\$ 35	
• Fabric price group 3	+\$ 145	
• Fabric price group 4	+\$ 263	
• Fabric price group 5	+\$ 475	
• Fabric price group 6	+\$ 494	
• Fabric price group 7	+\$ 569	
• Fabric price group 8	+\$ 813	
• Fabric price group 9	+\$ 994	
• Fabric price group 10	+\$1040	
• Customer's Own Material (COM)	+\$ 27	

Related Products	Options	Required to Specify
------------------	---------	---------------------

- | | |
|-----------------------------------------------------------|--------------------------------------------------------------|
| <ul style="list-style-type: none"> Ottoman | <ul style="list-style-type: none"> ▶ Page 552 |
|-----------------------------------------------------------|--------------------------------------------------------------|

Specification Information

• Dimensions			• Style	• U.S.
D	W	H	Number	Base Price
32"	66"	29"	TS3BCW	\$4046

For Canadian Pricing
Multiply U.S. Price by the Canadian price factor.
▶ See page 1 for details.

Half Lounge

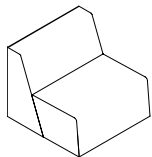

Standard Includes	Required to Specify
<ul style="list-style-type: none"> ▶ Need help? Product details, page 534 Fully upholstered armless lounge: fabric price group 1 Foot: black plastic Shipped fully assembled Meets Cal. 117 requirements 	<ul style="list-style-type: none"> 1 Style number 2 Fabric color number for upholstery 3 Options, if selected (see below) ▶ See <i>Surface Materials</i>, page 634.

Surface Materials	Options	U.S. Price	Required to Specify
	Single upholstery fabric		
	• Fabric price group 1	No cost	Specify fabric color number.
	• Fabric price group 2	+\$ 28	Specify fabric color number.
	• Fabric price group 3	+\$101	Specify fabric color number.
	• Fabric price group 4	+\$211	Specify fabric color number.
	• Fabric price group 5	+\$376	Specify fabric color number.
	• Fabric price group 6	+\$404	Specify fabric color number.
	• Fabric price group 7	+\$427	Specify fabric color number.
	• Fabric price group 8	+\$613	Specify fabric color number.
	• Fabric price group 9	+\$714	Specify fabric color number.
	• Fabric price group 10	+\$754	Specify fabric color number.
	• Customer's Own Material (COM)	+\$ 56	▶ See <i>Understanding Customer's Own Material (COM)</i> , page 642.

Tip: Campfire Lounges can be ordered as a single or multi-fabric upholstery.

Tip: When specifying multiple COM fabrics, indicate all surfaces where COM applies. Example: TS3HLM with Designtex 1234 on seat and Designtex 5678 on back.

	Multiple upholstery fabric		
	• Different fabric on seat and back	+\$ 93	Add suffix M to Half Lounge chair style number and select fabric color number for: 1 Seat, 2 Back
	① Fabric on seat		
	• Fabric price group 1	No cost	Specify fabric color number.
	• Fabric price group 2	+\$ 17	Specify fabric color number.
	• Fabric price group 3	+\$ 37	Specify fabric color number.
	• Fabric price group 4	+\$ 85	Specify fabric color number.
	• Fabric price group 5	+\$129	Specify fabric color number.
	• Fabric price group 6	+\$235	Specify fabric color number.
	• Fabric price group 7	+\$255	Specify fabric color number.
	• Fabric price group 8	+\$268	Specify fabric color number.
	• Fabric price group 9	+\$376	Specify fabric color number.
	• Fabric price group 10	+\$416	Specify fabric color number.
	• Customer's Own Material (COM)	+\$ 27	▶ See <i>Understanding Customer's Own Material (COM)</i> , page 642.
	② Fabric on back		
	• Fabric price group 1	No cost	Specify fabric color number.
	• Fabric price group 2	+\$ 24	Specify fabric color number.
	• Fabric price group 3	+\$ 78	Specify fabric color number.
	• Fabric price group 4	+\$144	Specify fabric color number.
	• Fabric price group 5	+\$255	Specify fabric color number.
	• Fabric price group 6	+\$263	Specify fabric color number.
	• Fabric price group 7	+\$279	Specify fabric color number.
	• Fabric price group 8	+\$427	Specify fabric color number.
	• Fabric price group 9	+\$460	Specify fabric color number.
	• Fabric price group 10	+\$465	Specify fabric color number.
	• Customer's Own Material (COM)	+\$ 27	▶ See <i>Understanding Customer's Own Material (COM)</i> , page 642.

Specification Information

• Dimensions			• Style	• U.S.
D	W	H	Number	Base Price
32"	33"	29"	TS3HL	\$2325



For Canadian Pricing

Multiply U.S. Price by the Canadian price factor.

▶ See page 1 for details.

Half Lounge—Seam

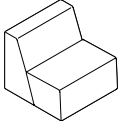

Tip: Seams are located at the top of the back and the front edge of the seat to match seams on Corner Lounges. Corner Lounges come standard with seams. Specify Big and Half Lounges with seams when creating an application with Corner Lounges to create a cohesive design aesthetic.

Tip: Campfire Lounges with seams can be ordered as a single or multi-fabric upholstery.

Tip: When specifying multiple COM fabrics, indicate all surfaces where COM applies. Example: TS3HLM with Designtex 1234 on seat and Designtex 5678 on back.

Tip: Order ganging brackets TS3GANGING to gang units together for more stable applications.

Standard Includes	Required to Specify
-------------------	---------------------

- | | | |
|----------------------------------------|-------------------------------------------------------------------------------------------------------------------------------------------------------------------------------------------------------------|-------------------------------------------------------------------------------------------------------------------------------------------------------------------------------------------------------------|
| ▶ Need help? Product details, page 534 | <ul style="list-style-type: none"> Fully upholstered armless lounge: fabric price group 1 Foot: black plastic Shipped fully assembled Meets Cal. 117 requirements | <ul style="list-style-type: none"> 1 Style number 2 Fabric color number for upholstery 3 Options, if selected (see below) <p>▶ See <i>Surface Materials</i>, page 634.</p> |
|----------------------------------------|-------------------------------------------------------------------------------------------------------------------------------------------------------------------------------------------------------------|-------------------------------------------------------------------------------------------------------------------------------------------------------------------------------------------------------------|

Surface Materials	Options	U.S. Price	Required to Specify
-------------------	---------	------------	---------------------

Surface Materials	Single upholstery fabric		Specify fabric color number. Specify fabric color number. Specify fabric color number. Specify fabric color number. Specify fabric color number. Specify fabric color number. Specify fabric color number. Specify fabric color number. Specify fabric color number. Specify fabric color number. Specify fabric color number. ▶ See <i>Understanding Customer's Own Material (COM)</i> , page 642.
	• Fabric price group 1	No cost	
	• Fabric price group 2	+\$ 28	
	• Fabric price group 3	+\$101	
	• Fabric price group 4	+\$211	
	• Fabric price group 5	+\$376	
	• Fabric price group 6	+\$404	
	• Fabric price group 7	+\$427	
	• Fabric price group 8	+\$613	
	• Fabric price group 9	+\$714	
	• Fabric price group 10	+\$754	
	• Customer's Own Material (COM)	+\$ 56	

	Multiple upholstery fabric		Add suffix M to Half Lounge chair style number and select fabric color number for: 1 Seat, 2 Back
	• Different fabric on seat and back	+\$ 93	

	① Fabric on seat		Specify fabric color number. Specify fabric color number. Specify fabric color number. Specify fabric color number. Specify fabric color number. Specify fabric color number. Specify fabric color number. Specify fabric color number. Specify fabric color number. Specify fabric color number. Specify fabric color number. ▶ See <i>Understanding Customer's Own Material (COM)</i> , page 642.
	• Fabric price group 1	No cost	
	• Fabric price group 2	+\$ 17	
	• Fabric price group 3	+\$ 37	
	• Fabric price group 4	+\$ 85	
	• Fabric price group 5	+\$129	
	• Fabric price group 6	+\$235	
	• Fabric price group 7	+\$255	
	• Fabric price group 8	+\$268	
	• Fabric price group 9	+\$376	
	• Fabric price group 10	+\$416	
	• Customer's Own Material (COM)	+\$ 27	

	② Fabric on back		Specify fabric color number. Specify fabric color number. Specify fabric color number. Specify fabric color number. Specify fabric color number. Specify fabric color number. Specify fabric color number. Specify fabric color number. Specify fabric color number. Specify fabric color number. Specify fabric color number. ▶ See <i>Understanding Customer's Own Material (COM)</i> , page 642.
	• Fabric price group 1	No cost	
	• Fabric price group 2	+\$ 24	
	• Fabric price group 3	+\$ 78	
	• Fabric price group 4	+\$144	
	• Fabric price group 5	+\$255	
	• Fabric price group 6	+\$263	
	• Fabric price group 7	+\$279	
	• Fabric price group 8	+\$427	
	• Fabric price group 9	+\$460	
	• Fabric price group 10	+\$465	
	• Customer's Own Material (COM)	+\$ 27	

Specification Information

• Dimensions			• Style	• U.S.
D	W	H	Number	Base Price
32"	33"	29"	TS3HLS	\$2352

For Canadian Pricing
Multiply U.S. Price by the Canadian price factor.
▶ See page 1 for details.

Half Lounge—Waterfall

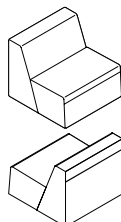

Tip: Waterfall seams are located at the top of the back, the front edge of the seat, 3½" below the front edge seam and 3½" below the top edge seam on the back of the lounge.

Tip: Campfire Lounges with waterfall upholstery can be ordered as a single or multi-fabric upholstery.

Tip: When specifying multiple COM fabrics, indicate all surfaces where COM applies. Example: TS3HLM with Designtex 1234 on seat and Designtex 5678 on back.

Tip: One thread color is used on waterfall lounges with multiple fabrics. The thread color used on the waterfall upholstery will be used on the entire unit.

Tip: Order ganging brackets TS3GANGING to gang units together for more stable applications.

Standard Includes	Required to Specify
<ul style="list-style-type: none"> ▶ Need help? Product details, page 534 Fully upholstered armless lounge: fabric price group 1 Foot: black plastic Shipped fully assembled Meets Cal. 117 requirements 	<ul style="list-style-type: none"> 1 Style number 2 Fabric color number for upholstery 3 Options, if selected (see below) ▶ See <i>Surface Materials</i>, page 634.

Surface Materials	Options	U.S. Price	Required to Specify
	Single upholstery fabric		Specify fabric color number. Specify fabric color number. Specify fabric color number. Specify fabric color number. Specify fabric color number. Specify fabric color number. Specify fabric color number. Specify fabric color number. Specify fabric color number. Specify fabric color number. ▶ See <i>Understanding Customer's Own Material (COM)</i> , page 642.
	• Fabric price group 1	No cost	
	• Fabric price group 2	+\$ 28	
	• Fabric price group 3	+\$101	
	• Fabric price group 4	+\$211	
	• Fabric price group 5	+\$376	
	• Fabric price group 6	+\$404	
	• Fabric price group 7	+\$427	
	• Fabric price group 8	+\$613	
	• Fabric price group 9	+\$714	
• Fabric price group 10	+\$754		
• Customer's Own Material (COM)	+\$ 56		
	Multiple upholstery fabric		Add suffix M to Half Lounge chair style number and select fabric color number for: 1 Seat, 2 Back Specify fabric color number. Specify fabric color number. Specify fabric color number. Specify fabric color number. Specify fabric color number. Specify fabric color number. Specify fabric color number. Specify fabric color number. Specify fabric color number. Specify fabric color number. ▶ See <i>Understanding Customer's Own Material (COM)</i> , page 642.
	• Different fabric on seat and back	+\$ 93	
	① Fabric on seat		
	• Fabric price group 1	No cost	
	• Fabric price group 2	+\$ 21	
	• Fabric price group 3	+\$ 57	
	• Fabric price group 4	+\$111	
	• Fabric price group 5	+\$183	
	• Fabric price group 6	+\$239	
	• Fabric price group 7	+\$258	
• Fabric price group 8	+\$336		
• Fabric price group 9	+\$402		
• Fabric price group 10	+\$426		
• Customer's Own Material (COM)	+\$ 27		
② Fabric on back			
• Fabric price group 1	No cost		
• Fabric price group 2	+\$ 24		
• Fabric price group 3	+\$ 69		
• Fabric price group 4	+\$136		
• Fabric price group 5	+\$225		
• Fabric price group 6	+\$292		
• Fabric price group 7	+\$315		
• Fabric price group 8	+\$408		
• Fabric price group 9	+\$492		
• Fabric price group 10	+\$518		
• Customer's Own Material (COM)	+\$ 27		

Specification Information				
• Dimensions			• Style	• U.S.
D	W	H	Number	Base Price
32"	33"	29"	TS3HLW	\$2394

For Canadian Pricing
Multiply U.S. Price by the Canadian price factor.
▶ See page 1 for details.

Specification Information

Dimensions			Style	U.S.
D	W	H	Number	Base Price
:	:	:	:	:

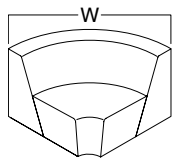

Inside Corner Lounge

32"	54½"	29"	TS3CRIN90S	\$2981
:	:	:	:	:

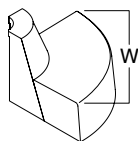

Outside Corner Lounge

32"	55¼"	29"	TS3CROUT90S	\$2981
:	:	:	:	:



For Canadian Pricing

Multiply U.S. Price by the Canadian price factor.

▶ See page 1 for details.

Lounges, continued

90° Corner Lounges—Waterfall

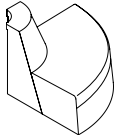
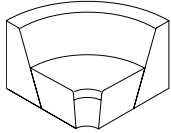

Tip: 90° Corner Lounges available inside or outside facing.

Tip: Waterfall seams are located at the top of the back, the front edge of the seat, 3½" below the front edge seam and 3½" below the top edge seam on the back of the lounge.

Tip: When creating an application using Big or Half Lounges, specify the Big and Half Lounges with a seam for a cohesive design aesthetic.

Tip: Campfire Corner Lounges with waterfall upholstery can be ordered as a single or multi-fabric upholstery.

Tip: When specifying multiple COM fabrics, indicate all surfaces where COM applies. Example: TS3HLM with Designtex 1234 on seat and Designtex 5678 on back.

Tip: One thread color is used on waterfall lounges with multiple fabrics. The thread color used on the waterfall upholstery will be used on the entire unit.

Tip: Order ganging brackets TS3GANGING to gang units together for more stable applications.

Standard Includes **Required to Specify**

- | | | |
|-----------------------------------------------|----------------------------------------------------------------------------------------------------------------------------------------------------------------------------------------------------------------------------|-------------------------------------------------------------------------------------------------------------------------------------------------------------------------------------------------------------|
| <p>▶ Need help? Product details, page 534</p> | <ul style="list-style-type: none"> • Fully upholstered armless corner lounge: fabric price group 1 • Foot: black plastic • Shipped fully assembled • Meets Cal. 117 requirements | <ul style="list-style-type: none"> 1 Style number 2 Fabric color number for upholstery 3 Options, if selected (see below) <p>▶ See <i>Surface Materials</i>, page 634.</p> |
|-----------------------------------------------|----------------------------------------------------------------------------------------------------------------------------------------------------------------------------------------------------------------------------|-------------------------------------------------------------------------------------------------------------------------------------------------------------------------------------------------------------|

Options **U.S. Price** **Required to Specify**

Surface Materials	Single upholstery fabric	
	• Fabric price group 1	No cost
	• Fabric price group 2	+\$ 41
	• Fabric price group 3	+\$ 159
	• Fabric price group 4	+\$ 305
	• Fabric price group 5	+\$ 544
	• Fabric price group 6	+\$ 577
	• Fabric price group 7	+\$ 637
	• Fabric price group 8	+\$ 909
	• Fabric price group 9	+\$1086
	• Fabric price group 10	+\$1142
	• Customer's Own Material (COM)	+\$ 56
	Multiple upholstery fabric	
	• Different fabric on seat and back	+\$ 93
	① Fabric on seat	
	• Fabric price group 1	No cost
	• Fabric price group 2	+\$ 25
	• Fabric price group 3	+\$ 87
	• Fabric price group 4	+\$ 164
	• Fabric price group 5	+\$ 281
	• Fabric price group 6	+\$ 329
	• Fabric price group 7	+\$ 367
	• Fabric price group 8	+\$ 498
	• Fabric price group 9	+\$ 603
	• Fabric price group 10	+\$ 637
	• Customer's Own Material (COM)	+\$ 27
	② Fabric on back	
	• Fabric price group 1	No cost
	• Fabric price group 2	+\$ 31
	• Fabric price group 3	+\$ 107
	• Fabric price group 4	+\$ 201
	• Fabric price group 5	+\$ 344
	• Fabric price group 6	+\$ 402
	• Fabric price group 7	+\$ 448
	• Fabric price group 8	+\$ 610
	• Fabric price group 9	+\$ 739
	• Fabric price group 10	+\$ 777
	• Customer's Own Material (COM)	+\$ 27

Specify fabric color number.
Specify fabric color number.
Specify fabric color number.
Specify fabric color number.
Specify fabric color number.
Specify fabric color number.
Specify fabric color number.
Specify fabric color number.
Specify fabric color number.
Specify fabric color number.
▶ See *Understanding Customer's Own Material (COM)*, page 642.

Add suffix **M** to Half Lounge chair style number and select fabric color number for: 1 Seat, 2 Back

Specify fabric color number.
Specify fabric color number.
Specify fabric color number.
Specify fabric color number.
Specify fabric color number.
Specify fabric color number.
Specify fabric color number.
Specify fabric color number.
Specify fabric color number.
Specify fabric color number.
▶ See *Understanding Customer's Own Material (COM)*, page 642.

Specify fabric color number.
Specify fabric color number.
Specify fabric color number.
Specify fabric color number.
Specify fabric color number.
Specify fabric color number.
Specify fabric color number.
Specify fabric color number.
Specify fabric color number.
Specify fabric color number.
▶ See *Understanding Customer's Own Material (COM)*, page 642.

For Canadian Pricing
Multiply U.S. Price by the Canadian price factor.
▶ See page 1 for details.

Specification Information

Dimensions			Style	U.S.
D	W	H	Number	Base Price

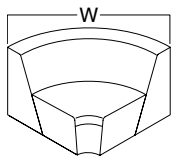

Inside Corner Lounge

32"	54½"	29"	TS3CRIN90W	\$3023
-----	------	-----	-------------------	--------

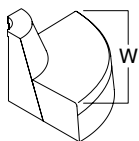

Outside Corner Lounge

32"	55¼"	29"	TS3CROUT90W	\$3023
-----	------	-----	--------------------	--------



For Canadian Pricing

Multiply U.S. Price by the Canadian price factor.

▶ See page 1 for details.

60° Corner Lounges

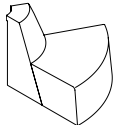
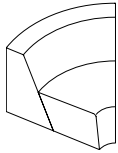

Tip: 60° Corner Lounges available inside or outside facing.

Tip: When creating an application using Big or Half Lounges, specify the Big and Half Lounges with a seam for a cohesive design aesthetic.

Tip: Campfire Corner Lounges can be ordered as a single or multi-fabric upholstery.

Tip: When specifying multiple COM fabrics, indicate all surfaces where COM applies. Example: TS3HLM with Designtex 1234 on seat and Designtex 5678 on back.

Tip: Order ganging brackets TS3GANGING to gang units together for more stable applications.

Standard Includes	Required to Specify
-------------------	---------------------

- | | | |
|----------------------------------------|--------------------------------------------------------------------------------------------------------------------------------------------------------------------------------------------------------------------|-------------------------------------------------------------------------------------------------------------------------------------------------------------------------------------------------------------|
| ▶ Need help? Product details, page 534 | <ul style="list-style-type: none"> Fully upholstered armless corner lounge: fabric price group 1 Foot: black plastic Shipped fully assembled Meets Cal. 117 requirements | <ul style="list-style-type: none"> 1 Style number 2 Fabric color number for upholstery 3 Options, if selected (see below) <p>▶ See <i>Surface Materials</i>, page 634.</p> |
|----------------------------------------|--------------------------------------------------------------------------------------------------------------------------------------------------------------------------------------------------------------------|-------------------------------------------------------------------------------------------------------------------------------------------------------------------------------------------------------------|

Surface Materials	Options	U.S. Price	Required to Specify
-------------------	---------	------------	---------------------

Surface Materials	Single upholstery fabric			
	• Fabric price group 1	No cost		Specify fabric color number.
	• Fabric price group 2	+\$ 36		Specify fabric color number.
	• Fabric price group 3	+\$ 141		Specify fabric color number.
	• Fabric price group 4	+\$ 273		Specify fabric color number.
	• Fabric price group 5	+\$ 483		Specify fabric color number.
	• Fabric price group 6	+\$ 513		Specify fabric color number.
	• Fabric price group 7	+\$ 566		Specify fabric color number.
	• Fabric price group 8	+\$ 807		Specify fabric color number.
	• Fabric price group 9	+\$ 967		Specify fabric color number.
• Fabric price group 10	+\$1018	Specify fabric color number.		
• Customer's Own Material (COM)	+\$ 56	Specify fabric color number.		
	Multiple upholstery fabric			
	• Different fabric on seat and back	+\$ 93	▶ See <i>Understanding Customer's Own Material (COM)</i> , page 642.	
	① Fabric on seat			
	• Fabric price group 1	No cost	Add suffix M to Half Lounge chair style number and select fabric color number for: 1 Seat, 2 Back	
	• Fabric price group 2	+\$ 21	Specify fabric color number.	
	• Fabric price group 3	+\$ 66	Specify fabric color number.	
	• Fabric price group 4	+\$ 126	Specify fabric color number.	
	• Fabric price group 5	+\$ 202	Specify fabric color number.	
	• Fabric price group 6	+\$ 306	Specify fabric color number.	
	• Fabric price group 7	+\$ 348	Specify fabric color number.	
	• Fabric price group 8	+\$ 401	Specify fabric color number.	
	• Fabric price group 9	+\$ 535	Specify fabric color number.	
	• Fabric price group 10	+\$ 576	Specify fabric color number.	
	• Customer's Own Material (COM)	+\$ 27	Specify fabric color number.	
	② Fabric on back			
	• Fabric price group 1	No cost	Specify fabric color number.	
	• Fabric price group 2	+\$ 27	Specify fabric color number.	
	• Fabric price group 3	+\$ 96	Specify fabric color number.	
	• Fabric price group 4	+\$ 174	Specify fabric color number.	
	• Fabric price group 5	+\$ 303	Specify fabric color number.	
	• Fabric price group 6	+\$ 320	Specify fabric color number.	
	• Fabric price group 7	+\$ 356	Specify fabric color number.	
	• Fabric price group 8	+\$ 519	Specify fabric color number.	
	• Fabric price group 9	+\$ 585	Specify fabric color number.	
	• Fabric price group 10	+\$ 598	Specify fabric color number.	
	• Customer's Own Material (COM)	+\$ 27	Specify fabric color number.	



For Canadian Pricing

Multiply U.S. Price by the Canadian price factor.

▶ See page 1 for details.

Specification Information

Dimensions			Style	U.S.
D	W	H	Number	Base Price

Inside Corner Lounge

32"	38½"	29"	TS3CRIN60S	\$2650
-----	------	-----	-------------------	--------

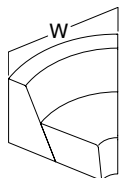

Outside Corner Lounge

32"	39¼"	29"	TS3CROUT60S	\$2650
-----	------	-----	--------------------	--------



For Canadian Pricing

Multiply U.S. Price by the Canadian price factor.

▶ See page 1 for details.

60° Corner Lounges—Waterfall

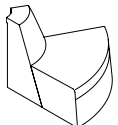
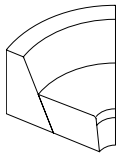

Tip: 60° Corner Lounges available inside or outside facing.

Tip: Waterfall seams are located at the top of the back, the front edge of the seat, 3½" below the front edge seam and 3½" below the top edge seam on the back of the lounge.

Tip: When creating an application using Big or Half Lounges, specify the Big and Half Lounges with a seam for a cohesive design aesthetic.

Tip: Campfire Corner Lounges with waterfall upholstery can be ordered as a single or multi-fabric upholstery.

Tip: When specifying multiple COM fabrics, indicate all surfaces where COM applies. Example: TS3HLM with Designtex 1234 on seat and Designtex 5678 on back.

Tip: One thread color is used on waterfall lounges with multiple fabrics. The thread color used on the waterfall upholstery will be used on the entire unit.

Tip: Order ganging brackets TS3GANGING to gang units together for more stable applications.

Standard Includes	Required to Specify
-------------------	---------------------

- | | | |
|------------------------------------------------------------------------------------------|----------------------------------------------------------------------------------------------------------------------------------------------------------------------------------------------------------------------------|---------------------------------------------------------------------------------------------------------------------------------------------------------------------------------------------------------------|
| <ul style="list-style-type: none"> ▶ Need help? Product details, page 534 | <ul style="list-style-type: none"> • Fully upholstered armless corner lounge: fabric price group 1 • Foot: black plastic • Shipped fully assembled • Meets Cal. 117 requirements | <ul style="list-style-type: none"> 1 Style number 2 Fabric color number for upholstery 3 Options, if selected (see below) ▶ See <i>Surface Materials</i>, page 634. |
|------------------------------------------------------------------------------------------|----------------------------------------------------------------------------------------------------------------------------------------------------------------------------------------------------------------------------|---------------------------------------------------------------------------------------------------------------------------------------------------------------------------------------------------------------|

Surface Materials	Options	U.S. Price	Required to Specify
-------------------	---------	------------	---------------------

Surface Materials	Single upholstery fabric		Specify fabric color number. Specify fabric color number. Specify fabric color number. Specify fabric color number. Specify fabric color number. Specify fabric color number. Specify fabric color number. Specify fabric color number. Specify fabric color number. Specify fabric color number. ▶ See <i>Understanding Customer's Own Material (COM)</i> , page 642.
	• Fabric price group 1	No cost	
	• Fabric price group 2	+\$ 36	
	• Fabric price group 3	+\$ 141	
	• Fabric price group 4	+\$ 273	
	• Fabric price group 5	+\$ 483	
	• Fabric price group 6	+\$ 513	
	• Fabric price group 7	+\$ 566	
	• Fabric price group 8	+\$ 807	
	• Fabric price group 9	+\$ 967	
	• Fabric price group 10	+\$1018	
	• Customer's Own Material (COM)	+\$ 56	
Multiple upholstery fabric		Add suffix M to Half Lounge chair style number and select fabric color number for: 1 Seat, 2 Back Specify fabric color number. Specify fabric color number. Specify fabric color number. Specify fabric color number. Specify fabric color number. Specify fabric color number. Specify fabric color number. Specify fabric color number. Specify fabric color number. Specify fabric color number. Specify fabric color number. ▶ See <i>Understanding Customer's Own Material (COM)</i> , page 642.	
• Different fabric on seat and back	+\$ 93		
① Fabric on seat			
• Fabric price group 1	No cost		
• Fabric price group 2	+\$ 23		
• Fabric price group 3	+\$ 78		
• Fabric price group 4	+\$ 144		
• Fabric price group 5	+\$ 250		
• Fabric price group 6	+\$ 292		
• Fabric price group 7	+\$ 327		
• Fabric price group 8	+\$ 444		
• Fabric price group 9	+\$ 538		
• Fabric price group 10	+\$ 566		
• Customer's Own Material (COM)	+\$ 27		
② Fabric on back			
• Fabric price group 1	No cost		
• Fabric price group 2	+\$ 27		
• Fabric price group 3	+\$ 96		
• Fabric price group 4	+\$ 177		
• Fabric price group 5	+\$ 307		
• Fabric price group 6	+\$ 358		
• Fabric price group 7	+\$ 398		
• Fabric price group 8	+\$ 543		
• Fabric price group 9	+\$ 659		
• Fabric price group 10	+\$ 693		
• Customer's Own Material (COM)	+\$ 27		



For Canadian Pricing

Multiply U.S. Price by the Canadian price factor.

▶ See page 1 for details.

Specification Information

• Dimensions			• Style	• U.S.
D	W	H	Number	Base Price

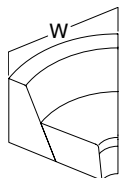

Inside Corner Lounge

32"	38½"	29"	TS3CRIN60W	\$2692
-----	------	-----	-------------------	--------



Outside Corner Lounge

32"	39¼"	29"	TS3CROUT60W	\$2692
-----	------	-----	--------------------	--------

Gangling Brackets



Standard Includes **Required to Specify**

- Set of two gangling brackets: black plastic
- Hardware kit

Style number

Related Products

- Corner Lounges

▶ Pages 544–550

Specification Information

• Style Number	• U.S. Price
----------------	--------------

TS3GANGING	\$76
-------------------	------



For Canadian Pricing

Multiply U.S. Price by the Canadian price factor.

▶ See page 1 for details.

Ottoman



Standard Includes	Required to Specify
-------------------	---------------------

- | | | |
|------------------------------------------------------------------------------------------|-----------------------------------------------------------------------------------------------------------------------------------------------------------------------------------------------------|---------------------------------------------------------------------------------------------------------------------------------------------------------------------------------------------------------------|
| <ul style="list-style-type: none"> ▶ Need help? Product details, page 534 | <ul style="list-style-type: none"> • Fully upholstered Ottoman: fabric price group 1 • Four adjustable-height legs: brushed aluminum • Meets Cal. 117 requirements | <ul style="list-style-type: none"> 1 Style number 2 Fabric color number for upholstery 3 Options, if selected (see below) ▶ See <i>Surface Materials</i>, page 634. |
|------------------------------------------------------------------------------------------|-----------------------------------------------------------------------------------------------------------------------------------------------------------------------------------------------------|---------------------------------------------------------------------------------------------------------------------------------------------------------------------------------------------------------------|

Options	U.S. Price	Required to Specify
---------	------------	---------------------

Surface Materials	Upholstery	U.S. Price	Required to Specify
	<ul style="list-style-type: none"> • Fabric price group 1 • Fabric price group 2 • Fabric price group 3 • Fabric price group 4 • Fabric price group 5 • Fabric price group 6 • Fabric price group 7 • Fabric price group 8 • Fabric price group 9 • Fabric price group 10 • Customer's Own Material (COM) 	<ul style="list-style-type: none"> No cost +\$ 23 +\$ 61 +\$ 92 +\$114 +\$141 +\$168 +\$216 +\$265 +\$303 +\$ 55 	<ul style="list-style-type: none"> Specify fabric color number. Specify fabric color number. Specify fabric color number. Specify fabric color number. Specify fabric color number. Specify fabric color number. Specify fabric color number. Specify fabric color number. Specify fabric color number. Specify fabric color number. ▶ See <i>Understanding Customer's Own Material (COM)</i>, page 642.

Tip: Wood legs are natural wood and may show variations in grain and color.

Tip: The Ottoman must be specified with low profile glides.

Legs	U.S. Price	Required to Specify
<ul style="list-style-type: none"> • Solid round wood legs 	<ul style="list-style-type: none"> +\$233 	<ul style="list-style-type: none"> Specify <i>with solid round wood legs</i> and select V1AC Natural Cherry, V1AM Clear Maple, or V1EW Dark Walnut.

Glides	U.S. Price	Required to Specify
<ul style="list-style-type: none"> • Low profile glide 	<ul style="list-style-type: none"> No cost 	<ul style="list-style-type: none"> Specify <i>with low profile glides</i>.

Specification Information

Style Number	U.S. Base Price
TS34401	\$775

For Canadian Pricing
 Multiply U.S. Price by the Canadian price factor.
 ▶ See page 1 for details.

Pouf



Standard Includes	Required to Specify
<ul style="list-style-type: none"> ▶ Need help? Product details, page 534 • Upholstered body: fabric price group 1 • Base: black plastic • Handle: nylon • Glides: plastic • Ships fully assembled 	<ol style="list-style-type: none"> 1 Style number 2 Fabric color number for body 3 Nylon color number for handle: <ul style="list-style-type: none"> 5JG0 Black 5JG1 Burgundy 5JG2 Taupe 5JG3 Silver 5JG4 Teal 5JG5 Red 5JG6 Pacific Blue 4 Options, if selected (see below) <ul style="list-style-type: none"> ▶ See <i>Surface Materials</i>, page 634.

Options	U.S. Price	Required to Specify
Surface Materials <ul style="list-style-type: none"> • Upholstery <ul style="list-style-type: none"> • Fabric price group 1 • Fabric price group 5 • Customer's Own Material (COM) 	<ul style="list-style-type: none"> No cost +\$112 +\$ 56 	<ul style="list-style-type: none"> Specify fabric color number. Specify fabric color number. ▶ See <i>Understanding Customer's Own Material (COM)</i>, page 642.
Contrasting stitching <ul style="list-style-type: none"> • No contrast stitching • Contrast stitching 	<ul style="list-style-type: none"> No cost +\$ 41 	<ul style="list-style-type: none"> Specify <i>with no contrast stitching</i>. Specify <i>with contrasting stitching</i> and specify color number. ▶ See <i>Surface Materials</i>, page 634.

Tip: Contrast stitching will be 138 weight thread. Thread is normal weight when no contrast stitching is selected.

Tip: Pouf is designed to support weights up to 225 pounds.

Specification Information				
• Dimensions			• Style	• U.S.
D	W	H	Number	Base Price
15"	15"	18"	TS4PF	\$642



For Canadian Pricing

Multiply U.S. Price by the Canadian price factor.

▶ See page 1 for details.

Wedge

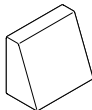

Tip: Wedge connects only to Big or Half Lounge, not corner lounges.

Standard Includes		Required to Specify
<ul style="list-style-type: none"> ▶ Need help? Product details, page 534 	<ul style="list-style-type: none"> Fully upholstered Wedge: fabric price group 1 Foot: black plastic Deck stitch detail Connecting hardware 	<ul style="list-style-type: none"> 1 Style number 2 Fabric color number for upholstery 3 Options, if selected (see below) ▶ See <i>Surface Materials</i>, page 634.

Options	U.S. Price	Required to Specify
Surface Materials <ul style="list-style-type: none"> Fabric price group 1 Fabric price group 2 Fabric price group 3 Fabric price group 4 Fabric price group 5 Fabric price group 6 Fabric price group 7 Fabric price group 8 Fabric price group 9 Fabric price group 10 Customer's Own Material (COM) 	Upholstery <ul style="list-style-type: none"> No cost +\$ 23 +\$ 61 +\$104 +\$162 +\$268 +\$340 +\$376 +\$441 +\$500 +\$ 56 	<ul style="list-style-type: none"> Specify fabric color number. Specify fabric color number. Specify fabric color number. Specify fabric color number. Specify fabric color number. Specify fabric color number. Specify fabric color number. Specify fabric color number. Specify fabric color number. Specify fabric color number. ▶ See <i>Understanding Customer's Own Material (COM)</i>, page 642.

Specification Information	
Style Number	U.S. Base Price
TS3WG	\$1408



For Canadian Pricing

Multiply U.S. Price by the Canadian price factor.

▶ See page 1 for details.

Footrest



Standard Includes	Required to Specify
-------------------	---------------------

- | | | |
|----------------------------------------------|----------------------------------------------------------------------|-------------------------------------------------------------------------------------------------|
| ▶ Need help?
Product details,
page 537 | ▶ Footrest: grey expanded polypropylene foam
▶ Band: 3 mm plastic | 1 Style number
2 Plastic color number for band
▶ See <i>Surface Materials</i> , page 634. |
|----------------------------------------------|----------------------------------------------------------------------|-------------------------------------------------------------------------------------------------|

Related Products

- | | |
|---------------|------------|
| • Big Lounge | ▶ Page 538 |
| • Half Lounge | ▶ Page 541 |

Specification Information				
• Dimensions	• Style		• U.S.	
D	W	H	Number	Price

16 ⁵ / ₈ "	16 ¹ / ₄ "	11"	TS3FR	\$308
----------------------------------	----------------------------------	-----	-------	-------

Screens X10/24

Standard Includes	Required to Specify
-------------------	---------------------

- | | | |
|----------------------------------------------|--------------------------------------------------------------------------|-------------------------------------------------------------------------------------------------------|
| ▶ Need help?
Product details,
page 537 | • Screen: mesh
• Frame: 0835 Black paint
• Ships ready to assemble | 1 Style number
2 Fabric color number for mesh screen
▶ See <i>Surface Materials</i> , page 634. |
|----------------------------------------------|--------------------------------------------------------------------------|-------------------------------------------------------------------------------------------------------|

Related Products

- | | |
|--------------|------------------------------------------------------------------------|
| • Big Lamp | ▶ See <i>Conference and Collaborative Tables Specification Guide</i> . |
| • Big Lounge | ▶ Page 538 |

Specification Information		
• Height	• Style	• U.S.
:	Number	Price

:	:	:
---	---	---

Screens

Right-Hand

54"	TS4TSCRNR X10/24	\$1454
-----	-------------------------------------------------------	--------

Left-Hand

54"	TS4TSCRNL X10/24	\$1454
-----	-------------------------------------------------------	--------

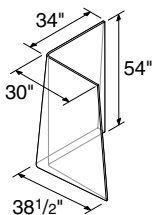
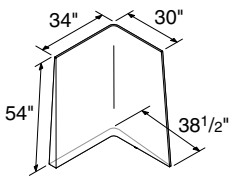

X10/24 = Last order entry
October 20, 2024

