

Slim Leg Height-adjustable Desk - Corner

The Slim Leg height-adjustable desk was designed to support wellbeing and the dynamic work of workers today. The light and modern aesthetic provides a visual richness with a range of styles, applications and materials.

Versatile laminates. Beautiful metal finishes. Slim Leg offers an array of material choices, providing organizations with extensive options to enhance their environment and express their brand and culture.

Slim Leg height-adjustable desk – Corner is available in a standard width of 72" x 72", with 1, 2, or 3 shrouded legs. The top has two variations – radius or square corner. Additional sizes and options can be requested as a Special using the style numbers listed on page 2.

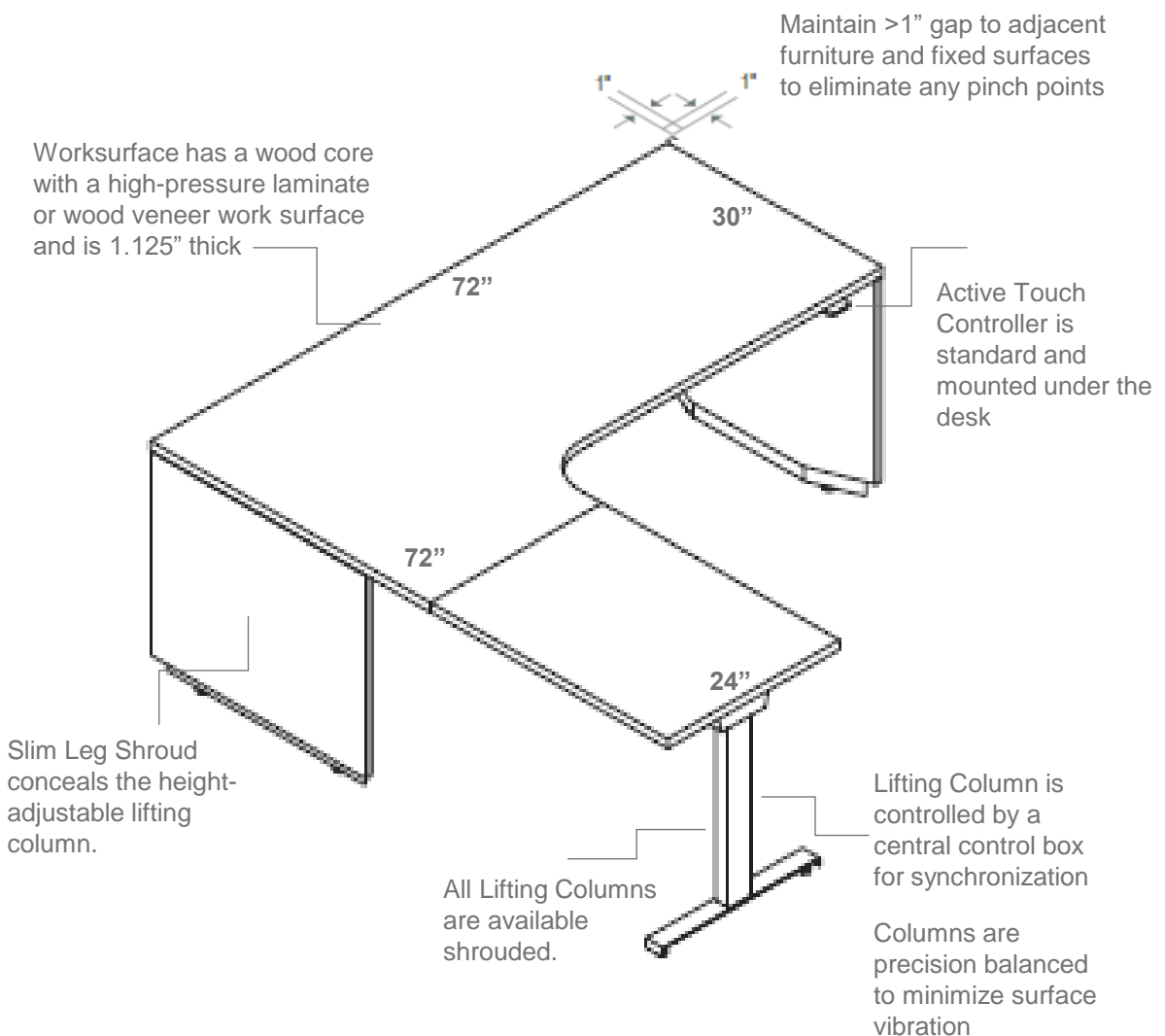

Statement of Line

Specification Details for Slim Leg HAD - Corner	
Width	Standard Width: 72"x72" <i>Available up to 84"x84" with work surface depth limitations as a Special.</i>
Depth	Standard Depth Main Surface: 30" Standard Depth Return Surface: 24" <i>Return Depths of as low as 22" and as high as 30" are allowed on the return work surface as a Special.</i>
Surface Materials	Standard in Laminate PG1. Available in all Steelcase Laminates & Veneers (upcharge might apply)
Profile	Square 3mm Veneer & Laminate on user and guest side.
Integrated Storage	Standard with Currency Enhanced: CRHAD1H; CRHAD15H; CRHADCT
Power	Standard provides power solution required to conceal power cord through shroud. A 4-port and 6-port PDUs are available. Accessory power provided includes clamp-on attachment.
Modesty Panels	Standard on main surface only.
Grommet	Not standard.
Cable Riser for Dual Shroud HAD	Not standard.
Alternative Surfaces	Not standard.
Surface Extending Past Shroud.	Not standard.

Slim Leg Radius

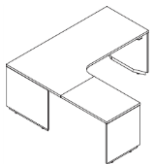

SLH3SLHCNRR

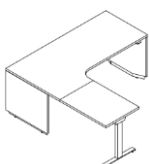

SLH2SLHCNRR

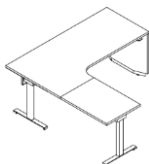

SLH1SLHCNRR

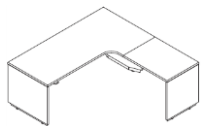

SLH3SRHCNRR

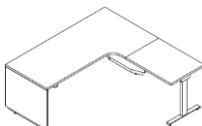

SLH2SRHCNRR

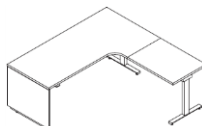

SLH1SRHCNRR

Slim Leg 90 Degree

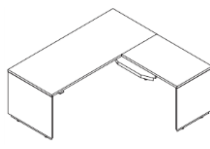

SLH3SRHCNR90

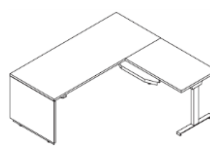

SLH2SRHCNR90

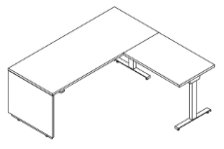

SLH1SRHCNR90

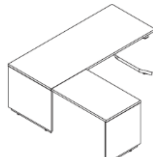

SLH3SLHCNR90

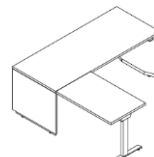

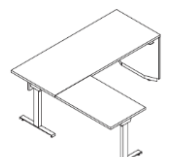

SLH2SLHCNR90

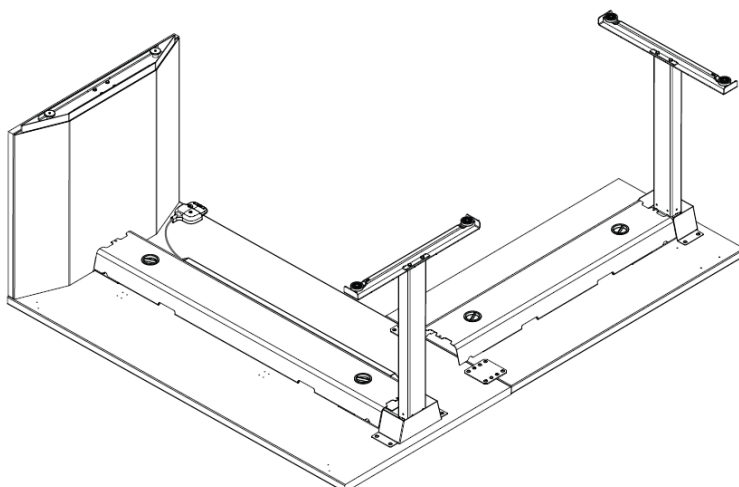

SLH1SLHCNR90

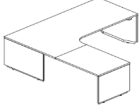
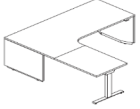
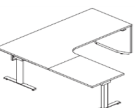
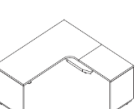
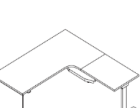
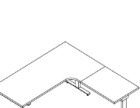
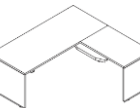
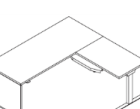
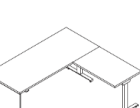
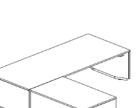

Slim Leg HAD - Corner Pricing

Item	Style Number	List Price* Laminate (PL198)	List Price* Veneer (L198)
Slim Leg HAD Corners - Radius			
	SLH3SLHCNRR	\$8,370	\$13,569
	SLH2SLHCNRR	\$7,264	\$11,626
	SLH1SLHCNRR	\$6,113	\$9,638
	SLH3SRHCNRR	\$8,370	\$13,569
	SLH2SRHCNRR	\$7,264	\$11,626
	SLH1SRHCNRR	\$6,113	\$9,638
Slim Leg HAD Corners - 90 Degree			
	SLH3SRHCNR90	\$7,929	\$12,577
	SLH2SRHCNR90	\$6,823	\$10,634
	SLH1SRHCNR90	\$5,672	\$8,646
	SLH3SLHCNR90	\$7,929	\$12,577
	SLH2SLHCNR90	\$6,823	\$10,634
	SLH1SLHCNR90	\$5,672	\$8,646

**Price may change based on the options selected. For exact pricing refer to SmartTools.*

Slim Leg HAD - Corner Pricing – Options*

	Options	Price (PL198)
Shroud Finish Group	<ul style="list-style-type: none"> • Smooth Paint • Textured Paint • Accessory Paint • Smooth Metallic • Smooth Paint PG2 • Textured Metallic • Accent Paint • Lux Coating • Coatings PG3 • Perfect Match 	No Cost +\$81 +\$81 +\$81 +\$81 +\$81 +\$132 +\$132 +\$132 +\$132
Cable Tray Finish Group	<ul style="list-style-type: none"> • Smooth Paint • Textured Paint • Accessory Paint • Smooth Metallic • Smooth Paint PG2 • Textured Metallic • Accent Paint • Lux Coating • Coatings PG3 • Perfect Match 	No Cost No Cost +\$24 +\$46 +\$24 +\$24 +\$49 +\$49 +\$49 +\$49
Cord Management (Outside Shroud)	<ul style="list-style-type: none"> • No Cord Management • With Vert Cable Magnet Cover 	No Cost +\$92
Cable Cover Finish Group (With Vert Cable Magnet Cover)	<ul style="list-style-type: none"> • Smooth Paint • Textured Paint • Accessory Paint • Smooth Metallic • Smooth Paint PG2 • Textured Metallic • Accent Paint • Lux Coating • Coatings PG3 • Perfect Match 	No Cost No Cost +\$19 +\$19 +\$19 +\$19 +\$36 +\$36 +\$36 +\$36
Power Configuration	<ul style="list-style-type: none"> • No Power • Under Worksurface 4 Outlet • Under Worksurface 6 Outlet 	No Cost No Cost +\$45
Clamp on Power Configuration (When Under Worksurface Power is Specified)	<ul style="list-style-type: none"> • Utility Power Only • Utility Power with Clamp On 	+\$326 +\$612
Clamp on Power Finish Group	<ul style="list-style-type: none"> • Plastic PG1 • Plastic PG2 	No Cost +\$44
Tamper Resistance	<ul style="list-style-type: none"> • No Tamper Resistance • Tamper Resistance 	No Cost +\$78
Power	<ul style="list-style-type: none"> • 3 Power • 2 Power 1 USB A • 2 Power 1 USB C • 2 Power 1 USB A + C 	No Cost +\$122 +\$364 +\$346
Cord Length	<ul style="list-style-type: none"> • 9 Feet (Chicago) • 10 Feet 	+\$22 +\$24
Cord Type	<ul style="list-style-type: none"> • Standard • Braided 	No Cost +\$73

*For exact pricing refer to SmartTools.

FAQ

What is the size of the worksurface for the Slim Leg HAD?

- 90 degree: Main Surface - 30"D x 72"W; Return Worksurface - 24"D x 42"W

What is the pinch point guideline for the Slim Leg HAD?

- 1" application rules apply similar to other HADs.

Is there an obstruction sensor?

- Yes

What types of controllers are available?

- Both Simple Touch and Active Touch Controllers are available.

What is the height range for Slim Leg HAD?

- Height range of single stage is 28.1" - 47.8".

What is the maximum height for storage?

- Slim Leg HAD will accommodate a 1.5 high storage. The height range to the TOP of the worksurface is 28.1" and worksurfaces are 1.125" thick. Be sure to factor in cable trough and a 1" pinch point.

What is the depth/thickness of the Slim Leg shroud?

- About 3 7/8" (nominal), which includes the end panel.

What is the floor clearance of the end panel of the Slim Leg shroud when the desk is at its lowest point?

- See Slim Leg HAD Spec guide to learn more about clearance.

What surface materials are available?

- All surface materials available on Slim Leg HAD. Refer to the spec guide for more information.

Is laminate offered in vertical grain on the worksurface?

- No, due to the sheet size of laminate. Worksurfaces are over 60" and cannot be vertical grain.

Can I combine a laminate with a veneer end panel and vice versa?

- Yes.

What color does the exposed leg come in?

- 0835 Black, 4243 Merle and 4799 Platinum metallic.

What if I want to embed the exposed leg into storage or common top?

- Can work with select Currency Enhanced storage: CRHAD1H; CRHAD15H; CRHADCT. Veneer is available – quote through E6HAD.

How do modesty panels work with Slim Leg HAD?

- A modesty panel is available as an option on the straight worksurface.

Does the modesty panel touch the leg?

- No, there is a small gap on either side of the modesty panel.

Can monitor arms be used?

- Yes, any Steelcase monitor arms can be used (both clamp-mounted and through-mounted). Be mindful of the 1" pinch point requirement.

Can I clamp on a power unit?

- Yes. Be mindful of the 1" pinch point requirement.

How do I route cords beneath the surface?

- Cords can be routed inside the cable trough.

Can I run cords inside the metal cover of the Slim Leg?

- **Only** Steelcase provided power and data cord. The power cord is secured on either side of the shroud and snakes into the opening on the left or right side of the shroud. Refer to the Slim Leg HAD spec guide for installation guidance.