Screens, Cableways, and Cable and Power Management

Understanding

Universal Privacy/Modesty Screens	212
Universal Privacy Screens and Aligners	214
Universal Rear and Side Hard Surface Screens	215
Sarto Privacy/Modesty Screens	216
Sarto Privacy Screens	217
Sarto Curved Screens	218
Universal and Sarto Screens Specific Guidelines	220
Soffio Screen	222
Worksurface Side Screens	224
Acrylic Screens	226
Table-Mounted Translucent and Slatwall Screens	228
Cableways	229
Cable and Power Management	230

Specifying

Universal Privacy/Modesty Screens	239
Universal Privacy Screens and Aligners	240
Universal Rear Hard Surface Screens with Solid Clear Plastic	242
Universal Side Hard Surface Screens with Solid Clear Plastic	244
Sarto Privacy/Modesty Screens	246
Sarto Privacy Screens	248
Sarto Alignment Clip	250
Sarto Curved Screens	252
Soffio Screen	255
Worksurface Side Screens	256
Acrylic Screens	260
Table-Mounted Screens	262
Cableways	264
Cable and Power Management	265

Universal Privacy/Modesty Screens

Universal privacy/modesty screen

provides a boundary element for height adjustable desks and fixed worksurfaces. It can be used with Ology, Migration SE, Airtouch, Elective Elements, Universal tables, and Universal panel mount worksurfaces.

► Specifying, page 239

Universal privacy/modesty screens

are available in one height, 25⁷/₁₀" , with two mount location options to provide either privacy or privacy/modesty.

Universal privacy/modesty screens

cannot be used on surfaces that have intergrated rails or an additive SOTO rail.

Universal privacy/modesty screen is pin tackable.

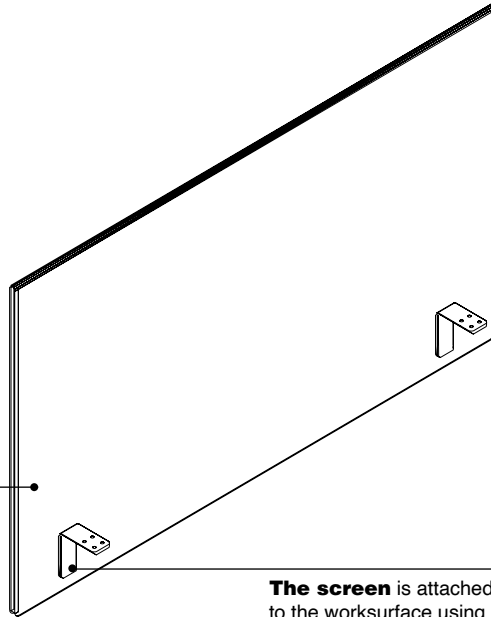

The screen is attached to the worksurface using simple L-brackets and 1" screws.

Product Details

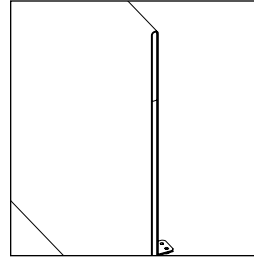

The edge of the screen is comprised of two different materials. The upper segment is merle plastic. The lower portion is PET which can be specified in medium heather grey to provide contrast or dark heather grey for a uniform visual.

The screen may be used on 3/4"-1 1/2" thick worksurfaces.

The width of the screen can be equal to or less than the width of the worksurface to which it will attach. Some restrictions apply due to location of worksurface legs and supports.

Surface Materials

Screen

- Fabric
- See *Surface Materials*, page 280.

Edge (upper segment)

- 7360 Merle

Edge (lower segment)

- P630 Medium Heather Grey PET
- P631 Dark Heather Grey PET

Brackets

- 7360 Merle

Application Topics

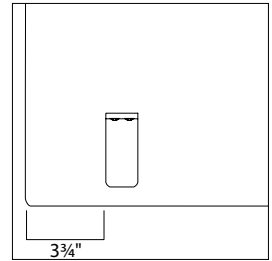

Universal privacy/modesty screen mounts to worksurfaces using simple L-brackets and screws. The brackets are positioned 3 3/4" in from each side of the screen.

Tip: When specifying grommets on Ology, verify the position of the screen in CET SmartTools Planning.

Screen height attachment locations are determined when specifying privacy (top of screen will be at 48") or privacy/modesty (top of screen will be at 42"). The location cannot be changed in the field.

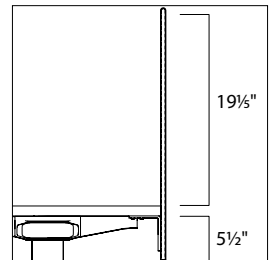

Privacy configuration provides 19¹/₈" of screen above the worksurface and 5¹/₂" of screen below the worksurface. The height is measured from the top of the mounting surface to the top of the screen, and from the bottom of the mounting surface to the bottom of the screen. The top of the screen will align with the bottom of the top trim on a 48"H Answer panel.

Actual Dimensions

Width	42", 48", 54", 60", or 66"
Height	25 ⁷ / ₁₀ "
Weight	9.79 lb, 10.315 lb, 10.84 lb, 11.365 lb, 11.89 lb
Thickness	3/4"

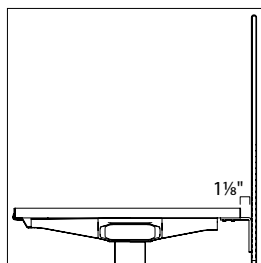

Screen can be mounted with a 1 1/8" cord drop or flush with no cord drop.

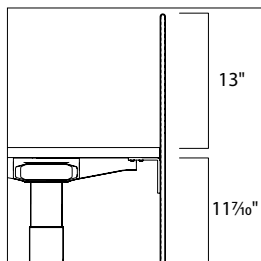

Privacy/modesty configuration provides 13" of screen above the worksurface and 11 7/10" of screen below the worksurface. The height is measured from the top of the mounting surface to the top of the screen, and from the bottom of the mounting surface to the bottom of the screen. The top of the screen will align with the bottom of the top trim on a 42"H Answer panel.

Both the privacy and privacy/modesty configurations allow the height-adjustable desks to be lowered to the lowest position (22") while preserving pinch point gap. Privacy version will not interfere with integrated storage.

Privacy/modesty screens must never be wider than the surface to which they are attached.
Tip: It is recommended that CET SmartTools Planning aid be used to ensure proper application of screen to worksurface or tables.

Universal privacy/modesty screens cannot be used with 58"W Ology desks with leg integrated into storage. The smallest screen width is 42" which would collide with the storage. Must use a minimum 64"W desk when using storage and Universal privacy/modesty screens.

When used with One-High integrated storage, Universal privacy/modesty screens must be a minimum of 18" shorter than worksurface width to allow for pinch point clearances.

Universal Privacy Screens and Aligners

Universal privacy screens provide a boundary and privacy element for height adjustable desks and fixed workspaces. It can be used with Ology, Migration SE, Elective Elements, panel supported Universal workspaces, and TS Series workspaces.

► Specifying, page 240

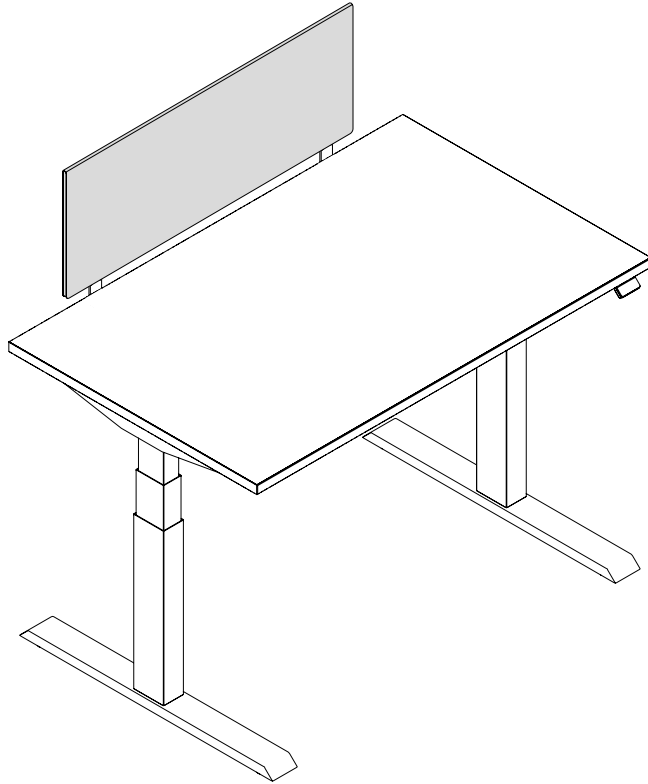

Product Details

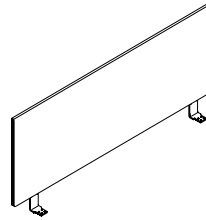

Universal privacy screens are tackable and available in 13½"H and 19½"H, and have widths from 24"W to 96"W.

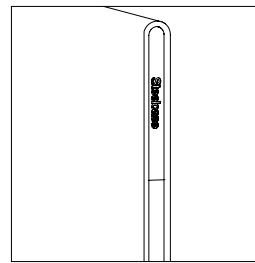

The edge of the screen is comprised of two different materials. The upper segment is merle plastic. The lower portion is PET which can be specified in medium heather grey to provide contrast or dark heather grey for a uniform visual.

The screen may be used on ¾"–1½" thick worksurface.

The width of the screen can be equal to or less than the width of the worksurface to which it will attach. Some restrictions apply due to location of worksurface legs and supports.

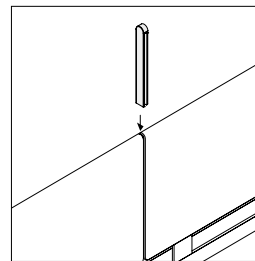

When fabric screens are placed directly adjacent to each other, a small aligner can be placed in between the screens at the top to connect them for planar alignment. Aligners are ordered separately in packages of 10.

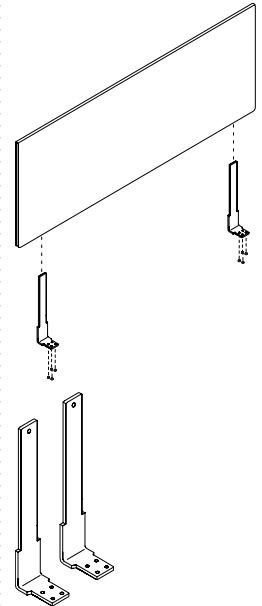

Brackets are included with screens. Two brackets are used on all screens.

Universal privacy screen slides onto brackets.

Surface Materials

Screen

- Fabric
- See *Surface Materials*, page 280.

Edge (upper segment)

- 7360 Merle

Edge (lower segment)

- P630 Medium Heather Grey PET
- P631 Dark Heather Grey PET

Brackets

- 7241 Textured Arctic White
- 7360 Textured Merle
- 4799 Platinum

Actual Dimensions

Height	12½" or 18½"
Overall Height	13½" or 19½"
Width	24", 30", 36", 42", 48", 54", 60", 66", 72", 78", 84", 90", or 96"

Tip: Overall height is measured from top of mounting surface to the top of the screen.

Tip: 13½"H screen aligns with a 42" datum from the floor. 19½" screen aligns with a 48" datum from the floor.

Universal Rear and Side Hard Surface Screens

For Use on Height-Adjustable, Universal, and Elective Elements Worksurfaces

Universal Rear and Side
Hard Surface Screens

Universal hard surface screens are made of solid clear plastic and mount to worksurfaces, providing a boundary element for height-adjustable desks and fixed surfaces.

► Specifying, pages 242–244

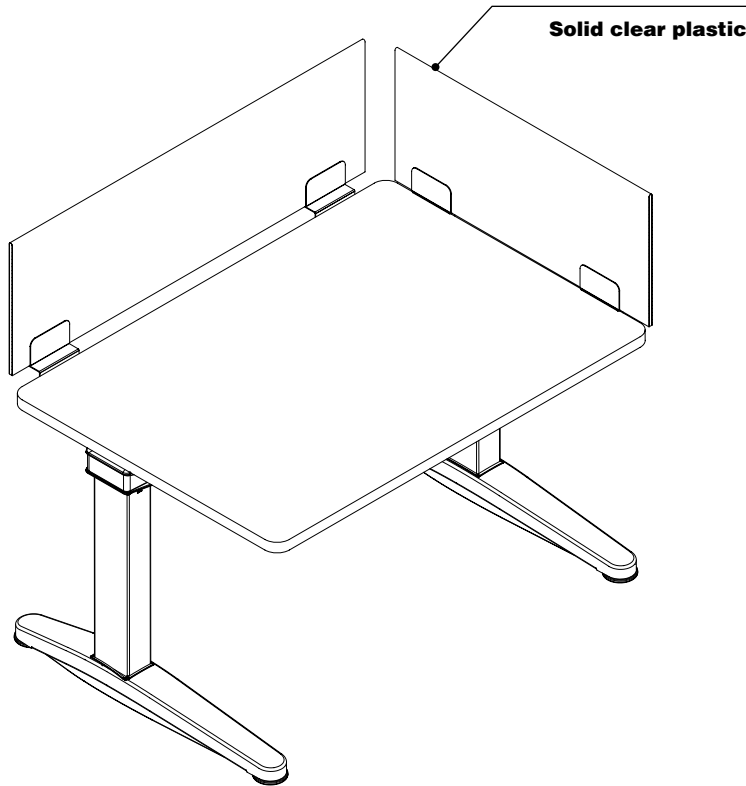

Actual Dimensions

Solid Clear Screen	
Width	15"–72"
Height	12"–24"
Thickness	0.220"

Tip: Not all dimensions are available for all screens. Please consult the specifying pages or CET SmartTools for list of available sizes.

Tip: Height of solid clear screens are measured from the worksurface to the top of the screen. Final height of screen will be 0.150" shorter than specified height.

Product Details

Screens may be used on 1"–1½" thick worksurfaces. Style numbers are available for standard Steelcase work-surface thicknesses.

Tip: Screen styles ending in '__HS' are for most Steelcase height adjustable worksurfaces (1").

Tip: Screen styles ending in '__US' are for Universal worksurfaces (1½").

Tip: Screen styles ending in '__ES' are for Elective Elements worksurfaces (1½").

The width of the screens can be equal to or less than the width/depth of the worksurface to which it will attach. Some restrictions apply due to location of worksurface legs and supports.

Tip: Refer to existing guidelines about maximum screen widths when installed on height-adjustable desks.

Application Topics

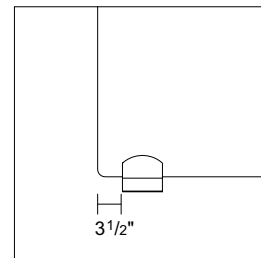

Brackets are positioned 3½" from the edge of the screen.

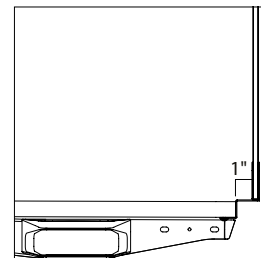

Rear screens mount with a 1" cord drop for cable management and are attached using 7/8" screws. Cord drop also allows for mounting of clamp-on worktools to the back edge of the worksurface.

Rear screens align with the top edge of the work-surface and do not provide modesty.

Clear solid plastic screens cannot be used on surfaces with integrated rail, an additive SOTO Rail, acrylic modesty panel, or an additive cableway.

Tip: When specifying grommets on Ology, verify the position of the screen in CET SmartTools.

Clear solid plastic screens under 60"W come standard with two brackets. Screens 60"W and wider come with three brackets.

Side screens attach to the side (depth) of a work-surface only.

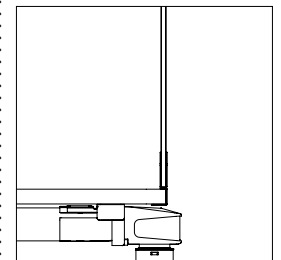

Side screen brackets wrap over the top of the worksurface to maintain adequate pinch point clearances between adjacent work-surfaces, panels, or walls and are attached using 7/8" screws.

Clear solid rear screens can be used with Ology modesty panels on desks equal to or less than 29" deep. Screens and modesty panels must be a minimum of 6" narrower than the width of the worksurface. Screens can be a maximum of 18"H when used on a worksurface with an Ology modesty panel.

Surface Materials

Screen

- 6560 Solid Clear Plastic

Brackets

- Paint

Sarto Privacy/Modesty Screens

Sarto privacy/modesty screen provides a light scale boundary element for height adjustable desks and fixed worksurfaces. It can be used with Ology, Migration SE, Elective Elements, universal tables, and universal panel-mount worksurfaces. ▶ Specifying, page 246

Sarto privacy/modesty screens are available in overall heights from 24" to 30", with a privacy height option to provide varying levels of privacy and modesty.

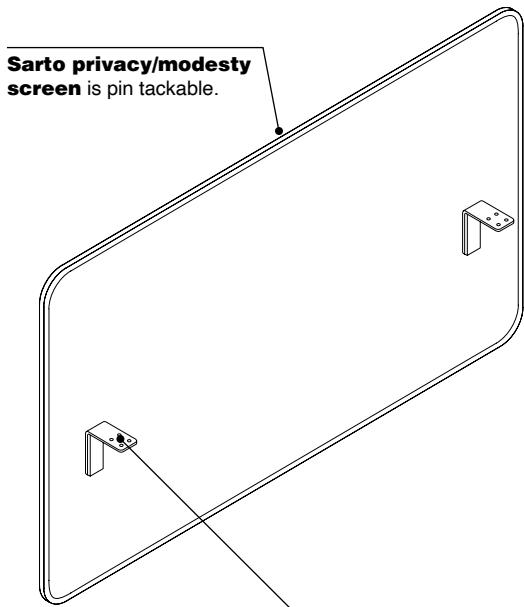

The screen is attached to the worksurface using simple L-brackets and 1" screws.

Product Details

The screen may be used on 3/4"–1 1/2" thick worksurfaces.

Screens are available in modular or parametric sizes.

The width of the screen can be equal to or less than the width of the worksurface to which it will attach. Some restrictions apply due to location of worksurface legs and supports.

Weight of screens are calculated as follows:
Screen: 0.0044 lb per inch²
Bracket: 0.2 lb per bracket.

Application Topics

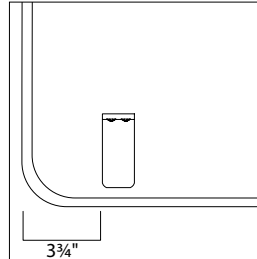

Sarto privacy/modesty screen mounts to worksurfaces using simple L-brackets and screws. The brackets are positioned 3 3/4" in from each side of the screen. Two L-brackets are included with screens narrower than 60"W. Three or four L-brackets are included on screens 60"W and wider.

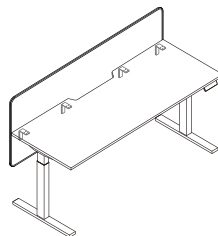

Worksurface type is available for screens 60" wide or wider, and allows the Sarto privacy/modesty screen to mount to a scalloped worksurface (for example Bivi Height-Adjustable Desk).

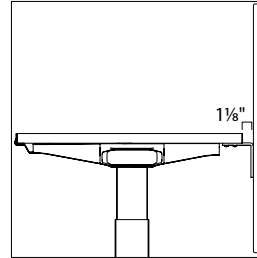

Screen can be mounted to the back edge of the worksurface with a 1 1/8" cord drop or flush with no cord drop.

Screens 36"W and narrower can be mounted as side screens, and are always mounted flush to the edge of the worksurface. This application grows the footprint of the workstation by 9/16" per screen.

Screens are specified with a privacy height above the worksurface. A 1" thick worksurface is assumed. This privacy height sets the position of the brackets and cannot be changed in the field.

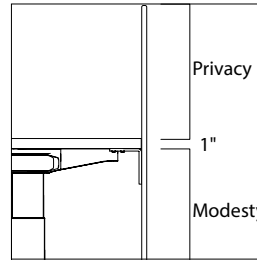

Screens are specified by first selecting an overall screen height (24"–30"), then specifying a privacy height. Privacy height is measured from the top of the screen to the top of the worksurface. Allowable privacy height selection changes based on the specified overall height.

All privacy heights allow a height adjustable desk to be lowered to the lowest position (22") while preserving pinch point gap.

To match screens

ordered on or before June 20, 2021, please consult the following information to determine proper privacy height.

- 24"H Screen, Privacy/Modesty Configuration – Privacy Height = 13 1/2"
- 24"H Screen, Privacy Configuration – Privacy Height = 16 1/2"
- 30"H Screen, Privacy Configuration – Privacy Height = 22 1/2"

Sarto privacy/modesty screens can be used with universal worksurfaces and tables where surface supports and leg brackets are not in same location of the screen L-bracket attachment points.

- Example 1—Worksurfaces supported by a panel side bracket or cantilever can accept privacy/modesty screen placed 6" in from end with these brackets.
- Example 2—Tables with cabby leg or double elliptical post C-legs can accept screens 6" shorter than total table width but not same width.

Privacy/modesty screens can also be used with Elective Elements surfaces with some restrictions when combined with gate leg or the Elective Elements adjustable-height leg.

Privacy/modesty screens must never be wider than the surface to which they are attached.

Tip: It is recommended that CET SmartTools planning aid be used to ensure proper application of screen to worksurface or tables.

Surface Materials

Screen

- Fabric
- ▶ See *Surface Materials*, page 280.

Brackets

- 7360 Merle

Actual Dimensions

Width	23"–70"
Height	24"–30"
Thickness	9/16"

Sarto privacy screens provide a light scale boundary and privacy element for height-adjustable desks and fixed worksurfaces. It can be used with Ology, Migration SE, Elective Elements, universal worksurfaces, and TS Series worksurfaces.
 ▶ Specifying, page 248

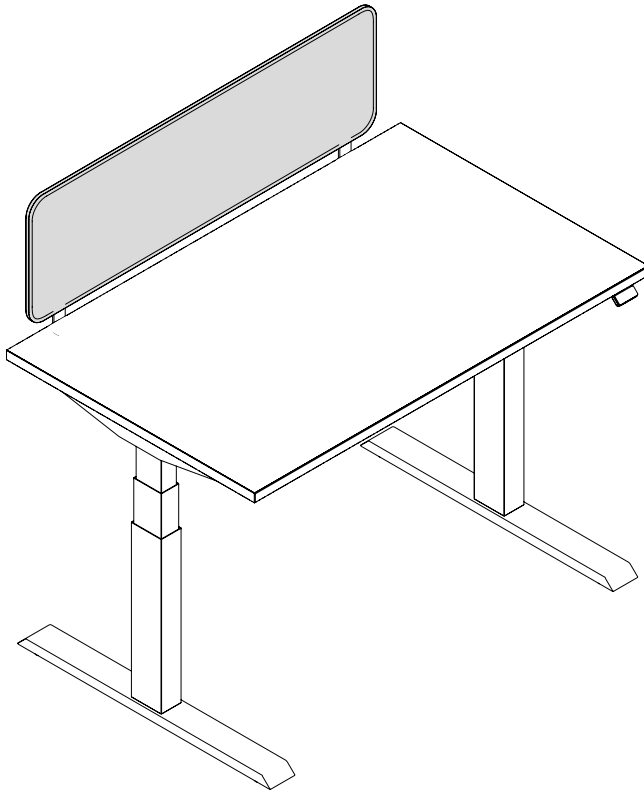

Product Details

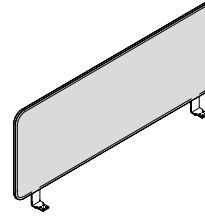

Sarto privacy screens are tackable. They are available in four modular heights, 13½"H, 19½"H, 23½"H, and 35½"H, and have widths ranging from 24"W to 96"W. Screens can also be specified parametrically.

The screen may be used on ¾"–1½" thick worksurfaces.

The width of the screen can be equal to or less than the width of the worksurface to which it will attach. Some restrictions apply due to location of worksurface legs and supports.

Tip: It is recommended that CET SmartTools planning aid be used to ensure proper application of screen to worksurface or tables.

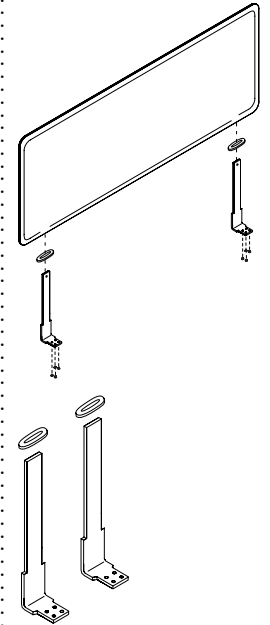

Brackets and hard stops are included with screens. Screens narrower than 60"W use two brackets, while screens 60"W and larger utilize three brackets. The third bracket is centered on the width of the screen.

Offset brackets are included with 29"W screens, to help maintain appropriate pinch points between the screen and adjacent objects. Side screen option is available for screens 36"W and narrower.

Sarto privacy screen slides onto brackets.

Alignment brackets are available to help eliminate gapping and misalignment between back and side screens. Alignment brackets are available as their own style (**PSCB**).

Weight of screens are calculated as follows:
 Screen: 0.0044 lb per inch²
 Bracket: 1.2 lb per bracket.

Surface Materials

Screen

- Fabric

▶ See *Surface Materials*, page 280.

Brackets and hard stops

- 7360 Merle

Actual Dimensions

Screen Height	12½"–34½"
Overall Height	13½"–25½"
Width	24"–96"

Tip: Overall height is measured from top of mounting surface to the top of the screen.

Sarto Curved Screens

Sarto curved screens provide light scale privacy and modesty for height-adjustable desks and work tables.
 ▶ Specifying, pages 252-254

Curved screens are pin tackable.

Curved screens are attached to the work surface with simple metal L-brackets.

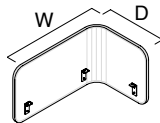
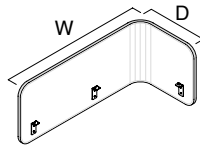
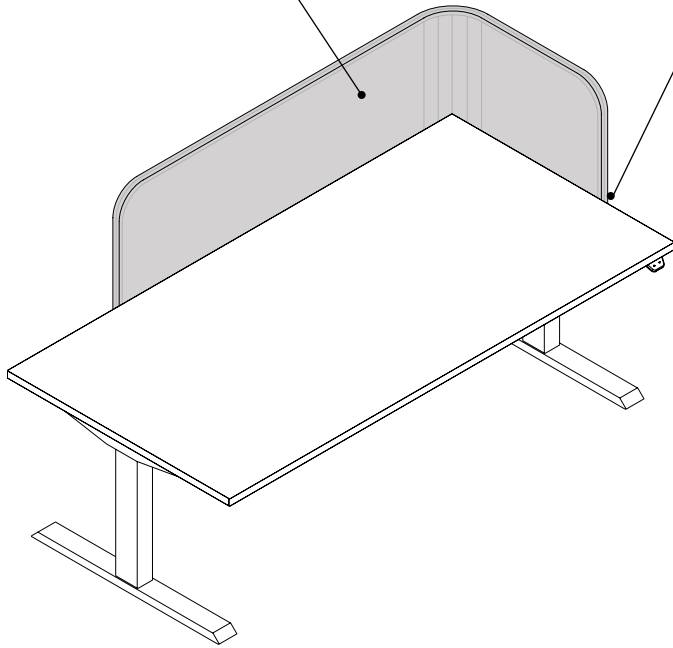

Application Topics

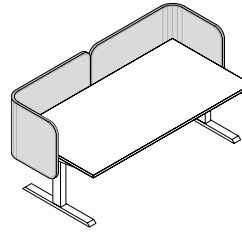

Half desk screens are sized to work with modular size desks. Mounting a pair of half desk screens on a parametric sized desk will create a gap between screens. Parametric width screens are available to create a full wrap of parametric work surfaces.

Tip: It is recommended that CET SmartTools be used to evaluate the gap on the desk.

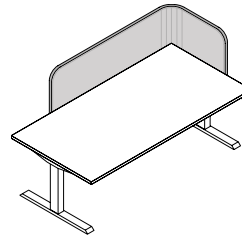

L-screens are sized to work with popular sized modular width desks. When mounted, the modular widths of the L-screen are designed to cover two thirds of the back of the work surface.

Tip: It is recommended that CET SmartTools be used to evaluate the placement of the screen on the desk.

Fabric is applied in a warp horizontal direction. Due to the size of the screens, fabric is unable to be applied in a warp vertical direction.

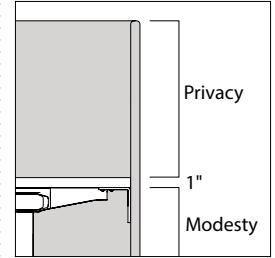

Screens are specified by first selecting an overall screen height (18"-24"), then specifying a privacy height. Privacy height is measured from the top of the screen to the top of the work surface. Allowable privacy height selection changes based on the specified overall height.

All privacy heights allow a height-adjustable desk to be lowered to the lowest position (22") while preserving pinch point gap.

To match screens ordered on or before June 20, 2021, please consult the following information to determine proper privacy height.

- 24"H Screen, Privacy/Modesty Configuration – Privacy Height = 13½"
- 24"H Screen, Privacy Configuration – Privacy Height = 16½"

When ordering a single screen, selecting the correct hand is important. Handedness is assigned from the user position when the curved screen is mounted.

Screen is not applicable on shaped work surface edges (knife edge, bullnose, P-edge, etc).

Actual Dimensions

	L-Screen	Half-Desk Screen
Overall Width	43"–66"	43", 49", or 55"
Depth	20"	20"
Width	23"–46"	23", 29", or 35"
Height	17.909", 18", or 24"	17.909", 18", or 24"
Thickness	7/8"	7/8"
Weight: 18"H	5.7 lb, 6.5 lb, 7.2 lb	5.0 lb, 5.6 lb, 6.2 lb
Weight: 24"H	7.3 lb, 8.4 lb, 9.4 lb	6.4 lb, 7.2 lb, 8.0 lb

Surface Materials

Screen

- Fabric

Tip: Some thin, light colored fabrics are not available on these screens. Please see Surface Materials for available fabric finishes.

▶ Page 284

Brackets

- 6527 Merle

Universal and Sarto Screens Specific Guidelines

Migration SE Specific Guidelines

Rectangular 29"D and 35"D

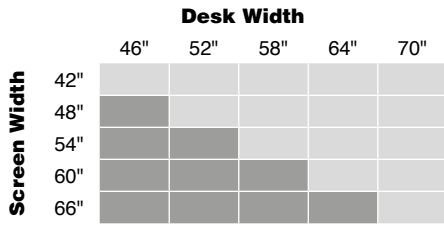

All guidelines assume the screen is centered on the desk.

Screens are sized to be a minimum of 4" smaller than worksurfaces. They can be placed anywhere along the back edge of a desk but cannot extend past the desk edge.

Ology Specific Guidelines

Rectangular 23"D, 29"D, and 35"D

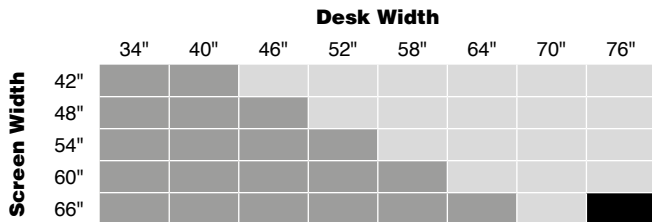

Tapered 23"D and 29"D

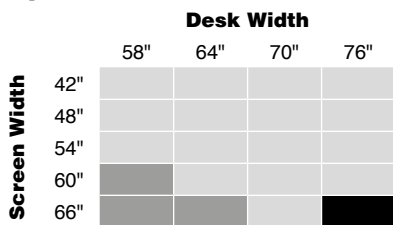

The screen can be placed on the back edge of an Ology without an integrated rail desk utilizing either the 1 1/8" cord drop or no cord drop placement. Screens are sized to be a minimum of 4" smaller than worksurfaces. Optional cable trays and grommets on Ology may cause some interference with screen mounting brackets.

Legend

No interference
Interference or cannot be used
Cannot specify a grommet

Ology Specific Guidelines, continued

90° Corner 23"D

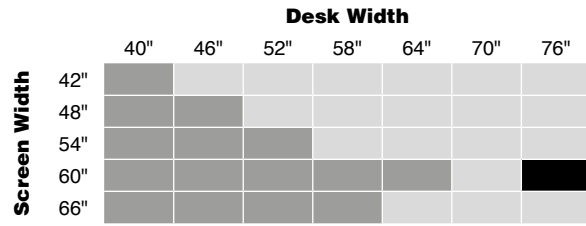

120° Corner 23"D

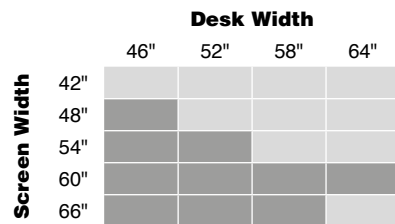

All guidelines assume the screen is centered on the desk.

When using the universal or sarto privacy/modesty screen on Ology with 1 1/8" cable drop, there are no limits on the horizontal placement of the cable tray beneath the desk.

The universal or sarto privacy/modesty screen can be used with the Ology modesty panel without causing interference.

The universal or sarto privacy/modesty screen can be used on either back edge of a 90° or 120° corner desk configuration.

Ology desks using an integrated storage leg may only mount the universal privacy/modesty screen in the privacy position and cannot use sarto screens due to interference.

The universal or sarto privacy/modesty screen does not mount to an Ology rail or into the Ology cantilevers.

If using overhangs, the leg must be at least 3 1/2" in from its standard position to avoid interference with the screen bracket.

Airtouch Specific Guidelines

Rectangular 22¹/₄" D and 28¹/₄" D

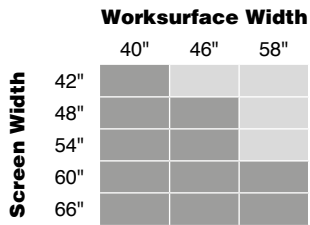

90° 22¹/₄" D

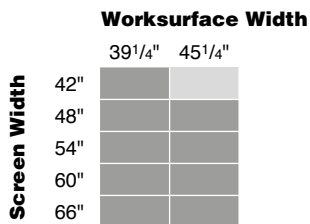

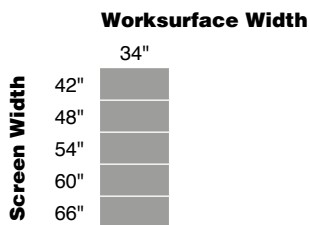

120° 22¹/₄" D



Universal or sarto privacy/modesty screen weight should be considered, along with other items to be used on Airtouch, so as not to exceed weight limit.

Universal or sarto privacy/modesty screens can be placed on the back edge of an Airtouch worksurface, utilizing either the 1¹/₈" cord drop or no cord drop placement without creating interference. The screen must be narrower than the width of the worksurface. Screen cannot exceed the width of table.

Legend

-  No interference
-  Interference or cannot be used
-  Cannot specify a grommet

Soffio Screen

Soffio screen provides privacy and modesty in nearly infinite configurations for height-adjustable desks and fixed workspaces.

► Specifying, page 255

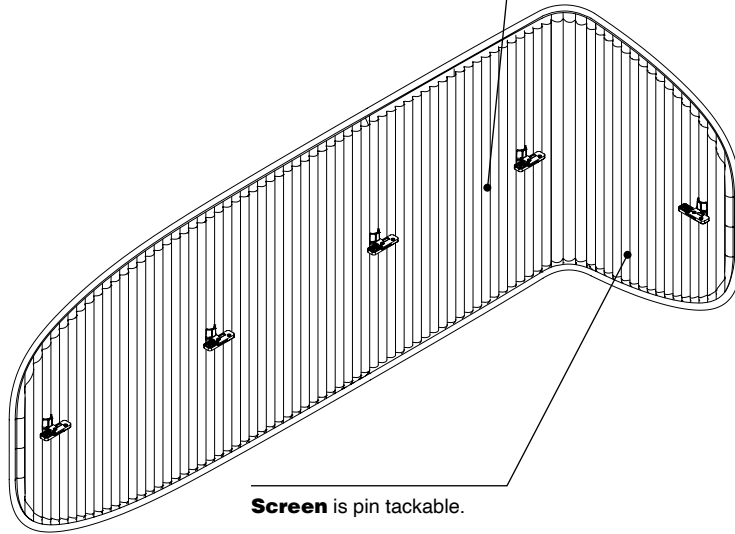

Screen is attached to the worksurface with brackets.

Screen is pin tackable.

Screen includes corrugations, allowing for the screen to curve at any point along the width.

Application Topics

Screen is available in three standard sizes, allowing for a variety of mounting configurations on desks of different sizes.

Tip: It is strongly recommended that CET SmartTools be used to evaluate the placement of the screen on the desk.

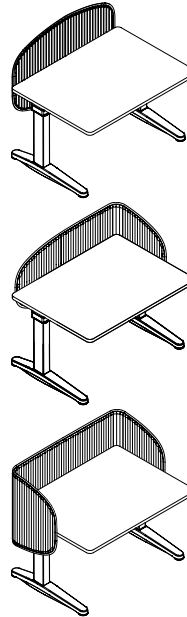

Fabric is applied in a warp horizontal direction. Due to the size of the screens, fabric is unable to be applied in a warp vertical direction.

Screen provides 13" of screen above the worksurface and 12" of screen below the worksurface. The height is measured from the top of the mounting surface to the top of the screen, and from the bottom of the mounting surface to the bottom of the screen.

Screen is not handed. The screen can be mounted in a right- or left-hand configuration.

Screen is not applicable on shaped worksurface edges (knife edge, bullnose, P-edge, etc).

Surface Materials

Screen

- Fabric

Brackets

- 6527 Merle

Actual Dimensions

Desk width	56", 68", or 80"
Height	26"
Weight	2.9 lb, 3.6 lb, 4.2 lb
Thickness	1"

Worksurface Side Screens

For Use on Desking, Benching, and Table Worksurfaces with Varying Thickness

Worksurface side

screens provide a territorial boundary between users. Fabric, frosted glass, or clear glass screens are available for different levels of privacy. They are used on worksurfaces 0.808", 1", 1.185" and 1.5" thick. ▶ Specifying, pages 256–258

Worksurface bracket

sits on the worksurface and allows the side screen to work on worksurfaces 22"D–30"D or deeper worksurfaces.

Worksurface side

screen is available in fabric or glass. Fabric screen is pin tackable.

Worksurface bracket is powder coat paint.

Clamp at front of bracket attaches to the front edge of four specific worksurface thicknesses.

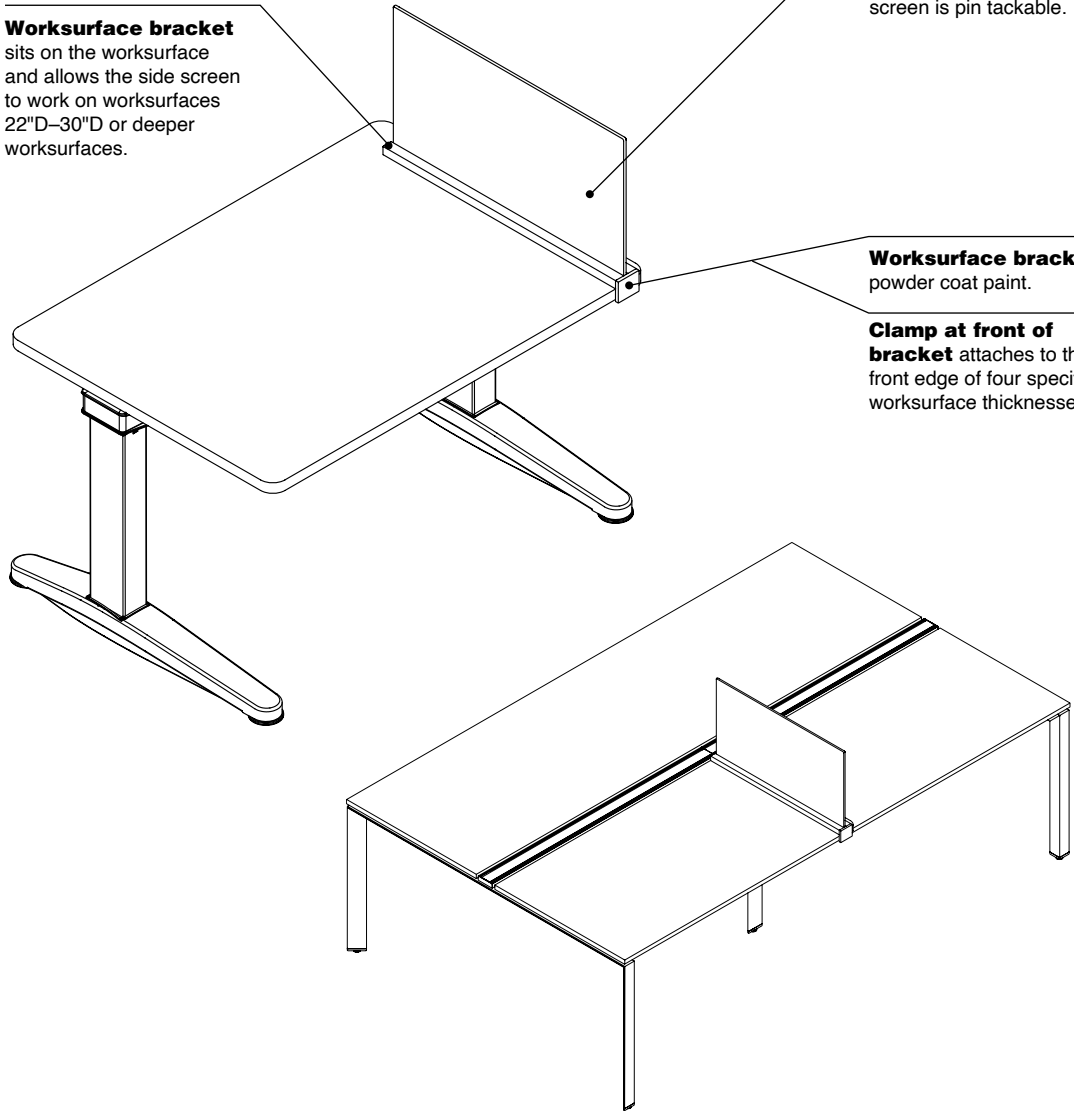

Actual Dimensions

	Fabric and Glass Screen	Application
Width	22" or 28" 24" or 30" 23½" or 29½"	FrameOne, Ology, Migration SE, and Flex worksurfaces Elective Elements and Universal worksurfaces Universal worksurfaces with cord drop
Height	12" or 19½"	
Fabric Screen Thickness	¾"	
Glass Thickness	¼"	
Worksurface Bracket Clamp	0.808" thickness 1" thickness 1.185" thickness 1.5" thickness	FrameOne worksurfaces Ology, Migration SE, and Flex worksurfaces Universal worksurfaces Elective Elements worksurfaces

Product Details

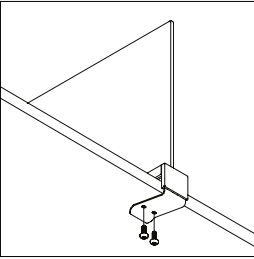

Worksurface side screens attach with two screws (#8 x 1/2" large buttonhead wood screws) through the clamp at the front on the underneath of the worksurface. The bracket clamp must be flush to the worksurface flat front edge.

Worksurfaces 0.808" thick utilize the smallest clamp at the front (FrameOne).

Worksurfaces 1" thick utilize a different clamp at the front (Ology, Migration SE, Flex).

Worksurfaces 1.185" thick utilize another clamp at the front (Universal).

Worksurfaces 1.5" thick utilize the largest clamp at the front (Elective Elements).

Tip: Worksurface bracket clamp must be used with the corresponding top thickness as noted above.

Application Topics

Side screens run parallel to the side (depth) of a worksurface only. They can attach anywhere along the front edge of a worksurface as long as the underwork-surface clearance is free from any obstructions.

Worksurface side screen must be clear of any obstruction or interference on top of the worksurface.

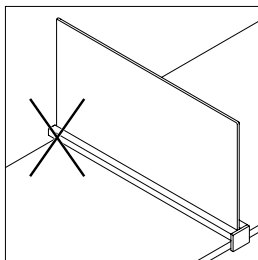

The width of screens can be equal to or less than the depth of the worksurface to which it will attach. No overhang is allowed. Some restrictions apply due to location of worksurface legs and supports.
Tip: Consult SmartTools for any application restrictions.

Surface Materials

Bracket

- 4799 Platinum Metallic
- 7207 Black
- 7241 Arctic White
- 7360 Merle

Screen

- 6500 Clear Glass
- 6530 Frosted Glass
- Fabric

▶ See *Surface Materials*, page 280.

Acrylic Screens

Acrylic Privacy Screens



► Specifying, page 260

Tip: Screen may need to be shorter than worksurface width. To determine screen/cableway and height-adjustable worksurface compatibility, see Worktools Compatibility Charts, page 40.

Product Details

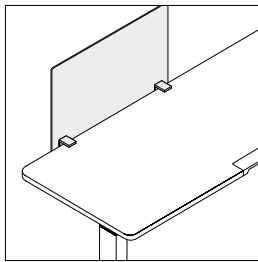

Privacy screen provides lightweight space division above worksurface.

Gap between worksurface and screen/cableway is 1" to allow for cable feed through.

Privacy screen top is a fixed height 19" above worksurface.

Privacy screen can be used in combination with modesty screen and cableways.

Privacy screen ships with Universal clamps for field installation.

Application Topics

Cableway/Screen Width	SlatRail Width					
	24"	30"	36"	42"	48"	60"
22"	Light Gray	Light Gray	Light Gray	Light Gray	Light Gray	Light Gray
25"/28"	Black	Light Gray	Light Gray	Light Gray	Light Gray	Light Gray
31"/34"	Light Gray	Black	Light Gray	Light Gray	Light Gray	Light Gray
37"/40"	Light Gray	Light Gray	Black	Light Gray	Light Gray	Light Gray
43"/46"	Light Gray	Light Gray	Light Gray	Black	Light Gray	Light Gray
49"/52"	Light Gray	Light Gray	Light Gray	Light Gray	Black	Light Gray
55"/58"	Light Gray	Light Gray	Light Gray	Light Gray	Light Gray	Black
61"/64"	Light Gray	Light Gray	Light Gray	Light Gray	Light Gray	Black

SlatRail stanchions mount on the outside of the screen or cableway

SlatRail stanchions will not work with the screen or cableway

SlatRail stanchions mount on the inside of the screen or cableway

Tip: SlatRail does not overhang the SlatRail stanchions; therefore, it is important to order the appropriate SlatRail size when used in combination with screens and cableway.

Surface Materials

Screen
• 6544 Frost only

Universal clamp
• 0835 Black
• 4799 Platinum

Actual Dimensions

Depth 1/4"

Width 22", 28", 34", 40",
46", 52", 58", and
64"

Height 22"

Acrylic Modesty Screens



► Specifying, page 260

Tip: Screen may need to be shorter than worksurface width. To determine screen/cableway and height-adjustable worksurface compatibility, see Worktools Compatibility Charts, page 40.

Product Details

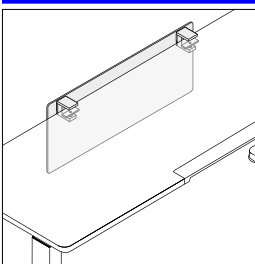

Modesty screen provides below worksurface modesty.

Gap between worksurface and screen/cableway is 1" to allow for cable feed through.

Modesty screen top is a fixed height 1/4" above and 12 1/2" below worksurface.

Modesty screen can be used in combination with privacy screen and cableways.

Modesty screen ships with Universal clamps for field installation.

When used with One-High integrated storage, acrylic modesty screens must be a minimum of 18" shorter than worksurface width to allow for pinch point clearances.

Application Topics

Cableway/Screen Width	SlatRail Width					
	24"	30"	36"	42"	48"	60"
22"	Light Gray	Light Gray	Light Gray	Light Gray	Light Gray	Light Gray
25"/28"	Black	Light Gray	Light Gray	Light Gray	Light Gray	Light Gray
31"/34"	Light Gray	Black	Light Gray	Light Gray	Light Gray	Light Gray
37"/40"	Light Gray	Light Gray	Black	Light Gray	Light Gray	Light Gray
43"/46"	Light Gray	Light Gray	Light Gray	Black	Light Gray	Light Gray
49"/52"	Light Gray	Light Gray	Light Gray	Light Gray	Black	Light Gray
55"/58"	Light Gray	Light Gray	Light Gray	Light Gray	Light Gray	Black
61"/64"	Light Gray	Light Gray	Light Gray	Light Gray	Light Gray	Black

- SlatRail stanchions mount on the outside of the screen or cableway
- SlatRail stanchions will not work with the screen or cableway
- SlatRail stanchions mount on the inside of the screen or cableway

Tip: SlatRail does not overhang the SlatRail stanchions; therefore, it is important to order the appropriate SlatRail size when used in combination with screens and cableway.

Surface Materials

Screen
• 6544 Frost only

Universal clamp
• 0835 Black
• 4799 Platinum

Actual Dimensions

Depth	1/4"
Width	22", 28", 34", 40", 46", 52", 58", and 64"
Height	14"

Table-Mounted Translucent and Slatwall Screens

► Specifying, page 262

Screens can be attached above the worksurface to the left, right, and rear sides of table desks with post legs.

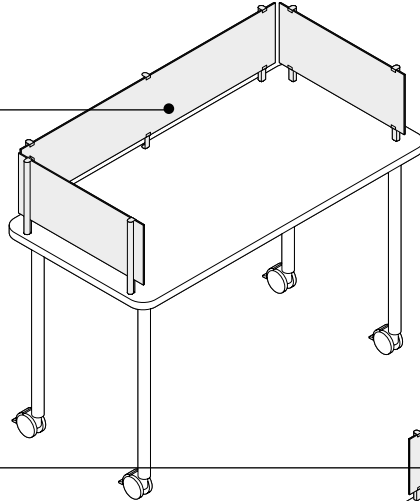

Screen attaches to the rear of rectangular table desk top.

Screens are not flush with tables. 12" screens are 15"H from the tabletop and 18" screens are 21"H from the tabletop.

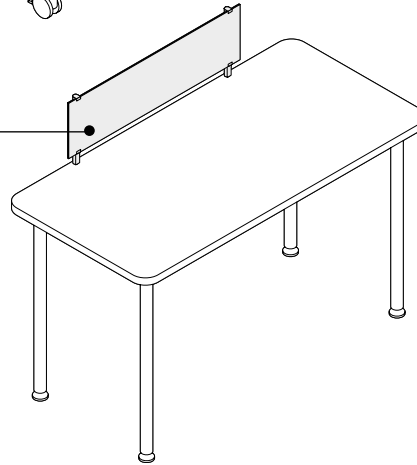

Product Details

Screens, 6" smaller than table desks, do not extend full width or full depth of worksurface.

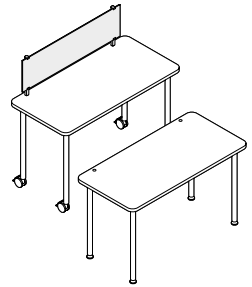
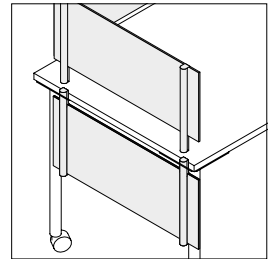
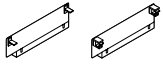

Table desk tops are shipped without screen holes. To attach screens, holes must be drilled on site using the supplied template. Plugs are available through Service Parts (**TS5YGMTSR**) when screens are not in use and have been removed from the top.



Screen attaches above the worksurface for use as a privacy panel or below the worksurface for use as a modesty panel. Mounting brackets, ordered separately, must be used when attaching screens above and below a worksurface.



► Specifying, page 264

Tip: Cableways may need to be shorter than worksurface width. To determine screen/cableway and height-adjustable worksurface compatibility, see Worktools Compatibility Charts, page 40.

Product Details

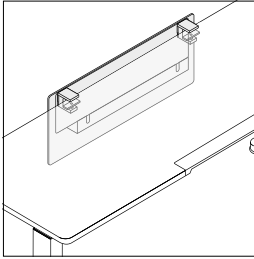

Cableway allows user to manage cables and power at worksurface height for a clean aesthetic.

Cableway is a fixed height $\frac{1}{4}$ " above the worksurface.

Cableway with Universal clamp can be used in combination with privacy and modesty screens. ► See page 264

Gap between worksurface and cableway is 1" to allow for cables to feed through.

Cableway is 3" shorter than screen width to accommodate Universal clamp.

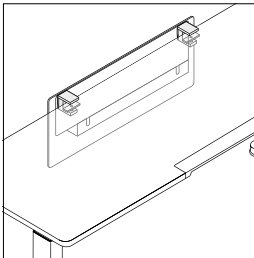

Universal clamp, if selected, is for use with worksurfaces 1" to 2" thick.

Universal clamp, if selected, uses a 2" footprint above and below worksurface.

Universal clamp, if selected, is standard with rubber feet to ensure a tight fit without marring worksurface.

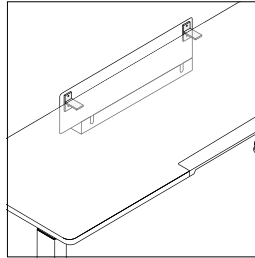

Horizontal brackets, if selected, screw into underside of worksurface.

Horizontal brackets, if selected, require 2" of clearance below worksurface.

Application Topics

Cableway/Screen Width	SlatRail Width					
	24"	30"	36"	42"	48"	60"
22"	Grey	Grey	Grey	Grey	Grey	Grey
25 $\frac{1}{2}$ "/28"	Black	Grey	Grey	Grey	Grey	Grey
31 $\frac{1}{2}$ "/34"	Grey	Black	Grey	Grey	Grey	Grey
37 $\frac{1}{2}$ "/40"	Grey	Grey	Black	Grey	Grey	Grey
43 $\frac{1}{2}$ "/46"	Grey	Grey	Grey	Black	Grey	Grey
49 $\frac{1}{2}$ "/52"	Grey	Grey	Grey	Grey	Black	Grey
55 $\frac{1}{2}$ "/58"	Grey	Grey	Grey	Grey	Grey	Black
61 $\frac{1}{2}$ "/64"	Grey	Grey	Grey	Grey	Grey	Black

Grey SlatRail stanchions mount on the outside of the screen or cableway

Black SlatRail stanchions will not work with the screen or cableway

Light Grey SlatRail stanchions mount on the inside of the screen or cableway

Tip: SlatRail does not overhang the SlatRail stanchions; therefore, it is important to order the appropriate SlatRail size when used in combination with screens and cableway.

Surface Materials

Cableway, Universal clamp, and horizontal bracket

- 0835 Black
- 4799 Platinum

Actual Dimensions

Depth 2 $\frac{1}{2}$ "

Width 25", 31", 37", 43", 49", 55", or 61"

Height 8"

Weight 4.7 lb–15.15 lb

► See specifying page 264 for exact weight.

Cable and Power Management

Vertical Cable Carrier



► Specifying, page 265

Product Details

Vertical cable carrier has a 52" flexible spine with two management channels to manage cords from below worksurface to the floor.

Vertical cable carrier bracket attaches to the underside of the worksurface and weighted base sits on floor.

Surface Materials

Vertical cable carrier

- 6688 Steel

Actual Dimensions

Width 2½"

Height 52"

Weight 1 lb

6"D Wire Managers

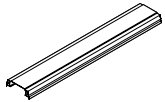

► Specifying, page 265

Product Details

Wire manager is flexible to manage cords underneath the worksurface.

PVC-free ABX material is resistant to fatigue and recyclable.

Surface Materials

Wire manager

- 6000 Black
- 6249 Platinum

Actual Dimensions

Depth 6"

Width 30", 36", 42", 48", 54", and 60"

Height 1 lb

1¾"D Wire Managers

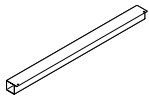

► Specifying, page 266

Product Details

Wire manager is flexible to manage cords underneath the worksurface.

PVC-free polypropylene material is resistant to fatigue and recyclable.

Surface Materials

Wire manager

- 6000 Black

Actual Dimensions

Depth 1¾"

Width 6", 12", 18", 23¼", 30", 35", 42", and 48"

Height 1¾"

Power and Data Strips with Cord and Rail Attachment Brackets

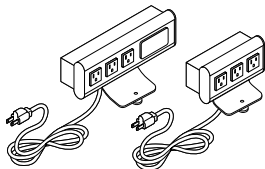

► Specifying, page 267

Product Details

Power strip have a 8' cord and are ordered separately.

Power and data strip provides additional electrical and voice and data receptacles.

Power and data strip are field-installed on either a SOTO rail or worksurface. Specify appropriate attachment bracket depending on application.

Power strips can be mounted on the SOTO rail. Cord length is 8'. Available PVC only.

Surface Materials

Power and Data Strip
 • 8043 Clear Anodized Aluminum cover with black faceplate.

Attachment brackets
 • 4799 Platinum paint only

Actual Dimensions

Depth 2¼"

Width 10¼"

Height 3"

Power and Data Strips with Cord with Worksurface Attachment Bracket

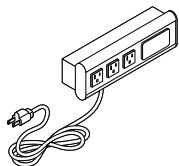

► Specifying, page 267

Product Details

Power and data strip worksurface bracket attaches to worksurfaces 5½" to 15½" thick. Available with an 8' long cord with plug.

Surface Materials

Power and Data Strip
 • 8043 Clear Anodized Aluminum cover with black faceplate.

Attachment brackets
 • 4799 Platinum paint only

Actual Dimensions

Depth 2¼"

Width 6¾"

Height 8"

Powerstrip Intro

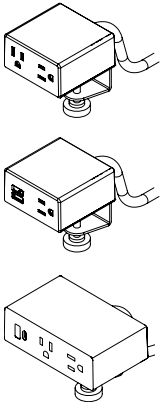

► Specifying, page 268

Product Details

Powerstrip intro offers two power, one power and dual USB-A or two power, one USB-A and one USB-C intelligent 20W with a C-clamp mount for the desktop.

Desktop power configuration options and specifications include:

- Two power
- One power and dual USB-A
- Two power, one USB-A and one USB-C 20W
- Power outlet is 15A, 120V, 60Hz
- Tamper resistant power outlets

Meets spill test criteria.

Two power with 20 watt intelligent USB A+C (3 port):

- If only USB-C in use: delivers what the device needs up to 20 watts
- If only USB-A in use, up to 10 watts
- If both USB A+C in use, USB-A delivers up to 10 watts and 10 watts to USB-C. If USB-A device needs less than 10W, the remainder up to 20 watts goes to the USB-C device
- USB-A watt/amp output (2 port) is 10W/2A per port with dedicated charging ports

Under worksurface optional utility power blocks do not ship with independent mounting hardware. They are designed to mount into the universal cable management kit without additional hardware.

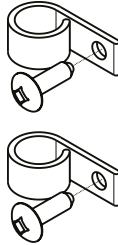

Cable management kit comes standard with each powerstrip. Mounts under the worksurface to manage cords.

Optional Under Worksurface Utility Power

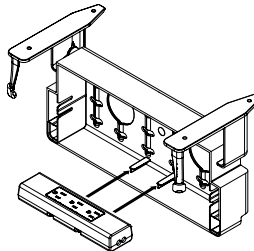
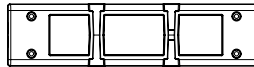
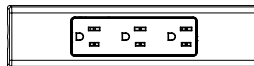

The bottom of each utility powerstrip block has slots. The slots allow the block to slide onto raised bars in the universal cable management trays. These help keep the powerstrip in place when the tray is opened or closed.

Overcurrent protection via a circuit breaker

prevents one powerstrip plus assembly from drawing more than 15 amps of power.

Overcurrent protection

is included as standard with powerstrip plus configurations with more than four outlets and is an option on configurations with less than four outlets. Check with your local authorities having jurisdiction to see if overcurrent protection is required for assemblies with less than four outlets.

USB-A watt/amp output is 10W/2A per port, with dedicated charging ports.

Powerstrip intro includes a 9-foot standard smooth cord with a diameter of 3/8".

Powerstrip intro includes a standard straight 3-prong plug. An overcurrent protection (OCP) 90° plug is also an option. Check with your local authorities having jurisdiction to see if overcurrent protection is required.

Overcurrent protection (OCP) includes a circuit breaker rated for 15 amps.

C-clamp is designed to accommodate worksurfaces up to 1 1/2" thick.

Surface Materials

Housing

- 6009 Arctic White
- 6527 Merle

Tip: Arctic white housing will have arctic white cord and merle housing will have black cord.

Actual Dimensions

	2 Port	3 Port
Depth	3 1/16"	3 7/16"
Width	3 1/16"	4 1 1/16"
Height	1 5/8"	1 5/8"

Underwriters Laboratory (UL) Listed. These products have been designed to meet U.S. and Canadian national electrical and energy codes and most local building codes. Local electrical codes vary, so consult with your local authority having jurisdiction as they have final say if the products as installed are compliant with local code.

Certifications include:

- cULus

Standard 3-Prong Plug

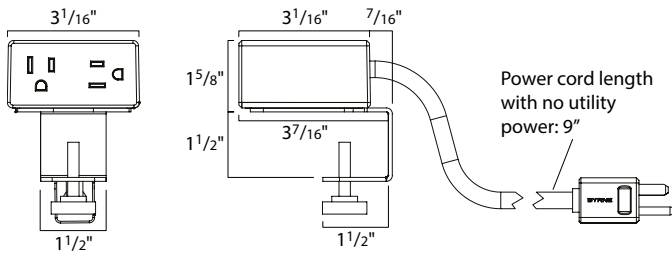
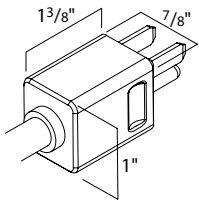

Overcurrent Protection (OCP) 90° Plug

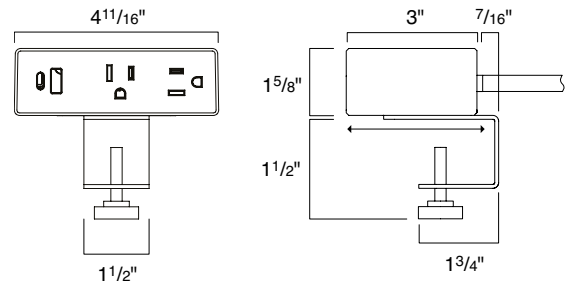
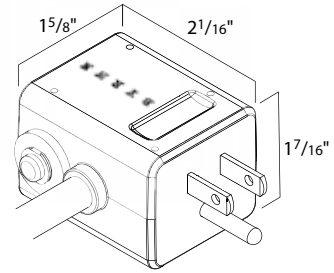

Powerstrip Plus

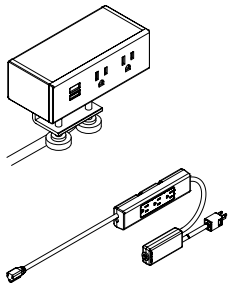

► Specifying, page 270

Product Details

Desktop power offers multiple power, USB, and data options; and can be specified with a C-clamp, rail mount, or front edge mount.

C-clamp is designed to accommodate worksurfaces between 1/2" and 1 3/8" thick.

Under worksurface optional utility power blocks do not ship with independent mounting hardware. They are designed to mount into the Universal cable management kit without additional hardware.

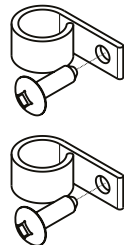

Cable management kit comes standard with each powerstrip. Mounts under the worksurface to manage cords.

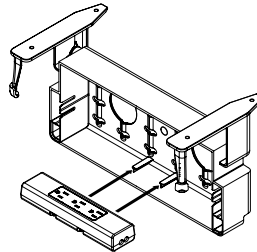
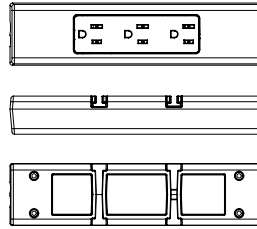

The bottom of each utility powerstrip block has slots. The slots allow the block to slide onto raised bars in the universal cable management trays. These help keep the powerstrip in place when the tray is opened or closed.

Overcurrent protection via a circuit breaker prevents one powerstrip plus assembly from drawing more than 15 amps of power.

Overcurrent protection is included as standard with powerstrip plus configurations with more than four outlets and is an option on configurations with less than four outlets. Check with your local authorities having jurisdiction to see if overcurrent protection is required for assemblies with less than four outlets.

Surface Materials

- Desktop power**
- 6000 Black
 - 6009 Arctic White
 - 6053 Seagull
 - 6302 Baltic
 - 6338 Chili
 - 6527 Merle
 - 6BD1 Aubergine
 - 6BD2 Peacock
 - 6BD5 Honey
 - 6BD6 Lagoon
 - 6BD7 Saffron
 - 6BE2 Light Peacock

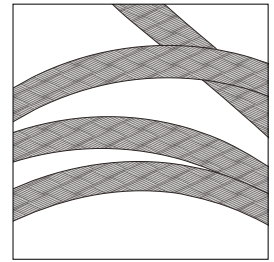

- Braided cord**
- 9009 Black
 - 9011 Seagull

Actual Dimensions

Diameter of Powerstrip Plus power cords:

Standard	1/3"
Braided	2/5"
Curly	1/3"

(coiled area 1 1/2" diameter)

Underwriters Laboratory (UL) Listed. These products have been designed to meet U.S. and Canadian national electrical and energy codes and most local building codes. Local electrical codes vary, so consult with your local authority having jurisdiction as they have final say if the products as installed are compliant with local code.

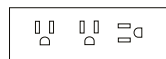

3 power

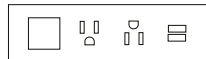

1 data, 2 power
2 10W USB-A

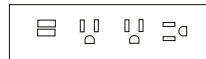

2 10W USB-A, 3 power

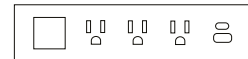

1 data, 3 power
1 10W USB-C, 1 10W USB-A



2 10W USB-A,
2 power

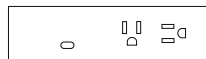

1 60W USB-C
2 power

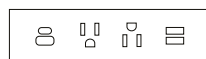

1 USB A+C 20W, 2 power
2 10W USB-A

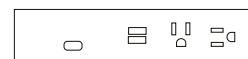

1 60W USB-C
2 10W USB-A, 2 power



1 10W USB-C
1 10W USB-A, 2 power

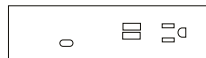

1 power, 2 10W USB-A
1 60W USB-C



2 10W USB-C, 2 10W USB-A
3 power

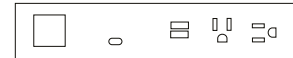

1 data, 1 60W USB-C
2 10W USB-A, 2 power

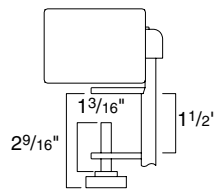
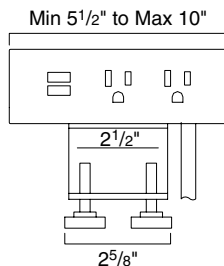
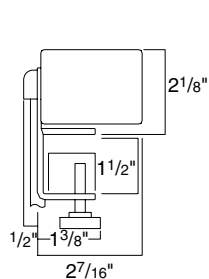

Optional data port adapter information chart. (Coupler/jack not included)

Note: Please verify fit of jack in adapter before ordering large quantities as manufacturer designs may change without notice.

Adapter	Manufacturer
BBB	L-Com Keystone Modular
BBB	NETCONNECT, and 110 Connect Series Modular Jack
BBB	Siemon ZMAX Style
BBB	Allen Tel Versa Tap Series
BBB	Leviton Quick Port Series
BBB	Belden REVConnect
BBB	HDMI Adapter Cable
CCC	Hubbell Nextspeed Keystone Series
CCC	ADC Truenet series
DDD	Blank (no coupler/jack)
EEE	Ortronics TracJack Series
FFF	Panduit Mini-Com Series
HHH	Video Monitor Jack/DB-15, panel mount solder style

Power configurations options guide

Hedberg Option Code	Power Outlet	Number per Powerstrip		Data
		USB-A	USB-C/ Wattage	
3P	3			
2P1A	2	2		
2P1AC10	2	1	1 – 10W	
2P1A1D	2	2		1
2P1C60	2		1 – 60W	
3P1A	3	2		
1P1A1C60	1	2	1 – 60W	
2P1A1C60	2	2	1 – 60W	
2P3A1C20	2	3	1 – 20W	
3P2AC10	3	2	2 – 10W	
3P1AC101D	3	1	1 – 10W	1
2P1A1C601D	2	2	1 – 60W	1

Under Worksurface Utility Power

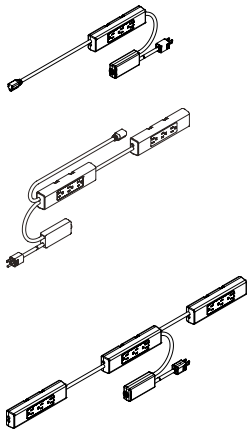

► Specifying, page 272

Product Details

Under worksurface utility power provides multiple power outlets for plugging in a height adjustable desk, computer, and desktop necessities with a one cord out solution.

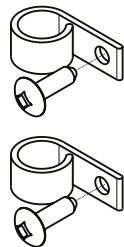

Cable management kit comes standard and mounts under the worksurface to manage cords.

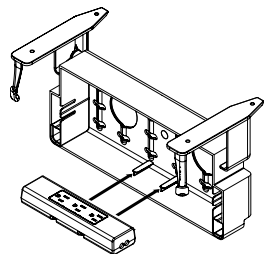

Utility power blocks do not ship with independent mounting hardware. The blocks are designed to mount into the universal cable management kit without additional hardware.

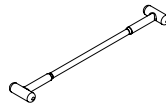
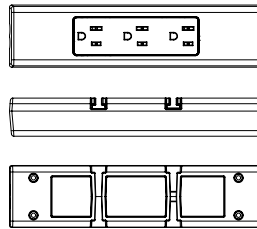

The bottom of each utility powerstrip block has slots. The slots allow the block to slide onto raised bars in the universal cable management kit trays. This design helps keep the powerstrip in place when the tray is opened or closed. Universal cable management kit's smart straps, if selected, are used to hold the power cord in place. ► See page 273 for universal cable management kit understanding content.

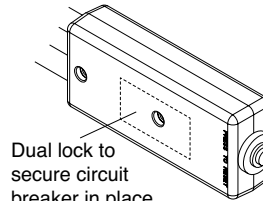
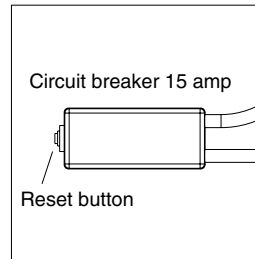

Overcurrent protection is required by UL on these products.

UL Listed: Utility power block outlets are hardwired together in a complete, UL listed assembly.
Tip: Underwriters laboratory (UL) listed. These products have been designed to meet U.S. and Canadian national electrical and energy codes and most local building codes. Local electrical codes vary, so consult with your local authority having jurisdiction as they have final say if the products as installed are compliant with local code.

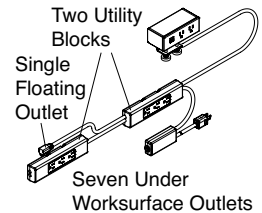
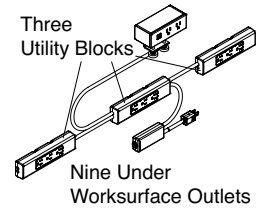

Tip: Do not plug a powerstrip into another powerstrip or plug a powerstrip in an extension cord.

Tip: Desktop power with optional utility power is hard wired together and safe with a UL listing.

Actual Dimensions

Power blocks

Depth	2"
Width	8 1/4"
Thickness	1"

Four outlets total – One utility block, with three outlets each and one floating female outlet

Seven outlets total – Two utility block, with three outlets each and one floating female outlet

Nine outlets total – Three utility block, with three outlets each.

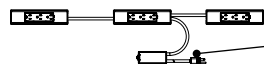
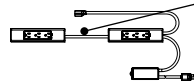
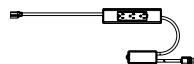

Floating female outlet for oversized drivers.

Standard NEMA 3-prong plug.

Dimensions

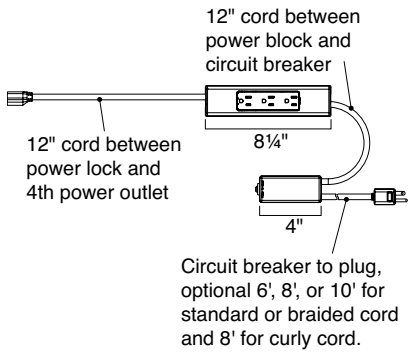
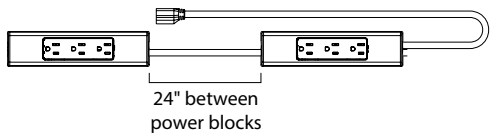

Universal Cable Management Kit

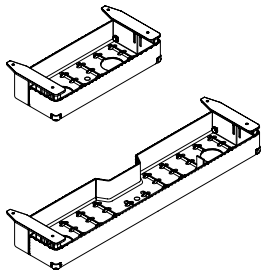

► Specifying, page 273

Product Details

Universal cable management kit provides easy management and access to cords, cables, and power blocks under a workstation.

Optional smart straps allow for easy management of cables and cords in the cable management tray. The large tray ships with 10 straps and the small tray ships with five straps. Straps are 5³/₄" long.

Cable management tray is designed to fit behind the stretcher bar and under-structure of most Steelcase height-adjustable tables.

Cable management tray provides tool-free and hardware-free mounting of under worksurface power from the powerstrip plus.

Cable management tray allows for a 4/5" gap around all four sides between the tray and the worksurface when mounted to allow for cable egress.

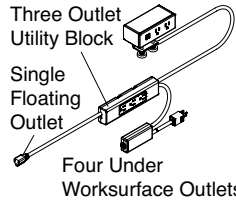
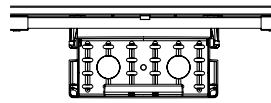

The small cable management tray is designed to hold one utility powerstrip and it has four outlets. The tray does not have the capacity to hold more than one utility powerstrip.

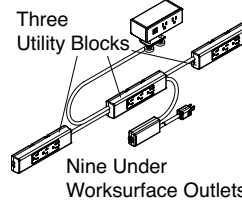
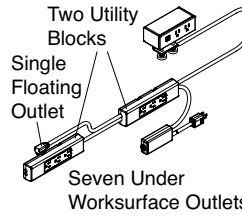
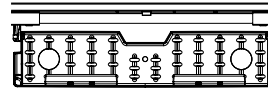

The large cable management tray holds two utility powerstrips in the raised bars section. There is capacity to add three utility powerstrips, two in the raised bar area and one more in the tray, strapped down.

Surface Materials

Cable tray
• 6527 Merle

Actual Dimensions

Depth 6⁵/₁₆"
(7⁴/₅" with bracket)

Width 15¹/₂", 30"

Height 2⁵/₈"
(3¹/₂" when installed)

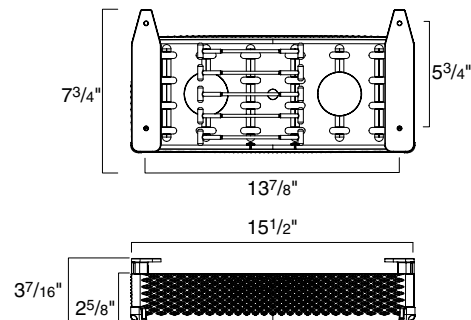
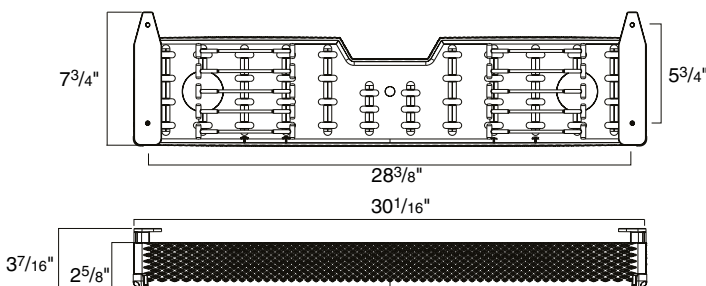

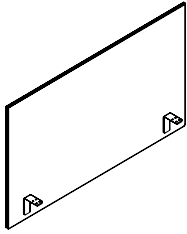

Tip: Universal privacy/modesty screens can be attached to 3/4"-1 1/2" thick worksurface, including height adjustable work-surfaces, universal work-surfaces, and Elective Elements worksurfaces.

Tip: The screens weigh between 9.79 lb and 11.89 lb. Take this into consideration when planning for use on height-adjustable worksurfaces.

Tip: The universal privacy/modesty screen is intended for use on the back of a worksurface.

Tip: Fabric is applied horizontally on the screen.

Tip: Screen allows for 1 1/8" cord drop or no cord drop. See understanding pages for product specific application guidelines.

Standard Includes	Required to Specify
-------------------	---------------------

- | | | |
|--|---|---|
| <ul style="list-style-type: none"> ▶ Need help? Product details, page 212 | <ul style="list-style-type: none"> • Screen: privacy or privacy/modesty: fabric price group 1 • Brackets: 7360 Merle • Edge: PET | <ol style="list-style-type: none"> 1 Style number 2 Width (see below under Required Selections) 3 Mount location (see below under Required Selections) 4 Fabric color number for screen 5 Edge color: <ul style="list-style-type: none"> P630 Medium Heather Grey PET P631 Dark Heather Grey PET 6 Options, if selected (see below) <p>▶ See <i>Surface Materials</i>, page 280.</p> |
|--|---|---|

Width	Required Selections	U.S. Price	Required to Specify
-------	---------------------	------------	---------------------

Width	<ul style="list-style-type: none"> • 42"W • 48"W • 54"W • 60"W • 66"W 	<p>Prices below</p> <p>Prices below</p> <p>Prices below</p> <p>Prices below</p> <p>Prices below</p>	<p>Specify width.</p> <p>Specify width.</p> <p>Specify width.</p> <p>Specify width.</p> <p>Specify width.</p>
--------------	--	---	---

Mount Location	Required Selections	U.S. Price	Required to Specify
----------------	---------------------	------------	---------------------

Mount Location	<ul style="list-style-type: none"> • Privacy (19 1/8" above the worksurface, 5 1/2" below the worksurface) • Privacy/modesty (13" above the worksurface, 11 7/10" below the worksurface) 	<p>No cost</p> <p>No cost</p>	<p>Specify with privacy application.</p> <p>Specify with privacy/modesty application.</p>
-----------------------	--	-------------------------------	---

Surface Materials	Options	U.S. Price	Required to Specify
-------------------	---------	------------	---------------------

Surface Materials	<ul style="list-style-type: none"> • Fabric price group 1 • Fabric price group 2 • Fabric price group 3 • Fabric price group 4 • Fabric price group 5 • Fabric price group 6 • Fabric price group 7 • Fabric price group 8 • Fabric price group 9 • Fabric price group 10 • Customer's Own Material (COM) 	<p>No cost</p> <p>+\$ 57</p> <p>+\$161</p> <p>+\$205</p> <p>+\$246</p> <p>+\$288</p> <p>+\$334</p> <p>+\$375</p> <p>+\$417</p> <p>+\$459</p> <p>+\$ 23</p>	<p>Specify fabric color number.</p> <p>Specify fabric color number.</p> <p>Specify fabric color number.</p> <p>Specify fabric color number.</p> <p>Specify fabric color number.</p> <p>Specify fabric color number.</p> <p>Specify fabric color number.</p> <p>Specify fabric color number.</p> <p>Specify fabric color number.</p> <p>Specify fabric color number.</p> <p>▶ See <i>Surface Materials Reference Manual</i>.</p>
--------------------------	--	--	---

Specification Information

Style Number	U.S. Base Prices				
	42"W	48"W	54"W	60"W	66"W
UFPM	\$677	\$719	\$765	\$812	\$857



For Canadian Pricing
Multiply U.S. Price by the Canadian price factor.
▶ See page 1 for details.

Universal Privacy Screens and Aligners

Universal Privacy Screens

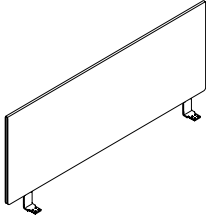

Standard Includes	Required to Specify
<ul style="list-style-type: none"> ▶ Need help? Product details, page 214 • Screen: fabric price group 1 • Brackets: paint price group 1 • Edge: PET 	<ol style="list-style-type: none"> 1 Style number 2 Width (see below under Required Selections) 3 Height (see below under Required Selections) 4 Fabric color number for screen 5 Bracket finish color number 6 Edge color: <ul style="list-style-type: none"> P630 Medium Heather Grey PET P631 Dark Heather Grey PET 7 Options, if selected (see below) <ul style="list-style-type: none"> ▶ See <i>Surface Materials</i>, page 280.

Required Selections	U.S. Price	Required to Specify	
Width	<ul style="list-style-type: none"> • 24"W • 30"W • 36"W • 42"W • 48"W • 54"W • 60"W • 66"W • 72"W • 78"W • 84"W • 90"W • 96"W 	<ul style="list-style-type: none"> Prices at right Prices at right Prices at right Prices at right Prices at right Prices at right Prices at right Prices at right Prices at right Prices at right Prices at right Prices at right Prices at right Prices at right 	<ul style="list-style-type: none"> Specify width. Specify width. Specify width. Specify width. Specify width. Specify width. Specify width. Specify width. Specify width. Specify width. Specify width. Specify width. Specify width. Specify width.
Height	<ul style="list-style-type: none"> • 13½"H • 19½"H 	<ul style="list-style-type: none"> Prices at right Prices at right 	<ul style="list-style-type: none"> Specify height. Specify height.

Tip: 13½"H screen will align at a 42" datum. 19½"H screen will align at a 48" datum.

Options	U.S. Price	Required to Specify	
Surface Materials	<ul style="list-style-type: none"> • Fabric price group 1 • Fabric price group 2 • Fabric price group 3 • Fabric price group 4 • Fabric price group 5 • Fabric price group 6 • Fabric price group 7 • Fabric price group 8 • Fabric price group 9 • Fabric price group 10 • Customer's Own Material (COM) 	<ul style="list-style-type: none"> No cost +\$ 49 +\$132 +\$165 +\$203 +\$237 +\$274 +\$307 +\$343 +\$378 +\$ 23 	<ul style="list-style-type: none"> Specify fabric color number. Specify fabric color number. Specify fabric color number. Specify fabric color number. Specify fabric color number. Specify fabric color number. Specify fabric color number. Specify fabric color number. Specify fabric color number. Specify fabric color number. Specify fabric color number. <ul style="list-style-type: none"> ▶ See <i>Surface Materials Reference Manual</i>.
Bracket	<ul style="list-style-type: none"> • Paint price group 1 • Paint price group 2 	<ul style="list-style-type: none"> No cost +\$ 16 	<ul style="list-style-type: none"> Specify paint color number. Specify paint color number.
Related Products	<ul style="list-style-type: none"> • Aligners 		<ul style="list-style-type: none"> ▶ See below

▶ **Specification Information, on next page**



For Canadian Pricing
 Multiply U.S. Price by the Canadian price factor.
 ▶ See page 1 for details.

► Options, on previous page

Specification Information									
Style Number	Height	U.S. Base Prices							
		24"W	30"W	36"W	42"W	48"W	54"W	60"W	66"W
UFPS	13½"	\$443	\$475	\$505	\$540	\$571	\$605	\$637	\$670
	19½"	\$505	\$557	\$608	\$658	\$713	\$763	\$814	\$862

► Specification Information, continued from above

Style Number	Height	U.S. Base Prices				
		72"W	78"W	84"W	90"W	96"W
UFPS	13½"	\$704	\$735	\$766	\$798	\$831
	19½"	\$915	\$965	\$1014	\$1065	\$1112

Aligners

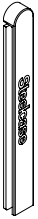

Tip: Aligners are for use with fabric screens only.

Standard Includes	Required to Specify
<p>► Need help? Product details, page 214</p> <ul style="list-style-type: none"> Aligner, package of 10: translucent plastic 	Style number

Specification Information	
Style Number	U.S. Price
UFAL	\$36



For Canadian Pricing
Multiply U.S. Price by the Canadian price factor.
► See page 1 for details.

Universal Rear Hard Surface Screens with Solid Clear Plastic

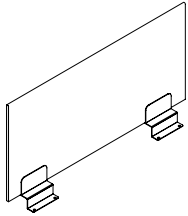

Tip: Style numbers with solid clear plastic (UHSPRHS, UHSPRUS, UHSPRES, UHSPSHS, UHSPSUS, UHSPSES) are specified in parametric heights. These heights may not equal actual heights. It is recommended to utilize CET SmartTools to verify actual heights.

Standard Includes	Required to Specify
-------------------	---------------------

<ul style="list-style-type: none"> Need help? Product details, page 215 Screen: 6560 Solid Clear Universal clamps: paint price group 1 	<ol style="list-style-type: none"> 1 Style number 2 Height (see below under Required Selections) 3 Width (see below under Required Selections) 4 Options, if selected (see below) <p>► See <i>Surface Materials</i>, page 280.</p>
---	--

Required Selections	U.S. Price	Required to Specify
---------------------	------------	---------------------

Height Parametric <ul style="list-style-type: none"> • 12"H • 12¹/₁₆"H–18"H • 18¹/₁₆"H–22"H • 22¹/₁₆"H–24"H 	<ul style="list-style-type: none"> Prices below and at right Prices below and at right Prices below and at right Prices below and at right 	<ul style="list-style-type: none"> Specify height. Specify height. Specify height. Specify height.
Width Parametric For screens 12"H–24"H <ul style="list-style-type: none"> • 30"W • 30¹/₁₆"W–36"W • 36¹/₁₆"W–42"W • 42¹/₁₆"W–48"W • 48¹/₁₆"W–54"W • 54¹/₁₆"W–60"W • 60¹/₁₆"W–66"W For screens 12"H–22"H <ul style="list-style-type: none"> • 66¹/₁₆"W–72"W 	<ul style="list-style-type: none"> Prices below and at right Prices below and at right Prices below and at right Prices below and at right Prices below and at right Prices below and at right Prices below and at right Prices below and at right 	<ul style="list-style-type: none"> Specify width. Specify width. Specify width. Specify width. Specify width. Specify width. Specify width. Specify width.

Options	U.S. Price	Required to Specify
---------	------------	---------------------

Bracket Finish <ul style="list-style-type: none"> • Paint price group 1 • Paint price group 2 • Paint price group 3 	<ul style="list-style-type: none"> No cost +\$16 +\$33 	<ul style="list-style-type: none"> Specify paint color number. Specify paint color number. Specify paint color number.
Bracket Shape <ul style="list-style-type: none"> • Rectilinear • Curvilinear 	<ul style="list-style-type: none"> No cost No cost 	<ul style="list-style-type: none"> Specify <i>with rectilinear</i>. Specify <i>with curvilinear</i>.

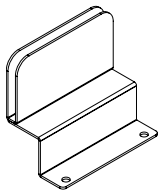

Rectilinear

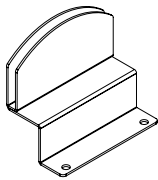

Curvilinear

Specification Information

Style Number	Height Parametric Width	U.S. Base Prices							
		30"W	30 ¹ / ₁₆ "W–36"W	36 ¹ / ₁₆ "W–42"W	42 ¹ / ₁₆ "W–48"W	48 ¹ / ₁₆ "W–54"W	54 ¹ / ₁₆ "W–60"W	60 ¹ / ₁₆ "W–66"W	66 ¹ / ₁₆ "W–72"W

Rear Privacy Screen for Use with 1" Thick Height-Adjustable Worksurfaces

UHSPRHS	12"	\$438	\$472	\$505	\$540	\$572	\$ 606	\$ 640	\$ 675
	12 ¹ / ₁₆ "–18"	\$525	\$579	\$632	\$687	\$740	\$ 795	\$ 848	\$ 903
	18 ¹ / ₁₆ "–22"	\$625	\$707	\$792	\$875	\$961	\$1044	\$1129	\$1212
	22 ¹ / ₁₆ "–24"	\$625	\$707	\$792	\$875	\$961	\$1044	\$1129	N.A.

Rear Privacy Screen for Use with 1¹/₈" Thick Universal Worksurfaces

UHSPRUS	12"	\$438	\$472	\$505	\$540	\$572	\$ 606	\$ 640	\$ 675
	12 ¹ / ₁₆ "–18"	\$525	\$579	\$632	\$687	\$740	\$ 795	\$ 848	\$ 903
	18 ¹ / ₁₆ "–22"	\$625	\$707	\$792	\$875	\$961	\$1044	\$1129	\$1212
	22 ¹ / ₁₆ "–24"	\$625	\$707	\$792	\$875	\$961	\$1044	\$1129	N.A.

► Specification Information, continued on next page



For Canadian Pricing
 Multiply U.S. Price by the Canadian price factor.
 ► See page 1 for details.

► **Specification Information, continued from previous page**

Specification Information									
Style Number	Height Parametric Width	U.S. Base Prices							
		30"W	30 ¹ / ₁₆ "W-	36 ¹ / ₁₆ "W-	42 ¹ / ₁₆ "W-	48 ¹ / ₁₆ "W-	54 ¹ / ₁₆ "W-	60 ¹ / ₁₆ "W-	66 ¹ / ₁₆ "W-

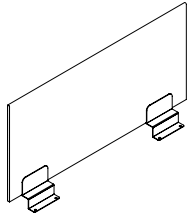

Rear Privacy Screen for Use with 1¹/₂" Thick Elective Elements Worksurfaces

UHSPRES	Height	30"W	30 ¹ / ₁₆ "W-	36 ¹ / ₁₆ "W-	42 ¹ / ₁₆ "W-	48 ¹ / ₁₆ "W-	54 ¹ / ₁₆ "W-	60 ¹ / ₁₆ "W-	66 ¹ / ₁₆ "W-	72"W
	12"	\$438	\$472	\$505	\$540	\$572	\$ 606	\$ 640	\$ 675	
	12 ¹ / ₁₆ "-18"	\$525	\$579	\$632	\$687	\$740	\$ 795	\$ 848	\$ 903	
	18 ¹ / ₁₆ "-22"	\$625	\$707	\$792	\$875	\$961	\$1044	\$1129	\$1212	
	22 ¹ / ₁₆ "-24"	\$625	\$707	\$792	\$875	\$961	\$1044	\$1129	N.A.	



For Canadian Pricing
Multiply U.S. Price by the
Canadian price factor.
► See page 1 for details.

Universal Side Hard Surface Screens with Solid Clear Plastic

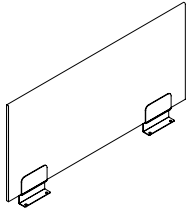

Tip: Style numbers with solid clear plastic (ttS, UHSPRUS, UHSPRES, UHSPSHS, UHSPSUS, UHSPSES) are specified in parametric heights. These heights may not equal actual heights. It is recommended to utilize CET SmartTools to verify actual heights.

Standard Includes	Required to Specify
-------------------	---------------------

<ul style="list-style-type: none"> Need help? Product details, page 215 Screen: 6560 Solid Clear Universal clamps: paint price group 1 	<ol style="list-style-type: none"> Style number Height (see below under Required Selections) Width (see below under Required Selections) Options, if selected (see below) <ul style="list-style-type: none"> See <i>Surface Materials</i>, page 280.
---	---

Required Selections	U.S. Price	Required to Specify
---------------------	------------	---------------------

Height Parametric <ul style="list-style-type: none"> 12"H 12¹/₁₆"H–18"H 18¹/₁₆"H–22"H 22¹/₁₆"H–24"H 	Prices below and at right Prices below and at right Prices below and at right Prices below and at right	Specify height. Specify height. Specify height. Specify height.
Width Parametric <ul style="list-style-type: none"> 15"W–18"W 18¹/₁₆"W–24"W 24¹/₁₆"W–30"W 30¹/₁₆"W–36"W 36¹/₁₆"W–42"W 42¹/₁₆"W–48"W 	Prices below and at right Prices below and at right Prices below and at right Prices below and at right Prices below and at right Prices below and at right	Specify width. Specify width. Specify width. Specify width. Specify width. Specify width.

Options	U.S. Price	Required to Specify
---------	------------	---------------------

Bracket Finish <ul style="list-style-type: none"> Paint price group 1 Paint price group 2 Paint price group 3 	No cost +\$16 +\$33	Specify paint color number. Specify paint color number. Specify paint color number.
Bracket Shape <ul style="list-style-type: none"> Rectilinear Curvilinear 	No cost No cost	Specify <i>with rectilinear</i> . Specify <i>with curvilinear</i> .

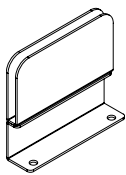

Rectilinear

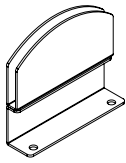

Curvilinear

Specification Information

Style Number	Height	U.S. Base Prices
	Parametric Width	15"W–18"W 18 ¹ / ₁₆ "W–24"W 24 ¹ / ₁₆ "W–30"W 30 ¹ / ₁₆ "W–36"W 36 ¹ / ₁₆ "W–42"W 42 ¹ / ₁₆ "W–48"W

Side Privacy Screen for Use with 1" Thick Height-Adjustable Worksurfaces

UHSPSHS	Height	15"W–18"W	18 ¹ / ₁₆ "W–24"W	24 ¹ / ₁₆ "W–30"W	30 ¹ / ₁₆ "W–36"W	36 ¹ / ₁₆ "W–42"W	42 ¹ / ₁₆ "W–48"W
	12"	\$370	\$403	\$438	\$472	\$505	\$540
	12 ¹ / ₁₆ "–18"	\$417	\$472	\$525	\$579	\$632	\$687
	18 ¹ / ₁₆ "–24"	\$456	\$540	\$625	\$707	\$792	\$875

Side Privacy Screen for Use with 1¹/₈" Thick Height-Adjustable Worksurfaces

UHSPSUS	Height	15"W–18"W	18 ¹ / ₁₆ "W–24"W	24 ¹ / ₁₆ "W–30"W	30 ¹ / ₁₆ "W–36"W	36 ¹ / ₁₆ "W–42"W	42 ¹ / ₁₆ "W–48"W
	12"	\$370	\$403	\$438	\$472	\$505	\$540
	12 ¹ / ₁₆ "–18"	\$417	\$472	\$525	\$579	\$632	\$687
	18 ¹ / ₁₆ "–24"	\$456	\$540	\$625	\$707	\$792	\$875

Side Privacy Screen for Use with 1¹/₂" Thick Height-Adjustable Worksurfaces

UHSPSES	Height	15"W–18"W	18 ¹ / ₁₆ "W–24"W	24 ¹ / ₁₆ "W–30"W	30 ¹ / ₁₆ "W–36"W	36 ¹ / ₁₆ "W–42"W	42 ¹ / ₁₆ "W–48"W
	12"	\$370	\$403	\$438	\$472	\$505	\$540
	12 ¹ / ₁₆ "–18"	\$417	\$472	\$525	\$579	\$632	\$687
	18 ¹ / ₁₆ "–24"	\$456	\$540	\$625	\$707	\$792	\$875



For Canadian Pricing

Multiply U.S. Price by the Canadian price factor.

► See page 1 for details.

Sarto Privacy/Modesty Screens

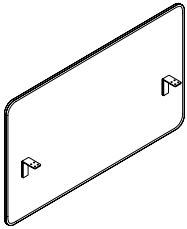

Tip: Sarto privacy/modesty screens can be attached to 3/4"-1 1/2" thick worksurface, including Ology, Migration SE, Elective Elements, universal tables, and universal panel-mount worksurfaces.

Tip: The screens weigh between 3.51 and 11.64 lb. Take this into consideration when planning for use on height-adjustable worksurfaces. See understanding pages to calculate screen weight.

Tip: Worksurface type option adds a fourth worksurface bracket and repositions brackets to avoid worksurface scallops.

Tip: Side screen option changes standard brackets for smaller L-brackets and only mount flush to the side of the worksurface. Side screen option is only available on screens 36"W and narrower.

Standard Includes	Required to Specify
-------------------	---------------------

<ul style="list-style-type: none"> ▶ Need help? Product details, page 211 • Screen: fabric price group 1 • Brackets: 7360 Merle 	<ol style="list-style-type: none"> 1 Style number 2 Size option (see below under Required Selections) 3 Width (see below under Required Selections) 4 Height (see below under Required Selections) 5 Privacy height (see below under Required Selections) 6 Worksurface type (see below under Required Selections) 7 Screen type (see below under Required Selections) 8 Fabric color number for screen 9 Options, if selected (see below) <p>▶ See <i>Surface Materials</i>, page 280.</p>
--	--

Size Option	Required Selections	U.S. Price	Required to Specify
-------------	---------------------	------------	---------------------

Size Option	<ul style="list-style-type: none"> • Modular • Parametric 	No cost No cost	Specify <i>with modular</i> . Specify <i>with parametric</i> .
--------------------	---	--------------------	---

Width	Modular	Parametric	U.S. Price	Required to Specify
-------	---------	------------	------------	---------------------

Width	Modular	Parametric		
	• N.A.	23"W-28 ¹ / ₁₆ "W	Prices at right	Specify width.
	• 24"W	N.A.	Prices at right	Specify width.
	• 29"W	29"W	Prices at right	Specify width.
	• N.A.	29 ¹ / ₁₆ "W-36"W	Prices at right	Specify width.
	• 42"W	36 ¹ / ₁₆ "W-42"W	Prices at right	Specify width.
	• 46"W	N.A.	Prices at right	Specify width.
	• 48"W	42 ¹ / ₁₆ "W-48"W	Prices at right	Specify width.
	• 54"W	48 ¹ / ₁₆ "W-54"W	Prices at right	Specify width.
	• 58"W	N.A.	Prices at right	Specify width.
	• 60"W	54 ¹ / ₁₆ "W-60"W	Prices at right	Specify width.
	• 66"W	60 ¹ / ₁₆ "W-66"W	Prices at right	Specify width.
	• 70"W	66 ¹ / ₁₆ "W-70"W	Prices at right	Specify width.

Height	Modular	Parametric	U.S. Price	Required to Specify
--------	---------	------------	------------	---------------------

Height	Modular	Parametric		
	• 24"H	24"H	Prices at right	Specify height.
	• 30"H	24 ¹ / ₂ "H-30"H	Prices at right	Specify height.

Privacy Height	Screen Height	Minimum Privacy Height	Maximum Privacy Height	U.S. Price	Required to Specify
----------------	---------------	------------------------	------------------------	------------	---------------------

Privacy Height	Screen Height	Minimum Privacy Height	Maximum Privacy Height		
	• 24"H	9"H	16 ¹ / ₂ "H	No cost	Specify privacy height.
	• 24 ¹ / ₂ "H	9 ¹ / ₂ "H	17"H	No cost	Specify privacy height.
	• 25"H	10"H	17 ¹ / ₂ "H	No cost	Specify privacy height.
	• 25 ¹ / ₂ "H	10 ¹ / ₂ "H	18"H	No cost	Specify privacy height.
	• 26"H	11"H	18 ¹ / ₂ "H	No cost	Specify privacy height.
	• 26 ¹ / ₂ "H	11 ¹ / ₂ "H	19"H	No cost	Specify privacy height.
	• 27"H	12"H	19 ¹ / ₂ "H	No cost	Specify privacy height.
	• 27 ¹ / ₂ "H	12 ¹ / ₂ "H	20"H	No cost	Specify privacy height.
	• 28"H	13"H	20 ¹ / ₂ "H	No cost	Specify privacy height.
	• 28 ¹ / ₂ "H	13 ¹ / ₂ "H	21"H	No cost	Specify privacy height.
	• 29"H	14"H	21 ¹ / ₂ "H	No cost	Specify privacy height.
	• 29 ¹ / ₂ "H	14 ¹ / ₂ "H	22"H	No cost	Specify privacy height.
	• 30"H	15"H	22 ¹ / ₂ "H	No cost	Specify privacy height.

Worksurface Type	For screens 60"W or greater	U.S. Price	Required to Specify
------------------	-----------------------------	------------	---------------------

Worksurface Type	For screens 60"W or greater		
	• Without scallop	No cost	Specify <i>without scallop</i> .
	• With scallop	+\$55	Specify <i>with scallop</i> .

Screen Type	U.S. Price	Required to Specify
-------------	------------	---------------------

Screen Type		
• Rear screen	No cost	Specify <i>with rear screen</i> .
• Side screen	No cost	Specify <i>with side screen</i> .

Tip: Fabric is applied horizontally on the screen.

Tip: Screen allows for 1 1/8" cord drop or no cord drop when mounted to the rear of a worksurface. See understanding pages for product specific application guidelines.

Options	U.S. Price	Required to Specify
Surface Materials		
• Fabric price group 2	+\$ 57	Specify fabric color number.
• Fabric price group 3	+\$161	Specify fabric color number.
• Fabric price group 4	+\$205	Specify fabric color number.
• Fabric price group 5	+\$246	Specify fabric color number.
• Fabric price group 6	+\$288	Specify fabric color number.
• Fabric price group 7	+\$334	Specify fabric color number.
• Fabric price group 8	+\$375	Specify fabric color number.
• Fabric price group 9	+\$417	Specify fabric color number.
• Fabric price group 10	+\$459	Specify fabric color number.
• Customer's Own Material (COM)	+\$ 23	▶ See <i>Surface Materials Reference Manual</i> .

Specification Information

• Style Number	• Parametric Height	• Modular width	• U.S. Base Prices								
			24"W	29"W	N.A.	42"W	46"W or 48"W	54"W	58"W or 60"W	66"W	70"W
		• Parametric width	23"W–28 15/16"W	29"W	29 1/16"W	36 1/16"W	42 1/16"W	48 1/16"W	54 1/16"W	60 1/16"W	66 1/16"W
					–36"W	–42"W	–48"W	–54"W	–60"W	–66"W	–70"W

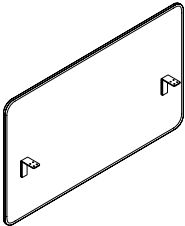

PSPM	24"	24 1/2"–30"								
	\$431	\$589	\$484	\$650	\$516	\$680	\$546	\$711	\$578	\$743
	\$611	\$777	\$644	\$812	\$678	\$845	\$711	\$876		



For Canadian Pricing
Multiply U.S. Price by the Canadian price factor.
▶ See page 1 for details.

Sarto Privacy Screens

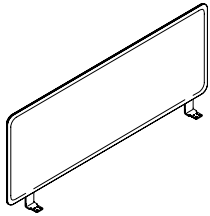

Standard Includes	Required to Specify
<ul style="list-style-type: none"> ▶ Need help? Product details, page 217 • Screen: fabric price group 1 • Brackets and hard stops: 7360 Merle 	<ol style="list-style-type: none"> 1 Style number 2 Size option (see below under Required Selections) 3 Width (see below under Required Selections) 4 Height (see below under Required Selections) 5 Screen type (see below under Required Selections) 6 Fabric color number for screen 7 Options, if selected (see below) <p>▶ See <i>Surface Materials</i>, page 280.</p>

Size Options	Required Selections	U.S. Price	Required to Specify																																				
	<ul style="list-style-type: none"> • Modular • Parametric 	<p>No cost</p> <p>No cost</p>	<p>Specify <i>with modular</i>.</p> <p>Specify <i>with parametric</i>.</p>																																				
Width	<table border="1"> <thead> <tr> <th style="background-color: #000000; color: white;">Modular</th> <th style="background-color: #000000; color: white;">Parametric</th> </tr> </thead> <tbody> <tr><td>• 24"W</td><td>24"W</td></tr> <tr><td>• 29"W</td><td>N.A.</td></tr> <tr><td>• 30"W</td><td>24¹/₁₆"W–30"W</td></tr> <tr><td>• 36"W</td><td>30¹/₁₆"W–36"W</td></tr> <tr><td>• 42"W</td><td>36¹/₁₆"W–42"W</td></tr> <tr><td>• 46"W</td><td>N.A.</td></tr> <tr><td>• 48"W</td><td>42¹/₁₆"W–48"W</td></tr> <tr><td>• 54"W</td><td>48¹/₁₆"W–54"W</td></tr> <tr><td>• 58"W</td><td>N.A.</td></tr> <tr><td>• 60"W</td><td>54¹/₁₆"W–60"W</td></tr> <tr><td>• 66"W</td><td>60¹/₁₆"W–66"W</td></tr> <tr><td>• 70"W</td><td>N.A.</td></tr> <tr><td>• 72"W</td><td>66¹/₁₆"W–72"W</td></tr> <tr><td>• 78"W</td><td>72¹/₁₆"W–78"W</td></tr> <tr><td>• 84"W</td><td>78¹/₁₆"W–84"W</td></tr> <tr><td>• 90"W</td><td>84¹/₁₆"W–90"W</td></tr> <tr><td>• 96"W</td><td>90¹/₁₆"W–96"W</td></tr> </tbody> </table>	Modular	Parametric	• 24"W	24"W	• 29"W	N.A.	• 30"W	24 ¹ / ₁₆ "W–30"W	• 36"W	30 ¹ / ₁₆ "W–36"W	• 42"W	36 ¹ / ₁₆ "W–42"W	• 46"W	N.A.	• 48"W	42 ¹ / ₁₆ "W–48"W	• 54"W	48 ¹ / ₁₆ "W–54"W	• 58"W	N.A.	• 60"W	54 ¹ / ₁₆ "W–60"W	• 66"W	60 ¹ / ₁₆ "W–66"W	• 70"W	N.A.	• 72"W	66 ¹ / ₁₆ "W–72"W	• 78"W	72 ¹ / ₁₆ "W–78"W	• 84"W	78 ¹ / ₁₆ "W–84"W	• 90"W	84 ¹ / ₁₆ "W–90"W	• 96"W	90 ¹ / ₁₆ "W–96"W	<p>Prices at right</p> <p>Prices at right</p> <p>Prices at right</p> <p>Prices at right</p> <p>Prices at right</p> <p>Prices at right</p> <p>Prices at right</p> <p>Prices at right</p> <p>Prices at right</p> <p>Prices at right</p> <p>Prices at right</p> <p>Prices at right</p> <p>Prices at right</p> <p>Prices at right</p> <p>Prices at right</p> <p>Prices at right</p> <p>Prices at right</p> <p>Prices at right</p> <p>Prices at right</p> <p>Prices at right</p> <p>Prices at right</p>	<p>Specify width.</p> <p>Specify width.</p> <p>Specify width.</p> <p>Specify width.</p> <p>Specify width.</p> <p>Specify width.</p> <p>Specify width.</p> <p>Specify width.</p> <p>Specify width.</p> <p>Specify width.</p> <p>Specify width.</p> <p>Specify width.</p> <p>Specify width.</p> <p>Specify width.</p> <p>Specify width.</p> <p>Specify width.</p> <p>Specify width.</p> <p>Specify width.</p> <p>Specify width.</p> <p>Specify width.</p>
Modular	Parametric																																						
• 24"W	24"W																																						
• 29"W	N.A.																																						
• 30"W	24 ¹ / ₁₆ "W–30"W																																						
• 36"W	30 ¹ / ₁₆ "W–36"W																																						
• 42"W	36 ¹ / ₁₆ "W–42"W																																						
• 46"W	N.A.																																						
• 48"W	42 ¹ / ₁₆ "W–48"W																																						
• 54"W	48 ¹ / ₁₆ "W–54"W																																						
• 58"W	N.A.																																						
• 60"W	54 ¹ / ₁₆ "W–60"W																																						
• 66"W	60 ¹ / ₁₆ "W–66"W																																						
• 70"W	N.A.																																						
• 72"W	66 ¹ / ₁₆ "W–72"W																																						
• 78"W	72 ¹ / ₁₆ "W–78"W																																						
• 84"W	78 ¹ / ₁₆ "W–84"W																																						
• 90"W	84 ¹ / ₁₆ "W–90"W																																						
• 96"W	90 ¹ / ₁₆ "W–96"W																																						
Height	<table border="1"> <thead> <tr> <th style="background-color: #000000; color: white;">Modular</th> <th style="background-color: #000000; color: white;">Parametric</th> </tr> </thead> <tbody> <tr><td>• 13¹/₂"H</td><td>13¹/₂"H</td></tr> <tr><td>• 19¹/₂"H</td><td>14"H–19¹/₂"H</td></tr> <tr><td>• 23¹/₂"H</td><td>20"H–24"H</td></tr> <tr><td>• N.A.</td><td>24¹/₂"H–30"H</td></tr> <tr><td>• 35¹/₂"H</td><td>30¹/₂"H–35¹/₂"H</td></tr> </tbody> </table>	Modular	Parametric	• 13 ¹ / ₂ "H	13 ¹ / ₂ "H	• 19 ¹ / ₂ "H	14"H–19 ¹ / ₂ "H	• 23 ¹ / ₂ "H	20"H–24"H	• N.A.	24 ¹ / ₂ "H–30"H	• 35 ¹ / ₂ "H	30 ¹ / ₂ "H–35 ¹ / ₂ "H	<p>Prices at right</p> <p>Prices at right</p> <p>Prices at right</p> <p>Prices at right</p> <p>Prices at right</p>	<p>Specify height.</p> <p>Specify height.</p> <p>Specify height.</p> <p>Specify height.</p> <p>Specify height.</p>																								
Modular	Parametric																																						
• 13 ¹ / ₂ "H	13 ¹ / ₂ "H																																						
• 19 ¹ / ₂ "H	14"H–19 ¹ / ₂ "H																																						
• 23 ¹ / ₂ "H	20"H–24"H																																						
• N.A.	24 ¹ / ₂ "H–30"H																																						
• 35 ¹ / ₂ "H	30 ¹ / ₂ "H–35 ¹ / ₂ "H																																						
Screen Type	<ul style="list-style-type: none"> • Rear screen • Side screen 	<p>No cost</p> <p>No cost</p>	<p>Specify <i>with rear screen</i>.</p> <p>Specify <i>with side screen</i>.</p>																																				

Tip: Side screen option changes brackets smaller L-brackets and only mount flush to the side of the worksurface. Side screen option is only available on screens 36"W and narrower.

Options	U.S. Price	Required to Specify
Surface Materials	<ul style="list-style-type: none"> • Fabric price group 2 +\$ 49 • Fabric price group 3 +\$132 • Fabric price group 4 +\$165 • Fabric price group 5 +\$203 • Fabric price group 6 +\$237 • Fabric price group 7 +\$274 • Fabric price group 8 +\$307 • Fabric price group 9 +\$343 • Fabric price group 10 +\$378 • Customer's Own Material (COM) +\$ 23 	<p>Specify fabric color number.</p> <p>Specify fabric color number.</p> <p>Specify fabric color number.</p> <p>Specify fabric color number.</p> <p>Specify fabric color number.</p> <p>Specify fabric color number.</p> <p>Specify fabric color number.</p> <p>Specify fabric color number.</p> <p>Specify fabric color number.</p> <p>Specify fabric color number.</p> <p>▶ See <i>Surface Materials Reference Manual</i>.</p>



For Canadian Pricing
 Multiply U.S. Price by the Canadian price factor.
 ▶ See page 1 for details.

Specification Information

Style Number	Parametric Height	Modular Width	U.S. Base Prices													
			24"W	30"W	36"W	42"W	48"W	54"W	60"W	66"W	72"W	78"W	84"W	90"W	96"W	
		Parametric Width	24"W	24½"W	30½"W	36½"W	42½"W	48½"W	54½"W	60½"W	66½"W	72½"W	78½"W	84½"W	90½"W	96"W
				-30"W	-36"W	-42"W	-48"W	-54"W	-60"W	-66"W	-72"W	-78"W	-84"W	-90"W	-96"W	

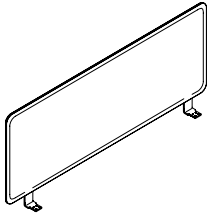

PSPS	Height	24"W	30"W	36"W	42"W	48"W	54"W	60"W	66"W	72"W	78"W	84"W	90"W	96"W
	13½"H	\$324	\$348	\$372	\$395	\$420	\$446	\$470	\$493	\$518	\$ 560	\$ 583	\$ 608	\$ 632
	14"-19½"	\$370	\$408	\$446	\$484	\$521	\$558	\$596	\$632	\$673	\$ 735	\$ 770	\$ 812	\$ 847
	20"-24"	\$452	\$484	\$516	\$546	\$578	\$611	\$644	\$678	\$711	\$ 752	\$ 792	\$ 832	\$ 873
	24½"-30"	\$617	\$650	\$680	\$711	\$743	\$777	\$812	\$845	\$876	\$1088	\$1158	\$1227	\$1297
	30½"-35½"	\$701	\$734	\$764	\$795	\$827	\$859	\$892	\$925	\$960	\$1170	\$1239	\$1310	\$1380



For Canadian Pricing
 Multiply U.S. Price by the Canadian price factor.
 ▶ See page 1 for details.

Sarto Alignment Clip

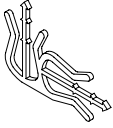

Tip: Alignment clip is for use with Sarto privacy or Sarto privacy/modesty screens.

Tip: Alignment clip is for Sarto screens in perpendicular applications.

Standard Includes	Required to Specify
-------------------	---------------------

▶ Need help? Product details, page 217	• Alignment clip: 7360 Merle Style number
--	--

Specification Information	
---------------------------	--

• Style • Number	• U.S. • Price
---------------------	-------------------

PSCB	\$7
•	•



For Canadian Pricing

Multiply U.S. Price by the Canadian price factor.

▶ See page 1 for details.

Sarto Curved Screens

L-Screen

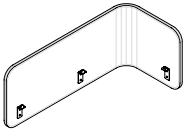

Tip: Sarto screens can be attached to 3/4" – 1 1/2" thick worksurfaces, including Ology, Migration SE, Elective Elements, Universal tables, and Universal panel-mount worksurfaces.

Tip: Screens weigh between 5.7 and 9 pounds. Take this into consideration when planning for use on height-adjustable worksurfaces.

Tip: Fabric is applied horizontally on the screen.

Tip: All Sarto curved screens have a 20" side leg depth.

Tip: Width refers to the distance from the corner of the worksurface to the edge of the screen when the screen is applied to the back of a worksurface.

Standard Includes	Required to Specify
-------------------	---------------------

<ul style="list-style-type: none"> ▶ Need help? Product details, page 218 	<ul style="list-style-type: none"> • Desk screen: fabric price group 1 • Brackets: 7360 Merle 	<ol style="list-style-type: none"> 1 Style number 2 Size option (see below under Required Selections) 3 Width (see below under Required Selections) 4 Height (see below under Required Selections) 5 Handedness (see below under Required Selections) 6 Privacy height (see below under Required Selections) 7 Fabric color number for screen 8 Options, if selected (see below) <p>▶ See <i>Surface Materials</i>, page 280.</p>
--	---	---

Size Options	Required Selections	U.S. Price	Required to Specify
--------------	---------------------	------------	---------------------

Size Options	<ul style="list-style-type: none"> • Modular • Parametric 	<p>No cost</p> <p>No cost</p>	<p>Specify <i>with modular</i>.</p> <p>Specify <i>with parametric</i>.</p>
---------------------	---	-------------------------------	--

Width	Modular	Parametric	U.S. Price	Required to Specify
-------	---------	------------	------------	---------------------

Width	<ul style="list-style-type: none"> • 23"W • 29"W • 35"W • 41"W • 46"W 	<ul style="list-style-type: none"> • 23"W • 23 1/8"W–29"W • 29 1/8"W–35"W • 35 1/8"W–41"W • 41 1/8"W–46"W 	<p>Prices at right</p> <p>Prices at right</p> <p>Prices at right</p> <p>Prices at right</p> <p>Prices at right</p>	<p>Specify width.</p> <p>Specify width.</p> <p>Specify width.</p> <p>Specify width.</p> <p>Specify width.</p>
--------------	--	--	--	---

Height	Modular	Parametric	U.S. Price	Required to Specify
--------	---------	------------	------------	---------------------

Height	<ul style="list-style-type: none"> • 17.909"H • 18"H • 24"H 	<ul style="list-style-type: none"> • 18"H • 18 1/2"H–24"H 	<p>No cost</p> <p>Prices at right</p> <p>Prices at right</p>	<p>Specify height.</p> <p>Specify height.</p> <p>Specify height.</p>
---------------	--	---	--	--

Handedness	U.S. Price	Required to Specify
------------	------------	---------------------

Handedness	<ul style="list-style-type: none"> • Left-hand application • Right-hand application 	<p>No cost</p> <p>No cost</p>	<p>Specify <i>with left-hand application</i>.</p> <p>Specify <i>with right-hand application</i>.</p>
-------------------	---	-------------------------------	--

Privacy Height	Screen Height	Minimum Privacy Height	Maximum Privacy Height	U.S. Price	Required to Specify
----------------	---------------	------------------------	------------------------	------------	---------------------

Privacy Height	<ul style="list-style-type: none"> • 18"H • 18 1/2"H • 19"H • 19 1/2"H • 20"H • 20 1/2"H • 21"H • 21 1/2"H • 22"H • 22 1/2"H • 23"H • 23 1/2"H • 24"H 	<ul style="list-style-type: none"> • 7"H • 7"H • 7"H • 7"H • 7"H • 7"H • 7"H • 7"H • 7"H • 7 1/2"H • 8"H • 8 1/2"H • 9"H 	<ul style="list-style-type: none"> • 10 1/2"H • 11"H • 11 1/2"H • 12"H • 12 1/2"H • 13"H • 13 1/2"H • 14"H • 14 1/2"H • 15"H • 15 1/2"H • 16"H • 16 1/2"H 	<p>No cost</p> <p>No cost</p> <p>No cost</p> <p>No cost</p> <p>No cost</p> <p>No cost</p> <p>No cost</p> <p>No cost</p> <p>No cost</p> <p>No cost</p> <p>No cost</p> <p>No cost</p> <p>No cost</p>	<p>Specify privacy height.</p> <p>Specify privacy height.</p> <p>Specify privacy height.</p> <p>Specify privacy height.</p> <p>Specify privacy height.</p> <p>Specify privacy height.</p> <p>Specify privacy height.</p> <p>Specify privacy height.</p> <p>Specify privacy height.</p> <p>Specify privacy height.</p> <p>Specify privacy height.</p> <p>Specify privacy height.</p> <p>Specify privacy height.</p>
-----------------------	--	---	--	--	--

Surface Materials	Options	U.S. Price	Required to Specify
-------------------	---------	------------	---------------------

Surface Materials	<ul style="list-style-type: none"> • Fabric price group 2 • Fabric price group 3 • Fabric price group 4 • Fabric price group 5 • Fabric price group 6 • Fabric price group 7 • Fabric price group 8 • Fabric price group 9 • Fabric price group 10 • Customer's Own Material (COM) 	<p>+\$ 49</p> <p>+\$132</p> <p>+\$166</p> <p>+\$204</p> <p>+\$237</p> <p>+\$274</p> <p>+\$308</p> <p>+\$344</p> <p>+\$378</p> <p>+\$ 23</p>	<p>Specify fabric color number.</p> <p>Specify fabric color number.</p> <p>Specify fabric color number.</p> <p>Specify fabric color number.</p> <p>Specify fabric color number.</p> <p>Specify fabric color number.</p> <p>Specify fabric color number.</p> <p>Specify fabric color number.</p> <p>Specify fabric color number.</p> <p>Specify fabric color number.</p> <p>▶ See <i>Surface Materials Reference Manual</i>.</p>
--------------------------	--	---	---

For Canadian Pricing
 Multiply U.S. Price by the Canadian price factor.
 ▶ See page 1 for details.

Specification Information

• Style Number	• Parametric Height	Modular Width Parametric Width	• U.S. Base Prices				
			23"W	29"W	35"W	41"W	46"W
			23"W	23½"W	29½"W	35½"W	41½"W
			-29"W	-35"W	-41"W	-46"W	
PLSCRN	18"H		\$586	\$649	\$709	\$768	\$829
	18½"-24"		\$606	\$669	\$729	\$788	\$849

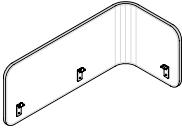

 **For Canadian Pricing**
 Multiply U.S. Price by the Canadian price factor.
 ▶ See page 1 for details.

Sarto Curved Screens

Half-Desk Screen

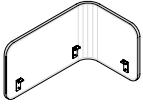

Tip: Sarto curved screens can be attached to 3/4" – 1 1/2" thick worksurfaces, including Ology, Migration SE, Elective Elements, Universal tables, and Universal panel-mount worksurfaces.

Tip: Screens weigh between 5.0 and 8 pounds. Take this into consideration when planning for use on height-adjustable worksurfaces.

Tip: Fabric is applied horizontally on the screen.

Tip: All Sarto curved screens have a 20" side leg depth.

Tip: Width refers to the distance from the corner of the worksurface to the edge of the screen when the screen is applied to the back of a worksurface.

Tip: Two half-desk screens (one LH and one RH) are required to wrap a full worksurface.

Standard Includes

- ▶ Need help? Product details, page 218
- Curved desk screen: fabric price group 1
- Brackets: 7360 Merle

Required to Specify

- 1 Style number
 - 2 Width (see below under Required Selections)
 - 3 Height (see below under Required Selections)
 - 4 Handedness (see below under Required Selections)
 - 5 Privacy height (see below under Required Selections)
 - 6 Fabric color number for screen
 - 7 Options, if selected (see below)
- ▶ See *Surface Materials*, page 280.

Required Selections

Required Selections	U.S. Price	Required to Specify
Width		
• 23"W	Price below	Specify with 23"W.
• 29"W	Price below	Specify with 29"W.
• 35"W	Price below	Specify with 35"W.

Height	Modular Parametric	U.S. Price	Required to Specify
	• 17.909"H	No cost	Specify height.
	• 18"H 18"H	No cost	Specify height.
	• 24"H 18 1/2"H-24"H	+\$ 20	Specify height.

Handedness	U.S. Price	Required to Specify
• Left-hand application	No cost	Specify with left-hand application.
• Right-hand application	No cost	Specify with right-hand application.

Privacy Height	Screen Height	Minimum Privacy Height	Maximum Privacy Height	U.S. Price	Required to Specify
	• 18"H	7"H	10 1/2"H	No cost	Specify privacy height.
	• 18 1/2"H	7"H	11"H	No cost	Specify privacy height.
	• 19"H	7"H	11 1/2"H	No cost	Specify privacy height.
	• 19 1/2"H	7"H	12"H	No cost	Specify privacy height.
	• 20"H	7"H	12 1/2"H	No cost	Specify privacy height.
	• 20 1/2"H	7"H	13"H	No cost	Specify privacy height.
	• 21"H	7"H	13 1/2"H	No cost	Specify privacy height.
	• 21 1/2"H	7"H	14"H	No cost	Specify privacy height.
	• 22"H	7"H	14 1/2"H	No cost	Specify privacy height.
	• 22 1/2"H	7 1/2"H	15"H	No cost	Specify privacy height.
	• 23"H	8"H	15 1/2"H	No cost	Specify privacy height.
	• 23 1/2"H	8 1/2"H	16"H	No cost	Specify privacy height.
	• 24"H	9"H	16 1/2"H	No cost	Specify privacy height.

Options

Options	U.S. Price	Required to Specify
Surface Materials		
• Fabric price group 2	+\$ 49	Specify fabric color number.
• Fabric price group 3	+\$132	Specify fabric color number.
• Fabric price group 4	+\$166	Specify fabric color number.
• Fabric price group 5	+\$204	Specify fabric color number.
• Fabric price group 6	+\$237	Specify fabric color number.
• Fabric price group 7	+\$274	Specify fabric color number.
• Fabric price group 8	+\$308	Specify fabric color number.
• Fabric price group 9	+\$344	Specify fabric color number.
• Fabric price group 10	+\$378	Specify fabric color number.
• Customer's Own Material (COM)	+\$ 23	▶ See <i>Surface Materials Reference Manual</i> .

Specification Information

Style Number	U.S. Base Prices		
	23"W	29"W	35"W
PHSCRN	\$586	\$649	\$709



For Canadian Pricing
Multiply U.S. Price by the Canadian price factor.

▶ See page 1 for details.

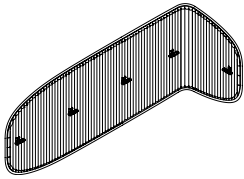

Tip: Soffio screens can be attached to 3/4" – 1 1/2" thick worksurfaces, including Ology, Migration SE, Elective Elements, Universal tables, and Universal panel-mount worksurfaces.

Tip: Screens weigh between 2.9 and 4.2 pounds. Take this into consideration when planning for use on height-adjustable worksurfaces.

Tip: Fabric is applied horizontally on the screen.

Standard Includes		Required to Specify
<ul style="list-style-type: none"> ▶ Need help? Product details, page 222 	<ul style="list-style-type: none"> • 26"H curved desk screen: fabric price group 3 • Brackets: 6527 Merle 	<ol style="list-style-type: none"> 1 Style number 2 Desk width (see below under Required Selections) 3 Fabric color number for screen <ul style="list-style-type: none"> ▶ See <i>Surface Materials</i>, page 280.

	Required Selections	U.S. Price	Required to Specify
Width	<ul style="list-style-type: none"> • 56"W • 68"W • 80"W 	<ul style="list-style-type: none"> Price below Price below Price below 	<ul style="list-style-type: none"> Specify with 56"W. Specify with 68"W. Specify with 80"W.

	Options	U.S. Price	Required to Specify
Surface Materials	<ul style="list-style-type: none"> • Fabric price group 3 • Fabric price group 4 	<ul style="list-style-type: none"> No cost +\$243 	<ul style="list-style-type: none"> Specify fabric color number. Specify fabric color number.

Specification Information			
Style Number	U.S. Base Prices		
	Desk Width		
	56"W	68"W	80"W
SSCRN	\$1065	\$1138	\$1207

 **For Canadian Pricing**
 Multiply U.S. Price by the Canadian price factor.
 ▶ See page 1 for details.

Screens, Cable and Power Management

Worksurface Fabric Side Screens

For Use on Desking, Benching, and Table Worksurfaces with Varying Thickness

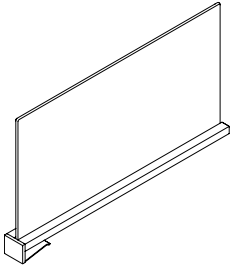

Tip: The worksurface side screen is intended to clamp to the front of a worksurface.

Tip: The worksurface side screen does not work on knife edge profiles.

Tip: Fabric is applied horizontally on the screen.

Standard Includes	Required to Specify
-------------------	---------------------

<ul style="list-style-type: none"> ▶ Need help? Product details, page 224 • Screen: fabric price group 1 • Bracket with integrated worksurface clamp: paint price group 1 	<ol style="list-style-type: none"> 1 Style number 2 Height (see below under Required Selections) 3 Width (see below under Required Selections) 4 Options, if selected (see below) <ul style="list-style-type: none"> ▶ See <i>Surface Materials</i>, page 280.
--	---

Required Selections	U.S. Price	Required to Specify
---------------------	------------	---------------------

Height	<ul style="list-style-type: none"> • 12"H • 19½"H 	Prices below Prices below Specify with 12"H. Specify with 19½"H.
Width	FrameOne, Ology, Migration SE, and Flex <ul style="list-style-type: none"> • 22"W • 28"W Elective Elements and Universal <ul style="list-style-type: none"> • 24"W • 30"W Universal with Cord Drop <ul style="list-style-type: none"> • 23½"W • 29½"W 	Prices below Prices below Prices below Prices below Prices below Prices below Specify with 22"W. Specify with 28"W. Specify with 24"W. Specify with 30"W. Specify with 23½"W. Specify with 29½"W.

Options	U.S. Price	Required to Specify
---------	------------	---------------------

Bracket Finish	<ul style="list-style-type: none"> • Paint price group 1 • Paint price group 2 	No cost +\$ 16 Specify paint color number. Specify paint color number.
Surface Materials	<ul style="list-style-type: none"> • Fabric price group 1 • Fabric price group 2 • Fabric price group 3 • Fabric price group 4 • Fabric price group 5 • Fabric price group 6 • Fabric price group 7 • Fabric price group 8 • Fabric price group 9 • Fabric price group 10 • Customer's Own Material (COM) 	No cost +\$ 38 +\$107 +\$134 +\$164 +\$191 +\$220 +\$250 +\$277 +\$305 +\$ 23 Specify fabric color number. Specify fabric color number. Specify fabric color number. Specify fabric color number. Specify fabric color number. Specify fabric color number. Specify fabric color number. Specify fabric color number. Specify fabric color number. Specify fabric color number. Specify fabric color number. ▶ See <i>Surface Materials Reference Manual</i> .

Specification Information

Style Number	Height	Width	U.S. Base Prices
--------------	--------	-------	------------------

Fabric Side Screen for Use with FrameOne (0.808") Worksurface Thickness

WKSSFF	12"	22"	\$ 990
	12"	28"	\$1067
	19½"	22"	\$1086
	19½"	28"	\$1163

▶ **Specification Information, continued on next page**



For Canadian Pricing

Multiply U.S. Price by the Canadian price factor.

▶ See page 1 for details.

► **Specification Information, continued from previous page**

Specification Information

Style Number	Height	Width	U.S. Base Prices
--------------	--------	-------	------------------

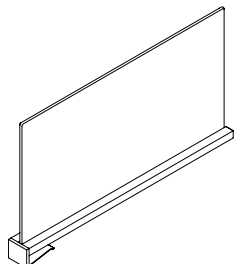

Fabric Side Screen for Use with Ology, Migration SE, and Flex (1") Worksurface Thicknesses

WKSSFHA	12"	22"	\$ 990
	12"	28"	\$1067
	19 1/2"	22"	\$1086
	19 1/2"	28"	\$1163

Fabric Side Screen for Use with Universal (1.185") Worksurface Thickness

WKSSFU	12"	24"	\$1003
	12"	30"	\$1080
	19 1/2"	24"	\$1099
	19 1/2"	30"	\$1176

For Use with Cord Drop Worksurfaces

	12"	23 1/2"	\$1003
	12"	29 1/2"	\$1080
	19 1/2"	23 1/2"	\$1099
	19 1/2"	29 1/2"	\$1176

Fabric Side Screen for Use with Elective Elements (1.5") Worksurface Thickness

WKSSFEE	12"	24"	\$1003
	12"	30"	\$1080
	19 1/2"	24"	\$1099
	19 1/2"	30"	\$1176



For Canadian Pricing

Multiply U.S. Price by the Canadian price factor.

► See page 1 for details.

Worksurface Glass Side Screens

For Use on Desking, Benching, and Table Worksurfaces with Varying Thickness

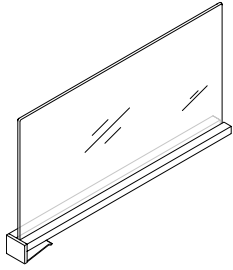

Tip: The work surface side screen is intended to clamp to the front of a work surface.

Tip: The work surface side screen does not work on knife edge profiles.

Standard Includes	Required to Specify
<ul style="list-style-type: none"> ▶ Need help? Product details, page 224 • Screen: 6500 Clear Glass • Bracket with integrated work surface clamp: paint price group 1 	<ol style="list-style-type: none"> 1 Style number 2 Height (see below under Required Selections) 3 Width (see below under Required Selections) 4 Options, if selected (see below) <ul style="list-style-type: none"> ▶ See <i>Surface Materials</i>, page 280.

Required Selections	U.S. Price	Required to Specify
Height		
• 12"H	Prices below	Specify with 12"H.
• 19½"H	Prices below	Specify with 19½"H.
Width		
FrameOne, Ology, Migration SE, and Flex		
• 22"W	Prices below	Specify with 22"W.
• 28"W	Prices below	Specify with 28"W.
Elective Elements and Universal		
• 24"W	Prices below	Specify with 24"W.
• 30"W	Prices below	Specify with 30"W.
Universal with Cord Drop		
• 23½"W	Prices below	Specify with 23½"W.
• 29½"W	Prices below	Specify with 29½"W.

Options	U.S. Price	Required to Specify
Bracket Finish		
• Paint price group 1	No cost	Specify paint color number.
• Paint price group 2	+\$ 16	Specify paint color number.
Surface Materials		
• 6500 Clear Glass	No cost	Specify with 6500 Clear Glass.
• 6530 Frosted Glass	+\$173	Specify with 6530 Frosted Glass.

Specification Information			
Style Number	Height	Width	U.S. Base Prices

Glass Side Screen for Use with FrameOne (0.808") Worksurface Thickness

WKSSGF	Height	Width	U.S. Base Price
	12"	22"	\$679
	12"	28"	\$756
	19½"	22"	\$808
	19½"	28"	\$885

Glass Side Screen for Use with Ology, Migration SE, and Flex (1") Worksurface Thicknesses

WKSSGHA	Height	Width	U.S. Base Price
	12"	22"	\$679
	12"	28"	\$756
	19½"	22"	\$808
	19½"	28"	\$885

▶ Specification Information, continued on next page



For Canadian Pricing
Multiply U.S. Price by the Canadian price factor.
▶ See page 1 for details.

► **Specification Information, continued from previous page**

Specification Information

• Style • Number	• Height	• Width	• U.S. Base • Prices
---------------------	----------	---------	-------------------------

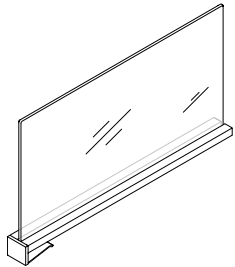

Glass Side Screen for Use with Universal (1.185") Worksurface Thickness

WKSSGU	12"	24"	\$706
	12"	30"	\$783
	19 ¹ / ₂ "	24"	\$835
	19 ¹ / ₂ "	30"	\$912

For use with Cord Drop Worksurfaces

	12"	23 ¹ / ₂ "	\$706
	12"	29 ¹ / ₂ "	\$783
	19 ¹ / ₂ "	23 ¹ / ₂ "	\$835
	19 ¹ / ₂ "	29 ¹ / ₂ "	\$912

Glass Side Screen for Use with Elective Elements (1.5") Worksurface Thickness

WKSSGE	12"	24"	\$706
	12"	30"	\$783
	19 ¹ / ₂ "	24"	\$835
	19 ¹ / ₂ "	30"	\$912



For Canadian Pricing

Multiply U.S. Price by the Canadian price factor.

► See page 1 for details.

Acrylic Screens

Tip: Screen may need to be shorter than worksurface width. To determine screen/cableway and height-adjustable worksurface compatibility, see *Worktools Compatibility Charts*, page 40.

Tip: 58"W and 64"W screens are not recommended for use with 22¼"D rectangular Airtouch worksurfaces.



Tip: 58"W and 64"W screens ship with three Universal clamps. All other screen widths ship with two Universal clamps.



 **For Canadian Pricing**
Multiply U.S. Price by the Canadian price factor.
▶ See page 1 for details.

Standard Includes	Required to Specify
-------------------	---------------------

- | | | |
|--|--|---|
| ▶ Need help? Product details, page 226 | <ul style="list-style-type: none"> • Screen: 6544 Frost only • Universal clamps: paint | <ul style="list-style-type: none"> 1 Style number 2 Paint color number for Universal clamp: 0835 Black, 4799 Platinum |
|--|--|---|

Specification Information

Screen Width	Cableway Width	Weight	Style Number	U.S. Price
--------------	----------------	--------	--------------	------------

Privacy Screens Only

22"	N.A.	5.67 lb	AP22	\$ 501
28"	N.A.	5.77 lb	AP28	\$ 525
34"	N.A.	6.17 lb	AP34	\$ 555
40"	N.A.	6.57 lb	AP40	\$ 580
46"	N.A.	6.77 lb	AP46	\$ 611
52"	N.A.	6.97 lb	AP52	\$ 639
58"	N.A.	7.27 lb	AP58	\$ 715
64"	N.A.	7.77 lb	AP64	\$ 741
:	:	:	:	:

Privacy Screens with Cableway

28"	25"	9.46 lb	ACP28	\$ 631
34"	31"	10.81 lb	ACP34	\$ 686
40"	37"	12.15 lb	ACP40	\$ 739
46"	43"	13.3 lb	ACP46	\$ 795
52"	49"	14.44 lb	ACP52	\$ 850
58"	55"	15.68 lb	ACP58	\$ 955
64"	61"	17.13 lb	ACP64	\$1012
:	:	:	:	:

Modesty Screens Only

22"	N.A.	4.27 lb	AM22	\$ 456
28"	N.A.	4.57 lb	AM28	\$ 487
34"	N.A.	4.87 lb	AM34	\$ 513
40"	N.A.	5.17 lb	AM40	\$ 538
46"	N.A.	5.52 lb	AM46	\$ 568
52"	N.A.	5.77 lb	AM52	\$ 596
58"	N.A.	5.97 lb	AM58	\$ 670
64"	N.A.	6.27 lb	AM64	\$ 691
:	:	:	:	:

▶ **Specification Information, continued on next page**

► Specification Information, continued from previous page

Specification Information

Screen Width	Cableway Width	Weight	Style Number	U.S. Price
--------------	----------------	--------	--------------	------------

Modesty Screens with Cableway

28"	25"	8.26 lb	ACM28	\$ 596
34"	31"	9.51 lb	ACM34	\$ 649
40"	37"	10.75 lb	ACM40	\$ 705
46"	43"	12.05 lb	ACM46	\$ 762
52"	49"	13.24 lb	ACM52	\$ 813
58"	55"	14.38 lb	ACM58	\$ 913
64"	61"	15.63 lb	ACM64	\$ 968

Modesty and Privacy Screens

22"	N.A.	8.07 lb	AMP22	\$ 816
28"	N.A.	8.57 lb	AMP28	\$ 873
34"	N.A.	9.27 lb	AMP34	\$ 925
40"	N.A.	9.97 lb	AMP40	\$ 982
46"	N.A.	10.52 lb	AMP46	\$1040
52"	N.A.	10.97 lb	AMP52	\$1097
58"	N.A.	11.47 lb	AMP58	\$1195
64"	N.A.	12.27 lb	AMP64	\$1250

Modesty and Privacy Screens with Cableway

28"	25"	12.26 lb	ACMP28	\$ 982
34"	31"	13.9 lb	ACMP34	\$1066
40"	37"	15.55 lb	ACMP40	\$1151
46"	43"	17.05 lb	ACMP46	\$1234
52"	49"	18.44 lb	ACMP52	\$1317
58"	55"	19.88 lb	ACMP58	\$1448
64"	61"	21.63 lb	ACMP64	\$1528

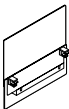
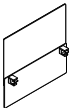
**For Canadian Pricing**

Multiply U.S. Price by the Canadian price factor.

► See page 1 for details.

Table-Mounted Screens

Table-Mounted Translucent and Slatwall Screens

For Use Above or Below the Worksurface

Standard Includes	Required to Specify
<ul style="list-style-type: none"> ▶ Need help? Product details, page 228 • Translucent screen, if selected: 6505 Frosted White • Slatwall screen, if selected: paint price group 1 	<ul style="list-style-type: none"> 1 Style number 2 Paint color number for slatwall screen, if selected 3 Options, if selected (see below) ▶ See <i>Surface Materials</i>, page 280.

Options	U.S. Price	Required to Specify
Surface Materials Slatwall screen <ul style="list-style-type: none"> • Paint price group 1 • Paint price group 2 	No cost +\$24	Specify paint color number. Specify paint color number.
Related Products <ul style="list-style-type: none"> • Mounting brackets • Privacy-modesty adapters 		<ul style="list-style-type: none"> ▶ Page 263 ▶ Page 263

Tip: Mounting brackets must be ordered with screens.

Specification Information			
Dimensions	Style Number	U.S. Base Price	
D	W	H	

Translucent Screens

1/4"	18"	12"	TS5YTS1218	\$235
1/4"	27"	12"	TS5YTS1227	\$255
1/4"	30"	12"	TS5YTS1230	\$277
1/4"	36"	12"	TS5YTS1236	\$324
1/4"	44"	12"	TS5YTS1244	\$393
1/4"	60"	12"	TS5YTS1260	\$413
1/4"	18"	18"	TS5YTS1818	\$255
1/4"	27"	18"	TS5YTS1827	\$325
1/4"	30"	18"	TS5YTS1830	\$416
1/4"	36"	18"	TS5YTS1836	\$463
1/4"	44"	18"	TS5YTS1844	\$483
1/4"	60"	18"	TS5YTS1860	\$534
:	:	:	:	:

Slatwall Screens

1/4"	18"	12"	TS5YSL1218	\$290
1/4"	26 ³ / ₄ "	12"	TS5YSL1226	\$364
1/4"	30"	12"	TS5YSL1230	\$391
1/4"	36"	12"	TS5YSL1236	\$431
1/4"	43 ¹ / ₂ "	12"	TS5YSL1244	\$480
1/4"	60"	12"	TS5YSL1260	\$562
:	:	:	:	:

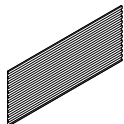
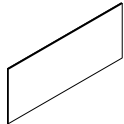

 **For Canadian Pricing**
 Multiply U.S. Price by the Canadian price factor.
 ▶ See page 1 for details.

Screen Mounting Brackets

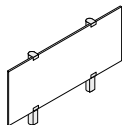

Tip: Package of three mounting brackets is to be used with 60"W screens only. Package of two mounting brackets is for use with all other applications.

Standard Includes		Required to Specify
<ul style="list-style-type: none"> ▶ Need help? Product details, page 228 	<ul style="list-style-type: none"> • Mounting brackets and hardware: paint price group 1 	<ul style="list-style-type: none"> 1 Style number 2 Paint color number for mounting brackets and hardware 3 Options, if selected (see below) ▶ See <i>Surface Materials</i>, page 280.

Options	U.S. Price	Required to Specify
Surface Materials <ul style="list-style-type: none"> • Paint price group 1 • Paint price group 2 	No cost +\$12	Specify paint color number. Specify paint color number.

Specification Information

• Dimensions			• Style	• U.S.
D	W	H	Number	Base Price
⋮	⋮	⋮	⋮	⋮

Package of Two Mounting Brackets

1½"	2"	15"	TS5YMB212	\$242
1½"	3"	21"	TS5YMB218	\$268
⋮	⋮	⋮	⋮	⋮

Package of Three Mounting Brackets

1½"	2"	15"	TS5YMB312	\$322
1½"	3"	21"	TS5YMB318	\$332
⋮	⋮	⋮	⋮	⋮

Privacy-Modesty Adapters

Standard Includes	Required to Specify
<ul style="list-style-type: none"> • Package of two privacy-modesty adapters 	Style number

Specification Information

• Height	• Style	• U.S.
⋮	• Number	• Price
4"	TS5YMBADP	\$35
⋮	⋮	⋮

Tip: Order privacy-modesty adapter when attaching one screen directly above or below another.



For Canadian Pricing

Multiply U.S. Price by the Canadian price factor.

▶ See page 1 for details.

Cableways

Standard Includes		Required to Specify
<ul style="list-style-type: none"> ▶ Need help? Product details, page 229 	<ul style="list-style-type: none"> • Cableway: paint • Universal clamp, if selected: paint to match cableway • Horizontal mounting bracket, if selected: paint to match cableway 	<ul style="list-style-type: none"> 1 Style number 2 Paint color number for cableway: 0835 Black, 4799 Platinum

Specification Information

• Dimensions			• Weight	• Style Number	• U.S. Price
D	W	H			

With Horizontal Mounting Bracket

2½"	25"	8"	7.45 lb	AHORZ25	\$108
2½"	31"	8"	8.40 lb	AHORZ31	\$137
2½"	37"	8"	9.35 lb	AHORZ37	\$167
2½"	43"	8"	10.30 lb	AHORZ43	\$192
2½"	49"	8"	11.25 lb	AHORZ49	\$223
2½"	55"	8"	14.20 lb	AHORZ55	\$266
2½"	61"	8"	15.15 lb	AHORZ61	\$293

With Universal Clamp

2½"	25"	8"	4.70 lb	AC25	\$232
2½"	31"	8"	5.65 lb	AC31	\$257
2½"	37"	8"	6.60 lb	AC37	\$283
2½"	43"	8"	7.55 lb	AC43	\$310
2½"	49"	8"	8.50 lb	AC49	\$337
2½"	55"	8"	9.95 lb	AC55	\$405
2½"	61"	8"	10.91 lb	AC61	\$429



Tip: Cableway with Universal clamp can be used in combination with privacy and modesty screens.

▶ See page 212

Tip: Cableways may need to be shorter than worksurface width. To determine screen/cableway and height-adjustable worksurface compatibility, see *Worktools Compatibility Charts*, page 40.

Tip: Cableways are not recommended for use with 22¼"D rectangular Airtouch worksurfaces.

Tip: Cableways with Universal clamp are 3" shorter than privacy and modesty screen widths.

Tip: 55"W and 61"W cableways ship with three Universal clamps or horizontal brackets. All other cableway widths ship with two Universal clamps or horizontal brackets.



For Canadian Pricing

Multiply U.S. Price by the Canadian price factor.

▶ See page 1 for details.

Vertical Cable Carrier



Tip: Vertical cable carrier is recommended for use with height-adjustable workspaces.

Tip: Vertical cable carrier affixes under the work surface and has a weighted base to hold it in place.

Standard Includes		Required to Specify
<ul style="list-style-type: none"> ▶ Need help? Product details, page 230 	<ul style="list-style-type: none"> • Cable carrier: 6688 Steel • Attachment hardware 	Style number

Specification Information			
Dimensions		Style Number	U.S. Price
W	H		
2½"	52"	AHCC	\$232
:	:	:	:

6"D Wire Managers

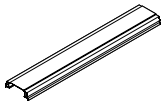

Tip: Wire manager attaches to a clip that is affixed to the underside of a work surface.

Standard Includes		Required to Specify
<ul style="list-style-type: none"> ▶ Need help? Product details, page 230 	<ul style="list-style-type: none"> • Wire manager: 6000 Black or 6249 Platinum • Attachment hardware 	Style number

Specification Information					
Dimensions			Weight	Style Number	U.S. Price
D	W	H			
6"	30"	2"	0.13 lb	AWMXL30	\$101
6"	36"	2"	0.24 lb	AWMXL36	\$116
6"	42"	2"	0.34 lb	AWMXL42	\$132
6"	48"	2"	0.44 lb	AWMXL48	\$144
6"	54"	2"	0.56 lb	AWMXL54	\$162
6"	60"	2"	0.65 lb	AWMXL60	\$179
:	:	:	:	:	:



For Canadian Pricing
 Multiply U.S. Price by the Canadian price factor.
 ▶ See page 1 for details.

1 1/4"D Wire Managers

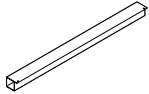

Standard Includes	Required to Specify
<ul style="list-style-type: none"> ▶ Need help? Product details, page 230 • Wire manager: 6000 Black • Attachment hardware 	Style number

Specification Information					
• Dimensions			• Weight	• Style Number	• U.S. Price
D	W	H			
1 1/4"	6"	1 3/4"	0.13 lb	AWM06	\$35
1 1/4"	12"	1 3/4"	0.24 lb	AWM12	\$46
1 1/4"	18"	1 3/4"	0.34 lb	AWM18	\$53
1 1/4"	23"	1 3/4"	0.44 lb	AWM23	\$60
1 1/4"	30"	1 3/4"	0.56 lb	AWM30	\$70
1 1/4"	35"	1 3/4"	0.65 lb	AWM35	\$77
1 1/4"	42"	1 3/4"	0.77 lb	AWM42	\$85
1 1/4"	48"	1 3/4"	0.88 lb	AWM48	\$96

Tip: Actual width of AWM23 is 23 1/4".

Power and Data Strips with Cord and Rail Attachment Brackets

Standard Includes	Required to Specify
<ul style="list-style-type: none"> ▶ Need help? Product details, page 231 • Power strip with 8' PVC cord • Attachment bracket: 4799 Platinum 	Style number

Specification Information	
• Style Number	• U.S. Price

Power and Data Strip with Cord and Rail Attachment Bracket	
FMVPDS	\$355

Power Strip with Cord and Rail Attachment Bracket	
FMVPS	\$322

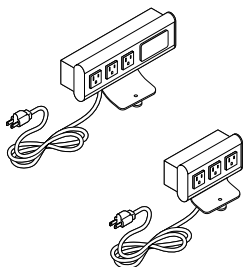

 **For Canadian Pricing**
 Multiply U.S. Price by the Canadian price factor.
 ▶ See page 1 for details.

Power and Data Strips with Cord with Worksurface Attachment Bracket

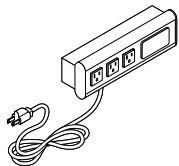

Standard Includes	Required to Specify
-------------------	---------------------

- | | |
|--|--|
| ▶ Need help? Product details, page 231 | <ul style="list-style-type: none"> • Power and data strip with cord: 8043 Clear Anodized Aluminum cover with black faceplate • Worksurface attachment bracket: 4799 Platinum |
|--|--|

Style number

Specification Information

• Dimensions			• Style	• U.S.
D	W	H	Number	Price
2¼"	10¼"	3"	BPDSWSPL	\$378

Products on this page are Benching products. They are here to simplify your planning. They are ordered through the Benching electronic catalog (SFM).



For Canadian Pricing

Multiply U.S. Price by the Canadian price factor.

▶ See page 1 for details.

Powerstrip Intro

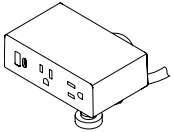
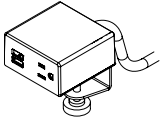
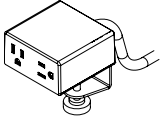

Tip: C-clamp is designed to accommodate worksurfaces up to 1½" thick.

Tip: Each USB port can provide up to 10 watts (2 amps). Configuration with dual USB-A, each port is independent of the other.

Tip: Overcurrent protection includes a 15 amp circuit breaker.

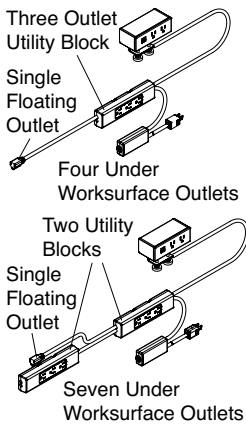

Standard Includes	Required to Specify
<ul style="list-style-type: none"> ▶ Need help? Product details, page 232 • Powerstrip intro: plastic • Straight 3-prong plug • C-clamp mount 	<ol style="list-style-type: none"> 1 Style number 2 Desktop power configuration (see below under Required Selections) 3 Plastic color number for housing: 6009 Arctic White, 6527 Merle 4 Options, (if selected) see below

Required Selections	U.S. Price	Required to Specify
Desktop Power Configuration	<ul style="list-style-type: none"> • Two power outlets: No cost • One power outlet with 10-watt dual USB-A: No cost • Two power outlets with one USB-A and one USB-C intelligent 20W: +\$123 	<p>Specify with two power outlets.</p> <p>Specify with one power outlet with 10-watt dual USB-A.</p> <p>Specify with two power outlets with one USB-A and one USB-C intelligent 20W.</p>

Options	U.S. Price	Required to Specify
Power Plug Type	<ul style="list-style-type: none"> • Standard NEMA 3-prong: No cost • 90° NEMA with overcurrent protection (OCP, used when desktop power only is specified, no utility power): +\$ 52 • 90° NEMA (No OCP, used when utility power option is specified): +\$ 36 	<p>Specify with standard NEMA plug.</p> <p>Specify with 90° NEMA plug with overcurrent protection (OCP).</p> <p>Specify with 90° NEMA (no OCP).</p>

Under Worksurface Utility Power Configuration	<ul style="list-style-type: none"> • Four outlets total—one utility block, with three outlets each, and one floating female outlet: +\$130 • Seven outlets total—two utility blocks, with three outlets each, and one floating female outlet: +\$258 	<p>Specify with one utility and one female plug.</p> <p>Specify with two utility and one female plug.</p>
--	--	---

Specification Information				
• Dimensions			• Style	• U.S. Base
D	W	H	Number	Price
3"	3"	3⅛"	DSPINTRO	\$206

For Canadian Pricing
 Multiply U.S. Price by the Canadian price factor.
 ▶ See page 1 for details.

Powerstrip Plus

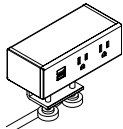

Standard Includes	Required to Specify
<ul style="list-style-type: none"> ▶ Need help? Product details, page 234 • Powerstrip plus: plastic price group 1 and group 2 • 6' standard power cord: black or white • C-clamp mount 	<ol style="list-style-type: none"> 1 Style number 2 Desktop power mount (see below under Required Selections) 3 Desktop power configuration (see below under Required Selections) 4 Plastic color number for powerstrip 5 Plastic color number for power cord 6 Options, (if selected) see below <p>▶ See <i>Surface Materials</i>, page 280.</p>

Tip: C-clamp is designed to accommodate worksurfaces between 1/2" and 1 3/8" thick.

Tip: Desktop power cord exit extends 1/2" off of the back of the worksurface when C-clamped.

Tip: 10- and 18-watt USB-C provides wattage to charge cell phones. 60-watt USB-C is required to charge larger devices like tablets and laptops.

Tip: Cord length between desktop power and underworksurface power is 48" and length between underworksurface blocks is 24".

Tip: Underworksurface power blocks do not ship with independent mounting hardware. They are designed to mount into the Universal cable management kit without additional hardware.

Required Selections	U.S. Price	Required to Specify
Desktop Power Mount <ul style="list-style-type: none"> • C-clamp • Front edge under mount • Rail mount 	No cost +\$ 21 +\$ 32	Specify with C-clamp power mount. Specify with front-edge under mount. Specify with rail power mount.
Desktop Power Configuration <ul style="list-style-type: none"> • Three power outlets • Two power outlets with 10-watt dual USB-A • Two power outlets with 10-watt USB-A and USB-C • Two power outlets with 10-watt dual USB-A and open data port • Three power outlets with 10-watt dual USB-A • Three power with dual 10-watt USB-A and USB-C and open data port • Three power with two dual 10-watt USB-A and USB-C • Two power outlets with three 10-watt USB-A and 20-watt USB-C • Two power outlets with 60-watt USB-C • One power outlet with 10-watt dual USB-A and 60-watt USB-C • Two power outlets with 10-watt dual USB-A and 60-watt USB-C • Two power outlets with dual 10-watt USB-A, 60-watt USB-C, and open data port 	No cost No cost +\$ 64 +\$ 97 +\$ 97 +\$130 +\$258 +\$323 +\$323 +\$451 +\$517 +\$580	Specify with three power outlets with 10-watt dual USB-A. Specify with two power outlets with 10-watt dual USB-A. Specify with two power outlets with 10-watt USB-A and USB-C. Specify with two power outlets with 10-watt dual USB-A and open data port. Specify with three power outlets with 10-watt dual USB-A. Specify with three power with dual 10-watt USB-A and USB-C and open data port. Specify with three power with two dual 10-watt USB-A and USB-C. Specify with two power outlets with three 10-watt dual USB-A and 20-watt USB-C. Specify with two power outlets with 60-watt USB-C. Specify with one power outlet with 10-watt dual USB-A and 60-watt USB-C. Specify with two power outlets with 10-watt dual USB-A and 60-watt USB-C. Specify with two power outlets with dual 10-watt USB-A, 60-watt USB-C, and open data port.



For Canadian Pricing
 Multiply U.S. Price by the Canadian price factor.
 ▶ See page 1 for details.

Tip: Overcurrent protection includes a 15 amp circuit breaker.

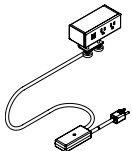

With overcurrent protection

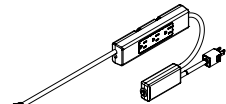

Four under worksurface outlets

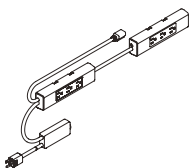

Seven under worksurface outlets

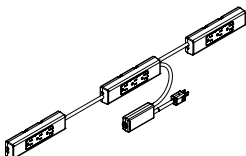

Nine under worksurface outlets

Tip: Configurations with outlets under the worksurface are standard with overcurrent protection.

Tip: Check with your local fire inspector and other authorities with jurisdiction, to understand if overcurrent protection is required for your municipality on units without under worksurface outlets.

Options	U.S. Price	Required to Specify
Surface Materials	Power <ul style="list-style-type: none"> Plastic price groups 1 and 2 	No cost Specify plastic color number.
Under Worksurface (Utility) Power Configuration	<ul style="list-style-type: none"> No under worksurface power No under worksurface with overcurrent protection Four outlets total—one utility block, with three outlets each, and one floating female outlet Seven outlets total—two utility blocks, with three outlets each, and one floating female outlet Nine outlets total—three utility blocks, with three outlets each 	No cost +\$ 52 +\$130 +\$258 +\$388 Specify <i>with no utility</i> . Specify <i>with no utility and with overcurrent protection</i> . Specify <i>with one utility and one female plug</i> . Specify <i>with two utility and one female plug</i> . Specify <i>with three utility</i> .
Power Cord	<ul style="list-style-type: none"> 6' standard cord 8' standard cord 10' standard cord 6' braided cord 10' braided cord 8' curly cord 	No cost +\$ 21 +\$ 21 +\$ 69 +\$206 +\$258 Specify <i>with 6' standard cord</i> . Specify <i>with 8' standard cord</i> . Specify <i>with 10' standard cord</i> . Specify <i>with 6' braided cord</i> . Specify <i>with 10' braided cord</i> . Specify <i>with 8' curly cord</i> .
Power Cord Color	Standard and curly cord <ul style="list-style-type: none"> Black White 	No cost No cost Specify <i>with black cord</i> . Specify <i>with white cord</i> .
	Braided cord <ul style="list-style-type: none"> Black Seagull 	No cost No cost Specify <i>with black braided cord</i> . Specify <i>with seagull braided cord</i> .
Power Plug Type	<ul style="list-style-type: none"> Standard NEMA 3-prong 90° NEMA Thread low profile 	No cost +\$ 36 +\$ 40 Specify <i>with standard NEMA plug</i> . Specify <i>with 90° NEMA plug</i> . Specify <i>with Thread low profile plug</i> .

Specification Information

Style Number	U.S. Base Price
DSPower	\$388



For Canadian Pricing
 Multiply U.S. Price by the Canadian price factor.
 ▶ See page 1 for details.

Under Worksurface Utility Power

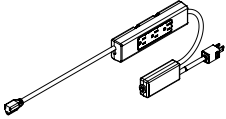

Standard Includes	Required to Specify
<p>▶ Need help? Product details, page 236</p> <ul style="list-style-type: none"> • Under worksurface utility power: 4 outlets • 6' standard cord: plastic • Circuit breaker • Cord managers • Power blocks in merle finish 	<ul style="list-style-type: none"> 1 Style number 2 Under worksurface utility power configuration (see below under Required Selections) 3 Options, (if selected) see below

Tip: Underworksurface power blocks do not ship with independent mounting hardware. They are designed to mount into the universal cable management kit without additional hardware.

Tip: Overcurrent protection includes a 15 amp circuit breaker.

Tip: Do not use a vertical cable manager with a curly cord or braided cord.

Tip: Cord length between blocks is 24", if applicable.

Tip: Never plug a powerstrip into another powerstrip.

Tip: 4 outlet utility block fits in the small tray universal cable management kit, 7 outlet utility block fits in large tray universal cable management kit, and 9 outlets with three utility blocks, specify one large and one small universal cable management kit.

Required Selections	U.S. Price	Required to Specify
Under Worksurface Utility Power Configuration		
• Four outlets total – one utility block, with three outlets each and one floating female outlet	No cost	Specify with one utility and one female plug.
• Seven outlets total – two utility blocks, with three outlets each and one floating female outlet	+\$123	Specify with two utility and one female plug.
• Nine outlets total – three utility blocks, with three outlets each	+\$246	Specify with three utility.

Options	U.S. Price	Required to Specify
Power Cord		
• 6' standard cord	No cost	Specify with 6' standard cord.
• 8' standard cord	+\$ 21	Specify with 8' standard cord.
• 10' standard cord	+\$ 21	Specify with 10' standard cord.
• 6' braided cord	+\$ 69	Specify with 6' braided cord.
• 8' braided cord	+\$206	Specify with 8' braided cord.
• 10' braided cord	+\$206	Specify with 10' braided cord.
• 8' curly cord	+\$258	Specify with 8' curly cord.
Power Cord Color		
Standard and curly cord		
• Black	No cost	Specify with black cord.
• White	No cost	Specify with white cord.
Braided cord		
• Black	No cost	Specify with black braided cord.
• Seagull	No cost	Specify with seagull braided cord.
Power Plug Type		
• Standard NEMA 3-prong	No cost	Specify with standard NEMA plug.
• 90° NEMA	+\$ 36	Specify with 90° NEMA plug.
• Thread low profile	+\$ 40	Specify with Thread low profile plug.

Related Products • Universal cable management kits ▶ Page 273

Specification Information	
Style Number	U.S. Base Price
DSUP	\$167



For Canadian Pricing
Multiply U.S. Price by the Canadian price factor.
▶ See page 1 for details.

Universal Cable Management Kit(s)

Standard Includes		Required to Specify
<ul style="list-style-type: none"> ▶ Need help? Product details, page 238 	<ul style="list-style-type: none"> • Cable management tray: 6527 Merle • Five red rubber: smart straps, if small cable management kit is selected • 10 red rubber: smart straps, if large cable management kit is selected • Attachment hardware 	<ul style="list-style-type: none"> 1 Style number 2 Options, if selected (see below)

Options	U.S. Price	Required to Specify
Strap <ul style="list-style-type: none"> • Smart straps 	No cost	Specify <i>with smart straps</i> .

Specification Information				
Dimensions			Style	U.S.
D	W	H	Number	Price
.....

Tip: The weight limit of the 15½" tray is five pounds, while the weight limit of the 30" tray is 10 pounds.

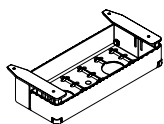

Small Cable Management Kit

6 ⁵ / ₁₆ "	15½"	3½"	DSTRAYSM	\$ 97
.....

Large Cable Management Kit

6 ⁵ / ₁₆ "	30"	3½"	DSTRAYLG	\$130
.....

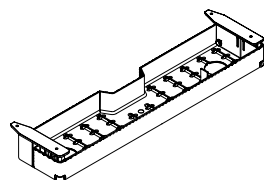

Tip: When installed, tray provides ¼" of clearance on all sides to allow for cable egress between the underside of the worksurface and the top of the tray.

Tip: Tray attachment hardware accommodates work-surfaces more than ¾" in thickness. Screws may pop through thinner work-surfaces.



For Canadian Pricing

Multiply U.S. Price by the Canadian price factor.

▶ See page 1 for details.

