Ology

Understanding

Ology Height-Adjustable Desks	46
Ology Corner Desks and Bases Size Restrictions	66
Ology Options Availability Chart	72
Ology Modesty Panels	74
Universal Steel One-High and 1.5-High Open Laterals	76
Elective Elements One-High Open Plinth Base Pedestals and Common Tops	78

Specifying

Ology Height-Adjustable Rectangular Desks	80
Ology Height-Adjustable Tapered Desks	84
Ology Height-Adjustable 3-Leg Corner Desks	86
Ology Height-Adjustable Bases	100
Ology Modesty Panels	110
Ology Cable and Power Management	111
Active Touch Controller Kit	112
Universal Steel One-High and 1.5-High Open Laterals	114
Universal Shrouds	116
Universal Filler	117
Universal Common Tops	118
Elective Elements One-High Open Plinth Base Pedestals	120
Elective Elements Common Tops	122

Ology Height-Adjustable Desks

Ology brings together physiology and biology to support wellbeing at work. It allows users to quickly, quietly, and intuitively change posture without disrupting their coworkers. Ology offers a one button solution for quick eye-to-eye collaboration. The integrated rail offers today's workers a range of ergonomic tools. Ology provides Bactiblock, an antimicrobial additive, can be molded into the most frequently touched components.

► Specifying, page 80.

Desk has a wood core with a High-Pressure Laminate or wood veneer surface and is 1" thick.

Lifting column is controlled by central control box for synchronization. Columns are precision balanced to minimize surface vibrations.

Access door and tray with power provides user access to 120V and USB power and data as well as cord management. Available as an option.

Integrated rail, available as an option, supports space division, lighting, or worktools to give users choice and control for their physical wellbeing.

Extended height-adjustable base adjusts from 22³/₈"H to 48⁷/₁₀"H in any increment.

Basic height-adjustable base adjusts from 27³/₁₀"H–46²/₅"H in any increment.

Leveling glides adjust 1/2" to install desk on uneven floors. 1" adjustable glides are available as an option.

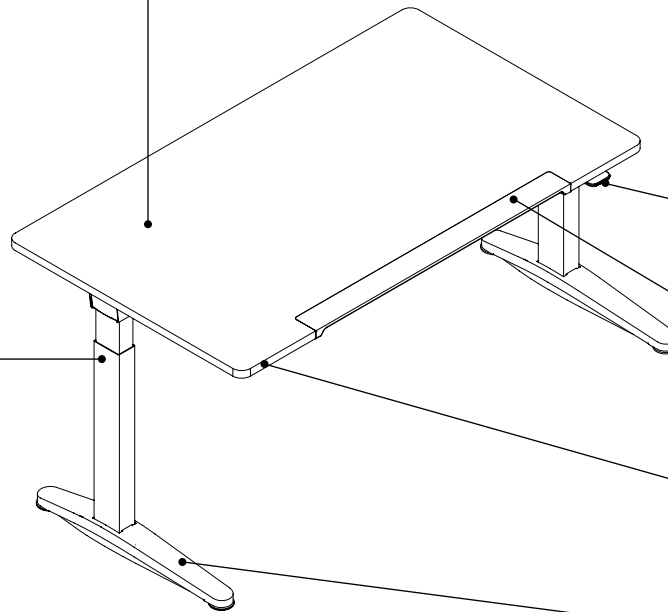

CarbonNeutral.com

Now available as a CarbonNeutral product, making sure our commitment to a more sustainable future helps yours too.

Push button simple touch controller adjusts height at a rate of 1 1/2" per second.

Soft edge, available as option, reduces unhealthy pressure on forearms, as well as feelings of shoulder and neck fatigue. Soft edge is 36"W.

Edge is available in 3 mm edge profile for radius corner and square corner is 3 mm on the user's edge and 1 mm sides and back.

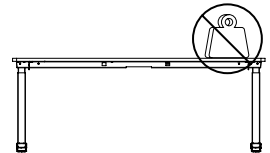

Distribute weight evenly. **Base** supports a maximum distributed weight load of 360 pounds (2-leg) and 500 pounds (3-leg).

Tip: 2-leg desks that have an overhang, or are 35"D or 36"D will have a distributed weight capacity of 300 pounds (136.1 kg).

Tip: When calculating lifting capacity, subtract the weight of the worksurface, understructure, and options selected.

► See page 52 for worksurface weights.

Active touch controller is Bluetooth-enabled and includes digital display, two preset buttons, double-tap automatic drive, and active motion posture reminders. *Tip: Active touch controller is standard.*

Tip: Steelcase Rise mobile app is available that pairs with any active touch controller to support preferences, presets, and activity tracking.

Product Details

High-Pressure Laminate Desks

Front (user's) edge profile is available in 3 mm edge profile.

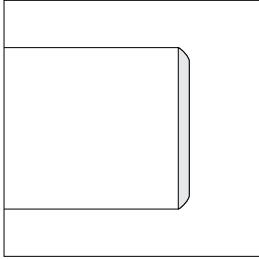

PVC-free, 3 mm edge profiles are proprietary polyolefin blend for all solid colors and seven woodgrain finishes. Matching 1 mm side and back edges are also PVC-free.

► See *Surface Materials* in this book for specific PVC-free availability, page 274.

Edge profile finishes are specified separately from laminate color.

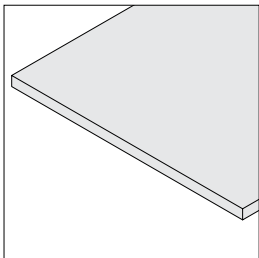

Square corners, available as an option, have 90° corners on all four sides with a front user's edge.

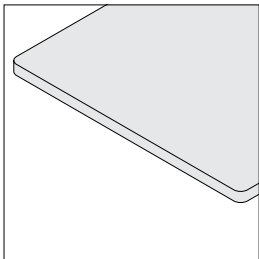

Radius corners, available as an option, have 1¼" radius on all four sides with a continuous user's edge. Radius corners eliminate sharp edges and are appropriate for freestanding furniture.

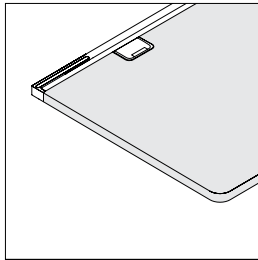

When radius corners are specified in applications with integrated rail, the front corners of the desk will be radius and the back corners will be square.

Wood Veneer Desks

Front (user's) edge profile is wood veneer with a square (3 mm) radius.

Side and back edges are flat. Wood edge color matches finish specified for desk. Corner style for wood veneer desks are square corners.

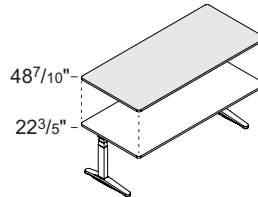

Extended ology desks adjust 22¾"H to 48⅞"H in any increment. Basic height-adjustable base adjusts from 27⅜"H-46⅝"H in any increment.

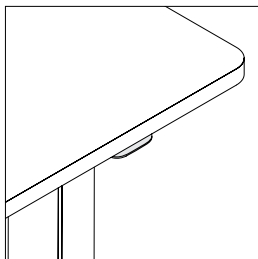

Simple touch controller is available as an option and easily adjusts height of desk, at a rate of 1½" per second, by lifting or pressing down on the controller.

Tip: Optional antimicrobial additive available.

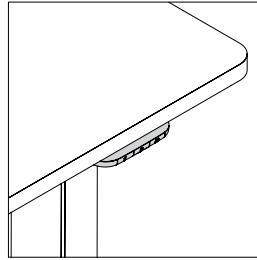

Active touch controller is Bluetooth-enabled and is standard and includes digital display, two preset buttons, double-tap automatic drive, and active motion posture reminders.

Tip: Steelcase Rise mobile app is available that pairs with any active touch controller to support preferences, presets, and activity tracking.

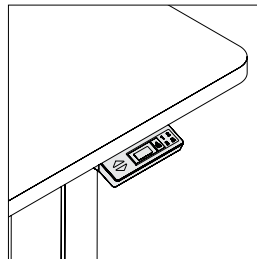

4 pre-set programmable controller is available as an option. It allows users to set the seated and standing height positions or pre-set heights for multiple users. The collaboration button can be programmed to raise the desk to an average standing height for shoulder to shoulder/dyadic collaboration. Digital display will show the height of the desk when adjusting and at rest before it enters sleep mode.

Gyroscopic obstruction sensing technology

is standard with all Ology desks. The worksurface will backtrack when it makes contact with an object or detects tilt.

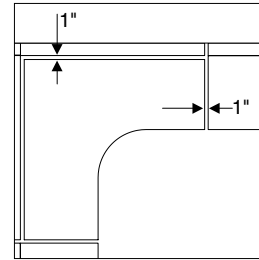

Desk sizes are listed in actual dimensions to allow for 1" gap to adjacent furniture eliminating any pinch points.

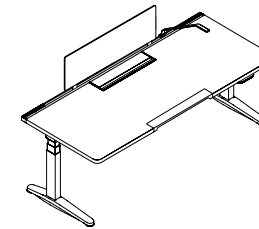

Integrated rail, available as an option, allows for the mounting of personal/modesty screens, lights, power strips, and other worktools.

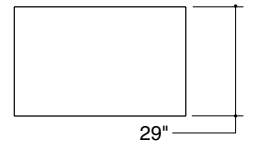

The overall dimension of the worksurface is 23"D, 29"D, or 35"D. If full depth worksurfaces are desired, add 1" to each depth.

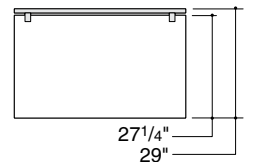

Integrated rail is optional and must be specified on initial order. It cannot be added after install. Worksurface depth is shortened by 1¾" to accommodate the integrated rail so the overall footprint remains the same.

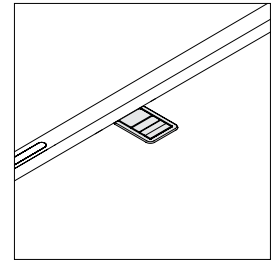

Cord drop is standard when rail is specified and power door or grommets are not optioned to allow for cords to drop below the surface. Corner desks will have a cord drop on opposite side when power door or grommets are specified on a single side.

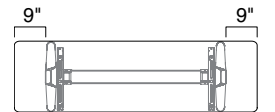
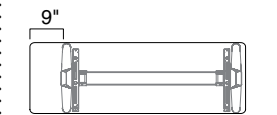
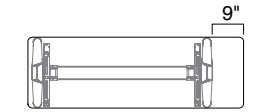

Desk overhang for CPU holder or layering of low storage and pedestals is available as an option on rectangular desks. The overhang is 9" and available on 64"W or larger desks. Desk widths 70"W or larger allow for single or dual overhang.

Tip: Overhang not available on 35"D or 36"D.

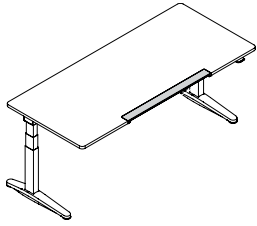

Soft edge, available as an option, is polyurthane and is offered with Bactiblock, an antimicrobial additive. Soft edge is available on rectangular and tapered desks that are 58"W or wider without overhang. With a left or right overhang, soft edge is available on 70"W and 76"W only. Soft edge cannot be used on desks that have overhang on both left and right.

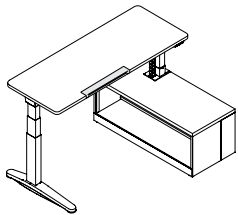

Soft edge can be positioned left or right on desks that are 64"W or wider for use with integrated storage. *Tip: Soft edge is shifted 3" on 64"W, 6" on 70"W, and 9" on 76"W, without overhang.*

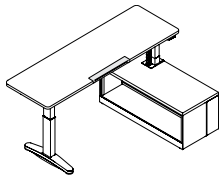

Worksurface overhang can be positioned left or right on desks that are 70" wide or wider for use with integrated storage. *Tip: Overhang not available on 35"D or 36"D.*

Ology desk with integrated storage must be specified with modular widths only. When opting for parametric widths, integrated storage is not available.

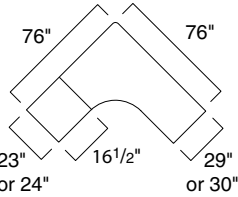

90° desks, 60¹/₁₆" x 60¹/₁₆" and wider, are manufactured in two pieces due to laminate sheet size. Flush mounted desk bracing is provided. The desk split is located on the left side if an equal corner is specified. The split is located on the longest side if an extended corner is specified.

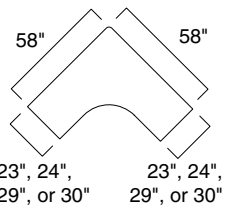

90° desks can be specified 23", 24", 29", or 30" deep. Right- and left-hand depths are not required to match.

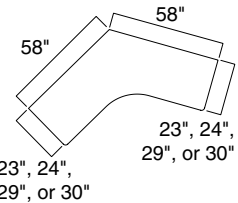

120° desks can be specified 23", 24", 29", or 30" deep. Right- and left-hand depths must match.



CarbonNeutral.com
CarbonNeutral product in the Ology portfolio helps organizations achieve their carbon emissions goals. Order **OLSLRQCN**, **OLELRQCN**, **OLSLL3CN**, or **OLELL3CN** to specify Ology with CarbonNeutral product certification.

Wiring and Cabling

Low surge electric motor with quiet operation adjusts at 1¹/₂" per second. Motor is 110V and includes a 10⁴/₅' power cord. Motor has 0.1W standby power.

Chicago requires that desks shipping into Illinois ship with a 9' power cord.

Ology desks are NRTL listed, and the Ology base is NRTL listed when constructed in accordance with the assembly directions.

Controllers must be located next to the control box. The control box can be placed on either the right or left side of the desk and is field-installed.

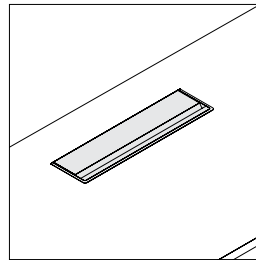

Power and data access door and tray with USB is available as an option. The door is 16¹/₂"W and centered on the surface, providing user access to power, data, and USB, as well as cord management. Corner desks can support the access door on either side of the desk or on both sides and will have a cord drop on opposite side when an integrated rail is specified.

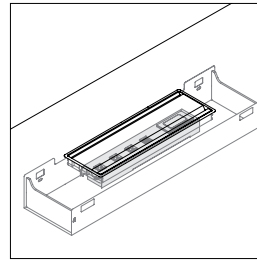

Power strip, located in tray, includes three outlets and easy access to two USB charging ports. Each port provides two amperage of output. USB receptacles conveniently charge a wide range of electronic devices, though not all devices are USB compatible. Cord length is 10'. Data can be terminated and accessed in the tray, and it is positioned to the right. Both modular furniture and NEMA faceplates can be used. Chicago and California have special requirements. Desks shipping to Illinois and California with the power access door option have a powerstrip with overcurrent protection.

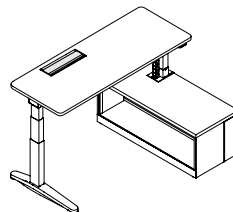

Power and data access door and tray can be positioned left or right on desks that are 64"W or wider for use with integrated storage. *Tip: Power and data access door and tray is shifted 3" on 64"W, 6" on 70"W, and 9" on 76"W, without overhang.*

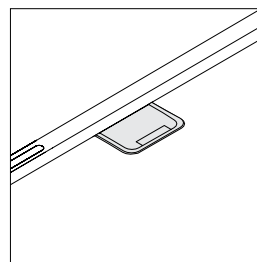

Grommets, available as an option, help manage cable/cords going from the top of desk to the underside. Grommet inside dimensions are 3¹/₄"W X 3³/₄"D.

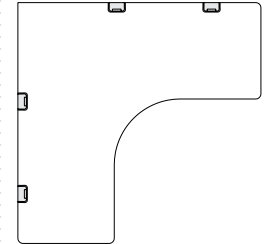

Grommets come in pairs. 90° and 120° corners offer pairs of grommets on the left side, right side, or both sides. 90° widths smaller than 58"W and 120° widths smaller than 40"W have a single grommet. *Tip: When grommet is optional, power and data access door cannot be applied on the same side of the worksurface.*

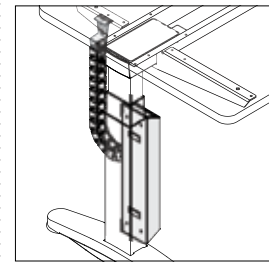

Cable riser supports cable management vertically between the floor and the underside of the desk. It is available in 6527 Merle and is specified separately. ▶Specifying, page 111

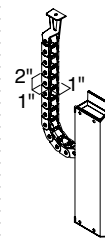

Cable riser, with leg connection, inside dimensions are 1"D x 1"W to accommodate a variety of cord sizes. Overall depth is 2".

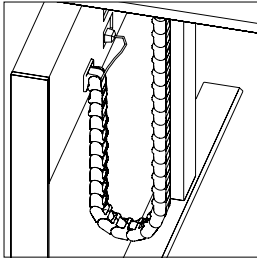

Cable riser, with fence connection, inside dimensions are 1"D x 1"W to accommodate a variety of cord sizes. Overall depth is 2".

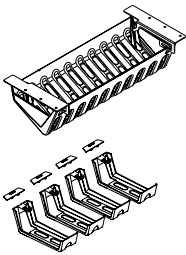

Cable basket and cable brackets, ordered separately, support horizontal cable management below the worksurface.
▶ Specifying, page 111

Cable baskets are available on rectangular, tapered, and 90° corner desks 46¹/₁₆"W or larger, and 120° corner desks 40¹/₁₆"W or larger.

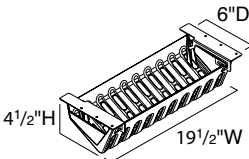

Cable baskets inside dimensions are 6"D x 17³/₄"W x 4¹/₄"H and the overall width is 19¹/₂"W with a height of 4¹/₂"H.

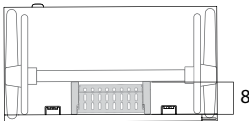

Cable basket requires 8"D of clearance to install. The cable basket bracket is universal which allows for front or back facing orientation.

Tip: If the rail is specified on Ology, the cable basket is only allowed in the back facing orientation.

Tip: If a modesty panel is used on Ology, the cable basket is only allowed in the front facing orientation.

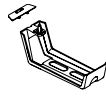

Inside dimensions of cable brackets are 6"D x 2"H.

Surface Materials

High-Pressure Laminate Desk

- Laminate
- ▶ See *Surface Materials Reference Manual*.
- Open Line laminate (option)
- A program including non-Steelcase laminates which are suitable for use on Steelcase products.
- ▶ See *Surface Materials Reference Manual*.

3 mm edge profile

- Plastic

Wood Veneer Desk

- Wood veneer (standard)
- Customiz stain (option)
- Full-Fill Finish (option)

Square 3 mm edge profile

- Wood veneer to match desk

Height-adjustable base

- 4799 Platinum Metallic
- 7207 Black
- 7241 Arctic White
- 7360 Merle

Soft edge and grommet

- 6527 Merle

Power and Data Access Door and Tray

- Door
- Paint
- Anodized Aluminum

Door bezel

- 6527 Merle

Application Topics

Moving desks can collide with other components. Do not install overhead storage, desk-height power, or desk accessories in the path of height-adjustable desks.
▶ See page 26

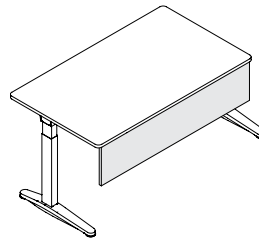

Modesty panels, available in laminate and wood veneer, attach to the understructure of the desk. It is parametric in width from ¹/₁₆". Width of modesty panel can be equal to or less than the width of the desk.

Tip: Full-width modesty panels cannot be used on desks with integrated rail. To use with the integrated rail, the modesty panel must be undersized by a minimum of 12" (rectangular and tapered) and inset from the edge of the worksurface.

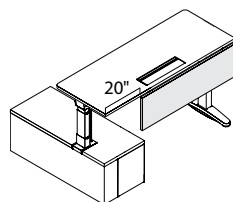

When using modesty panels with integrated storage, modesty panels must be specified 20" smaller than the width of the desk.

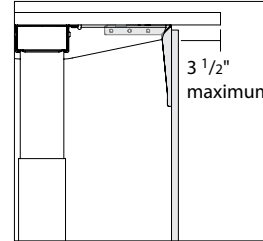

Modesty panels may be inset a maximum of 3¹/₂" from the back of the worksurface to allow for c-clamping.

Tip: Inset modesty panels do not work with the power access door option or the cable basket and cable brackets.

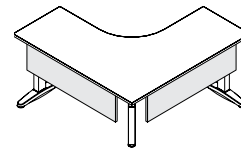

In order to inset, modesty panels must be specified a minimum of 12" smaller (rectangular and tapered) or 7³/₄" smaller (90°) and 7" smaller (120°) than the width of the desk understructure.

Tip: To use with integrated rail, the modesty panel must be undersized by a minimum of 12" (rectangular and taper) or 21" (90°) and 16" (120°) and inset from the edge of the worksurface.

Tip: Inset modesty panels do not work with the power access door option or the cable basket and cable brackets.

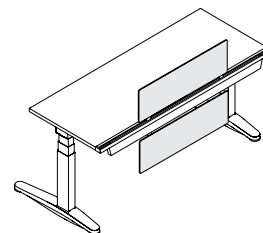

Fixed privacy/modesty screens mount on the integrated rail above for privacy and below for modesty.

Tip: 19¹/₂"H and 24"H are for privacy use only.

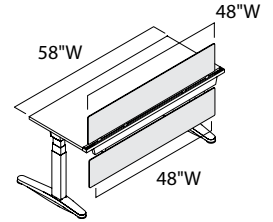

When using fixed screens in the modesty position, the desk must be at least 10" wider than the width of the screen.

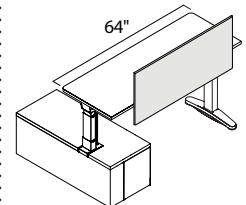

When mounting universal privacy/modesty screens with One-High integrated storage, desks must be 64"W and wider.

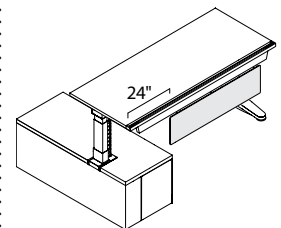

When using fixed screens in the modesty position with One-High integrated storage, the desk must be at least 24" wider than the width of the screen.

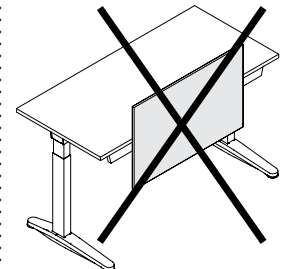

Universal boundary screens are not permitted on height-adjustable desks, as they do not pass minimum safety requirements which could result in the desk tipping over.

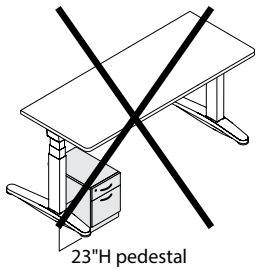

23"H pedestal

On extended height desks, any storage higher than 19" will impede the height range of the desk. On basic height desks, any storage higher than 23⁷/₁₀" will impede the height range of the desk.
Tip: Do not place storage underneath controller.

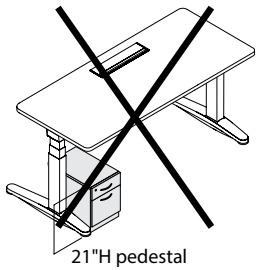

21"H pedestal

When the power access door is optioned, on extended height desks any storage taller than 16¹/₂"H will impede the height range of the desk. On basic height desks, any storage taller than 21¹/₅"H will impede the height range of the desk.
Tip: Do not place storage underneath controller.

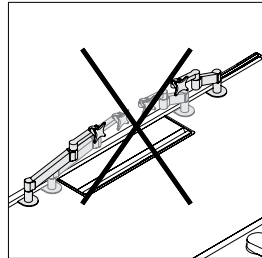
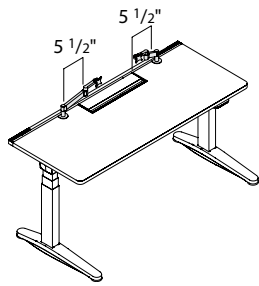

When optioning both the integrated rail and power access door, flat panel monitor arms cannot be c-clamped 5¹/₂" on either side of the power door.

CF monitor arms cannot be rail mounted.
 ▶ See page 43 for *Steelcase Monitor Arm Guidelines*.

When optioning the integrated rail and using a cable basket, there will not be enough room to C-clamp behind the basket.

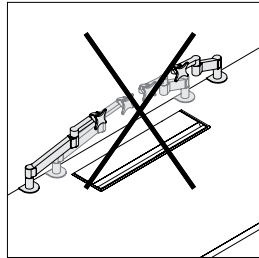
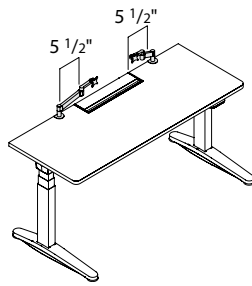

When optioning the power access door only, flat panel monitor arms cannot be c-clamped behind the power door or within 5¹/₂" to either side.

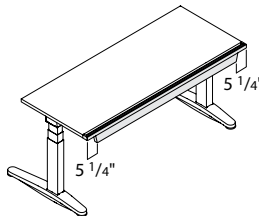

When attaching lighting to the integrated rail, there is a 5¹/₄" mounting free zone on each end of the rail.

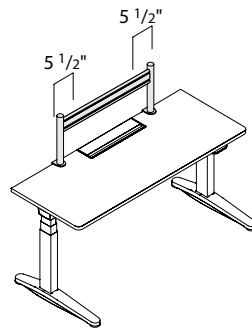

When installing SlatRail with a power door only, do not c-clamp the stanchions within 5¹/₂" on either side of the power door.

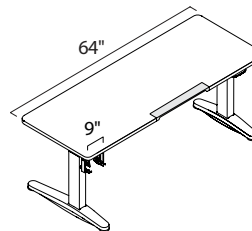

When mounting CPU holders, specify the overhang option.
Tip: CPU holders that require less than 12"D clearance may be mounted inboard of legs.

Tip: Maximum CPU weight capacity is 40 lbs.

Tip: Only standard Stella or 5" lift and lock mechanisms should be used.

Tip: CPU holders are not allowed on 35"D or 36"D worksurfaces.

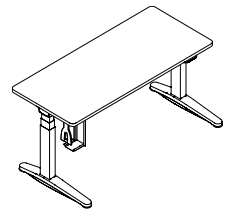

On extended height desks, CPUs installed in a CPU holder should not be installed over the foot or exceed 16" high, or it will impede the height range of the desk.

All assemblies meet or exceed ANSI/BIFMA standards.

WARNING

Read base only warranty limitations.
 ▶ See page 26 for *Workstation Design Guidelines and Requirements*.

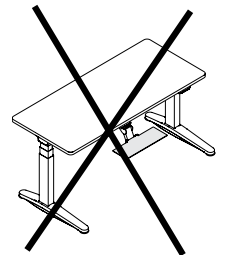

Keyboard assemblies are not allowed on 23"D or smaller than 46"W height-adjustable desks. They do not meet minimum safety requirements.

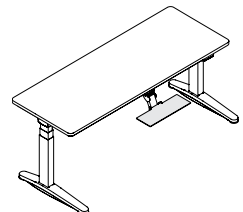

Steelcase keyboard assemblies can be installed on 29"/30"D Ology. Specify desks 46"W and wider and with an 11" track.

Supporting Multiple Monitors on 2-Leg Height Adjustable Desks

Application Guidelines

Rules:

- Minimum worksurface size: 29/30"D x 58"W
- No more than three single monitor arms (maximum monitor weight of 15 pounds per arm) permitted on 2-leg desk
- No more than six monitors permitted on 2-leg desk
- No more than 60 pounds maximum for monitor weight per 2-leg desk
- Not permitted on 2-leg desks with casters or height saver feet
- When calculating height-adjustable desk lifting capacity, subtract the weight of the worksurface, understructure, options, and add-on products (e.g. flat panel monitor arm, monitors, and CPUs)
- No worksurface overhangs permitted on the height-adjustable desk

Monitor Arm Assemblies	Migration SE T-Leg Only	Ology	AMQ T-Leg Only	Flex
Single Dynamic/Single Static Monitor Arm	X	X	X	X
Dual Dynamic/Dual Static Monitor Arm	X	X	X	X
Triple Dynamic/Triple Static Monitor Arm	X	X	X	Static only
One over One Static Monitor Arm	X	X	X	
Two over Two Static/Wide Static Monitor Arm	X	X	X	
Three over Three Static/Wide Static Monitor Arm	X	X		

Installation

Desks ship with pre-drilled holes for mounting bases.

Two-piece tops ship with flush mounted desk bracing.

Height-adjustable base requires attachment to the worksurface.

Base supports a maximum distributed weight capacity of 360 pounds (2-leg) and 500 pounds (3-leg).

Tip: 2-leg desks that have an overhang, or are 35"D or 36"D will have a distributed weight capacity of 300 pounds (136.1 kg).

Tip: When calculating lifting capacity, subtract the weight of the worksurface, understructure and options (i.e. integrated rail, power and data access door or soft edge).

Tip: A label applied to the underside of the worksurface will include the load-capacity for each desk.

Worksurface Weight

Worksurface Shape W LD RD Worksurface Weight

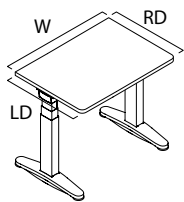

				23"D	24"D
Rectangular	34"	23" or 24"	23" or 24"	20 lb	21 lb
	40"	23" or 24"	23" or 24"	24 lb	25 lb
	46"	23" or 24"	23" or 24"	27 lb	29 lb
	52"	23" or 24"	23" or 24"	31 lb	32 lb
	58"	23" or 24"	23" or 24"	35 lb	36 lb
	64"	23" or 24"	23" or 24"	39 lb	40 lb
	70"	23" or 24"	23" or 24"	42 lb	43 lb
	76"	23" or 24"	23" or 24"	46 lb	47 lb
				29"D	30"D
	34"	29" or 30"	29" or 30"	26 lb	27 lb
	40"	29" or 30"	29" or 30"	30 lb	31 lb
	46"	29" or 30"	29" or 30"	34 lb	36 lb
	52"	29" or 30"	29" or 30"	39 lb	41 lb
	58"	29" or 30"	29" or 30"	43 lb	45 lb
	64"	29" or 30"	29" or 30"	48 lb	50 lb
	70"	29" or 30"	29" or 30"	52 lb	54 lb
	76"	29" or 30"	29" or 30"	56 lb	59 lb
				35"D	36"D
	34"	35" or 36"	35" or 36"	31 lb	32 lb
	40"	35" or 36"	35" or 36"	36 lb	37 lb
	46"	35" or 36"	35" or 36"	42 lb	43 lb
	52"	35" or 36"	35" or 36"	47 lb	48 lb
	58"	35" or 36"	35" or 36"	52 lb	54 lb
	64"	35" or 36"	35" or 36"	58 lb	60 lb
	70"	35" or 36"	35" or 36"	63 lb	65 lb
	76"	35" or 36"	35" or 36"	69 lb	71 lb

Understructure Weight	Options		Soft Edge Weight	Accessory	
	Integrated Rail Weight	Power and Data Access Door Weight		Modesty Panel Weight*	
7.8 lb	5.1 lb	N.A.	N.A.		15.2 lb
9.0 lb	5.8 lb	6.9 lb	N.A.		17.6 lb
10.1 lb	6.6 lb	6.9 lb	N.A.		20.0 lb
11.3 lb	7.3 lb	6.9 lb	N.A.		22.4 lb
12.4 lb	8.0 lb	6.9 lb	2.6 lb		24.8 lb
13.6 lb	8.8 lb	6.9 lb	2.6 lb		27.3 lb
14.8 lb	9.5 lb	6.9 lb	2.6 lb		29.7 lb
15.9 lb	10.2 lb	6.9 lb	2.6 lb		32.1 lb
7.8 lb	5.1 lb	N.A.	N.A.		15.2 lb
9.0 lb	5.8 lb	6.9 lb	N.A.		17.6 lb
10.1 lb	6.6 lb	6.9 lb	N.A.		20.0 lb
11.3 lb	7.3 lb	6.9 lb	N.A.		22.4 lb
12.4 lb	8.0 lb	6.9 lb	2.6 lb		24.8 lb
13.6 lb	8.8 lb	6.9 lb	2.6 lb		27.3 lb
14.8 lb	9.5 lb	6.9 lb	2.6 lb		29.7 lb
15.9 lb	10.2 lb	6.9 lb	2.6 lb		32.1 lb
8.9 lb	5.1 lb	N.A.	N.A.		15.2 lb
10.1 lb	5.8 lb	6.9 lb	N.A.		17.6 lb
11.1 lb	6.6 lb	6.9 lb	N.A.		20.0 lb
12.3 lb	7.3 lb	6.9 lb	N.A.		22.4 lb
13.5 lb	8.0 lb	6.9 lb	2.6 lb		24.8 lb
14.6 lb	8.8 lb	6.9 lb	2.6 lb		27.3 lb
15.8 lb	9.5 lb	6.9 lb	2.6 lb		29.7 lb
17.0 lb	10.2 lb	6.9 lb	2.6 lb		32.1 lb

*For detailed modesty panel information, see page 74

Ology Height-Adjustable Desks, continued

Base supports a maximum distributed weight capacity of 360 pounds (2-leg) and 500 pounds (3-leg).
 Tip: 2-leg desks that have an overhang, or are 35"D or 36"D will have a distributed weight capacity of 300 pounds (136.1 kg).

Tip: When calculating lifting capacity, subtract the weight of the worksurface, understructure and options (i.e. integrated rail, power and data access door or soft edge).

Tip: A label applied to the underside of the worksurface will include the load-capacity for each desk.

Worksurface Weight, continued

Worksurface Shape	W	LD	RD	Worksurface Weight	
				23"D/29"D	24"D/30"D

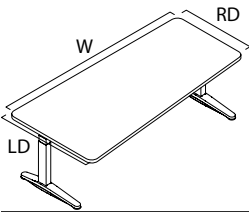

Tapered	58"	29" or 30"	23" or 24"	39 lb	40 lb
	64"	29" or 30"	23" or 24"	43 lb	45 lb
	70"	29" or 30"	23" or 24"	47 lb	49 lb
	76"	29" or 30"	23" or 24"	51 lb	53 lb
	58"	23" or 24"	29" or 30"	39 lb	40 lb
	64"	23" or 24"	29" or 30"	43 lb	45 lb
	70"	23" or 24"	29" or 30"	47 lb	49 lb
	76"	23" or 24"	29" or 30"	51 lb	53 lb

Worksurface Shape	LW	LD	RW	RD	Worksurface Weight	
					23"D	24"D

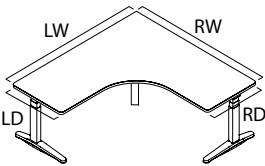

90° Equal 3-Leg	52"	23" or 24"	52"	23" or 24"	58.2 lb	59.2 lb
	58"	23" or 24"	58"	23" or 24"	66.6 lb	67.6 lb
	64"	23" or 24"	64"	23" or 24"	75.0 lb	77.0 lb
	70"	23" or 24"	70"	23" or 24"	83.4 lb	85.4 lb
	76"	23" or 24"	76"	23" or 24"	91.8 lb	94.8 lb

Understructure Weight	Options		Soft Edge Weight	Accessory Modesty Panel Weight*
	Integrated Rail Weight	Power and Data Access Door Weight		
12.4 lb	8.0 lb	6.9 lb	2.6 lb	24.8 lb
13.6 lb	8.8 lb	6.9 lb	2.6 lb	27.3 lb
14.8 lb	9.5 lb	6.9 lb	2.6 lb	29.7 lb
15.9 lb	10.2 lb	6.9 lb	2.6 lb	32.1 lb
12.4 lb	8.0 lb	6.9 lb	2.6 lb	24.8 lb
13.6 lb	8.8 lb	6.9 lb	2.6 lb	27.3 lb
14.8 lb	9.5 lb	6.9 lb	2.6 lb	29.7 lb
15.9 lb	10.2 lb	6.9 lb	2.6 lb	32.1 lb

Understructure Weight	Options		Soft Edge Weight
	Integrated Rail Weight	Power and Data Access Door Weight	
15.1 lb	15.8 lb	N.A.	N.A.
17.5 lb	17.3 lb	6.9 lb each	N.A.
19.6 lb	18.7 lb	6.9 lb each	N.A.
22.0 lb	20.2 lb	6.9 lb each	N.A.
24.3 lb	21.7 lb	6.9 lb each	N.A.

*For detailed modesty panel information, see page 74

Ology Height-Adjustable Desks, continued

Base supports a maximum distributed weight capacity of 360 pounds (2-leg) and 500 pounds (3-leg).
Tip: 2-leg desks that have an overhang, or are 35"D or 36"D will have a distributed weight capacity of 300 pounds (136.1 kg).

Tip: When calculating lifting capacity, subtract the weight of the worksurface, understructure and options (i.e. integrated rail, power and data access door or soft edge).

Tip: A label applied to the underside of the worksurface will include the load-capacity for each desk.

Worksurface Weight, continued

Worksurface Shape	LW	LD	RW	RD	Worksurface Weight	
					23"D/23"D	24"D/24"D

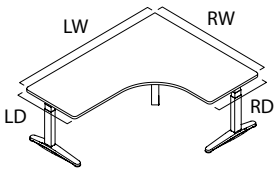

90° Extended 3-Leg	40"	23" or 24"	52"	23" or 24"	49.8 lb	50.8 lb
	40"	23" or 24"	58"	23" or 24"	54.1 lb	55.1 lb
	40"	23" or 24"	64"	23" or 24"	58.2 lb	59.2 lb
	40"	23" or 24"	70"	23" or 24"	62.4 lb	63.4 lb
	40"	23" or 24"	76"	23" or 24"	66.6 lb	67.6 lb
	46"	23" or 24"	52"	23" or 24"	54.0 lb	55.0 lb
	46"	23" or 24"	58"	23" or 24"	58.2 lb	59.2 lb
	46"	23" or 24"	64"	23" or 24"	62.4 lb	64.4 lb
	46"	23" or 24"	70"	23" or 24"	66.6 lb	68.6 lb
	46"	23" or 24"	76"	23" or 24"	70.8 lb	72.8 lb
	52"	23" or 24"	40"	23" or 24"	49.8 lb	50.8 lb
	52"	23" or 24"	46"	23" or 24"	54.0 lb	55.0 lb
	52"	23" or 24"	58"	23" or 24"	62.4 lb	63.4 lb
	52"	23" or 24"	64"	23" or 24"	66.6 lb	67.6 lb
	52"	23" or 24"	70"	23" or 24"	70.8 lb	72.8 lb
	52"	23" or 24"	76"	23" or 24"	75.0 lb	77.0 lb
	58"	23" or 24"	40"	23" or 24"	54.1 lb	55.1 lb
	58"	23" or 24"	46"	23" or 24"	58.2 lb	59.2 lb
	58"	23" or 24"	52"	23" or 24"	62.4 lb	63.4 lb
	58"	23" or 24"	64"	23" or 24"	70.8 lb	72.8 lb
	58"	23" or 24"	70"	23" or 24"	75.0 lb	77.0 lb
	58"	23" or 24"	76"	23" or 24"	79.2 lb	81.2 lb
	64"	23" or 24"	40"	23" or 24"	58.2 lb	59.2 lb
	64"	23" or 24"	46"	23" or 24"	62.4 lb	64.4 lb
	64"	23" or 24"	52"	23" or 24"	66.6 lb	67.6 lb
	64"	23" or 24"	58"	23" or 24"	70.8 lb	72.8 lb
	64"	23" or 24"	70"	23" or 24"	79.2 lb	82.2 lb
	64"	23" or 24"	76"	23" or 24"	83.4 lb	86.4 lb

Understructure Weight	Options		
	Integrated Rail Weight	Power and Data Access Door Weight	Soft Edge Weight
13.5 lb	18.8 lb	6.9 lb each	N.A.
14.6 lb	19.9 lb	6.9 lb each	N.A.
15.7 lb	20.9 lb	6.9 lb each	N.A.
16.9 lb	21.9 lb	6.9 lb each	N.A.
18.0 lb	23.0 lb	6.9 lb each	N.A.
14.7 lb	19.9 lb	6.9 lb each	N.A.
15.8 lb	20.9 lb	6.9 lb each	N.A.
16.9 lb	21.9 lb	6.9 lb each	N.A.
18.1 lb	23.0 lb	6.9 lb each	N.A.
19.2 lb	24.0 lb	6.9 lb each	N.A.
13.5 lb	18.8 lb	6.9 lb each	N.A.
14.7 lb	19.9 lb	6.9 lb each	N.A.
16.3 lb	21.9 lb	6.9 lb each	N.A.
17.4 lb	23.0 lb	6.9 lb each	N.A.
18.5 lb	24.0 lb	6.9 lb each	N.A.
19.7 lb	25.1 lb	6.9 lb each	N.A.
14.6 lb	19.9 lb	6.9 lb each	N.A.
15.8 lb	20.9 lb	6.9 lb each	N.A.
16.3 lb	21.9 lb	6.9 lb each	N.A.
18.5 lb	24.0 lb	6.9 lb each	N.A.
19.7 lb	25.1 lb	6.9 lb each	N.A.
20.9 lb	26.1 lb	6.9 lb each	N.A.
15.7 lb	20.9 lb	6.9 lb each	N.A.
16.9 lb	21.9 lb	6.9 lb each	N.A.
17.4 lb	23.0 lb	6.9 lb each	N.A.
18.5 lb	24.0 lb	6.9 lb each	N.A.
20.8 lb	26.1 lb	6.9 lb each	N.A.
22.0 lb	27.1 lb	6.9 lb each	N.A.

Ology Height-Adjustable Desks, continued

Base supports a maximum distributed weight capacity of 360 pounds (2-leg) and 500 pounds (3-leg).
Tip: 2-leg desks that have an overhang, or are 35"D or 36"D will have a distributed weight capacity of 300 pounds (136.1 kg).

Tip: When calculating lifting capacity, subtract the weight of the worksurface, understructure and options (i.e. integrated rail, power and data access door or soft edge).

Tip: A label applied to the underside of the worksurface will include the load-capacity for each desk.

Worksurface Weight, continued

Worksurface Shape	LW	LD	RW	RD	Worksurface Weight	
					23"D	24"D

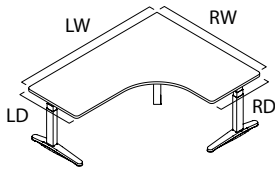

90° Extended 3-Leg, continued	70"	23" or 24"	40"	23" or 24"	62.4 lb	63.4 lb
	70"	23" or 24"	46"	23" or 24"	66.6 lb	68.6 lb
	70"	23" or 24"	52"	23" or 24"	70.8 lb	72.8 lb
	70"	23" or 24"	58"	23" or 24"	75.0 lb	77.0 lb
	70"	23" or 24"	64"	23" or 24"	79.2 lb	82.2 lb
	70"	23" or 24"	76"	23" or 24"	87.6 lb	90.6 lb
	76"	23" or 24"	40"	23" or 24"	66.6 lb	67.6 lb
	76"	23" or 24"	46"	23" or 24"	70.8 lb	72.8 lb
	76"	23" or 24"	52"	23" or 24"	75.0 lb	77.0 lb
	76"	23" or 24"	58"	23" or 24"	79.2 lb	81.2 lb
	76"	23" or 24"	64"	23" or 24"	83.4 lb	86.4 lb
	76"	23" or 24"	70"	23" or 24"	87.6 lb	90.6 lb

Understructure Weight	Options		
	Integrated Rail Weight	Power and Data Access Door Weight	Soft Edge Weight
16.9 lb	21.9 lb	6.9 lb each	N.A.
18.1 lb	23.0 lb	6.9 lb each	N.A.
18.5 lb	24.0 lb	6.9 lb each	N.A.
19.7 lb	25.1 lb	6.9 lb each	N.A.
20.8 lb	26.1 lb	6.9 lb each	N.A.
23.1 lb	28.2 lb	6.9 lb each	N.A.
18.0 lb	23.0 lb	6.9 lb each	N.A.
19.2 lb	24.0 lb	6.9 lb each	N.A.
19.7 lb	25.1 lb	6.9 lb each	N.A.
20.9 lb	26.1 lb	6.9 lb each	N.A.
22.0 lb	27.1 lb	6.9 lb each	N.A.
23.1 lb	28.2 lb	6.9 lb each	N.A.

Ology Height-Adjustable Desks, continued

Base supports a maximum distributed weight capacity of 360 pounds (2-leg) and 500 pounds (3-leg).
 Tip: 2-leg desks that have an overhang, or are 35"D or 36"D will have a distributed weight capacity of 300 pounds (136.1 kg).

Tip: When calculating lifting capacity, subtract the weight of the worksurface, under-structure and options (i.e. integrated rail, power and data access door or soft edge).

Tip: A label applied to the underside of the worksurface will include the load-capacity for each desk.

Worksurface Weight, continued

Worksurface Shape	LW	RW	Worksurface Weight	Worksurface Weight	Worksurface Weight
			LD and RD	LD and RD	LD and RD
			23"D/29"D	23"D/30"D	24"D/29"D
90° Extended 3-Leg	46"	40"	48.8 lb	49.3 lb	49.3 lb
	46"	52"	59.3 lb	60.2 lb	59.9 lb
	46"	58"	64.6 lb	65.7 lb	65.2 lb
	46"	64"	69.9 lb	71.2 lb	70.4 lb
	46"	70"	75.2 lb	76.6 lb	75.7 lb
	46"	76"	80.5 lb	82.1 lb	81.0 lb
	46"	78"	82.3 lb	83.9 lb	82.8 lb
	52"	40"	53.0 lb	53.5 lb	53.7 lb
	52"	46"	58.3 lb	59.0 lb	59.0 lb
	52"	58"	68.8 lb	69.9 lb	69.5 lb
	52"	64"	74.1 lb	75.4 lb	74.8 lb
	52"	70"	79.4 lb	80.8 lb	80.1 lb
	52"	76"	84.7 lb	86.3 lb	85.4 lb
	52"	78"	86.5 lb	88.1 lb	87.2 lb
	58"	40"	57.2 lb	57.7 lb	58.0 lb
	58"	46"	62.4 lb	63.1 lb	63.3 lb
	58"	52"	67.7 lb	68.6 lb	68.6 lb
	58"	64"	78.3 lb	79.6 lb	79.2 lb
	58"	70"	83.6 lb	85.0 lb	84.5 lb
	58"	76"	88.9 lb	90.5 lb	89.8 lb
58"	78"	90.7 lb	92.3 lb	91.5 lb	
64"	40"	61.4 lb	61.9 lb	62.4 lb	
64"	46"	66.6 lb	67.3 lb	67.7 lb	
64"	52"	71.9 lb	72.8 lb	73.0 lb	
64"	58"	77.2 lb	78.3 lb	78.3 lb	
64"	70"	87.8 lb	89.2 lb	88.9 lb	
64"	76"	93.1 lb	94.7 lb	94.2 lb	
64"	78"	94.9 lb	96.5 lb	95.9 lb	

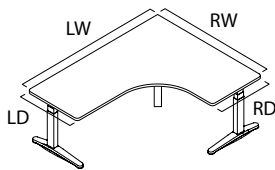

• Worksurface Weight LD and RD	• Worksurface Weight LD and RD	• Worksurface Weight LD and RD	• Worksurface Weight LD and RD
24"D/30"D	29"D/29"D	29"D/30"D	30"D/30"D

49.8 lb	N.A.	N.A.	N.A.
60.7 lb	62.4 lb	63.1 lb	63.6 lb
66.2 lb	67.7 lb	68.6 lb	69.1 lb
71.7 lb	73.0 lb	74.1 lb	74.6 lb
77.1 lb	78.3 lb	79.6 lb	80.0 lb
82.6 lb	83.6 lb	85.0 lb	85.5 lb
84.4 lb	85.4 lb	86.9 lb	87.3 lb
54.1 lb	N.A.	N.A.	N.A.
59.6 lb	62.4 lb	63.0 lb	63.6 lb
70.6 lb	73.0 lb	73.9 lb	74.6 lb
76.0 lb	78.3 lb	79.4 lb	80.0 lb
81.5 lb	83.6 lb	84.9 lb	85.5 lb
87.0 lb	88.9 lb	90.3 lb	91.0 lb
88.8 lb	90.7 lb	92.1 lb	92.8 lb
58.5 lb	N.A.	N.A.	N.A.
64.0 lb	67.7 lb	68.3 lb	69.1 lb
69.5 lb	73.0 lb	73.7 lb	74.6 lb
80.4 lb	83.6 lb	84.7 lb	85.5 lb
85.9 lb	88.9 lb	90.1 lb	91.0 lb
91.4 lb	94.2 lb	95.6 lb	96.5 lb
93.2 lb	95.9 lb	97.4 lb	98.3 lb
62.9 lb	N.A.	N.A.	N.A.
68.4 lb	73.0 lb	73.5 lb	74.6 lb
73.8 lb	78.3 lb	79.0 lb	80.0 lb
79.3 lb	83.6 lb	84.5 lb	85.5 lb
90.3 lb	94.2 lb	95.4 lb	96.5 lb
95.7 lb	99.5 lb	100.9 lb	101.9 lb
97.6 lb	101.2 lb	102.7 lb	103.8 lb

Ology Height-Adjustable Desks, continued

Base supports a maximum distributed weight capacity of 360 pounds (2-leg) and 500 pounds (3-leg).
 Tip: 2-leg desks that have an overhang, or are 35"D or 36"D will have a distributed weight capacity of 300 pounds (136.1 kg).

Tip: When calculating lifting capacity, subtract the weight of the worksurface, under-structure and options (i.e. integrated rail, power and data access door or soft edge).

Tip: A label applied to the underside of the worksurface will include the load-capacity for each desk.

Worksurface Weight, continued

Worksurface Shape	LW	RW	Worksurface Weight	Worksurface Weight	Worksurface Weight
			LD and RD	LD and RD	LD and RD
			23"D/29"D	23"D/30"D	24"D/29"D

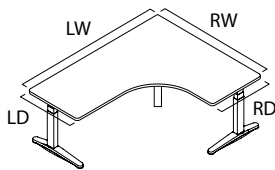

90° Extended 3-Leg	70"	40"	65.5 lb	66.1 lb	66.8 lb
	70"	46"	70.8 lb	71.5 lb	72.1 lb
	70"	52"	76.1 lb	77.0 lb	77.4 lb
	70"	58"	81.4 lb	82.5 lb	82.7 lb
	70"	64"	86.7 lb	88.0 lb	88.0 lb
	70"	76"	97.3 lb	98.9 lb	98.5 lb
	70"	78"	99.0 lb	100.7 lb	100.3 lb
	76"	40"	69.7 lb	70.3 lb	71.2 lb
	76"	46"	75.0 lb	75.7 lb	76.5 lb
	76"	52"	80.3 lb	81.2 lb	81.8 lb
	76"	58"	85.6 lb	86.7 lb	87.0 lb
	76"	64"	90.9 lb	92.1 lb	92.3 lb
	76"	70"	96.2 lb	97.6 lb	97.6 lb
	76"	78"	103.2 lb	104.9 lb	104.7 lb

Worksurface Weight LD and RD	Worksurface Weight LD and RD	Worksurface Weight LD and RD	Worksurface Weight LD and RD
24"D/30"D	29"D/29"D	29"D/30"D	30"D/30"D

67.3 lb	N.A.	N.A.	N.A.
72.8 lb	78.3 lb	78.8 lb	80.0 lb
78.2 lb	83.6 lb	84.3 lb	85.5 lb
83.7 lb	88.9 lb	89.8 lb	91.0 lb
89.2 lb	94.2 lb	95.2 lb	96.5 lb
100.1 lb	104.8 lb	106.2 lb	107.4 lb
101.9 lb	106.5 lb	108.0 lb	109.2 lb
71.7 lb	N.A.	N.A.	N.A.
77.1 lb	83.6 lb	84.1 lb	85.5 lb
82.6 lb	88.9 lb	89.6 lb	91.0 lb
88.1 lb	94.2 lb	95.1 lb	96.5 lb
93.5 lb	99.5 lb	100.5 lb	101.9 lb
99.0 lb	104.8 lb	106.0 lb	107.4 lb
106.3 lb	111.8 lb	113.3 lb	114.7 lb

Ology Height-Adjustable Desks, continued

Base supports a maximum distributed weight capacity of 360 pounds (2-leg) and 500 pounds (3-leg).
Tip: 2-leg desks that have an overhang, or are 35"D or 36"D will have a distributed weight capacity of 300 pounds (136.1 kg).

Tip: When calculating lifting capacity, subtract the weight of the worksurface, understructure and options (i.e. integrated rail, power and data access door or soft edge).

Tip: A label applied to the underside of the worksurface will include the load-capacity for each desk.

Worksurface Weight, continued

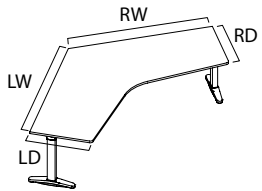
Worksurface Shape	LW	LD	RW	RD	Worksurface Weight			
					23"D	24"D	29"D	30"D
	34"	23", 24", 29" or 30"	34"	23", 24", 29" or 30"	38.7 lb	39.7 lb	38.9 lb	39.6 lb
	40"	23", 24", 29" or 30"	40"	23", 24", 29" or 30"	47.1 lb	48.1 lb	47.9 lb	48.9 lb
	46"	23", 24", 29" or 30"	46"	23", 24", 29" or 30"	55.5 lb	56.5 lb	57.3 lb	58.5 lb
	52"	23", 24", 29" or 30"	52"	23", 24", 29" or 30"	63.9 lb	65.9 lb	62.7 lb	64.2 lb
	58"	23", 24", 29" or 30"	58"	23", 24", 29" or 30"	72.3 lb	74.3 lb	72.0 lb	73.8 lb
	64"	23", 24", 29" or 30"	64"	23", 24", 29" or 30"	80.7 lb	82.7 lb	81.4 lb	83.5 lb

Tip: Right- and left-hand depths must match.

Understructure Weight	Integrated Rail Weight	Power and Data Access Door Weight	Soft Edge Weight
11.8 lb	11.5 lb	N.A.	N.A.
14.2 lb	13.0 lb	N.A.	N.A.
15.1 lb	14.5 lb	N.A.	N.A.
17.5 lb	15.9 lb	6.9 lb each	N.A.
19.6 lb	17.4 lb	6.9 lb each	N.A.
22.0 lb	18.9 lb	6.9 lb each	N.A.

Ology Corner Desks and Bases Size Restrictions

Style	Desks Specified as	Base Price	Desks Specified as	Base Price
90° Corner Desks — Extended Height (Different Depth Opposite Ends 23"/24" Right/Left and 29"/30" Left/Right)				
High-Pressure Laminate Desks				
OLELL3	40WL x 23DL x 52WR x 29DR	N.A.	40WL x 29DL x 52WR x 23DR	\$3839
	40WL x 24DL x 52WR x 29DR	N.A.	40WL x 29DL x 52WR x 24DR	\$3839
	40WL x 23DL x 58WR x 29DR	N.A.	40WL x 29DL x 58WR x 23DR	\$3968
	40WL x 24DL x 58WR x 29DR	N.A.	40WL x 29DL x 58WR x 24DR	\$3968
	40WL x 23DL x 64WR x 29DR	N.A.	40WL x 29DL x 64WR x 23DR	\$4095
	40WL x 24DL x 64WR x 29DR	N.A.	40WL x 29DL x 64WR x 24DR	\$4095
	40WL x 23DL x 70WR x 29DR	N.A.	40WL x 29DL x 70WR x 23DR	\$4222
	40WL x 24DL x 70WR x 29DR	N.A.	40WL x 29DL x 70WR x 24DR	\$4222
	40WL x 23DL x 76WR x 29DR	N.A.	40WL x 29DL x 76WR x 23DR	\$4350
	40WL x 24DL x 76WR x 29DR	N.A.	40WL x 29DL x 76WR x 24DR	\$4350
	40WL x 23DL x 52WR x 30DR	N.A.	40WL x 30DL x 52WR x 23DR	\$3839
	40WL x 24DL x 52WR x 30DR	N.A.	40WL x 30DL x 52WR x 24DR	\$3839
	40WL x 23DL x 58WR x 30DR	N.A.	40WL x 30DL x 58WR x 23DR	\$3968
	40WL x 24DL x 58WR x 30DR	N.A.	40WL x 30DL x 58WR x 24DR	\$3968
	40WL x 23DL x 64WR x 30DR	N.A.	40WL x 30DL x 64WR x 23DR	\$4095
	40WL x 24DL x 64WR x 30DR	N.A.	40WL x 30DL x 64WR x 24DR	\$4095
	40WL x 23DL x 70WR x 30DR	N.A.	40WL x 30DL x 70WR x 23DR	\$4222
	40WL x 24DL x 70WR x 30DR	N.A.	40WL x 30DL x 70WR x 24DR	\$4222
	40WL x 23DL x 76WR x 30DR	N.A.	40WL x 30DL x 76WR x 23DR	\$4350
	40WL x 24DL x 76WR x 30DR	N.A.	40WL x 30DL x 76WR x 24DR	\$4350
	52WL x 29DL x 40WR x 23DR	N.A.	52WL x 23DL x 40WR x 29DR	\$3839
	52WL x 29DL x 40WR x 24DR	N.A.	52WL x 24DL x 40WR x 29DR	\$3839
	52WL x 30DL x 40WR x 23DR	N.A.	52WL x 23DL x 40WR x 30DR	\$3839
	52WL x 30DL x 40WR x 24DR	N.A.	52WL x 24DL x 40WR x 30DR	\$3839

Tip: When the 90° desk width is 40"-42" and 23"/24" deep on one end AND the opposite end is 29"/30" deep, product size limits apply. The width must be increased to 46"W or greater.

Tip: When specifying 3-leg 90° equal corners the smallest width available is 52" x 52", regardless of depth.

Tip: When specifying 3-leg 90° extended corners the smallest width available is 40" x 52", when 23"/24" deep is selected on both ends.

Tip: When specifying 3-leg 90° extended corners the smallest width available is 46" x 52", when 29"/30" deep is selected on both ends.

 **For Canadian Pricing**
 Multiply U.S. Price by the Canadian price factor.
 ▶ See page 1 for details.

Style	Desks Specified as	Base Price	Desks Specified as	Base Price
-------	--------------------	------------	--------------------	------------

90° Corner Desks — Extended Height (Different Depth Opposite Ends 23"/24" Right/Left and 29"/30" Left/Right)

Wood Veneer Desks

OLELL3	40WL x 23DL x 52WR x 29DR	N.A.	40WL x 29DL x 52WR x 23DR	\$5126
	40WL x 24DL x 52WR x 29DR	N.A.	40WL x 29DL x 52WR x 24DR	\$5126
	40WL x 23DL x 58WR x 29DR	N.A.	40WL x 29DL x 58WR x 23DR	\$5273
	40WL x 24DL x 58WR x 29DR	N.A.	40WL x 29DL x 58WR x 24DR	\$5273
	40WL x 23DL x 64WR x 29DR	N.A.	40WL x 29DL x 64WR x 23DR	\$5421
	40WL x 24DL x 64WR x 29DR	N.A.	40WL x 29DL x 64WR x 24DR	\$5421
	40WL x 23DL x 70WR x 29DR	N.A.	40WL x 29DL x 70WR x 23DR	\$5563
	40WL x 24DL x 70WR x 29DR	N.A.	40WL x 29DL x 70WR x 24DR	\$5563
	40WL x 23DL x 76WR x 29DR	N.A.	40WL x 29DL x 76WR x 23DR	\$5717
	40WL x 24DL x 76WR x 29DR	N.A.	40WL x 29DL x 76WR x 24DR	\$5717
	40WL x 23DL x 52WR x 30DR	N.A.	40WL x 30DL x 52WR x 23DR	\$5126
	40WL x 24DL x 52WR x 30DR	N.A.	40WL x 30DL x 52WR x 24DR	\$5126
	40WL x 23DL x 58WR x 30DR	N.A.	40WL x 30DL x 58WR x 23DR	\$5273
	40WL x 24DL x 58WR x 30DR	N.A.	40WL x 30DL x 58WR x 24DR	\$5273
	40WL x 23DL x 64WR x 30DR	N.A.	40WL x 30DL x 64WR x 23DR	\$5421
	40WL x 24DL x 64WR x 30DR	N.A.	40WL x 30DL x 64WR x 24DR	\$5421
	40WL x 23DL x 70WR x 30DR	N.A.	40WL x 30DL x 70WR x 23DR	\$5563
	40WL x 24DL x 70WR x 30DR	N.A.	40WL x 30DL x 70WR x 24DR	\$5563
	40WL x 23DL x 76WR x 30DR	N.A.	40WL x 30DL x 76WR x 23DR	\$5717
	40WL x 24DL x 76WR x 30DR	N.A.	40WL x 30DL x 76WR x 24DR	\$5717
	52WL x 29DL x 40WR x 23DR	N.A.	52WL x 23DL x 40WR x 29DR	\$5126
	52WL x 29DL x 40WR x 24DR	N.A.	52WL x 24DL x 40WR x 29DR	\$5126
	52WL x 30DL x 40WR x 23DR	N.A.	52WL x 23DL x 40WR x 30DR	\$5126
	52WL x 30DL x 40WR x 24DR	N.A.	52WL x 24DL x 40WR x 30DR	\$5126

Tip: When the 90° desk width is 40"-42" and 23"/24" deep on one end AND the opposite end is 29"/30" deep, product size limits apply. The width must be increased to 46"W or greater.

Tip: When specifying 3-leg 90° equal corners the smallest width available is 52" x 52", regardless of depth.

Tip: When specifying 3-leg 90° extended corners the smallest width available is 40" x 52", when 23"/24" deep is selected on both ends.

Tip: When specifying 3-leg 90° extended corners the smallest width available is 46" x 52", when 29"/30" deep is selected on both ends.



For Canadian Pricing

Multiply U.S. Price by the Canadian price factor.

▶ See page 1 for details.

Style	Desks Specified as	Base Price	Desks Specified as	Base Price
90° Corner Desks — Basic Height (Different Depth Opposite Ends 23"/24" Right/Left and 29"/30" Left/Right)				
High-Pressure Laminate Desks				
OLSL3	40WL x 23DL x 52WR x 29DR	N.A.	40WL x 29DL x 52WR x 23DR	\$3540
	40WL x 24DL x 52WR x 29DR	N.A.	40WL x 29DL x 52WR x 24DR	\$3540
	40WL x 23DL x 58WR x 29DR	N.A.	40WL x 29DL x 58WR x 23DR	\$3655
	40WL x 24DL x 58WR x 29DR	N.A.	40WL x 29DL x 58WR x 24DR	\$3655
	40WL x 23DL x 64WR x 29DR	N.A.	40WL x 29DL x 64WR x 23DR	\$3774
	40WL x 24DL x 64WR x 29DR	N.A.	40WL x 29DL x 64WR x 24DR	\$3774
	40WL x 23DL x 70WR x 29DR	N.A.	40WL x 29DL x 70WR x 23DR	\$3891
	40WL x 24DL x 70WR x 29DR	N.A.	40WL x 29DL x 70WR x 24DR	\$3891
	40WL x 23DL x 76WR x 29DR	N.A.	40WL x 29DL x 76WR x 23DR	\$4007
	40WL x 24DL x 76WR x 29DR	N.A.	40WL x 29DL x 76WR x 24DR	\$4007
	40WL x 23DL x 52WR x 30DR	N.A.	40WL x 30DL x 52WR x 23DR	\$3540
	40WL x 24DL x 52WR x 30DR	N.A.	40WL x 30DL x 52WR x 24DR	\$3540
	40WL x 23DL x 58WR x 30DR	N.A.	40WL x 30DL x 58WR x 23DR	\$3655
	40WL x 24DL x 58WR x 30DR	N.A.	40WL x 30DL x 58WR x 24DR	\$3655
	40WL x 23DL x 64WR x 30DR	N.A.	40WL x 30DL x 64WR x 23DR	\$3774
	40WL x 24DL x 64WR x 30DR	N.A.	40WL x 30DL x 64WR x 24DR	\$3774
	40WL x 23DL x 70WR x 30DR	N.A.	40WL x 30DL x 70WR x 23DR	\$3891
	40WL x 24DL x 70WR x 30DR	N.A.	40WL x 30DL x 70WR x 24DR	\$3891
	40WL x 23DL x 76WR x 30DR	N.A.	40WL x 30DL x 76WR x 23DR	\$4007
	40WL x 24DL x 76WR x 30DR	N.A.	40WL x 30DL x 76WR x 24DR	\$4007
	52WL x 29DL x 40WR x 23DR	N.A.	52WL x 23DL x 40WR x 29DR	\$3540
	52WL x 29DL x 40WR x 24DR	N.A.	52WL x 24DL x 40WR x 29DR	\$3540
	52WL x 30DL x 40WR x 23DR	N.A.	52WL x 23DL x 40WR x 30DR	\$3540
	52WL x 30DL x 40WR x 24DR	N.A.	52WL x 24DL x 40WR x 30DR	\$3540

Tip: When the 90° desk width is 40"-42" and 23"/24" deep on one end AND the opposite end is 29"/30" deep, product size limits apply. The width must be increased to 46"W or greater.

Tip: When specifying 3-leg 90° equal corners the smallest width available is 52" x 52", regardless of depth.

Tip: When specifying 3-leg 90° extended corners the smallest width available is 40" x 52", when 23"/24" deep is selected on both ends.

Tip: When specifying 3-leg 90° extended corners the smallest width available is 46" x 52", when 29"/30" deep is selected on both ends.

 **For Canadian Pricing**
 Multiply U.S. Price by the Canadian price factor.
 ▶ See page 1 for details.

Style	Desks Specified as	Base Price	Desks Specified as	Base Price
-------	--------------------	------------	--------------------	------------

90° Corner Desks — Basic Height (Different Depth Opposite Ends 23"/24" Right/Left and 29"/30" Left/Right)

Wood Veneer Desks

OLSLL3	40WL x 23DL x 52WR x 29DR	N.A.	40WL x 29DL x 52WR x 23DR	\$4832
	40WL x 24DL x 52WR x 29DR	N.A.	40WL x 29DL x 52WR x 24DR	\$4832
	40WL x 23DL x 58WR x 29DR	N.A.	40WL x 29DL x 58WR x 23DR	\$4962
	40WL x 24DL x 58WR x 29DR	N.A.	40WL x 29DL x 58WR x 24DR	\$4962
	40WL x 23DL x 64WR x 29DR	N.A.	40WL x 29DL x 64WR x 23DR	\$5099
	40WL x 24DL x 64WR x 29DR	N.A.	40WL x 29DL x 64WR x 24DR	\$5099
	40WL x 23DL x 70WR x 29DR	N.A.	40WL x 29DL x 70WR x 23DR	\$5233
	40WL x 24DL x 70WR x 29DR	N.A.	40WL x 29DL x 70WR x 24DR	\$5233
	40WL x 23DL x 76WR x 29DR	N.A.	40WL x 29DL x 76WR x 23DR	\$5374
	40WL x 24DL x 76WR x 29DR	N.A.	40WL x 29DL x 76WR x 24DR	\$5374
	40WL x 23DL x 52WR x 30DR	N.A.	40WL x 30DL x 52WR x 23DR	\$4832
	40WL x 24DL x 52WR x 30DR	N.A.	40WL x 30DL x 52WR x 24DR	\$4832
	40WL x 23DL x 58WR x 30DR	N.A.	40WL x 30DL x 58WR x 23DR	\$4962
	40WL x 24DL x 58WR x 30DR	N.A.	40WL x 30DL x 58WR x 24DR	\$4962
	40WL x 23DL x 64WR x 30DR	N.A.	40WL x 30DL x 64WR x 23DR	\$5099
	40WL x 24DL x 64WR x 30DR	N.A.	40WL x 30DL x 64WR x 24DR	\$5099
	40WL x 23DL x 70WR x 30DR	N.A.	40WL x 30DL x 70WR x 23DR	\$5233
	40WL x 24DL x 70WR x 30DR	N.A.	40WL x 30DL x 70WR x 24DR	\$5233
	40WL x 23DL x 76WR x 30DR	N.A.	40WL x 30DL x 76WR x 23DR	\$5374
	40WL x 24DL x 76WR x 30DR	N.A.	40WL x 30DL x 76WR x 24DR	\$5374
	52WL x 29DL x 40WR x 23DR	N.A.	52WL x 23DL x 40WR x 29DR	\$4832
	52WL x 29DL x 40WR x 24DR	N.A.	52WL x 24DL x 40WR x 29DR	\$4832
	52WL x 30DL x 40WR x 23DR	N.A.	52WL x 23DL x 40WR x 30DR	\$4832
	52WL x 30DL x 40WR x 24DR	N.A.	52WL x 24DL x 40WR x 30DR	\$4832

Tip: When the 90° desk width is 40"-42" and 23"/24" deep on one end AND the opposite end is 29"/30" deep, product size limits apply. The width must be increased to 46"W or greater.

Tip: When specifying 3-leg 90° equal corners the smallest width available is 52" x 52", regardless of depth.

Tip: When specifying 3-leg 90° extended corners the smallest width available is 40" x 52", when 23"/24" deep is selected on both ends.

Tip: When specifying 3-leg 90° extended corners the smallest width available is 46" x 52", when 29"/30" deep is selected on both ends.



For Canadian Pricing

Multiply U.S. Price by the Canadian price factor.

► See page 1 for details.

• Style	• Desks Specified as	• Base Price	• Desks Specified as	• Base Price
90° Corner Base — Extended Height (Different Depth Opposite Ends 23"/24" Right/Left and 29"/30" Left/Right)				
OLELL3B	40WL x 23DL x 52WR x 29DR	N.A.	40WL x 29DL x 52WR x 23DR	\$3691
	40WL x 24DL x 52WR x 29DR	N.A.	40WL x 29DL x 52WR x 24DR	\$3691
	40WL x 23DL x 58WR x 29DR	N.A.	40WL x 29DL x 58WR x 23DR	\$3746
	40WL x 24DL x 58WR x 29DR	N.A.	40WL x 29DL x 58WR x 24DR	\$3746
	40WL x 23DL x 64WR x 29DR	N.A.	40WL x 29DL x 64WR x 23DR	\$3805
	40WL x 24DL x 64WR x 29DR	N.A.	40WL x 29DL x 64WR x 24DR	\$3805
	40WL x 23DL x 70WR x 29DR	N.A.	40WL x 29DL x 70WR x 23DR	\$3861
	40WL x 24DL x 70WR x 29DR	N.A.	40WL x 29DL x 70WR x 24DR	\$3861
	40WL x 23DL x 76WR x 29DR	N.A.	40WL x 29DL x 76WR x 23DR	\$3917
	40WL x 24DL x 76WR x 29DR	N.A.	40WL x 29DL x 76WR x 24DR	\$3917
	40WL x 23DL x 52WR x 30DR	N.A.	40WL x 30DL x 52WR x 23DR	\$3691
	40WL x 24DL x 52WR x 30DR	N.A.	40WL x 30DL x 52WR x 24DR	\$3691
	40WL x 23DL x 58WR x 30DR	N.A.	40WL x 30DL x 58WR x 23DR	\$3746
	40WL x 24DL x 58WR x 30DR	N.A.	40WL x 30DL x 58WR x 24DR	\$3746
	40WL x 23DL x 64WR x 30DR	N.A.	40WL x 30DL x 64WR x 23DR	\$3805
	40WL x 24DL x 64WR x 30DR	N.A.	40WL x 30DL x 64WR x 24DR	\$3805
	40WL x 23DL x 70WR x 30DR	N.A.	40WL x 30DL x 70WR x 23DR	\$3861
	40WL x 24DL x 70WR x 30DR	N.A.	40WL x 30DL x 70WR x 24DR	\$3861
	40WL x 23DL x 76WR x 30DR	N.A.	40WL x 30DL x 76WR x 23DR	\$3917
	40WL x 24DL x 76WR x 30DR	N.A.	40WL x 30DL x 76WR x 24DR	\$3917
	52WL x 29DL x 40WR x 23DR	N.A.	52WL x 23DL x 40WR x 29DR	\$3691
	52WL x 29DL x 40WR x 24DR	N.A.	52WL x 24DL x 40WR x 29DR	\$3691
	52WL x 30DL x 40WR x 23DR	N.A.	52WL x 23DL x 40WR x 30DR	\$3691
	52WL x 30DL x 40WR x 24DR	N.A.	52WL x 24DL x 40WR x 30DR	\$3691

Tip: When the 90° desk width is 40"-42" and 23"/24" deep on one end AND the opposite end is 29"/30" deep, product size limits apply. The width must be increased to 46"W or greater.

Tip: When specifying 3-leg 90° equal corners the smallest width available is 52" x 52", regardless of depth.

Tip: When specifying 3-leg 90° extended corners the smallest width available is 40" x 52", when 23"/24" deep is selected on both ends.

Tip: When specifying 3-leg 90° extended corners the smallest width available is 46" x 52", when 29"/30" deep is selected on both ends.

For Canadian Pricing
 Multiply U.S. Price by the
 Canadian price factor.
 ▶ See page 1 for details.

Style	Desks Specified as	Base Price	Desks Specified as	Base Price
-------	--------------------	------------	--------------------	------------

90° Corner Base — Basic Height (Different Depth Opposite Ends 23"/24" Right/Left and 29"/30" Left/Right)

OLSL3B	40WL x 23DL x 52WR x 29DR	N.A.	40WL x 29DL x 52WR x 23DR	\$3399
	40WL x 24DL x 52WR x 29DR	N.A.	40WL x 29DL x 52WR x 24DR	\$3399
	40WL x 23DL x 58WR x 29DR	N.A.	40WL x 29DL x 58WR x 23DR	\$3453
	40WL x 24DL x 58WR x 29DR	N.A.	40WL x 29DL x 58WR x 24DR	\$3453
	40WL x 23DL x 64WR x 29DR	N.A.	40WL x 29DL x 64WR x 23DR	\$3503
	40WL x 24DL x 64WR x 29DR	N.A.	40WL x 29DL x 64WR x 24DR	\$3503
	40WL x 23DL x 70WR x 29DR	N.A.	40WL x 29DL x 70WR x 23DR	\$3557
	40WL x 24DL x 70WR x 29DR	N.A.	40WL x 29DL x 70WR x 24DR	\$3557
	40WL x 23DL x 76WR x 29DR	N.A.	40WL x 29DL x 76WR x 23DR	\$3608
	40WL x 24DL x 76WR x 29DR	N.A.	40WL x 29DL x 76WR x 24DR	\$3608
	40WL x 23DL x 52WR x 30DR	N.A.	40WL x 30DL x 52WR x 23DR	\$3399
	40WL x 24DL x 52WR x 30DR	N.A.	40WL x 30DL x 52WR x 24DR	\$3399
	40WL x 23DL x 58WR x 30DR	N.A.	40WL x 30DL x 58WR x 23DR	\$3453
	40WL x 24DL x 58WR x 30DR	N.A.	40WL x 30DL x 58WR x 24DR	\$3453
	40WL x 23DL x 64WR x 30DR	N.A.	40WL x 30DL x 64WR x 23DR	\$3503
	40WL x 24DL x 64WR x 30DR	N.A.	40WL x 30DL x 64WR x 24DR	\$3503
	40WL x 23DL x 70WR x 30DR	N.A.	40WL x 30DL x 70WR x 23DR	\$3557
	40WL x 24DL x 70WR x 30DR	N.A.	40WL x 30DL x 70WR x 24DR	\$3557
	40WL x 23DL x 76WR x 30DR	N.A.	40WL x 30DL x 76WR x 23DR	\$3608
	40WL x 24DL x 76WR x 30DR	N.A.	40WL x 30DL x 76WR x 24DR	\$3608
	52WL x 29DL x 40WR x 23DR	N.A.	52WL x 23DL x 40WR x 29DR	\$3399
	52WL x 29DL x 40WR x 24DR	N.A.	52WL x 24DL x 40WR x 29DR	\$3399
	52WL x 30DL x 40WR x 23DR	N.A.	52WL x 23DL x 40WR x 30DR	\$3399
	52WL x 30DL x 40WR x 24DR	N.A.	52WL x 24DL x 40WR x 30DR	\$3399

Tip: When the 90° desk width is 40"-42" and 23"/24" deep on one end AND the opposite end is 29"/30" deep, product size limits apply. The width must be increased to 46"W or greater.

Tip: When specifying 3-leg 90° equal corners the smallest width available is 52" x 52", regardless of depth.

Tip: When specifying 3-leg 90° extended corners the smallest width available is 40" x 52", when 23"/24" deep is selected on both ends.

Tip: When specifying 3-leg 90° extended corners the smallest width available is 46" x 52", when 29"/30" deep is selected on both ends.



For Canadian Pricing

Multiply U.S. Price by the Canadian price factor.

► See page 1 for details.

Ology Options Availability Chart

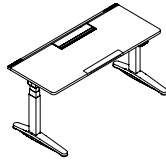
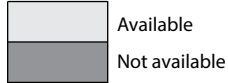

	Rectangular							
	34"W	40"W	46"W	52"W	58"W	64"W	70"W	76"W
Grommet	Available	Available	Available	Available	Available	Available	Available	Available
Integrated Rail	Available	Available	Available	Available	Available	Available	Available	Available
Overhang	Not available	Not available	Not available	Not available	Not available	Left or Right	Left or Right or Left and Right	Left or Right or Left and Right
Overhang + Power Door	Not available	Not available	Not available	Not available	Not available	Center	Center	Center
Overhang + Soft Edge	Not available	Not available	Not available	Not available	Not available	Center	Left or Right	Left or Right
Power Door	Not available	Available	Available	Available	Available	Left, Right, or Center	Left, Right, or Center	Left, Right, or Center
Soft Edge	Not available	Not available	Not available	Not available	Available	Left, Right, or Center	Left, Right, or Center	Left, Right, or Center

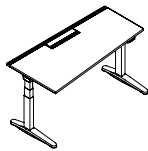

	Tapered			
	58"W	64"W	70"W	76"W
Grommet	Available	Available	Available	Available
Integrated Rail	Available	Available	Available	Available
Power Door	Available	Left, Right or Center	Left, Right or Center	Left, Right or Center
Soft Edge	Available	Left, Right or Center	Left, Right or Center	Left, Right or Center

Tip: When integrated storage is present, power door and soft edge can be positioned left or right on desks that are 64"W or wider. Position must shift away from the storage.

Tip: Overhang can be positioned left or right on desks that are 70" wide or wider when used with integrated storage.

Tip: Overhang not available on 35"D or 36"D.

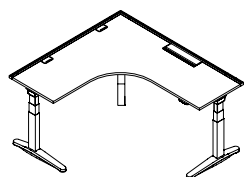
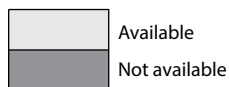

	90°						
	40"W	46"W	52"W	58"W	64"W	70"W	76"W
Grommet	Available	Available	Available	Available	Available	Available	Available
Integrated Rail	Available	Available	Available	Available	Available	Available	Available
Overhang	Not available	Not available	Not available	Not available	Not available	Not available	Not available
Power Door	Not available	Not available	Not available	One or Both Sides	One or Both Sides	One or Both Sides	One or Both Sides
Soft Edge	Not available	Not available	Not available	Not available	Not available	Not available	Not available

Tip: Integrated storage can be used on 90° Ology desks that are 70" wide or wider.

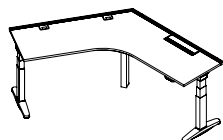

	120°					
	34"W	40"W	46"W	52"W	58"W	64"W
Grommet	Available	Available	Available	Available	Available	Available
Integrated Rail	Available	Available	Available	Available	Available	Available
Power Door	Not available	Not available	Not available	One or Both Sides	One or Both Sides	One or Both Sides
Soft Edge	Not available	Not available	Not available	Not available	Not available	Not available

Tip: Integrated storage can be used on 120° Ology desks that are 52" wide or wider.

Ology Modesty Panels

Modesty panels provide modesty when needed. Modesty panels, available in laminate and veneer, connect to the desk frame.

► Specifying, page 110

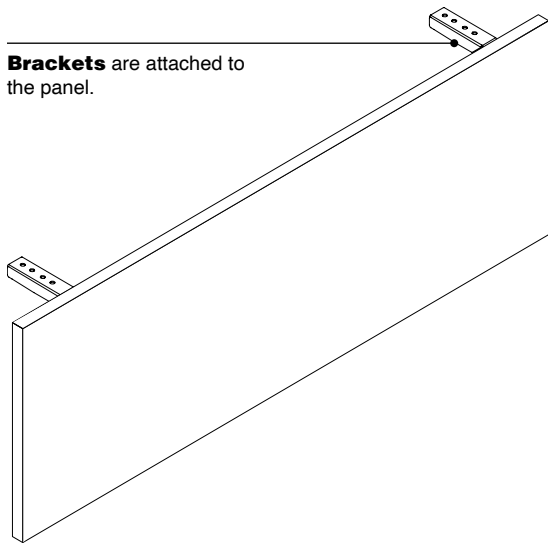

Brackets are attached to the panel.

Product Details

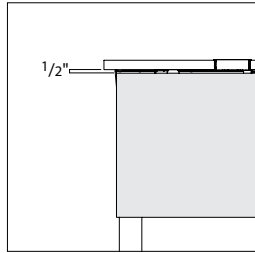

Gap is 1/2" between underside of the worksurface and top of modesty panel. Panel can be flush to the worksurface or inset.

Modesty panels are undersized 2 1/2" to account for desks with radius corners.

C-clamp mounting is not allowed with flush mount. C-clamp mount when panel is inset.

Modesty panels are defaulted in the horizontal grain direction for both laminate and wood veneer. Optional vertical grain direction can be specified, however, laminate specification is only allowed up to 60" wide.

Surface Materials

High-Pressure Laminate Panel

- Laminate
- See *Surface Materials Reference Manual*.
- Open Line laminate (option)
- A program including non-Steelcase laminates which are suitable for use on Steelcase products.
- See *Surface Materials Reference Manual*.

3 mm edge profile

- Plastic

Wood veneer panel

- Wood veneer (standard)
- Customiz stain (option)
- Full-Fill Finish (option)

Square 3 mm edge profile

- Wood veneer to match panel

Bracket

- 7360 Merle

Application Topics

Modesty panels are parametric in width from 34"W to 78"W in 1/16" increments. Modesty panel can be equal to the width of the desk or shorter.

Tip: When using a modesty panel on straight and taper parametric sized desks, modesty panel width must be verified in CET to avoid interference.

When used with integrated storage, modesty panel must be a minimum of 20" shorter than worksurface width to allow for pinch point clearances.

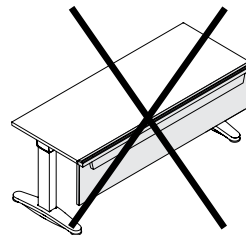

Full width modesty panels cannot be used on desks with integrated rail.

Tip: To use with the integrated rail, the modesty panel must be undersized by a minimum of 12" (rectangular and tapered) or 21" smaller (90°) and 16" smaller (120°) than the width of the desk understructure.

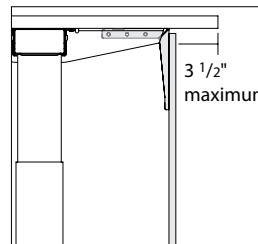

Modesty panels may be inset a maximum of 3 1/2" from the back of the worksurface to allow for c-clamping.

Tip: Inset modesty panels do not work with the power access door option or the cable basket and cable brackets.

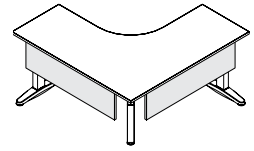

In order to inset, modesty panels must be specified a minimum of 12" smaller (rectangular and tapered) or 7 3/4" smaller (90°) and 7" smaller (120°) than the width of the desk understructure. Utilize the mounting plates and screws to attach the modesty panel to the underside of the worksurface instead of to the cantilevers.

Tip: Inset modesty panels do not work with the power access door option or the cable basket and cable brackets.

Universal or Sarto privacy/modesty screens cannot be used with Ology modesty panels.

When using a modesty panel with Universal or Sarto privacy screens, verify placement in CET to avoid interference.

Actual Dimensions

Modular Modesty Panels	
Width	31 1/2", 37 1/2", 43 1/2", 49 1/2", 54 1/2", 61 1/2", 67 1/2", or 73 1/2"
Height	14 3/8"
Overall height	14 7/8"
Thickness	3/4"

Tip: Overall height is measured from bottom of mounting surface to the bottom of the screen.

Tip: Parametric modesty panel widths can be specified from 34"–78"W in 1/16" increments.

Universal Steel One-High and 1.5-High Open Laterals

For Ology Application

Universal One-High and 1.5-High open laterals for Ology application seamlessly integrates the Ology desk leg into universal storage. It provides a clean aesthetic with an efficient footprint. Ease of access to your items under the desk is convenient with this open storage configuration.

► Specifying, page 114

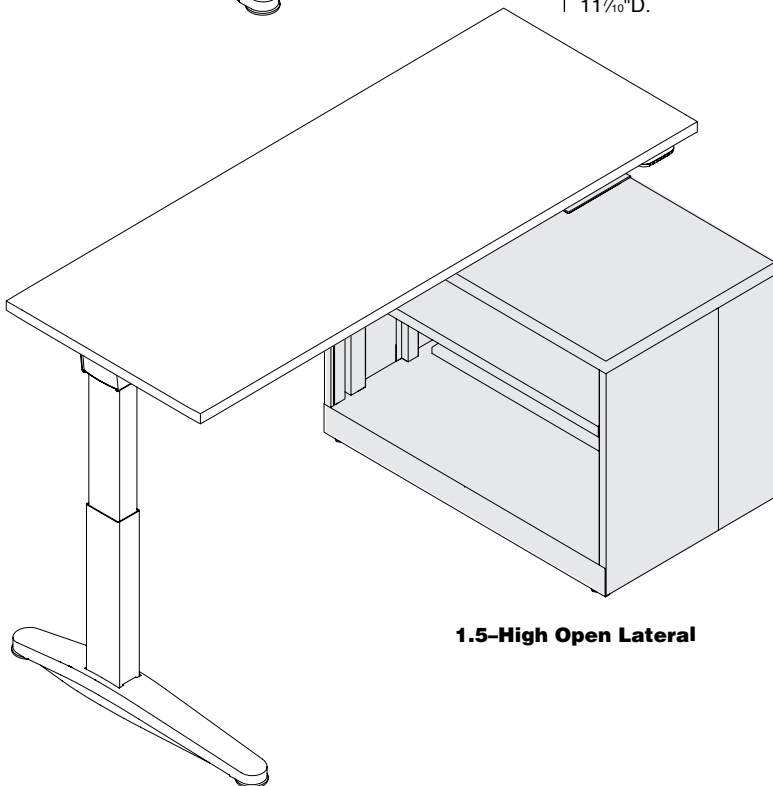
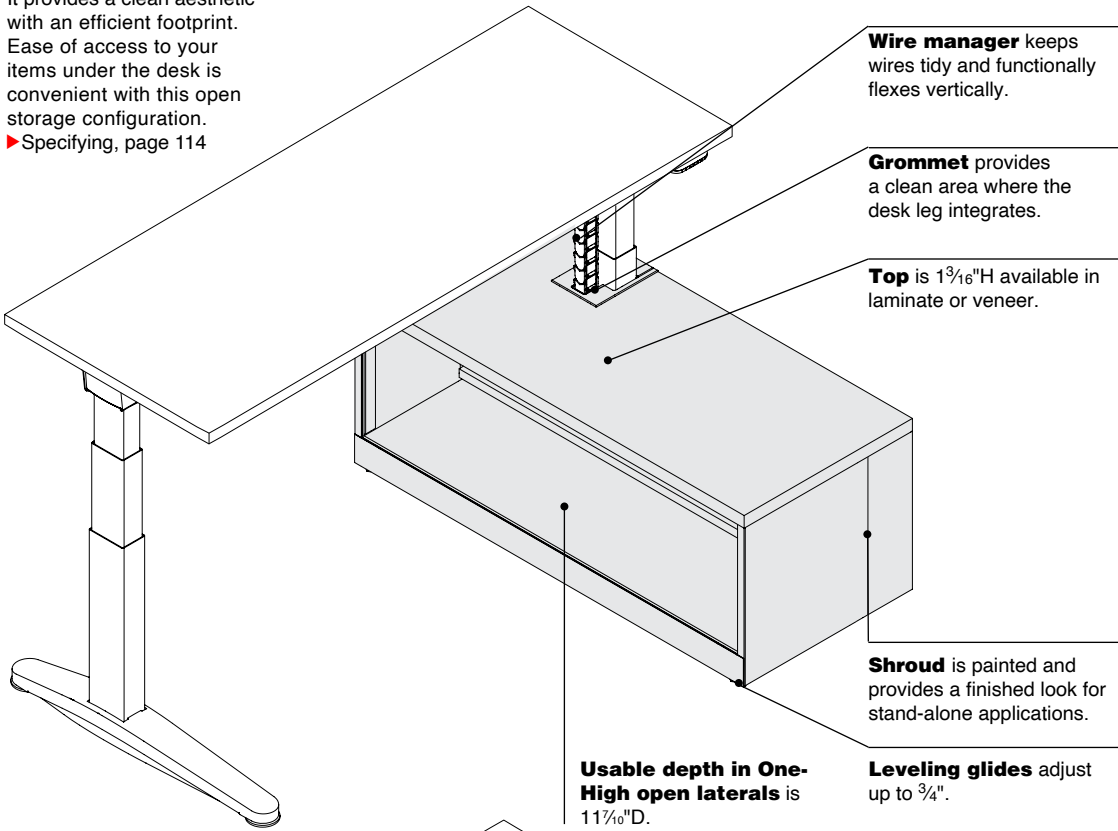

Product Details

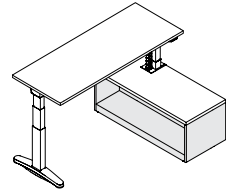

One-High storage can be used with Ology extended range desks or basic range desks.

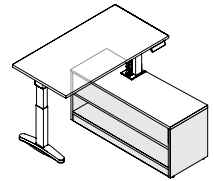

1.5-High storage can only be used with Ology basic range desks.

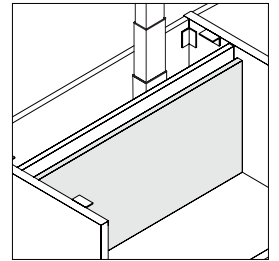

One-High and 1.5-High storage for Ology application have a removeable interior back panel to allow access to the Ology base.

Ology desk with integrated storage must be specified with modular widths only. When opting for parametric widths, integrated storage is not available.

Actual Dimensions

	One-High	1.5-High
Depth with flush steel open front	18"	18"
Depth with proud steel open front	18 ⁷ / ₈ "	18 ⁷ / ₈ "
Usable depth	11 ⁷ / ₁₆ "	11 ⁷ / ₁₆ "
Width	30", 36", and 42"	30", 36", and 42"
Height	16"	22"

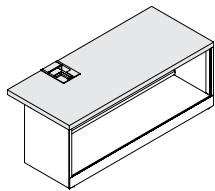

Laminate and wood veneer tops with square edge profile are available. Tops are 1³/₁₆"H.

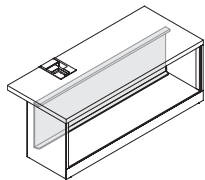

Removable interior cover provides access to power outlets that can be located in the panel behind storage unit.

Case Widths and Ology Foot Dimensions

30"W Ology open laterals can house Ology legs of 24" or 30" in length. 36"W and 42"W units can house Ology legs with feet of 24", 30", or 36" in length.

Integrated leg options apply to One-High and 1.5-High units only and are meant for use with Ology height-adjustable desks only.

Application Topics

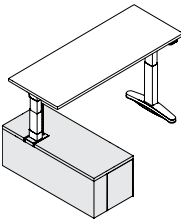

Application: Ology left

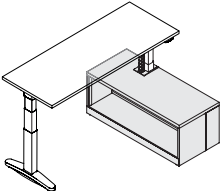

Application: Ology right

Application is determined by which leg of the Ology desk is located inside the storage.

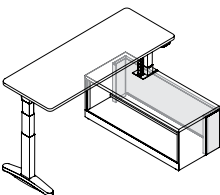

Shroud is used to finish off the back of the storage when application is used as stand-alone unit.

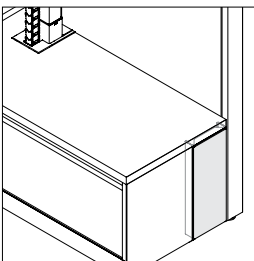

Filler is used in end-of-run applications where end of storage unit will be visible.

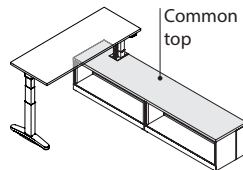

No top option on lateral file is available for use with a Universal common top shared with an adjacent lateral.

Universal common top for Ology application, ordered separately, is available in laminate or veneer. Cut-out for Ology leg is available on the left side or the right side of the Universal common top. Ology desk cannot be placed in the middle of the Universal common top.

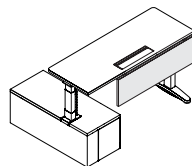

Ology modesty panel or fixed personal/modesty screens must be undersized and justified to the outside when used with One-High and 1.5-High storage units. Only one open lateral file is permitted on Ology 90° corner desks.

When used with One-High and 1.5-High integrated storage, screens used in the modesty position must be a minimum of 18" shorter than worksurface width to allow for pinch point clearances.

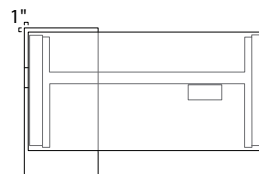

To help avoid pinch points, the Universal One-High and 1.5-High open laterals for Ology application extends 1" past the back of the Ology worksurface.

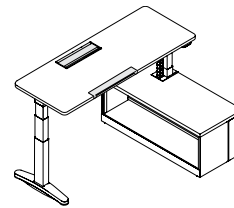

Soft edge and power and data access door can be positioned left or right on Ology desks that are 64"W or wider for use with One-High and 1.5-High integrated storage.

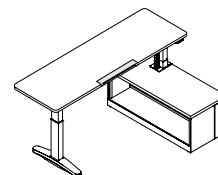

Work surface overhang can be positioned left or right on desks that are 70" wide or wider.

Tip: Overhang not available on 35"D or 36"D.

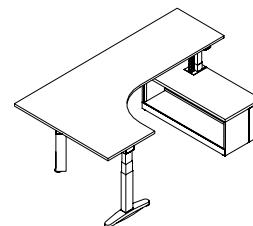

Ology 90° corners that are 70" wide and wider can be used with One-High and 1.5-High storage units.

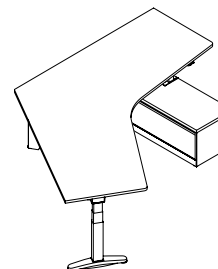

Ology 120° corners that are 52" wide and wider can be used with One-High and 1.5-High storage units. Only one open lateral file is permitted on Ology 120° corner desks.

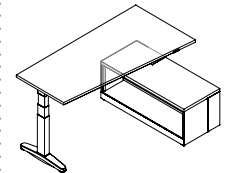

Tapered desks that are 70" wide and wider can be used with One-High and 1.5-High storage units.

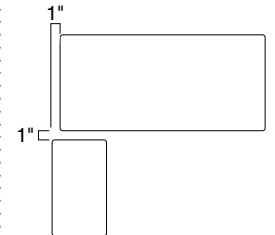

When specifying One-High and 1.5 High storage that matches the worksurface depth, only One-High storage should be placed adjacent to the desk.

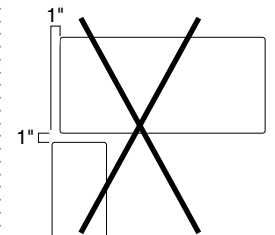

Pinch point clearances are not maintained when 1.5-High or taller storage is used adjacent to One-High integrated storage that matches the worksurface depth.

Surface Materials

Lateral case

- Paint

Laminate top

- Laminate
- Open Line laminate (option)

Edge on laminate top

- Plastic

Wood veneer top

- Wood veneer—open pore finishes
- Full-fill (option) is available on wood veneer tops only.

Shroud and filler

- Paint

Elective Elements One-High Open Plinth Base Pedestals and Common Tops

For Ology Application

One-High open plinth base pedestal and common top for Ology application seamlessly integrate the Ology desk into Elective Elements. They provide a clean aesthetic with an efficient footprint. Ease of access to your items under the desk is convenient with this open storage configuration.

► Specifying, pages 120 and 122.

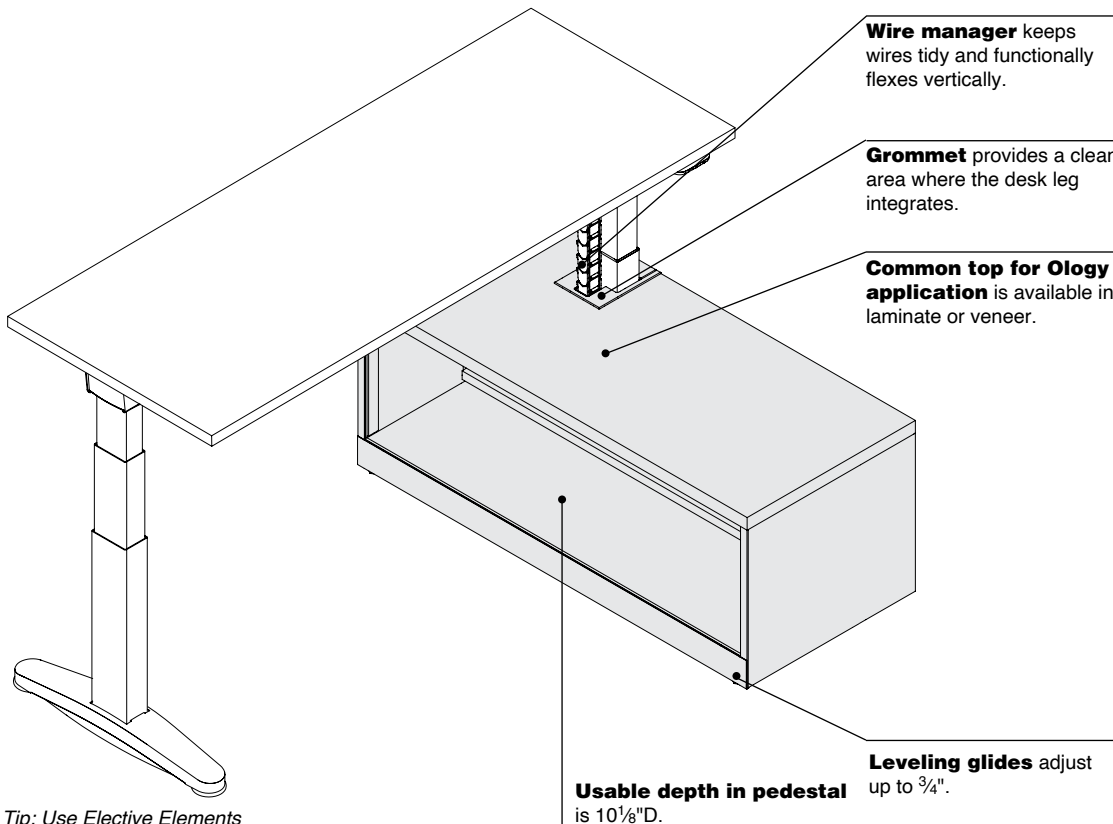

Tip: Use Elective Elements common tops with Ology base to create an Elective Elements height adjustable desk.

Actual Dimensions

One-High Open Plinth Base Pedestal

Depth	17¼"
Width	24", 30", 36", and 42"
Height	15½"

Common Top

Depth	18"
Width	24", 30", 36", 42", 48", 54", 60", 66", 72", 78", 84", 90", 96", 102", 108", 114", and 120"
Height	N.A.

Product Details

Pedestal Base

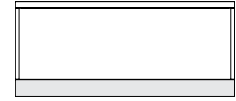

3" Base

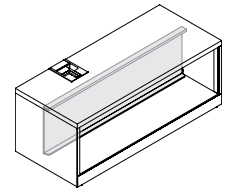

Removable interior cover provides access to power outlets that can be located in the panel behind storage unit.

Base widths and Ology foot:

- 24"W Ology base units can house Ology legs 24" in length.
- 30"W Ology base units can house Ology legs of 24" or 30" in length.
- 36"W and 42"W units can house Ology legs of 24", 30", or 36" in length.

Ology desk with integrated storage must be specified with modular widths only. When opting for parametric widths, integrated storage is not available.

Surface Materials

Pedestal case

- Veneer
- Laminate

Laminate top on pedestal and common top

- Laminate
- Open Line laminate (option)

Edges on pedestal and common top

- Wood veneer
- Plastic

Wood veneer top on pedestal and common top

- Wood veneer—open pore finishes
- Full-fill (option) is available on wood veneer tops only.

Application Topics

Storage

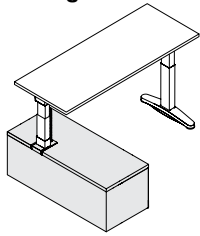

Application: Ology left

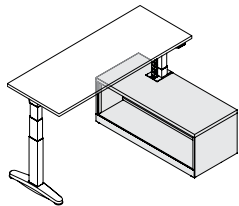

Application: Ology right

Application is determined by which leg of the Ology base is located inside the pedestal.

Common tops for Ology application can be used with two units side-by-side when one storage unit is required for Ology leg integration.

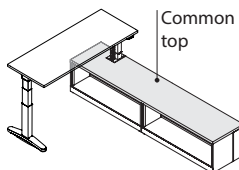

Common top for Ology application, ordered separately, is available in laminate or veneer. Cut-out for Ology leg is available on the left side or the right side of the common top. Ology desk cannot be placed in the middle of the common top.

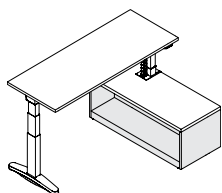

Common tops for Ology application are available when ganging Ology base units to other Elective Elements pedestals of the same height.

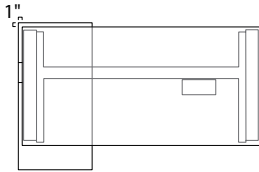

To help avoid pinch points, the pedestal for Ology application extends 1" past the back of the common top.

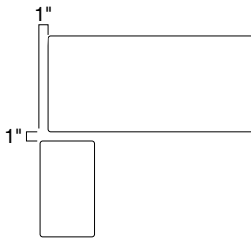

When specifying One-High storage that matches the worksurface depth, only One-High storage should be placed adjacent to the desk.

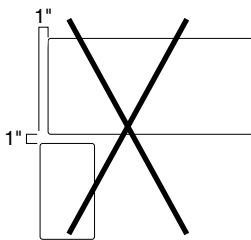

Pinch point clearances are not maintained when 1.5-High or taller storage is used adjacent to One-High integrated storage that matches the worksurface depth.

Desk

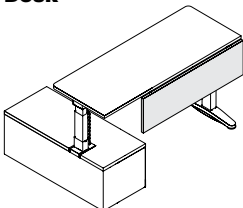

Modesty panel or fixed personal/modesty screens must be undersized and justified to the outside of the common top when used with pedestal.

When used with One-High integrated storage, screens used in the modesty position must be a minimum of 18" shorter than worksurface width to allow for pinch point clearances.

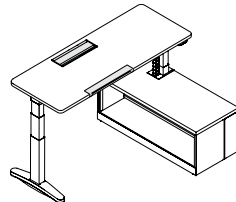

Soft edge and power and data access door can be positioned left or right on Ology desks that are 64"W or wider for use with One-High integrated storage.

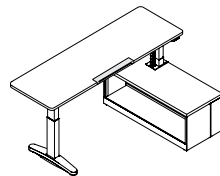

Worksurface overhang can be positioned left or right on desks that are 70" wide or wider.
Tip: Overhang not available on 35"D or 36"D.

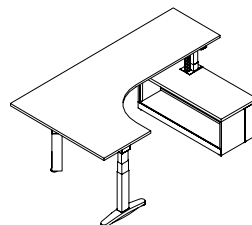

Ology 90° corners that are 70" wide and wider can be used with One-High storage unit.

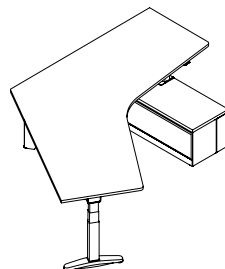

Ology 120° corners that are 52" wide and wider can be used with One-High storage unit.

Ology Height-Adjustable Rectangular Desks

High-Pressure Laminate or Wood Veneer

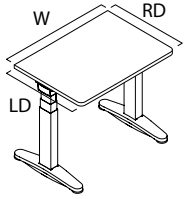

Tip: On extended height desks, any storage higher than 19", or 16½" if the power access door is optioned, will impede lowest height range of worksurface. On basic height desks, any storage higher than 23⅞", or 21⅞" if the power access door is optioned, will impede lowest height range of worksurface. Do not place storage underneath controller.

Tip: On 23⅞"D and less than 58"W desks, only single and dual flat panel monitor arm applications are permitted for use.

▶ See page 43 for *Steelcase Monitor Arm Guidelines*.

Tip: For desks 29⅞"Dx58"W and greater additional monitor arm configurations are allowed.

▶ See page 43, *Steelcase Monitor Arm Guidelines*.

Tip: Base supports a maximum distributed weight capacity of 360 pounds (2-leg) and 500 pounds (3-leg).

When calculating lifting capacity, subtract the weight of the worksurface, understructure, and options selected.

Tip: 2-leg desks that have an overhang, or are 35"D or 36"D will have a distributed weight capacity of 300 pounds (136.1 kg).

▶ See page 52 for *worksurface weights*.

Tip: Antimicrobial additives can be specified only when specifying simple touch controller and/or soft edge.

For laminate group 2 and 3 pricing, please refer to the electronic catalog or SmartTools.

Standard Includes		Required to Specify
▶ Need help? Product details, page 46	<ul style="list-style-type: none"> • Worksurface: High-Pressure Laminate price group 1 with 3 mm plastic edge or wood group 1 veneer • Electric height-adjustable sit-to-stand base: paint • Active touch controller • Modular widths: 34"–76" • ½" adjustable glides • Power cord: 10½' • Attachment hardware 	<ol style="list-style-type: none"> 1 Style number 2 Desk depth 3 Desk width 4 High-Pressure Laminate or wood color for worksurface 5 Plastic color number for profile edge on laminate worksurface, if selected 6 Desk corner style, if laminate desk selected (see below under Required Selections) 7 Paint color number for base: <ul style="list-style-type: none"> 4799 Platinum Metallic 7207 Black 7241 Arctic White 7360 Merle 8 Integrated rail (see below under Required Selections) 9 Antimicrobial or non-antimicrobial components, if simple touch controller selected (see below under Required Selections) 10 Options, if selected (see below) <p>▶ See <i>Surface Materials</i>, page 274</p>

Required Selections	U.S. Price	Required to Specify
Desk Corner Style (Laminate Desks Only)	<ul style="list-style-type: none"> • Square corners No cost • Radius corners +\$ 93 	Specify <i>with square corners</i> . Specify <i>with radius corners</i> .
Integrated Rail	<ul style="list-style-type: none"> • Without integrated rail No cost • With integrated rail +\$448 	Specify <i>without integrated rail</i> . Specify <i>with integrated rail</i> .
Antimicrobial Components	<ul style="list-style-type: none"> • Non-antimicrobial components No cost • Antimicrobial components No cost 	Specify <i>with non-antimicrobial components</i> . Specify <i>with antimicrobial components</i> .

Options	U.S. Price	Required to Specify
Surface Materials	<p>High-Pressure Laminate desks</p> <ul style="list-style-type: none"> • Laminate price group 2 See information at left • Laminate price group 3 See information at left • Open Line laminate +\$102 plus cost of laminate <p>Wood veneer desks</p> <ul style="list-style-type: none"> • Wood group 2 +\$102 • Wood group 3 +\$359 • Customiz stain No cost • Full-fill finish on wood group 1 +\$102 <p>Base</p> <ul style="list-style-type: none"> • Paint price group 1 No cost • Paint price group 2 +\$ 44 	Specify laminate color number. Specify laminate color number. ▶ See <i>Surface Materials Reference Manual</i> . Specify wood color number. Specify wood color number. Specify <i>with customiz stain</i> . ▶ See <i>Surface Materials Reference Manual</i> . Specify full-fill finish number. Specify paint color number. Specify paint color number. ▶ See <i>Surface Materials</i> , page 274.
Desk Type	<ul style="list-style-type: none"> • Parametric width desk No cost 	Specify <i>with parametric desk type</i> .

▶ Options, continued on next page

► **Options, continued from previous page**

	Options	U.S. Price	Required to Specify
Overhang	• Desk overhang on left	No cost	Specify <i>with desk overhang left</i> .
	• Desk overhang on right	No cost	Specify <i>with desk overhang right</i> .
	• Desk overhang left and right	No cost	Specify <i>with desk overhang left and right</i> .
Controller	• Simple touch controller	–\$ 74	Specify <i>with simple touch controller</i> .
	• 4 Pre-set controller	+\$ 173	Specify <i>with 4 pre-set controller</i> .
Soft Edge	• With soft edge	+\$ 328	Specify <i>with soft edge</i> .
Power and Data Access Door, Tray and USB	• Power and data access door, tray and USB: paint group 1 or 2	+\$1124	Specify <i>with power and data access door</i> and select paint color number.
	• Power and data access door, tray and USB: anodized aluminum	+\$1140	Specify <i>with power and data access door</i> and select anodized aluminum.
Power and Data Access Door and Soft Edge Position	• Centered	No cost	Specify <i>with centered position</i> .
	• Left	No cost	Specify <i>with left position</i> .
	• Right	No cost	Specify <i>with right position</i> .
Grommet	• Grommet	+\$ 61	Specify <i>with grommet</i> .
Glides	• 1" adjustable glides	+\$ 46	Specify <i>with 1" glides</i> .
CarbonNeutral Product	CarbonNeutral product certification	+\$ 45	Add suffix CN to the end of the style number.
Related Products	• Modesty panels		► Page 110
	• Fixed personal/modesty screens		► Page 254
	• Cable and power management		► Page 111

► **Specification Information, on next page**

Tip: Overhang not available on 35"D or 36"D.

Tip: 9" overhang is available on desks 64"W and larger. Overhang on both sides is available on 70"W and larger.

Tip: The standard active touch controller is Bluetooth-enabled to allow pairing with the Steelcase Rise app.

Tip: Soft edge is available on desks 58"W and larger. If overhang left or overhang right is selected, soft edge is available on desks 70"W or 76"W. Soft edge cannot be specified on desks that have overhang on both sides.

Tip: Power and data access door is available on desks 40"W or greater.

Tip: Power access door and soft edge can be positioned left or right on desks that are 64"W or wider for use with One-High integrated storage.

Tip: Rectangular desks accommodate either power and data access door or grommet, but not both.



For Canadian Pricing

Multiply U.S. Price by the Canadian price factor.

► See page 1 for details.

Ology Height-Adjustable Rectangular Desks, High-Pressure Laminate or Wood Veneer, continued

► Options, on previous page

Specification Information

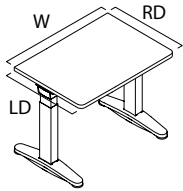

U.S. Base Prices

Style Number	Dimensions D	Desk Type	U.S. Base Prices							
			34"W	40"W	46"W	52"W	58"W	64"W	70"W	76"W
		Modular	34"W	40"W	46"W	52"W	58"W	64"W	70"W	76"W
		Parametric	34"W	36 ¹ / ₁₆ "W	42 ¹ / ₁₆ "W	48 ¹ / ₁₆ "W	54 ¹ / ₁₆ "W	60 ¹ / ₁₆ "W	66 ¹ / ₁₆ "W	72 ¹ / ₁₆ "W
			-36"W	-42"W	-48"W	-54"W	-60"W	-66"W	-72"W	-78"W

High-Pressure Laminate Desks — Extended Height

OLELRQ	23" or 24"	29" or 30"	35" or 36"	34"W	40"W	46"W	52"W	58"W	64"W	70"W	76"W
				\$2452	\$2529	\$2604	\$2683	\$2765	\$2852	\$2935	\$3024
				\$2750	\$2834	\$2920	\$3010	\$3102	\$3196	\$3292	\$3392
				\$3050	\$3142	\$3238	\$3336	\$3441	\$3541	\$3650	\$3765

Wood Veneer Desks — Extended Height

OLELRQ	23" or 24"	29" or 30"	35" or 36"	34"W	40"W	46"W	52"W	58"W	64"W	70"W	76"W
				\$3236	\$3327	\$3411	\$3503	\$3598	\$3700	\$3793	\$3899
				\$3566	\$3665	\$3763	\$3865	\$3967	\$4079	\$4183	\$4300
				\$3898	\$4002	\$4114	\$4224	\$4340	\$4458	\$4575	\$4703

High-Pressure Laminate Desks — Basic Height

OLSLRQ	23" or 24"	29" or 30"	35" or 36"	34"W	40"W	46"W	52"W	58"W	64"W	70"W	76"W
				\$2263	\$2331	\$2400	\$2474	\$2548	\$2629	\$2709	\$2789
				\$2536	\$2616	\$2691	\$2777	\$2859	\$2946	\$3037	\$3128
				\$2812	\$2898	\$2985	\$3076	\$3172	\$3263	\$3365	\$3469

Wood Veneer Desks — Basic Height

OLSLRQ	23" or 24"	29" or 30"	35" or 36"	34"W	40"W	46"W	52"W	58"W	64"W	70"W	76"W
				\$3047	\$3129	\$3207	\$3294	\$3381	\$3477	\$3567	\$3664
				\$3352	\$3447	\$3534	\$3632	\$3724	\$3829	\$3928	\$4036
				\$3660	\$3758	\$3861	\$3964	\$4071	\$4180	\$4290	\$4407



For Canadian Pricing

Multiply U.S. Price by the Canadian price factor.

► See page 1 for details.



Ology Height-Adjustable Tapered Desks

High-Pressure Laminate or Wood Veneer

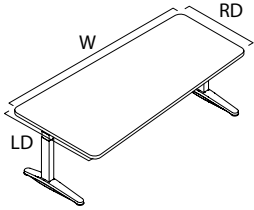

Tip: On extended height desks, any storage higher than 19", or 16 1/2" if the power access door is optioned, will impede lowest height range of worksurface. On basic height desks, any storage higher than 23 7/10", or 21 1/5" if the power access door is optioned, will impede lowest height range of worksurface. Do not place storage underneath controller.

Tip: On 23"/24"D and less than 58"W desks, only single and dual flat panel monitor arm applications are permitted for use.

▶ See *Steelcase Worktools Specification Guide*.

Tip: For desks 29"/30"Dx58"W and greater additional monitor arm configurations are allowed.

▶ See page 43, *Steelcase Monitor Arm Guidelines*.

Tip: Base supports a maximum distributed weight capacity of 360 pounds (2-leg) and 500 pounds (3-leg). When calculating lifting capacity, subtract the weight of the worksurface, understructure, and options selected.

Tip: 2-leg desks that have an overhang, or are 35"D or 36"D will have a distributed weight capacity of 300 pounds (136.1 kg).

▶ See page 52 for *worksurface weights*.

Tip: Antimicrobial additives can be specified only when specifying simple touch controller and/or soft edge.

For laminate group 2 and 3 pricing, please refer to the electronic catalog or SmartTools.

Tip: Soft edge is available on desks 58"W and larger.

Tip: Power access door and soft edge can be positioned left or right on desks that are 64"W or wider for use with One-High integrated storage.

Standard Includes		Required to Specify
▶ Need help? Product details, page 46	<ul style="list-style-type: none"> • Worksurface: High-Pressure Laminate price group 1 with 3 mm plastic edge or wood group 1 veneer • Electric height-adjustable sit-to-stand base: paint • Active touch controller • Modular widths: 58"–76" • 1/2" adjustable glides • Power cord: 10 1/2' • Attachment hardware 	<ol style="list-style-type: none"> 1 Style number 2 Desk depth 3 Desk width 4 High-Pressure Laminate or wood color for worksurface 5 Plastic color number for profile edge on laminate worksurface, if selected 6 Desk corner style, if laminate desk selected (see below under Required Selections) 7 Paint color number for base 4799 Platinum Metallic 7207 Black 7241 Arctic White 7360 Merle 8 Integrated rail (see below under Required Selections) 9 Antimicrobial or non-antimicrobial components, if simple touch controller selected (see below under Required Selections) 10 Options, if selected (see below) <p>▶ See <i>Surface Materials</i>, page 274</p>

Required Selections	U.S. Price	Required to Specify
Desk Corner Style (Laminate Desks Only)	<ul style="list-style-type: none"> • Square corners No cost • Radius corners +\$ 93 	Specify <i>with square corners</i> . Specify <i>with radius corners</i> .
Integrated Rail	<ul style="list-style-type: none"> • Without integrated rail No cost • With integrated rail +\$ 448 	Specify <i>without integrated rail</i> . Specify <i>with integrated rail</i> .
Antimicrobial Components	<ul style="list-style-type: none"> • Non-antimicrobial components No cost • Antimicrobial components No cost 	Specify <i>with non-antimicrobial components</i> . Specify <i>with antimicrobial components</i> .

Options	U.S. Price	Required to Specify
Surface Materials	<p>High-Pressure Laminate desks</p> <ul style="list-style-type: none"> • Laminate price group 2 See information at left • Laminate price group 3 See information at left • Open Line laminate +\$ 102 plus cost of laminate <p>Wood veneer desks</p> <ul style="list-style-type: none"> • Wood group 2 +\$ 102 • Wood group 3 +\$ 359 • Customiz stain No cost • Full-fill finish on wood group 1 +\$ 102 <p>Base</p> <ul style="list-style-type: none"> • Paint price group 1 No cost • Paint price group 2 +\$ 44 	Specify laminate color number. Specify laminate color number. ▶ See <i>Surface Materials Reference Manual</i> . Specify wood color number. Specify wood color number. Specify <i>with customiz stain</i> . ▶ See <i>Surface Materials Reference Manual</i> . Specify full-fill finish number. Specify paint color number. Specify paint color number. ▶ See <i>Surface Materials</i> , page 274.
Desk Type	<ul style="list-style-type: none"> • Parametric width desk No cost 	Specify <i>with parametric desk type</i> .
Soft Edge	<ul style="list-style-type: none"> • With soft edge +\$ 328 	Specify <i>with soft edge</i> .
Power and Data Access Door, Tray and USB	<ul style="list-style-type: none"> • Power and data access door, tray and USB: paint group 1 or 2 +\$1124 • Power and data access door, tray and USB: anodized aluminum +\$1140 	Specify <i>with power and data access door</i> and select paint color number. Specify <i>with power and data access door</i> and select anodized aluminum.

▶ Options, continued on next page

► Options, continued from previous page

Tip: The standard active touch controller is Bluetooth-enabled to allow pairing with the Steelcase Rise app.

Tip: Tapered desks accommodate either power and data access door or grommet, but not both.

Options	U.S. Price	Required to Specify	
Controller	• Simple touch controller • 4 Pre-set controller	–\$ 74 +\$ 173	Specify with simple touch controller. Specify with 4 pre-set controller.
Power and Data Access Door and Soft Edge Position	• Centered • Left • Right	No cost No cost No cost	Specify with centered position. Specify with left position. Specify with right position.
Grommet	• Grommet	+\$61	Specify with grommet.
Glides	• 1" adjustable glides	+\$46	Specify with 1" glides.
Related Products	• Modesty panels • Fixed personal/modesty screens • Cable and power management		► Page 110 ► Page 254 ► Page 111

Specification Information

Style Number	Dimensions		Desk Type	U.S. Base Prices			
	LD	RD		58"W	64"W	70"W	76"W
			Modular				
			Parametric	58 ¹ / ₁₆ "W–60"W	60 ¹ / ₁₆ "W–66"W	66 ¹ / ₁₆ "W–72"W	72 ¹ / ₁₆ "W–78"W

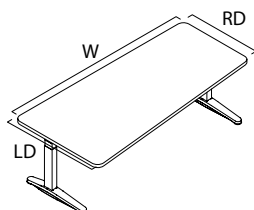

High-Pressure Laminate Desks — Extended Height

OLELRT	23" or 24"	29" or 30"	\$3102	\$3196	\$3292	\$3392
	29" or 30"	23" or 24"	\$3102	\$3196	\$3292	\$3392

Wood Veneer Desks — Extended Height

OLELRT	23" or 24"	29" or 30"	\$3967	\$4079	\$4183	\$4300
	29" or 30"	23" or 24"	\$3967	\$4079	\$4183	\$4300

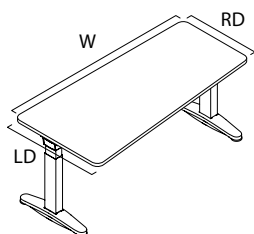

High-Pressure Laminate Desks — Basic Height

OLSLRT	23" or 24"	29" or 30"	\$2859	\$2946	\$3037	\$3128
	29" or 30"	23" or 24"	\$2859	\$2946	\$3037	\$3128

Wood Veneer Desks — Basic Height

OLSLRT	23" or 24"	29" or 30"	\$3724	\$3829	\$3928	\$4036
	29" or 30"	23" or 24"	\$3724	\$3829	\$3928	\$4036

Ology Height-Adjustable 3-Leg Corner Desks

High-Pressure Laminate or Wood Veneer

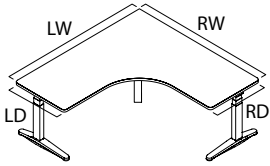

Tip: On extended height desks, any storage higher than 19", or 16½" if the power access door is optional, will impede lowest height range of worksurface. On basic height desks, any storage higher than 23⁷/₁₀", or 21½" if the power access door is optional, will impede lowest height range of worksurface. Do not place storage underneath controller.

Tip: Base supports a maximum distributed weight capacity of 360 pounds (2-leg) and 500 pounds (3-leg). When calculating lifting capacity, subtract the weight of the worksurface, understructure and options selected.

*Tip: 2-leg desks that have an overhang, or are 35"D or 36"D will have a distributed weight capacity of 300 pounds (136.1 kg).
▶ See page 52 for worksurface weights.*

Tip: Antimicrobial additives can be specified only when specifying simple touch controller

For laminate price group 2 and 3 pricing, please refer to the electronic catalog or SmartTools.

Tip: For a conversion chart of old to new 3-leg corner style numbers refer to page 284.

Tip: The standard active touch controller is Bluetooth-enabled to allow pairing with the Steelcase Rise app.



For Canadian Pricing
Multiply U.S. Price by the Canadian price factor.
▶ See page 1 for details.

Standard Includes		Required to Specify
▶ Need help? Product details, page 46	<ul style="list-style-type: none"> • Worksurface: High-Pressure Laminate price group 1 with 3 mm plastic edge or wood group 1 veneer • Electric height-adjustable sit-to-stand base: paint • Active touch controller • Modular widths: <ul style="list-style-type: none"> – 90° equal corner: 52"–76" – 90° extended corner: 40"–76" – 120° equal corner: 34"–64" • ½" adjustable glides • Power cord: 10½' • Attachment hardware 	<ol style="list-style-type: none"> 1 Style number 2 Desk depth 3 Desk width 4 High-Pressure Laminate or wood color for worksurface 5 Plastic color number for profile edge on laminate worksurface, if selected 6 Desk corner style, if laminate desk selected (see below under Required Selections) 7 Paint color number for base <ul style="list-style-type: none"> 4799 Platinum Metallic 7207 Black 7241 Arctic White 7360 Merle 8 Integrated rail (see below under Required Selections) 9 Antimicrobial or non-antimicrobial components, if simple touch controller selected (see below under Required Selections) 10 Options, if selected (see below) <ul style="list-style-type: none"> ▶ See <i>Surface Materials</i>, page 274

Required Selections	U.S. Price	Required to Specify
Desk Corner Style (Laminate Desks Only) <ul style="list-style-type: none"> • Square corners • Radius corners 	No cost +\$ 93	Specify <i>with square corners</i> . Specify <i>with radius corners</i> .
Integrated Rail <ul style="list-style-type: none"> • Without integrated rail • With integrated rail 	No cost +\$896	Specify <i>without integrated rail</i> . Specify <i>with integrated rail</i> .
Antimicrobial Components <ul style="list-style-type: none"> • Non-antimicrobial components • Antimicrobial components 	No cost No cost	Specify <i>with non-antimicrobial components</i> . Specify <i>with antimicrobial components</i> .

Options	U.S. Price	Required to Specify	
Surface Materials	High-Pressure Laminate desks		
<ul style="list-style-type: none"> • Laminate price group 2 • Laminate price group 3 • Open Line laminate 	See information at left See information at left +\$102 plus cost of laminate	Specify laminate color number. Specify laminate color number. ▶ See <i>Surface Materials Reference Manual</i> .	
	Wood veneer desks		
<ul style="list-style-type: none"> • Wood group 2 • Wood group 3 • Customiz stain • Full-fill finish on wood group 1 	+\$102 +\$359 No cost +\$102	Specify wood color number. Specify wood color number. Specify <i>with customiz stain</i> . ▶ See <i>Surface Materials Reference Manual</i> . Specify full-fill finish number.	
	Base		
<ul style="list-style-type: none"> • Paint price group 1 • Paint price group 2 	No cost +\$ 66	Specify paint color number. Specify paint color number. ▶ See <i>Surface Materials</i> , page 274.	
Desk Type	<ul style="list-style-type: none"> • Modular width desk • Parametric width desk 	No cost No cost	Specify <i>with modular desk type</i> . Specify <i>with parametric desk type</i> .
Controller	<ul style="list-style-type: none"> • Simple touch controller • 4 Pre-set controller 	–\$ 74 +\$173	Specify <i>with simple touch controller</i> . Specify <i>with 4 pre-set controller</i> .

▶ Options, continued on next page

► Options, continued from previous page

Tip: Power and data access door and grommet cannot be located on the same side of the desk.

Tip: Power and data access door is available on desks 58"W or greater.

Tip: When selecting power and data access door or grommet on one side, a cord drop will be standard on opposite side if integrated rail is present.

Tip: CarbonNeutral option is not available for 120° corner desks.

Options	U.S. Price	Required to Specify
Power and Data Access Door, Tray and USB	<ul style="list-style-type: none"> Power and data access door on left or right: paint group 1 or 2 +\$1124 Power and data access door on left or right: anodized aluminum +\$1140 Power and data access door on left and right: paint group 1 or 2 +\$2248 Power and data access door on left and right: anodized aluminum +\$2280 	<ul style="list-style-type: none"> Specify <i>with power and data access door on left or right</i> and select paint color number. Specify <i>with power and data access door on left or right</i> and select anodized aluminum. Specify <i>with power and data access door on left and right</i> and select paint color number. Specify <i>with power and data access door on left and right</i> and select anodized aluminum.
Grommet	<ul style="list-style-type: none"> Grommet on left- or right-hand side. +\$ 61 Grommet on left- and right-hand side. +\$ 122 	<ul style="list-style-type: none"> Specify <i>with grommet</i> and select left- or right-hand sides. Specify <i>with grommet</i> and select left- and right-hand sides.
Glides	<ul style="list-style-type: none"> 1" adjustable glides +\$ 69 	Specify <i>with 1" glides</i> .
CarbonNeutral Product	<ul style="list-style-type: none"> CarbonNeutral product certification +\$ 45 	Add suffix CN to the end of the style number.
Related Products	<ul style="list-style-type: none"> Modesty panels Fixed personal/modesty screens Cable and power management 	<ul style="list-style-type: none"> ► Page 110 ► Page 254 ► Page 111

Specification Information

Style Number	Dimensions D	Modular Left Width	Parametric Left Width	Modular Right Width	Parametric Right Width	U.S. Base Prices												
						40"W	46"W	52"W	58"W	64"W	70"W	76"W						
						40"W—42"W	42 ¹ / ₁₆ "W—48"W	48 ¹ / ₁₆ "W—54"W	54 ¹ / ₁₆ "W—60"W	60 ¹ / ₁₆ "W—66"W	66 ¹ / ₁₆ "W—72"W	72 ¹ / ₁₆ "W—78"W						

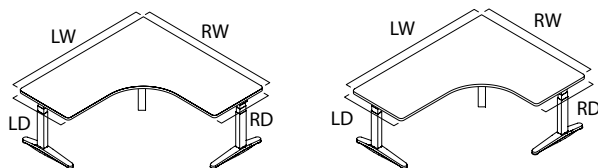

90° 3-Leg Corner Desks — Extended Height (Same Depth Both Ends 23"/24")

High-Pressure Laminate Desks

OLELL3	23" or 24"	40"W	40"W—42"W	N.A.	N.A.	\$3735	\$3853	\$3973	\$4093	\$4216
	23" or 24"	46"W	42 ¹ / ₁₆ "W—48"W	N.A.	N.A.	\$3853	\$3973	\$4093	\$4216	\$4349
	23" or 24"	52"W	48 ¹ / ₁₆ "W—54"W	\$3735	\$3853	\$3973	\$4093	\$4216	\$4349	\$4483
	23" or 24"	58"W	54 ¹ / ₁₆ "W—60"W	\$3853	\$3973	\$4093	\$4216	\$4349	\$4483	\$4620
	23" or 24"	64"W	60 ¹ / ₁₆ "W—66"W	\$3973	\$4093	\$4216	\$4349	\$4483	\$4620	\$4763
	23" or 24"	70"W	66 ¹ / ₁₆ "W—72"W	\$4093	\$4216	\$4349	\$4483	\$4620	\$4763	\$4915
	23" or 24"	76"W	72 ¹ / ₁₆ "W—78"W	\$4216	\$4349	\$4483	\$4620	\$4763	\$4915	\$5062

Tip: At least one side must be 52"W or greater.

Tip: Equal corner widths are parametric to 1/16" from 52"W—78"W.

Tip: 90° desks, 60¹/₁₆"W x 60¹/₁₆"W and wider, are manufactured in two pieces. The work surface split is located on the left side of an equal corner and on the longest side of an extended corner.

► Specification Information, continued on next page

► **Specification Information, continued from previous page**

Specification Information													
Style Number	Dimensions				U.S. Base Prices								
	D		Modular Left Width	Parametric Left Width	Modular Right Width	Parametric Right Width	40"W	46"W	52"W	58"W	64"W	70"W	76"W
							40"W	42 ¹ / ₁₆ "W	48 ¹ / ₁₆ "W	54 ¹ / ₁₆ "W	60 ¹ / ₁₆ "W	66 ¹ / ₁₆ "W	72 ¹ / ₁₆ "W
							42"W	48"W	54"W	60"W	66"W	72"W	78"W

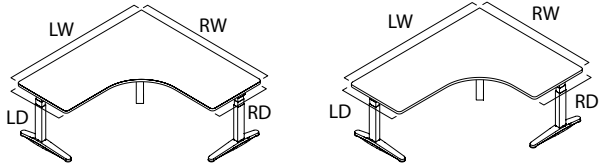

90° 3-Leg Corner Desks — Extended Height (Different Depth Opposite Ends 23"/24" Right/Left and 29"/30" Left/Right)

High-Pressure Laminate Desks												
OLELL3	23" or 24" R/L	29" or 30" L/R	40"W	40"W–42"W	N.A.	N.A.	► See page 66	► See page 66	► See page 66	► See page 66	► See page 66	► See page 66
	23" or 24" R/L	29" or 30" L/R	46"W	42 ¹ / ₁₆ "W–48"W	N.A.	N.A.	\$3967	\$4095	\$4221	\$4350	\$4485	\$4485
	23" or 24" R/L	29" or 30" L/R	52"W	48 ¹ / ₁₆ "W–54"W	► See page 66	\$3967	\$4095	\$4221	\$4350	\$4485	\$4485	\$4625
	23" or 24" R/L	29" or 30" L/R	58"W	54 ¹ / ₁₆ "W–60"W	\$3967	\$4095	\$4221	\$4350	\$4485	\$4485	\$4625	\$4762
	23" or 24" R/L	29" or 30" L/R	64"W	60 ¹ / ₁₆ "W–66"W	\$4095	\$4221	\$4350	\$4485	\$4485	\$4625	\$4762	\$4909
	23" or 24" R/L	29" or 30" L/R	70"W	66 ¹ / ₁₆ "W–72"W	\$4221	\$4350	\$4485	\$4625	\$4625	\$4762	\$4909	\$5063
	23" or 24" R/L	29" or 30" L/R	76"W	72 ¹ / ₁₆ "W–78"W	\$4350	\$4485	\$4625	\$4762	\$4762	\$4909	\$5063	\$5207

Tip: At least one side must be 52"W or greater.

Tip: Equal corner widths are parametric to 1/16" from 52"W–78"W.

Tip: 90° desks, 60¹/₁₆"W x 60¹/₁₆"W and wider, are manufactured in two pieces. The worksurface split is located on the left side of an equal corner and on the longest side of an extended corner.

► **Specification Information, continued on next page**

 **For Canadian Pricing**
 Multiply U.S. Price by the Canadian price factor.
 ► See page 1 for details.

► **Specification Information, continued from previous page**

Specification Information											
• Style Number	• Dimensions D			• Modular Right Width	• U.S. Base Prices						
	• Modular Left Width	• Parametric Left Width	• Parametric Right Width		40"W	46"W	52"W	58"W	64"W	70"W	76"W
				40"W—42"W	42 ¹ / ₁₆ "W—48"W	48 ¹ / ₁₆ "W—54"W	54 ¹ / ₁₆ "W—60"W	60 ¹ / ₁₆ "W—66"W	66 ¹ / ₁₆ "W—72"W	72 ¹ / ₁₆ "W—78"W	

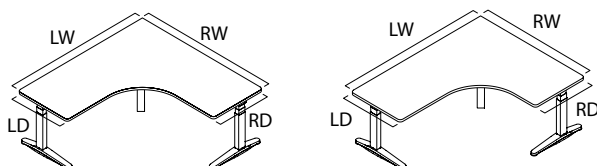

90° 3-Leg Corner Desks — Extended Height (Same Depth Both Ends 29"/30")

High-Pressure Laminate Desks

OLELL3	29" or 30"	40"W	40"W—42"W	N.A.	N.A.	N.A.	N.A.	N.A.	N.A.	N.A.
	29" or 30"	46"W	42 ¹ / ₁₆ "W—48"W	N.A.	N.A.	\$4079	\$4216	\$4353	\$4483	\$4620
	29" or 30"	52"W	48 ¹ / ₁₆ "W—54"W	N.A.	\$4079	\$4216	\$4353	\$4483	\$4620	\$4763
	29" or 30"	58"W	54 ¹ / ₁₆ "W—60"W	N.A.	\$4216	\$4353	\$4483	\$4620	\$4763	\$4908
	29" or 30"	64"W	60 ¹ / ₁₆ "W—66"W	N.A.	\$4353	\$4483	\$4620	\$4763	\$4908	\$5053
	29" or 30"	70"W	66 ¹ / ₁₆ "W—72"W	N.A.	\$4483	\$4620	\$4763	\$4908	\$5053	\$5208
	29" or 30"	76"W	72 ¹ / ₁₆ "W—78"W	N.A.	\$4620	\$4763	\$4908	\$5053	\$5208	\$5354

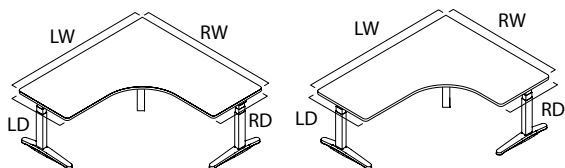

90° 3-Leg Corner Desks — Extended Height (Same Depth Both Ends 23"/24")

Wood Veneer Desks

OLELL3	23" or 24"	40"W	40"W—42"W	N.A.	N.A.	\$5022	\$5159	\$5298	\$5435	\$5583
	23" or 24"	46"W	42 ¹ / ₁₆ "W—48"W	N.A.	N.A.	\$5159	\$5298	\$5435	\$5583	\$5735
	23" or 24"	52"W	48 ¹ / ₁₆ "W—54"W	\$5022	\$5159	\$5298	\$5418	\$5583	\$5735	\$5889
	23" or 24"	58"W	54 ¹ / ₁₆ "W—60"W	\$5159	\$5298	\$5418	\$5583	\$5735	\$5889	\$6046
	23" or 24"	64"W	60 ¹ / ₁₆ "W—66"W	\$5298	\$5435	\$5583	\$5735	\$5889	\$6046	\$6209
	23" or 24"	70"W	66 ¹ / ₁₆ "W—72"W	\$5435	\$5583	\$5735	\$5889	\$6046	\$6195	\$6377
	23" or 24"	76"W	72 ¹ / ₁₆ "W—78"W	\$5583	\$5735	\$5889	\$6046	\$6209	\$6377	\$6559

Tip: At least one side must be 52"W or greater.

Tip: Equal corner widths are parametric to 1/16" from 52"W—78"W.

Tip: 90° desks, 60¹/₁₆"W x 60¹/₁₆"W and wider, are manufactured in two pieces. The worksurface split is located on the left side of an equal corner and on the longest side of an extended corner.

► **Specification Information, continued on next page**

► **Specification Information, continued from previous page**

Specification Information												
• Style Number	• Dimensions			• U.S. Base Prices								
	D	• Modular Left Width	• Parametric Left Width	• Modular Right Width	• Parametric Right Width	40"W	46"W	52"W	58"W	64"W	70"W	76"W
						40"W	42 ¹ / ₁₆ "W	48 ¹ / ₁₆ "W	54 ¹ / ₁₆ "W	60 ¹ / ₁₆ "W	66 ¹ / ₁₆ "W	72 ¹ / ₁₆ "W
						42"W	48"W	54"W	60"W	66"W	72"W	78"W

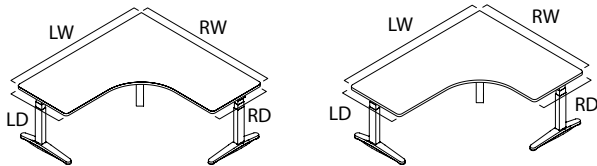

90° 3-Leg Corner Desks — Extended Height (Different Depth Opposite Ends 23"/24" Right/Left and 29"/30" Left/Right)

Wood Veneer Desks

OLELL3	23" or 24" R/L	29" or 30" L/R	40"W	40"W–42"W	N.A.	N.A.	► See page 67	► See page 67	► See page 67	► See page 67	► See page 67
	23" or 24" R/L	29" or 30" L/R	46"W	42 ¹ / ₁₆ "W–48"W	N.A.	N.A.	\$5273	\$5420	\$5563	\$5717	\$5870
	23" or 24" R/L	29" or 30" L/R	52"W	48 ¹ / ₁₆ "W–54"W	► See page 67	\$5273	\$5420	\$5563	\$5717	\$5870	\$6031
	23" or 24" R/L	29" or 30" L/R	58"W	54 ¹ / ₁₆ "W–60"W	\$5273	\$5420	\$5563	\$5717	\$5870	\$6031	\$6188
	23" or 24" R/L	29" or 30" L/R	64"W	60 ¹ / ₁₆ "W–66"W	\$5420	\$5563	\$5717	\$5870	\$6031	\$6188	\$6357
	23" or 24" R/L	29" or 30" L/R	70"W	66 ¹ / ₁₆ "W–72"W	\$5563	\$5717	\$5870	\$6031	\$6188	\$6357	\$6526
	23" or 24" R/L	29" or 30" L/R	76"W	72 ¹ / ₁₆ "W–78"W	\$5717	\$5870	\$6031	\$6188	\$6357	\$6526	\$6704

Tip: At least one side must be 52"W or greater.

Tip: Equal corner widths are parametric to 1/16" from 52"W–78"W.

Tip: 90° desks, 60¹/₁₆"W x 60¹/₁₆"W and wider, are manufactured in two pieces. The worksurface split is located on the left side of an equal corner and on the longest side of an extended corner.

► **Specification Information, continued on next page**

 **For Canadian Pricing**
 Multiply U.S. Price by the Canadian price factor.
 ► See page 1 for details.

► **Specification Information, continued from previous page**

Specification Information											
• Style Number	• Dimensions D			• Modular Right Width	• U.S. Base Prices						
	• Modular Left Width	• Parametric Left Width	• Parametric Right Width		40"W	46"W	52"W	58"W	64"W	70"W	76"W
				40"W—42"W	42 ¹ / ₁₆ "W—48"W	48 ¹ / ₁₆ "W—54"W	54 ¹ / ₁₆ "W—60"W	60 ¹ / ₁₆ "W—66"W	66 ¹ / ₁₆ "W—72"W	72 ¹ / ₁₆ "W—78"W	

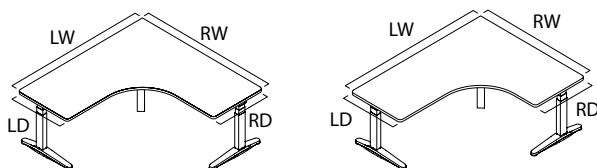

90° 3-Leg Corner Desks — Extended Height (Same Depth Both Ends 29"/30")

Wood Veneer Desks

OLELL3	29" or 30"	40"W	40"W–42"W	N.A.	N.A.	N.A.	N.A.	N.A.	N.A.	N.A.
	29" or 30"	46"W	42 ¹ / ₁₆ "W–48"W	N.A.	N.A.	\$5385	\$5541	\$5694	\$5850	\$6006
	29" or 30"	52"W	48 ¹ / ₁₆ "W–54"W	N.A.	\$5385	\$5541	\$5694	\$5850	\$6006	\$6169
	29" or 30"	58"W	54 ¹ / ₁₆ "W–60"W	N.A.	\$5541	\$5694	\$5850	\$6006	\$6169	\$6334
	29" or 30"	64"W	60 ¹ / ₁₆ "W–66"W	N.A.	\$5694	\$5850	\$6006	\$6169	\$6334	\$6499
	29" or 30"	70"W	66 ¹ / ₁₆ "W–72"W	N.A.	\$5850	\$6006	\$6169	\$6334	\$6499	\$6671
	29" or 30"	76"W	72 ¹ / ₁₆ "W–78"W	N.A.	\$6006	\$6169	\$6334	\$6499	\$6671	\$6851

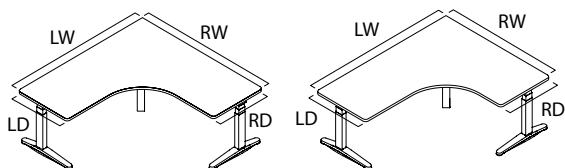

90° 3-Leg Corner Desks — Basic Height (Same Depth Both Ends 23"/24")

High-Pressure Laminate Desks

OLSLL3	23" or 24"	40"W	40"W–42"W	N.A.	N.A.	\$3441	\$3553	\$3663	\$3771	\$3887
	23" or 24"	46"W	42 ¹ / ₁₆ "W–48"W	N.A.	N.A.	\$3553	\$3663	\$3771	\$3887	\$4006
	23" or 24"	52"W	48 ¹ / ₁₆ "W–54"W	\$3441	\$3553	\$3663	\$3771	\$3887	\$4006	\$4130
	23" or 24"	58"W	54 ¹ / ₁₆ "W–60"W	\$3553	\$3663	\$3771	\$3887	\$4006	\$4130	\$4256
	23" or 24"	64"W	60 ¹ / ₁₆ "W–66"W	\$3663	\$3771	\$3887	\$4006	\$4130	\$4256	\$4387
	23" or 24"	70"W	66 ¹ / ₁₆ "W–72"W	\$3771	\$3887	\$4006	\$4130	\$4256	\$4387	\$4528
	23" or 24"	76"W	72 ¹ / ₁₆ "W–78"W	\$3887	\$4006	\$4130	\$4256	\$4387	\$4528	\$4661

Tip: At least one side must be 52"W or greater.

Tip: Equal corner widths are parametric to 1/16" from 52"W–78"W.

Tip: 90° desks, 60¹/₁₆"W x 60¹/₁₆"W and wider, are manufactured in two pieces. The worksurface split is located on the left side of an equal corner and on the longest side of an extended corner.

► **Specification Information, continued on next page**

► **Specification Information, continued from previous page**

Specification Information											
• Style Number	• Dimensions			• U.S. Base Prices							
	D			• Modular Right Width	• 40"W	• 46"W	• 52"W	• 58"W	• 64"W	• 70"W	• 76"W
		• Modular Left Width	• Parametric Left Width	• Parametric Right Width	• 40"W—42"W	• 42 ¹ / ₁₆ "W—48"W	• 48 ¹ / ₁₆ "W—54"W	• 54 ¹ / ₁₆ "W—60"W	• 60 ¹ / ₁₆ "W—66"W	• 66 ¹ / ₁₆ "W—72"W	• 72 ¹ / ₁₆ "W—78"W

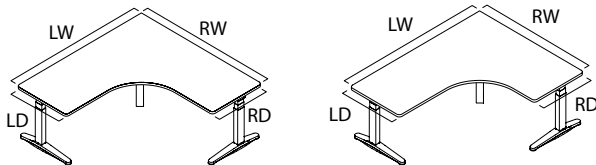

90° 3-Leg Corner Desks — Basic Height (Different Depth Opposite Ends 23"/24" Right/Left and 29"/30" Left/Right)

High-Pressure Laminate Desks

OLSLL3	23" or 24" R/L	29" or 30" L/R	40"W	40"W—42"W	N.A.	N.A.	► See page 68	► See page 66	► See page 66	► See page 66	► See page 66
	23" or 24" R/L	29" or 30" L/R	46"W	42 ¹ / ₁₆ "W—48"W	N.A.	N.A.	\$3655	\$3773	\$3891	\$4007	\$4133
	23" or 24" R/L	29" or 30" L/R	52"W	48 ¹ / ₁₆ "W—54"W	► See page 66	\$3655	\$3773	\$3891	\$4007	\$4133	\$4261
	23" or 24" R/L	29" or 30" L/R	58"W	54 ¹ / ₁₆ "W—60"W	\$3655	\$3773	\$3891	\$4007	\$4133	\$4261	\$4387
	23" or 24" R/L	29" or 30" L/R	64"W	60 ¹ / ₁₆ "W—66"W	\$3773	\$3891	\$4007	\$4133	\$4261	\$4387	\$4522
	23" or 24" R/L	29" or 30" L/R	70"W	66 ¹ / ₁₆ "W—72"W	\$3891	\$4007	\$4133	\$4261	\$4387	\$4522	\$4657
	23" or 24" R/L	29" or 30" L/R	76"W	72 ¹ / ₁₆ "W—78"W	\$4007	\$4133	\$4261	\$4387	\$4522	\$4657	\$4796

Tip: At least one side must be 52"W or greater.

Tip: Equal corner widths are parametric to ¹/₁₆" from 52"W—78"W.

Tip: 90° desks, 60¹/₁₆"W x 60¹/₁₆"W and wider, are manufactured in two pieces. The worksurface split is located on the left side of an equal corner and on the longest side of an extended corner.

► **Specification Information, continued on next page**

 **For Canadian Pricing**
 Multiply U.S. Price by the Canadian price factor.
 ► See page 1 for details.

► **Specification Information, continued from previous page**

Specification Information										
• Style Number	• Dimensions D			• U.S. Base Prices						
	• Modular Left Width	• Parametric Left Width	• Modular Right Width	40"W	46"W	52"W	58"W	64"W	70"W	76"W
			• Parametric Right Width	40"W—42"W	42 ¹ / ₁₆ "W—48"W	48 ¹ / ₁₆ "W—54"W	54 ¹ / ₁₆ "W—60"W	60 ¹ / ₁₆ "W—66"W	66 ¹ / ₁₆ "W—72"W	72 ¹ / ₁₆ "W—78"W

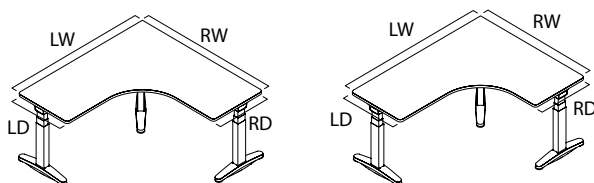

90° 3-Leg Corner Desks — Basic Height (Same Depth Both Ends 29"/30")

High-Pressure Laminate Desks

OLSLL3	29" or 30"	40"W	40"W—42"W	N.A.	N.A.	N.A.	N.A.	N.A.	N.A.	N.A.
	29" or 30"	46"W	42 ¹ / ₁₆ "W—48"W	N.A.	N.A.	\$3759	\$3887	\$4008	\$4130	\$4256
	29" or 30"	52"W	48 ¹ / ₁₆ "W—54"W	N.A.	\$3759	\$3887	\$4008	\$4130	\$4256	\$4387
	29" or 30"	58"W	54 ¹ / ₁₆ "W—60"W	N.A.	\$3887	\$4008	\$4130	\$4256	\$4387	\$4520
	29" or 30"	64"W	60 ¹ / ₁₆ "W—66"W	N.A.	\$4008	\$4130	\$4256	\$4387	\$4520	\$4655
	29" or 30"	70"W	66 ¹ / ₁₆ "W—72"W	N.A.	\$4130	\$4256	\$4387	\$4520	\$4655	\$4797
	29" or 30"	76"W	72 ¹ / ₁₆ "W—78"W	N.A.	\$4256	\$4387	\$4520	\$4655	\$4797	\$4931

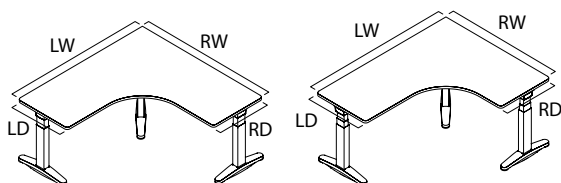

90° 3-Leg Corner Desks — Basic Height (Same Depth Both Ends 23"/24")

Wood Veneer Desks

OLSLL3	23" or 24"	40"W	40"W—42"W	N.A.	N.A.	\$4728	\$4859	\$4988	\$5113	\$5254
	23" or 24"	46"W	42 ¹ / ₁₆ "W—48"W	N.A.	N.A.	\$4859	\$4988	\$5113	\$5254	\$5392
	23" or 24"	52"W	48 ¹ / ₁₆ "W—54"W	\$4728	\$4859	\$4988	\$5096	\$5254	\$5392	\$5536
	23" or 24"	58"W	54 ¹ / ₁₆ "W—60"W	\$4859	\$4988	\$5096	\$5254	\$5392	\$5536	\$5682
	23" or 24"	64"W	60 ¹ / ₁₆ "W—66"W	\$4988	\$5113	\$5254	\$5392	\$5536	\$5682	\$5833
	23" or 24"	70"W	66 ¹ / ₁₆ "W—72"W	\$5113	\$5254	\$5392	\$5536	\$5682	\$5833	\$5989
	23" or 24"	76"W	72 ¹ / ₁₆ "W—78"W	\$5254	\$5392	\$5536	\$5682	\$5833	\$5989	\$6158

Tip: At least one side must be 52"W or greater.

Tip: Equal corner widths are parametric to 1/16" from 52"W—78"W.

Tip: 90° desks, 60¹/₁₆"W x 60¹/₁₆"W and wider, are manufactured in two pieces. The worksurface split is located on the left side of an equal corner and on the longest side of an extended corner.

► **Specification Information, continued on next page**

► **Specification Information, continued from previous page**

Specification Information											
• Style Number	• Dimensions			• U.S. Base Prices							
	D			• Modular Right Width	• 40"W	• 46"W	• 52"W	• 58"W	• 64"W	• 70"W	• 76"W
		• Modular Left Width	• Parametric Left Width	• Parametric Right Width	• 40"W—42"W	• 42 ¹ / ₁₆ "W—48"W	• 48 ¹ / ₁₆ "W—54"W	• 54 ¹ / ₁₆ "W—60"W	• 60 ¹ / ₁₆ "W—66"W	• 66 ¹ / ₁₆ "W—72"W	• 72 ¹ / ₁₆ "W—78"W

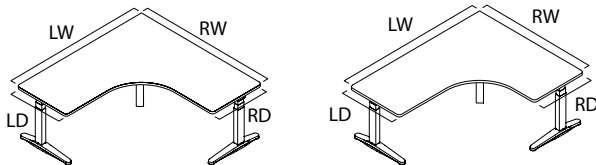

90° 3-Leg Corner Desks — Basic Height (Different Depth Opposite Ends 23"/24" Right/Left and 29"/30" Left/Right)

Wood Veneer Desks

OLSLL3	23" or 24" R/L	29" or 30" L/R	40"W	40"W–42"W	N.A.	N.A.	► See page 69	► See page 69	► See page 69	► See page 69	► See page 69
	23" or 24" R/L	29" or 30" L/R	46"W	42 ¹ / ₁₆ "W–48"W	N.A.	N.A.	\$4962	\$5098	\$5233	\$5374	\$5519
	23" or 24" R/L	29" or 30" L/R	52"W	48 ¹ / ₁₆ "W–54"W	► See page 69	\$4962	\$5098	\$5233	\$5374	\$5519	\$5667
	23" or 24" R/L	29" or 30" L/R	58"W	54 ¹ / ₁₆ "W–60"W	\$4962	\$5098	\$5233	\$5374	\$5519	\$5667	\$5813
	23" or 24" R/L	29" or 30" L/R	64"W	60 ¹ / ₁₆ "W–66"W	\$5098	\$5233	\$5374	\$5519	\$5667	\$5813	\$5970
	23" or 24" R/L	29" or 30" L/R	70"W	66 ¹ / ₁₆ "W–72"W	\$5233	\$5374	\$5519	\$5667	\$5813	\$5970	\$6126
	23" or 24" R/L	29" or 30" L/R	76"W	72 ¹ / ₁₆ "W–78"W	\$5374	\$5519	\$5667	\$5813	\$5970	\$6126	\$6293

Tip: At least one side must be 52"W or greater.

Tip: Equal corner widths are parametric to ¹/₁₆" from 52"W–78"W.

Tip: 90° desks, 60¹/₁₆"W x 60¹/₁₆"W and wider, are manufactured in two pieces. The worksurface split is located on the left side of an equal corner and on the longest side of an extended corner.

► **Specification Information, continued on next page**

 **For Canadian Pricing**
 Multiply U.S. Price by the Canadian price factor.
 ► See page 1 for details.

► **Specification Information, continued from previous page**

Specification Information											
Style Number	Dimensions D	Modular		Modular Right Width	U.S. Base Prices						
		Left Width	Parametric Left Width		40"W	46"W	52"W	58"W	64"W	70"W	76"W
				Parametric Right Width	40"W—42"W	42 ¹ / ₁₆ "W—48"W	48 ¹ / ₁₆ "W—54"W	54 ¹ / ₁₆ "W—60"W	60 ¹ / ₁₆ "W—66"W	66 ¹ / ₁₆ "W—72"W	72 ¹ / ₁₆ "W—78"W

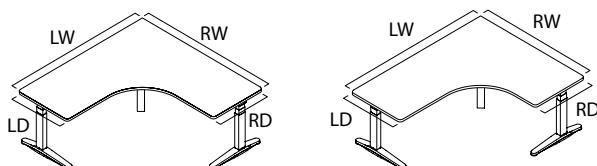

90° 3-Leg Corner Desks — Basic Height (Same Depth Both Ends 29"/30")

Wood Veneer Desks

OLSL3	Depth	Modular Left Width	Modular Right Width	Parametric Right Width	40"W	46"W	52"W	58"W	64"W	70"W	76"W
	29" or 30"	40"W	40"W—42"W	N.A.	N.A.	N.A.	N.A.	N.A.	N.A.	N.A.	N.A.
	29" or 30"	46"W	42 ¹ / ₁₆ "W—48"W	N.A.	N.A.	\$5065	\$5212	\$5350	\$5497	\$5642	\$5642
	29" or 30"	52"W	48 ¹ / ₁₆ "W—54"W	N.A.	\$5065	\$5212	\$5350	\$5497	\$5642	\$5793	\$5793
	29" or 30"	58"W	54 ¹ / ₁₆ "W—60"W	N.A.	\$5212	\$5350	\$5497	\$5642	\$5793	\$5946	\$5946
	29" or 30"	64"W	60 ¹ / ₁₆ "W—66"W	N.A.	\$5350	\$5497	\$5642	\$5793	\$5946	\$6101	\$6101
	29" or 30"	70"W	66 ¹ / ₁₆ "W—72"W	N.A.	\$5497	\$5642	\$5793	\$5946	\$6101	\$6258	\$6258
	29" or 30"	76"W	72 ¹ / ₁₆ "W—78"W	N.A.	\$5642	\$5793	\$5946	\$6101	\$6258	\$6428	\$6428

Tip: At least one side must be 52"W or greater.

Tip: Equal corner widths are parametric to 1/16" from 52"W—78"W.

Tip: 90° desks, 60¹/₁₆"W x 60¹/₁₆"W and wider, are manufactured in two pieces. The worksurface split is located on the left side of an equal corner and on the longest side of an extended corner.

► **Specification Information, continued on next page**



For Canadian Pricing

Multiply U.S. Price by the Canadian price factor.

► See page 1 for details.

► **Specification Information, continued from previous page**

Specification Information									
Style Number	Dimensions D		Modular Right Width	U.S. Base Prices					
	Modular Left Width	Parametric Left Width		Parametric Right Width	34"W	40"W	46"W	52"W	58"W
				34"W	40"W	46"W	52"W	58"W	64"W
				34"W—	36 ¹ / ₁₆ "W—	42 ¹ / ₁₆ "W—	48 ¹ / ₁₆ "W—	54 ¹ / ₁₆ "W—	60 ¹ / ₁₆ "W—
				36"W	42"W	48"W	54"W	60"W	66"W

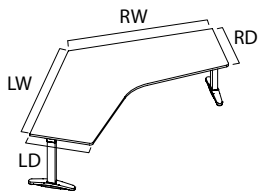

120° 3-Leg Corner Desks — Extended Height

High-Pressure Laminate Desks

OLELW3	23" or 24"	34"W	34"W–36"W	\$3441	\$3559	\$3674	\$3791	\$3908	\$4029
	23" or 24"	40"W	36 ¹ / ₁₆ "W–42"W	\$3559	\$3674	\$3791	\$3908	\$4029	\$4153
	23" or 24"	46"W	42 ¹ / ₁₆ "W–48"W	\$3674	\$3791	\$3908	\$4029	\$4153	\$4280
	23" or 24"	52"W	48 ¹ / ₁₆ "W–54"W	\$3791	\$3908	\$4029	\$4153	\$4280	\$4412
	23" or 24"	58"W	54 ¹ / ₁₆ "W–60"W	\$3908	\$4029	\$4153	\$4280	\$4412	\$4544
	23" or 24"	64"W	60 ¹ / ₁₆ "W–66"W	\$4029	\$4153	\$4280	\$4412	\$4544	\$4678

Wood Veneer Desks

OLELW3	23" or 24"	34"W	34"W–36"W	\$4467	\$4895	\$5044	\$5161	\$5278	\$5417
	23" or 24"	40"W	36 ¹ / ₁₆ "W–42"W	\$4895	\$5010	\$5161	\$5296	\$5417	\$5561
	23" or 24"	46"W	42 ¹ / ₁₆ "W–48"W	\$5044	\$5161	\$5278	\$5437	\$5561	\$5710
	23" or 24"	52"W	48 ¹ / ₁₆ "W–54"W	\$5161	\$5296	\$5437	\$5561	\$5713	\$5845
	23" or 24"	58"W	54 ¹ / ₁₆ "W–60"W	\$5278	\$5417	\$5561	\$5713	\$5845	\$5995
	23" or 24"	64"W	60 ¹ / ₁₆ "W–66"W	\$5417	\$5561	\$5710	\$5845	\$5995	\$6151

► **Specification Information, continued on next page**

 **For Canadian Pricing**
 Multiply U.S. Price by the Canadian price factor.
 ► See page 1 for details.

► Specification Information, continued from previous page

Specification Information										
Style Number	Dimensions D			U.S. Base Prices						
		Modular Left Width	Parametric Left Width	Modular Right Width	34"W	40"W	46"W	52"W	58"W	64"W
				Parametric Right Width	34"W—	36 ¹ / ₁₆ "W—	42 ¹ / ₁₆ "W—	48 ¹ / ₁₆ "W—	54 ¹ / ₁₆ "W—	60 ¹ / ₁₆ "W—
					36"W	42"W	48"W	54"W	60"W	66"W

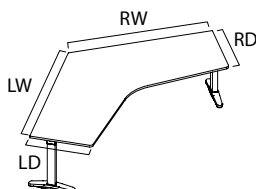

120° 3-Leg Corner Desks — Extended Height

High-Pressure Laminate Desks

OLELW3	29" or 30"	34"W	34"W–36"W	\$3740	\$3860	\$3974	\$4091	\$4207	\$4326
	29" or 30"	40"W	36 ¹ / ₁₆ "W–42"W	\$3860	\$3974	\$4091	\$4207	\$4326	\$4451
	29" or 30"	46"W	42 ¹ / ₁₆ "W–48"W	\$3974	\$4091	\$4207	\$4326	\$4451	\$4580
	29" or 30"	52"W	48 ¹ / ₁₆ "W–54"W	\$4091	\$4207	\$4326	\$4451	\$4580	\$4713
	29" or 30"	58"W	54 ¹ / ₁₆ "W–60"W	\$4207	\$4326	\$4451	\$4580	\$4713	\$4843
	29" or 30"	64"W	60 ¹ / ₁₆ "W–66"W	\$4326	\$4451	\$4580	\$4713	\$4843	\$4977

Wood Veneer Desks

OLELW3	29" or 30"	34"W	34"W–36"W	\$5076	\$5216	\$5344	\$5479	\$5615	\$5746
	29" or 30"	40"W	36 ¹ / ₁₆ "W–42"W	\$5216	\$5344	\$5479	\$5615	\$5746	\$5884
	29" or 30"	46"W	42 ¹ / ₁₆ "W–48"W	\$5344	\$5479	\$5615	\$5746	\$5884	\$6031
	29" or 30"	52"W	48 ¹ / ₁₆ "W–54"W	\$5479	\$5615	\$5746	\$5884	\$6031	\$6186
	29" or 30"	58"W	54 ¹ / ₁₆ "W–60"W	\$5615	\$5746	\$5884	\$6031	\$6186	\$6338
	29" or 30"	64"W	60 ¹ / ₁₆ "W–66"W	\$5746	\$5884	\$6031	\$6186	\$6338	\$6491

► Specification Information, continued on next page



For Canadian Pricing

Multiply U.S. Price by the Canadian price factor.

► See page 1 for details.

► **Specification Information, continued from previous page**

Specification Information										
• Style Number	• Dimensions		• Modular Right Width	• U.S. Base Prices						
	• D			• Parametric Right Width	• 34"W	• 40"W	• 46"W	• 52"W	• 58"W	• 64"W
	• Modular Left Width	• Parametric Left Width	• Parametric Right Width	• 34"W—	• 36 ¹ / ₁₆ "W—	• 42 ¹ / ₁₆ "W—	• 48 ¹ / ₁₆ "W—	• 54 ¹ / ₁₆ "W—	• 60 ¹ / ₁₆ "W—	• 66"W

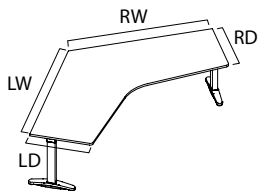

120° 3-Leg Corner Desks — Basic Height

High-Pressure Laminate Desks

OLSLW3	23" or 24"	34"W	34"W–36"W	\$3171	\$3280	\$3387	\$3494	\$3600	\$3710
	23" or 24"	40"W	36 ¹ / ₁₆ "W–42"W	\$3280	\$3387	\$3494	\$3600	\$3710	\$3826
	23" or 24"	46"W	42 ¹ / ₁₆ "W–48"W	\$3387	\$3494	\$3600	\$3710	\$3826	\$3946
	23" or 24"	52"W	48 ¹ / ₁₆ "W–54"W	\$3494	\$3600	\$3710	\$3826	\$3946	\$4068
	23" or 24"	58"W	54 ¹ / ₁₆ "W–60"W	\$3600	\$3710	\$3826	\$3946	\$4068	\$4188
	23" or 24"	64"W	60 ¹ / ₁₆ "W–66"W	\$3710	\$3826	\$3946	\$4068	\$4188	\$4313

Wood Veneer Desks

OLSLW3	23" or 24"	34"W	34"W–36"W	\$4197	\$4616	\$4757	\$4864	\$4970	\$5098
	23" or 24"	40"W	36 ¹ / ₁₆ "W–42"W	\$4616	\$4723	\$4864	\$4988	\$5098	\$5234
	23" or 24"	46"W	42 ¹ / ₁₆ "W–48"W	\$4757	\$4864	\$4970	\$5118	\$5234	\$5376
	23" or 24"	52"W	48 ¹ / ₁₆ "W–54"W	\$4864	\$4988	\$5118	\$5234	\$5379	\$5501
	23" or 24"	58"W	54 ¹ / ₁₆ "W–60"W	\$4970	\$5098	\$5234	\$5379	\$5501	\$5639
	23" or 24"	64"W	60 ¹ / ₁₆ "W–66"W	\$5098	\$5234	\$5376	\$5501	\$5639	\$5786

► **Specification Information, continued on next page**

 **For Canadian Pricing**
 Multiply U.S. Price by the Canadian price factor.
 ► See page 1 for details.

► **Specification Information, continued from previous page**

Specification Information										
• Style Number	• Dimensions			• U.S. Base Prices						
	D			• Modular Right Width	• Parametric Right Width					
		• Modular Left Width	• Parametric Left Width		34"W	34"W—36"W	40"W	36 ¹ / ₁₆ "W—42"W	46"W	42 ¹ / ₁₆ "W—48"W
					52"W	48 ¹ / ₁₆ "W—54"W	58"W	54 ¹ / ₁₆ "W—60"W	64"W	60 ¹ / ₁₆ "W—66"W

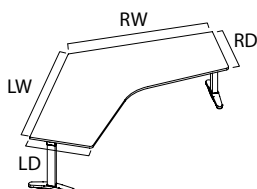

120° 3-Leg Corner Desks — Basic Height

High Pressure Laminate Desks

OLSLW3	29" or 30"	34"W	34"W—36"W	\$3446	\$3555	\$3662	\$3768	\$3875	\$3984
	29" or 30"	40"W	36 ¹ / ₁₆ "W—42"W	\$3555	\$3662	\$3768	\$3875	\$3984	\$4100
	29" or 30"	46"W	42 ¹ / ₁₆ "W—48"W	\$3662	\$3768	\$3875	\$3984	\$4100	\$4218
	29" or 30"	52"W	48 ¹ / ₁₆ "W—54"W	\$3768	\$3875	\$3984	\$4100	\$4218	\$4341
	29" or 30"	58"W	54 ¹ / ₁₆ "W—60"W	\$3875	\$3984	\$4100	\$4218	\$4341	\$4461
	29" or 30"	64"W	60 ¹ / ₁₆ "W—66"W	\$3984	\$4100	\$4218	\$4341	\$4461	\$4586

Wood Veneer Desks

OLSLW3	29" or 30"	34"W	34"W—36"W	\$4782	\$4911	\$5032	\$5156	\$5283	\$5404
	29" or 30"	40"W	36 ¹ / ₁₆ "W—42"W	\$4911	\$5032	\$5156	\$5283	\$5404	\$5533
	29" or 30"	46"W	42 ¹ / ₁₆ "W—48"W	\$5032	\$5156	\$5283	\$5404	\$5533	\$5669
	29" or 30"	52"W	48 ¹ / ₁₆ "W—54"W	\$5156	\$5283	\$5404	\$5533	\$5669	\$5814
	29" or 30"	58"W	54 ¹ / ₁₆ "W—60"W	\$5283	\$5404	\$5533	\$5669	\$5814	\$5956
	29" or 30"	64"W	60 ¹ / ₁₆ "W—66"W	\$5404	\$5533	\$5669	\$5814	\$5956	\$6100

 **For Canadian Pricing**
Multiply U.S. Price by the Canadian price factor.
► See page 1 for details.

Ology Height-Adjustable Bases

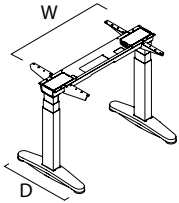

Tip: Any storage higher than 19" will impede lowest height range of worksurface. On basic height desks, any storage higher than 23⁷/₁₀" will impede lowest height range of worksurface. Do not place storage underneath controller.

Tip: On 23¹/₂"D and less than 58"W desks, only single and dual flat panel monitor arm applications are permitted for use.

▶ See page 43 for *Steelcase Monitor Arm Guidelines*.

Tip: For desks 29¹/₂"Dx58"W and greater additional monitor arm configurations are allowed.

▶ See page 43, *Steelcase Monitor Arm Guidelines*.

Tip: Base supports a maximum distributed weight capacity of 360 pounds (2-leg) and 500 pounds (3-leg). When calculating lifting capacity, subtract the weight of the worksurface and understructure.

Tip: 2-leg desks that have an overhang, or are 35"D or 36"D will have a distributed weight capacity of 300 pounds (136.1 kg).

▶ See page 52 for understructure weights.

Tip: Antimicrobial additives can be specified only when specifying simple touch controller.

Tip: Attachment hardware is intended for worksurfaces 1" thick only.

Tip: 9" overhang is available on desks 64"W and larger. Overhang on both sides is available on 70"W and 76"W only.

Tip: Overhang not available on 35"D or 36"D.

Tip: Overhang is available on rectangular bases only.

Standard Includes		Required to Specify
▶ Need help? Product details, page 46	<ul style="list-style-type: none"> • Electric height-adjustable sit-to-stand base: paint • Active touch controller • Modular width: <ul style="list-style-type: none"> – Rectangular base: 34"–76" – Tapered base: 58"–76" – 90° equal corner base: 52"–76" – 90° extended corner base: 40"–76" – 120° equal corner base: 34"–64" • 1/2" adjustable glides • Power cord: 10⁴/₅' • Attachment hardware 	<ol style="list-style-type: none"> 1 Style number 2 Desk depth 3 Desk width 4 Paint color number for base: <ul style="list-style-type: none"> 4799 Platinum Metallic 7207 Black 7241 Arctic White 7360 Merle 5 Antimicrobial or non-antimicrobial components, if simple touch controller selected (see below under Required Selections) 6 Options, if selected (see below) <p>▶ See <i>Surface Materials</i>, page 274.</p>

Required Selections		U.S. Price	Required to Specify
Antimicrobial Components	• Non-antimicrobial components	No cost	Specify with non-antimicrobial components.
	• Antimicrobial components	No cost	Specify with antimicrobial components.
Options		U.S. Price	Required to Specify
Surface Materials	Bases		
	• Paint price group 1	No cost	Specify paint color number.
	• Paint price group 2 for rectangular and tapered bases	+\$ 44	Specify paint color number.
	• Paint price group 2 for corner bases	+\$ 66	Specify paint color number.
			▶ See <i>Surface Materials</i> , page 274.
Desk Type	• Parametric width desk	No cost	Specify with parametric desk type.
Overhang	• Desk overhang on left	No cost	Specify with desk overhang left.
	• Desk overhang on right	No cost	Specify with desk overhang right.
	• Desk overhang left and right	No cost	Specify with desk overhang left and right.
Glides	• 1" adjustable glides	+\$ 23 per glide	Specify with 1" glides.
Controller	• Simple touch controller	–\$ 74	Specify with simple touch controller.
	• 4 pre-set controller	+\$173	Specify with 4 pre-set controller.

Tip: The standard active touch controller is Bluetooth-enabled to allow pairing with the *Steelcase Rise* app.

⚠ WARNING

Read base only warranty limitations.

▶ See page 26 for *Workstation Design Guidelines and Requirements*.

Specification Information

Style Number	Dimension D	Desk Type	U.S. Base Prices							
			34"W	40"W	46"W	52"W	58"W	64"W	70"W	76"W
		Modular	34"W	40"W	46"W	52"W	58"W	64"W	70"W	76"W
		Parametric	34"W	36 ¹ / ₁₆ "W	42 ¹ / ₁₆ "W	48 ¹ / ₁₆ "W	54 ¹ / ₁₆ "W	60 ¹ / ₁₆ "W	66 ¹ / ₁₆ "W	72 ¹ / ₁₆ "W
			-36"W	-42"W	-48"W	-54"W	-60"W	-66"W	-72"W	-78"W

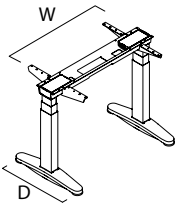

Rectangular Bases — Extended Height

OLELRQB	23" or 24"	\$2312	\$2386	\$2462	\$2542	\$2620	\$2710	\$2796	\$2882
	29" or 30"	\$2605	\$2688	\$2774	\$2862	\$2896	\$2943	\$2970	\$2989
	35" or 36"	\$2862	\$2888	\$2919	\$2933	\$2960	\$3002	\$3015	\$3020

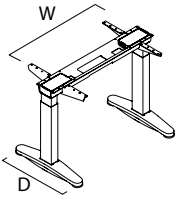

Rectangular Bases — Basic Height

OLSLRQB	23" or 24"	\$2132	\$2200	\$2271	\$2344	\$2418	\$2500	\$2577	\$2658
	29" or 30"	\$2402	\$2479	\$2557	\$2641	\$2668	\$2715	\$2740	\$2755
	35" or 36"	\$2641	\$2665	\$2692	\$2703	\$2730	\$2767	\$2778	\$2784

► Specification Information, continued on next page

 **For Canadian Pricing**
Multiply U.S. Price by the Canadian price factor.
► See page 1 for details.



► **Specification Information, continued from previous page**

Specification Information							
Style Number	Dimensions LD RD		Desk Type	U.S. Base Prices			
			Modular	58"W	64"W	70"W	76"W
			Parametric	58 ¹ / ₁₆ "W-60"W	60 ¹ / ₁₆ "W-66"W	66 ¹ / ₁₆ "W-72"W	72 ¹ / ₁₆ "W-78"W

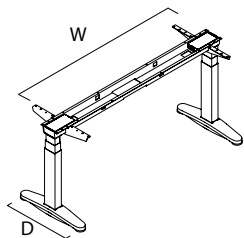

Tapered Bases — Extended Height

OLELRTB	23" or 24"	29" or 30"	\$2896	\$2943	\$2970	\$2989
	29" or 30"	23" or 24"	\$2896	\$2943	\$2970	\$2989

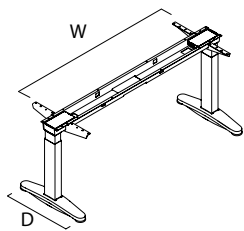

Tapered Bases — Basic Height

OLSLRTB	23" or 24"	29" or 30"	\$2668	\$2715	\$2740	\$2755
	29" or 30"	23" or 24"	\$2668	\$2715	\$2740	\$2755

► **Specification Information, continued on next page**



For Canadian Pricing

Multiply U.S. Price by the Canadian price factor.

► See page 1 for details.

► **Specification Information, continued from previous page**

Specification Information											
• Style Number	• Dimensions		• Modular	• U.S. Base Prices							
	D			Right Width	40"W	46"W	52"W	58"W	64"W	70"W	76"W
	• Modular	• Parametric	• Parametric	40"W	42 ¹ / ₁₆ "W	48 ¹ / ₁₆ "W	54 ¹ / ₁₆ "W	60 ¹ / ₁₆ "W	66 ¹ / ₁₆ "W	72 ¹ / ₁₆ "W	
	Left Width	Left Width	Right Width	42"W	48"W	54"W	60"W	66"W	72"W	78"W	

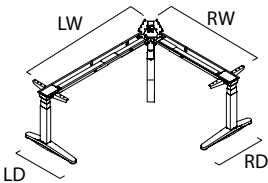

90° Corner 3-Leg Bases — Extended Height (Same Depth Both Ends 23"/24")

OLELL3B	23" or 24"	40"W	40"W—42"W	N.A.	N.A.	\$3536	\$3591	\$3647	\$3703	\$3760
	23" or 24"	46"W	42 ¹ / ₁₆ "W—48"W	N.A.	N.A.	\$3591	\$3647	\$3703	\$3760	\$3817
	23" or 24"	52"W	48 ¹ / ₁₆ "W—54"W	\$3536	\$3591	\$3647	\$3703	\$3760	\$3817	\$3873
	23" or 24"	58"W	54 ¹ / ₁₆ "W—60"W	\$3591	\$3647	\$3703	\$3760	\$3817	\$3873	\$3929
	23" or 24"	64"W	60 ¹ / ₁₆ "W—66"W	\$3647	\$3703	\$3760	\$3817	\$3873	\$3929	\$3984
	23" or 24"	70"W	66 ¹ / ₁₆ "W—72"W	\$3703	\$3760	\$3817	\$3873	\$3929	\$3984	\$4043
	23" or 24"	76"W	72 ¹ / ₁₆ "W—76"W	\$3760	\$3817	\$3873	\$3929	\$3984	\$4043	\$4102

Tip: At least one side must be 52"W or greater.

► **Specification Information, continued on next page**



For Canadian Pricing

Multiply U.S. Price by the Canadian price factor.

► See page 1 for details.

► **Specification Information, continued from previous page**

Specification Information												
Style Number	Dimensions				U.S. Base Prices							
	D		Modular Left Width	Parametric Left Width	Modular Right Width	Parametric Right Width	40"W	46"W	52"W	58"W	64"W	70"W
						40"W—42"W	42 ¹ / ₁₆ "W—48"W	48 ¹ / ₁₆ "W—54"W	54 ¹ / ₁₆ "W—60"W	60 ¹ / ₁₆ "W—66"W	66 ¹ / ₁₆ "W—72"W	72 ¹ / ₁₆ "W—78"W

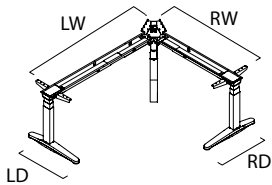

90° Corner 3-Leg Bases — Extended Height (Different Depth Opposite Ends 23"/24" Right/Left and 29"/30" Left/Right)

OLELL3B	23" or 24" R/L	29" or 30" L/R	40"W	40"W—42"W	N.A.	N.A.	► See page 70	► See page 70	► See page 70	► See page 70	► See page 70
	23" or 24" R/L	29" or 30" L/R	46"W	42 ¹ / ₁₆ "W—48"W	N.A.	N.A.	\$3746	\$3805	\$3861	\$3917	\$3973
	23" or 24" R/L	29" or 30" L/R	52"W	48 ¹ / ₁₆ "W—54"W	► See page 70	\$3746	\$3805	\$3861	\$3917	\$3973	\$4030
	23" or 24" R/L	29" or 30" L/R	58"W	54 ¹ / ₁₆ "W—60"W	\$3746	\$3805	\$3861	\$3917	\$3973	\$4030	\$4086
	23" or 24" R/L	29" or 30" L/R	64"W	60 ¹ / ₁₆ "W—66"W	\$3805	\$3861	\$3917	\$3973	\$4030	\$4086	\$4143
	23" or 24" R/L	29" or 30" L/R	70"W	66 ¹ / ₁₆ "W—72"W	\$3861	\$3917	\$3973	\$4030	\$4086	\$4143	\$4199
	23" or 24" R/L	29" or 30" L/R	76"W	72 ¹ / ₁₆ "W—78"W	\$3917	\$3973	\$4030	\$4086	\$4143	\$4199	\$4260

Tip: At least one side must be 52"W or greater.

► **Specification Information, continued on next page**

 **For Canadian Pricing**
 Multiply U.S. Price by the Canadian price factor.
 ► See page 1 for details.

► **Specification Information, continued from previous page**

Specification Information										
• Style Number	• Dimensions		• U.S. Base Prices							
	D		• Modular Right Width	40"W	46"W	52"W	58"W	64"W	70"W	76"W
	• Modular Left Width	• Parametric Left Width	• Parametric Right Width	40"W	42 ¹ / ₁₆ "W	48 ¹ / ₁₆ "W	54 ¹ / ₁₆ "W	60 ¹ / ₁₆ "W	66 ¹ / ₁₆ "W	72 ¹ / ₁₆ "W

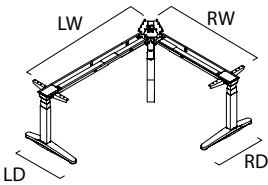

90° Corner 3-Leg Bases — Extended Height (Same Depth Both Ends 29"/30")

OLELL3B	29" or 30"	40"W	40"W—42"W	N.A.	N.A.	N.A.	N.A.	N.A.	N.A.	N.A.
	29" or 30"	46"W	42 ¹ / ₁₆ "W—48"W	N.A.	N.A.	\$3901	\$3958	\$4017	\$4072	\$4129
	29" or 30"	52"W	48 ¹ / ₁₆ "W—54"W	N.A.	\$3901	\$3958	\$4017	\$4072	\$4129	\$4184
	29" or 30"	58"W	54 ¹ / ₁₆ "W—60"W	N.A.	\$3958	\$4017	\$4072	\$4129	\$4184	\$4242
	29" or 30"	64"W	60 ¹ / ₁₆ "W—66"W	N.A.	\$4017	\$4072	\$4129	\$4184	\$4242	\$4298
	29" or 30"	70"W	66 ¹ / ₁₆ "W—72"W	N.A.	\$4072	\$4129	\$4184	\$4242	\$4298	\$4354
	29" or 30"	76"W	72 ¹ / ₁₆ "W—78"W	N.A.	\$4129	\$4184	\$4242	\$4298	\$4354	\$4412

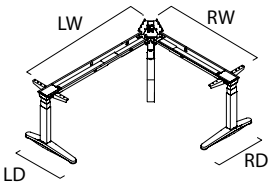

90° Corner 3-Leg Bases — Basic Height (Same Depth Both Ends 23"/24")

OLSLL3B	23" or 24"	40"W	40"W—42"W	N.A.	N.A.	\$3258	\$3310	\$3361	\$3415	\$3465
	23" or 24"	46"W	42 ¹ / ₁₆ "W—48"W	N.A.	N.A.	\$3310	\$3361	\$3415	\$3465	\$3516
	23" or 24"	52"W	48 ¹ / ₁₆ "W—54"W	\$3258	\$3310	\$3361	\$3415	\$3465	\$3516	\$3569
	23" or 24"	58"W	54 ¹ / ₁₆ "W—60"W	\$3310	\$3361	\$3415	\$3465	\$3516	\$3569	\$3621
	23" or 24"	64"W	60 ¹ / ₁₆ "W—66"W	\$3361	\$3415	\$3465	\$3516	\$3569	\$3621	\$3673
	23" or 24"	70"W	66 ¹ / ₁₆ "W—72"W	\$3415	\$3465	\$3516	\$3569	\$3621	\$3673	\$3724
	23" or 24"	76"W	72 ¹ / ₁₆ "W—78"W	\$3465	\$3516	\$3569	\$3621	\$3673	\$3724	\$3781

Tip: At least one side must be 52"W or greater.

► **Specification Information, continued on next page**



For Canadian Pricing

Multiply U.S. Price by the Canadian price factor.

► See page 1 for details.

► **Specification Information, continued from previous page**

Specification Information											
• Style Number	• Dimensions			• U.S. Base Prices							
	D			• Modular Right Width	• 40"W	• 46"W	• 52"W	• 58"W	• 64"W	• 70"W	• 76"W
		• Modular Left Width	• Parametric Left Width	• Parametric Right Width	• 40"W—	• 42 ¹ / ₁₆ "W—	• 48 ¹ / ₁₆ "W—	• 54 ¹ / ₁₆ "W—	• 60 ¹ / ₁₆ "W—	• 66 ¹ / ₁₆ "W—	• 72 ¹ / ₁₆ "W—
					42"W	48"W	54"W	60"W	66"W	72"W	78"W

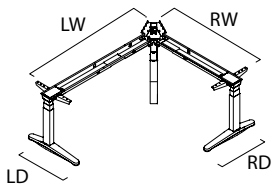

90° Corner 3-Leg Bases — Basic Height (Different Depth Opposite Ends 23"/24" Right/Left and 29"/30" Left/Right)

OLSLL3B	23" or 24" R/L	29" or 30" L/R	40"W	40"W—42"W	N.A.	N.A.	► See page 71	► See page 71	► See page 71	► See page 71	► See page 71
	23" or 24" R/L	29" or 30" L/R	46"W	42 ¹ / ₁₆ "W—48"W	N.A.	N.A.	\$3453	\$3503	\$3557	\$3608	\$3662
	23" or 24" R/L	29" or 30" L/R	52"W	48 ¹ / ₁₆ "W—54"W	► See page 71	\$3453	\$3503	\$3557	\$3608	\$3662	\$3712
	23" or 24" R/L	29" or 30" L/R	58"W	54 ¹ / ₁₆ "W—60"W	\$3453	\$3503	\$3557	\$3608	\$3662	\$3712	\$3764
	23" or 24" R/L	29" or 30" L/R	64"W	60 ¹ / ₁₆ "W—66"W	\$3503	\$3557	\$3608	\$3662	\$3712	\$3764	\$3816
	23" or 24" R/L	29" or 30" L/R	70"W	66 ¹ / ₁₆ "W—72"W	\$3557	\$3608	\$3662	\$3712	\$3764	\$3816	\$3867
	23" or 24" R/L	29" or 30" L/R	76"W	72 ¹ / ₁₆ "W—78"W	\$3608	\$3662	\$3712	\$3764	\$3816	\$3867	\$3924

Tip: At least one side must be 52"W or greater.

► **Specification Information, continued on next page**

 **For Canadian Pricing**
 Multiply U.S. Price by the Canadian price factor.
 ► See page 1 for details.

► **Specification Information, continued from previous page**

Specification Information										
• Style Number	• Dimensions		• Modular	• U.S. Base Prices						
	D			Right Width	40"W	46"W	52"W	58"W	64"W	70"W
	• Modular Left Width	• Parametric Left Width	• Parametric	40"W	42 ¹ / ₁₆ "W	48 ¹ / ₁₆ "W	54 ¹ / ₁₆ "W	60 ¹ / ₁₆ "W	66 ¹ / ₁₆ "W	72 ¹ / ₁₆ "W
			Right Width	42"W	48"W	54"W	60"W	66"W	72"W	78"W

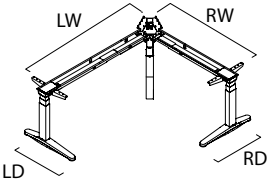

90° Corner 3-Leg Base — Basic Height (Same Depth Both Ends 29"/30")

OLSL3B	29" or 30"	40"W	40"W—42"W	N.A.	N.A.	N.A.	N.A.	N.A.	N.A.	N.A.
	29" or 30"	46"W	42 ¹ / ₁₆ "W—48"W	N.A.	N.A.	\$3596	\$3647	\$3699	\$3751	\$3805
	29" or 30"	52"W	48 ¹ / ₁₆ "W—54"W	N.A.	\$3596	\$3647	\$3699	\$3751	\$3805	\$3854
	29" or 30"	58"W	54 ¹ / ₁₆ "W—60"W	N.A.	\$3647	\$3699	\$3751	\$3805	\$3854	\$3908
	29" or 30"	64"W	60 ¹ / ₁₆ "W—66"W	N.A.	\$3699	\$3751	\$3805	\$3854	\$3908	\$3958
	29" or 30"	70"W	66 ¹ / ₁₆ "W—72"W	N.A.	\$3751	\$3805	\$3854	\$3908	\$3958	\$4012
	29" or 30"	76"W	72 ¹ / ₁₆ "W—78"W	N.A.	\$3805	\$3854	\$3908	\$3958	\$4012	\$4067

Tip: At least one side must be 52"W or greater.

► **Specification Information, continued on next page**

 **For Canadian Pricing**
Multiply U.S. Price by the Canadian price factor.
► See page 1 for details.

► **Specification Information, continued from previous page**

Specification Information											
• Style Number	• Dimensions D			• U.S. Base Prices							
		• Modular Left Width	• Parametric Left Width	• Modular Right Width	• Parametric Right Width	34"W	40"W	46"W	52"W	58"W	64"W
						34"W	40"W	46"W	52"W	58"W	64"W
						34"W	36 ¹ / ₁₆ "W	42 ¹ / ₁₆ "W	48 ¹ / ₁₆ "W	54 ¹ / ₁₆ "W	60 ¹ / ₁₆ "W
						36"W	42"W	48"W	54"W	60"W	66"W

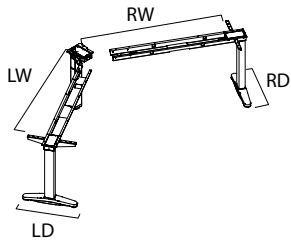

120° 3-Leg Corner Bases — Extended Height

OLELW3B	23" or 24"	34"W	34"W—36"W	\$3352	\$3405	\$3458	\$3512	\$3567	\$3621
		40"W	36 ¹ / ₁₆ "W—42"W	\$3405	\$3458	\$3512	\$3567	\$3621	\$3675
		46"W	42 ¹ / ₁₆ "W—48"W	\$3458	\$3512	\$3567	\$3621	\$3675	\$3730
		52"W	48 ¹ / ₁₆ "W—54"W	\$3512	\$3567	\$3621	\$3675	\$3730	\$3785
		58"W	54 ¹ / ₁₆ "W—60"W	\$3567	\$3621	\$3675	\$3730	\$3785	\$3839
		64"W	60 ¹ / ₁₆ "W—66"W	\$3621	\$3675	\$3730	\$3785	\$3839	\$3893

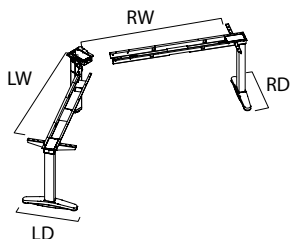

120° 3-Leg Corner Bases — Extended Height

OLELW3B	29" or 30"	34"W	34"W—36"W	\$3499	\$3554	\$3608	\$3663	\$3717	\$3770
		40"W	36 ¹ / ₁₆ "W—42"W	\$3554	\$3608	\$3663	\$3717	\$3770	\$3825
		46"W	42 ¹ / ₁₆ "W—48"W	\$3608	\$3663	\$3717	\$3770	\$3825	\$3878
		52"W	48 ¹ / ₁₆ "W—54"W	\$3663	\$3717	\$3770	\$3825	\$3878	\$3933
		58"W	54 ¹ / ₁₆ "W—60"W	\$3717	\$3770	\$3825	\$3878	\$3933	\$3987
		64"W	60 ¹ / ₁₆ "W—66"W	\$3770	\$3825	\$3878	\$3933	\$3987	\$4043

► **Specification Information, continued on next page**

For Canadian Pricing
 Multiply U.S. Price by the Canadian price factor.
 ► See page 1 for details.

► Specification Information, continued from previous page

Specification Information									
• Style Number	• Dimensions D	• U.S. Base Prices							
		• Modular Right Width	• Parametric Left Width	• Modular Right Width	• Parametric Left Width	• Modular Right Width	• Parametric Left Width	• Modular Right Width	• Parametric Left Width
		34"W	40"W	46"W	52"W	58"W	64"W		
		34"W	36 ¹ / ₁₆ "W	42 ¹ / ₁₆ "W	48 ¹ / ₁₆ "W	54 ¹ / ₁₆ "W	60 ¹ / ₁₆ "W		
		-36"W	-42"W	-48"W	-54"W	-60"W	-66"W		

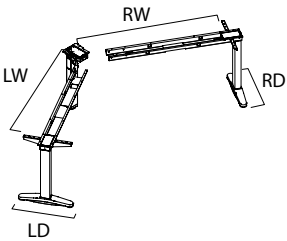

120° Corner 3-Leg Bases — Basic Height

OLSLW3B	23" or 24"	34"W	34"W—36"W	\$3077	\$3127	\$3176	\$3228	\$3279	\$3330
		40"W	36 ¹ / ₁₆ "W—42"W	\$3127	\$3176	\$3228	\$3279	\$3330	\$3380
		46"W	42 ¹ / ₁₆ "W—48"W	\$3176	\$3228	\$3279	\$3330	\$3380	\$3430
		52"W	48 ¹ / ₁₆ "W—54"W	\$3228	\$3279	\$3330	\$3380	\$3430	\$3479
		58"W	54 ¹ / ₁₆ "W—60"W	\$3279	\$3330	\$3380	\$3430	\$3479	\$3529
		64"W	60 ¹ / ₁₆ "W—66"W	\$3330	\$3380	\$3430	\$3479	\$3529	\$3581

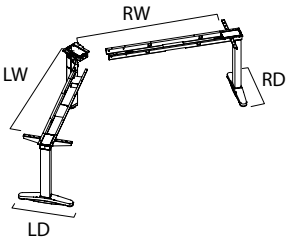

120° 3-Leg Corner Bases — Basic Height

OLSLW3B	29" or 30"	34"W	34"W—36"W	\$3225	\$3276	\$3328	\$3378	\$3426	\$3475
		40"W	36 ¹ / ₁₆ "W—42"W	\$3276	\$3328	\$3378	\$3426	\$3475	\$3525
		46"W	42 ¹ / ₁₆ "W—48"W	\$3328	\$3378	\$3426	\$3475	\$3525	\$3575
		52"W	48 ¹ / ₁₆ "W—54"W	\$3378	\$3426	\$3475	\$3525	\$3575	\$3624
		58"W	54 ¹ / ₁₆ "W—60"W	\$3426	\$3475	\$3525	\$3575	\$3624	\$3674
		64"W	60 ¹ / ₁₆ "W—66"W	\$3475	\$3525	\$3575	\$3624	\$3674	\$3724

 **For Canadian Pricing**
Multiply U.S. Price by the Canadian price factor.
► See page 1 for details.



Ology Modesty Panels

High-Pressure Laminate or Wood Veneer

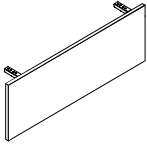

Tip: Modesty panels cannot be used on desks with integrated rail. To use with the integrated rail, the modesty panel must be undersized by a minimum of 12" (rectangular and tapered) or 7" (90°) and inset from the edge of the worksurface.

For laminate price group 2 and 3 pricing, please refer to the electronic catalog or SmartTools.

Tip: Modular modesty panels are undersized 2½" to account for desks with radius corners.

Tip: When using a modesty panel on straight and taper parametric sized desks, modesty panel width must be verified in CET to avoid interference.

Tip: Modesty panels are defaulted in the horizontal grain direction for both laminate and wood veneer. Optional vertical grain direction can be specified, however, laminate specification is only allowed up to 60" wide.

Standard Includes	Required to Specify
-------------------	---------------------

<ul style="list-style-type: none"> ▶ Need help? Product details, page 74 • Panel: High-Pressure Laminate price group 1 or wood group 1 veneer • Modular widths: 34"—76" • Attachment hardware 	<ol style="list-style-type: none"> 1 Style number 2 Panel type (see below under Required Selections) 3 Panel width 4 High-Pressure Laminate or wood color for panel 5 Options, if selected (see below) <ul style="list-style-type: none"> ▶ See <i>Surface Materials</i>, page 274.
---	---

Panel Type	Required Selections	U.S. Price	Required to Specify
------------	---------------------	------------	---------------------

Panel Type	<ul style="list-style-type: none"> • Modular width panel • Parametric width panel 	No cost No cost	Specify <i>with modular panel type</i> . Specify <i>with parametric panel type</i> .
-------------------	---	--------------------	---

Surface Materials	Options	U.S. Price	Required to Specify
-------------------	---------	------------	---------------------

Surface Materials	High-Pressure Laminate		
	<ul style="list-style-type: none"> • Laminate price group 2 • Laminate price group 3 • Open Line laminate 	See information at left See information at left +\$102 plus cost of laminate	Specify laminate color number. Specify laminate color number. ▶ See <i>Surface Materials Reference Manual</i> .
	Wood veneer		
	<ul style="list-style-type: none"> • Wood group 2 • Wood group 3 • Customiz stain 	+\$102 +\$359 No cost	Specify wood color number. Specify wood color number. Specify <i>with customiz stain</i> . ▶ See <i>Surface Materials Reference Manual</i> .
	<ul style="list-style-type: none"> • Full-fill finish on wood group 1 	+\$102	Specify full-fill finish number.
	Grain direction		
	<ul style="list-style-type: none"> • Horizontal grain direction • Vertical grain direction 	No cost No cost	Specify <i>with horizontal grain direction</i> . Specify <i>with vertical grain direction</i> .

Specification Information

Style Number	Panel Type	U.S. Base Prices								
		34"W	40"W	46"W	52"W	58"W	64"W	70"W	76"W	
	Modular	34"W	40"W	46"W	52"W	58"W	64"W	70"W	76"W	
	Parametric	34"W	36½" W	42½" W	48½" W	54½" W	60½" W	66½" W	72½" W	
		36"W	42"W	48"W	54"W	60"W	66"W	72"W	78"W	
	Weight	15.2 lb	17.6 lb	20.0 lb	22.4 lb	24.8 lb	27.3 lb	29.7 lb	32.1 lb	

High-Pressure Laminate

OLMP	\$288	\$289	\$295	\$301	\$305	\$314	\$322	\$330
-------------	-------	-------	-------	-------	-------	-------	-------	-------

Wood Veneer

OLMP	\$360	\$365	\$373	\$379	\$383	\$394	\$404	\$415
-------------	-------	-------	-------	-------	-------	-------	-------	-------

Cable Riser

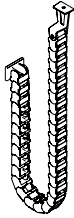

Fence connection



Leg connection

Tip: Cable riser leg connection is not compatible with the Flex height adjustable desk.

Standard Includes		Required to Specify
<ul style="list-style-type: none"> ▶ Need help? Product details, page 48 	<ul style="list-style-type: none"> • Cable riser with fence connection: 7360 Merle paint • Attachment hardware 	<ul style="list-style-type: none"> 1 Style number 2 Options, if selected (see below)
Options		Required to Specify
Connection	<ul style="list-style-type: none"> • Fence • Leg 	<ul style="list-style-type: none"> Specify with fence connection. Specify with leg connection.
	U.S. Price	
	No cost	
	+\$152	

Specification Information	
Style Number	U.S. Base Price
OLCR	\$104

Cable Basket

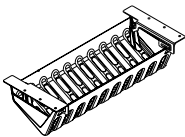

Tip: Cable baskets are compatible with rectangular, tapered, or 90° corner desks 46¹/₈"W or larger and 120° corner desks 40¹/₁₆"W or larger.

Tip: Cable basket attaches to the worksurface with brackets, which requires an 8" depth clearance to mount.

Standard Includes		Required to Specify
<ul style="list-style-type: none"> ▶ Need help? Product details, page 48 	<ul style="list-style-type: none"> • Cable basket: 6527 Merle plastic 	<ul style="list-style-type: none"> Style number
Specification Information		
Dimensions	Style Number	U.S. Price
D W H		
8" 18" 4 ¹ / ₂ "	OLCB	\$82

Cable Brackets

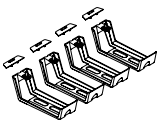

For Canadian Pricing
 Multiply U.S. Price by the Canadian price factor.
 ▶ See page 1 for details.

Standard Includes		Required to Specify
<ul style="list-style-type: none"> ▶ Need help? Product details, page 48 	<ul style="list-style-type: none"> • Cable brackets, quantity of four: 6527 Merle plastic 	<ul style="list-style-type: none"> Style number
Specification Information		
Dimensions	Style Number	U.S. Price
D H		
6" 2"	OLCBK4	\$50

Active Touch Controller Kit

For Ology Desks

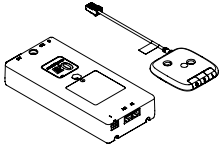

Tip: Active touch controller kit can upgrade any existing Ology desk or base as a replacement to the up/down or 4-preset programmable controller.

Tip: Tapered and rectangle Ology desks require the standard 2-leg application; corner Ology desks require 3-leg application.

Tip: The standard active touch controller is Bluetooth-enabled to allow pairing with the Steelcase Rise app.

Standard Includes	Required to Specify
-------------------	---------------------

- Active touch controller
- 2-leg application

- 1 Style number
- 2 Options, if selected (see below)

Options	U.S. Price	Required to Specify
---------	------------	---------------------

Leg Application

- 3-leg

+\$195

Specify *with 3-leg*.

Specification Information

Style Number	U.S. Base Price
--------------	-----------------

OLATKT	\$388
---------------	-------



For Canadian Pricing

Multiply U.S. Price by the Canadian price factor.

► See page 1 for details.

Universal Steel One-High and 1.5-High Open Laterals

For Ology Application

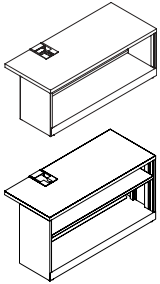

Drawings show right-hand application, left hand is also available.

Tip: Right-hand or left-hand application is determined by which leg of the Ology desk is located inside the storage.

Tip: Only available for Ology desks specified with modular widths.

For laminate group 2 and 3 pricing, please refer to the electronic catalog or SmartTools.

Standard Includes		Required to Specify
<ul style="list-style-type: none"> ▶ Need help? Product details, page 76 	<ul style="list-style-type: none"> Lateral case: paint price group 1 1$\frac{3}{4}$"H top: laminate price group 1, if selected <ul style="list-style-type: none"> – Edge: plastic 1$\frac{3}{4}$"H top: wood group 1, if selected Four adjustable leveling glides Grommet Wire manager Ganging hardware 	<ol style="list-style-type: none"> Style number Paint color number for lateral case Width (see below under Required Selections) Laminate color number for top, if laminate top selected Plastic color number for edge, if laminate top selected Wood color number for top, if wood top selected Front style (see below under Required Selections) Application (see below under Required Selections) Options, if selected (see below) <ul style="list-style-type: none"> ▶ See <i>Surface Materials</i>, page 274.

	Required Selections	U.S. Price	Required to Specify
Width	<ul style="list-style-type: none"> 30"W 36"W 42"W 	Prices at right Prices at right Prices at right	Specify with 30" width. Specify with 36" width. Specify with 42" width.
Front Style	<ul style="list-style-type: none"> Flush steel front Proud steel front 	Prices at right Prices at right	Specify with flush steel front. Specify with proud steel front.
Application	<ul style="list-style-type: none"> Right hand Left hand 	No cost No cost	Specify with right-hand application. Specify with left-hand application.

	Options	U.S. Price	Required to Specify
Surface Materials	<ul style="list-style-type: none"> Paint price group 1 Paint price group 2 Paint price group 3 	No cost +\$111 +\$192	Specify paint color number. Specify paint color number. Specify paint color number.
Tops	<p>No top</p> <ul style="list-style-type: none"> For use beneath a Universal common top <p>Laminate top</p> <ul style="list-style-type: none"> Laminate price group 2 Laminate price group 3 Open Line laminate <p>Wood veneer top</p> <ul style="list-style-type: none"> Wood group 1 Wood group 2 Wood group 3 Customiz stain 	–\$147 See information at left See information at left +\$102 plus cost of laminate +\$619 +\$663 +\$758 No cost	Specify with no top. Specify laminate color number. Specify laminate color number. ▶ See <i>Surface Materials Reference Manual</i> . Specify with wood veneer top and indicate wood color number. Specify with wood veneer top and indicate wood color number. Specify with wood veneer top and indicate wood color number. Specify with customiz stain. ▶ See <i>Surface Materials Reference Manual</i> .
Related Products	<ul style="list-style-type: none"> Universal common tops Universal shrouds Universal filler 		<ul style="list-style-type: none"> ▶ Page 118 ▶ Page 116 ▶ Page 117



For Canadian Pricing
 Multiply U.S. Price by the Canadian price factor.
 ▶ See page 1 for details.

Specification Information

Style Number	Dimensions			U.S. Base Prices	
	D	W	H	Flush Steel Front	Proud Steel Front

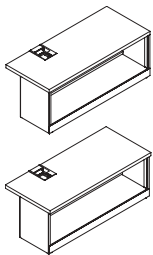

One-High Open Lateral

RSCHAD	D	W	H	Flush Steel Front	Proud Steel Front
	18"	18 ⁷ / ₈ "	30"	\$1509	\$1596
	18"	18 ⁷ / ₈ "	36"	\$1666	\$1773
	18"	18 ⁷ / ₈ "	42"	\$1815	\$1932

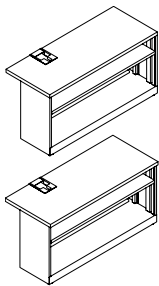

1.5-High Open Lateral

RSCBHD	D	W	H	Flush Steel Front	Proud Steel Front
	18"	18 ⁷ / ₈ "	30"	\$1839	\$1946
	18"	18 ⁷ / ₈ "	36"	\$2031	\$2162
	18"	18 ⁷ / ₈ "	42"	\$2214	\$2357

 **For Canadian Pricing**
Multiply U.S. Price by the
Canadian price factor.
▶ See page 1 for details.



Universal Shrouds

For Use with Universal Steel One-High and 1.5-High Open Laterals, Ology Application

Standard Includes		Required to Specify
-------------------	--	---------------------

▶ Need help? Product details, page 76	<ul style="list-style-type: none"> • Shroud: paint price group 1 • Attachment hardware 	1 Style number 2 Width (see below under Required Selections) 3 Paint color number for shroud 4 Options, if selected (see below) ▶ See <i>Surface Materials</i> , page 274.
---	--	--

Tip: Universal shroud width must match width of the universal Steel One-High or 1.5-High open lateral for Ology applications.

Required Selections	U.S. Price	Required to Specify
---------------------	------------	---------------------

Width	<ul style="list-style-type: none"> • 30"W • 36"W • 42"W 	No cost No cost No cost
		Specify with 30" width. Specify with 36" width. Specify with 42" width.

Options	U.S. Price	Required to Specify
---------	------------	---------------------

Surface Materials	<ul style="list-style-type: none"> • Paint price group 1 • Paint price group 2 • Paint price group 3 	No cost +\$45 +\$74
		Specify paint color number. Specify paint color number. Specify paint color number.

Related Products	<ul style="list-style-type: none"> • Universal Steel One-High and 1.5-High open lateral files for Ology application 	▶ Page 114
-------------------------	--	------------

Specification Information

Dimensions		Style Number	U.S. Base Price
D	H		
:	:	:	:
:	:	:	:

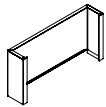

One-High Shroud

6"	16"	RPXSHAD	\$114
:	:	:	:

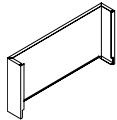

1.5-High Shroud

6"	22"	RPXSBHAD	\$129
:	:	:	:



For Canadian Pricing

Multiply U.S. Price by the Canadian price factor.

▶ See page 1 for details.

Universal Filler

For Use with Universal Steel One-High and 1.5-High Open Laterals, Ology Application

Standard Includes		Required to Specify
▶ Need help? Product details, page 76	<ul style="list-style-type: none"> • Filler: paint • Attachment hardware 	1 Style number 2 Paint color number for filler ▶ See <i>Surface Materials</i> , page 274.

Related Products	
<ul style="list-style-type: none"> • Universal Steel One-High and 1.5-High open lateral files for Ology applications 	▶ Page 114

Specification Information			
Dimensions		Style	U.S.
D	H	Number	Price

One-High Filler

6"	16"	RPXFHAD	\$ 81
:	:	:	:

1.5-High Filler

6"	22"	RPXFBHAD	\$101
:	:	:	:



For Canadian Pricing

Multiply U.S. Price by the Canadian price factor.

▶ See page 1 for details.

Universal Common Tops

For Use with Universal Steel One-High and 1.5-High Open Laterals and Credenzas, Ology Application

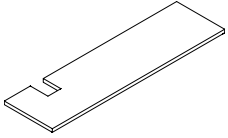

Drawing shows right-hand application, left hand is also available.

	Standard Includes	Required to Specify
▶ Need help? Product details, page 78	<ul style="list-style-type: none"> 1 3/16"H top: laminate price group 1, if selected <ul style="list-style-type: none"> – Edge: plastic 1 3/16"H top: wood group 1, if selected 	<ol style="list-style-type: none"> Style number Width (see below under Required Selections) Laminate color number for top, if laminate top selected Plastic color number for edge, if laminate top selected Wood color number on top, if wood top selected Front style (see below under Required Selections) Application (see below under Required Selections) Options, if selected (see below) <p>▶ See <i>Surface Materials</i>, page 274.</p>

	Required Selections	U.S. Price	Required to Specify
Width	<ul style="list-style-type: none"> 60"W 66"W 72"W 78"W 84"W 90"W 96"W 108"W 	<ul style="list-style-type: none"> Prices at right Prices at right Prices at right Prices at right Prices at right Prices at right Prices at right Prices at right 	<ul style="list-style-type: none"> Specify with 60" width. Specify with 66" width. Specify with 72" width. Specify with 78" width. Specify with 84" width. Specify with 90" width. Specify with 96" width. Specify with 108" width.
Front Style	<ul style="list-style-type: none"> Flush front Proud front 	<ul style="list-style-type: none"> No cost No cost 	<ul style="list-style-type: none"> Specify with flush front. Specify with proud front.
Application	<ul style="list-style-type: none"> Right hand Left hand 	<ul style="list-style-type: none"> No cost No cost 	<ul style="list-style-type: none"> Specify with right-hand application. Specify with left-hand application.

Tip: Right-hand or left-hand application is determined by which leg of the Ology desk is located inside the storage.

For wood and laminate group 2 and 3 pricing, please refer to the electronic catalog or SmartTools.

	Options	U.S. Price	Required to Specify
Surface Materials	<p>Laminate top</p> <ul style="list-style-type: none"> Laminate price group 2 Laminate price group 3 Open Line laminate 	<ul style="list-style-type: none"> See information at left See information at left +\$102 plus cost of laminate 	<ul style="list-style-type: none"> Specify laminate color number. Specify laminate color number. ▶ See <i>Surface Materials Reference Manual</i>.
	<p>Wood veneer top</p> <ul style="list-style-type: none"> Wood group 2 Wood group 3 Customiz stain Full-fill finish on wood group 1 	<ul style="list-style-type: none"> See information at left See information at left No cost Prices at right 	<ul style="list-style-type: none"> Specify with wood veneer top and indicate wood color number. Specify with wood veneer top and indicate wood color number. Specify with customiz stain. ▶ See <i>Surface Materials Reference Manual</i>. Specify with full-fill finish and select wood color number. ▶ See <i>Surface Materials Reference Manual</i>.
Related Products	<ul style="list-style-type: none"> Universal Steel One-High and 1.5-High open lateral files for Ology application Universal shrouds Universal filler 		<ul style="list-style-type: none"> ▶ Page 114 ▶ Page 116 ▶ Page 117



For Canadian Pricing
Multiply U.S. Price by the Canadian price factor.
▶ See page 1 for details.

Specification Information						
Style Number	Dimensions		W	U.S. Base Prices		Options (Add \$ to Base Price)
	Flush Front	Proud Front		Laminate	Veneer	
RATCTHAD	18"	18 ⁷ / ₈ "	60"	\$ 463	\$1040	+\$ 69
	18"	18 ⁷ / ₈ "	66"	\$ 534	\$1097	+\$ 69
	18"	18 ⁷ / ₈ "	72"	\$ 603	\$1150	+\$ 69
	18"	18 ⁷ / ₈ "	78"	\$ 763	\$1376	+\$ 69
	18"	18 ⁷ / ₈ "	84"	\$ 862	\$1565	+\$102
	18"	18 ⁷ / ₈ "	90"	\$ 960	\$1655	+\$102
	18"	18 ⁷ / ₈ "	96"	\$1059	\$1825	+\$102
	18"	18 ⁷ / ₈ "	108"	\$1272	N.A.	N.A.

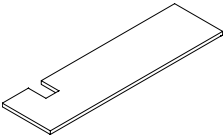

Tip: Can not order veneer on 108"W Universal common top.

Ology

 **For Canadian Pricing**
 Multiply U.S. Price by the Canadian price factor.
 ▶ See page 1 for details.

Elective Elements One-High Open Plinth Base Pedestals

For Ology Application

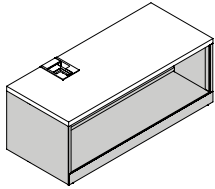

Tip: Leveling glides adjust up to 3/4".

Tip: Drawings show right-hand application, left hand is also available.

Tip: Right-hand or left-hand application is determined by which leg of the Ology desk is located inside the storage.

For laminate price group 2 and 3 pricing, please refer to the electronic catalog or SmartTools.

Tip: Only available for Ology desks specified with modular widths.

Standard Includes		Required to Specify
<ul style="list-style-type: none"> ▶ Need help? Product details, page 78 	<ul style="list-style-type: none"> • Case with back panel: wood group 1 veneer or laminate price group 1 • Grommet • Removable interior cover • Wire manager • Leveling glides 	<ol style="list-style-type: none"> 1 Style number 2 Width (see below under Required Selections) 3 Wood or laminate color number for case 4 Application (see below under Required Selections) 5 Options, if selected (see below) <ul style="list-style-type: none"> ▶ See <i>Surface Materials</i>, page 274.

Required Selections	U.S. Price	Required to Specify
Width	<ul style="list-style-type: none"> • 24"W Price below • 30"W Price below • 36"W Price below • 42"W Price below 	<ul style="list-style-type: none"> Specify with 24"W. Specify with 30"W. Specify with 36"W. Specify with 42"W.
Application	<ul style="list-style-type: none"> • Right hand No cost • Left hand No cost 	<ul style="list-style-type: none"> Specify with right-hand application. Specify with left-hand application.

Options	U.S. Price	Required to Specify
Surface Materials	<p>Case</p> <ul style="list-style-type: none"> • Laminate price group 1 -\$215 • Laminate price group 2 See information at left • Laminate price group 3 See information at left • Open Line laminate -\$181 plus cost of laminate • Wood group 2 +\$ 62 • Wood group 3 +\$222 • Full-fill finish on wood group 1 No cost • Customiz stain No cost 	<ul style="list-style-type: none"> Specify laminate color number. Specify laminate color number. Specify laminate color number. ▶ See <i>Surface Materials Reference Manual</i>. Specify wood color number. Specify wood color number. Specify wood veneer color number. Specify with <i>Customiz stain</i>.
Grain Direction	<ul style="list-style-type: none"> • No grain direction No cost • Vertical No cost • Horizontal No cost 	<ul style="list-style-type: none"> Specify with no grain direction. Specify with vertical grain direction. Specify with horizontal grain direction.
Related Products	<ul style="list-style-type: none"> • Elective Elements common tops for Ology application 	<ul style="list-style-type: none"> ▶ Page 122

Specification Information					
Style Number	Dimensions			U.S. Base Price	Option (Add \$ to Base Price)
	D	H	W		
E6PDHAD	17 1/4"	15 1/2"	24"	\$2170	-\$178
	17 1/4"	15 1/2"	30"	\$2316	-\$204
	17 1/4"	15 1/2"	36"	\$2460	-\$227
	17 1/4"	15 1/2"	42"	\$2609	-\$254
:	:	:	:	:	:

 **For Canadian Pricing**
 Multiply U.S. Price by the Canadian price factor.
 ▶ See page 1 for details.



Elective Elements Common Tops

For Ology Application

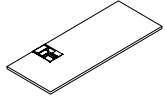

Tip: Drawings show right-hand application, left hand is also available.

Standard Includes	Required to Specify
<ul style="list-style-type: none"> ▶ Need help? Product details, page 78 • Tops: wood group 1 veneer or laminate price group 1 • Wood tops with wood edge: <ul style="list-style-type: none"> – 3 mm wood square profile on user side – 0.5 mm veneer on other sides • Laminate tops with plastic edge: <ul style="list-style-type: none"> – 3 mm plastic edge on user's side – 1 mm plastic edge on other sides, plastic default to match user's side • Laminate tops with wood edge: <ul style="list-style-type: none"> – Solid wood edge on user's side – 1 mm plastic edge on other sides, plastic default to match worksurface 	<ol style="list-style-type: none"> 1 Style number 2 Width (see below under Required Selections) 3 Wood or laminate color number 4 Wood edge color number for all sides on wood worksurfaces, if selected 5 Plastic edge color number for all sides on laminate worksurfaces, if selected 6 Tops profile (see below under Required Selections) 7 Application (see below under Required Selections) 8 Options, if selected (see below) <p>▶ See <i>Surface Materials</i>, page 274.</p>

Width	Required Selections	U.S. Price	Required to Specify
	• 24"W	Prices at right	Specify with 24"W.
	• 30"W	Prices at right	Specify with 30"W.
	• 36"W	Prices at right	Specify with 36"W.
	• 42"W	Prices at right	Specify with 42"W.
	• 48"W	Prices at right	Specify with 48"W.
	• 54"W	Prices at right	Specify with 54"W.
	• 60"W	Prices at right	Specify with 60"W.
	• 66"W	Prices at right	Specify with 66"W.
	• 72"W	Prices at right	Specify with 72"W.
	• 78"W	Prices at right	Specify with 78"W.
	• 84"W	Prices at right	Specify with 84"W.
	• 90"W	Prices at right	Specify with 90"W.
	• 96"W	Prices at right	Specify with 96"W.
	• 102"W	Prices at right	Specify with 102"W.
	• 108"W	Prices at right	Specify with 108"W.
	• 114"W	Prices at right	Specify with 114"W.
	• 120"W	Prices at right	Specify with 120"W.

Wood Common Top Edge Profile **Laminate Common Top Edge Profile**

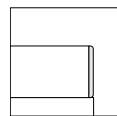

Wood Square Profile

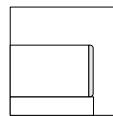

Plastic Square Profile

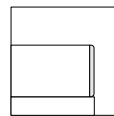

Wood Square Profile

Prices at right

Tip: Right-hand or left-hand application is determined by which leg of the Ology desk is located inside the storage.

Application			
• Left-hand application	No cost		Specify with Ology left-hand application.
• Right-hand application	No cost		Specify with Ology right-hand application.



For Canadian Pricing

Multiply U.S. Price by the Canadian price factor.

▶ See page 1 for details.

	Options	U.S. Price	Required to Specify
Surface Materials	Wood veneer tops		
	<ul style="list-style-type: none"> • Wood group 2 • Wood group 3 • Full-fill finish on wood group 1 • Customiz stain 	Prices below Prices below Prices below No cost	Specify wood color number. Specify wood color number. Specify wood veneer color number. Specify with <i>Customiz stain</i> .
	Laminate tops		
	<ul style="list-style-type: none"> • Laminate price group 1 • Laminate price group 2 • Laminate price group 3 • Open Line laminate 	Prices below See information at left See information at left Prices below plus cost of laminate	Specify laminate color number. Specify laminate color number. Specify laminate color number. ▶ See <i>Surface Materials Reference Manual</i> .
	<ul style="list-style-type: none"> • Wood group 2 • Wood group 3 	Prices below Prices below	Specify wood color number. Specify wood color number.
Grain Direction	Veneer tops		
	<ul style="list-style-type: none"> • Long grain • Short grain 	No cost No cost	Specify with <i>long grain</i> . Specify with <i>short grain</i> .
	Laminate tops		
	<ul style="list-style-type: none"> • No grain direction • Long grain • Short grain (on 60"W) 	No cost No cost No cost	Specify with <i>no grain direction</i> . Specify with <i>long grain</i> . Specify with <i>short grain</i> .
Related Products	<ul style="list-style-type: none"> • Elective Elements One-High open plinth base pedestals for Ology application • Ology modesty panels • Fixed personal/modesty screens 		▶ Page 120 ▶ Page 110 ▶ Page 254

For laminate group 2 and 3 pricing, please refer to the electronic catalog or SmartTools.

Tip: Short grain on laminate tops is only available on 60"W.

Specification Information

Style Number	Dimensions		U.S. Base Prices			Options (Add \$ to Base Price)			
	D	W	Wood Group 1	Laminate		Wood		Full-Fill Finish on Wood Group 1	Open Line Laminate
			Wood Square Edge	3 mm Plastic Square Edge	Wood Square Edge	Wood Group 2	Wood Group 3		
E6WSHAD	18"	24"	\$ 743	\$ 315	\$ 644	+\$ 41	+\$138	+\$ 44	-\$327
	18"	30"	\$ 789	\$ 361	\$ 690	+\$ 41	+\$138	+\$ 44	-\$327
	18"	36"	\$ 809	\$ 381	\$ 710	+\$ 69	+\$240	+\$ 69	-\$327
	18"	42"	\$ 896	\$ 414	\$ 792	+\$ 69	+\$240	+\$ 69	-\$379
	18"	48"	\$ 967	\$ 485	\$ 863	+\$ 69	+\$240	+\$ 69	-\$379
	18"	54"	\$1000	\$ 518	\$ 896	+\$ 69	+\$240	+\$ 69	-\$379
	18"	60"	\$1090	\$ 552	\$ 973	+\$102	+\$358	+\$102	-\$435
	18"	66"	\$1159	\$ 621	\$1042	+\$102	+\$358	+\$102	-\$435
	18"	72"	\$1239	\$ 701	\$1122	+\$102	+\$358	+\$102	-\$435
	18"	78"	\$1305	\$ 767	\$1188	+\$102	+\$358	+\$102	-\$435
	18"	84"	\$1585	\$1047	\$1468	+\$102	+\$358	+\$102	-\$435
	18"	90"	\$1850	\$1312	\$1733	+\$102	+\$358	+\$102	-\$435
	18"	96"	\$2128	\$1590	\$2011	+\$102	+\$358	+\$102	-\$435
	18"	102"	\$2446	\$1854	\$2321	+\$141	+\$493	+\$141	-\$488
	18"	108"	\$2811	\$2219	\$2686	+\$141	+\$493	+\$141	-\$488
	18"	114"	\$3235	\$2643	\$3110	+\$141	+\$493	+\$141	-\$488
	18"	120"	\$3719	\$3127	\$3594	+\$141	+\$493	+\$141	-\$488

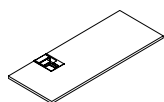

 **For Canadian Pricing**
 Multiply U.S. Price by the Canadian price factor.
 ▶ See page 1 for details.

