



West Elm Work Collection Specification Guide

Availability

Electronic price list updated with release 200.M (U.S.) and 156.M (Canada), dated June 17, 2024.

All specifications subject to change without notice. Reference the electronic catalog/Hedberg for current pricing.

Transitional products in this specification guide are **maintained for existing customers only** and are likely to be phased out over time. These products are indicated with a . Products that are scheduled to be culled are indicated with an , followed by the last order entry date.

Surface Materials

The surface materials team has announced the launch of the Finish Library, found at www.steelcase.com/finishlibrary/.

► For a list of all trademarks, refer to the last page of this specification guide. © 2024 Steelcase Inc.

Additional Resources 2

Statement of Line 4

Seating

Belle	18
Boardwalk	22
Brighton	26
Mesa	30
Willow	34
Slope	38
Sterling	42
Kent	46
Lucas	50
Fulton	54

Furniture

Greenpoint	57
Sutton	84

Specifying

West Elm – Steelcase	89
West Elm – Licensed	243

Resources and Surface Materials 257



For Canadian Pricing

Canadian factor can be found at www.steelcase.com/CADpricing.

Calculate in the following order to avoid rounding errors:

- Multiply the base price and each option by the Canadian factor.
- Round each to the nearest dollar.
- Add base and options for total list price.

Additional Resources

The West Elm Work Collection is supported with an array of informational materials, tools, and software to help you plan and install efficiently.

Surface Materials

West Elm Work Collection Materials Swatches Individual swatches, larger memo samples, and family group swatch cards are available by contacting Ad Stock at 1.800.784.0358 or by ordering electronically at village.steelcase.com.

Computer Tools

Digital Publications You can access these digital publications at www.steelcase.com or village.steelcase.com.

Electronic Catalog

Accurate sales quotations and purchase orders for West Elm products are created with specification software that uses West Elm Electronic Catalog data. Use the data to specify and price style numbers and options for every West Elm product. The data is updated bimonthly by Steelcase and provided to software programs like the Hedberg Business System, 20-20 CAP Studio.

Furniture Symbol Graphic Data

Steelcase creates 2D and 3D furniture symbols (with attributes) for planning and initially specifying Steelcase products. This data is incorporated into several add-on software packages that work in either a Microstation or an AutoCAD drafting environment.

For more information about these and other software tools to help you plan effective work environments, please email fsl@steelcase.com.

Support

Steelcase Capabilities

Steelcase products are distributed, installed, and serviced through a network of more than 600 dealers worldwide. Steelcase is also represented with offices and corporate showrooms in 26 U.S. cities, 4 Canadian cities, and in France, Germany, Great Britain, and Japan. Every Steelcase product meets our exceptionally high standards of quality and durability and comes with the Steelcase assurance of excellence in service.

For ordering or product assistance,

call your local dealer, the Steelcase Solutions Resource Team, or the Steelcase Solutions Fulfillment Team at 1.888.STEELCASE or send an e-mail to lineone@steelcase.com.

Call the Steelcase Solutions Resource Team prior to placing an order, when working on a bid, or when you need information about product applications and specifications.

Call the Steelcase Solutions Fulfillment Team if you have submitted an order to Steelcase and you need to speak to your Solutions Fulfillment Team Representative about the order. Also call if you have any post-shipment quality concerns or service parts questions.

For warranty information, please go to <http://www.steelcase.com/warranty/>.

Outside the U.S.A., Canada, Mexico, Puerto Rico, and the U.S. Virgin Islands, call 1.616.247.2500.

Statement of Line

Seating

Belle

Lounge Seating

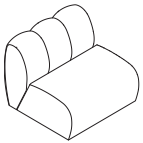

Belle One-Seat Lounge

Understanding
▶ Page 18
Specifying
▶ Page 90

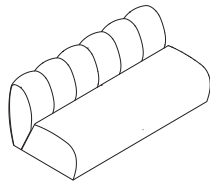

Belle Two-Seat Lounge

Understanding
▶ Page 18
Specifying
▶ Page 92

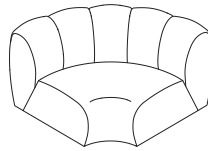

Belle Corner Lounge

Understanding
▶ Page 18
Specifying
▶ Page 95

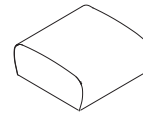

Belle Ottoman

Understanding
▶ Page 18
Specifying
▶ Page 97

Boardwalk

Lounge Seating

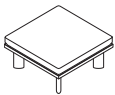

Boardwalk One-Seat Lounge

Understanding
▶ Page 22
Specifying
▶ Page 98

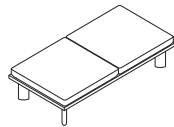

Boardwalk Two-Seat Lounge

Understanding
▶ Page 22
Specifying
▶ Page 100

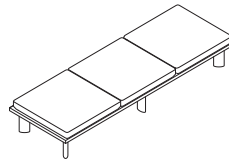

Boardwalk Three-Seat Lounge

Understanding
▶ Page 22
Specifying
▶ Page 103

Occasional Tables

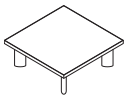

Boardwalk 30\"/>

Understanding
▶ Page 22
Specifying
▶ Page 107

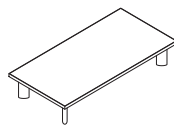

Boardwalk 30\"/>

Understanding
▶ Page 22
Specifying
▶ Page 108

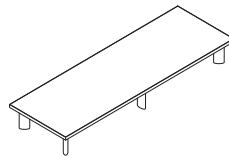

Boardwalk 30\"/>

Understanding
▶ Page 22
Specifying
▶ Page 109

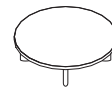

Boardwalk 40\"/>

Understanding
▶ Page 22
Specifying
▶ Page 110

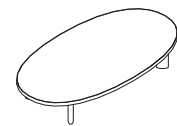

Boardwalk 35\"/>

Understanding
▶ Page 22
Specifying
▶ Page 111

Accessories

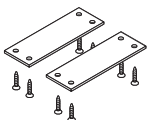

Ganging Kit

Understanding
▶ Page 23
Specifying
▶ Page 112

Seating, continued

Brighton

Lounge Seating



Brighton One-Seat Lounge
Understanding
▶ Page 26
Specifying
▶ Page 114

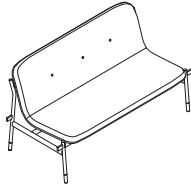

Brighton Two-Seat Lounge
Understanding
▶ Page 26
Specifying
▶ Page 116



Brighton Ottoman
Understanding
▶ Page 26
Specifying
▶ Page 118

Occasional Tables



Brighton 60° Ganging Table
Understanding
▶ Page 26
Specifying
▶ Page 119



Brighton 90° Ganging Table
Understanding
▶ Page 26
Specifying
▶ Page 120

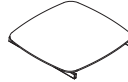

Brighton Straight Ganging Table
Understanding
▶ Page 26
Specifying
▶ Page 121



Brighton End Table
Understanding
▶ Page 26
Specifying
▶ Page 122



Brighton Square Table
Understanding
▶ Page 26
Specifying
▶ Page 123



Brighton Rectangle Table
Understanding
▶ Page 26
Specifying
▶ Page 124

Accessories

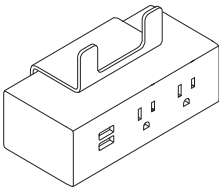

Brighton Module Power
Specifying
▶ Page 125

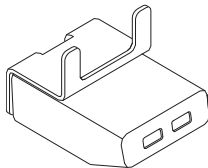

Brighton USB Power
Specifying
▶ Page 125

Seating, continued

Mesa

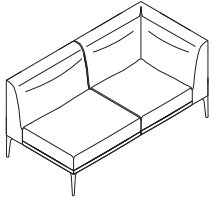

Mesa Left-Hand Chaise Lounge
Understanding
▶ Page 30
Specifying
▶ Page 126

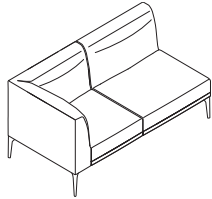

Mesa Right-Hand Chaise Lounge
Understanding
▶ Page 30
Specifying
▶ Page 127

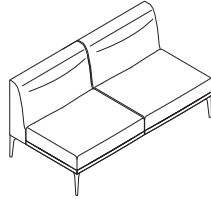

Mesa Two-Seat Lounge
Understanding
▶ Page 30
Specifying
▶ Page 128

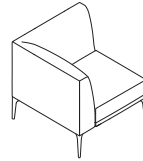

Mesa Corner Lounge
Understanding
▶ Page 30
Specifying
▶ Page 129

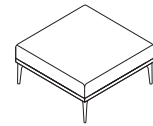

Ottoman
Understanding
▶ Page 30
Specifying
▶ Page 130

Willow

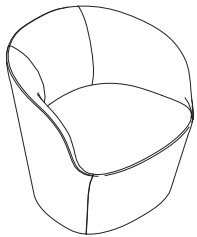

Willow Fixed Base Lounge
Understanding
▶ Page 34
Specifying
▶ Page 132

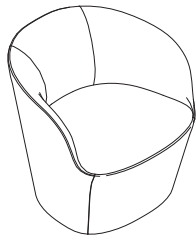

Willow Swivel Base Lounge
Understanding
▶ Page 34
Specifying
▶ Page 134

Slope

Guest Chairs and Stools



Slope Guest Chair
Understanding
▶ Page 38
Specifying
▶ Page 136



Slope Lounge Chair
Understanding
▶ Page 38
Specifying
▶ Page 137



Slope Counter-Height Stool
Understanding
▶ Page 38
Specifying
▶ Page 138



Slope Bar-Height Stool
Understanding
▶ Page 38
Specifying
▶ Page 139



Slope Stacking Chair
Understanding
▶ Page 38
Specifying
▶ Page 141

Seating, continued

Conference Chairs



Slope Conference Chair

Understanding
 ▶ Page 38
 Specifying
 ▶ Page 140

Sterling

Guest Chairs and Stools

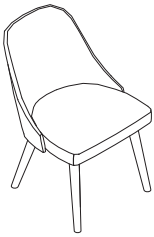

Sterling Guest Chair-Armless

Understanding
 ▶ Page 42
 Specifying
 ▶ Page 142

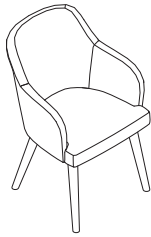

Sterling Guest Chair

Understanding
 ▶ Page 42
 Specifying
 ▶ Page 143



Sterling Counter Height Stool

Understanding
 ▶ Page 43
 Specifying
 ▶ Page 144



Sterling Bar Height Stool

Understanding
 ▶ Page 43
 Specifying
 ▶ Page 145

Conference Chairs



Sterling Conference Chair—Five-Star Armless

Understanding
 ▶ Page 42
 Specifying
 ▶ Page 146



Sterling Conference Chair—Five-Star with Arms

Understanding
 ▶ Page 42
 Specifying
 ▶ Page 147



Sterling Conference Chair—Four-Star Armless

Understanding
 ▶ Page 42
 Specifying
 ▶ Page 148



Sterling Conference Chair—Four-Star with Arms

Understanding
 ▶ Page 42
 Specifying
 ▶ Page 149

Seating, continued

Sterling, continued

Lounge



Sterling Lounge
Understanding
▶ Page 43
Specifying
▶ Page 150



Sterling Health Guest Chairs
Specifying
▶ Page 152

Kent

Conference Chairs



Kent Conference Chair—Five-Star with Arms
Understanding
▶ Page 46
Specifying
▶ Page 154



Kent Conference Chair—Five-Star Armless
Understanding
▶ Page 46
Specifying
▶ Page 155



Kent Conference Chair—Four-Star with Arms
Understanding
▶ Page 46
Specifying
▶ Page 156



Kent Conference Chair—Four-Star Armless
Understanding
▶ Page 46
Specifying
▶ Page 157

Guest Chairs



Kent Guest Chair Four Legs with Arms
Understanding
▶ Page 46
Specifying
▶ Page 158

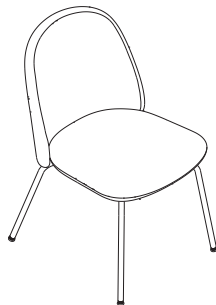

Kent Guest Chair Four Legs Armless
Understanding
▶ Page 46
Specifying
▶ Page 159

Conference Stools

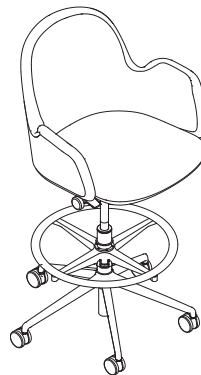

Kent Conference Stool—Five-Star with Arms
Understanding
▶ Page 46
Specifying
▶ Page 160

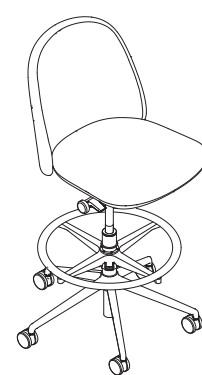

Kent Conference Stool—Five-Star Armless
Understanding
▶ Page 46
Specifying
▶ Page 161

Seating, continued

Lucas

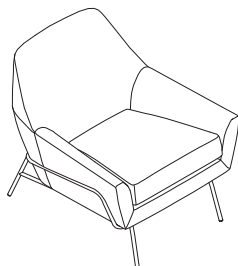

Lucas Wire Chair

Understanding

- ▶ Page 50
- Specifying
- ▶ Page 162

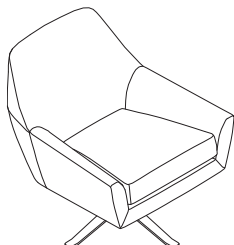

Lucas Swivel Chair

Understanding

- ▶ Page 50
- Specifying
- ▶ Page 163

Fulton



Fulton Guest Chair

Understanding

- ▶ Page 54
- Specifying
- ▶ Page 164

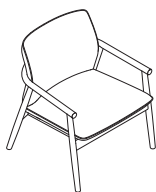

Fulton Lounge Chair

Understanding

- ▶ Page 54
- Specifying
- ▶ Page 165

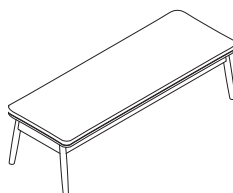

Fulton Bench

Understanding

- ▶ Page 54
- Specifying
- ▶ Page 166

Furniture

Greenpoint Private Office

Desks and Returns

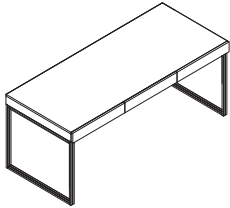

Executive Desk
Understanding
▶ Page 58
Specifying
▶ Page 168

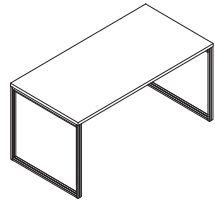

Private Desk
Understanding
▶ Page 58
Specifying
▶ Page 169

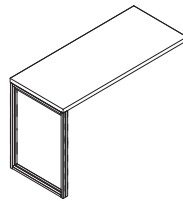

Desk Return with Leg
Understanding
▶ Page 58
Specifying
▶ Page 170

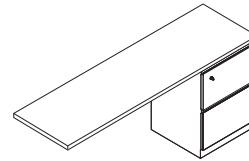

Desk Return with Pedestal
Understanding
▶ Page 58
Specifying
▶ Page 171

Modesty Panel

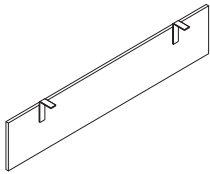

Understanding
▶ Page 58
Specifying
▶ Page 173

Credenzas

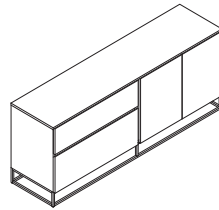

Filing Credenza
Understanding
▶ Page 59
Specifying
▶ Page 174

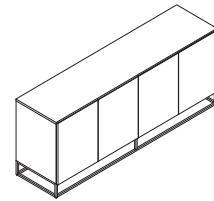

Storage Credenza
Understanding
▶ Page 59
Specifying
▶ Page 175

Furniture, continued

Greenpoint Private Office, continued

Wood Lateral File

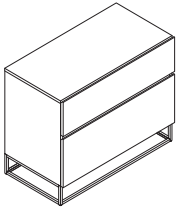

Understanding
 ▶ Page 59
 Specifying
 ▶ Page 176

Bookcases



Open Bookcase—Low
 Understanding
 ▶ Page 60
 Specifying
 ▶ Page 177



Open Bookcase—Narrow
 Understanding
 ▶ Page 60
 Specifying
 ▶ Page 178



Open Bookcase—Tall
 Understanding
 ▶ Page 60
 Specifying
 ▶ Page 179



Storage Bookcase
 Understanding
 ▶ Page 60
 Specifying
 ▶ Page 180

Metal Lateral Files

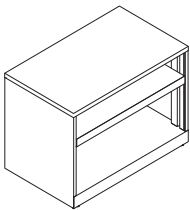

1.5-High Open-Open Lateral File
 Understanding
 ▶ Page 60
 Specifying
 ▶ Page 181

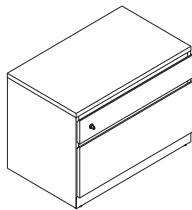

1.5-High Drawer-Drawer Lateral File
 Understanding
 ▶ Page 60
 Specifying
 ▶ Page 182

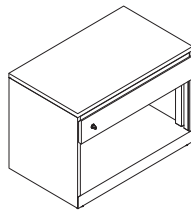

1.5-High Drawer-Open Lateral File
 Understanding
 ▶ Page 60
 Specifying
 ▶ Page 183

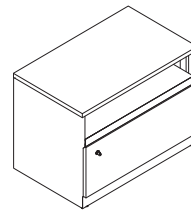

1.5-High Open-Drawer Lateral File
 Understanding
 ▶ Page 60
 Specifying
 ▶ Page 184

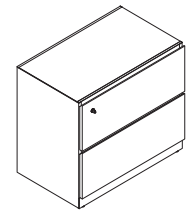

Two Drawer Lateral File
 Understanding
 ▶ Page 60
 Specifying
 ▶ Page 185

Furniture, continued

Greenpoint Private Office, continued

Metal Mobile Pedestal

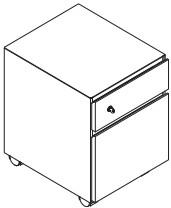

Understanding
▶ Page 60
Specifying
▶ Page 186

Basic Cushion Enhanced

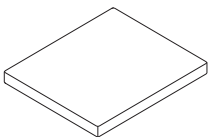

Understanding
▶ Page 60
Specifying
▶ Page 187

Wire Managers



Wire Clip
Specifying
▶ Page 188



2½" Round Grommet
Specifying
▶ Page 188

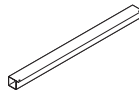

Wire Manager
Specifying
▶ Page 189

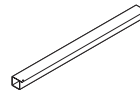

1¾" D Wire Managers
Specifying
▶ Page 189

Power and Data

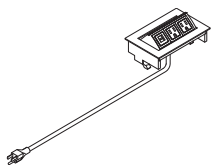

Greenpoint Desk Power Unit
Specifying
▶ Page 190



Greenpoint Round/Square Power Unit
Specifying
▶ Page 191

Furniture, continued

Greenpoint Benching

Worksurfaces and Returns

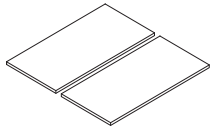

Dual-Sided

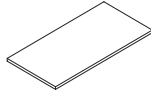

Single-Sided

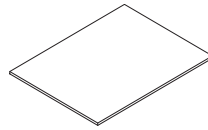

Continuous Top

Understanding
 ▶ Page 66
 Specifying
 ▶ Pages 192-200

Greenpoint 24"D or 30"D Worksurfaces

	Dual-Sided Leg/Leg	Dual-Sided Leg/Credenza*	Dual-Sided Credenza/Credenza*	Single-Sided Leg/Leg	Single-Sided Leg/Credenza*	Single-Sided Credenza/Credenza*	Continuous Top Leg/Leg	Continuous Top Leg/Credenza	Continuous Top Credenza/Credenza
48"W	●	●	●	●	●	●	●	●	●
54"W	●	●	●	●	●	●	●	●	●
60"W	●	●	●	●	●	●	●	●	●
66"W	●	●	●	●	●	●	●	●	●
72"W	●	●	●	●	●	●	●	●	●
78"W	●	●		●	●		●	●	●

*Add 3"W to the leg/credenza work surface and 6"W to the credenza/credenza work surface.

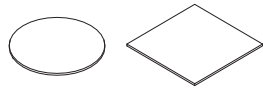

Understanding
 ▶ Page 68
 Specifying
 ▶ Pages 201–202

Round and Square

	48"W	60"W
48"D/Dia.	●	
60"D/Dia.		●

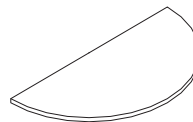

Understanding
 ▶ Page 68
 Specifying
 ▶ Page 203

Half-Round

	48"W	60"W
24"D	●	
30"D		●

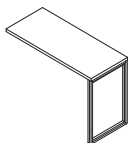

Understanding
 ▶ Page 70
 Specifying
 ▶ Page 204

Greenpoint Bench Returns

	42"W	48"W	54"W	60"W
18"D	●	●	●	●
24"D	●	●	●	●

Furniture, continued

Greenpoint Benching, continued

Legs

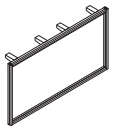

Greenpoint Dual-Sided End Leg

Understanding
▶ Page 69
Specifying
▶ Page 205



Greenpoint Single-Sided End Leg

Understanding
▶ Page 69
Specifying
▶ Page 206

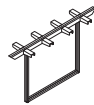

Greenpoint Dual-Sided Intermediate Leg

Understanding
▶ Page 69
Specifying
▶ Page 207



Greenpoint Single-Sided Intermediate Leg

Understanding
▶ Page 69
Specifying
▶ Page 208

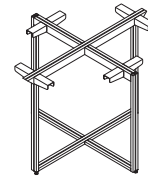

Greenpoint Round and Square Top, X-Leg

Understanding
▶ Page 69
Specifying
▶ Page 209

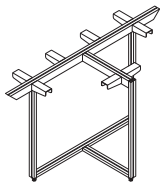

Greenpoint Half-Round Top, T-Leg

Understanding
▶ Page 69
Specifying
▶ Page 210

Credenzas

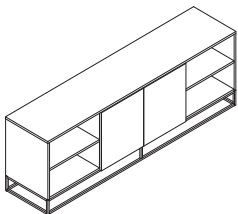

Greenpoint End Credenza

Understanding
▶ Page 70
Specifying
▶ Page 211

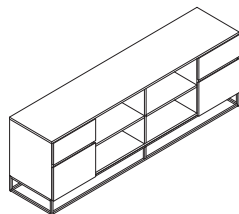

Greenpoint Personal Credenza

Understanding
▶ Page 70
Specifying
▶ Page 212

Upmount

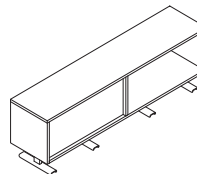

Greenpoint Upmount Bin

Understanding
▶ Page 70
Specifying
▶ Page 213

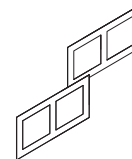

Greenpoint Whiteboard Bin Insert

Understanding
▶ Page 70
Specifying
▶ Page 214

Furniture, continued

Greenpoint Benching, continued

Center Screens

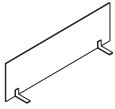

**Greenpoint
Glass Center Screen**

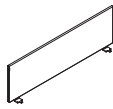
Understanding
 ▶ Page 70
 Specifying
 ▶ Page 215

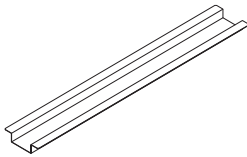

**Universal Tackable
Center Screen for Use
with Greenpoint**

Understanding
 ▶ Page 74
 Specifying
 ▶ Page 216

Power and Data

**Greenpoint
Dual-Sided Power
Support**

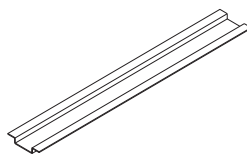
Understanding
 ▶ Page 71
 Specifying
 ▶ Page 218

**Greenpoint
Single-Sided Power
Support**

Understanding
 ▶ Page 71
 Specifying
 ▶ Page 218

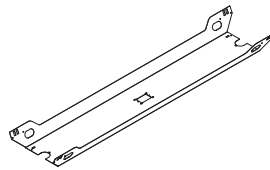
**Greenpoint
Dual-Sided Tray**

Understanding
 ▶ Page 71
 Specifying
 ▶ Page 219

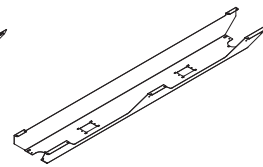
**Greenpoint
Single-Sided Tray**

Understanding
 ▶ Page 71
 Specifying
 ▶ Page 219

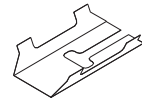
**Greenpoint
Dual-Sided Extension
Tray**

Understanding
 ▶ Page 71
 Specifying
 ▶ Page 220

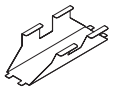
**Greenpoint
Single-Sided
Extension Tray**

Understanding
 ▶ Page 71
 Specifying
 ▶ Page 220

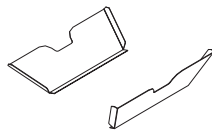
**Greenpoint
Dual-Sided
End Cap Tray**

Understanding
 ▶ Page 71
 Specifying
 ▶ Page 220

**Greenpoint
Single-Sided
End Cap Tray**

Understanding
 ▶ Page 71
 Specifying
 ▶ Page 220

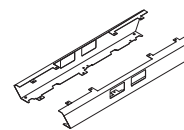
**Greenpoint
Dual-Sided Power
Cover**

Understanding
 ▶ Page 71
 Specifying
 ▶ Page 221

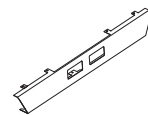
**Greenpoint
Single-Sided Power
Cover**

Understanding
 ▶ Page 71
 Specifying
 ▶ Page 221

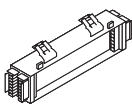
**Modular Power Block—
Standard-Capacity**

Specifying
 ▶ Page 222

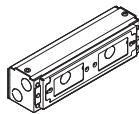
**Chicago Hardwire
Power Kit**

Specifying
 ▶ Page 223

Duplex Receptacle

Specifying
 ▶ Page 224

USB Receptacle

Specifying
 ▶ Page 224



**Filler Package—
Power/Data**

Specifying
 ▶ Page 225

Furniture, continued

Greenpoint Benching, continued

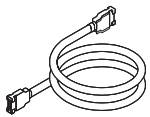
Power and Data, continued



Modular Harnesses
Specifying
▶ Page 226

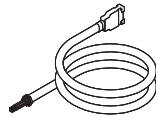

Hardwire-to-Modular Power Infeed
Specifying
▶ Page 227

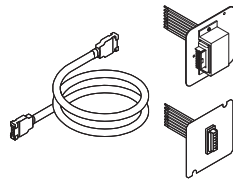

Modular-to-Modular Power Infeed
Specifying
▶ Page 228

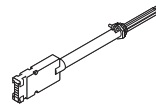

San Francisco Power Infeed
Specifying
▶ Page 228

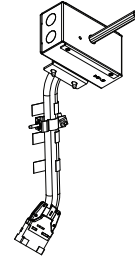

New York City Power Infeed
Specifying
▶ Page 229

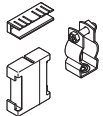

Bracket Kit Power
Specifying
▶ Page 230



Vertebral Cable Riser
Specifying
▶ Page 231



Extension Vertebral Cable Riser
Specifying
▶ Page 231

Sutton

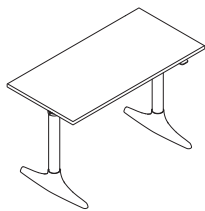

Understanding
▶ Page 84
Specifying
▶ Page 232–234

Rectangle Height-Adjustable Desks

	46"W	52"W	58"W	64"W	70"W
23"D	●	●	●	●	●
29"D	●	●	●	●	●

Tip: Widths are parametric to 1/16" from 46"–72".



Furniture, continued

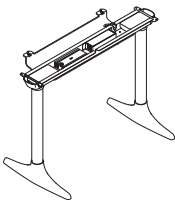

Understanding
 ▶ Page 84
 Specifying
 ▶ Pages 238–238

Rectangle Height-Adjustable Bases

	46"W	52"W	58"W	64"W	70"W
23"D	●	●	●	●	●
29"D	●	●	●	●	●

Tip: Widths are parametric to 1/16" from 46"–72".

Accessories

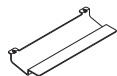

Cable Tray
 Understanding
 ▶ Page 85
 Specifying
 ▶ Page 240

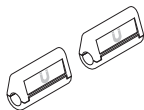

Magnetic Cable Clips
 Understanding
 ▶ Page 85
 Specifying
 ▶ Page 240

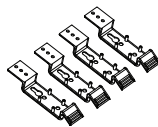

Cable Brackets
 Understanding
 ▶ Page 85
 Specifying
 ▶ Page 240

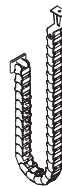

Cable Riser
 Understanding
 ▶ Page 85
 Specifying
 ▶ Page 241

Belle Lounge Seating

Belle lounge features deco inspired tufted forms and soft curves that have been expertly tailored to create an inviting venue for solo work and coworker congregations alike. Each modular piece has been thoughtfully designed to function either freestanding or connected, setting the stage for applications that are both expressive and memorable. Generous corners and versatile ottomans allow limitless flexibility in planning, where Belle's curves can be appreciated from any angle.

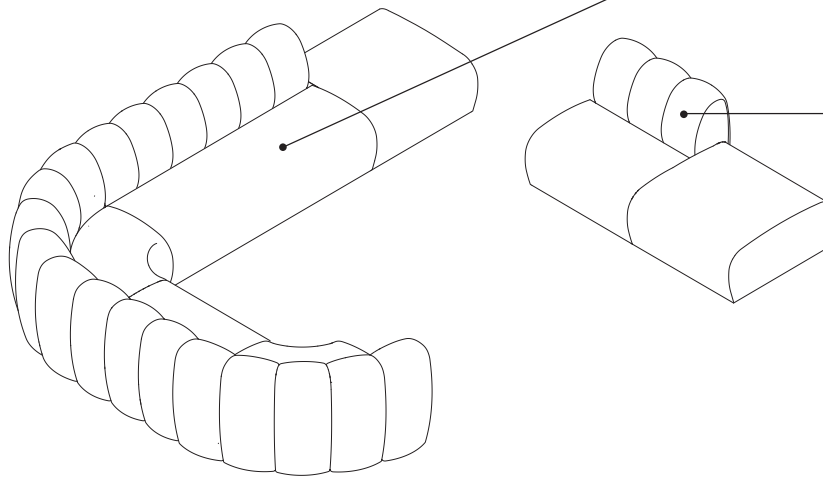

Lounge units are available in one-seat lounge, two-seat lounge, and corner lounge.

Lounge units can be connected together to create a wide range of configurations.

Upholstered seat and back cushions are attached.

Integrated ganging brackets are included.

Glides are not adjustable.

Product Details

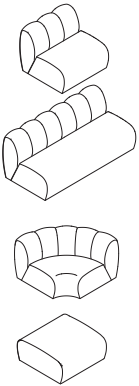

Lounge seating features four fully upholstered, complementary models: one-seat lounge, two-seat lounge, corner lounge, and ottoman. Legs are concealed for a streamlined profile.

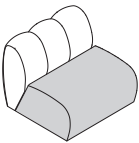

Lounges are available in contrasting seat and back fabrics. Seat and back fabrics do not have to be in the same fabric family.

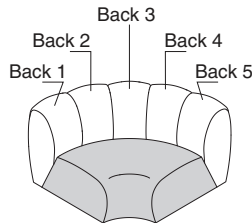
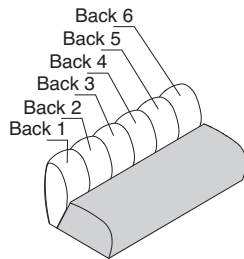
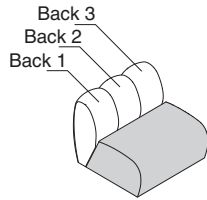

Contrasting all option is available on the one-seat lounge, two-seat lounge, and corner lounge. Back channels and seat can be specified separately.
Tip: Contrasting back channels must be in the same fabric family.

Contrasting fabrics are specified from the right handed seated position.

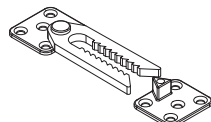

Integrated ganging device is included and keeps units aligned.

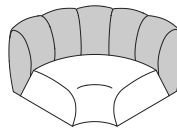
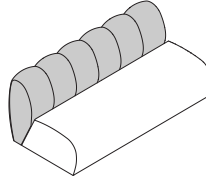
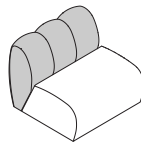

Crown of back channels may vary depending on stiffness of fabric. It is recommended to use the same back fabric when connecting multiple pieces.

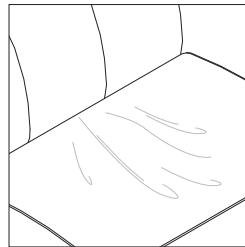

Comfort wrinkles are expected to occur over time. Smooth the cushion fabric with a sweeping/wiping motion to reduce the definition.

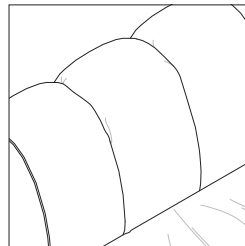

Tufted seams can loosen over time or during installation and may require occasional manual adjustment by pushing fabric into seams.

Surface Materials

Upholstery

- Fabric
- ▶ See *Surface Materials*, page 258 for specific availability, or refer to the *Surface Materials Reference Manual* for further information.

Visit <https://srh.steelcase.com/comcalculator.aspx> for Steelcase Textile calculator.

Dimensions

- ▶ Page 20

Dimensions

Belle Lounge Seating

• **Features** • **Overall**
: : **Depth** **Width** **Height**
:
:

Belle

Lounge Seating

One-Seat	36"	36"	32"
Two-Seat	36"	72"	32"
Corner	45"	45"	32"
Ottoman	35"	35"	17"

: :

Boardwalk Lounge Seating and Occasional Tables

East meets west in the design of our modular Boardwalk system. Pillow-like cushions inspired by Japanese "zaisu" are lifted off the ground by a simple modular platform with natural wood detailing—a nod to California-cool residential design. In a celebration of minimalism, Boardwalk offers a respite within an office landscape and configures to provide seating, table surfaces, and power access.

Boardwalk lounge system is based on a 30"D x 30"W planning module with platforms available in 30"D x 30"W, 30"D x 60"W, and 30"D x 90"W sizes.

Cushions or open table positions can be specified in each 30" module. Cushions can be specified as single seat only, mid back, left corner, or right corner.

Edge finish has an edge band that is defaulted to match the laminate surface, or can be specified in another color.

Mounting holes for cushions are symmetrical, allowing for them to be positioned facing any direction.

Lounge units can be connected together to create a variety of configurations.

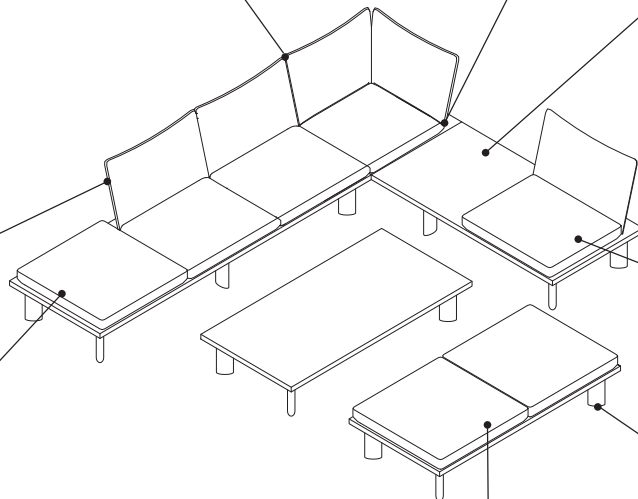

Connector brackets are not included with lounge units but can be ordered separately as style number: **TS31410**.

When a module is specified with no cushion, that module is left open as a table position. It will have a surface in the finish specified for the rest of the platform with no holes or cutouts for mounting cushions. Cushions are not retro-fittable.

Cushions are bolted to the seating platform. They are not retro-fittable to open table positions. Legs, platform, and cushions ship separately and require assembly.

Legs are hardwood oak and available in several hardwood finishes that complement platform finishes.

Units specified with seat cushions can be used to create ottomans or benches.

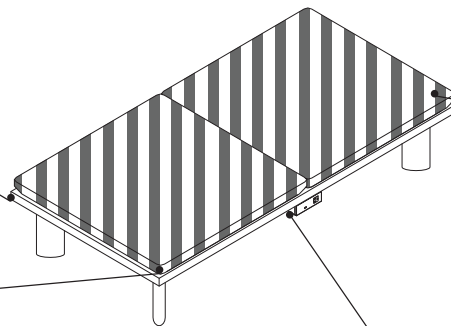

Cushion orientation can be changed or determined in the field. However, specifiers should be mindful of fabric direction when using directional or patterned fabrics on adjacent cushions.

Power units can be installed beneath lounges and tables. All lounge and table platforms are shipped with inserts on the underside for power units to be mounted. Power style number (**COSISPWR**) must be ordered separately. ▶ See *Coalesse Seating Specification Guide*.

Product Details



Single Seat



Mid Back Seat



Corner Seat

Cushions can be specified as seat only, mid back, left corner, and right corner. Lounge styles must have at least one cushion specified.



Single Platform

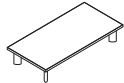

Double Platform

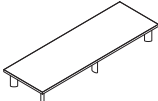

Triple Platform

Platforms and tables come in three sizes: 30" x 30", 30" x 60", and 30" x 90". Platforms are 11"H with a seat height of 16³/₄", when a cushion is specified. Tables are available in 11"H or 15"H. The same platform is used in both the seating and the 11"H table applications.

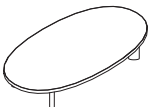

Tables are also available in a 40" round and 65" x 35" oval version.

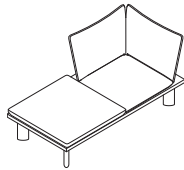

Left Corner

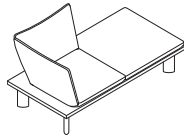

Right Corner

Corner cushions can be specified as left or right. Orientation is determined in the seated position. Corners are symmetrical; however, the fabric direction for the seat is determined by left or right specification.

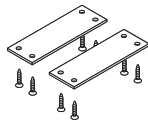

Ganging plate (TS31410) can be ordered separately to permanently gang units.

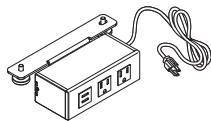

Power block style number (COSISPWR) can be mounted to any platform.
▶ See *Coalesse Seating Specification Guide*.

Power blocks can be specified with either two power, one USB A dual port or one power, or one USB C single 60"W.

Surface Materials

Upholstery

- Fabric
- Leather
- Vinyl

Tip: Contrasting fabric is not an option.

▶ See *Surface Materials*, page 258 for specific availability, or refer to the *Surface Materials Reference Manual* for further information.

Visit <https://srh.steelcase.com/comcalculator.aspx> for Steelcase Textile calculator.

Platform

- High-Pressure Laminate
- Veneer

▶ See *Surface Materials*, page 258

Edge

- Plastic

Tip: Edge finish has an edge band that is defaulted to match the laminate surface, or can be specified in another color.

Leg

- Customiz stain
- VP01 Oak Light
- VP03 Black Oak
- VP05 White Oak

Leg Bracket

- 0835 Black

Dimensions

▶ Page 24

Dimensions

Boardwalk Lounge Seating

Features	Overall Depth	Width	Height	Functional Seat Depth	Seat Width	Seat Height from Floor	Back Width	Back Height from Seat
Boardwalk								
Lounge Seating								
One-Seat Platform	30"	30"	11"	N.A.	N.A.	N.A.	N.A.	N.A.
Two-Seat Platform	30"	60"	11"	N.A.	N.A.	N.A.	N.A.	N.A.
Three-Seat Platform	30"	90"	11"	N.A.	N.A.	N.A.	N.A.	N.A.
Seat Cushion	30"	30"	16¾"	30"	30"	16¾"	30"	N.A.
Mid Back	30"	30"	31"	22½"	30"	16¾"	30"	20"
Corner Cushion	30"	30"	31"	22½"	22½"	16¾"	30"	20"
Occasional Tables								
Square Table	30"	30"	11" or 15"	N.A.	N.A.	N.A.	N.A.	N.A.
Rectangle Table	30"	60"	11" or 15"	N.A.	N.A.	N.A.	N.A.	N.A.
Rectangle Table	30"	90"	11" or 15"	N.A.	N.A.	N.A.	N.A.	N.A.
Round Table	N.A.	40" Dia.	11" or 15"	N.A.	N.A.	N.A.	N.A.	N.A.
Oval Table	35"	65"	11" or 15"	N.A.	N.A.	N.A.	N.A.	N.A.

Tip: Height and seat height dimensions are included for cushion mounted to platform.

Brighton Lounge Seating

Inspired by the traditional wood frame joinery of mid-century design, Brighton lounge seating offers an updated take with sleek metal construction while optional brass accents add a deco-friendly spark. It's configurability allows Brighton to arrange into infinite formations, while freestanding lounge and table options create even more choice.

Ganging tables are available in laminate or veneer. Tables come with ganging brackets to attach between or on the end of lounge units.

Lounge seat and backs are fully upholstered. Back shells can be specified with contrasting fabric.

Frame caps can be specified to match or contrast the frame. Caps are offered in a range of powder coat finishes, antique brass, and brushed nickel.

Frames are offered in a range of powder coat finishes.

Arms are available on lounge units. Arm caps are solid oak and can be specified in a range of finishes.

Freestanding tables are available in laminate and veneer. Frames are offered in a range of powder coat finishes.

Frame foot can be specified to match or contrast the frame. Feet are offered in a range of powder coat finishes, antique brass, and brushed nickel.

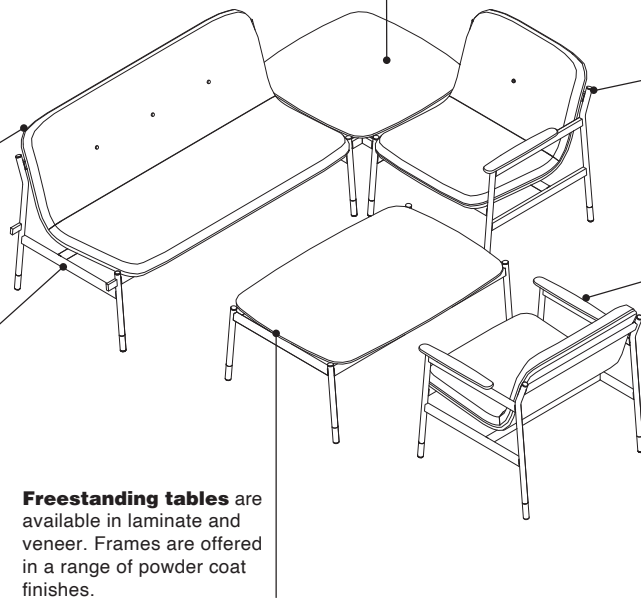

Product Details

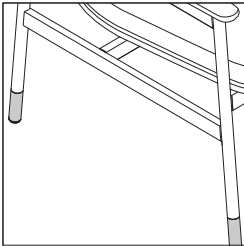

Frame feet can be specified to match or contrast the frame. Feet are offered in a range of powder coat finishes, antique brass, and brushed nickel.

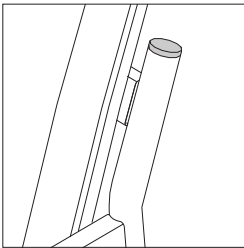

Frame caps can be specified to match or contrast the frame. Caps are offered in a range of powder coat finishes, antique brass, and brushed nickel.

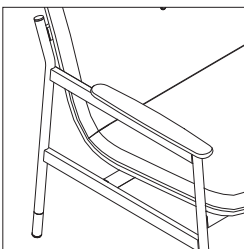

Armcaps are solid oak wood and are available on both one- and two-seat lounges in a range of wood finishes.

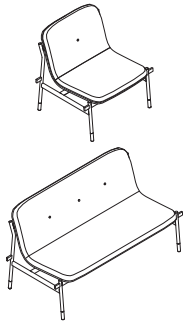

Button tufting is standard on all lounges that are upholstered in fabric, vinyl, and faux-leather. One-seat lounges come standard with one button, two-seat lounges come with three buttons. There will be no button tufting when leather upholstery is specified.

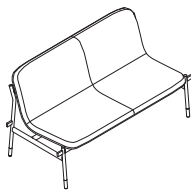

When leather is specified on the two-seat lounge, there will be an additional seam down the center of the seat and back.

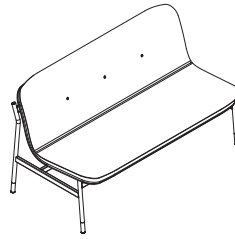

Arm Right



Arm Left

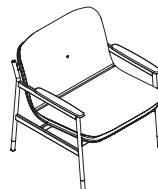

One- and two-seat lounges are available with and without arms and can be specified with ganging hardware or as freestanding.

Lounges must be specified with ganging hardware when used with end or ganging tables. Ganging hardware and arms cannot be specified on the same side of a lounge unit.

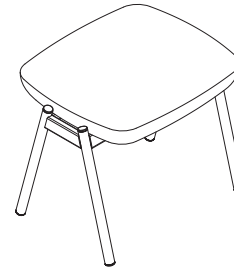

Ottoman is upholstered with a metal frame that is available in a range of powder coat finishes. Contrasting frame caps are optional.

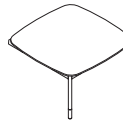

Ganging tables are available in three options: 60°, 90° and straight. Tables can be attached facing either direction and must be attached between lounge units.



End table is available in one size 28" square and can be added to either side of a lounge unit.

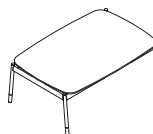

Freestanding tables are available in 28" square and 28"D x 42"W rectangle.

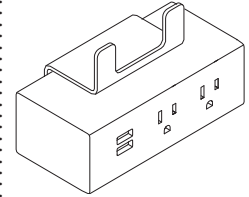

Power module has a 9' cord.

Surface Materials

Upholstery

(available in contrasting front and back)

- Fabric
- Leather
- Vinyl

▶ See *Surface Materials*, page 258 for specific availability, or refer to the *Surface Materials Reference Manual* for further information.

Visit <https://srh.steelcase.com/comcalculator.aspx> for Steelcase Textile calculator.

Table tops

- High-Pressure Laminate
 - Veneer
- ▶ See *Surface Materials*, page 258

Frames

- Paint
 - Accent paint
 - Lux Coatings
- ▶ See *Surface Materials*, page 258

Feet and caps

- Paint
- Accent paint
- Lux Coatings
- WE03 Antique Brass
- WE04 Brushed Nickel

Arms

- Customiz stain
- VP01 Light Oak
- VP03 Black Oak
- VP04 Gray Oak
- VP05 White Oak

Power

- 6000 Black
- 6052 Milk

Dimensions

▶ Page 28

Dimensions

Brighton Lounge Seating

Features	Overall Depth	Width	Height	Functional Seat Depth	Seat Width	Seat Height from Floor
----------	---------------	-------	--------	-----------------------	------------	------------------------

Brighton

Lounge Seating

One-Seat Lounge	29 ³ / ₄ "	29 ⁷ / ₈ "	33 ¹ / ₁₆ "	19 ⁷ / ₁₆ "	26 ¹ / ₄ "	17 ⁷ / ₁₆ "
Two-Seat Lounge	29 ³ / ₄ "	57 ⁹ / ₁₆ "	33 ¹ / ₁₆ "	19 ⁷ / ₁₆ "	54"	17 ⁷ / ₁₆ "
Ottoman	16 ³¹ / ₃₂ "	19 ¹⁵ / ₃₂ "	16 ²³ / ₃₂ "	N.A.	N.A.	N.A.
60° Ganging Table	28 ¹ / ₄ "	37 ³ / ₄ "	15 ¹¹ / ₁₆ "	N.A.	N.A.	N.A.
90° Ganging Table	29"	29"	15 ¹¹ / ₁₆ "	N.A.	N.A.	N.A.
End Table	28 ¹ / ₂ "	28 ¹ / ₄ "	15 ¹¹ / ₁₆ "	N.A.	N.A.	N.A.
Square Table	28 ¹ / ₂ "	28 ¹ / ₄ "	15 ¹¹ / ₁₆ "	N.A.	N.A.	N.A.
Rectangle Table	28 ¹ / ₂ "	42"	15 ¹¹ / ₁₆ "	N.A.	N.A.	N.A.

Mesa Lounge Seating

Mesa lounge seating adds style to any work-space with its modern form and tapered legs. Modular pieces can easily create common areas of any size.

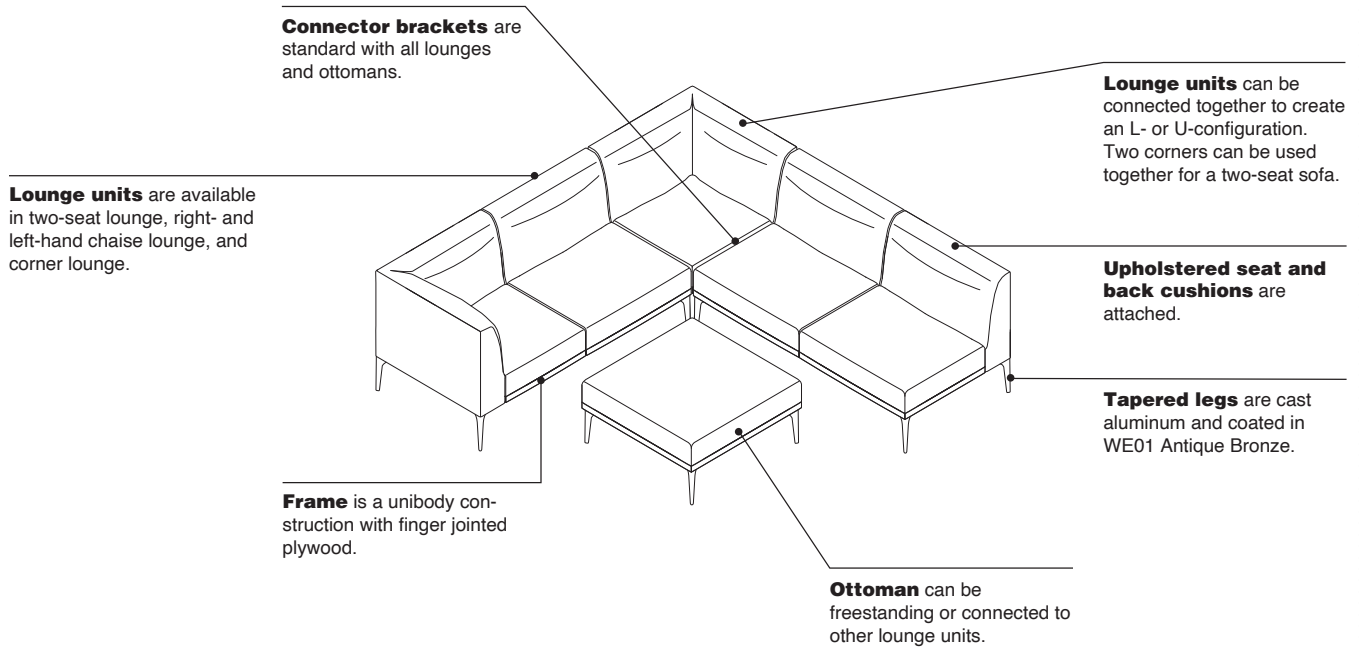

Product Details

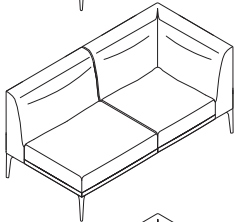
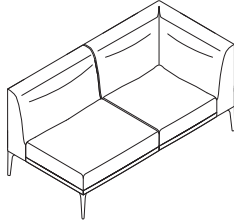
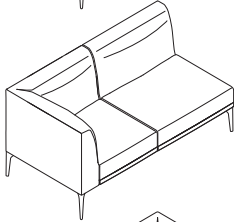
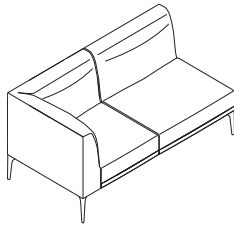
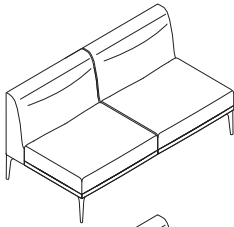

Chaise lounge can be specified in a right- or left-hand configuration.
Tip: Handedness is determined while in the seated position.

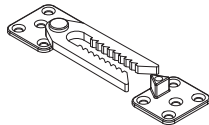
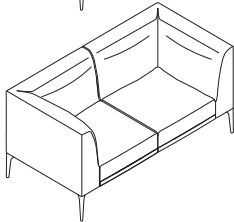

Integrated ganging device is included and keeps units aligned.

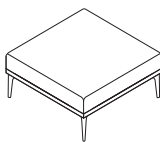
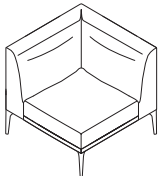

Lounge seating features five fully upholstered, complementary models: two-seater lounge, right-hand chaise lounge, left-hand chaise lounge, corner lounge, and ottoman. All models feature a four-leg, cast aluminum base with a powder coat painted finish.

Surface Materials

Upholstery

► See *Surface Materials*, page 258 for specific availability, or refer to the *Surface Materials Reference Manual* for further information.

Visit <https://srh.steelcase.com/comcalculator.aspx> for Steelcase Textile calculator.

Legs

- WE01 Antique Bronze
Tip: Contrasting fabric is not available on Mesa.

Dimensions

► Page 32

Dimensions

Mesa Lounge Seating

• Features	• Overall Depth	Width	Height	• Functional Seat Depth	• Seat Width	• Seat Height from Floor
Mesa						
Lounge Seating						
Two-Seat	32 ¹ / ₄ "	64 ¹ / ₄ "	28 ³ / ₄ "	22 ³ / ₄ "	64 ¹ / ₄ "	18 ³ / ₄ "
Chaise	32 ¹ / ₄ "	64 ¹ / ₄ "	28 ³ / ₄ "	22 ³ / ₄ "	55"	18 ³ / ₄ "
Corner	32 ¹ / ₄ "	32 ¹ / ₄ "	28 ³ / ₄ "	22 ³ / ₄ "	22 ³ / ₄ "	18 ³ / ₄ "
Ottoman	32 ¹ / ₄ "	32 ¹ / ₄ "	17 ³ / ₄ "	N.A.	N.A.	N.A.
:	:	:	:	:	:	:

Willow Seating

Willow is a fresh take on the classic club chair. Sporting either a smooth upholstered interior for a clean and versatile look or soft upholstery treatment that's casual and elevated, Willow can blend in or stand out.

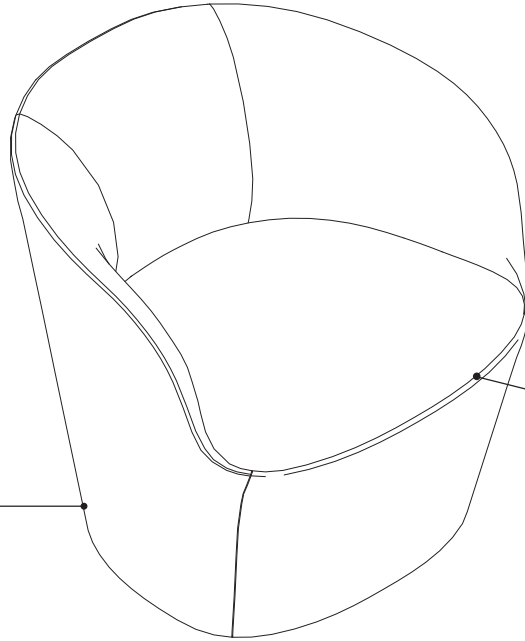

Seat height is 19" from the ground.

Willow comes in either a fixed or swivel base. Swivel automatically returns to center.

Upholstery treatment is available in smooth or soft and refers to the inside of the back of the chair.

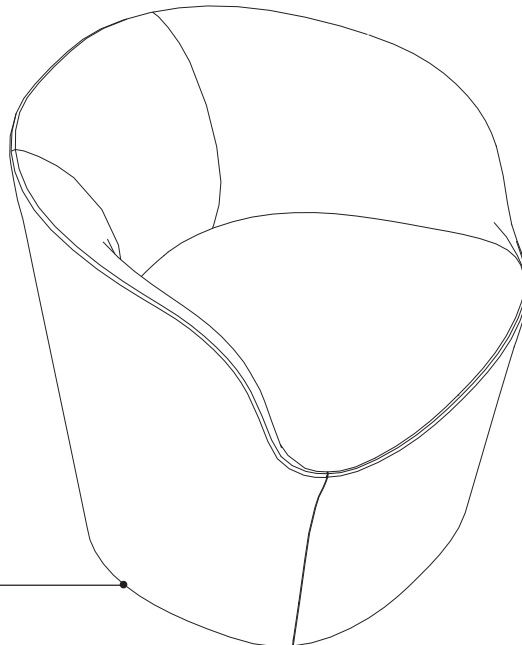

The base of the chair has 1 1/2" of clearance for both the fixed and swivel bases.

Fabric is applied in vertical direction. Optional contrasting fabric is available between the seat interior and outer shell.

Product Details

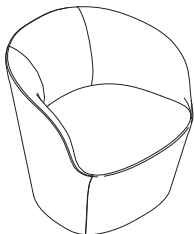

An optional swivel base is available. The swivel has an auto-return feature.

All product in the Willow product line ships fully assembled in one package.

Surface Materials

See surface materials matrix on page 272 for upholstery options.

Optional contrasting fabric is available between the seat interior and outer shell.

Visit <https://srh.steelcase.com/comcalculator.aspx> for Steelcase Textile calculator.

Dimensions

▶ Page 36

Dimensions

Willow Seating

• Features	• Base Depth	• Width	• Overall Height	• Seat Height	• Weight (lb)
Willow Seating					
Fixed Base Lounge					
	30"	31 ³ / ₁₀ "	29 ¹ / ₂ "	19"	58 lb
Swivel Base Lounge					
	30"	31 ³ / ₁₀ "	29 ¹ / ₂ "	19"	78 lb

Slope Seating

Simple yet timeless design allows the Slope family of seating to blend seamlessly into the modern office. A wide range of paint colors and upholstery options ranging from muted to playful add personality.

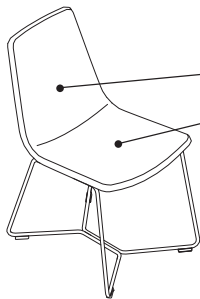

Seat and back are always fully upholstered.

The double-needle stitch down the center of the slope seat and back is an iconic detail of the slope chair. As an option, slope upholstery can be specified with this seam.

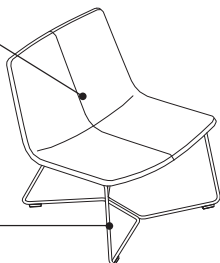

Wire frame base is painted and available in a range of standard, accent and Lux Coatings.

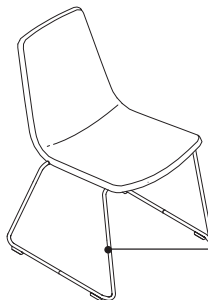

Stackable base configuration allows for easier storage and cleaning. Stacking chairs can be stacked up to five high.

Seat height adjusts 4", from 17½"H to 20½"H, with a pneumatic adjustment mechanism.

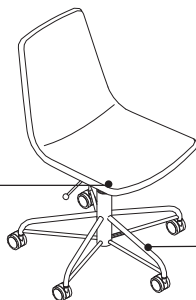

Glides are polyethylene for superior durability on carpeted and hard floors. Glides are available in milk or black.

Five-star base is available in hot rolled steel finish only.

Product Details



Guest chair



Stacking chair



Lounge chair



Counter-height stool



Conference chair



Bar-height stool

Five-star and wire-frame bases are available for guest chair and stool.

Slope wire frame stool is available in two heights to pair with counter and bar height tables.

360° adjustable height swivel mechanism is standard on five-star base models.

Slope ships knocked down and the seat must be assembled to the frame on site, with the exception of the stacker with arms and the guest chair with arms which ship fully assembled. All slope styles come in a single carton.

Arms are available as an option for guest, stacking, and conference chair.

Slope stacking chairs can be stacked up to five chairs high.

	Made-to-order	Stocked
Guest Chair	WESSLPCG	WEM1
Stacking Chair	WESSLPCS	N.A.
Lounge Chair	WESSLPCL	WEM2
Conference Chair	WESSLPCC	WEM3
Counter Stool	WESSLPSC	WEM50
Bar Stool	WESSLPSB	WEM66
Height-Adjustable Bar Stool	N.A.	WEM67

Tip: Slope is available made-to-order in a broad selection of frame colors and upholstery options. Slope is also available stocked in West Elm leather and a single frame color. Stocked styles are shipped with a rapid 2-week lead time and have specific style numbers. Please refer to the table above for the made-to-order and stocked style numbers.

Adjustment Features

Adjustability instructions are included with every swivel-base chair. Instructions can also be found at www.steelcase.com.

Seat Adjustments

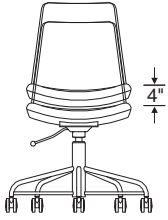

Conference Chair

Seat height adjusts

pneumatically. To lower, pull lever up while seated. To raise, pull lever up and keep your weight off the chair.

Other features

Soft wheel casters for hard floors on five-star base models are available for specific applications.

Surface Materials

Stocked Slope chairs are only available in pre-configured base color and leather combinations. When Saddle or Fog leather are specified, the base will be Hot Rolled Steel. When Aegean leather is specified, the base will be Antique Brass.

Seat and back upholstery

▶ See *Surface Materials*, page 258 for specific availability, or refer to the *Surface Materials Reference Manual* for further information.

Visit <https://srh.steelcase.com/comcalculator.aspx> for Steelcase Textile calculator.

Wire frame base

- Paint
 - Accent paint
 - Lux Coatings
- ▶ See *Surface Materials*, page 258

Five-star base

- Hot-rolled steel

Casters

- 6205 Black

Glides

- 6205 Black
- 6052 Milk

Tip: 6052 Milk glides are available on 4242 Milk wire frame painted bases only, all other colors will have black glides.

All Steelcase seating with standard upholstery fabrics complies with requirements of the State of California Technical Bulletin 117-2013. All standard seating is labeled to be in compliance with California 117-2013.

Dimensions

▶ Page 40

Dimensions

Slope Seating

• Features	• Overall Depth	Width	Height	• Functional Seat Depth	• Seat Width	• Seat Height from Floor	• Back Width	• Back Height from Seat	• Weight
Slope Seating									
Guest Chair									
	21½"	19¼"	33¼"	17¾"	17¾"	18¾"	16¾"	18¾"	33.15 lb
Stacking Chair									
	21½"	19¼"	33¼"	17¾"	17¾"	18¾"	16¾"	18¾"	N.A.
Lounge Chair									
	26½"	26½"	28"	21¾"	26½"	15¾"	25¾"	19¼"	28 lb
Counter Stool									
	21½"	19"	35¾"	17¾"	17¾"	25¼"	16¾"	13"	35.75 lb
Bar Stool									
	21½"	19¼"	40"	17¾"	17¾"	29½"	14¼"	13"	40 lb
Conference Chair									
	21½"	19¼"	32" – 36"	17¾"	17¾"	17½" – 20½"	16¾"	18¾"	28.25 lb

* Overall width does not include the base.

Tip: The diameter of the chair with the five-arm base is 25".

Sterling Seating

Sterling is a family of seating inspired by classic mid-century design. The style and generous sit brings retro-inspired comfort to the office. Hardwood legs or a classic aluminum base and arm options make the Sterling collection relevant across the floor plan.

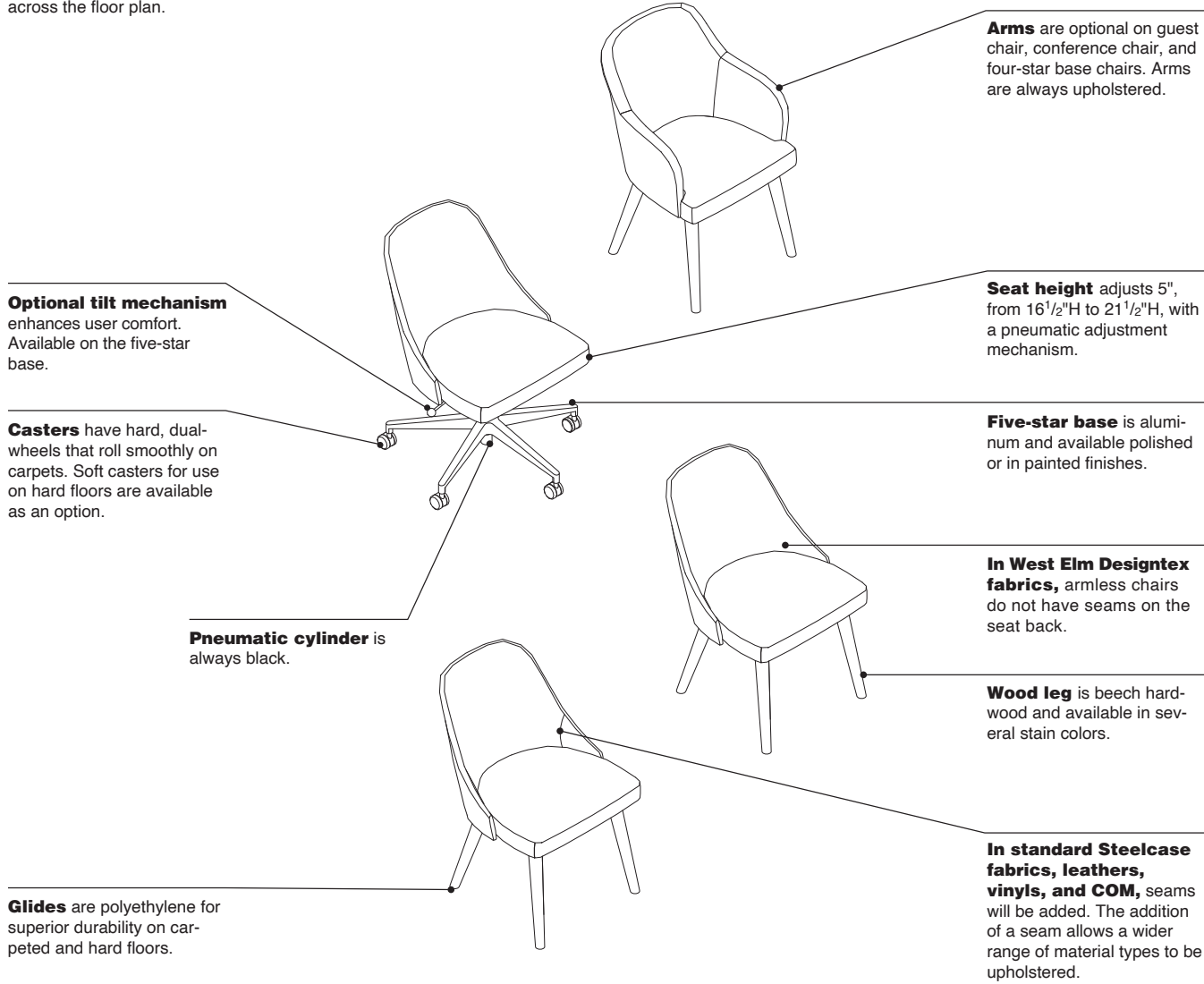

Sterling stools have a 360° swivel feature that comes standard and does not have auto-return feature.

Sterling stools include footrest for added comfort.
Tip: The footrest is 8 1/2" from the ground on the counter-height stool and 14 1/4" on the bar-height stool.

Glides are polyethylene for superior durability on carpeted and hard floors.

Sterling lounge is available with arms only.

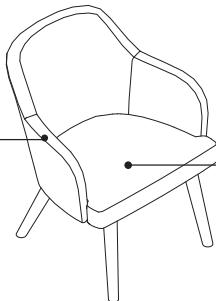
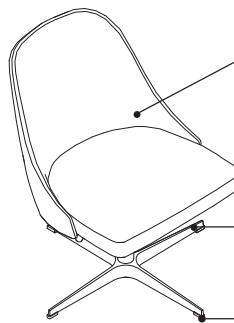
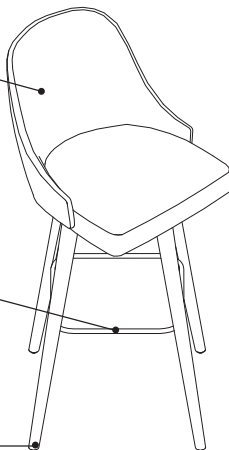

Sterling four-star chair comes with 360° swivel and height adjustable mechanism. It does not have an auto-return feature or tilt option.

Four-star base is available in polished aluminum only.

Glides are polyethylene for superior durability on carpeted and hard floors. Casters are not available.

Sterling lounge has a seat height of 17 1/4" and more reclined seat and back to encourage a more relaxed posture.

Product Details



Five-star, four-star, and four-leg chairs are available with and without arms.

Optional tilt mechanism is available on five-star chairs and has 10° rearward and 2° forward tilt range. The seat and back always remain in a fixed position relative to each other (i.e. no recline).

360° adjustable height swivel mechanism is standard on five-star and four-star base models.

Adjustment Features

Adjustability instructions are included with every swivel-base chair. Instructions can also be found at www.steelcase.com.

Seat Adjustments

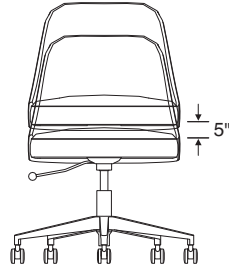

Seat height adjusts pneumatically. To lower, pull lever up while seated. To raise, pull lever up and keep your weight off the chair.

Other features

Soft wheel casters for hard floors on five-star base models are available for specific applications.

Surface Materials

Upholstery

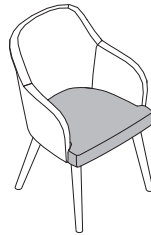

Optional contrasting fabric is available between the seat and back/arms.

- Fabric
- Leather
- Vinyl

▶ See *Surface Materials*, page 258 for specific availability, or refer to the *Surface Materials Reference Manual* for further information.

Customer's Own Material (COM)

Four-leg and stool base

- Customiz stain
- VP01 Light Oak
- VP03 Black Oak
- VP04 Grey Oak
- VP05 White Oak

Five-star base

- 0835 Black
- 4242 Milk
- 4B22 Matte Brass
- 4B24 Night Bronze
- 7278 Dark Bronze
- 8046 Polished Aluminum

Four-star base

- 8046 Polished Aluminum

Casters and glides

- 6205 Black

All Steelcase seating with standard upholstery fabrics complies with requirements of the State of California Technical Bulletin 117-2013. All standard seating is labeled to be in compliance with California 117-2013.

Dimensions

▶ Page 45

Dimensions

Sterling Seating

Features	Overall Depth	Width	Height	Functional Seat Depth	Seat Width	Seat Height from Floor	Back Width	Back Height from Seat	Arm Height from Floor
West Elm Work Sterling									
Guest Chairs									
	25 ¹ / ₈ "	26 ³ / ₄ "	32 ⁵ / ₈ "	18 ⁵ / ₈ "	22"	18 ¹ / ₂ "	21"	15 ¹ / ₂ "	26 ¹ / ₂ "
Guest Chairs—Armless									
	24 ¹ / ₂ "	23 ¹ / ₂ "	32 ⁵ / ₈ "	18 ⁵ / ₈ "	22"	18 ¹ / ₂ "	21"	15 ¹ / ₂ "	N.A.
Conference Chairs—Five-Star with Arms									
	25 ¹ / ₈ "	26 ³ / ₄ "	31 ³ / ₄ "—36 ³ / ₄ "	18 ⁵ / ₈ "	22"	16 ¹ / ₂ "—21 ¹ / ₂ "	21"	15 ¹ / ₂ "	25 ¹ / ₂ "—30 ¹ / ₂ "
Conference Chairs—Five-Star Armless									
	24 ¹ / ₂ "	23 ¹ / ₂ "	31 ³ / ₄ "—36 ³ / ₄ "	18 ⁵ / ₈ "	22"	16 ¹ / ₂ "—21 ¹ / ₂ "	21"	15 ¹ / ₂ "	N.A.
Counter Height Stool									
	26 ¹ / ₄ "	26 ¹ / ₄ "	38"	17"	17 ¹ / ₂ "	26"	19 ¹ / ₄ "	12 ³ / ₈ "	N.A.
Bar Height Stool									
	26 ¹ / ₄ "	26 ¹ / ₄ "	44"	17"	17 ¹ / ₂ "	32"	19 ¹ / ₄ "	12 ³ / ₈ "	N.A.
Conference Chairs—Four-Star with Arms									
	25 ¹ / ₈ "	26 ³ / ₄ "	30"—35"	18 ⁵ / ₈ "	22"	15 ³ / ₁₆ "—20 ³ / ₁₆ "	21"	15 ¹ / ₂ "	23 ¹ / ₂ "—28 ¹ / ₂ "
Conference Chairs—Four-Star Armless									
	24 ¹ / ₂ "	23 ¹ / ₂ "	30"—35"	18 ⁵ / ₈ "	22"	15 ³ / ₁₆ "—20 ³ / ₁₆ "	21"	15 ¹ / ₂ "	N.A.
Lounge									
	25 ¹ / ₄ "	26 ³ / ₄ "	30"	18 ⁵ / ₈ "	22"	17 ¹ / ₄ "	21"	15 ¹ / ₂ "	24"

*Overall width does not include the base.

The diameter of the chair with the five-star base is 26".

The diameter of the chair with the four-star base is 26¹/₂".

Kent Seating

Soft, modern minimalism meets the performance and comfort needed for today's collaborative workplace with West Elm Work Kent seating. The broad collection offers a range of application possibilities – from meeting rooms to the private office.

Kent is available in five base options and three seat backs. Base options are five-star, four-star (with glides or casters), guest chair (four-leg), or stool. Seat back options are armless, with arms, and high-back with arms.

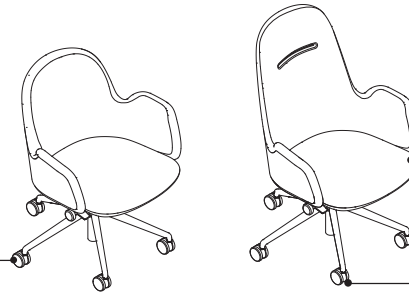

Five-star seat height adjusts 5" from 17 $\frac{1}{4}$ " to 22 $\frac{1}{4}$ ".

Hard, dual wheeled casters are standard for use on carpets. Soft, roll-control, dual-wheel casters are available for use on hard floors or chair mats. Casters are 2 $\frac{1}{2}$ " diameter.

Tip: Do not roll the chair across asphalt during installation as this may damage the casters.

Five-star base is only available with casters.

The five-star base includes tilt and lock features on the standard application.



Four-star base swivels and is not height adjustable. It is available with casters or glides.

Stool seat height adjusts 7", from 25" to 32".

Stools cannot be specified with a high-back.

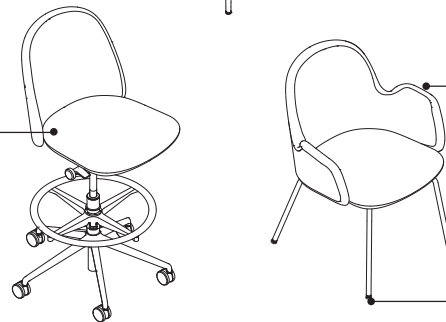

If arms are specified, they are always upholstered.

Glides come standard in black.

Product Details

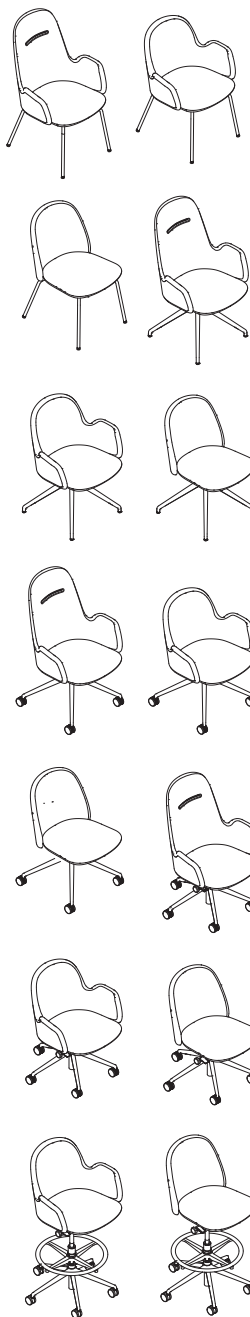

All products in the Kent product line ship in one package. The four-leg guest chair ships fully assembled. Four-star, five-star, and stools ship knocked down and feature a tool-less assembly.

Adjustment Features

Adjustability instructions are included with every swivel-base chair. Instructions can also be found at www.steelcase.com.

Seat Adjustments

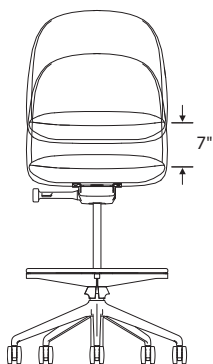
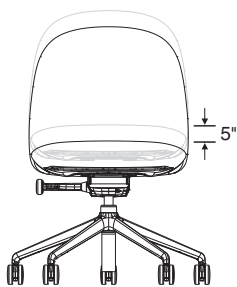

Seat height adjusts pneumatically. To lower, pull lever up while seated. To raise, pull lever up and keep your weight off the chair.

Surface Materials

Upholstery

► See *Surface Materials*, page 272 for upholstery options.

Visit <https://srh.steelcase.com/comcalculator.aspx> for Steelcase Textile calculator.



Fabric is applied in the vertical direction. Optional contrasting fabric is available between the seat and back/arms.

Five-star, four-star, and stool bases are available to be painted or in 8046 Polished Aluminum.

Guest (four-leg) bases are available to be painted or in 9201 Chrome.

Pneumatic cylinders

- 6205 Black

Foot ring

- 6205 Black

Dimensions

► Page 48

Dimensions

Kent Seating

Features Base	Depth	Width	Seat Height	Arm Height	Overall Height	Weight (lb)
Kent						
Conference Chairs—Five-Star with Arms						
	27"	25 ³ / ₁₆ "	17 ⁵ / ₁₆ " – 22 ³ / ₁₆ "	25 ¹ / ₂ "	31 ⁵ / ₈ " – 36 ¹ / ₂ "	29 lb
Conference Chairs—Five-Star High Back with Arms						
	27"	25 ³ / ₁₆ "	17 ⁵ / ₁₆ " – 22 ³ / ₁₆ "	25 ¹ / ₂ "	38 ¹ / ₂ " – 43 ⁵ / ₁₆ "	30 lb
Conference Chairs—Five-Star Armless						
	27"	25 ³ / ₁₆ "	17 ⁵ / ₁₆ " – 22 ³ / ₁₆ "		31 ⁵ / ₈ " – 36 ¹ / ₂ "	28 lb
Conference Chairs—Four-Star with Arms						
	24 ⁵ / ₁₆ "	24 ¹¹ / ₁₆ "	19"	25 ¹ / ₂ "	33 ⁵ / ₁₆ "	29 lb
Conference Chairs—Four-Star High Back with Arms						
	24 ⁵ / ₁₆ "	24 ¹¹ / ₁₆ "	19"	25 ¹ / ₂ "	40 ³ / ₁₆ "	30 lb
Conference Chairs—Four-Star Armless						
	24 ⁵ / ₁₆ "	19 ¹³ / ₁₆ "	19"		33 ⁵ / ₁₆ "	28 lb
Guest Chairs—Four-Legs with Arms						
	23 ⁷ / ₈ "	25 ³ / ₁₆ "	19"	25 ¹ / ₂ "	33 ⁵ / ₁₆ "	29 lb
Guest Chairs—Four-Legs High Back with Arms						
	23 ⁷ / ₈ "	25 ³ / ₁₆ "	19"	25 ¹ / ₂ "	40 ³ / ₁₆ "	30 lb
Guest Chairs—Four-Legs Armless						
	23 ⁷ / ₈ "	19 ¹³ / ₁₆ "	19"		33 ⁵ / ₁₆ "	28 lb
Conference Stools—Five-Star with Arms						
	27"	25 ³ / ₁₆ "	25" – 32"	25 ¹ / ₂ "	38 ⁵ / ₁₆ " – 45 ¹³ / ₁₆ "	29 lb
Conference Stools—Five-Star Armless						
	27"	25 ³ / ₁₆ "	25" – 32"		38 ⁵ / ₁₆ " – 45 ¹³ / ₁₆ "	28 lb

*Overall width does not include the base.
 The diameter of the chair with the five-star base is 26".
 The diameter of the chair with the four-star base is 26¹/₂".

Lucas Seating

Modern lines give Lucas a streamlined look, while a wide seat and reclined pitch make it a comfortable spot to sit during long meetings and busy days.

Lucas comes standard with arms at a height of 20½".

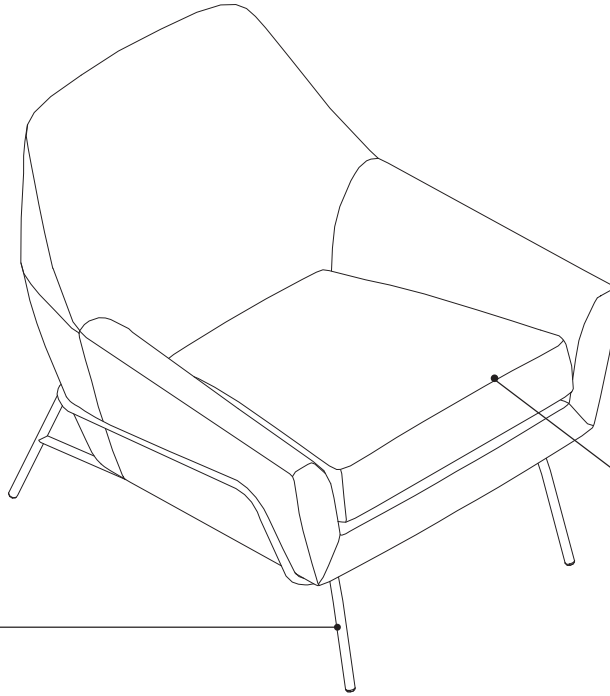

Seat height on wire base chair is fixed at 18½".

The wire base comes standard in West Elm WE05 Burnished Bronze with black glides.

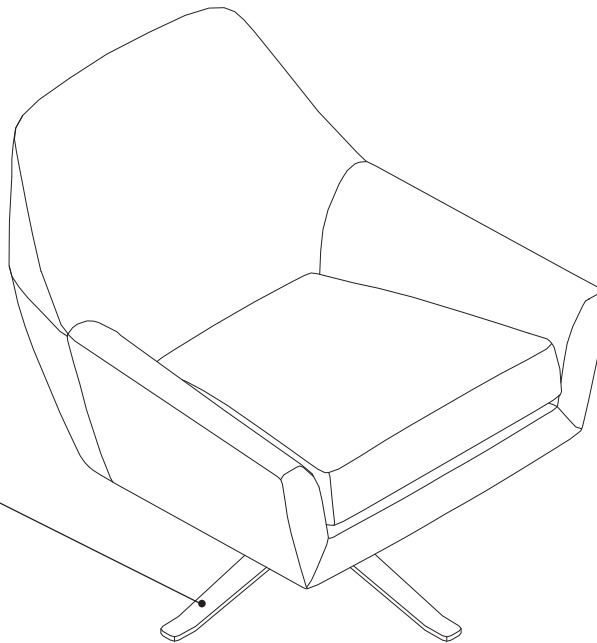

Swivel base comes standard in 8046 Polished Aluminum. Swivel is a full 360° without an automatic return.

Product Details

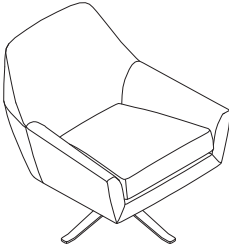

Cushion is detachable.

All product in the Lucas product line ships fully assembled.

Surface Materials

Swivel base is 8046 Polished Aluminum. The base of the Lucas swivel chair will match the previous style number **WEM3598978**.

Wire base is WE05 West Elm Burnished Bronze. The base of the Lucas wire base will match the previous style number **WEM3406073**.

Contrasting fabric is not available.

Visit <https://srh.steelcase.com/comcalculator.aspx> for Steelcase Textile calculator.

Dimensions

Lucas Seating

• Features	• Overall Depth	• Width	• Height	• Seat Depth	• Seat Width	• Seat Height	• Arm Height	• Weight
Lucas Seating								
Wire Base Chair								
	32"	30½"	31"	21"	22"	18½"	20½"	53.7 lb
Swivel Base Chair								
	32"	30½"	31"	21"	22"	20¾"	20½"	60.1 lb

Fulton Seating

Fulton is a timeless wood-frame collection of a guest chair, lounge chair, and bench; great for shared spaces and private offices.

Upholstery treatment is available in contrasting or non-contrasting cord, which wraps around the perimeter of the seat and back cushions. Cord wraps around seat cushion of the bench.

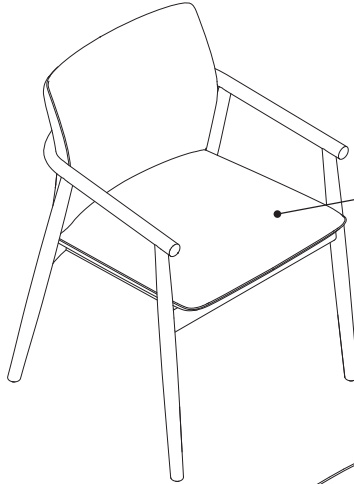

Seat height for the guest chair is 18³/₄"H.

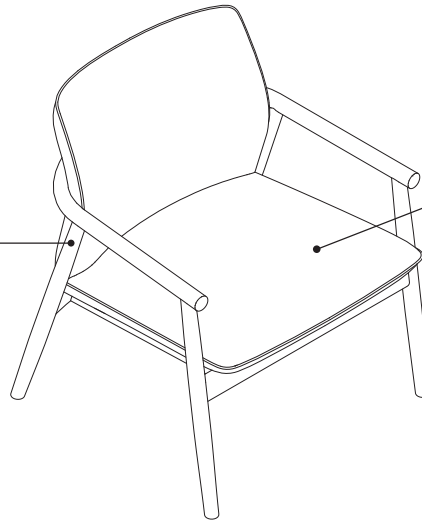

Seat height for the lounge chair is 17¹/₄"H.

The frame of the guest chair, lounge chair, and bench comes in stained ash.

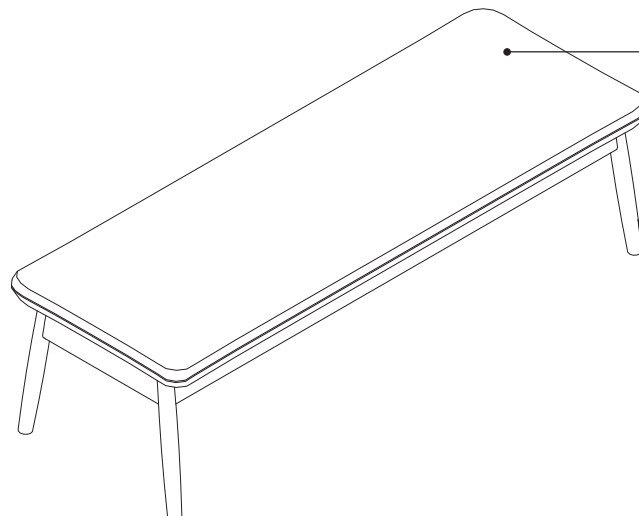

Seat height for the bench is 17³/₄"H.

Product Details

All products include plastic glides.

All product in the Fulton product line ships fully assembled in one package.

Surface Materials

Optional contrasting cord is available on the perimeter of the seat and back.

Visit <https://srh.steelcase.com/comcalculator.aspx> for Steelcase Textile calculator.

See surface materials matrix on page 272 for upholstery options.

Dimensions

Fulton Seating

• Features	• Depth	• Width	• Overall Height	• Seat Height
Fulton Seating				
Guest Chair				
	22"	22 ¹ / ₄ "	32"	18 ³ / ₄ "
Lounge Chair				
	28 ³ / ₄ "	27 ³ / ₄ "	30 ³ / ₄ "	17 ¹ / ₄ "
Bench				
	22"	58 ¹ / ₂ "	17 ³ / ₄ "	17 ³ / ₄ "

Understanding Greenpoint

Private Office	58
Storage Capacities	64
Benching	66
Storage Capacities	73
Universal Tackable Center Screens	74
Power Routing Harness Chart	76
Distribution and Access	78
Building Interface	80
Stability Guidelines	82
Directional Laminate and Edge Profile Detail	83

Greenpoint Private Office

Greenpoint private office offers a contemporary take on the private office with its distinct visual language and fresh material options.

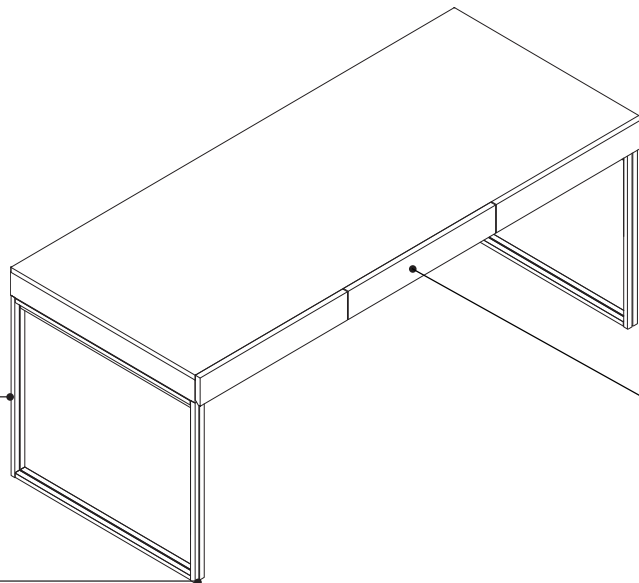

Executive desk work-surfaces are standard 4" thick overall. They can be specified in either wood veneer or High-Pressure Laminate. Executive desk is available in a 72" width. Height of the executive desk is 29¹/₂".

Square tube steel legs are flush with the outside of the desk and are offered in a range of powder coat finishes. Legs are fixed height with top of surface at 29¹/₂".

Three box drawers open their full depth using ball-bearing suspensions.

Leveling glides provide 1¹/₂" adjustment.

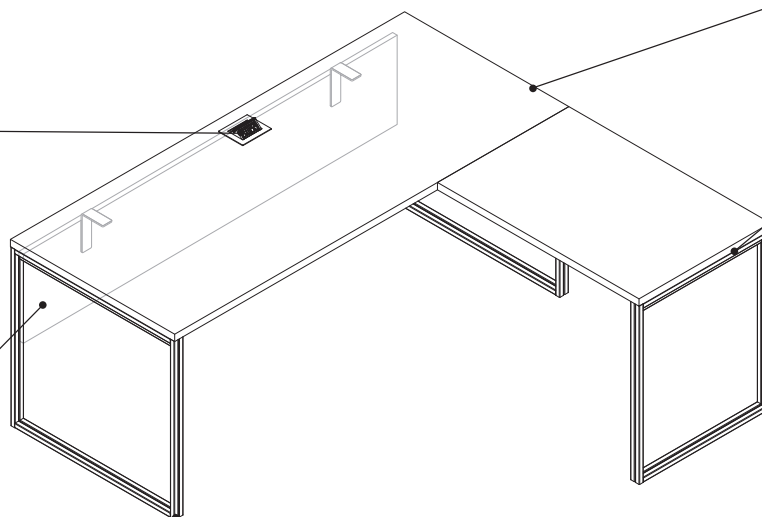

Private desk work-surfaces are 1¹/₈" thick. They can be specified with either wood veneer or High-Pressure Laminate. Height of the private desk is 29¹/₂".

Desk returns are available for private desks and can be specified with a leg or pedestal support.

A power cutout can be specified in the center, the left, or the right side of the desk worksurface. The desk power unit is ordered separately.

*Tip: The style number for desk power unit is **WESINDPWR**.*

A modesty panel is available and ordered separately, in widths from 48" to 78". They can be specified in either wood veneer or High-Pressure Laminate. Modesty panels are specified one size smaller than the desk to allow for 3" clearance on both ends to accommodate the legs. Modesty panel can be mounted flush or inset.

Leveling glides provide 1¹/₂" adjustment.

Product Details

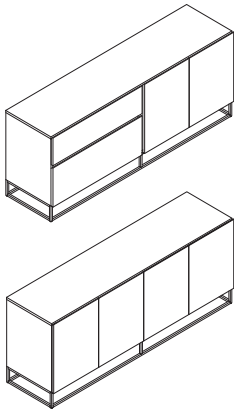

Credenzas come in two non-locking configurations—storage and filing. Storage credenzas have two sets of doors with adjustable shelves. Filing credenzas have two drawers and a set of doors with adjustable shelves. Back panels are finished. Leveling glides provide 1 1/2" adjustment.

Counterweights are included with filing credenza.

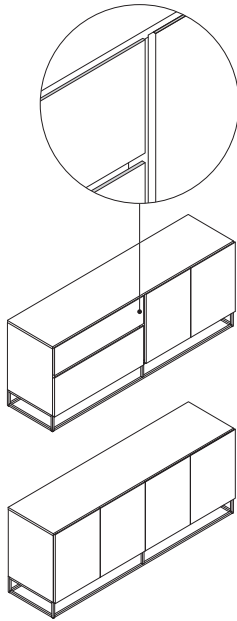

Door and drawer fronts on credenzas, lateral files, pedestals, and executive desk drawers that are specified in High-Pressure Laminate have a corresponding painted top edge. For more information, see the matrix in *Surface Materials* section.

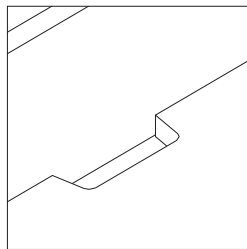

Cutout in lower cabinet shelf is standard on all credenzas to allow cord pass-through.

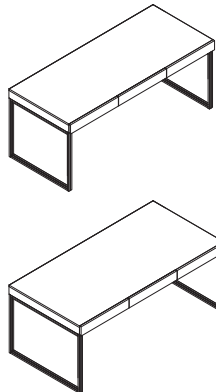

Executive desks are available in 30"D and 36"D. Overall thickness of the worksurface is 4" and inner drawer height is 2 1/2". Executive desks come standard with three non-locking drawers. Modesty panels are also available. Power cutouts are available in center, left, and right.

▶ See wiring on cabling, page 62.

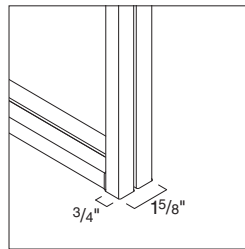

Legs are welded metal.

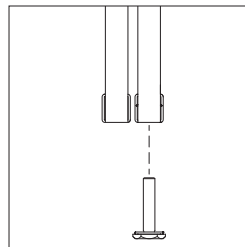

Glides are adjustable and provide 1 1/2" adjustment.

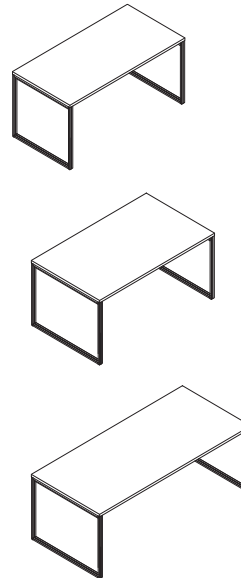

Private desks are available in a range of sizes and come standard with two legs. Desk returns and modesty panels are also available. Power cutouts are available in center, left, and right.

▶ See wiring on cabling, page 62.

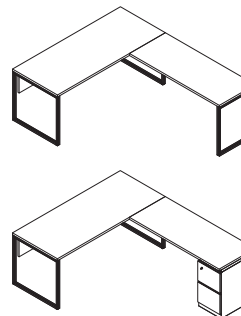

Desk returns are used with private desks to form L-shape configurations, where everything is in reach. Specify with leg or pedestal support.

Modesty panels cannot be used on the return side of this configuration.

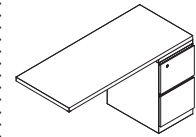

File/file

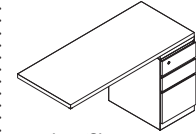

Box/box/file

Under-worksurface pedestals are available 18"D and 24"D for desk returns. Pedestals are available in file/file or box/box/file configurations.

Lock comes standard on pedestals.

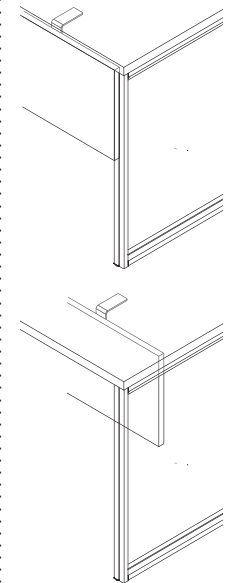

Modesty panel can be mounted flush or inset. Height can be adjusted to provide cord pass-through.

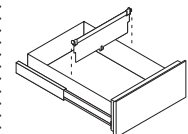

Box drawers are a welded steel construction and available with wide integral pull fronts. One divider is included with each box drawer.

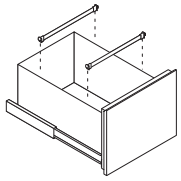

File drawers are a welded steel construction and available with wide integral pull fronts. Drawer body sides are full height and accommodate front-to-back filing of hanging letter-size file folders.

Optional rails accommodate side-to-side filing of letter-, A4-, and legal-size hanging folders.

Exception: Legal-size file folders cannot be filed in 17¹/₈"D or 18³/₈"D pedestals.

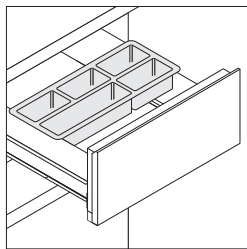

Pencil tray to hold small office supplies

comes standard with each box/box/file and mobile pedestal, but can be excluded in the basic drawer option.

Optional basic drawer interior allows box/box/file pedestals to be ordered without rails, box drawer dividers, or pencil trays.

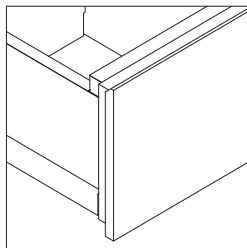

Pull on drawer and door fronts is full width and integral.

Drawer and door fronts are available in wood veneer or High-Pressure Laminate.

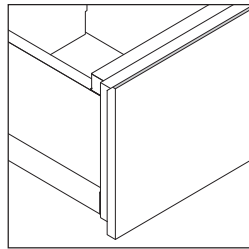

Door and drawer fronts on credenzas, lateral files, pedestals, and executive desk drawers that are specified in High-Pressure Laminate have a corresponding painted top edge. For more information, see the table *High-Pressure Laminate Top Edge* from the next page.

3"H base is integral to pedestal and lateral cases.

Leveling glides adjust to install under-worksurface pedestals and lateral files on uneven floors.

Lateral files are ideal for high-density paper storage.

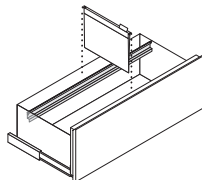

Hanging folder bar accommodates side-to-side filing of letter-, A4 international-, and legal-size hanging folders.

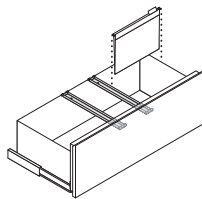

Rails accommodate front-to-back filing of letter-, A4 international-, and legal-size hanging folders. Rail packages accommodate two rows of letter-size files in 30"W and 36"W drawers.

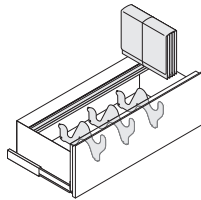

Dividers accommodate side-to-side filing of expandable folders and other objects. Divider packages include three dividers and one hanging folder bar per drawer.

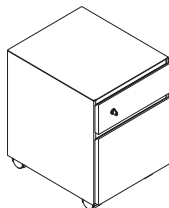

Metal lateral files and mobile pedestals have limited finishes.

Metal mobile pedestals are 18"D. Clearance from the ground to the bottom of the pedestal is 2¹/₂".

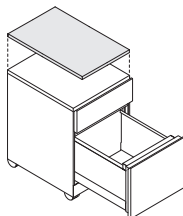

Basic cushion enhanced is ordered separately for use on mobile pedestals. Basic cushion enhanced is field-installed and attaches to the existing top with hook and loop fastener.

Counterweight packages are required to ensure product stability and are ordered as an option or separately.

Four casters are hard composition and non-locking, with a full-rotation swivel mechanism. Casters are exposed at the base of box/file pedestals.

Bookcases offer convenient storage for binders, books, and other objects.



Storage



Tall Open

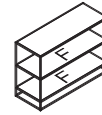

Low Open

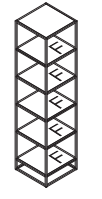

Narrow Open

F - Fixed shelf

Bookcases, are available in several different configurations and ship fully assembled. Shelf inside storage bookcase is adjustable. Shelves are standard 1/2" thick and can carry a load of 100 pounds. Back panels are finished. Shelf inside storage bookcase is adjustable.

Bookcases and lateral files cannot be used to support worksurfaces.

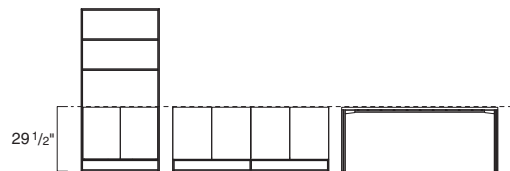

Storage bookcases align with executive desks, private desks, and storage or filing credenzas.

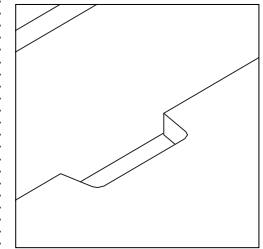

Cutout in lower cabinet shelf is standard on storage bookcase to allow cord pass-through.

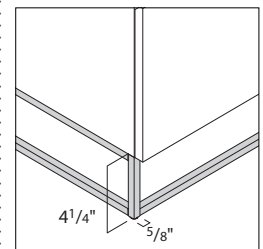

Metal bases are standard on all credenzas, bookcases, and wood lateral files. Leveling glides provide 1¹/₂" adjustment.

High-Pressure Laminate Top Edge

Door and Drawer Front HPL Finish	Top Edge Corresponding Paint Color	Door and Drawer Front HPL Finish	Top Edge Corresponding Paint Color
2406 Clear Cherry	CLRF Clear	2HAE Dark Olivine	CLRF Clear
2409 Clear Maple	4700 Warm White	2HAF Cloudy	CLRF Clear
2410 Graphite Walnut	7245 Carbon Metallic	2HAK Clear Oak	4242 Milk
2412 Natural Cherry	CLRF Clear	2HAN Ash Noce	4242 Milk
2422 Medium Cherry	7278 Dark Bronze	2HAT Acacia	4700 Warm White
2511 Winter on Maple	4700 Warm White	2HAW Ash Wenge	4242 Milk
2535 Virginia Walnut	7245 Carbon Metallic	2HBN Bisque Noce	4242 Milk
2536 Blackwood	7245 Carbon Metallic	2HBW Bisque Wenge	4242 Milk
2538 Clear Walnut	7278 Dark Bronze	2HCN Clay Noce	4242 Milk
2592 Blonde on Maple	7243 Seagull	2HCW Clay Wenge	4242 Milk
2612 Marbled Maple	4700 Warm White	2HMG Merle	7360 Merle
2614 Chocolate Walnut	7278 Dark Bronze	2HSN Storm Noce	7360 Merle
2615 Marbled Cherry V2	4700 Warm White	2HSW Storm Wenge	7360 Merle
2714 Natural Walnut	7278 Dark Bronze	2TH2 Fawn Cypress	4700 Warm White
2722 Cream	4700 Warm White	2TH4 Saddle Oak	7245 Carbon Metallic
2730 Arctic White	4231 Arctic White	2TH5 Veranda Teak	7245 Carbon Metallic
2746 Black	0835 Black	2TH7 Walnut Heights	7245 Carbon Metallic
2759 Warm White	4700 Warm White	2UH1 Reclaimed Aggregate	4242 Milk
2811 Mist	7243 Seagull	2UH2 Reclaimed Gravel	7360 Merle
2820 Coffee Speckle	4700 Warm White	2UH4 Cement	4242 Milk
2823 Driftwood Speckle	4700 Warm White	2UH6 Sheetrock	4242 Milk
2824 Smoke Speckle	7243 Seagull	WE40 Natural Oak	CLRF Clear
2825 Vanadium Speckle	4242 Milk	WE41 Black Walnut	7245 Carbon Metallic
2850 Vanadium Fiber	4231 Arctic White	WE42 Gray Ash	7245 Carbon Metallic
2852 Tungsten Fiber	7243 Seagull		
2854 Vellum Fiber	4700 Warm White		
2860 Granite Fiber	7360 Merle		
2862 Stucco Fiber	7243 Seagull		
2870 Blonde Bronze Patina	4700 Warm White		
2873 Instant Iron Patina	7360 Merle		
2883 Seagull	7243 Seagull		
2884 Milk	4242 Milk		
2885 Dune	4242 Milk		
2920 Marl Micro	7243 Seagull		
2921 Gypsum Micro	4242 Milk		
2922 Clay Micro	4700 Warm White		
2HAA Persian Salt	CLRF Clear		
2HAB Rose	CLRF Clear		
2HAC Indigo	CLRF Clear		
2HAD Green Citrine	CLRF Clear		

Lock and Keying

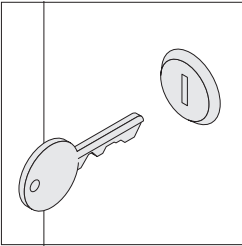

Locks are available field-installed. Field-installed locks are available with consecutive, specific, and random keying options. Master-keyed locks are also available. Lock cylinders must be specified separately.

Locks are standard on under-worksurface pedestals, metal pedestals, and metal lateral files. Lock is located in the top drawer. Key will lock both drawers if applicable. Locks are standard factory installed, keyed random.

▶ *Lock and Keying*, page 274

Wiring and Cabling



Field-installed 2½" grommet, ordered separately, provides wire and cable management for workspaces.

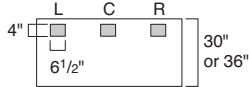

Worksurface power modules are available on executive and private desks. Cutouts can be specified for left, center, and right locations.

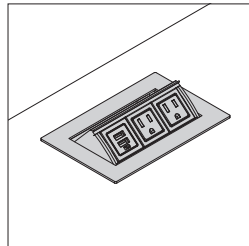
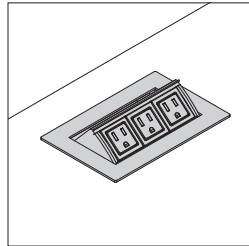

Power modules are available in three simplex and two simplex/USB configurations. The one-touch retractable door allows easy access.

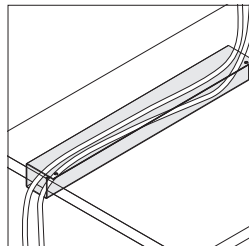

Cable tray is available to keep cords and cables out of the way.

Application Topics

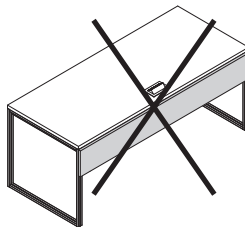
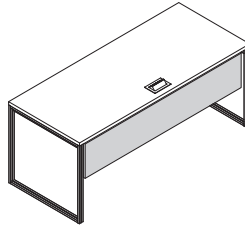

Modesty panels are specified one size smaller than the desk to allow for 3" clearance on both ends to accommodate the legs.

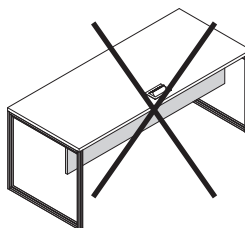
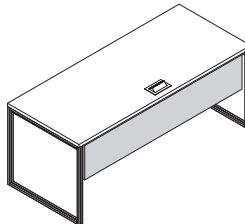

When a power cutout has been specified, modesty panel must be mounted flush to front of desk.

Storage Capacities and Dimensions

▶ Page 64

Surface Materials

Executive desk

- High-Pressure Laminate
- Wood veneer

Private desk and personal desk worksurface

- High-Pressure Laminate
- Wood veneer

Desk return with pedestal

- Drawer fronts are available in limited High-Pressure Laminate and veneer finishes.

Drawer and door fronts

- High-Pressure Laminate
- Wood veneer

Modesty panels

- High-Pressure Laminate
- Wood veneer

Credenzas, bookcases, and lateral files

- High-Pressure Laminate
- Wood veneer

Metal lateral files, and metal mobile pedestal

Drawer fronts are available in limited High-Pressure Laminate and veneer finishes:

- 2884 Milk
- 2HAN Ash Noce
- 2HMG Merle
- 36A2 Volcanic Oak
- 37A2 Thunder Walnut
- WE20 Natural Oak
- WE40 Natural Oak
- WE41 Gray Ash
- WE42 Black Walnut

Metal storage cases and metal bases

- 0835 Black
- 4B22 Matte Brass
- 4B24 Night Brass
- 4242 Milk
- 7278 Dark Bronze

Basic cushion enhanced

- Fabric

Lock

- 9201 Polished Chrome
- 9250 Ember Chrome

Desk power unit

- 6000 Black
- 6052 Milk

2½" round grommet





- 0835 Black
- 4799 Platinum Metallic
- 7241 Arctic White
- 7278 Dark Bronze
- 9201 Polished Chrome
- 9211 Nickel

Tip: When selecting a Steelcase top surface finish, a corresponding Steelcase edge finish must be selected. When selecting West Elm top surface finish, a corresponding West Elm edge finish must be selected.

Greenpoint Private Office

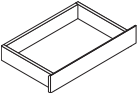
Storage Capacities

Greenpoint Storage

Box Drawer	Size/Type	Inside Dimensions		
		D	W	H
	<ul style="list-style-type: none"> Return pedestal 	15 ¹ / ₈ "	12"	4 ¹ / ₄ " (includes drawer front) 2 ³ / ₄ " (box drawer body only)
Executive Desk Drawer	Size/Type	Inside Dimensions		
		D	W	H
	<ul style="list-style-type: none"> Desk drawer 	17"	21"	2 ¹ / ₂ " (includes drawer front)
File Drawer	Size/Type	Inside Dimensions		
		D	W	H
	<ul style="list-style-type: none"> Return pedestals Mobile pedestals 	15 ¹ / ₈ "	12"	10 ¹ / ₂ " (includes drawer front) 9 ¹ / ₄ " (file drawer body only)
Metal Lateral File Drawer	Size/Type	Inside Dimensions		
		D	W	H
	<ul style="list-style-type: none"> 1¹/₂"H Box drawer 1¹/₂"H File drawer 	15"	32 ³ / ₈ "	10 ¹ / ₂ " (includes drawer front) 9 ¹ / ₄ " (box drawer body only)
Wood Lateral File Drawer	Size/Type	Inside Dimensions		
		D	W	H
	<ul style="list-style-type: none"> Wood lateral 	13"	32"	8 ¹ / ₁₀ " (includes drawer front)

Tip: When specified in High-Pressure Laminate, the drawer fronts will be painted according to the matrix in the Surface Materials section.

Tip: Drawer fronts on pedestal and metal lateral files are available in limited High-Pressure Laminate and veneer finishes. See Surface Materials section for more information.

Greenpoint Storage, continued

Filing Credenza

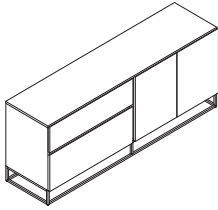

Size/Type

- Top drawer
- Bottom drawer
- Storage cabinet

Inside Dimensions

D	W	H
13"	31½"	8 ¹ / ₁₀ " (includes drawer front)
13"	31½"	11 ³ / ₈ " (file drawer body only)
17 ³ / ₁₆ "	34"	22½"

Outside Dimensions

D	W	H
18 ³ / ₄ "	72"	29½"

*Five holes for adjustable shelf
1½" apart—first hole from top and
bottom = 8¼".

Storage Credenza

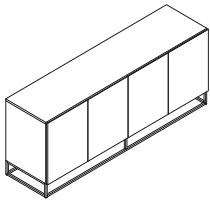

Size/Type

- Storage cabinet

Inside Dimensions

D	W	H
17 ³ / ₁₆ "	34"	22½" (per opening)

Outside Dimensions

D	W	H
18 ³ / ₄ "	72"	29½"

*Five holes for adjustable shelf
1½" apart—first hole from top and
bottom = 8¼".

Bookcase Storage

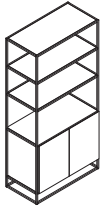

Size/Type

- Open shelf
- Storage cabinet

Inside Dimensions

D	W	H
18"	36"	75"
17"	32¼"	22¼" (1 shelf at ¾" = 22 ³ / ₈ ")

*Five holes for adjustable shelf
1½" apart—first hole from top and
bottom = 8¼".

Bookcases

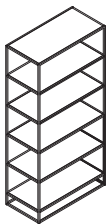

Size/Type

- Storage
- Tall open
- Low open
- Narrow open

Outside Dimensions

D	W	H
18"	36"	75"
18"	36"	75"
18"	48"	33"
18"	18"	75"

Lateral File

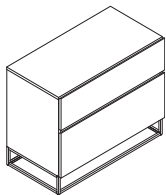

Outside Dimensions

D	W	H
18 ³ / ₄ "	36"	29½"

Greenpoint Benching

Greenpoint benching

is designed to keep things simple while providing a rich range of design options that blends performance with a light and airy appeal.

Privacy screens provide privacy and are available for single- or dual-sided applications. Available in tackable fabric and glass. Glass options include clear or fluted.

A 2 1/2" gap between worksurfaces accommodates screens, worktools, and cords.

Credenzas can be used to support worksurfaces and provide storage. All brackets and mounting hardware are included.

Upmount bins offer convenient storage above the worksurface. Optional whiteboard inserts are available.

Optional center power cutout is available. Power units are specified separately.

End legs are available on dual-sided units in 48" and 60" widths. End legs are designed to be flush with the corners of the worksurface and include all brackets and mounting hardware. Leveling glides provide 1 1/2" adjustment. Legs are fixed height with top of surface at 28 1/2"H.

Dual-sided worksurfaces are available in overall depths of 24" and 30". Worksurfaces are 1 1/8" thick and can be supported by legs or credenzas. Widths range from 48" to 78".

Intermediate legs are used to connect dual-sided units. Intermediate legs are 30"W for 48"W and 60"W dual-sided worksurfaces and include all brackets and mounting hardware. Leveling glides provide 1 1/2" adjustment. Legs are fixed height with top of surface at 28 1/2"H.

End legs are available on single-sided units in 24" and 30" depths. End legs are designed to be flush with the corners of the worksurface and include all brackets and mounting hardware. Leveling glides provide 1 1/2" adjustment. Legs are fixed height with top of surface at 28 1/2"H.

Intermediate legs are used to connect single-sided units. Intermediate legs are available in 24" and 30" depths to match the depth of the worksurface and include all brackets and mounting hardware. Leveling glides provide 1 1/2" adjustment. Legs are fixed height with top of surface at 28 1/2"H.

A modesty panel is available and ordered separately, in widths from 48" to 78". They can be specified in either wood veneer or High-Pressure Laminate. Modesty panels are specified one size smaller than the desk to allow for 3" clearance on both ends to accommodate the legs. Modesty panel can be mounted flush or inset.

Leveling glides provide 1 1/2" adjustment.

Bench returns offer additional worksurface space and are available in depths of 18" or 24" and widths of 42", 48", 54", and 60" for single- and dual-sided applications.

Continuous tops are available in a depth of 48". Worksurfaces are 1¹/₈" thick and can be supported by legs or credenzas. Widths range from 48" to 78".

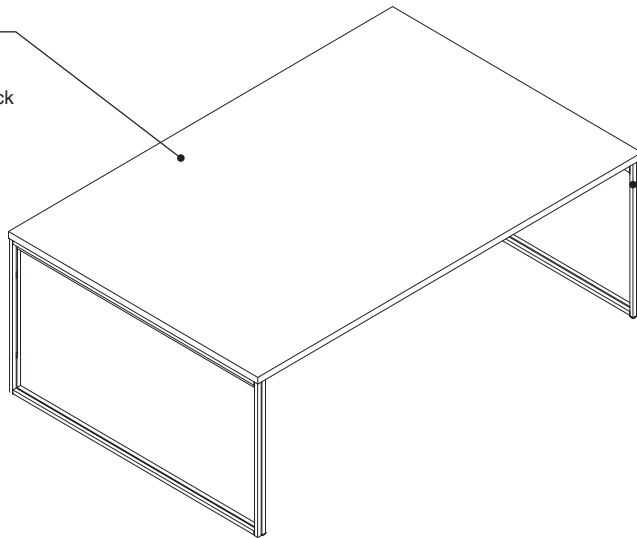

End legs are designed to be flush with the corners of the worksurface and include all brackets and mounting hardware. Leveling glides provide 1¹/₂" adjustment. Legs are fixed height with top of surface at 28¹/₂"H.

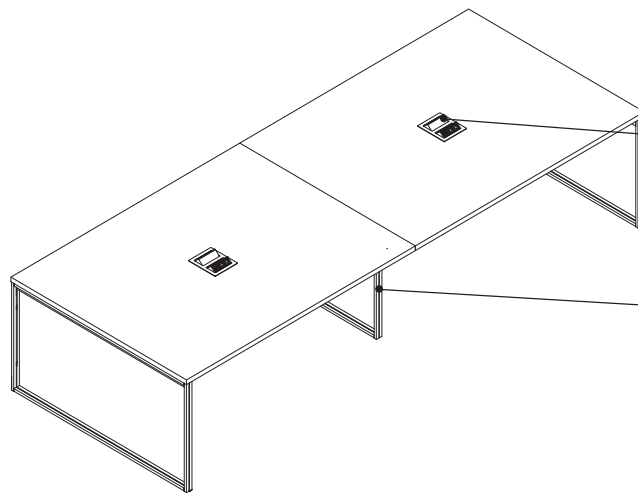

Optional center power cutout is available. Power units are specified separately.

Intermediate legs are used to connect continuous tops. Intermediate legs are 30"W for the 48"D continuous top worksurface and include all brackets and mounting hardware. Leveling glides provide 1¹/₂" adjustment. Legs are fixed height with top of surface at 28¹/₂"H.

Greenpoint Benching

Round, Square, and Half-Round Tables

Round tops are available in 48" or 60" diameters. The worksurface is 1 1/8" thick.

Square tops are available in 48" x 48" or 60" x 60". The worksurface is 1 1/8" thick.

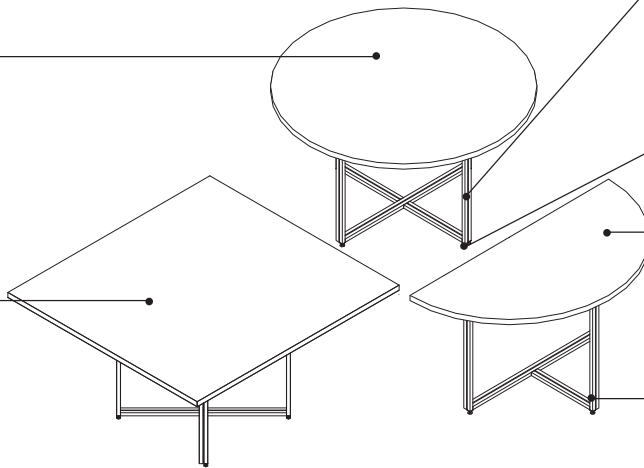

Legs for both the 48" round and square tops are inset by 4 3/4" and 7 1/2" from the edge of the worksurface. Legs for both the 60" round and square tops are inset by 5 7/8" and 9 1/8" from the edge of the worksurface.

Leveling glides provide 1 1/2" adjustment. Legs are fixed height with top surface at 28 1/2"H.

Half-round tops are available in 48" or 60" diameters.

Half-round tops must attach to a continuous top or dual-sided bench of the same dimension.

Legs for the half-round tops are inset by 8 7/8" for the 48"W and 10 3/8" for the 60"W from the edge of the worksurface.

Half-round legs include all brackets and hardware to attach a half-round top to either a continuous top or dual-sided bench.

Actual Dimensions

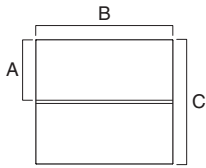

Dual-Sided

A	24" or 30"
B	48", 54", 60", 66", 72", 78"
C	50 1/2" or 62 1/5"

Thickness 1 1/8"

*78"W not available in credenza/credenza application.

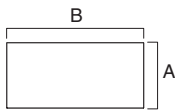

Single-Sided

A	24" or 30"
B	48", 54", 60", 66", 72", 78"

Thickness 1 1/8"

*78"W not available in credenza/credenza application.

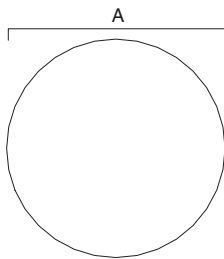

Round

A	48" or 60"
---	------------

Thickness 1 1/8"

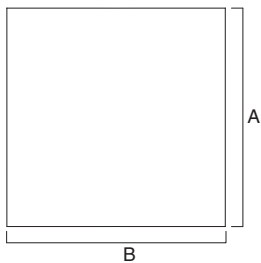

Square

A	48" or 60"
B	48" or 60"

Thickness 1 1/8"

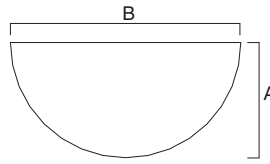

Half-Round

A	24" or 30"
---	------------

B	48" or 60"
---	------------

Thickness 1 1/8"

Product Details

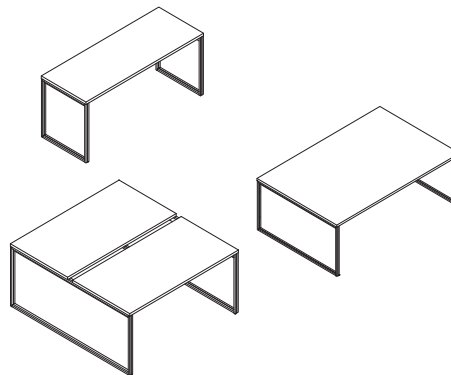

Worksurfaces are available for single-, dual-sided, or continuous top applications in depths of 24" or 30" for single- and dual-sided, and 48" for continuous top, and widths of 48", 54", 60", 66", 72", and 78". Leg and credenza supports are sold separately.

Tip: 78"W not available in credenza/credenza application.

Half-round worksurfaces must attach to a continuous top or dual-sided bench of the same dimension.

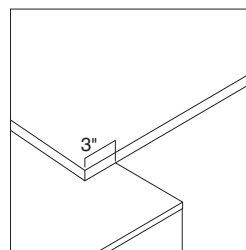

Worksurfaces using one credenza support are 3" wider than those used between leg supports. Worksurfaces used with credenza supports on both ends are 6" wider. Mounting hardware is included with credenzas for applications with credenza support.

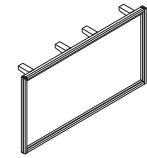

Dual Sided End Leg

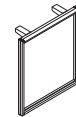

Single Sided End Leg

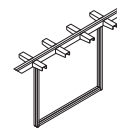

Dual Sided Intermediate Leg

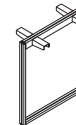

Single Sided Intermediate Leg

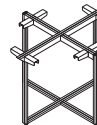

X-Leg

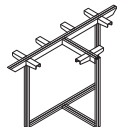

T-Leg

Leg support single- and dual-sided applications used to support worksurfaces at the end-of-run or intermediately.

24"W or 30"W single-sided end legs are to be used with 24"W or 30"W single-sided worksurfaces.

48"W or 60"W dual-sided end legs are to be used with 48"W or 60"W dual-sided worksurfaces.

Round and square worksurfaces must be specified with round/square legs. Half-round worksurfaces must be specified with half-round legs and be adjacent to a continuous top or dual-sided bench.

Intermediate legs are to be used between a run of worksurfaces. Dual-sided intermediate legs are 30"D and work for both 48"D and 60"D worksurfaces. Single-sided intermediate legs are available in 24"D and 30"D.

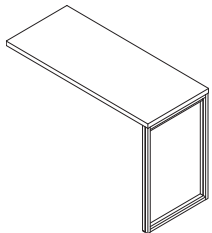

Bench returns are available on dual- and single-sided applications in depths of 18" or 24" and widths of 42", 48", 54", and 60".

Bench returns include return worksurface, leg support, all brackets, and mounting hardware.

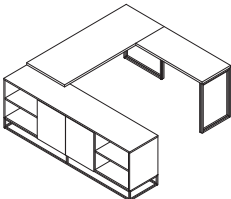
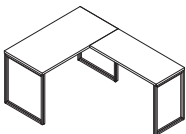

Bench returns can be used with a leg-leg worksurface or leg-credenza worksurface.

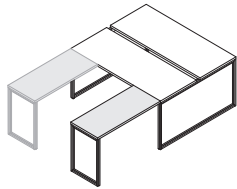

Returns must be placed flush to either end of the worksurface.

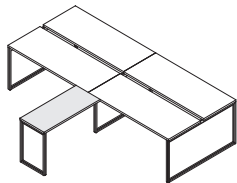

Returns can span equally across adjoining worksurfaces.

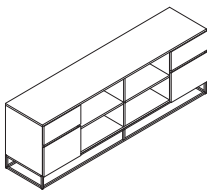

Personal credenza

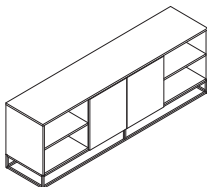

End credenza

Credenzas are available in two configurations – personal and end. The case can be specified as an inward or outward orientation, and single or dual-sided application, resulting in the correct hardware. If specifying as a stand-alone credenza, the orientation and application do not matter.

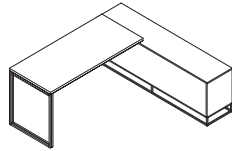
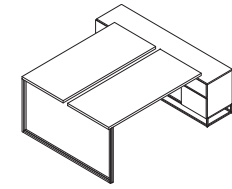

Personal credenzas can be used facing inwards or outwards in dual-sided applications. Specify with 24"D worksurfaces when orienting towards the user to allow easier access to storage drawers. In single-sided applications, the credenza must face outward.

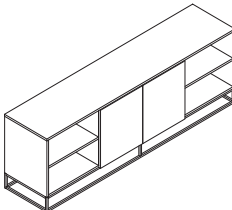

End credenzas can face inward or outward in 24"D single-sided applications. When 30" single-sided is specified, inward facing end credenza is not allowed. In dual-sided applications, credenza must face outward. Both open and closed sections come with adjustable shelves.

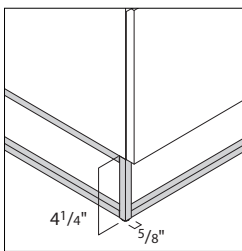

Steel bases are standard on credenzas.

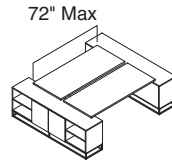

Dual- and single-sided worksurfaces using credenza/credenza support cannot exceed 72"W.

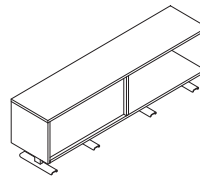

Uppmount bins are double-sided and provide additional above worksurface storage as well as privacy in dual-sided benching applications. Bins are available in widths of 60", 66", and 72" for use with worksurface widths of 66", 72", and 78". Worksurface mounting brackets are included.

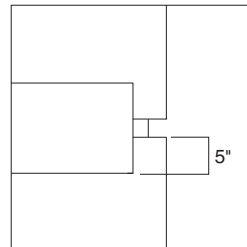

Uppmount bins extend 5" over the worksurface on each side of a dual-sided application.

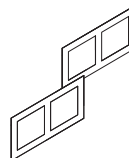

Whiteboard upmount bin inserts can be specified separately in packages of two. Inserts are easily removed as needed and are held in place using strong magnets.

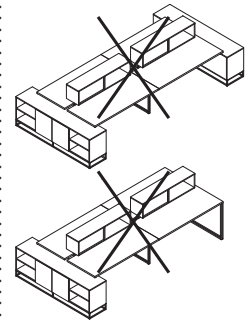

Uppmount bins cannot be used on dual-sided applications with leg/credenza or credenza/credenza worksurfaces.

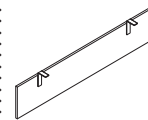

A modesty panel is available and ordered separately, in widths from 48" to 78". They can be specified in either wood veneer or High-Pressure Laminate. Modesty panels are specified one size smaller than the desk to allow for 3" clearance on both ends to accommodate the legs. Modesty panel can be mounted flush or inset.

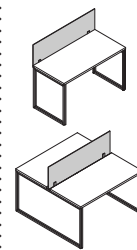

Glass screens are available for single- or dual-sided applications. Worksurface mounting brackets are included. Screens align with a 42"H datum from the floor.

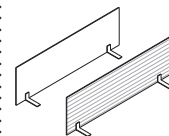

Glass screens are available in clear or fluted glass.

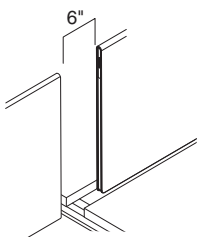

Open

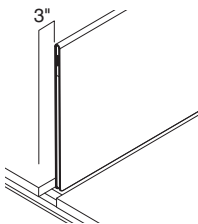

Full

Universal screens will have a 3" gap to the end of a bench run and 6" gap between screens. Screens do not run full worksurface width.

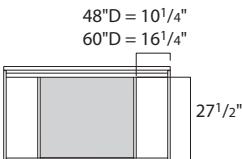

48"D desks have 10 1/4" clearance to intermediate leg. 60"D desks have 16 1/4" clearance.

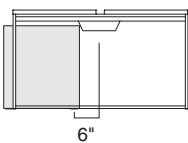

Storage must be at least 6" from centerline when trays are used.

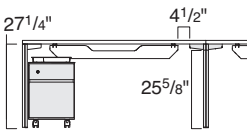

Storage can nest under the bench. The clearance is 27 1/4" except when within 4 1/2" of an intermediate leg, the clearance is 25 5/8".

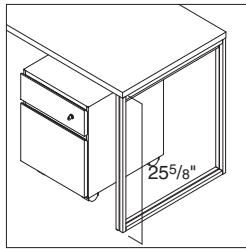

Storage can nest under the return. The clearance is 25 5/8".

Wiring and Cabling

Modular power cannot be routed through personal and end credenzas in any configuration.

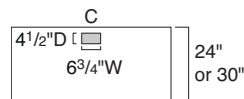

Worksurface power modules are available on dual- and single-sided bench units. Cutouts are centered on the worksurface.

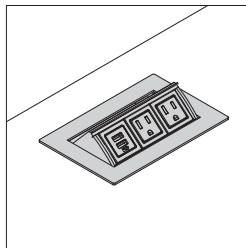
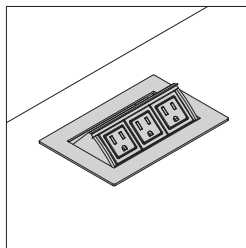

Power modules are available in three simplex and two simplex/USB configurations. The one-touch retractable door allows easy access.

Tip: When using modular power under the worksurface, specify 18" L cord length.

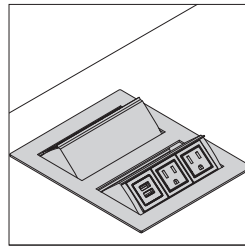

Continuous top power modules are available in six simplex and four simplex/USB configurations. The one-touch retractable door allows easy access.

Tip: When using modular power under the worksurface, specify 18" L cord length.

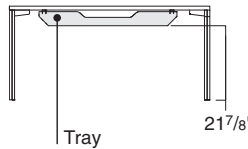

Power trays are optional and provide under the surface cord management and accommodate standard capacity power only. Power trays include all brackets and mounting hardware.

Power trays work with single-sided and dual-sided benches as well as continuous tops.

If center cutout is specified on single-sided worksurfaces, specify either left-hand or right-hand power tray.

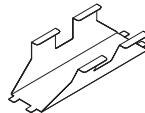

Single-sided tray extension

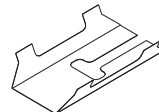

Dual-sided tray extension

Extension trays conceal conduit or wires between sections using power trays. They also allow for wires or conduit to be brought up through the bottom.

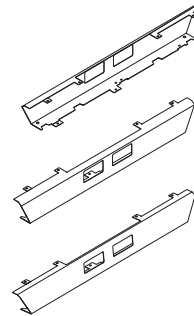

Power covers can be added to provide decorative trim around receptacles. Power covers are available for dual- and single-sided applications.

If power covers are not selected, any connection points on modular power blocks not being used by a harness, infeed, or connector must be filled with dust covers. Order style number (FMVBK) separately.

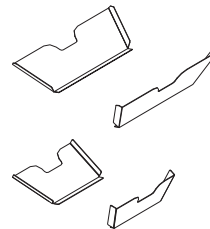

End caps can be added to power trays and are sold in pairs. End caps are painted metal.

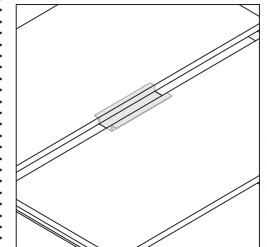
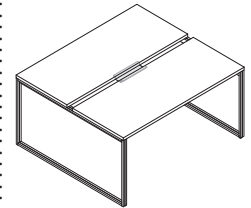

Power support is required when using modular power and provides an attachment location for a modular power block. Location is centered between worksurfaces for dual-sided applications and off-center for single-sided applications.

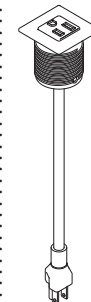
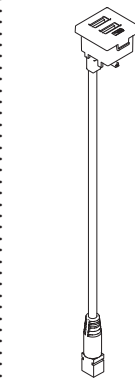

Round and square worksurfaces can be specified with a power cutout. Round/square power comes in configurations of 1 power or 2 USB and has a 72" cord length.

Related Products

The following monitor arms work with the Greenpoint bench dual- and single-sided worksurfaces: **CFINTRO** and **CFINTROSLIDE**, single FYI monitor arm with C-clamp mounting bracket, and single and dual Volley monitor arms with C-clamp mounting bracket. For more information, see *Worktools Specification Guide*.
Tip: Dual monitor mounts are not approved on 24"D worksurface applications.

Surface Materials

Worksurfaces and returns

- High-Pressure Laminate
- Wood veneer

Modesty panels

- High-Pressure Laminate
- Wood veneer

Credenzas and upmount bins

- High-Pressure Laminate
- Wood veneer

Tip: Credenzas specified in High-Pressure Laminate, will have a corresponding painted pull, according to the matrix in the Surface Materials section.

Legs, trays, extensions, end caps, and covers

- Paint

Desk power unit

- 6000 Black
- 6052 Milk

Glass screen

- 6500 Clear Glass
- WE80 Fluted Glass

Tip: When selecting a Steelcase top surface finish, a corresponding Steelcase edge finish must be selected. When selecting West Elm top surface finish, a corresponding West Elm edge finish must be selected.

Greenpoint Storage

End Credenza

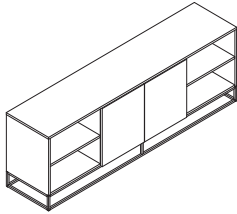

Size/Type

- Storage cabinet
- Open section
- Closed section

Inside Dimensions

D	W	H
18"	80"	27 ¹ / ₄ "
17 ¹ / ₈ "	17 ¹ / ₄ "	20 ¹ / ₄ "
17 ¹ / ₈ "	34 ¹ / ₂ "	20 ¹ / ₄ "

Outside Dimensions

D	W	H
18"	80"	27 ¹ / ₄ "

Personal Credenza

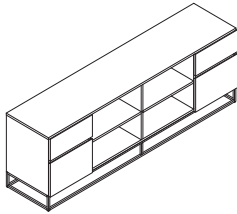

Size/Type

- Storage cabinet
- Top drawer
- Bottom drawer

Inside Dimensions

D	W	H
18"	80"	27 ¹ / ₄ "

Outside Dimensions

D	W	H
18"	80"	27 ¹ / ₄ "

Upmount Bin

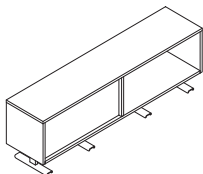

Size/Type

- Storage

Inside Dimensions

D	W	H
13"	60"	13 ¹ / ₂ "
13"	66"	13 ¹ / ₂ "
13"	72"	13 ¹ / ₂ "

Universal Tackable Center Screens

For Use with Greenpoint

Universal tackable center screens provide a boundary element along the bench. They are available in two heights to accommodate varying levels of privacy.
 ▶ Specifying, page 208

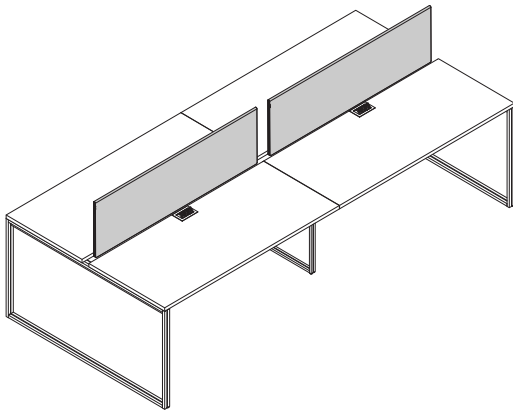

Product Details

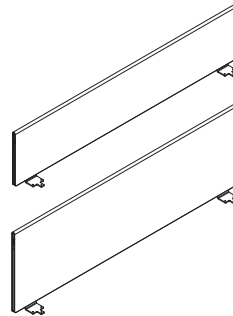

Universal tackable center screens are tackable and available in 13½"H and 19½"H. These screens are available in widths from 48"W-78"W.

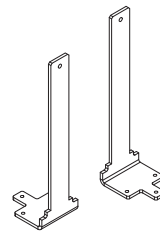

Brackets are included with screens. Two brackets are used on all screens.

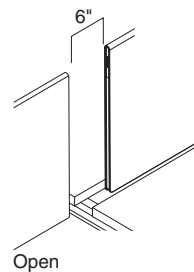

Open

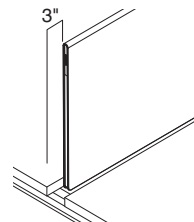

Full

Universal screens will have a 3" gap to the end of a bench run and 6" gap between screens. Screens do not run full worksurface width.

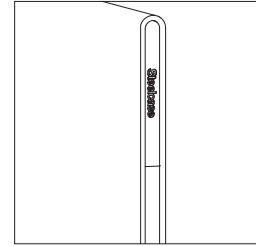

The edge of the screen is comprised of two different materials. The upper segment is merle plastic. The lower portion is PET which can be specified in medium heather grey to provide contrast or dark heather grey for a uniform visual.

Surface Materials

Fabric

▶ See *Surface Materials*, page 258

Edge

- P630 Medium Heather Grey PET
- P631 Dark Heather Grey PET

Brackets

▶ See *Surface Materials*, page 258

Front



Back



All fabrics are wrapped over the top of the screen. Approved fabrics are non-directional, and non-patterned.

Actual Dimensions

	13½" Screen	19½" Screen
Height	12½"	18½"
Thickness	¾"	¾"
Width	48", 54", 60", 66", 72", or 78"	48", 54", 60", 66", 72", or 78"

Tip: 13½"H screen aligns with a 40½"H datum from the floor. 19½"H screen aligns with a 46½"H datum from the floor.

Tip: Screens will have a 3" gap to the end of a bench run and a 6" gap between screens. Screens do not run full worksurface width.

Greenpoint Benching

Power Routing Harness Chart

Dual-Sided Benches

Bench A

Bench B	Bench A					
	48	54	60	66	72	78
48	45	48	51	54	57	60
54	48	51	54	57	60	63
60	51	54	57	60	63	66
66	54	57	60	63	66	69
72	57	60	63	66	69	72
78	60	63	66	69	72	75

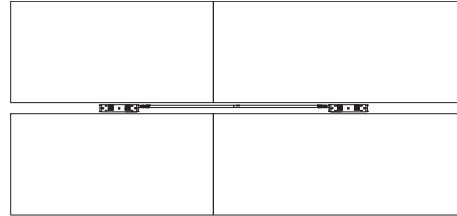

Single-Sided Benches, Left to Left or Right to Right

Bench A

Bench B	Bench A					
	48	54	60	66	72	78
48	45	48	51	54	57	60
54	48	51	54	57	60	63
60	51	54	57	60	63	66
66	54	57	60	63	66	69
72	57	60	63	66	69	72
78	60	63	66	69	72	75



Single-Sided Benches, Right to Left

Bench A

Bench B	Bench A					
	48	54	60	66	72	78
48	27	30	33	36	39	42
54	30	33	36	39	42	45
60	33	36	39	42	45	48
66	36	39	42	45	48	51
72	39	42	45	48	51	54
78	42	45	48	51	54	57

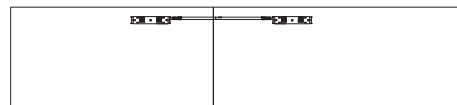

Tip: When skipping over a bench, add the width of the bench to the calculations above.

Tip: Power module is always mounted in the center for dual-sided benches.

Tip: Power modules are mounted off-center for single-sided benches.

Single-Sided Benches, Left to Right

Bench A

		48	54	60	66	72	78
Bench B	48	66	69	72	75	78	
	54	69	72	75	78		
	60	72	75	78			
	66	75	78				
	72	78					
	78						

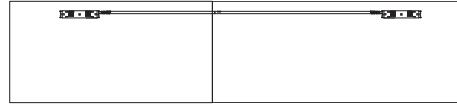

- Tip: When skipping over a bench, add the width of the bench to the calculations above.
- Tip: Power module is always mounted in the center for dual-sided benches.
- Tip: Power modules are mounted off-center for single-sided benches.

Greenpoint Benching

Distribution and Access

Power blocks can be attached to power supports that are mounted to the underside of the worksurface. The location is centered on dual-sided application and off-center on single-sided applications.

Because single-sided application is off-centered, the power tray (**WESINDPTSS**) is either left- or right-handed.

Standard-capacity power includes one power block, provides back-to-back power, and accepts two receptacles per side.

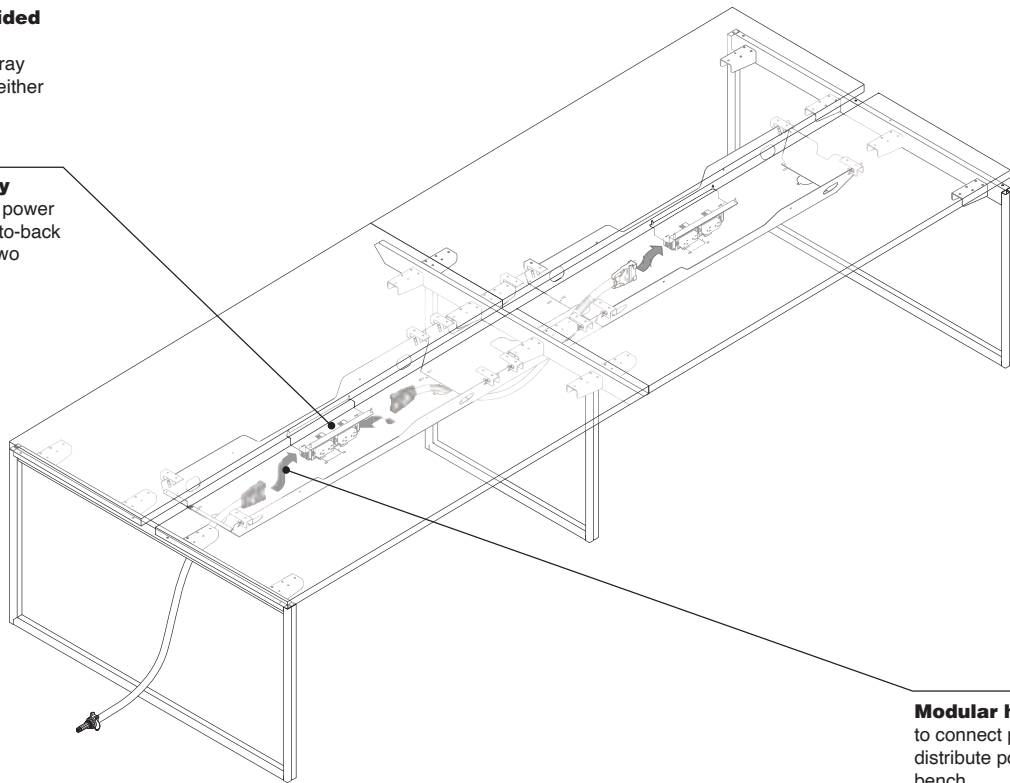

Modular harness is used to connect power blocks and distribute power through the bench.

Wiring and Cabling

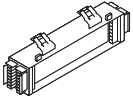

Standard-capacity power includes one power block, provides back-to-back power, and accepts two receptacles per side.

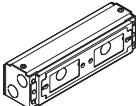

Chicago hardwire box is available. It accommodates two receptacles per side.



Duplex receptacles are available in 15- and 20-amps, isolated or system ground, with multiple line options. Receptacles have two outlets and are ordered separately.



USB receptacles are available in three wiring schematics with multiple line options. USB receptacles offer easy access to two charging ports. Each port provides 1 ampere of output. USB receptacles conveniently charge a wide range of electronic devices. Some devices may not be compatible.

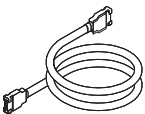

Modular harnesses are used to connect power blocks.

► See *Power Routing Harness Chart*, page 76, to determine lengths needed.

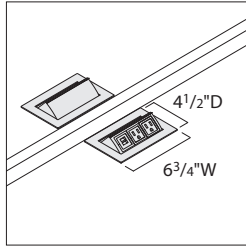

Power unit can be added when a worksurface cutout is specified. It is centered on the surface and provides user access to power.

If power unit and cutout is not specified, power and data is accessible under the worksurface. Dual-sided power trays can be removed without tools to provide additional clearance to plug in devices if needed. Single-sided power trays require tools to remove.

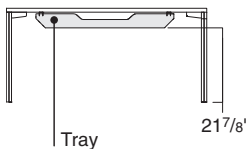

Power trays are available on dual- and single-sided units. Power trays hang from the underside of the worksurface and include all brackets and mounting hardware to provide cord management and conceal the standard capacity power blocks and conduit.

Modular power in a dual-sided base or extension unit, without trays, must be secured with a strain relief bracket. Order style number (**FMBVK**) for each unit.

Power infeed on single- and dual-sided applications must be secured with a strain relief bracket. To order one, use style number (**FMBVK**) for each unit.

Filler packages are available to fill unused power or data options. Order separately in packages of 20.

Three wiring schematics are available—3+1, 2+2, and three circuits with separate neutrals (3SN). All the components in an electrical distribution system must use the same wiring schematic. For safety, the components are keyed, labeled, and color-coded to make it impossible to connect mismatched parts.

All electrical components are cULus listed to the appropriate industry standards in accordance with the National and Canadian Electrical code.

Local electrical codes vary, so consult with your local authority having jurisdiction as they have final say if the products as installed are compliant with local code. Consult a qualified electrical contractor or engineer for the proper installation of all electrical components.

Greenpoint Benching

Building Interface

Building power and data can interface with the bench from floor or wall. Both modular and hardwire infeeds are available.

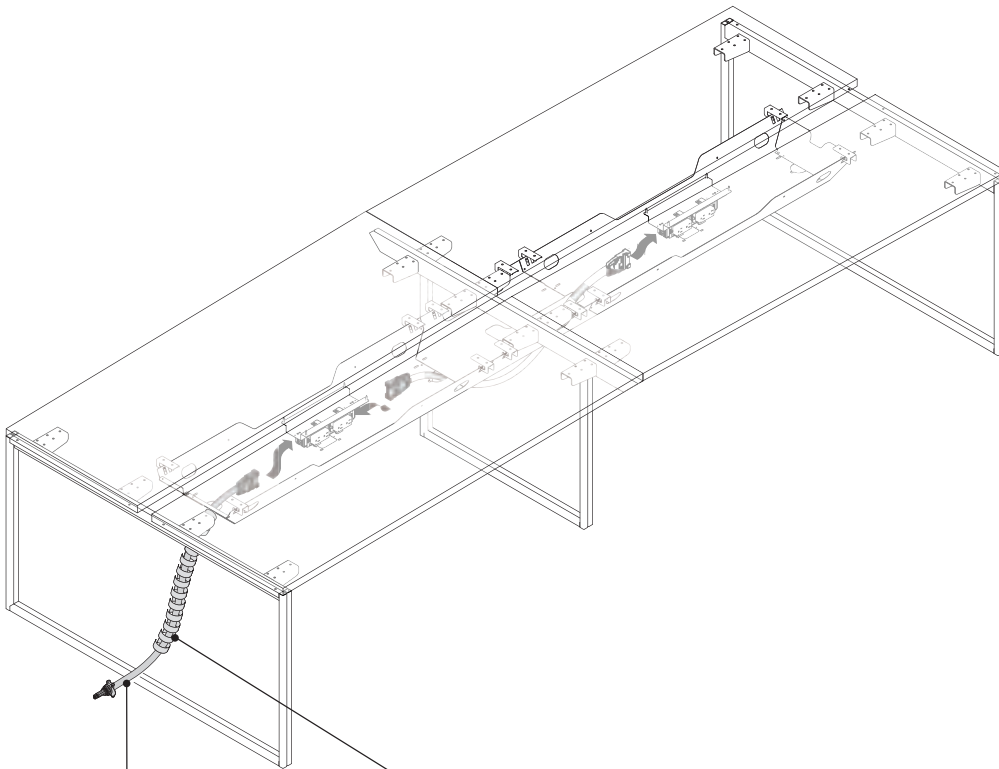

Infeeds can enter anywhere along the bench. If power trays are being used, infeeds can enter approximately 18" from either end of the bench section.

A vertebral riser is available to conceal the power and data.

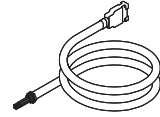

Hardwire-to-modular power infeed is available in 6, 12, and 24 foot lengths. If a shorter harness is needed, it can be cut by the electrician. The hard-wired end is connected by an electrician to a junction box wherever it is located in the building. The harness is routed into the bench and connected to a power block. Non-PVC is standard. PVC version can be optioned.

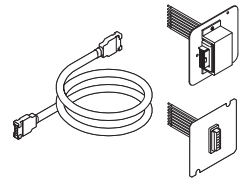

Modular-to-modular power infeed is available in 6, 12, and 24 foot lengths. A straight/flush modular junction box faceplate cover is standard and is wired to a 4¹/₁₆" square junction box located in the building. The harness is then routed into the bench and connected to a power block. A 90° junction box faceplate can be optioned and is recommended for use at a wall or column. The straight/flush is generally used in the floor. Non-PVC is standard. PVC version can be optioned.

Straight/
Flush

90°

Modular junction box faceplate can be ordered separately and used with any modular harness length when 12 and 24 foot lengths are not appropriate. Straight/flush and 90° faceplates are available. A 90° junction box faceplate is recommended for use at a wall or column. Non-PVC is standard. PVC version can be optioned.

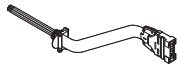
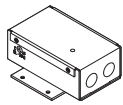

New York power infeeds are available. The junction box is mounted to the underside of the desk. A 50" harness is included to reach the first power block in the bench. If a shorter harness is needed, it can be cut by the electrician. Non-PVC is standard. PVC version can be optioned. Hardwire-to-modular infeeds can also be used.

Hardwired/Chicago power infeeds are supplied by the electrician.

San Francisco can use hardwire or modular infeeds. When infeed is coming from floor or wall, liquid tight metallic conduit may be required. In this case, order infeed specific to San Francisco.

Base power infeeds are not available.

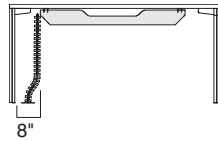

Vertebral riser can attach to the lower tray or simple tray. Its position is approximately 18" from either end of the desk unit. Length is 30".



Extension vertebral riser can be used to conceal conduit and cables along the floor. Length is 15". Risers can be linked to each other for longer length requirements.

Power and data can enter the bench through the end of the power tray. The opening is approximately 14" from the end of the desk.

Three wiring schematics are available—3+1, 2+2, and three circuits with separate neutrals (3SN). All the components in an electrical distribution system must use the same wiring schematic. For safety, the components are keyed, labeled, and color-coded to make it impossible to connect mismatched parts.

Non-PVC modular electrical components are the standard offering with the option to order PVC on some components. For those trying to gain the LEED Innovation and Design credit, non-PVC should be selected.

All electrical components are cULus listed to the appropriate industry standards in accordance with the National and Canadian Electrical code.

Local electrical codes vary, so consult with your local authority having jurisdiction as they have final say if the products as installed are compliant with local code. Consult a qualified electrical contractor or engineer for the proper installation of all electrical components.

Greenpoint Benching

Stability Guidelines

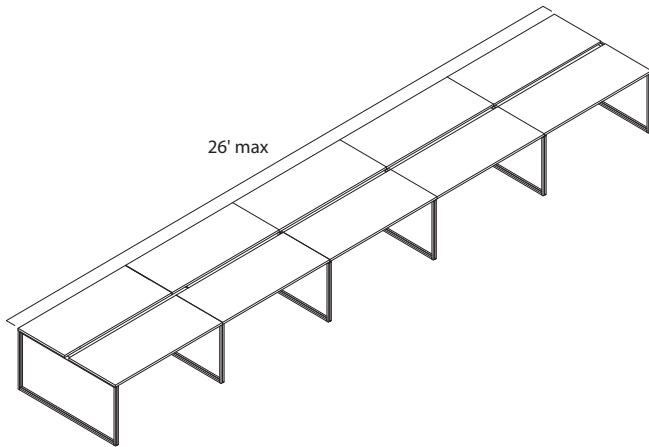

Maximum run on dual-sided and extension is 26'.

▶ See page 72 for approved monitor arm on dual-sided worksurfaces.

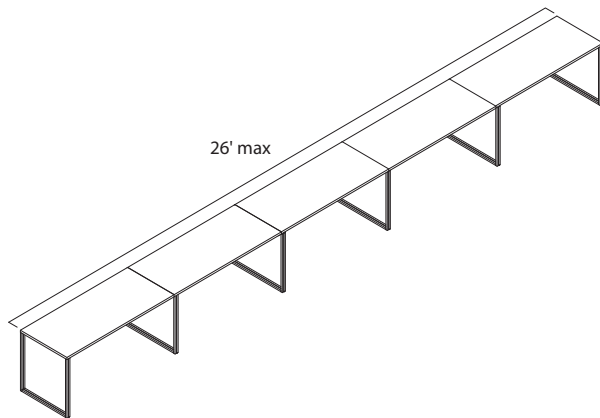

Maximum run on single-sided and extension is 26'.

▶ See page 72 for approved monitor arm on single-sided worksurfaces.

Greenpoint Benching

Directional Laminate and Edge Profile Detail

The appearance of laminate may change slightly depending on the angle from which it is viewed. This natural phenomenon is called polarization, and it can be seen on natural veneer, and to a lesser extent on composite veneer. Polarization is often noticed on worksurfaces installed at a 90° angle with each other. Please refer to the following illustrations for an understanding of grain direction on your installation.

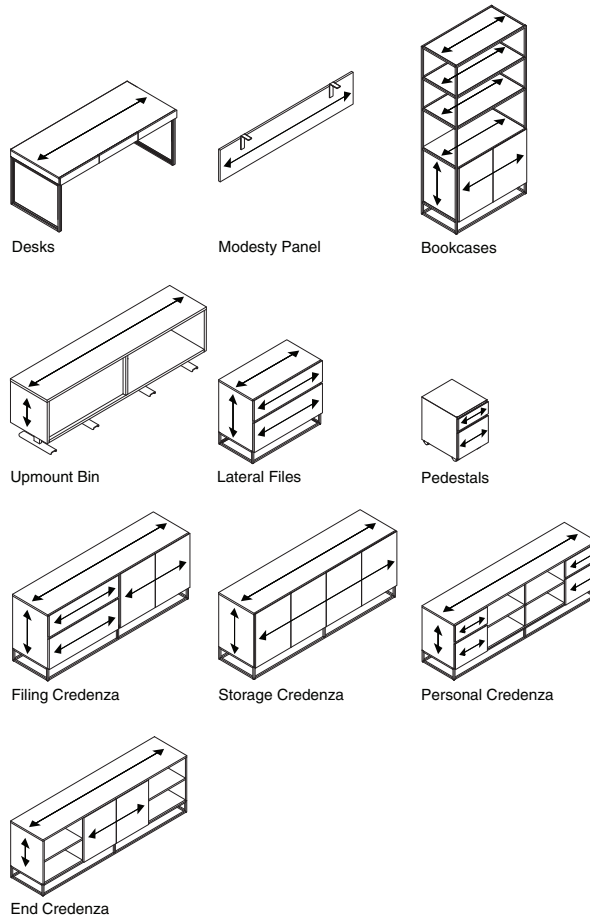

Product Details



3 mm radius front edge profile
(1 1/8" thick)

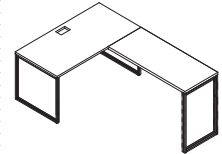

3 mm edge profile is on all four worksurface sides.

Sutton

Rectangle Height-Adjustable Desks and Bases

Rectangle height-adjustable desks bring mobility and wellbeing, allowing users to change posture and location to suit their work needs. Optional integrated power includes a single power cord that comes out of the desk for ease of movement.
▶ Specifying pages 232-236

Desk has a wood core with a High-Pressure Laminate or wood veneer surface, and is 1" thick.

Radius corners are available with a square edge profile. Corners feature a 2" radius.

Square edge is available in 3 mm edge profile, when High-Pressure Laminate or wood veneer is selected.

Basic height-adjustable base adjusts from 27³/₈"H–46⁹/₁₀"H in any increment.

Square corners are available with a square edge or blade edge.

Extended height-adjustable base adjusts from 22³/₈"H to 48⁷/₁₀"H in any increment.

Leveling glides adjust 1/2" to install desk on uneven floors. Glides are black.

Push button simple touch controller adjusts height at a rate of 1 1/2" per second.

Base supports a maximum distributed weight load of 360 pounds (2-leg).
Tip: When calculating lifting capacity, subtract the weight of the worksurface, understructure, and options selected.
▶ See page 88 for worksurface weights.

Active touch controller is Bluetooth-enabled; is standard and includes digital display, two preset buttons, double-tap automatic drive, and active motion posture reminders.
Tip: Steelcase Rise mobile app is available that pairs with any active touch controller to support preferences, presets, and activity tracking.

Lifting column is controlled by central control box for synchronization. Columns are precision balanced to minimize surface vibrations.

Blade edge is available on the front user edge when square corners are selected.

Product Details

Radius corners have rounded 2" corners on all four sides with a continuous user edge. Radius corners eliminate sharp edges and are appropriate for free-standing furniture. Radius corners are not available in combination with a blade edge profile.

Square corners have a 90 degree corner on all four sides.

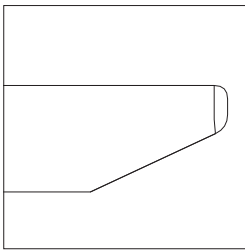

Blade edge profile is available on the front user edge with a clear coat over MDF. It is not available on desks with radius corners.

Desk overhang is not available. Distance from edge of worksurface to lift column is 4.96".

High-Pressure Laminate Desks

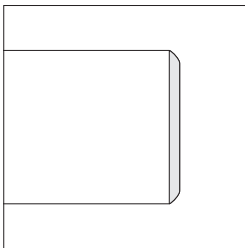

Edge profile is available in 3 mm edge profile for desks with radius corners and square corners. Blade edge profile is not available on desks with radius corner profile.

PVC-free, 3 mm edge profiles are proprietary polyolefin blend for all solid colors and woodgrain finishes.

Edge profile finishes are specified separately from laminate color.

Wood Veneer Desks

Edge profile is available in 3 mm edge profile for desks with radius corners and square corners. Blade edge profile is not available on desks with radius corner profile.

Simple touch controller is available as an option and easily adjusts height of desk, at a rate of 1 1/2" per second, by lifting or pressing down on the controller.

Active touch controller is Bluetooth-enabled; is standard and includes digital display, two preset buttons, double-tap automatic drive, and active motion posture reminders.
Tip: Mobile app is available that pairs with any active touch controller to support preferences, presets, and activity tracking.

Obstruction sensing technology is standard with all desks. The worksurface will backtrack when it makes contact with an object.

The overall depth of the worksurface is 23"D or 29"D.

Extended height desks and bases adjust 22 3/8"H to 48 7/10"H in any increment.

Basic height-adjustable desks and bases adjust from 27 3/8"H to 46 9/10"H in any increment.

Desk sizes are listed in actual dimensions to allow for 1" gap to adjacent furniture, eliminating any pinch points.

Wiring and Cabling

Low surge electric motor with quiet operation adjusts at 1 1/2" per second. Motor is 110V and includes a 10' power cord. Motor has 0.1W standby power.

Chicago requires that desks shipping into Illinois ship with a 9' power cord.

Sutton desks and bases are listed by ETL.

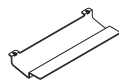

Cable trays are available as an option or can be ordered separately. 46"W–57 15/16"W desks use the 28" cable tray. 58"W–72"W desks use the 40"W cable tray.

Integrated power is optional and is located in the understructure of a desk. Integrated power consolidates technology to provide one cord out of the desk for convenience to the user. Two versions are available: underworksurface only and underworksurface plus worksurface clamp on convenience power. Worksurface power has two power outlet options, either dual USB-A or USB-C. Desks 57 15/16"W and under receive three power outlets in the understructure and desks 58"W and above receive five power outlets. Over-current power protection is standard on the integrated power option. If the over-current protection trips, reset by pushing the button located on the face of the understructure.

Integrated power is standard with a 10' standard black power cord. A 20' cord option is available if additional length is needed. For extra color, braided cord option is available.

Integrated power is available with either a standard three prong NEMA plug for use with standard receptacles or with Steelcase's proprietary thread low-profile plug for use with one-door and two-door low-profile connectors.

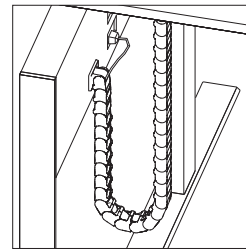

Cable riser, with fence connection, inside dimensions are 1"D x 1"W to accommodate a variety of cord sizes. Overall depth is 2". Order style number **OLCR** separately.

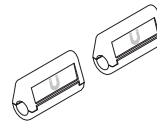

Magnetic cable clips are optimized for the braided one-cord out solution. However, the magnetic cable clips will work on Sutton, Ology, Migration SE, and the standard Flex power cords. The clips are used to manage power cords out of the users way. Order style numbers **FLXMCC2** or **FLXMCC10** separately.

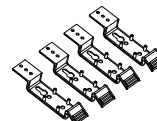

Cable brackets, ordered separately, support horizontal cable management below the worksurface. Order style number **FLXCBK4** separately.

Inside dimensions of cable brackets are 6"D x 2 1/4"W x 1/18"H.

Surface Materials

High-Pressure Laminate Desk

- Laminate
- ▶ See *Surface Materials Reference Manual*.
- Open Line laminate (option)
A program including non-Steelcase laminates which are suitable for use on Steelcase products.
- ▶ See *Surface Materials Reference Manual*.

3 mm edge profile

- Plastic

Blade edge profile

- Clear coat

Wood Veneer Desk

- Wood veneer (standard)
- Full-fill finish (option)
- Customiz stain (option)

Square 3 mm edge profile

- Wood veneer to match desk

Blade edge profile

- Clear coat

Height-adjustable base

- 4799 Platinum Metallic
- 7207 Black
- 7243 Seagull
- 7360 Merle

Foot

- Paint
- Accent paint
- Lux Coatings

Ring

- Paint
- Accent paint
- Lux Coatings
- WE04 Brushed Nickel
- WE06 Smooth Brass
- 9201 Polished Chrome

Braided Cord Color Matrix

Braided cord samples are not available to order. Use matrix below that compares the braided cord finish to the nearest Steelcase finish color for color reference purposes.

Tip: Braided cord color is defaulted to 9007 Sterling.

Finish	Similar Steelcase Color
9003 Fuchsia	4BQ7 Fuchsia
9004 Marlin	4AZ5 Marlin
9006 Chili	6338 Chili
9007 Sterling*	6059 Sterling Dark Solid
9008 Honey	4CZ5 Honey
9009 Black	0835 Black
9010 Light Peacock	4CZ8 Light Peacock
9011 Seagull	4858 Seagull

*Default finish on integrated power.

Application Topics

Moving desks can collide with other components. Do not install overhead storage, desk-height power, or desk accessories in the path of height-adjustable desks.

Universal boundary screens are not permitted on height-adjustable desks, as they do not pass minimum safety requirements which could result in the desk tipping over.

Sarto screens are recommended to be used with Sutton height-adjustable desks. Universal and Soffio screens are also compatible.

On extended height desks, any storage higher than 19" will impede the height range of the desk. On basic height desks, any storage higher than 23⁷/₁₀" will impede the height range of the desk.
Tip: Do not place storage underneath controller.

CPU holders are not allowed for use on Sutton. There is no overhang option available to support CPU holders.

All assemblies meet or exceed ANSI/BIFMA standards.

WARNING

Read base only warranty limitations.

Keyboard assemblies are not allowed for use on height-adjustable desks. They do not meet minimum safety requirements.

A modesty panel is available and ordered separately, in widths from 48" to 78". They can be specified in either wood veneer or High-Pressure Laminate. Modesty panels are specified one size smaller than the desk to allow for 2" clearance on both ends to accommodate the legs. Modesty panel can be mounted flush or inset.

Modesty panels may be inset from the back edge of the worksurface to allow for worktool clamps.

For monitor arms, only single and dual flat panel monitor arm applications are permitted for use with height adjustable desks. For further information, see the *Steelcase Worktools Specification Guide*.

Dual monitor arms are not allowed on 23"D worksurfaces.

Height-Adjustable Desks Comparison Chart

Rectangle Height-Adjustable Desks

Basic Height

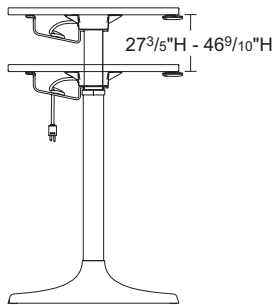

Extended Height

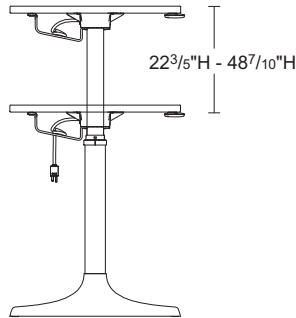

Enhanced sit-to-stand height-adjustability

A push button delivers electric adjustability up to 1 1/2" per second. Includes two controller options:

- Simple touch
- Active touch

	Weight Capacity
Sutton Desk	360 lb

Tip: When calculating lifting capacity, subtract the weight of the worksurface, understructure, and options selected.

Adjustables Comparison Chart

	Sutton Desk Sit-to-Stand
Range of Adjustment	Extended height: 22 ³ / ₅ " – 48 ⁷ / ₁₀ " Basic height: 27 ³ / ₅ " – 46 ⁹ / ₁₀ "
Type of Adjustment	Electric
Distributed Weight Capacity	360 lb
Worksurface Weight	See page 88 for worksurface weights
Worksurface Thickness	1"
Controller	Simple touch, Active touch
Integrated Rail	No
Integrated Soft Edge	No
Integrated Power	Yes
Motor	Enclosed
Decibel Rating	< 45 dBA
Volts	120v AC
Input Amps	2.5A
Watts	300W
Standby Power	0.1W
Frequency and Phase	60 Hz Single Phase
Adjustability Speed	1 1/2" per second
Stretcher or Understructure Design	Fixed
Base Only Availability	Yes
ANSI/BIFMA (29"D Knee depth requirement for worksurface)	Meet or Exceed

Sutton, Height-Adjustable Desks Comparison Chart, continued

Installation

Desks ship with pre-drilled holes for mounting bases.

Height-adjustable base requires attachment to the worksurface.

Base supports a maximum distributed weight capacity of 360 pounds.

Tip: When calculating lifting capacity, subtract the weight of the worksurface, understructure, and options.

Tip: A label applied to the underside of the worksurface will include the load-capacity for each desk.

Worksurface Weight

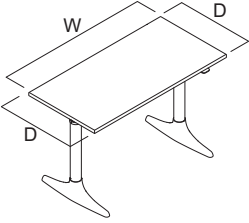
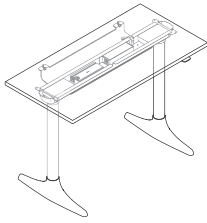
Worksurface Shape	W	D	Worksurface Weight	Understructure Weight	Leg Clearance (A)	Options Integrated Power Weight
 	46"	23"	27 lb	7.1 lb	9 ¹ / ₂ "	5.0 lb
	58"	23"	35 lb	9.4 lb	9 ¹ / ₂ "	5.0 lb
	70"	23"	42 lb	11.7 lb	9 ¹ / ₂ "	5.0 lb
	46"	29"	34 lb	7.1 lb	12 ¹ / ₂ "	5.0 lb
	58"	29"	43 lb	9.4 lb	12 ¹ / ₂ "	5.0 lb
	70"	29"	52 lb	11.7 lb	12 ¹ / ₂ "	5.0 lb

West Elm—Steelcase

Specifying

Seating

Belle

Lounge Seating **90**

Boardwalk

Lounge Seating **98**

Occasional Tables **107**

Accessories **112**

Brighton

Lounge Seating **114**

Occasional Tables **119**

Power **125**

Mesa

Lounge Seating **126**

Willow

Lounge Seating **132**

Slope

Guest Chairs and Stools **136**

Conference Chair **140**

Stacking Chair **141**

Sterling

Guest Chairs and Stools **142**

Conference Chairs **146**

Lounge **150**

Sterling Health

Guest Chairs **152**

Kent

Conference Chairs **154**

Guest Chairs **158**

Stools **160**

Lucas

Guest Chair **164**

Lounge Chair **165**

Bench **166**

Fulton

Furniture

Greenpoint Private Office

Desks and Returns **168**

Modesty Panels **173**

Credenzas **174**

Wood Lateral File **176**

Bookcases **177**

Lateral Files **181**

Metal Mobile Pedestal **186**

Basic Cushions Enhanced **187**

Accessories **188**

Power Units **190**

Greenpoint Bench

Worksurfaces and Returns **192**

Legs **205**

Credenzas **211**

Upmount Bins **213**

Center Screens **215**

Power and Data

Power Supports **218**

Power Trays **220**

Power Covers **221**

Modular Power Blocks **222**

Chicago Hardwire Box **223**

Power and Data Receptacles and Filler Package **224**

Modular Harnesses **226**

Power Infeeds **228**

Bracket Kit **230**

Vertabral Risers **231**

Sutton

Desks **232**

Bases **236**

Accessories **240**

Belle

Lounge Seating

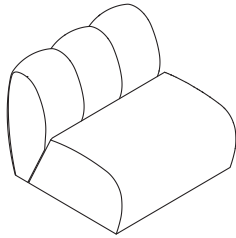

Tip: Contrasting back channels can have contrasting color within the same fabric family. (For example, 59DB Birdseye specified on back channel 1 and 59DB Birdseye specified on back channel 2; both are Birdseye by DesignTex.)

Tip: Contrasting seat and back can be from two different fabric families.

Tip: Contrasting back channel fabrics are specified from the right handed seated position.

Standard Includes

- Fully upholstered non-contrasting lounge: fabric price group 01
- Ganging brackets: plastic
- Glides: plastic

Options

Color Scheme	Non Contrasting	No cost
	Contrasting Seat and Back	+\$167
	Contrasting All Target Surfs	+\$300
Seat Finish	Fabric Customer's Own Material	No cost
	Fabric Price Group 01	No cost
	Fabric Price Group 02	+\$11
	Fabric Price Group 03	+\$60
	Fabric Price Group 04	+\$114
	Fabric Price Group 05	+\$206
	Fabric Price Group 06	+\$305
	Fabric Price Group 07	+\$425
	Fabric Price Group 08	+\$552
	Fabric Price Group 09	+\$680
Fabric Price Group 10	+\$802	
Back Finish	Fabric Customer's Own Material	No cost
	Fabric Price Group 01	No cost
	Fabric Price Group 02	+\$12
	Fabric Price Group 03	+\$93
	Fabric Price Group 04	+\$183
	Fabric Price Group 05	+\$324
	Fabric Price Group 06	+\$483
	Fabric Price Group 07	+\$675
	Fabric Price Group 08	+\$873
	Fabric Price Group 09	+\$1080
Fabric Price Group 10	+\$1278	
Back 1 Finish	Fabric Customer's Own Material	No cost
	Fabric Price Group 01	No cost
	Fabric Price Group 02	+\$4
	Fabric Price Group 03	+\$31
	Fabric Price Group 04	+\$61
	Fabric Price Group 05	+\$108
	Fabric Price Group 06	+\$161
	Fabric Price Group 07	+\$225
	Fabric Price Group 08	+\$291
	Fabric Price Group 09	+\$360
Fabric Price Group 10	+\$426	
Back 2 Finish	Fabric Customer's Own Material	No cost
	Fabric Price Group 01	No cost
	Fabric Price Group 02	+\$4
	Fabric Price Group 03	+\$31
	Fabric Price Group 04	+\$61
	Fabric Price Group 05	+\$108
	Fabric Price Group 06	+\$161
	Fabric Price Group 07	+\$225
Fabric Price Group 08	+\$291	

► **Product Information continued on next page**

Belle
Lounge Seating

► **Product Information continued from previous page**

Options		
Back 2 Finish	Fabric Price Group 09	+\$360
	Fabric Price Group 10	+\$426
Back 3 Finish	Fabric Customer's Own Material	No cost
	Fabric Price Group 01	No cost
	Fabric Price Group 02	+\$4
	Fabric Price Group 03	+\$31
	Fabric Price Group 04	+\$61
	Fabric Price Group 05	+\$108
	Fabric Price Group 06	+\$161
	Fabric Price Group 07	+\$225
	Fabric Price Group 08	+\$291
	Fabric Price Group 09	+\$360
	Fabric Price Group 10	+\$426

Specification Information

Style Number Base Price

Belle One Seat Lounge

WESBELLNG1 \$3275



Belle

Lounge Seating

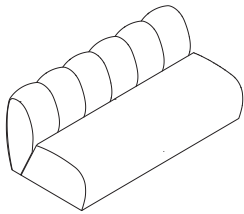

Tip: Contrasting back channels can have contrasting color within the same fabric family. (For example, 59DB Birdseye specified on back channel 1 and 59DB Birdseye specified on back channel 2; both are Birdseye by DesignTex.)

Tip: Contrasting seat and back can be from two different fabric families.

Tip: Contrasting back channel fabrics are specified from the right handed seated position.

Standard Includes

- Fully upholstered non-contrasting lounge: fabric price group 01
- Ganging brackets: plastic
- Glides: plastic

Options

Color Scheme	Non Contrasting	No cost
	Contrasting Seat and Back	+\$167
	Contrasting All Target Surfs	+\$846
Seat Finish	Fabric Customer's Own Material	No cost
	Fabric Price Group 01	No cost
	Fabric Price Group 02	+\$20
	Fabric Price Group 03	+\$88
	Fabric Price Group 04	+\$173
	Fabric Price Group 05	+\$312
	Fabric Price Group 06	+\$458
	Fabric Price Group 07	+\$639
	Fabric Price Group 08	+\$828
	Fabric Price Group 09	+\$1021
Fabric Price Group 10	+\$1206	
Back Finish	Fabric Customer's Own Material	No cost
	Fabric Price Group 01	No cost
	Fabric Price Group 02	+\$24
	Fabric Price Group 03	+\$186
	Fabric Price Group 04	+\$366
	Fabric Price Group 05	+\$648
	Fabric Price Group 06	+\$966
	Fabric Price Group 07	+\$1350
	Fabric Price Group 08	+\$1746
	Fabric Price Group 09	+\$2160
Fabric Price Group 10	+\$2556	
Back 1 Finish	Fabric Customer's Own Material	No cost
	Fabric Price Group 01	No cost
	Fabric Price Group 02	+\$4
	Fabric Price Group 03	+\$31
	Fabric Price Group 04	+\$61
	Fabric Price Group 05	+\$108
	Fabric Price Group 06	+\$161
	Fabric Price Group 07	+\$225
	Fabric Price Group 08	+\$291
	Fabric Price Group 09	+\$360
Fabric Price Group 10	+\$426	
Back 2 Finish	Fabric Customer's Own Material	No cost
	Fabric Price Group 01	No cost
	Fabric Price Group 02	+\$4
	Fabric Price Group 03	+\$31
	Fabric Price Group 04	+\$61
	Fabric Price Group 05	+\$108
	Fabric Price Group 06	+\$161
	Fabric Price Group 07	+\$225
Fabric Price Group 08	+\$291	

► **Product Information continued on next page**

► **Product Information continued from previous page**

Options		
Back 2 Finish	Fabric Price Group 09	+\$360
	Fabric Price Group 10	+\$426
Back 3 Finish	Fabric Customer's Own Material	No cost
	Fabric Price Group 01	No cost
	Fabric Price Group 02	+\$4
	Fabric Price Group 03	+\$31
	Fabric Price Group 04	+\$61
	Fabric Price Group 05	+\$108
	Fabric Price Group 06	+\$161
	Fabric Price Group 07	+\$225
	Fabric Price Group 08	+\$291
	Fabric Price Group 09	+\$360
Back 4 Finish	Fabric Customer's Own Material	No cost
	Fabric Price Group 01	No cost
	Fabric Price Group 02	+\$4
	Fabric Price Group 03	+\$31
	Fabric Price Group 04	+\$61
	Fabric Price Group 05	+\$108
	Fabric Price Group 06	+\$161
	Fabric Price Group 07	+\$225
	Fabric Price Group 08	+\$291
	Fabric Price Group 09	+\$360
Back 5 Finish	Fabric Customer's Own Material	No cost
	Fabric Price Group 01	No cost
	Fabric Price Group 02	+\$4
	Fabric Price Group 03	+\$31
	Fabric Price Group 04	+\$61
	Fabric Price Group 05	+\$108
	Fabric Price Group 06	+\$161
	Fabric Price Group 07	+\$225
	Fabric Price Group 08	+\$291
	Fabric Price Group 09	+\$360
Back 6 Finish	Fabric Customer's Own Material	No cost
	Fabric Price Group 01	No cost
	Fabric Price Group 02	+\$4
	Fabric Price Group 03	+\$31
	Fabric Price Group 04	+\$61
	Fabric Price Group 05	+\$108
	Fabric Price Group 06	+\$161
	Fabric Price Group 07	+\$225
	Fabric Price Group 08	+\$291
	Fabric Price Group 09	+\$360
	Fabric Price Group 10	+\$426

► **Product Information continued on next page**

Belle

Lounge Seating

▶ **Product Information continued from previous page**

Specification Information

Style Number	Base Price
--------------	------------

Belle Two Seat Lounge

WESBELLNG2 \$5737

Belle

Lounge Seating

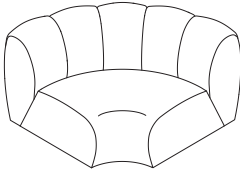

Tip: Contrasting back channels can have contrasting color within the same fabric family. (For example, 59DB Birdseye specified on back channel 1 and 59DB Birdseye specified on back channel 2; both are Birdseye by Designtex.)

Tip: Contrasting seat and back can be from two different fabric families.

Tip: Contrasting back channel fabrics are specified from the right handed seated position.

Standard Includes

- Fully upholstered non-contrasting lounge: fabric price group 01
- Ganging brackets: plastic
- Glides: plastic

Options

Color Scheme	Non Contrasting	No cost
	Contrasting Seat and Back	+\$167
	Contrasting All Target Surfs	+\$545
Seat Finish	Fabric Customer's Own Material	No cost
	Fabric Price Group 01	No cost
	Fabric Price Group 02	+\$12
	Fabric Price Group 03	+\$69
	Fabric Price Group 04	+\$134
	Fabric Price Group 05	+\$238
	Fabric Price Group 06	+\$352
	Fabric Price Group 07	+\$488
	Fabric Price Group 08	+\$635
	Fabric Price Group 09	+\$784
Back Finish	Fabric Customer's Own Material	No cost
	Fabric Price Group 01	No cost
	Fabric Price Group 02	+\$20
	Fabric Price Group 03	+\$155
	Fabric Price Group 04	+\$305
	Fabric Price Group 05	+\$540
	Fabric Price Group 06	+\$805
	Fabric Price Group 07	+\$1125
	Fabric Price Group 08	+\$1455
	Fabric Price Group 09	+\$1800
Back 1 Finish	Fabric Customer's Own Material	No cost
	Fabric Price Group 01	No cost
	Fabric Price Group 02	+\$4
	Fabric Price Group 03	+\$31
	Fabric Price Group 04	+\$61
	Fabric Price Group 05	+\$108
	Fabric Price Group 06	+\$161
	Fabric Price Group 07	+\$225
	Fabric Price Group 08	+\$291
	Fabric Price Group 09	+\$360
Back 2 Finish	Fabric Customer's Own Material	No cost
	Fabric Price Group 01	No cost
	Fabric Price Group 02	+\$4
	Fabric Price Group 03	+\$31
	Fabric Price Group 04	+\$61
	Fabric Price Group 05	+\$108
	Fabric Price Group 06	+\$161
	Fabric Price Group 07	+\$225
Fabric Price Group 08	+\$291	

▶ **Product Information continued on next page**

Belle

Lounge Seating

► **Product Information continued from previous page**

Options		
Back 2 Finish	Fabric Price Group 09	+\$360
	Fabric Price Group 10	+\$426
Back 3 Finish	Fabric Customer's Own Material	No cost
	Fabric Price Group 01	No cost
	Fabric Price Group 02	+\$4
	Fabric Price Group 03	+\$31
	Fabric Price Group 04	+\$61
	Fabric Price Group 05	+\$108
	Fabric Price Group 06	+\$161
	Fabric Price Group 07	+\$225
	Fabric Price Group 08	+\$291
	Fabric Price Group 09	+\$360
Back 4 Finish	Fabric Customer's Own Material	No cost
	Fabric Price Group 01	No cost
	Fabric Price Group 02	+\$4
	Fabric Price Group 03	+\$31
	Fabric Price Group 04	+\$61
	Fabric Price Group 05	+\$108
	Fabric Price Group 06	+\$161
	Fabric Price Group 07	+\$225
	Fabric Price Group 08	+\$291
	Fabric Price Group 09	+\$360
Back 5 Finish	Fabric Customer's Own Material	No cost
	Fabric Price Group 01	No cost
	Fabric Price Group 02	+\$4
	Fabric Price Group 03	+\$31
	Fabric Price Group 04	+\$61
	Fabric Price Group 05	+\$108
	Fabric Price Group 06	+\$161
	Fabric Price Group 07	+\$225
	Fabric Price Group 08	+\$291
	Fabric Price Group 09	+\$360
Fabric Price Group 10	+\$426	

Specification Information

Style Number Base Price

Belle Corner Lounge

WESBELC \$4425

Belle
Lounge Seating

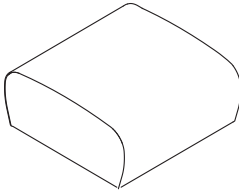

Standard Includes

- Fully upholstered ottoman: fabric price group 01
- Ganging brackets: plastic
- Glides: plastic

Options

Upholstery Finish	Fabric Customer's Own Material	No cost
	Fabric Price Group 01	No cost
	Fabric Price Group 02	+\$22
	Fabric Price Group 03	+\$97
	Fabric Price Group 04	+\$186
	Fabric Price Group 05	+\$332
	Fabric Price Group 06	+\$488
	Fabric Price Group 07	+\$682
	Fabric Price Group 08	+\$883
	Fabric Price Group 09	+\$1087
	Fabric Price Group 10	+\$1285

Specification Information

Style Number Base Price

Belle Ottoman

WESBELO \$1911



Boardwalk

Lounge Seating

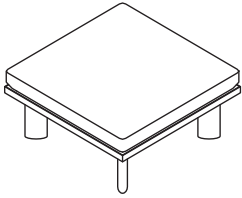

Tip: To gang Boardwalk lounge seating order ganging kit TS31410.

Standard Includes

- Modular platform: High-Pressure Laminate price group 01 with 3 mm plastic edge
- Fully upholstered cushions, if selected: fabric price group 01
- Legs: veneer price group 01
- Leg brackets: range
- Requires assembly

Options

Cushion Option	Seat	+\$688
	Mid Back	+\$1305
	Left Corner	+\$1781
	Right Corner	+\$1781
Platform Finish	Laminate HPL Price Group 01	No cost
	Veneer Custom Stain	No cost
	Laminate HPL Price Group 02	+\$152
	Composite Veneer Price Group 01	+\$617
	Composite Veneer Price Group 02	+\$746
	Veneer Price Group 01	+\$617
	Veneer Full Fill	+\$680
	OLL Price Group 1	+\$102
Edge Finish	Plastic - PG1	No cost
Leg Finish	Veneer Custom Stain	No cost
	Veneer Price Group 01	No cost
Bracket Finish	Smooth Paint PG2	No cost

Specification Information

Cushion Finish

Options (Add \$ to Base Price)			
	Seat	Mid Back	Left or Right Corner
Fabric Price Group 1	No cost	No cost	No cost
Fabric Price Group 2	+\$8	+\$16	+\$20
Fabric Price Group 3	+\$46	+\$75	+\$88
Fabric Price Group 4	+\$87	+\$144	+\$173
Fabric Price Group 5	+\$195	+\$320	+\$385
Fabric Price Group 6	+\$231	+\$380	+\$458
Fabric Price Group 7	+\$319	+\$532	+\$639
Fabric Price Group 8	+\$415	+\$691	+\$828
Fabric Price Group 9	+\$492	+\$820	+\$982
Fabric Price Group 10	+\$601	+\$1002	+\$1206
COM	No cost	No cost	No cost
COL	+\$198	+\$198	+\$198
Leather Price Group 1	+\$659	+\$1098	+\$1405
Leather Price Group 2	+\$812	+\$1349	+\$1729

► **Product Information continued on next page**

Boardwalk

Lounge Seating

▶ **Product Information continued from previous page**

Specification Information

Style Number Base Price

Boardwalk One Seat Lounge

WESHTSLNG1 \$1239

Boardwalk

Lounge Seating

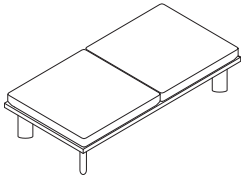

Tip: To gang Boardwalk lounge seating order ganging kit TS31410.

Standard Includes

- Modular platform: High-Pressure Laminate price group 01 with 3 mm plastic edge
- Fully upholstered cushions, if selected: fabric price group 01
- Legs: veneer price group 01
- Leg brackets: range
- Requires assembly

Options

Right Position	No Cushion	No cost
	Seat	+\$688
	Mid Back	+\$1305
	Left Corner	+\$1781
	Right Corner	+\$1781
Left Position	No Cushion	No cost
	Seat	+\$688
	Mid Back	+\$1305
	Left Corner	+\$1781
	Right Corner	+\$1781
Platform Finish	Laminate HPL Price Group 01	No cost
	Veneer Custom Stain	No cost
	Laminate HPL Price Group 02	+\$165
	Composite Veneer Price Group 01	+\$740
	Composite Veneer Price Group 02	+\$906
	Veneer Price Group 01	+\$740
	Veneer Full Fill	+\$845
OLL Price Group 1	+\$102	
Edge Finish	Plastic - PG1	No cost
Leg Finish	Veneer Custom Stain	No cost
	Veneer Price Group 01	No cost
Bracket Finish	Smooth Paint PG2	No cost

► **Product Information continued on next page**

► **Product Information continued from previous page**

Specification Information

Cushion Finish- Right Position

	Options (Add \$ to Base Price)		
	Seat	Mid Back	Left or Right Corner
Fabric Price Group 1	No cost	No cost	No cost
Fabric Price Group 2	+\$8	+\$16	+\$20
Fabric Price Group 3	+\$46	+\$75	+\$88
Fabric Price Group 4	+\$87	+\$144	+\$173
Fabric Price Group 5	+\$195	+\$320	+\$385
Fabric Price Group 6	+\$231	+\$380	+\$458
Fabric Price Group 7	+\$319	+\$532	+\$639
Fabric Price Group 8	+\$415	+\$691	+\$828
Fabric Price Group 9	+\$492	+\$820	+\$982
Fabric Price Group 10	+\$601	+\$1002	+\$1206
COM	No cost	No cost	No cost
COL	+\$198	+\$198	+\$198
Leather Price Group 1	+\$659	+\$1098	+\$1405
Leather Price Group 2	+\$812	+\$1349	+\$1729

► **Product Information continued on next page**

Boardwalk

Lounge Seating

► **Product Information continued from previous page**

Specification Information

Cushion Finish- Left Position

Options (Add \$ to Base Price)			
	Seat	Mid Back	Left or Right Corner
Fabric Price Group 1	No cost	No cost	No cost
Fabric Price Group 2	+\$8	+\$16	+\$20
Fabric Price Group 3	+\$46	+\$75	+\$88
Fabric Price Group 4	+\$87	+\$144	+\$173
Fabric Price Group 5	+\$195	+\$320	+\$385
Fabric Price Group 6	+\$231	+\$380	+\$458
Fabric Price Group 7	+\$319	+\$532	+\$639
Fabric Price Group 8	+\$415	+\$691	+\$828
Fabric Price Group 9	+\$492	+\$820	+\$982
Fabric Price Group 10	+\$601	+\$1002	+\$1206
COM	No cost	No cost	No cost
COL	+\$198	+\$198	+\$198
Leather Price Group 1	+\$659	+\$1098	+\$1405
Leather Price Group 2	+\$812	+\$1349	+\$1729

Style Number **Base Price**

Boardwalk Two Seat Lounge

WESHTSLNG2 \$1703

Boardwalk

Lounge Seating

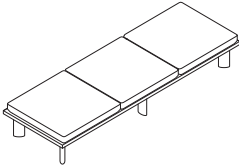

Tip: To gang Boardwalk lounge seating order ganging kit **TS31410**.

Standard Includes

- Modular platform: High-Pressure Laminate price group 01 with 3 mm plastic edge
- Fully upholstered cushions, if selected: fabric price group 01
- Legs: veneer price group 01
- Leg brackets: range
- Requires assembly

Options

Right Position	No Cushion	No cost
	Seat	+\$688
	Mid Back	+\$1305
	Left Corner	+\$1781
	Right Corner	+\$1781
Center Position	No Cushion	No cost
	Seat	+\$688
	Mid Back	+\$1305
	Left Corner	+\$1781
	Right Corner	+\$1781
Left Position	No Cushion	No cost
	Seat	+\$688
	Mid Back	+\$1305
	Left Corner	+\$1781
	Right Corner	+\$1781
Platform Finish	Laminate HPL Price Group 01	No cost
	Veneer Custom Stain	No cost
	Laminate HPL Price Group 02	+\$180
	Composite Veneer Price Group 01	+\$925
	Composite Veneer Price Group 02	+\$1127
	Veneer Price Group 01	+\$925
	Veneer Full Fill	+\$1073
OLL Price Group 1	+\$102	
Edge Finish	Plastic - PG1	No cost
Leg Finish	Veneer Custom Stain	No cost
	Veneer Price Group 01	No cost
Bracket Finish	Smooth Paint PG2	No cost

► **Product Information continued on next page**

Boardwalk

Lounge Seating

► **Product Information continued from previous page**

Specification Information

Cushion Finish- Right Position

	Options (Add \$ to Base Price)		
	Seat	Mid Back	Left or Right Corner
Fabric Price Group 1	No cost	No cost	No cost
Fabric Price Group 2	+\$8	+\$16	+\$20
Fabric Price Group 3	+\$46	+\$75	+\$88
Fabric Price Group 4	+\$87	+\$144	+\$173
Fabric Price Group 5	+\$195	+\$320	+\$385
Fabric Price Group 6	+\$231	+\$380	+\$458
Fabric Price Group 7	+\$319	+\$532	+\$639
Fabric Price Group 8	+\$415	+\$691	+\$828
Fabric Price Group 9	+\$492	+\$820	+\$982
Fabric Price Group 10	+\$601	+\$1002	+\$1206
COM	No cost	No cost	No cost
COL	+\$198	+\$198	+\$198
Leather Price Group 1	+\$659	+\$1098	+\$1405
Leather Price Group 2	+\$812	+\$1349	+\$1729

► **Product Information continued on next page**

► Product Information continued from previous page

Specification Information

Cushion Finish- Center Position

	Options (Add \$ to Base Price)		
	Seat	Mid Back	Left or Right Corner
Fabric Price Group 1	No cost	No cost	No cost
Fabric Price Group 2	+\$8	+\$16	+\$20
Fabric Price Group 3	+\$46	+\$75	+\$88
Fabric Price Group 4	+\$87	+\$144	+\$173
Fabric Price Group 5	+\$195	+\$320	+\$385
Fabric Price Group 6	+\$231	+\$380	+\$458
Fabric Price Group 7	+\$319	+\$532	+\$639
Fabric Price Group 8	+\$415	+\$691	+\$828
Fabric Price Group 9	+\$492	+\$820	+\$982
Fabric Price Group 10	+\$601	+\$1002	+\$1206
COM	No cost	No cost	No cost
COL	+\$198	+\$198	+\$198
Leather Price Group 1	+\$659	+\$1098	+\$1405
Leather Price Group 2	+\$812	+\$1349	+\$1729

► Product Information continued on next page

Boardwalk

Lounge Seating

► **Product Information continued from previous page**

Specification Information

Cushion Finish- Left Position

	Options (Add \$ to Base Price)		
	Seat	Mid Back	Left or Right Corner
Fabric Price Group 1	No cost	No cost	No cost
Fabric Price Group 2	+\$8	+\$16	+\$20
Fabric Price Group 3	+\$46	+\$75	+\$88
Fabric Price Group 4	+\$87	+\$144	+\$173
Fabric Price Group 5	+\$195	+\$320	+\$385
Fabric Price Group 6	+\$231	+\$380	+\$458
Fabric Price Group 7	+\$319	+\$532	+\$639
Fabric Price Group 8	+\$415	+\$691	+\$828
Fabric Price Group 9	+\$492	+\$820	+\$982
Fabric Price Group 10	+\$601	+\$1002	+\$1206
COM	No cost	No cost	No cost
COL	+\$198	+\$198	+\$198
Leather Price Group 1	+\$659	+\$1098	+\$1405
Leather Price Group 2	+\$812	+\$1349	+\$1729

Style Number **Base Price**

Boardwalk Three Seat Lounge

WESHTSLNG3 \$2167

Boardwalk

Occasional Tables

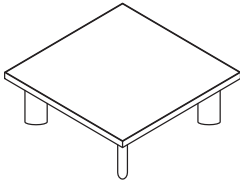

Tip: To gang Boardwalk lounge seating order ganging kit **TS31410**.

Standard Includes

- Table: High-Pressure Laminate price group 01 with 3 mm plastic edge
- Legs: veneer price group 01
- Leg brackets: range
- Requires assembly

Options

Table Height	11"	No cost
	15"	+\$52
Platform Finish	Laminate HPL Price Group 01	No cost
	Veneer Custom Stain	No cost
	Laminate HPL Price Group 02	+\$152
	Composite Veneer Price Group 01	+\$617
	Composite Veneer Price Group 02	+\$746
	Veneer Price Group 01	+\$617
Edge Finish	Veneer Full Fill	+\$680
	OLL Price Group 1	+\$102
	Plastic - PG1	No cost
Leg Finish	Veneer Custom Stain	No cost
	Veneer Price Group 01	No cost
Bracket Finish	Smooth Paint PG2	No cost

Specification Information

Style Number	Base Price
--------------	------------

Boardwalk 30"D x 30"W Square Table

WESHTSTBL30 \$1525



Boardwalk

Occasional Tables

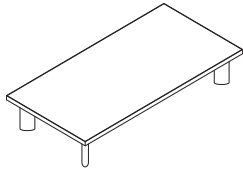

Tip: To gang Boardwalk lounge seating order ganging kit TS31410.

Standard Includes

- Table: High-Pressure Laminate price group 01 with 3 mm plastic edge
- Legs: veneer price group 01
- Leg brackets: range
- Requires assembly

Options

Table Height	11"	No cost
	15"	+\$52
Platform Finish	Laminate HPL Price Group 01	No cost
	Veneer Custom Stain	No cost
	Laminate HPL Price Group 02	+\$165
	Composite Veneer Price Group 01	+\$740
	Composite Veneer Price Group 02	+\$906
	Veneer Price Group 01	+\$740
Edge Finish	Veneer Full Fill	+\$845
	OLL Price Group 1	+\$102
	Plastic - PG1	No cost
Leg Finish	Veneer Custom Stain	No cost
	Veneer Price Group 01	No cost
Bracket Finish	Smooth Paint PG2	No cost

Specification Information

Style Number	Base Price
--------------	------------

Boardwalk 30"D x 60"W Rectangle Table

WESHTSTBL60 \$1748

Boardwalk

Occasional Tables

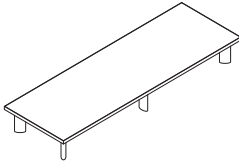

Tip: To gang Boardwalk lounge seating order ganging kit **TS31410**.

Standard Includes

- Table: High-Pressure Laminate price group 01 with 3 mm plastic edge
- Legs: veneer price group 01
- Leg brackets: range
- Requires assembly

Options

Table Height	11"	No cost
	15"	+\$81
Platform Finish	Laminate HPL Price Group 01	No cost
	Veneer Custom Stain	No cost
	Laminate HPL Price Group 02	+\$180
	Composite Veneer Price Group 01	+\$925
	Composite Veneer Price Group 02	+\$1127
	Veneer Price Group 01	+\$925
	Veneer Full Fill	+\$1073
	OLL Price Group 1	+\$102
Edge Finish	Plastic - PG1	No cost
Leg Finish	Veneer Custom Stain	No cost
	Veneer Price Group 01	No cost
Bracket Finish	Smooth Paint PG2	No cost

Specification Information

Style Number Base Price

Boardwalk 30"D x 90"W Rectangle Table

WESHTSTBL90 \$2518

Boardwalk

Occasional Tables

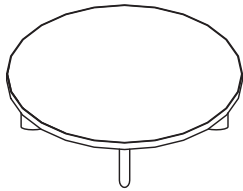

Standard Includes

- Table: High-Pressure Laminate price group 01 with 3 mm plastic edge
- Legs: veneer price group 01
- Leg brackets: range
- Requires assembly

Options

Table Height	11"	No cost
	15"	+\$52
Platform Finish	Laminate HPL Price Group 01	No cost
	Veneer Custom Stain	No cost
	Laminate HPL Price Group 02	+\$165
	Composite Veneer Price Group 01	+\$673
	Composite Veneer Price Group 02	+\$850
	Veneer Price Group 01	+\$673
Edge Finish	Veneer Full Fill	+\$788
	OLL Price Group 1	+\$102
	Plastic - PG1	No cost
Leg Finish	Veneer Custom Stain	No cost
	Veneer Price Group 01	No cost
Bracket Finish	Smooth Paint PG2	No cost

Specification Information

Style Number	Base Price
--------------	------------

Boardwalk 40" Round Table

WESHTSTBLRD40 \$1710

Boardwalk

Occasional Tables

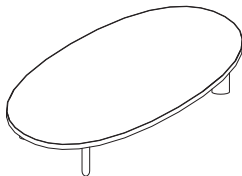

Standard Includes

- Table: High-Pressure Laminate price group 01 with 3 mm plastic edge
- Legs: veneer price group 01
- Leg brackets: range
- Requires assembly

Options

Table Height	11"	No cost
	15"	+\$52
Platform Finish	Laminate HPL Price Group 01	No cost
	Veneer Custom Stain	No cost
	Laminate HPL Price Group 02	+\$165
	Composite Veneer Price Group 01	+\$797
	Composite Veneer Price Group 02	+\$1007
	Veneer Price Group 01	+\$797
Edge Finish	Veneer Full Fill	+\$945
	OLL Price Group 1	+\$102
	Plastic - PG1	No cost
Leg Finish	Veneer Custom Stain	No cost
	Veneer Price Group 01	No cost
Bracket Finish	Smooth Paint PG2	No cost

Specification Information

Style Number	Base Price
--------------	------------

Boardwalk 35"D x 65"D Oval Table

WESHTSTBLOV65 \$1894



Boardwalk

Accessories

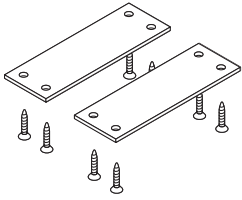

Standard Includes

- Ganging kit
- Two plates: range
- Attachment hardware

Specification Information

Style Number	Price
--------------	-------

Ganging Kit

TS31410	\$44
----------------	------

Boardwalk

Accessories

Brighton

Lounge Seating

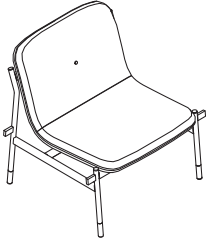

Standard Includes

- Fully upholstered lounge chair: fabric price group 01
- Frame: paint price group 01
- Frame caps: paint price group 01
- Frame feet: paint price group 01
- Arms, if selected: veneer price group 01

Options

Color Scheme	Non Contrasting	No cost
	Contrasting	+\$167
Inner Finish	Fabric Customer's Own Material	No cost
	Fabric Price Group 01	No cost
	Fabric Price Group 02	+\$5
	Fabric Price Group 03	+\$31
	Fabric Price Group 04	+\$59
	Customer's Own Leather	+\$100
	Fabric Price Group 05	+\$104
	Fabric Price Group 06	+\$153
	Fabric Price Group 07	+\$214
	Fabric Price Group 08	+\$277
	Fabric Price Group 09	+\$341
	Fabric Price Group 10	+\$402
Outer Finish	Leather Price Group 01	+\$438
	Leather Price Group 02	+\$541
	Fabric Customer's Own Material	No cost
	Fabric Price Group 01	No cost
	Fabric Price Group 02	+\$5
	Fabric Price Group 03	+\$31
	Fabric Price Group 04	+\$59
	Customer's Own Leather	+\$100
	Fabric Price Group 05	+\$104
	Fabric Price Group 06	+\$153
	Fabric Price Group 07	+\$214
	Fabric Price Group 08	+\$277
Frame Finish	Fabric Price Group 09	+\$341
	Fabric Price Group 10	+\$402
	Leather Price Group 01	+\$438
Arm Position	Leather Price Group 02	+\$541
	Paint Price Group 01	No cost
	Paint Price Group 02	+\$78
Arm Position	Paint Price Group 03	+\$165
	No Arm	No cost
	Arm Left	+\$240
	Arm Right	+\$240
Arms Finish	Arms-Left & Right	+\$480
	Veneer Custom Stain	No cost
	Veneer Price Group 01	No cost
Arms Finish	Veneer Price Group 02	+\$27
	Ganging	No cost
Ganging	Not Ganging	No cost
	Left	+\$57

Tip: Handedness is determined while in the seated position.

► **Product Information continued on next page**

Brighton

Lounge Seating

► **Product Information continued from previous page**

Options		
Ganging	Right	+\$57
	Left and Right	+\$114
Foot Finish	Paint Price Group 01	No cost
	Paint Price Group 02	+\$9
	Paint Price Group 03	+\$22
Cap Surface Finish	Paint Price Group 01	No cost
	Paint Price Group 02	+\$3
	Paint Price Group 03	+\$5

Specification Information

Style Number Base Price

Brighton One Seat Lounge Chair

WESARYLNG1 \$2230

Brighton

Lounge Seating

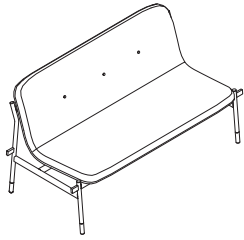

Standard Includes

- Fully upholstered lounge chair: fabric price group 01
- Frame: paint price group 01
- Frame caps: paint price group 01
- Frame feet: paint price group 01
- Arms, if selected: veneer price group 01

Options

Color Scheme	Non Contrasting	No cost	
	Contrasting	+\$167	
Inner Finish	Fabric Customer's Own Material	No cost	
	Fabric Price Group 01	No cost	
	Fabric Price Group 02	+\$11	
	Fabric Price Group 03	+\$60	
	Customer's Own Leather	+\$100	
	Fabric Price Group 04	+\$117	
	Fabric Price Group 05	+\$207	
	Fabric Price Group 06	+\$306	
	Fabric Price Group 07	+\$426	
	Fabric Price Group 08	+\$556	
	Fabric Price Group 09	+\$682	
Outer Finish	Fabric Price Group 10	+\$802	
	Leather Price Group 01	+\$876	
	Leather Price Group 02	+\$1080	
	Outer Finish	Fabric Customer's Own Material	No cost
		Fabric Price Group 01	No cost
		Fabric Price Group 02	+\$11
		Fabric Price Group 03	+\$60
		Customer's Own Leather	+\$100
		Fabric Price Group 04	+\$117
		Fabric Price Group 05	+\$207
		Fabric Price Group 06	+\$306
Fabric Price Group 07		+\$426	
Fabric Price Group 08		+\$556	
Fabric Price Group 09		+\$682	
Frame Finish	Fabric Price Group 10	+\$802	
	Leather Price Group 01	+\$876	
	Leather Price Group 02	+\$1080	
	Paint Price Group 01	No cost	
Frame Finish	Paint Price Group 02	+\$102	
	Paint Price Group 03	+\$228	
	Arm Position	No Arm	No cost
Arm Left		+\$240	
Arm Right		+\$240	
Arms-Left & Right		+\$480	
Arms Finish	Veneer Custom Stain	No cost	
	Veneer Price Group 01	No cost	
	Veneer Price Group 02	+\$27	
Ganging	Not Ganging	No cost	
	Left	+\$57	

Tip: Handedness is determined while in the seated position.

► **Product Information continued on next page**

Brighton

Lounge Seating

► **Product Information continued from previous page**

Options		
Ganging	Right	+\$57
	Left and Right	+\$114
Foot Finish	Paint Price Group 01	No cost
	Paint Price Group 02	+\$9
	Paint Price Group 03	+\$22
Cap Surface Finish	Paint Price Group 01	No cost
	Paint Price Group 02	+\$3
	Paint Price Group 03	+\$5

Specification Information

Style Number Base Price

Brighton Two Seat Lounge Chair

WESARYLNG2 \$3327

Brighton

Lounge Seating



Standard Includes

- Fully upholstered lounge chair: fabric price group 01
- Frame: paint price group 01
- Frame caps: paint price group 01

Options

Upholstery Finish	Fabric Customer's Own Material	No cost
	Fabric Price Group 01	No cost
	Fabric Price Group 02	+\$1
	Fabric Price Group 03	+\$5
	Fabric Price Group 04	+\$12
	Fabric Price Group 05	+\$25
	Fabric Price Group 06	+\$36
	Fabric Price Group 07	+\$53
	Fabric Price Group 08	+\$69
	Fabric Price Group 09	+\$84
	Fabric Price Group 10	+\$101
Leather Price Group 01		+\$108
	Leather Price Group 02	+\$135
	Customer's Own Leather	+\$198
Frame Finish	Paint Price Group 01	No cost
	Paint Price Group 02	+\$33
	Paint Price Group 03	+\$62
Cap Surface Finish	Paint Price Group 01	No cost
	Paint Price Group 02	+\$3
	Paint Price Group 03	+\$5

Specification Information

Style Number Base Price

Brighton Ottoman

WESARYO \$701

Brighton
Occasional Tables

Brighton

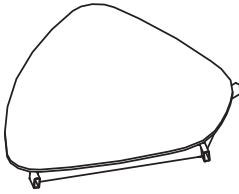

Standard Includes

- Table: High-Pressure Laminate price group 01 with 3 mm plastic edge
- Frame: paint price group 01
- Ganging brackets: plastic

Options

Frame Finish	Paint Price Group 01	No cost
	Paint Price Group 02	+\$31
	Paint Price Group 03	+\$55
Top Surface Finish	Laminate HPL Price Group 01	No cost
	Veneer Custom Stain	No cost
	Laminate HPL Price Group 02	+\$97
	Composite Veneer Price Group 01	+\$576
	Composite Veneer Price Group 02	+\$692
	Veneer Price Group 01	+\$576
	Veneer Full Fill	+\$641
Ganging	Veneer Price Group 03	+\$1153
	OLL Price Group 1	+\$102
	Left and Right	No cost

Tip: Ganging tables or end table must be used when specifying ganging hardware on lounge units. Ganging hardware and arms cannot be specified on the same side of a lounge unit.

Specification Information

Style Number	Base Price
--------------	------------

Brighton 60° Ganging Table

WESARYTBL60	\$1168
--------------------	--------

Brighton

Occasional Tables

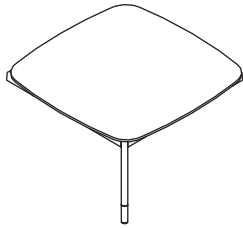

Tip: Ganging tables or end table must be used when specifying ganging hardware on lounge units. Ganging hardware and arms cannot be specified on the same side of a lounge unit.

Standard Includes

- Table: High-Pressure Laminate price group 01 with 3 mm plastic edge
- Frame: paint price group 01
- Frame feet: paint price group 01
- Ganging brackets: plastic

Options

Frame Finish	Paint Price Group 01	No cost
	Paint Price Group 02	+\$36
	Paint Price Group 03	+\$72
Top Surface Finish	Laminate HPL Price Group 01	No cost
	Veneer Custom Stain	No cost
	Laminate HPL Price Group 02	+\$109
	Composite Veneer Price Group 01	+\$590
	Composite Veneer Price Group 02	+\$706
	Veneer Price Group 01	+\$590
	Veneer Full Fill	+\$654
Veneer Price Group 03		+\$1180
	OLL Price Group 1	+\$102
Ganging	Left and Right	No cost
Foot Finish	Paint Price Group 01	No cost
	Paint Price Group 02	+\$9
	Paint Price Group 03	+\$22

Specification Information

Style Number Base Price

Brighton 90° Ganging Table

WESARYTBL90 \$1236

Brighton
Occasional Tables

Brighton

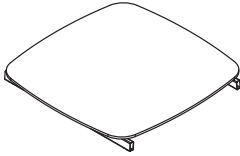

Standard Includes

- Table: High-Pressure Laminate price group 01 with 3 mm plastic edge
- Frame: paint price group 01
- Ganging brackets: plastic

Options

Frame Finish	Paint Price Group 01	No cost
	Paint Price Group 02	+\$36
	Paint Price Group 03	+\$72
Top Surface Finish	Laminate HPL Price Group 01	No cost
	Veneer Custom Stain	No cost
	Laminate HPL Price Group 02	+\$109
	Composite Veneer Price Group 01	+\$590
	Composite Veneer Price Group 02	+\$706
	Veneer Price Group 01	+\$590
	Veneer Full Fill	+\$654
Ganging	Veneer Price Group 03	+\$1180
	OLL Price Group 1	+\$102
	Left and Right	No cost

Tip: Ganging tables or end table must be used when specifying ganging hardware on lounge units. Ganging hardware and arms cannot be specified on the same side of a lounge unit.

Specification Information

Style Number **Base Price**

Brighton Straight Ganging Table

WESARYTBLSG \$1168

Brighton

Occasional Tables

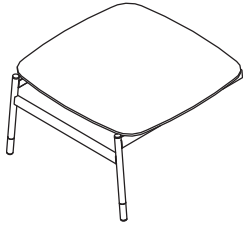

Standard Includes

- Table: High-Pressure Laminate price group 01 with 3 mm plastic edge
- Frame: paint price group 01
- Frame feet: paint price group 01
- Frame caps: paint price group 01
- Ganging brackets: plastic

Options

Frame Finish	Paint Price Group 01	No cost
	Paint Price Group 02	+\$41
	Paint Price Group 03	+\$77
Top Surface Finish	Laminate HPL Price Group 01	No cost
	Veneer Custom Stain	No cost
	Laminate HPL Price Group 02	+\$109
	Composite Veneer Price Group 01	+\$590
	Composite Veneer Price Group 02	+\$706
	Veneer Price Group 01	+\$590
	Veneer Full Fill	+\$654
Veneer Price Group 03		+\$1180
	OLL Price Group 1	+\$102
Ganging	Left	No cost
	Right	No cost
Foot Finish	Paint Price Group 01	No cost
	Paint Price Group 02	+\$9
	Paint Price Group 03	+\$22
Cap Surface Finish	Paint Price Group 01	No cost
	Paint Price Group 02	+\$3
	Paint Price Group 03	+\$5

Tip: Ganging tables or end table must be used when specifying ganging hardware on lounge units. Ganging hardware and arms cannot be specified on the same side of a lounge unit.

Specification Information

Style Number	Base Price
--------------	------------

Brighton End Table

WESARYTBLED \$1298

Brighton

Occasional Tables

Brighton

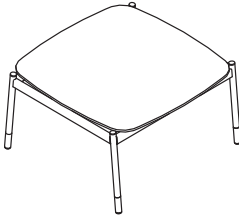

Standard Includes

- Table: High-Pressure Laminate price group 01 with 3 mm plastic edge
- Frame: paint price group 01
- Frame feet: paint price group 01
- Frame caps: paint price group 01

Options

Frame Finish	Paint Price Group 01	No cost
	Paint Price Group 02	+\$48
	Paint Price Group 03	+\$88
Top Surface Finish	Laminate HPL Price Group 01	No cost
	Veneer Custom Stain	No cost
	Laminate HPL Price Group 02	+\$109
	Composite Veneer Price Group 01	+\$590
	Composite Veneer Price Group 02	+\$706
	Veneer Price Group 01	+\$590
	Veneer Full Fill	+\$654
Foot Finish	Paint Price Group 01	No cost
	Paint Price Group 02	+\$9
	Paint Price Group 03	+\$22
Cap Surface Finish	Paint Price Group 01	No cost
	Paint Price Group 02	+\$3
	Paint Price Group 03	+\$5

Specification Information

Style Number	Base Price
Brighton Square Table	
WESARYTBSQ	\$1430

Brighton

Occasional Tables

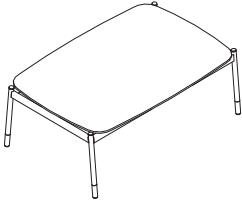

Standard Includes

- Table: High-Pressure Laminate price group 01 with 3 mm plastic edge
- Frame: paint price group 01
- Frame feet: paint price group 01
- Frame caps: paint price group 01

Options

Frame Finish	Paint Price Group 01	No cost
	Paint Price Group 02	+\$55
	Paint Price Group 03	+\$97
Top Surface Finish	Laminate HPL Price Group 01	No cost
	Veneer Custom Stain	No cost
	Laminate HPL Price Group 02	+\$124
	Composite Veneer Price Group 01	+\$700
	Composite Veneer Price Group 02	+\$839
	Veneer Price Group 01	+\$700
	Veneer Full Fill	+\$763
Foot Finish	Paint Price Group 01	No cost
	Paint Price Group 02	+\$9
	Paint Price Group 03	+\$22
Cap Surface Finish	Paint Price Group 01	No cost
	Paint Price Group 02	+\$3
	Paint Price Group 03	+\$5

Specification Information

Style Number Base Price

Brighton Rectangle Table

WESARYTBLRT \$1625

Brighton

Power

Brighton

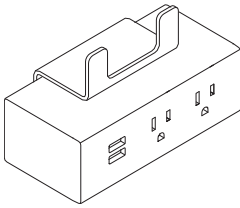

Standard Includes

- Power module:
 - 6000 Black
 - 6052 Milk
- 9' cord with three-prong plug: black plastic only

Options

Power Configuration	2 Power 1 USB	No cost
	1 Power 1 USBC	+\$123

Specification Information

Style Number	Base Price
--------------	------------

Brighton Module Power

WESARYPWR \$425

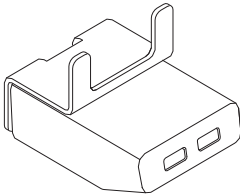

Standard Includes

- Power module:
 - 6000 Black
 - 6052 Milk
- 9' cord with three-prong plug: black plastic only

Specification Information

Style Number	Price
--------------	-------

Brighton USB Power

WESARYUSB \$281

Mesa

Lounge Seating

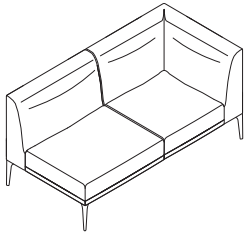

Tip: Contrasting fabric is not available on Mesa lounge seating.

Tip: Handedness is determined while in the seated position.

Standard Includes

- Fully upholstered non-contrasting lounge: fabric price group 01
- Four leg cast aluminum base: WE01 Antique Bronze
- Ganging brackets: plastic

Options

Inner Finish	Fabric Customer's Own Material	No cost
	Fabric Price Group 01	No cost
	Fabric Price Group 02	+\$31
	Customer's Own Leather	+\$100
	Fabric Price Group 03	+\$143
	Fabric Price Group 04	+\$278
	Fabric Price Group 05	+\$495
	Fabric Price Group 06	+\$732
	Fabric Price Group 07	+\$1021
	Fabric Price Group 08	+\$1324
	Fabric Price Group 09	+\$1636
	Fabric Price Group 10	+\$1925
Outer Finish	Leather Price Group 01	+\$2106
	Leather Price Group 02	+\$2595
	Fabric Customer's Own Material	No cost
	Fabric Price Group 01	No cost
	Fabric Price Group 02	+\$8
	Fabric Price Group 03	+\$47
	Fabric Price Group 04	+\$94
	Customer's Own Leather	+\$100
	Fabric Price Group 05	+\$165
	Fabric Price Group 06	+\$245
	Fabric Price Group 07	+\$341
	Fabric Price Group 08	+\$443
Fabric Price Group 09	+\$545	
Fabric Price Group 10	+\$642	
Leather Price Group 01	+\$702	
Leather Price Group 02	+\$865	

Specification Information

Style Number	Base Price
--------------	------------

Mesa Chaise Lounge - Left Hand

WESMESCHLH	\$5224
-------------------	--------

Mesa

Lounge Seating

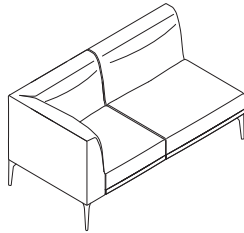

Tip: Contrasting fabric is not available on Mesa lounge seating.

Tip: Handedness is determined while in the seated position.

Standard Includes

- Fully upholstered non-contrasting lounge: fabric price group 01
- Four leg cast aluminum base: WE01 Antique Bronze
- Ganging brackets: plastic

Options

Options		
Inner Finish	Fabric Customer's Own Material	No cost
	Fabric Price Group 01	No cost
	Fabric Price Group 02	+\$31
	Customer's Own Leather	+\$100
	Fabric Price Group 03	+\$143
	Fabric Price Group 04	+\$278
	Fabric Price Group 05	+\$495
	Fabric Price Group 06	+\$732
	Fabric Price Group 07	+\$1021
	Fabric Price Group 08	+\$1324
	Fabric Price Group 09	+\$1636
Fabric Price Group 10	+\$1925	
	Leather Price Group 01	+\$2106
	Leather Price Group 02	+\$2595
Outer Finish	Fabric Customer's Own Material	No cost
	Fabric Price Group 01	No cost
	Fabric Price Group 02	+\$8
	Fabric Price Group 03	+\$47
	Fabric Price Group 04	+\$94
	Customer's Own Leather	+\$100
	Fabric Price Group 05	+\$165
	Fabric Price Group 06	+\$245
	Fabric Price Group 07	+\$341
	Fabric Price Group 08	+\$443
	Fabric Price Group 09	+\$545
	Fabric Price Group 10	+\$642
		Leather Price Group 01
	Leather Price Group 02	+\$865

Specification Information

Style Number Base Price

Mesa Chaise Lounge - Right Hand

WESMESCHRH \$5224

Mesa

Mesa

Lounge Seating

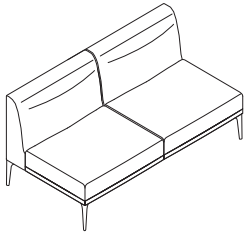

Tip: Contrasting fabric is not available on Mesa lounge seating.

Standard Includes

- Fully upholstered non-contrasting lounge: fabric price group 01
- Four leg cast aluminum base: WE01 Antique Bronze
- Ganging brackets: plastic

Options

Inner Finish	Fabric Customer's Own Material	No cost
	Fabric Price Group 01	No cost
	Fabric Price Group 02	+\$27
	Customer's Own Leather	+\$100
	Fabric Price Group 03	+\$133
	Fabric Price Group 04	+\$255
	Fabric Price Group 05	+\$458
	Fabric Price Group 06	+\$676
	Fabric Price Group 07	+\$942
	Fabric Price Group 08	+\$1221
	Fabric Price Group 09	+\$1505
	Fabric Price Group 10	+\$1777
Outer Finish	Leather Price Group 01	+\$1940
	Leather Price Group 02	+\$2389
	Fabric Customer's Own Material	No cost
	Fabric Price Group 01	No cost
	Fabric Price Group 02	+\$8
	Fabric Price Group 03	+\$45
	Fabric Price Group 04	+\$84
	Customer's Own Leather	+\$100
	Fabric Price Group 05	+\$153
	Fabric Price Group 06	+\$225
	Fabric Price Group 07	+\$315
	Fabric Price Group 08	+\$407
Fabric Price Group 09	+\$502	
Fabric Price Group 10	+\$593	
Leather Price Group 01	+\$646	
Leather Price Group 02	+\$798	

Specification Information

Style Number Base Price

Mesa Armless Lounge

WESMES2SEAT \$4742

Mesa

Lounge Seating

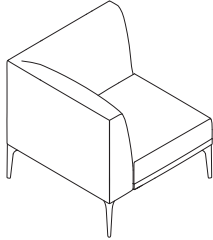

Tip: Contrasting fabric is not available on Mesa lounge seating.

Standard Includes

- Fully upholstered non-contrasting lounge: fabric price group 01
- Four leg cast aluminum base: WE01 Antique Bronze
- Ganging brackets: plastic

Options

Inner Finish	Fabric Customer's Own Material	No cost
	Fabric Price Group 01	No cost
	Fabric Price Group 02	+\$17
	Fabric Price Group 03	+\$82
	Customer's Own Leather	+\$100
	Fabric Price Group 04	+\$161
	Fabric Price Group 05	+\$286
	Fabric Price Group 06	+\$425
	Fabric Price Group 07	+\$590
	Fabric Price Group 08	+\$765
	Fabric Price Group 09	+\$944
	Fabric Price Group 10	+\$1112
	Leather Price Group 01	+\$1216
	Leather Price Group 02	+\$1500
Outer Finish	Fabric Customer's Own Material	No cost
	Fabric Price Group 01	No cost
	Fabric Price Group 02	+\$4
	Fabric Price Group 03	+\$27
	Fabric Price Group 04	+\$55
	Fabric Price Group 05	+\$97
	Customer's Own Leather	+\$100
	Fabric Price Group 06	+\$141
	Fabric Price Group 07	+\$197
	Fabric Price Group 08	+\$255
	Fabric Price Group 09	+\$315
	Fabric Price Group 10	+\$372
	Leather Price Group 01	+\$405
	Leather Price Group 02	+\$498

Specification Information

Style Number Base Price

Mesa Corner Lounge Unit

WESMESC \$3083

Mesa

Lounge Seating

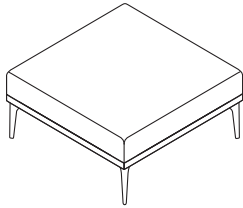

Standard Includes

- Fully upholstered ottoman: fabric price group 01
- Four leg cast aluminum base: WE01 Antique Bronze
- Ganging brackets: plastic

Options

Upholstery Finish	Fabric Customer's Own Material	No cost
	Fabric Price Group 01	No cost
	Fabric Price Group 02	+\$12
	Fabric Price Group 03	+\$69
	Fabric Price Group 04	+\$134
	Customer's Own Leather	+\$198
	Fabric Price Group 05	+\$238
	Fabric Price Group 06	+\$352
	Fabric Price Group 07	+\$488
	Fabric Price Group 08	+\$635
	Fabric Price Group 09	+\$784
	Fabric Price Group 10	+\$924
	Leather Price Group 01	+\$1008
	Leather Price Group 02	+\$1243

Specification Information

Style Number Base Price

Mesa Ottoman

WESMESO \$2107

Mesa
Lounge Seating

Mesa

Willow

Lounge Seating

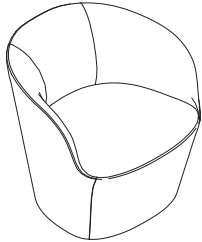

Standard Includes

- Fully upholstered non-contrasting seat with back: fabric price group 01
- Back detail: smooth
- Glides

Options

Color Scheme	Non Contrasting	No cost
	Contrasting Inner & Outer	+\$129
Upholstery Finish	Fabric Customer's Own Material	No cost
	Fabric Price Group 01	No cost
	Fabric Price Group 02	+\$57
	Vinyl Price Group 02	+\$57
	Fabric Price Group 03	+\$134
	Customer's Own Leather	+\$180
	Fabric Price Group 04	+\$270
	Fabric Price Group 05	+\$386
	Fabric Price Group 06	+\$634
	Fabric Price Group 07	+\$751
	Fabric Price Group 08	+\$1038
	Fabric Price Group 09	+\$1232
	Fabric Price Group 10	+\$1404
Inner Finish	Leather Price Group 01	+\$1729
	Leather Price Group 02	+\$2020
	Fabric Customer's Own Material	No cost
	Fabric Price Group 01	No cost
	Fabric Price Group 02	+\$28
	Vinyl Price Group 02	+\$28
	Fabric Price Group 03	+\$67
	Fabric Price Group 04	+\$135
	Customer's Own Leather	+\$180
	Fabric Price Group 05	+\$193
	Fabric Price Group 06	+\$317
	Fabric Price Group 07	+\$375
	Fabric Price Group 08	+\$519
Fabric Price Group 09	+\$616	
Fabric Price Group 10	+\$702	
Outer Finish	Leather Price Group 01	+\$865
	Leather Price Group 02	+\$1010
	Fabric Customer's Own Material	No cost
	Fabric Price Group 01	No cost
	Fabric Price Group 02	+\$29
	Vinyl Price Group 02	+\$29
	Fabric Price Group 03	+\$67
	Fabric Price Group 04	+\$135
	Customer's Own Leather	+\$180
	Fabric Price Group 05	+\$193
	Fabric Price Group 06	+\$317
	Fabric Price Group 07	+\$376
	Fabric Price Group 08	+\$519
Fabric Price Group 09	+\$616	
Fabric Price Group 10	+\$702	

► **Product Information continued on next page**

Willow

Lounge Seating

► **Product Information continued from previous page**

Options		
Outer Finish	Leather Price Group 01	+\$866
	Leather Price Group 02	+\$1010
Back Detail	Smooth	No cost
	Soft	+\$200

Specification Information

Style Number	Base Price
Willow Fixed Base Lounge	
WESWL0LNGF	\$2500



Willow

Lounge Seating

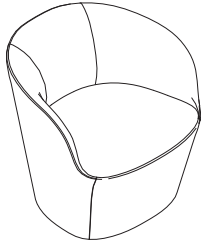

Standard Includes

- Fully upholstered non-contrasting seat with back: fabric price group 01
- Back detail: smooth
- Swivel base

Options

Color Scheme	Non Contrasting	No cost	
	Contrasting Inner & Outer	+\$129	
Upholstery Finish	Fabric Customer's Own Material	No cost	
	Fabric Price Group 01	No cost	
	Fabric Price Group 02	+\$57	
	Vinyl Price Group 02	+\$57	
	Fabric Price Group 03	+\$134	
	Customer's Own Leather	+\$180	
	Fabric Price Group 04	+\$270	
	Fabric Price Group 05	+\$386	
	Fabric Price Group 06	+\$634	
	Fabric Price Group 07	+\$751	
	Fabric Price Group 08	+\$1038	
	Fabric Price Group 09	+\$1232	
Inner Finish	Fabric Price Group 10	+\$1404	
	Leather Price Group 01	+\$1729	
	Leather Price Group 02	+\$2020	
	Inner Finish	Fabric Customer's Own Material	No cost
		Fabric Price Group 01	No cost
		Fabric Price Group 02	+\$28
		Vinyl Price Group 02	+\$28
		Fabric Price Group 03	+\$67
		Fabric Price Group 04	+\$135
		Customer's Own Leather	+\$180
		Fabric Price Group 05	+\$193
		Fabric Price Group 06	+\$317
Fabric Price Group 07		+\$375	
Fabric Price Group 08		+\$519	
Fabric Price Group 09		+\$616	
Outer Finish	Fabric Price Group 10	+\$702	
	Leather Price Group 01	+\$865	
	Leather Price Group 02	+\$1010	
	Outer Finish	Fabric Customer's Own Material	No cost
		Fabric Price Group 01	No cost
		Fabric Price Group 02	+\$29
		Vinyl Price Group 02	+\$29
		Fabric Price Group 03	+\$67
		Fabric Price Group 04	+\$135
		Customer's Own Leather	+\$180
		Fabric Price Group 05	+\$193
		Fabric Price Group 06	+\$317
Fabric Price Group 07		+\$376	
Fabric Price Group 08		+\$519	
Fabric Price Group 09		+\$616	
Fabric Price Group 10	+\$702		

► **Product Information continued on next page**

Willow

Lounge Seating

► **Product Information continued from previous page**

Options		
Outer Finish	Leather Price Group 01	+\$866
	Leather Price Group 02	+\$1010
Back Detail	Smooth	No cost
	Soft	+\$200

Specification Information

Style Number	Base Price
Willow Swivel Base Lounge	
WESWLNLNGS	\$2855



Slope

Guest Chairs and Stools

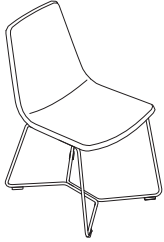

Tip: Slope guest chair with arms is shipped fully assembled; without arms will require assembly.

Tip: Upholstery and paint available on Steelcase Slope. Licensed Slope (stocked) guest chair available in saddle or fog with a hot rolled steel frame. Licensed Slope guest chair is also available in aegean leather with antique brass frame.

Standard Includes

- Fully upholstered seat with back: fabric price group 01
- Wire frame base: paint price group 01
- Glides:
 - Natural
 - Black

Options

Upholstery Finish	Fabric Customer's Own Material	No cost
	Fabric Price Group 01	No cost
	Fabric Price Group 02	+\$5
	Fabric Price Group 03	+\$31
	Fabric Price Group 04	+\$59
	Fabric Price Group 05	+\$130
	Fabric Price Group 06	+\$153
	Customer's Own Leather	+\$198
	Fabric Price Group 07	+\$214
	Fabric Price Group 08	+\$277
	Fabric Price Group 09	+\$328
Fabric Price Group 10	+\$402	
Leather Price Group 01	+\$440	
Leather Price Group 02	+\$542	
Base Finish	Paint Price Group 01	No cost
	Paint Price Group 02	+\$41
	Paint Price Group 03	+\$83
Vertical Seam	Without Seam	No cost
	With Seam	+\$11
Arm Type	Without Arm	No cost
	With Arm	+\$159

Specification Information

Style Number Base Price

Slope Guest Chair

WESSLPCG \$877

Slope

Guest Chairs and Stools

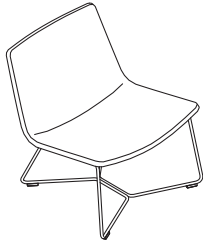

Tip: Upholstery and paint available on Steelcase Slope. Licensed Slope (stocked) lounge chair only available in saddle and fog with hot rolled steel frame.

Standard Includes

- Fully upholstered seat with back: fabric price group 01
- Wire frame base: paint price group 01
- Glides:
 - Natural
 - Black
- Requires assembly

Options

Upholstery Finish	Fabric Customer's Own Material	No cost
	Fabric Price Group 01	No cost
	Fabric Price Group 02	+\$8
	Fabric Price Group 03	+\$46
	Fabric Price Group 04	+\$87
	Fabric Price Group 05	+\$195
	Customer's Own Leather	+\$198
	Fabric Price Group 06	+\$231
	Fabric Price Group 07	+\$319
	Fabric Price Group 08	+\$415
	Fabric Price Group 09	+\$492
Base Finish	Fabric Price Group 10	+\$601
	Leather Price Group 01	+\$686
	Leather Price Group 02	+\$838
Vertical Seam	Paint Price Group 01	No cost
	Paint Price Group 02	+\$41
	Paint Price Group 03	+\$83
Vertical Seam	Without Seam	No cost
	With Seam	+\$11

Specification Information

Style Number Base Price

Slope Lounge Chair

WESSLPCL \$1210

Slope

Slope

Guest Chairs and Stools

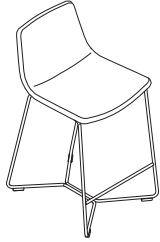

Tip: Upholstery and paint available on Steelcase Slope. Licensed Slope (stocked) counter height stool only available in saddle with hot rolled steel frame.

Standard Includes

- Fully upholstered seat with back: fabric price group 01
- Wire frame base: paint price group 01
- Glides:
 - Natural
 - Black
- Requires assembly

Options

Upholstery Finish	Fabric Customer's Own Material	No cost
	Fabric Price Group 01	No cost
	Fabric Price Group 02	+\$5
	Fabric Price Group 03	+\$31
	Fabric Price Group 04	+\$59
	Fabric Price Group 05	+\$130
	Fabric Price Group 06	+\$153
	Customer's Own Leather	+\$198
	Fabric Price Group 07	+\$214
	Fabric Price Group 08	+\$277
	Fabric Price Group 09	+\$328
Base Finish	Fabric Price Group 10	+\$402
	Leather Price Group 01	+\$440
	Leather Price Group 02	+\$542
Vertical Seam	Paint Price Group 01	No cost
	Paint Price Group 02	+\$41
	Paint Price Group 03	+\$83
Vertical Seam	Without Seam	No cost
	With Seam	+\$11

Specification Information

Style Number Base Price

Slope Counter Height Stool

WESSLPSC \$1092

Slope

Guest Chairs and Stools

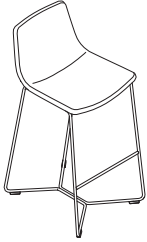

Tip: Upholstery and paint available on Steelcase Slope. Licensed Slope (stocked) bar height stool is only available in saddle with hot rolled steel frame.

Standard Includes

- Fully upholstered seat with back: fabric price group 01
- Wire frame base: paint price group 01
- Glides:
 - Natural
 - Black
- Requires assembly

Options

Upholstery Finish	Fabric Customer's Own Material	No cost
	Fabric Price Group 01	No cost
	Fabric Price Group 02	+\$5
	Fabric Price Group 03	+\$31
	Fabric Price Group 04	+\$59
	Fabric Price Group 05	+\$130
	Fabric Price Group 06	+\$153
	Customer's Own Leather	+\$198
	Fabric Price Group 07	+\$214
	Fabric Price Group 08	+\$277
	Fabric Price Group 09	+\$328
Fabric Price Group 10	+\$402	
Leather Price Group 01	+\$440	
Leather Price Group 02	+\$542	
Base Finish	Paint Price Group 01	No cost
	Paint Price Group 02	+\$41
	Paint Price Group 03	+\$83
Vertical Seam	Without Seam	No cost
	With Seam	+\$11

Specification Information

Style Number Base Price

Slope Bar Height Stool

WESSLPSB \$1143

Slope

Slope

Conference Chair

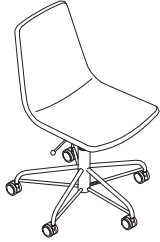

Tip: Upholstery and paint available on Steelcase Slope. Licensed Slope (stocked) conference chair only available in saddle and fog with hot rolled steel frame.

Standard Includes

- Fully upholstered seat with back: fabric price group 01
- Five-star adjustable base: hot-rolled steel finish
- Hard casters: 6205 Black
- Requires assembly

Options

Upholstery Finish	Fabric Customer's Own Material	No cost
	Fabric Price Group 01	No cost
	Fabric Price Group 02	+\$5
	Fabric Price Group 03	+\$31
	Fabric Price Group 04	+\$59
	Fabric Price Group 05	+\$130
	Fabric Price Group 06	+\$153
	Customer's Own Leather	+\$198
	Fabric Price Group 07	+\$214
	Fabric Price Group 08	+\$277
	Fabric Price Group 09	+\$328
	Fabric Price Group 10	+\$402
Leather Price Group 01		+\$440
	Leather Price Group 02	+\$542
Vertical Seam	Without Seam	No cost
	With Seam	+\$11
Arm Type	Without Arm	No cost
	With Arm	+\$159
Caster or Glide	Hard Casters	No cost
	Soft Casters	+\$35

Specification Information

Style Number Base Price

Slope Height-Adjustable Conference Chair

WESSLPCC \$1196

Slope

Stacking Chair

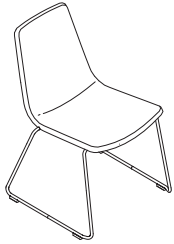

Tip: Slope stacking chair with arms is shipped fully assembled; without arms will require assembly.

Standard Includes

- Fully upholstered seat with back: fabric price group 01
- Wire frame base: paint price group 01
- Glides:
 - Natural
 - Black

Options

Upholstery Finish	Fabric Customer's Own Material	No cost
	Fabric Price Group 01	No cost
	Fabric Price Group 02	+\$5
	Fabric Price Group 03	+\$31
	Fabric Price Group 04	+\$59
	Fabric Price Group 05	+\$130
	Fabric Price Group 06	+\$153
	Customer's Own Leather	+\$198
	Fabric Price Group 07	+\$214
	Fabric Price Group 08	+\$277
	Fabric Price Group 09	+\$328
Fabric Price Group 10	+\$402	
Leather Price Group 01	+\$440	
Leather Price Group 02	+\$542	
Base Finish	Paint Price Group 01	No cost
	Paint Price Group 02	+\$41
	Paint Price Group 03	+\$83
Vertical Seam	Without Seam	No cost
	With Seam	+\$11
Arm Type	Without Arm	No cost
	With Arm	+\$159
Glides	Black	No cost
	Natural	No cost

Specification Information

Style Number Base Price

Slope Stacking Chair

WESSLPCS \$888



Sterling

Guest Chairs and Stools

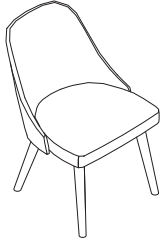

Standard Includes

- Fully upholstered non-contrasting seat with back: fabric price group 01
- Legs (base): veneer price group 01
- Glides: plastic

Options

Color Scheme	Non Contrasting	No cost
	Contrasting	+\$177
Back Finish	Fabric Customer's Own Material	No cost
	Fabric Price Group 01	No cost
	Fabric Price Group 02	+\$5
	Fabric Price Group 03	+\$36
	Fabric Price Group 04	+\$74
	Customer's Own Leather	+\$100
	Fabric Price Group 05	+\$160
	Fabric Price Group 06	+\$190
	Fabric Price Group 07	+\$265
	Fabric Price Group 08	+\$344
	Fabric Price Group 09	+\$409
	Fabric Price Group 10	+\$502
Seat Finish	Leather Price Group 01	+\$547
	Leather Price Group 02	+\$675
	Fabric Customer's Own Material	No cost
	Fabric Price Group 01	No cost
	Fabric Price Group 02	+\$5
	Fabric Price Group 03	+\$31
	Fabric Price Group 04	+\$59
	Customer's Own Leather	+\$100
	Fabric Price Group 05	+\$130
	Fabric Price Group 06	+\$153
	Fabric Price Group 07	+\$214
	Fabric Price Group 08	+\$277
Fabric Price Group 09	+\$328	
Fabric Price Group 10	+\$402	
Leather Price Group 01	+\$440	
Leather Price Group 02	+\$542	
Base Finish	Veneer Custom Stain	No cost
	Veneer Price Group 01	No cost
	Veneer Price Group 02	+\$41

Specification Information

Style Number Base Price

Sterling 4-Leg Armless Guest Chair

WESMDC4NA \$1113

Sterling

Guest Chairs and Stools

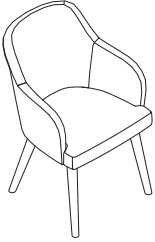

Standard Includes

- Fully upholstered non-contrasting seat with back: fabric price group 01
- Legs (base): veneer price group 01
- Glides: plastic

Options

Color Scheme	Non Contrasting	No cost
	Contrasting	+\$177
Back Finish	Fabric Customer's Own Material	No cost
	Fabric Price Group 01	No cost
	Fabric Price Group 02	+\$8
	Fabric Price Group 03	+\$46
	Fabric Price Group 04	+\$87
	Customer's Own Leather	+\$100
	Fabric Price Group 05	+\$195
	Fabric Price Group 06	+\$231
	Fabric Price Group 07	+\$319
	Fabric Price Group 08	+\$415
	Fabric Price Group 09	+\$492
	Fabric Price Group 10	+\$601
Seat Finish	Leather Price Group 01	+\$659
	Leather Price Group 02	+\$812
	Fabric Customer's Own Material	No cost
	Fabric Price Group 01	No cost
	Fabric Price Group 02	+\$5
	Fabric Price Group 03	+\$31
	Fabric Price Group 04	+\$59
	Customer's Own Leather	+\$100
	Fabric Price Group 05	+\$130
	Fabric Price Group 06	+\$153
	Fabric Price Group 07	+\$214
	Fabric Price Group 08	+\$277
Fabric Price Group 09	+\$328	
Fabric Price Group 10	+\$402	
Base Finish	Leather Price Group 01	+\$440
	Leather Price Group 02	+\$542
	Veneer Custom Stain	No cost
	Veneer Price Group 01	No cost
	Veneer Price Group 02	+\$41

Specification Information

Style Number Base Price

Sterling 4-Leg with Arms Guest Chair

WESMDC4WA \$1242

Sterling

Guest Chairs and Stools



Standard Includes

- Fully upholstered non-contrasting seat with back: fabric price group 01
- Legs (base): veneer price group 01
- Glides: plastic

Options

Color Scheme	Non Contrasting	No cost
	Contrasting	+\$177
Back Finish	Fabric Customer's Own Material	No cost
	Fabric Price Group 01	No cost
	Fabric Price Group 02	+\$5
	Fabric Price Group 03	+\$36
	Fabric Price Group 04	+\$74
	Customer's Own Leather	+\$100
	Fabric Price Group 05	+\$160
	Fabric Price Group 06	+\$190
	Fabric Price Group 07	+\$265
	Fabric Price Group 08	+\$344
	Fabric Price Group 09	+\$409
	Fabric Price Group 10	+\$502
Seat Finish	Leather Price Group 01	+\$547
	Leather Price Group 02	+\$675
	Fabric Customer's Own Material	No cost
	Fabric Price Group 01	No cost
	Fabric Price Group 02	+\$5
	Fabric Price Group 03	+\$31
	Fabric Price Group 04	+\$59
	Customer's Own Leather	+\$100
	Fabric Price Group 05	+\$130
	Fabric Price Group 06	+\$153
	Fabric Price Group 07	+\$214
	Fabric Price Group 08	+\$277
Fabric Price Group 09	+\$328	
Fabric Price Group 10	+\$402	
Leather Price Group 01	+\$440	
Leather Price Group 02	+\$542	
Base Finish	Veneer Custom Stain	No cost
	Veneer Price Group 01	No cost
	Veneer Price Group 02	+\$59

Specification Information

Style Number	Base Price
--------------	------------

Sterling Counter Height Armless Stool

WESMDCSCHNA \$1322

Sterling

Guest Chairs and Stools



Standard Includes

- Fully upholstered non-contrasting seat with back: fabric price group 01
- Legs (base): veneer price group 01
- Glides: plastic

Options

Color Scheme	Non Contrasting	No cost
	Contrasting	+\$177
Back Finish	Fabric Customer's Own Material	No cost
	Fabric Price Group 01	No cost
	Fabric Price Group 02	+\$5
	Fabric Price Group 03	+\$36
	Fabric Price Group 04	+\$74
	Customer's Own Leather	+\$100
	Fabric Price Group 05	+\$160
	Fabric Price Group 06	+\$190
	Fabric Price Group 07	+\$265
	Fabric Price Group 08	+\$344
	Fabric Price Group 09	+\$409
	Fabric Price Group 10	+\$502
Seat Finish	Leather Price Group 01	+\$547
	Leather Price Group 02	+\$675
	Fabric Customer's Own Material	No cost
	Fabric Price Group 01	No cost
	Fabric Price Group 02	+\$5
	Fabric Price Group 03	+\$31
	Fabric Price Group 04	+\$59
	Customer's Own Leather	+\$100
	Fabric Price Group 05	+\$130
	Fabric Price Group 06	+\$153
	Fabric Price Group 07	+\$214
	Fabric Price Group 08	+\$277
Fabric Price Group 09	+\$328	
Fabric Price Group 10	+\$402	
Base Finish	Leather Price Group 01	+\$440
	Leather Price Group 02	+\$542
	Veneer Custom Stain	No cost
	Veneer Price Group 01	No cost
	Veneer Price Group 02	+\$59

Specification Information

Style Number	Base Price
--------------	------------

Sterling Bar Height Armless Stool

WESMDCSBHNA \$1437

Sterling

Sterling

Conference Chairs



Standard Includes

- Fully upholstered non-contrasting seat with back: fabric price group 01
- Five-star adjustable base: paint price group 01
- Hard casters: 6205 Black

Options

Color Scheme	Non Contrasting	No cost
	Contrasting	+\$177
Back Finish	Fabric Customer's Own Material	No cost
	Fabric Price Group 01	No cost
	Fabric Price Group 02	+\$5
	Fabric Price Group 03	+\$36
	Fabric Price Group 04	+\$74
	Customer's Own Leather	+\$100
	Fabric Price Group 05	+\$160
	Fabric Price Group 06	+\$190
	Fabric Price Group 07	+\$265
	Fabric Price Group 08	+\$344
	Fabric Price Group 09	+\$409
	Fabric Price Group 10	+\$502
Seat Finish	Leather Price Group 01	+\$547
	Leather Price Group 02	+\$675
	Fabric Customer's Own Material	No cost
	Fabric Price Group 01	No cost
	Fabric Price Group 02	+\$5
	Fabric Price Group 03	+\$31
	Fabric Price Group 04	+\$59
	Customer's Own Leather	+\$100
	Fabric Price Group 05	+\$130
	Fabric Price Group 06	+\$153
	Fabric Price Group 07	+\$214
	Fabric Price Group 08	+\$277
Fabric Price Group 09	+\$328	
Fabric Price Group 10	+\$402	
Leather Price Group 01	+\$440	
Leather Price Group 02	+\$542	
Base Finish	Paint Price Group 01	No cost
	Paint Price Group 02	+\$41
	Paint Price Group 03	+\$83
	Polished Aluminum	+\$126
Caster or Glide	Hard Casters	No cost
	Soft Casters	+\$35
Tilt Mechanism	Without Tilt	No cost
	With Tilt	+\$98

Specification Information

Style Number Base Price

Sterling 5-Star Armless Conference Chair

WESMDC5NA \$1254

Sterling

Conference Chairs



Standard Includes

- Fully upholstered non-contrasting seat with back: fabric price group 01
- Five-star adjustable base: paint price group 01
- Hard casters: 6205 Black

Options

Color Scheme	Non Contrasting	No cost
	Contrasting	+\$177
Back Finish	Fabric Customer's Own Material	No cost
	Fabric Price Group 01	No cost
	Fabric Price Group 02	+\$8
	Fabric Price Group 03	+\$46
	Fabric Price Group 04	+\$87
	Customer's Own Leather	+\$100
	Fabric Price Group 05	+\$195
	Fabric Price Group 06	+\$231
	Fabric Price Group 07	+\$319
	Fabric Price Group 08	+\$415
	Fabric Price Group 09	+\$492
	Fabric Price Group 10	+\$601
Seat Finish	Leather Price Group 01	+\$659
	Leather Price Group 02	+\$812
	Fabric Customer's Own Material	No cost
	Fabric Price Group 01	No cost
	Fabric Price Group 02	+\$5
	Fabric Price Group 03	+\$31
	Fabric Price Group 04	+\$59
	Customer's Own Leather	+\$100
	Fabric Price Group 05	+\$130
	Fabric Price Group 06	+\$153
	Fabric Price Group 07	+\$214
	Fabric Price Group 08	+\$277
Fabric Price Group 09	+\$328	
Fabric Price Group 10	+\$402	
Leather Price Group 01	+\$440	
Leather Price Group 02	+\$542	
Base Finish	Paint Price Group 01	No cost
	Paint Price Group 02	+\$41
	Paint Price Group 03	+\$83
	Polished Aluminum	+\$126
Caster or Glide	Hard Casters	No cost
	Soft Casters	+\$35
Tilt Mechanism	Without Tilt	No cost
	With Tilt	+\$98

Specification Information

Style Number Base Price

Sterling 5-Star with Arm Conference Chair

WESMDC5WA \$1369

Sterling

Conference Chairs



Standard Includes

- Fully upholstered non-contrasting seat with back: fabric price group 01
- Four-star base: 8046 Polished Aluminum
- Glides: plastic

Options

Color Scheme	Non Contrasting	No cost
	Contrasting	+\$177
Back Finish	Fabric Customer's Own Material	No cost
	Fabric Price Group 01	No cost
	Fabric Price Group 02	+\$5
	Fabric Price Group 03	+\$36
	Fabric Price Group 04	+\$74
	Customer's Own Leather	+\$100
	Fabric Price Group 05	+\$160
	Fabric Price Group 06	+\$190
	Fabric Price Group 07	+\$265
	Fabric Price Group 08	+\$344
	Fabric Price Group 09	+\$409
	Fabric Price Group 10	+\$502
Seat Finish	Leather Price Group 01	+\$547
	Leather Price Group 02	+\$675
	Fabric Customer's Own Material	No cost
	Fabric Price Group 01	No cost
	Fabric Price Group 02	+\$5
	Fabric Price Group 03	+\$31
	Fabric Price Group 04	+\$59
	Customer's Own Leather	+\$100
	Fabric Price Group 05	+\$130
	Fabric Price Group 06	+\$153
	Fabric Price Group 07	+\$214
	Fabric Price Group 08	+\$277
Fabric Price Group 09	+\$328	
Fabric Price Group 10	+\$402	
Leather Price Group 01	+\$440	
Leather Price Group 02	+\$542	

Specification Information

Style Number	Base Price
--------------	------------

Sterling 4-Star Armless Conference Chair

WESMDC4CNFNA \$1046

Sterling

Conference Chairs



Standard Includes

- Fully upholstered non-contrasting seat with back: fabric price group 01
- Four-star base: 8046 Polished Aluminum
- Glides: plastic

Options

Color Scheme	Non Contrasting	No cost
	Contrasting	+\$177
Back Finish	Fabric Customer's Own Material	No cost
	Fabric Price Group 01	No cost
	Fabric Price Group 02	+\$8
	Fabric Price Group 03	+\$46
	Fabric Price Group 04	+\$87
	Customer's Own Leather	+\$100
	Fabric Price Group 05	+\$195
	Fabric Price Group 06	+\$231
	Fabric Price Group 07	+\$319
	Fabric Price Group 08	+\$415
	Fabric Price Group 09	+\$492
	Fabric Price Group 10	+\$601
Seat Finish	Leather Price Group 01	+\$659
	Leather Price Group 02	+\$812
	Fabric Customer's Own Material	No cost
	Fabric Price Group 01	No cost
	Fabric Price Group 02	+\$5
	Fabric Price Group 03	+\$31
	Fabric Price Group 04	+\$59
	Customer's Own Leather	+\$100
	Fabric Price Group 05	+\$130
	Fabric Price Group 06	+\$153
	Fabric Price Group 07	+\$214
	Fabric Price Group 08	+\$277
Fabric Price Group 09	+\$328	
Fabric Price Group 10	+\$402	
Leather Price Group 01	+\$440	
Leather Price Group 02	+\$542	

Specification Information

Style Number	Base Price
--------------	------------

Sterling 4-Star with Arm Conference Chair

WESMDC4CNFWA	\$1152
---------------------	--------

Sterling

Lounge

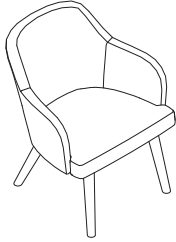

Standard Includes

- Fully upholstered seat with back: fabric price group 01
- Legs (base): veneer price group 01
- Glides: plastic

Options

Color Scheme	Non Contrasting	No cost
	Contrasting	+\$177
Back Finish	Fabric Customer's Own Material	No cost
	Fabric Price Group 01	No cost
	Fabric Price Group 02	+\$8
	Fabric Price Group 03	+\$46
	Fabric Price Group 04	+\$87
	Customer's Own Leather	+\$100
	Fabric Price Group 05	+\$195
	Fabric Price Group 06	+\$231
	Fabric Price Group 07	+\$319
	Fabric Price Group 08	+\$415
	Fabric Price Group 09	+\$492
	Fabric Price Group 10	+\$601
Seat Finish	Leather Price Group 01	+\$659
	Leather Price Group 02	+\$812
	Fabric Customer's Own Material	No cost
	Fabric Price Group 01	No cost
	Fabric Price Group 02	+\$5
	Fabric Price Group 03	+\$31
	Fabric Price Group 04	+\$59
	Customer's Own Leather	+\$100
	Fabric Price Group 05	+\$130
	Fabric Price Group 06	+\$153
	Fabric Price Group 07	+\$214
	Fabric Price Group 08	+\$277
Fabric Price Group 09	+\$328	
Fabric Price Group 10	+\$402	
Base Finish	Leather Price Group 01	+\$440
	Leather Price Group 02	+\$542
	Veneer Custom Stain	No cost
	Veneer Price Group 01	No cost
	Veneer Price Group 02	+\$41

Specification Information

Style Number Base Price

Sterling Lounge

WESMDC4LNG \$1240

Sterling
Lounge

Sterling

Sterling Health

Guest Chairs



Sterling Chair- Health, Guest Metal Leg, Armless

Style Number	List Price
WEHMDC4MNA	\$1499

Options

Color Scheme	Non Contrasting	No cost
	Contrasting	+\$177
Back Finish	Fabric Customer's Own Material	No cost
	Fabric Price Group 01	No cost
	Vinyl Price Group 02	No cost
	Fabric Price Group 02	+\$5
	Fabric Price Group 03	+\$36
	Fabric Price Group 04	+\$74
	Customer's Own Leather	+\$100
	Fabric Price Group 05	+\$160
	Fabric Price Group 06	+\$190
	Fabric Price Group 07	+\$265
	Fabric Price Group 08	+\$344
	Fabric Price Group 09	+\$409
	Fabric Price Group 10	+\$502
	Leather Price Group 01	+\$547
	Leather Price Group 02	+\$675
Seat Finish	Fabric Customer's Own Material	No cost
	Fabric Price Group 01	No cost
	Vinyl Price Group 02	No cost
	Fabric Price Group 02	+\$5
	Fabric Price Group 03	+\$31
	Fabric Price Group 04	+\$59
	Customer's Own Leather	+\$100
	Fabric Price Group 05	+\$130
	Fabric Price Group 06	+\$153
	Fabric Price Group 07	+\$214
	Fabric Price Group 08	+\$277
	Fabric Price Group 09	+\$328
	Fabric Price Group 10	+\$402
	Leather Price Group 01	+\$440
	Leather Price Group 02	+\$542
Base Finish	Paint Price Group 01	No cost
	Paint Price Group 02	+\$41
	Paint Price Group 03	+\$83

Sterling Health

Guest Chairs



Sterling Chair- Health, Guest Metal Leg, Arms

Style Number	List Price
WEHMDC4MWA	\$1628

Options

Color Scheme	Non Contrasting	No cost
	Contrasting	+\$177
Back Finish	Fabric Customer's Own Material	No cost
	Fabric Price Group 01	No cost
	Vinyl Price Group 02	No cost
	Fabric Price Group 02	+\$8
	Fabric Price Group 03	+\$46
	Fabric Price Group 04	+\$87
	Customer's Own Leather	+\$100
	Fabric Price Group 05	+\$195
	Fabric Price Group 06	+\$231
	Fabric Price Group 07	+\$319
	Fabric Price Group 08	+\$415
	Fabric Price Group 09	+\$492
	Fabric Price Group 10	+\$601
	Leather Price Group 01	+\$659
	Leather Price Group 02	+\$812
Seat Finish	Fabric Customer's Own Material	No cost
	Fabric Price Group 01	No cost
	Vinyl Price Group 02	No cost
	Fabric Price Group 02	+\$5
	Fabric Price Group 03	+\$31
	Fabric Price Group 04	+\$59
	Customer's Own Leather	+\$100
	Fabric Price Group 05	+\$130
	Fabric Price Group 06	+\$153
	Fabric Price Group 07	+\$214
	Fabric Price Group 08	+\$277
	Fabric Price Group 09	+\$328
	Fabric Price Group 10	+\$402
	Leather Price Group 01	+\$440
	Leather Price Group 02	+\$542
Base Finish	Paint Price Group 01	No cost
	Paint Price Group 02	+\$41
	Paint Price Group 03	+\$83

Kent

Conference Chairs



Standard Includes

- Fully upholstered non-contrasting seat with back: fabric price group 01
- Five-star adjustable base: paint price group 01
- Hard casters: 6205 Black
- Requires assembly

Options

Color Scheme	Non Contrasting	No cost
	Contrasting	+\$155
Back	Low Back	No cost
	High Back	+\$352
Back Finish	Fabric Customer's Own Material	No cost
	Fabric Price Group 01	No cost
	Fabric Price Group 02	+\$20
	Fabric Price Group 03	+\$48
	Customer's Own Leather	+\$88
	Fabric Price Group 04	+\$109
	Fabric Price Group 05	+\$179
	Fabric Price Group 06	+\$331
	Fabric Price Group 07	+\$452
	Fabric Price Group 08	+\$582
	Leather Price Group 01	+\$628
Seat Finish	Fabric Price Group 09	+\$697
	Leather Price Group 02	+\$773
	Fabric Price Group 10	+\$818
	Fabric Customer's Own Material	No cost
	Fabric Price Group 01	No cost
	Fabric Price Group 02	+\$9
	Fabric Price Group 03	+\$26
	Fabric Price Group 04	+\$60
	Customer's Own Leather	+\$88
	Fabric Price Group 05	+\$97
	Fabric Price Group 06	+\$180
Fabric Price Group 07	+\$246	
Fabric Price Group 08	+\$316	
Fabric Price Group 09	+\$379	
Leather Price Group 01	+\$420	
Fabric Price Group 10	+\$446	
Leather Price Group 02	+\$511	
Base Finish	Paint Price Group 01	No cost
	Paint Price Group 02	+\$41
	Paint Price Group 03	+\$80
	Polished Aluminum	+\$121
Caster or Glide	Hard Casters	No cost
	Soft Casters	+\$33

Specification Information

Style Number Base Price

Kent 5-Star with Arms Conference Chair

WESKNT5CWA \$1675

Kent

Conference Chairs



Standard Includes

- Fully upholstered non-contrasting seat with back: fabric price group 01
- Five-star adjustable base: paint price group 01
- Hard casters: 6205 Black
- Requires assembly

Options

Color Scheme	Non Contrasting	No cost	
	Contrasting	+\$155	
Back Finish	Fabric Customer's Own Material	No cost	
	Fabric Price Group 01	No cost	
	Fabric Price Group 02	+\$9	
	Fabric Price Group 03	+\$26	
	Fabric Price Group 04	+\$60	
	Customer's Own Leather	+\$88	
	Fabric Price Group 05	+\$97	
	Fabric Price Group 06	+\$180	
	Fabric Price Group 07	+\$246	
	Fabric Price Group 08	+\$316	
	Fabric Price Group 09	+\$379	
Seat Finish	Leather Price Group 01	+\$420	
	Fabric Price Group 10	+\$446	
	Leather Price Group 02	+\$511	
	Seat Finish	Fabric Customer's Own Material	No cost
		Fabric Price Group 01	No cost
		Fabric Price Group 02	+\$9
		Fabric Price Group 03	+\$26
		Fabric Price Group 04	+\$60
		Customer's Own Leather	+\$88
		Fabric Price Group 05	+\$97
		Fabric Price Group 06	+\$180
Fabric Price Group 07		+\$246	
Fabric Price Group 08		+\$316	
Fabric Price Group 09		+\$379	
Base Finish	Leather Price Group 01	+\$420	
	Fabric Price Group 10	+\$446	
	Leather Price Group 02	+\$511	
	Base Finish	Paint Price Group 01	No cost
Paint Price Group 02		+\$41	
Paint Price Group 03		+\$80	
Polished Aluminum		+\$121	
Caster or Glide	Hard Casters	No cost	
	Soft Casters	+\$33	

Specification Information

Style Number Base Price

Kent 5-Star Armless Conference Chair

WESKNT5CNA \$1521

Kent

Conference Chairs



Standard Includes

- Fully upholstered non-contrasting seat with back: fabric price group 01
- Four-star base: paint price group 01
- Glides or hard casters: 6205 Black
- Requires assembly

Options

Color Scheme	Non Contrasting	No cost
	Contrasting	+\$155
Back	Low Back	No cost
	High Back	+\$352
Back Finish	Fabric Customer's Own Material	No cost
	Fabric Price Group 01	No cost
	Fabric Price Group 02	+\$20
	Fabric Price Group 03	+\$48
	Customer's Own Leather	+\$88
	Fabric Price Group 04	+\$109
	Fabric Price Group 05	+\$179
	Fabric Price Group 06	+\$331
	Fabric Price Group 07	+\$452
	Fabric Price Group 08	+\$582
	Leather Price Group 01	+\$628
Seat Finish	Fabric Price Group 09	+\$697
	Leather Price Group 02	+\$773
	Fabric Price Group 10	+\$818
	Fabric Customer's Own Material	No cost
	Fabric Price Group 01	No cost
	Fabric Price Group 02	+\$9
	Fabric Price Group 03	+\$26
	Fabric Price Group 04	+\$60
	Customer's Own Leather	+\$88
	Fabric Price Group 05	+\$97
	Fabric Price Group 06	+\$180
Fabric Price Group 07	+\$246	
Fabric Price Group 08	+\$316	
Fabric Price Group 09	+\$379	
Leather Price Group 01	+\$420	
Fabric Price Group 10	+\$446	
Leather Price Group 02	+\$511	
Base Finish	Paint Price Group 01	No cost
	Paint Price Group 02	+\$41
	Paint Price Group 03	+\$80
	Polished Aluminum	+\$121
Caster or Glide	Glides	No cost
	Hard Casters	No cost
	Soft Casters	+\$33

Specification Information

Style Number Base Price

Kent 4-Star with Arms Conference Chair

WESKNT4CWA \$1675

Kent

Conference Chairs



Standard Includes

- Fully upholstered non-contrasting seat with back: fabric price group 01
- Four-star base: paint price group 01
- Glides or hard casters: 6205 Black
- Requires assembly

Options

Color Scheme	Non Contrasting	No cost	
	Contrasting	+\$155	
Back Finish	Fabric Customer's Own Material	No cost	
	Fabric Price Group 01	No cost	
	Fabric Price Group 02	+\$9	
	Fabric Price Group 03	+\$26	
	Fabric Price Group 04	+\$60	
	Customer's Own Leather	+\$88	
	Fabric Price Group 05	+\$97	
	Fabric Price Group 06	+\$180	
	Fabric Price Group 07	+\$246	
	Fabric Price Group 08	+\$316	
	Fabric Price Group 09	+\$379	
Seat Finish	Leather Price Group 01	+\$420	
	Fabric Price Group 10	+\$446	
	Leather Price Group 02	+\$511	
	Seat Finish	Fabric Customer's Own Material	No cost
		Fabric Price Group 01	No cost
		Fabric Price Group 02	+\$9
		Fabric Price Group 03	+\$26
		Fabric Price Group 04	+\$60
		Customer's Own Leather	+\$88
		Fabric Price Group 05	+\$97
		Fabric Price Group 06	+\$180
Fabric Price Group 07		+\$246	
Fabric Price Group 08		+\$316	
Fabric Price Group 09		+\$379	
Base Finish	Leather Price Group 01	+\$420	
	Fabric Price Group 10	+\$446	
	Leather Price Group 02	+\$511	
	Base Finish	Paint Price Group 01	No cost
Paint Price Group 02		+\$41	
Paint Price Group 03		+\$80	
Polished Aluminum		+\$121	
Caster or Glide	Glides	No cost	
	Hard Casters	No cost	
	Soft Casters	+\$33	

Specification Information

Style Number Base Price

Kent 4-Star Armless Conference Chair

WESKNT4CNA \$1521

Kent

Guest Chairs



Standard Includes

- Fully upholstered non-contrasting seat with back: fabric price group 01
- Legs (base): paint price group 01
- Glides: plastic

Options

Color Scheme	Non Contrasting	No cost	
	Contrasting	+\$155	
Back	Low Back	No cost	
	High Back	+\$214	
Back Finish	Fabric Customer's Own Material	No cost	
	Fabric Price Group 01	No cost	
	Fabric Price Group 02	+\$20	
	Fabric Price Group 03	+\$48	
	Customer's Own Leather	+\$88	
	Fabric Price Group 04	+\$109	
	Fabric Price Group 05	+\$179	
	Fabric Price Group 06	+\$331	
	Fabric Price Group 07	+\$452	
	Fabric Price Group 08	+\$582	
	Leather Price Group 01	+\$628	
Seat Finish	Fabric Price Group 09	+\$697	
	Leather Price Group 02	+\$773	
	Fabric Price Group 10	+\$818	
	Seat Finish	Fabric Customer's Own Material	No cost
		Fabric Price Group 01	No cost
		Fabric Price Group 02	+\$9
		Fabric Price Group 03	+\$26
		Fabric Price Group 04	+\$60
		Customer's Own Leather	+\$88
		Fabric Price Group 05	+\$97
		Fabric Price Group 06	+\$180
Fabric Price Group 07		+\$246	
Fabric Price Group 08		+\$316	
Fabric Price Group 09		+\$379	
Base Finish	Leather Price Group 01	+\$420	
	Fabric Price Group 10	+\$446	
	Leather Price Group 02	+\$511	
	Paint Price Group 01	No cost	
Base Finish	Paint Price Group 02	+\$41	
	Paint Price Group 03	+\$80	
	Polished Chrome	+\$121	

Specification Information

Style Number Base Price

Kent 4-Leg with Arms Guest Chair

WESKNT4LWA \$1442

Kent

Guest Chairs



Standard Includes

- Fully upholstered non-contrasting seat with back: fabric price group 01
- Legs (base): paint price group 01
- Glides: plastic

Options

Color Scheme	Non Contrasting	No cost	
	Contrasting	+\$155	
Back Finish	Fabric Customer's Own Material	No cost	
	Fabric Price Group 01	No cost	
	Fabric Price Group 02	+\$9	
	Fabric Price Group 03	+\$26	
	Fabric Price Group 04	+\$60	
	Customer's Own Leather	+\$88	
	Fabric Price Group 05	+\$97	
	Fabric Price Group 06	+\$180	
	Fabric Price Group 07	+\$246	
	Fabric Price Group 08	+\$316	
	Fabric Price Group 09	+\$379	
Seat Finish	Leather Price Group 01	+\$420	
	Fabric Price Group 10	+\$446	
	Leather Price Group 02	+\$511	
	Seat Finish	Fabric Customer's Own Material	No cost
		Fabric Price Group 01	No cost
		Fabric Price Group 02	+\$9
		Fabric Price Group 03	+\$26
		Fabric Price Group 04	+\$60
		Customer's Own Leather	+\$88
		Fabric Price Group 05	+\$97
		Fabric Price Group 06	+\$180
Fabric Price Group 07		+\$246	
Fabric Price Group 08		+\$316	
Fabric Price Group 09		+\$379	
Base Finish	Leather Price Group 01	+\$420	
	Fabric Price Group 10	+\$446	
	Leather Price Group 02	+\$511	
	Paint Price Group 01	No cost	
Base Finish	Paint Price Group 02	+\$41	
	Paint Price Group 03	+\$80	
	Polished Chrome	+\$121	

Specification Information

Style Number Base Price

Kent 4-Leg Armless Guest Chair

WESKNT4LNA \$1286

Kent

Stools

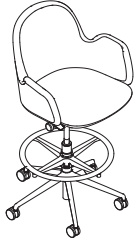

Standard Includes

- Fully upholstered non-contrasting seat with back: fabric price group 01
- Five-star adjustable base with stool ring: paint price group 01
- Hard casters: 6205 Black
- Requires assembly

Options

Color Scheme	Non Contrasting	No cost
	Contrasting	+\$155
Back Finish	Fabric Customer's Own Material	No cost
	Fabric Price Group 01	No cost
	Fabric Price Group 02	+\$19
	Fabric Price Group 03	+\$45
	Customer's Own Leather	+\$88
	Fabric Price Group 04	+\$100
	Fabric Price Group 05	+\$162
	Fabric Price Group 06	+\$301
	Fabric Price Group 07	+\$412
	Fabric Price Group 08	+\$529
	Leather Price Group 01	+\$628
Seat Finish	Fabric Price Group 09	+\$633
	Fabric Price Group 10	+\$742
	Leather Price Group 02	+\$773
	Fabric Customer's Own Material	No cost
	Fabric Price Group 01	No cost
	Fabric Price Group 02	+\$9
	Fabric Price Group 03	+\$26
	Fabric Price Group 04	+\$60
	Customer's Own Leather	+\$88
	Fabric Price Group 05	+\$97
	Fabric Price Group 06	+\$180
Base Finish	Fabric Price Group 07	+\$246
	Fabric Price Group 08	+\$316
	Fabric Price Group 09	+\$379
	Leather Price Group 01	+\$420
	Fabric Price Group 10	+\$446
	Leather Price Group 02	+\$511
	Paint Price Group 01	No cost
	Paint Price Group 02	+\$41
	Paint Price Group 03	+\$80
	Polished Aluminum	+\$121
	Caster or Glide	Hard Casters
Soft Casters		+\$33

Specification Information

Style Number Base Price

Kent 5-Star with Arms Conference Stool

WESKNT5SWA \$2179

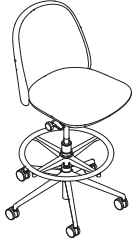
**Standard Includes**

- Fully upholstered non-contrasting seat with back: fabric price group 01
- Five-star adjustable base with stool ring: paint price group 01
- Hard casters: 6205 Black
- Requires assembly

Options

Color Scheme	Non Contrasting	No cost	
	Contrasting	+\$155	
Back Finish	Fabric Customer's Own Material	No cost	
	Fabric Price Group 01	No cost	
	Fabric Price Group 02	+\$9	
	Fabric Price Group 03	+\$26	
	Fabric Price Group 04	+\$60	
	Customer's Own Leather	+\$88	
	Fabric Price Group 05	+\$97	
	Fabric Price Group 06	+\$180	
	Fabric Price Group 07	+\$246	
	Fabric Price Group 08	+\$316	
	Fabric Price Group 09	+\$379	
Seat Finish	Leather Price Group 01	+\$420	
	Fabric Price Group 10	+\$446	
	Leather Price Group 02	+\$511	
	Seat Finish	Fabric Customer's Own Material	No cost
		Fabric Price Group 01	No cost
		Fabric Price Group 02	+\$9
		Fabric Price Group 03	+\$26
		Fabric Price Group 04	+\$60
		Customer's Own Leather	+\$88
		Fabric Price Group 05	+\$97
		Fabric Price Group 06	+\$180
Fabric Price Group 07		+\$246	
Fabric Price Group 08		+\$316	
Fabric Price Group 09		+\$379	
Base Finish	Leather Price Group 01	+\$420	
	Fabric Price Group 10	+\$446	
	Leather Price Group 02	+\$511	
	Base Finish	Paint Price Group 01	No cost
Paint Price Group 02		+\$41	
Paint Price Group 03		+\$80	
Polished Aluminum		+\$121	
Caster or Glide	Hard Casters	No cost	
	Soft Casters	+\$33	

Specification Information

Style Number	Base Price
Kent 5-Star Armless Conference Stool	
WESKNT5SNA	\$2022

Kent 5-Star Armless Conference Stool

WESKNT5SNA	\$2022
-------------------	--------

Lucas

Guest Chairs

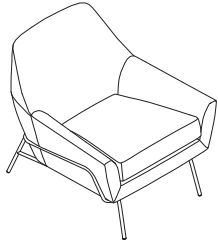

Standard Includes

- Fully upholstered seat with back: fabric price group 01
- Wire frame base: WE05 West Elm Burnished Bronze

Options

Upholstery Finish		
	Fabric Customer's Own Material	No cost
	Fabric Price Group 01	No cost
	Vinyl Price Group 02	No cost
	Fabric Price Group 02	+\$62
	Fabric Price Group 03	+\$146
	Customer's Own Leather	+\$180
	Fabric Price Group 04	+\$294
	Fabric Price Group 05	+\$421
	Fabric Price Group 06	+\$691
	Fabric Price Group 07	+\$819
	Fabric Price Group 08	+\$1131
	Fabric Price Group 09	+\$1343
	Fabric Price Group 10	+\$1530
	Leather Price Group 01	+\$2055
	Leather Price Group 02	+\$2400

Specification Information

Style Number Base Price

Lucas Wire Chair

WESLUCW \$2648

Lucas
Guest Chairs

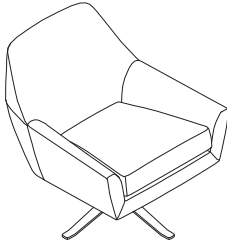

Standard Includes

- Fully upholstered seat with back: fabric price group 01
- Swivel base: 8046 Polished Aluminum

Options

Upholstery Finish		
	Fabric Customer's Own Material	No cost
	Fabric Price Group 01	No cost
	Vinyl Price Group 02	No cost
	Fabric Price Group 02	+\$62
	Fabric Price Group 03	+\$146
	Customer's Own Leather	+\$180
	Fabric Price Group 04	+\$294
	Fabric Price Group 05	+\$421
	Fabric Price Group 06	+\$691
	Fabric Price Group 07	+\$819
	Fabric Price Group 08	+\$1131
	Fabric Price Group 09	+\$1343
	Fabric Price Group 10	+\$1530
	Leather Price Group 01	+\$2055
	Leather Price Group 02	+\$2400

Specification Information

Style Number Base Price

Lucas Swivel Chair

WESLUCS \$2849

Fulton Seating

Guest Chair

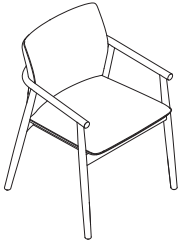

Standard Includes

- Fully upholstered non-contrasting seat with back: fabric price group 01
- Glides

Options

Upholstery	Finish Fabric Customer's Own Material	No cost
	Fabric Price Group 01	No cost
	Vinyl Price Group 02	+\$18
	Fabric Price Group 02	+\$18
	Fabric Price Group 03	+\$60
	Customer's Own Leather	+\$100
	Fabric Price Group 04	+\$127
	Fabric Price Group 05	+\$238
	Fabric Price Group 06	+\$308
	Fabric Price Group 07	+\$397
	Fabric Price Group 08	+\$477
	Fabric Price Group 09	+\$546
	Fabric Price Group 10	+\$636
	Leather Price Group 01	+\$1074
Leather Price Group 02	+\$1319	
Frame Finish	Veneer Custom Stain	No cost
	Veneer Price Group 01	No cost
	Veneer Price Group 02	+\$59
Color Cord	Non Contrasting	No cost
	Contrasting	+\$30
Cord Finish	Fabric Customer's Own Material	No cost
	Fabric Price Group 01	No cost
	Vinyl Price Group 02	+\$5
	Fabric Price Group 02	+\$5
	Fabric Price Group 03	+\$15
	Customer's Own Leather	+\$15
	Fabric Price Group 04	+\$32
	Fabric Price Group 05	+\$60
	Fabric Price Group 06	+\$77
	Fabric Price Group 07	+\$99
	Fabric Price Group 08	+\$119
	Fabric Price Group 09	+\$137
	Fabric Price Group 10	+\$159
	Leather Price Group 01	+\$269
Leather Price Group 02	+\$330	

Specification Information

Style Number Base Price

Fulton Guest Chair

WESFTNCG \$1841

Fulton Seating

Lounge Chair

Fulton

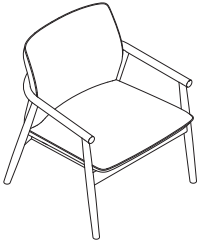

Standard Includes

- Fully upholstered non-contrasting seat with back: fabric price group 01
- Glides

Options

Upholstery	Finish Fabric Customer's Own Material	No cost
	Fabric Price Group 01	No cost
	Vinyl Price Group 02	+\$24
	Fabric Price Group 02	+\$24
	Fabric Price Group 03	+\$80
	Customer's Own Leather	+\$100
	Fabric Price Group 04	+\$169
	Fabric Price Group 05	+\$317
	Fabric Price Group 06	+\$411
	Fabric Price Group 07	+\$529
	Fabric Price Group 08	+\$636
	Fabric Price Group 09	+\$728
	Fabric Price Group 10	+\$848
Leather Price Group 01	+\$1432	
Leather Price Group 02	+\$1759	
Frame Finish	Veneer Custom Stain	No cost
	Veneer Price Group 01	No cost
	Veneer Price Group 02	+\$59
Color Cord	Non Contrasting	No cost
	Contrasting	+\$30
Cord Finish	Fabric Customer's Own Material	No cost
	Fabric Price Group 01	No cost
	Vinyl Price Group 02	+\$6
	Fabric Price Group 02	+\$6
	Fabric Price Group 03	+\$20
	Customer's Own Leather	+\$20
	Fabric Price Group 04	+\$42
	Fabric Price Group 05	+\$79
	Fabric Price Group 06	+\$103
	Fabric Price Group 07	+\$132
	Fabric Price Group 08	+\$159
	Fabric Price Group 09	+\$182
	Fabric Price Group 10	+\$212
Leather Price Group 01	+\$358	
Leather Price Group 02	+\$440	

Specification Information

Style Number	Base Price
--------------	------------

Fulton Lounge Chair

WESFTNCL	\$2631
-----------------	--------

Fulton Seating

Bench

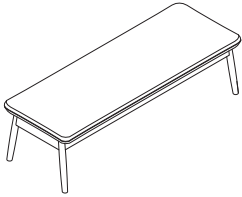

Standard Includes

- Fully upholstered non-contrasting seat: fabric price group 01
- Glides

Options

Upholstery	Finish Fabric Customer's Own Material	No cost
	Fabric Price Group 01	No cost
	Vinyl Price Group 02	+\$24
	Fabric Price Group 02	+\$24
	Fabric Price Group 03	+\$80
	Customer's Own Leather	+\$100
	Fabric Price Group 04	+\$169
	Fabric Price Group 05	+\$317
	Fabric Price Group 06	+\$411
	Fabric Price Group 07	+\$529
	Fabric Price Group 08	+\$636
	Fabric Price Group 09	+\$728
	Fabric Price Group 10	+\$848
	Leather Price Group 01	+\$1432
Leather Price Group 02	+\$1759	
Frame Finish	Veneer Custom Stain	No cost
	Veneer Price Group 01	No cost
	Veneer Price Group 02	+\$59
Color Cord	Non Contrasting	No cost
	Contrasting	+\$30
Cord Finish	Fabric Customer's Own Material	No cost
	Fabric Price Group 01	No cost
	Vinyl Price Group 02	+\$6
	Fabric Price Group 02	+\$6
	Fabric Price Group 03	+\$20
	Customer's Own Leather	+\$20
	Fabric Price Group 04	+\$42
	Fabric Price Group 05	+\$79
	Fabric Price Group 06	+\$103
	Fabric Price Group 07	+\$132
	Fabric Price Group 08	+\$159
	Fabric Price Group 09	+\$182
	Fabric Price Group 10	+\$212
	Leather Price Group 01	+\$358
Leather Price Group 02	+\$440	

Specification Information

Style Number	Base Price
--------------	------------

Fulton Bench

WESFTBNH	\$2104
-----------------	--------

Fulton Seating

Bench

Fulton

Greenpoint Private Office

Desks and Returns

X 10/24

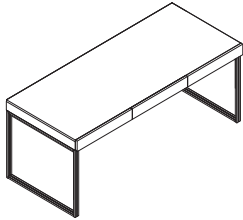

Standard Includes

- Desk worksurface: High-Pressure Laminate price group 01
- Square tube legs (frame): paint price group 01
- Three full depth drawers
- 1 1/2" leveling glides

Options

Depth	30"	Prices below
	36"	Prices below
Width	72"	Prices below
Top Surface Finish	Laminate HPL Price Group 01	Prices below
	Laminate HPL Price Group 02	Prices below
	Veneer Price Group 01	Prices below
	West Elm Veneer	Prices below
Cutout Type	No Cutout	No cost
	Cutout Center	+\$69
	Cutout Left	+\$69
	Cutout Right	+\$69
Frame Finish	Paint Price Group 01	No cost
	Paint Price Group 02	30"D: +\$41 36"D: +\$48
	Paint Price Group 03	30"D: +\$83 36"D: +\$97

Specification Information

Style Number	Dimensions		Base Prices
	Depth	Width	Width
		72"	

Greenpoint Executive Desk **X 10/24**

Laminate HPL Price Group 01		
WESINDED	30"	\$3619
	36"	\$3716
Laminate HPL Price Group 02		
WESINDED	30"	\$4507
	36"	\$4645
West Elm Veneer		
WESINDED	30"	\$4854
	36"	\$4962
Veneer Price Group 01		
WESINDED	30"	\$7841
	36"	\$7970

X 10/24 = Last order entry
October 20, 2024

Greenpoint Private Office

Desks and Returns

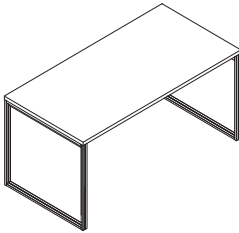

Tip: Edge will be matching veneer flat profile on side and back edges when wood top surface is selected, or 3 mm plastic edge when laminate top surface is selected.

Standard Includes

- Desk worksurface: High-Pressure Laminate price group 01
- Square tube legs (frame): paint price group 01
- 1 1/2" leveling glides

Options

Depth	30"	Prices below
	36"	Prices below
Width	60"	Prices below
	66"	Prices below
	72"	Prices below
Top Surface Finish	Laminate HPL Price Group 01	Prices below
	Laminate HPL Price Group 02	Prices below
	Veneer Price Group 01	Prices below
	West Elm Veneer	Prices below
Cutout Type	No Cutout	No cost
	Cutout Center	+\$69
	Cutout Left	+\$69
	Cutout Right	+\$69
	Frame Finish	Paint Price Group 01
	Paint Price Group 02	30"D: +\$41 36"D: +\$48
	Paint Price Group 03	30"D: +\$83 36"D: +\$97

Specification Information

Style Number	Dimensions		Base Prices		
	Depth	Width	60"	66"	72"

Greenpoint Private Desk

Laminate HPL Price Group 01					
WESINDPD	30"	\$2141	\$2202	\$2265	
	36"	N.A.	N.A.	\$2388	
Laminate HPL Price Group 02					
WESINDPD	30"	\$2299	\$2362	\$2422	
	36"	N.A.	N.A.	\$2546	
West Elm Veneer					
WESINDPD	30"	\$2553	\$2615	\$2677	
	36"	N.A.	N.A.	\$2799	
Veneer Price Group 01					
WESINDPD	30"	\$2950	\$3047	\$3141	
	36"	N.A.	N.A.	\$3333	

Greenpoint Private Office

Greenpoint Private Office

Desks and Returns

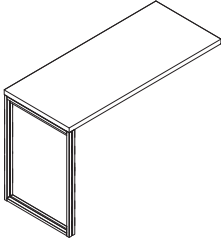

Tip: Edge will be matching veneer flat profile on side and back edges when wood top surface is selected, or 3 mm plastic edge when laminate top surface is selected.

Standard Includes

- Desk worksurface: High-Pressure Laminate price group 01
- Square tube legs (frame): paint price group 01
- 1 1/2" leveling glides

Options

Depth	18"	Prices below
	24"	Prices below
Width	42"	Prices below
	48"	Prices below
	54"	Prices below
	60"	Prices below
Top Surface Finish	Laminate HPL Price Group 01	Prices below
	Laminate HPL Price Group 02	Prices below
	Veneer Price Group 01	Prices below
	West Elm Veneer	Prices below
Frame Finish	Paint Price Group 01	No cost
	Paint Price Group 02	18"D: +\$15 24"D: +\$19
	Paint Price Group 03	18"D: +\$27 24"D: +\$34

Specification Information

Style Number	Dimensions		Prices			
	Depth	Width	42"	48"	54"	60"

Greenpoint Desk Return with Leg

Laminate HPL Price Group 01

WESINDRL	Depth	42"	48"	54"	60"
	18"	\$1111	\$1172	\$1235	\$1297
	24"	\$1183	\$1243	\$1304	\$1366

Laminate HPL Price Group 02

WESINDRL	Depth	42"	48"	54"	60"
	18"	\$1229	\$1291	\$1351	\$1415
	24"	\$1297	\$1358	\$1423	\$1483

West Elm Veneer

WESINDRL	Depth	42"	48"	54"	60"
	18"	\$1372	\$1434	\$1495	\$1557
	24"	\$1440	\$1500	\$1564	\$1624

Veneer Price Group 01

WESINDRL	Depth	42"	48"	54"	60"
	18"	\$1531	\$1592	\$1695	\$1755
	24"	\$1640	\$1701	\$1811	\$1872

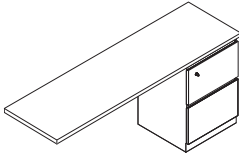
Greenpoint Private Office**Desks and Returns****Standard Includes**

- Desk worksurface: High-Pressure Laminate price group 01
- Under worksurface file/file pedestal case: paint price group 01
- Under worksurface file/file pedestal front: High-Pressure Laminate price group 01
- Lock on pedestal
- 1 1/2" leveling glides

Options

Depth	18"	Prices below
	24"	Prices below
Width	42"	Prices below
	48"	Prices below
	54"	Prices below
	60"	Prices below
Top Surface Finish	Laminate HPL Price Group 01	Prices below
	Laminate HPL Price Group 02	Prices below
	Veneer Price Group 01	Prices below
	West Elm Veneer	Prices below
Case Finish	Paint Price Group 01	No cost
	Paint Price Group 03	+\$41
	Paint Price Group 02	+\$75
Front	Natural Veneer	No cost
	Solid HPL	No cost
	West Elm Open Pore	No cost
	Woodgrain HPL	No cost
	Woodgrain HPL Price Grade 02	No cost
Lock Option	Standard Key Plug	No cost
	Standard Key Random	► See Lock and Keying
Lock Finish	Ember Chrome	No cost
	Polished Chrome	No cost
Drawer Configuration	File/File	No cost
	Box/Box/File	+\$160
Drawer Interior	Basic Drawer	No cost
	Full Drawer	+\$69
Drawer Accessories	No Rail	No cost
	With Rail	No cost

► **Product Information continued on next page**

Tip: Edge will be matching veneer flat profile on side and back edges when wood top surface is selected, or 3 mm plastic edge when laminate top surface is selected.

Tip: When specified in High-Pressure Laminate, the pull of the drawer will be painted according to the matrix in the Surface Materials section.

Tip: Drawer fronts on pedestal are available in limited High-Pressure Laminate and veneer finishes. See Surface Materials section for more information.

Greenpoint Private Office

Desks and Returns

► **Product Information continued from previous page**

Specification Information

Style Number	Dimensions Depth	Base Prices			
		Width			
		42"	48"	54"	60"

Greenpoint Desk Return with Pedestal

Laminate HPL Price Group 01

WESINDRP	18"	\$1960	\$2021	\$2084	\$2146
	24"	\$2037	\$2097	\$2159	\$2222

Laminate HPL Price Group 02

WESINDRP	18"	\$2078	\$2140	\$2200	\$2264
	24"	\$2153	\$2215	\$2277	\$2338

West Elm Veneer

WESINDRP	18"	\$2221	\$2283	\$2344	\$2406
	24"	\$2296	\$2357	\$2419	\$2480

Veneer Price Group 01

WESINDRP	18"	\$2419	\$2480	\$2582	\$2646
	24"	\$2536	\$2599	\$2707	\$2769

Greenpoint Private Office

Modesty Panels

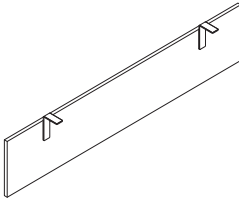

Tip: A modesty panel is available and ordered separately, in widths from 48" to 78". They can be specified in either wood veneer or High-Pressure Laminate. Modesty panels are specified one size smaller than the desk to allow for 3" clearance on both ends to accommodate the legs. Modesty panel can be mounted flush or inset with the edge of the worksurface. Modesty panel allows for 1" cord gap between the surface.

Standard Includes

- Modesty panel: High-Pressure Laminate price group 01
- Mounting brackets: black paint

Options

Width	48"	Prices below
	54"	Prices below
	60"	Prices below
	66"	Prices below
	72"	Prices below
	78"	Prices below
Modesty Panel Finish	Laminate HPL Price Group 01	Prices below
	Laminate HPL Price Group 02	Prices below
	Veneer Price Group 01	Prices below
	West Elm Veneer	Prices below

Specification Information

Style Number	Dimensions Height	Base Prices					
		Width					
		48"	54"	60"	66"	72"	78"

Greenpoint Modesty Panel

Laminate HPL Price Group 01

WESINDMP	12 1/2"	\$449	\$476	\$504	\$532	\$558	\$586
-----------------	---------	-------	-------	-------	-------	-------	-------

Laminate HPL Price Group 02

WESINDMP	12 1/2"	\$537	\$567	\$593	\$621	\$648	\$676
-----------------	---------	-------	-------	-------	-------	-------	-------

West Elm Veneer

WESINDMP	12 1/2"	\$688	\$715	\$742	\$772	\$798	\$826
-----------------	---------	-------	-------	-------	-------	-------	-------

Veneer Price Group 01

WESINDMP	12 1/2"	\$791	\$819	\$861	\$887	\$996	\$1025
-----------------	---------	-------	-------	-------	-------	-------	--------

Greenpoint Private Office

Credenzas

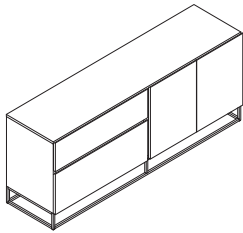

Tip: When specified in High-Pressure Laminate, the pull of the drawer will be painted according to the matrix in the Surface Materials section.

Standard Includes

- Credenza: High-Pressure Laminate price group 01
- Square tube legs (frame): paint price group 01
- 1 1/2" leveling glides

Options

Case Finish	Laminate HPL Price Group 01	No cost
	Laminate HPL Price Group 02	+\$897
	West Elm Veneer Veneer Price Group 01	+\$1322 +\$5818
Frame Finish	Paint Price Group 01	No cost
	Paint Price Group 02	+\$41
	Paint Price Group 03	+\$72

Specification Information

Style Number Base Price

Greenpoint Filing Credenza

WESINDFC \$5207

Greenpoint Private Office

Credenzas

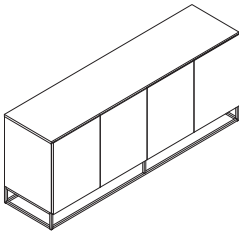

Tip: When specified in High-Pressure Laminate, the pull of the drawer will be painted according to the matrix in the Surface Materials section.

Standard Includes

- Credenza: High-Pressure Laminate price group 01
- Square tube legs (frame): paint price group 01
- 1 1/2" leveling glides

Options

Case Finish	Laminate HPL Price Group 01	No cost
	Laminate HPL Price Group 02	+\$1026
	West Elm Veneer Veneer Price Group 01	+\$1316 +\$5661
Frame Finish	Paint Price Group 01	No cost
	Paint Price Group 02	+\$41
	Paint Price Group 03	+\$72

Specification Information

Style Number Base Price

Greenpoint Storage Credenza

WESINDSC \$4531

Greenpoint Private Office

Wood Lateral File

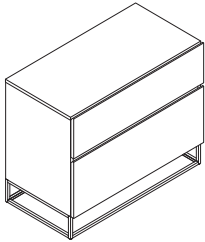

Tip: When specified in High-Pressure Laminate, the pull of the drawer will be painted according to the matrix in the Surface Materials section.

Standard Includes

- Lateral file: High-Pressure Laminate price group 01
- Square tube legs (frame): paint price group 01
- 1 1/2" leveling glides

Options

Case Finish	Laminate HPL Price Group 01	No cost
	Laminate HPL Price Group 02	+\$495
	West Elm Veneer Veneer Price Group 01	+\$828 +\$3069
Frame Finish	Paint Price Group 01	No cost
	Paint Price Group 02	+\$22
	Paint Price Group 03	+\$34

Specification Information

Style Number Base Price

Greenpoint Lateral File

WESINDLF \$3481

Greenpoint Private Office

Bookcases

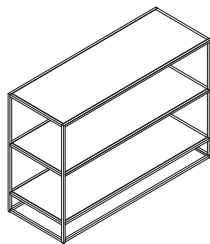

Standard Includes

- Bookcase shelf: High-Pressure Laminate price group 01
- Square tube legs (frame): paint price group 01
- 1 1/2" leveling glides

Options

Shelf Finish	Laminate HPL Price Group 01	No cost
	Laminate HPL Price Group 02	+\$207
	West Elm Veneer	+\$207
	Veneer Price Group 01	+\$700
Frame Finish	Paint Price Group 01	No cost
	Paint Price Group 02	+\$41
	Paint Price Group 03	+\$83

Specification Information

Style Number	Base Price
--------------	------------

Greenpoint Low Bookcase - Open

WESINDLOB	\$2499
------------------	--------

Greenpoint Private Office

Greenpoint Private Office

Bookcases

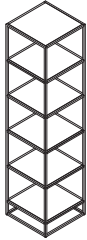

Standard Includes

- Bookcase shelf: High-Pressure Laminate price group 01
- Square tube legs (frame): paint price group 01
- 1 1/2" leveling glides

Options

Shelf Finish	Laminate HPL Price Group 01	No cost
	West Elm Veneer	+\$206
	Laminate HPL Price Group 02	+\$207
Frame Finish	Veneer Price Group 01	+\$420
	Paint Price Group 01	No cost
	Paint Price Group 02	+\$36
	Paint Price Group 03	+\$72

Specification Information

Style Number Base Price

Greenpoint Narrow Bookcase - Open

WESINDNOB \$2770

Greenpoint Private Office

Bookcases

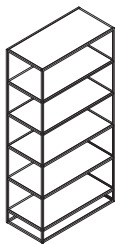

Standard Includes

- Bookcase shelf: High-Pressure Laminate price group 01
- Square tube legs (frame): paint price group 01
- 1 1/2" leveling glides

Options

Shelf Finish	Laminate HPL Price Group 01	No cost
	West Elm Veneer	+\$239
	Laminate HPL Price Group 02	+\$240
Frame Finish	Veneer Price Group 01	+\$1453
	Paint Price Group 01	No cost
	Paint Price Group 02	+\$65
	Paint Price Group 03	+\$138

Specification Information

Style Number Base Price

Greenpoint Tall Bookcase - Open

WESINDOB \$3464

Greenpoint Private Office

Greenpoint Private Office

Bookcases

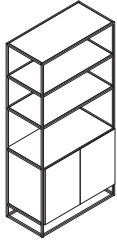

Standard Includes

- Bookcase shelf: High-Pressure Laminate price group 01
- Square tube legs (frame): paint price group 01
- 1 1/2" leveling glides

Options

Shelf Finish	Laminate HPL Price Group 01	No cost
	West Elm Veneer	+\$342
	Laminate HPL Price Group 02	+\$344
	Veneer Price Group 01	+\$2776
Frame Finish	Paint Price Group 01	No cost
	Paint Price Group 02	+\$65
	Paint Price Group 03	+\$138

Specification Information

Style Number Base Price

Greenpoint Storage Bookcase

WESINDSB \$4713

Greenpoint Private Office

Lateral Files

X 10/24

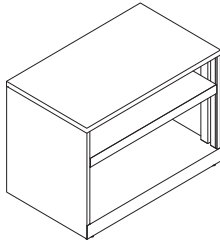

Tip: The shelf is affixed with screws. The screws can be removed to adjust the clips/shelf to a different height.

Standard Includes

- Lateral file: paint price group 01
- 1 1/2" leveling glides

Options

Depth	18"	Prices below
Width	30"	Prices below
	36"	Prices below
Case Finish	Paint Price Group 01	No cost
	Paint Price Group 02	+\$24
	Paint Price Group 03	+\$41

Specification Information

Dimensions			Style Number	Base Prices
D	W	H		

Greenpoint 1.5-High Lateral File - Open/Open **X 10/24**

18"	30"	22 11/32"	WESINDLFM1A	\$678
18"	36"	22 11/32"	WESINDLFM1A	\$818

Greenpoint Private Office

X 10/24 = Last order entry
October 20, 2024

Greenpoint Private Office

Lateral Files

X 10/24

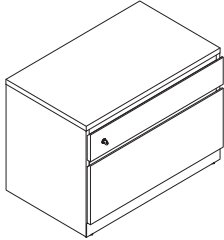

Tip: Drawer fronts on pedestal are available in limited High-Pressure Laminate and veneer finishes. See Surface Materials section for more information.

Tip: When specified in High-Pressure Laminate, the pull of the drawer will be painted according to the matrix in the Surface Materials section.

Tip: Counterweight packages are required to ensure product stability and are ordered as an option or separately.

Standard Includes

- Lateral file: paint price group 01
- Drawer/drawer configuration with hanging folder bar
- Lock
- 1 1/2" leveling glides

Options

Depth	18"	Prices below
Width	30"	Prices below
	36"	Prices below
Case Finish	Paint Price Group 01	No cost
	Paint Price Group 02	+\$24
	Paint Price Group 03	+\$41
Front	Natural Veneer	Prices below
	Solid HPL	Prices below
	West Elm Open Pore	Prices below
	Woodgrain HPL	Prices below
	Woodgrain HPL Price Grade 02	Prices below
Lock Option	Standard Key Plug	No cost
	Standard Key Random	► See Lock and Keying
Lock Finish	Ember Chrome	No cost
	Polished Chrome	No cost
Drawer Interior	Hanging Folder	No cost
	Divider Package	+\$34
	Rail	+\$50
Counterweight	No Counterweight	No cost
	With Counterweight	Prices below

Specification Information

Dimensions	Style Number	Base Prices	Options (Add \$ to Base Price)
D W H			Counterweight Package

Greenpoint 1.5-High Lateral File - Drawer/Drawer **X 10/24**

Solid HPL or Woodgrain HPL

18" 30" 22 11/32" **WESINDLFM1B** \$2191 +\$199

18" 36" 22 11/32" **WESINDLFM1B** \$2335 +\$142

Woodgrain HPL Price Grade 02

18" 30" 22 11/32" **WESINDLFM1B** \$2232 +\$199

18" 36" 22 11/32" **WESINDLFM1B** \$2377 +\$142

West Elm Open Pore

18" 30" 22 11/32" **WESINDLFM1B** \$2397 +\$199

18" 36" 22 11/32" **WESINDLFM1B** \$2540 +\$142

Natural Veneer

18" 30" 22 11/32" **WESINDLFM1B** \$2438 +\$199

18" 36" 22 11/32" **WESINDLFM1B** \$2580 +\$142

X 10/24 = Last order entry
October 20, 2024

Greenpoint Private Office

Lateral Files

X 10/24

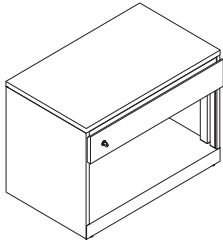

Tip: When specified in High-Pressure Laminate, the pull of the drawer will be painted according to the matrix in the Surface Materials section.

Tip: Drawer fronts on pedestal are available in limited High-Pressure Laminate and veneer finishes. See Surface Materials section for more information.

Tip: Counterweight packages are required to ensure product stability and are ordered as an option or separately.

Standard Includes

- Lateral file: paint price group 01
- Drawer/open configuration
- Lock
- 1 1/2" leveling glides

Options

Depth	18"	Prices below
Width	30"	Prices below
	36"	Prices below
Case Finish	Paint Price Group 01	No cost
	Paint Price Group 02	+\$24
	Paint Price Group 03	+\$41
Front	Natural Veneer	Prices below
	Solid HPL	Prices below
	West Elm Open Pore	Prices below
	Woodgrain HPL	Prices below
	Woodgrain HPL Price Grade 02	Prices below
Lock Option	Standard Key Plug	No cost
	Standard Key Random	► See Lock and Keying
Lock Finish	Ember Chrome	No cost
	Polished Chrome	No cost
Counterweight	No Counterweight	No cost
	With Counterweight	Prices below

Specification Information

Dimensions	Style Number	Base Prices	Options (Add \$ to Base Price)
D W H			Counterweight Package

Greenpoint 1.5-High Lateral File Drawer/Open **X 10/24**

Solid HPL or Woodgrain HPL

18" 30" 22 11/32"	WESINDLFM1C	\$1741	+\$108
18" 36" 22 11/32"	WESINDLFM1C	\$1873	+\$142

Woodgrain HPL Price Grade 02

18" 30" 22 11/32"	WESINDLFM1C	\$1762	+\$108
18" 36" 22 11/32"	WESINDLFM1C	\$1893	+\$142

West Elm Open Pore

18" 30" 22 11/32"	WESINDLFM1C	\$1878	+\$108
18" 36" 22 11/32"	WESINDLFM1C	\$2007	+\$142

Natural Veneer

18" 30" 22 11/32"	WESINDLFM1C	\$1899	+\$108
18" 36" 22 11/32"	WESINDLFM1C	\$2028	+\$142

X 10/24 = Last order entry
October 20, 2024

Greenpoint Private Office

Lateral Files

X 10/24

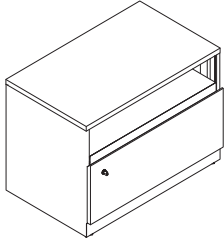

Tip: Drawer fronts on pedestal are available in limited High-Pressure Laminate and veneer finishes. See Surface Materials section for more information.

Tip: When specified in High-Pressure Laminate, the pull of the drawer will be painted according to the matrix in the Surface Materials section.

Tip: Counterweight packages are required to ensure product stability and are ordered as an option or separately.

Standard Includes

- Lateral file: paint price group 01
- Open/drawer configuration with hanging folder bar
- Lock
- 1 1/2" leveling glides

Options

Depth	18"	Prices below
Width	30"	Prices below
	36"	Prices below
Case Finish	Paint Price Group 01	No cost
	Paint Price Group 02	+\$24
	Paint Price Group 03	+\$41
Front	Natural Veneer	Prices below
	Solid HPL	Prices below
	West Elm Open Pore	Prices below
	Woodgrain HPL	Prices below
Lock Option	Standard Key Plug	No cost
	Standard Key Random	► See Lock and Keying
Lock Finish	Ember Chrome	No cost
	Polished Chrome	No cost
Drawer Interior	Hanging Folder	No cost
	Divider Package	+\$34
	Rail	+\$50
Counterweight	No Counterweight	No cost
	With Counterweight	Prices below

Specification Information

Dimensions	Style Number	Base Prices	Options (Add \$ to Base Price)
D W H			Counterweight Package

Greenpoint 1.5-High Lateral File - Open/Drawer **X 10/24**

Solid HPL or Woodgrain HPL

18" 30" 22 11/32" **WESINDLFM1D** \$1741 +\$199

18" 36" 22 11/32" **WESINDLFM1D** \$1873 +\$142

Woodgrain HPL Price Grade 02

18" 30" 22 11/32" **WESINDLFM1D** \$1762 +\$199

18" 36" 22 11/32" **WESINDLFM1D** \$1893 +\$142

West Elm Open Pore

18" 30" 22 11/32" **WESINDLFM1D** \$1878 +\$199

18" 36" 22 11/32" **WESINDLFM1D** \$2007 +\$142

Natural Veneer

18" 30" 22 11/32" **WESINDLFM1D** \$1899 +\$199

18" 36" 22 11/32" **WESINDLFM1D** \$2028 +\$142

X 10/24 = Last order entry
October 20, 2024

Greenpoint Private Office

Lateral Files

X 10/24

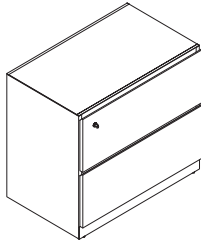

Tip: Drawer fronts on pedestal are available in limited High-Pressure Laminate and veneer finishes. See Surface Materials section for more information.

Tip: When specified in High-Pressure Laminate, the pull of the drawer will be painted according to the matrix in the Surface Materials section.

Standard Includes

- Two drawer lateral file: paint price group 01
- Hanging folder bar
- Lock
- 1 1/2" leveling glides

Options

Case Finish	Paint Price Group 01	No cost
	Paint Price Group 02	+\$24
	Paint Price Group 03	+\$41
Front	Natural Veneer	Prices below
	Solid HPL	Prices below
	West Elm Open Pore	Prices below
	Woodgrain HPL	Prices below
	Woodgrain HPL Price Grade 02	Prices below
Lock Finish	Ember Chrome	No cost
	Polished Chrome	No cost

Specification Information

Dimensions	Style Number	Base	Options
D W H		Prices	(Add \$ to Base Price) Counterweight Package

Greenpoint Two Drawer Lateral File **X 10/24**

Solid HPL or Woodgrain HPL

18" 30" 28 11/32"	WESINDLFM2	\$2199	+\$108
18" 36" 28 11/32"	WESINDLFM2	\$2343	+\$142
24" 30" 28 11/32"	WESINDLFM2	\$2511	+\$108
24" 36" 28 11/32"	WESINDLFM2	\$2687	+\$142

Woodgrain HPL Price Grade 02

18" 30" 28 11/32"	WESINDLFM2	\$2240	+\$108
18" 36" 28 11/32"	WESINDLFM2	\$2385	+\$142
24" 30" 28 11/32"	WESINDLFM2	\$2551	+\$108
24" 36" 28 11/32"	WESINDLFM2	\$2731	+\$142

West Elm Open Pore

18" 30" 28 11/32"	WESINDLFM2	\$2438	+\$108
18" 36" 28 11/32"	WESINDLFM2	\$2583	+\$142
24" 30" 28 11/32"	WESINDLFM2	\$2746	+\$108
24" 36" 28 11/32"	WESINDLFM2	\$2925	+\$142

Natural Veneer

18" 30" 28 11/32"	WESINDLFM2	\$2479	+\$108
18" 36" 28 11/32"	WESINDLFM2	\$2625	+\$142
24" 30" 28 11/32"	WESINDLFM2	\$2789	+\$108
24" 36" 28 11/32"	WESINDLFM2	\$2965	+\$142

X 10/24 = Last order entry
October 20, 2024

Greenpoint Private Office

Greenpoint Private Office

Metal Mobile Pedestal

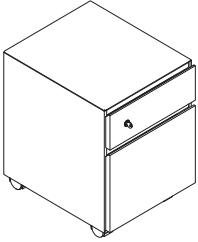

Tip: Drawer fronts on pedestal are available in limited High-Pressure Laminate and veneer finishes. See Surface Materials section for more information.

Tip: When specified in High-Pressure Laminate, the pull of the drawer will be painted according to the matrix in the Surface Materials section.

Standard Includes

- Mobile pedestal: paint price group 01, paint price group 01
- Box/file configuration with full drawer
- Lock
- Castors: black plastic

Options

Depth	18"	No cost
Width	15"	No cost
Case Finish	Paint Price Group 01	No cost
	Paint Price Group 02	+\$24
	Paint Price Group 03	+\$41
Front	Solid HPL	No cost
	Woodgrain HPL	No cost
	Woodgrain HPL Price Grade 02	+\$41
	West Elm Open Pore	+\$137
Lock Option	Standard Key Plug	No cost
	Standard Key Random	▶ See Lock and Keying
Lock Finish	Ember Chrome	No cost
	Polished Chrome	No cost
Drawer Interior	Full Drawer	No cost
	Basic Drawer	-\$70
Drawer Accessories	No Rail	No cost
	With Rail	No cost

Specification Information

Style Number Base Price

Greenpoint Mobile Pedestal - Box/File

WESINDMPM \$1227

Greenpoint Private Office

Basic Cushions Enhanced

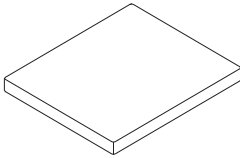

Tip: Basic cushion enhanced is field-installed and supplies to attach are included.

Tip: Basic cushion enhanced is constructed with a thin solid base.

Tip: For both cushion top and basic cushion enhanced: Fabric patterns with a linear design will always be applied from the front to back of the unit (depth of the unit).

Tip: For both cushion top and basic cushion enhanced: Pattern matching will not be done on COM.

Tip: Support Brace is for 30"W and 36" steel laterals with an open configuration.

Standard Includes

- Enhanced cushion top: fabric price group 01
- Attachment supplies: hook and loop fastener

Options

Upholstery	Fabric 2	No cost
	Group 01	No cost
	Group 02	+\$12
	Customer's Own Material (COM)	+\$23
	Group 03	+\$59
	Group 04	+\$73
	Group 05	+\$92
	Group 06	+\$129
	Group 07	+\$154
	Group 08	+\$223
Storage Bracing Options	Group 09	+\$286
	Group 10	+\$348
	Bracing for 30"W Storage	+\$77
	Bracing for 36"W Storage	+\$77

Specification Information

Dimensions			Style	Base
D	W	H	Number	Price

Basic Cushions Enhanced

17 1/2"	15"	1 1/2"	RCHE1715	\$275
18"	30"	1 1/2"	RCHE1830	\$374
18"	36"	1 1/2"	RCHE1836	\$397

Greenpoint Private Office

Accessories



Standard Includes

- Carton of six wire clips: black plastic only
- Foam tape
- Mounting screws

Specification Information

Style Number Price

Wire Clip, Package of 6

999CHT \$106



Standard Includes

- Grommet: paint or metal
- Installation instructions

Specification Information

Style Number Price

2 1/2" Round Grommet

AWAG2 \$100

Tip: Grommet AWAG2 is for use on worksurfaces only.

Greenpoint Private Office

Accessories

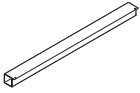

Standard Includes

- 25" wire manager with double-sided tape: black plastic
- Attachment hardware

Specification Information

Style Number Price

Wire Manager

AWVW \$22

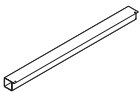

Standard Includes

- Wire manager: 6000 Black
- Attachment hardware

Specification Information

Dimensions Weight Style Number Prices
D W H

1 3/4"D Wire Managers

1 3/4"	12"	1 3/4"	0.24 lb	AWM12	\$46
1 3/4"	18"	1 3/4"	0.34 lb	AWM18	\$53
1 3/4"	23"	1 3/4"	0.44 lb	AWM23	\$60
1 3/4"	30"	1 3/4"	0.56 lb	AWM30	\$70
1 3/4"	35"	1 3/4"	0.65 lb	AWM35	\$77
1 3/4"	42"	1 3/4"	0.77 lb	AWM42	\$85

Tip: Actual width of **AWM23** is 23 1/4".

Greenpoint Private Office

Power Units

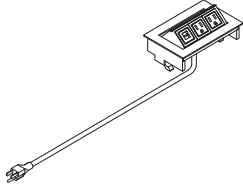

Tip: When using modular power under the worksurface specify 18"L cord length.

Standard Includes

- Power unit: paint price group 01, or paint price group 02
- 18" cord

Options

Power Configuration	3 Power	No cost
	2 Power 1 USB	+\$134
Power Finish	Paint Price Group 01	No cost
	Paint Price Group 02	No cost
Cord Length	18"	No cost
	108"	+\$12

Specification Information

Style Number Base Price

Greenpoint Power Unit

WESINDPWR \$401

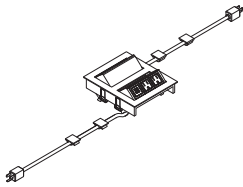

Standard Includes

- Power unit: paint price group 01, or paint price group 02
- 18" cord

Options

Power Finish	Paint Price Group 01	No cost
	Paint Price Group 02	No cost
Power Configuration	6 Power	No cost
	4 Power 2 USB	+\$268
Cord Length	18"	No cost
	108"	+\$26

Specification Information

Style Number Base Price

Greenpoint Power Unit for use with Continuous Top

WESINDPWRCT \$676

Greenpoint Private Office

Power Units

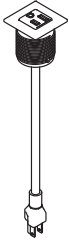

Standard Includes

- Power unit: plastic price group 01

Options

Power Finish	Plastic - PG1	No cost
Power Configuration	1 Power	No cost
	2 USB	+\$98

Specification Information

Style Number	Base Price
--------------	------------

Greenpoint Round/Square Power Unit

WESINDPWRFR \$129

Greenpoint Private Office

Greenpoint Bench

Worksurfaces and Returns

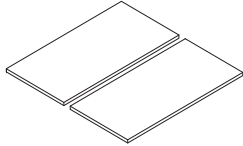

Tip: Edge will be matching veneer flat profile on side and back edges when wood top surface is selected, or 3 mm plastic edge when laminate top surface is selected.

Standard Includes

- Worksurface: High-Pressure Laminate price group 01 with 3 mm plastic edge

Options

Depth	24"	Prices below
	30"	Prices below
Width	48"	Prices below
	54"	Prices below
	60"	Prices below
	66"	Prices below
	72"	Prices below
	78"	Prices below
Top Surface Finish	Laminate HPL Price Group 01	Prices below
	Laminate HPL Price Group 02	Prices below
	Veneer Price Group 01	Prices below
	West Elm Veneer	Prices below
Cutout Type	Cutout Center	No cost
	No Cutout	No cost

Specification Information

Style Number	Dimensions Depth	Base Prices Width					
		48"	54"	60"	66"	72"	78"

Greenpoint Dual Sided Worksurface - Leg/Leg Application

Laminate HPL Price Group 01

WESINDWLLDS	Depth	48"	54"	60"	66"	72"	78"
	24"	\$1216	\$1338	\$1464	\$1588	\$1710	\$1840
	30"	\$1480	\$1602	\$1726	\$1850	\$1972	\$2098

Laminate HPL Price Group 02

WESINDWLLDS	Depth	48"	54"	60"	66"	72"	78"
	24"	\$1532	\$1658	\$1778	\$1904	\$2026	\$2150
	30"	\$1792	\$1920	\$2042	\$2166	\$2292	\$2412

West Elm Veneer

WESINDWLLDS	Depth	48"	54"	60"	66"	72"	78"
	24"	\$2040	\$2164	\$2288	\$2408	\$2532	\$2654
	30"	\$2300	\$2420	\$2546	\$2668	\$2792	\$2916

Veneer Price Group 01

WESINDWLLDS	Depth	48"	54"	60"	66"	72"	78"
	24"	\$2588	\$2766	\$2942	\$3122	\$3302	\$3482
	30"	\$2982	\$3162	\$3338	\$3522	\$3696	\$3874

Greenpoint Bench

Worksurfaces and Returns

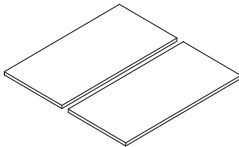

Tip: Edge will be matching veneer flat profile on side and back edges when wood top surface is selected, or 3 mm plastic edge when laminate top surface is selected.

Standard Includes

- Worksurface: High-Pressure Laminate price group 01 with 3 mm plastic edge

Options

Depth	24"	Prices below
	30"	Prices below
Width	48"	Prices below
	54"	Prices below
	60"	Prices below
	66"	Prices below
	72"	Prices below
	78"	Prices below
Top Surface Finish	Laminate HPL Price Group 01	Prices below
	Laminate HPL Price Group 02	Prices below
	Veneer Price Group 01	Prices below
	West Elm Veneer	Prices below
Cutout Type	Cutout Center	No cost
	No Cutout	No cost

Specification Information

Style Number	Dimensions Depth	Base Prices Width					
		48"	54"	60"	66"	72"	78"

Greenpoint Dual Sided Worksurface - Leg/Credenza Application

Laminate HPL Price Group 01

WESINDWLCDS	Depth	48"	54"	60"	66"	72"	78"
	24"	\$1284	\$1406	\$1532	\$1656	\$1778	\$1908
	30"	\$1548	\$1670	\$1794	\$1918	\$2040	\$2166

Laminate HPL Price Group 02

WESINDWLCDS	Depth	48"	54"	60"	66"	72"	78"
	24"	\$1600	\$1726	\$1846	\$1972	\$2094	\$2218
	30"	\$1860	\$1988	\$2110	\$2234	\$2360	\$2480

West Elm Veneer

WESINDWLCDS	Depth	48"	54"	60"	66"	72"	78"
	24"	\$2108	\$2232	\$2356	\$2476	\$2600	\$2722
	30"	\$2368	\$2488	\$2614	\$2736	\$2860	\$2984

Veneer Price Group 01

WESINDWLCDS	Depth	48"	54"	60"	66"	72"	78"
	24"	\$2656	\$2834	\$3010	\$3190	\$3370	\$3550
	30"	\$3050	\$3230	\$3406	\$3590	\$3764	\$3942

Greenpoint Bench

Worksurfaces and Returns

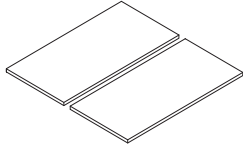

Tip: Edge will be matching veneer flat profile on side and back edges when wood top surface is selected, or 3 mm plastic edge when laminate top surface is selected.

Standard Includes

- Worksurface: High-Pressure Laminate price group 01 with 3 mm plastic edge

Options

Depth	24"	Prices below
	30"	Prices below
Width	48"	Prices below
	54"	Prices below
	60"	Prices below
	66"	Prices below
	72"	Prices below
Top Surface Finish	Laminate HPL Price Group 01	Prices below
	Laminate HPL Price Group 02	Prices below
	Veneer Price Group 01	Prices below
	West Elm Veneer	Prices below
Cutout Type	Cutout Center	No cost
	No Cutout	No cost

Specification Information

Style Number	Dimensions Depth	Base Prices Width				
		48"	54"	60"	66"	72"

Greenpoint Dual Sided Worksurface - Credenza/Credenza Application

Laminate HPL Price Group 01						
WESINDWCCDS	24"	\$1338	\$1460	\$1586	\$1710	\$1832
	30"	\$1602	\$1724	\$1848	\$1972	\$2094
Laminate HPL Price Group 02						
WESINDWCCDS	24"	\$1654	\$1780	\$1900	\$2026	\$2148
	30"	\$1914	\$2042	\$2164	\$2288	\$2414
West Elm Veneer						
WESINDWCCDS	24"	\$2162	\$2286	\$2410	\$2530	\$2654
	30"	\$2422	\$2542	\$2668	\$2790	\$2914
Veneer Price Group 01						
WESINDWCCDS	24"	\$2710	\$2888	\$3064	\$3244	\$3424
	30"	\$3104	\$3284	\$3460	\$3644	\$3818

Greenpoint Bench

Worksurfaces and Returns

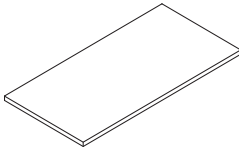

Tip: Edge will be matching veneer flat profile on side and back edges when wood top surface is selected, or 3 mm plastic edge when laminate top surface is selected.

Standard Includes

- Worksurface: High-Pressure Laminate price group 01 with 3 mm plastic edge

Options

Depth	24"	Prices below
	30"	Prices below
Width	42"	Prices below
	48"	Prices below
	54"	Prices below
	60"	Prices below
	66"	Prices below
	72"	Prices below
Top Surface Finish	Laminate HPL Price Group 01	Prices below
	Laminate HPL Price Group 02	Prices below
	Veneer Price Group 01	Prices below
	West Elm Veneer	Prices below
Cutout Type	Cutout Center	No cost
	No Cutout	No cost

Specification Information

Style Number	Dimensions Depth	Base Prices							
		Width							
		42"	48"	54"	60"	66"	72"	78"	

Greenpoint Single Sided Worksurface - Leg/Leg Application

Laminate HPL Price Group 01									
WESINDWLLSS	Depth	42"	48"	54"	60"	66"	72"	78"	
	24"	\$459	\$611	\$674	\$735	\$797	\$859	\$920	
	30"	\$680	\$740	\$803	\$864	\$926	\$991	\$1052	
Laminate HPL Price Group 02									
WESINDWLLSS	Depth	42"	48"	54"	60"	66"	72"	78"	
	24"	\$617	\$771	\$831	\$893	\$954	\$1018	\$1079	
	30"	\$837	\$900	\$963	\$1024	\$1085	\$1148	\$1208	
West Elm Veneer									
WESINDWLLSS	Depth	42"	48"	54"	60"	66"	72"	78"	
	24"	\$959	\$1021	\$1081	\$1145	\$1206	\$1268	\$1329	
	30"	\$1090	\$1152	\$1213	\$1275	\$1335	\$1399	\$1459	
Veneer Price Group 01									
WESINDWLLSS	Depth	42"	48"	54"	60"	66"	72"	78"	
	24"	\$1234	\$1294	\$1384	\$1475	\$1562	\$1651	\$1740	
	30"	\$1404	\$1495	\$1585	\$1672	\$1762	\$1850	\$1940	

Greenpoint Bench

Greenpoint Bench

Worksurfaces and Returns

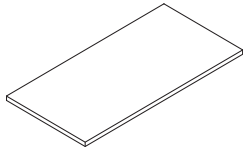

Tip: Edge will be matching veneer flat profile on side and back edges when wood top surface is selected, or 3 mm plastic edge when laminate top surface is selected.

Standard Includes

- Worksurface: High-Pressure Laminate price group 01 with 3 mm plastic edge

Options

Depth	24"	Prices below
	30"	Prices below
Width	48"	Prices below
	54"	Prices below
	60"	Prices below
	66"	Prices below
	72"	Prices below
	78"	Prices below
Top Surface Finish	Laminate HPL Price Group 01	Prices below
	Laminate HPL Price Group 02	Prices below
	Veneer Price Group 01	Prices below
	West Elm Veneer	Prices below
Cutout Type	Cutout Center	No cost
	No Cutout	No cost

Specification Information

Style Number	Dimensions		Base Prices				
	Depth	Width	48"	54"	60"	66"	72"

Greenpoint Single Sided Worksurface - Leg/Credenza Application

Laminate HPL Price Group 01							
WESINDWLCSS	24"	\$642	\$703	\$766	\$828	\$889	\$954
	30"	\$774	\$835	\$897	\$959	\$1020	\$1083
Laminate HPL Price Group 02							
WESINDWLCSS	24"	\$800	\$863	\$923	\$986	\$1047	\$1109
	30"	\$930	\$994	\$1055	\$1117	\$1180	\$1240
West Elm Veneer							
WESINDWLCSS	24"	\$1054	\$1116	\$1178	\$1238	\$1300	\$1361
	30"	\$1184	\$1244	\$1307	\$1368	\$1430	\$1492
Veneer Price Group 01							
WESINDWLCSS	24"	\$1328	\$1417	\$1505	\$1595	\$1685	\$1775
	30"	\$1525	\$1615	\$1703	\$1795	\$1882	\$1971

Greenpoint Bench

Worksurfaces and Returns

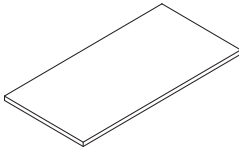

Tip: Edge will be matching veneer flat profile on side and back edges when wood top surface is selected, or 3 mm plastic edge when laminate top surface is selected.

Standard Includes

- Worksurface: High-Pressure Laminate price group 01 with 3 mm plastic edge

Options

Depth	24"	Prices below
	30"	Prices below
Width	48"	Prices below
	54"	Prices below
	60"	Prices below
	66"	Prices below
	72"	Prices below
Top Surface Finish	Laminate HPL Price Group 01	Prices below
	Laminate HPL Price Group 02	Prices below
	Veneer Price Group 01	Prices below
	West Elm Veneer	Prices below
Cutout Type	Cutout Center	No cost
	No Cutout	No cost

Specification Information

Style Number	Dimensions Depth	Base Prices Width				
		48"	54"	60"	66"	72"

Greenpoint Single Sided Worksurface - Credenza/Credenza Application

Laminate HPL Price Group 01

WESINDWCCSS	Depth	48"	54"	60"	66"	72"
	24"	\$669	\$730	\$793	\$855	\$916
	30"	\$801	\$862	\$924	\$986	\$1047

Laminate HPL Price Group 02

WESINDWCCSS	Depth	48"	54"	60"	66"	72"
	24"	\$827	\$890	\$950	\$1013	\$1074
	30"	\$957	\$1021	\$1082	\$1144	\$1207

West Elm Veneer

WESINDWCCSS	Depth	48"	54"	60"	66"	72"
	24"	\$1081	\$1143	\$1205	\$1265	\$1327
	30"	\$1211	\$1271	\$1334	\$1395	\$1457

Veneer Price Group 01

WESINDWCCSS	Depth	48"	54"	60"	66"	72"
	24"	\$1355	\$1444	\$1532	\$1622	\$1712
	30"	\$1552	\$1642	\$1730	\$1822	\$1909

Greenpoint Bench

Worksurfaces and Returns

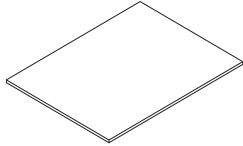

Tip: Edge will be matching veneer flat profile on side and back edges when wood top surface is selected, or 3 mm plastic edge when laminate top surface is selected.

Standard Includes

- Worksurface: High-Pressure Laminate price group 01 with 3 mm plastic edge

Options

Depth	48"	Prices below
Width	48"	Prices below
	54"	Prices below
	60"	Prices below
	66"	Prices below
	72"	Prices below
	78"	Prices below
Top Surface Finish	Laminate HPL Price Group 01	Prices below
	Laminate HPL Price Group 02	Prices below
	Veneer Price Group 01	Prices below
	West Elm Veneer	Prices below
Cutout Type	Cutout Center	No cost
	No Cutout	No cost

Specification Information

Style Number	Dimensions Depth	Base Prices					
		Width					
		48"	54"	60"	66"	72"	78"

Greenpoint Continuous Worksurface - Leg/Leg Application

Laminate HPL Price Group 01 or West Elm Veneer

WESINDWLLCT	48"	\$812	\$936	\$1059	\$1184	\$1307	\$1432
--------------------	-----	-------	-------	--------	--------	--------	--------

Laminate HPL Price Group 02

WESINDWLLCT	48"	\$1129	\$1253	\$1377	\$1501	\$1626	\$1748
--------------------	-----	--------	--------	--------	--------	--------	--------

Veneer Price Group 01

WESINDWLLCT	48"	\$1772	\$1894	\$2019	\$2141	\$2265	\$2388
--------------------	-----	--------	--------	--------	--------	--------	--------

Greenpoint Bench

Worksurfaces and Returns

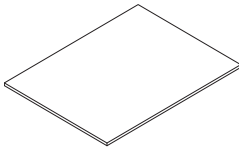

Tip: Edge will be matching veneer flat profile on side and back edges when wood top surface is selected, or 3 mm plastic edge when laminate top surface is selected.

Standard Includes

- Worksurface: High-Pressure Laminate price group 01 with 3 mm plastic edge

Options

Depth	48"	Prices below
Width	48"	Prices below
	54"	Prices below
	60"	Prices below
	66"	Prices below
	72"	Prices below
	78"	Prices below
Top Surface Finish	Laminate HPL Price Group 01	Prices below
	Laminate HPL Price Group 02	Prices below
	Veneer Price Group 01	Prices below
	West Elm Veneer	Prices below
Cutout Type	Cutout Center	No cost
	No Cutout	No cost

Specification Information

Style Number	Dimensions Depth	Base Prices					
		Width					
		48"	54"	60"	66"	72"	78"

Greenpoint Continuous Worksurface - Leg/Credenza Application

Laminate HPL Price Group 01 or West Elm Veneer

WESINDWLCCT	48"	\$844	\$968	\$1091	\$1216	\$1339	\$1464
--------------------	-----	-------	-------	--------	--------	--------	--------

Laminate HPL Price Group 02

WESINDWLCCT	48"	\$1161	\$1285	\$1409	\$1533	\$1658	\$1780
--------------------	-----	--------	--------	--------	--------	--------	--------

Veneer Price Group 01

WESINDWLCCT	48"	\$1804	\$1926	\$2051	\$2173	\$2297	\$2420
--------------------	-----	--------	--------	--------	--------	--------	--------

Greenpoint Bench

Worksurfaces and Returns

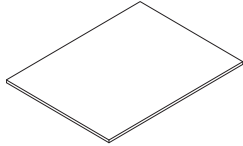

Tip: Edge will be matching veneer flat profile on side and back edges when wood top surface is selected, or 3 mm plastic edge when laminate top surface is selected.

Standard Includes

- Worksurface: High-Pressure Laminate price group 01 with 3 mm plastic edge

Options

Depth	48"	Prices below
Width	48"	Prices below
	54"	Prices below
	60"	Prices below
	66"	Prices below
	72"	Prices below
	78"	Prices below
Top Surface Finish	Laminate HPL Price Group 01	Prices below
	Laminate HPL Price Group 02	Prices below
	Veneer Price Group 01	Prices below
	West Elm Veneer	Prices below
Cutout Type	Cutout Center	No cost
	No Cutout	No cost

Specification Information

Style Number	Dimensions Depth	Base Prices Width					
		48"	54"	60"	66"	72"	78"

Greenpoint Continuous Worksurface - Credenza/Credenza Application

Laminate HPL Price Group 01 or West Elm Veneer

WESINDWCCCT	48"	\$870	\$994	\$1117	\$1242	\$1365	\$1490
--------------------	-----	-------	-------	--------	--------	--------	--------

Laminate HPL Price Group 02

WESINDWCCCT	48"	\$1187	\$1311	\$1435	\$1559	\$1684	\$1806
--------------------	-----	--------	--------	--------	--------	--------	--------

Veneer Price Group 01

WESINDWCCCT	48"	\$1830	\$1952	\$2077	\$2199	\$2323	\$2446
--------------------	-----	--------	--------	--------	--------	--------	--------

Greenpoint Bench

Worksurfaces and Returns

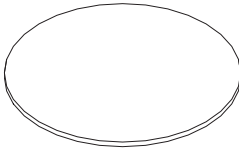

Standard Includes

- Worksurface: High-Pressure Laminate price group 01 with 3 mm plastic edge

Options

Diameter	48"	Prices below
	60"	Prices below
Top Surface Finish	Laminate HPL Price Group 01	Prices below
	Laminate HPL Price Group 02	Prices below
	Veneer Price Group 01	Prices below
	West Elm Veneer	Prices below
Cutout Type	No Cutout	No cost
	Power Cutout	No cost

Specification Information

Style Number	Dimensions	Base Prices
	Diameter	

Greenpoint Round Worksurface

Laminate HPL Price Group 01 or West Elm Veneer

WESINDWFR	Dimensions	Base Prices
	48"	\$794
	60"	\$1389

Laminate HPL Price Group 02

WESINDWFR	Dimensions	Base Prices
	48"	\$1098
	60"	\$1693

Veneer Price Group 01

WESINDWFR	Dimensions	Base Prices
	48"	\$1719
	60"	\$2315

Greenpoint Bench

Worksurfaces and Returns

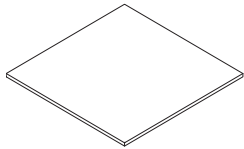

Standard Includes

- Worksurface: High-Pressure Laminate price group 01 with 3 mm plastic edge

Options

Depth	48"	Prices below
	60"	Prices below
Width	48"	Prices below
	60"	Prices below
Top Surface Finish	Laminate HPL Price Group 01	Prices below
	Laminate HPL Price Group 02	Prices below
	Veneer Price Group 01	Prices below
	West Elm Veneer	Prices below
Cutout Type	No Cutout	No cost
	Power Cutout	No cost

Specification Information

Style Number Dimensions Base Prices

Greenpoint Square Worksurface

Laminate HPL Price Group 01 or West Elm Veneer

WESINDWSQ	48"	\$794
	60"	\$1389

Laminate HPL Price Group 02

WESINDWSQ	48"	\$1098
	60"	\$1693

Veneer Price Group 01

WESINDWSQ	48"	\$1719
	60"	\$2315

Greenpoint Bench

Worksurfaces and Returns

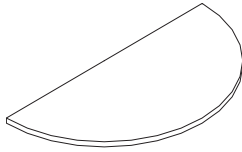

Standard Includes

- Worksurface: High-Pressure Laminate price group 01 with 3 mm plastic edge

Options

Width	48"	Prices below
	60"	Prices below
Top Surface Finish	Laminate HPL Price Group 01	Prices below
	Laminate HPL Price Group 02	Prices below
	Veneer Price Group 01	Prices below
	West Elm Veneer	Prices below

Specification Information

Style Number Dimensions Base Prices

Greenpoint Half Round Worksurface

Laminate HPL Price Group 01 or West Elm Veneer

WESINDWHR	48"	\$627
	60"	\$872

Laminate HPL Price Group 02

WESINDWHR	48"	\$780
	60"	\$1024

Veneer Price Group 01

WESINDWHR	48"	\$1122
	60"	\$1367

Greenpoint Bench

Greenpoint Bench

Worksurfaces and Returns

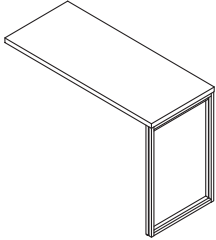

Tip: Edge will be matching veneer flat profile on side and back edges when wood top surface is selected, or 3 mm plastic edge when laminate top surface is selected.

Standard Includes

- Worksurface: High-Pressure Laminate price group 01 with 3 mm plastic edge
- Square tube leg (frame): paint price group 01
- Height: 28 1/2"H

Options

Depth	18"	Prices below
	24"	Prices below
Width	42"	Prices below
	48"	Prices below
	54"	Prices below
	60"	Prices below
Top Surface Finish	Laminate HPL Price Group 01	Prices below
	Laminate HPL Price Group 02	Prices below
	Veneer Price Group 01	Prices below
	West Elm Veneer	Prices below
Frame Finish	Paint Price Group 01	No cost
	Paint Price Group 02	18"D: +\$15 24"D: +\$19
	Paint Price Group 03	18"D: +\$27 24"D: +\$34

Specification Information

Style Number	Dimensions Depth	Prices Width			
		42"	48"	54"	60"

Greenpoint Worksurface - Return

Laminate HPL Price Group 01

WESINDRB	Depth	42"	48"	54"	60"
	18"	\$1122	\$1183	\$1246	\$1308
	24"	\$1194	\$1254	\$1315	\$1377

Laminate HPL Price Group 02

WESINDRB	Depth	42"	48"	54"	60"
	18"	\$1240	\$1302	\$1362	\$1426
	24"	\$1308	\$1369	\$1434	\$1494

West Elm Veneer

WESINDRB	Depth	42"	48"	54"	60"
	18"	\$1383	\$1445	\$1506	\$1568
	24"	\$1451	\$1511	\$1575	\$1635

Veneer Price Group 01

WESINDRB	Depth	42"	48"	54"	60"
	18"	\$1542	\$1603	\$1706	\$1766
	24"	\$1651	\$1712	\$1822	\$1883

Greenpoint Bench

Legs

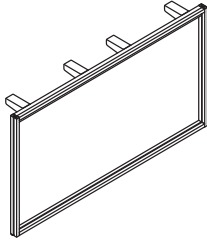

Standard Includes

- Square tube leg (frame): paint price group 01
- 1 1/2" leveling glides

Options

Depth	48"	Prices below
	60"	Prices below
Frame Finish	Paint Price Group 01	No cost
	Paint Price Group 02	48"D: +\$36 60"D: +\$41
	Paint Price Group 03	48"D: +\$72 60"D: +\$83

Specification Information

Style Number	Dimensions	Base Prices
--------------	------------	-------------

Greenpoint Dual Leg

Style Number	Dimensions	Base Prices
WESINDELDS	48"	\$669
	60"	\$777

Greenpoint Bench

Legs

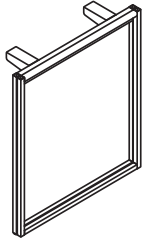

Standard Includes

- Square tube leg (frame): paint price group 01
- 1 1/2" leveling glides

Options

Depth	24"	Prices below
	30"	Prices below
Frame Finish	Paint Price Group 01	No cost
	Paint Price Group 02	24"D: +\$19
		30"D: +\$41
	Paint Price Group 03	24"D: +\$34
30"D: +\$41		

Specification Information

Style Number	Dimensions	Base Prices
	Depth	

Greenpoint Single Sided End Leg

WESINDELSS	24"	\$507
	30"	\$540

Greenpoint Bench

Legs

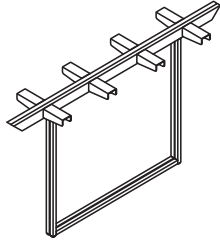

Standard Includes

- Square tube leg (frame): paint price group 01
- 1 1/2" leveling glides

Options

Frame Finish	Paint Price Group	Cost
	Paint Price Group 01	No cost
	Paint Price Group 02	+\$36
	Paint Price Group 03	+\$72

Specification Information

Style Number Base Price

Greenpoint Intermediate Dual Leg

WESINDILDS \$573

Greenpoint Bench

Greenpoint Bench

Legs

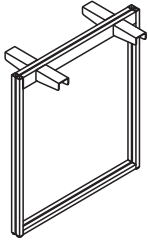

Standard Includes

- Square tube leg (frame): paint price group 01
- 1 1/2" leveling glides

Options

Depth	24"	Prices below
	30"	Prices below
Frame Finish	Paint Price Group 01	No cost
	Paint Price Group 02	24"D: +\$19
		30"D: +\$22
	Paint Price Group 03	24"D: +\$34
30"D: +\$41		

Specification Information

Style Number	Dimensions	Base Prices
	Depth	

Greenpoint Intermediate Single Leg

WESINDILSS	24"	\$474
	30"	\$507

Greenpoint Bench

Legs

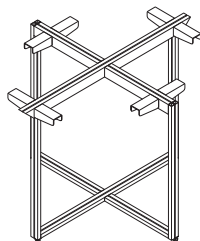

Standard Includes

- Square tube legs (frame): paint price group 01
- 1 1/2" leveling glides
- Height: 28 1/2"H

Options

Depth	48"	Prices below
	60"	Prices below
Frame Finish	Paint Price Group 01	No cost
	Paint Price Group 02	48"D: +\$55 60"D: +\$60
	Paint Price Group 03	48"D: +\$106 60"D: +\$119

Specification Information

Style Number	Dimensions	Base Prices
--------------	------------	-------------

Greenpoint Round/Square Leg

Style Number	Dimensions	Base Prices
WESINDLFR	48"	\$1249
	60"	\$1337

Greenpoint Bench

Greenpoint Bench

Legs

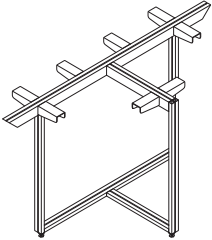

Standard Includes

- Square tube leg (frame): paint price group 01
- 1 1/2" leveling glides
- Height: 28 1/2"H

Options

Width	48"	Prices below
	60"	Prices below
Frame Finish	Paint Price Group 01	No cost
	Paint Price Group 02	48"W: +\$55
		60"W: +\$60
	Paint Price Group 03	48"W: +\$106
60"W: +\$119		

Specification Information

Style Number	Dimensions	Base Prices
	Width	

Greenpoint Half Round Leg

WESINDLHR	48"	\$937
	60"	\$1005

Greenpoint Bench

Credenzas

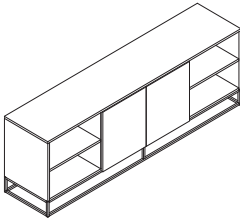

Tip: When specified in High-Pressure Laminate, the pull of the drawer will be painted according to the matrix in the Surface Materials section.

Standard Includes

- Credenza: High-Pressure Laminate price group 01
- Square legs: paint price group 01
- 1 1/2" leveling glides

Options

Case Finish	Laminate HPL Price Group 01	No cost
	Laminate HPL Price Group 02	+\$682
	West Elm Veneer Veneer Price Group 01	+\$973 +\$6148
Frame Finish	Paint Price Group 01	No cost
	Paint Price Group 02	+\$36
	Paint Price Group 03	+\$72
Case Orientation	Inward	No cost
	Outward	No cost
Application	Dual Sided	No cost
	Single Sided	No cost

Specification Information

Style Number Base Price

Greenpoint End Credenza

WESINDEC \$4531

Greenpoint Bench

Greenpoint Bench

Credenzas

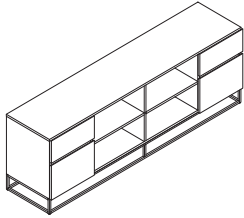

Tip: When specified in High-Pressure Laminate, the pull of the drawer will be painted according to the matrix in the Surface Materials section.

Standard Includes

- Credenza: High-Pressure Laminate price group 01
- Square legs: paint price group 01
- 1 1/2" leveling glides

Options

Case Finish	Laminate HPL Price Group 01	No cost
	Laminate HPL Price Group 02	+\$998
	West Elm Veneer Veneer Price Group 01	+\$1329 +\$6592
Frame Finish	Paint Price Group 01	No cost
	Paint Price Group 02	+\$36
	Paint Price Group 03	+\$72
Case Orientation	Inward	No cost
	Outward	No cost
Application	Dual Sided	No cost
	Single Sided	No cost

Specification Information

Style Number Base Price

Greenpoint Personal Credenza

WESINDPC \$5260

Greenpoint Bench

Upmount Bins

X 10/24

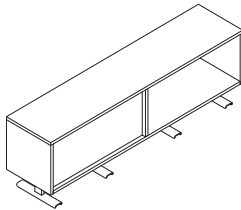

Standard Includes

- Upmount bin: High-Pressure Laminate price group 01
- Brackets: paint price group 01

Options

Width	60"	Prices below
	66"	Prices below
	72"	Prices below
Top Surface Finish	Laminate HPL Price Group 01	Prices below
	Laminate HPL Price Group 02	Prices below
	Veneer Price Group 01	Prices below
	West Elm Veneer	Prices below
Bracket Finish	Paint Price Group 01	No cost
	Paint Price Group 02	+\$19
	Paint Price Group 03	+\$41

Specification Information

Style Number	Base Prices		
	Width		
	60"	66"	72"

Greenpoint Upmount Bin **X 10/24**

Laminate HPL Price Group 01			
WESINDUB	\$2187	\$2228	\$2264
Laminate HPL Price Group 02			
WESINDUB	\$2359	\$2402	\$2434
West Elm Veneer			
WESINDUB	\$2386	\$2426	\$2467
Veneer Price Group 01			
WESINDUB	\$4359	\$4401	\$4443

Greenpoint Bench

X 10/24 = Last order entry
October 20, 2024

Greenpoint Bench

Upmount Bins

X 10/24

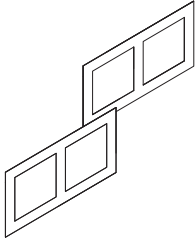

Standard Includes

- Whiteboards
- Magnets for mounting

Options

Width	60"	No cost
	66"	+\$12
	72"	+\$26

Specification Information

Style Number Base Price

Greenpoint Whiteboards for use with Upmount Bins **X 10/24**

WESINDUBWB \$263

Greenpoint Bench

Center Screens

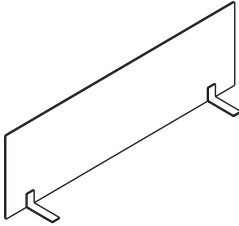

Standard Includes

- Screen: glass price group 01
- Brackets: paint price group 01

Options

Width	48"	No cost
	54"	+\$33
	60"	+\$69
	66"	+\$102
	72"	+\$135
	78"	+\$168
Glass Finish	Glass Price Group 01	No cost
	Glass Price Group 02	+\$342
Bracket Finish	Paint Price Group 01	No cost
	Paint Price Group 02	+\$19
	Paint Price Group 03	+\$41

Specification Information

Style Number Base Price

Greenpoint Glass Screen

WESINDCSG \$716

Greenpoint Bench

Greenpoint Bench

Center Screens

X 10/24

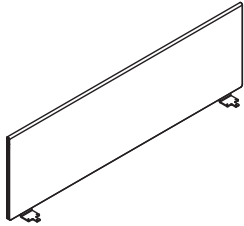

Tip: 13 1/2"H screen aligns with a 40 1/2"H datum from the floor. 19 1/2"H screen aligns with a 46 1/2"H datum from the floor.

Standard Includes

- Screen: fabric price group 01
- Edge: PET
- Bracket: Fire Retardant polyurethane foam.

Options

Height	13 1/2"	Prices below
	19 1/2"	Prices below
Width	48"	Prices below
	54"	Prices below
	60"	Prices below
	66"	Prices below
	72"	Prices below
	78"	Prices below
Surface Finish	Fabric Price Group 01	No cost
	Fabric Customer's Own Material	+\$23
	Fabric Price Group 02	+\$49
	Fabric Price Group 03	+\$132
	Fabric Price Group 04	+\$165
	Fabric Price Group 05	+\$203
	Fabric Price Group 06	+\$237
	Fabric Price Group 07	+\$274
	Fabric Price Group 08	+\$307
	Fabric Price Group 09	+\$343
Fabric Price Group 10	+\$378	

Specification Information

Style Number	Dimensions H	Base Prices W					
		48"	54"	60"	66"	72"	78"

Greenpoint Universal Screen **X 10/24**

WESINDCST	13 1/2"	\$532	\$559	\$589	\$618	\$649	\$677
WESINDCST	19 1/2"	\$656	\$698	\$750	\$794	\$840	\$888

X 10/24 = Last order entry
October 20, 2024

Greenpoint Bench

Center Screens

Power and Data

Power Supports

Standard Includes

- Power support: black paint
- Attachment hardware

Specification Information

Style Number	Prices
--------------	--------

Greenpoint Single Sided Power Support

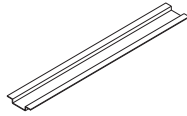

WESINDPSSS \$59

Greenpoint Dual Sided Power Support

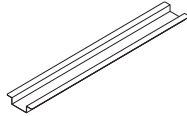

WESINDPSDS \$59

Power and Data

Power Trays

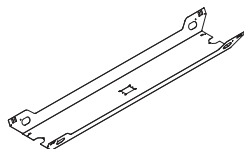

Standard Includes

- Power tray: black paint
- Attachment hardware

Options

Width	48"	No cost
	54"	+\$5
	60"	+\$12
	66"	+\$21
	72"	+\$26
	78"	+\$33

Specification Information

Style Number Base Price

Greenpoint Dual-Sided Power Cover

WESINDPTDS \$189

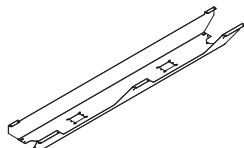

Standard Includes

- Power tray: black paint
- Attachment hardware

Options

Width	48"	No cost
	54"	+\$5
	60"	+\$12
	66"	+\$21
	72"	+\$26
	78"	+\$33
Handedness	Left Hand	No cost
	Right Hand	No cost

Specification Information

Style Number Base Price

Greenpoint Single-Sided Power Cover

WESINDPTSS \$168

Power and Data

Power and Data

Power Trays

Standard Includes

- Tray end cap or extension: black paint
- Attachment hardware

Specification Information

Style Number	Prices
--------------	--------

Greenpoint Single Sided Tray End Cap

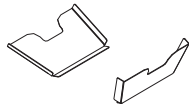

WESINDCTSS \$39

Greenpoint Dual Sided Tray End Cap

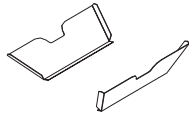

WESINDCTDS \$39

Greenpoint Single Sided Tray Extension

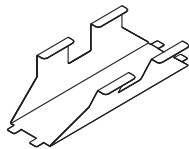

WESINETSS \$69

Greenpoint Dual Sided Tray Extension

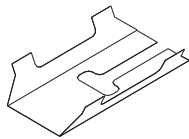

WESINETDS \$69

Power and Data

Power Covers

Tip: If power covers are not selected, any connection points on modular power blocks not being used by a harness, infeed, or connector must be filled with dust covers. Order style number FMVBK separately.

Standard Includes

- Power cover: black paint
- Attachment hardware

Specification Information

Style Number	Prices
--------------	--------

Greenpoint Single Sided Power Cover

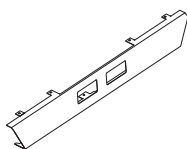

WESINDPCSS	\$47
-------------------	------

Greenpoint Dual Sided Power Cover

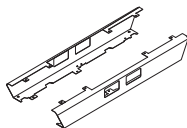

WESINDPCDS	\$47
-------------------	------

Power and Data

Modular Power Blocks

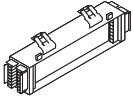

Standard Includes

- Non-PVC power block

Options

Power Schematic	2+2	No cost
	3+1	No cost
	3SN	No cost

Specification Information

Style Number Price

Power Block - Standard Capacity

FMVPBS	\$252
---------------	-------

Power and Data

Chicago Hardwire Box

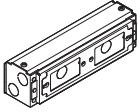

Standard Includes

- Hardwire box: black

Specification Information

Style Number Price

Power Kit - Chicago Hardwire

FMVCP \$372

Power and Data

Power and Data Receptacles and Filler Package



Tip: For designation of controlled receptacles, order permanent ink stamp with controlled icon; service part 1063909001SR. It includes a pair of stamps, one white and one black. Appropriate receptacles can be stamped at the job site during installation.

Standard Includes

- 15-amp, system ground duplex receptacle:
 - 6000 Black
 - 6009 Arctic White
 - 6527 Merle
 - 6899 Platinum Metallic

Options

3+1 Power Options	Line 1	No cost
	Line 2	No cost
	Line 3	No cost
	Line 4	No cost
2+2 Power Options	Line 1	No cost
	Line 2	No cost
	Line 3	No cost
	Line 4	No cost
3SN Power Options	Line 1	No cost
	Line 2	No cost
	Line 3	No cost
Amperage Options	15 Amp	No cost
	20 Amp	+\$34
Ground Type Options	System	No cost
	Isolated	+\$19
Controlled Stamp Option	No Stamp	No cost
	With Controlled Stamp	+\$5

Specification Information

Style Number Base Price

Receptacle - Duplex

FMVRD \$48



Standard Includes

- USB receptacle:
 - 6000 Black
 - 6009 Arctic White
 - 6527 Merle
 - 6899 Platinum Metallic

Options

3+1 Power Options	Line 1	No cost
	Line 2	No cost
	Line 3	No cost
	Line 4	No cost
2+2 Power Options	Line 1	No cost
	Line 2	No cost

► **Product Information continued on next page**

Power and Data

Power and Data Receptacles and Filler Package

► **Product Information continued from previous page**

Options		
2+2 Power Options	Line 3	No cost
	Line 4	No cost
3SN Power Options	Line 1	No cost
	Line 2	No cost
	Line 3	No cost

Specification Information

Style Number Price

Receptacle - USB

FMVRUSB \$113



Standard Includes

- Package of 20 fillers:
 - 6000 Black
 - 6009 Arctic White
 - 6527 Merle
 - 6899 Platinum Metallic

Specification Information

Style Number Price

Filler Package, Package of 20

FMVF \$51

Power and Data

Modular Harnesses

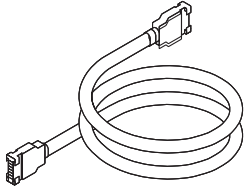

Tip: Refer to Power Routing Harness Chart for recommended harness lengths.

Standard Includes

- Non-PVC modular harness

Options

Power Schematic	2+2	No cost
	3+1	No cost
	3SN	No cost
PVC Option	With PVC	-\$12
	Non PVC	No cost

Specification Information

Dimensions

Length Style Number Base Prices

Modular Harnesses

24"	FMVH24	\$174
27"	FMVH27	\$174
30"	FMVH30	\$174
33"	FMVH33	\$174
36"	FMVH36	\$174
39"	FMVH39	\$174
42"	FMVH42	\$174
45"	FMVH45	\$193
48"	FMVH48	\$193
51"	FMVH51	\$193
54"	FMVH54	\$193
57"	FMVH57	\$193
60"	FMVH60	\$221
63"	FMVH63	\$221
66"	FMVH66	\$221
69"	FMVH69	\$221
72"	FMVH72	\$242

Power and Data

Power Infeeds

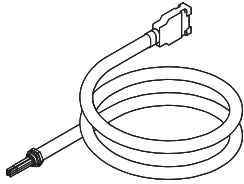

Standard Includes

- Non-PVC infeed harness

Options

Power Schematic	2+2	No cost
	3+1	No cost
	3SN	No cost
PVC Option	With PVC	-\$12
	Non PVC	No cost

Specification Information

Dimensions

Length Style Number Base Prices

Power Infeeds, Hardwire to Modular

6'	FMVI6H	\$277
12'	FMVI12H	\$356
24'	FMVI24H	\$514

Power and Data

Power Infeeds

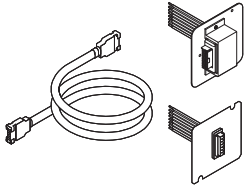

Standard Includes

- Non-PVC infeed harness
- Straight/flush junction box faceplate

Options

Power Schematic	2+2	No cost
	3+1	No cost
	3SN	No cost
Plate Type Options	Straight/Flush Faceplate	No cost
	90 Degree Faceplate	+\$61
PVC Option	With PVC	-\$12
	Non PVC	No cost

Specification Information

Dimensions

Length Style Number Base Prices

Power Infeeds, Modular to Modular

6'	FMVI6M	\$377
12'	FMVI12M	\$469
24'	FMVI24M	\$628

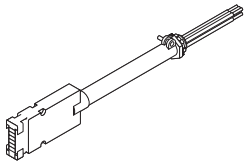

Standard Includes

- 12' PVC infeed harness with liquid tight metallic conduit

Options

Power Schematic	2+2	No cost
	3+1	No cost
	3SN	No cost

Specification Information

Style Number Price

Power Infeed - San Francisco

FMVISS	\$446
---------------	-------

Power and Data

Power Infeeds

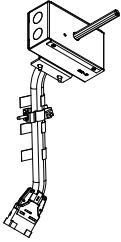

Standard Includes

- 50" non-PVC infeed harness
- Junction box
- Strain relief brackets

Options

Wiring Schematic	2+2	No cost
	3 Separate Neutrals	No cost
	3+1	No cost
PVC	With PVC	-\$12

Specification Information

Style Number Base Price

Ology Infeed - New York

OLBVINN \$282

Power and Data

Power and Data

Bracket Kit

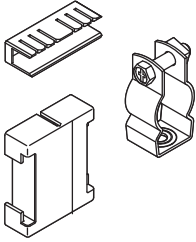

Standard Includes

- Brackets and dust covers

Specification Information

Style Number Price

Bracket Kit

FMVBK \$55

Power and Data

Vertabral Risers

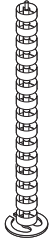

Standard Includes

- Wire manager

Specification Information

Style Number Price

Wire Manager Assembly - Vertabral

FMVC \$240



Standard Includes

- Wire manager

Specification Information

Style Number Price

Wire Manager Assembly - Vertabral Extension

FMVCE \$70

Sutton

Desks

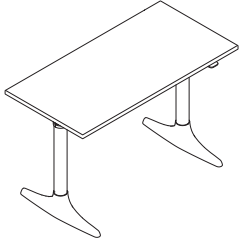

Standard Includes

- Basic height-adjustable desk
- Worksurface:
 - High-Pressure Laminate price group 01 with 3 mm plastic edge
 - Wood group 01 veneer with matching 3 mm square edge, if selected
- Electric height-adjustable sit-to-stand base: paint price group 01
- Simple touch controller
- Foot: paint price group 01
- Leg ring: paint price group 01
- Modular widths: 46", 52", 58", 64", or 70"
- Attachment hardware
- Power cord: 10' with standard plug

Options

Size Option	Modular Parametric	No cost No cost
Top Surface Finish	Veneer Custom Stain Laminate HPL Price Group 01 Laminate HPL Price Group 02 Laminate HPL Price Group 03 Composite Veneer Price Group 01 Composite Veneer Price Group 02 Veneer Price Group 01 Veneer Full Fill Veneer Price Group 03 West Elm Veneer OLL Price Group 1	No cost Prices below 46"W-54"W: +\$25 54 1/16"W-66"W: +\$33 66 1/16"W-72"W: +\$41 46"W-54"W: +\$49 54 1/16"W-66"W: +\$65 66 1/16"W-72"W: +\$82 Prices below +\$102 Prices below +\$102 +\$359 +\$412 +\$102
Edge Type	3mm Plastic Edge 3mm Wood Edge Blade Edge	No cost No cost +\$328
Edge Finish	Plastic - PG1	No cost
Corner	Square Corner Radius Corner	No cost +\$93
Foot Finish	Paint Price Group 01 Paint Price Group 02 Paint Price Group 03 Polished Aluminum	No cost +\$22 +\$41 +\$41
Base Finish	Paint Price Group 01 Paint Price Group 02	No cost +\$22
Leg Ring Finish	Paint Price Group 01 Paint Price Group 02 Paint Price Group 03 Polished Chrome	No cost +\$5 +\$15 +\$20
Cable Tray	No Cable Tray With Cable Tray	No cost Prices below
Controller	Simple Touch Controller Active Touch Controller	No cost +\$74

► **Product Information continued on next page**

► **Product Information continued from previous page**

Options		
Power Configuration	No under Worksurface Power	No cost
	Under Worksurf Clamp with USB-A	46"W-57 15/16"W: +\$801 58"W-72"W: +\$834
	Under Worksurf Clamp with USB-C	46"W-57 15/16"W: +\$1,122 58"W-72"W: +\$1,153
	Under Worksurface Only	46"W-57 15/16"W: +\$476 58"W-72"W: +\$508
Power Cord	10' Standard Cord	No cost
	9' Standard Cord	No cost
	10' Braided Cord	+\$74
	20' Standard Cord	+\$74
	20' Braided Cord	+\$220
	8' Curly Cord	+\$319
Power Plug Type	Standard NEMA 5-15 3-Prong	No cost
	Thread Low Profile Plug	+\$40
PVC	With PVC	No cost
	Non PVC	+\$34
Power Cord Finish	Braided Cord	No cost
Power Finish	Plastic - PG1	No cost

Specification Information

Style Number	Dimensions Depth	Size Option	Base Prices					Options (Add \$ to Base Price)
			Width					
		Modular	46"W	52"W	58"W	64"W	70"W	Cable Tray
		Parametric	46"W-	48 1/16"W-	54 1/16"W-	60 1/16"W-	66 1/16"W-	
			48"W	54"W	60"W	66"W	72"W	

Basic Height-Adjustable Desks

Laminate HPL Price Group 01

WESSUTSRQ	23"	\$2162	\$2229	\$2298	\$2367	\$2438	+\$183
	29"	\$2429	\$2505	\$2582	\$2659	\$2739	+\$205

Composite Veneer Price Group 01

WESSUTSRQ	23"	\$2876	\$2965	\$3056	\$3148	\$3243	+\$183
	29"	\$3163	\$3262	\$3362	\$3462	\$3566	+\$205

Veneer Price Group 01

WESSUTSRQ	23"	\$2876	\$2965	\$3056	\$3148	\$3243	+\$183
	29"	\$3163	\$3262	\$3362	\$3462	\$3566	+\$205

Sutton

Desks

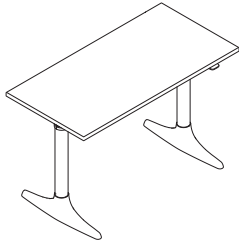

Standard Includes

- Extended height-adjustable desk
- Worksurface:
 - High-Pressure Laminate price group 01 with 3 mm plastic edge
 - Wood group 01 veneer with matching 3 mm square edge, if selected
- Electric height-adjustable sit-to-stand base: paint price group 01
- Simple touch controller
- Foot: paint price group 01
- Leg ring: paint price group 01
- Modular widths: 46", 52", 58", 64", or 70"
- Attachment hardware
- Power cord: 10' with standard plug

Options

Size Option	Modular Parametric	No cost No cost
Top Surface Finish	Veneer Custom Stain Laminate HPL Price Group 01 Laminate HPL Price Group 02 Laminate HPL Price Group 03 Composite Veneer Price Group 01 Composite Veneer Price Group 02 Veneer Price Group 01 Veneer Full Fill Veneer Price Group 03 West Elm Veneer OLL Price Group 1	No cost Prices below 46"W-54"W: +\$25 54 1/16"W-66"W: +\$33 66 1/16"W-72":+\$41 46"W-54"W: +\$49 54 1/16"W-66"W: +\$65 66 1/16"W-72":+\$82 Prices below +\$102 Prices below +\$102 +\$359 +\$412 +\$102
Edge Type	3mm Plastic Edge 3mm Wood Edge Blade Edge	No cost No cost +\$328
Edge Finish	Plastic - PG1	No cost
Corner	Square Corner Radius Corner	No cost +\$93
Foot Finish	Paint Price Group 01 Paint Price Group 02 Paint Price Group 03 Polished Aluminum	No cost +\$22 +\$41 +\$41
Base Finish	Paint Price Group 01 Paint Price Group 02	No cost +\$22
Leg Ring Finish	Paint Price Group 01 Paint Price Group 02 Paint Price Group 03 Polished Chrome	No cost +\$5 +\$15 +\$20
Cable Tray	No Cable Tray With Cable Tray	No cost Prices below
Controller	Simple Touch Controller Active Touch Controller	No cost +\$74

► **Product Information continued on next page**

► **Product Information continued from previous page**

Options		
Power Configuration	No under Worksurface Power	No cost
	Under Worksurf Clamp with USB-A	46"W-57 15/16"W: +\$801 58"W-72"W: +\$834
	Under Worksurf Clamp with USB-C	46"W-57 15/16"W: +\$1,122 58"W-72"W: +\$1,153
	Under Worksurface Only	46"W-57 15/16"W: +\$476 58"W-72"W: +\$508
Power Cord	10' Standard Cord	No cost
	9' Standard Cord	No cost
	10' Braided Cord	+\$74
	20' Standard Cord	+\$74
	20' Braided Cord	+\$220
	8' Curly Cord	+\$319
Power Plug Type	Standard NEMA 5-15 3-Prong	No cost
	Thread Low Profile Plug	+\$40
PVC	With PVC	No cost
	Non PVC	+\$34
Power Cord Finish	Braided Cord	No cost
Power Finish	Plastic - PG1	No cost

Specification Information

Style Number	Dimensions Depth	Size Option	Base Prices					Options (Add \$ to Base Price)
			Width					
		Modular	46"W	52"W	58"W	64"W	70"W	Cable Tray
		Parametric	46"W-	48 1/16"W-	54 1/16"W-	60 1/16"W-	66 1/16"W-	
			48"W	54"W	60"W	66"W	72"W	

Extended Height-Adjustable Desks

Laminate HPL Price Group 01

WESSUTERQ	23"	\$2357	\$2430	\$2505	\$2580	\$2657	+\$183
	29"	\$2648	\$2730	\$2814	\$2899	\$2986	+\$205

Composite Veneer Price Group 01

WESSUTERQ	23"	\$3071	\$3166	\$3263	\$3361	\$3462	+\$183
	29"	\$3382	\$3487	\$3594	\$3702	\$3813	+\$205

Veneer Price Group 01

WESSUTERQ	23"	\$3071	\$3166	\$3263	\$3361	\$3462	+\$183
	29"	\$3382	\$3487	\$3594	\$3702	\$3813	+\$205

Sutton

Bases

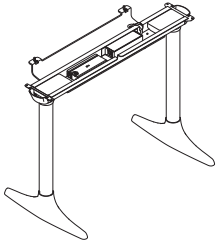

Standard Includes

- Basic height-adjustable base
- Electric height-adjustable sit-to-stand base: paint price group 01
- Foot: paint price group 01
- Leg ring: paint price group 01
- Simple touch controller
- Modular widths: 46", 52", 58", 64", or 70"
- Attachment hardware
- Power cord: 10' with standard plug

Options

Size Option	Modular	No cost
	Parametric	No cost
Foot Finish	Paint Price Group 01	No cost
	Paint Price Group 02	+\$22
	Paint Price Group 03	+\$41
	Polished Aluminum	+\$41
Base Finish	Paint Price Group 01	No cost
	Paint Price Group 02	+\$22
Leg Ring Finish	Paint Price Group 01	No cost
	Paint Price Group 02	+\$5
	Paint Price Group 03	+\$15
	Polished Chrome	+\$20
Cable Tray	No Cable Tray	No cost
	With Cable Tray	Prices below
Controller	Simple Touch Controller	No cost
	Active Touch Controller	+\$74
Power Configuration	No under Worksurface Power	No cost
	Under Worksurf Clamp with USB-A	46"W-57 15/16"W: +\$801 58"W-72"W: +\$834
	Under Worksurf Clamp with USB-C	46"W-57 15/16"W: +\$1,122 58"W-72"W: +\$1,153
	Under Worksurface Only	46"W-57 15/16"W: +\$476 58"W-72"W: +\$508
Power Cord	10' Standard Cord	No cost
	9' Standard Cord	No cost
	10' Braided Cord	+\$74
	20' Standard Cord	+\$74
	20' Braided Cord	+\$220
	8' Curly Cord	+\$319
Power Plug Type	Standard NEMA 5-15 3-Prong	No cost
	Thread Low Profile Plug	+\$40
PVC	With PVC	No cost
	Non PVC	+\$34
Power Cord Finish	Braided Cord	No cost
Power Finish	Plastic - PG1	No cost

► **Product Information continued on next page**

▶ **Product Information continued from previous page**

Specification Information

Style Number	Dimensions Depth	Size Option	Base Prices					Options (Add \$ to Base Price)
			Width					
		Modular	46"W	52"W	58"W	64"W	70"W	Cable Tray
		Parametric	46"W-	48 1/16"W-	54 1/16"W-	60 1/16"W-	66 1/16"W-	
			48"W	54"W	60"W	66"W	72"W	

Basic Height-Adjustable Base

Style Number	Depth	46"W	52"W	58"W	64"W	70"W	Options
WESSUTSRQB	23"	\$1980	\$2021	\$2109	\$2175	\$2242	+\$183
	29"	\$2234	\$2305	\$2327	\$2373	\$2391	+\$205



Sutton

Bases

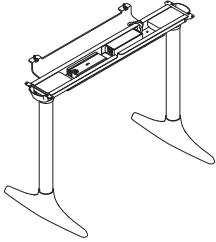

Standard Includes

- Extended height-adjustable base
- Electric height-adjustable sit-to-stand base: paint price group 01
- Foot: paint price group 01
- Leg ring: paint price group 01
- Simple touch controller
- Modular widths: 46", 52", 58", 64", or 70"
- Attachment hardware
- Power cord: 10' with standard plug

Options

Size Option	Modular	No cost
	Parametric	No cost
Foot Finish	Paint Price Group 01	No cost
	Paint Price Group 02	+\$22
	Paint Price Group 03	+\$41
	Polished Aluminum	+\$41
Base Finish	Paint Price Group 01	No cost
	Paint Price Group 02	+\$22
Leg Ring Finish	Paint Price Group 01	No cost
	Paint Price Group 02	+\$5
	Paint Price Group 03	+\$15
	Polished Chrome	+\$20
Cable Tray	No Cable Tray	No cost
	With Cable Tray	Prices below
Controller	Simple Touch Controller	No cost
	Active Touch Controller	+\$74
Power Configuration	No under Worksurface Power	No cost
	Under Worksurf Clamp with USB-A	46"W-57 15/16"W: +\$801 58"W-72"W: +\$834
	Under Worksurf Clamp with USB-C	46"W-57 15/16"W: +\$1,122 58"W-72"W: +\$1,153
	Under Worksurface Only	46"W-57 15/16"W: +\$476 58"W-72"W: +\$508
Power Cord	10' Standard Cord	No cost
	9' Standard Cord	No cost
	10' Braided Cord	+\$74
	20' Standard Cord	+\$74
	20' Braided Cord	+\$220
	8' Curly Cord	+\$319
Power Plug Type	Standard NEMA 5-15 3-Prong	No cost
	Thread Low Profile Plug	+\$40
PVC	With PVC	No cost
	Non PVC	+\$34
Power Cord Finish	Braided Cord	No cost
Power Finish	Plastic - PG1	No cost

► **Product Information continued on next page**

► **Product Information continued from previous page**

Specification Information

Style Number	Dimensions Depth	Size Option	Base Prices					Options (Add \$ to Base Price)
			Width					
		Modular	46"W	52"W	58"W	64"W	70"W	Cable Tray
		Parametric	46"W-	48 1/16"W-	54 1/16"W-	60 1/16"W-	66 1/16"W-	
			48"W	54"W	60"W	66"W	72"W	

Extended Height-Adjustable Base

Style Number	Dimensions Depth	Base Price	46"W	52"W	58"W	64"W	70"W	Options
WESSUTERQB	23"	\$2141	\$2210	\$2281	\$2377	\$2450	+\$183	
	29"	\$2442	\$2519	\$2543	\$2593	\$2613	+\$205	

Sutton

Accessories

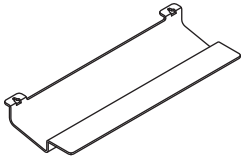

Standard Includes

- Cable tray: P631 Dark Heather Grey molded PET felt
- Attachment hardware
- 28"W cable tray, if 46"W–57 15/16"W worksurface selected
- 40"W cable tray, if 58"W–72"W worksurface selected

Options

Depth Worksurface	23"	Prices below
	29"	Prices below

Specification Information

Style Number	Dimensions Worksurface Width	Prices Worksurface Depth
		23"D 29"D

Cable Tray

WESSUTCT	46"-72"	\$183	\$205
-----------------	---------	-------	-------

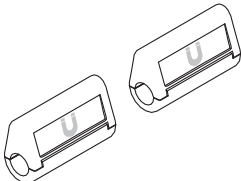

Standard Includes

- Magnetic clips: 6053 Seagull

Specification Information

Style Number	Price
--------------	-------

Magnetic Cable Clips, Quantity 2

FLXMCC2	\$97
----------------	------

Magnetic Cable Clips, Quantity 10

FLXMCC10	\$385
-----------------	-------

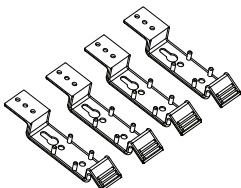

Standard Includes

- Cable brackets, quantity of four: 6527 Merle

Specification Information

Style Number	Price
--------------	-------

Cable Brackets

FLXCBK4	\$51
----------------	------

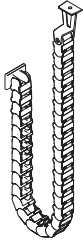

Standard Includes

- Cable riser with fence connection: 7360 Merle paint
- Attachment hardware

Options

Connection Type	Fence Connection	No cost
	Leg Connection	+\$152

Specification Information

Style Number Base Price

Cable Riser

OLCR \$104



West Elm—Licensed Specifying



Seating

Nimbus

Conference Chairs 244

Pebble

Guest Chairs and Stools 245

Slope

Guest Chairs and Stools 246

Conference Chairs 248

Furniture

Horizon

Occasional Tables 249

Lily Pad

Occasional Tables 250

Linear

Occasional Tables 251

Maisie

Occasional Tables 252

Mesa

Occasional Tables 253

Nolan

Occasional Tables 254

Stump Side Table

Occasional Tables 255

Accessories

Linear Led Light 256

Nimbus

Conference Chairs



Nimbus Conference Chair

Style Number

List Price

WEM70

\$1098

- Depth 24.4"
- Width 26"
- Height 31.5"
- Weight 40 lbs

- Warranty 5 Years
- Certifications BIFMA Compliant

Options

Color Platinum

No cost

Pebble

Guest Chairs and Stools

Pebble

Tip: This style number is subject to inventory availability.

Pebble Stacking Chair

Style Number	List Price
WEM64	\$662

Options

Color	Walnut	No cost
-------	--------	---------

Pebble Upholstered Chair



Style Number	List Price		
WEM65	\$904		
• Depth	18"	• Warranty	5 Years
• Width	21"	• Certifications	BIFMA Compliant
• Height	31.5"		
• Weight	32.56 lbs		

Options

Color	Onyx	No cost
	Walnut	No cost

Slope

Guest Chairs and Stools



Slope Lounge Chair

Style Number		List Price
WEM2		\$1190
• Depth	26.5"	• Warranty
• Width	26.5"	• Certifications
• Height	28"	5 Years
• Weight	27 lbs	BIFMA Compliant

Options

Color	Fog	No cost
	Saddle	No cost



Slope Bar Stool

Style Number		List Price
WEM66		\$1024
• Depth	21.5"	• Warranty
• Width	19.25"	• Certifications
• Height	40"	5 Years
• Weight	29 lbs	BIFMA Compliant

Options

Color	Saddle	No cost
-------	--------	---------



Slope Counter Stool

Style Number		List Price
WEM50		\$1024
• Depth	21.5"	• Warranty
• Width	19"	• Certifications
• Height	35.75"	5 Years
• Weight	28 lbs	BIFMA Compliant

Options

Color	Saddle	No cost
-------	--------	---------

Slope

Guest Chairs and Stools



Slope Guest Chair

Style Number			List Price
WEM1			\$941
• Depth	21.5"	• Warranty	5 Years
• Width	19.25"	• Certifications	BIFMA Compliant
• Height	33.25"		
• Weight	27 lbs		

Options

Color	Agean	No cost
	Fog	No cost
	Saddle	No cost



Slope Height Adjustable Bar Stool

Style Number			List Price
WEM67			\$1260
• Depth	21.5"	• Warranty	5 Years
• Width	19"	• Certifications	BIFMA Compliant
• Height	34.25 - 40.25"		
• Weight	41 lbs		

Options

Color	Saddle	No cost
-------	--------	---------

Slope

Conference Chairs



Slope Conference Chair

Style Number

List Price

WEM3

\$1190

- Depth 21.5"
- Width 19.25"
- Height 32"-36"
- Weight 38 lbs

- Warranty 5 Years
- Certifications BIFMA Compliant

Options

Color	Fog	No cost
	Saddle	No cost

Horizon
Occasional Tables

Horizon Nesting Table Narrow - Rectangle Walnut, 19"



Style Number

WEM7634567

List Price

\$1206

- Depth 16"
- Width 48"
- Height 19"
- Weight 25 lbs

- Warranty 5 Years
- Certifications BIFMA Compliant

Options

Color Walnut No cost

Horizon Nesting Table - Square Black Marble, 15"



Style Number

WEM1196073

List Price

\$2161

- Depth 38"
- Width 38"
- Height 15"
- Weight 35 lbs

- Warranty 5 Years
- Certifications BIFMA Compliant

Options

Color Black No cost

Horizon Nesting Table - Round White Marble 17"



Style Number

WEM5646176

List Price

\$2418

- Depth 38"
- Width 38"
- Height 17"
- Weight 35 lbs

- Warranty 5 Years
- Certifications BIFMA Compliant

Options

Color White No cost

Horizon

Lily Pad

Occasional Tables



Lily Pad Nesting Tables, 16 In

Style Number		List Price
WEM7		\$792
• Depth	25"	• Warranty
• Width	30"	• Certifications
• Height	16"	5 Years
• Weight	16 lbs	BIFMA Compliant

Options

Color	Dry Erase Board	No cost
	White Marble	No cost
	Walnut	+\$255
	White Marble	+\$744



Lily Pad Nesting Tables, 18 In

Style Number		List Price
WEM59		\$812
• Depth	25"	• Warranty
• Width	30"	• Certifications
• Height	18"	5 Years
• Weight	18 lbs	BIFMA Compliant

Options

Color	Dry Erase Board	No cost
	Walnut	+\$275
	White Marble	+\$765



Lily Pad Nesting Table, 20 In

Style Number		List Price
WEM60		\$825
• Depth	25"	• Warranty
• Width	30"	• Certifications
• Height	20"	5 Years
• Weight	20 lbs	BIFMA Level 1/SCS Indoor Advantage [®]

Options

Color	Dry Erase Board	No cost
	Walnut	+\$301
	White Marble	+\$791

Linear

Occasional Tables



Linear C Table

Style Number

List Price

WEM8

\$673

- Depth 13.5"
- Width 24"
- Height 26.5"
- Weight 38 lbs

- Warranty 5 Years
- Certifications BIFMA Compliant

Options

Color Natural Oak No cost



Maisie

Occasional Tables



Maisie Side Table, 22 In

Style Number			List Price
WEM11			\$851
• Depth	18"	• Warranty	5 Years
• Width	18"	• Certifications	BIFMA Compliant
• Height	22"		Indoor Advantage
• Weight	35 lbs		

Options

Color	Walnut	No cost
	Marble	+\$222



Maisie Side Table, 25 In

Style Number			List Price
WEM4			\$884
• Depth	18"	• Warranty	5 Years
• Width	18"	• Certifications	BIFMA Compliant
• Height	25"		
• Weight	35 lbs		

Options

Color	Walnut	No cost
	Marble	+\$229

Mesa

Occasional Tables



Mesa Sectional Coffee Table

Style Number

WEM68

- Depth 32"
- Width 32"
- Height 12"
- Weight 20 lbs

List Price

\$1624

- Warranty
- Certifications

Limited Lifetime
BIFMA Compliant

Options

Color Black No cost



Nolan

Occasional Tables

X 10/24



Nolan Side Table

Style Number

WEM9 X10/24

List Price

\$525

- Depth 14"
- Width 14"
- Height 18"
- Weight 10 lbs

- Warranty 5 Years
- Certifications BIFMA Compliant

Options

Color

Antique Brass

No cost

X10/24 = Last order entry
October 20, 2024

Stump Side Table

Occasional Tables

X 10/24



Tip: This style number is subject to inventory availability.

Stump Side Table		
Style Number		List Price
WEM5 X 10/24		\$668
• Depth	12.5"	• Warranty
• Width	12.5"	• Certifications
• Height	19"	5 Years
• Weight	25 lbs	BIFMA Compliant
Options		
Color	Cypress	No cost

Stump Side Table

X 10/24 = Last order entry
October 20, 2024

Accessories

Linear Led Light

X 10/24



Linear Wood LED Task Lamp

Style Number		List Price	
WEM61 X10/24		\$374	
• Depth	16"	• Warranty	5 Years
• Width	16"	• Certifications	BIFMA Compliant
• Height	18"		
• Weight	6 lbs		

Options

Color	Walnut	No cost
-------	--------	---------

X10/24 = Last order entry
October 20, 2024

Resources and Surface Materials

Surface Materials	258
Color Availability Matrix	
Plastic, Metal, and Paint Availability Matrix	260
Laminate Availability Matrix	264
Wood Availability Matrix	268
Upholstery Matrix	272
Lock and Keying Options	274
Style Number Index	276

Surface Materials

Wood

Tip: Known for its uniqueness, planked veneer has intentional and natural variations that include, but are not limited to: character marks, grain pattern, color, and natural color aging.

Select Surfaces

For information on products within Select Surfaces, including accent paints and fabrics from Designtex, Gabriel, Kvadrat, and Pollack, please refer to the *Surface Materials Reference Manual* or visit steelcase.com/surface-materials under the Select Surfaces section.

Composite Veneer

Composite veneers are an engineered wood intended to create specific grain patterns and characteristics. They are pre-stained and finished with Steelcase's Clarity water-borne UV topcoat, which protects the environment while providing durability and clarity. Only open-pore finishes are available on composite wood. Composite veneers with natural solid nosings because composite and natural wood grain and color matching are rarely compatible. Composite veneers are Select Surfaces and available as Wood Group 1 pricing.

Upholstery

Select Surfaces Program: Upholstery

Applies to:

- Belle
- Boardwalk
- Brighton
- Mesa
- Willow
- Slope
- Sterling

A collection of textiles

are available as part of a Select Surfaces Program. The collection from the leading suppliers in the market consists of high-performance textiles.

To order these fabrics, enter the finish code which corresponds with the fabric price group.

Price Group	Finish Code
1	59DA
2	59DB
3	59DC
4	59DD
5	59DE
6	59DF
7	59DG
8	59DH
9	59DJ
10	59DK

Then enter the fabric information in the Special Fabric Information pop up window.

Custom Surfaces

Price Group COM (Customer's Own Material)

Fabric Approval and Yardage To confirm whether a particular COM material has already been tested for use on a specific Steelcase product or to determine actual yardage requirements:

- Visit www.steelcase.com

Visit <https://srh.steelcase.com/comcalculator.aspx> for Steelcase Textile calculator.

For additional information regarding Customer's Own Material, call

1.888.STEELCASE (1.888.783.3522) or send an e-mail to lineone@steelcase.com.

Laminate

Tip: When selecting a Steelcase top surface finish, a corresponding Steelcase edge finish must be selected. When selecting West Elm top surface finish, a corresponding West Elm edge finish must be selected.

Color Availability Matrix

Plastic, Metal, and Paint Availability Matrix

Legend

- = Not available
- = Available
- = Available with exceptions
- ⊕ = Established
- ▶ See specification pages for details.

		Plastic Price Group 1		Paint Price Group 1 (Accessory)		Paint Price Group 1 (Smooth)		Paint Price Group 1 (Textured)													
		6000 Black	6052 Milk	4140 Arctic White Gloss	4144 Black Gloss	4238 Mocha	4239 Clay	4240 Chalk	4242 Milk	4710 Low Gloss Black	WE00 Hot Rolled Steel	WE01 Antique Bronze	7207 Black	7225 Sand	7237 Slate	7238 Fieldstone	7239 Midnight	7241 Arctic White	7243 Seagull	7250 Sterling Dark Solid	
Boardwalk	Platform	•	•	•	•	•	•	•	•	•	•	•	•	•	•	•	•	•	•	•	•
	Legs	•	•	•	•	•	•	•	•	•	•	•	•	•	•	•	•	•	•	•	•
Brighton	Table top	•	•	•	•	•	•	•	•	•	•	•	•	•	•	•	•	•	•	•	•
	Frame	•	•	■	■	■	■	■	■	■	•	•	■	■	■	■	■	■	■	■	■
	Foot and frame caps	•	•	■	■	■	■	■	■	■	■	•	•	■	■	■	■	■	■	■	■
	Hardwood arms	•	•	•	•	•	•	•	•	•	•	•	•	•	•	•	•	•	•	•	•
	Power	■	■	•	•	•	•	•	•	•	•	•	•	•	•	•	•	•	•	•	•
	Mesa	Feet	•	•	•	•	•	•	•	•	•	•	■	•	•	•	•	•	•	•	•
Willow	Fixed base	•	•	•	•	•	•	•	•	•	•	•	•	•	•	•	•	•	•	•	•
	Swivel base	•	•	•	•	•	•	•	•	•	•	•	•	•	•	•	•	•	•	•	•
Slope*	Wire frame base	•	•	■	■	■	■	■	■	■	•	•	■	■	■	■	■	■	■	■	■
	Five-star base	•	•	•	•	•	•	•	•	•	■	•	•	•	•	•	•	•	•	•	•
Sterling	Five-star base	•	•	•	•	•	•	•	•	■	■	•	•	•	•	•	•	•	•	•	•
	Four-star base	•	•	•	•	•	•	•	•	•	•	•	•	•	•	•	•	•	•	•	•
	Hardwood legs	•	•	•	•	•	•	•	•	•	•	•	•	•	•	•	•	•	•	•	•
Kent	Five-star base	•	•	■	■	■	■	■	■	■	•	•	■	■	■	■	■	■	■	■	■
	Four-star base	•	•	■	■	■	■	■	■	■	•	•	■	■	■	■	■	■	■	■	■
	Four-leg base	•	•	■	■	■	■	■	■	■	•	•	■	■	■	■	■	■	■	■	■
	Stool	•	•	■	■	■	■	■	■	■	•	•	■	■	■	■	■	■	■	■	■
Greenpoint	Desk and bench frames	•	•	■	■	■	■	■	■	■	•	•	■	■	■	■	■	■	■	■	■
	Desk and bench worksurfaces	•	•	•	•	•	•	•	•	•	•	•	•	•	•	•	•	•	•	•	•
	Storage frames and metal bodies	•	•	■	■	■	■	■	■	■	•	•	■	■	■	■	■	■	■	■	■
	Wood storage—bodies, faces, and shelves	•	•	•	•	•	•	•	•	•	•	•	•	•	•	•	•	•	•	•	•
	Metal storage—faces and shelves	•	•	•	•	•	•	•	•	•	•	•	•	•	•	•	•	•	•	•	•
	Power	•	•	•	■	■	■	■	■	■	•	•	•	•	•	•	•	•	•	•	•
	Brackets	•	•	■	■	■	■	■	■	■	•	•	■	■	■	■	■	■	■	■	■
Sutton HAD	Top	•	•	•	•	•	•	•	•	•	•	•	•	•	•	•	•	•	•	•	•
	Foot	•	•	•	•	•	•	•	•	•	•	•	•	•	•	•	•	•	•	•	•
	Base	•	•	•	•	•	•	•	•	•	•	•	■	•	•	•	•	•	■	•	•
	Leg Ring	•	•	■	■	■	■	■	■	■	•	•	■	■	■	■	■	■	■	■	■

* Paint options available on Steelcase Slope shown. Licensed Slope (stocked) frame will be defaulted to WE00 Hot Rolled Steel.
 Exception: Aegean leather Slope (stocked) frame is defaulted to Antique Brass.

Color Availability Matrix, continued

Plastic, Metal, and Paint Availability Matrix, continued

Legend

- = Not available
- = Available
- = Available with exceptions
- ▶ See specification pages for details.

		Paint Price Group 3 (Accent)								Paint Price Group 3 (Smooth)	Paint Price Group 3 (Coatings)	Paint Price Group 3 (Lux Coatings)																											
		1ATG	Rose Quartz	4AV3	Blue Jay	4AV4	Baltic	4AX1	Citron	4AY2	Chili	4AZ5	Marlin	4CZ5	Honey	4CZ6	Lagoon	4CZ8	Light Peacock	WE03	Antique Brass	1ATT	Cast Shadow	4B20	Obsidian	4B22	Matte Brass	4B23	Burnished Bronze	4B24	Night Bronze	4B25	Matte Copper	4B26	Smoked Mica	4B29	Cast Iron		
Boardwalk	Platform	•	•	•	•	•	•	•	•	•	•	•	•	•	•	•	•	•	•	•	•	•	•	•	•	•	•	•	•	•	•	•	•	•	•	•	•		
	Legs	•	•	•	•	•	•	•	•	•	•	•	•	•	•	•	•	•	•	•	•	•	•	•	•	•	•	•	•	•	•	•	•	•	•	•	•	•	
Brighton	Table top	•	•	•	•	•	•	•	•	•	•	•	•	•	•	•	•	•	•	•	•	•	•	•	•	•	•	•	•	•	•	•	•	•	•	•	•		
	Frame	■	■	■	■	■	■	■	■	■	■	■	■	■	■	■	■	■	■	■	•	■	■	■	■	■	■	■	■	■	■	■	■	■	■	■	■	■	
	Foot and frame caps	■	■	■	■	■	■	■	■	■	■	■	■	■	■	■	■	■	■	■	■	■	■	■	■	■	■	■	■	■	■	■	■	■	■	■	■	■	
	Hardwood arms	•	•	•	•	•	•	•	•	•	•	•	•	•	•	•	•	•	•	•	•	•	•	•	•	•	•	•	•	•	•	•	•	•	•	•	•	•	
	Power	•	•	•	•	•	•	•	•	•	•	•	•	•	•	•	•	•	•	•	•	•	•	•	•	•	•	•	•	•	•	•	•	•	•	•	•	•	
	Mesa	Feet	•	•	•	•	•	•	•	•	•	•	•	•	•	•	•	•	•	•	•	•	•	•	•	•	•	•	•	•	•	•	•	•	•	•	•	•	
Willow	Fixed base	•	•	•	•	•	•	•	•	•	•	•	•	•	•	•	•	•	•	•	•	•	•	•	•	•	•	•	•	•	•	•	•	•	•	•	•		
	Swivel base	•	•	•	•	•	•	•	•	•	•	•	•	•	•	•	•	•	•	•	•	•	•	•	•	•	•	•	•	•	•	•	•	•	•	•	•	•	
Slope*	Wire frame base	■	■	■	■	■	■	■	■	■	■	■	■	■	■	■	■	■	■	•	■	■	■	■	■	■	■	■	■	■	■	■	■	■	■	■	■	■	
	Five-star base	•	•	•	•	•	•	•	•	•	•	•	•	•	•	•	•	•	•	•	•	•	•	•	•	•	•	•	•	•	•	•	•	•	•	•	•	•	
Sterling	Five-star base	•	•	•	•	•	•	•	•	•	•	•	•	•	•	•	•	•	•	•	•	•	•	•	•	■	•	•	■	•	•	•	•	•	•	•	•	•	
	Four-star base	•	•	•	•	•	•	•	•	•	•	•	•	•	•	•	•	•	•	•	•	•	•	•	•	•	•	•	•	•	•	•	•	•	•	•	•	•	
	Hardwood legs	•	•	•	•	•	•	•	•	•	•	•	•	•	•	•	•	•	•	•	•	•	•	•	•	•	•	•	•	•	•	•	•	•	•	•	•	•	
Kent	Five-star base	■	■	■	■	■	■	■	■	■	■	■	■	■	■	■	■	■	■	•	■	■	■	■	■	■	■	■	■	■	■	■	■	■	■	■	■	■	
	Four-star base	■	■	■	■	■	■	■	■	■	■	■	■	■	■	■	■	■	■	•	■	■	■	■	■	■	■	■	■	■	■	■	■	■	■	■	■	■	■
	Four-leg base	■	■	■	■	■	■	■	■	■	■	■	■	■	■	■	■	■	■	•	■	■	■	■	■	■	■	■	■	■	■	■	■	■	■	■	■	■	■
	Stool	■	■	■	■	■	■	■	■	■	■	■	■	■	■	■	■	■	■	•	■	■	■	■	■	■	■	■	■	■	■	■	■	■	■	■	■	■	■
Greenpoint	Desk and bench frames	■	■	■	■	■	■	■	■	■	■	■	■	■	■	■	■	■	■	■	■	■	■	■	■	■	■	■	■	■	■	■	■	■	■	■	■	■	
	Desk and bench worksurfaces	•	•	•	•	•	•	•	•	•	•	•	•	•	•	•	•	•	•	•	•	•	•	•	•	•	•	•	•	•	•	•	•	•	•	•	•	•	
	Storage frames and metal bodies	■	■	■	■	■	■	■	■	■	■	■	■	■	■	■	■	■	■	■	■	■	■	■	■	■	■	■	■	■	■	■	■	■	■	■	■	■	■
	Wood storage—bodies, faces, and shelves	•	•	•	•	•	•	•	•	•	•	•	•	•	•	•	•	•	•	•	•	•	•	•	•	•	•	•	•	•	•	•	•	•	•	•	•	•	
	Metal storage—faces and shelves	•	•	•	•	•	•	•	•	•	•	•	•	•	•	•	•	•	•	•	•	•	•	•	•	•	•	•	•	•	•	•	•	•	•	•	•	•	
	Power	•	•	•	•	•	•	•	•	•	•	•	•	•	•	•	•	•	•	•	•	•	•	•	•	•	•	•	•	•	•	•	•	•	•	•	•	•	
Sutton HAD	Brackets	■	■	■	■	■	■	■	■	■	■	■	■	■	■	■	■	■	■	•	■	■	■	■	■	■	■	■	■	■	■	■	■	■	■	■	■	■	■
Sutton HAD	Top	•	•	•	•	•	•	•	•	•	•	•	•	•	•	•	•	•	•	•	•	•	•	•	•	•	•	•	•	•	•	•	•	•	•	•	•	•	
	Foot	■	■	■	■	■	■	■	■	■	■	■	■	■	■	■	■	■	■	■	•	■	■	■	■	■	■	■	■	■	■	■	■	■	■	■	■	■	■
	Base	□	□	□	□	□	□	□	□	□	□	□	□	□	□	□	□	□	□	□	□	□	□	□	□	■	■	■	■	■	■	■	■	■	■	■	■	■	■
	Leg Ring	■	■	■	■	■	■	■	■	■	■	■	■	■	■	■	■	■	■	■	•	■	■	■	■	■	■	■	■	■	■	■	■	■	■	■	■	■	■

* Paint options available on Steelcase Slope shown. Licensed Slope (stocked) frame will be defaulted to WE00 Hot Rolled Steel.
 Exception: Aegean leather Slope (stocked) frame is defaulted to Antique Brass.

Laminate Availability Matrix

Legend

- = Not available
- = Available
- = Available with exceptions
- Ⓜ = Established
- ▶ See specification pages for details.

		HPL Price Group 1 (Woodgrain)	2406 Clear Cherry Ⓜ	2409 Clear Maple	2410 Graphite Walnut	2412 Natural Cherry	2422 Medium Cherry	2503 Brushed Silver	2511 Winter on Maple	2535 Virginia Walnut	2536 Blackwood Ⓜ	2538 Clear Walnut	2539 Warm Oak	2592 Blonde on Maple	2612 Marbled Maple Ⓜ	2614 Chocolate Walnut	2615 Marbled Cherry V2	2714 Natural Walnut	2759 Warm White	2772 Medium Mahogany on Walnut	2822 Woodrose Speckle	2851 Rhyme Fiber	2923 Shadow Micro	2HAK Clear Oak	2HAN Ash Noce
Boardwalk	Platform	■	■	■	■	■	■	■	■	■	■	■	■	■	■	■	■	■	■	■	■	■	■	■	■
	Legs	•	•	•	•	•	•	•	•	•	•	•	•	•	•	•	•	•	•	•	•	•	•	•	•
Brighton	Table top	■	■	■	■	■	•	■	■	■	■	■	■	■	■	■	■	■	•	■	•	•	•	■	■
	Frame	•	•	•	•	•	•	•	•	•	•	•	•	•	•	•	•	•	•	•	•	•	•	•	•
	Foot and frame caps	•	•	•	•	•	•	•	•	•	•	•	•	•	•	•	•	•	•	•	•	•	•	•	•
	Hardwood arms	•	•	•	•	•	•	•	•	•	•	•	•	•	•	•	•	•	•	•	•	•	•	•	•
	Power	•	•	•	•	•	•	•	•	•	•	•	•	•	•	•	•	•	•	•	•	•	•	•	•
Mesa	Feet	•	•	•	•	•	•	•	•	•	•	•	•	•	•	•	•	•	•	•	•	•	•	•	•
Willow	Fixed base	•	•	•	•	•	•	•	•	•	•	•	•	•	•	•	•	•	•	•	•	•	•	•	•
	Swivel base	•	•	•	•	•	•	•	•	•	•	•	•	•	•	•	•	•	•	•	•	•	•	•	•
Slope	Wire frame base	•	•	•	•	•	•	•	•	•	•	•	•	•	•	•	•	•	•	•	•	•	•	•	•
	Five-star base	•	•	•	•	•	•	•	•	•	•	•	•	•	•	•	•	•	•	•	•	•	•	•	•
Sterling	Five-star base	•	•	•	•	•	•	•	•	•	•	•	•	•	•	•	•	•	•	•	•	•	•	•	•
	Four-star base	•	•	•	•	•	•	•	•	•	•	•	•	•	•	•	•	•	•	•	•	•	•	•	•
	Hardwood legs	•	•	•	•	•	•	•	•	•	•	•	•	•	•	•	•	•	•	•	•	•	•	•	•
Kent	Five-star base	•	•	•	•	•	•	•	•	•	•	•	•	•	•	•	•	•	•	•	•	•	•	•	•
	Four-star base	•	•	•	•	•	•	•	•	•	•	•	•	•	•	•	•	•	•	•	•	•	•	•	•
	Four-leg base	•	•	•	•	•	•	•	•	•	•	•	•	•	•	•	•	•	•	•	•	•	•	•	•
	Stool	•	•	•	•	•	•	•	•	•	•	•	•	•	•	•	•	•	•	•	•	•	•	•	•
Greenpoint	Desk and bench frames	•	•	•	•	•	•	•	•	•	•	•	•	•	•	•	•	•	•	•	•	•	•	•	•
	Desk and bench worksurfaces	■	■	■	■	■	•	■	■	■	■	■	■	■	■	■	■	■	•	■	•	•	•	■	■
	Storage frames and metal bodies	•	•	•	•	•	•	•	•	•	•	•	•	•	•	•	•	•	•	•	•	•	•	•	•
	Wood storage—bodies, faces, and shelves	□	□	□	□	□	•	□	□	□	□	□	□	□	□	□	□	□	•	□	•	•	•	□	■
	Metal storage—faces and shelves	•	•	•	•	•	•	•	•	•	•	•	•	•	•	•	•	•	•	•	•	•	•	•	■
Power	•	•	•	•	•	•	•	•	•	•	•	•	•	•	•	•	•	•	•	•	•	•	•	•	•
Sutton HAD	Top	■	■	■	■	■	■	•	•	•	•	■	•	■	■	■	■	•	•	■	■	■	■	•	•
	Foot	■	■	■	■	■	■	■	■	■	■	■	■	■	■	■	■	■	■	■	■	■	■	■	■
	Base	■	■	■	■	■	■	■	■	■	■	■	■	■	■	■	■	■	■	■	■	■	■	■	■
	Leg Ring	■	■	■	■	■	■	■	■	■	■	■	■	■	■	■	■	■	■	■	■	■	■	■	■

Laminate Availability Matrix, continued

Legend

- = Not available
- = Available
- = Available with exceptions
- Ⓜ = Established
- ▶ See specification pages for details.

		HPL Price Group 1 (Solid)								HPL Price Group 1 (Speckle)				HPL Price Group 2 (Textured)								
		2722 Cream	2730 Arctic White	2746 Black	2759 Warm White	2811 Mist Ⓜ	2883 Seagull	2884 Milk	2885 Dune	2HMG Merle	2820 Coffee Speckle	2823 Driftwood Speckle	2824 Smoke Speckle	2825 Vanadium Speckle	2TH2 Fawn Cypress	2TH4 Saddle Oak	2TH5 Veranda Teak	2TH7 Walnut Heights	2UH1 Reclaimed Aggregate	2UH2 Reclaimed Gravel	2UH4 Cement	2UH6 Sheetrock
Boardwalk	Platform	■	■	■	■	■	■	■	■	■	■	■	■	■	■	■	■	■	■	■	■	■
	Legs	•	•	•	•	•	•	•	•	•	•	•	•	•	•	•	•	•	•	•	•	•
Brighton	Table top	■	■	■	■	■	■	■	■	■	■	■	■	■	■	■	■	■	■	■	■	■
	Frame	•	•	•	•	•	•	•	•	•	•	•	•	•	•	•	•	•	•	•	•	•
	Foot and frame caps	•	•	•	•	•	•	•	•	•	•	•	•	•	•	•	•	•	•	•	•	•
	Hardwood arms	•	•	•	•	•	•	•	•	•	•	•	•	•	•	•	•	•	•	•	•	•
	Power	•	•	•	•	•	•	•	•	•	•	•	•	•	•	•	•	•	•	•	•	•
Mesa	Feet	•	•	•	•	•	•	•	•	•	•	•	•	•	•	•	•	•	•	•	•	•
Willow	Fixed base	•	•	•	•	•	•	•	•	•	•	•	•	•	•	•	•	•	•	•	•	•
	Swivel base	•	•	•	•	•	•	•	•	•	•	•	•	•	•	•	•	•	•	•	•	•
Slope	Wire frame base	•	•	•	•	•	•	•	•	•	•	•	•	•	•	•	•	•	•	•	•	•
	Five-star base	•	•	•	•	•	•	•	•	•	•	•	•	•	•	•	•	•	•	•	•	•
Sterling	Five-star base	•	•	•	•	•	•	•	•	•	•	•	•	•	•	•	•	•	•	•	•	•
	Four-star base	•	•	•	•	•	•	•	•	•	•	•	•	•	•	•	•	•	•	•	•	•
	Hardwood legs	•	•	•	•	•	•	•	•	•	•	•	•	•	•	•	•	•	•	•	•	•
Kent	Five-star base	•	•	•	•	•	•	•	•	•	•	•	•	•	•	•	•	•	•	•	•	•
	Four-star base	•	•	•	•	•	•	•	•	•	•	•	•	•	•	•	•	•	•	•	•	•
	Four-leg base	•	•	•	•	•	•	•	•	•	•	•	•	•	•	•	•	•	•	•	•	•
	Stool	•	•	•	•	•	•	•	•	•	•	•	•	•	•	•	•	•	•	•	•	•
Greenpoint	Desk and bench frames	•	•	•	•	•	•	•	•	•	•	•	•	•	•	•	•	•	•	•	•	•
	Desk and bench worksurfaces	■	■	■	■	■	■	■	■	■	■	■	■	■	■	■	■	■	■	■	■	■
	Storage frames and metal bodies	•	•	•	•	•	•	•	•	•	•	•	•	•	•	•	•	•	•	•	•	•
	Wood storage—bodies, faces, and shelves	□	□	□	□	□	□	■	□	■	□	□	□	□	□	□	□	□	□	□	□	□
	Metal storage—faces and shelves	•	•	•	•	•	•	■	•	■	•	•	•	•	•	•	•	•	•	•	•	•
Power	•	•	•	•	•	•	•	•	•	•	•	•	•	•	•	•	•	•	•	•	•	•
Sutton HAD	Top	•	•	•	•	•	•	•	•	•	•	•	•	•	•	•	•	•	•	•	•	■
	Foot	■	■	■	■	■	■	■	■	■	■	■	■	■	■	■	■	■	■	■	■	■
	Base	■	■	■	■	■	■	■	■	■	■	■	■	■	■	■	■	■	■	■	■	■
	Leg Ring	■	■	■	■	■	■	■	■	■	■	■	■	■	■	■	■	■	■	■	■	■

Wood Availability Matrix

Legend

- = Not available
- = Available
- = Available with exceptions
- Ⓜ = Established
- ▶ See specification pages for details.

		Wood	Price Group 1 (Flat Cut)																			
			Cherry			Maple			Walnut													
			3402	3412	3422	V1AC	V1CC	3522	3592	35A2	V1AM	3062	3082	3342	3702	3712	3752	3762	3772	37A2	V1EW	
			FC/OP Clear Cherry (Aged)	FC/OP Natural Cherry Ⓜ	FC/OP Medium Cherry	FC/OP Natural Cherry	FC/OP Medium Amber Cherry	FC/OP Clear Maple	FC/OP Blonde on Maple	FC/OP Blanch Maple	FC/OP Clear Maple	FC/OP Graphite Walnut	FC/OP Washed Walnut	FC/OP Black Walnut	FC/OP Clear Walnut	FC/OP Natural Walnut	FC/OP Medium Walnut Ⓜ	FC/OP Dark Walnut	FC/OP Medium Mahogany on Walnut	FC/OP Thunder Walnut	FC/OP Dark Walnut	
Boardwalk	Platform		•	•	•	•	•	•	•	•	•	•	•	•	•	•	•	•	•	•	•	•
	Legs		•	•	•	•	•	•	•	•	•	•	•	•	•	•	•	•	•	•	•	•
Brighton	Table top		■	■	■	■	■	■	■	■	■	■	■	■	■	■	■	■	■	■	■	■
	Frame		•	•	•	•	•	•	•	•	•	•	•	•	•	•	•	•	•	•	•	•
	Foot and frame caps		•	•	•	•	•	•	•	•	•	•	•	•	•	•	•	•	•	•	•	•
	Hardwood arms		•	•	•	•	•	•	•	•	•	•	•	•	•	•	•	•	•	•	•	•
	Power		•	•	•	•	•	•	•	•	•	•	•	•	•	•	•	•	•	•	•	•
Mesa	Feet		•	•	•	•	•	•	•	•	•	•	•	•	•	•	•	•	•	•	•	•
Willow	Fixed base		•	•	•	•	•	•	•	•	•	•	•	•	•	•	•	•	•	•	•	•
	Swivel base		•	•	•	•	•	•	•	•	•	•	•	•	•	•	•	•	•	•	•	•
Slope	Wire frame base		•	•	•	•	•	•	•	•	•	•	•	•	•	•	•	•	•	•	•	•
	Five-star base		•	•	•	•	•	•	•	•	•	•	•	•	•	•	•	•	•	•	•	•
Sterling	Five-star base		•	•	•	•	•	•	•	•	•	•	•	•	•	•	•	•	•	•	•	•
	Four-star base		•	•	•	•	•	•	•	•	•	•	•	•	•	•	•	•	•	•	•	•
	Hardwood legs		•	•	•	•	•	•	•	•	•	•	•	•	•	•	•	•	•	•	•	•
Kent	Five-star base		•	•	•	•	•	•	•	•	•	•	•	•	•	•	•	•	•	•	•	•
	Four-star base		•	•	•	•	•	•	•	•	•	•	•	•	•	•	•	•	•	•	•	•
	Four-leg base		•	•	•	•	•	•	•	•	•	•	•	•	•	•	•	•	•	•	•	•
	Stool		•	•	•	•	•	•	•	•	•	•	•	•	•	•	•	•	•	•	•	•
Greenpoint	Desk and bench frames		•	•	•	•	•	•	•	•	•	•	•	•	•	•	•	•	•	•	•	•
	Desk and bench worksurfaces		■	■	■	•	•	■	■	■	•	■	•	■	■	■	■	■	■	■	■	•
	Storage frames and metal bodies		•	•	•	•	•	•	•	•	•	•	•	•	•	•	•	•	•	•	•	•
	Wood storage—bodies, faces, and shelves		□	□	□	•	•	□	□	□	•	□	•	□	□	□	□	□	□	■	•	•
	Metal storage—faces and shelves		•	•	•	•	•	•	•	•	•	•	•	•	•	•	•	•	•	•	■	•
Power		•	•	•	•	•	•	•	•	•	•	•	•	•	•	•	•	•	•	•	•	•
Sutton HAD	Top		•	•	•	■	■	•	•	•	■	•	•	•	•	•	•	•	•	•	•	■
	Foot		■	■	■	■	■	■	■	■	■	■	■	■	■	■	■	■	■	■	■	■
	Base		■	■	■	■	■	■	■	■	■	■	■	■	■	■	■	■	■	■	■	■
	Leg Ring		■	■	■	■	■	■	■	■	■	■	■	■	■	■	■	■	■	■	■	■

Wood Availability Matrix, continued

Legend

- = Not available
- = Available
- = Available with exceptions
- Ⓜ = Established
- ▶ See specification pages for details.

		Wood, continued				Price Group 1 (Planked)					Price Group 1 (Hardwood)				
		Price Group 1 (Rift Cut)				Cherry	Maple	Oak	Walnut	Oak					
		3602 RC/OP Desert Oak	3611 RC/OP Natural Oak	3612 RC/OP Warm Oak	36A2 RC/OP Volcanic Oak	3P41 OP Planked Cherry	3P51 OP Planked Maple	3P61 OP Planked Oak	3VFX OP Natural Recon	WE20 OP Natural Oak	3P71 OP Planked Walnut	VP01 RC/LS Light Oak	VP03 RC/LS Black Oak	VP04 RC/LS Gray Oak	VP05 RC/LS White Oak
Boardwalk	Platform	■	■	■	■	•	•	■	■	•	•	•	•	•	•
	Legs	•	•	•	•	•	•	•	•	•	•	■	■	•	■
Brighton	Table top	■	■	■	■	■	■	■	■	•	■	•	•	•	•
	Frame	•	•	•	•	•	•	•	•	•	•	•	•	•	•
	Foot and frame caps	•	•	•	•	•	•	•	•	•	•	•	•	•	•
	Hardwood arms	•	•	•	•	•	•	•	•	•	•	■	■	■	■
	Power	•	•	•	•	•	•	•	•	•	•	•	•	•	•
Mesa	Feet	•	•	•	•	•	•	•	•	•	•	•	•	•	•
Willow	Fixed base	•	•	•	•	•	•	•	•	•	•	•	•	•	•
	Swivel base	•	•	•	•	•	•	•	•	•	•	•	•	•	•
Slope	Wire frame base	•	•	•	•	•	•	•	•	•	•	•	•	•	•
	Five-star base	•	•	•	•	•	•	•	•	•	•	•	•	•	•
Sterling	Five-star base	•	•	•	•	•	•	•	•	•	•	•	•	•	•
	Four-star base	•	•	•	•	•	•	•	•	•	•	■	■	■	■
	Hardwood legs	•	•	•	•	•	•	•	•	•	•	■	■	■	■
Kent	Five-star base	•	•	•	•	•	•	•	•	•	•	•	•	•	•
	Four-star base	•	•	•	•	•	•	•	•	•	•	•	•	•	•
	Four-leg base	•	•	•	•	•	•	•	•	•	•	•	•	•	•
	Stool	•	•	•	•	•	•	•	•	•	•	•	•	•	•
Greenpoint	Desk and bench frames	•	•	•	•	•	•	•	•	•	•	•	•	•	•
	Desk and bench worksurfaces	■	•	•	■	■	■	■	■	■	■	•	•	•	•
	Storage frames and metal bodies	•	•	•	•	•	•	•	•	•	•	•	•	•	•
	Wood storage—bodies, faces, and shelves	□	•	•	■	□	□	□	□	■	□	•	•	•	•
	Metal storage—faces and shelves	•	•	•	■	•	•	•	•	■	•	•	•	•	•
Power	•	•	•	•	•	•	•	•	•	•	•	•	•	•	
Sutton HAD	Top	•	•	•	•	•	•	•	•	•	•	•	•	•	•

Price Group 2 (Flat Cut)		Cherry	Maple	Walnut			Comp Veneer
		3404 FC/FF Clear Cherry (Aged)					
		3414 FC/FF Natural Cherry E					
		3424 FC/FF Medium Cherry					
		3524 FC/FF Clear Maple					
		3544 FC/FF Blonde Maple E					
		3064 FC/FF Graphite Walnut					
		3704 FC/FF Clear Walnut					
		3714 FC/FF Natural Walnut					
		3734 FC/FF Black Walnut					
		3754 FC/FF Medium Walnut E					
		3764 FC/FF Dark Walnut					
		3774 FC/FF Medium Mahogany on Walnut					
		3LHX FC/OP Espresso on Walnut Composite					
Price Group 2 (Quarter Cut)		Maple	Walnut			Composite Veneer	
		3224 QC/FF Clear Maple					
		3294 QC/FF Blonde on Maple					
		3304 QC/FF Clear Walnut					
		3314 QC/FF Natural Walnut					
		3324 QC/FF Dark Mahogany on Walnut					
		3354 QC/FF Medium Walnut					
		3364 QC/FF Dark Walnut					
		3374 QC/FF Medium Mahogany on Walnut					
		3384 QC/FF Graphite Walnut					
		3394 QC/FF Black Walnut					
		3LEX QC/OP Desert Oak on Oak Composite					
		3LGX QC/OP Chai on Walnut Composite					
		3LJX QC/OP Ebony on Walnut Composite					
Price Group 2 (Rift Cut)		Oak					
		3604 RC/FF Desert Oak					
		3614 RC/FF Warm Oak					

Upholstery Matrix

Legend

- = Available in the default direction
- V = Only available in the vertical direction
- H = Only available in the horizontal direction
- = Not available

	Price Group	Belle	Boardwalk	Brighton	Kent	Lucas Wire and Swivel	Mesa	Slope	Sterling	Willow
3014 Speckle Boucle	6	•	■	H	■	■	■	•	■	■
3018 Cube Geo	6	V	■	H	■	•	•	•	■	•
3019 Boucle Houndstooth	6	V	■	H	■	■	■	H	■	■
3020 Plush Grid	6	•	■	•	■	•	•	•	•	•
3063 Cozy Texture	4	V	•	H	•	•	■	H	■	•
3064 Tweedy Twill	4	V	■	H	■	■	■	H	■	■
3170 Corded	7	•	•	H	•	■	■	•	■	■
3171 Boucle Melange	7	V	■	H	■	■	■	•	■	■
3172 Chunky Tweed	7	•	•	H	•	■	■	H	■	■
3173 Chenille Chevron	7	•	•	H	•	•	•	■	■	•
3722 Tweed Multi	3	V	■	■	■	■	■	■	■	■
3741 Tiny Herringbone	6	V	■	■	■	■	•	■	■	•
3746 Bark Cloth	6	V	■	■	■	■	■	■	■	■
3747 Reppweave	5	V	■	H	■	■	■	•	■	■
3748 Starburst	7	V	■	•	■	•	•	•	■	•
3749 Tack Cloth	6	V	■	•	■	•	•	■	■	•
3752 Hem Stitch	5	V	■	■	■	■	■	•	■	■
3761 Hatchmark	8	V	■	■	■	■	•	■	■	•
3762 Crossweave	4	V	■	■	■	■	■	■	■	■
3797 Brushed Flannel	4	V	■	■	■	■	■	■	■	■
3815 Big Texture	7	V	■	■	■	■	■	■	■	■
3928 Linen Like	5	V	■	■	•	•	■	■	■	•
3931 Fomo	5	V	■	■	■	■	■	V	■	■
3935 Distressed Texture	7	V	■	■	•	•	■	■	■	•
4142 Birdseye	2	V	■	■	■	■	■	•	■	■
4144 Cloud Velvet	4	V	■	■	■	■	■	■	■	■
Mont Blanc - Moore & Giles	L	•	■	H	■	■	■	•	■	■

* Upholstery available on Steelcase Slope shown.
Licensed slope available only in saddle, fog, and aegean leather.

Legend

- = Not available
- = Available
- = Available with exceptions
- ▶ See specification pages for details.

Steelcase

Price Group 1

	Belle	Boardwalk	Brighton	Fulton	Kent	Mesa	Willow	Slope*	Sterling
Buzz2	■	■	■	■	■	■	■	■	■
Era	■	■	■	■	■	■	■	■	■
Foundation	•	■	■	■	■	•	■	•	■
Jacks	■	■	■	■	■	■	•	■	■
Link	•	■	■	■	■	■	■	■	■
New Black: Henry and Bruce	■	■	■	■	■	■	■	■	■

Price Group 2

Chainmail	■	■	■	■	■	■	■	■	■
Cogent: Connect	■	■	■	■	■	■	■	■	■
Dovetail by Designtex	■	■	■	■	■	■	■	■	■
New Black: James, Harley, Jack	■	■	■	■	■	■	■	■	■
Nitelights	■	■	■	■	■	■	■	■	■
SoftNext	■	■	■	■	■	■	■	■	■
Spyder	•	■	■	•	■	■	•	•	■
Stand In	•	•	■	■	■	•	■	•	•

Price Group 3

Billiard Multi-Use by Designtex	■	■	■	■	■	■	■	■	■
Gaja	■	■	■	■	■	■	■	■	■
Redeem	■	■	■	■	■	■	■	■	■
Retrieve	■	■	■	■	■	■	■	■	■
Tweed Multi by Designtex**	•	•	•	■	■	•	■	•	•

Price Group 4

Cloud Velvet by Designtex***	•	•	•	■	■	•	■	•	•
------------------------------	---	---	---	---	---	---	---	---	---

Price Group 5

Bo Peep	•	■	■	■	■	■	■	■	■
Remix	■	■	■	■	■	■	■	■	■
Silk	■	■	■	■	■	■	■	■	■

Price Group 6

Brisa	•	■	■	■	■	■	■	■	■
-------	---	---	---	---	---	---	---	---	---

Price Group 7

Steelcut Trio	•	■	■	■	■	■	■	■	■
---------------	---	---	---	---	---	---	---	---	---

Leather Price Group 1

Cafe	•	■	■	■	■	■	•	•	■
------	---	---	---	---	---	---	---	---	---

* Upholstery available on Steelcase Slope shown. Licensed Slope available only in saddle, fog, and aegean leather.

** Tweed Multi available in medium grey, medium blue, light grey, and all other finishes are available as graded-in.

*** Cloud Velvet available in light mocha, black indigo, slate, and all other finishes are available as graded-in.

Lock and Keying Options

Greenpoint Pedestals and Greenpoint Lateral Files

All locking products are standard with factory-installed, keyed-random locks. Consecutive, specific, and random keying are available as field-installed options.

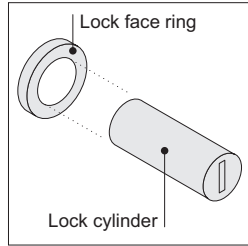

Locks consist of a field-installed lock cylinder and a factory-installed lock face ring.

Two types of locks are available — the standard keying system (FR series) and the master keying system (XF series). All the locks in the XF series can be opened with a single master key.

Field-Installed Keying

Field-installed locks are only available on products that include factory-installed lock mechanisms.

Specify "plug" when specifying furniture, and the product will ship with a plastic plug in place of the lock cylinder.

Tip: For products with optional lock colors, make sure to specify the color for both the lock and lock face ring.

Front-removable lock cylinders must be specified separately. You must also order a special lock tool to install or remove lock cylinders in the field.

Tip: Lock tools are reusable. You do not need to order additional lock tools with every furniture order.

Lock cylinders will be shipped separately so that you can install the locks when you are ready.

Three keying choices are available for field installation—random (standard), specific, and consecutive. All three are also available with master keying, which means that all locks can be opened with a single master key.

Key random means that the locks will be assigned arbitrarily at the factory with key numbers ranging from FR305 to FR454 (Master keying numbers: XF1001 to XF1150).

Tip: Random keying can mean that different furniture units will have the same key number. If you must have all locks keyed differently, you should specify key specific or key consecutive lock cylinders.

Key specific means that you can specify any key number from FR305 to FR454 (Master keying numbers: XF1001 to XF1150). This option can be used to key all the furniture units in a workstation or department the same.

Tip: Designate the quantity per key number in your specification.



▶ See below.

Key consecutive means that you can specify lock numbers in a consecutive order to ensure that no two locks have the same key number until the key sequence repeats. You must select a beginning key number from FR305 to FR454 (Master keying numbers: XF1001 to XF1150).







Example of a typical lock cylinder specification is shown below:

10	LOCK9201FR FR320
5	LOCK9201FR FR350
15	LOCK9201XF XF1100
30	Total
1	877102003SR standard lock tool
1	877102002SR master lock tool



Key Random

-  FR305
-  FR421
-  FR305







or

-  XF1011
 -  XF1042
 -  XF1011
-  XF
 Master
 Key



Key Specific

-  FR350
-  FR350
-  FR350







or

-  XF1020
 -  XF1020
 -  XF1020
-  XF
 Master
 Key

Key Consecutive

-  FR350
-  FR351
-  FR352

or

-  XF1020
 -  XF1021
 -  XF1022
-  XF
 Master
 Key

Lock Cylinders

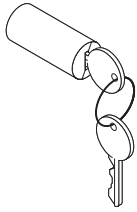

Tip: Lock price is included in price of furniture with locks.

Tip: For replacement lock cylinders, refer to Service Parts.

Tip: You can change lock cylinders in the field by using the appropriate lock tool.

Standard Includes	Required to Specify
<ul style="list-style-type: none"> Lock cylinder, keyed random: 9201 Polished Chrome or 9250 Ember Chrome Two keys 	<ul style="list-style-type: none"> 1 Style number 2 Options, if selected (see below)

Options	Price	Required to Specify
Key specific	No cost	Select key number from FR305–FR454.
Key consecutive	No cost	Specify <i>key consecutive</i> and must select beginning key number from FR305–FR454.
Master key random	+\$36 each	Specify master key random.
Master key specific	+\$36 each	Specify key number from XF1001–XF1150.
Master key consecutive	+\$36 each	Specify <i>master key consecutive</i> and must select beginning key number from XF1001–XF1150.

Specification Information		
Color	Style Number	Base Price
:	:	:
:	:	:

FR Series (Standard Keying System)—Lock Cylinder

Polished Chrome	LOCK9201FR	No cost
Ember Chrome	LOCK9250FR	No cost
:	:	:

Standard Lock Tool

	877102003SR	\$36
:	:	:

XF Series (Master Keying System)—Lock Cylinder

Polished Chrome	LOCK9201XF	No additional cost. Price included in price of furniture with master-keyed locks.
Ember Chrome	LOCK9250XF	No additional cost. Price included in price of furniture with master-keyed locks.
:	:	:

Master Lock Tool

	877102002SR	\$36
:	:	:

Style Number Index

Style Number	Page	Description
877102002SR	275	Master Lock Tool
877102003SR	275	Standard Lock Tool
999CHT	188	Wire Clips
AWAG2	188	Round Grommet
AWM12	189	12" Wire Manager
AWM18	189	18" Wire Manager
AWM23	189	23" Wire Manager
AWM30	189	30" Wire Manager
AWM35	189	35" Wire Manager
AWM42	189	42" Wire Manager
AWVW	189	Wire Mgr
FLXCBK4	240	Cable Brackets
FLXMCC10	240	Magnetic Cable Clips
FLXMCC2	240	Magnetic Cable Clips
FMVBK	230	Brckt Kit for Dsk w/Pwer and No Power Tray
FMVC	231	Vertebral Riser
FMVCE	231	Vertebral Riser
FMVCP	223	Chicago Hardwire Box
FMVF	225	Filler Pkg Pwr/Data
FMVH24	226	Modular Harness
FMVH27	226	Modular Harness
FMVH30	226	Modular Harness
FMVH33	226	Modular Harness
FMVH36	226	Modular Harness
FMVH39	226	Modular Harness
FMVH42	226	Modular Harness
FMVH45	226	Modular Harness
FMVH48	226	Modular Harness
FMVH51	226	Modular Harness
FMVH54	226	Modular Harness
FMVH57	226	Modular Harness
FMVH60	226	Modular Harness
FMVH63	226	Modular Harness
FMVH66	226	Modular Harness
FMVH69	226	Modular Harness
FMVH72	226	Modular Harness
FMVI12H	227	Hardwire-to-Modular Power Infeed
FMVI12M	228	Modular-to-Modular Power Infeed
FMVI24H	227	Hardwire-to-Modular Power Infeed
FMVI24M	228	Modular-to-Modular Power Infeed
FMVI6H	227	Hardwire-to-Modular Power Infeed
FMVI6M	228	Modular-to-Modular Power Infeed
FMVISS	228	San Francisco Power Infeed
FMVPBS	222	Modular Power Block—Standard-Capacity
FMVRD	224	Duplex Receptacle
FMVRUSB	225	USB Receptacle
LOCK9201FR	275	Lock Cylinder
LOCK9201XF	275	Lock Cylinder
LOCK9250FR	275	Lock Cylinder
LOCK9250XF	275	Lock Cylinder
OLBVINN	229	New York Power Infeed
OLCR	241	Cable Riser
RCHE1715	187	Bsc Cushion E
RCHE1830	187	Bsc Cushion E
RCHE1836	187	Bsc Cushion E
TS31410	112	Alight Ganging Kit
WEHMDC4MNA	152	Sterling—Health Guest Chair
WEHMDC4MWA	153	Sterling—Health Guest Chair
WEM1	247	Slope Guest Chair
WEM11	252	Maisie Side Table
WEM1196073	249	Horizon Nesting Table

Style Number	Page	Description
WEM2	246	Slope Lounge Chair
WEM3	248	Slope Conference Chair
WEM4	252	Maisie Side Table
WEM5	255	Stump Side Table
WEM50	246	Slope Counter Stool
WEM5646176	249	Horizon Nesting Table
WEM59	250	Lily Pad Nesting Table
WEM60	250	Lily Pad Nesting Table
WEM61	256	Linear Task Lamp
WEM64	245	Pebble Stacking Chair
WEM65	245	Pebble Upholsterd Chair
WEM66	246	Slope Bar Stool
WEM67	247	Slope Bar Stool
WEM68	253	Mesa Sectional Coffee Table
WEM7	250	Lily Pad Nesting Table
WEM70	244	Nimbus Conference Chair
WEM7634567	249	Horizon Nesting Table Narrow
WEM8	251	Linear C Table
WEM9	254	Nolan Side Table
WESARYLNG1	115	Brighton One Seat
WESARYLNG2	117	Brighton Two Seat
WESARYO	118	Brighton Ottoman
WESARYPWR	125	Brighton Module Power
WESARYTBL60	119	Brighton Ganging Table
WESARYTBL90	120	Brighton Ganging Table
WESARYTBLED	122	Brighton End Table
WESARYTBLRT	124	Brighton Rectangle Table
WESARYTBLSG	121	Brighton Occasional Tables
WESARYTBLSQ	123	Brighton Square Table
WESARYUSB	125	Brighton USB Power
WESBELC	96	Belle Corner Lounge
WESBELLNG1	91	Belle One-Seat Lounge
WESBELLNG2	94	Belle Two-Seat Lounge
WESBELO	97	Belle Ottoman
WESFTNBH	166	Fulton Bench
WESFTNCG	164	Fulton Guest Chair
WESFTNCL	165	Fulton Lounge Chair
WESHTSLNG1	99	Boardwalk One-Seat Lounge
WESHTSLNG2	102	Boardwalk Two-Seat Lounge
WESHTSLNG3	106	Boardwalk Three Seat
WESHTSTBL30	107	Boardwalk Square Table
WESHTSTBL60	108	Boardwalk Rectangle Table
WESHTSTBL90	109	Boardwalk Rectangle Table
WESHTSTBLOV65	111	Boardwalk Oval Table
WESHTSTBLRD40	110	Boardwalk Round Table
WESINDCSG	215	Greenpoint Glass Screen
WESINDCST	216	Universal Screen Greenpoint
WESINDCTDS	220	Greenpoint Tray End
WESINDCTSS	220	Greenpoint Tray End
WESINDEC	211	Greenpoint End Credenza
WESINDED	168	Greenpoint Executive Desk
WESINELDS	205	Greenpoint Leg
WESINDELSS	206	Greenpoint Leg
WESINDETDS	220	Greenpoint Tray Extension
WESINDETSS	220	Greenpoint Tray Extension
WESINDFC	174	Greenpoint Filing Credenza
WESINDILDS	207	Greenpoint Leg
WESINDILSS	208	Greenpoint Leg
WESINDLF	176	Greenpoint Lateral File
WESINDLFM1A	181	Greenpoint Lateral File
WESINDLFM1B	182	Greenpoint Lateral File

Style Number	Page	Description	Style Number	Page	Description
WESINDLFM1C	183	Greenpoint Lateral File	WESMESCHLH	126	Mesa Two Seat Chaise
WESINDLFM1D	184	Greenpoint Lateral File	WESMESCHRH	127	Mesa Two-Seat Chaise
WESINDLFM2	185	Greenpoint Lateral File	WESMESO	130	Mesa Ottoman
WESINDLFR	209	Greenpoint Leg Round/Square	WESSLPCC	140	Slope Conference Chair
WESINDLHR	210	Greenpoint Leg Half Round	WESSLPCG	136	Slope Guest Chair
WESINDLOB	177	Greenpoint Bookcase	WESSLPCL	137	Slope Lounge Chair
WESINDMP	173	Greenpoint Modesty Panel	WESSLPCS	141	Slope Stacking Chair
WESINDMPM	186	Greenpoint Mobile Ped	WESSLPSB	139	Slope Bar Stool
WESINDNOB	178	Greenpoint Bookcase	WESSLPC	138	Slope Counter Stool
WESINDOB	179	Greenpoint Bookcase	WESSUTCT	240	Sutton Cable Tray
WESINDPC	212	Greenpoint Personal Credenza	WESSUTERQ	235	Sutton Extended Height-Adjustable Desk
WESINDPCDS	221	Greenpoint Power Cover	WESSUTERQB	239	Sutton Extended Height-Adjustable Base
WESINDPCSS	221	Greenpoint Power Cover	WESSUTSRQ	233	Sutton Basic Height-Adjustable Desk
WESINDPD	169	Greenpoint Private Desk	WESSUTSRQB	237	Sutton Basic Height-Adjustable Base
WESINDPSDS	218	Greenpoint Power Support	WESWLOLNGF	133	Willow Lounge Seating
WESINDPSSS	218	Greenpoint Power Support	WESWLOLNGS	135	Willow Lounge Seating
WESINDPTDS	219	Greenpoint Tray			
WESINDPTSS	219	Greenpoint Tray			
WESINDPWR	190	Greenpoint Power Unit			
WESINDPWRCT	190	Greenpoint Continuous Top Power			
WESINDPWRFR	191	Greenpoint Round/Square Power Unit			
WESINDRB	204	Greenpoint Bench Return			
WESINDRL	170	Greenpoint Desk Return			
WESINDRP	172	Greenpoint Desk Return			
WESINDSB	180	Greenpoint Bookcase			
WESINDSC	175	Greenpoint Credenza			
WESINDUB	213	Greenpoint Upmount Bin			
WESINDUBWB	214	Greenpoint Whiteboard Insert			
WESINDWCCCT	200	Greenpoint Continuous Top, Cred/Cred			
WESINDWCCDS	194	Greenpoint Worksurface			
WESINDWCCSS	197	Greenpoint Worksurface			
WESINDWFR	201	Greenpoint Worksurface Round			
WESINDWHR	203	Greenpoint Worksurface Round			
WESINDWLCCT	199	Greenpoint Continuous Top, Leg/Cred			
WESINDWLCDS	193	Greenpoint Worksurface			
WESINDWLCSS	196	Greenpoint Worksurface			
WESINDWLLCT	198	Greenpoint Continuous Top, Leg/Leg			
WESINDWLLDS	192	Greenpoint Worksurface			
WESINDWLLSS	195	Greenpoint Worksurface			
WESINDWSQ	202	Greenpoint Worksurface Square			
WESKNT4CNA	157	Kent Conference Chair			
WESKNT4CWA	156	Kent Conference Chair			
WESKNT4LNA	159	Kent Guest Chair			
WESKNT4LWA	158	Kent Guest Chair			
WESKNT5CNA	155	Kent Conference Chair			
WESKNT5CWA	154	Kent Conference Chair			
WESKNT5SNA	161	Kent Conference Stool			
WESKNT5SWA	160	Kent Conference Stool			
WESLUCS	163	Lucas Swivel Chair			
WESLUCW	162	Lucas Wire Chair			
WESMDC4CNFNA	148	Sterling Conference Chair			
WESMDC4CNFWA	149	Sterling Conference Chair			
WESMDC4LNG	150	Sterling Lounge Chair			
WESMDC4NA	142	Sterling Guest Chair			
WESMDC4WA	143	Sterling Guest Chair			
WESMDC5NA	146	Sterling Conference Chair			
WESMDC5WA	147	Sterling Conference Chair			
WESMDCSBHNA	145	Sterling Guest Stool			
WESMDCSCHNA	144	Sterling Guest Stool			
WESMES2SEAT	128	Mesa Two-Seat Lounge			
WESMESC	129	Mesa Corner Lounge			

Trademark List

™/® The following is a non-exhaustive list of trademarks and registered trademarks for products of Steelcase Inc. or one of its related corporate entities: Agree, Airtouch, Alight, Amia, Answer, Aspekt, Avenir, Await, B-Free, Ballet, Bassline, Bindu, Bivi, Bix, Bottomline, Brody, Buoy, Cachet, Campfire, Capa, CF Series, CG_1, Chord, Circa, Clipper, Cobi, Collaboration, Convene, Coupe, Cura, Currency, dash, Divisio, Duo, E-Table 2, Edge Series, Elbrook, Elective Elements, Embold, Empath, Everwall, Exponents, Folio, FrameOne, Gesture, Groupwork, Host, Hosu, i2i, Jenny, Kart, Kathryn, Kick, Lagunitas, Leap, Leela, LessThanFive, LiveBack, LiveSeat, Mackinac, Marien152, Max-Stacker, media:scape, Migration, Millbrae, Mineral, Mitra, Montage, Montara650, MoreThanFive, Move, Node, Ocular, Ology, Opus, Paperflo, Passerelle, Player, Pocket, Potrero415, QiVi, Radia, Regard, Relay, Reply, Ripple, Roam, Sarto, Scoop, Sebastopol, Senti Series, Senza, Shortcut, Sidewalk, Siento, Sieste, SILQ, Soffio, Sorrel, SOTO, Steelcase Eclipse, Steelcase Flex, Steelcase Karman, Steelcase Relay, Steelcase Rise, Steelcase Series, Surround, SW_1, Switch, Sync, Tava, Tenor, Think, Thoughtful, Thread, Together, Train, Trees, Turnstone, Umami, Underscore, V.I.A., Verb, Verge, Verlay, Victor2, Visalia, WorkValet, and X-tenz.

™/® The following are trademarks or registered trademarks of AMQ Solutions, LLC: 3F, Activ, Amobi, Bixby, Bodi, Cluvo, Concur, Embank, FL-X, Iline, Jaku, Kinex, Personality Plus, Revi, S-Series, Siya, Tektis, Tizu, Uptake, and Zilo.

™/® The following are trademarks or registered trademarks of Orangebox Ltd., Cardiff, UK: Air3, Aspect, Avi, Away from the Desk, Border, Campers & Dens, Coppice, Cubb, Kirm, On the QT, Ramsey, Skomer, Sully, Track-B, and Vale.

™/® The following are trademarks or registered trademarks of Viccarbe Habitat, S.L.: Aleta, Cambio, Designed in The Sun, Foro, Funda, Holy Day, Kelly, Last Minute, Noha, Savina, Sistema, Sistema, Viable, and Wrapp.

® The following are registered brands of Steelcase Inc. and its family of companies: Steelcase, AMQ, Coalesse, Designtex, Halcon, Orangebox, Smith System, and Viccarbe.

® The following registered trademarks are under license from AWI Licensing Company, Dover, DE: SoundScapes, DuraBrite, BioBlock, and Armstrong.

® The following registered trademarks are under license from Byrne Electrical, Rockford, MI: Interport, Mini-Port, Axil Z, and Ellora.

® The following is a registered trademark of DuPont, Wilmington, DE: Corian.

® The following is a registered trademark of Genlyte Thomas Company, Louisville, KY: Lightolier.

® The following is a registered trademark of Hilti Corporation, FL-9494 Schaan, Principality of Liechtenstein: Hilti.

® The following is a registered trademark of Leviton Manufacturing Company, Little Neck, NY: Decora.

® The following is a registered trademark of Mechanical Plastics Corp, Elmsford, NY: Toggler.

® The following is a registered trademark of Microsoft Corporation, Redmond, WA: Microsoft.

® The following are registered trademarks of Orangebox Ltd., Cardiff, UK: Orangebox.

® The following is a registered trademark of Panduit Corporation, Lockport, IL: Panduit.

® The following is a registered trademark of Trav (Press), Cuneo, Italy: Assisa.

® The following is a registered trademark of Virtual Ink, Boston, MA: mimioActive.

® The following registered trademarks are under license from Wilkhahn Furniture Products: Avera, Senzo, Versal, and Wilkhahn FS.

® The following are registered trademarks of Polyvision Corp: Flow, Motif, Polyvision, Sans, and Serif.

® The following is a registered trademark of Wilsonart International, Temple, TX: Chemsurf.

® The following is a registered trademark of Wiremold, West Hartford, CT: Wiremold.

® The following is a registered trademark of EMU Group S.P.A., Perugia, Italy: EMU.

® The following is a registered trademark of Security People, Inc.: Digilock.

® The following are registered trademarks of Natural Capital Partners Europe Limited: CarbonNeutral and the CarbonNeutral Certified logo.

™ The following is a trademark of Microsoft Corporation, Redmond, WA: Windows.

™ The following is a trademark of Rodman Industries, Inc., Oconomowoc, WI: ResinCore1.

™ The following is a trademark of Ultrafabrics, LLC, Elmsford, NY: Ultraeather.

™ The following trademarks are under license from Wilkhahn Furniture products: Cana, Linus, Logon, Picto, Range, Stitz, Thema, Timetable, and Tubis.

™ The following trademarks are under license from Walter Knoll: Andoo, Bob, Lazlo, Lox, Ribbon, and Together.

™ The following trademarks are under license from PP Mobler: Bar and Flag Halyard.

™ The following trademarks are under license from Carl Hansen: Elbow, Paddle, Shell, Wing, and Wishbone.

™ The following trademarks are under license from Cambridge Sound Management, LLC Cambridge, MA: QtPro Soundmasking, Qt Quiet Technology, and Sonet Qt.

™ The following is a trademark of Electri-Cable Assemblies, Shelton, CT: Interact.

™ The following is a trademark of Clestra Hauserman: IRYS.

™ The following is a trademark of Wiesner-Hager Möbel GmbH: Nooi.

™ The following are trademarks of Polyvision: Accord, a3, e3, Boundri, and Nota.

™ The following is a trademark of Bostock Company, Inc: SnapCab.

™ The following is a trademark of Williams-Sonoma, Inc: West Elm.

™ The following is a trademark of Elena Marquina Testor: nanimarquina.

™ The following is a trademark of Forbo International SA: Forbo.

Trademarks used herein are the property of Steelcase Inc. or their respective owners.