

---

# Steelcase Health



## Volume 1 Seating

### Specification Guide

#### Availability

**Electronic price list updated** with release 200.M (U.S.) and 156.M (Canada), dated June 17, 2024.

All specifications subject to change without notice. Reference the electronic catalog/Hedberg for current pricing.

Transitional products in this specification guide are **maintained for existing customers only** and are likely to be phased out over time. These products are indicated with a . Products that are scheduled to be culled are indicated with an , followed by the last order entry date.

#### Surface Materials

**The surface materials team** has announced the launch of the Finish Library, found at [www.steelcase.com/finishlibrary/](http://www.steelcase.com/finishlibrary/).

► For a list of all trademarks, refer to the last page of this specification guide. © 2024 Steelcase Inc.

#### Working With This Specification Guide

Ten Tips: How to Get the Most Out of This Book	2
Additional Resources	4

#### Understanding and Specifying

Seating	5
---------	---

#### Related Products

Seating	471
---------	-----

#### Surface Materials

473

#### Resources

521



#### For Canadian Pricing

Canadian factor can be found at [www.steelcase.com/CADpricing/](http://www.steelcase.com/CADpricing/). Calculate in the following order to avoid rounding errors:

- Multiply the base price and each option by the Canadian factor.
- Round each to the nearest dollar.
- Add base and options for total list price.

# Ten Tips: How to Get the Most Out of This Book

## Tip 1

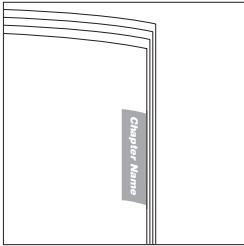

**Watch** the tabs on the right-hand edges of the pages. They'll always indicate which chapter you are in.

## Tip 2

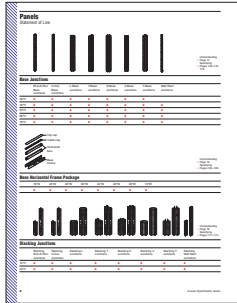

**Use the Statement of Line pages** for an overview of the available components, their sizes, and page references for additional information. Each *Understanding* chapter includes a statement of line after the table of contents.

## Tip 3



**Find cross references** by looking for page numbers flagged with an arrow.

## Tip 4

**Study the product detail pages** in the *Understanding* section to learn everything an expert knows about specific products. Each product detail page in this section contains the following features, where applicable:

- Product Drawing
- Actual Dimensions
- Product Details
- Connections
- Wiring and Cabling
- Surface Materials
- Application Topics

**Product Drawing** shows you what the product looks like and points out important features.

**Product Details** gives specific information on the product and how it is used.

**Connections** describes how the product is assembled or how it attaches to another product.

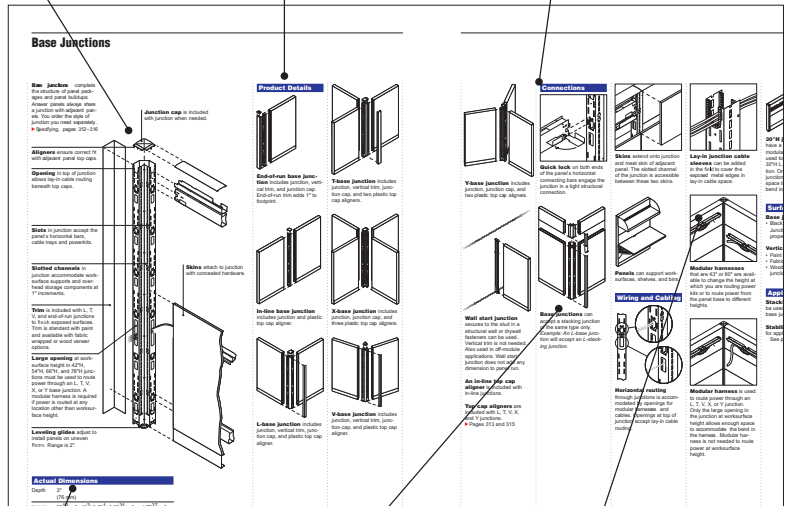

**Actual Dimensions** table lists the dimensions of the product.

**Wiring and Cabling** details the power and cable-management and cable routing capabilities of the product.

**Surface Materials** lists what material is used for each part of the product.

**Tip 5**

**Refer to the specifying pages** for all the information needed to order a product. Each product specifying page contains a variety of elements to help you complete a specification:

- Product Drawing
- Standard Includes
- Required to Specify
- Options
- Related Products
- Specification Information
- Dimensions
- Style Number
- Price

**Standard Includes** (under the red or dark grey band) provides a list of what comes standard with the product.

**Required to Specify** (under the red or dark grey band) itemizes the information that you must provide to order the standard product and the preferred sequence for specification.

**Specification Information** (under the teal or light grey band) provides product dimensions, style numbers, and prices for the standard product and any surface material choices that are available.

**Product Drawing** shows you what the product looks like.

**Standard Includes**

- Includes all hardware and fasteners for the product.
- Includes all surface material for the product.
- Includes all finish for the product.
- Includes all dimensions for the product.
- Includes all weight for the product.
- Includes all lead time for the product.
- Includes all warranty for the product.
- Includes all shipping for the product.
- Includes all installation for the product.
- Includes all maintenance for the product.
- Includes all cleaning for the product.
- Includes all repair for the product.
- Includes all replacement for the product.
- Includes all accessories for the product.
- Includes all options for the product.
- Includes all related products for the product.

**Required to Specify**

- Finish
- Color
- Material
- Dimensions
- Weight
- Lead time
- Warranty
- Shipping
- Installation
- Maintenance
- Cleaning
- Repair
- Replacement
- Accessories
- Options
- Related products

**Options**

- Option 1
- Option 2
- Option 3
- Option 4
- Option 5
- Option 6
- Option 7
- Option 8
- Option 9
- Option 10
- Option 11
- Option 12
- Option 13
- Option 14
- Option 15
- Option 16
- Option 17
- Option 18
- Option 19
- Option 20

**Specification Information**

Width	Height	Style	Price
24"	24"	TS7042BL	\$120.00
24"	24"	TS7042S	\$120.00
24"	24"	TS7048BL	\$120.00
24"	24"	TS7048S	\$120.00
24"	24"	TS7060BL	\$120.00
24"	24"	TS7060S	\$120.00
24"	24"	TS7072BL	\$120.00

**Tip 6**

**Required to Specify**

Specify with *Customiz Stain*

**Italic typeface** on specifying pages usually identifies wording that you should use in your order

**Tip 7**

**To determine** how many skins are needed to complete a panel, consult the table at the right.

*Tip: Remember to order skins for both sides of the panel buildup.*

**Watch for tips** throughout the text that give you explanations and helpful instructions.

**Tip 8**

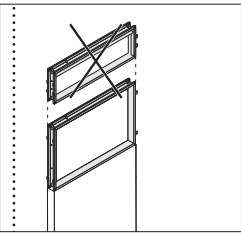

**Learn what you cannot do** by looking for drawings crossed out with an "X."

**Tip 9**

**Use the surface materials listings** in the Surface Materials section of this book to find surface material color numbers.

**Tip 10**

Style Number	Page
TS7042BL	131
TS7042S	130
TS7048BL	131
TS7048S	130
TS7060BL	131
TS7060S	130
TS7072BL	131

**Refer to the style number index** when you know a style number and you need to find the page that has more details about the product.

# Additional Resources

**Steelcase Health products** are supported with an array of informational materials, tools, and software to help you plan an installation efficiently.

**Product brochures and planning tools** can be ordered through your Steelcase area office by calling 1.800.784.0358 or through the AdStock web site at [village.steelcase.com](http://village.steelcase.com).

## Printed Materials

### Surface Materials Reference Manual

This publication provides surface material information for Steelcase products:

- An explanation of the surface materials
- “Available on” matrices
- Vertical surface fabric selection listing
- Technical data for surface materials
- Surface material care and cleaning instructions

### Steelcase Health Specification Guides

These specification guides contain multiple Steelcase, Steelcase Health, and Coalesse products which are most commonly used in healthcare environments. This collection of products has been pulled together for your convenience.

### Other Specification Guides

Steelcase offers a comprehensive portfolio of furniture and solutions. For the full offering of products, refer to the individual product specification guides. These can be accessed at the [www.steelcase.com](http://www.steelcase.com) web site or at [village.steelcase.com](http://village.steelcase.com).

Additional seating products can be found in the following specification guides:

*Seating Specification Guide*

*Coalesse Seating Specification Guide*

## Planning Tools

### Quick Ship Guide

This handbook describes all Steelcase and Coalesse products that are available for Rapid2 (ships in 2 days), Rapid5 (ships in 5-7 days), or Coalesse Rapid10 (ships in 10 days).

## Computer Tools

### Electronic Catalog

Accurate sales quotations and purchase orders for Steelcase products are created with specification software that uses Steelcase Electronic Catalog data. Use the data to specify and price style numbers and options for every Steelcase product. The data is updated bimonthly by Steelcase and provided to software programs including: the Hedberg Business System, SmartTools – Steelcase’s design and specification software (for more information on SmartTools, please email [SmartTools@steelcase.com](mailto:SmartTools@steelcase.com)), the ProjectMatrix ProjectSymbols libraries, as well as 20-20 CAP Studio.

### Furniture Symbol Graphic Data

Steelcase creates 2D and 3D furniture symbols (with attributes) for planning and initially specifying Steelcase products. This data is incorporated into several add-on software packages that work in either a Microstation or an AutoCAD drafting environment.

### Digital Publications

You can access these digital publications at [www.steelcase.com](http://www.steelcase.com) or [village.steelcase.com](http://village.steelcase.com).

### Product Training

Basic training for many Steelcase products is part of the Building Product Muscle (BPM) curriculum on the Steelcase University web site at [village.steelcase.com](http://village.steelcase.com).

### More Information

For more information about these and other software tools to help you plan effective healthcare environments, email [fsl@steelcase.com](mailto:fsl@steelcase.com)

## Support

### Steelcase Capabilities

Steelcase products are distributed, installed, and serviced through a network of more than 600 dealers worldwide. Steelcase is also represented with offices and corporate showrooms in 26 U.S. cities, 4 Canadian cities, and in France, Germany, Great Britain, and Japan. Every Steelcase product meets our exceptionally high standards of quality and durability and comes with the Steelcase assurance of excellence in service.

### For ordering or product assistance,

please call your local dealer, the Steelcase Solutions Resource Team, or the Steelcase Solutions Fulfillment Team at 1.888.STEELCASE (1.888.783.3522) or send an e-mail to [lineone@steelcase.com](mailto:lineone@steelcase.com).

Call the Steelcase Solutions Resource Team prior to placing an order, when working on a bid, or when you need information about product applications and specifications.

Call the Steelcase Solutions Fulfillment Team if you have submitted an order to Steelcase and you need to speak to your Solutions Fulfillment Team Representative about the order. Also call if you have any post-shipment quality concerns or service parts questions.

For warranty information, please go to <http://www.steelcase.com/warranty/>.







Outside the U.S.A., Canada, Mexico, Puerto Rico, and the U.S. Virgin Islands, call 1.616.247.2500.

For information about Steelcase, the name of your nearest Steelcase dealer, or for product literature, call 1.800.333.9939 or visit our Web site: [www.steelcase.com](http://www.steelcase.com).

## Sustainability

**At Steelcase**, we believe business can be a force for good. We create long-lasting products that are better for people and better for the planet. Our products and operations use life cycle thinking to meet our commitment to reducing climate change. This commitment is reinforced by practices such as designing to minimize global warming and other life cycle impacts, ensuring material health, and enabling end-of-use strategies. To learn more at a corporate level, visit: <https://www.steelcase.com/discover/steelcase/esg-overview/environmental/> Product Environmental Profiles, which provide key environmental attributes such as recycled content, embodied carbon and recyclability, as well as product certifications can be found by searching for Steelcase at *Origin.build*.

# Seating

			
<b>Statement of Line</b>	<b>6</b>	<b>Recliner Seating</b>	
		Empath Recliners	<b>342</b>
<b>Families of Seating</b>		Mineral Recliners	<b>356</b>
Aspekt Straight Arm	<b>32</b>	Mitra Recliners	<b>360</b>
Aspekt Wave Arm	<b>48</b>		
Aspekt Tables	<b>59</b>	<b>Sleeper Seating</b>	
Cura	<b>62</b>	Mitra Sleeper Chair	<b>364</b>
Embold	<b>68</b>	Sieste Sleeper	<b>366</b>
Leela	<b>104</b>	Surround	<b>370</b>
Mitra	<b>110</b>	X–tenz Sleeper Chairs	<b>434</b>
Mitra Tables	<b>117</b>		
Outlook Tables	<b>120</b>	<b>West Elm Health</b>	
Radia	<b>124</b>	Mesa	<b>438</b>
Sieste	<b>132</b>	Slope	<b>448</b>
Tava	<b>138</b>	Sterling	<b>454</b>
Tava Tables	<b>149</b>	Lucas by West Elm Work Collection	<b>468</b>
			
<b>Lounge Seating</b>			
Circa Lounge System by Coalesse	<b>152</b>		
Turnstone Jenny Lounge	<b>168</b>		
Regard	<b>197</b>		
			
<b>Multi-Purpose Seating</b>			
Node by Steelcase	<b>264</b>		
Verge Stool	<b>289</b>		
<b>Stackable Seating</b>			
Enea Stacker by Coalesse	<b>291</b>		
Move 490 Series by Steelcase	<b>296</b>		
Player 475 Series by Steelcase	<b>312</b>		
Sorrel	<b>328</b>		
Sorrel Tables	<b>338</b>		

# Statement of Line

## Families of Seating

### Aspekt Straight Arm

Understanding  
 ▶ Page 32  
 Specifying  
 ▶ Pages 34–47

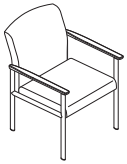

Single-Seat Chair\*

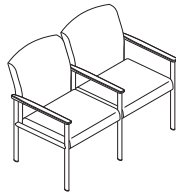

Two-Seat Chair\*

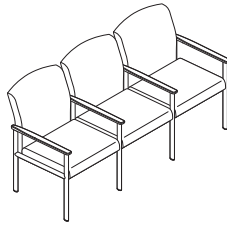

Three-Seat Chair\*

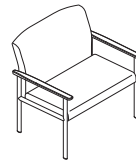

Bariatric Chair\*

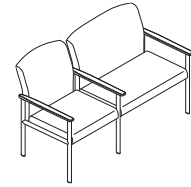

Two-Seat Bariatric Combination Unit\*

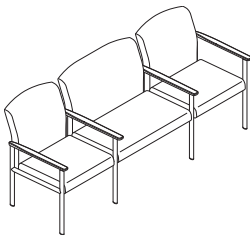

Three-Seat Bariatric Combination Unit\*

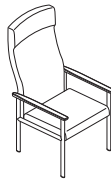

High-Back Chair

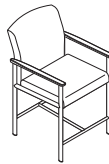

Easy Access Chair\*

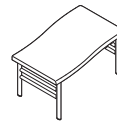

Bench



Footstool

\* Available with straight or wallsaver legs.

Tip: Bariatric seat location on two- and three-seat combination units can be specified on left, right, or center.

### Aspekt Wave Arm

Understanding  
 ▶ Page 48  
 Specifying  
 ▶ Pages 50–58

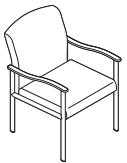

Single-Seat Chair\*

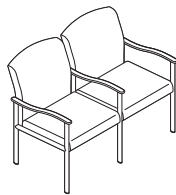

Two-Seat Chair\*

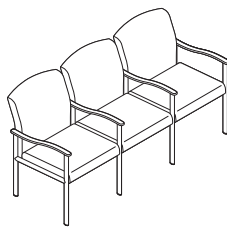

Three-Seat Chair\*

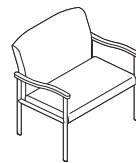

Bariatric Chair\*

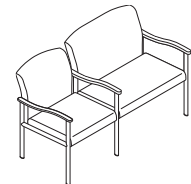

Two-Seat Bariatric Combination Unit\*

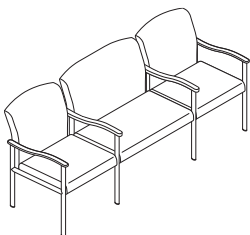

Three-Seat Bariatric Combination Unit\*

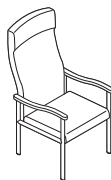

High-Back Chair

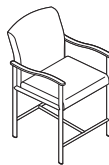

Easy Access Chair\*

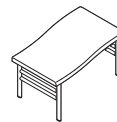

Bench



Footstool

\* Available with straight or wallsaver legs.

Tip: Bariatric seat location on two- and three-seat combination units can be specified on left, right, or center.

**Families of Seating, continued**

**Aspekt Tables**

Understanding  
▶ Page 59  
Specifying  
▶ Pages 60 and 61

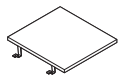

In-line  
Ganging  
Table



Left-Hand  
Ganging End  
Table



Right-Hand  
Ganging End  
Table



Corner  
Ganging  
Table



90°  
Ganging  
Table



Oval  
Table

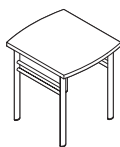

Bow  
Table



Round  
Table

**Cura**

Understanding  
▶ Page 62  
Specifying  
▶ Page 64



Four-Leg Base Chair



Sled-Base Chair



Ottoman

**Families of Seating, continued**

**Embold**

Understanding  
▶ Pages 68–74  
Specifying  
▶ Pages 86–103



21"W Single Seat

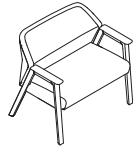

24"W Midsize Single Seat

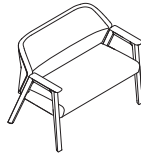

32"W Bariatric Single Seat

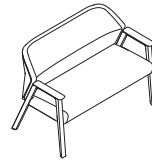

43"W Loveseat

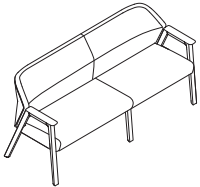

66"W Multiple Seat

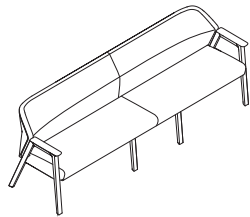

88"W Multiple Seat

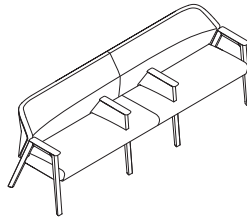

88"W Multiple Seat  
Bariatric Combination



21"W Easy Access Seat

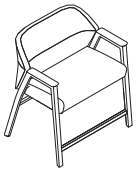

32"W Easy Access Seat



20" Diameter  
Circular Table



19"D x 32"W Rounded  
Rectangle Table



20"D x 42"W Racetrack  
Table

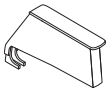

Midarm

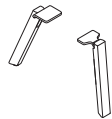

Midleg

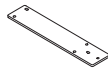

Midleg and Midarm  
Support Plate



**Families of Seating, continued**

**Leela**

Understanding  
▶ Page 104  
Specifying  
▶ Pages 106–108

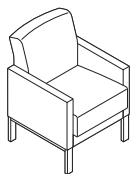

21"W Lounge Chair

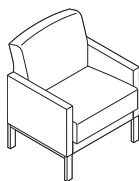

24"W Lounge Chair

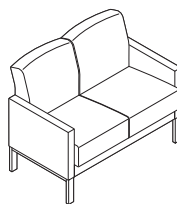

Loveseat

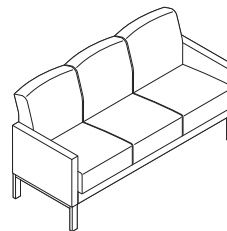

Sofa

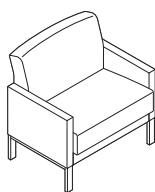

30"W Bariatric Chair

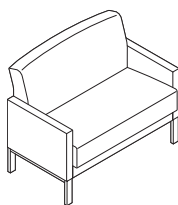

40"W Bariatric Chair

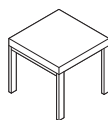

Square Freestanding Table

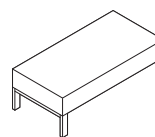

Rectangle Freestanding Table

**Families of Seating, continued**

**Mitra**

Understanding  
▶ Page 110  
Specifying  
▶ Pages 112–116



Single-Seat Chair

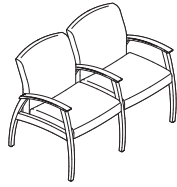

Two-Seat Chair

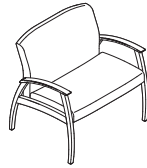

Bariatric Chair

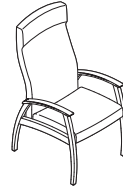

High-Back Chair

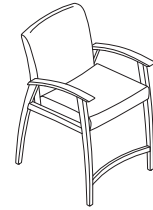

Easy Access Chair

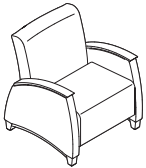

Lounge Chair

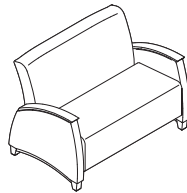

Loveseat

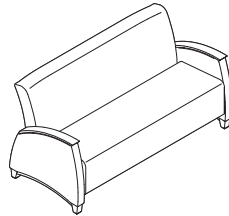

Sofa

**Mitra Tables**

Understanding  
▶ Page 117  
Specifying  
▶ Pages 118–119



Round Table



Oval Table

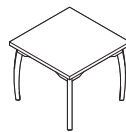

Square Table

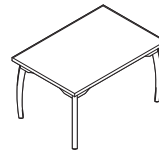

Rectangular Table



Round Drum Table

**Outlook Tables**

Understanding  
▶ Page 120  
Specifying  
▶ Pages 122–123

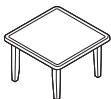

Freestanding Square Table

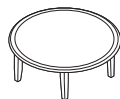

Freestanding Round Table



Freestanding Rectangular Table



Drum Table

**Families of Seating, continued**

**Radia**

Understanding  
▶ Page 124  
Specifying  
▶ Pages 126–131



Armless



Single

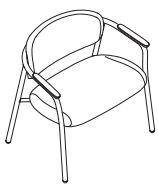

Bariatric

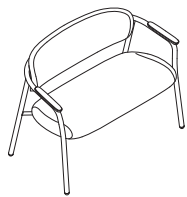

Loveseat



High-Back

*Tip: The chairs above are shown with overhang arm caps.*

**Sieste**

Understanding  
▶ Page 132  
Specifying  
▶ Pages 134–136



Lounge Chair

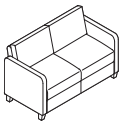

Loveseat

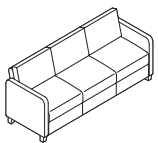

Sofa

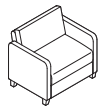

Bariatric Chair



Freestanding Square Table

Families of Seating, continued

Tava

Understanding  
▶ Page 138  
Specifying  
▶ Pages 142–148

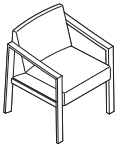

Open Arm Single-Seat Guest Chair

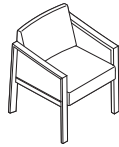

Closed Arm Single-Seat Guest Chair

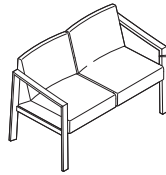

Open Arm Two-Seat Guest Chair

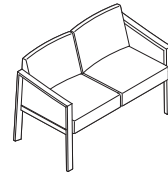

Closed Arm Two-Seat Guest Chair

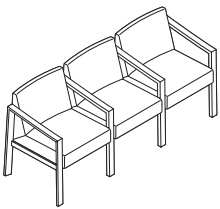

Open Arm Three-Seat Guest Chair

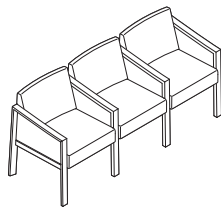

Closed Arm Three-Seat Guest Chair

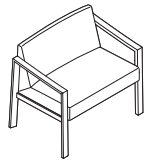

Open Arm Bariatric Guest Chair

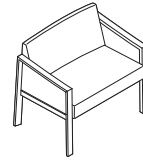

Closed Arm Bariatric Guest Chair

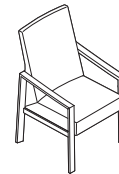

Open Arm High-Back Chair

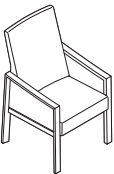

Closed Arm High-Back Chair

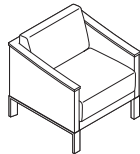

Lounge Chair

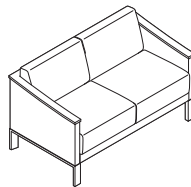

Loveseat

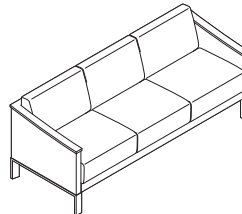

Sofa

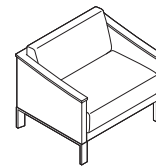

Bariatric Lounge

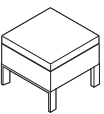

21"W Bench

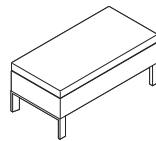

42"W Bench

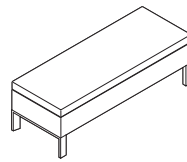

56"W Bench

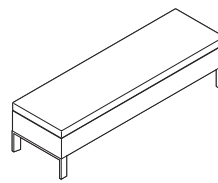

70"W Bench

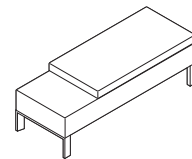

56"W Bench with One Table

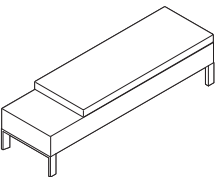

70"W Bench with One Table

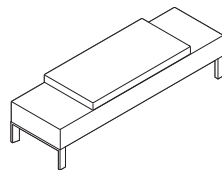

70"W Bench with Two Tables

**Families of Seating, continued**

**Tava Tables**

Understanding  
▶ Page 149  
Specifying  
▶ Page 150

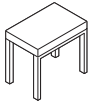

14"W Side Table

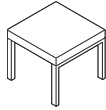

21"W Side Table

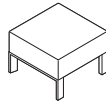

21"W Coffee Table

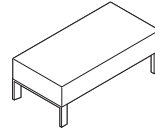

42"W Coffee Table

**Lounge Seating**

**Circa Lounge System by Coalesse**

Understanding  
▶ Page 152  
Specifying  
▶ Page 156

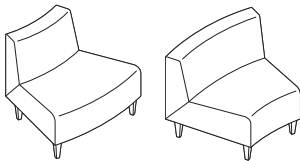

30° Outside/Inside  
Facing Wedge  
1-Seat Lounge

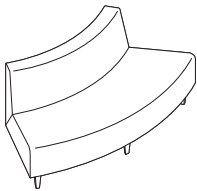

60° Wedge 2-Seat  
Lounge

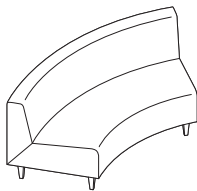

Wedge Bench

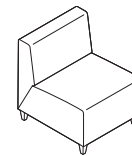
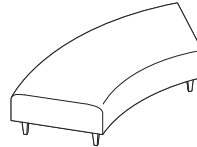
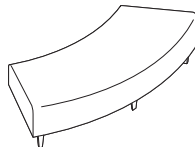

Straight 1-Seat  
Lounge

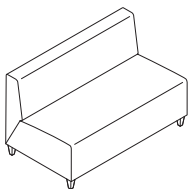

Straight 2-Seat  
Lounge

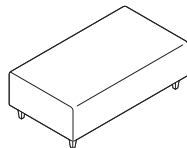

Straight Bench

**Lounge Seating, continued**

**Circa Lounge System Upholstered Modular Arm Rests and Ottoman by Coalesse**

Understanding  
▶ Page 152  
Specifying  
▶ Page 160



Straight Armrest  
Intermediate without  
Legs



Straight Armrest  
End-of-Run with Two  
Legs



15° Inside Armrest  
Intermediate without  
Legs



15° Inside Armrest  
End-of-Run with Two  
Legs



15° Outside Armrest  
Intermediate without  
Legs



15° Outside Armrest  
End-of-Run with Two  
Legs

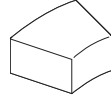

30° Inside Armrest  
Intermediate without  
Legs

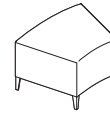

30° Inside Armrest  
End-of-Run with Two  
Legs

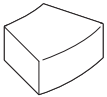

30° Outside Armrest  
Intermediate without  
Legs

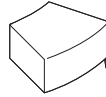

30° Outside Armrest  
End-of-Run with Two  
Legs

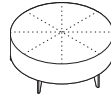

Round Ottoman





Seating

**Lounge Seating, continued**

**Circa Lounge System Ganging and Occasional Tables by Coalesse**

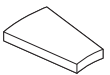
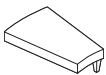
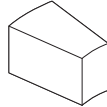
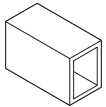
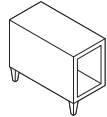
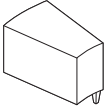
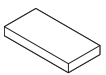
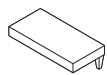
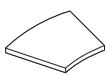
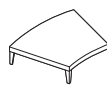
Understanding  
▶ Page 152  
Specifying  
▶ Page 164

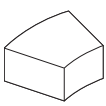
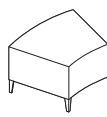
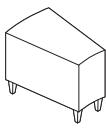
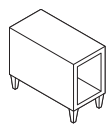
				
15° Low Wedge Table, Ganging	15° Low Wedge Table, End-of-Run, Two Legs	15° High wedge Table, Ganging	Straight High Table, Ganging	Straight High Table, End-of-Run, Two Legs
				
15° High Wedge Table, End-of-Run, Two Legs	Straight Low Table, Ganging	Straight Low Table, End-of-Run, Two Legs	30° Low Wedge Table, Ganging	30° Low Wedge Table, End-of-Run, Two Legs
				
30° End-of-Run with One Leg	30° High Wedge Table, Ganging	30° High Wedge Table, End-of-Run, Two Legs	High Wedge	High Straight

**Circa Lounge System Freestanding Round Table by Coalesse**

Understanding  
▶ Page 152  
Specifying  
▶ Page 166

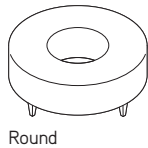

Round

**Lounge Seating, continued**

**Jenny Lounge**

Understanding  
 ▶ Page 168  
 Specifying  
 ▶ Pages 174–196

*Tip: Jenny armless lounge chairs shown comprise full statement of line.*

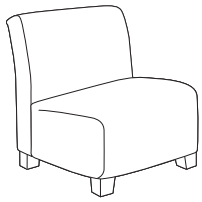

Armless Lounge Chair

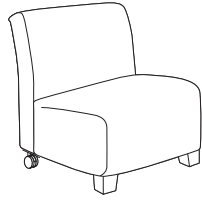

Armless Lounge Chair with Casters

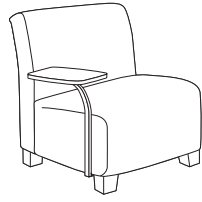

Armless Lounge Chair with Tablet Arm

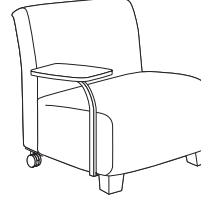

Armless Lounge Chair with Casters and Tablet Arm

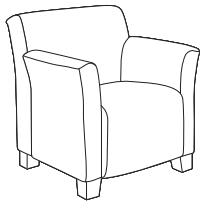

\*Lounge Chair with Arms

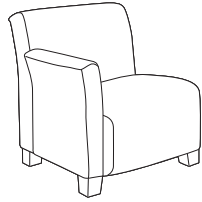

\*Lounge Chair with Arm Right

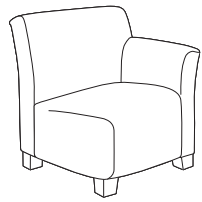

\*Lounge Chair with Arm Left

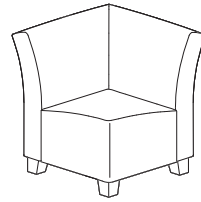

\*Corner Lounge Chair

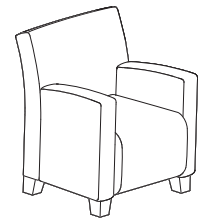

\*Club Lounge Chair

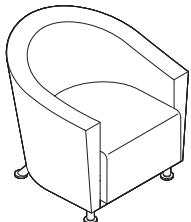

Round Lounge Chair

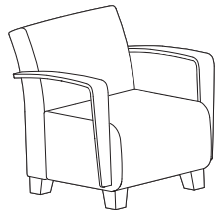

\*Lounge Chair with Wood Arms

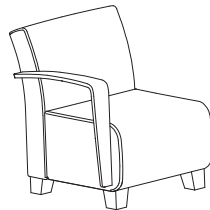

\*Lounge Chair with Wood Arm Right

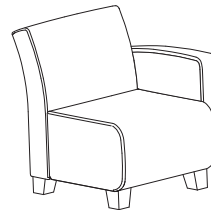

\*Lounge Chair with Wood Arm Left

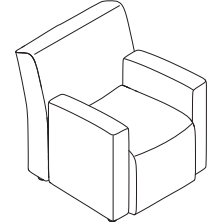

Club Low Lounge Chair

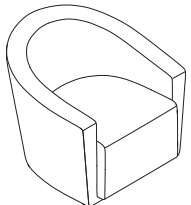

Round Low Lounge Chair

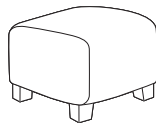

\*Ottoman

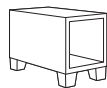

End Table

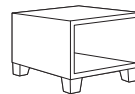

Coffee Table

\*See specifying pages for availability of casters and tablet arm.



**Lounge Seating, continued**

**Regard**

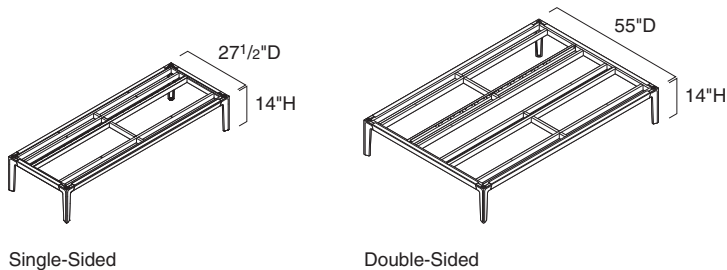

Understanding  
 ▶ Page 208  
 Specifying  
 ▶ Page 238

**Base Frames**

	44"W	55"W	60 1/2"W	66"W	71 1/2"W	77"W	82 1/2"W	88"W
Single-sided	●	●	●	●	●	●	●	●
Double-sided	●	●	●	●	●	●	●	●

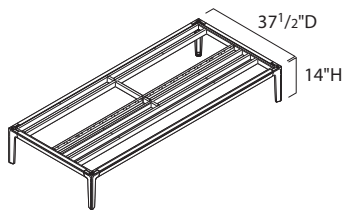

Understanding  
 ▶ Page 208  
 Specifying  
 ▶ Page 238

**Planter Frames**

	44"W	55"W	60 1/2"W	66"W	71 1/2"W	77"W	82 1/2"W	88"W
Planter	●	●	●	●	●	●	●	●

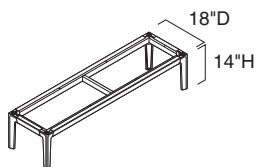

Understanding  
 ▶ Page 208  
 Specifying  
 ▶ Page 238

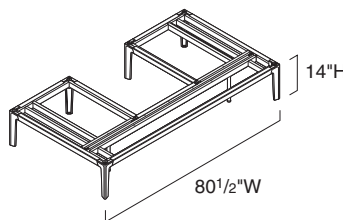

Understanding  
 ▶ Page 208  
 Specifying  
 ▶ Page 238

**Bench Frames**

	44"W	66"W
Bench	●	●

**Booth Frames**

	44"D	55"D
Booth	●	●

**Lounge Seating, continued**

**Regard, continued**

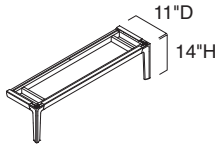

Understanding  
 ▶ Page 208  
 Specifying  
 ▶ Page 238

**Wall-Mounted Cabinet Frame**

55"W

Wall-Mounted Cabinet

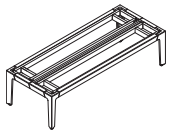

Understanding  
 ▶ Page 208  
 Specifying  
 ▶ Page 238

**Freestanding Back-to-Back Cabinet**

55"W

Freestanding Back-to-Back Cabinet

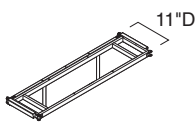

Cabinet

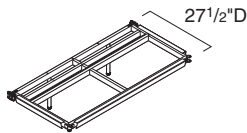

Seating

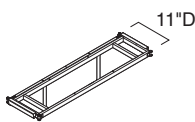

Planter

Understanding  
 ▶ Page 208  
 Specifying  
 ▶ Page 240

**Frame Extensions**

	44"W	55"W	61"W	66"W	72"W	77"W	83"W	88"W
Cabinet Frame Extensions		●						
Seating Frame Extensions		●						
Planter Frame Extensions	●		●	●	●	●	●	●



Ganging Bracket

Understanding  
 ▶ Page 210  
 Specifying  
 ▶ Page 241

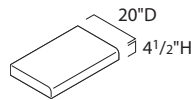

Seat

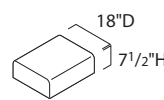

Bench

Understanding  
 ▶ Page 212  
 Specifying  
 ▶ Page 242

**Frame Bracket**

**Seat and Bench Cushions**

	22"W	33"W
Seat Cushions	●	●
Bench Cushion	●	

**Lounge Seating, continued**

**Regard, continued**

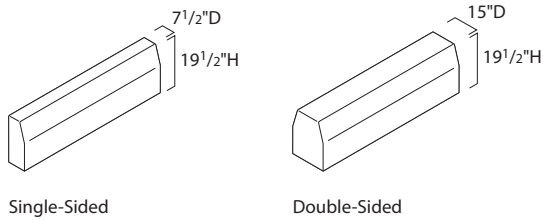

Understanding  
 ▶ Page 214  
 Specifying  
 ▶ Page 244

**Backs**

	33"W	38 1/2"W	44"W	49 1/2"W	55"W	60 1/2"W	66"W	71 1/2"W	77"W	82 1/2"W	88"W
Single-sided	●		●		●	●	●	●	●	●	●
Double-sided	●	●	●	●	●	●	●	●	●	●	●

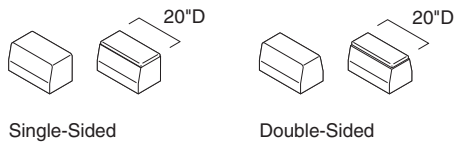

Understanding  
 ▶ Page 216  
 Specifying  
 ▶ Page 247

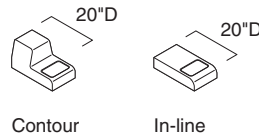

Understanding  
 ▶ Page 216  
 Specifying  
 ▶ Page 248

**Arms**

	5 1/2"W	11"W
Single-Sided Arms	●	●
Double-Sided Arms	●	●

**Utility Arms**

	11"W
Contour Arm	●
In-line Table	●

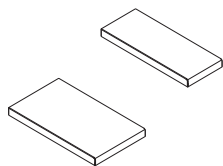

Understanding  
 ▶ Page 217  
 Specifying  
 ▶ Page 249

**Storage End Tables**

	11"W	16 1/2"W
Storage End Tables	●	●

**Lounge Seating, continued**

**Regard, continued**

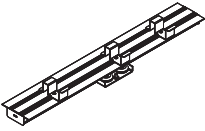

Specifying  
▶ Page 250

**Tablet Rails**

	44"W	55"W	60½"W	66"W	71½"W	77"W	82½"W	88"W
Tablet Rails	●	●	●	●	●	●	●	●

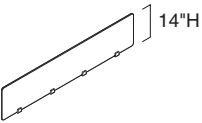

Understanding  
▶ Page 220  
Specifying  
▶ Page 251

**Privacy Screens**

	33"W	38½"W	44"W	49½"W	55"W	60½"W	66"W	71½"W	77"W	82½"W	88"W
Privacy Screens	●	●	●	●	●	●	●	●	●	●	●

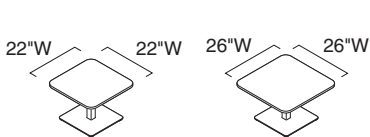

Square Tables

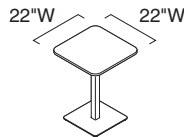

Personal Table

Understanding  
▶ Page 222  
Specifying  
▶ Page 252

**Tables**

	15"H	29"H
Square Tables	●	
Personal Table		●

**Lounge Seating, continued**

**Regard, continued**

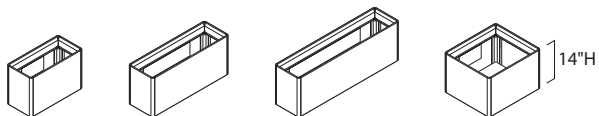

Understanding  
 ▶ Page 223  
 Specifying  
 ▶ Page 253

**Planters**

	22"W	33"W	44"W
11"D	●	●	●
22"D	●		

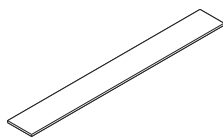

Understanding  
 ▶ Page 223  
 Specifying  
 ▶ Page 254

**Planter Shelves**

	44"W	55"W	60½"W	66"W	71½"W	77"W	82½"W	88"W
11"D	●	●	●	●	●	●	●	●

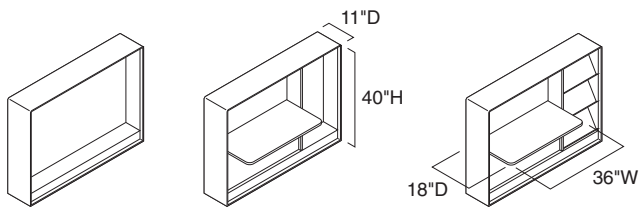

Media

Open Desk

Desk Cabinet with  
 Display Shelves

Understanding  
 ▶ Page 224  
 Specifying  
 ▶ Page 256

**Cabinets**

	55"W
Media Cabinets	●
Desk Cabinets	●

**Lounge Seating, continued**

**Regard, continued**

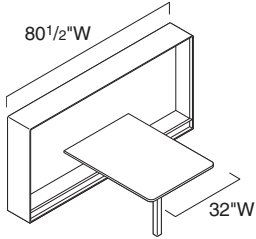





Understanding  
 ▶ Page 226  
 Specifying  
 ▶ Page 258

**Booth with Table**

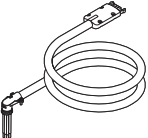
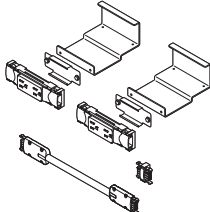
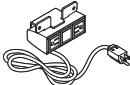
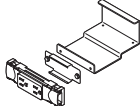
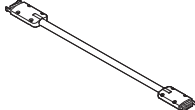
	44"D	55"D
Booth with Table	●	●

**Regard Electrical Components**

 <b>Hardwire Power Infeed</b> Understanding ▶ Page 228 Specifying ▶ Page 259	 <b>Power Kits</b> Understanding ▶ Page 228 Specifying ▶ Page 259	 <b>Power Strips</b> Understanding ▶ Page 228 Specifying ▶ Page 260	 <b>Receptacle Kits</b> Understanding ▶ Page 228 Specifying ▶ Page 261	 <b>Modular Harness</b> Understanding ▶ Page 228 Specifying ▶ Page 261
 <b>Connectors</b> Understanding ▶ Page 228 Specifying ▶ Page 262	 <b>Vertical Cable Riser</b> Understanding ▶ Page 228 Specifying ▶ Page 262	 <b>Cable Clamp</b> Understanding ▶ Page 228 Specifying ▶ Page 263		

**Multi-Purpose Seating**

**Node 480 Series** by Steelcase

Understanding  
▶ Page 264  
Specifying  
▶ Pages 276–288



Collaborative Mid-Back Chair



Collaborative Mid-Back Chair with Personal Worksurface



Collaborative Mid-Back Chair with Swivel-Base



Collaborative Mid-Back Chair with Swivel-Base and Personal Worksurface



Collaborative Mid-Back Stool with Swivel-Base



Collaborative Chair

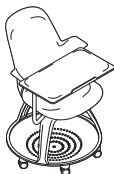

Collaborative Chair with Personal Worksurface



Collaborative Chair with Swivel-Base



Collaborative Chair with Swivel-Base and Personal Worksurface

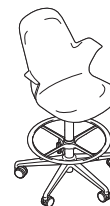

Collaborative Stool with Swivel-Base

**Verge**

Understanding  
▶ Page 289  
Specifying  
▶ Page 290



With Casters



With Glides

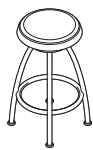

With Glides



With Glides

**Stackable Seating**

**Enea Stacker Chairs by Coalesse**

Understanding  
 ▶ Page 291  
 Specifying  
 ▶ Pages 292–294



Wood Seat and Back with Arms

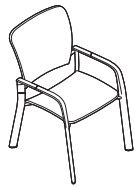

Metal Stacker with Upholstered Seat and Back with Arms



Metal Stacker with Upholstered Seat and Wood Back with Arms

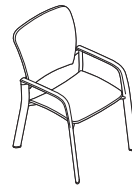

Metal Stacker with Polypropylene Seat and Back with Arms



Wood Seat and Back Without Arms



Upholstered Seat and Back Without Arms

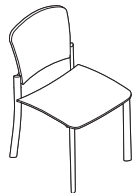

Upholstered Seat and Wood Back Without Arms

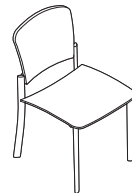

Polypropylene Seat and Back Without Arms

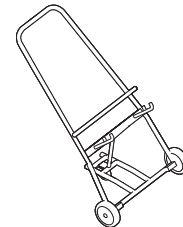

Dolly

**Move 490 Series** by Steelcase

Understanding  
 ▶ Page 296  
 Specifying  
 ▶ Pages 300–311



Multi-Use Chair With Arms



Multi-Use Chair Without Arms



Multi-Use Chair With Arms and With Casters



Multi-Use Chair Without Arms and With Casters



Stool Without Arms

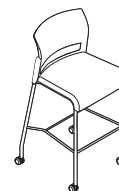

Stool Without Arms With Casters



Stool With Arms



Stool With Arms With Casters



Perching Stool Without Arms



Perching Stool With Arms



**Stackable Seating, continued**

**Player 475 Series** by Steelcase

Understanding  
 ▶ Page 312  
 Specifying  
 ▶ Pages 316–326



Leg-Base\*  
 Multi-Use Chair  
 Without Arms



Leg-Base\*  
 Multi-Use Chair  
 With Arms



Sled-Base  
 Multi-Use Chair  
 Without Arms



Sled-Base  
 Multi-Use Chair  
 With Arms



Stool With Arms



Stool  
 Without Arms

\*Player leg-base chair models also stack.

**Sorrel**

Understanding  
 ▶ Page 328  
 Specifying  
 ▶ Pages 330–337



18"W Stacking  
 Chair Without Arms\*

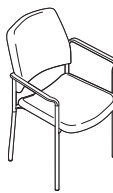

18"W Stacking  
 Chair With Arms\*



22"W Stacking  
 Chair Without Arms\*

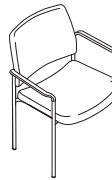

22"W Stacking  
 Chair With Arms\*

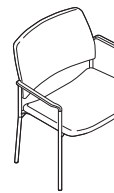

Bariatric Chair\*

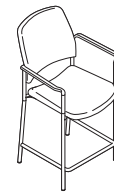

18"W Easy Access  
 Chair

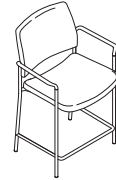

22"W Easy Access  
 Chair

\*Available with straight or wall saver legs.

**Sorrel Tables**

Understanding  
 ▶ Page 338  
 Specifying  
 ▶ Pages 339–340



Freestanding Table



10"W In-Line  
 Ganging Table



17"W In-Line  
 Ganging Table

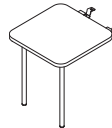

Left-Hand Ganging  
 End Table

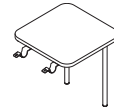

Right-Hand  
 Ganging End Table



Corner Ganging  
 Table

## Recliner Seating

### Empath Recliners

Understanding  
▶ Page 342  
Specifying  
▶ Pages 348 and 352

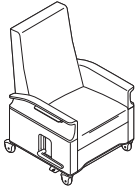

With Fixed Arms\*

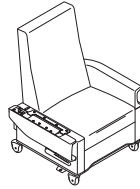

With Left Flip-Down Arm\*

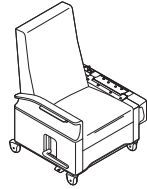

With Right Flip-Down Arm\*

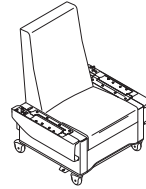

With Dual Flip-Down Arms\*



With Fully Upholstered Arms\*

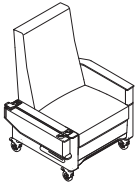

With Left Flip-Down Arm\*



With Right Flip-Down Arm\*

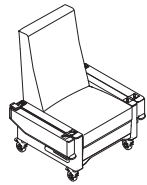

With Dual Flip-Down Arms\*

\*Available with Trendelenburg

### Mineral Recliners

Understanding  
▶ Page 356  
Specifying  
▶ Page 358



With Fixed Arms

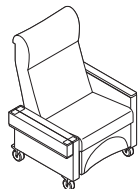

With Left Flip-Down Arm

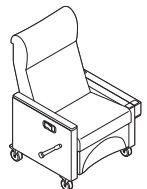

With Right Flip-Down Arm

### Mitra Recliners

Understanding  
▶ Page 360  
Specifying  
▶ Page 362



Recliner



Trendelenburg Recliner

### Sleeper Seating

#### Mitra Sleeper Chair

- Understanding
- ▶ Page 364
- Specifying
- ▶ Page 365

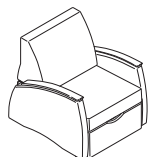

#### Sieste Sleeper

- Understanding
- ▶ Page 366
- Specifying
- ▶ Page 368

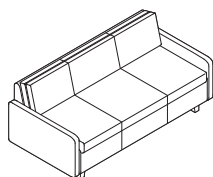

Sleeper with Arms

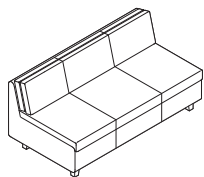

Sleeper with End Panels

#### Surround

- Understanding
- ▶ Pages 380–386
- Specifying
- ▶ Pages 388–433

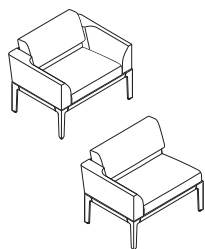

Lounge, 44" Frame Width

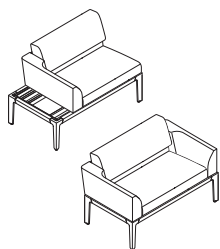

Lounge, 55" Frame Width

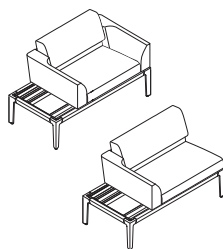

Lounge, 60 1/2" Frame Width

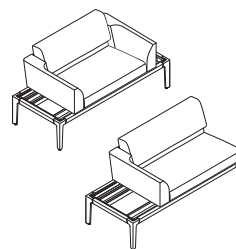

Lounge, 66" Frame Width

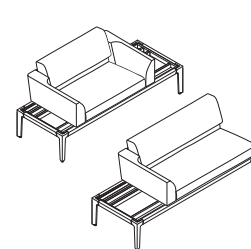

Lounge, 71 1/2" Frame Width

**Sleeper Seating, continued**

**Surround, continued**

Understanding  
▶ Pages 380–386  
Specifying  
▶ Pages 388–433

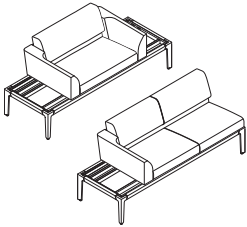

Lounge, 77" Frame Width

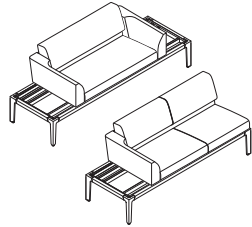

Lounge, 82 1/2" Frame Width

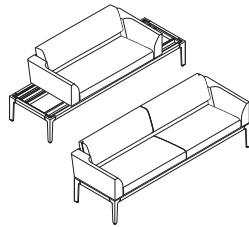

Lounge, 88" Frame Width

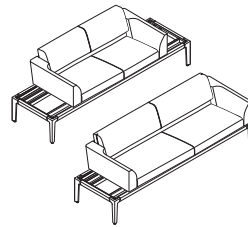

Lounge, 93 1/2" Frame Width

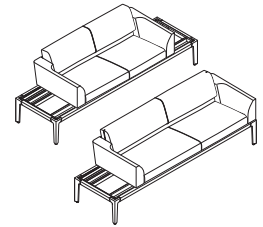

Lounge, 99" Frame Width

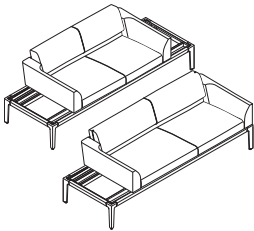

Lounge, 104 1/2" Frame Width

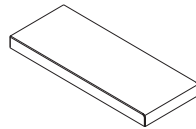

Storage, End Table

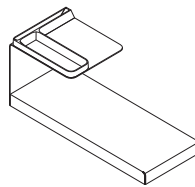

Storage, Two-Tier End Table

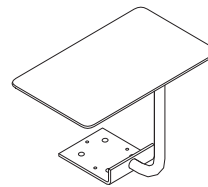

Mobile Tablet

**X-tenz Sleeper Chairs**

Understanding  
▶ Page 434  
Specifying  
▶ Pages 436 and 437

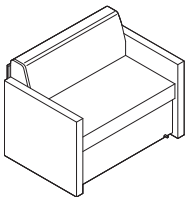

Single Sleeper Chair with Glides

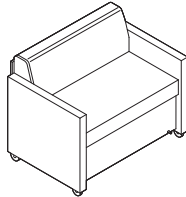

Single Sleeper Chair with Casters

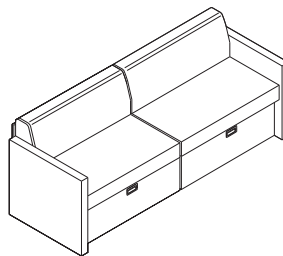

Double Sleeper Chair

## West Elm Health

## Mesa

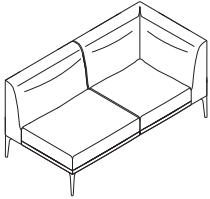
**Mesa Left-Hand Chaise Lounge**

Understanding  
 ▶ Page 438  
 Specifying  
 ▶ Page 442

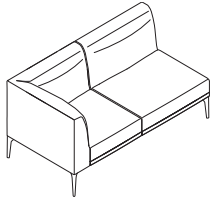
**Mesa Right-Hand Chaise Lounge**

Understanding  
 ▶ Page 438  
 Specifying  
 ▶ Page 443

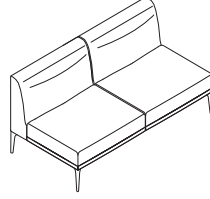
**Mesa Two-Seat Lounge**

Understanding  
 ▶ Page 438  
 Specifying  
 ▶ Page 444

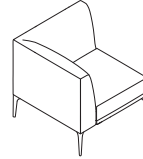
**Mesa Corner Lounge**

Understanding  
 ▶ Page 438  
 Specifying  
 ▶ Page 445

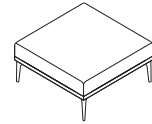
**Ottoman**

Understanding  
 ▶ Page 438  
 Specifying  
 ▶ Page 446

## Slope

## Guest Chairs

**Slope Guest Chair**

Understanding  
 ▶ Page 448  
 Specifying  
 ▶ Page 451

**Slope Bariatric Guest Chair**

Understanding  
 ▶ Page 448  
 Specifying  
 ▶ Page 452

**Slope Stacking Guest Chair**

Understanding  
 ▶ Page 448  
 Specifying  
 ▶ Page 453

**West Elm Health, continued**

**Sterling**

**Guest Chairs and Stools**

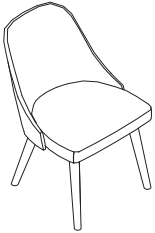

**Sterling Guest Armless Wood Leg Chair**

Understanding  
▶ Page 454  
Specifying  
▶ Page 458

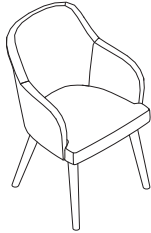

**Sterling Guest with Arm Wood Leg Chair**

Understanding  
▶ Page 454  
Specifying  
▶ Page 459

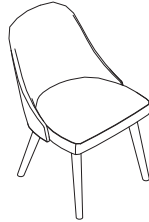

**Sterling Guest Armless Metal Leg Chair**

Understanding  
▶ Page 454  
Specifying  
▶ Page 460



**Sterling Guest with Arm Metal Leg Chair**

Understanding  
▶ Page 454  
Specifying  
▶ Page 461



**Sterling Counter-Height Armless Stool**

Understanding  
▶ Page 455  
Specifying  
▶ Page 466



**Sterling Bar-Height Armless Stool**

Understanding  
▶ Page 455  
Specifying  
▶ Page 467

**Conference Chairs**



**Sterling Conference Chair—5-Star Armless**

Understanding  
▶ Page 454  
Specifying  
▶ Page 462



**Sterling Conference Chair—5-Star with Arms**

Understanding  
▶ Page 454  
Specifying  
▶ Page 463



**Sterling Conference Chair—4-Star Armless**

Understanding  
▶ Page 455  
Specifying  
▶ Page 464



**Sterling Conference Chair—4-Star with Arms**

Understanding  
▶ Page 455  
Specifying  
▶ Page 465

**West Elm Health, continued**

**Lucas**

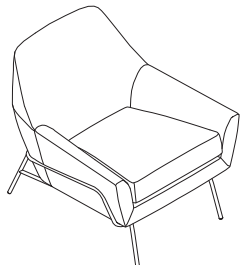

**Lucas Wire Chair**

Understanding  
▶ Page 468

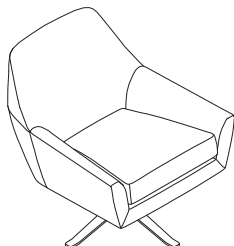

**Lucas Swivel Chair**

Understanding  
▶ Page 468

# Aspekt Straight Arm

**Aspekt seating with straight arm caps** provides clean modern styling to any setting. Seating can stand alone or be grouped into a variety of ganged configurations.

**Back cushions** are available with a convex shape that curves upward or a concave shape that curves downward.

**Legs** are available as straight or wall saver. High back chairs available with straight legs only.

**Frame and legs** are constructed with steel for structural integrity. They have a powdercoat paint finish that is corrosion resistant.

**Glides** are standard on legs.

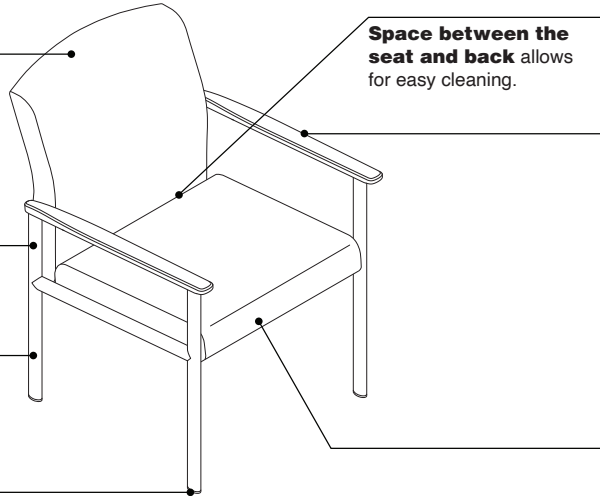

**Space between the seat and back** allows for easy cleaning.

**Arm caps** overhang the legs to provide a comfortable hand grip for ease of entry and exit from the chair.

**Arm caps** are plastic, solid maple wood, or solid surface.

**Seat cushion and back** are fully upholstered.

## Actual Dimensions

Features	Overall Depth	Width	Height	Seat Depth	Width	Height	Arm Height
<b>Single-Seat Chair</b>	27"	22 <sup>3</sup> / <sub>4</sub> "	33"	19 <sup>3</sup> / <sub>4</sub> "	20"	18 <sup>3</sup> / <sub>8</sub> "	25 <sup>3</sup> / <sub>4</sub> "
<b>Two-Seat Chairs</b>							
No center arm or center legs	27"	43"	33"	19 <sup>3</sup> / <sub>4</sub> "	40"	18 <sup>3</sup> / <sub>8</sub> "	25 <sup>3</sup> / <sub>4</sub> "
With center arm	27"	44"	33"	19 <sup>3</sup> / <sub>4</sub> "	20"	18 <sup>3</sup> / <sub>8</sub> "	25 <sup>3</sup> / <sub>4</sub> "
With center arm and center legs	27"	44"	33"	19 <sup>3</sup> / <sub>4</sub> "	20"	18 <sup>3</sup> / <sub>8</sub> "	25 <sup>3</sup> / <sub>4</sub> "
<b>Three-Seat Chairs</b>							
No center arms or center legs	27"	63 <sup>1</sup> / <sub>4</sub> "	33"	19 <sup>3</sup> / <sub>4</sub> "	60"	18 <sup>3</sup> / <sub>8</sub> "	25 <sup>3</sup> / <sub>4</sub> "
With center arms	27"	65 <sup>1</sup> / <sub>2</sub> "	33"	19 <sup>3</sup> / <sub>4</sub> "	20"	18 <sup>3</sup> / <sub>8</sub> "	25 <sup>3</sup> / <sub>4</sub> "
With center arms and center legs	27"	65 <sup>1</sup> / <sub>2</sub> "	33"	19 <sup>3</sup> / <sub>4</sub> "	20"	18 <sup>3</sup> / <sub>8</sub> "	25 <sup>3</sup> / <sub>4</sub> "
<b>Bariatric Chairs</b>							
Single-seat chair	27"	32 <sup>3</sup> / <sub>4</sub> "	33"	19 <sup>3</sup> / <sub>4</sub> "	30"	18 <sup>3</sup> / <sub>8</sub> "	25 <sup>3</sup> / <sub>4</sub> "
Two-seat combination unit	27"	54"	33"	19 <sup>3</sup> / <sub>4</sub> "	20"/30"	18 <sup>3</sup> / <sub>8</sub> "	25 <sup>3</sup> / <sub>4</sub> "
Three-seat combination unit	27"	75 <sup>1</sup> / <sub>4</sub> "	33"	19 <sup>3</sup> / <sub>4</sub> "	20"/20"/30"	18 <sup>3</sup> / <sub>8</sub> "	25 <sup>3</sup> / <sub>4</sub> "
<b>High-Back Chair</b>	29"	22 <sup>3</sup> / <sub>4</sub> "	45"	19 <sup>3</sup> / <sub>4</sub> "	20"	18 <sup>3</sup> / <sub>8</sub> "	25 <sup>3</sup> / <sub>4</sub> "
<b>Easy Access Chair</b>	27"	22 <sup>3</sup> / <sub>4</sub> "	39"	19 <sup>3</sup> / <sub>4</sub> "	20"	24"	31 <sup>3</sup> / <sub>16</sub> "
<b>Bench</b>	22"	32"	18"	19 <sup>3</sup> / <sub>4</sub> "	32"	18 <sup>3</sup> / <sub>8</sub> "	N.A.
<b>Footstool</b>	12"	18 <sup>1</sup> / <sub>2</sub> "	14"	N.A.	N.A.	N.A.	N.A.

Tip: All overall height dimensions listed are for the convex back style. Concave back style is 1" less than convex dimension shown.

Tip: All overall depth dimensions listed are for straight leg styles. For wall saver styles, add 1" to dimensions shown.

Tip: Combination units include one bariatric single-seat chair and either one or two standard width single-seat chairs.



**Product Details**

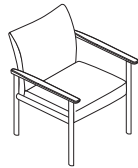

**Concave back style** is available on one-, two-, and three-seat versions.

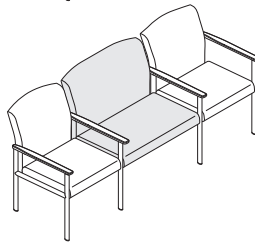
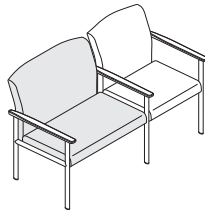
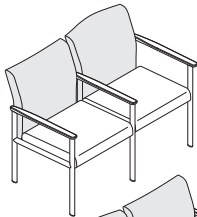
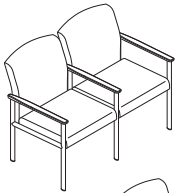

**Bariatric combination units** are available in two- and three-seat configurations and consist of a bariatric chair connected to one or two standard width chairs. The bariatric seat location can be specified in the left facing, right facing, or center (three-seat units) position. Combination units include center arms and legs.

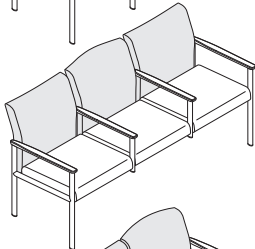
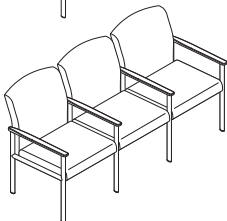

**Arm chairs** are available in one-, two-, and three-seat versions.

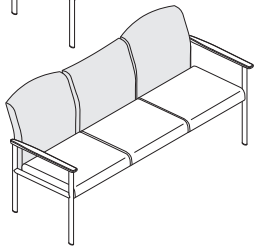
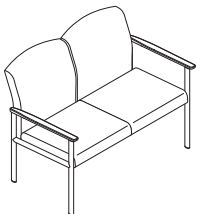

**Combinations of convex and concave back cushions** may be specified on the same multi-seat unit to create a wave-like contour.

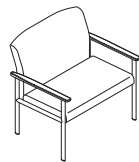
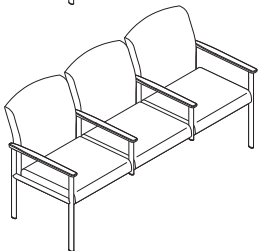

**Bariatric chair** is available with a 30"W seat and has been tested to a dynamic load of 300 pounds and a static load of 750 pounds. Back cushion has a convex shape.

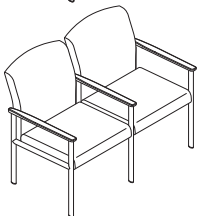

**Two- and three-seat units** are offered in three configurations – no center arms or center legs, with center arms, and with center arms and center legs.

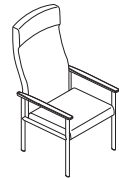

**High-back chair** has a tapered, 29"H convex back and straight legs.

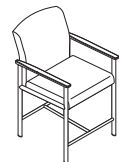

**Easy access chair** has a 24" seat height and includes a foot rest. Back cushion has a convex shape.

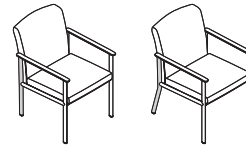

**Straight or wallsaver legs** are available on single, two-seat, three-seat, bariatric, combo-unit, and easy access chairs.

*Tip: Wallsaver legs are not available on three-seat chairs with center arms and no center legs.*

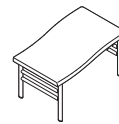

**Bench** has a wave-shape and is 18 $\frac{3}{8}$ "H. Bench is a shared component between the straight arm and wave arm Aspekt family of seating.



**Footstool** has an angled, cushion surface. Footstool is a shared component between the straight arm and wave arm Aspekt family of seating.

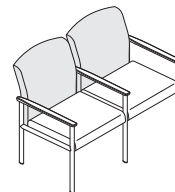

**Different fabrics** can be specified on the seat and back. On two- and three-seat units, the back fabric will be consistent throughout the whole unit as shown above. Contrasting fabric deviating from this standard needs to be processed through Specials.

**Arm caps** are available in plastic, solid maple wood, or solid surface.

**Back and seat covers** have zippers and can be removed for cleaning.

**Moisture barrier** is available as an option on seat only.

**Ganging brackets** are available to link chairs in the field.

**When chairs** are ganged, the spacing between arms is 1 $\frac{1}{2}$ " and the spacing between legs is 2 $\frac{1}{8}$ ".

**All Steelcase Health seating with standard upholstery fabrics** comply with the State of California Technical Bulletin 117-2013.

**Seat and back**

- Fabric
- Fabric with moisture barrier (option on seat only)

**Arm**

- Plastic
  - Maple wood
  - Solid surface
- Tip: Select Surface solid surfaces are available.*

▶ See *Surface Materials* section for complete listing on page 473.

**Frame and legs**

- 4750 Champagne Metallic
- 4799 Platinum Metallic
- 7207 Black
- 7360 Merle

**Glides**

- Black plastic only

# Aspekt Straight Arm

## Single-Seat Chair



*Tip: Different fabrics for the seat and back can be specified. If the fabrics are in different price groups, calculate list price by adding the two price groups together and dividing by two.*

	Standard Includes	Required to Specify
<ul style="list-style-type: none"> <li>▶ Need help? Product details, page 32</li> </ul>	<ul style="list-style-type: none"> <li>• Seat and back: fabric</li> <li>• Arm caps: plastic, maple wood, or solid surface</li> <li>• Back style: convex</li> <li>• Frame and legs: paint</li> <li>• Glides: black nylon</li> <li>• Ganging brackets, if selected: paint (ordered separately)</li> </ul>	<ol style="list-style-type: none"> <li>1 Style number</li> <li>2 Fabric color number for seat and back</li> <li>3 Plastic, wood, or solid surface color number for arm caps (see below under Required Selections)</li> <li>4 Leg style (see below under Required Selections)</li> <li>5 Paint color number for frame and legs</li> <li>6 Paint color number for ganging brackets, if selected</li> <li>7 Options, if selected (see below)</li> </ol> <p>▶ See <i>Surface Materials</i>, page 473.</p>

	Required Selections	U.S. Price	Required to Specify
<b>Arm Caps</b>	<ul style="list-style-type: none"> <li>• Plastic</li> <li>• Maple wood</li> <li>• Solid surface price group A</li> <li>• Solid surface price group B</li> <li>• Solid surface price group C</li> <li>• Solid surface price group D</li> </ul>	<p>No cost</p> <p>No cost</p> <p>+\$456</p> <p>+\$490</p> <p>+\$524</p> <p>+\$556</p>	<p>Specify with <i>plastic arm caps</i> and select plastic color number.</p> <p>Specify with <i>wood arm caps</i> and select wood color number.</p> <p>Specify with <i>solid surface arm caps</i> and select solid surface color number.</p> <p>Specify with <i>solid surface arm caps</i> and select solid surface color number.</p> <p>Specify with <i>solid surface arm caps</i> and select solid surface color number.</p> <p>Specify with <i>solid surface arm caps</i> and select solid surface color number.</p>
<b>Leg Style</b>	<ul style="list-style-type: none"> <li>• Straight legs</li> <li>• Wallsaver legs</li> </ul>	<p>No cost</p> <p>+\$ 44</p>	<p>Specify with <i>straight legs</i>.</p> <p>Specify with <i>wallsaver legs</i>.</p>

	Options	U.S. Price	Required to Specify
<b>Surface Materials</b>	<ul style="list-style-type: none"> <li>• Moisture barrier</li> </ul>	+\$134	Specify with <i>moisture barrier</i> .
<b>Back Style</b>	<ul style="list-style-type: none"> <li>• Concave</li> </ul>	No cost	Specify with <i>concave back</i> .

### Specification Information

Style Number	U.S. Base Prices										COM
	Fabric Price Group 1	Fabric Price Group 2	Fabric Price Group 3	Fabric Price Group 4	Fabric Price Group 5	Fabric Price Group 6	Fabric Price Group 7	Fabric Price Group 8	Fabric Price Group 9	Fabric Price Group 10	
SC4210	\$1010	\$1098	\$1178	\$1250	\$1320	\$1368	\$1438	\$1546	\$1666	\$1746	\$1062



**For Canadian Pricing**  
 Multiply U.S. Price by the Canadian price factor.  
 ▶ See page 1 for details.

**Related Product**

Style Number	U.S. Price
--------------	------------

**Set of Ganging Brackets**

SC4009	\$93
--------	------



**For Canadian Pricing**

Multiply U.S. Price by the Canadian price factor.

▶ See page 1 for details.

Aspekt Straight Arm, continued

Two-Seat Chairs



No Center Arm or Legs

*Tip: Different fabrics for the seat and back can be specified. If the fabrics are in different price groups, calculate list price by adding the two price groups together and dividing by two.*

*Tip: Left and right is determined when facing the chair.*

	Standard Includes	Required to Specify
<p>► Need help? Product details, page 32</p>	<ul style="list-style-type: none"> <li>• Seat and back: fabric</li> <li>• Arm caps: plastic, maple wood, or solid surface</li> <li>• Back style: convex</li> <li>• Frame and legs: paint</li> <li>• Glides: black nylon</li> <li>• Ganging brackets, if selected: paint (ordered separately)</li> </ul>	<ol style="list-style-type: none"> <li>1 Style number</li> <li>2 Fabric color number for seat and back</li> <li>3 Plastic, wood, or solid surface color number for arm caps (see below under Required Selections)</li> <li>4 Leg style (see below under Required Selections)</li> <li>5 Paint color number for frame and legs</li> <li>6 Paint color number for ganging brackets, if selected</li> <li>7 Options, if selected (see below)</li> </ol> <p>► See <i>Surface Materials</i>, page 473.</p>

	Required Selections	U.S. Price	Required to Specify
<b>Arm Caps</b>	<ul style="list-style-type: none"> <li>• Plastic</li> <li>• Maple wood</li> <li>• Solid surface price group A</li> <li>• Solid surface price group B</li> <li>• Solid surface price group C</li> <li>• Solid surface price group D</li> </ul>	<p>No cost</p> <p>No cost</p> <p>+\$228 per arm cap</p> <p>+\$245 per arm cap</p> <p>+\$262 per arm cap</p> <p>+\$278 per arm cap</p>	<p>Specify with <i>plastic arm caps</i> and select plastic color number.</p> <p>Specify with <i>wood arm caps</i> and select wood color number.</p> <p>Specify with <i>solid surface arm caps</i> and select solid surface color number.</p> <p>Specify with <i>solid surface arm caps</i> and select solid surface color number.</p> <p>Specify with <i>solid surface arm caps</i> and select solid surface color number.</p> <p>Specify with <i>solid surface arm caps</i> and select solid surface color number.</p>
<b>Leg Style</b>	<ul style="list-style-type: none"> <li>• Straight legs</li> <li>• Wallsaver legs</li> </ul>	<p>No cost</p> <p>+\$ 22 per rear leg</p>	<p>Specify with <i>straight legs</i>.</p> <p>Specify with <i>wallsaver legs</i>.</p>

	Options	U.S. Price	Required to Specify
<b>Surface Materials</b>	<ul style="list-style-type: none"> <li>• Moisture barrier</li> </ul>	<p>+\$268</p>	<p>Specify with <i>moisture barrier</i>.</p>
<b>Arms and Legs Configuration</b>	<ul style="list-style-type: none"> <li>• No center arm or legs</li> <li>• Center arm</li> <li>• Center arm and center legs</li> </ul>	<p>No cost</p> <p>+\$149</p> <p>+\$171</p>	<p>Specify with <i>no center arm or legs</i>.</p> <p>Specify with <i>center arm</i>.</p> <p>Specify with <i>center arm and legs</i>.</p>
<b>Back Style</b>	<ul style="list-style-type: none"> <li>• Concave</li> <li>• Convex left, concave right</li> <li>• Concave left, convex right</li> </ul>	<p>No cost</p> <p>No cost</p> <p>No cost</p>	<p>Specify with <i>concave back</i>.</p> <p>Specify with <i>convex left, concave right back</i>.</p> <p>Specify with <i>concave left, convex right back</i>.</p>



Center Arm



Center Arm and Center Legs



**For Canadian Pricing**

Multiply U.S. Price by the Canadian price factor.

► See page 1 for details.

**Specification Information**

Style Number	U.S. Base Prices										COM
	Fabric Price Group 1	Fabric Price Group 2	Fabric Price Group 3	Fabric Price Group 4	Fabric Price Group 5	Fabric Price Group 6	Fabric Price Group 7	Fabric Price Group 8	Fabric Price Group 9	Fabric Price Group 10	



<b>SC4220</b>	\$1603	\$1771	\$1945	\$2087	\$2229	\$2313	\$2455	\$2685	\$2913	\$3079	\$1655
---------------	--------	--------	--------	--------	--------	--------	--------	--------	--------	--------	--------

**Related Product**

Style Number	U.S. Price
--------------	------------

**Set of Ganging Brackets**

<b>SC4009</b>	\$93
---------------	------

Families of Seating



**For Canadian Pricing**  
 Multiply U.S. Price by the Canadian price factor.  
 ▶ See page 1 for details.

Aspekt Straight Arm, continued

Three-Seat Chairs

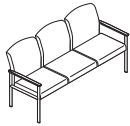

No Center Arms or Legs

*Tip: Different fabrics for the seat and back can be specified. If the fabrics are in different price groups, calculate list price by adding the two price groups together and dividing by two.*

*Tip: Left and right is determined when facing the chair.*

*Tip: Wallsaver legs are not available with center arms only configuration.*

	Standard Includes	Required to Specify
▶ Need help? Product details, page 32	<ul style="list-style-type: none"> <li>• Seat and back: fabric</li> <li>• Arm caps: plastic, maple wood, or solid surface</li> <li>• Back style: convex</li> <li>• Frame and legs: paint</li> <li>• Glides: black nylon</li> <li>• Ganging brackets, if selected: paint (ordered separately)</li> </ul>	<ol style="list-style-type: none"> <li>1 Style number</li> <li>2 Fabric color number for seat and back</li> <li>3 Plastic, wood, or solid surface color number for arm caps (see below under Required Selections)</li> <li>4 Leg style (see below under Required Selections)</li> <li>5 Paint color number for frame and legs</li> <li>6 Paint color number for ganging brackets, if selected</li> <li>7 Options, if selected (see below)</li> </ol> <p>▶ See <i>Surface Materials</i>, page 473.</p>

	Required Selections	U.S. Price	Required to Specify
<b>Arm Caps</b>	<ul style="list-style-type: none"> <li>• Plastic</li> <li>• Maple wood</li> <li>• Solid surface price group A</li> <li>• Solid surface price group B</li> <li>• Solid surface price group C</li> <li>• Solid surface price group D</li> </ul>	<p>No cost</p> <p>No cost</p> <p>+\$228 per arm cap</p> <p>+\$245 per arm cap</p> <p>+\$262 per arm cap</p> <p>+\$278 per arm cap</p>	<p>Specify with <i>plastic arm caps</i> and select plastic color number.</p> <p>Specify with <i>wood arm caps</i> and select wood color number.</p> <p>Specify with <i>solid surface arm caps</i> and select solid surface color number.</p> <p>Specify with <i>solid surface arm caps</i> and select solid surface color number.</p> <p>Specify with <i>solid surface arm caps</i> and select solid surface color number.</p> <p>Specify with <i>solid surface arm caps</i> and select solid surface color number.</p>
<b>Leg Style</b>	<ul style="list-style-type: none"> <li>• Straight legs</li> <li>• Wallsaver legs</li> </ul>	<p>No cost</p> <p>+\$ 22 per rear leg</p>	<p>Specify with <i>straight legs</i>.</p> <p>Specify with <i>wallsaver legs</i>.</p>

	Options	U.S. Price	Required to Specify
<b>Surface Materials</b>	<ul style="list-style-type: none"> <li>• Moisture barrier</li> </ul>	<p>+\$402</p>	<p>Specify with <i>moisture barrier</i>.</p>
<b>Arms and Legs Configuration</b>	<ul style="list-style-type: none"> <li>• No center arms or legs</li> <li>• Center arms</li> <li>• Center arms and center legs</li> </ul>	<p>No cost</p> <p>+\$299</p> <p>+\$342</p>	<p>Specify with <i>no center arms or legs</i>.</p> <p>Specify with <i>center arms</i>.</p> <p>Specify with <i>center arms and legs</i>.</p>
<b>Back Style</b>	<ul style="list-style-type: none"> <li>• Concave</li> <li>• Convex left, concave center, convex right</li> <li>• Concave left, convex center concave right</li> </ul>	<p>No cost</p> <p>No cost</p> <p>No cost</p>	<p>Specify with <i>concave back</i>.</p> <p>Specify with <i>convex left, concave center, convex right back</i>.</p> <p>Specify with <i>concave left, convex center, concave right back</i>.</p>

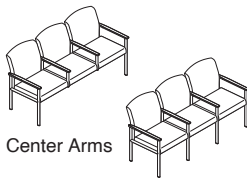

Center Arms

Center Arms and Center Legs



**For Canadian Pricing**

Multiply U.S. Price by the Canadian price factor.

▶ See page 1 for details.

**Specification Information**

Style Number	U.S. Base Prices										COM
	Fabric Price Group 1	Fabric Price Group 2	Fabric Price Group 3	Fabric Price Group 4	Fabric Price Group 5	Fabric Price Group 6	Fabric Price Group 7	Fabric Price Group 8	Fabric Price Group 9	Fabric Price Group 10	

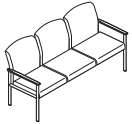

<b>SC4230</b>	\$2185	\$2443	\$2695	\$2907	\$3119	\$3253	\$3463	\$3799	\$4149	\$4397	\$2237
---------------	--------	--------	--------	--------	--------	--------	--------	--------	--------	--------	--------

**Related Product**

Style Number	U.S. Price
--------------	------------

**Set of Ganging Brackets**

<b>SC4009</b>	\$93
---------------	------

Families of Seating



**For Canadian Pricing**

Multiply U.S. Price by the Canadian price factor.

▶ See page 1 for details.

**Bariatric Chair**

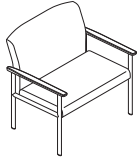

Tip: Bariatric chair is available with a convex back style only.

Tip: Different fabrics for the seat and back can be specified. If the fabrics are in different price groups, calculate list price by adding the two price groups together and dividing by two.

Standard Includes	Required to Specify
-------------------	---------------------

- |   |   |   |
|---|---|---|
| <ul style="list-style-type: none"> <li>▶ Need help? Product details, page 32</li> </ul> | <ul style="list-style-type: none"> <li>• Seat and back: fabric</li> <li>• Arm caps: plastic, maple wood, or solid surface</li> <li>• Back style: convex</li> <li>• Frame and legs: paint</li> <li>• Glides: black nylon</li> <li>• Ganging brackets, if selected: paint (ordered separately)</li> </ul> | <ol style="list-style-type: none"> <li>1 Style number</li> <li>2 Fabric color number for seat and back</li> <li>3 Plastic, wood, or solid surface color number for arm caps (see below under Required Selections)</li> <li>4 Leg style (see below under Required Selections)</li> <li>5 Paint color number for frame and legs</li> <li>6 Paint color number for ganging brackets, if selected</li> <li>7 Options, if selected (see below)</li> </ol> <p>▶ See <i>Surface Materials</i>, page 473.</p> |
|---|---|---|

Required Selections	U.S. Price	Required to Specify
---------------------	------------	---------------------

<b>Arm Caps</b>	• Plastic	No cost	Specify with <i>plastic arm caps</i> and select plastic color number.
	• Maple wood	No cost	Specify with <i>wood arm caps</i> and select wood color number.
	• Solid surface price group A	+\$456	Specify with <i>solid surface arm caps</i> and select solid surface color number.
	• Solid surface price group B	+\$490	Specify with <i>solid surface arm caps</i> and select solid surface color number.
	• Solid surface price group C	+\$524	Specify with <i>solid surface arm caps</i> and select solid surface color number.
	• Solid surface price group D	+\$556	Specify with <i>solid surface arm caps</i> and select solid surface color number.
<b>Leg Style</b>	• Straight legs	No cost	Specify with <i>straight legs</i> .
	• Wallsaver legs	+\$ 44	Specify with <i>wallsaver legs</i> .

Options	U.S. Price	Required to Specify
---------	------------	---------------------

<b>Surface Materials</b>	• Moisture barrier	+\$134	Specify with <i>moisture barrier</i> .
--------------------------	--------------------	--------	--

**Specification Information**

Style Number	Fabric Price	Fabric Price	Fabric Price	Fabric Price	Fabric Price	Fabric Price	Fabric Price	Fabric Price	Fabric Price	Fabric Price	COM
	Group 1	Group 2	Group 3	Group 4	Group 5	Group 6	Group 7	Group 8	Group 9	Group 10	
<b>SC4260</b>	\$1373	\$1525	\$1667	\$1795	\$1921	\$1997	\$2121	\$2317	\$2521	\$2663	\$1425

**Related Product**

Style Number	U.S. Price

**Set of Ganging Brackets**

<b>SC4009</b>	\$93
---------------	------



**For Canadian Pricing**  
 Multiply U.S. Price by the Canadian price factor.  
 ▶ See page 1 for details.





**Bariatric Combination Units**



*Tip: Combination units are available with a convex back style only and include center arms and legs.*

*Tip: Left and right is determined when facing the chair.*

*Tip: Different fabrics for the seat and back can be specified. If the fabrics are in different price groups, calculate list price by adding the two price groups together and dividing by two.*

	Standard Includes	Required to Specify
<p>► Need help? Product details, page 32</p>	<ul style="list-style-type: none"> <li>• Seat and back: fabric</li> <li>• Arm caps: plastic, maple wood, or solid surface</li> <li>• Back style: convex</li> <li>• Frame and legs: paint</li> <li>• Glides: black nylon</li> <li>• Ganging brackets, if selected: paint (ordered separately)</li> </ul>	<ol style="list-style-type: none"> <li>1 Style number</li> <li>2 Fabric color number for seat and back</li> <li>3 Plastic, wood, or solid surface color number for arm caps (see below under Required Selections)</li> <li>4 Bariatric seat location (see below under Required Selections)</li> <li>5 Leg style (see below under Required Selections)</li> <li>6 Paint color number for frame and legs</li> <li>7 Paint color number for ganging brackets, if selected</li> <li>8 Options, if selected (see below)</li> </ol> <p>► See <i>Surface Materials</i>, page 473.</p>

	Required Selections	U.S. Price	Required to Specify
<b>Arm Caps</b>	• Plastic	No cost	Specify <i>with plastic arm caps</i> and select plastic color number.
	• Maple wood	No cost	Specify <i>with wood arm caps</i> and select wood color number.
	• Solid surface price group A	+\$228 per arm cap	Specify <i>with solid surface arm caps</i> and select solid surface color number.
	• Solid surface price group B	+\$245 per arm cap	Specify <i>with solid surface arm caps</i> and select solid surface color number.
	• Solid surface price group C	+\$262 per arm cap	Specify <i>with solid surface arm caps</i> and select solid surface color number.
	• Solid surface price group D	+\$278 per arm cap	Specify <i>with solid surface arm caps</i> and select solid surface color number.
<b>Bariatric Seat Location</b>	• Bariatric seat in left facing position	No cost	Specify <i>with bariatric seat left</i> .
	• Bariatric seat in right facing position	No cost	Specify <i>with bariatric seat right</i> .
	• Bariatric seat in center position (three-seat units only)	No cost	Specify <i>with bariatric seat center</i> .
<b>Leg Style</b>	• Straight legs	No cost	Specify <i>with straight legs</i> .
	• Wallsaver legs	+\$ 22 per rear leg	Specify <i>with wallsaver legs</i> .

	Options	U.S. Price	Required to Specify
<b>Surface Materials</b>	<b>Moisture barrier</b>		
	• Two-seat combination units	+\$268	Specify <i>with moisture barrier</i> .
	• Three-seat combination units	+\$402	Specify <i>with moisture barrier</i> .



**For Canadian Pricing**  
Multiply U.S. Price by the Canadian price factor.  
► See page 1 for details.

**Specification Information**

Style Number	U.S. Base Prices										COM
	Fabric Price Group 1	Fabric Price Group 2	Fabric Price Group 3	Fabric Price Group 4	Fabric Price Group 5	Fabric Price Group 6	Fabric Price Group 7	Fabric Price Group 8	Fabric Price Group 9	Fabric Price Group 10	

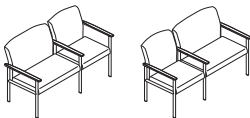

**Two-Seat Combination Unit**

<b>SC4262</b>	\$2151	\$2385	\$2621	\$2819	\$3009	\$3125	\$3323	\$3631	\$3953	\$4183	\$2203
---------------	--------	--------	--------	--------	--------	--------	--------	--------	--------	--------	--------

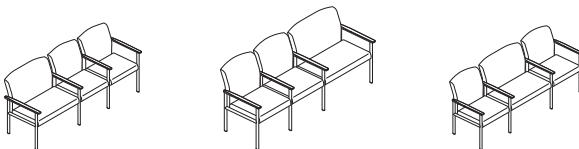

**Three-Seat Combination Unit**

<b>SC4263</b>	\$2909	\$3203	\$3509	\$3755	\$4001	\$4151	\$4395	\$4795	\$5207	\$5491	\$2961
---------------	--------	--------	--------	--------	--------	--------	--------	--------	--------	--------	--------

Families of Seating



**For Canadian Pricing**

Multiply U.S. Price by the Canadian price factor.

▶ See page 1 for details.

**High-Back Chair**

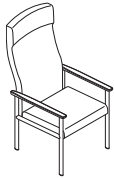

Tip: High-back chair is available with a convex back style only.

Tip: Different fabrics for the seat and back can be specified. If the fabrics are in different price groups, calculate list price by adding the two price groups together and dividing by two.

Standard Includes	Required to Specify
-------------------	---------------------

- |   |   |  |
|---|---|--|
| <ul style="list-style-type: none"> <li>▶ Need help? Product details, page 32</li> </ul> | <ul style="list-style-type: none"> <li>• Seat and back: fabric</li> <li>• Arm caps: plastic, maple wood, or solid surface</li> <li>• Back style: convex</li> <li>• Frame and legs: paint</li> <li>• Glides: black nylon</li> <li>• Ganging brackets, if selected: paint (ordered separately)</li> </ul> | <ol style="list-style-type: none"> <li>1 Style number</li> <li>2 Fabric color number for seat and back</li> <li>3 Plastic, wood, or solid surface color number for arm caps (see below under Required Selections)</li> <li>4 Paint color number for frame and legs</li> <li>5 Paint color number for ganging brackets, if selected</li> <li>6 Options, if selected (see below)</li> </ol> <p>▶ See <i>Surface Materials</i>, page 473.</p> |
|---|---|--|

Required Selections	U.S. Price	Required to Specify
---------------------	------------	---------------------

<b>Arm Caps</b>	• Plastic	No cost	Specify with <i>plastic arm caps</i> and select plastic color number.
	• Maple wood	No cost	Specify with <i>wood arm caps</i> and select wood color number.
	• Solid surface price group A	+\$456	Specify with <i>solid surface arm caps</i> and select solid surface color number.
	• Solid surface price group B	+\$490	Specify with <i>solid surface arm caps</i> and select solid surface color number.
	• Solid surface price group C	+\$524	Specify with <i>solid surface arm caps</i> and select solid surface color number.
	• Solid surface price group D	+\$556	Specify with <i>solid surface arm caps</i> and select solid surface color number.

Options	U.S. Price	Required to Specify
---------	------------	---------------------

<b>Surface Materials</b>	• Moisture barrier	+\$134	Specify with <i>moisture barrier</i> .
--------------------------	--------------------	--------	--

**Specification Information**

Style Number	U.S. Base Prices										COM
	Fabric Price Group 1	Fabric Price Group 2	Fabric Price Group 3	Fabric Price Group 4	Fabric Price Group 5	Fabric Price Group 6	Fabric Price Group 7	Fabric Price Group 8	Fabric Price Group 9	Fabric Price Group 10	
<b>SC4285</b>	\$1125	\$1251	\$1383	\$1487	\$1593	\$1657	\$1763	\$1933	\$2109	\$2237	\$1177



**For Canadian Pricing**

Multiply U.S. Price by the Canadian price factor.

▶ See page 1 for details.

## Easy Access Chair



*Tip: Easy access chair is available with a convex back style only.*

*Tip: Different fabrics for the seat and back can be specified. If the fabrics are in different price groups, calculate list price by adding the two price groups together and dividing by two.*

	Standard Includes	Required to Specify
▶ Need help? Product details, page 32	<ul style="list-style-type: none"> <li>• Seat and back: fabric</li> <li>• Arm caps: plastic, maple wood, or solid surface</li> <li>• Back style: convex</li> <li>• Frame and legs: paint</li> <li>• Glides: black nylon</li> <li>• Ganging brackets, if selected: paint (ordered separately)</li> </ul>	<ol style="list-style-type: none"> <li>1 Style number</li> <li>2 Fabric color number for seat and back</li> <li>3 Plastic, wood, or solid surface color number for arm caps (see below under Required Selections)</li> <li>4 Leg style (see below under Required Selections)</li> <li>5 Paint color number for frame and legs</li> <li>6 Paint color number for ganging brackets, if selected</li> <li>7 Options, if selected (see below)</li> </ol> <p>▶ See <i>Surface Materials</i>, page 473.</p>

	Required Selections	U.S. Price	Required to Specify
<b>Arm Caps</b>	• Plastic	No cost	Specify with <i>plastic arm caps</i> and select plastic color number.
	• Maple wood	No cost	Specify with <i>wood arm caps</i> and select wood color number.
	• Solid surface price group A	+\$456	Specify with <i>solid surface arm caps</i> and select solid surface color number.
	• Solid surface price group B	+\$490	Specify with <i>solid surface arm caps</i> and select solid surface color number.
	• Solid surface price group C	+\$524	Specify with <i>solid surface arm caps</i> and select solid surface color number.
	• Solid surface price group D	+\$556	Specify with <i>solid surface arm caps</i> and select solid surface color number.
<b>Leg Style</b>	• Straight legs	No cost	Specify with <i>straight legs</i> .
	• Wallsaver legs	+\$ 44	Specify with <i>wallsaver legs</i> .

	Options	U.S. Price	Required to Specify
<b>Surface Materials</b>	• Moisture barrier	+\$134	Specify with <i>moisture barrier</i> .

Specification Information											
Style Number	U.S. Base Prices										COM
	Fabric Price Group 1	Fabric Price Group 2	Fabric Price Group 3	Fabric Price Group 4	Fabric Price Group 5	Fabric Price Group 6	Fabric Price Group 7	Fabric Price Group 8	Fabric Price Group 9	Fabric Price Group 10	
	1	2	3	4	5	6	7	8	9	10	
<b>SC4207</b>	\$1185	\$1273	\$1353	\$1425	\$1495	\$1543	\$1613	\$1721	\$1841	\$1921	\$1237

Families of Seating

 **For Canadian Pricing**  
Multiply U.S. Price by the Canadian price factor.  
▶ See page 1 for details.

Aspekt Straight Arm, continued

**Bench**

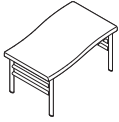

Standard Includes	Required to Specify
-------------------	---------------------

- |   |   |  |
|---|---|--|
| <ul style="list-style-type: none"> <li>▶ Need help? Product details, page 32</li> </ul> | <ul style="list-style-type: none"> <li>• Seat: fabric</li> <li>• Frame and legs: paint</li> <li>• Glides: black nylon only</li> </ul> | <ul style="list-style-type: none"> <li>1 Style number</li> <li>2 Fabric color number for seat</li> <li>3 Paint color number for frame and legs</li> <li>4 Options, if selected (see below)</li> <li>▶ See <i>Surface Materials</i>, page 473.</li> </ul> |
|---|---|--|

Options	U.S. Price	Required to Specify
---------	------------	---------------------

<b>Surface Materials</b>	• Moisture barrier	+\$134	Specify <i>with moisture barrier</i> .
--------------------------	--------------------	--------	--

Specification Information											
U.S. Base Prices											
• Style Number	• Fabric Price Group 1	• Fabric Price Group 2	• Fabric Price Group 3	• Fabric Price Group 4	• Fabric Price Group 5	• Fabric Price Group 6	• Fabric Price Group 7	• Fabric Price Group 8	• Fabric Price Group 9	• Fabric Price Group 10	• COM

<b>SC4043</b>	\$795	\$839	\$879	\$915	\$950	\$974	\$1009	\$1063	\$1123	\$1163	\$848
---------------	-------	-------	-------	-------	-------	-------	--------	--------	--------	--------	-------



**For Canadian Pricing**

Multiply U.S. Price by the Canadian price factor.

▶ See page 1 for details.

Footstool



Standard Includes	Required to Specify
-------------------	---------------------

<ul style="list-style-type: none"> <li>▶ Need help? Product details, page 32</li> </ul>	<ul style="list-style-type: none"> <li>• Cushion top: fabric</li> <li>• Frame and legs: paint</li> <li>• Glides: black nylon only</li> </ul>	<ul style="list-style-type: none"> <li>1 Style number</li> <li>2 Fabric color number for cushion top</li> <li>3 Paint color number for frame and legs</li> <li>4 Options, if selected (see below)</li> <li>▶ See <i>Surface Materials</i>, page 473.</li> </ul>
---	--	---

Options	U.S. Price	Required to Specify
---------	------------	---------------------

<b>Surface Materials</b>	<ul style="list-style-type: none"> <li>• Moisture barrier</li> </ul>	+\$134  Specify with <i>moisture barrier</i> .
--------------------------	--	--

**Specification Information**

Style Number	U.S. Base Prices										COM
	Fabric Price Group 1	Fabric Price Group 2	Fabric Price Group 3	Fabric Price Group 4	Fabric Price Group 5	Fabric Price Group 6	Fabric Price Group 7	Fabric Price Group 8	Fabric Price Group 9	Fabric Price Group 10	
<b>SC4045</b>	\$456	\$488	\$519	\$548	\$573	\$590	\$616	\$659	\$702	\$733	\$509

Families of Seating

**For Canadian Pricing**  
 Multiply U.S. Price by the Canadian price factor.  
 ▶ See page 1 for details.

# Aspekt Wave Arm

**Aspekt seating** is sleek and welcoming with wave-shaped arms and two styles of back contours – concave and convex. Seating can stand alone or be grouped into a variety of ganged configurations.

**Back cushions** are available with a convex shape that curves upward or a concave shape that curves downward.

**Space between the seat and back** allows for easy cleaning.

**Arm caps** overhang the legs to provide a comfortable hand grip for ease of entry and exit from the chair. Arm caps are solid maple wood or plastisol.

**Seat cushion and back** are fully upholstered.

**Legs** are available as straight or wall saver. High back chairs available with straight legs only.

**Frame and legs** are constructed with steel for structural integrity. They have a powdercoat paint finish that is corrosion resistant.

**Glides** are standard on legs.

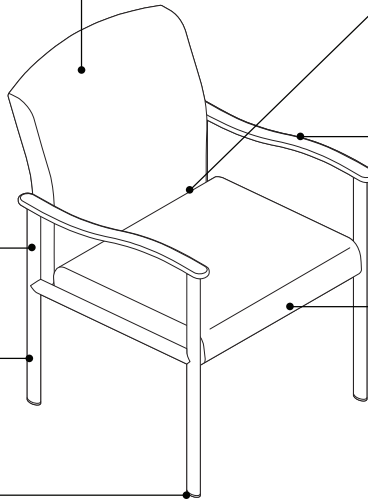

## Actual Dimensions

Features	Overall Depth	Width	Height	Seat Depth	Width	Height	Arm Height
<b>Single-Seat Chair</b>	27"	22 <sup>3</sup> / <sub>4</sub> "	33"	19 <sup>3</sup> / <sub>4</sub> "	20"	18 <sup>3</sup> / <sub>8</sub> "	26"
<b>Two-Seat Chairs</b>							
No center arm or center legs	27"	43"	33"	19 <sup>3</sup> / <sub>4</sub> "	40"	18 <sup>3</sup> / <sub>8</sub> "	26"
With center arm	27"	44"	33"	19 <sup>3</sup> / <sub>4</sub> "	20"	18 <sup>3</sup> / <sub>8</sub> "	26"
With center arm and center legs	27"	44"	33"	19 <sup>3</sup> / <sub>4</sub> "	20"	18 <sup>3</sup> / <sub>8</sub> "	26"
<b>Three-Seat Chairs</b>							
No center arms or center legs	27"	63 <sup>1</sup> / <sub>4</sub> "	33"	19 <sup>3</sup> / <sub>4</sub> "	60"	18 <sup>3</sup> / <sub>8</sub> "	26"
With center arms	27"	65 <sup>1</sup> / <sub>2</sub> "	33"	19 <sup>3</sup> / <sub>4</sub> "	20"	18 <sup>3</sup> / <sub>8</sub> "	26"
With center arms and center legs	27"	65 <sup>1</sup> / <sub>2</sub> "	33"	19 <sup>3</sup> / <sub>4</sub> "	20"	18 <sup>3</sup> / <sub>8</sub> "	26"
<b>Bariatric Chairs</b>							
Single-seat chair	27"	32 <sup>3</sup> / <sub>4</sub> "	33"	19 <sup>3</sup> / <sub>4</sub> "	30"	18 <sup>3</sup> / <sub>8</sub> "	26"
Two-seat combination unit	27"	54"	33"	19 <sup>3</sup> / <sub>4</sub> "	20"/30"	18 <sup>3</sup> / <sub>8</sub> "	26"
Three-seat combination unit	27"	75 <sup>1</sup> / <sub>4</sub> "	33"	19 <sup>3</sup> / <sub>4</sub> "	20"/20"/30"	18 <sup>3</sup> / <sub>8</sub> "	26"
<b>High-Back Chair</b>	29"	22 <sup>3</sup> / <sub>4</sub> "	45"	19 <sup>3</sup> / <sub>4</sub> "	20"	18 <sup>3</sup> / <sub>8</sub> "	26"
<b>Easy Access Chair</b>	27"	22 <sup>3</sup> / <sub>4</sub> "	39"	19 <sup>3</sup> / <sub>4</sub> "	20"	24"	32"
<b>Bench</b>	22"	32"	18"	19 <sup>3</sup> / <sub>4</sub> "	32"	18 <sup>3</sup> / <sub>8</sub> "	N.A.
<b>Footstool</b>	12"	18 <sup>1</sup> / <sub>2</sub> "	14"	N.A.	N.A.	N.A.	N.A.

Tip: All overall height dimensions listed are for the convex back style. Concave back style is 1" less than convex dimension shown.

Tip: All overall depth dimensions listed are for straight leg styles. For wall saver styles, add 1" to dimensions shown.

Tip: Combination units include one bariatric single-seat chair and either one or two standard width single-seat chairs.



**Product Details**

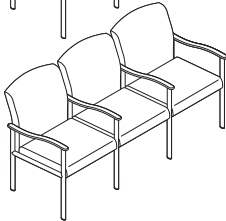
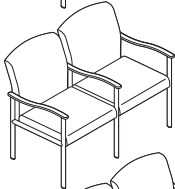
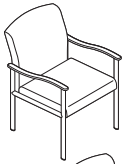

**Arm chairs** are available in one-, two-, and three-seat versions.

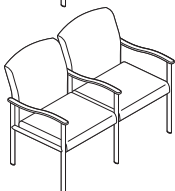
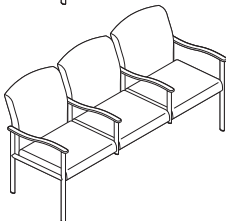
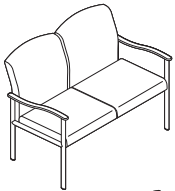

**Two- and three-seat units** are offered in three configurations – no center arms or center legs, with center arms, and with center arms and center legs.

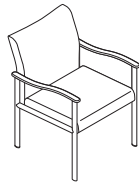

**Concave back style** is available on one-, two-, and three-seat versions.

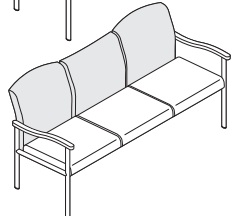
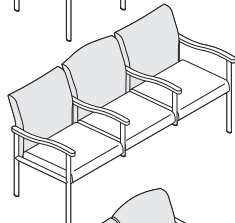
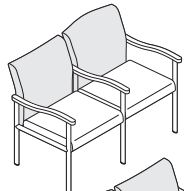

**Combinations of convex and concave back cushions** may be specified on the same multi-seat unit to create a wave-like contour.

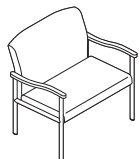

**Bariatric chair** is available with a 30"W seat and has been tested to a dynamic load of 300 pounds and a static load of 750 pounds. Back cushion has a convex shape.

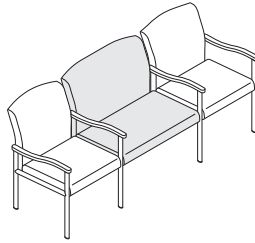
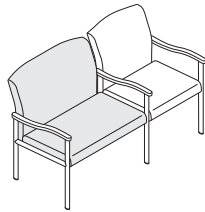

**Bariatric combination units** are available in two- and three-seat configurations and consist of a bariatric chair connected to one or two standard width chairs. The bariatric seat location can be specified in the left facing, right facing, or center (three-seat units) position. Combination units include center arms and legs.

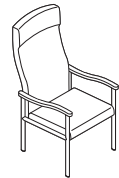

**High-back chair** has a tapered, 29"H convex back and straight legs.

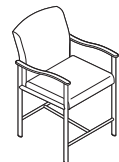

**Easy access chair** has a 24" seat height and includes a foot rest. Back cushion has a convex shape.

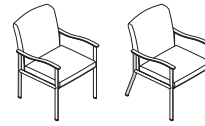

**Straight or wall-saver legs** are available on single, two-seat, three-seat, bariatric, combo-unit, and easy access chairs. *Tip: Wall-saver legs are not available on three-seat chairs with center arms and no center legs.*

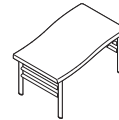

**Bench** has a wave-shape and is 18 $\frac{3}{8}$ "H. Bench is a shared component between the straight arm and wave arm Aspekt family of seating.



**Footstool** has an angled, cushion surface. Footstool is a shared component between the straight arm and wave arm Aspekt family of seating.

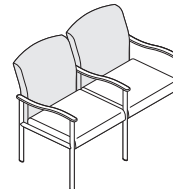

**Different fabrics** can be specified on the seat and back. On two- and three-seat units, the back fabric will be consistent throughout the whole unit as shown above. Contrasting fabric deviating from this standard needs to be processed through Specials.

**Arm caps** are available in plastisol or solid maple wood.

**Back and seat covers** have zippers and can be removed for cleaning.

**Moisture barrier** is available as an option on seat only.

**Ganging brackets** are available to link chairs in the field.

**When chairs** are ganged, the spacing between arms is 1 $\frac{1}{2}$ " and the spacing between legs is 2 $\frac{1}{8}$ ".

**All Steelcase Health seating with standard upholstery fabrics** comply with the State of California Technical Bulletin 117-2013.

**Seat and back**

- Fabric
- Fabric with moisture barrier (option on seat only)

**Arm**

- Maple wood
- Plastisol

**Frame and legs**

- 4750 Champagne Metallic
- 4799 Platinum Metallic
- 7207 Black
- 7360 Merle

**Glides**

- Black plastic only

# Aspekt Wave Arm

## Single-Seat Chairs

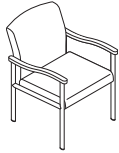

Tip: Different fabrics for the seat and back can be specified. If the fabrics are in different price groups, calculate list price by adding the two price groups together and dividing by two.

Standard Includes	Required to Specify
-------------------	---------------------

<ul style="list-style-type: none"> <li>▶ Need help? Product details, page 48</li> </ul>	<ul style="list-style-type: none"> <li>• Seat and back: fabric</li> <li>• Arm caps: plastisol or maple wood</li> <li>• Back style: convex</li> <li>• Frame and legs: paint</li> <li>• Glides: black nylon</li> <li>• Ganging brackets, if selected: paint (ordered separately)</li> </ul>	<ol style="list-style-type: none"> <li>1 Style number</li> <li>2 Fabric color number for seat and back</li> <li>3 Plastic or wood color number for arm caps (see below under Required Selections)</li> <li>4 Leg style (see below under Required Selections)</li> <li>5 Paint color number for frame and legs</li> <li>6 Paint color number for ganging brackets, if selected</li> <li>7 Options, if selected (see below)</li> </ol> <p>▶ See <i>Surface Materials</i>, page 473.</p>
---	---	---

	Required Selections	U.S. Price	Required to Specify
--	---------------------	------------	---------------------

<b>Arm Caps</b>	• Plastisol	No cost	Specify with <i>plastisol arm caps</i> and select plastic color number.
	• Maple wood	No cost	Specify with <i>wood arm caps</i> and select wood color number.

<b>Leg Style</b>	• Straight legs	No cost	Specify with <i>straight legs</i> .
	• Wallsaver legs	+\$ 44	Specify with <i>wallsaver legs</i> .

	Options	U.S. Price	Required to Specify
--	---------	------------	---------------------

<b>Surface Materials</b>	• Moisture barrier	+\$134	Specify with <i>moisture barrier</i> .
--------------------------	--------------------	--------	--

<b>Back Style</b>	• Concave	No cost	Specify with <i>concave back</i> .
-------------------	-----------	---------	------------------------------------

### Specification Information

**U.S. Base Prices**

Style Number	Fabric Price Group 1	Fabric Price Group 2	Fabric Price Group 3	Fabric Price Group 4	Fabric Price Group 5	Fabric Price Group 6	Fabric Price Group 7	Fabric Price Group 8	Fabric Price Group 9	Fabric Price Group 10	COM
<b>SC4010</b>	\$1010	\$1098	\$1178	\$1250	\$1320	\$1368	\$1438	\$1546	\$1666	\$1746	\$1062

### Related Product

Style Number	U.S. Price

## Set of Ganging Brackets

<b>SC4009</b>	\$93
---------------	------



#### For Canadian Pricing

Multiply U.S. Price by the Canadian price factor.

▶ See page 1 for details.

## Two-Seat Chairs



No Center Arm or Legs

Standard Includes	Required to Specify
<ul style="list-style-type: none"> <li>▶ Need help? Product details, page 48</li> <li>• Seat and back: fabric</li> <li>• Arm caps: plastisol or maple wood</li> <li>• Back style: convex</li> <li>• Frame and legs: paint</li> <li>• Glides: black nylon</li> <li>• Ganging brackets, if selected: paint (ordered separately)</li> </ul>	<ol style="list-style-type: none"> <li>1 Style number</li> <li>2 Fabric color number for seat and back</li> <li>3 Plastic or wood color number for arm caps (see below under Required Selections)</li> <li>4 Leg style (see below under Required Selections)</li> <li>5 Paint color number for frame and legs</li> <li>6 Paint color number for ganging brackets, if selected</li> <li>7 Options, if selected (see below)</li> </ol> <p>▶ See <i>Surface Materials</i>, page 473.</p>

*Tip: Different fabrics for the seat and back can be specified. If the fabrics are in different price groups, calculate list price by adding the two price groups together and dividing by two.*

*Tip: Left and right is determined when facing the chair.*

	Required Selections	U.S. Price	Required to Specify
<b>Arm Caps</b>	<ul style="list-style-type: none"> <li>• Plastisol</li> <li>• Maple wood</li> </ul>	No cost No cost	Specify with <i>plastisol arm caps</i> and select plastic color number. Specify with <i>wood arm caps</i> and select wood color number.

<b>Leg Style</b>	<ul style="list-style-type: none"> <li>• Straight legs</li> <li>• Wallsaver legs</li> </ul>	No cost +\$ 22 per rear leg	Specify with <i>straight legs</i> . Specify with <i>wallsaver legs</i> .
------------------	---	--------------------------------	---

	Options	U.S. Price	Required to Specify
<b>Surface Materials</b>	<ul style="list-style-type: none"> <li>• Moisture barrier</li> </ul>	+\$268	Specify with <i>moisture barrier</i> .



Center Arm



Center Arm and Center Legs

<b>Arms and Legs Configuration</b>	<ul style="list-style-type: none"> <li>• No center arm or legs</li> <li>• Center arm</li> <li>• Center arm and center legs</li> </ul>	No cost +\$149 +\$171	Specify with <i>no center arm or legs</i> . Specify with <i>center arm</i> . Specify with <i>center arm and legs</i> .
------------------------------------	---	-----------------------------	--

<b>Back Style</b>	<ul style="list-style-type: none"> <li>• Concave</li> <li>• Convex left, concave right</li> <li>• Concave left, convex right</li> </ul>	No cost No cost No cost	Specify with <i>concave back</i> . Specify with <i>convex left, concave right back</i> . Specify with <i>concave left, convex right back</i> .
-------------------	---	-------------------------------	--

### Specification Information

• Style Number	• U.S. Base Prices										• COM
	• Fabric Price Group 1	• Fabric Price Group 2	• Fabric Price Group 3	• Fabric Price Group 4	• Fabric Price Group 5	• Fabric Price Group 6	• Fabric Price Group 7	• Fabric Price Group 8	• Fabric Price Group 9	• Fabric Price Group 10	
<b>SC4020</b>	\$1603	\$1771	\$1945	\$2087	\$2229	\$2313	\$2455	\$2685	\$2913	\$3079	\$1655

### Related Product

• Style Number	• U.S. Price

### Set of Ganging Brackets

<b>SC4009</b>	\$93
---------------	------

Aspekt Wave Arm, continued

Three-Seat Chairs

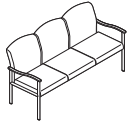

No Center Arms or Legs

Tip: Different fabrics for the seat and back can be specified. If the fabrics are in different price groups, calculate list price by adding the two price groups together and dividing by two.

Tip: Left and right is determined when facing the chair.

Tip: Wallsaver legs are not available with center arms only configuration.

Standard Includes		Required to Specify
<ul style="list-style-type: none"> <li>▶ Need help? Product details, page 48</li> </ul>	<ul style="list-style-type: none"> <li>• Seat and back: fabric</li> <li>• Arm caps: plastisol or maple wood</li> <li>• Back style: convex</li> <li>• Frame and legs: paint</li> <li>• Glides: black nylon</li> <li>• Ganging brackets, if selected: paint (ordered separately)</li> </ul>	<ol style="list-style-type: none"> <li>1 Style number</li> <li>2 Fabric color number for seat and back</li> <li>3 Plastic or wood color number for arm caps (see below under Required Selections)</li> <li>4 Leg style (see below under Required Selections)</li> <li>5 Paint color number for frame and legs</li> <li>6 Paint color number for ganging brackets, if selected</li> <li>7 Options, if selected (see below)</li> </ol> <p>▶ See <i>Surface Materials</i>, page 473.</p>

	Required Selections	U.S. Price	Required to Specify
<b>Arm Caps</b>	• Plastisol	No cost	Specify with <i>plastisol arm caps</i> and select plastic color number.
	• Maple wood	No cost	Specify with <i>wood arm caps</i> and select wood color number.
<b>Leg Style</b>	• Straight legs	No cost	Specify with <i>straight legs</i> .
	• Wallsaver legs	+\$ 22 per rear leg	Specify with <i>wallsaver legs</i> .

	Options	U.S. Price	Required to Specify
<b>Surface Materials</b>	• Moisture barrier	+\$402	Specify with <i>moisture barrier</i> .
<b>Arms and Legs Configuration</b>	• No center arms or legs	No cost	Specify with <i>no center arms or legs</i> .
	• Center arms	+\$299	Specify with <i>center arms</i> .
	• Center arms and center legs	+\$342	Specify with <i>center arms and legs</i> .
<b>Back Style</b>	• Concave	No cost	Specify with <i>concave back</i> .
	• Convex left, concave center, convex right	No cost	Specify with <i>convex left, concave center, convex right back</i> .
	• Concave left, convex center, concave right	No cost	Specify with <i>concave left, convex center, concave right back</i> .

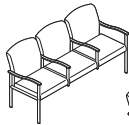

Center Arms

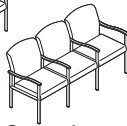

Center Arms and Center Legs

Specification Information

Style Number	U.S. Base Prices										COM
	Fabric Price Group 1	Fabric Price Group 2	Fabric Price Group 3	Fabric Price Group 4	Fabric Price Group 5	Fabric Price Group 6	Fabric Price Group 7	Fabric Price Group 8	Fabric Price Group 9	Fabric Price Group 10	
SC4030	\$2185	\$2443	\$2695	\$2907	\$3119	\$3253	\$3463	\$3799	\$4149	\$4397	\$2237

Related Product

Style Number	U.S. Price

Set of Ganging Brackets

SC4009	\$93
--------	------

## Bariatric Chair

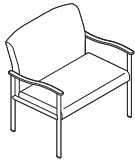

Tip: Bariatric chair is available with a convex back style only.

Tip: Different fabrics for the seat and back can be specified. If the fabrics are in different price groups, calculate list price by adding the two price groups together and dividing by two.

	Standard Includes	Required to Specify
▶ Need help? Product details, page 48	<ul style="list-style-type: none"> <li>• Seat and back: fabric</li> <li>• Arm caps: plastisol or maple wood</li> <li>• Back style: convex</li> <li>• Frame and legs: paint</li> <li>• Glides: black nylon</li> <li>• Ganging brackets, if selected: paint (ordered separately)</li> </ul>	<ol style="list-style-type: none"> <li>1 Style number</li> <li>2 Fabric color number for seat and back</li> <li>3 Plastic or wood color number for arm caps (see below under Required Selections)</li> <li>4 Leg style (see below under Required Selections)</li> <li>5 Paint color number for frame and legs</li> <li>6 Paint color number for ganging brackets, if selected</li> <li>7 Options, if selected (see below)</li> </ol> <p>▶ See <i>Surface Materials</i>, page 473.</p>

	Required Selections	U.S. Price	Required to Specify
<b>Arm Caps</b>	<ul style="list-style-type: none"> <li>• Plastisol</li> <li>• Maple wood</li> </ul>	No cost  No cost	Specify with <i>plastisol arm caps</i> and select plastic color number. Specify with <i>wood arm caps</i> and select wood color number.

<b>Leg Style</b>	<ul style="list-style-type: none"> <li>• Straight legs</li> <li>• Wallsaver legs</li> </ul>	No cost +\$ 44	Specify with <i>straight legs</i> . Specify with <i>wallsaver legs</i> .
------------------	---	-------------------	---

	Options	U.S. Price	Required to Specify
<b>Surface Materials</b>	<ul style="list-style-type: none"> <li>• Moisture barrier</li> </ul>	+\$134	Specify with <i>moisture barrier</i> .

Specification Information											
U.S. Base Prices											
Style Number	Fabric Price Group 1	Fabric Price Group 2	Fabric Price Group 3	Fabric Price Group 4	Fabric Price Group 5	Fabric Price Group 6	Fabric Price Group 7	Fabric Price Group 8	Fabric Price Group 9	Fabric Price Group 10	COM Price
SC4060	\$1373	\$1525	\$1667	\$1795	\$1921	\$1997	\$2121	\$2317	\$2521	\$2663	\$1425

Related Product	
Style Number	U.S. Price

Set of Ganging Brackets	
Style Number	U.S. Price
SC4009	\$93

 **For Canadian Pricing**  
Multiply U.S. Price by the Canadian price factor.  
▶ See page 1 for details.

**Bariatric Combination Units**

Tip: Combination units are available with a convex back style only and include center arms and legs.

Tip: Left and right is determined when facing the chair.

Tip: Different fabrics for the seat and back can be specified. If the fabrics are in different price groups, calculate list price by adding the two price groups together and dividing by two.

	Standard Includes	Required to Specify
<p>▶ Need help? Product details, page 48</p>	<ul style="list-style-type: none"> <li>• Seat and back: fabric</li> <li>• Arm caps: plastisol or maple wood</li> <li>• Back style: convex</li> <li>• Frame and legs: paint</li> <li>• Glides: black nylon</li> <li>• Ganging brackets, if selected: paint (ordered separately)</li> </ul>	<ol style="list-style-type: none"> <li>1 Style number</li> <li>2 Fabric color number for seat and back</li> <li>3 Plastic or wood color number for arm caps (see below under Required Selections)</li> <li>4 Bariatric seat location (see below under Required Selections)</li> <li>5 Leg style (see below under Required Selections)</li> <li>6 Paint color number for frame and legs</li> <li>7 Paint color number for ganging brackets, if selected</li> <li>8 Options, if selected (see below)</li> </ol> <p>▶ See <i>Surface Materials</i>, page 473.</p>

	Required Selections	U.S. Price	Required to Specify
<b>Arm Caps</b>	<ul style="list-style-type: none"> <li>• Plastisol</li> <li>• Maple wood</li> </ul>	No cost  No cost	Specify with <i>plastisol arm caps</i> and select plastic color number. Specify with <i>wood caps</i> and select wood color number.
<b>Bariatric Seat Location</b>	<ul style="list-style-type: none"> <li>• Bariatric seat in left facing position</li> <li>• Bariatric seat in right facing position</li> <li>• Bariatric seat in center position (three-seat units only)</li> </ul>	No cost No cost No cost	Specify with <i>bariatric seat left</i> . Specify with <i>bariatric seat right</i> . Specify with <i>bariatric seat center</i> .
<b>Leg Style</b>	<ul style="list-style-type: none"> <li>• Straight legs</li> <li>• Wallsaver legs</li> </ul>	No cost +\$ 22 per rear leg	Specify with <i>straight legs</i> . Specify with <i>wallsaver legs</i> .

	Options	U.S. Price	Required to Specify
<b>Surface Materials</b>	<b>Moisture barrier</b>		
	<ul style="list-style-type: none"> <li>• Two-seat combination units</li> <li>• Three-seat combination units</li> </ul>	+\$268 +\$402	Specify with <i>moisture barrier</i> . Specify with <i>moisture barrier</i> .

Specification Information											
U.S. Base Prices											
Style Number	Fabric Price Group 1	Fabric Price Group 2	Fabric Price Group 3	Fabric Price Group 4	Fabric Price Group 5	Fabric Price Group 6	Fabric Price Group 7	Fabric Price Group 8	Fabric Price Group 9	Fabric Price Group 10	COM

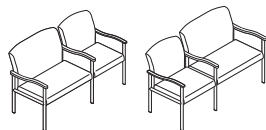

**Two-Seat Combination Unit**

<b>SC4062</b>	\$2151	\$2385	\$2621	\$2819	\$3009	\$3125	\$3323	\$3631	\$3953	\$4183	\$2203
---------------	--------	--------	--------	--------	--------	--------	--------	--------	--------	--------	--------

▶ Specification Information, continued on next page



**For Canadian Pricing**  
Multiply U.S. Price by the Canadian price factor.  
▶ See page 1 for details.

► Specification Information, continued from previous page

**Specification Information**

Style Number	U.S. Base Prices										COM
	Fabric Price Group 1	Fabric Price Group 2	Fabric Price Group 3	Fabric Price Group 4	Fabric Price Group 5	Fabric Price Group 6	Fabric Price Group 7	Fabric Price Group 8	Fabric Price Group 9	Fabric Price Group 10	

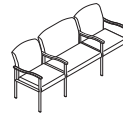
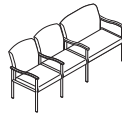

**Three-Seat Combination Unit**

<b>SC4063</b>	\$2909	\$3203	\$3509	\$3755	\$4001	\$4151	\$4395	\$4795	\$5207	\$5491	\$2961
---------------	--------	--------	--------	--------	--------	--------	--------	--------	--------	--------	--------



**For Canadian Pricing**

Multiply U.S. Price by the Canadian price factor.

► See page 1 for details.

Aspekt Wave Arm, continued

**High-Back Chair**

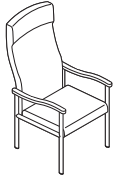

Tip: High-back chair is available with a convex back style only.

Tip: Different fabrics for the seat and back can be specified. If the fabrics are in different price groups, calculate list price by adding the two price groups together and dividing by two.

Standard Includes	Required to Specify
-------------------	---------------------

<ul style="list-style-type: none"> <li>▶ Need help? Product details, page 48</li> </ul>	<ul style="list-style-type: none"> <li>• Seat and back: fabric</li> <li>• Arm caps: plastisol or maple wood</li> <li>• Back style: convex</li> <li>• Frame and legs: paint</li> <li>• Glides: black nylon</li> <li>• Ganging brackets, if selected: paint (ordered separately)</li> </ul>	<ul style="list-style-type: none"> <li>1 Style number</li> <li>2 Fabric color number for seat and back</li> <li>3 Plastic or wood color number for arm caps (see below under Required Selections)</li> <li>4 Paint color number for frame and legs</li> <li>5 Paint color number for ganging brackets, if selected</li> <li>6 Options, if selected (see below)</li> <li>▶ See <i>Surface Materials</i>, page 473.</li> </ul>
---	---	--

Required Selections	U.S. Price	Required to Specify
---------------------	------------	---------------------

<b>Arm Caps</b>	<ul style="list-style-type: none"> <li>• Plastisol</li> <li>• Maple wood</li> </ul>	<ul style="list-style-type: none"> <li>No cost</li> <li>No cost</li> </ul>	<ul style="list-style-type: none"> <li>Specify with <i>plastisol arm caps</i> and select plastic color number.</li> <li>Specify with <i>wood arm caps</i> and select wood color number.</li> </ul>
-----------------	---	--	--

Options	U.S. Price	Required to Specify
---------	------------	---------------------

<b>Surface Materials</b>	<ul style="list-style-type: none"> <li>• Moisture barrier</li> </ul>	<ul style="list-style-type: none"> <li>+\$134</li> </ul>	<ul style="list-style-type: none"> <li>Specify with <i>moisture barrier</i>.</li> </ul>
--------------------------	--	--	---

**Specification Information**

Style Number	U.S. Base Prices										COM
	Fabric Price Group 1	Fabric Price Group 2	Fabric Price Group 3	Fabric Price Group 4	Fabric Price Group 5	Fabric Price Group 6	Fabric Price Group 7	Fabric Price Group 8	Fabric Price Group 9	Fabric Price Group 10	
	Price	Price	Price	Price	Price	Price	Price	Price	Price	Price	
<b>SC4085</b>	\$1125	\$1251	\$1383	\$1487	\$1593	\$1657	\$1763	\$1933	\$2109	\$2237	\$1177



**For Canadian Pricing**  
 Multiply U.S. Price by the Canadian price factor.  
 ▶ See page 1 for details.



## Easy Access Chair



Tip: Easy access chair is available with a convex back style only.

Tip: Different fabrics for the seat and back can be specified. If the fabrics are in different price groups, calculate list price by adding the two price groups together and dividing by two.

	Standard Includes	Required to Specify
▶ Need help? Product details, page 48	<ul style="list-style-type: none"> <li>• Seat and back: fabric</li> <li>• Arm caps: plastisol or maple wood</li> <li>• Back style: convex</li> <li>• Frame and legs: paint</li> <li>• Glides: black nylon</li> <li>• Ganging brackets, if selected: paint (ordered separately)</li> </ul>	<ol style="list-style-type: none"> <li>1 Style number</li> <li>2 Fabric color number for seat and back</li> <li>3 Plastic or wood color number for arm caps (see below under Required Selections)</li> <li>4 Leg style (see below under Required Selections)</li> <li>5 Paint color number for frame and legs</li> <li>6 Paint color number for ganging brackets, if selected</li> <li>7 Options, if selected (see below)</li> </ol> <p>▶ See <i>Surface Materials</i>, page 473.</p>

	Required Selections	U.S. Price	Required to Specify
<b>Arm Caps</b>	<ul style="list-style-type: none"> <li>• Plastisol</li> <li>• Maple wood</li> </ul>	No cost  No cost	Specify with <i>plastisol arm caps</i> and select plastic color number. Specify with <i>wood arm caps</i> and select wood color number.

<b>Leg Style</b>	<ul style="list-style-type: none"> <li>• Straight legs</li> <li>• Wallsaver legs</li> </ul>	No cost +\$ 44	Specify with <i>straight legs</i> . Specify with <i>wallsaver legs</i> .
------------------	---	-------------------	---

	Options	U.S. Price	Required to Specify
<b>Surface Materials</b>	<ul style="list-style-type: none"> <li>• Moisture barrier</li> </ul>	+\$134	Specify with <i>moisture barrier</i> .

Specification Information											
U.S. Base Prices											
Style Number	Fabric Price Group 1	Fabric Price Group 2	Fabric Price Group 3	Fabric Price Group 4	Fabric Price Group 5	Fabric Price Group 6	Fabric Price Group 7	Fabric Price Group 8	Fabric Price Group 9	Fabric Price Group 10	COM
SC4007	\$1185	\$1273	\$1353	\$1425	\$1495	\$1543	\$1613	\$1721	\$1841	\$1921	\$1237

 **For Canadian Pricing**  
Multiply U.S. Price by the Canadian price factor.  
▶ See page 1 for details.

Aspekt Wave Arm, continued

**Bench**

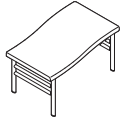

**Standard Includes** **Required to Specify**

- |   |   |  |
|---|---|--|
| <ul style="list-style-type: none"> <li>▶ Need help? Product details, page 48</li> </ul> | <ul style="list-style-type: none"> <li>• Seat: fabric</li> <li>• Frame and legs: paint</li> <li>• Glides: black nylon only</li> </ul> | <ul style="list-style-type: none"> <li>1 Style number</li> <li>2 Fabric color number for seat</li> <li>3 Paint color number for frame and legs</li> <li>4 Options, if selected (see below)</li> <li>▶ See <i>Surface Materials</i>, page 473.</li> </ul> |
|---|---|--|

Options	U.S. Price	Required to Specify
<b>Surface Materials</b> • Moisture barrier	+\$134	Specify with moisture barrier.

Specification Information											
U.S. Base Prices											
Style Number	Fabric Price Group 1	Fabric Price Group 2	Fabric Price Group 3	Fabric Price Group 4	Fabric Price Group 5	Fabric Price Group 6	Fabric Price Group 7	Fabric Price Group 8	Fabric Price Group 9	Fabric Price Group 10	COM
<b>SC4043</b>	\$795	\$839	\$879	\$915	\$950	\$974	\$1009	\$1063	\$1123	\$1163	\$848

**Footstool**



**Standard Includes** **Required to Specify**

- |   |  |   |
|---|--|---|
| <ul style="list-style-type: none"> <li>▶ Need help? Product details, page 48</li> </ul> | <ul style="list-style-type: none"> <li>• Cushion top: fabric</li> <li>• Frame and legs: paint</li> <li>• Glides: black nylon only</li> </ul> | <ul style="list-style-type: none"> <li>1 Style number</li> <li>2 Fabric color number for cushion top</li> <li>3 Paint color number for frame and legs</li> <li>4 Options, if selected (see below)</li> <li>▶ See <i>Surface Materials</i>, page 473.</li> </ul> |
|---|--|---|

Options	U.S. Price	Required to Specify
<b>Surface Materials</b> • Moisture barrier	+\$134	Specify with moisture barrier.

Specification Information											
U.S. Base Prices											
Style Number	Fabric Price Group 1	Fabric Price Group 2	Fabric Price Group 3	Fabric Price Group 4	Fabric Price Group 5	Fabric Price Group 6	Fabric Price Group 7	Fabric Price Group 8	Fabric Price Group 9	Fabric Price Group 10	COM
<b>SC4045</b>	\$456	\$488	\$519	\$548	\$573	\$590	\$616	\$659	\$702	\$733	\$509



**For Canadian Pricing**  
 Multiply U.S. Price by the Canadian price factor.  
 ▶ See page 1 for details.

# Aspekt Tables

**Aspekt ganging and freestanding tables** are available in a variety of shapes to coordinate with Aspekt seating.

**High-Pressure Laminate tops** are 1" thick and have 3 mm plastic edges.

**Table ganging brackets** are standard with all ganging tops.

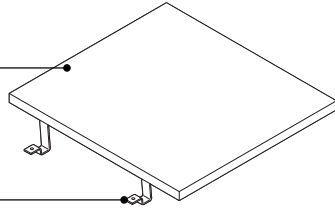

**Legs** are constructed with steel and are finished with powdercoat paint. Legs are included with all tops, except the in-line ganging table.

**Glides** are standard on tables with legs.

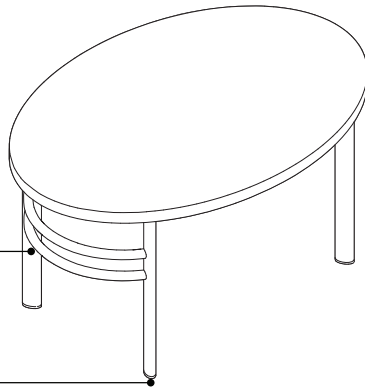

## Actual Dimensions

Features	Overall Depth	Width	Height
<b>Ganging Tables</b>			
Inline table	21 <sup>3</sup> / <sub>4</sub> "	20 <sup>1</sup> / <sub>4</sub> "	16"
End table	21 <sup>3</sup> / <sub>4</sub> "	16"	16"
90° table	29 <sup>3</sup> / <sub>4</sub> "	29 <sup>3</sup> / <sub>4</sub> "	16"
Corner table	29 <sup>3</sup> / <sub>4</sub> "	29 <sup>3</sup> / <sub>4</sub> "	16"
<b>Freestanding Tables</b>			
Oval table	22"	32"	16"
Bow table	18"	20"	21"
Round table	22" dia.	N.A.	21"

## Product Details

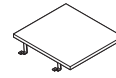

**Inline table** is used to connect two seating units in a straight line configuration.

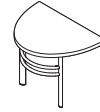

**End tables** have a curved shape and are available in left- and right-hand versions. End tables have legs on one side.



**90° table** has a curved back edge and is used to create an L-shape seating configuration. 90° tables have legs on one side.



**Corner table** is diamond shaped and is used to connect two seating units to create an L-shape seating configuration. Corner tables have legs on one side and ganging brackets on two sides.

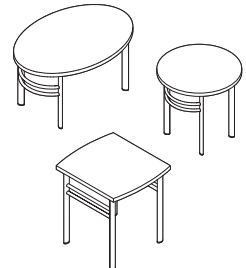

**Freestanding tables** are available in three shapes – oval, bow, and round. Bow tables are square with front and back edges that bow outward.

**Top**  
• High-Pressure Laminate

**Edge profile**  
• 3 mm plastic

**Legs**  
• 4750 Champagne Metallic  
• 4799 Platinum Metallic  
• 7207 Black  
• 7360 Merle

**Glides**  
• Black nylon only

**Ganging brackets**  
• 4750 Champagne Metallic  
• 4799 Platinum Metallic  
• 7207 Black  
• 7360 Merle

# Aspekt Ganging Tables

Tip: Ganging tables are compatible with chairs built after March 1, 2009.

Standard Includes		Required to Specify
<ul style="list-style-type: none"> <li>▶ Need help? Product details, page 59</li> </ul>	<ul style="list-style-type: none"> <li>• Table top: High-Pressure Laminate with 3 mm plastic edge</li> <li>• Ganging brackets: paint</li> <li>• Leg on end table, 90° table, and corner table: paint</li> <li>• Glides: black nylon only</li> </ul>	<ul style="list-style-type: none"> <li>1 Style number</li> <li>2 Laminate color number for top</li> <li>3 Paint color number for bracket and legs, if selected</li> <li>▶ See <i>Surface Materials</i>, page 473.</li> </ul>

## Specification Information

Dimensions			Style Number	U.S. Price
D	W	H		

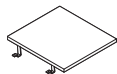

Inline Table				
21 <sup>3</sup> / <sub>4</sub> "	20 <sup>1</sup> / <sub>4</sub> "	16"	<b>SC4050</b>	\$590
:	:	:	:	:



End Tables				
Left-Hand Table				
21 <sup>3</sup> / <sub>4</sub> "	16"	16"	<b>SC4051L</b>	\$777



Right-Hand Table				
21 <sup>3</sup> / <sub>4</sub> "	16"	16"	<b>SC4051R</b>	\$777
:	:	:	:	:



90° Table				
29 <sup>3</sup> / <sub>4</sub> "	29 <sup>3</sup> / <sub>4</sub> "	16"	<b>SC4054</b>	\$740
:	:	:	:	:



Corner Table				
29 <sup>3</sup> / <sub>4</sub> "	29 <sup>3</sup> / <sub>4</sub> "	16"	<b>SC4053</b>	\$740
:	:	:	:	:

Tip: SC4053 is used to connect two seating units to create an L-shape seating configuration. It has legs on one side and ganging brackets on two sides.



**For Canadian Pricing**  
 Multiply U.S. Price by the Canadian price factor.  
 ▶ See page 1 for details.

# Aspekt Freestanding Tables

Standard Includes		Required to Specify
<ul style="list-style-type: none"> <li>▶ Need help? Product details, page 59</li> </ul>	<ul style="list-style-type: none"> <li>• Table top: High-Pressure Laminate with 3 mm plastic edge</li> <li>• Legs: paint</li> <li>• Glides: black nylon only</li> </ul>	<ul style="list-style-type: none"> <li>1 Style number</li> <li>2 Laminate color number for top</li> <li>3 Paint color number for legs</li> <li>▶ See <i>Surface Materials</i>, page 473.</li> </ul>

## Specification Information

Dimensions			Style	U.S.
D	W	H	Number	Price

Oval Table				
22"	32"	16"	<b>SC4055</b>	\$977

Bow Table				
18"	20"	21"	<b>SC4057</b>	\$868

Round Table				
22" dia.		21"	<b>SC4058</b>	\$938

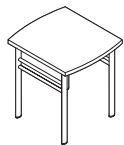

Families of Seating

 **For Canadian Pricing**  
 Multiply U.S. Price by the Canadian price factor.  
 ▶ See page 1 for details.

# Cura

**Cura seating** is a comfortable solution for both patient and guest seating. The modular design allows each chair to be reduced to single components so they can be reversed or replaced in the field.

**Seat and back** are independent of one another to provide additional comfort to the user.

**Seats** are available with upholstery or breathable CuraNet mesh.

**Headrest** is standard on all units. Headrest is upholstered with Promessa material on CuraNet mesh backs. Headrest will match the upholstery specified on a mid-back upholstered back.

**Urethane arm caps** are standard. Wood arm caps are available as an option.

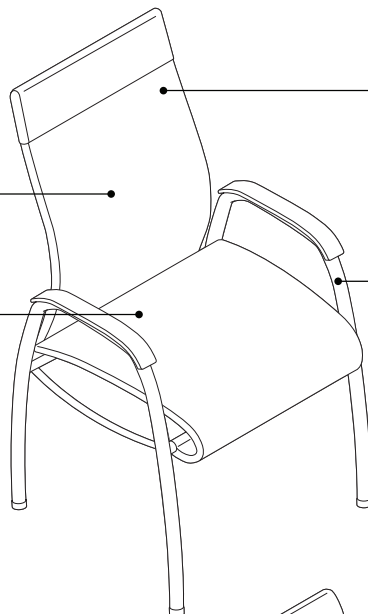

**High-back chairs** are standard with breathable CuraNet mesh back only. Mid-back Cura chairs are available with upholstery or breathable CuraNet mesh backs.

**Frame** is constructed with steel tubing and steel plates for structural integrity. It has a powdercoat paint finish that is corrosion resistant.

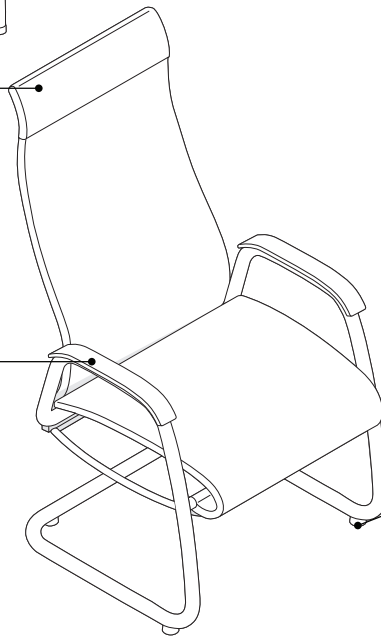

**Stainless steel glides** are standard on all chairs. Plastic glides are standard on ottomans and available as an option on chairs. Casters are available as an option to aid in moving the chair (not intended for patient transport use).

## Actual Dimensions

Features	Overall Depth	Width	Height	Seat Depth	Width	Height	Arm Height
Mid-back sled base	24½"	26" or 29"	40½"	19"	21" or 24"	18½"	25¾"
High-back sled base	24½"	26" or 29"	48"	19"	21" or 24"	18½"	25¾"
Mid-back four-leg base	24½"	26" or 29"	40½"	19"	21" or 24"	18½"	25¾"
High-back four-leg base	24½"	26" or 29"	48"	19"	21" or 24"	18½"	25¾"
Ottoman	18¼"	16"	12¼"	N.A.	N.A.	N.A.	N.A.

**Product Details**

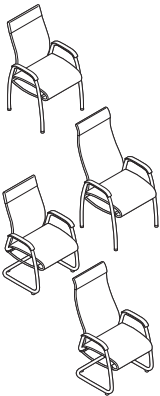

**Chairs** are available with a mid-back or high-back and with a sled or four-leg base. Two seat widths are available—21"W or 24"W. Mid-back chairs are offered with an upholstered back. High-back chairs are not available with an upholstered back.



**Ottoman** is available for use with the high-back chair. It fits beneath the chair and is equipped with a personal storage shelf.

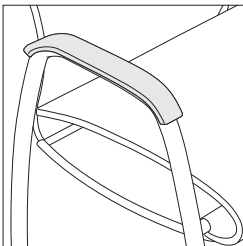

**Urethane arm caps** are standard. Wood arm caps are optional.



**Tablet arm** is 10½" by 15⅓" and swivels 360 degrees. It can be mounted on the left or right (shown) of a single chair.



**MM suffix models** denote that CuraNet mesh is standard on the back and seat. Headrest is standard in Promessa.

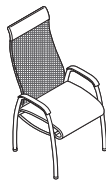

**ML suffix models** denote that CuraNet mesh is standard on the back. Promessa is standard on the seat and headrest.



**MU suffix models** denote that the CuraNet mesh is standard on the back. Steelcase, Select Surfaces, or COM fabrics can be specified on the seat. Headrest is standard in Promessa.

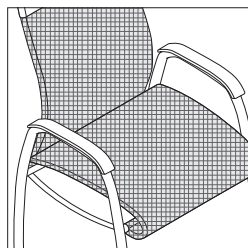

**CuraNet mesh** is standard on all backs. It can also be specified on the seat (style numbers ending in MM). It is available in the following colors: 5081 Ash (Silver Grey) 5085 Ebony (Black) 5086 Camel 5087 Cocoa 5088 Aquamarine

**Promessa** is a durable polyurethane (PVC-free) material that is used on the headrest and can also be specified on the seat (models ending in ML). For ease of specifying, the colors that match the CuraNet colors are supported with finish codes.

- UL81 Ash
  - UL85 Ebony
  - UL86 Camel
  - UL87 Cocoa
  - UL88 Aquamarine
- The remaining Promessa color palette from Ultrafabrics can be specified on ML models for a contrasting aesthetic. These materials can be specified using the Steelcase Health Select Surfaces program at no additional upcharge. Specify with 59DG.

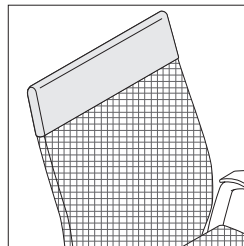

**Headrests on mesh back/mesh seat models (MM) and mesh back/upholstered seat models (MU)** are standard in the five Promessa colors that match the CuraNet.

**Headrest on mesh back/Promessa seat models (ML)** are standard in the five Promessa colors that match the mesh or any other color of Promessa ordered through the Steelcase Health Select Surfaces Program.

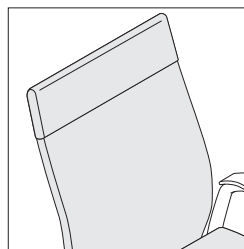

**Headrest on upholstered mid-back** will match upholstery specified on back.

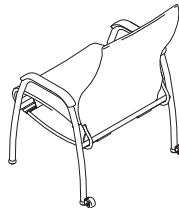

**Optional 2" casters** are available on all Cura styles. Casters are welded to the back frame of the chair to allow the chair to be rolled when tilted back. Casters are not intended for patient transport use.

**Connections**

**Frame, seat, and back components** can be removed and replaced in the field with simple hand tools.

**Surface Materials**

**All Steelcase Health seating with standard upholstery fabrics** comply with the State of California Technical Bulletin 117-2013.

**Frame**

- Powdercoat paint

**Seat**

- CuraNet mesh
- Fabric
- Promessa

**Back**

- CuraNet mesh
- Fabric (Fabric offered on mid-back chairs only)

**Headrest**

- Promessa

**Arms and caps**

- Urethane in Sterling Dark finish
- Maple wood (option)

**Chair glides**

- Stainless steel
- Plastic (option)

**Ottoman glides**

- Plastic

**Chair casters**

- Black (roller caster)

**Tablet arm**

- Thermoform

# Cura

## Chairs and Ottoman

Standard Includes	Required to Specify
<ul style="list-style-type: none"> <li>▶ Need help? Product details, page 62</li> <li>• Frame: paint</li> <li>• Back: CuraNet mesh or fabric (mid-back only)</li> <li>• Seat: mesh, fabric, or Promessa</li> <li>• Headrest: Promessa or fabric (mid-back only)</li> <li>• Arm caps: Urethane in Sterling Dark Finish</li> <li>• Glides: stainless steel on chairs, plastic on ottomans</li> </ul>	<ol style="list-style-type: none"> <li>1 Style number</li> <li>2 Paint color for frame</li> <li>3 CuraNet color for back or fabric (mid-back only)</li> <li>4 Mesh, fabric, or Promessa color number for seat</li> <li>5 Promessa or fabric (mid-back only) color number for headrest</li> <li>6 Options, if selected (see below)</li> </ol> <p>▶ See <i>Surface Materials</i>, page 473.</p>

Tip: Left and right determined when facing the chair.

Options	U.S. Price	Required to Specify
<b>Surface Materials</b> <ul style="list-style-type: none"> <li>• Wood arm caps</li> </ul>	+\$172	Specify with wood arm caps and select wood color.
<b>Tablet Arm</b> <ul style="list-style-type: none"> <li>• Tablet arm</li> </ul>	+\$386	Specify with tablet, indicate left or right facing, and select thermoform color number.
<b>Plastic Glides</b> <ul style="list-style-type: none"> <li>• Plastic glides on chairs</li> </ul>	No cost	Specify with plastic glides.
<b>Casters</b> <ul style="list-style-type: none"> <li>• Two 2" casters on back legs or frame of chairs</li> </ul>	+\$292	Specify with casters.

Specification Information												
U.S. Base Prices												
Style Number	Width	Fabric Price Group 1	Fabric Price Group 2	Fabric Price Group 3	Fabric Price Group 4	Fabric Price Group 5	Fabric Price Group 6	Fabric Price Group 7	Fabric Price Group 8	Fabric Price Group 9	Fabric Price Group 10	COM



### Mid-Back, Sled-Base Chairs

#### CuraNet Back and Seat

**HN2305MM** 21" \$2293

**HN2305EMM** 24" \$2378

#### CuraNet Back and Promessa Seat

**HN2315ML** 21" \$2466

**HN2315EML** 24" \$2551

#### CuraNet Back and Upholstered Seat

**HN2315MU** 21" \$2274 \$2337 \$2403 \$2455 \$2508 \$2539 \$2593 \$2700 \$2763 \$2830 \$2327

**HN2315EMU** 24" \$2358 \$2434 \$2505 \$2569 \$2632 \$2670 \$2732 \$2853 \$2930 \$3003 \$2411

▶ Specification Information, continued on next page



#### For Canadian Pricing

Multiply U.S. Price by the Canadian price factor.

▶ See page 1 for details.



► Specification Information, continued from previous page

Specification Information													
Style Number	U.S. Base Price	Fabric Upcharges	Fabric Price Group 1	Fabric Price Group 2	Fabric Price Group 3	Fabric Price Group 4	Fabric Price Group 5	Fabric Price Group 6	Fabric Price Group 7	Fabric Price Group 8	Fabric Price Group 9	Fabric Price Group 10	COM

**Mid-Back, Sled-Base Chairs, continued**

**21"W Promessa Back and Seat**

<b>HN2315MLSB</b>	\$2641												
-------------------	--------	--	--	--	--	--	--	--	--	--	--	--	--

**24"W Promessa Back and Seat**

<b>HN2315EMLSB</b>	\$2725												
--------------------	--------	--	--	--	--	--	--	--	--	--	--	--	--

**21"W Upholstered Seat and Upholstered Back**

<b>HN2315MUSB</b>	\$2254	Seat	No cost	+\$63	+\$129	+\$181	+\$234	+\$265	+\$319	+\$426	+\$489	+\$556	+\$53
		Back	N.A.	+\$73	N.A.	N.A.	N.A.	+\$305	N.A.	N.A.	N.A.	N.A.	N.A.

**24"W Upholstered Seat and Upholstered Back**

<b>HN2315EMUSB</b>	\$2338	Seat	No cost	+\$76	+\$147	+\$211	+\$274	+\$312	+\$374	+\$495	+\$572	+\$645	+\$53
		Back	N.A.	+\$86	N.A.	N.A.	N.A.	+\$357	N.A.	N.A.	N.A.	N.A.	N.A.

Specification Information													
U.S. Base Prices													
Style Number	Width	Fabric Price Group 1	Fabric Price Group 2	Fabric Price Group 3	Fabric Price Group 4	Fabric Price Group 5	Fabric Price Group 6	Fabric Price Group 7	Fabric Price Group 8	Fabric Price Group 9	Fabric Price Group 10	COM	

**High-Back, Sled-Base Chairs**

**CuraNet Back and Seat**

<b>HN2306MM</b>	21"	\$2398											
<b>HN2306EMM</b>	24"	\$2482											

**CuraNet Back and Promessa Seat**

<b>HN2316ML</b>	21"	\$2570											
<b>HN2316EML</b>	24"	\$2653											

**CuraNet Back and Upholstered Seat**

<b>HN2316MU</b>	21"	\$2378	\$2441	\$2507	\$2559	\$2612	\$2643	\$2697	\$2804	\$2867	\$2934	\$2431
<b>HN2316EMU</b>	24"	\$2459	\$2535	\$2606	\$2670	\$2733	\$2771	\$2833	\$2954	\$3031	\$3104	\$2512

► Specification Information, continued on next page



 **For Canadian Pricing**  
 Multiply U.S. Price by the Canadian price factor.  
 ► See page 1 for details.

► Specification Information, continued from previous page

Specification Information												
Style Number	Width	U.S. Base Prices										COM
		Fabric Price Group 1	Fabric Price Group 2	Fabric Price Group 3	Fabric Price Group 4	Fabric Price Group 5	Fabric Price Group 6	Fabric Price Group 7	Fabric Price Group 8	Fabric Price Group 9	Fabric Price Group 10	



**Mid-Back, Four-Leg Base Chairs**

**CuraNet Back and Seat**

**HN2300MM** 21" \$2040

**HN2300EMM** 24" \$2124

**CuraNet Back and Promessa Seat**

**HN2310ML** 21" \$2214

**HN2310EML** 24" \$2298

**CuraNet Back and Upholstered Seat**

**HN2310MU** 21" \$2021 \$2084 \$2150 \$2202 \$2255 \$2286 \$2340 \$2447 \$2510 \$2577 \$2074

**HN2310EMU** 24" \$2104 \$2180 \$2251 \$2315 \$2378 \$2416 \$2478 \$2599 \$2676 \$2749 \$2157

**Specification Information**

Style Number	U.S. Base Price	Fabric Upcharges	Fabric Price Group 1	Fabric Price Group 2	Fabric Price Group 3	Fabric Price Group 4	Fabric Price Group 5	Fabric Price Group 6	Fabric Price Group 7	Fabric Price Group 8	Fabric Price Group 9	Fabric Price Group 10	COM
--------------	-----------------	------------------	----------------------	----------------------	----------------------	----------------------	----------------------	----------------------	----------------------	----------------------	----------------------	-----------------------	-----

**Mid-Back, Four-Leg Base Chairs, continued**

**21"W Promessa Back and Seat**

**HN2310MSB**  
\$2387

**24"W Promessa Back and Seat**

**HN2310EMSB**  
\$2471

**21"W Upholstered Seat and Upholstered Back**

<b>HN2310MUSB</b>													
\$2001	Seat	No cost	+\$63	+\$129	+\$181	+\$234	+\$265	+\$319	+\$426	+\$489	+\$556	+\$53	
	Back	N.A.	+\$73	N.A.	N.A.	N.A.	+\$305	N.A.	N.A.	N.A.	N.A.	N.A.	

**24"W Upholstered Seat and Upholstered Back**

<b>HN2310EMUSB</b>													
\$2085	Seat	No cost	+\$76	+\$147	+\$211	+\$274	+\$312	+\$374	+\$495	+\$572	+\$645	+\$53	
	Back	N.A.	+\$86	N.A.	N.A.	N.A.	+\$357	N.A.	N.A.	N.A.	N.A.	N.A.	

► Specification Information, continued on next page



**For Canadian Pricing**

Multiply U.S. Price by the Canadian price factor.

► See page 1 for details.

► Specification Information, continued from previous page

**Specification Information**

Style Number	Width	U.S. Base Prices										COM
		Fabric Price	Fabric Price	Fabric Price	Fabric Price	Fabric Price	Fabric Price	Fabric Price	Fabric Price	Fabric Price	Fabric Price	
		Group 1	Group 2	Group 3	Group 4	Group 5	Group 6	Group 7	Group 8	Group 9	Group 10	

**High-Back, Four-Leg Base Chairs**

**CuraNet Back and Seat**

**HN2301MM** 21" \$2145

**HN2301EMM** 24" \$2227

**CuraNet Back and Promessa Seat**

**HN2311ML** 21" \$2318

**HN2311EML** 24" \$2401

**CuraNet Back and Upholstered Seat**

**HN2311MU** 21" \$2124 \$2187 \$2253 \$2305 \$2358 \$2389 \$2443 \$2550 \$2613 \$2680 \$2177

**HN2311EMU** 24" \$2206 \$2282 \$2353 \$2417 \$2480 \$2518 \$2580 \$2701 \$2778 \$2851 \$2259

**Ottoman**

**Promessa**

**HN2305HL** 16" \$1221

**Upholstered**

**HN2305HS** 16" \$1045 \$1089 \$1129 \$1165 \$1200 \$1224 \$1259 \$1327 \$1373 \$1413 \$1098



**For Canadian Pricing**

Multiply U.S. Price by the Canadian price factor.

► See page 1 for details.

# Embold

**Embold** features versatile seating configurations that can be utilized in multiple environments.

**Seat and back** are fully upholstered.

**Space between entire back and seat** allows for easy cleaning.

**Frame** is available as solid maple wood or metal.

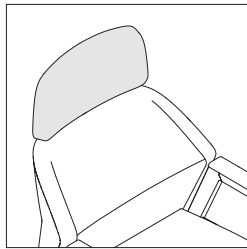

**High back option** creates additional upper back support. The high back is available on the single seat 21"W and 32"W seats, and on the easy access 21"W and the 32"W seats.

**Curved back design** accommodates a range of seating postures and offers comprehensive back support.

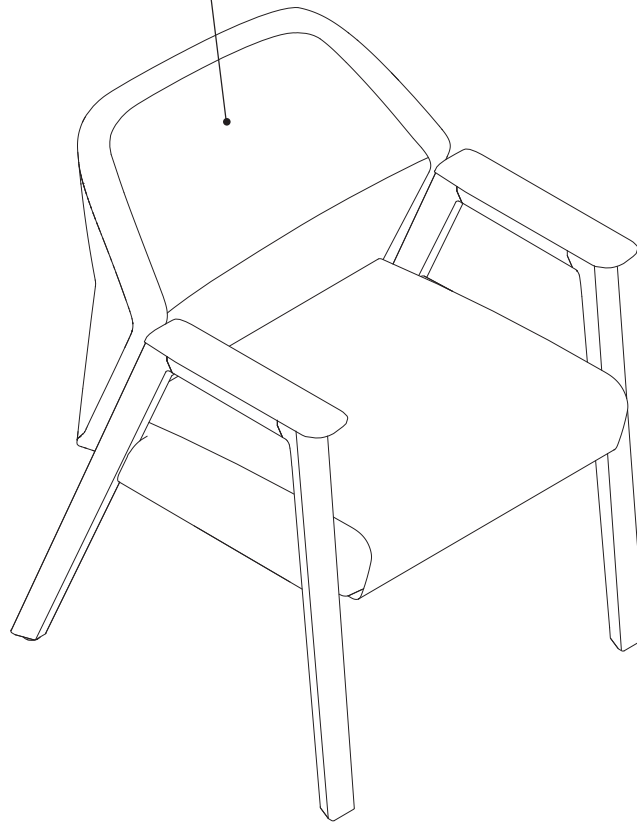

**Two arm cap shapes** are available and are both offered in plastic, solid maple wood, and solid surface.

**Upholstery for seat and back** is specified separately. The back can be specified with one upholstery or contrasting (multiple) upholsteries. Contrasting back upholsteries can be specified for the upper and lower back or the inner and outer back.

**Multiple seating units** can be specified with different seat configurations.

**Midarms** are available on loveseats and multiple seating units. Midarms allow for flexibility through creating specific designation of seat space that can be reconfigured over time.

**Midlegs** can be added to configurations and are structurally required every 44".

**Support plates** may need to be added or removed for future reconfiguration of midarms or midlegs in the field.

**Footrest** is standard on the easy access chairs and is located on the front of the chair. A support bar is located on the back of the chair for structural support.

**Footrest and support bar** are anodized aluminum.

**Adjustable glides** are standard on legs. Optional wallsaver glides are available.

## Actual Dimensions

Chairs	Overall			Seat		
	Depth	Width with overhang arm cap	Height	Depth	Width	Height
Single Seat	25¼"	25½"	33¼"	18½"	21"	18½"
Midsize Single Seat	25¼"	29⅝"	33¼"	18½"	24¾"	18½"
Bariatric Single Seat	25¼"	36⅞"	33¼"	18½"	31¾"	18½"
Loveseat	25¼"	47⅝"	33¼"	18½"	43"	18½"
66"W Multiple Seat	25¼"	70⅛"	33¼"	18½"	66"	18½"
88"W Multiple Seat	25¼"	92⅝"	33¼"	18½"	88"	18½"
88"W Multiple Seat Bariatric Combination	25¼"	92⅝"	33¼"	18½"	88"	18½"
21"W Easy Access	25¼"	25½"	39⅞"	18½"	21"	24½"
32"W Easy Access	25¼"	36⅞"	39⅞"	18½"	31¾"	24½"

Tip: Subtract 1¼" from overall width when using non-overhang arm caps.

**Product Details**

**Embold** is a family of seating that encompasses a variety of seating needs and configurations.

**Chair frames** are available as solid maple wood or painted metal.

**Plastic, solid maple wood, and solid surface arm caps** are available on wood or metal chair frames.

**Two arm cap shapes** are available to specify—overhang and no overhang.

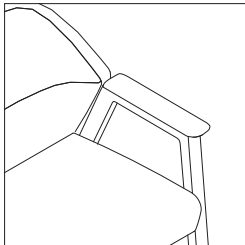

**Overhang arm caps** have an intentional handed overhang designed to help users grip the chair during ingress and egress. Overhang arms are recommended for use in clinical areas.

*Tip: Solid surface overhang arm caps have a slightly different aesthetic than the solid maple or plastic arms and are non-handed for both styles.*

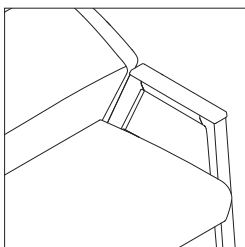

**No overhang arm caps** have a sleek minimal profile.

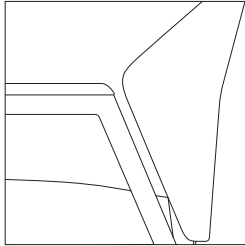

**Space** between seat and back allows for easy cleaning along the entire back.

**Curved back design** supports multiple seating postures and offers comprehensive back support.

**Back** has a gentle flex for comfort.

**The back** can be specified with one upholstery or contrasting (multiple) upholsteries. Contrasting back upholsteries can be specified for the upper and lower back or the inner and outer back. 66"W and 88"W multiple seat units have a vertical center seam on the back.

*Tip: Only one color scheme can be selected for the back. All backs have center horizontal seam and zipper.*

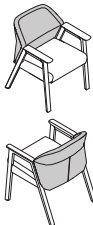

**Monolithic back color scheme** should be selected when choosing one upholstery for the entire back.



**Contrasting upper back and lower back color scheme** should be selected when choosing contrasting upholsteries for the upper and lower back.

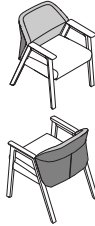

**Contrasting inner back and outer back color scheme** should be selected when choosing contrasting upholsteries for the inner back and outer back.

**No scheme** can be selected for seat, as it is only available in one upholstery.

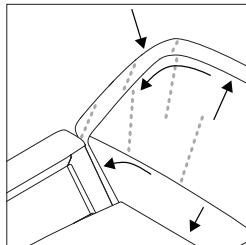

**Fabrics with a repeating pattern** will not remain aligned between the curved corners (inner or outer corner) and the top outer edges of the chair. Misalignment can also occur around the vertical center seam on multiple seating units.

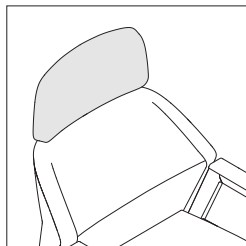

**Optional high back** can be added to provide additional upper back support. High back is available on the single seat 21"W and 32"W seats, and on the easy access 21"W and 32"W seats. The high back adds approximately 9" to the height of the chair.

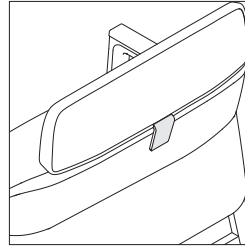

**High back** will have attachment bracket centered on the back of 21"W chairs. There are two attachment brackets on the back of 32"W chairs. Bracket comes with bracket cover and its finish is specifiable. High back can be ordered retroactively and installed in the field but cannot be removed without damaging chair upholstery.

**Multiple seating units** can be configured in various ways to create different seat widths by adding or removing midarms.

**Midarms** can be added to loveseats and multiple seating units to designate seats. Midarms also create different seat width configurations. Midarms attach to the under seat structure and fit through the crumbsweep between the back and seat. Midarm can be specified separately to be retrofitted in the field for a new configuration. Moving or removing a midarm cannot be done without tools. Refer to installation instructions.

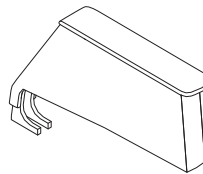

**Midarms** can only be specified in the center on loveseats. Multiple seat units can have midarms specified in a variety of positions. **► For better understanding of possible arm configurations, please see Embold Configurations on page 74.**

**Arm caps for midarms** are available in plastic, solid maple wood, and solid surface. Midarm caps are available with or without an overhang and are non-handed for both styles.

**Midarm** overhang arm caps have an overhang on both sides.

**Midarms** are upholstered and are specified separately from the seat. Midarms rest on the top of seat upholstery and do not puncture or damage seat upholstery.

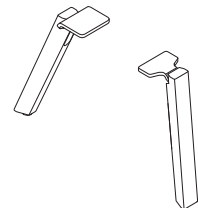

**Minimum midleg placement** is dependent on seating configuration. Midlegs are required every 44"W on multiple seat units. Two midlegs are required for an 88"W multiple seat unit without any midarms. All configurations on an 88"W multiple seat combination unit (**HSBM88C**) requires two midlegs, which come standard.

**Midleg** is only available in the center position on the loveseat and is not needed for structural support.

**Midlegs** can be added for aesthetic purposes in some applications.

**Midleg** can be specified separately to be retrofitted in the field for reconfiguration. Moving or removing a midleg cannot be done without tools. *Tip: Support plates, midarms, and midlegs should be ordered as options when specifying the seating units, but would need to be ordered separately for future reconfigurations in the field.*

**Footrest** is standard on the easy access chairs and is located on the front and back of the chair. Footrest is anodized aluminum.

Embold, continued

**Moisture barrier** is available as an option on the seat only.

**Non-marring, black plastic glides** are standard on both wood and metal chairs.

**Adjustable glides** are standard on legs. Optional wallsaver glides are available. Glides are interchangeable and can be retrofitted in the field. Wallsaver and standard glide options are available on midlegs as well as standard chair legs.

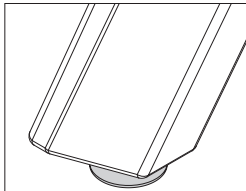

Standard Adjustable Glide

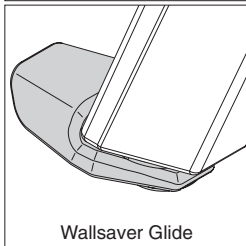

Wallsaver Glide

*Tip: When specified on seating, wallsaver glides will be applied to the rear legs and standard glides will be applied to the front legs.*

**Related Products**



**Embold Circular Table**  
▶ See page 71

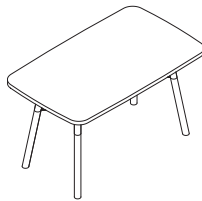

**Embold Rounded Rectangular Table**  
▶ See page 71

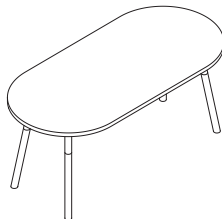

**Embold Racetrack Table**  
▶ See page 71

**Surface Materials**

**All Steelcase Health seating with standard upholstery fabrics** comply with the State of California Technical Bulletin 117-2013.

**Seat and back**

- Fabric
- Fabric with moisture barrier (option on seat only)

**Arm caps**

- Solid maple wood
- Plastic
- Solid surface

**Legs and frame**

- Solid maple wood
- Paint

**Standard adjustable glides**

- Black plastic

**Wallsaver glides**

- Merle plastic

**High back chair bracket and bracket cover (option)**

- Paint

**Midarm**

- Upholstery

**Midleg**

- Solid maple wood
- Paint

**Easy access footrest**

- Anodized aluminum

# Embold Tables

**Embold tables** are available in three styles to coordinate with Embold seating.

**Table tops** are available in High-Pressure Laminate or solid surface. Solid wood table tops are available for the circular table only.

**Legs** are available in solid maple, solid oak, or solid walnut wood. Legs are also available in painted metal.

**Braided power cord covers** are available. These cord covers are intended for non-clinical areas and are for decorative purposes.

**Solid maple, solid oak, and solid walnut table tops** are available for the circular table only. Solid walnut, maple, or oak tops must be specified with metal or matching wood species legs. Solid wood table tops are advised for non-clinical areas and are not appropriate for clinical areas. Solid wood tables have a raised lip around the table edge.  
*Tip: These are cuts of solid wood of wood and not veneered wood products.*

**Power** is available on tables and includes one standard outlet or two USB ports. Power cord exits through underside of table top. Standard outlet power is tamper and spill resistant. Steelcase recommends to check with all local and facility authorities prior to specification and order, to confirm acceptance of proposed product and applications.  
*Tip: The USB cord is approximately 1/8" wide and contains AC/DC adapter that measures 2 3/4"D x 1 1/4"W x 3 1/2"H.*

*Tip: Braided power cord is not available with USB option for power.*

## Actual Dimensions

Features	Overall		
	Depth	Width	Height
Circular Table	20" Dia.	N.A.	19"
Rounded Rectangle Table	19"	32"	19"
Racetrack Table	20"	42"	19"

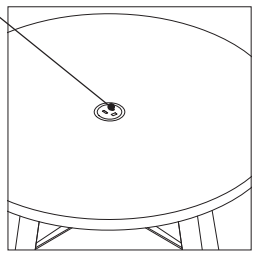
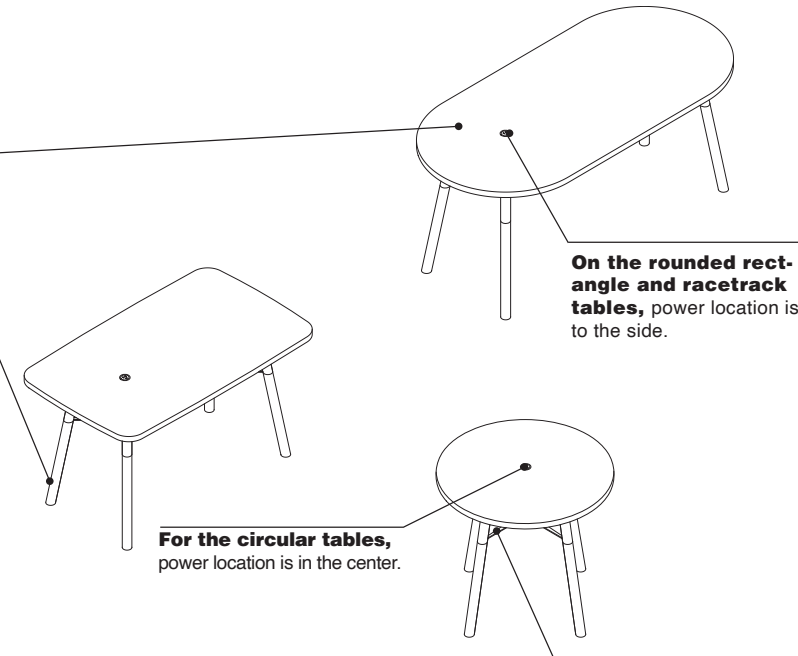

## Product Details

**Cutout** is available as an option on solid wood or solid surface table tops to thread other power through, such as a lamp. Cutout is available in same location as power.

## Surface Materials

### Frame

- Paint
- Lux Coatings

### Top for rectangle and racetrack tables

- High-Pressure Laminate
- Solid surface

### Top for circular table

- High-Pressure Laminate
- Solid surface
- Solid walnut wood
- Solid oak wood
- Solid maple wood

*Tip: Because no stain is used for 3P51 OP Planked Maple, 3P61 OP Planked Oak, and 3P71 OP Planked Walnut, a sign-off will be required prior to orders being accepted for this finish. The sign-off sheets are available through Marketing Resource. Form numbers are: 17-0005742 for 3P51, 17-0005619 for 3P61, and 17-0005626 for 3P71.*

### Edge profile (if High-Pressure Laminate is specified)

- 3 mm plastic

### Legs

- Paint
- Solid maple wood
- Solid walnut wood
- Solid oak wood

### Power

- 5U23 Blue Jay
- 6249 Platinum Solid
- 6337 Element
- 6338 Chili
- 6527 Merle

### Power cord

- White
- Black

### Braided power cord cover (intended for non-clinical use only)

- Cotton

## Braided Cord Color Matrix

**Braided cord samples** are not available to order. Use matrix below that compares the braided cord finish to the nearest Steelcase finish or Pantone color for color reference purposes.

Finish	Color Reference
9002 Silver	10388 C (Pantone Color)
9003 Fuchsia	PerfectMatch
9004 Marlin	4AZ5 Marlin
9006 Chili	6338 Chili
9007 Sterling	6059 Sterling Dark Solid
9008 Honey	4CZ5 Honey
9009 Black	0835 Black
9010 Light Peacock	4CZ8 Light Peacock
9011 Seagull	4858 Seagull
9012 Merle	6527 Merle
9013 Brass	10362 C (Pantone Color)

# Embold Accessories

**Midarms** allow for flexibility in seat configurations. Midarms can be specified separately from Embold seating and can be added to a loveseat or multiple seating unit.

**Midlegs** allow for flexibility in seat configurations. For some configurations midlegs can be specified separately from Embold seating and can be added to a loveseat or multiple seating unit.

**Midleg placement** is dependent on seating configuration. 66"W and 88"W multiple seating configurations come standard with a minimum of one midleg, but additional midlegs can be ordered for different configurations. Midlegs are required every 44" on multiple seat units. All 66"W and 88"W multiple seating units require at least one midleg. A minimum of one midleg is needed for multiple seat units with one midarm. Two midlegs are required for an 88"W unit without any midarms. All configurations on an 88"W multiple seat combination unit (**HSBM88C**) requires two midlegs, which come standard.

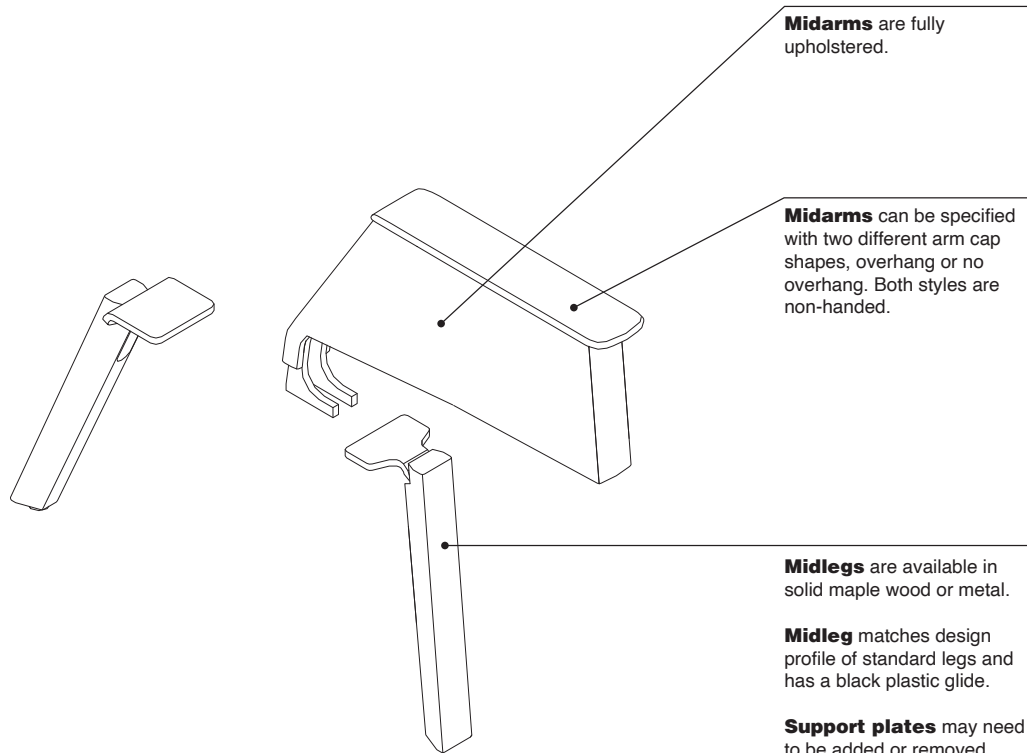

**Midarms** are fully upholstered.

**Midarms** can be specified with two different arm cap shapes, overhang or no overhang. Both styles are non-handed.

**Midlegs** are available in solid maple wood or metal.

**Midleg** matches design profile of standard legs and has a black plastic glide.

**Support plates** may need to be added or removed for future reconfiguration of midarms or midlegs in the field.



**Product Details**

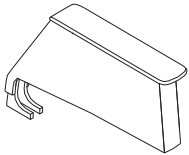

**Midarms** can be added to multiple seating units to divide the seat into various sizes. Midarms can be added to existing Embold loveseat and multiple seating units for further seat definition. Moving or removing a midarm cannot be done without tools. Adding midarms to an existing product may require ordering an additional support plate for attachment to the seating unit. Midarms can only be added to certain locations on loveseats and multiple seating units.

▶ See *Embold Configurations* on page 74 for further information on how to configure seating with a midarm.

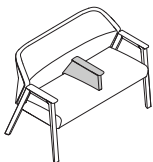

**Arm caps for midarm** are available in plastic, solid maple wood, and solid surface. Midarm caps are available with or without an overhang. Both midarm cap styles are non-handed. Overhang arm caps have an overhang on both sides. Midarms are upholstered and are specified separately from the seat, except for the multiple seat bariatric combination where they are pre-configured in set positions.

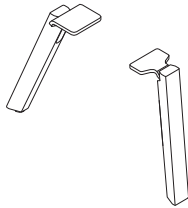

**Midlegs** can be added to existing loveseat and multiple seating units. 66"W and 88"W multiple seating configurations will ship with a minimum of one midleg, but additional midlegs can be ordered for different configurations. Midlegs are required every 44" with one midarm. Two midlegs are required for an 88"W multiple seat unit without any midarms. To change the unit of an existing multiple seating configuration, an additional leg and support plate may be required for structural purposes. Adding a midleg requires installers and cannot be done without tools. Refer to installation instructions.

▶ See *Embold Configurations* on page 74 for further information on how to configure seating with a midleg.

*Tip: Support plates, midarms, and midlegs should be ordered as options when specifying the seating units, but would need to be ordered separately for future reconfigurations in the field.*

**Surface Materials**

**All Steelcase Health seating with standard upholstery fabrics** comply with the State of California Technical Bulletin 117-2013.

**Midarm**  
 • Upholstery

**Arm caps**  
 • Solid maple wood  
 • Plastic  
 • Solid surface

**Midleg**  
 • Solid maple wood  
 • Paint

▶ See *Surface Materials* section for complete listing on page 474.

# Embold Configurations

For Loveseat and Multiple Seating Units

**Embold** offers flexibility through midarms and midlegs on loveseats and multiple seat units. Midarms and midlegs allow for organizations to reconfigure these units over time to serve new needs. Midlegs are required every 44" on multiple units, so configurations must always include one leg for structural support with the exception of an 88"W seat with no midarms. 88"W seat units with no midarms require two midlegs. Midarms are not required on any unit, but come standard on the multiple seat bariatric combination unit (**HSBM88C**). Some configurations may require additional support plates or midlegs to be ordered to support a new configuration.

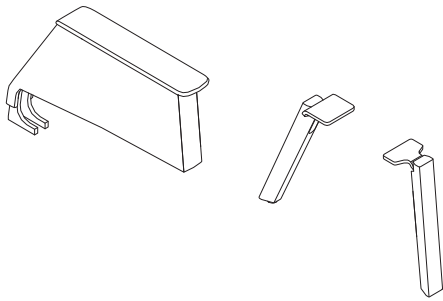

**Midarms** allow for more prescriptive seating and can be specified on any loveseat or multiple seating unit. Additionally, a midarm can be specified separately and retrofitted on a loveseat or multiple seating unit.

**Midarms and midlegs** can also be reconfigured or removed to create new seating configurations.

**Support plates** may need to be added or removed for future reconfiguration of midarms or midlegs in the field.

## Loveseat

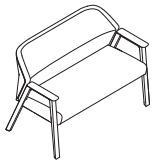

**Embold** loveseats are standard with no midarm or midleg. Midleg is not needed for structural support.

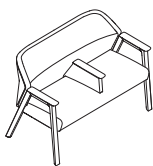

Specified as midarm center and no midleg.

This configuration requires one support plate.

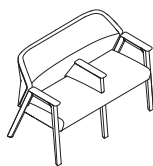

Specified as midarm center and midleg center.

This configuration requires one support plate.

**A midarm** can be added to the loveseat to divide the seat into two 21" wide seats. No midleg is needed for structural support, but one can be added if desired for aesthetic reasons. A loveseat with a midleg but no midarm is not available as standard product.

## Multiple Seating

**Multiple seating** is available in seat widths of 66" and 88". These larger seat widths allow for the units to be specified in a multitude of ways to create different seat configurations. Midlegs are required every 44" on multiple units, so configurations must always include a minimum of one leg for structural purpose with the exception of an 88"W seat with no midarms. 88"W seat units with no midarms require two midlegs. Midarms are not required on any unit, but come standard on the multiple seat bariatric combination unit (**HSBM88C**). Some configurations may require additional support plates or midlegs to be ordered to support a new configuration.

### Multiple Seating 66"W Seat Configurations

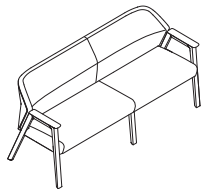

This configuration does not require a support plate.

The default 66"W seat configuration is a unit with one center midleg and no midarm.

#### Two Seat Configuration

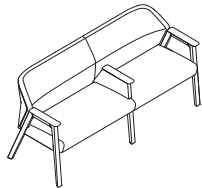

Specified as midarm center and midleg center.

This configuration does not require a support plate.

**Two 32" bariatric seats** can be configured with the addition of a midarm.

#### Three Seat Configurations

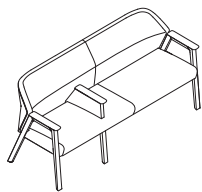

Specified as midarm left-side facing and midleg left-side facing.

This configuration requires one support plate.

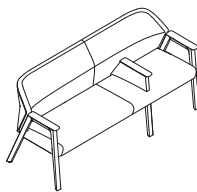

Specified as midarm right-side facing and midleg right-side facing.

This configuration requires one support plate.

**One 21"W seat and one 44"W seat** can be configured with the addition of a midarm. The 21"W seat can be specified to be right- or left-side facing.

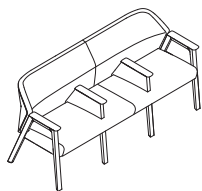

Specified as two midarms and two midlegs.

This configuration requires two support plates.

**Three 21"W seats** can be configured with the addition of two midarms and an additional midleg.

### Multiple Seating 88"W Seat Configurations

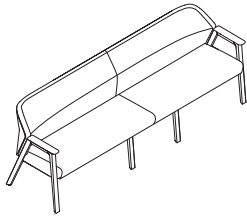

This configuration does not require a support plate.

The default 88"W seat configuration is the unit with two center midlegs and no midarm.

#### Two Seat Configuration

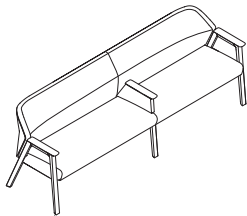

Specified as midarm center and midleg center.

This configuration requires one support plate.

Two 44"W seats can be configured with the addition of one midarm and removal of one midleg. This configuration requires one support plate.

#### Three Seat Configurations

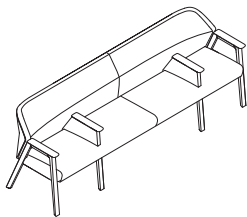

Specified as left-side facing and right-side facing midarms and left-side facing and right-side facing midlegs.

This configuration requires two support plates.

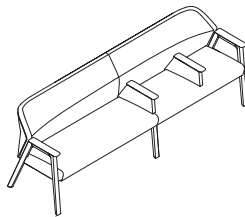

Specified as center and right-side facing midarms and center midleg. Also available with center and left-side facing midarms.

This configuration requires two support plates.

One 44"W seat and two 21"W seats can be configured through the addition of two midarms, or two midarms and removal of one midleg, dependent on location.

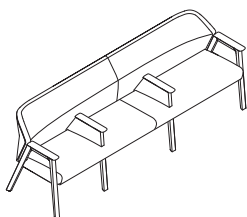

Specified as center and right-side facing bariatric seat.

This configuration requires one support plate.

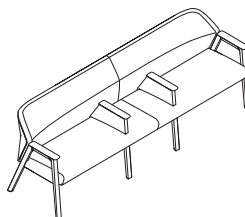

Specified as left-side facing and right-side facing bariatric seat.

This configuration does not require a support plate.

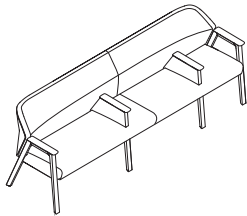

Specified as center and left-side facing bariatric seat.

This configuration requires one support plate.

Two 32"W seats and one 21"W seat can be configured with the addition of two midarms and one midleg. Two 32"W seats always require use of two midlegs for structural support. This configuration is ordered through the bariatric multiple seat combination style number. However, this unit can be reconfigured to other 88"W seating combinations in the future and may not require two support legs.

## Multiple Seating 88"W Seat Configurations, continued

### Four Seat Configurations

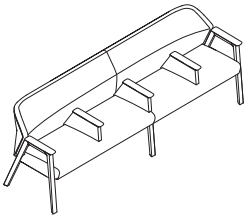

Specified as three midarms and midleg center.  
This configuration requires three support plates.

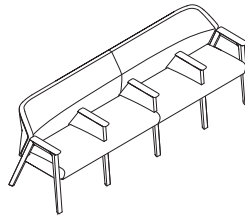

Specified as three midarms and three midlegs.  
This configuration requires three support plates.

**Four 21"W seats** can be configured through the addition of three midarms, or three midarms and three midlegs, dependent on configuration.

## Midleg and Midarm Configurations

### 66"W Unit

Midarm Quantity	Midleg Quantity	Configurations
0	1	
1	1	
2	2	

**Midleg and Midarm Configurations, continued**

88"W Unit

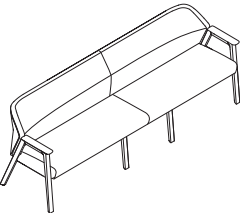
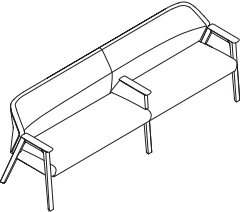
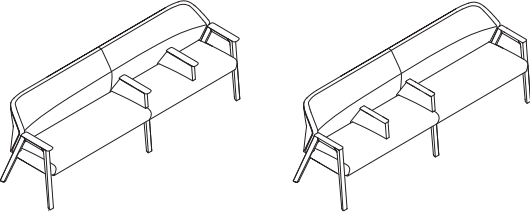
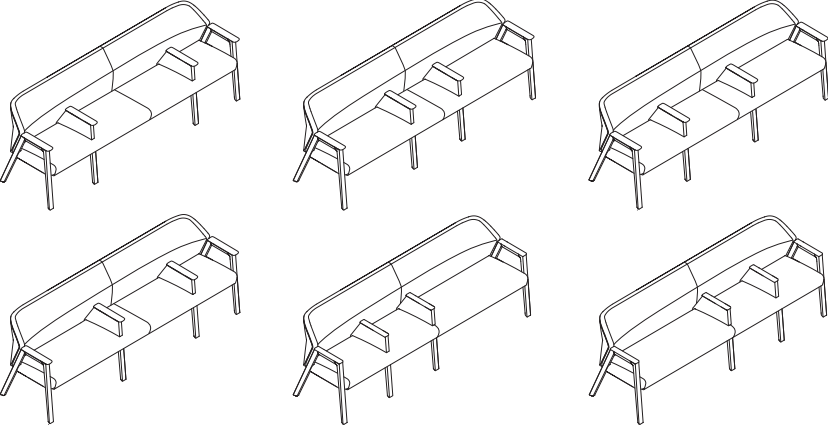
Midarm Quantity	Midleg Quantity	Configurations
0	2	
1	1	
2	1	
2	2	

**Midleg and Midarm Configurations, continued**

**88"W Unit**

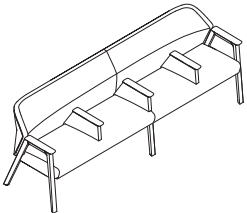
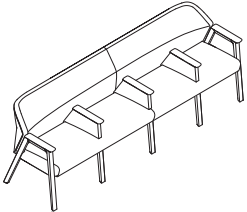
Midarm Quantity	Midleg Quantity	Configurations
3	1	
3	3	









Families of Seating

Embold Configurations For Loveseat and Multiple Seating Units, continued

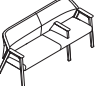
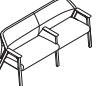
**Plate Configurations**

**66"W Unit**

**Number of additional mid arm/leg plates required to go from the configuration on the left to the configuration on the top line.**

		Has:				
						
		<b>Specified as two midarms and two midlegs.</b>	<b>Specified as midarm right-side facing and midleg right-side facing.</b>	<b>Specified as no midarm and midleg center.</b>	<b>Specified as midarm left-side facing and midleg left-side facing.</b>	<b>Specified as midarm center and midleg center.</b>
Needs:		2	1	0	1	0
Specified as two midarms and two midlegs.		2	0	0	0	0
Specified as midarm right-side facing and midleg right-side facing.		1	1	0	0	0
Specified as no midarm and midleg center.		0	2	1	0	1
Specified as midarm left-side facing and midleg left-side facing.		1	1	0	0	0
Specified as midarm center and midleg center.		0	2	1	0	1









Embold Configurations For Loveseat and Multiple Seating Units, continued

**Plate Configurations, continued**

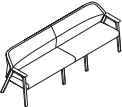
**88"W Unit**

Number of additional mid arm/leg plates required to go from the configuration on the left to the configuration on the top line.

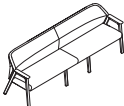
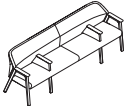
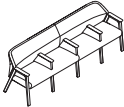
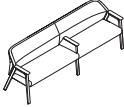
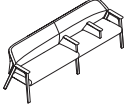
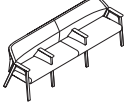
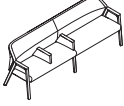
	Has:						
		<b>Specified as no midarm and two midlegs.</b>	<b>Specified as left-side facing and right-side facing midarms and left-side facing and right-side facing midlegs.</b>	<b>Specified as three midarms and midlegs.</b>	<b>Specified as midarm center and midleg center.</b>	<b>Specified as center and right-side facing midarms and center midleg.</b>	
Needs:		0	2	3	1	2	
Specified as no midarm and two midlegs.		0	0	2	3	1	2
Specified as left-side facing and right-side facing midarms and left-side facing and right-side facing midlegs.		2	0	0	1	0	0
Specified as three midarms and midlegs.		3	0	0	0	0	0
Specified as midarm center and midleg center.		1	0	1	2	0	1
Specified as center and right-side facing midarms and center midleg.		2	0	0	1	0	0
Specified as right-side facing and center bariatric seat.		1	0	1	2	0	1
Specified as center and left-side facing midarms and center midleg.		2	0	0	1	0	0

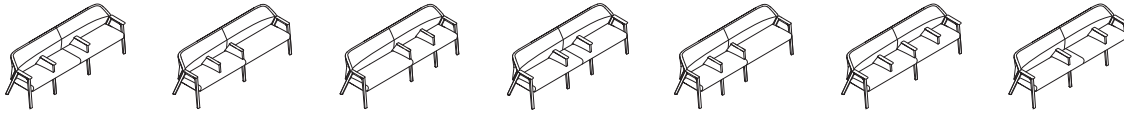







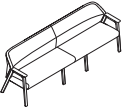

Specified as right-side facing and center bariatric seat.	Specified as center and left-side facing midarms and center midleg.	Specified as center and right-side facing midarms and center and right-side facing midleg.	Specified as left-side facing and right-side facing bariatric seat.	Specified as center and left-side facing midarms and center and left-side facing midleg.	Specified as three midarms and midleg center.	Specified as left-side facing and center bariatric seat.
1	2	2	0	2	3	1
1	2	2	0	2	3	1
0	0	0	0	0	1	0
0	0	0	0	0	0	0
0	1	1	0	1	2	0
0	0	0	0	0	1	0
0	1	1	0	1	2	0
0	0	0	0	0	1	0

Embold Configurations For Loveseat and Multiple Seating Units, continued

Plate Configurations, continued

88"W Unit, continued

Number of additional mid arm/leg plates required to go from the configuration on the left to the configuration on the top line.

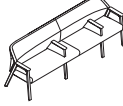
		Has:					
							
		Specified as no midarm and two midlegs.	Specified as left-side facing and right-side facing midarms and left-side facing and right-side facing midlegs.	Specified as three midarms and midlegs.	Specified as midarm center and midleg center.	Specified as center and right-side facing midarms and center midleg.	
Needs:		0	2	3	1	2	
Specified as center and right-side facing midarms and center and right-side facing midleg.		2	0	0	1	0	0
Specified as left-side facing and right-side facing bariatric seat.		0	0	2	3	1	2
Specified as center and left-side facing midarms and center and left-side facing midleg.		2	0	0	1	0	0
Specified as three midarms and center midleg.		3	0	0	0	0	0
Specified as left-side facing and center bariatric seat.		1	0	1	2	0	1



<b>Specified as right-side facing and center bariatric seat.</b>	<b>Specified as center and left-side facing midarms and center midleg.</b>	<b>Specified as center and right-side facing midarms and center and right-side facing midleg.</b>	<b>Specified as left-side facing and right-side facing bariatric seat.</b>	<b>Specified as center and left-side facing midarms and center and left-side facing midleg.</b>	<b>Specified as three midarms and midleg center.</b>	<b>Specified as left-side facing and center bariatric seat.</b>
--	--	---	--	---	--	---

1	2	2	0	2	3	1
0	0	0	0	0	1	0
1	2	2	0	2	3	1
0	0	0	0	0	1	0
0	0	0	0	0	0	0
0	1	1	0	1	2	0

# Embold

## Single Seat



Tip: Only one back color scheme can be chosen.

► For more information on the different color schemes, see page 68

Tip: Fabrics with a repeating pattern will not remain aligned around the corners of the chair or in the boxing (the outer perimeter).

Tip: Wood chair frame and wood arm caps must be specified in the same finish.

Tip: Overhang arm is suggested for clinical applications to aid in user ingress and egress.

 **For Canadian Pricing**  
Multiply U.S. Price by the Canadian price factor.  
► See page 1 for details.

Standard Includes		Required to Specify
► Need help? Product details, page 68	<ul style="list-style-type: none"> <li>Seat and monolithic back: fabric price group 1</li> <li>Plastic arm caps with overhang: 6527 Merle</li> <li>Frame finish: solid maple wood or paint</li> <li>Glides: standard adjustable, if selected: 6205 Black plastic or wallsaver, if selected: 6527 Merle plastic</li> <li>Bracket and cover, if high back selected: paint</li> <li>Flexing back</li> </ul>	<ol style="list-style-type: none"> <li>Style number</li> <li>Back color scheme (see below under Required Selections)</li> <li>Wallsaver or standard adjustable glides (see below under Required Selections)</li> <li>Fabric color number for seat and back</li> <li>Wood or paint color number for frame</li> <li>Paint color number for bracket and cover finish, if high back selected</li> <li>Options, if selected (see below)</li> </ol> <p>► See <i>Surface Materials</i>, page 473.</p>

Required Selections	U.S. Price	Required to Specify
<b>Back Color Scheme</b>	<ul style="list-style-type: none"> <li>Monolithic</li> <li>Contrasting inner back/outer back</li> <li>Contrasting upper back/lower back</li> </ul>	<p>Prices at right</p> <p>Prices at right</p> <p>Prices at right</p> <p>Specify with <i>monolithic back</i>. Specify with <i>contrasting inner/outer back</i>. Specify with <i>contrasting upper/lower back</i>.</p>
<b>Glides</b>	<ul style="list-style-type: none"> <li>Adjustable glides</li> <li>Wallsaver glides</li> </ul>	<p>No cost</p> <p>No cost</p> <p>Specify with <i>standard adjustable glides</i>. Specify with <i>wallsaver glides</i>.</p>

Options	U.S. Price	Required to Specify
<b>Surface Materials</b>	<p><b>Frame</b></p> <ul style="list-style-type: none"> <li>Solid maple wood</li> <li>Paint</li> </ul>	<p>No cost</p> <p>No cost</p> <p>Select wood color number. Select paint color number.</p>
	<p><b>Arm caps with no overhang</b></p> <ul style="list-style-type: none"> <li>Plastic</li> <li>Solid maple wood</li> <li>Solid surface price group A</li> <li>Solid surface price group B</li> <li>Solid surface price group C</li> <li>Solid surface price group D</li> </ul>	<p>No cost</p> <p>+\$ 32 per arm</p> <p>+\$283 per cap</p> <p>+\$298 per cap</p> <p>+\$312 per cap</p> <p>+\$327 per cap</p> <p>Specify with <i>no arm cap overhang</i> and select plastic color number. Specify with <i>no arm cap overhang</i> and select wood color number. Specify with <i>no arm cap overhang</i> and select solid surface color number. Specify with <i>no arm cap overhang</i> and select solid surface color number. Specify with <i>no arm cap overhang</i> and select solid surface color number. Specify with <i>no arm cap overhang</i> and select solid surface color number.</p>
	<p><b>Arm caps with overhang</b></p> <ul style="list-style-type: none"> <li>Plastic</li> <li>Solid maple wood</li> <li>Solid surface price group A</li> <li>Solid surface price group B</li> <li>Solid surface price group C</li> <li>Solid surface price group D</li> </ul>	<p>No cost</p> <p>+\$ 69 per arm</p> <p>+\$324 per cap</p> <p>+\$339 per cap</p> <p>+\$352 per cap</p> <p>+\$367 per cap</p> <p>Specify with <i>arm cap overhang</i> and select plastic color number. Specify with <i>arm cap overhang</i> and select wood color number. Specify with <i>arm cap overhang</i> and select solid surface color number. Specify with <i>arm cap overhang</i> and select solid surface color number. Specify with <i>arm cap overhang</i> and select solid surface color number. Specify with <i>arm cap overhang</i> and select solid surface color number.</p>
	<p><b>Moisture barrier on seat</b></p> <ul style="list-style-type: none"> <li>No moisture barrier</li> <li>Moisture barrier</li> </ul>	<p>No cost</p> <p>+\$125</p> <p>Specify with <i>no moisture barrier</i>. Specify with <i>moisture barrier</i>.</p>

► Options, continued on next page

► Options, continued from previous page

	Options	U.S. Price	Required to Specify
<b>Surface Materials, continued</b>	<b>High back upholstery for 21"W single seat</b>		
	• Fabric price group 1	No cost	Specify fabric color number.
	• Fabric price group 2	+\$ 8	Specify fabric color number.
	• Fabric price group 3	+\$ 46	Specify fabric color number.
	• Fabric price group 4	+\$ 102	Specify fabric color number.
	• Fabric price group 5	+\$ 168	Specify fabric color number.
	• Fabric price group 6	+\$ 252	Specify fabric color number.
	• Fabric price group 7	+\$ 348	Specify fabric color number.
	• Fabric price group 8	+\$ 476	Specify fabric color number.
	• Fabric price group 9	+\$ 624	Specify fabric color number.
• Fabric price group 10	+\$ 794	Specify fabric color number.	
• Customer's Own Material (COM)	+\$ 20	► See <i>Surface Materials Reference Manual</i> .	
	<b>High back upholstery for 32"W single seat</b>		
	• Fabric price group 1	No cost	Specify fabric color number.
	• Fabric price group 2	+\$ 12	Specify fabric color number.
	• Fabric price group 3	+\$ 36	Specify fabric color number.
	• Fabric price group 4	+\$ 78	Specify fabric color number.
	• Fabric price group 5	+\$ 144	Specify fabric color number.
	• Fabric price group 6	+\$ 242	Specify fabric color number.
	• Fabric price group 7	+\$ 378	Specify fabric color number.
	• Fabric price group 8	+\$ 550	Specify fabric color number.
	• Fabric price group 9	+\$ 760	Specify fabric color number.
• Fabric price group 10	+\$1006	Specify fabric color number.	
• Customer's Own Material (COM)	+\$ 24	► See <i>Surface Materials Reference Manual</i> .	
<b>High Back</b>	<b>High back for 21"W single seat</b>		
	• No high back	No cost	Specify <i>without high back</i> .
	• With high back	+\$ 130	Specify <i>with high back</i> .
	<b>High back for 32"W single seat</b>		
	• No high back	No cost	Specify <i>without high back</i> .
	• With high back	+\$ 204	Specify <i>with high back</i> .
<b>Related Products</b>	• Multiple seat		► Page 92
	• Circular table		► Page 100
	• Rounded rectangle table		► Page 100
	• Racetrack table		► Page 100

► Specificaiton Information, on next page

*Tip: If monolithic or contrasting upper/lower upholstery is selected, then the high back will be specifiable in only one upholstery. If inner/outer contrasting upholstery is selected, then the upholstery selected on the chair back will be applied to the inner and outer high back.*

*Tip: Thread color that is associated with the more dominant fabric color or surface area will be applied throughout the upholstery when contrasting fabrics.*

*Tip: High back is only available on 21"W and 32"W seats.*

Families of Seating

 **For Canadian Pricing**  
 Multiply U.S. Price by the Canadian price factor.  
 ► See page 1 for details.

Embold, continued

► Options, on previous page

Specification Information

Style Number	U.S. Base Price	Fabric Upcharges	Fabric Price Group 1	Fabric Price Group 2	Fabric Price Group 3	Fabric Price Group 4	Fabric Price Group 5	Fabric Price Group 6	Fabric Price Group 7	Fabric Price Group 8	Fabric Price Group 9	Fabric Price Group 10	COM
--------------	-----------------	------------------	----------------------	----------------------	----------------------	----------------------	----------------------	----------------------	----------------------	----------------------	----------------------	-----------------------	-----



Tip: If a separate price grade is desired for upper back, lower back, inner back, or outer back for the contrasting back color schemes, divide the fabric upcharge in half to get the price of one back location in that price grade.

Tip: When specifying upper back and lower back or inner back and outer back, you may specify a different fabric color number for each surface separately. For example, one upholstery grade on the upper back and a different upholstery grade on the lower back.

21"W Single Seat

HSBS21	\$1377	Seat	No cost	+\$ 28	+\$ 57	+\$ 81	+\$102	+\$119	+\$143	+\$191	+\$ 218	+\$ 246	+\$14
		Monolithic back, if selected	No cost	+\$ 55	+\$102	+\$145	+\$188	+\$210	+\$256	+\$340	+\$ 393	+\$ 445	+\$30
		Contrasting upper and lower back, if selected	+\$37	+\$ 70	+\$144	+\$201	+\$259	+\$296	+\$352	+\$474	+\$ 547	+\$ 616	+\$30
		Contrasting inner and outer back, if selected	+\$37	+\$ 70	+\$144	+\$201	+\$259	+\$296	+\$352	+\$474	+\$ 547	+\$ 616	+\$30

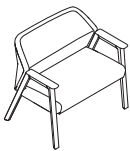

Tip: If a separate price grade is desired for upper back, lower back, inner back, or outer back for the contrasting back color schemes, divide the fabric upcharge in half to get the price of one back location in that price grade.

Tip: When specifying upper back and lower back or inner back and outer back, you may specify a different fabric color number for each surface separately. For example, one upholstery grade on the upper back and a different upholstery grade on the lower back.

24"W Midsize Single Seat

HSBS24	\$1427	Seat	No cost	+\$ 44	+\$ 75	+\$120	+\$172	+\$213	+\$265	+\$332	+\$ 419	+\$ 498	+\$14
		Monolithic back, if selected	No cost	+\$ 86	+\$134	+\$213	+\$305	+\$381	+\$477	+\$594	+\$ 746	+\$ 890	+\$30
		Contrasting upper and lower back, if selected	+\$57	+\$115	+\$190	+\$301	+\$429	+\$529	+\$663	+\$830	+\$1035	+\$1239	+\$30
		Contrasting inner and outer back, if selected	+\$57	+\$115	+\$190	+\$301	+\$429	+\$529	+\$663	+\$830	+\$1035	+\$1239	+\$30

► Specificaiton Information, continued on next page



For Canadian Pricing

Multiply U.S. Price by the Canadian price factor.

► See page 1 for details.



► Specification Information, continued from previous page

Specification Information													
Style Number	U.S. Base Price	Fabric Upcharges	Fabric Price Group 1	Fabric Price Group 2	Fabric Price Group 3	Fabric Price Group 4	Fabric Price Group 5	Fabric Price Group 6	Fabric Price Group 7	Fabric Price Group 8	Fabric Price Group 9	Fabric Price Group 10	COM



*Tip: If a separate price grade is desired for upper back, lower back, inner back, or outer back for the contrasting back color schemes, divide the fabric upcharge in half to get the price of one back location in that price grade.*

*Tip: When specifying upper back and lower back or inner back and outer back, you may specify a different fabric color number for each surface separately. For example, one upholstery grade on the upper back and a different upholstery grade on the lower back.*

**32"W Bariatric Single Seat**

HSBB32	\$1679	Seat	No cost	+\$ 51	+\$104	+\$147	+\$192	+\$218	+\$277	+\$356	+\$ 429	+\$ 505	+\$14
		Monolithic back, if selected	No cost	+\$ 94	+\$186	+\$269	+\$346	+\$388	+\$494	+\$640	+\$ 763	+\$ 894	+\$30
		Contrasting upper and lower back, if selected	+\$65	+\$134	+\$258	+\$372	+\$478	+\$543	+\$647	+\$867	+\$1001	+\$1122	+\$30
		Contrasting inner and outer back, if selected	+\$65	+\$134	+\$258	+\$372	+\$478	+\$543	+\$647	+\$867	+\$1001	+\$1122	+\$30

Families of Seating

 **For Canadian Pricing**  
 Multiply U.S. Price by the Canadian price factor.  
 ► See page 1 for details.

**Loveseat**

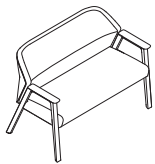

*Tip: Fabrics with a repeating pattern will not remain aligned around the corners of the chair or in the boxing (the outer perimeter).*

*Tip: Only one back color scheme can be chosen.*

► For more information on the different color schemes, see page 68

*Tip: Wood chair frame and wood arm caps must be specified in the same finish.*

*Tip: Overhang arm is suggested for clinical applications to aid in user ingress and egress.*

Standard Includes	Required to Specify
<p>► Need help? Product details, page 68</p> <ul style="list-style-type: none"> <li>• Seat and monolithic back: fabric price group 1</li> <li>• Plastic arm caps with overhang: 6527 Merle</li> <li>• Frame finish: solid maple wood or paint</li> <li>• Glides: standard adjustable, if selected: 6205 Black plastic or wallsaver, if selected: 6527 Merle plastic</li> <li>• Midarm, if selected: fabric price group 1</li> </ul>	<ol style="list-style-type: none"> <li>1 Style number</li> <li>2 Back color scheme (see below under Required Selections)</li> <li>3 Wallsaver or standard adjustable glides (see below under Required Selections)</li> <li>4 Fabric color number for seat and back</li> <li>5 Fabric color number for midarm, if selected</li> <li>6 Wood or paint color number for frame</li> <li>7 Options, if selected (see below)</li> </ol> <p>► See <i>Surface Materials</i>, page 473.</p>

Required Selections	U.S. Price	Required to Specify
<p><b>Back Color Scheme</b></p> <ul style="list-style-type: none"> <li>• Monolithic</li> <li>• Contrasting inner back/ outer back</li> <li>• Contrasting upper back/ lower back</li> </ul>	<p>Prices at right</p> <p>Prices at right</p> <p>Prices at right</p>	<p>Specify <i>with monolithic back</i>.</p> <p>Specify <i>with contrasting inner/outer back</i>.</p> <p>Specify <i>with contrasting upper/lower back</i>.</p>
<p><b>Glides</b></p> <ul style="list-style-type: none"> <li>• Adjustable glides</li> <li>• Wallsaver glides</li> </ul>	<p>No cost</p> <p>No cost</p>	<p>Specify <i>with standard adjustable glides</i>.</p> <p>Specify <i>with wallsaver glides</i>.</p>

Options	U.S. Price	Required to Specify
<p><b>Surface Materials</b></p> <p><b>Frame</b></p> <ul style="list-style-type: none"> <li>• Solid maple wood</li> <li>• Paint</li> </ul>	<p>No cost</p> <p>No cost</p>	<p>Select wood color number.</p> <p>Select paint color number.</p>
<p><b>Arm caps with no overhang</b></p> <ul style="list-style-type: none"> <li>• Plastic</li> <li>• Solid maple wood</li> <li>• Solid surface price group A</li> <li>• Solid surface price group B</li> <li>• Solid surface price group C</li> <li>• Solid surface price group D</li> </ul>	<p>No cost</p> <p>+\$ 32 per arm</p> <p>+\$283 per cap</p> <p>+\$298 per cap</p> <p>+\$312 per cap</p> <p>+\$327 per cap</p>	<p>Specify <i>with no arm cap overhang</i> and select plastic color number.</p> <p>Specify <i>with no arm cap overhang</i> and select wood color number.</p> <p>Specify <i>with no arm cap overhang</i> and select solid surface color number.</p> <p>Specify <i>with no arm cap overhang</i> and select solid surface color number.</p> <p>Specify <i>with no arm cap overhang</i> and select solid surface color number.</p> <p>Specify <i>with no arm cap overhang</i> and select solid surface color number.</p>
<p><b>Arm caps with overhang</b></p> <ul style="list-style-type: none"> <li>• Plastic</li> <li>• Solid maple wood</li> <li>• Solid surface price group A</li> <li>• Solid surface price group B</li> <li>• Solid surface price group C</li> <li>• Solid surface price group D</li> </ul>	<p>No cost</p> <p>+\$ 69 per arm</p> <p>+\$324 per cap</p> <p>+\$339 per cap</p> <p>+\$352 per cap</p> <p>+\$367 per cap</p>	<p>Specify <i>with arm cap overhang</i> and select plastic color number.</p> <p>Specify <i>with arm cap overhang</i> and select wood color number.</p> <p>Specify <i>with arm cap overhang</i> and select solid surface color number.</p> <p>Specify <i>with arm cap overhang</i> and select solid surface color number.</p> <p>Specify <i>with arm cap overhang</i> and select solid surface color number.</p> <p>Specify <i>with arm cap overhang</i> and select solid surface color number.</p>

► Options, continued on next page



**For Canadian Pricing**

Multiply U.S. Price by the Canadian price factor.

► See page 1 for details.

► Options, continued from previous page

	Options	U.S. Price	Required to Specify
<b>Surface Materials, continued</b>	<b>Moisture barrier on seat</b>		
	• No moisture barrier	No cost	Specify with no moisture barrier.
	• Moisture barrier	+\$252	Specify with moisture barrier.
	<b>Midarm position</b>		
	• No midarm	No cost	Specify with no midarm.
	• Midarm center	+\$320	Specify with midarm center.
	<b>Midleg position</b>		
	• No midleg	No cost	Specify with no midleg.
	• Midleg center	+\$174	Specify with midleg center.
<b>Related Products</b>	• Multiple seat		► Page 92
	• Circular table		► Page 100
	• Rounded rectangle table		► Page 100
	• Racetrack table		► Page 100

Tip: Midarms will include support plates when needed for configurations.

Tip: If monolithic or contrasting upper/lower upholstery is selected, then the high back will be specifiable in only one upholstery. If inner/outer contrasting upholstery is selected, then the upholstery will match the inner/outer contrasting upholstery selected on the chair back will be applied to the inner and outer high back.

Tip: Thread color that is associated with the more dominant fabric color or surface area will be applied throughout the upholstery when contrasting fabrics.

Families of Seating

Specification Information													
Style Number	U.S. Base Price	Fabric Upcharges	Fabric Price Group 1	Fabric Price Group 2	Fabric Price Group 3	Fabric Price Group 4	Fabric Price Group 5	Fabric Price Group 6	Fabric Price Group 7	Fabric Price Group 8	Fabric Price Group 9	Fabric Price Group 10	COM

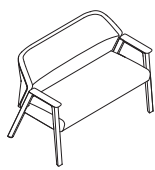

Tip: If a separate price grade is desired for upper back, lower back, inner back, or outer back for the contrasting back color schemes, divide the fabric upcharge in half to get the price of one back location in that price grade.

Tip: When specifying upper back and lower back or inner back and outer back, you may specify a different fabric color number for each surface separately. For example, one upholstery grade on the upper back and a different upholstery grade on the lower back.

**43"W Loveseat**

HSBL43	\$2270	Seat	No cost	+\$ 58	+\$117	+\$165	+\$210	+\$240	+\$288	+\$383	+\$ 443	+\$ 509	+\$31
		Monolithic back, if selected	No cost	+\$100	+\$202	+\$288	+\$377	+\$426	+\$505	+\$681	+\$ 785	+\$ 900	+\$55
		Contrasting upper and lower back, if selected	+\$68	+\$140	+\$284	+\$399	+\$523	+\$589	+\$710	+\$950	+\$1097	+\$1248	+\$55
		Contrasting inner and outer back, if selected	+\$68	+\$140	+\$284	+\$399	+\$523	+\$589	+\$710	+\$950	+\$1097	+\$1248	+\$55

 **For Canadian Pricing**  
 Multiply U.S. Price by the Canadian price factor.  
 ► See page 1 for details.

**Multiple Seat**

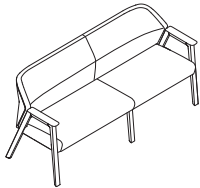

*Tip: Fabrics with a repeating pattern will not remain aligned around the corners of the chair or in the boxing (the outer perimeter).*

*Tip: Only one back color scheme can be chosen.*

► For more information on the different color schemes, see page 68

*Tip: Back and seat have vertical center seam on 66"W and 88"W seat units.*

*Tip: Wood chair frame and wood arm caps must be specified in the same finish.*

Standard Includes	Required to Specify
<p>► Need help? Product details, page 68</p> <ul style="list-style-type: none"> <li>• Seat and monolithic back: fabric price group 1</li> <li>• Plastic arm caps with overhang: 6527 Merle</li> <li>• Frame finish: solid maple wood or paint</li> <li>• Glides: standard adjustable, if selected: 6205 Black plastic or wallsaver, if selected: 6527 Merle plastic</li> <li>• Midarm, if selected: fabric price group 1</li> </ul>	<ol style="list-style-type: none"> <li>1 Style number</li> <li>2 Back color scheme (see below under Required Selections)</li> <li>3 Wallsaver or standard adjustable glides (see below under Required Selections)</li> <li>4 Bariatric seat location (see below under Required Selections)</li> <li>5 Fabric color number for seat and back</li> <li>6 Fabric color number for midarm, if selected</li> <li>7 Wood or paint color number for frame</li> <li>7 Options, if selected (see below)</li> </ol> <p>► See <i>Surface Materials</i>, page 473.</p>

Required Selections	U.S. Price	Required to Specify	
<p><b>Back Color Scheme</b></p> <ul style="list-style-type: none"> <li>• Monolithic</li> <li>• Contrasting inner back/outer back</li> <li>• Contrasting upper back/lower back</li> </ul>	<p>Prices at right</p> <p>Prices at right</p> <p>Prices at right</p>	<p>Specify <i>with monolithic back</i>.</p> <p>Specify <i>with contrasting inner/outer back</i>.</p> <p>Specify <i>with contrasting upper/lower back</i>.</p>	
<p><b>Glides</b></p> <ul style="list-style-type: none"> <li>• Adjustable glides</li> <li>• Wallsaver glides</li> </ul>	<p>No cost</p> <p>No cost</p>	<p>Specify <i>with standard adjustable glides</i>.</p> <p>Specify <i>with wallsaver glides</i>.</p>	
<p><b>Bariatric Seat Location</b></p>	<p><b>Bariatric multiple seat combination</b></p> <ul style="list-style-type: none"> <li>• Left side facing and right side facing</li> <li>• Left side facing and center</li> <li>• Right side facing and center</li> </ul>	<p>No cost</p> <p>+\$ 46</p> <p>+\$ 46</p>	<p>Specify <i>with left side facing and right side facing</i>.</p> <p>Specify <i>with left side facing and center</i>.</p> <p>Specify <i>with right side facing and center</i>.</p>

Options	U.S. Price	Required to Specify
<p><b>Surface Materials</b></p> <p><b>Frame</b></p> <ul style="list-style-type: none"> <li>• Solid maple wood</li> <li>• Paint</li> </ul>	<p>No cost</p> <p>No cost</p>	<p>Select wood color number.</p> <p>Select paint color number.</p>
<p><b>Arm caps with no overhang</b></p> <ul style="list-style-type: none"> <li>• Plastic</li> <li>• Solid maple wood</li> <li>• Solid surface price group A</li> <li>• Solid surface price group B</li> <li>• Solid surface price group C</li> <li>• Solid surface price group D</li> </ul>	<p>No cost</p> <p>+\$ 32 per arm</p> <p>+\$283 per cap</p> <p>+\$298 per cap</p> <p>+\$312 per cap</p> <p>+\$327 per cap</p>	<p>Specify <i>with no arm cap overhang</i> and select plastic color number.</p> <p>Specify <i>with no arm cap overhang</i> and select wood color number.</p> <p>Specify <i>with no arm cap overhang</i> and select solid surface color number.</p> <p>Specify <i>with no arm cap overhang</i> and select solid surface color number.</p> <p>Specify <i>with no arm cap overhang</i> and select solid surface color number.</p> <p>Specify <i>with no arm cap overhang</i> and select solid surface color number.</p>

► Options, continued on next page



**For Canadian Pricing**

Multiply U.S. Price by the Canadian price factor.

► See page 1 for details.

► Options, continued from previous page

	Options	U.S. Price	Required to Specify
<b>Surface Materials, continued</b>	<b>Arm caps with overhang</b>		
	• Plastic	No cost	Specify with <i>arm cap overhang</i> and select plastic color number.
	• Solid maple wood	+\$ 69 per arm	Specify with <i>arm cap overhang</i> and select wood color number.
	• Solid surface price group A	+\$324 per cap	Specify with <i>arm cap overhang</i> and select solid surface color number.
	• Solid surface price group B	+\$339 per cap	Specify with <i>arm cap overhang</i> and select solid surface color number.
	• Solid surface price group C	+\$352 per cap	Specify with <i>arm cap overhang</i> and select solid surface color number.
	• Solid surface price group D	+\$367 per cap	Specify with <i>arm cap overhang</i> and select solid surface color number.
	<b>Moisture barrier on seat</b>		
	• No moisture barrier	No cost	Specify with <i>no moisture barrier</i> .
	• Moisture barrier	+\$377	Specify with <i>moisture barrier</i> .
<b>Midarm Position</b>	<b>Midarm position for 66"W multiple seat</b>		
	• No midarm	No cost	Specify with <i>no midarm</i> .
	• Midarm center	+\$274	Specify with <i>midarm center</i> .
	• Midarm left side facing	+\$320	Specify with <i>midarm left side facing</i> .
	• Midarm right side facing	+\$320	Specify with <i>midarm right side facing</i> .
	• Two midarms	+\$640	Specify with <i>two midarms</i> .
	<b>Midarm position for 88"W multiple seat</b>		
	• No midarm	No cost	Specify with <i>no midarm</i> .
	• Midarm center	+\$320	Specify with <i>midarm center</i> .
	• Midarm left side facing and right side facing	+\$640	Specify with <i>midarm left side facing and right side facing</i> .
• Midarm center and left side facing	+\$640	Specify with <i>midarm center and left side facing</i> .	
• Midarm center and right side facing	+\$640	Specify with <i>midarm center and right side facing</i> .	
• Three midarms	+\$960	Specify with <i>three midarms</i> .	
<b>Midleg Position</b>	<b>Midleg position for 66"W multiple seat</b>		
	• Midleg left side facing	+\$174	Specify with <i>midleg left side facing</i> .
	• Midleg right side facing	+\$174	Specify with <i>midleg right side facing</i> .
	• Midleg center	+\$174	Specify with <i>midleg center</i> .
	• Two midlegs	+\$348	Specify with <i>two midlegs</i> .
	<b>Midleg position for 88"W multiple seat</b>		
	• Midleg center	+\$174	Specify with <i>midleg center</i> .
	• Midleg left side facing and right side facing	+\$348	Specify with <i>midleg left side facing and right side facing</i> .
	• Midleg center and left side facing	+\$348	Specify with <i>midleg center and left side facing</i> .
	• Midleg center and right side facing	+\$348	Specify with <i>midleg center and right side facing</i> .
• Three midlegs	+\$522	Specify with <i>three midlegs</i> .	
<b>Related Products</b>	• Circular table		► Page 100
	• Rounded rectangle table		► Page 100
	• Racetrack table		► Page 100

► Specification Information, on next page

Tip: Overhang arm is suggested for clinical applications to aid in user ingress and egress.

Tip: Midarms will include support plates when needed for configurations. All midarms require support plates except midarm center on 66"W multiple seating unit and the 88"W multiple seat bariatric combination unit with the left-side facing and right-side facing seat location.

Tip: If monolithic or contrasting upper/lower upholstery is selected, then the high back will be specifiable in only one upholstery. If inner/outer contrasting upholstery is selected, then the upholstery will match the inner/outer contrasting upholstery selected on the chair back will be applied to the inner and outer high back.

Tip: Thread color that is associated with the more dominant fabric color or surface area will be applied throughout the upholstery when contrasting fabrics.

Tip: When midarm is selected, only left-side facing and right-side facing midlegs are available.

Tip: Two midlegs are required for a 88" wide unit without any midarms.

 **For Canadian Pricing**  
Multiply U.S. Price by the Canadian price factor.  
► See page 1 for details.

Families of Seating

Embold, continued

► Options, on previous page

Specification Information

Style Number	U.S. Base Price	Fabric Upcharges	Fabric Price Group 1	Fabric Price Group 2	Fabric Price Group 3	Fabric Price Group 4	Fabric Price Group 5	Fabric Price Group 6	Fabric Price Group 7	Fabric Price Group 8	Fabric Price Group 9	Fabric Price Group 10	COM
--------------	-----------------	------------------	----------------------	----------------------	----------------------	----------------------	----------------------	----------------------	----------------------	----------------------	----------------------	-----------------------	-----

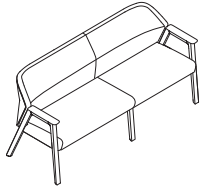

Tip: If a separate price grade is desired for upper back, lower back, inner back, or outer back for the contrasting back color schemes, divide the fabric upcharge in half to get the price of one back location in that price grade.

Tip: When specifying upper back and lower back or inner back and outer back, you may specify a different fabric color number for each surface separately. For example, one upholstery grade on the upper back and a different upholstery grade on the lower back.

66"W Multiple Seat

HSBM66	\$3696	Seat	No cost	+\$ 88	+\$169	+\$231	+\$ 288	+\$ 307	+\$ 347	+\$ 447	+\$ 487	+\$ 509	+\$31
		Monolithic back, if selected	No cost	+\$157	+\$299	+\$414	+\$ 517	+\$ 547	+\$ 617	+\$ 797	+\$ 867	+\$ 903	+\$55
		Contrasting upper and lower back, if selected	+\$106	+\$213	+\$420	+\$577	+\$ 716	+\$ 760	+\$ 857	+\$1109	+\$1206	+\$1253	+\$55
		Contrasting inner and outer back, if selected	+\$106	+\$213	+\$420	+\$577	+\$ 716	+\$ 760	+\$ 857	+\$1109	+\$1206	+\$1253	+\$55
		Midarm (per arm), if selected	No cost	+\$ 6	+\$ 25	+\$ 54	+\$ 106	+\$ 179	+\$ 276	+\$ 407	+\$ 555	+\$ 739	+\$21

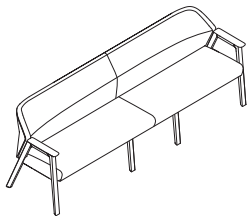

Tip: If a separate price grade is desired for upper back, lower back, inner back, or outer back for the contrasting back color schemes, divide the fabric upcharge in half to get the price of one back location in that price grade.

Tip: When specifying upper back and lower back or inner back and outer back, you may specify a different fabric color number for each surface separately. For example, one upholstery grade on the upper back and a different upholstery grade on the lower back.

Tip: Two midlegs are included in the base price of the 88"W multiple seat.

88"W Multiple Seat

HSBM88	\$4525	Seat	No cost	+\$119	+\$231	+\$323	+\$ 402	+\$ 437	+\$ 505	+\$ 656	+\$ 728	+\$ 778	+\$31
		Monolithic back, if selected	No cost	+\$206	+\$408	+\$570	+\$ 719	+\$ 777	+\$ 892	+\$1170	+\$1296	+\$1384	+\$55
		Contrasting upper and lower back, if selected	+\$145	+\$290	+\$574	+\$789	+\$1000	+\$1081	+\$1242	+\$1626	+\$1800	+\$1922	+\$55
		Contrasting inner and outer back, if selected	+\$145	+\$290	+\$574	+\$789	+\$1000	+\$1081	+\$1242	+\$1626	+\$1800	+\$1922	+\$55
		Midarm (per arm), if selected	No cost	+\$ 6	+\$ 25	+\$ 54	+\$ 106	+\$ 179	+\$ 276	+\$ 407	+\$ 555	+\$ 739	+\$21

► Specification Information, on next page



For Canadian Pricing

Multiply U.S. Price by the Canadian price factor.

► See page 1 for details.

► Specification Information, continued from previous page

Specification Information													
Style Number	U.S. Base Price	Fabric Upcharges	Fabric Price Group 1	Fabric Price Group 2	Fabric Price Group 3	Fabric Price Group 4	Fabric Price Group 5	Fabric Price Group 6	Fabric Price Group 7	Fabric Price Group 8	Fabric Price Group 9	Fabric Price Group 10	COM

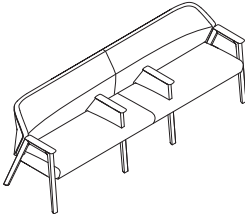

*Tip: If a separate price grade is desired for upper back, lower back, inner back, or outer back for the contrasting back color schemes, divide the fabric upcharge in half to get the price of one back location in that price grade.*

*Tip: When specifying upper back and lower back or inner back and outer back, you may specify a different fabric color number for each surface separately. For example, one upholstery grade on the upper back and a different upholstery grade on the lower back.*

*Tip: Two midlegs and two midarms are included in the base price of the 88"W multiple seat bariatric combination.*

**88"W Multiple Seat Bariatric Combination**

HSBM88C	\$4525	Seat	No cost	+\$119	+\$231	+\$323	+\$ 402	+\$ 437	+\$ 505	+\$ 656	+\$ 728	+\$ 778	+\$31
		Monolithic back, if selected	No cost	+\$206	+\$408	+\$570	+\$ 719	+\$ 777	+\$ 892	+\$1170	+\$1296	+\$1384	+\$55
		Contrasting upper and lower back, if selected	+\$145	+\$290	+\$574	+\$789	+\$1000	+\$1081	+\$1242	+\$1626	+\$1800	+\$1922	+\$55
		Contrasting inner and outer back, if selected	+\$145	+\$290	+\$574	+\$789	+\$1000	+\$1081	+\$1242	+\$1626	+\$1800	+\$1922	+\$55
		Midarm (per arm)	No cost	+\$ 6	+\$ 25	+\$ 54	+\$ 106	+\$ 179	+\$ 276	+\$ 407	+\$ 555	+\$ 739	+\$21

Families of Seating

 **For Canadian Pricing**  
 Multiply U.S. Price by the Canadian price factor.  
 ► See page 1 for details.

Easy Access



Tip: Fabrics with a repeating pattern will not remain aligned around the corners of the chair or in the boxing (the outer perimeter).

Tip: Only one back color scheme can be chosen.  
 ▶ For more information on the different color schemes, see page 68

Standard Includes	Required to Specify
-------------------	---------------------

<p>▶ Need help? Product details, page 68</p> <ul style="list-style-type: none"> <li>• Seat and monolithic back: fabric price group 1</li> <li>• Plastic arm caps with overhang: 6527 Merle</li> <li>• Frame finish: solid maple wood or paint</li> <li>• Glides: standard adjustable, if selected: 6205 Black plastic or wallsaver, if selected: 6527 Merle plastic</li> <li>• Bracket and cover, if high back selected: paint</li> <li>• Flexing back</li> <li>• Footrest</li> </ul>	<ol style="list-style-type: none"> <li>1 Style number</li> <li>2 Back color scheme (see below under Required Selections)</li> <li>3 Wallsaver or standard adjustable glides (see below under Required Selections)</li> <li>4 Fabric color number for seat and back</li> <li>5 Wood or paint color number for frame</li> <li>6 Paint color number for bracket and cover finish, if high back selected.</li> <li>7 Options, if selected (see below)</li> </ol> <p>▶ See <i>Surface Materials</i>, page 473.</p>
---	---

Required Selections	U.S. Price	Required to Specify
---------------------	------------	---------------------

<p><b>Back Color Scheme</b></p> <ul style="list-style-type: none"> <li>• Monolithic</li> <li>• Contrasting inner back/ outer back</li> <li>• Contrasting upper back/ lower back</li> </ul>	<p>Prices at right</p> <p>Prices at right</p> <p>Prices at right</p>	<p>Specify with <i>monolithic back</i>.</p> <p>Specify with <i>contrasting inner/outer back</i>.</p> <p>Specify with <i>contrasting upper/lower back</i>.</p>
<p><b>Glides</b></p> <ul style="list-style-type: none"> <li>• Adjustable glides</li> <li>• Wallsaver glides</li> </ul>	<p>No cost</p> <p>No cost</p>	<p>Specify with <i>standard adjustable glides</i>.</p> <p>Specify with <i>wallsaver glides</i>.</p>

Options	U.S. Price	Required to Specify
---------	------------	---------------------

<p><b>Surface Materials</b></p> <p><b>Frame</b></p> <ul style="list-style-type: none"> <li>• Solid maple wood</li> <li>• Paint</li> </ul>	<p>No cost</p> <p>No cost</p>	<p>Select wood color number.</p> <p>Select paint color number.</p>
<b>Arm caps with no overhang</b>		
<ul style="list-style-type: none"> <li>• Plastic</li> <li>• Solid maple wood</li> <li>• Solid surface price group A</li> <li>• Solid surface price group B</li> <li>• Solid surface price group C</li> <li>• Solid surface price group D</li> </ul>	<p>No cost</p> <p>+\$ 32 per arm</p> <p>+\$283 per cap</p> <p>+\$298 per cap</p> <p>+\$312 per cap</p> <p>+\$327 per cap</p>	<p>Specify with <i>no arm cap overhang</i> and select plastic color number.</p> <p>Specify with <i>no arm cap overhang</i> and select wood color number.</p> <p>Specify with <i>no arm cap overhang</i> and select solid surface color number.</p> <p>Specify with <i>no arm cap overhang</i> and select solid surface color number.</p> <p>Specify with <i>no arm cap overhang</i> and select solid surface color number.</p> <p>Specify with <i>no arm cap overhang</i> and select solid surface color number.</p>
<b>Arm caps with overhang</b>		
<ul style="list-style-type: none"> <li>• Plastic</li> <li>• Solid maple wood</li> <li>• Solid surface price group A</li> <li>• Solid surface price group B</li> <li>• Solid surface price group C</li> <li>• Solid surface price group D</li> </ul>	<p>No cost</p> <p>+\$ 69 per arm</p> <p>+\$324 per cap</p> <p>+\$339 per cap</p> <p>+\$352 per cap</p> <p>+\$367 per cap</p>	<p>Specify with <i>arm cap overhang</i> and select plastic color number.</p> <p>Specify with <i>arm cap overhang</i> and select wood color number.</p> <p>Specify with <i>arm cap overhang</i> and select solid surface color number.</p> <p>Specify with <i>arm cap overhang</i> and select solid surface color number.</p> <p>Specify with <i>arm cap overhang</i> and select solid surface color number.</p> <p>Specify with <i>arm cap overhang</i> and select solid surface color number.</p>
<b>Moisture barrier on seat</b>		
<ul style="list-style-type: none"> <li>• No moisture barrier</li> <li>• Moisture barrier</li> </ul>	<p>No cost</p> <p>+\$125</p>	<p>Specify with <i>no moisture barrier</i>.</p> <p>Specify with <i>moisture barrier</i>.</p>

Tip: Wood chair frame and wood arm caps must be specified in the same finish.

Tip: Overhang arm is suggested for clinical applications to aid in user ingress and egress.

▶ Options, continued on next page



**For Canadian Pricing**  
 Multiply U.S. Price by the Canadian price factor.  
 ▶ See page 1 for details.



► Options, continued from previous page

*Tip: If monolithic or contrasting upper/lower upholstery is selected, then the high back will be specifiable in only one upholstery. If inner/outer contrasting upholstery is selected, then the upholstery will match the inner/outer contrasting upholstery selected on the chair back will be applied to the inner and outer high back.*

*Tip: Thread color that is associated with the more dominant fabric color or surface area will be applied throughout the upholstery when contrasting fabrics.*

Options	U.S. Price	Required to Specify
<b>Surface Materials, continued</b>	<b>High back upholstery for 21"W easy access</b>	
• Fabric price group 1	No cost	Specify fabric color number.
• Fabric price group 2	+\$ 8	Specify fabric color number.
• Fabric price group 3	+\$ 46	Specify fabric color number.
• Fabric price group 4	+\$ 102	Specify fabric color number.
• Fabric price group 5	+\$ 168	Specify fabric color number.
• Fabric price group 6	+\$ 252	Specify fabric color number.
• Fabric price group 7	+\$ 348	Specify fabric color number.
• Fabric price group 8	+\$ 476	Specify fabric color number.
• Fabric price group 9	+\$ 624	Specify fabric color number.
• Fabric price group 10	+\$ 794	Specify fabric color number.
• Customer's Own Material (COM)	+\$ 20	► See <i>Surface Materials Reference Manual</i> .
	<b>High back upholstery for 32"W easy access</b>	
• Fabric price group 1	No cost	Specify fabric color number.
• Fabric price group 2	+\$ 12	Specify fabric color number.
• Fabric price group 3	+\$ 36	Specify fabric color number.
• Fabric price group 4	+\$ 78	Specify fabric color number.
• Fabric price group 5	+\$ 144	Specify fabric color number.
• Fabric price group 6	+\$ 242	Specify fabric color number.
• Fabric price group 7	+\$ 378	Specify fabric color number.
• Fabric price group 8	+\$ 550	Specify fabric color number.
• Fabric price group 9	+\$ 760	Specify fabric color number.
• Fabric price group 10	+\$1006	Specify fabric color number.
• Customer's Own Material (COM)	+\$ 24	► See <i>Surface Materials Reference Manual</i> .
<b>High Back</b>	<b>High back for 21"W easy access</b>	
• No high back	No cost	Specify <i>without high back</i> .
• With high back	+\$ 130	Specify <i>with high back</i> .
	<b>High back for 32"W easy access</b>	
• No high back	No cost	Specify <i>without high back</i> .
• With high back	+\$ 204	Specify <i>with high back</i> .
<b>Related Products</b>	• Multiple seat • Circular table • Rounded rectangle table • Racetrack table	► Page 92 ► Page 100 ► Page 100 ► Page 100

► Specification Information, on next page

 **For Canadian Pricing**  
Multiply U.S. Price by the Canadian price factor.  
► See page 1 for details.

Embold, continued

► Options, on previous page

Specification Information

Style Number	U.S. Base Price	Fabric Upcharges	Fabric Price Group 1	Fabric Price Group 2	Fabric Price Group 3	Fabric Price Group 4	Fabric Price Group 5	Fabric Price Group 6	Fabric Price Group 7	Fabric Price Group 8	Fabric Price Group 9	Fabric Price Group 10	COM
--------------	-----------------	------------------	----------------------	----------------------	----------------------	----------------------	----------------------	----------------------	----------------------	----------------------	----------------------	-----------------------	-----



Tip: If a separate price grade is desired for upper back, lower back, inner back, or outer back for the contrasting back color schemes, divide the fabric upcharge in half to get the price of one back location in that price grade.

Tip: When specifying upper back and lower back or inner back and outer back, you may specify a different fabric color number for each surface separately. For example, one upholstery grade on the upper back and a different upholstery grade on the lower back.

21"W Easy Access

Style Number	U.S. Base Price	Option	Fabric Price Group 1	Fabric Price Group 2	Fabric Price Group 3	Fabric Price Group 4	Fabric Price Group 5	Fabric Price Group 6	Fabric Price Group 7	Fabric Price Group 8	Fabric Price Group 9	Fabric Price Group 10	COM
HSBE21	\$1788	Seat	No cost	+\$ 28	+\$ 57	+\$ 81	+\$102	+\$119	+\$143	+\$191	+\$ 218	+\$ 246	+\$14
		Monolithic back, if selected	No cost	+\$ 55	+\$102	+\$145	+\$188	+\$210	+\$256	+\$340	+\$ 393	+\$ 445	+\$30
		Contrasting upper and lower back, if selected	+\$37	+\$ 70	+\$144	+\$201	+\$259	+\$296	+\$352	+\$474	+\$ 547	+\$ 616	+\$30
		Contrasting inner and outer back, if selected	+\$37	+\$ 70	+\$144	+\$201	+\$259	+\$296	+\$352	+\$474	+\$ 547	+\$ 616	+\$30

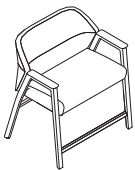

Tip: If a separate price grade is desired for upper back, lower back, inner back, or outer back for the contrasting back color schemes, divide the fabric upcharge in half to get the price of one back location in that price grade.

Tip: When specifying upper back and lower back or inner back and outer back, you may specify a different fabric color number for each surface separately. For example, one upholstery grade on the upper back and a different upholstery grade on the lower back.

32"W Easy Access

Style Number	U.S. Base Price	Option	Fabric Price Group 1	Fabric Price Group 2	Fabric Price Group 3	Fabric Price Group 4	Fabric Price Group 5	Fabric Price Group 6	Fabric Price Group 7	Fabric Price Group 8	Fabric Price Group 9	Fabric Price Group 10	COM
HSBE32	\$1952	Seat	No cost	+\$ 63	+\$122	+\$174	+\$226	+\$255	+\$325	+\$416	+\$ 499	+\$ 585	+\$14
		Monolithic back, if selected	No cost	+\$106	+\$215	+\$305	+\$397	+\$454	+\$576	+\$744	+\$ 888	+\$1047	+\$30
		Contrasting upper and lower back, if selected	+\$65	+\$134	+\$258	+\$372	+\$478	+\$543	+\$647	+\$867	+\$1001	+\$1122	+\$30
		Contrasting inner and outer back, if selected	+\$65	+\$134	+\$258	+\$372	+\$478	+\$543	+\$647	+\$867	+\$1001	+\$1122	+\$30



**For Canadian Pricing**

Multiply U.S. Price by the Canadian price factor.

► See page 1 for details.



# Embold Tables



Tip: Edge finish only applies to the High-Pressure Laminate worksurfaces.

**For laminate group 2 and 3 pricing, please refer to the electronic catalog or SmartTools.**

Tip: Solid maple, solid oak, and solid walnut wood tops are only available for the circular table. Solid wood tops can only be specified with metal or matching species of wood legs.

Tip: Solid maple, solid oak, and solid walnut wood tops are solid cuts of wood, not veneered pieces. Natural variation occurs with wood products.

Tip: Solid wood circular tables have a low-sheen clear coat applied to them and will have intentional and natural variations that include, but are not limited to: character marks, grain pattern, color, and natural color aging.

Tip: Solid wood table tops should be specified for non-clinical areas only.



**For Canadian Pricing**  
Multiply U.S. Price by the Canadian price factor.  
▶ See page 1 for details.

Standard Includes	Required to Specify
<ul style="list-style-type: none"> <li>▶ Need help? Product details, page 71</li> <li>• Frame: paint price groups 1 and 2</li> <li>• Table top: High-Pressure Laminate price group 1 with 3 mm plastic edge</li> <li>• Legs: solid maple wood or paint price groups 1 and 2</li> </ul>	<ol style="list-style-type: none"> <li>1 Style number</li> <li>2 Paint color number for frame</li> <li>3 Laminate color number for top</li> <li>4 Plastic color number for edge</li> <li>5 Wood or paint color number for legs</li> <li>6 Options, if selected (see below)</li> </ol> <p>▶ See <i>Surface Materials</i>, page 473.</p>

Surface Materials	Options	U.S. Price	Required to Specify
	<b>Frame</b>		
	<ul style="list-style-type: none"> <li>• Paint price group 3</li> <li>-Circular table</li> <li>-Rectangle table</li> <li>-Racetrack table</li> </ul>	<ul style="list-style-type: none"> <li>+\$ 32</li> <li>+\$ 41</li> <li>+\$ 55</li> </ul>	<ul style="list-style-type: none"> <li>Specify paint color number.</li> <li>Specify paint color number.</li> <li>Specify paint color number.</li> </ul>
	<b>Top surface for circular table</b>		
	<ul style="list-style-type: none"> <li>• High-Pressure Laminate price group 1</li> <li>• High-Pressure Laminate price group 2</li> <li>• High-Pressure Laminate price group 3</li> <li>• Open Line laminate</li> <li>• Solid maple wood</li> <li>• Solid oak wood</li> <li>• Solid walnut wood</li> <li>• Solid surface price group A</li> <li>• Solid surface price group B</li> <li>• Solid surface price group C</li> <li>• Solid surface price group D</li> </ul>	<ul style="list-style-type: none"> <li>No cost</li> <li>See information at left</li> <li>See information at left</li> <li>+\$ 102 plus cost of laminate</li> <li>+\$ 298</li> <li>+\$ 462</li> <li>+\$ 726</li> <li>+\$ 931</li> <li>+\$1031</li> <li>+\$1148</li> <li>+\$1796</li> </ul>	<ul style="list-style-type: none"> <li>Specify with <i>laminate top surface</i> and select laminate color number.</li> <li>Specify with <i>laminate top surface</i> and select laminate color number.</li> <li>Specify with <i>laminate top surface</i> and select laminate color number.</li> <li>▶ See <i>Surface Materials Reference Manual</i>.</li> <li>Specify with <i>maple top surface</i> and select 3P51 OP Planked Maple.</li> <li>Specify with <i>oak top surface</i> and select 3P61 OP Planked Oak.</li> <li>Specify with <i>walnut top surface</i> and select 3P71 OP Planked Walnut.</li> <li>Specify with <i>solid surface top surface</i> and select solid surface color number.</li> <li>Specify with <i>solid surface top surface</i> and select solid surface color number.</li> <li>Specify with <i>solid surface top surface</i> and select solid surface color number.</li> <li>Specify with <i>solid surface top surface</i> and select solid surface color number.</li> </ul>
	<b>Top surface for rectangle table</b>		
	<ul style="list-style-type: none"> <li>• High-Pressure Laminate price group 1</li> <li>• High-Pressure Laminate price group 2</li> <li>• High-Pressure Laminate price group 3</li> <li>• Open Line laminate</li> <li>• Solid surface price group A</li> <li>• Solid surface price group B</li> <li>• Solid surface price group C</li> <li>• Solid surface price group D</li> </ul>	<ul style="list-style-type: none"> <li>No cost</li> <li>See information at left</li> <li>See information at left</li> <li>+\$ 102 plus cost of laminate</li> <li>+\$1081</li> <li>+\$1201</li> <li>+\$1344</li> <li>+\$2124</li> </ul>	<ul style="list-style-type: none"> <li>Specify with <i>laminate top surface</i> and select laminate color number.</li> <li>Specify with <i>laminate top surface</i> and select laminate color number.</li> <li>Specify with <i>laminate top surface</i> and select laminate color number.</li> <li>▶ See <i>Surface Materials Reference Manual</i>.</li> <li>Specify with <i>solid surface top surface</i> and select solid surface color number.</li> <li>Specify with <i>solid surface top surface</i> and select solid surface color number.</li> <li>Specify with <i>solid surface top surface</i> and select solid surface color number.</li> <li>Specify with <i>solid surface top surface</i> and select solid surface color number.</li> </ul>
	<b>Top surface for racetrack table</b>		
	<ul style="list-style-type: none"> <li>• High-Pressure Laminate price group 1</li> <li>• High-Pressure Laminate price group 2</li> <li>• High-Pressure Laminate price group 3</li> <li>• Open Line laminate</li> </ul>	<ul style="list-style-type: none"> <li>No cost</li> <li>See information at left</li> <li>See information at left</li> <li>+\$ 102 plus cost of laminate</li> </ul>	<ul style="list-style-type: none"> <li>Specify with <i>laminate top surface</i> and select laminate color number.</li> <li>Specify with <i>laminate top surface</i> and select laminate color number.</li> <li>Specify with <i>laminate top surface</i> and select laminate color number.</li> <li>▶ See <i>Surface Materials Reference Manual</i>.</li> </ul>

▶ Options, continued on next page

► Options, continued from previous page

Options	U.S. Price	Required to Specify	
<b>Surface Materials, continued</b>	<b>Top surface for racetrack table, cont.</b>		
• Solid surface price group A	+\$1289	Specify with <i>solid surface top surface</i> and select solid surface color number. Specify with <i>solid surface top surface</i> and select solid surface color number. Specify with <i>solid surface top surface</i> and select solid surface color number. Specify with <i>solid surface top surface</i> and select solid surface color number.	
• Solid surface price group B	+\$1430		
• Solid surface price group C	+\$1596		
• Solid surface price group D	+\$2518		
	<b>Legs</b>		
	• Paint	No cost	Specify paint color number.
	• Solid maple wood	No cost	Specify wood color number.
	• Solid oak wood	+\$ 31	Specify with <i>3P61 OP Planked Oak</i> .
	• Solid walnut wood	+\$ 69	Specify with <i>3P71 OP Planked Walnut</i> .
<b>Power</b>	• No power	No cost	Specify with <i>no power</i> .
	• Power	+\$ 124	Specify with <i>power</i> .
	• Dual USB	+\$ 218	Specify with <i>dual USB</i> .
<b>Power Cord</b> (If power selected)	• Standard cord	No cost	Specify with <i>standard cord</i> .
	• Braided cord	+\$ 49	Specify with <i>braided cord</i> .
<b>Cutout</b>	• No cutout	No cost	Specify with <i>no cutout</i> .
	• With cutout	+\$ 23	Specify with <i>cutout</i> .
<b>Related Products</b>	• Single seat		► Page 86
	• Multiple seat		► Page 92

Tip: Steelcase recommends to check with all local and facility authorities prior to specification and order, to confirm acceptance of proposed product and applications.

Tip: Power location is centered on the circular table. Power location is located at the side on the rounded rectangle table and racetrack table.

Tip: Cutout is only available for solid oak, solid walnut, solid maple, and solid surface tops and follows power location.

Tip: Braided cords should be specified for non-clinical spaces only.

Tip: Braided cords are not available when USB option is selected.

Specification Information

Dimensions			Style	U.S. Base
D	W	H	Number	Price

Circular Table

20" Dia.	N.A.	19"	<b>HSBT20</b>	\$ 808
----------	------	-----	---------------	--------



Rounded Rectangle Table

19"	32"	19"	<b>HSBT3219</b>	\$1009
-----	-----	-----	-----------------	--------

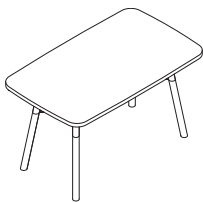

Racetrack Table

20"	42"	19"	<b>HSBT4220</b>	\$1179
-----	-----	-----	-----------------	--------



**For Canadian Pricing**  
Multiply U.S. Price by the Canadian price factor.  
► See page 1 for details.

# Embold Accessories

## Midarm

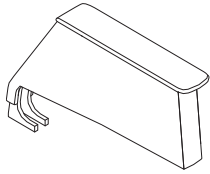

Tip: A support plate may need to be ordered depending on configuration desired.

Standard Includes	Required to Specify
<ul style="list-style-type: none"> <li>▶ Need help? Product details, page 72</li> <li>• Midarm: fabric price group 1</li> <li>• Plastic arm caps with overhang: 6527 Merle</li> </ul>	<ul style="list-style-type: none"> <li>1 Style number</li> <li>2 Fabric color number for midarm</li> <li>3 Options, if selected (see below)</li> <li>▶ See <i>Surface Materials</i>, page 473.</li> </ul>

Options	U.S. Price	Required to Specify
<b>Arm Cap Overhang</b>		
<b>Plastic arm</b>		
• No overhang	No cost	Specify <i>with no overhang</i> .
• Overhang	No cost	Specify <i>with overhang</i> .
<b>Solid maple wood arm</b>		
• No overhang	+\$ 32	Specify <i>with no overhang</i> .
• Overhang	+\$ 69	Specify <i>with overhang</i> .
<b>Solid surface arm caps with no overhang</b>		
• Solid surface price group A	+\$283 per cap	Specify <i>with solid surface arm caps</i> and select solid surface color number.
• Solid surface price group B	+\$298 per cap	Specify <i>with solid surface arm caps</i> and select solid surface color number.
• Solid surface price group C	+\$312 per cap	Specify <i>with solid surface arm caps</i> and select solid surface color number.
• Solid surface price group D	+\$327 per cap	Specify <i>with solid surface arm caps</i> and select solid surface color number.
<b>Solid surface arm caps with overhang</b>		
• Solid surface price group A	+\$324 per cap	Specify <i>with solid surface arm caps</i> and select solid surface color number.
• Solid surface price group B	+\$339 per cap	Specify <i>with solid surface arm caps</i> and select solid surface color number.
• Solid surface price group C	+\$352 per cap	Specify <i>with solid surface arm caps</i> and select solid surface color number.
• Solid surface price group D	+\$367 per cap	Specify <i>with solid surface arm caps</i> and select solid surface color number.

Specification Information											
Style Number	U.S. Base Price	Fabric Price Group 2	Fabric Price Group 3	Fabric Price Group 4	Fabric Price Group 5	Fabric Price Group 6	Fabric Price Group 7	Fabric Price Group 8	Fabric Price Group 9	Fabric Price Group 10	COM
<b>HSBARM</b>	\$289	+\$6	+\$25	+\$54	+\$106	+\$179	+\$276	+\$407	+\$555	+\$739	+\$21



**For Canadian Pricing**  
 Multiply U.S. Price by the Canadian price factor.  
 ▶ See page 1 for details.

## Midleg

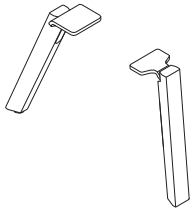

Tip: A support plate may need to be ordered depending on configuration desired.

Standard Includes		Required to Specify
<ul style="list-style-type: none"> <li>▶ Need help? Product details, page 72</li> </ul>	<ul style="list-style-type: none"> <li>• Midleg: paint or solid maple wood</li> <li>• Glides: adjustable, if selected: 6205 Black plastic or wallsaver, if selected: 6527 Merle plastic</li> </ul>	<ul style="list-style-type: none"> <li>1 Style number</li> <li>2 Paint or wood color number</li> <li>3 Wallsaver or standard adjustable glides (see below under Required Selections)</li> <li>▶ See <i>Surface Materials</i>, page 473.</li> </ul>

Required Selections	U.S. Price	Required to Specify
<b>Glides</b> <ul style="list-style-type: none"> <li>• Adjustable glides</li> <li>• Wallsaver glides</li> </ul>	No cost No cost	Specify with <i>standard adjustable glides</i> . Specify with <i>wallsaver glides</i> .

Specification Information	
Style Number	U.S. Price
HSBLEG	\$198
.	.

## Midleg and Midarm Support Plate

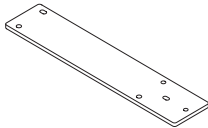

Standard Includes		Required to Specify
<ul style="list-style-type: none"> <li>▶ Need help? Product details, page 72</li> </ul>	<ul style="list-style-type: none"> <li>• Support plate</li> </ul>	Style number

Specification Information	
Style Number	U.S. Price
HSBLEGP	\$49
.	.



**For Canadian Pricing**  
 Multiply U.S. Price by the Canadian price factor.  
 ▶ See page 1 for details.

# Leela

**Leela seating** is a lounge seating collection with applications focused on waiting areas and transition spaces. The collection includes lounge seating and tables.

**Back and seat** are fully upholstered.

**Arm panels** are standard with upholstery. Maple wood or plastisol arm caps are available as an option.

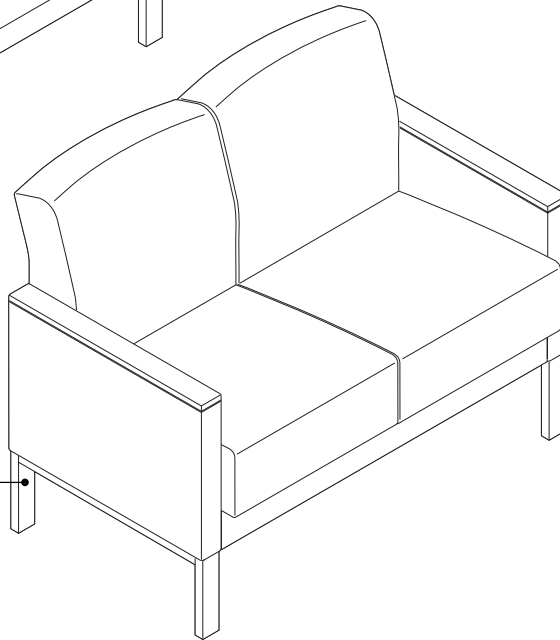
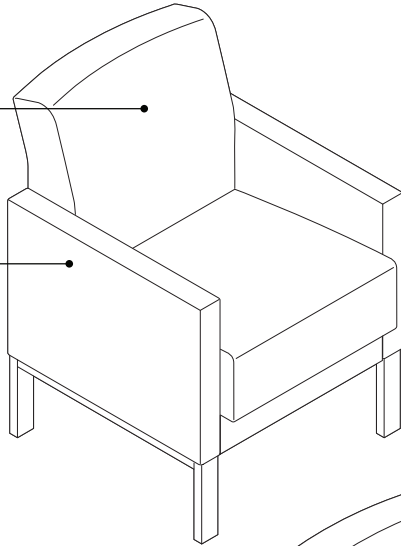

**Legs** are powder coated steel.

## Actual Dimensions

Features	Overall Depth	Width	Height	Seat Depth	Width of seat	Height of back	Seat Height	Arm Height
<b>Lounge seating</b>								
Single-seat lounge	27 1/2"	24 1/2" or 28 1/2"	33 3/4"	19"	19 1/4" or 23 1/4"	16 1/2"	18 3/4"	24 1/8"
Two-seat lounge	27 1/2"	43 3/4"	33 3/4"	19"	38 3/4"	16 1/2"	18 3/4"	24 1/8"
Three-seat lounge	27 1/2"	63"	33 3/4"	19"	58"	16 1/2"	18 3/4"	24 1/8"
Bariatric Lounge	27 1/2"	34 1/4" or 43 3/4"	33 3/4"	19"	29 1/4" or 38 3/4"	16 1/2"	18 3/4"	24 1/8"
<b>Tables</b>								
21"W side tables	21"	21"	21"	N.A.	N.A.	N.A.	N.A.	N.A.
Rectangular coffee table	21"	42"	16"	N.A.	N.A.	N.A.	N.A.	N.A.



**Product Details**

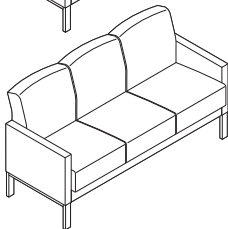
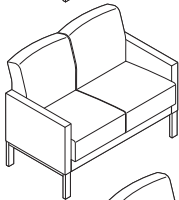
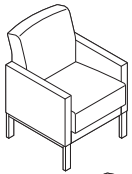

**Stand-alone units** are available in one-, two-, and three-seat versions.

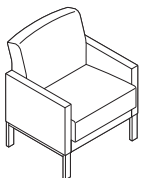

**24"W seats** are available on single-seat arm chairs only.

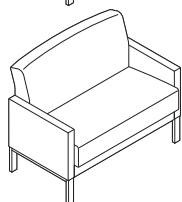
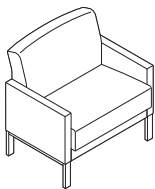

**Bariatric seating** is available in 30" and 40" seat widths.

**Bariatric seats** have been tested to a dynamic load of 500 pounds and a static load of 1000 pounds.

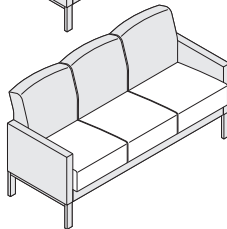
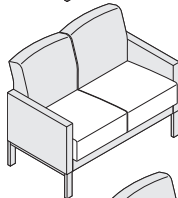
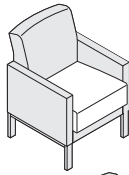

**Different fabrics** can be specified on the seat and back. Back fabric will match the fabric used on the arm and side panel.

**Moisture barrier** is available as an option on seat only.

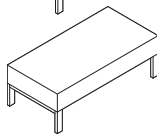
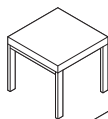

**Freestanding tables** are available in square and rectilinear shapes. Both shapes are available with metal legs and metal or solid surface tops.

**Surface Materials**

**All Steelcase Health seating with standard upholstery fabrics** comply with the State of California Technical Bulletin 117-2013.

**Seat and back**

- Fabric
- Fabric with moisture barrier (option on seat only legs)

**Chair legs and table base**

- Textured paint

**Table top surface**

- Powder coated steel
- Solid surface

**Arm caps**

- Fabric (standard)
- Maple wood (option)
- Plastisol (option)

**Shipping**

**Leela table components** ship separately for field assembly.

# Leela

## Lounge Seating

Standard Includes		Required to Specify
<ul style="list-style-type: none"> <li>▶ Need help? Product details, page 104</li> </ul>	<ul style="list-style-type: none"> <li>• Seat and back: fabric</li> <li>• Arm panels: fabric to match back</li> <li>• Legs: painted steel</li> <li>• Glides: black</li> </ul>	<ul style="list-style-type: none"> <li>1 Style number</li> <li>2 Fabric color number for back and seat</li> <li>3 Paint color number for legs</li> <li>4 Options, if selected (see below)</li> <li>▶ See <i>Surface Materials</i>, page 473.</li> </ul>

*Tip: Different fabrics for the seat and back can be specified. If the fabrics are in different price groups, calculate list price by adding the two price groups together and dividing by two.*

Options	U.S. Price	Required to Specify
<b>Surface Materials</b> <ul style="list-style-type: none"> <li>• Moisture barrier</li> <li>• Lounge chair</li> <li>• Loveseat</li> <li>• Sofa</li> </ul>	<ul style="list-style-type: none"> <li>+\$134</li> <li>+\$268</li> <li>+\$402</li> </ul>	<ul style="list-style-type: none"> <li>Specify with moisture barrier.</li> <li>Specify with moisture barrier.</li> <li>Specify with moisture barrier.</li> </ul>
<b>Arm caps</b> <ul style="list-style-type: none"> <li>• Plastisol arm caps: black only</li> <li>• Maple wood arm caps</li> </ul>	<ul style="list-style-type: none"> <li>+\$146</li> <li>+\$225</li> </ul>	<ul style="list-style-type: none"> <li>Specify with plastisol arm caps.</li> <li>Specify with wood arm caps and select wood color number.</li> </ul>

Specification Information												
U.S. Base Prices												
Style Number	Width	Fabric Price Group 1	Fabric Price Group 2	Fabric Price Group 3	Fabric Price Group 4	Fabric Price Group 5	Fabric Price Group 6	Fabric Price Group 7	Fabric Price Group 8	Fabric Price Group 9	Fabric Price Group 10	COM

### 21"W Lounge Chair

<b>HS2L121</b>	20"	\$1869	\$2053	\$2231	\$2379	\$2533	\$2623	\$2775	\$3073	\$3265	\$3441	\$1963
----------------	-----	--------	--------	--------	--------	--------	--------	--------	--------	--------	--------	--------

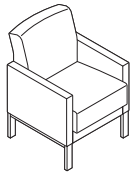

### 24"W Lounge Chair

<b>HS2L124</b>	24"	\$2056	\$2270	\$2484	\$2662	\$2834	\$2944	\$3124	\$3474	\$3696	\$3902	\$2150
----------------	-----	--------	--------	--------	--------	--------	--------	--------	--------	--------	--------	--------

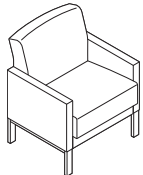

### Loveseat

<b>HS2L2</b>	40"	\$2940	\$3270	\$3598	\$3870	\$4146	\$4314	\$4590	\$5142	\$5480	\$5798	\$3034
--------------	-----	--------	--------	--------	--------	--------	--------	--------	--------	--------	--------	--------

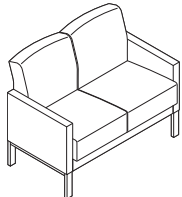

### Sofa

<b>HS2L3</b>	58"	\$4117	\$4585	\$5051	\$5445	\$5833	\$6065	\$6461	\$7239	\$7723	\$8173	\$4211
--------------	-----	--------	--------	--------	--------	--------	--------	--------	--------	--------	--------	--------

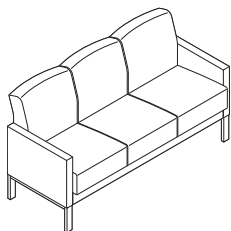

## Bariatric Lounge Seating

Standard Includes		Required to Specify
<ul style="list-style-type: none"> <li>▶ Need help? Product details, page 104</li> </ul>	<ul style="list-style-type: none"> <li>• Seat and back: fabric</li> <li>• Arm panels: fabric to match back</li> <li>• Legs: painted steel</li> <li>• Glides: black</li> </ul>	<ol style="list-style-type: none"> <li>1 Style number</li> <li>2 Fabric color number for back and seat</li> <li>3 Paint color number for legs</li> <li>4 Options, if selected (see below)</li> </ol> <p>▶ See <i>Surface Materials</i>, page 473.</p>

*Tip: Different fabrics for the seat and back can be specified. If the fabrics are in different price groups, calculate list price by adding the two price groups together and dividing by two.*

Options	U.S. Price	Required to Specify
<b>Surface Materials</b> <ul style="list-style-type: none"> <li>• Moisture barrier</li> </ul>	+\$134	Specify with moisture barrier.
<b>Arm caps</b> <ul style="list-style-type: none"> <li>• Plastisol arm caps: black only</li> <li>• Maple wood arm caps</li> </ul>	+\$146 +\$225	Specify with plastisol arm caps. Specify with wood arm caps and select wood color number.

### Specification Information

Style Number	Width	U.S. Base Prices										COM
		Fabric Price Group 1	Fabric Price Group 2	Fabric Price Group 3	Fabric Price Group 4	Fabric Price Group 5	Fabric Price Group 6	Fabric Price Group 7	Fabric Price Group 8	Fabric Price Group 9	Fabric Price Group 10	

### Bariatric Lounge

<b>HS2L130</b>	30"	\$2573	\$2787	\$3001	\$3179	\$3351	\$3461	\$3641	\$3991	\$4213	\$4419	\$2667
----------------	-----	--------	--------	--------	--------	--------	--------	--------	--------	--------	--------	--------

<b>HS2L140</b>	40"	\$3463	\$3721	\$3973	\$4185	\$4397	\$4531	\$4741	\$5163	\$5427	\$5675	\$3557
----------------	-----	--------	--------	--------	--------	--------	--------	--------	--------	--------	--------	--------

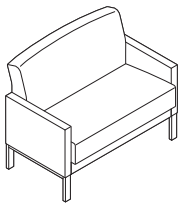
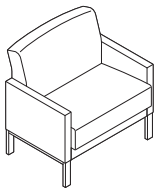

**For Canadian Pricing**  
 Multiply U.S. Price by the Canadian price factor.  
 ▶ See page 1 for details.

# Leela Tables

## Freestanding Tables

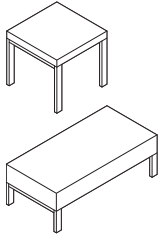

Tip: For finish codes and more information on the solid surface Select Surfaces program see Surface Materials.  
 ▶ Page 473

Standard Includes	Required to Specify
-------------------	---------------------

<ul style="list-style-type: none"> <li>▶ Need help? Product details, page 104</li> <li>• Table: steel</li> <li>• Top: metal or solid surface</li> </ul>	<ol style="list-style-type: none"> <li>1 Style number</li> <li>2 Paint color number for metal top, if selected</li> <li>3 Solid surface color number for top, if selected</li> <li>4 Paint color number for legs</li> <li>5 Options, if selected (see below)</li> </ol> <p>▶ See <i>Surface Materials</i>, page 473.</p>
---	--

Surface Materials	Options	U.S. Price	Required to Specify
-------------------	---------	------------	---------------------

<b>Surface Materials</b>	<b>Square tables</b>		
	• Solid surface price group A	Prices below	Specify solid surface color number.
	• Solid surface price group B	Prices below	Specify solid surface color number.
	• Solid surface price group C	Prices below	Specify solid surface color number.
	• Solid surface price group D	Prices below	Specify solid surface color number.

Specification Information							
Dimensions			Style	U.S. Base Prices			
D	W	H	Number	Price Group A	Price Group B	Price Group C	Price Group D

### Table with Metal Top

21"	21"	21"	<b>HS2T212121C</b>	\$1427	N.A.	N.A.	N.A.
21"	42"	16"	<b>HS2T422116C</b>	\$2137	N.A.	N.A.	N.A.
:	:	:	:	:	:	:	:

### Table with Solid Surface Top

21"	21"	21"	<b>HS2T212121S</b>	\$2284	\$2332	\$2398	\$2564
21"	42"	16"	<b>HS2T422116S</b>	\$3424	\$3522	\$3677	\$4019
:	:	:	:	:	:	:	:



**For Canadian Pricing**  
 Multiply U.S. Price by the Canadian price factor.  
 ▶ See page 1 for details.



# Mitra

**Mitra seating** features an energetically curved frame design. A variety of configurations are available to create a cohesive design across healthcare spaces.

**Seat and back** are fully upholstered.

**Space between seat and back** allows for easy cleaning.

**Wallsaver legs** are standard on guest and bariatric seating.

**Curved legs and frame** are solid maple wood.

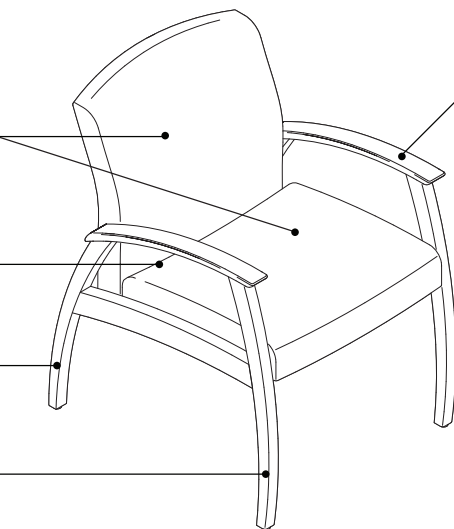

**Arm caps** feature a reverse bevel and overhang the legs to provide a comfortable hand grip for ease of entry and exit from the chair. Arm caps are solid maple wood, plastic, or solid surface.

**Arm caps on lounge seating** are solid maple wood or plastisol.

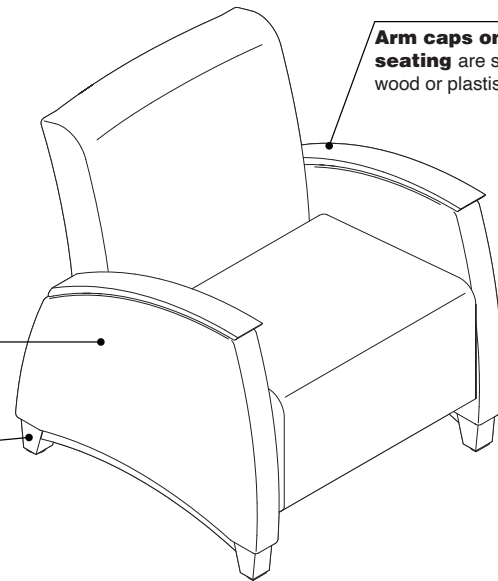

**Side panels on lounge seating** are upholstered with solid maple arm caps and bases.

**Glides** are standard on legs.

## Actual Dimensions

Features	Overall Depth	Width	Height	Seat Depth	Width	Height	Arm Height
<b>Guest Seating</b>							
Single-seat chair	26 1/2"	23 1/4"	33"	19 1/4"	20"	19"	25 1/4"
Two-seat chair	26 1/2"	44 1/2"	33"	19 1/4"	20"/20"	19"	25 1/4"
<b>Bariatric Seating</b>							
Single-seat chair	26 1/2"	33 1/4"	33"	19 1/4"	30"	19"	25 1/4"
<b>High-Back Chair</b>							
	29"	23 1/4"	45"	19 1/4"	20"	19"	25 1/4"
<b>Easy Access Chair</b>							
	26 1/2"	23 1/4"	39 1/4"	19 1/4"	20"	25"	31 1/4"
<b>Lounge Chairs</b>							
Lounge chair	30 1/4"	29 1/4"	33 3/4"	20"	23"	17 1/4"	25 1/4"
Loveseat	30 1/4"	47 1/4"	33 3/4"	20"	41"	17 1/4"	25 1/4"
Sofa	30 1/4"	65 1/4"	33 3/4"	20"	59"	17 1/4"	25 1/4"

Note: Combination units include one bariatric single-seat chair and either one or two standard width single-seat chairs.  
 Note: Seat height on lounge chairs measured at the front of the seat cushion.

**Product Details**

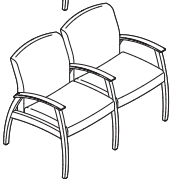

**Guest chairs** are available as a single-seat chair and two-seat chair. Two-seat chairs include arms and legs between each seat.

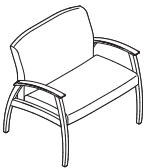

**Bariatric chair** is available with a 30"W seat and is tested to a dynamic load of 300 pounds and a static load of 750 pounds.



**High-back chair** has a tapered back. Chair is not available in a bariatric version.

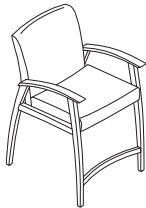

**Easy access seating** has a seat height of 25" with a footrest 6 1/4" from the floor.

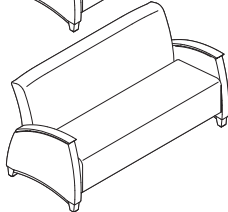
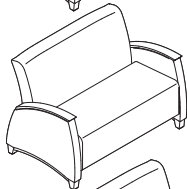
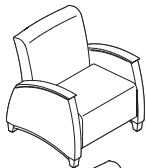

**Lounge seating** is available as a lounge chair, love-seat, and sofa.

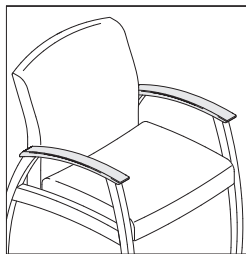

**Wood, plastic, and solid surface arms** are available on all guest seating. Plastic and solid surface arms completely replace wood arms.

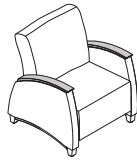

**Wood and plastisol arm caps** are available on lounge seating.

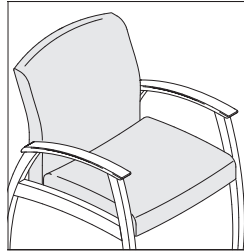

**Back and seat covers on guest, bariatric, and high-back chairs** have zippers and can be easily removed for cleaning. Back covers can be replaced.

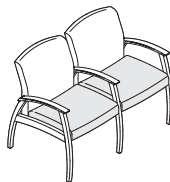

**Different fabrics** can be specified on the seat and back. On two-seat, three-seat, and combination units, the back fabric will be consistent throughout the whole unit as shown above. On lounge seating fabric on the back will match the fabric on the arm panel. Contrasting fabric deviating from these standards need to be processed through Specials.

**Moisture barrier** is available as an option on seat only.

**Related Products**

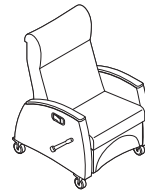

**Mitra Recliner**  
▶ See page 362

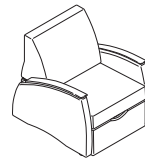

**Mitra Sleeper**  
▶ See page 365

**Surface Materials**

**All Steelcase Health seating with standard upholstery fabrics** comply with the State of California Technical Bulletin 117-2013.

**Seat and back**

- Fabric
- Fabric with moisture barrier (option on seat only)

**Arm caps**

- Maple wood
- Plastic (guest)
- Plastisol (lounge)
- Solid surface (guest)

*Tip: Select Surface solid surfaces are available.*

▶ See *Surface Materials* section for complete listing on page 473.

**Legs and frame**

- Maple wood

**Glides**

- Brown plastic only

**Footrest cover on easy access chair**

- Black plastic

# Mitra

## Guest Seating

Tip: Two-seat chairs have arms and legs between each seat.

Tip: Different fabrics for the seat and back can be specified. If the fabrics are in different price groups, calculate list price by adding the two price groups together and dividing by two.

Standard Includes	Required to Specify
<ul style="list-style-type: none"> <li>▶ Need help? Product details, page 110</li> <li>• Seat and back: fabric</li> <li>• Arm caps: maple wood</li> <li>• Legs and frame: maple wood</li> <li>• Glides: brown plastic</li> </ul>	<ol style="list-style-type: none"> <li>1 Style number</li> <li>2 Fabric color number for seat and back</li> <li>3 Wood color number for frame, legs, and arm caps</li> <li>4 Options, if selected (see below)</li> </ol> <p>▶ See <i>Surface Materials</i>, page 473.</p>

Surface Materials	Options	U.S. Price	Required to Specify
	<b>Moisture barrier</b> <ul style="list-style-type: none"> <li>• Single-seat chairs</li> <li>• Two-seat chairs</li> </ul>	+\$134 +\$268	Specify <i>with moisture barrier</i> . Specify <i>with moisture barrier</i> .
	<b>Arm caps</b> <ul style="list-style-type: none"> <li>• Plastic arm caps</li> <li>• Solid surface price group A</li> <li>• Solid surface price group B</li> <li>• Solid surface price group C</li> <li>• Solid surface price group D</li> </ul>	+\$ 77 per cap +\$299 per cap +\$315 per cap +\$331 per cap +\$346 per cap	Specify <i>with plastic arm caps</i> and select plastic color number. Specify <i>with solid surface arm caps</i> and select solid surface color number. Specify <i>with solid surface arm caps</i> and select solid surface color number. Specify <i>with solid surface arm caps</i> and select solid surface color number. Specify <i>with solid surface arm caps</i> and select solid surface color number.

### Specification Information



Single-Seat Chair



Two-Seat Chair

**U.S. Base Prices**

Style Number	Fabric Price Group 1	Fabric Price Group 2	Fabric Price Group 3	Fabric Price Group 4	Fabric Price Group 5	Fabric Price Group 6	Fabric Price Group 7	Fabric Price Group 8	Fabric Price Group 9	Fabric Price Group 10	COM

### Single-Seat Chair

<b>SC6010A</b>	\$1274	\$1362	\$1442	\$1514	\$1584	\$1632	\$1702	\$1838	\$1930	\$2010	\$1326
----------------	--------	--------	--------	--------	--------	--------	--------	--------	--------	--------	--------

### Two-Seat Chair

<b>SC6026A</b>	\$2176	\$2344	\$2514	\$2656	\$2802	\$2886	\$3028	\$3310	\$3486	\$3650	\$2228
----------------	--------	--------	--------	--------	--------	--------	--------	--------	--------	--------	--------



## Bariatric Chair

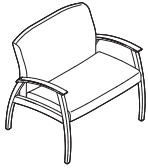

*Tip: Different fabrics for the seat and back can be specified. If the fabrics are in different price groups, calculate list price by adding the two price groups together and dividing by two.*

Standard Includes	Required to Specify
<ul style="list-style-type: none"> <li>▶ Need help? Product details, page 110</li> <li>• Seat and back: fabric</li> <li>• Arm caps: maple wood</li> <li>• Legs and frame: maple wood</li> <li>• Glides: brown plastic</li> </ul>	<ol style="list-style-type: none"> <li>1 Style number</li> <li>2 Fabric color number for seat and back</li> <li>3 Wood color number for frame, legs, and arm caps</li> <li>4 Options, if selected (see below)</li> </ol> <ul style="list-style-type: none"> <li>▶ See <i>Surface Materials</i>, page 473.</li> </ul>

Options	U.S. Price	Required to Specify
<b>Surface Materials</b>		
• Moisture barrier	+\$134	Specify with <i>moisture barrier</i> .
<b>Arm caps</b>		
• Plastic arm caps	+\$154	Specify with <i>plastic arm caps</i> and select plastic color number.
• Solid surface price group A	+\$598	Specify with <i>solid surface arm caps</i> and select solid surface color number.
• Solid surface price group B	+\$630	Specify with <i>solid surface arm caps</i> and select solid surface color number.
• Solid surface price group C	+\$662	Specify with <i>solid surface arm caps</i> and select solid surface color number.
• Solid surface price group D	+\$692	Specify with <i>solid surface arm caps</i> and select solid surface color number.

Families of Seating

### Specification Information

Style Number	U.S. Base Prices										COM
	Fabric Price Group 1	Fabric Price Group 2	Fabric Price Group 3	Fabric Price Group 4	Fabric Price Group 5	Fabric Price Group 6	Fabric Price Group 7	Fabric Price Group 8	Fabric Price Group 9	Fabric Price Group 10	
<b>SC6060A</b>	\$1530	\$1682	\$1824	\$1952	\$2078	\$2154	\$2278	\$2520	\$2674	\$2820	\$1582

 **For Canadian Pricing**  
 Multiply U.S. Price by the Canadian price factor.  
 ▶ See page 1 for details.

Mitra, continued

High-Back Chair



Tip: Different fabrics for the seat and back can be specified. If the fabrics are in different price groups, calculate list price by adding the two price groups together and dividing by two.

**Standard Includes** **Required to Specify**

- |  |  |   |
|--|--|---|
| <ul style="list-style-type: none"> <li>▶ Need help? Product details, page 111</li> </ul> | <ul style="list-style-type: none"> <li>• Seat and back: fabric</li> <li>• Arm caps: maple wood</li> <li>• Legs and frame: maple wood</li> <li>• Glides: brown plastic</li> </ul> | <ol style="list-style-type: none"> <li>1 Style number</li> <li>2 Fabric color number for seat and back</li> <li>3 Wood color number for frame, legs, and arm caps</li> <li>4 Options, if selected (see below)</li> </ol> <p>▶ See <i>Surface Materials</i>, page 473.</p> |
|--|--|---|

**Options** **U.S. Price** **Required to Specify**

<b>Surface Materials</b>	<b>Moisture barrier</b>	+\$134	Specify <i>with moisture barrier</i> .
	<b>Arm caps</b>		
	• Plastic arm caps	+\$154	Specify <i>with plastic arm caps</i> and select plastic color number.
	• Solid surface price group A	+\$598	Specify <i>with solid surface arm caps</i> and select solid surface color number.
	• Solid surface price group B	+\$630	Specify <i>with solid surface arm caps</i> and select solid surface color number.
	• Solid surface price group C	+\$662	Specify <i>with solid surface arm caps</i> and select solid surface color number.
	• Solid surface price group D	+\$692	Specify <i>with solid surface arm caps</i> and select solid surface color number.

**Specification Information**

Style Number	U.S. Base Prices										COM
	Fabric Price	Fabric Price	Fabric Price	Fabric Price	Fabric Price	Fabric Price	Fabric Price	Fabric Price	Fabric Price	Fabric Price	
	Group 1	Group 2	Group 3	Group 4	Group 5	Group 6	Group 7	Group 8	Group 9	Group 10	
<b>SC6085A</b>	\$1348	\$1474	\$1606	\$1710	\$1816	\$1878	\$1986	\$2200	\$2326	\$2460	\$1400



**For Canadian Pricing**  
 Multiply U.S. Price by the Canadian price factor.  
 ▶ See page 1 for details.

## Easy Access Chair



*Tip: Different fabrics for the seat and back can be specified. If the fabrics are in different price groups, calculate list price by adding the two price groups together and dividing by two.*

Standard Includes	Required to Specify
<ul style="list-style-type: none"> <li>▶ Need help? Product details, page 111</li> <li>• Seat and back: fabric</li> <li>• Arm caps: maple wood</li> <li>• Legs and frame: maple wood</li> <li>• Glides: brown plastic</li> <li>• Footrest cover: Black plastic</li> </ul>	<ul style="list-style-type: none"> <li>1 Style number</li> <li>2 Fabric color number for seat and back</li> <li>3 Wood color number for frame, legs, and arm caps</li> <li>4 Options, if selected (see below)</li> <li>▶ See <i>Surface Materials</i>, page 473.</li> </ul>

Options	U.S. Price	Required to Specify
<b>Surface Materials</b> <ul style="list-style-type: none"> <li>• <b>Moisture barrier</b></li> </ul>	+\$134	Specify with <i>moisture barrier</i> .
<ul style="list-style-type: none"> <li>• <b>Arm caps</b></li> </ul>	+\$154	Specify with <i>plastic arm caps</i> and select plastic color number.
<ul style="list-style-type: none"> <li>• Solid surface price group A</li> </ul>	+\$598	Specify with <i>solid surface arm caps</i> and select solid surface color number.
<ul style="list-style-type: none"> <li>• Solid surface price group B</li> </ul>	+\$630	Specify with <i>solid surface arm caps</i> and select solid surface color number.
<ul style="list-style-type: none"> <li>• Solid surface price group C</li> </ul>	+\$662	Specify with <i>solid surface arm caps</i> and select solid surface color number.
<ul style="list-style-type: none"> <li>• Solid surface price group D</li> </ul>	+\$692	Specify with <i>solid surface arm caps</i> and select solid surface color number.

### Specification Information

Style Number	U.S. Base Prices										COM
	Fabric Price	Fabric Price	Fabric Price	Fabric Price	Fabric Price	Fabric Price	Fabric Price	Fabric Price	Fabric Price	Fabric Price	
	Group 1	Group 2	Group 3	Group 4	Group 5	Group 6	Group 7	Group 8	Group 9	Group 10	
<b>SC6067EA</b>	\$1625	\$1713	\$1793	\$1865	\$1935	\$1983	\$2053	\$2189	\$2281	\$2361	\$1677

Families of Seating

**For Canadian Pricing**  
 Multiply U.S. Price by the Canadian price factor.  
 ▶ See page 1 for details.

# Mitra Lounge Chairs

*Tip: Different fabrics for the seat and back can be specified. If the fabrics are in different price groups, calculate list price by adding the two price groups together and dividing by two.*

Standard Includes		Required to Specify
<ul style="list-style-type: none"> <li>▶ Need help? Product details, page 110</li> </ul>	<ul style="list-style-type: none"> <li>• Seat and back: fabric</li> <li>• Legs and base: maple wood</li> <li>• Arm caps: maple wood</li> <li>• Glides: brown plastic</li> </ul>	<ol style="list-style-type: none"> <li>1 Style number</li> <li>2 Fabric color number for seat and back</li> <li>3 Wood color number for legs, base, and arm caps</li> <li>4 Options, if selected (see below)</li> </ol> <p>▶ See <i>Surface Materials</i>, page 473.</p>

Options	U.S. Price	Required to Specify
<b>Surface Materials</b> <b>Moisture barrier</b> <ul style="list-style-type: none"> <li>• Lounge chair</li> <li>• Loveseat</li> <li>• Sofa</li> </ul>	+\$134 +\$268 +\$402	Specify with <i>moisture barrier</i> . Specify with <i>moisture barrier</i> . Specify with <i>moisture barrier</i> .
<b>Arm caps</b> <ul style="list-style-type: none"> <li>• Plastisol arm caps</li> </ul>	+\$154	Specify with <i>plastisol arm caps</i> and select plastic color number.

## Specification Information



Lounge Chair



Loveseat

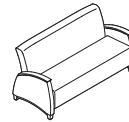

Sofa

### U.S. Base Prices

Style Number	Fabric Price Group 1	Fabric Price Group 2	Fabric Price Group 3	Fabric Price Group 4	Fabric Price Group 5	Fabric Price Group 6	Fabric Price Group 7	Fabric Price Group 8	Fabric Price Group 9	Fabric Price Group 10	COM
--------------	----------------------	----------------------	----------------------	----------------------	----------------------	----------------------	----------------------	----------------------	----------------------	-----------------------	-----

### Lounge Chair

<b>SC6110L</b>	\$2280	\$2502	\$2726	\$2914	\$3098	\$3208	\$3400	\$3768	\$4000	\$4216	\$2374
----------------	--------	--------	--------	--------	--------	--------	--------	--------	--------	--------	--------

### Loveseat

<b>SC6120L</b>	\$2841	\$3135	\$3441	\$3685	\$3933	\$4081	\$4329	\$4829	\$5139	\$5423	\$2935
----------------	--------	--------	--------	--------	--------	--------	--------	--------	--------	--------	--------

### Sofa

<b>SC6130L</b>	\$3425	\$3787	\$4147	\$4449	\$4753	\$4933	\$5235	\$5839	\$6211	\$6557	\$3519
----------------	--------	--------	--------	--------	--------	--------	--------	--------	--------	--------	--------



### For Canadian Pricing

Multiply U.S. Price by the Canadian price factor.

▶ See page 1 for details.

# Mitra Tables

**Mitra freestanding tables** are available in two styles and four shapes to coordinate with Mitra seating.

**High-Pressure Laminate tops** are 1" thick and have 3 mm plastic edges.

**Curved legs** are solid maple wood and coordinate with the styling of Mitra chair legs.

**Drum table bases** have a tapered design and are available wrapped with laminate or veneer.

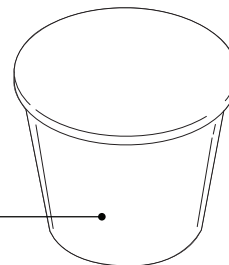
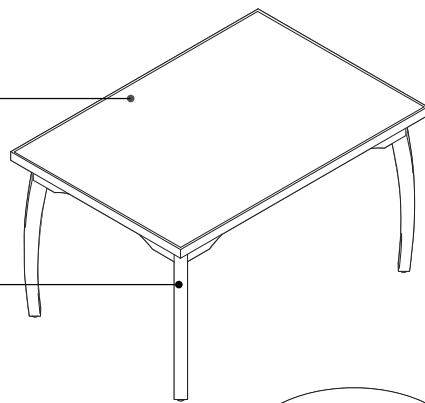

## Product Details

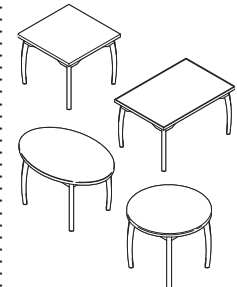

**Freestanding tables with curved legs** are available in four shapes – oval, rectangular, square, and round.

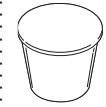

**Freestanding drum table** is available in one shape—round. Drum table is offered with a 3 mm plastic edge top and a maple veneer-wrapped base or with a 3 mm plastic edge top and a laminate-wrapped base. Bottom surface is particle board standard with brown plastic glides.

**Top**  
• High-Pressure Laminate

**Edge profile**  
• 3 mm plastic

**Legs**  
• Maple wood

**Base on drum table**  
• Laminate  
• Veneer

Families of Seating

## Actual Dimensions

Features	Overall Depth	Width	Height
Oval table	22"	32"	16"
Rectangular table	22"	32"	16"
Square table	22"	22"	16"
Round table	22" dia.	N.A.	16"
Round drum table	22" dia.	N.A.	18"

# Mitra Tables

## Freestanding Tables

Standard Includes		Required to Specify
<ul style="list-style-type: none"> <li>▶ Need help? Product details, page 117</li> </ul>	<ul style="list-style-type: none"> <li>• Table top: High-Pressure Laminate with 3 mm plastic edge</li> <li>• Curved legs: wood</li> </ul>	<ul style="list-style-type: none"> <li>1 Style number</li> <li>2 Laminate color number for top</li> <li>3 Wood color number for legs</li> <li>▶ See <i>Surface Materials</i>, page 473.</li> </ul>

Specification Information				
Dimensions			Style	U.S.
D	W	H	Number	Price



### Oval Table

22"	32"	16"	<b>SC6055</b>	\$1293
-----	-----	-----	---------------	--------

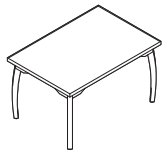

### Rectangular Table

22"	32"	16"	<b>SC6056</b>	\$1270
-----	-----	-----	---------------	--------



### Square Table

22"	22"	16"	<b>SC6057</b>	\$1136
-----	-----	-----	---------------	--------



### Round Table

22" dia.		16"	<b>SC6058</b>	\$1166
----------	--	-----	---------------	--------



**For Canadian Pricing**  
 Multiply U.S. Price by the Canadian price factor.  
 ▶ See page 1 for details.

## Freestanding Drum Table



Standard Includes		Required to Specify
<ul style="list-style-type: none"> <li>▶ Need help? Product details, page 117</li> </ul>	<ul style="list-style-type: none"> <li>• Table top: High-Pressure Laminate</li> <li>• 3 mm plastic edge</li> <li>• Laminate-wrapped base</li> </ul>	<ul style="list-style-type: none"> <li>1 Style number</li> <li>2 Laminate color number for top and base</li> <li>3 Options, if selected (see below)</li> <li>▶ See <i>Surface Materials</i>, page 473.</li> </ul>

Options	U.S. Price	Required to Specify
<b>Surface Materials</b> <ul style="list-style-type: none"> <li>• Veneer-wrapped base</li> </ul>	No cost	Specify with <i>veneer-wrapped base</i> and select laminate color for top and wood color for base.

Specification Information				
• Dimensions			• Style	• U.S.
D	W	H	Number	Price
:	:	:	:	:
:	:	:	:	:

Round table				
22" dia.		18"	<b>SC6158</b>	\$1981
:	:	:	:	:

Families of Seating



**For Canadian Pricing**  
 Multiply U.S. Price by the Canadian price factor.  
 ▶ See page 1 for details.

# Outlook Tables

**Outlook tables** are available to coordinate with multiple seating lines.

**Top** has a 1" thick wood core with a High-Pressure Laminate surface.

**Edge** is either maple wood or 3 mm plastic.

**Legs** coordinate with multiple seating lines.

**Apron**, on select freestanding tables, is maple wood.

**Glides** are standard on legs.

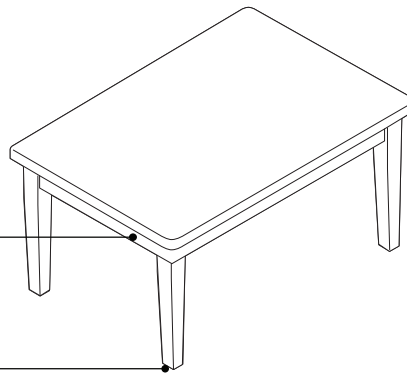
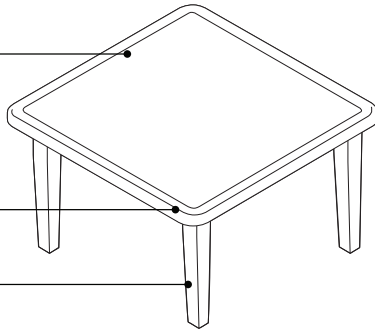

## Product Details

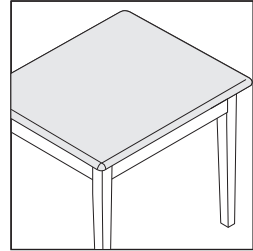

**Wood edge** is a 1" thick bullnose.

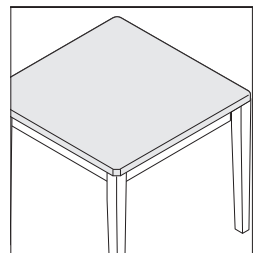

**Plastic edge** features a 3 mm radius.

*Tip: The plastic edge will match standard laminate tops. A black plastic edge will be used on tables with non-standard laminate tops.*

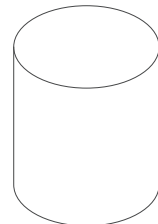

**Drum table** is available in two sizes. It has a High-Pressure Laminate top surface and body and particle board bottom surface. Brown plastic glides are standard.



Tapered

**Tapered legs** are maple wood construction.

## Actual Dimensions

Features	Overall Depth	Width	Height
<b>Freestanding Tables—Wood or Plastic Edge</b>			
Square	18", 26"	18", 26"	16" or 21"
Rectangle	20" or 22"	24"	21"



**Surface Materials**

**Table top**

- High-Pressure Laminate

**Edge**

- Maple wood
- Plastic

**Legs**

- Maple wood

**Table apron, if selected**

- Maple wood

**Glides**

- Black nylon only

**Shipping**

**Tables** are shipped unassembled and require field assembly of legs.

# Outlook Tables

## Freestanding Tables with Wood Edge

Standard Includes	Required to Specify
<ul style="list-style-type: none"> <li>▶ Need help? Product details, page 120</li> <li>• Top: High-Pressure Laminate</li> <li>• Edge: maple wood to match top</li> <li>• Legs: wood</li> <li>• Attachment brackets: black only</li> <li>• Glides: black nylon</li> </ul>	<ul style="list-style-type: none"> <li>1 Style number</li> <li>2 Laminate color number for top</li> <li>▶ See <i>Surface Materials</i>, page 473.</li> </ul>

Specification Information				
Dimensions			Style	U.S.
D	W	H	Number	Price

### Square Tables with Tapered Legs

18"	18"	21"	<b>HTT181821W</b>	\$1128
26"	26"	21"	<b>HTT262621W</b>	\$1288

### Rectangular Table with Tapered Legs

20"	24"	21"	<b>HTT242021W</b>	\$1153
-----	-----	-----	-------------------	--------

### Round Table with Tapered Legs

24" dia		21"	<b>HTT24R21W</b>	\$1259
---------	--	-----	------------------	--------



## Freestanding Tables with Plastic Edge

Standard Includes	Required to Specify
<ul style="list-style-type: none"> <li>▶ Need help? Product details, page 120</li> <li>• Top: High-Pressure Laminate</li> <li>• Edge: plastic to match</li> <li>• Legs: wood</li> <li>• Glides: black nylon</li> </ul>	<ul style="list-style-type: none"> <li>1 Style number</li> <li>2 Laminate color number for top</li> <li>▶ See <i>Surface Materials</i>, page 473.</li> </ul>

Specification Information				
Dimensions			Style	U.S.
D	W	H	Number	Price

### Square Table with Tapered Legs

26"	26"	21"	<b>HTT262621P</b>	\$1177
-----	-----	-----	-------------------	--------

### Rectangular Table with Tapered Legs

20"	24"	21"	<b>HTT242021P</b>	\$ 960
-----	-----	-----	-------------------	--------



**For Canadian Pricing**  
 Multiply U.S. Price by the Canadian price factor.  
 ▶ See page 1 for details.

## Drum Table

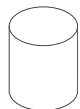

Standard Includes	Required to Specify
-------------------	---------------------

- |  |   |  |
|--|---|--|
| <ul style="list-style-type: none"> <li>▶ Need help? Product details, page 121</li> </ul> | <ul style="list-style-type: none"> <li>• Top: High-Pressure Laminate</li> <li>• Edge: plastic to match</li> </ul> | <ul style="list-style-type: none"> <li>1 Style number</li> <li>2 Laminate color number for top</li> <li>▶ See <i>Surface Materials</i>, page 473.</li> </ul> |
|--|---|--|

Specification Information			
Dimensions	H	Style Number	U.S. Price

D	H	Style Number	U.S. Price
18"	18"	<b>SC27DT18D</b>	\$ 776
24"	18"	<b>SC27DT24D</b>	\$1024



### For Canadian Pricing

Multiply U.S. Price by the Canadian price factor.

▶ See page 1 for details.

# Radia

**Radia's simple design** accommodates a range of spaces and body types.

**Frames** are available in a variety of paint finishes.

**Space between the seat and back** allows for easy cleaning.

**Curved back design** accommodates a range of seating postures and offers comprehensive back support.

**Frame and legs** are constructed with steel for structural integrity and durability. They have a powdercoat paint finish that is corrosion resistant.

**Wallsaver design** is integrated into chair leg.  
*Tip: High-back chair is not a wallsaver due to back recline.*

**Two arm cap shapes** are available and offered in three plastic finishes.

**Overhang arm cap style** are shown on chairs above.

**Seat and back** are fully upholstered.

**Spherical glides** help protect cove molding.

**Contour arms** follow the curvature of the arm frame and provide a grippable surface.

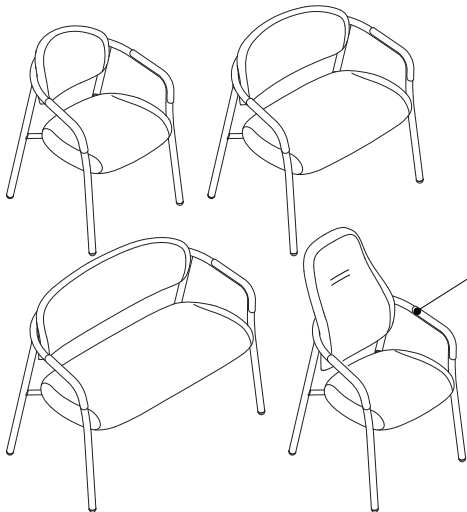

## Actual Dimensions

• Features	• Overall Depth	Width	Height	• Seat Depth	Width	Height	• Arm Height
Armless	26"	22½"	33"	19"	21"	19"	N.A.
Single	25½"	24¾"	33"	19"	21"	19"	27"
Bariatric	25½"	34¾"	33"	20"	30"	19"	27"
Loveseat	25½"	45¾"	33"	19½"	42"	19"	27"
High Back	26"	24¾"	44"	18½"	21"	19"	27"

**Product Details**

**Two arm cap shapes** are available to specify—overhang and contour.

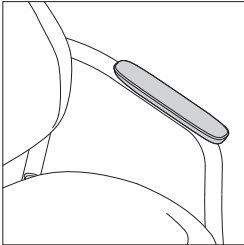

**Overhang arm caps** have an intentional overhang designed to help users grip the chair during ingress and egress. Overhang arm caps are recommended for use in clinical areas. Overhang arm caps are non-handed.

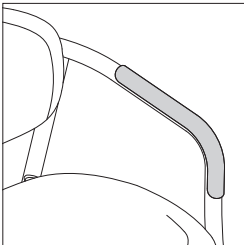

**Contour arm caps** follow the curvature of the chair frame, while providing a gripable and cleanable plastic surface.

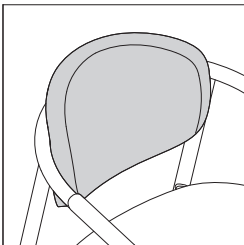

**Back and seat cushions** are available in the same upholstery or contrasting upholstery. Contrasting upholstery is considered any two fabrics that are not identical (including same fabric in different finishes). To maximize yield and cost, utilize back and seat cushions in the same exact fabric.

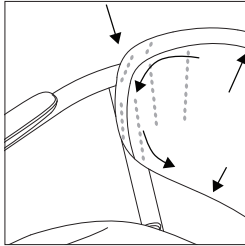

**Fabrics with a repeating pattern** will not remain aligned between the curved corners (inner or outer corner) and the top outer edges of the chair back.

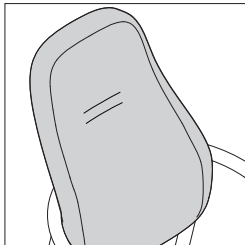

**High back** has minimal stitching in center of back to keep upholstery taut.

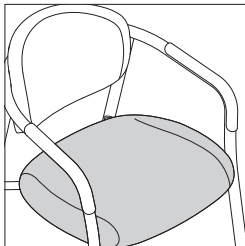

**Seat cushion** contains minimal waterfall seams to promote cleanability.

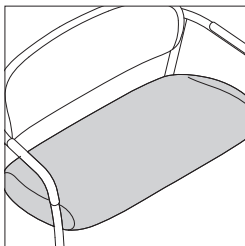

**Loveseat seat cushion** does not contain a vertical seam separating the two seats.

**Moisture barrier** is available as an option on the seat only.

**Spherical glides** are standard on legs and designed to help protect cove molding.

**Surface Materials**

**All Steelcase Health seating with standard upholstery fabrics** comply with the State of California Technical Bulletin 117-2013.

**Seat and back**

- Fabric
- Fabric with moisture barrier (option on seat only)

**Arm caps**

- Plastic
  - 6249 Platinum Solid
  - 6527 Merle
  - 6654 Sand

**Legs and frame**

- Paint

**Glides**

- Merle plastic

# Radia

## Armless Chair

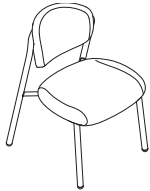

Tip: Fabrics with a repeating pattern will not remain aligned around the corners of the chair or in the boxing (the outer perimeter).

Standard Includes	Required to Specify
-------------------	---------------------

- |  |   |   |
|--|---|---|
| <ul style="list-style-type: none"> <li>▶ Need help? Product details, page 124</li> </ul> | <ul style="list-style-type: none"> <li>• Seat and back: fabric price group 1</li> <li>• Frame and legs: paint</li> <li>• Glides: merle plastic</li> </ul> | <ul style="list-style-type: none"> <li>1 Style number</li> <li>2 Fabric color number for seat and back</li> <li>3 Paint color number for frame and legs</li> <li>4 Options, if selected (see below)</li> <li>▶ See <i>Surface Materials</i>, page 473.</li> </ul> |
|--|---|---|

Options	U.S. Price	Required to Specify
---------	------------	---------------------

<b>Surface Materials</b>	<b>Moisture barrier</b>	Moisture barrier	+\$134	Specify with moisture barrier.
	<b>Frame</b>	Paint price group 1	No cost	Specify paint color number.
	Paint price group 2	+\$ 74	+\$146	Specify paint color number.
	Paint price group 3			Specify paint color number.

### Specification Information

Style Number	U.S. Base Price	Fabric Upcharges	Fabric Price Group 1	Fabric Price Group 2	Fabric Price Group 3	Fabric Price Group 4	Fabric Price Group 5	Fabric Price Group 6	Fabric Price Group 7	Fabric Price Group 8	Fabric Price Group 9	Fabric Price Group 10	COM
--------------	-----------------	------------------	----------------------	----------------------	----------------------	----------------------	----------------------	----------------------	----------------------	----------------------	----------------------	-----------------------	-----

### 21"W Armless Chair—One Upholstery

<b>HSP20N</b>	\$840	Monochromatic	\$840	\$946	\$982	\$1031	\$1110	\$1189	\$1291	\$1381	\$1461	\$1562	\$884
---------------	-------	---------------	-------	-------	-------	--------	--------	--------	--------	--------	--------	--------	-------

### 21"W Armless Chair—Contrasting Upholsteries

<b>HSP20N</b>	\$840	Contrasting											
		Seat	+\$41	+\$61	+\$81	+\$109	+\$154	+\$199	+\$257	+\$308	+\$353	+\$411	+\$62
		Back	+\$46	+\$68	+\$91	+\$122	+\$173	+\$223	+\$288	+\$345	+\$396	+\$460	+\$69

Tip: Back and seat cushions are available in the same upholstery or contrasting fabric. Contrasting upholstery is considered any two fabrics that are not identical (including same fabric in different finishes). To maximize yield and cost, utilize back and seat cushions in the same exact fabric.



#### For Canadian Pricing

Multiply U.S. Price by the Canadian price factor.

▶ See page 1 for details.

## Single Chair



Tip: Fabrics with a repeating pattern will not remain aligned around the corners of the chair or in the boxing (the outer perimeter).

Standard Includes		Required to Specify	
<ul style="list-style-type: none"> <li>▶ Need help? Product details, page 124</li> </ul>	<ul style="list-style-type: none"> <li>• Seat and back: fabric price group 1</li> <li>• Overhang arm caps: plastic</li> <li>• Frame and legs: paint</li> <li>• Glides: merle plastic</li> </ul>	<ul style="list-style-type: none"> <li>1 Style number</li> <li>2 Fabric color number for seat and back</li> <li>3 Plastic color number for arm caps</li> <li>4 Paint color number for frame and legs</li> <li>5 Options, if selected (see below)</li> <li>▶ See <i>Surface Materials</i>, page 473.</li> </ul>	

Options	U.S. Price	Required to Specify	
<b>Surface Materials</b>			
<ul style="list-style-type: none"> <li>• <b>Moisture barrier</b></li> </ul>	+\$134	Specify with moisture barrier.	
<ul style="list-style-type: none"> <li>• <b>Frame</b></li> </ul>		Specify paint color number.	
<ul style="list-style-type: none"> <li>• Paint price group 1</li> <li>• Paint price group 2</li> <li>• Paint price group 3</li> </ul>	No cost +\$ 74 +\$146	Specify paint color number. Specify paint color number. Specify paint color number.	
<b>Arm caps</b>			
<ul style="list-style-type: none"> <li>• Contour arm cap</li> </ul>	No cost	Specify with contour arm cap.	

Specification Information													
Style Number	U.S. Base Price	Fabric Upcharges	Fabric Price Group 1	Fabric Price Group 2	Fabric Price Group 3	Fabric Price Group 4	Fabric Price Group 5	Fabric Price Group 6	Fabric Price Group 7	Fabric Price Group 8	Fabric Price Group 9	Fabric Price Group 10	COM

### 21"W Single Chair—One Upholstery

<b>HSP20A</b>	\$990	Monochromatic	\$990	\$1096	\$1132	\$1181	\$1260	\$1339	\$1441	\$1531	\$1611	\$1712	\$1034
---------------	-------	---------------	-------	--------	--------	--------	--------	--------	--------	--------	--------	--------	--------

### 21"W Single Chair—Contrasting Upholsteries

<b>HSP20A</b>	\$990	Contrasting											
		Seat	+\$41	+\$ 61	+\$ 81	+\$109	+\$154	+\$199	+\$257	+\$308	+\$353	+\$411	+\$ 62
		Back	+\$46	+\$ 68	+\$ 91	+\$122	+\$173	+\$223	+\$288	+\$345	+\$396	+\$460	+\$ 69

Tip: Back and seat cushions are available in the same upholstery or contrasting fabric. Contrasting upholstery is considered any two fabrics that are not identical (including same fabric in different finishes). To maximize yield and cost, utilize back and seat cushions in the same exact fabric.

 **For Canadian Pricing**  
 Multiply U.S. Price by the Canadian price factor.  
 ▶ See page 1 for details.

Radia, continued

**Bariatric Chair**

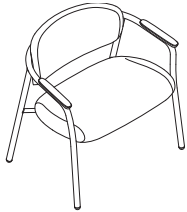

Tip: Fabrics with a repeating pattern will not remain aligned around the corners of the chair or in the boxing (the outer perimeter).

Standard Includes	Required to Specify
-------------------	---------------------

- |  |   |  |
|--|---|--|
| <ul style="list-style-type: none"> <li>▶ Need help? Product details, page 124</li> </ul> | <ul style="list-style-type: none"> <li>• Seat and back: fabric price group 1</li> <li>• Overhang arm caps: plastic</li> <li>• Frame and legs: paint</li> <li>• Glides: merle plastic</li> </ul> | <ol style="list-style-type: none"> <li>1 Style number</li> <li>2 Fabric color number for seat and back</li> <li>3 Plastic color number for arm caps</li> <li>4 Paint color number for frame and legs</li> <li>5 Options, if selected (see below)</li> </ol> <p>▶ See <i>Surface Materials</i>, page 473.</p> |
|--|---|--|

Options	U.S. Price	Required to Specify
---------	------------	---------------------

<b>Surface Materials</b>	<p><b>Moisture barrier</b></p> <ul style="list-style-type: none"> <li>• Moisture barrier</li> </ul>	+\$134	Specify with <i>moisture barrier</i> .
	<p><b>Frame</b></p> <ul style="list-style-type: none"> <li>• Paint price group 1</li> <li>• Paint price group 2</li> <li>• Paint price group 3</li> </ul>	No cost +\$ 74 +\$146	Specify paint color number. Specify paint color number. Specify paint color number.
<b>Arm caps</b>	<ul style="list-style-type: none"> <li>• Contour arm cap</li> </ul>	No cost	Specify with <i>contour arm cap</i> .

**Specification Information**

Style Number	U.S. Base Price	Fabric Upcharges	Fabric Price Group 1	Fabric Price Group 2	Fabric Price Group 3	Fabric Price Group 4	Fabric Price Group 5	Fabric Price Group 6	Fabric Price Group 7	Fabric Price Group 8	Fabric Price Group 9	Fabric Price Group 10	COM
--------------	-----------------	------------------	----------------------	----------------------	----------------------	----------------------	----------------------	----------------------	----------------------	----------------------	----------------------	-----------------------	-----

**30"W Bariatric Chair—One Upholstery**

<b>HSP30A</b>	\$1346	Monochromatic	\$1346	\$1486	\$1533	\$1595	\$1699	\$1802	\$1934	\$2052	\$2155	\$2287	\$1390
---------------	--------	---------------	--------	--------	--------	--------	--------	--------	--------	--------	--------	--------	--------

**30"W Bariatric Chair—Contrasting Upholsteries**

<b>HSP30A</b>	\$1346	Contrasting											
		Seat	+\$ 57	+\$ 84	+\$112	+\$151	+\$213	+\$275	+\$354	+\$425	+\$487	+\$567	+\$ 78
		Back	+\$ 67	+\$100	+\$134	+\$179	+\$253	+\$326	+\$421	+\$505	+\$579	+\$674	+\$ 90

Tip: Back and seat cushions are available in the same upholstery or contrasting fabric. Contrasting upholstery is considered any two fabrics that are not identical (including same fabric in different finishes). To maximize yield and cost, utilize back and seat cushions in the same exact fabric.



**For Canadian Pricing**

Multiply U.S. Price by the Canadian price factor.

▶ See page 1 for details.



## Loveseat

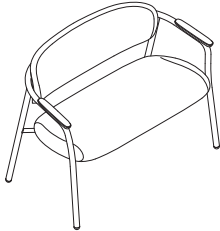

Tip: Fabrics with a repeating pattern will not remain aligned around the corners of the chair or in the boxing (the outer perimeter).

Standard Includes		Required to Specify	
<ul style="list-style-type: none"> <li>▶ Need help? Product details, page 124</li> </ul>	<ul style="list-style-type: none"> <li>• Seat and back: fabric price group 1</li> <li>• Overhang arm caps: plastic</li> <li>• Frame and legs: paint</li> <li>• Glides: merle plastic</li> </ul>	<ul style="list-style-type: none"> <li>1 Style number</li> <li>2 Fabric color number for seat and back</li> <li>3 Plastic color number for arm caps</li> <li>4 Paint color number for frame and legs</li> <li>5 Options, if selected (see below)</li> <li>▶ See <i>Surface Materials</i>, page 473.</li> </ul>	
Options		U.S. Price	Required to Specify
<b>Surface Materials</b>	<b>Moisture barrier</b>	+\$268	Specify with moisture barrier.
	<b>Frame</b>		
	• Paint price group 1	No cost	Specify paint color number.
	• Paint price group 2	+\$ 74	Specify paint color number.
	• Paint price group 3	+\$146	Specify paint color number.
<b>Arm caps</b>	• Contour arm cap	No cost	Specify with contour arm cap.

### Specification Information

Style Number	U.S. Base Price	Fabric Upcharges	Fabric Price Group 1	Fabric Price Group 2	Fabric Price Group 3	Fabric Price Group 4	Fabric Price Group 5	Fabric Price Group 6	Fabric Price Group 7	Fabric Price Group 8	Fabric Price Group 9	Fabric Price Group 10	COM

### 42"W Loveseat—One Upholstery

<b>HSP42A</b>	\$1571	Monochromatic	\$1571	\$1749	\$1809	\$1889	\$2021	\$2153	\$2321	\$2471	\$ 2603	\$ 2771	\$1657
---------------	--------	---------------	--------	--------	--------	--------	--------	--------	--------	--------	---------	---------	--------

### 42"W Loveseat—Contrasting Upholsteries

<b>HSP42A</b>	\$1571	Contrasting											
		Seat	+\$ 71	+\$125	+\$191	+\$280	+\$424	+\$568	+\$754	+\$919	+\$1063	+\$1249	+\$114
		Back	+\$ 71	+\$125	+\$191	+\$280	+\$424	+\$568	+\$754	+\$919	+\$1063	+\$1249	+\$114

Tip: Back and seat cushions are available in the same upholstery or contrasting fabric. Contrasting upholstery is considered any two fabrics that are not identical (including same fabric in different finishes). To maximize yield and cost, utilize back and seat cushions in the same exact fabric.



#### For Canadian Pricing

Multiply U.S. Price by the Canadian price factor.

▶ See page 1 for details.

Radia, continued

**High-Back Chair**

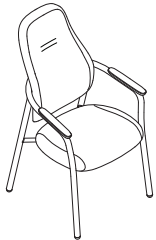

Tip: Fabrics with a repeating pattern will not remain aligned around the corners of the chair or in the boxing (the outer perimeter).

Tip: High-back chairs are not wallsavers.

Standard Includes	Required to Specify
-------------------	---------------------

- |  |   |   |
|--|---|---|
| <ul style="list-style-type: none"> <li>▶ Need help? Product details, page 124</li> </ul> | <ul style="list-style-type: none"> <li>• Seat and back: fabric price group 1</li> <li>• Overhang arm caps: plastic</li> <li>• Frame and legs: paint</li> <li>• Glides: merle plastic</li> </ul> | <ol style="list-style-type: none"> <li>1 Style number</li> <li>2 Fabric color number for seat and back</li> <li>3 Plastic color number for arm caps</li> <li>4 Paint color number for frame and legs</li> <li>5 Options, if selected (see below)</li> </ol> <ul style="list-style-type: none"> <li>▶ See <i>Surface Materials</i>, page 473.</li> </ul> |
|--|---|---|

Options	U.S. Price	Required to Specify
---------	------------	---------------------

<b>Surface Materials</b>	<ul style="list-style-type: none"> <li>• <b>Moisture barrier</b></li> <li>• <b>Frame</b></li> <li>• Paint price group 1</li> <li>• Paint price group 2</li> <li>• Paint price group 3</li> </ul>	<ul style="list-style-type: none"> <li>• Moisture barrier</li> </ul> <p style="text-align: right;">+\$134</p> <ul style="list-style-type: none"> <li>• No cost</li> <li>• +\$ 74</li> <li>• +\$146</li> </ul>	<p>Specify with <i>moisture barrier</i>.</p> <p>Specify paint color number.</p> <p>Specify paint color number.</p> <p>Specify paint color number.</p>
<b>Arm caps</b>	<ul style="list-style-type: none"> <li>• Contour arm cap</li> </ul>	<ul style="list-style-type: none"> <li>• No cost</li> </ul>	<p>Specify with <i>contour arm cap</i>.</p>

**Specification Information**

Style Number	U.S. Base Price	Fabric Upcharges	Fabric Price Group 1	Fabric Price Group 2	Fabric Price Group 3	Fabric Price Group 4	Fabric Price Group 5	Fabric Price Group 6	Fabric Price Group 7	Fabric Price Group 8	Fabric Price Group 9	Fabric Price Group 10	COM
--------------	-----------------	------------------	----------------------	----------------------	----------------------	----------------------	----------------------	----------------------	----------------------	----------------------	----------------------	-----------------------	-----

**21"W High-Back Chair—One Upholstery**

<b>HSP20HA</b>	\$1197	Monochromatic	\$1197	\$1338	\$1385	\$1449	\$1552	\$1655	\$1788	\$1906	\$2010	\$2142	\$1241
----------------	--------	---------------	--------	--------	--------	--------	--------	--------	--------	--------	--------	--------	--------

**21"W High-Back Chair—Contrasting Upholsteries**

<b>HSP20HA</b>	\$1197	Contrasting											
		Seat	+\$ 41	+\$ 61	+\$ 81	+\$109	+\$154	+\$199	+\$257	+\$308	+\$353	+\$411	+\$ 62
		Back	+\$ 82	+\$122	+\$163	+\$218	+\$308	+\$398	+\$514	+\$616	+\$706	+\$822	+\$105

Tip: Back and seat cushions are available in the same upholstery or contrasting fabric. Contrasting upholstery is considered any two fabrics that are not identical (including same fabric in different finishes). To maximize yield and cost, utilize back and seat cushions in the same exact fabric.



**For Canadian Pricing**

Multiply U.S. Price by the Canadian price factor.

▶ See page 1 for details.

## Bracket

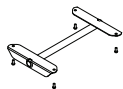

Standard Includes		Required to Specify
<ul style="list-style-type: none"> <li>▶ Need help? Product details, page 124</li> </ul>	<ul style="list-style-type: none"> <li>• Bracket: paint price group 1</li> </ul>	<ul style="list-style-type: none"> <li>1 Style number</li> <li>2 Paint color number for bracket</li> </ul>

Options	U.S. Price	Required to Specify
<b>Surface Materials</b> <ul style="list-style-type: none"> <li>• Paint price group 1</li> <li>• Paint price group 2</li> <li>• Paint price group 3</li> </ul>	<ul style="list-style-type: none"> <li>No cost</li> <li>+\$ 74</li> <li>+\$146</li> </ul>	<ul style="list-style-type: none"> <li>Specify paint color number.</li> <li>Specify paint color number.</li> <li>Specify paint color number.</li> </ul>

Specification Information	
Style Number	U.S. Base Price
HSPGB	\$137
:	:

Families of Seating



**For Canadian Pricing**  
 Multiply U.S. Price by the Canadian price factor.  
 ▶ See page 1 for details.

# Sieste

**Sieste** offers a family of seating that is flexible and comfortable with a clean design to fit almost any lounge setting.

**Back cushion** is a separate unit that is attached by a zipper at the top that allows 2"-3" of up and down adjustment with velcro that is sewn into the cushion and the back rest.

**Back** is upholstered. A zipper allows the cover to be field replaceable. The back is open on lounge and bariatric models.

**Arms** are enclosed and upholstered. Arms are standard without an arm cap. Optional wood and black plastisol arm caps are available.

**Legs** are constructed with maple hardwood solids.

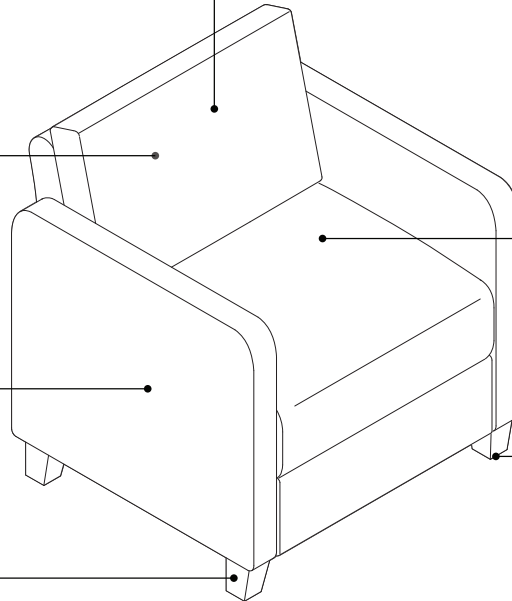

**Seat** is upholstered. A Velcro closure allows the cover to be field replaceable.

**Nylon glides** are standard on legs.

## Actual Dimensions

Features	Overall Depth	Width	Height	Seat Depth	Width	Height	Arm Height
Lounge chair	27½"	29¼"	32½"	19"	23¼"	18"	25"
Loveseat	27½"	52½"	32½"	19"	46½"	18"	25"
Sofa	27½"	75¾"	32½"	19"	69¾"	18"	25"
Bariatric chair	27½"	36"	32½"	19"	30"	18"	25"
Freestanding square table	26"	26"	18" or 23"	N.A.	N.A.	N.A.	N.A.

**Product Details**

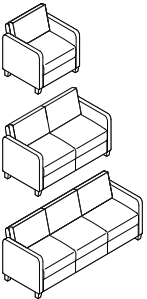

**Lounge chair** is available as a single unit, loveseat, or sofa.

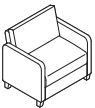

**Bariatric chair** offers extra seat width for additional comfort and is reinforced to support additional weight.

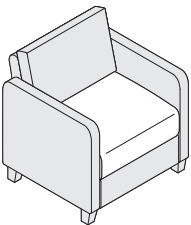

**Different fabrics** can be specified on the seat and back. Fabric on the back will match the fabric on the arm panel.

**Moisture barrier** on the seat is available as an option.



**Freestanding table** is available.

**Related Products**

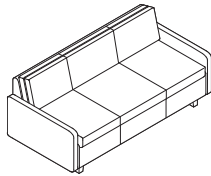

**Sieste Sleeper**  
▶ See page 368

**Surface Materials**

**All Steelcase Health seating with standard upholstery fabrics** comply with the State of California Technical Bulletin 117-2013.

**Legs**

- Maple wood

**Seat and back**

- Fabric
- Fabric with moisture barrier (option on seat only)

*Tip: Certain fabrics and vinyl will appear loose with comfort wrinkles when upholstered. Moisture barrier option may cause additional puddling on seat depending on the specified fabric.*

**Arms**

- Fabric
- Plastisol arm cap (option)
- Wood arm cap (option)

**Glides**

- Nylon

**Table frame and legs**

- Maple wood

**Top on freestanding tables**

- Laminate
- Maple wood (option)

**Edge band on tables**

- Wood

# Sieste

## Lounge Seating

Standard Includes	Required to Specify
<ul style="list-style-type: none"> <li>▶ Need help? Product details, page 132</li> <li>• Legs: maple wood</li> <li>• Seat, back, and closed arms: fabric</li> <li>• Nylon glides</li> </ul>	<ul style="list-style-type: none"> <li>1 Style number</li> <li>2 Wood color for legs</li> <li>3 Fabric color number for seat and back</li> <li>4 Options, if selected (see below)</li> <li>▶ See <i>Surface Materials</i>, page 473.</li> </ul>

*Tip: Different fabrics for the seat and back can be specified. If the fabrics are in different price groups, calculate list price by adding the two price groups together and dividing by two.*

*Tip: Wood arm cap finish color will match leg color selection.*

Options	U.S. Price	Required to Specify
<b>Surface Materials</b> <ul style="list-style-type: none"> <li>• <b>Moisture barrier</b></li> <li>• Lounge chair</li> <li>• Loveseat</li> <li>• Sofa</li> </ul>	<ul style="list-style-type: none"> <li>+ \$134</li> <li>+ \$268</li> <li>+ \$402</li> </ul>	<ul style="list-style-type: none"> <li>Specify with moisture barrier.</li> <li>Specify with moisture barrier.</li> <li>Specify with moisture barrier.</li> </ul>
<ul style="list-style-type: none"> <li>• <b>Arm caps</b></li> <li>• Wood arm caps</li> <li>• Plastisol arm caps: black only</li> </ul>	<ul style="list-style-type: none"> <li>+ \$332</li> <li>+ \$402</li> </ul>	<ul style="list-style-type: none"> <li>Specify with wood arm caps.</li> <li>Specify with plastisol arm caps.</li> </ul>

Specification Information											
U.S. Base Prices											
Style Number	Fabric Price Group 1	Fabric Price Group 2	Fabric Price Group 3	Fabric Price Group 4	Fabric Price Group 5	Fabric Price Group 6	Fabric Price Group 7	Fabric Price Group 8	Fabric Price Group 9	Fabric Price Group 10	COM



Lounge Chair											
<b>HN240</b>	\$2853	\$3087	\$3321	\$3517	\$3711	\$3827	\$4025	\$4413	\$4655	\$4883	\$2947

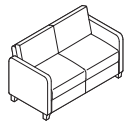

Loveseat											
<b>HN2402</b>	\$4263	\$4601	\$4945	\$5229	\$5509	\$5681	\$5963	\$6535	\$6883	\$7213	\$4357

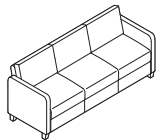

Sofa											
<b>HN2403</b>	\$5356	\$5802	\$6250	\$6620	\$6996	\$7222	\$7586	\$8336	\$8798	\$9228	\$5450



**For Canadian Pricing**  
 Multiply U.S. Price by the Canadian price factor.  
 ▶ See page 1 for details.

## Bariatric Seating

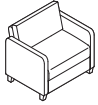

Standard Includes	Required to Specify
-------------------	---------------------

- |  |   |   |
|--|---|---|
| <ul style="list-style-type: none"> <li>▶ Need help? Product details, page 132</li> </ul> | <ul style="list-style-type: none"> <li>• Legs: maple wood</li> <li>• Seat, back, and closed arms: fabric</li> <li>• Nylon glides</li> </ul> | <ul style="list-style-type: none"> <li>1 Style number</li> <li>2 Wood color for legs</li> <li>3 Fabric color number for seat and back</li> <li>4 Options, if selected (see below)</li> <li>▶ See <i>Surface Materials</i>, page 473.</li> </ul> |
|--|---|---|

*Tip: Different fabrics for the seat and back can be specified. If the fabrics are in different price groups, calculate list price by adding the two price groups together and dividing by two.*

*Tip: Wood arm cap finish color will match leg color selection.*

Options	U.S. Price	Required to Specify
---------	------------	---------------------

<b>Surface Materials</b>	<b>Moisture barrier</b>	
	• Moisture barrier	+\$134
	<b>Arm caps</b>	
	• Wood arm caps	+\$332
	• Plastisol arm caps: black only	+\$402
		Specify with moisture barrier.
		Specify with wood arm caps.
		Specify with plastisol arm caps.

### Specification Information

Style Number	Width	U.S. Base Prices										COM
		Fabric Price Group 1	Fabric Price Group 2	Fabric Price Group 3	Fabric Price Group 4	Fabric Price Group 5	Fabric Price Group 6	Fabric Price Group 7	Fabric Price Group 8	Fabric Price Group 9	Fabric Price Group 10	
		HN240B30	30"	\$4004	\$4272	\$4534	\$4758	\$4978	\$5118	\$5334	\$5780	

**For Canadian Pricing**  
 Multiply U.S. Price by the Canadian price factor.  
 ▶ See page 1 for details.

Tables



Standard Includes	Required to Specify
-------------------	---------------------

<ul style="list-style-type: none"> <li>▶ Need help? Product details, page 132</li> </ul>	<ul style="list-style-type: none"> <li>• Frame and legs: maple wood</li> <li>• Top: laminate</li> <li>• Nylon glides on legs</li> </ul>	<ul style="list-style-type: none"> <li>1 Style number</li> <li>2 Wood color for frame and legs</li> <li>3 Laminate color number for top</li> <li>4 Options, if selected (see below)</li> <li>▶ See <i>Surface Materials</i>, page 473.</li> </ul>
--	---	---

Options	U.S. Price	Required to Specify
---------	------------	---------------------

<b>Top</b>	<ul style="list-style-type: none"> <li>• Wood</li> </ul>	+\$106  Specify <i>with wood top</i> and select wood color number.
------------	--	--

Specification Information				
Dimensions			Style	U.S.
D	W	H	Number	Base Price

:	:	:	:	:
:	:	:	:	:

**Freestanding Square Tables**

26"	26"	18"	<b>HN24T1L</b>	\$1740
26"	26"	23"	<b>HN24T1H</b>	\$1799
:	:	:	:	:



**For Canadian Pricing**

Multiply U.S. Price by the Canadian price factor.

▶ See page 1 for details.





# Tava

**Tava** offers a collection of seating and more which features a clean transitional design with appropriate function for a range of healthcare and corporate environments. The collection includes lounges, guest seating, highback seating, benches, and tables.

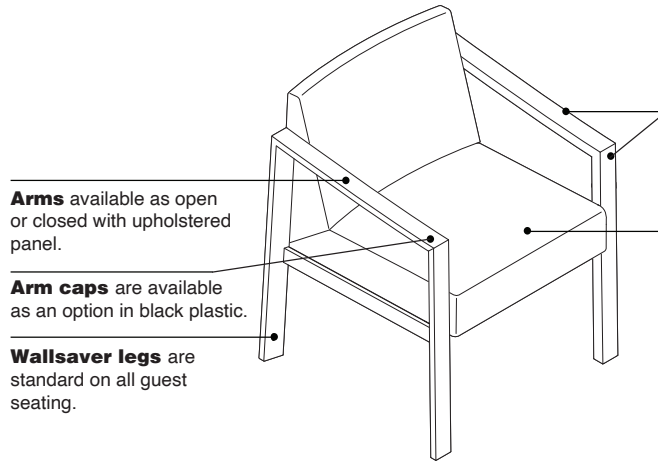

**Arms** available as open or closed with upholstered panel.

**Arm caps** are available as an option in black plastic.

**Wallsaver legs** are standard on all guest seating.

**Arm and leg assemblies** are ash wood with finger joints for structural integrity.

**Guest and highback chair seat** features a spring construction.

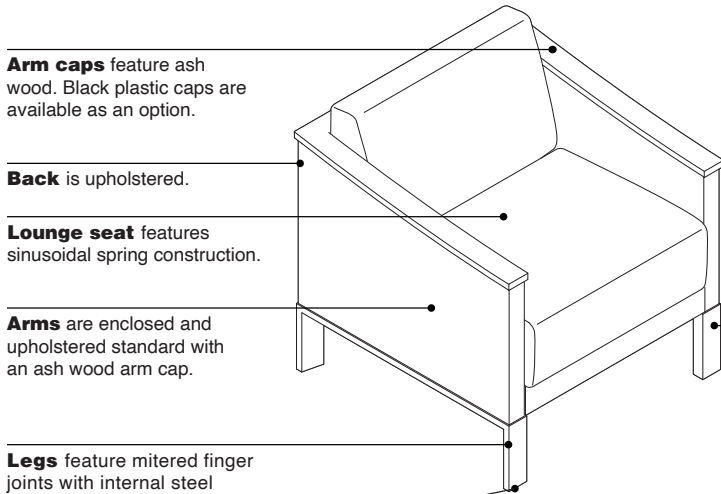

**Arm caps** feature ash wood. Black plastic caps are available as an option.

**Back** is upholstered.

**Lounge seat** features sinusoidal spring construction.

**Arms** are enclosed and upholstered standard with an ash wood arm cap.

**Legs** feature mitered finger joints with internal steel reinforcement.

**Legs** feature ash wood.

**Adjustable nylon glides** are standard on legs.

**Bench body** is available in powder coated steel.

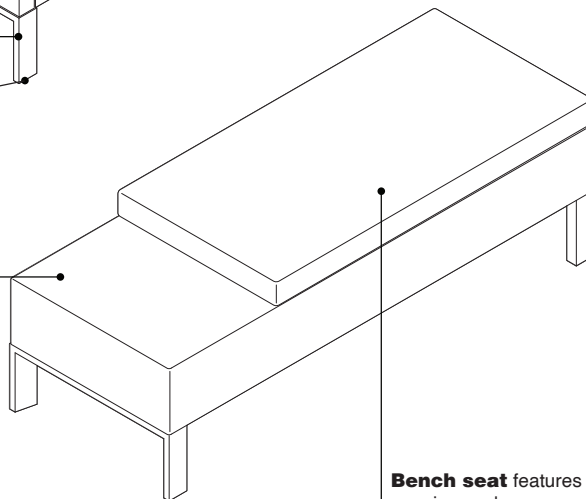

**Bench seat** features a spring pack.

**Actual Dimensions**

▶ See page 140

**Product Details**

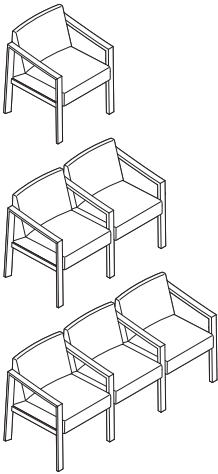

**Guest seating** is available in single, double, and triple seat versions.

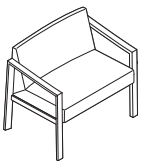

**Bariatric guest chair** is available with two seat widths: 30" and 40". Seats have been tested to a dynamic load of 500 pounds and a static load of 1500 pounds.

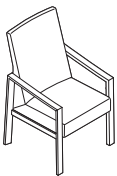

**High-back seating** is available.

**All Tava seating** features a crumb sweep for ease of cleaning.

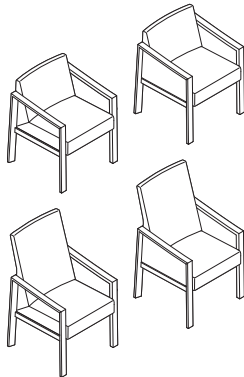

**Guest and high-back seating** available with an open arm or closed arm with upholstered panel.

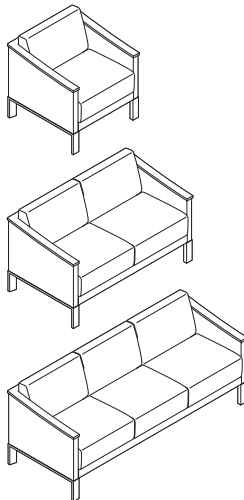

**Lounge chair** is available as a single-seat, loveseat, and sofa.

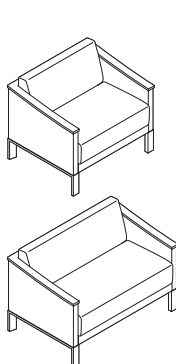

**Bariatric lounge** is available with two seat widths: 30" and 40". Seats have been tested to a dynamic load of 500 pounds and a static load of 1500 pounds.

**Ash wood** is featured on all Tava product. Wood is a natural product with inherent variation. Every piece of wood, even from the same tree, is slightly different in color, texture, and grain.

**Plastic arm caps** are available as an option on all seating. Plastic cap is mounted on top of existing wood cap, and is available in black only.

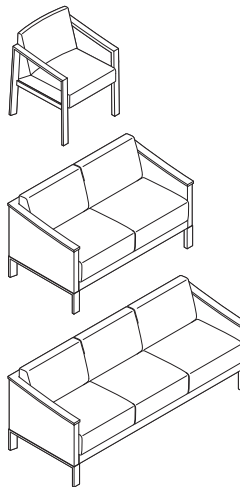

**Different fabrics** can be specified on the seat and back. Fabric on the back will match the fabric on the arm panel.

**Moisture barrier** on the seat is available as an option.

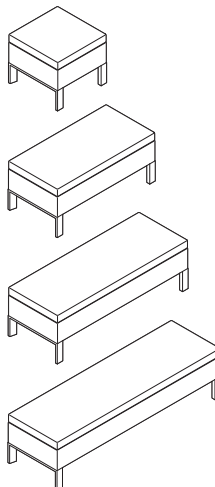

**Bench** is available in four width sizes: 21", 42", 56", and 70".

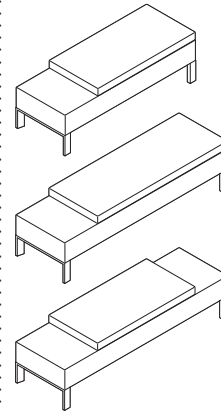

**Bench with table units** are available in 56" and 70" wide versions. The table portion of the bench is 14" wide. The 56"W bench has one table, the 70"W bench can have one or two tables.

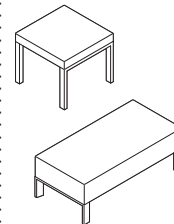

**Freestanding tables** are available.

**Surface Materials**

**All Steelcase Health seating with standard upholstery fabrics** comply with the State of California Technical Bulletin 117-2013.

**Seat and back**

- Fabric
- Fabric with moisture barrier (option on seat only)

**Arm caps**

- Ash wood
- Plastic (option)

**Arm panels**

- Fabric

**Legs**

- Ash wood

**Glides**

- Nylon

**Bench body and table**

- Powder coated steel

Tava, continued

Actual Dimensions							
Features	Overall Depth	Width	Height	Seat Depth	Width	Height	Arm Height
<b>Guest Seating</b>							
Single-Seat Guest Chair	23¾"	24"	31"	16½"	20"	18"	25"
Two-Seat Guest Chair (without center arm)	23¾"	44"	31"	16½"	40"	18"	25"
Two-Seat Guest Chair (with center arm)	23¾"	46"	31"	16½"	20"	18"	25"
Three-Seat Guest Chair (with center arm)	23¾"	64"	31"	16½"	20"	18"	25"
Bariatric Guest Chair	23¾"	34" or 44"	31"	16½"	30" or 40"	18"	25"
<b>High-Back Seating</b>							
High-Back Chair	24½"	24"	41½"	16½"	20"	18"	25"
<b>Lounge Seating</b>							
Lounge Chair	29"	28¼"	30¼"	19¾"	23¼"	18"	24"
Loveseat Lounge	29"	51½"	30¼"	19¾"	46½"	18"	24"
Sofa Lounge	29"	74¾"	30¼"	19¾"	69¾"	18"	24"
Bariatric Lounge Chair	29"	35" or 45"	30¼"	19¾"	30" or 40"	18"	24"
<b>Benches</b>							
Bench	21"	21", 42", 56", or 70"	18"	21"	21", 42", 56", or 70"	18"	N.A.
Bench with Table Unit	21"	56" or 70"	18"	21"	42" or 56"	18"	N.A.



# Tava

## Guest Seating

Standard Includes	Required to Specify
<ul style="list-style-type: none"> <li>▶ Need help? Product details, page 138</li> <li>• Seat and back: fabric</li> <li>• Arm panels, if selected: fabric</li> <li>• Leg and arm assemblies: wood</li> <li>• Glides: black</li> </ul>	<ol style="list-style-type: none"> <li>1 Style number</li> <li>2 Fabric color number for back and seat</li> <li>3 Wood color number for leg and arm assemblies</li> <li>4 Options, if selected (see below)</li> </ol> <ul style="list-style-type: none"> <li>▶ See <i>Surface Materials</i>, page 473.</li> </ul>

*Tip: Different fabrics for the seat and back can be specified. If the fabrics are in different price groups, calculate list price by adding the two price groups together and dividing by two.*

Options	U.S. Price	Required to Specify
<b>Surface Materials</b> <ul style="list-style-type: none"> <li>• Single-seat chair</li> <li>• Two-seat chair</li> <li>• Three-seat chair</li> </ul>	<ul style="list-style-type: none"> <li>+\$134</li> <li>+\$268</li> <li>+\$402</li> </ul>	<ul style="list-style-type: none"> <li>Specify with <i>moisture barrier</i>.</li> <li>Specify with <i>moisture barrier</i>.</li> <li>Specify with <i>moisture barrier</i>.</li> </ul>
<b>Arm caps</b> <ul style="list-style-type: none"> <li>• Plastic arm caps: black only</li> </ul>	<ul style="list-style-type: none"> <li>+\$ 97 per cap</li> </ul>	<ul style="list-style-type: none"> <li>Specify with <i>plastic arm caps</i>.</li> </ul>

Specification Information											
U.S. Base Prices											
Style Number	Fabric Price Group 1	Fabric Price Group 2	Fabric Price Group 3	Fabric Price Group 4	Fabric Price Group 5	Fabric Price Group 6	Fabric Price Group 7	Fabric Price Group 8	Fabric Price Group 9	Fabric Price Group 10	COM

### Single-Seat Guest Chair

#### Open Arm

<b>HS1C1</b>	\$2414	\$2510	\$2608	\$2686	\$2762	\$2816	\$2892	\$3052	\$3150	\$3246	\$2466
--------------	--------	--------	--------	--------	--------	--------	--------	--------	--------	--------	--------

#### Closed Arm

<b>HS1CU1</b>	\$2916	\$3060	\$3192	\$3310	\$3424	\$3492	\$3608	\$3838	\$3984	\$4112	\$2968
---------------	--------	--------	--------	--------	--------	--------	--------	--------	--------	--------	--------

### Two-Seat Guest Chair without Center Arm

#### Open Arm

<b>HS1C2</b>	\$3625	\$3787	\$3945	\$4079	\$4209	\$4293	\$4421	\$4693	\$4857	\$5011	\$3677
--------------	--------	--------	--------	--------	--------	--------	--------	--------	--------	--------	--------

#### Closed Arm

<b>HS1CU2</b>	\$4127	\$4331	\$4535	\$4699	\$4871	\$4971	\$5141	\$5477	\$5683	\$5877	\$4179
---------------	--------	--------	--------	--------	--------	--------	--------	--------	--------	--------	--------

▶ **Specification Information, continued on next page**

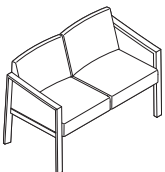
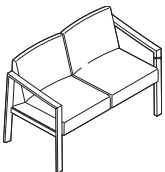
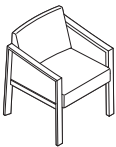
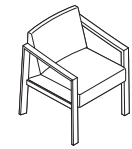

 **For Canadian Pricing**  
 Multiply U.S. Price by the Canadian price factor.  
 ▶ See page 1 for details.

► Specification Information, continued from previous page

**Specification Information**

Style Number	U.S. Base Prices										COM
	Fabric Price	Fabric Price	Fabric Price	Fabric Price	Fabric Price	Fabric Price	Fabric Price	Fabric Price	Fabric Price	Fabric Price	
	Group 1	Group 2	Group 3	Group 4	Group 5	Group 6	Group 7	Group 8	Group 9	Group 10	

**Two-Seat Guest Chair with Center Arm**

**Open Arm**

<b>HS1CA2</b>	\$4224	\$4386	\$4544	\$4678	\$4808	\$4892	\$5020	\$5292	\$5456	\$5610	\$4276
---------------	--------	--------	--------	--------	--------	--------	--------	--------	--------	--------	--------

**Closed Arm**

<b>HS1CAU2</b>	\$4978	\$5202	\$5424	\$5612	\$5796	\$5906	\$6098	\$6466	\$6698	\$6914	\$5030
----------------	--------	--------	--------	--------	--------	--------	--------	--------	--------	--------	--------

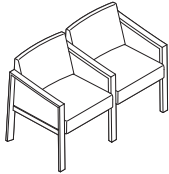
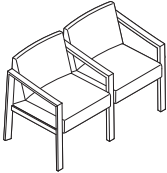

**Three-Seat Guest Chair with Center Arm**

**Open Arm**

<b>HS1CA3</b>	\$6030	\$6254	\$6476	\$6664	\$6848	\$6958	\$7150	\$7518	\$7750	\$7966	\$6082
---------------	--------	--------	--------	--------	--------	--------	--------	--------	--------	--------	--------

**Closed Arm**

<b>HS1CAU3</b>	\$7034	\$7322	\$7608	\$7848	\$8086	\$8230	\$8472	\$8952	\$9244	\$9524	\$7086
----------------	--------	--------	--------	--------	--------	--------	--------	--------	--------	--------	--------

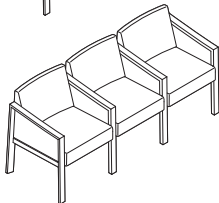
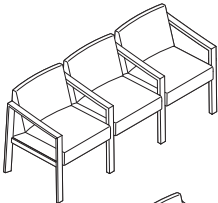

Families of Seating



**For Canadian Pricing**

Multiply U.S. Price by the Canadian price factor.

► See page 1 for details.

**Guest Bariatric Seating**

Standard Includes	Required to Specify
<ul style="list-style-type: none"> <li>▶ Need help? Product details, page 138</li> <li>• Seat and back: fabric</li> <li>• Arm panels, if selected: fabric</li> <li>• Leg and arm assemblies: wood</li> <li>• Glides: black</li> </ul>	<ul style="list-style-type: none"> <li>1 Style number</li> <li>2 Fabric color number for back and seat</li> <li>3 Wood color number for leg and arm assemblies</li> <li>4 Options, if selected (see below)</li> <li>▶ See <i>Surface Materials</i>, page 473.</li> </ul>

*Tip: Different fabrics for the seat and back can be specified. If the fabrics are in different price groups, calculate list price by adding the two price groups together and dividing by two.*

Options	U.S. Price	Required to Specify
<b>Surface Materials</b> <ul style="list-style-type: none"> <li>• <b>Moisture barrier</b></li> <li>• Moisture barrier</li> </ul>	+\$134	Specify with moisture barrier.
<ul style="list-style-type: none"> <li>• <b>Arm caps</b></li> <li>• Plastic arm caps: black only</li> </ul>	+\$194	Specify with plastic arm caps.

Specification Information											
U.S. Base Prices											
Style Number	Fabric Price Group 1	Fabric Price Group 2	Fabric Price Group 3	Fabric Price Group 4	Fabric Price Group 5	Fabric Price Group 6	Fabric Price Group 7	Fabric Price Group 8	Fabric Price Group 9	Fabric Price Group 10	COM

**Guest Chair 30" Wide Bariatric**

**Open Arm**

<b>HS1C130</b>	\$3430	\$3548	\$3664	\$3760	\$3862	\$3920	\$4014	\$4208	\$4334	\$4446	\$3482
----------------	--------	--------	--------	--------	--------	--------	--------	--------	--------	--------	--------

**Closed Arm**

<b>HS1CU130</b>	\$3933	\$4085	\$4227	\$4355	\$4483	\$4559	\$4681	\$4923	\$5081	\$5223	\$3985
-----------------	--------	--------	--------	--------	--------	--------	--------	--------	--------	--------	--------

**Guest Chair 40" Wide Bariatric**

**Open Arm**

<b>HS1C140</b>	\$3673	\$3817	\$3949	\$4067	\$4181	\$4249	\$4365	\$4595	\$4741	\$4869	\$3725
----------------	--------	--------	--------	--------	--------	--------	--------	--------	--------	--------	--------

**Closed Arm**

<b>HS1CU140</b>	\$4176	\$4338	\$4496	\$4630	\$4760	\$4844	\$4972	\$5244	\$5408	\$5562	\$4228
-----------------	--------	--------	--------	--------	--------	--------	--------	--------	--------	--------	--------

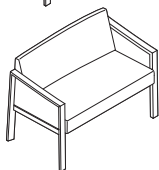
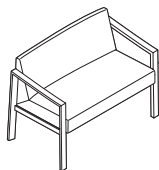
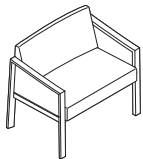
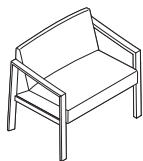

**For Canadian Pricing**

Multiply U.S. Price by the Canadian price factor.

▶ See page 1 for details.



## High-Back Seating

	Standard Includes	Required to Specify
▶ Need help? Product details, page 138	<ul style="list-style-type: none"> <li>• Seat and back: fabric</li> <li>• Arm panels, if selected: fabric</li> <li>• Leg and arm assemblies: wood</li> <li>• Glides: black</li> </ul>	<ol style="list-style-type: none"> <li>1 Style number</li> <li>2 Fabric color number for back and seat</li> <li>3 Wood color number for leg and arm assemblies</li> <li>4 Options, if selected (see below)</li> </ol> <p>▶ See <i>Surface Materials</i>, page 473.</p>

*Tip: Different fabrics for the seat and back can be specified. If the fabrics are in different price groups, calculate list price by adding the two price groups together and dividing by two.*

	Options	U.S. Price	Required to Specify
<b>Surface Materials</b>	<b>Moisture barrier</b> <ul style="list-style-type: none"> <li>• Single-seat chairs</li> </ul>	+\$134	Specify with moisture barrier.
	<b>Arm caps</b> <ul style="list-style-type: none"> <li>• Plastic arm caps: black only</li> </ul>	+\$194	Specify with plastic arm caps.

Specification Information											
U.S. Base Prices											
Style Number	Fabric Price Group 1	Fabric Price Group 2	Fabric Price Group 3	Fabric Price Group 4	Fabric Price Group 5	Fabric Price Group 6	Fabric Price Group 7	Fabric Price Group 8	Fabric Price Group 9	Fabric Price Group 10	COM

### High-Back Chair

#### Open Arm

<b>HS1P1</b>	\$2922	\$3048	\$3180	\$3284	\$3392	\$3454	\$3560	\$3774	\$3906	\$4034	\$2974
--------------	--------	--------	--------	--------	--------	--------	--------	--------	--------	--------	--------

#### Closed Arm

<b>HS1PU1</b>	\$3423	\$3567	\$3699	\$3817	\$3931	\$3999	\$4115	\$4345	\$4491	\$4619	\$3475
---------------	--------	--------	--------	--------	--------	--------	--------	--------	--------	--------	--------

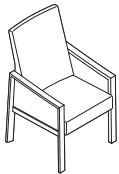
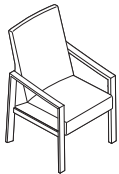

Lounge Seating

Standard Includes	Required to Specify
<ul style="list-style-type: none"> <li>▶ Need help? Product details, page 138</li> <li>• Seat and back: fabric</li> <li>• Arm and back panels: fabric to match back</li> <li>• Legs: wood</li> <li>• Arm caps: wood to match legs</li> <li>• Glides: black</li> </ul>	<ol style="list-style-type: none"> <li>1 Style number</li> <li>2 Fabric color number for seat and back</li> <li>3 Wood color number for legs</li> <li>4 Options, if selected (see below)</li> </ol> <p>▶ See <i>Surface Materials</i>, page 473.</p>

*Tip: Different fabrics for the seat and back can be specified. If the fabrics are in different price groups, calculate list price by adding the two price groups together and dividing by two.*

Options	U.S. Price	Required to Specify
<b>Surface Materials</b> <ul style="list-style-type: none"> <li>• <b>Moisture barrier</b></li> <li>• Lounge chair</li> <li>• Loveseat</li> <li>• Sofa</li> </ul>	<ul style="list-style-type: none"> <li>+\$134</li> <li>+\$268</li> <li>+\$402</li> </ul>	<ul style="list-style-type: none"> <li>Specify with moisture barrier.</li> <li>Specify with moisture barrier.</li> <li>Specify with moisture barrier.</li> </ul>
<b>Arm caps</b> <ul style="list-style-type: none"> <li>• Plastic arm caps: black only</li> </ul>	<ul style="list-style-type: none"> <li>+\$194</li> </ul>	<ul style="list-style-type: none"> <li>Specify with plastic arm caps.</li> </ul>

Specification Information											
U.S. Base Prices											
Style Number	Fabric Price Group 1	Fabric Price Group 2	Fabric Price Group 3	Fabric Price Group 4	Fabric Price Group 5	Fabric Price Group 6	Fabric Price Group 7	Fabric Price Group 8	Fabric Price Group 9	Fabric Price Group 10	COM

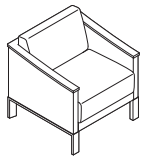

**Lounge Chair**

HS1L1	\$3219	\$3465	\$3709	\$3915	\$4117	\$4241	\$4447	\$4851	\$ 5105	\$ 5341	\$3313

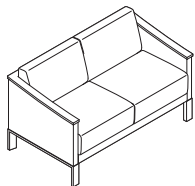

**Loveseat**

HS1L2	\$4987	\$5383	\$5773	\$6105	\$6431	\$6629	\$6953	\$7613	\$ 8021	\$ 8397	\$5081

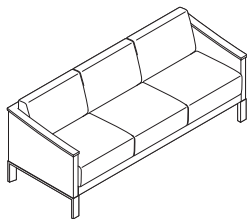

**Sofa**

HS1L3	\$6278	\$6824	\$7364	\$7818	\$8270	\$8546	\$8992	\$9894	\$10,454	\$10,980	\$6372



**For Canadian Pricing**  
 Multiply U.S. Price by the Canadian price factor.  
 ▶ See page 1 for details.

## Bariatric Lounge Seating

	Standard Includes	Required to Specify
▶ Need help? Product details, page 138	<ul style="list-style-type: none"> <li>• Seat and back: fabric</li> <li>• Arm and back panels: fabric to match back</li> <li>• Legs: wood</li> <li>• Arm caps: wood to match legs</li> <li>• Glides: black</li> </ul>	<ol style="list-style-type: none"> <li>1 Style number</li> <li>2 Fabric color number for seat and back</li> <li>3 Wood color number for legs</li> <li>4 Options, if selected (see below)</li> </ol> <p>▶ See <i>Surface Materials</i>, page 473.</p>

*Tip: Different fabrics for the seat and back can be specified. If the fabrics are in different price groups, calculate list price by adding the two price groups together and dividing by two.*

	Options	U.S. Price	Required to Specify
<b>Surface Materials</b>	<b>Moisture barrier</b> <ul style="list-style-type: none"> <li>• Moisture barrier</li> </ul>	+\$134	Specify with moisture barrier.
	<b>Arm caps</b> <ul style="list-style-type: none"> <li>• Plastic arm caps: black only</li> </ul>	+\$194	Specify with plastic arm caps.

Specification Information												
U.S. Base Prices												
Style Number	Width	Fabric Price Group 1	Fabric Price Group 2	Fabric Price Group 3	Fabric Price Group 4	Fabric Price Group 5	Fabric Price Group 6	Fabric Price Group 7	Fabric Price Group 8	Fabric Price Group 9	Fabric Price Group 10	COM

### Bariatric Lounge

<b>HS1L130</b>	30"	\$4568	\$4862	\$5168	\$5414	\$5660	\$5810	\$6056	\$6556	\$6866	\$7150	\$4662
<b>HS1L140</b>	40"	\$4896	\$5244	\$5600	\$5890	\$6184	\$6360	\$6648	\$7240	\$7602	\$7940	\$4990

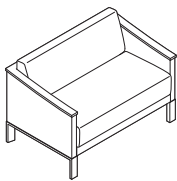
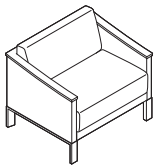

**For Canadian Pricing**  
Multiply U.S. Price by the Canadian price factor.  
▶ See page 1 for details.

## Benches

Powder Coated Steel

Standard Includes		Required to Specify
<ul style="list-style-type: none"> <li>▶ Need help? Product details, page 138</li> </ul>	<ul style="list-style-type: none"> <li>• Seat: fabric</li> <li>• Bench body: powder coated steel</li> <li>• Legs: wood</li> <li>• Table, if selected: paint to match bench body</li> <li>• Glides: black</li> </ul>	<ol style="list-style-type: none"> <li>1 Style number</li> <li>2 Fabric color number for seat</li> <li>3 Paint color number for bench body</li> <li>4 Wood color number for legs</li> <li>5 Options, if selected (see below)</li> </ol> <ul style="list-style-type: none"> <li>▶ See <i>Surface Materials</i>, page 473.</li> </ul>

Options	U.S. Price	Required to Specify
<b>Surface Materials</b> <b>Moisture barrier</b> <ul style="list-style-type: none"> <li>• 21"W Bench</li> <li>• 42"W Bench, 56"W Bench with table unit</li> <li>• 56"W and 70"W Benches, 70"W Bench with table unit</li> </ul>	+\$134 +\$268 +\$402	Specify with moisture barrier. Specify with moisture barrier. Specify with moisture barrier.

Specification Information												
U.S. Base Prices												
Style Number	Width	Fabric Price Group 1	Fabric Price Group 2	Fabric Price Group 3	Fabric Price Group 4	Fabric Price Group 5	Fabric Price Group 6	Fabric Price Group 7	Fabric Price Group 8	Fabric Price Group 9	Fabric Price Group 10	COM

### Benches

<b>HS1B21C</b>	21"	\$2444	\$2488	\$2528	\$2564	\$2599	\$2623	\$2658	\$2726	\$2772	\$2812	\$2540
<b>HS1B42C</b>	42"	\$3111	\$3187	\$3258	\$3322	\$3385	\$3423	\$3485	\$3606	\$3683	\$3756	\$3207
<b>HS1B56C</b>	56"	\$3767	\$3864	\$3960	\$4040	\$4118	\$4165	\$4247	\$4406	\$4504	\$4596	\$3863
<b>HS1B70C</b>	70"	\$4309	\$4426	\$4543	\$4641	\$4738	\$4796	\$4895	\$5089	\$5210	\$5324	\$4405

### Benches with Table

#### 56"W Bench with One Table

<b>HS1B56T1C</b>	56"	\$3767	\$3843	\$3914	\$3978	\$4041	\$4079	\$4141	\$4262	\$4339	\$4412	\$3863
------------------	-----	--------	--------	--------	--------	--------	--------	--------	--------	--------	--------	--------

#### 70"W Bench with One Table

<b>HS1B70T1C</b>	70"	\$4309	\$4406	\$4502	\$4582	\$4660	\$4707	\$4789	\$4948	\$5046	\$5138	\$4405
------------------	-----	--------	--------	--------	--------	--------	--------	--------	--------	--------	--------	--------

#### 70"W Bench with Two Tables

<b>HS1B70T2C</b>	70"	\$4309	\$4385	\$4456	\$4520	\$4583	\$4621	\$4683	\$4804	\$4881	\$4954	\$4405
------------------	-----	--------	--------	--------	--------	--------	--------	--------	--------	--------	--------	--------

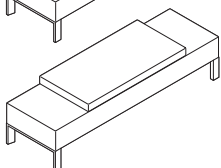
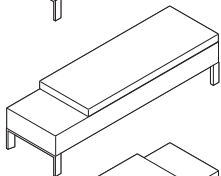
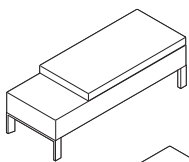
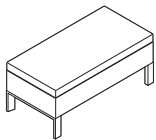

#### For Canadian Pricing

Multiply U.S. Price by the Canadian price factor.

▶ See page 1 for details.

# Tava Tables

**Tava tables** coordinate with the Tava seating line. Freestanding side and coffee tables are available.

**Table top** is available in powdercoated steel.

**Legs** feature mitered joints with internal steel reinforcement.

**Adjustable nylon glides** are standard on legs.

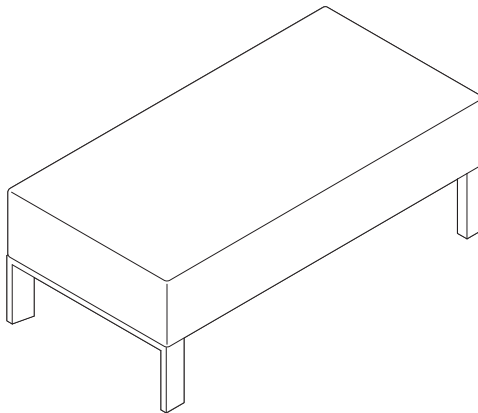
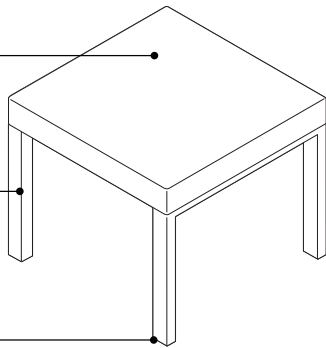

## Product Details

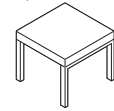
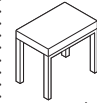

**Side tables** are available in two widths, 14" and 21".

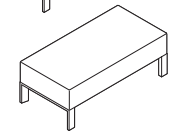
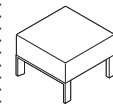

**Coffee tables** are available in two widths, 21" and 42".

## Surface Materials

### Legs

- Ash wood

### Table top

- Powder coated steel
- ▶ See the *Surface Material Reference Manual* for details.

## Actual Dimensions

Features	Overall Depth	Width	Height
Side Table	21"	14" or 21"	18"
Coffee Table	21"	21" or 42"	15"

# Tava Tables

## Freestanding Tables

Powder Coated Steel Top

Standard Includes	Required to Specify
<ul style="list-style-type: none"> <li>▶ Need help? Product details, page 149</li> <li>• Top: powder coated steel</li> <li>• Legs: wood</li> </ul>	<ul style="list-style-type: none"> <li>1 Style number</li> <li>2 Paint color number for top</li> <li>3 Wood color number for legs</li> <li>▶ See <i>Surface Materials</i>, page 473.</li> </ul>

Specification Information				
• Dimensions			• Style	• U.S.
D	W	H	Number	Price
:	:	:	:	:

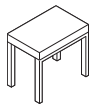

### Side Tables

21"	14"	18"	<b>HS1T1418C</b>	\$1663
21"	21"	18"	<b>HS1T2118C</b>	\$1903
:	:	:	:	:

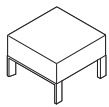

### Coffee Tables

21"	21"	15"	<b>HS1T2115C</b>	\$2124
21"	42"	15"	<b>HS1T4215C</b>	\$2467
:	:	:	:	:



### For Canadian Pricing

Multiply U.S. Price by the Canadian price factor.

▶ See page 1 for details.



# Circa Lounge System by Coalesse

DESIGN ALISON SPEAR, AIA DESIGN ORIGIN: UNITED STATES

Circa lounge system offers a dramatic, creative palette for configuring signature spaces with a wide array of large and small application expressions, from straight to curvilinear modular lounges and ganging or freestanding tables.

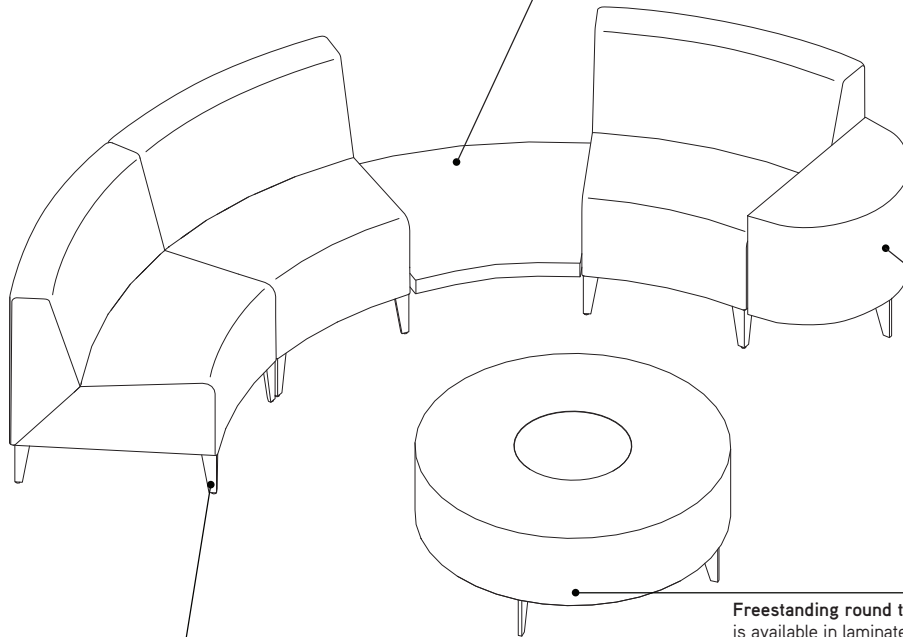

Intermediate tables are available in laminate (with self-edge) or veneer. Tables come with ganging brackets to attach to seating units. Shared application is an option.

End-of-run tables are available in laminate (with self-edge) or veneer. Tables come with ganging brackets to attach to seating unit.

Tapered legs are available in solid wood or metal. Solid wood legs are maple or walnut. Metal legs are offered in optional powder coat paint finishes. Tapered legs on lounge pieces support freestanding applications, allowing units to be easily rearranged.

Ganging kit is available to connect units together and maintain alignment.

Freestanding round table is available in laminate (with self-edge) or veneer. Optional center inserts are available: green tinted glass or power/data module (available in black anodized aluminum or silver anodized aluminum).



# Circa Lounge System by Coalesse

DESIGN ALISON SPEAR, AIA DESIGN ORIGIN: UNITED STATES

## Product Details

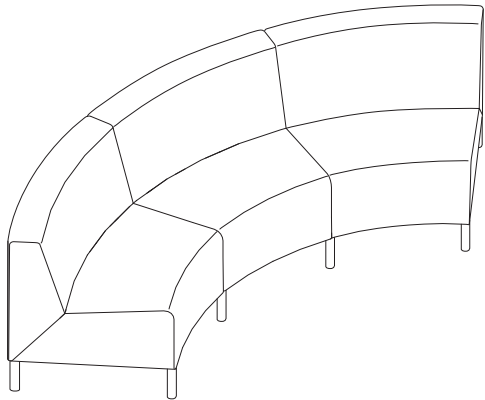

**Cylinder legs** are solid oak. Legs can be specified to be shared between adjacent lounge units, minimizing leg locations and ganging units together, as shown. Legs can also be specified freestanding, supporting individual units that can be easily rearranged.

**Modern metal legs** are available in powder coat paints. Legs can be specified to be shared between adjacent lounge units, minimizing leg locations and ganging units together, as shown. Legs can also be specified freestanding, supporting individual units that can be easily rearranged.

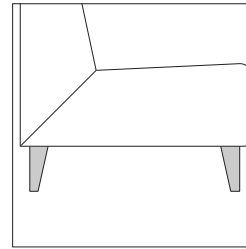

**Tapered legs** are available in solid maple or walnut, as well as optional metal in powder coat paints. Tapered legs on lounge units support freestanding applications, allowing units to be easily rearranged.

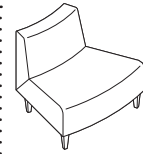

**30° wedge seat** is available outside facing or inside facing.

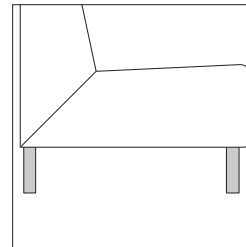
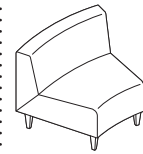

**Cylinder legs** are solid oak and are optional. Legs can be specified to be shared between adjacent lounge units or freestanding application, allowing units to be easily rearranged.

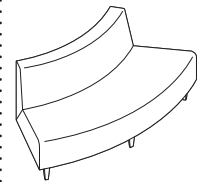

**60° wedge seat** is available outside facing or inside facing.

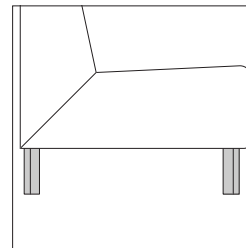
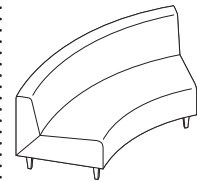

**Modern metal legs** are optional and are available in powder coat paints. Legs can be specified to be shared between adjacent lounge units or freestanding application, allowing units to be easily rearranged.

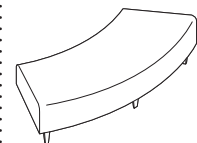

**60° wedge bench** is available and can be used in outside or inside facing applications.

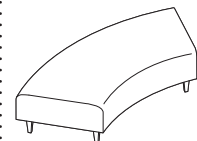

# Circa Lounge System by Coalesse *continued*

DESIGN ALISON SPEAR, AIA DESIGN ORIGIN: UNITED STATES

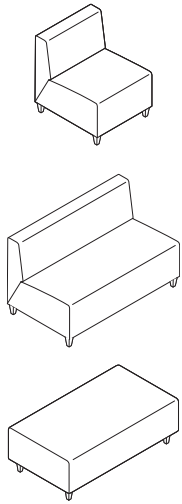

**Straight seating** available as 1-seat lounge, 2-seat lounge, or bench.

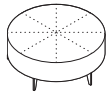

**Round ottoman** has five legs and is upholstered. Measures 42" diameter and 17"H. Tapered legs have a thin blade aesthetic and are available in solid maple and walnut, as well as optional metal in powder coat paints. Cylinder wood leg and modern metal leg are also available.

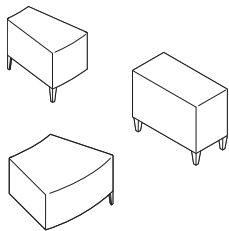

**Straight, inside, or outside (15° or 30°) armrests** can be specified without legs (intermediate) and ganged to adjacent lounge units. Or in end-of-run position, on left or right side.

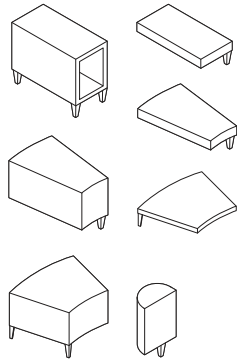

**High and low ganging tables** are available in three sizes: straight, 15° wedge, or 30° wedge. Tables can be specified without legs (intermediate) and ganged to adjacent lounge units or in end-of-run position, on left or right side.

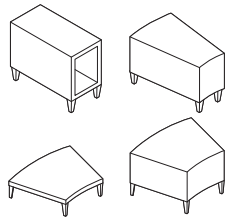

**High and low freestanding tables** are available straight, 15° wedge, or 30° wedge.

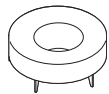

**Freestanding round table** is available in one size, 42" diameter, 15¾"H. Power/data module option available in black anodized aluminum or silver anodized aluminum. The round plate that houses the power module is powder coated to complement the module. Glass insert is available as an option.

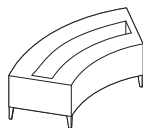

**Freestanding table-planter** is available in one size, 60° wedge. Planter is galvanized aluminum.

## Surface Materials

► See *Coalesse Surface Materials Reference Guide* for further information.

**Upholstery** (contrasting fabric available)

- Fabric
- Leather

## Table tops

- Laminate with self edge (option)
- Veneer
  - Maple veneer (flat cut, low sheen)
  - Walnut veneer (flat cut, low sheen)
  - Oak veneer (rift cut, high and low sheen)

## Tapered legs

- Solid maple (quarter cut, high and low sheen)
- Solid walnut (quarter cut, high and low sheen)
- Painted steel
- Lux Coatings (lounge, armrest, and ottoman only)

## Cylinder wood legs

- Solid oak (rift cut, high and low sheen)

## Modern metal legs

- Painted steel
- Lux Coatings (lounge, armrest, and ottoman only)

## Program and Services

**Customer's Own Material/Leather (COM/COL) Program** is available.

► See *Coalesse Surface Materials Reference Guide* for additional information.

Lounge Seating

# Circa Lounge System by Coalesse

DESIGN ALISON SPEAR, AIA DESIGN ORIGIN: UNITED STATES

Lounge Seating

# Circa Lounge System by Coalesse Upholstered Individual Lounge Units

DESIGN ALISON SPEAR, AIA DESIGN ORIGIN: UNITED STATES

*Tip: Fabrics and leathers will appear loose with comfort wrinkles when upholstered.*

*Tip: Lux Coatings are available on metal leg options for upholstered seating, armrests, and ottomans.*

*Tip: For contrasting fabric, pricing is based on highest grade textile specified.*

*Tip: For Customer's Own Material or Leather, see necessary requirements, important processing instructions, and ordering information. ▶ See Coalesse Surface Materials Reference Guide.*

*Tip: Benches are flat and 1-seat and 2-seat lounges are angled; therefore, seat angles will not be aligned when placed next to each other. A table is recommended between the units to minimize the difference.*

*Tip: All legs measure 6½" in height.*

Standard Includes	Required to Specify
<ul style="list-style-type: none"> <li>▶ Need help? Product details, page 152</li> <li>• Frame: unibody construction of hardwood plywood utilizing box joinery</li> <li>• Upholstery: multiple densities of polyurethane foam fixed seat and back with top stitch on seams</li> <li>• Legs:                             <ul style="list-style-type: none"> <li>– Tapered leg, if selected: solid maple or walnut</li> <li>– Cylinder leg, if selected: solid oak</li> </ul> </li> </ul>	<ol style="list-style-type: none"> <li>1 Style number</li> <li>2 Number of fabrics if contrasting fabric style number is selected</li> <li>3 Fabric or leather color number for upholstery on seat and back</li> <li>4 Wood leg type</li> <li>5 Wood color number for legs</li> <li>6 Options, if selected (see below)</li> </ol> <p>▶ See <i>Coalesse Surface Materials Reference Guide</i>.</p>

Options	U.S. Price	Required to Specify
<b>Surface Materials</b> <ul style="list-style-type: none"> <li>• Contrasting fabric</li> </ul>	+\$182 per fabric	Add suffix K to the style number and select fabric color number.
<b>Acrylic backer</b> <ul style="list-style-type: none"> <li>• 30° outside facing wedge 1-seat lounge</li> <li>• 30° inside facing wedge 1-seat lounge</li> <li>• 60° outside and inside wedge 2-seat lounge</li> <li>• 60° benches</li> <li>• Straight 1-seat lounge</li> <li>• Straight 2-seat lounge</li> <li>• Straight bench</li> </ul>	+\$ 49 +\$ 50 +\$ 88 +\$ 60 +\$ 33 +\$ 74 +\$ 47	Specify with acrylic backer. Specify with acrylic backer. Specify with acrylic backer. Specify with acrylic backer. Specify with acrylic backer. Specify with acrylic backer. Specify with acrylic backer. ▶ See <i>Coalesse Surface Materials Reference Guide</i> .
<b>Shared Leg Application</b> <ul style="list-style-type: none"> <li>• Cylinder wood legs</li> <li>• Modern metal legs</li> </ul>	-\$270 -\$270	Specify with cylinder wood legs. Specify with modern metal legs.
<b>Metal Legs</b> <ul style="list-style-type: none"> <li> <b>Tapered legs</b> <ul style="list-style-type: none"> <li>• Powder coat paint</li> </ul> </li> <li>• Lux Coatings</li> </ul>	+\$204 per leg +\$232 per leg	Specify with tapered metal legs and select color number. ▶ See <i>Coalesse Surface Materials Reference Guide</i> . Specify with tapered metal legs and select Lux Coatings color number. ▶ See <i>Coalesse Surface Materials Reference Guide</i> .
<ul style="list-style-type: none"> <li> <b>Modern legs</b> <ul style="list-style-type: none"> <li>• Powder coat paint</li> </ul> </li> <li>• Lux Coatings</li> </ul>	+\$204 per leg +\$232 per leg	Specify with modern metal legs and select color number. ▶ See <i>Coalesse Surface Materials Reference Guide</i> . Specify with modern metal legs and select Lux Coatings color number. ▶ See <i>Coalesse Surface Materials Reference Guide</i> .

Specification Information														
Style Number	U.S. Base Prices												Leather Grades:	
	Fabric Grades:												COL	C
	COM	6	7	8	9	10	11	12	13	14				

## 30° Outside Facing Wedge 1-Seat Lounge

451-3730FO	\$2079	\$2079	\$2113	\$2167	\$2334	\$2437	\$2561	\$2649	\$2803	\$3016	\$2402	\$4726	\$5153
------------	--------	--------	--------	--------	--------	--------	--------	--------	--------	--------	--------	--------	--------

COM/yds = 3¼, COL/sq ft = 72

▶ Specification Information, continued on next page

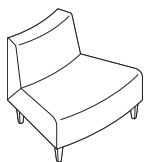

Overall: 28"D 36¾"W 29½"H  
 Inside: 20"D 36¾"W 12¼"H  
 Seat: 17¼"H  
 Angle Degree: 30°

# Circa Lounge System by Coalesse Upholstered Individual Lounge Units

DESIGN ALISON SPEAR, AIA DESIGN ORIGIN: UNITED STATES

► Specification Information, continued from previous page

## Specification Information

Style Number	U.S. Base Prices														Leather Grades:		
	Fabric Grades:														COL	C	E
	COM	6	7	8	9	10	11	12	13	14							

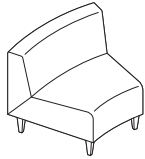

Overall: 28"D 36¾"W 29½"H  
 Inside: 20"D 36¾"W 12¼"H  
 Seat: 17¼"H  
 Angle Degree: 30°

### 30° Inside Facing Wedge 1-Seat Lounge

451-3730FI	\$2079	\$2079	\$2113	\$2167	\$2334	\$2437	\$2561	\$2649	\$2803	\$3016	\$2402	\$4726	\$5153
------------	--------	--------	--------	--------	--------	--------	--------	--------	--------	--------	--------	--------	--------

COM/yds = 3¼, COL/sq ft = 72

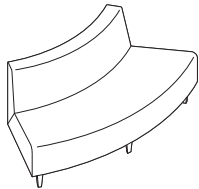

Overall: 28"D 71"W 29½"H  
 Inside: 20"D 71"W 12¼"H  
 Seat: 17¼"H  
 Angle Degree: 60°

### 60° Outside Wedge 2-Seat Lounge

451-7460FO	\$3306	\$3417	\$3478	\$3587	\$3919	\$4133	\$4379	\$4550	\$4858	\$5284	\$3556	\$8288	\$9136
------------	--------	--------	--------	--------	--------	--------	--------	--------	--------	--------	--------	--------	--------

COM/yds = 6½, COL/sq ft = 143

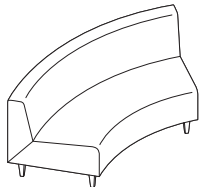

Overall: 28"D 71"W 29½"H  
 Inside: 20"D 71"W 12¼"H  
 Seat: 17¼"H  
 Angle Degree: 60°

### 60° Inside Wedge 2-Seat Lounge

451-7460FI	\$3306	\$3417	\$3478	\$3587	\$3919	\$4133	\$4379	\$4550	\$4858	\$5284	\$3556	\$8288	\$9136
------------	--------	--------	--------	--------	--------	--------	--------	--------	--------	--------	--------	--------	--------

COM/yds = 6½, COL/sq ft = 143

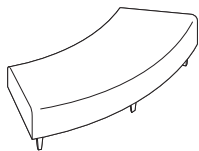

Overall: 28"D 71"W 17¼"H  
 Seat: 17¼"H  
 Angle Degree: 60°

### 60° Outside Wedge Bench

451-B7460FO	\$2621	\$2621	\$2652	\$2701	\$2852	\$2952	\$3064	\$3146	\$3288	\$3483	\$2949	\$5091	\$5491
-------------	--------	--------	--------	--------	--------	--------	--------	--------	--------	--------	--------	--------	--------

COM/yds = 3, COL/sq ft = 66

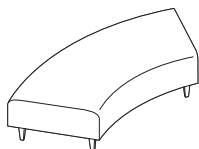

Overall: 28"D 71"W 17¼"H  
 Seat: 17¼"H  
 Angle Degree: 60°

### 60° Inside Wedge Bench

451-B7460FI	\$2621	\$2621	\$2652	\$2701	\$2852	\$2952	\$3064	\$3146	\$3288	\$3483	\$2949	\$5091	\$5491
-------------	--------	--------	--------	--------	--------	--------	--------	--------	--------	--------	--------	--------	--------

COM/yds = 3, COL/sq ft = 66

► Specification Information, continued on next page

 **For Canadian Pricing**  
 Multiply U.S. Price by the Canadian price factor.  
 ► See page 1 for details.

# Circa Lounge System by Coalesse Upholstered Individual Lounge Units *continued*

DESIGN ALISON SPEAR, AIA DESIGN ORIGIN: UNITED STATES

► Specification Information, continued from previous page

## Specification Information

Style Number	U.S. Base Prices													
	Fabric Grades:											Leather Grades:		
	COM	6	7	8	9	10	11	12	13	14	COL	C	E	

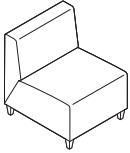

Overall: 28"D 25"W 29½"H  
 Inside: 20"D 25"W 12¼"H  
 Seat: 17¼"H  
 Angle Degree: 0°

### Straight 1-Seat Lounge

451-2500	\$1869	\$1869	\$1892	\$1935	\$2062	\$2143	\$2236	\$2305	\$2422	\$2584	\$2221	\$3988	\$4315
----------	--------	--------	--------	--------	--------	--------	--------	--------	--------	--------	--------	--------	--------

COM/yds = 2½, COL/sq ft = 55

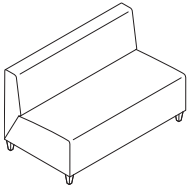

Overall: 28"D 50"W 29½"H  
 Inside: 20"D 50"W 12¼"H  
 Seat: 17¼"H  
 Angle Degree: 0°

### Straight 2-Seat Lounge

451-5000	\$2682	\$2712	\$2762	\$2846	\$3101	\$3263	\$3457	\$3590	\$3823	\$4152	\$2939	\$6556	\$7209
----------	--------	--------	--------	--------	--------	--------	--------	--------	--------	--------	--------	--------	--------

COM/yds = 5, COL/sq ft = 110

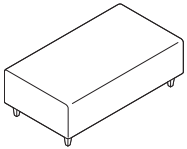

Overall: 28"D 50"W 17¼"H  
 Seat: 17¼"H  
 Angle Degree: 0°

### Straight Bench

451-B5000	\$2387	\$2387	\$2418	\$2467	\$2618	\$2718	\$2830	\$2912	\$3054	\$3249	\$2708	\$4864	\$5244
-----------	--------	--------	--------	--------	--------	--------	--------	--------	--------	--------	--------	--------	--------

COM/yds = 3, COL/sq ft = 66

*Tip: Please submit sketch for modular application. One kit is required per two chairs.*

### Ganging Kit

451-GANGPKG	\$ 56	N.A.	N.A.	N.A.	N.A.	N.A.	N.A.	N.A.	N.A.	N.A.	N.A.	N.A.	N.A.
-------------	-------	------	------	------	------	------	------	------	------	------	------	------	------



**For Canadian Pricing**  
 Multiply U.S. Price by the Canadian price factor.  
 ► See page 1 for details.

# Circa Lounge System by Coalesse Upholstered Individual Lounge Units

DESIGN ALISON SPEAR, AIA DESIGN ORIGIN: UNITED STATES

# Circa Lounge System by Coalesse Upholstered Modular Arm Rests—Straight, 15°, 30°, and Ottoman

DESIGN ALISON SPEAR, AIA DESIGN ORIGIN: UNITED STATES

*Tip: Fabrics and leathers will appear loose with comfort wrinkles when upholstered.*

*Tip: Cylinder wood and modern metal legs cannot be in shared position with armrests. The legs will always be on the lounge side.*

*Tip: Lux Coatings are available on metal leg options for upholstered seating, armrests, and ottomans only.*

*Tip: For Customer's Own Material or Leather, see necessary requirements, important processing instructions, and ordering information. ▶ See Coalesse Surface Materials Reference Guide.*

*Tip: All legs measure 6½" in height.*

Standard Includes		Required to Specify
▶ Need help? Product details, page 152	<ul style="list-style-type: none"> <li>• Frame: hardwood panels</li> <li>• Upholstery: multiple densities of polyurethane foam</li> <li>• Top stitch on seams</li> <li>• Legs:                             <ul style="list-style-type: none"> <li>– Tapered leg, if selected: solid maple or walnut</li> <li>– Cylinder leg, if selected: solid oak</li> </ul> </li> </ul>	1 Style number 2 Fabric or leather color number for arm rests 3 Wood leg type 4 Wood color number for legs 5 Options, if selected (see below) ▶ See <i>Coalesse Surface Materials Reference Guide</i> .

Options	U.S. Price	Required to Specify
<b>Surface Materials</b>		
• Contrasting fabric on ottoman	+\$182 per fabric	Add suffix K to the style number and select fabric color number.
<b>Acrylic backer</b>		
• Straight armrests and 15° armrests	+\$ 28	Specify with acrylic backer. ▶ See <i>Coalesse Surface Materials Reference Guide</i> .
• 30° armrests and ottoman	+\$ 49	Specify with acrylic backer. ▶ See <i>Coalesse Surface Materials Reference Guide</i> .
<b>Metal Legs</b>		
<b>Tapered legs</b>		
• Powder coat paint	+\$204 per leg	Specify with tapered metal legs and select color number. ▶ See <i>Coalesse Surface Materials Reference Guide</i> .
• Lux Coatings	+\$232 per leg	Specify with tapered metal legs and select Lux Coatings color number. ▶ See <i>Coalesse Surface Materials Reference Guide</i> .
<b>Modern legs</b>		
• Powder coat paint	+\$204 per leg	Specify with modern metal legs and select color number. ▶ See <i>Coalesse Surface Materials Reference Guide</i> .
• Lux Coatings	+\$232 per leg	Specify with modern metal legs and select Lux Coatings color number. ▶ See <i>Coalesse Surface Materials Reference Guide</i> .

## Specification Information

Style Number	U.S. Base Prices												Leather Grades:			
	Fabric Grades:												COL	C	E	
COM	6	7	8	9	10	11	12	13	14							

### Straight Armrest—Intermediate without Legs

451-A1800G	\$1152	\$1152	\$1175	\$1212	\$1326	\$1400	\$1487	\$1547	\$1655	\$1801	\$1463	\$2842	\$3095
COM/yds = 2¼, COL/sq ft = 50													

### Straight Armrest—End of Run with Two Legs

451-A1800ER	\$1334	\$1334	\$1357	\$1394	\$1508	\$1582	\$1669	\$1729	\$1837	\$1983	\$1645	\$3024	\$3277
COM/yds = 2¼, COL/sq ft = 50													

▶ Specification Information, continued on next page



Overall: 28"D 18½"W 17"H



Overall: 28"D 18½"W 23½"H

*Tip: Specify left or right facing.*



**For Canadian Pricing**  
 Multiply U.S. Price by the Canadian price factor.  
 ▶ See page 1 for details.



# Circa Lounge System by Coalesse

DESIGN ALISON SPEAR, AIA DESIGN ORIGIN: UNITED STATES

Upholstered Modular Arm Rests—Straight, 15°, 30°, and Ottoman

► Specification Information, continued from previous page

## Specification Information

Style Number	U.S. Base Prices											Leather Grades:		
	Fabric Grades:											COL	C	E
	COM	6	7	8	9	10	11	12	13	14				



Overall: 28¾"D 18½"W 17"H

### 15° Inside Armrest—Intermediate without Legs

451-A1815FIG	\$1142	\$1142	\$1162	\$1193	\$1295	\$1362	\$1439	\$1491	\$1584	\$1715	\$1463	\$2681	\$2902
COM/yds = 2, COL/sq ft = 44													



Overall: 28¾"D 18½"W 23½"H  
Tip: Specify left or right facing.

### 15° Inside Armrest—End of Run with Two Legs

451-A1815FIER	\$1402	\$1402	\$1422	\$1453	\$1555	\$1622	\$1699	\$1751	\$1844	\$1975	\$1723	\$2941	\$3162
COM/yds = 2, COL/sq ft = 44													

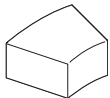

Overall: 29½"D 36¾"W 17"H

### 30° Inside Arm Rest—Intermediate without Legs

451-A3730FIG	\$1629	\$1629	\$1660	\$1709	\$1860	\$1960	\$2072	\$2154	\$2296	\$2491	\$1900	\$3763	\$4102
COM/yds = 3, COL/sq ft = 66													

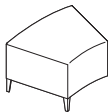

Overall: 29½"D 36¾"W 23½"H  
Tip: Specify left or right facing.

### 30° Inside Arm Rest—End of Run with Two Legs

451-A3730FIER	\$1827	\$1827	\$1858	\$1907	\$2058	\$2158	\$2270	\$2352	\$2494	\$2689	\$2098	\$3961	\$4300
COM/yds = 3, COL/sq ft = 66													



Overall: 28¾"D 18½"W 17"H

### 15° Outside Armrest—Intermediate without Legs

451-A1815FOG	\$1142	\$1142	\$1162	\$1193	\$1295	\$1362	\$1439	\$1491	\$1584	\$1715	\$1463	\$2681	\$2902
COM/yds = 2, COL/sq ft = 44													



Overall: 28¾"D 18½"W 23½"H  
Tip: Specify left or right facing.

### 15° Outside Armrest—End of Run with Two Legs

451-A1815FOER	\$1402	\$1402	\$1422	\$1453	\$1555	\$1622	\$1699	\$1751	\$1844	\$1975	\$1723	\$2941	\$3162
COM/yds = 2, COL/sq ft = 44													

► Specification Information, continued on next page

 **For Canadian Pricing**  
Multiply U.S. Price by the Canadian price factor.  
► See page 1 for details.

# Circa Lounge System by Coalesse Upholstered Modular Arm Rests—Straight,

DESIGN ALISON SPEAR, AIA DESIGN ORIGIN: UNITED STATES 15°, 30°, and Ottoman *continued.*

► Specification Information, continued from previous page

## Specification Information

Style Number	U.S. Base Prices											Leather Grades:		
	Fabric Grades:											COL	C	E
	COM	6	7	8	9	10	11	12	13	14				

### 30° Outside Arm Rest—Intermediate without Legs

451-A3730FOG	\$1629	\$1629	\$1660	\$1709	\$1860	\$1960	\$2072	\$2154	\$2296	\$2491	\$1900	\$3763	\$4102
COM/yds = 3, COL/sq ft = 66													

### 30° Outside Arm Rest—End of Run with Two Legs

451-A3730FOER	\$1827	\$1827	\$1858	\$1907	\$2058	\$2158	\$2270	\$2352	\$2494	\$2689	\$2098	\$3961	\$4300
COM/yds = 3, COL/sq ft = 66													

### Round Ottoman with Five Legs

451-B42RD	\$2489	\$2489	\$2523	\$2577	\$2744	\$2847	\$2971	\$3059	\$3213	\$3426	\$2749	\$4779	\$5139
COM/yds = 3¼, COL/sq ft = 72													

### Ganging Kit

451-GANGPKG	\$ 56	N.A.	N.A.	N.A.	N.A.	N.A.	N.A.	N.A.	N.A.	N.A.	N.A.	N.A.	N.A.
-------------	-------	------	------	------	------	------	------	------	------	------	------	------	------

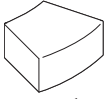

Overall: 29½"D 36¾"W 17"H

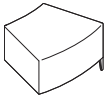

Overall: 29½"D 36¾"W 23½"H  
Tip: Specify left or right facing.

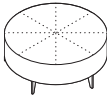

Overall: 42"Dia. 17"H

Tip: Please submit sketch for modular application. One kit is required per two chairs.



**For Canadian Pricing**  
Multiply U.S. Price by the Canadian price factor.  
► See page 1 for details.

# Circa Lounge System by Coalesse

DESIGN ALISON SPEAR, AIA DESIGN ORIGIN: UNITED STATES

Upholstered Modular Arm Rests—Straight,  
15°, 30°, and Ottoman

# Circa Lounge System by Coalesse Modular Tables

DESIGN ALISON SPEAR, AIA DESIGN ORIGIN: UNITED STATES

	Standard Includes	Required to Specify
► Need help? Product details, page 152	<ul style="list-style-type: none"> <li>Table: hardwood veneer</li> <li>Legs:                             <ul style="list-style-type: none"> <li>- Tapered leg, if selected: solid maple or walnut</li> <li>- Cylinder leg, if selected: solid oak</li> </ul> </li> <li>Brackets and hardware, if ganging or end-of-run tables selected</li> </ul>	<ol style="list-style-type: none"> <li>Style number</li> <li>Wood color number for table</li> <li>Wood leg type</li> <li>Wood color number for legs</li> <li>Options, if selected (see below)</li> </ol> ► See <i>Coalesse Surface Materials Reference Guide</i> .

	Options	U.S. Price	Required to Specify
<b>Surface Materials</b>	<b>Table</b> <ul style="list-style-type: none"> <li>Laminate with self edge</li> </ul>	Prices below	Specify with laminate and select laminate color number. ► See <i>Coalesse Surface Materials Reference Guide</i> .
<b>Metal Legs</b>	<b>Tapered legs</b> <ul style="list-style-type: none"> <li>Powder coat paint</li> </ul>	+\$204 per leg	Specify with tapered metal legs and select color number. ► See <i>Coalesse Surface Materials Reference Guide</i> .
	<b>Modern legs</b> <ul style="list-style-type: none"> <li>Powder coat paint</li> </ul>	+\$204 per leg	Specify with modern metal legs and select color number. ► See <i>Coalesse Surface Materials Reference Guide</i> .

Tip: All legs measure 6½" in height.

Specification Information		
Style Number	U.S. Base Prices	
	Laminate	Wood Veneer

## 15° Low Wedge Table, Ganging

45-T1815LG	\$1757	\$2023
------------	--------	--------

## 15° Low Wedge Table, End-of-Run, Two Legs

45-T1815LER	\$1882	\$2296
-------------	--------	--------

## 15° High Wedge Table, Ganging

45-T1815HG	\$2229	\$2793
------------	--------	--------

## 15° High Wedge Table, End-of-Run, Two Legs

45-T1815HER	\$2351	\$3053
-------------	--------	--------

## 15° High Wedge Table, Freestanding, Four Legs

45-T1815H	\$2473	\$3331
-----------	--------	--------

## 30° Low Wedge Table, Ganging

45-T3730LG	\$2203	\$2478
------------	--------	--------

## 30° Low Wedge Table, End-of-Run, Two Legs

45-T3730LER	\$2328	\$2772
-------------	--------	--------

► Specification Information, continued on next page

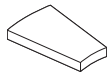

Overall: 28" D 18½" W 8½" H  
Angle Degree: 15°

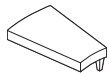

Overall: 28" D 18½" W 8½" H  
Angle Degree: 15°

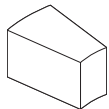

Overall: 28" D 18½" W 22½" H  
Angle Degree: 15°

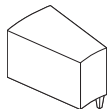

Overall: 28" D 18½" W 22½" H  
Angle Degree: 15°

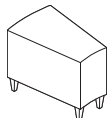

Overall: 28" D 18½" W 22½" H  
Angle Degree: 15°

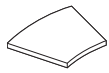

Overall: 29" D 36⅝" W 2" H  
(8½" from floor once assembled)

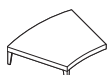

Overall: 29" D 36⅝" W 8½" H

# Circa Lounge System by Coalesse Modular Tables

DESIGN ALISON SPEAR, AIA DESIGN ORIGIN: UNITED STATES

► Specification Information, continued from previous page

## Specification Information

Style Number	U.S. Base Prices	
	Laminate	Wood Veneer

### 30° High Wedge Table, Ganging

45-T3730HG	\$3093	\$3531
------------	--------	--------

### 30° High Wedge Table, End-of-Run, Two Legs

45-T3730HER	\$3217	\$3818
-------------	--------	--------

### Straight Low Table, Ganging

45-T1300LG	\$1755	\$1977
------------	--------	--------

### Straight Low Table, End-of-Run, Two Legs

45-T1300LER	\$1882	\$2296
-------------	--------	--------

### Straight High Table, Ganging

45-T1300HG	\$2580	\$3166
------------	--------	--------

### Straight High Table, End-of-Run, Two Legs

45-T1300HER	\$2923	\$3707
-------------	--------	--------

### Straight High Table, Freestanding, Four Legs

45-T1300H	\$3045	\$3928
-----------	--------	--------

### 30° End-of-Run, One Leg

45-T28HER	\$2425	\$2992
-----------	--------	--------

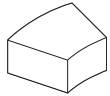

Overall: 29"D 36<sup>5</sup>/<sub>8</sub>"W 16"H

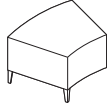

Overall: 29"D 36<sup>5</sup>/<sub>8</sub>"W 22<sup>1</sup>/<sub>2</sub>"H

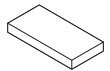

Overall: 27<sup>1</sup>/<sub>2</sub>"D 13<sup>1</sup>/<sub>2</sub>"W 8<sup>1</sup>/<sub>2</sub>"H  
Angle Degree: 0°

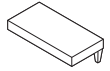

Overall: 27<sup>1</sup>/<sub>2</sub>"D 13<sup>1</sup>/<sub>2</sub>"W 8<sup>1</sup>/<sub>2</sub>"H  
Angle Degree: 0°

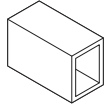

Overall: 27<sup>1</sup>/<sub>2</sub>"D 13<sup>1</sup>/<sub>2</sub>"W 22<sup>1</sup>/<sub>2</sub>"H  
Angle Degree: 0°

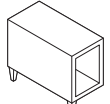

Overall: 27<sup>1</sup>/<sub>2</sub>"D 13<sup>1</sup>/<sub>2</sub>"W 22<sup>1</sup>/<sub>2</sub>"H  
Angle Degree: 0°

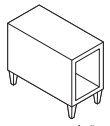

Overall: 27<sup>1</sup>/<sub>2</sub>"D 13<sup>1</sup>/<sub>2</sub>"W 22<sup>1</sup>/<sub>2</sub>"H  
Angle Degree: 0°



Overall: 13<sup>3</sup>/<sub>4</sub>"D 27<sup>1</sup>/<sub>2</sub>"W 22<sup>1</sup>/<sub>4</sub>"H  
(8<sup>1</sup>/<sub>2</sub>" from floor once assembled)  
*Tip: Model 45-T28HER has only a single width tapered leg, no corner.*

#### Options for Creating 90° Applications:

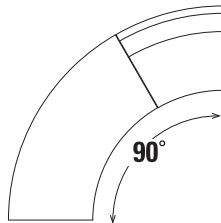

- (1) 30° Outside or Inside Facing Wedge Seat
- (1) 60° Wedge Bench

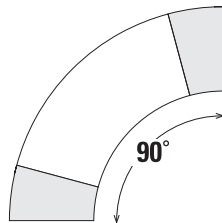

- (2) 15° Wedge Tables
- (1) 60° Wedge Bench

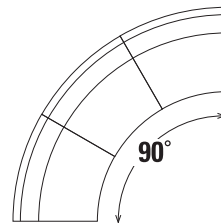

- (3) 30° Outside or Inside Facing Wedge Seats

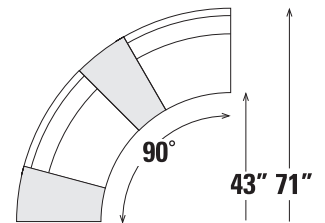

- (2) 30° Outside or Inside Facing Wedge Seats
- (2) 15° Wedge Tables



**For Canadian Pricing**  
Multiply U.S. Price by the Canadian price factor.  
► See page 1 for details.

# Circa Lounge System by Coalesse Freestanding Round Table

DESIGN ALISON SPEAR, AIA DESIGN ORIGIN: UNITED STATES

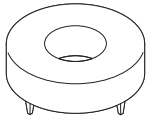

Overall: 42" dia. 15¾"H

*Tip: Tapered wood and metal legs have a thin, blade aesthetic.*

*Tip: All legs measure 6½" in height.*

*Tip: The round plate that houses the power/data module is powder coated to complement the power/data module finish. For the black anodized aluminum module, the round plate will be painted in 4710 Low Gloss Black. For the silver anodized aluminum module, the round plate will be painted 4799 Platinum.*

Standard Includes		Required to Specify
<ul style="list-style-type: none"> <li>▶ Need help? Product details, page 152</li> </ul>	<ul style="list-style-type: none"> <li>• Table: laminate</li> <li>• Legs:                             <ul style="list-style-type: none"> <li>- Tapered leg, if selected: solid maple or walnut</li> <li>- Cylinder leg, if selected: solid oak</li> </ul> </li> </ul>	<ol style="list-style-type: none"> <li>1 Style number</li> <li>2 Laminate color number for table</li> <li>3 Wood leg type</li> <li>4 Wood color number for legs</li> <li>5 Options, if selected (see below)</li> </ol> <p>▶ See <i>Coalesse Surface Materials Reference Guide</i>.</p>

Options		U.S. Price	Required to Specify
<b>Surface Materials</b>	<b>Table</b>		
	<ul style="list-style-type: none"> <li>• Wood veneer</li> </ul>	Price below	Specify with <i>wood veneer</i> and select wood color number. ▶ See <i>Coalesse Surface Materials Reference Guide</i> .
	<ul style="list-style-type: none"> <li>• Sunburst wood veneer</li> </ul>	Price below	Specify with <i>sunburst wood veneer</i> and select wood color number. ▶ See <i>Coalesse Surface Materials Reference Guide</i> .
<b>Metal Legs</b>	<b>Tapered legs</b>		
	<ul style="list-style-type: none"> <li>• Powder coat paint</li> </ul>	+\$204 per leg	Specify with <i>tapered metal legs</i> and select color number. ▶ See <i>Coalesse Surface Materials Reference Guide</i> .
	<b>Modern legs</b>		
	<ul style="list-style-type: none"> <li>• Powder coat paint</li> </ul>	+\$204 per leg	Specify with <i>modern metal legs</i> and select color number. ▶ See <i>Coalesse Surface Materials Reference Guide</i> .
<b>Glass Insert</b>	<ul style="list-style-type: none"> <li>• Green tinted glass insert ¾" thick with white enamel bottom square edge detail</li> </ul>	+\$399	Specify with <i>glass insert</i> .
<b>Power/Data Module</b>	<ul style="list-style-type: none"> <li>• Two power/two data ports black anodized aluminum or silver anodized aluminum</li> </ul>	+\$592	Specify finish color number.

Specification Information			
Style Number	U.S. Base Prices		
	Laminate	Wood Veneer	Sunburst Wood Veneer

Round Table, Freestanding, Four Legs			
45-T42RD	\$4172	\$5563	\$5994



**For Canadian Pricing**  
Multiply U.S. Price by the Canadian price factor.  
▶ See page 1 for details.

# Circa Lounge System by Coalesse Multi-Fabric Diagram

DESIGN ALISON SPEAR, AIA DESIGN ORIGIN: UNITED STATES

Applies to all Circa models including: Straight 1-Seat Lounge, Wedge, and Straight 2-Seat Lounge

TO: \_\_\_\_\_

FROM: \_\_\_\_\_

DATE: \_\_\_\_\_

FAX...888.413.5161

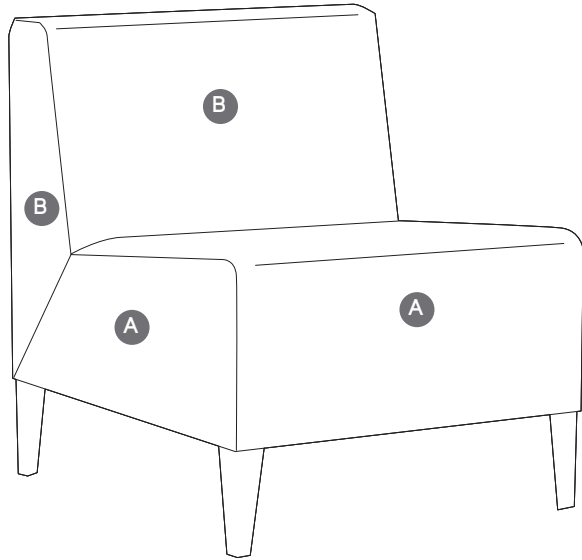

**A** Upholstery Selection (default for entire unit if B is not selected):

\_\_\_\_\_

\_\_\_\_\_

**B** Back: \_\_\_\_\_

\_\_\_\_\_

*\*See specifying for contrasting fabric upcharge. List price based on highest fabric grade usage.*

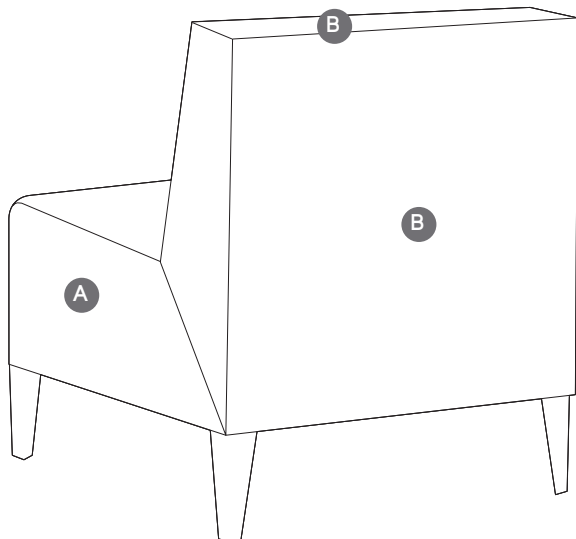

Specify model below:

451-7460FOK Outside Facing

451-7460FIK Inside Facing

451-5000K

451-2500K

451-3730FOK Outside Facing

451-3730FIK Inside Facing

# Jenny Lounge

**Jenny lounge products**

are fully upholstered and have a relaxed appearance. They may show soft comfort wrinkles upon use.

► Specifying, pages 174–196

**Standard Jenny chairs**

are available in one arm, armless, wood arms, corner, ottoman, round, and club.

*Tip: There are height differences between Jenny low and Jenny. Please use caution when mixing Jenny low chairs with standard Jenny due to the lower height of Jenny low.*

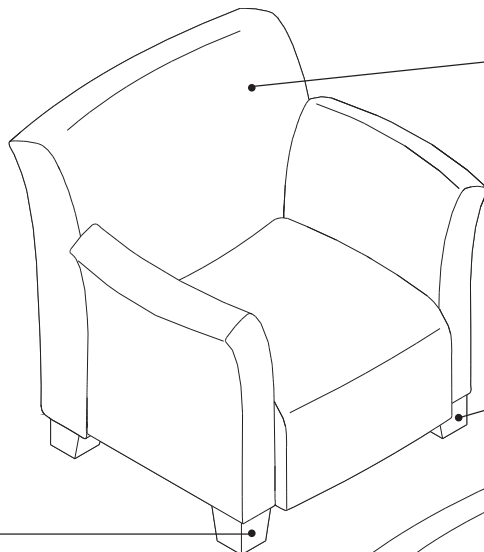

**Jenny** comes fully assembled.

**Legs** have options of wood (square or round), brushed aluminum, and/or with casters.

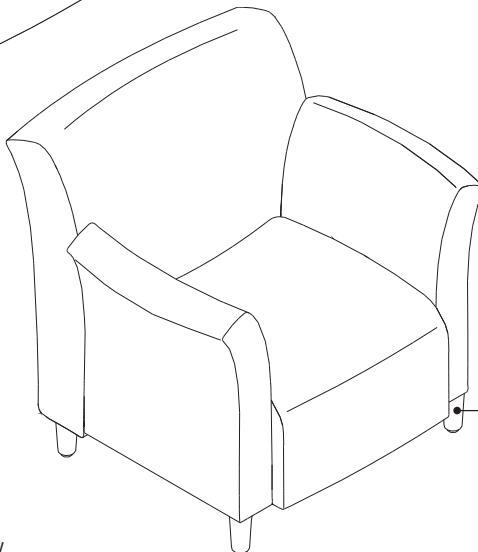

**Legs** are standard in black plastic except for Jenny round which has standard brushed aluminum legs.

**Jenny low chairs** are available in club and round.

They have an adjusted seat angle, and lowered height to align for work at lounge posture.

**Seat** is angled to allow a deeper sit.

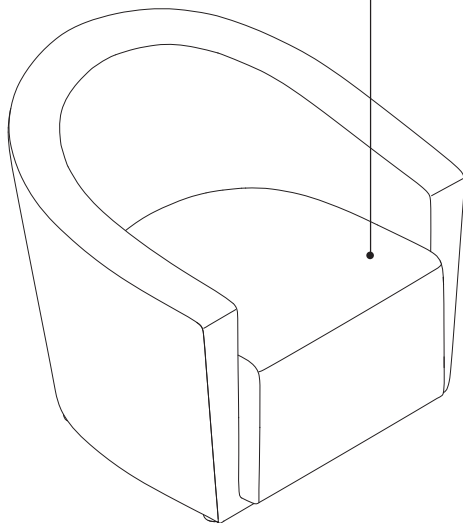

**Round wood legs** are solid maple and are available in three finishes. *Tip: Wood legs are natural wood and may have variations in color.*

**Seat** is angled to allow a deeper sit.

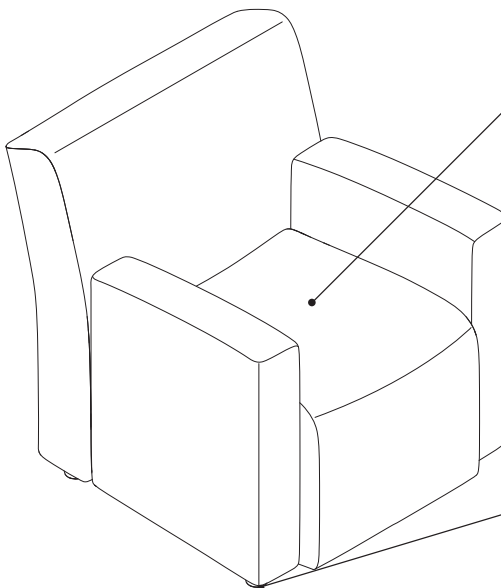

**Jenny low chairs** come standard with low feet.



**Jenny tables** are available as a coffee table or end table. Tops of tables are available in Low-Pressure Laminate and High-Pressure Laminate. Sides and bottom of table are only available in Low-Pressure Laminate. Jenny tables ship fully assembled without feet installed. Feet are ready to install.

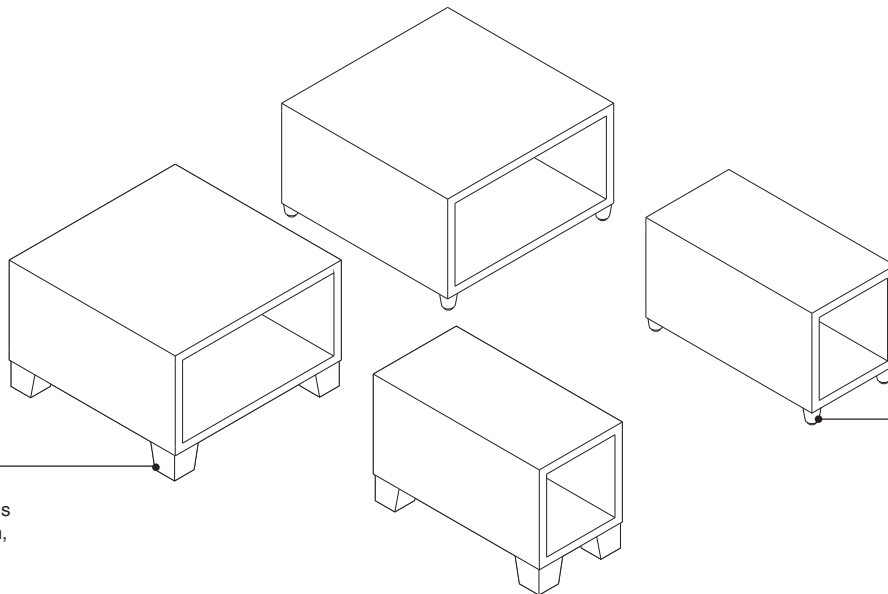

**Legs** are standard in black and have options for low feet, aluminum, and wood legs.

**Round wood legs** are solid maple and are available in three finishes. *Tip: Wood legs are natural wood and may have variations in color.*

Jenny Lounge, continued

**Product Details**

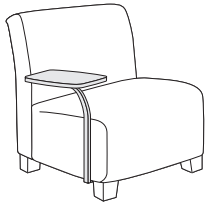

**Tablet arm** is only available on armless and one arm versions of Jenny.

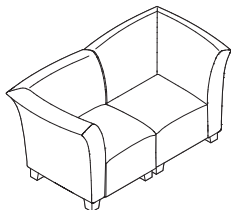

**Two Jenny pieces** shown as a love seat.

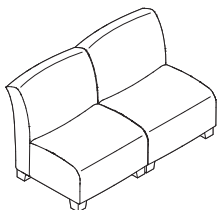

**Two armless Jenny pieces** shown as a bench.

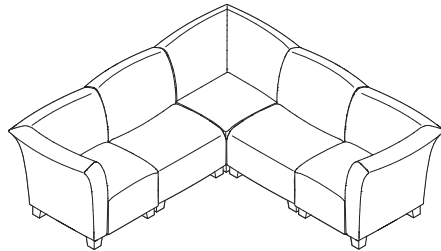

**Jenny seating shown** as a sectional.

**Hard dual-wheel casters** are for use on carpet. Use on hard surfaces, including floor mats, will affect chair stability and may result in personal injury.

**Brushed aluminum legs** are adjustable and have 3/4" of height adjustment.

**Casters and tablet arm** are not retrofittable on style numbers TS31403 or TS31404.

**There** are height differences between Jenny low and Jenny. Please use caution when mixing Jenny low chairs with standard Jenny due to the lower height of Jenny low.

**Club, club low, round, and round low** have deck stitch detail. The rest of Jenny has welting detail.

**Surface Materials**

**Upholstery and hard components**

There may be sheen or texture differences when using Low-Pressure Laminate and High-Pressure Laminate in adjacent applications. Please use caution when mixing and matching different work surface types.

Leather price group option ships at extended lead times.

**Jenny Corner**

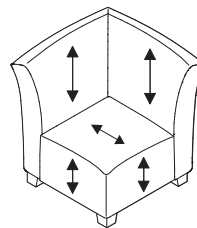

*Tip: Standard seat fabric directionality is applied as the diagram above indicates (e.g. TS31406).*

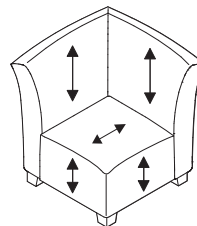

*Tip: Reverse seat fabric directionality is applied as the diagram above indicates (e.g. TS31426).*

**With Wood Arms**

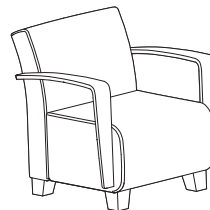

*Tip: On Jenny with wood arms, due to natural variations in wood, finished products may vary in color, texture, and grain.*

**Legs**

- Black plastic
- Brushed aluminum

**With Square Wood Legs**

- 3412 Natural Cherry
- 3522 Clear Maple
- 3762 Dark Walnut

**With Round Wood Legs**

- V1AM Clear Maple
- V1AC Natural Cherry
- V1EW Dark Walnut

*Tip: Finish 3522 Clear Maple is a clear coat and therefore natural variations in wood will be visible.*

*Tip: Wood legs are natural wood and may have variations in color.*

**Dimensions**

▶ Page 172

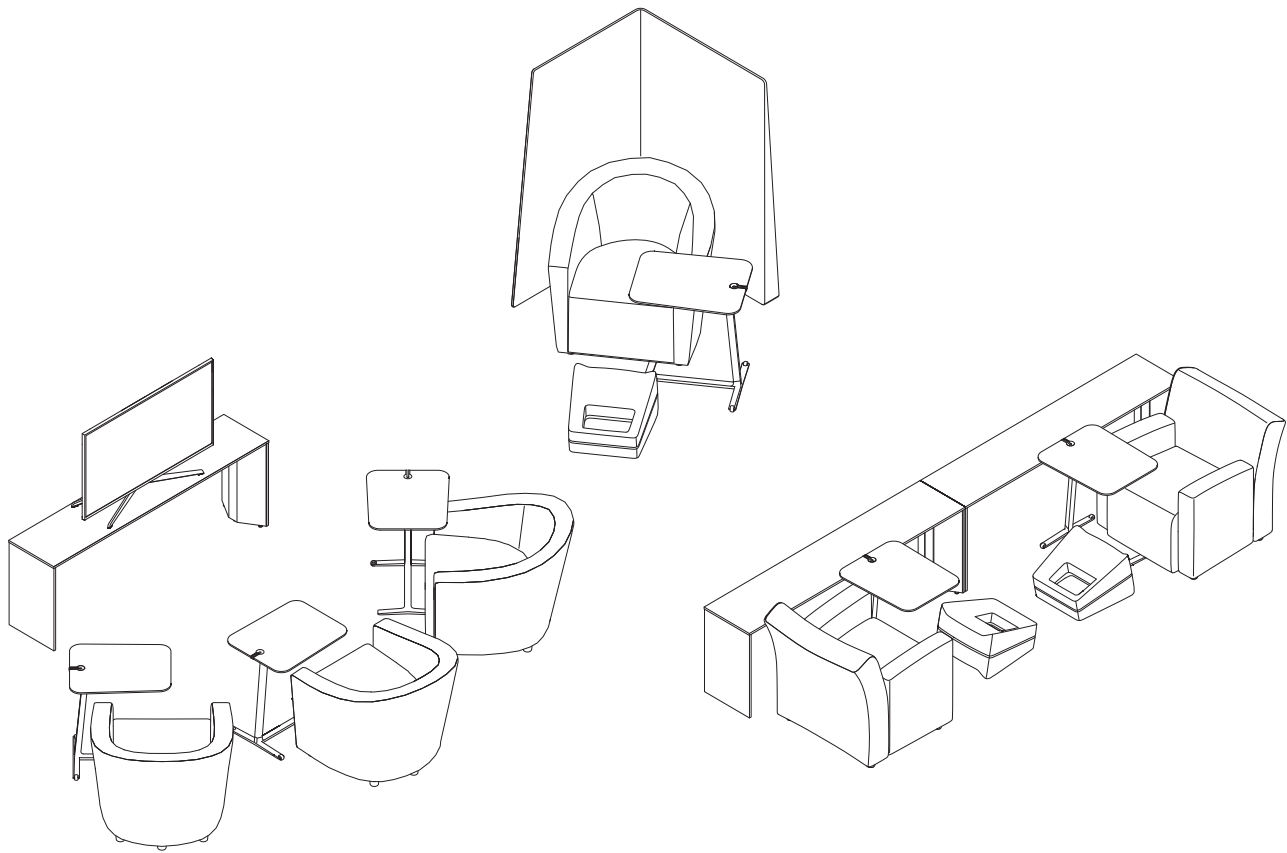

The **Campfire skate table** provides work space and slides easily around the Jenny low feet and over the arms.

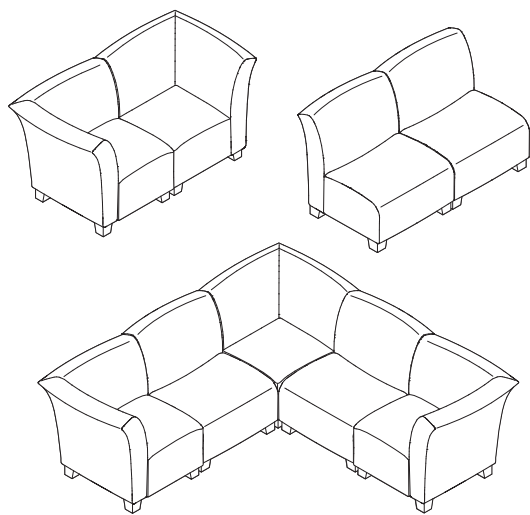

**Jenny seating** allows many different configurations using armless, left or right arms only, or corner version. Create a love seat, bench, or sectional using Jenny.

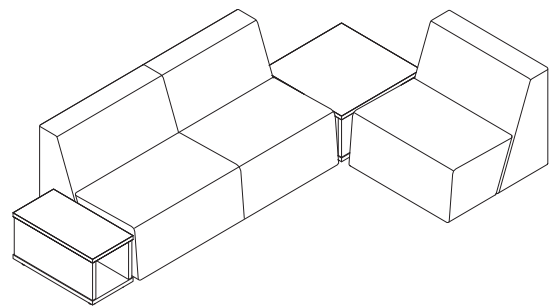

**Jenny tables with the optional low foot** align well with Campfire lounges.

# Dimensions

## Jenny Lounge

Features	Overall Depth	Width	Height	Functional Seat Depth	Seat Width	Seat Height from Floor	Back Width	Back Height from Seat	Width Between Arms
<b>Jenny Lounge</b>									
<b>Lounge Seating</b>									
Armless	32 <sup>1</sup> / <sub>2</sub> "	28 <sup>1</sup> / <sub>2</sub> "	32 <sup>1</sup> / <sub>4</sub> "	21"	28 <sup>1</sup> / <sub>2</sub> "	16", compressed	28 <sup>1</sup> / <sub>2</sub> "	18"	N.A.
Both Arms	32 <sup>1</sup> / <sub>2</sub> "	34 <sup>1</sup> / <sub>2</sub> "	32 <sup>1</sup> / <sub>4</sub> "	21"	19 <sup>3</sup> / <sub>4</sub> "	16", compressed	28 <sup>1</sup> / <sub>2</sub> "	18"	26"
Right arm or Left arm only	32 <sup>1</sup> / <sub>2</sub> "	31 <sup>1</sup> / <sub>2</sub> "	32 <sup>1</sup> / <sub>4</sub> "	21"	23 <sup>1</sup> / <sub>2</sub> "	16", compressed	28 <sup>1</sup> / <sub>2</sub> "	18"	N.A.
Corner	32"	32"	32"	20"	20"	N.A.	N.A.	18"	N.A.
Club	32"	31 <sup>3</sup> / <sub>4</sub> "	32 <sup>1</sup> / <sub>4</sub> "	21"	19"	16", compressed	28"	16"	19 <sup>1</sup> / <sub>2</sub> "
Round	32"	30"	31 <sup>3</sup> / <sub>4</sub> "	21"	20"	16", compressed	28 <sup>1</sup> / <sub>2</sub> "	13"	19 <sup>1</sup> / <sub>2</sub> "
Wood Arms	32 <sup>1</sup> / <sub>2</sub> "	32 <sup>1</sup> / <sub>2</sub> "	32 <sup>1</sup> / <sub>2</sub> "	21"	24"	16", compressed	24"	16"	24 <sup>1</sup> / <sub>4</sub> "
Ottoman	27 <sup>1</sup> / <sub>2</sub> "	28 <sup>1</sup> / <sub>2</sub> "	18"	N.A.	N.A.	N.A.	N.A.	N.A.	N.A.
Club Low	32"	31 <sup>3</sup> / <sub>4</sub> "	30"	21"	19"	14", compressed	28"	18 <sup>1</sup> / <sub>2</sub> "	19 <sup>1</sup> / <sub>2</sub> "
Round Low	32"	30"	28"	21"	20"	14", compressed	N.A.	14"	19 <sup>1</sup> / <sub>2</sub> "

• Arm Rest Width	• Arm Rest Length	• Arm Height to Floor	• Arm Height from Seat	• Tablet Width	• Tablet Length	• Tablet Height to Floor	• Tablet Height from Seat
N.A.	N.A.	N.A.	N.A.	9"	16"	24 <sup>1</sup> / <sub>2</sub> "	6 <sup>3</sup> / <sub>4</sub> "
4"	19 <sup>3</sup> / <sub>4</sub> "	26"	9 <sup>1</sup> / <sub>2</sub> "	N.A.	N.A.	N.A.	N.A.
4"	19 <sup>3</sup> / <sub>4</sub> "	26"	9 <sup>1</sup> / <sub>2</sub> "	9"	16"	24 <sup>1</sup> / <sub>2</sub> "	6 <sup>3</sup> / <sub>4</sub> "
N.A.	N.A.	N.A.	N.A.	N.A.	N.A.	N.A.	N.A.
4 <sup>1</sup> / <sub>2</sub> "	19 <sup>3</sup> / <sub>4</sub> "	26"	7 <sup>3</sup> / <sub>4</sub> "	N.A.	N.A.	N.A.	N.A.
4 <sup>1</sup> / <sub>2</sub> "	N.A.	25"	9 <sup>1</sup> / <sub>2</sub> "	N.A.	N.A.	N.A.	N.A.
3 <sup>1</sup> / <sub>2</sub> "	24"	26"	9"	N.A.	N.A.	N.A.	N.A.
N.A.	N.A.	N.A.	N.A.	N.A.	N.A.	N.A.	N.A.
4 <sup>1</sup> / <sub>2</sub> "	N.A.	22"	9 <sup>1</sup> / <sub>2</sub> "	N.A.	N.A.	N.A.	N.A.
4 <sup>1</sup> / <sub>2</sub> "	N.A.	22"	9 <sup>1</sup> / <sub>2</sub> "	N.A.	N.A.	N.A.	N.A.

Lounge Seating

# Jenny Lounge

## Armless

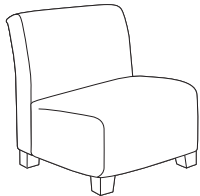

Tip: Tablet arm can be installed on either side.

Tip: Jenny lounge chairs are available with multiple fabrics.

▶ See at right to specify.

Tip: When specifying multiple COM fabrics, indicate all surfaces where COM applies. Example: TS31401M with Designtex 1234 on seat, Designtex 5678 on inner back, and Designtex 9012 on outer back.

Tip: When specifying multiple fabrics and leather, specify suffix **M** before suffix **L**. Example: TS31401ML TS31401CML

▶ Detailed dimensions, page 172



### For Canadian Pricing

Multiply U.S. Price by the Canadian price factor.

▶ See page 1 for details.

Standard Includes	Required to Specify
<ul style="list-style-type: none"> <li>▶ Need help? Product details, page 168</li> <li>Fully upholstered lounge chair: fabric price group 1</li> <li>Tablet arm, if selected: Low-Pressure Laminate (LPL), or High-Pressure Laminate (HPL)</li> <li>3 mm edge band for tablet arm, if selected: plastic</li> <li>Hard dual-wheel casters or legs with glides: black plastic</li> <li>Shipped fully assembled</li> <li>Exception: Tablet arm is shipped ready to assemble.</li> <li>Meets Cal. 117 requirements</li> </ul>	<ol style="list-style-type: none"> <li>1 Style number</li> <li>2 Fabric color number for upholstery</li> <li>3 Low-Pressure Laminate or High-Pressure Laminate color number for tablet arm, if selected</li> <li>4 Plastic edge band color number for tablet arm, if selected</li> <li>5 Options, if selected (see below)</li> </ol> <p>▶ See <i>Surface Materials</i>, page 473.</p>

Options	U.S. Price	Required to Specify
<p><b>Surface Materials</b></p> <p><b>Single upholstery fabric</b></p> <ul style="list-style-type: none"> <li>Fabric price group 1</li> <li>Fabric price group 2</li> <li>Fabric price group 3</li> <li>Fabric price group 4</li> <li>Fabric price group 5</li> <li>Fabric price group 6</li> <li>Fabric price group 7</li> <li>Fabric price group 8</li> <li>Fabric price group 9</li> <li>Fabric price group 10</li> <li>Leather price group</li> </ul> <p>Customer's Own Material (COM)</p> <p>Customer's Own Leather (COL)</p> <p><b>Multiple upholstery fabrics</b></p> <ul style="list-style-type: none"> <li>Two or more fabrics on different chair components</li> </ul> <p>▶ See below and at right.</p> <p><b>1 Fabric on seat</b></p> <ul style="list-style-type: none"> <li>Fabric price group 1</li> <li>Fabric price group 2</li> <li>Fabric price group 3</li> <li>Fabric price group 4</li> <li>Fabric price group 5</li> <li>Fabric price group 6</li> <li>Fabric price group 7</li> <li>Fabric price group 8</li> <li>Fabric price group 9</li> <li>Fabric price group 10</li> <li>Leather price group</li> </ul> <p>Customer's Own Material (COM)</p> <p>Customer's Own Leather (COL)</p>	<p>No cost</p> <p>+\$ 47</p> <p>+\$ 105</p> <p>+\$ 144</p> <p>+\$ 187</p> <p>+\$ 234</p> <p>+\$ 277</p> <p>+\$ 349</p> <p>+\$ 437</p> <p>+\$ 494</p> <p>+\$2996</p> <p>+\$ 56</p> <p>+\$ 53</p> <p>+\$ 98</p> <p>+\$ 17</p> <p>+\$ 49</p> <p>+\$ 63</p> <p>+\$ 85</p> <p>+\$ 106</p> <p>+\$ 126</p> <p>+\$ 161</p> <p>+\$ 197</p> <p>+\$ 227</p> <p>+\$1458</p> <p>+\$ 27</p> <p>+\$ 27</p>	<p>Specify fabric color number.</p> <p>Specify fabric color number.</p> <p>Specify fabric color number.</p> <p>Specify fabric color number.</p> <p>Specify fabric color number.</p> <p>Specify fabric color number.</p> <p>Specify fabric color number.</p> <p>Specify fabric color number.</p> <p>Specify fabric color number.</p> <p>Specify fabric color number.</p> <p>Specify fabric color number.</p> <p>Specify fabric color number.</p> <p>Specify fabric color number.</p> <p>Add suffix <b>L</b> to style number and specify leather color number.</p> <p>▶ See <i>Surface Materials</i>, page 473.</p> <p>Add suffix <b>L</b> to style number and specify leather color number.</p> <p>Add suffix <b>M</b> to lounge chair style number and select fabric color number for:</p> <ol style="list-style-type: none"> <li>1 Seat</li> <li>2 Inner back</li> <li>3 Outer back</li> </ol> <p>Example: TS31401M with 5G61 on seat, 5F15 on inner back, and 5G51 on outer back.</p> <p>Specify fabric color number.</p> <p>Specify fabric color number.</p> <p>Specify fabric color number.</p> <p>Specify fabric color number.</p> <p>Specify fabric color number.</p> <p>Specify fabric color number.</p> <p>Specify fabric color number.</p> <p>Specify fabric color number.</p> <p>Specify fabric color number.</p> <p>Specify fabric color number.</p> <p>Specify fabric color number.</p> <p>Specify fabric color number.</p> <p>Specify fabric color number.</p> <p>Add suffix <b>L</b> to style number and specify leather color number.</p> <p>▶ See <i>Surface Materials</i>, page 473.</p> <p>Add suffix <b>L</b> to style number and specify leather color number.</p>

▶ Options, continued on next page

► Options, continued from previous page

Options	U.S. Price	Required to Specify
<b>Surface Materials, continued</b>		
<b>② Fabric on inner back</b>		
• Fabric price group 1	No cost	Specify fabric color number.
• Fabric price group 2	+\$ 9	Specify fabric color number.
• Fabric price group 3	+\$ 35	Specify fabric color number.
• Fabric price group 4	+\$ 47	Specify fabric color number.
• Fabric price group 5	+\$ 60	Specify fabric color number.
• Fabric price group 6	+\$ 73	Specify fabric color number.
• Fabric price group 7	+\$ 87	Specify fabric color number.
• Fabric price group 8	+\$108	Specify fabric color number.
• Fabric price group 9	+\$136	Specify fabric color number.
• Fabric price group 10	+\$159	Specify fabric color number.
• Leather price group	+\$670	Specify fabric color number. Add suffix <b>L</b> to style number and specify leather color number.
• Customer's Own Material (COM)	+\$ 27	► See <i>Surface Materials</i> , page 473.
• Customer's Own Leather (COL)	+\$ 27	Add suffix <b>L</b> to style number and specify leather color number.
<b>③ Fabric on outer back</b>		
• Fabric price group 1	No cost	Specify fabric color number.
• Fabric price group 2	+\$ 7	Specify fabric color number.
• Fabric price group 3	+\$ 22	Specify fabric color number.
• Fabric price group 4	+\$ 36	Specify fabric color number.
• Fabric price group 5	+\$ 46	Specify fabric color number.
• Fabric price group 6	+\$ 56	Specify fabric color number.
• Fabric price group 7	+\$ 63	Specify fabric color number.
• Fabric price group 8	+\$ 81	Specify fabric color number.
• Fabric price group 9	+\$104	Specify fabric color number.
• Fabric price group 10	+\$114	Specify fabric color number.
• Leather price group	+\$929	Specify fabric color number. Add suffix <b>L</b> to style number and specify leather color number.
• Customer's Own Material (COM)	+\$ 27	► See <i>Surface Materials</i> , page 473.
• Customer's Own Leather (COL)	+\$ 27	Add suffix <b>L</b> to style number and specify leather color number.
<b>Legs</b>		
• Brushed aluminum legs	+\$167	Specify with <i>brushed aluminum legs</i> .
• Solid square wood legs	+\$222	Specify with <i>solid square wood legs</i> and select 3412 Natural Cherry, 3522 Clear Maple, or 3762 Dark Walnut.
• Solid round wood legs	+\$233	Specify with <i>solid round wood legs</i> and select V1AC Natural Cherry, V1AM Clear Maple, or V1EW Dark Walnut.

Tip: Brushed aluminum legs are adjustable and have 3/4" of height adjustment.

Tip: Wood legs are natural wood and may show variations in grain and color.

**Related Products** • Ganging kit ► Page 191

**Specification Information**

Style Number LPL	U.S. Base Price	Style Number HPL	U.S. Base Price	Style Number LPL	U.S. Base Price	Style Number HPL	U.S. Base Price
------------------	-----------------	------------------	-----------------	------------------	-----------------	------------------	-----------------

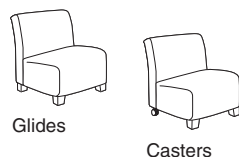

**With Glides**

<b>TS31401</b>	\$1711
----------------	--------

**With Two Casters and Two Glides**

<b>TS31401C</b>	\$1780
-----------------	--------

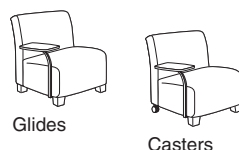

**With Tablet Arm with 180° Swivel**

<b>TS31401T</b>	\$2102	<b>TS31401H</b>	\$2157
-----------------	--------	-----------------	--------

**With Tablet Arm with 180° Swivel**

<b>TS31401CT</b>	\$2171	<b>TS31401CH</b>	\$2226
------------------	--------	------------------	--------

Jenny Lounge, continued

With Arms

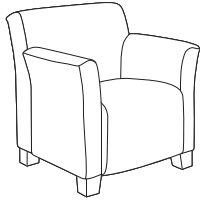

Tip: Jenny lounge chairs are available with multiple fabrics.

▶ See at right to specify.

Tip: When specifying multiple COM fabrics, indicate all surfaces where COM applies. Example: TS31402M with Designtex 1234 on seat, Designtex 5678 on inner back, Designtex 9012 on outer back, and Designtex 9012 on arms.

Tip: When specifying multiple fabrics and leather, specify suffix **M** before suffix **L**. Example: TS31402ML TS31402CML

Standard Includes		Required to Specify
▶ Need help? Product details, page 168	<ul style="list-style-type: none"> <li>Fully upholstered lounge chair with arms: fabric price group 1</li> <li>Hard dual-wheel casters or legs with glides: black plastic</li> <li>Shipped fully assembled</li> <li>Meets Cal. 117 requirements</li> </ul>	1 Style number 2 Fabric color number for upholstery 3 Options, if selected (see below) ▶ See <i>Surface Materials</i> , page 473.

Options	U.S. Price	Required to Specify
<b>Surface Materials</b>		
<b>Single upholstery fabric</b>		
• Fabric price group 1	No cost	Specify fabric color number.
• Fabric price group 2	+\$ 69	Specify fabric color number.
• Fabric price group 3	+\$ 164	Specify fabric color number.
• Fabric price group 4	+\$ 231	Specify fabric color number.
• Fabric price group 5	+\$ 301	Specify fabric color number.
• Fabric price group 6	+\$ 362	Specify fabric color number.
• Fabric price group 7	+\$ 434	Specify fabric color number.
• Fabric price group 8	+\$ 546	Specify fabric color number.
• Fabric price group 9	+\$ 682	Specify fabric color number.
• Fabric price group 10	+\$ 775	Specify fabric color number.
• Leather price group	+\$4630	Specify fabric color number. Add suffix <b>L</b> to style number and specify leather color number. ▶ See <i>Surface Materials</i> , page 473.
• Customer's Own Material (COM)	+\$ 56	
• Customer's Own Leather (COL)	+\$ 53	Add suffix <b>L</b> to style number and specify leather color number.

<b>Multiple upholstery fabrics</b>		
• Two or more fabrics on different chair components	+\$ 98	Add suffix <b>M</b> to lounge chair style number and select fabric color number for:
▶ See below and at right.		<ol style="list-style-type: none"> <li>Seat</li> <li>Inner back</li> <li>Outer back</li> <li>Arms</li> </ol> Example: TS31402M with 5G61 on seat, 5F15 on inner back, 5G51 on outer back, and 5F03 on arms.
<b>1 Fabric on seat</b>		
• Fabric price group 1	No cost	Specify fabric color number.
• Fabric price group 2	+\$ 17	Specify fabric color number.
• Fabric price group 3	+\$ 49	Specify fabric color number.
• Fabric price group 4	+\$ 63	Specify fabric color number.
• Fabric price group 5	+\$ 85	Specify fabric color number.
• Fabric price group 6	+\$ 106	Specify fabric color number.
• Fabric price group 7	+\$ 126	Specify fabric color number.
• Fabric price group 8	+\$ 161	Specify fabric color number.
• Fabric price group 9	+\$ 197	Specify fabric color number.
• Fabric price group 10	+\$ 227	Specify fabric color number.
• Leather price group	+\$1321	Specify fabric color number. Add suffix <b>L</b> to style number and specify leather color number. ▶ See <i>Surface Materials</i> , page 473.
• Customer's Own Material (COM)	+\$ 27	
• Customer's Own Leather (COL)	+\$ 27	Add suffix <b>L</b> to style number and specify leather color number.

▶ Options, continued on next page

▶ Detailed dimensions, page 172



**For Canadian Pricing**

Multiply U.S. Price by the Canadian price factor.

▶ See page 1 for details.



► Options, continued from previous page

Options	U.S. Price	Required to Specify
<b>Surface Materials, continued</b>		
<b>2 Fabric on inner back</b>		
• Fabric price group 1	No cost	Specify fabric color number.
• Fabric price group 2	+\$ 9	Specify fabric color number.
• Fabric price group 3	+\$ 35	Specify fabric color number.
• Fabric price group 4	+\$ 47	Specify fabric color number.
• Fabric price group 5	+\$ 60	Specify fabric color number.
• Fabric price group 6	+\$ 73	Specify fabric color number.
• Fabric price group 7	+\$ 87	Specify fabric color number.
• Fabric price group 8	+\$ 108	Specify fabric color number.
• Fabric price group 9	+\$ 136	Specify fabric color number.
• Fabric price group 10	+\$ 159	Specify fabric color number.
• Leather price group	+\$ 670	Add suffix <b>L</b> to style number and specify leather color number.
• Customer's Own Material (COM)	+\$ 27	► See <i>Surface Materials</i> , page 473.
• Customer's Own Leather (COL)	+\$ 27	Add suffix <b>L</b> to style number and specify leather color number.
<b>3 Fabric on outer back</b>		
• Fabric price group 1	No cost	Specify fabric color number.
• Fabric price group 2	+\$ 7	Specify fabric color number.
• Fabric price group 3	+\$ 22	Specify fabric color number.
• Fabric price group 4	+\$ 36	Specify fabric color number.
• Fabric price group 5	+\$ 46	Specify fabric color number.
• Fabric price group 6	+\$ 56	Specify fabric color number.
• Fabric price group 7	+\$ 63	Specify fabric color number.
• Fabric price group 8	+\$ 81	Specify fabric color number.
• Fabric price group 9	+\$ 104	Specify fabric color number.
• Fabric price group 10	+\$ 114	Specify fabric color number.
• Leather price group	+\$ 929	Add suffix <b>L</b> to style number and specify leather color number.
• Customer's Own Material (COM)	+\$ 27	► See <i>Surface Materials</i> , page 473.
• Customer's Own Leather (COL)	+\$ 27	Add suffix <b>L</b> to style number and specify leather color number.
<b>4 Fabric on arms</b>		
• Fabric price group 1	No cost	Specify fabric color number.
• Fabric price group 2	+\$ 23	Specify fabric color number.
• Fabric price group 3	+\$ 59	Specify fabric color number.
• Fabric price group 4	+\$ 81	Specify fabric color number.
• Fabric price group 5	+\$ 107	Specify fabric color number.
• Fabric price group 6	+\$ 132	Specify fabric color number.
• Fabric price group 7	+\$ 160	Specify fabric color number.
• Fabric price group 8	+\$ 196	Specify fabric color number.
• Fabric price group 9	+\$ 246	Specify fabric color number.
• Fabric price group 10	+\$ 278	Specify fabric color number.
• Leather price group	+\$1770	Add suffix <b>L</b> to style number and specify leather color number.
• Customer's Own Material (COM)	+\$ 27	► See <i>Surface Materials</i> , page 473.
• Customer's Own Leather (COL)	+\$ 27	Add suffix <b>L</b> to style number and specify leather color number.
<b>Legs</b>		
• Brushed aluminum legs	+\$ 167	Specify with <i>brushed aluminum legs</i> .
• Solid square wood legs	+\$ 222	Specify with <i>solid square wood legs</i> and select 3412 Natural Cherry, 3522 Clear Maple, or 3762 Dark Walnut.
• Solid round wood legs	+\$ 233	Specify with <i>solid round wood legs</i> and select V1AC Natural Cherry, V1AM Clear Maple, or V1EW Dark Walnut.

Lounge Seating

Tip: Brushed aluminum legs are adjustable and have <sup>3</sup>/<sub>4</sub>" of height adjustment.

Tip: Wood legs are natural wood and may show variations in grain and color.

Specification Information

Style Number	U.S. Base Price	Style Number	U.S. Base Price
<b>With Glides</b>		<b>With Two Casters and Two Glides</b>	
TS31402	\$1917	TS31402C	\$1986



Glides



Casters

Jenny Lounge, continued

With Arm Left or Right

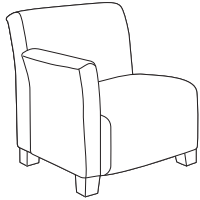

Tip: Jenny lounge chairs are available with multiple fabrics.

► See at right to specify.

Tip: When specifying multiple COM fabrics, indicate all surfaces where COM applies.

Example: TS31403M with Designtex 1234 on seat, Designtex 5678 on inner back, Designtex 9012 on outer back, and Designtex 9012 on arm.

Tip: When specifying multiple fabrics and leather, specify suffix M before suffix L.

Example: TS31403ML  
TS31403CML

► Detailed dimensions, page 172



**For Canadian Pricing**

Multiply U.S. Price by the Canadian price factor.

► See page 1 for details.

Standard Includes	Required to Specify
<p>► Need help? Product details, page 168</p> <ul style="list-style-type: none"> <li>Fully upholstered lounge chair with arm left or right: fabric price group 1</li> <li>Tablet arm, if selected: Low-Pressure Laminate (LPL), or High-Pressure Laminate (HPL)</li> <li>3 mm edge band for tablet arm, if selected: plastic</li> <li>Hard dual-wheel casters or legs with glides: black plastic</li> <li>Shipped fully assembled</li> <li>Exception: Tablet arm is shipped ready to assemble.</li> <li>Meets Cal. 117 requirements</li> </ul>	<ol style="list-style-type: none"> <li>Style number</li> <li>Fabric color number for upholstery</li> <li>Low-Pressure Laminate or High-Pressure Laminate color number for tablet arm, if selected</li> <li>Plastic edge band color number for tablet arm, if selected</li> <li>Options, if selected (see below)</li> </ol> <p>► See <i>Surface Materials</i>, page 473.</p>

Surface Materials	Options	U.S. Price	Required to Specify
	<p><b>Single upholstery fabric</b></p> <ul style="list-style-type: none"> <li>Fabric price group 1</li> <li>Fabric price group 2</li> <li>Fabric price group 3</li> <li>Fabric price group 4</li> <li>Fabric price group 5</li> <li>Fabric price group 6</li> <li>Fabric price group 7</li> <li>Fabric price group 8</li> <li>Fabric price group 9</li> <li>Fabric price group 10</li> <li>Leather price group</li> </ul>	<p>No cost</p> <p>+\$ 57</p> <p>+\$ 133</p> <p>+\$ 186</p> <p>+\$ 245</p> <p>+\$ 302</p> <p>+\$ 356</p> <p>+\$ 446</p> <p>+\$ 561</p> <p>+\$ 633</p> <p>+\$3856</p>	<p>Specify fabric color number.</p> <p>Specify fabric color number.</p> <p>Specify fabric color number.</p> <p>Specify fabric color number.</p> <p>Specify fabric color number.</p> <p>Specify fabric color number.</p> <p>Specify fabric color number.</p> <p>Specify fabric color number.</p> <p>Specify fabric color number.</p> <p>Specify fabric color number.</p> <p>Specify fabric color number.</p> <p>Add suffix <b>L</b> to style number and specify leather color number.</p> <p>► See <i>Surface Materials</i>, page 473.</p>
	<ul style="list-style-type: none"> <li>Customer's Own Material (COM)</li> <li>Customer's Own Leather (COL)</li> </ul>	<p>+\$ 56</p> <p>+\$ 53</p>	<p>Add suffix <b>L</b> to style number and specify leather color number.</p>
	<p><b>Multiple upholstery fabrics</b></p> <ul style="list-style-type: none"> <li>Two or more fabrics on different chair components</li> </ul> <p>► See below and at right.</p>	<p>+\$ 98</p>	<p>Add suffix <b>M</b> to lounge chair style number and select fabric color number for:</p> <ol style="list-style-type: none"> <li>Seat</li> <li>Inner back</li> <li>Outer back</li> <li>Arm</li> </ol> <p>Example: TS31403M with 5G61 on seat, 5F15 on inner back, 5G51 on outer back, and 5F03 on arm.</p>
	<p><b>1 Fabric on seat</b></p> <ul style="list-style-type: none"> <li>Fabric price group 1</li> <li>Fabric price group 2</li> <li>Fabric price group 3</li> <li>Fabric price group 4</li> <li>Fabric price group 5</li> <li>Fabric price group 6</li> <li>Fabric price group 7</li> <li>Fabric price group 8</li> <li>Fabric price group 9</li> <li>Fabric price group 10</li> <li>Leather price group</li> </ul>	<p>No cost</p> <p>+\$ 17</p> <p>+\$ 49</p> <p>+\$ 63</p> <p>+\$ 85</p> <p>+\$ 106</p> <p>+\$ 126</p> <p>+\$ 161</p> <p>+\$ 197</p> <p>+\$ 227</p> <p>+\$1430</p>	<p>Specify fabric color number.</p> <p>Specify fabric color number.</p> <p>Specify fabric color number.</p> <p>Specify fabric color number.</p> <p>Specify fabric color number.</p> <p>Specify fabric color number.</p> <p>Specify fabric color number.</p> <p>Specify fabric color number.</p> <p>Specify fabric color number.</p> <p>Specify fabric color number.</p> <p>Specify fabric color number.</p> <p>Add suffix <b>L</b> to style number and specify leather color number.</p> <p>► See <i>Surface Materials</i>, page 473.</p>
	<ul style="list-style-type: none"> <li>Customer's Own Material (COM)</li> <li>Customer's Own Leather (COL)</li> </ul>	<p>+\$ 27</p> <p>+\$ 27</p>	<p>Add suffix <b>L</b> to style number and specify leather color number.</p>

► Options, continued on next page

► Options, continued from previous page

	Options	U.S. Price	Required to Specify
<b>Surface Materials, continued</b>	<b>2 Fabric on inner back</b>		
	• Fabric price group 1	No cost	Specify fabric color number.
	• Fabric price group 2	+\$ 9	Specify fabric color number.
	• Fabric price group 3	+\$ 35	Specify fabric color number.
	• Fabric price group 4	+\$ 47	Specify fabric color number.
	• Fabric price group 5	+\$ 60	Specify fabric color number.
	• Fabric price group 6	+\$ 73	Specify fabric color number.
	• Fabric price group 7	+\$ 87	Specify fabric color number.
	• Fabric price group 8	+\$108	Specify fabric color number.
	• Fabric price group 9	+\$136	Specify fabric color number.
	• Fabric price group 10	+\$159	Specify fabric color number.
	• Leather price group	+\$670	Specify fabric color number. Add suffix <b>L</b> to style number and specify leather color number.
	• Customer's Own Material (COM)	+\$ 27	► See <i>Surface Materials</i> , page 473.
	• Customer's Own Leather (COL)	+\$ 27	Add suffix <b>L</b> to style number and specify leather color number.
	<b>3 Fabric on outer back</b>		
	• Fabric price group 1	No cost	Specify fabric color number.
	• Fabric price group 2	+\$ 7	Specify fabric color number.
	• Fabric price group 3	+\$ 22	Specify fabric color number.
	• Fabric price group 4	+\$ 36	Specify fabric color number.
	• Fabric price group 5	+\$ 46	Specify fabric color number.
• Fabric price group 6	+\$ 56	Specify fabric color number.	
• Fabric price group 7	+\$ 63	Specify fabric color number.	
• Fabric price group 8	+\$ 81	Specify fabric color number.	
• Fabric price group 9	+\$104	Specify fabric color number.	
• Fabric price group 10	+\$114	Specify fabric color number.	
• Leather price group	+\$929	Specify fabric color number. Add suffix <b>L</b> to style number and specify leather color number.	
• Customer's Own Material (COM)	+\$ 27	► See <i>Surface Materials</i> , page 473.	
• Customer's Own Leather (COL)	+\$ 27	Add suffix <b>L</b> to style number and specify leather color number.	
<b>4 Fabric on arm</b>			
• Fabric price group 1	No cost	Specify fabric color number.	
• Fabric price group 2	+\$ 8	Specify fabric color number.	
• Fabric price group 3	+\$ 34	Specify fabric color number.	
• Fabric price group 4	+\$ 46	Specify fabric color number.	
• Fabric price group 5	+\$ 57	Specify fabric color number.	
• Fabric price group 6	+\$ 69	Specify fabric color number.	
• Fabric price group 7	+\$ 81	Specify fabric color number.	
• Fabric price group 8	+\$105	Specify fabric color number.	
• Fabric price group 9	+\$130	Specify fabric color number.	
• Fabric price group 10	+\$144	Specify fabric color number.	
• Leather price group	+\$884	Specify fabric color number. Add suffix <b>L</b> to style number and specify leather color number.	
• Customer's Own Material (COM)	+\$ 27	► See <i>Surface Materials</i> , page 473.	
• Customer's Own Leather (COL)	+\$ 27	Add suffix <b>L</b> to style number and specify leather color number.	
	<b>High-Pressure Laminate tablet</b>		
	• Open Line laminate	+\$102 plus cost of laminate	► See <i>Surface Materials Reference Manual</i> .
	<b>Legs</b>		
	• Brushed aluminum legs	+\$167	Specify <i>with brushed aluminum legs</i> .
	• Solid square wood legs	+\$222	Specify <i>with solid square wood legs</i> and select 3412 Natural Cherry, 3522 Clear Maple, or 3762 Dark Walnut.
	• Solid round wood legs	+\$233	Specify <i>with solid round wood legs</i> and select V1AC Natural Cherry, V1AM Clear Maple, or V1EW Dark Walnut.
	<b>Related Products</b>	• Ganging kit	► Page 191

Tip: Brushed aluminum legs are adjustable and have 3/4" of height adjustment.

Tip: Wood legs are natural wood and may show variations in grain and color.



**For Canadian Pricing**  
Multiply U.S. Price by the Canadian price factor.  
► See page 1 for details.

**Related Products**  
► **Specification Information, on next page**

Jenny Lounge, continued

► Options, on previous page

Specification Information							
Style Number LPL	U.S. Base Price	Style Number HPL	U.S. Base Price	Style Number LPL	U.S. Base Price	Style Number HPL	U.S. Base Price

**With Glides**

**Arm Right**

<b>TS31403</b>	\$1812
----------------	--------

**With Two Casters and Two Glides**

**Arm Right**

<b>TS31403C</b>	\$1881
-----------------	--------



Glides



Casters

Tip: Casters and tablet arm are not retrofittable on style number TS31403.



Glides



Casters

**Arm Right with Tablet Arm with 180° Swivel**

<b>TS31403T</b>	\$2203	<b>TS31403H</b>	\$2258
-----------------	--------	-----------------	--------

**Arm Right with Tablet Arm with 180° Swivel**

<b>TS31403CT</b>	\$2272	<b>TS31403CH</b>	\$2327
------------------	--------	------------------	--------

**Arm Left**

<b>TS31404</b>	\$1812
----------------	--------

**Arm Left**

<b>TS31404C</b>	\$1881
-----------------	--------



Glides



Casters

Tip: Casters and tablet arm are not retrofittable on style number TS31404.



Glides



Casters

**Arm Left with Tablet Arm with 180° Swivel**

<b>TS31404T</b>	\$2203	<b>TS31404H</b>	\$2258
-----------------	--------	-----------------	--------

**Arm Left with Tablet Arm with 180° Swivel**

<b>TS31404CT</b>	\$2272	<b>TS31404CH</b>	\$2327
------------------	--------	------------------	--------



**For Canadian Pricing**

Multiply U.S. Price by the Canadian price factor.

► See page 1 for details.



Jenny Lounge, continued

Corner

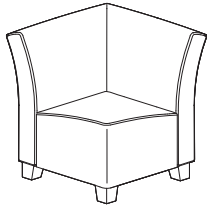

Tip: Jenny lounge chairs are available with multiple fabrics.

► See at right to specify.

Tip: When specifying multiple COM fabrics, indicate all surfaces where COM applies. Example: TS31406M with Designtex 1234 on seat, Designtex 5678 on inner back, and Designtex 9012 on outer back.

Tip: When specifying multiple fabrics and leather, specify suffix M before suffix L. Example: TS31406ML TS31406CML

Standard Includes	Required to Specify
<ul style="list-style-type: none"> <li>► Need help? Product details, page 170</li> <li>Fully upholstered lounge chair: fabric price group 1</li> <li>Hard dual-wheel casters or legs with glides: black plastic</li> <li>Shipped fully assembled</li> <li>Meets Cal. 117 requirements</li> </ul>	<ul style="list-style-type: none"> <li>1 Style number</li> <li>2 Fabric color number for upholstery</li> <li>3 Options, if selected (see below)</li> <li>► See <i>Surface Materials</i>, page 473.</li> </ul>

Surface Materials	Options	U.S. Price	Required to Specify
	<b>Single upholstery fabric</b>		
	• Fabric price group 1	No cost	Specify fabric color number.
	• Fabric price group 2	+\$ 47	Specify fabric color number.
	• Fabric price group 3	+\$ 105	Specify fabric color number.
	• Fabric price group 4	+\$ 144	Specify fabric color number.
	• Fabric price group 5	+\$ 187	Specify fabric color number.
	• Fabric price group 6	+\$ 234	Specify fabric color number.
	• Fabric price group 7	+\$ 277	Specify fabric color number.
	• Fabric price group 8	+\$ 349	Specify fabric color number.
	• Fabric price group 9	+\$ 437	Specify fabric color number.
	• Fabric price group 10	+\$ 494	Specify fabric color number.
	• Leather price group	+\$2996	Specify fabric color number.
	• Customer's Own Material (COM)	+\$ 56	Add suffix <b>L</b> to style number and specify leather color number.
	• Customer's Own Leather (COL)	+\$ 53	► See <i>Surface Materials</i> , page 473.
	<b>Multiple upholstery fabrics</b>		
	• Two or more fabrics on different chair components	+\$ 98	Add suffix <b>M</b> to lounge chair style number and select fabric color number for:
	► See below and at right.		<ul style="list-style-type: none"> <li>1 Seat</li> <li>2 Inner back</li> <li>3 Outer back</li> </ul>

<b>1 Fabric on seat</b>			
• Fabric price group 1	No cost		Specify fabric color number.
• Fabric price group 2	+\$ 17		Specify fabric color number.
• Fabric price group 3	+\$ 49		Specify fabric color number.
• Fabric price group 4	+\$ 63		Specify fabric color number.
• Fabric price group 5	+\$ 85		Specify fabric color number.
• Fabric price group 6	+\$ 106		Specify fabric color number.
• Fabric price group 7	+\$ 126		Specify fabric color number.
• Fabric price group 8	+\$ 161		Specify fabric color number.
• Fabric price group 9	+\$ 197		Specify fabric color number.
• Fabric price group 10	+\$ 227		Specify fabric color number.
• Leather price group	+\$1458		Specify fabric color number.
• Customer's Own Material (COM)	+\$ 27		Add suffix <b>L</b> to style number and specify leather color number.
• Customer's Own Leather (COL)	+\$ 27		► See <i>Surface Materials</i> , page 473.
			Add suffix <b>L</b> to style number and specify leather color number.

► Options, continued on next page

► Detailed dimensions, page 172



**For Canadian Pricing**

Multiply U.S. Price by the Canadian price factor.

► See page 1 for details.

► Options, continued from previous page

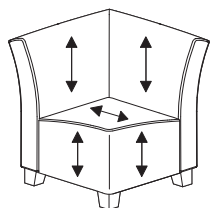

Tip: Standard seat fabric directionality is applied as the diagram above indicates (ex. TS31406).

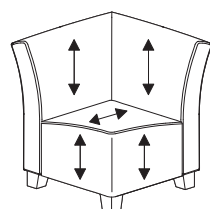

Tip: Reverse seat fabric directionality is applied as the diagram above indicates (ex. TS31426).

Tip: Brushed aluminum legs are adjustable and have 3/4" of height adjustment.

Tip: Wood legs are natural wood and may show variations in grain and color.

Options	U.S. Price	Required to Specify
<b>Surface Materials, continued</b>		
<b>② Fabric on inner back</b>		
• Fabric price group 1	No cost	Specify fabric color number.
• Fabric price group 2	+\$ 9	Specify fabric color number.
• Fabric price group 3	+\$ 35	Specify fabric color number.
• Fabric price group 4	+\$ 47	Specify fabric color number.
• Fabric price group 5	+\$ 60	Specify fabric color number.
• Fabric price group 6	+\$ 73	Specify fabric color number.
• Fabric price group 7	+\$ 87	Specify fabric color number.
• Fabric price group 8	+\$108	Specify fabric color number.
• Fabric price group 9	+\$136	Specify fabric color number.
• Fabric price group 10	+\$159	Specify fabric color number.
• Leather price group	+\$670	Specify fabric color number. Add suffix <b>L</b> to style number and specify leather color number.
• Customer's Own Material (COM)	+\$ 27	► See <i>Surface Materials</i> , page 473.
• Customer's Own Leather (COL)	+\$ 27	Add suffix <b>L</b> to style number and specify leather color number.
<b>③ Fabric on outer back</b>		
• Fabric price group 1	No cost	Specify fabric color number.
• Fabric price group 2	+\$ 7	Specify fabric color number.
• Fabric price group 3	+\$ 22	Specify fabric color number.
• Fabric price group 4	+\$ 36	Specify fabric color number.
• Fabric price group 5	+\$ 46	Specify fabric color number.
• Fabric price group 6	+\$ 56	Specify fabric color number.
• Fabric price group 7	+\$ 63	Specify fabric color number.
• Fabric price group 8	+\$ 81	Specify fabric color number.
• Fabric price group 9	+\$104	Specify fabric color number.
• Fabric price group 10	+\$114	Specify fabric color number.
• Leather price group	+\$929	Specify fabric color number. Add suffix <b>L</b> to style number and specify leather color number.
• Customer's Own Material (COM)	+\$ 27	► See <i>Surface Materials</i> , page 473.
• Customer's Own Leather (COL)	+\$ 27	Add suffix <b>L</b> to style number and specify leather color number.
<b>Legs</b>		
• Brushed aluminum legs	+\$167	Specify <i>with brushed aluminum legs</i> .
• Solid square wood legs	+\$222	Specify <i>with solid square wood legs</i> and select 3412 Natural Cherry, 3522 Clear Maple, or 3762 Dark Walnut.
• Solid round wood legs	+\$233	Specify <i>with solid round wood legs</i> and select V1AC Natural Cherry, V1AM Clear Maple, or V1EW Dark Walnut.

**Related Products** • Ganging kit ► Page 191

**Specification Information**

Style Number	U.S. Base Price	Style Number	U.S. Base Price

**Standard Seat Fabric Directionality**

**With Glides**

TS31406 \$1814

**With Casters**

TS31406C \$1883

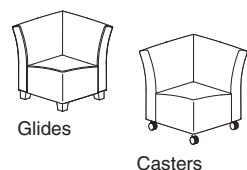

**Reverse Seat Fabric Directionality**

**With Glides**

TS31426 \$1814

**With Casters**

TS31426C \$1883

**For Canadian Pricing**  
Multiply U.S. Price by the Canadian price factor.  
► See page 1 for details.

Jenny Lounge, continued

Club

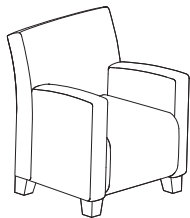

Tip: Jenny lounge chairs are available with multiple fabrics.

▶ See at right to specify.

Tip: When specifying multiple COM fabrics, indicate all surfaces where COM applies. Example: TS31407M with Designtex 1234 on seat, Designtex 5678 on inner back, Designtex 9012 on outer back, and Designtex 9012 on arms.

Tip: When specifying multiple fabrics and leather, specify suffix M before suffix L. Example: TS31407ML TS31407CML

▶ Detailed dimensions, page 172



**For Canadian Pricing**

Multiply U.S. Price by the Canadian price factor.

▶ See page 1 for details.

Standard Includes	Required to Specify
<ul style="list-style-type: none"> <li>▶ Need help? Product details, page 168</li> <li>Fully upholstered lounge chair with arms: fabric price group 1</li> <li>Deck stitch detail</li> <li>Hard dual wheel casters or legs with glides: black plastic</li> <li>Shipped fully assembled</li> <li>Meets Cal. 117 requirements</li> </ul>	<ul style="list-style-type: none"> <li>1 Style number</li> <li>2 Fabric color number for upholstery</li> <li>3 Options, if selected (see below)</li> <li>▶ See <i>Surface Materials</i>, page 473.</li> </ul>

Options	U.S. Price	Required to Specify
<p><b>Surface Materials</b></p> <p><b>Single upholstery fabric</b></p> <ul style="list-style-type: none"> <li>Fabric price group 1 No cost</li> <li>Fabric price group 2 +\$ 69</li> <li>Fabric price group 3 +\$ 164</li> <li>Fabric price group 4 +\$ 231</li> <li>Fabric price group 5 +\$ 301</li> <li>Fabric price group 6 +\$ 362</li> <li>Fabric price group 7 +\$ 434</li> <li>Fabric price group 8 +\$ 546</li> <li>Fabric price group 9 +\$ 682</li> <li>Fabric price group 10 +\$ 775</li> <li>Leather price group +\$4630</li> </ul> <p>Customer's Own Material (COM) +\$ 56</p> <p>Customer's Own Leather (COL) +\$ 53</p> <p><b>Multiple upholstery fabrics</b></p> <ul style="list-style-type: none"> <li>Two or more fabrics on different chair components +\$ 98</li> <li>▶ See below and at right.</li> </ul> <p><b>1 Fabric on seat</b></p> <ul style="list-style-type: none"> <li>Fabric price group 1 No cost</li> <li>Fabric price group 2 +\$ 17</li> <li>Fabric price group 3 +\$ 49</li> <li>Fabric price group 4 +\$ 63</li> <li>Fabric price group 5 +\$ 85</li> <li>Fabric price group 6 +\$ 106</li> <li>Fabric price group 7 +\$ 126</li> <li>Fabric price group 8 +\$ 161</li> <li>Fabric price group 9 +\$ 197</li> <li>Fabric price group 10 +\$ 227</li> <li>Leather price group +\$1321</li> </ul> <p>Customer's Own Material (COM) +\$ 27</p> <p>Customer's Own Leather (COL) +\$ 27</p>		<p>Specify fabric color number.</p> <p>Specify fabric color number.</p> <p>Specify fabric color number.</p> <p>Specify fabric color number.</p> <p>Specify fabric color number.</p> <p>Specify fabric color number.</p> <p>Specify fabric color number.</p> <p>Specify fabric color number.</p> <p>Specify fabric color number.</p> <p>Specify fabric color number.</p> <p>Specify fabric color number.</p> <p>Add suffix <b>L</b> to style number and specify leather color number.</p> <p>▶ See <i>Surface Materials</i>, page 473.</p> <p>Add suffix <b>L</b> to style number and specify leather color number.</p> <p>Add suffix <b>M</b> to lounge chair style number and select fabric color number for:</p> <ul style="list-style-type: none"> <li>1 Seat</li> <li>2 Inner back</li> <li>3 Outer back</li> <li>4 Arms</li> </ul> <p>Example: TS31407M with 5G61 on seat, 5F15 on inner back, 5G51 on outer back, and 5F03 on arms.</p> <p>Specify fabric color number.</p> <p>Specify fabric color number.</p> <p>Specify fabric color number.</p> <p>Specify fabric color number.</p> <p>Specify fabric color number.</p> <p>Specify fabric color number.</p> <p>Specify fabric color number.</p> <p>Specify fabric color number.</p> <p>Specify fabric color number.</p> <p>Specify fabric color number.</p> <p>Specify fabric color number.</p> <p>Add suffix <b>L</b> to style number and specify leather color number.</p> <p>▶ See <i>Surface Materials</i>, page 473.</p> <p>Add suffix <b>L</b> to style number and specify leather color number.</p>

▶ Options, continued on next page



► Options, continued from previous page

Options	U.S. Price	Required to Specify
<b>Surface Materials, continued</b>		
<b>2 Fabric on inner back</b>		
• Fabric price group 1	No cost	Specify fabric color number.
• Fabric price group 2	+\$ 9	Specify fabric color number.
• Fabric price group 3	+\$ 35	Specify fabric color number.
• Fabric price group 4	+\$ 47	Specify fabric color number.
• Fabric price group 5	+\$ 60	Specify fabric color number.
• Fabric price group 6	+\$ 73	Specify fabric color number.
• Fabric price group 7	+\$ 87	Specify fabric color number.
• Fabric price group 8	+\$ 108	Specify fabric color number.
• Fabric price group 9	+\$ 136	Specify fabric color number.
• Fabric price group 10	+\$ 159	Specify fabric color number.
• Leather price group	+\$ 670	Add suffix <b>L</b> to style number and specify leather color number.
• Customer's Own Material (COM)	+\$ 27	► See <i>Surface Materials</i> , page 473.
• Customer's Own Leather (COL)	+\$ 27	Add suffix <b>L</b> to style number and specify leather color number.
<b>3 Fabric on outer back</b>		
• Fabric price group 1	No cost	Specify fabric color number.
• Fabric price group 2	+\$ 7	Specify fabric color number.
• Fabric price group 3	+\$ 22	Specify fabric color number.
• Fabric price group 4	+\$ 36	Specify fabric color number.
• Fabric price group 5	+\$ 46	Specify fabric color number.
• Fabric price group 6	+\$ 56	Specify fabric color number.
• Fabric price group 7	+\$ 63	Specify fabric color number.
• Fabric price group 8	+\$ 81	Specify fabric color number.
• Fabric price group 9	+\$ 104	Specify fabric color number.
• Fabric price group 10	+\$ 114	Specify fabric color number.
• Leather price group	+\$ 929	Add suffix <b>L</b> to style number and specify leather color number.
• Customer's Own Material (COM)	+\$ 27	► See <i>Surface Materials</i> , page 473.
• Customer's Own Leather (COL)	+\$ 27	Add suffix <b>L</b> to style number and specify leather color number.
<b>4 Fabric on arms</b>		
• Fabric price group 1	No cost	Specify fabric color number.
• Fabric price group 2	+\$ 23	Specify fabric color number.
• Fabric price group 3	+\$ 59	Specify fabric color number.
• Fabric price group 4	+\$ 81	Specify fabric color number.
• Fabric price group 5	+\$ 107	Specify fabric color number.
• Fabric price group 6	+\$ 132	Specify fabric color number.
• Fabric price group 7	+\$ 160	Specify fabric color number.
• Fabric price group 8	+\$ 196	Specify fabric color number.
• Fabric price group 9	+\$ 246	Specify fabric color number.
• Fabric price group 10	+\$ 278	Specify fabric color number.
• Leather price group	+\$1770	Add suffix <b>L</b> to style number and specify leather color number.
• Customer's Own Material (COM)	+\$ 27	► See <i>Surface Materials</i> , page 473.
• Customer's Own Leather (COL)	+\$ 27	Add suffix <b>L</b> to style number and specify leather color number.
<b>Legs</b>		
• Brushed aluminum legs	+\$ 167	Specify with <i>brushed aluminum legs</i> .
• Solid square wood legs	+\$ 222	Specify with <i>solid square wood legs</i> and select 3412 Natural Cherry, 3522 Clear Maple, or 3762 Dark Walnut.
• Solid round wood legs	+\$ 233	Specify with <i>solid round wood legs</i> and select V1AC Natural Cherry, V1AM Clear Maple, or V1EW Dark Walnut.

Lounge Seating

Tip: Brushed aluminum legs are adjustable and have <sup>3</sup>/<sub>4</sub>" of height adjustment.

Tip: Wood legs are natural wood and may show variations in grain and color.

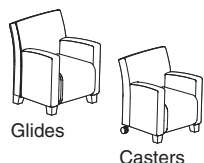

Specification Information			
Style Number	U.S. Base Price	Style Number	U.S. Base Price
<b>With Glides</b>		<b>With Two Casters and Two Glides</b>	
TS31407	\$1917	TS31407C	\$1986

Round

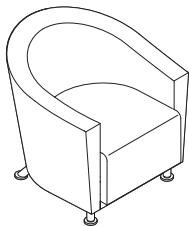

Tip: Jenny round chairs are available with multiple fabrics.

▶ See at right to specify.

Tip: When specifying multiple COM fabrics, indicate all surfaces where COM applies. Example: TS31407M with Designtex 1234 on seat, Designtex 5678 on inner back, Designtex 9012 on outer back, and Designtex 9012 on arms.

Tip: When specifying multiple fabrics and leather, specify suffix **M** before suffix **L**. Example: TS31409ML

**Standard Includes** **Required to Specify**

- |   |  |   |
|---|--|---|
| <p>▶ Need help? Product details, page 168</p> | <ul style="list-style-type: none"> <li>• Fully upholstered round chair with arms: fabric price group 1</li> <li>• Shipped fully assembled</li> <li>• Meets Cal. 117 requirements</li> <li>• Brushed aluminum legs</li> <li>• Deck stitch detail</li> </ul> | <p>1 Style number<br/>2 Fabric color number for upholstery<br/>3 Options, if selected (see below)<br/>▶ See <i>Surface Materials</i>, page 473.</p> |
|---|--|---|

**Options** **U.S. Price** **Required to Specify**

<b>Surface Materials</b>	<b>Single upholstery fabric</b>		
	• Fabric price group 1	No cost	Specify fabric color number.
	• Fabric price group 2	+\$ 69	Specify fabric color number.
	• Fabric price group 3	+\$ 164	Specify fabric color number.
	• Fabric price group 4	+\$ 231	Specify fabric color number.
	• Fabric price group 5	+\$ 301	Specify fabric color number.
	• Fabric price group 6	+\$ 362	Specify fabric color number.
	• Fabric price group 7	+\$ 434	Specify fabric color number.
	• Fabric price group 8	+\$ 546	Specify fabric color number.
	• Fabric price group 9	+\$ 682	Specify fabric color number.
	• Fabric price group 10	+\$ 775	Specify fabric color number.
	• Leather price group	+\$4686	Specify fabric color number. Add suffix <b>L</b> to style number and specify leather color number. ▶ See <i>Surface Materials</i> , page 473.
	• Customer's Own Material (COM)	+\$ 56	
	• Customer's Own Leather (COL)	+\$ 53	Add suffix <b>L</b> to style number and specify leather color number.
	<b>Multiple upholstery fabrics</b>		
	• Two or more fabrics on different chair components	+\$ 98	Add suffix <b>M</b> to round chair style number and select fabric color number for:
	▶ See below and at right.		<ol style="list-style-type: none"> <li>1 Seat</li> <li>2 Inner back</li> <li>3 Outer back</li> </ol> <p>Example: TS31409M with 5G61 on seat, 5F15 on inner back, and 5G51 on outer back.</p>
	<b>1 Fabric on seat</b>		
	• Fabric price group 1	No cost	Specify fabric color number.
	• Fabric price group 2	+\$ 23	Specify fabric color number.
	• Fabric price group 3	+\$ 49	Specify fabric color number.
	• Fabric price group 4	+\$ 92	Specify fabric color number.
	• Fabric price group 5	+\$ 113	Specify fabric color number.
	• Fabric price group 6	+\$ 130	Specify fabric color number.
	• Fabric price group 7	+\$ 161	Specify fabric color number.
	• Fabric price group 8	+\$ 197	Specify fabric color number.
	• Fabric price group 9	+\$ 227	Specify fabric color number.
	• Fabric price group 10	+\$ 254	Specify fabric color number.
	• Leather price group	+\$1542	Specify fabric color number. Add suffix <b>L</b> to style number and specify leather color number. ▶ See <i>Surface Materials</i> , page 473.
	• Customer's Own Material (COM)	+\$ 27	
	• Customer's Own Leather (COL)	+\$ 27	Add suffix <b>L</b> to style number and specify leather color number.

▶ Options, continued on next page

▶ Detailed dimensions, page 172



**For Canadian Pricing**

Multiply U.S. Price by the Canadian price factor.

▶ See page 1 for details.

► Options, continued from previous page

Options	U.S. Price	Required to Specify
<b>Surface Materials, continued</b>		
<b>② Fabric on inner back</b> <ul style="list-style-type: none"> <li>Fabric price group 1</li> <li>Fabric price group 2</li> <li>Fabric price group 3</li> <li>Fabric price group 4</li> <li>Fabric price group 5</li> <li>Fabric price group 6</li> <li>Fabric price group 7</li> <li>Fabric price group 8</li> <li>Fabric price group 9</li> <li>Fabric price group 10</li> <li>Leather price group</li> </ul>	No cost +\$ 24 +\$ 57 +\$ 66 +\$ 78 +\$ 98 +\$ 104 +\$ 119 +\$ 136 +\$ 159 +\$ 912	Specify fabric color number. Specify fabric color number. Specify fabric color number. Specify fabric color number. Specify fabric color number. Specify fabric color number. Specify fabric color number. Specify fabric color number. Specify fabric color number. Specify fabric color number. Add suffix <b>L</b> to style number and specify leather color number. ► See <i>Surface Materials</i> , page 473.
<ul style="list-style-type: none"> <li>Customer's Own Material (COM)</li> <li>Customer's Own Leather (COL)</li> </ul>	+\$ 27 +\$ 27	Add suffix <b>L</b> to style number and specify leather color number.
<b>③ Fabric on outer back</b> <ul style="list-style-type: none"> <li>Fabric price group 1</li> <li>Fabric price group 2</li> <li>Fabric price group 3</li> <li>Fabric price group 4</li> <li>Fabric price group 5</li> <li>Fabric price group 6</li> <li>Fabric price group 7</li> <li>Fabric price group 8</li> <li>Fabric price group 9</li> <li>Fabric price group 10</li> <li>Leather price group</li> </ul>	No cost +\$ 31 +\$ 60 +\$ 83 +\$ 109 +\$ 141 +\$ 179 +\$ 201 +\$ 231 +\$ 255 +\$1209	Specify fabric color number. Specify fabric color number. Specify fabric color number. Specify fabric color number. Specify fabric color number. Specify fabric color number. Specify fabric color number. Specify fabric color number. Specify fabric color number. Specify fabric color number. Add suffix <b>L</b> to style number and specify leather color number. ► See <i>Surface Materials</i> , page 473.
<ul style="list-style-type: none"> <li>Customer's Own Material (COM)</li> <li>Customer's Own Leather (COL)</li> </ul>	+\$ 27 +\$ 27	Add suffix <b>L</b> to style number and specify leather color number.
<b>Legs</b> <ul style="list-style-type: none"> <li>Solid round wood legs</li> </ul>	+\$ 136	Specify with <i>solid round wood legs</i> and select V1AC Natural Cherry, V1AM Clear Maple, or V1EW Dark Walnut.

Tip: Wood legs are natural wood and may show variations in grain and color.

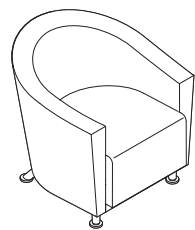

Specification Information

Style Number	U.S. Base Price
--------------	-----------------

Round

TS31409	\$2233
---------	--------

 **For Canadian Pricing**  
 Multiply U.S. Price by the Canadian price factor.  
 ► See page 1 for details.

Jenny Lounge, continued

With Wood Arms

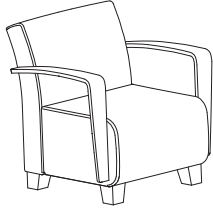

Tip: Jenny lounge chairs are available with multiple fabrics.

▶ See at right to specify.

Tip: When specifying multiple COM fabrics, indicate all surfaces where COM applies. Example: TS31407M with Designtex 1234 on seat, Designtex 5678 on inner back, Designtex 9012 on outer back, and Designtex 9012 on arms.

Tip: When specifying multiple fabrics and leather, specify suffix M before suffix L. Example: TS31408ML TS31408CML

Standard Includes	Required to Specify
<ul style="list-style-type: none"> <li>▶ Need help? Product details, page 170</li> <li>Fully upholstered lounge chair: fabric price group 1</li> <li>Plywood arm: maple veneer</li> <li>Legs with glides: black plastic</li> <li>Shipped fully assembled</li> <li>Meets Cal. 117 requirements</li> </ul>	<ul style="list-style-type: none"> <li>1 Style number</li> <li>2 Fabric color number for upholstery</li> <li>3 Wood color number for arms</li> <li>4 Options, if selected (see below)</li> <li>▶ See <i>Surface Materials</i>, page 473.</li> </ul>

Surface Materials	Options	U.S. Price	Required to Specify
	<b>Single upholstery fabric</b> <ul style="list-style-type: none"> <li>Fabric price group 1</li> <li>Fabric price group 2</li> <li>Fabric price group 3</li> <li>Fabric price group 4</li> <li>Fabric price group 5</li> <li>Fabric price group 6</li> <li>Fabric price group 7</li> <li>Fabric price group 8</li> <li>Fabric price group 9</li> <li>Fabric price group 10</li> <li>Leather price group</li> </ul>	<ul style="list-style-type: none"> <li>No cost</li> <li>+\$ 47</li> <li>+\$ 105</li> <li>+\$ 144</li> <li>+\$ 187</li> <li>+\$ 234</li> <li>+\$ 277</li> <li>+\$ 349</li> <li>+\$ 437</li> <li>+\$ 494</li> <li>+\$2996</li> </ul>	<ul style="list-style-type: none"> <li>Specify fabric color number.</li> <li>Specify fabric color number.</li> <li>Specify fabric color number.</li> <li>Specify fabric color number.</li> <li>Specify fabric color number.</li> <li>Specify fabric color number.</li> <li>Specify fabric color number.</li> <li>Specify fabric color number.</li> <li>Specify fabric color number.</li> <li>Specify fabric color number.</li> <li>Add suffix <b>L</b> to style number and specify leather color number.</li> <li>▶ See <i>Surface Materials</i>, page 473.</li> </ul>
	<ul style="list-style-type: none"> <li>Customer's Own Material (COM)</li> <li>Customer's Own Leather (COL)</li> </ul>	<ul style="list-style-type: none"> <li>+\$ 56</li> <li>+\$ 53</li> </ul>	<ul style="list-style-type: none"> <li>Add suffix <b>L</b> to style number and specify leather color number.</li> </ul>
	<b>Multiple upholstery fabrics</b> <ul style="list-style-type: none"> <li>Two or more fabrics on different chair components</li> </ul>	<ul style="list-style-type: none"> <li>+\$ 98</li> </ul>	<ul style="list-style-type: none"> <li>Add suffix <b>M</b> to lounge chair style number and select fabric color number for:</li> <li>1 Seat</li> <li>2 Inner back</li> <li>3 Outer back</li> <li>Example: TS31408M with 5G61 on seat, 5F15 on inner back, and 5G51 on outer back.</li> </ul>
	<b>1 Fabric on seat</b> <ul style="list-style-type: none"> <li>Fabric price group 1</li> <li>Fabric price group 2</li> <li>Fabric price group 3</li> <li>Fabric price group 4</li> <li>Fabric price group 5</li> <li>Fabric price group 6</li> <li>Fabric price group 7</li> <li>Fabric price group 8</li> <li>Fabric price group 9</li> <li>Fabric price group 10</li> <li>Leather price group</li> </ul>	<ul style="list-style-type: none"> <li>No cost</li> <li>+\$ 17</li> <li>+\$ 49</li> <li>+\$ 63</li> <li>+\$ 85</li> <li>+\$ 106</li> <li>+\$ 126</li> <li>+\$ 161</li> <li>+\$ 197</li> <li>+\$ 227</li> <li>+\$1430</li> </ul>	<ul style="list-style-type: none"> <li>Specify fabric color number.</li> <li>Specify fabric color number.</li> <li>Specify fabric color number.</li> <li>Specify fabric color number.</li> <li>Specify fabric color number.</li> <li>Specify fabric color number.</li> <li>Specify fabric color number.</li> <li>Specify fabric color number.</li> <li>Specify fabric color number.</li> <li>Specify fabric color number.</li> <li>Add suffix <b>L</b> to style number and specify leather color number.</li> <li>▶ See <i>Surface Materials</i>, page 473.</li> </ul>
	<ul style="list-style-type: none"> <li>Customer's Own Material (COM)</li> <li>Customer's Own Leather (COL)</li> </ul>	<ul style="list-style-type: none"> <li>+\$ 27</li> <li>+\$ 27</li> </ul>	<ul style="list-style-type: none"> <li>Add suffix <b>L</b> to style number and specify leather color number.</li> </ul>

▶ Options, continued on next page

▶ Detailed dimensions, page 172



**For Canadian Pricing**

Multiply U.S. Price by the Canadian price factor.

▶ See page 1 for details.

► Options, continued from previous page

	Options	U.S. Price	Required to Specify
<b>Surface Materials, continued</b>	<b>② Fabric on inner back</b>		
	• Fabric price group 1	No cost	Specify fabric color number.
	• Fabric price group 2	+\$ 9	Specify fabric color number.
	• Fabric price group 3	+\$ 35	Specify fabric color number.
	• Fabric price group 4	+\$ 47	Specify fabric color number.
	• Fabric price group 5	+\$ 60	Specify fabric color number.
	• Fabric price group 6	+\$ 73	Specify fabric color number.
	• Fabric price group 7	+\$ 87	Specify fabric color number.
	• Fabric price group 8	+\$108	Specify fabric color number.
	• Fabric price group 9	+\$136	Specify fabric color number.
	• Fabric price group 10	+\$159	Specify fabric color number.
	• Leather price group	+\$670	Specify fabric color number. Add suffix <b>L</b> to style number and specify leather color number.
	• Customer's Own Material (COM)	+\$ 27	► See <i>Surface Materials</i> , page 473.
	• Customer's Own Leather (COL)	+\$ 27	Add suffix <b>L</b> to style number and specify leather color number.
	<b>③ Fabric on outer back</b>		
	• Fabric price group 1	No cost	Specify fabric color number.
	• Fabric price group 2	+\$ 7	Specify fabric color number.
	• Fabric price group 3	+\$ 22	Specify fabric color number.
	• Fabric price group 4	+\$ 36	Specify fabric color number.
	• Fabric price group 5	+\$ 46	Specify fabric color number.
• Fabric price group 6	+\$ 56	Specify fabric color number.	
• Fabric price group 7	+\$ 63	Specify fabric color number.	
• Fabric price group 8	+\$ 81	Specify fabric color number.	
• Fabric price group 9	+\$104	Specify fabric color number.	
• Fabric price group 10	+\$114	Specify fabric color number.	
• Leather price group	+\$929	Specify fabric color number. Add suffix <b>L</b> to style number and specify leather color number.	
• Customer's Own Material (COM)	+\$ 27	► See <i>Surface Materials</i> , page 473.	
• Customer's Own Leather (COL)	+\$ 27	Add suffix <b>L</b> to style number and specify leather color number.	
	<b>Legs</b>		
	• Brushed aluminum legs	+\$167	Specify <i>with brushed aluminum legs</i> .
	• Solid square wood legs	+\$222	Specify <i>with solid square wood legs</i> and select 3412 Natural Cherry, 3522 Clear Maple, or 3762 Dark Walnut.
	• Solid round wood legs	+\$233	Specify <i>with solid round wood legs</i> and select V1AC Natural Cherry, V1AM Clear Maple, or V1EW Dark Walnut.

Lounge Seating

Tip: Brushed aluminum legs are adjustable and have 3/4" of height adjustment.

Tip: Wood legs are natural wood and may show variations in grain and color.

**Specification Information**

Style Number	U.S. Base Price
--------------	-----------------

**With Wood Arms**

TS31408 \$2317

**With Wood Arm Left**

TS31428 \$2037

**With Wood Arm Right**

TS31438 \$2037



Jenny Lounge, continued

Ottoman

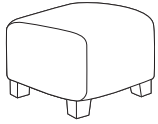

Tip: Hard dual-wheel casters are for use on carpet. Use on hard surfaces, including floor mats, will affect chair stability and may result in personal injury.

Tip: Jenny ottoman is available with multiple fabrics. See at right to specify.

Tip: When specifying multiple COM fabrics, indicate all surfaces where COM applies. Example: TS31405M with Designtex 1234 on seat, front, and back and Designtex 9012 on sides.

Tip: When specifying multiple fabrics and leather, specify suffix **M** before suffix **L**. Example: TS31405ML TS31405CML

Standard Includes	Required to Specify
<ul style="list-style-type: none"> <li>▶ Need help? Product details, page 168</li> <li>Fully upholstered ottoman: fabric price group 1</li> <li>Hard dual-wheel casters or legs with glides: black plastic</li> <li>Meets Cal. 117 requirements</li> </ul>	<ul style="list-style-type: none"> <li>1 Style number</li> <li>2 Fabric color number for upholstery</li> <li>3 Options, if selected (see below)</li> <li>▶ See <i>Surface Materials</i>, page 473.</li> </ul>

Options	U.S. Price	Required to Specify
<b>Surface Materials</b>		
<b>Single upholstery fabric</b>		
• Fabric price group 1	No cost	Specify fabric color number.
• Fabric price group 2	+\$ 24	Specify fabric color number.
• Fabric price group 3	+\$ 62	Specify fabric color number.
• Fabric price group 4	+\$ 94	Specify fabric color number.
• Fabric price group 5	+\$ 117	Specify fabric color number.
• Fabric price group 6	+\$ 144	Specify fabric color number.
• Fabric price group 7	+\$ 172	Specify fabric color number.
• Fabric price group 8	+\$ 221	Specify fabric color number.
• Fabric price group 9	+\$ 273	Specify fabric color number.
• Fabric price group 10	+\$ 308	Specify fabric color number.
• Leather price group	+\$1555	Specify fabric color number.
• Customer's Own Material (COM)	+\$ 56	Add suffix <b>L</b> to style number and specify leather color number.
• Customer's Own Leather (COL)	+\$ 53	▶ See <i>Surface Materials</i> , page 473.
<b>Multiple upholstery fabrics</b>		
• Two or more fabrics on different components	+\$ 98	Add suffix <b>M</b> to ottoman style number and select fabric color number for:
▶ See below and at right.		<ul style="list-style-type: none"> <li>1 Seat, front, and back</li> <li>2 Sides</li> </ul>
		Example: TS31405M with 5G61 on seat, front, and back and 5F15 on sides.
<b>1 Fabric on seat, front, and back</b>		
• Fabric price group 1	No cost	Specify fabric color number.
• Fabric price group 2	+\$ 17	Specify fabric color number.
• Fabric price group 3	+\$ 49	Specify fabric color number.
• Fabric price group 4	+\$ 69	Specify fabric color number.
• Fabric price group 5	+\$ 88	Specify fabric color number.
• Fabric price group 6	+\$ 108	Specify fabric color number.
• Fabric price group 7	+\$ 130	Specify fabric color number.
• Fabric price group 8	+\$ 165	Specify fabric color number.
• Fabric price group 9	+\$ 206	Specify fabric color number.
• Fabric price group 10	+\$ 234	Specify fabric color number.
• Leather price group	+\$1074	Specify fabric color number.
• Customer's Own Material (COM)	+\$ 27	Add suffix <b>L</b> to style number and specify leather color number.
• Customer's Own Leather (COL)	+\$ 27	▶ See <i>Surface Materials</i> , page 473.

▶ Options, continued on next page

▶ Detailed dimensions, page 172



**For Canadian Pricing**

Multiply U.S. Price by the Canadian price factor.

▶ See page 1 for details.

► Options, continued from previous page

Options		U.S. Price	Required to Specify
<b>Surface Materials, continued</b>	<b>② Fabric on sides</b>		
	• Fabric price group 1	No cost	Specify fabric color number.
	• Fabric price group 2	+\$ 4	Specify fabric color number.
	• Fabric price group 3	+\$ 11	Specify fabric color number.
	• Fabric price group 4	+\$ 22	Specify fabric color number.
	• Fabric price group 5	+\$ 28	Specify fabric color number.
	• Fabric price group 6	+\$ 37	Specify fabric color number.
	• Fabric price group 7	+\$ 46	Specify fabric color number.
	• Fabric price group 8	+\$ 56	Specify fabric color number.
	• Fabric price group 9	+\$ 69	Specify fabric color number.
	• Fabric price group 10	+\$ 77	Specify fabric color number.
	• Leather price group	+\$546	Specify fabric color number. Add suffix <b>L</b> to style number and specify leather color number.
	• Customer's Own Material (COM)	+\$ 27	► See <i>Surface Materials</i> , page 473.
• Customer's Own Leather (COL)	+\$ 27	Add suffix <b>L</b> to style number and specify leather color number.	
	<b>Legs</b>		
	• Brushed aluminum legs	+\$167	Specify <i>with brushed aluminum legs</i> .
	• Solid square wood legs	+\$222	Specify <i>with solid square wood legs</i> and select 3412 Natural Cherry, 3522 Clear Maple, or 3762 Dark Walnut.
	• Solid round wood legs	+\$233	Specify <i>with solid round wood legs</i> and select V1AC Natural Cherry, V1AM Clear Maple, or V1EW Dark Walnut.

Tip: Brushed aluminum legs are adjustable and have 3/4" of height adjustment.

Tip: Wood legs are natural wood and may show variations in grain and color.

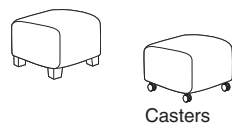

Specification Information			
Style Number	U.S. Base Price	Style Number	U.S. Base Price

**With Glides**

TS31405 \$824

**With Casters**

TS31405C \$957

**Ganging Kit**

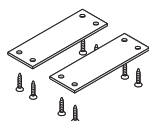

Standard Includes	Required to Specify
<ul style="list-style-type: none"> <li>• Ganging kit</li> <li>• Two plates</li> <li>• Attachment hardware</li> </ul>	Style number

Specification Information			
Dimensions D W	Style Number	U.S. Price	
2" 6"	TS31410	\$44	

 **For Canadian Pricing**  
Multiply U.S. Price by the Canadian price factor.  
► See page 1 for details.

Jenny Lounge, continued

Club Low

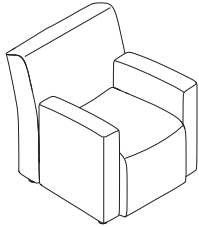

Tip: Jenny low chairs come standard with low feet to allow for a lower chair height supporting working lounge posture.

Tip: Jenny lounge chairs are available with multiple fabrics.

▶ See at right to specify.

Tip: When specifying multiple COM fabrics, indicate all surfaces where COM applies. Example: TS31407M with Designtex 1234 on seat, Designtex 5678 on inner back, Designtex 9012 on outer back, and Designtex 9012 on arms.

Tip: When specifying multiple fabrics and leather, specify suffix **M** before suffix **L**. Example: TS31412ML

Standard Includes	Required to Specify
<ul style="list-style-type: none"> <li>▶ Need help? Product details, page 168</li> <li>Fully upholstered lounge chair with arms:                             <ul style="list-style-type: none"> <li>fabric price group 1</li> <li>Deck stitch detail</li> <li>Shipped fully assembled</li> <li>Meets Cal. 117 requirements</li> <li>Low foot, black plastic</li> </ul> </li> </ul>	<ul style="list-style-type: none"> <li>1 Style number</li> <li>2 Fabric color number for upholstery</li> <li>3 Options, if selected (see below)</li> <li>▶ See <i>Surface Materials</i>, page 473.</li> </ul>

Surface Materials	Options	U.S. Price	Required to Specify
	<b>Single upholstery fabric</b> <ul style="list-style-type: none"> <li>Fabric price group 1</li> <li>Fabric price group 2</li> <li>Fabric price group 3</li> <li>Fabric price group 4</li> <li>Fabric price group 5</li> <li>Fabric price group 6</li> <li>Fabric price group 7</li> <li>Fabric price group 8</li> <li>Fabric price group 9</li> <li>Fabric price group 10</li> <li>Leather price group</li> </ul>	<ul style="list-style-type: none"> <li>No cost</li> <li>+\$ 69</li> <li>+\$ 164</li> <li>+\$ 231</li> <li>+\$ 301</li> <li>+\$ 362</li> <li>+\$ 434</li> <li>+\$ 546</li> <li>+\$ 682</li> <li>+\$ 775</li> <li>+\$4630</li> </ul>	<ul style="list-style-type: none"> <li>Specify fabric color number.</li> <li>Specify fabric color number.</li> <li>Specify fabric color number.</li> <li>Specify fabric color number.</li> <li>Specify fabric color number.</li> <li>Specify fabric color number.</li> <li>Specify fabric color number.</li> <li>Specify fabric color number.</li> <li>Specify fabric color number.</li> <li>Specify fabric color number.</li> <li>Specify fabric color number.</li> <li>Add suffix <b>L</b> to style number and specify leather color number.</li> <li>▶ See <i>Surface Materials</i>, page 473.</li> </ul>
	<ul style="list-style-type: none"> <li>Customer's Own Material (COM)</li> <li>Customer's Own Leather (COL)</li> </ul>	<ul style="list-style-type: none"> <li>+\$ 56</li> <li>+\$ 56</li> </ul>	<ul style="list-style-type: none"> <li>Add suffix <b>L</b> to style number and specify leather color number.</li> </ul>

	<b>Multiple upholstery fabrics</b> <ul style="list-style-type: none"> <li>Two or more fabrics on different chair components</li> </ul>	<ul style="list-style-type: none"> <li>+\$ 98</li> </ul>	<ul style="list-style-type: none"> <li>Add suffix <b>M</b> to lounge chair style number and select fabric color number for:</li> <li>1 Seat</li> <li>2 Inner back</li> <li>3 Outer back</li> <li>4 Arms</li> <li>Example: TS31412M with 5G61 on seat, 5F15 on inner back, 5G51 on outer back, and 5F03 on arms.</li> </ul>
	<b>1 Fabric on seat</b> <ul style="list-style-type: none"> <li>Fabric price group 1</li> <li>Fabric price group 2</li> <li>Fabric price group 3</li> <li>Fabric price group 4</li> <li>Fabric price group 5</li> <li>Fabric price group 6</li> <li>Fabric price group 7</li> <li>Fabric price group 8</li> <li>Fabric price group 9</li> <li>Fabric price group 10</li> <li>Leather price group</li> </ul>	<ul style="list-style-type: none"> <li>No cost</li> <li>+\$ 17</li> <li>+\$ 49</li> <li>+\$ 63</li> <li>+\$ 85</li> <li>+\$ 106</li> <li>+\$ 126</li> <li>+\$ 161</li> <li>+\$ 197</li> <li>+\$ 227</li> <li>+\$1321</li> </ul>	<ul style="list-style-type: none"> <li>Specify fabric color number.</li> <li>Specify fabric color number.</li> <li>Specify fabric color number.</li> <li>Specify fabric color number.</li> <li>Specify fabric color number.</li> <li>Specify fabric color number.</li> <li>Specify fabric color number.</li> <li>Specify fabric color number.</li> <li>Specify fabric color number.</li> <li>Specify fabric color number.</li> <li>Specify fabric color number.</li> <li>Add suffix <b>L</b> to style number and specify leather color number.</li> <li>▶ See <i>Surface Materials</i>, page 473.</li> </ul>
	<ul style="list-style-type: none"> <li>Customer's Own Material (COM)</li> <li>Customer's Own Leather (COL)</li> </ul>	<ul style="list-style-type: none"> <li>+\$ 27</li> <li>+\$ 27</li> </ul>	<ul style="list-style-type: none"> <li>Add suffix <b>L</b> to style number and specify leather color number.</li> </ul>

▶ Options, continued on next page

▶ Detailed dimensions, page 172



**For Canadian Pricing**  
Multiply U.S. Price by the Canadian price factor.  
▶ See page 1 for details.



► Options, continued from previous page

Options	U.S. Price	Required to Specify	
<b>Surface Materials, continued</b>	<b>2 Fabric on inner back</b>		
	• Fabric price group 1	No cost	Specify fabric color number.
	• Fabric price group 2	+\$ 9	Specify fabric color number.
	• Fabric price group 3	+\$ 35	Specify fabric color number.
	• Fabric price group 4	+\$ 47	Specify fabric color number.
	• Fabric price group 5	+\$ 60	Specify fabric color number.
	• Fabric price group 6	+\$ 73	Specify fabric color number.
	• Fabric price group 7	+\$ 87	Specify fabric color number.
	• Fabric price group 8	+\$ 108	Specify fabric color number.
	• Fabric price group 9	+\$ 136	Specify fabric color number.
• Fabric price group 10	+\$ 159	Specify fabric color number.	
• Leather price group	+\$ 670	Add suffix <b>L</b> to style number and specify leather color number.	
• Customer's Own Material (COM)	+\$ 27	► See <i>Surface Materials</i> , page 473.	
• Customer's Own Leather (COL)	+\$ 27	Add suffix <b>L</b> to style number and specify leather color number.	
<b>3 Fabric on outer back</b>			
	• Fabric price group 1	No cost	Specify fabric color number.
	• Fabric price group 2	+\$ 7	Specify fabric color number.
	• Fabric price group 3	+\$ 22	Specify fabric color number.
	• Fabric price group 4	+\$ 36	Specify fabric color number.
	• Fabric price group 5	+\$ 46	Specify fabric color number.
	• Fabric price group 6	+\$ 56	Specify fabric color number.
	• Fabric price group 7	+\$ 63	Specify fabric color number.
	• Fabric price group 8	+\$ 81	Specify fabric color number.
	• Fabric price group 9	+\$ 104	Specify fabric color number.
• Fabric price group 10	+\$ 114	Specify fabric color number.	
• Leather price group	+\$ 929	Add suffix <b>L</b> to style number and specify leather color number.	
• Customer's Own Material (COM)	+\$ 27	► See <i>Surface Materials</i> , page 473.	
• Customer's Own Leather (COL)	+\$ 27	Add suffix <b>L</b> to style number and specify leather color number.	
<b>4 Fabric on arms</b>			
	• Fabric price group 1	No cost	Specify fabric color number.
	• Fabric price group 2	+\$ 23	Specify fabric color number.
	• Fabric price group 3	+\$ 59	Specify fabric color number.
	• Fabric price group 4	+\$ 81	Specify fabric color number.
	• Fabric price group 5	+\$ 107	Specify fabric color number.
	• Fabric price group 6	+\$ 132	Specify fabric color number.
	• Fabric price group 7	+\$ 160	Specify fabric color number.
	• Fabric price group 8	+\$ 196	Specify fabric color number.
	• Fabric price group 9	+\$ 246	Specify fabric color number.
• Fabric price group 10	+\$ 278	Specify fabric color number.	
• Leather price group	+\$1770	Add suffix <b>L</b> to style number and specify leather color number.	
• Customer's Own Material (COM)	+\$ 27	► See <i>Surface Materials</i> , page 473.	
• Customer's Own Leather (COL)	+\$ 27	Add suffix <b>L</b> to style number and specify leather color number.	

Lounge Seating

**Specification Information**

• <b>Style Number</b>	• <b>U.S. Base Price</b>
•	•
•	•
•	•

**Club Low**

<b>TS31412</b>	\$1917
•	•
•	•

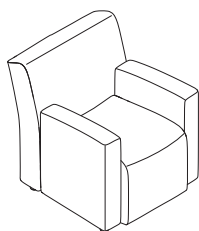

Jenny Lounge, continued

Round Low

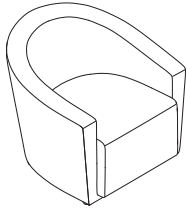

Tip: Jenny low chairs come standard with low feet to allow for a lower chair height supporting working lounge posture.

Tip: Jenny round chairs are available with multiple fabrics. See at right to specify.

Tip: When specifying multiple COM fabrics, indicate all surfaces where COM applies. Example: TS31407M with Designtex 1234 on seat, Designtex 5678 on inner back, Designtex 9012 on outer back, and Designtex 9012 on arms.

Tip: When specifying multiple fabrics and leather, specify suffix **M** before suffix **L**. Example: TS31413ML

Standard Includes	Required to Specify
<ul style="list-style-type: none"> <li>▶ Need help? Product details, page 168</li> <li>Fully upholstered round chair with arms: fabric price group 1</li> <li>Deck stitch detail</li> <li>Shipped fully assembled</li> <li>Meets Cal. 117 requirements</li> <li>Low foot, black plastic</li> </ul>	<ul style="list-style-type: none"> <li>1 Style number</li> <li>2 Fabric color number for upholstery</li> <li>3 Options, if selected (see below)</li> <li>▶ See <i>Surface Materials</i>, page 473.</li> </ul>

Surface Materials	Options	U.S. Price	Required to Specify
	<b>Single upholstery fabric</b> <ul style="list-style-type: none"> <li>Fabric price group 1</li> <li>Fabric price group 2</li> <li>Fabric price group 3</li> <li>Fabric price group 4</li> <li>Fabric price group 5</li> <li>Fabric price group 6</li> <li>Fabric price group 7</li> <li>Fabric price group 8</li> <li>Fabric price group 9</li> <li>Fabric price group 10</li> <li>Leather price group</li> </ul>	<ul style="list-style-type: none"> <li>No cost</li> <li>+\$ 69</li> <li>+\$ 164</li> <li>+\$ 231</li> <li>+\$ 301</li> <li>+\$ 362</li> <li>+\$ 434</li> <li>+\$ 546</li> <li>+\$ 682</li> <li>+\$ 775</li> <li>+\$4686</li> </ul>	<ul style="list-style-type: none"> <li>Specify fabric color number.</li> <li>Specify fabric color number.</li> <li>Specify fabric color number.</li> <li>Specify fabric color number.</li> <li>Specify fabric color number.</li> <li>Specify fabric color number.</li> <li>Specify fabric color number.</li> <li>Specify fabric color number.</li> <li>Specify fabric color number.</li> <li>Specify fabric color number.</li> <li>Specify fabric color number.</li> <li>Add suffix <b>L</b> to style number and specify leather color number.</li> <li>▶ See <i>Surface Materials</i>, page 473.</li> </ul>
	<ul style="list-style-type: none"> <li>Customer's Own Material (COM)</li> <li>Customer's Own Leather (COL)</li> </ul>	<ul style="list-style-type: none"> <li>+\$ 56</li> <li>+\$ 56</li> </ul>	<ul style="list-style-type: none"> <li>Add suffix <b>L</b> to style number and specify leather color number.</li> </ul>

	<b>Multiple upholstery fabrics</b> <ul style="list-style-type: none"> <li>Two or more fabrics on different chair components</li> </ul>	<ul style="list-style-type: none"> <li>+\$ 98</li> </ul>	<ul style="list-style-type: none"> <li>Add suffix <b>M</b> to round chair style number and select fabric color number for:</li> <li>1 Seat</li> <li>2 Inner back</li> <li>3 Outer back</li> <li>Example: TS31413M with 5G61 on seat, 5F15 on inner back, and 5G51 on outer back.</li> </ul>
	<b>1 Fabric on seat</b> <ul style="list-style-type: none"> <li>Fabric price group 1</li> <li>Fabric price group 2</li> <li>Fabric price group 3</li> <li>Fabric price group 4</li> <li>Fabric price group 5</li> <li>Fabric price group 6</li> <li>Fabric price group 7</li> <li>Fabric price group 8</li> <li>Fabric price group 9</li> <li>Fabric price group 10</li> <li>Leather price group</li> </ul>	<ul style="list-style-type: none"> <li>No cost</li> <li>+\$ 17</li> <li>+\$ 49</li> <li>+\$ 92</li> <li>+\$ 113</li> <li>+\$ 130</li> <li>+\$ 161</li> <li>+\$ 197</li> <li>+\$ 227</li> <li>+\$ 254</li> <li>+\$1542</li> </ul>	<ul style="list-style-type: none"> <li>Specify fabric color number.</li> <li>Specify fabric color number.</li> <li>Specify fabric color number.</li> <li>Specify fabric color number.</li> <li>Specify fabric color number.</li> <li>Specify fabric color number.</li> <li>Specify fabric color number.</li> <li>Specify fabric color number.</li> <li>Specify fabric color number.</li> <li>Specify fabric color number.</li> <li>Specify fabric color number.</li> <li>Add suffix <b>L</b> to style number and specify leather color number.</li> <li>▶ See <i>Surface Materials</i>, page 473.</li> </ul>
	<ul style="list-style-type: none"> <li>Customer's Own Material (COM)</li> <li>Customer's Own Leather (COL)</li> </ul>	<ul style="list-style-type: none"> <li>+\$ 27</li> <li>+\$ 27</li> </ul>	<ul style="list-style-type: none"> <li>Add suffix <b>L</b> to style number and specify leather color number.</li> </ul>

▶ Options, continued on next page

▶ Detailed dimensions, page 172



**For Canadian Pricing**  
Multiply U.S. Price by the Canadian price factor.  
▶ See page 1 for details.

► Options, continued from previous page

Options	U.S. Price	Required to Specify
<b>Surface Materials, continued</b>		
<b>② Fabric on inner back</b>		
• Fabric price group 1	No cost	Specify fabric color number.
• Fabric price group 2	+\$ 24	Specify fabric color number.
• Fabric price group 3	+\$ 57	Specify fabric color number.
• Fabric price group 4	+\$ 66	Specify fabric color number.
• Fabric price group 5	+\$ 78	Specify fabric color number.
• Fabric price group 6	+\$ 98	Specify fabric color number.
• Fabric price group 7	+\$ 104	Specify fabric color number.
• Fabric price group 8	+\$ 119	Specify fabric color number.
• Fabric price group 9	+\$ 136	Specify fabric color number.
• Fabric price group 10	+\$ 159	Specify fabric color number.
• Leather price group	+\$ 912	Specify fabric color number. Add suffix <b>L</b> to style number and specify leather color number.
• Customer's Own Material (COM)	+\$ 27	► See <i>Surface Materials</i> , page 473.
• Customer's Own Leather (COL)	+\$ 27	Add suffix <b>L</b> to style number and specify leather color number.
<b>③ Fabric on outer back</b>		
• Fabric price group 1	No cost	Specify fabric color number.
• Fabric price group 2	+\$ 31	Specify fabric color number.
• Fabric price group 3	+\$ 60	Specify fabric color number.
• Fabric price group 4	+\$ 83	Specify fabric color number.
• Fabric price group 5	+\$ 109	Specify fabric color number.
• Fabric price group 6	+\$ 141	Specify fabric color number.
• Fabric price group 7	+\$ 179	Specify fabric color number.
• Fabric price group 8	+\$ 201	Specify fabric color number.
• Fabric price group 9	+\$ 231	Specify fabric color number.
• Fabric price group 10	+\$ 255	Specify fabric color number.
• Leather price group	+\$1209	Specify fabric color number. Add suffix <b>L</b> to style number and specify leather color number.
• Customer's Own Material (COM)	+\$ 27	► See <i>Surface Materials</i> , page 473.
• Customer's Own Leather (COL)	+\$ 27	Add suffix <b>L</b> to style number and specify leather color number.

Lounge Seating

Specification Information

Style Number	U.S. Base Price
--------------	-----------------

Round Low

TS31413	\$2233
---------	--------

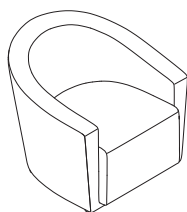

**For Canadian Pricing**

Multiply U.S. Price by the Canadian price factor.

► See page 1 for details.

Jenny Lounge, continued

Occasional Tables

Tip: There may be sheen or texture differences when using Low-Pressure Laminate and High-Pressure Laminate in adjacent applications. Please use caution when mixing and matching different worksurface types.

Tip: Edge band applies to entire table, not just the worksurface.

Tip: Brushed aluminum legs are adjustable and have 3/4" of height adjustment.

Tip: Wood legs are natural wood and may show variations in grain and color.

Tip: Low foot option reduces overall table height to 15".

Standard Includes		Required to Specify	
<ul style="list-style-type: none"> <li>▶ Need help? Product details, page 169</li> </ul>	<ul style="list-style-type: none"> <li>• Table: Low-Pressure Laminate (LPL) or High-Pressure Laminate (HPL)</li> <li>• 3 mm edge band: plastic</li> <li>• Legs with glides: black plastic</li> <li>• Shipped ready to assemble</li> </ul>	<ol style="list-style-type: none"> <li>1 Style number</li> <li>2 Low-Pressure Laminate or High-Pressure Laminate color number for table top, as appropriate</li> <li>3 Plastic edge band color number for table</li> <li>4 Low-Pressure Laminate color number for sides and base of table</li> <li>5 Options, if selected</li> </ol>	<ul style="list-style-type: none"> <li>▶ See <i>Surface Materials</i>, page 473.</li> </ul>

  

Options	U.S. Price	Required to Specify	
<b>Surface Materials</b> <ul style="list-style-type: none"> <li>• High-Pressure Laminate worksurfaces</li> <li>• Open Line laminate</li> </ul>	+\$102 plus cost of laminate	<ul style="list-style-type: none"> <li>▶ See <i>Surface Materials Reference Manual</i>.</li> </ul>	
<b>Legs</b> <ul style="list-style-type: none"> <li>• Brushed aluminum legs</li> <li>• Solid square wood legs</li> </ul>	+\$167 +\$222	Specify with <i>brushed aluminum legs</i> . Specify with <i>solid square wood legs</i> and select 3412 Natural Cherry, 3522 Clear Maple, or 3762 Dark Walnut. Specify with <i>solid round wood legs</i> and select V1AC Natural Cherry, V1AM Clear Maple, or V1EW Dark Walnut.	
<ul style="list-style-type: none"> <li>• Solid round wood legs</li> </ul>	+\$233		
<b>Legs</b> <ul style="list-style-type: none"> <li>• Low foot</li> </ul>	No cost	Specify with <i>low foot</i> .	

Specification Information						
Dimensions			Style Number LPL	U.S. Base Price	Style Number HPL	U.S. Base Price
D	W	H				

End Table						
26 1/2"	13 1/2"	17"	TS31415L	\$488	TS31415H	\$538
:	:	:	:	:	:	:

Coffee Table						
26 1/2"	26 1/2"	17"	TS31416L	\$665	TS31416H	\$715
:	:	:	:	:	:	:

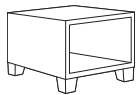
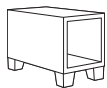

 **For Canadian Pricing**  
 Multiply U.S. Price by the Canadian price factor.  
 ▶ See page 1 for details.

# Regard General Overview

**Regard** is a frame-based, modular system of reconfigurable seating elements, privacy screens, tables, desk cabinets, media cabinets, and technology components.

**Regard** readily accommodates public and personal technology through media and desk cabinets as well as optional power integration.

**Regard** provides privacy for individuals and groups by incorporating screens, wide arms, and cabinets.

**Regard** supports a variety of postures from lounge, to seated or perched.

**Desk and media cabinets** ensure productive waiting and optimize technology support.

**Frame extensions** are available in 11" and 27½" depths to accommodate desk cabinets, media cabinets, and end-of-run seating.

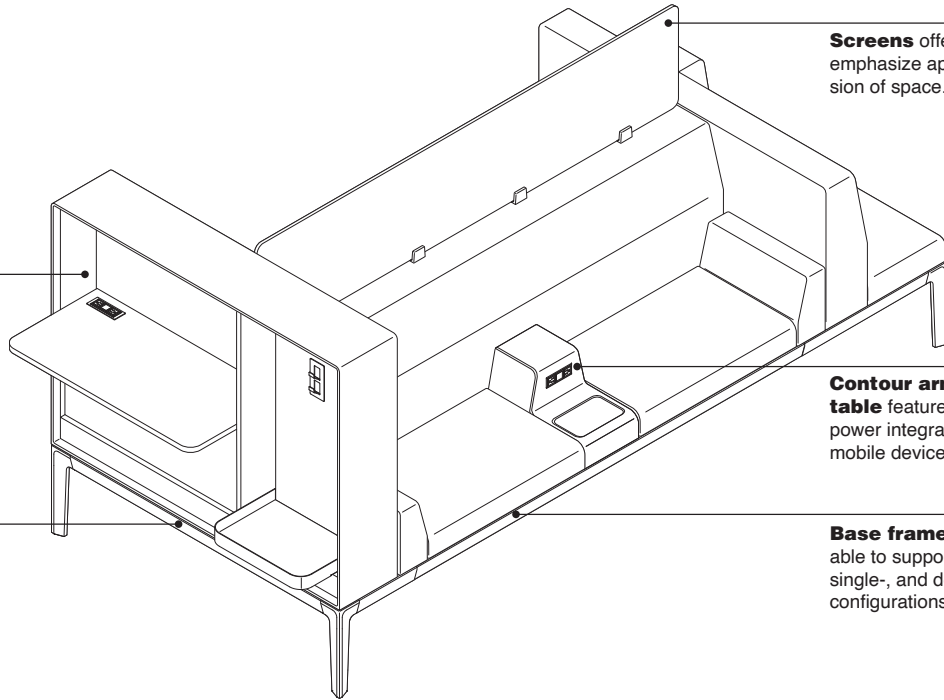

**Screens** offer privacy and emphasize appropriate division of space.

**Contour arm and in-line table** features optional power integration to support mobile devices.

**Base frames** are available to support bench, single-, and double-sided configurations.

**Mobile tablet surface** is designed to accommodate eating, working, entertaining, and writing.  
 ▶ See *Surround Mobile Tablet*, page 433.

**Storage end tables** provide place for personal items.

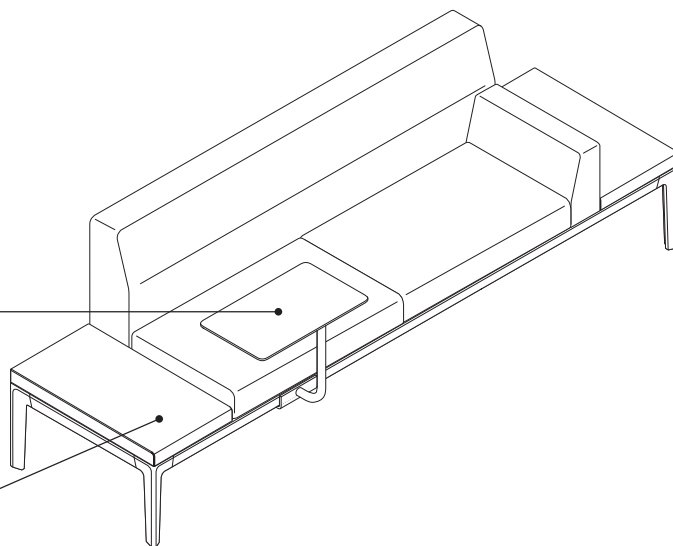

# Regard Thought Starters and Applications

## 44"W Single-Sided Seating

**11"W arm and in-line table** provide space for personal belongings and optional technology support.

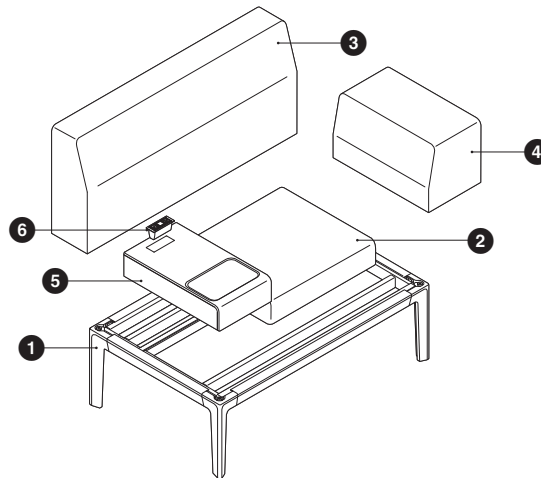
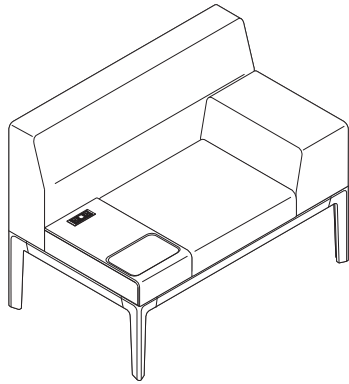

## 44"W Single-Sided Seating

### Recommended Components

	Quantity	Style Number	Description
①	1	<b>HS4FS44</b>	Single-Sided Frame – 27½"D x 44"W
②	1	<b>HS4H22</b>	Seat Cushion – 20"D x 22"W
③	1	<b>HS4BS44</b>	Single-Sided Back – 7½"D x 44"W
④	1	<b>HS4AS11</b>	Single-Sided Arm – 20"D x 11"W
⑤	1	<b>HS4TL11</b>	In-line Table (with power cutout) – 20"D x 11"W
⑥	1	<b>HS4VPSDC</b>	Power Strip

### 88"W Single-Sided Seating

**Three-seat unit** offers comfortable seating capacity with convenient optional power access.

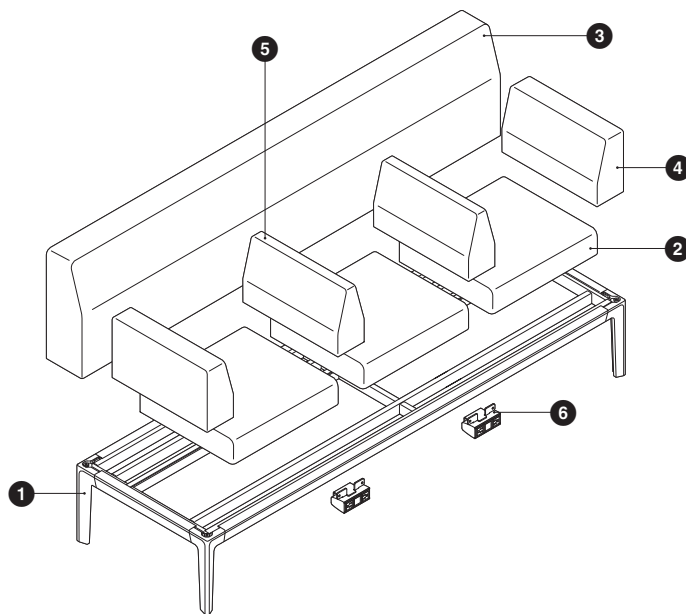
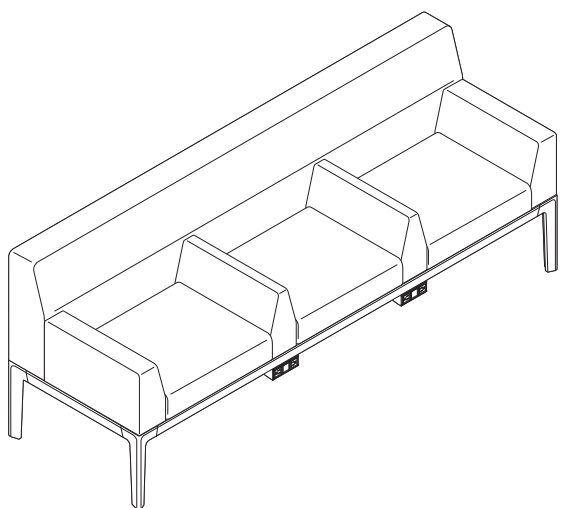

### 88"W Single-Sided Seating

**Recommended Components**

	Quantity	Style Number	Description
1	1	<b>HS4FS88</b>	Single-Sided Frame – 27½"D x 88"W
2	3	<b>HS4H22</b>	Seat Cushion – 20"D x 22"W
3	1	<b>HS4BS88</b>	Single-Sided Back – 7½"D x 88"W
4	2	<b>HS4AS6</b>	Single-Sided Arm – 20"D x 5½"W
5	2	<b>HS4AD6</b>	Double-Sided Arm – 20"D x 5½"W
6	2	<b>HS4VPSFC*</b>	Power Strip

\*Additional power components may be required to complete installation.

### 88"W Double-Sided Seating with 11"D Cabinet Extension

**Wide cushion and powered arms** ensure physical comfort by accommodating a variety of user needs and postures.

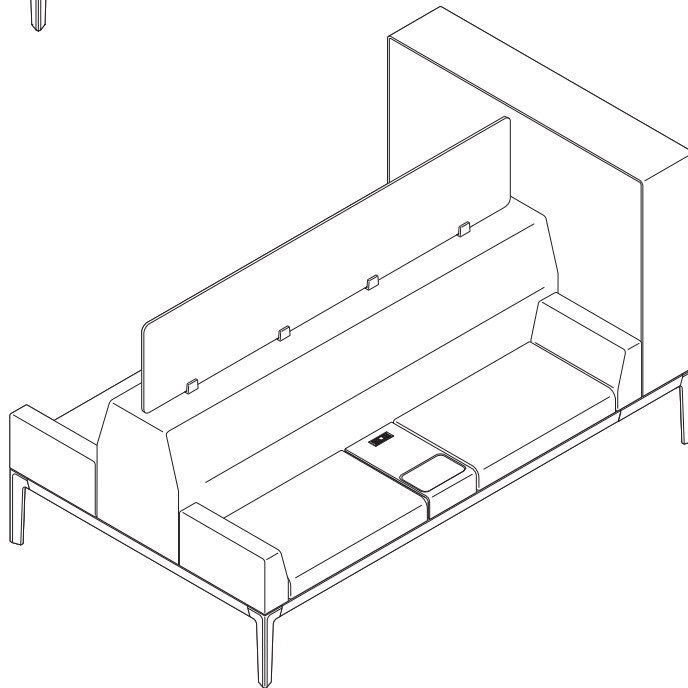
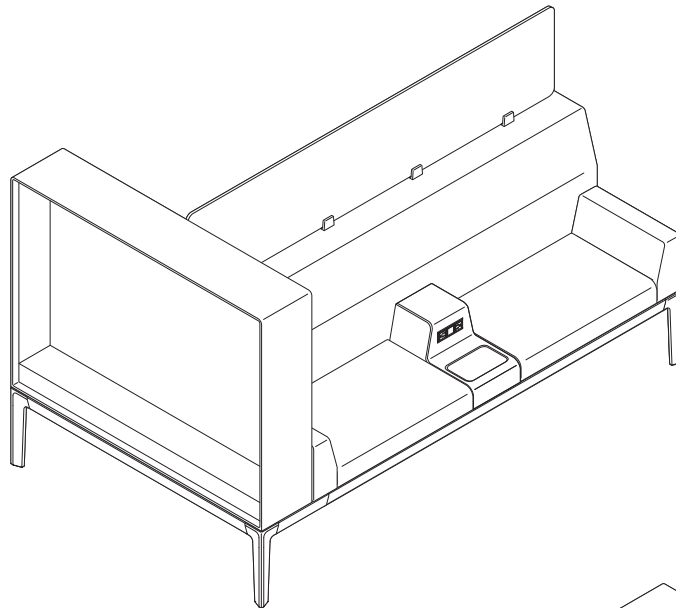



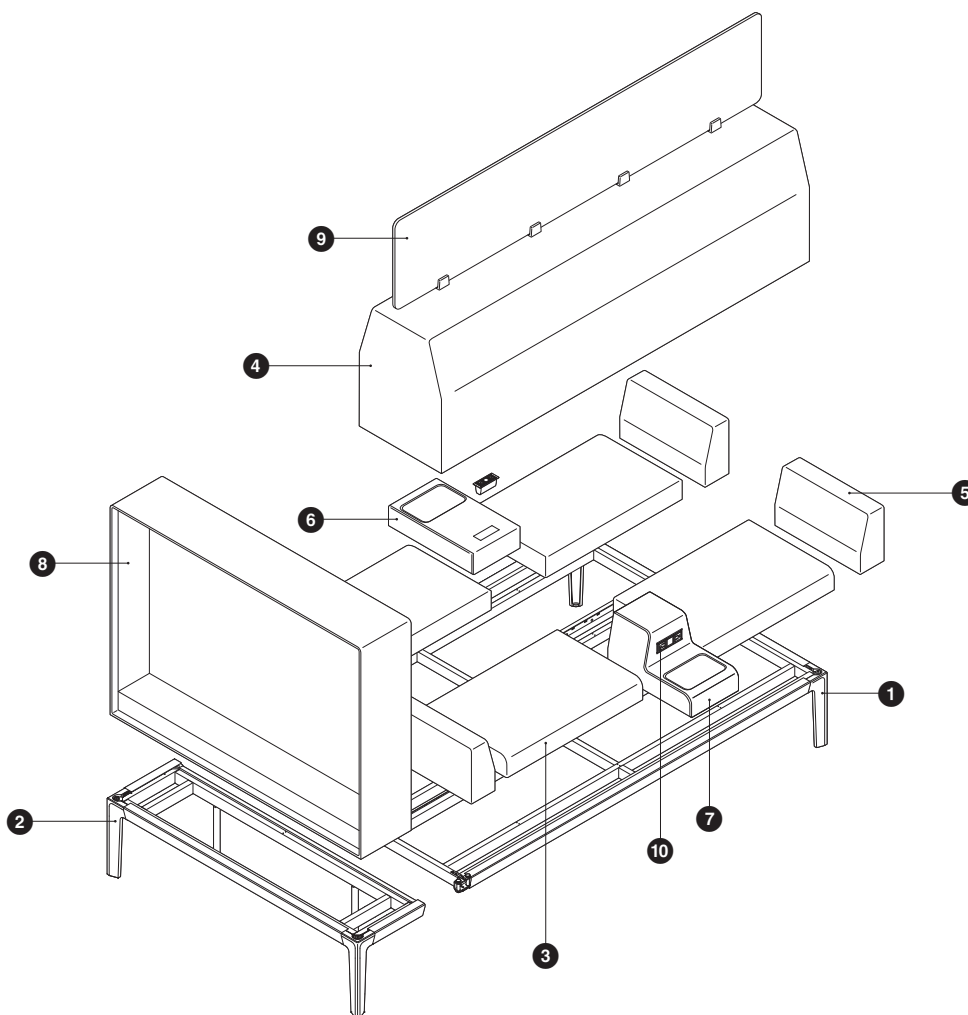

Lounge Seating

### 88\"/>

**Recommended Components**

	Quantity	Style Number	Description
1	1	<b>HS4FD88</b>	Double-Sided Frame – 55\"/>
2	1	<b>HS4FE1155</b>	Frame Extension – 11\"/>
3	4	<b>HS4H33</b>	Seat Cushion – 20\"/>
4	1	<b>HS4BD88</b>	Double-Sided Back – 15\"/>
5	4	<b>HS4AS6</b>	Single-Sided Arm – 20\"/>
6	1	<b>HS4TL11</b>	In-line table (with power cutout) – 20\"/>
7	1	<b>HS4AU11</b>	Contour Arm (with power cutout) – 20\"/>
8	1	<b>HS4CM</b>	Media Cabinet – 11\"/>
9	1	<b>HS4S88G</b>	Privacy Screen – 88\"/>
10	2	<b>HS4VPSDC*</b>	Power Strip

\*Additional power components may be required to complete installation.

**88"W Double-Sided Seating with 11"D and 27½"D Extensions**

**Double-sided and end-of-run seating** supports desires for privacy and intimacy.

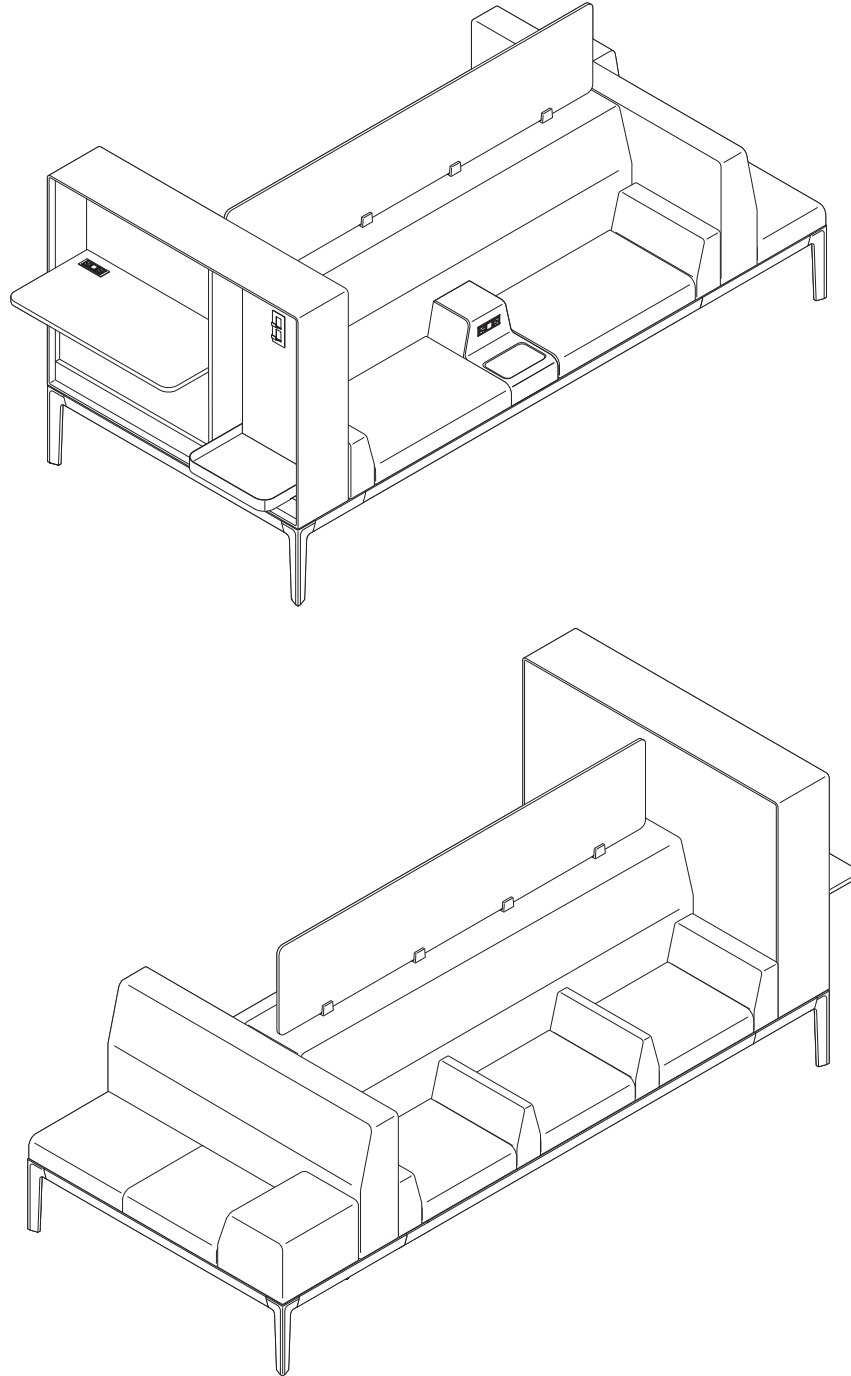

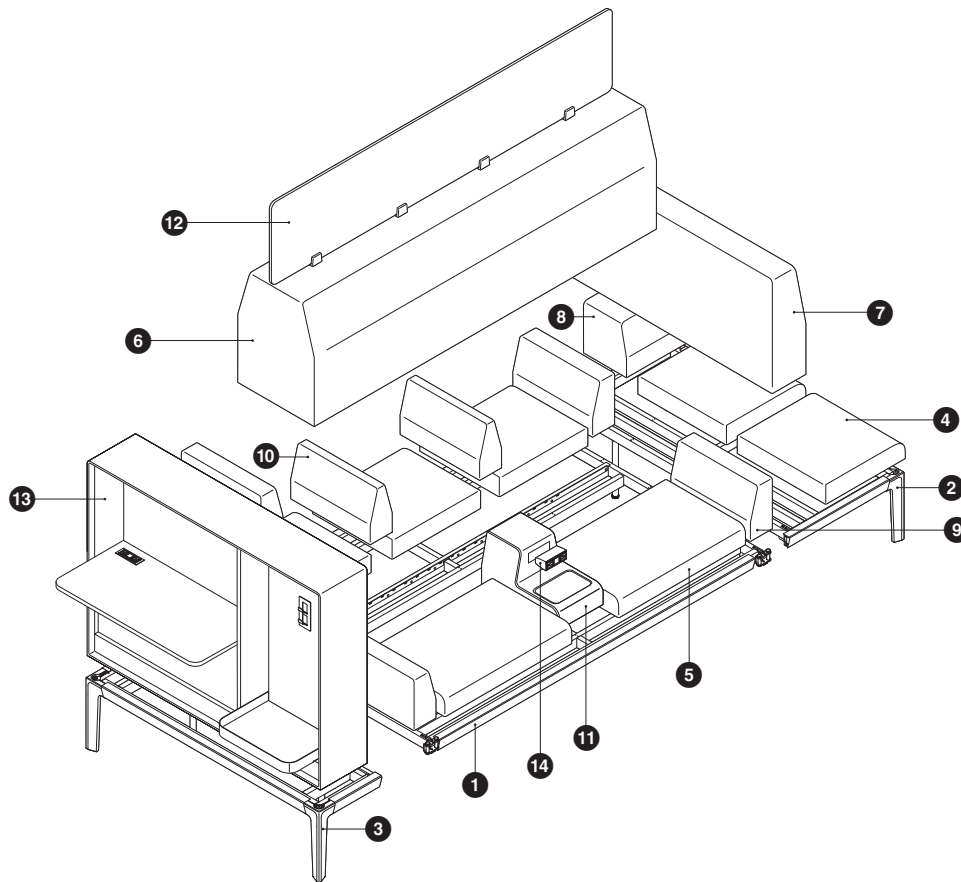

Lounge Seating

### 88"W Double-Sided Seating with 11"D and 27½"D Extensions

#### Recommended Components

	Quantity	Style Number	Description
1	1	<b>HS4FD88</b>	Double-Sided Frame – 55"D x 88"W
2	1	<b>HS4FE2855</b>	Frame Extension – 27½"D x 55"W
3	1	<b>HS4FE1155</b>	Frame Extension – 11"D x 55"W
4	5	<b>HS4H22</b>	Seat Cushion – 20"D x 22"W
5	2	<b>HS4H33</b>	Seat Cushion – 20"D x 33"W
6	1	<b>HS4BD88</b>	Double-Sided Back – 15"D x 88"W
7	1	<b>HS4BS55</b>	Single-Sided Back – 7½"D x 55"W
8	1	<b>HS4AS11</b>	Single-Sided Arm – 20"D x 11"W
9	4	<b>HS4AS6</b>	Single-Sided Arm – 20"D x 5½"W
10	2	<b>HS4AD6</b>	Double-Sided Arm – 20"D x 5½"W
11	1	<b>HS4AU11</b>	Contour Arm (with power cutout) – 20"D x 11"W
12	1	<b>HS4S88G</b>	Privacy Screen – 88"W x 14"H
13	1	<b>HS4D1836L</b>	Desk Cabinet with Bag Retainer and Coat Hook
14	2	<b>HS4VPSDC*</b>	Power Strip

\*Additional power components may be required to complete installation.

### 55"W Booth with Four 22"W Cushions

**Booth seating** provides a boundary from the surrounding environment with consideration for families and small groups.

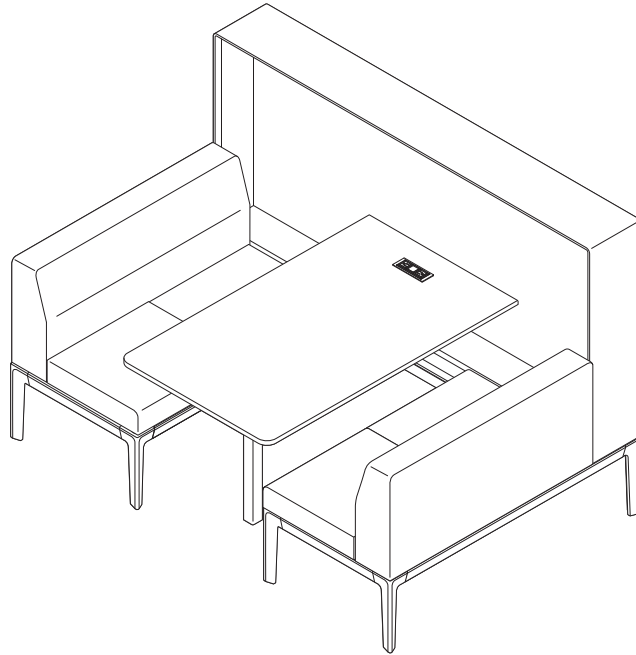

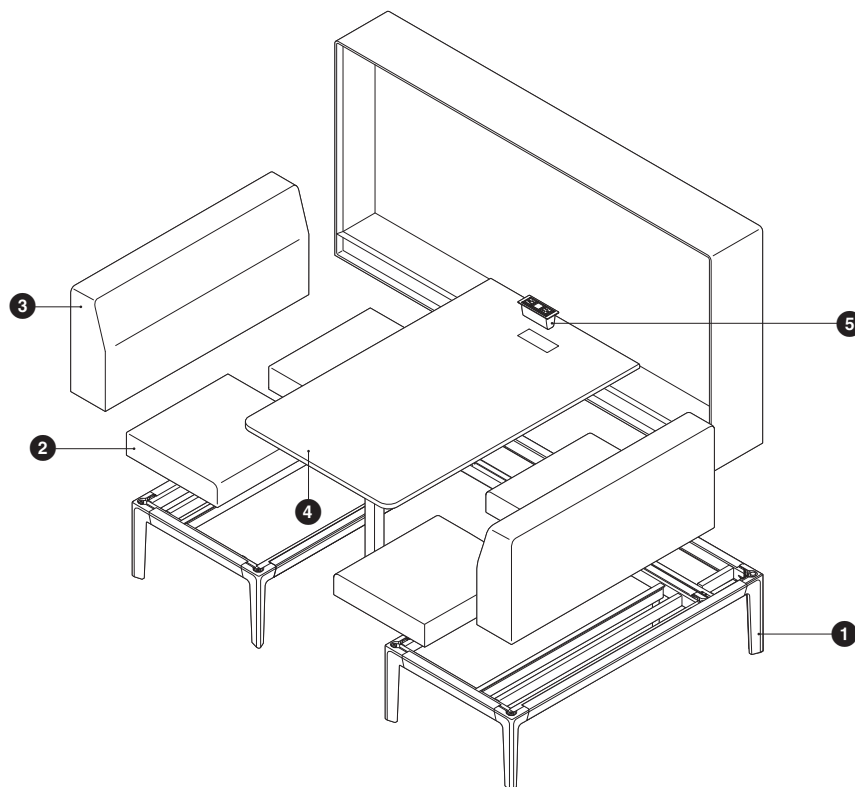

Lounge Seating

### 55"W Booth with Four 22"W Cushions

#### Recommended Components

	Quantity	Style Number	Description
①	1	<b>HS4FC5581</b>	Booth Frame – 55"D x 80½"W
②	4	<b>HS4H22</b>	Seat Cushion – 20"D x 22"W
③	2	<b>HS4BS44</b>	Single-Sided Back – 7½"D x 44"W
④	1	<b>HS4TC5581L</b>	Booth with Table (with LED light option) – 55"D x 80½"W
⑤	1	<b>HS4VPSDC*</b>	Power Strip

\*Assume power plugged directly into wall or floor outlet.

# Regard Height Diagram

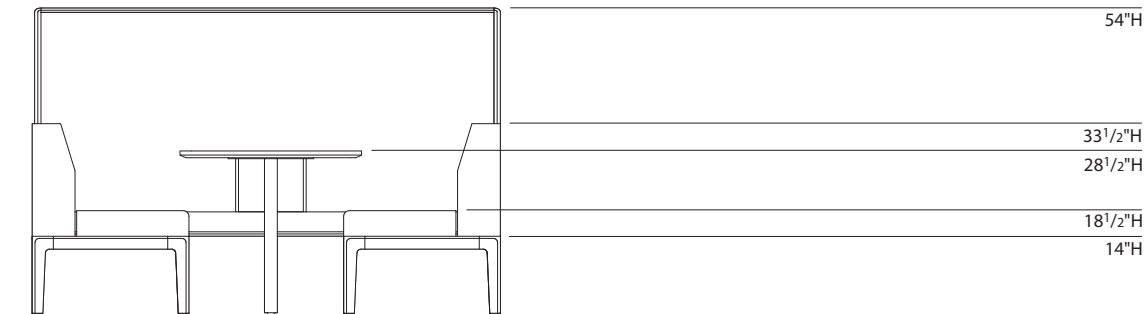
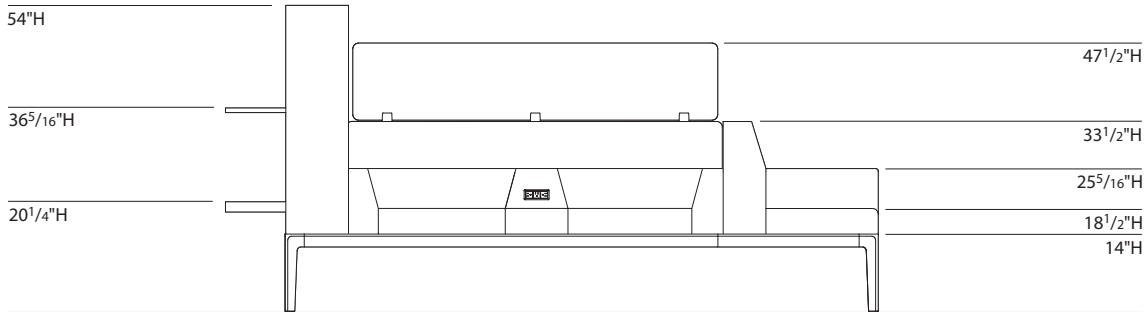
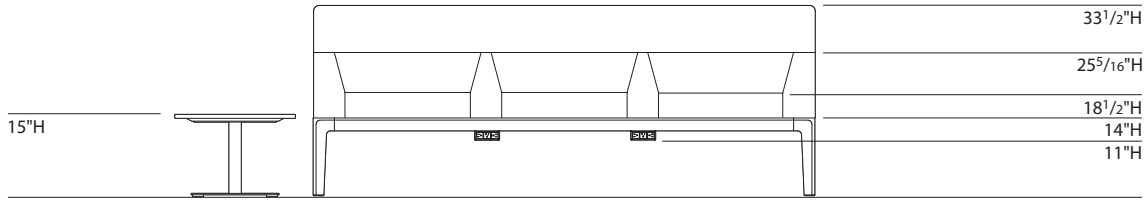
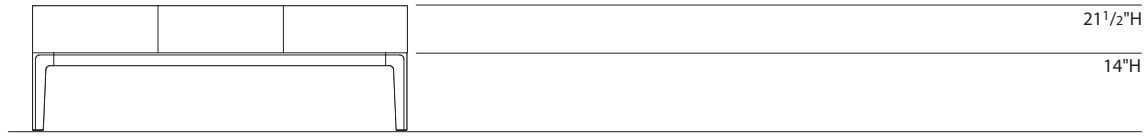



# Regard Base Frames and Frame Extensions

**Frame understructure** is welded tubular steel.

**Single-sided base frames** support modular seating with accompanying single-sided backs.

**Cast aluminum legs** connect to steel understructure to provide support and add visual continuity.

**Double-sided base frames** accommodate seating on opposite sides with a double-sided back in between.

**Glides** have a 1 1/2" adjustment range.

**Bench base frames** support two or three bench cushions.

**Single-sided planter frame** accommodates both seating and planter components.

**Frame extensions** are available to accommodate 11"D cabinets or 27 1/2"D seating end caps.

**Planter frame extension** provides foundation for end-of-run planter applications.

**Cabinet frame extension** provides foundation for end-of-run desk and media cabinets. Frame extensions can be added to either end of double-sided frames or to the back of a 55" single-sided unit for additional configurations.

**Booth base frames** accommodate booth cabinet and attached seating configurations.

**Seating frame extensions** provide foundation for end-of-run seating. Frame extensions can be added to either end of double-sided frames for additional configurations.

**Freestanding back-to-back frame** accommodates back-to-back media and desk cabinet applications.

**Base frames and seating components** allow for configuration on a 5 1/2" module. Each base frame width can support various combinations of components.

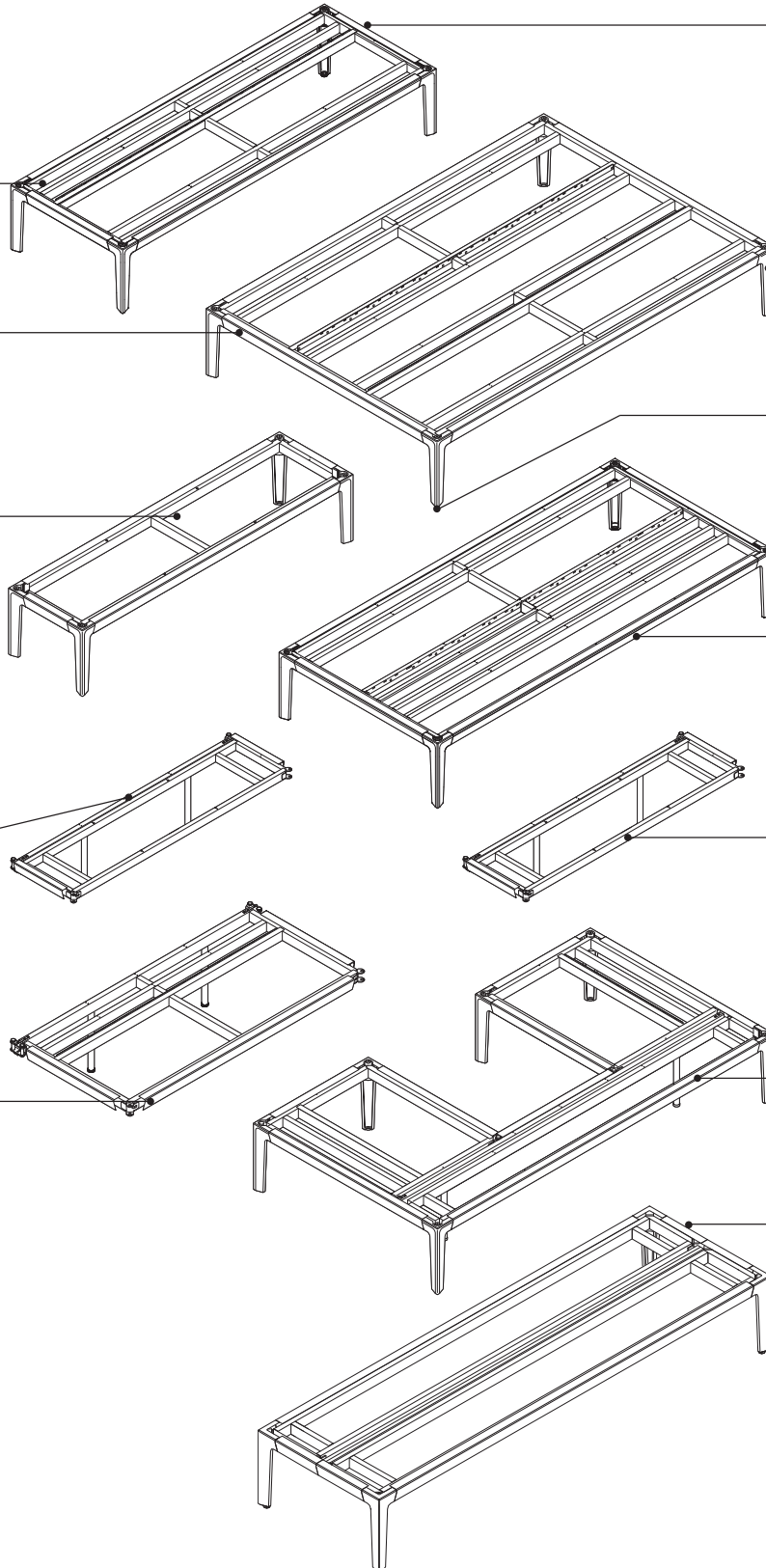



**Actual Dimensions**

	• Depth	• Width	• Height
<b>Base Frames</b>			
Single-Sided	27½"	33", 44", 55", 60½", 66", 71½", 77", 82½", and 88"	14"
Single-Sided Planter	37½"	44", 55", 60½", 66", 71½", 77", 82½", and 88"	14"
Double-Sided	55"	44", 55", 60½", 66", 71½", 77", 82½", and 88"	14"
Bench	18"	44" and 66"	14"
Booth	44" and 55"	80½"	14"
Wall-mount	11"	55"	14"
Freestanding Back-to-Back Cabinet	22"	55"	14"
<b>Frame Extensions</b>			
Seating	27½"	55"	14"
Cabinet	11"	55"	14"
Planter	11"	44", 60½", 66", 71½", 77", 82½", and 88"	14"

**Product Details**

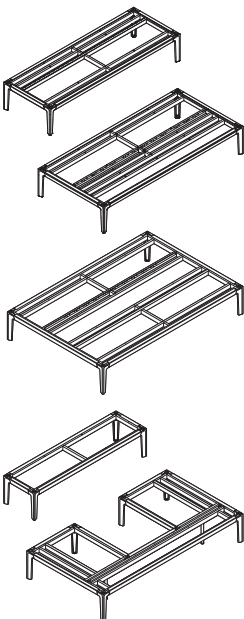

**Base frames** are available in single-sided, double-sided, planter, bench, freestanding back-to-back cabinets, and booth configurations.

**Base frames** are available in two depths, 27½" for single-sided seating and 55" for double-sided seating.

**Base frames** are available in widths from 33"–88" for single-sided and 44"–88" for double-sided on a 5½" increment.

**Planter base frames** are available 37½"D and in widths from 44"–88".

**Bench base frames** have a standard depth of 18" and feature either 44" or 66" widths for two- or three-seat configurations.

**Booth base frames** have a standard width of 80½" and feature 44" or 55" depths.

**Wall-mounted frame** includes two corner legs, trim, and wall-mount hardware.

**Freestanding back-to-back cabinet frames** have a standard depth of 22" and include four legs and trim pieces.

**Frames** include legs and all required trim pieces.

**Frames** are dynamically tested to 500 pounds and statically tested to 750 pounds in all seating positions.

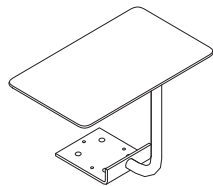

**The Surround mobile tablet** is designed to accommodate eating, working, entertaining, and writing. The surface is offered in a variety of Steelcase plastic finishes. The tablet arm is offered in a variety of Steelcase paint finishes.

**Connections**

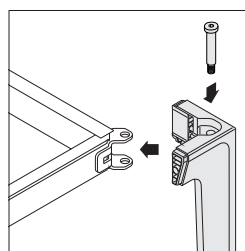

**Cast legs** attach to steel frame with bolts at each corner of the frame.

**Aluminum extrusion trims** span between each corner leg to lock in seats and arms. Seats can be reconfigured by removing trims.

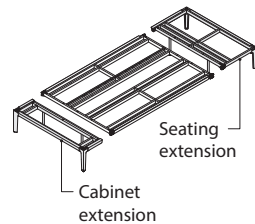

**Seating, cabinet, and planter frame extensions** attach to either end or both ends of a double-sided frame.

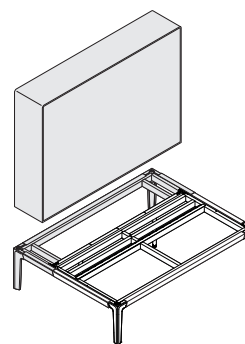

**Cabinet frame extension** can be added to the back side of 55"W single-sided frame.

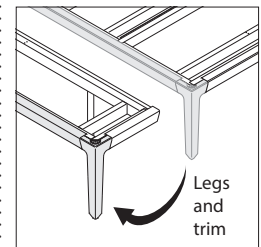

**Base frame extensions** link to existing base frame understructure. Legs and trim from the existing double-sided base frame are brought to the outside of the base frame extension.

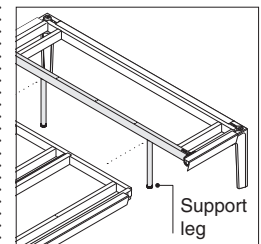

**Base frame extensions** include two additional support legs as standard.

Regard Base Frames and Frame Extensions, continued

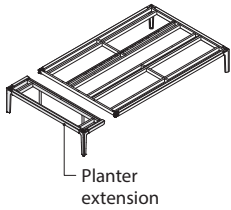

**Planter frame extension** attaches to existing base frame understructure allowing for the integration of a planter.

**Tablet frame option** modifies 44" through 71"W single-sided and frame extension frames to allow for the Surround mobile tablet to be installed on the Regard frame. Single-sided frames 77" through 88"W are standard with this feature. Double-sided frames are also standard with this feature which allows the mobile tablet to be retrofitted onto existing frames. The tablet frame option is not available on the 33" single-sided frame, the planter frames, or the planter frame extensions.

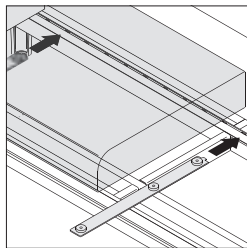

**Seat cushions** have standard brackets that secure to frame and frame extension without fasteners.  
▶ Page 212

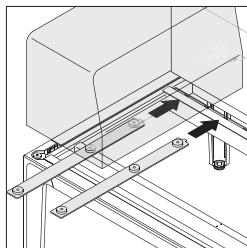

**Arms and inline table** connect to the frame and frame extensions in same manner as seat cushions.

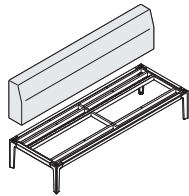

**Single-sided backs** attach to single-sided frame with included hardware.

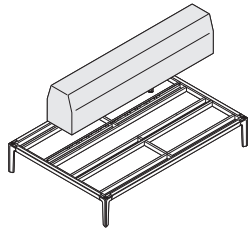

**Double-sided backs** attach to the middle of double-sided frames.

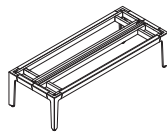

**Freestanding back-to-back frames** can accommodate desk, media, or combinations of desk and media cabinets.

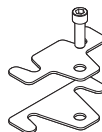

**Ganging brackets** are required when connecting power between two adjacent frames.

**Wiring & Cabling**

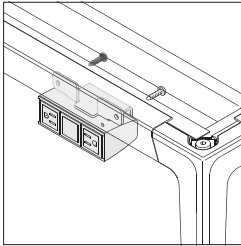

**Power strips** can attach to underside of any base frame. It can be mounted anywhere along the frame, but must avoid locations that interfere with leg connections.

**When the Surround mobile tablet is installed on the frame,** power cannot be mounted to the front edge of the frame.  
*Tip: Power strips are not recommended in middle of seat cushion.*

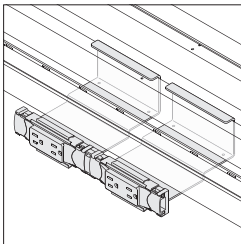

**Modular power components** attach to the frame with included brackets.

**Power components, cords, and conduit** can be attached and routed on the bottom of the steel frame.

▶ See *Regard Electrical Components*, page 228

**Power** can be connected frame-to-frame using a modular harness. Frame-ganging brackets must be specified.

▶ See *Ganging Harness Length Guidelines*, page 234

**Power components** are ordered separately.

▶ See *Regard Electrical Components*, page 228

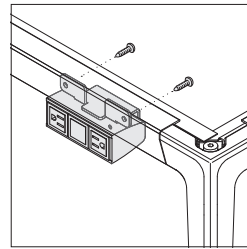

**Power strips** can be mounted to bench frames.

**Application Topics**

**Base frames** can accept backs, seat cushions, arms, and casegoods in a variety of configurations. Seating configuration is determined during specification.

*Tip: For seat cushion and back configurations, refer to seat cushion or seat back.*

▶ Pages 212–214

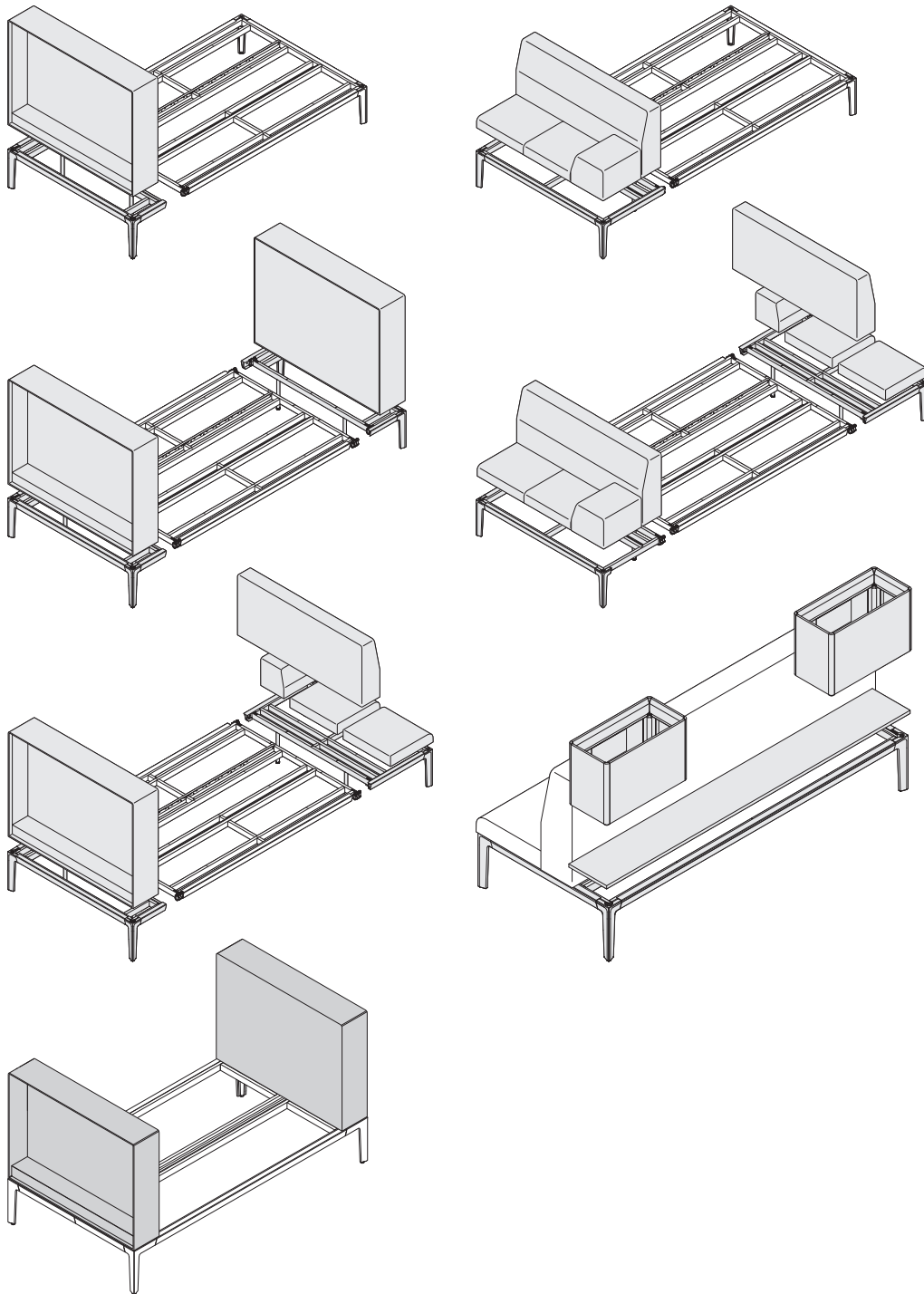

**Ganging brackets** are available for mechanically attaching single- or double-sided frames.

**Surface Materials**

**Frames and legs**

- Paint
- Lux Coatings

**Adjustable glides**

- Platinum solid plastic only

**Shipping**

**Base frames** ship knocked down in three packs that contain the steel frame, aluminum extrusion trims, and legs. Frames require field assembly, and attachment hardware is included.

# Regard Seat and Bench Cushions

**Seat and bench cushions** are available in three sizes to provide a comfortable sitting experience.

**Seat cushions** are available in three sizes and can attach in any position on the base frame on a 5½" module.

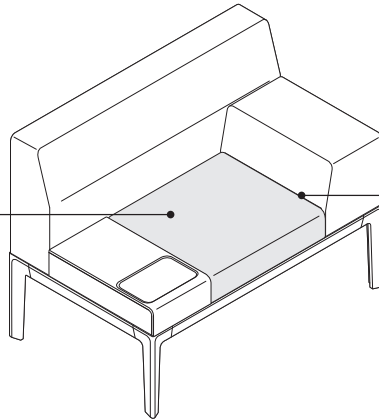

**Crumb sweeps** are on all three sides of seat cushion.

**Bench cushion** features a thicker cushion to accommodate a shorter, more active sit.

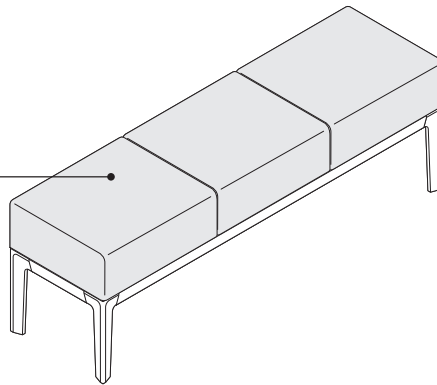

## Actual Dimensions

	• Depth	• Width	• Height
Seat Cushions	20"	22", 27½", 33"	4½"
Bench Cushion	18"	22"	7½"

**Product Details**

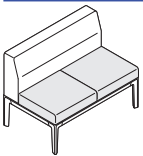

**Seat cushions** are 22"W, 27<sup>1</sup>/<sub>2</sub>"W, and 33"W, 41<sup>1</sup>/<sub>2</sub>"H, and 20"D and available for single-sided, double-sided, booth frames, and 27"D frame extensions. When mounted to a frame seat height is 18" off the floor.

**33"W seat cushion** provides extra width for barrier support or parent/child. 33"W cushion also supports alternative postures.

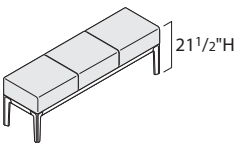

**Bench cushions** feature a height of 7<sup>1</sup>/<sub>2</sub>", and when mounted to a bench frame, they provide a seat that is 21<sup>1</sup>/<sub>2</sub>" off the ground.

**Bench cushions** can only be used with bench frames.

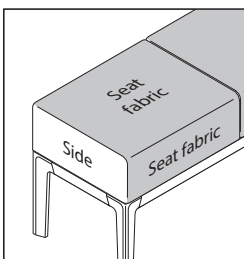

**Bench cushions** are available with contrasting fabric. Seat fabric is located on top, front, and back of cushion. Side fabric is located on each end of cushion.

*Tip: Thread color that is associated with the more dominant fabric color or surface area will be applied throughout the upholstery.*

**Moisture barrier** is an option on all seat cushions.

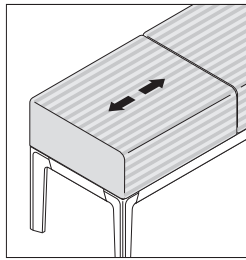

**Fabric** is applied to seat cushions in the railroaded or horizontal direction to remain consistent with the backs.

*Tip: Vertical application of fabrics is not allowed on Regard products as standard. If vertical application is required, then request through Specials.*

**Patterned fabrics** will not match between seats, arms, and backs.

**Large patterned fabrics** should be used selectively and are not recommended for use on all components. Patterns will not match between components.

**Connections**

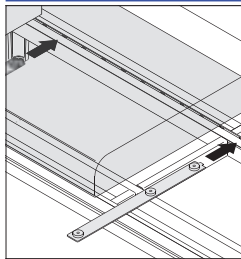

**Seat cushions** have brackets that secure to frames and frame extensions without fasteners.   
▶ Page 212

**Seats** can be placed in any location along frame on a 5<sup>1</sup>/<sub>2</sub>" module and can be next to any arm or other seat cushion.

**Application Topics**

**Benches** can be incorporated to achieve higher density in Regard applications.

**Surface Materials**

**All Steelcase Health seating with standard upholstery fabrics** comply with the State of California Technical Bulletin 117-2013.

**Seat and sides**

- Fabric
- Fabric with moisture barrier (option)

# Regard Backs

**Backs** integrate with single-sided, double-sided, or booth frames.

**Single-sided backs** must attach to single-sided frames or seating frame extensions.

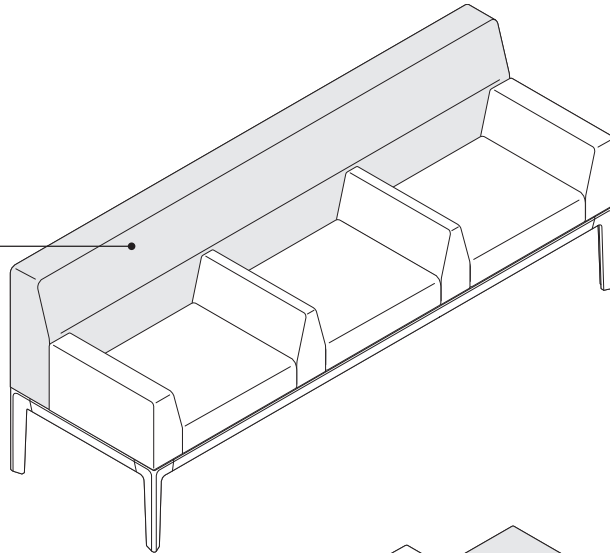

**Double-sided backs** must attach to double-sided frames.

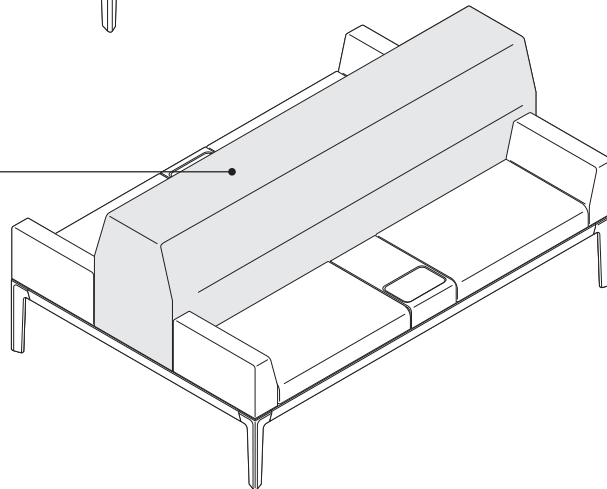

## Actual Dimensions

### Single-Sided Back

Depth	7½"
Width	33", 44", 55", 60½", 66", 71½", 77", 82½", and 88"
Height	19½"

### Double-Sided Back

Depth	15"
Width	33", 38½", 44", 49½", 55", 60½", 66", 71½", 77", 82½", and 88"
Height	19½"

**Product Details**

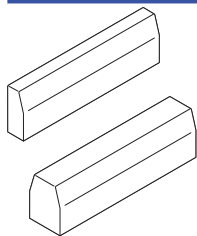

**Backs** are available in single-sided and double-sided options.

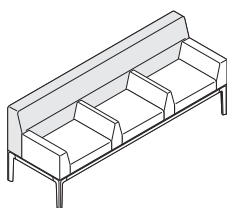

**Single-sided backs** attach to single-sided frames or seating frame extensions.

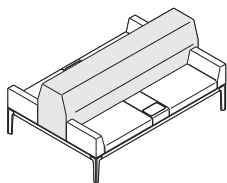

**Double-sided backs** attach to double-sided frames only. All backs must match the width of the of the frame.

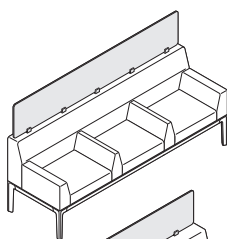

**Privacy screens** are available on single and double backs. Screens match the length of the back.

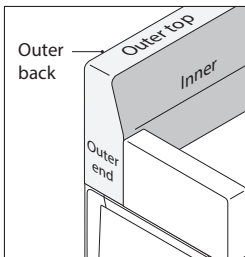

**Single-sided back outer fabric** is located on ends, top, and back facing away from seat cushion. Inner fabric is on the side of back facing seat cushion.

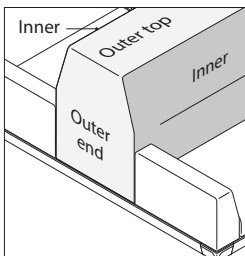

**Double-sided back outer fabric** is located on ends and top of back cushion. Inner fabric is on both sides of back facing both sets of seat cushions.

*Tip: Thread color that is associated with the more dominant fabric color or surface area will be applied throughout the upholstery.*

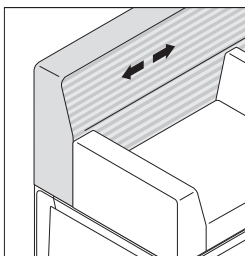

**Back fabric** is applied in the railroading or horizontal direction to remain consistent with seat cushions.

*Tip: Vertical application of fabrics is not allowed on Regard products as standard. If vertical application is required, then request through Specials.*

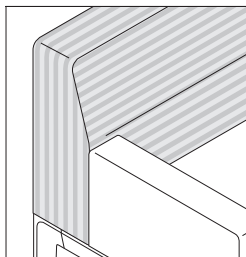

**Fabric on the top of the back** will match patterns on the front of the back but is applied to waterfall over the ends. Ends will not match top and front of back.

**Patterned fabrics** will not match between seats, arms, and backs.

**Connections**

**Backs** attach to frames with stanchions and brackets that are shipped with the back.

**Privacy screen option** must be specified when attaching a screen to the back and must match width of the back.

**Privacy screens, available as a separate style number**, can attach to all backs.

▶ See *Regard Privacy Screens*, page 220

**Application Topics**

**Single- and double-sided backs** should always be ordered to match the base frame length.

**Surface Materials**

**All Steelcase Health seating with standard upholstery fabrics** comply with the State of California Technical Bulletin 117-2013.

**Back, top, and sides**

- Fabric

# Regard Arms and Storage End Tables

**Arms** lend posture and personal belonging support to the user while providing spacial boundaries and separation between users.

**Double-sided arms** are available for placement between seat cushions.

**In-line arm** is standard with durable plastic top. Power cutout is optional with in-line arm.

**In-line arm sides** are standard in fabric.

**Single-sided arms** are available for placement at the end-of-seating runs.

**Contour arm** is standard with durable plastic top. Power cutout is optional with contour arm.

**Contour arm sides** are standard in fabric.

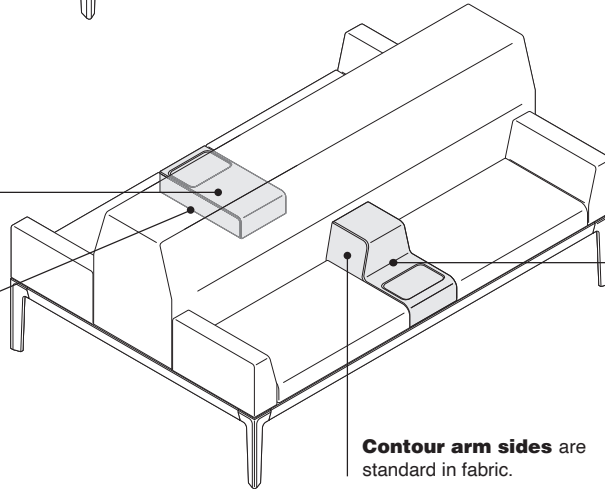
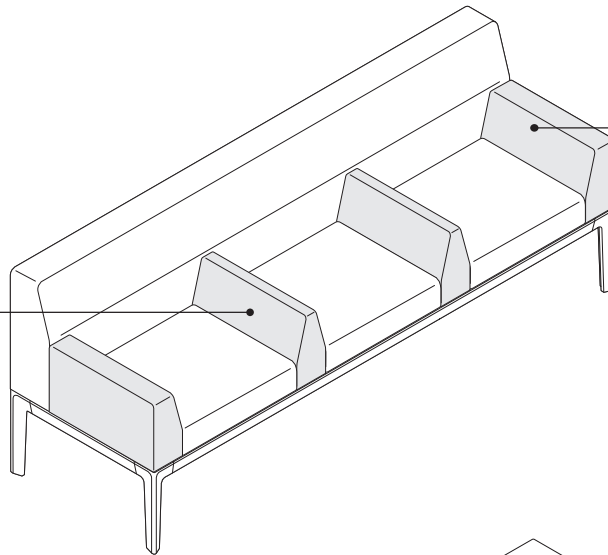

## Actual Dimensions

**Depth** 20"

**Width** 5½" and 11"



Storage end table is available in an 11"W.

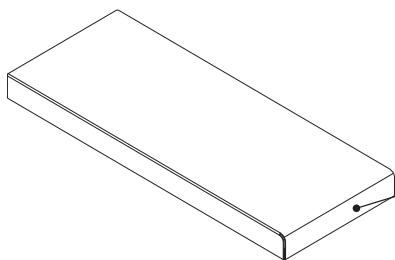

Storage is offered in a variety of Steelcase paint finishes.

**Product Details**

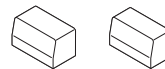

Arm options include single- and double-sided, contour, and in-line designs.

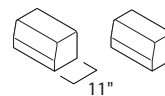
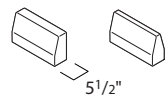

Single- and double-sided arms are available in 5 1/2" and 11" widths, consistent with the 5 1/2" modularity.



Single- and double-sided arms are available with plastic arm caps.

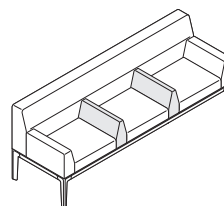

Double-sided arms are designed to be placed between seats with the angled edges adjacent to the occupants, providing the benefit of additional space, and posture support.

**Actual Dimensions**

	• Depth	• Width	• Height
Storage End Tables	27 1/2"	11"	2"

Regard Arms and Storage End Tables, continued

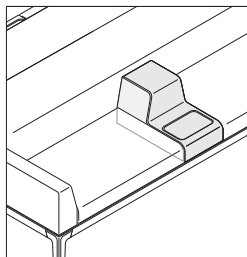

**Contour and in-line arms** feature durable plastic tops and upholstered sides.

**Contour arms** should only be specified between seat cushions.

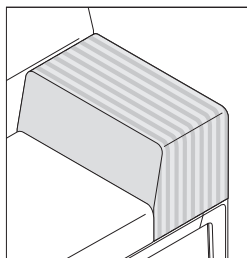

**Contrasting fabrics** are available on single- and double-sided arms.

*Tip: Thread color that is associated with the more dominant fabric color or surface area will be applied throughout the upholstery.*

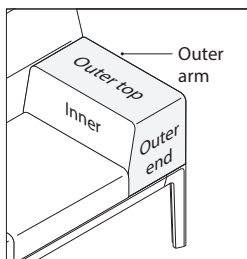

**Single-sided arm outer fabric** is located on ends, top, and back facing away from seat cushion. Inner fabric is on the side of arm, facing seat cushion.

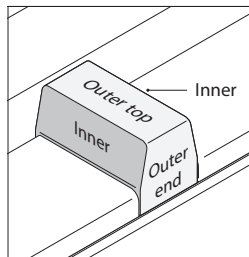

**Double-sided arm outer fabric** is located on ends and top of back cushion. Inner fabric is on both sides of arm facing both sets of seat cushions.

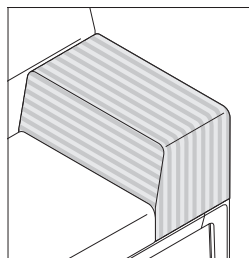

**Fabric on the top of the arm** will match patterns on inner arm but is applied to waterfall over the ends. Ends will not match top and sides of arm.

**Patterned fabrics** will not match between seats, arms, and backs.

**Large patterned fabrics** should be used selectively and are not recommended for use on all components. Patterns will not match between components.

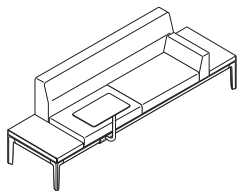

**Storage end table** extends the full depth of the Regard frame. The table can be installed on either end of a single-sided or double-sided frame.

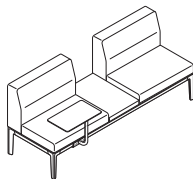

**Storage end table** can be placed between two backs on both single- and double-sided frames.

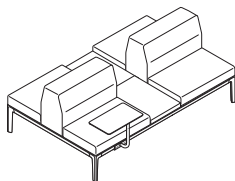

**Storage end table** can be placed back-to-back on double-sided frames on either end or between two back cushions.

**Fillers** should be ordered when specifying storage end tables back-to-back. The filler fills the gap between the two tables.

**Connections**

**Arms** are shipped with brackets for attachment.

**Application Topics**

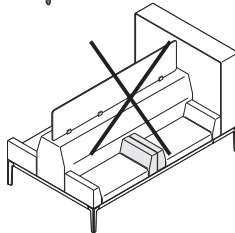
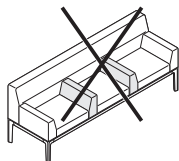

**Single-sided arms** should not be placed between seat cushions or next to other arms.

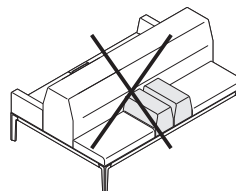
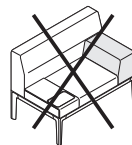

**Double-sided arms** should not be placed at end-of-run seating or other double-sided arms.

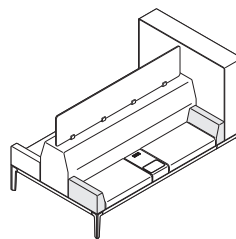

**Single-sided arms** are designed to be placed in the end positions. Frame extensions fit tight to single-sided arms if specified.

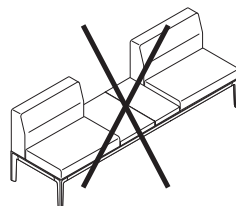

**Storage end table** should not be placed side by side on either single- or double-sided frames.

**Storage end table** should not be used on planter frames or frames with the planter extension.

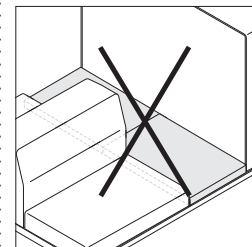

**Storage end tables** should not be placed next to desk or media cabinets.

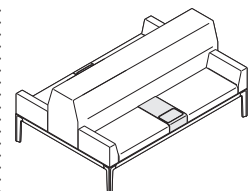

**In-line arms** can be positioned between seats or in the end positions.

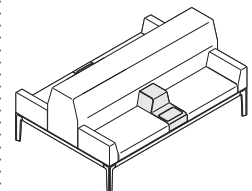

**Contour arm** should only be placed between seat cushions.

**Wiring & Cabling**

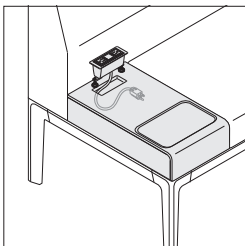

**Contour and in-line arms** can be specified to accommodate power integration.

**Power cutout option** must be specified when incorporating power.

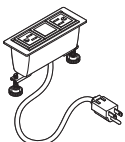

**Power strip with cord or hardwire option** must be specified when power is needed for use with contour or in-line arm. Over current protection is required in California.

▶ See *Regard Electrical Components*, page 228

**Surface Materials**

**All Steelcase Health seating with standard upholstery fabrics** comply with the State of California Technical Bulletin 117-2013.

**Single- and double-sided arms**

- Fabric

**Sides of contour and in-line arms**

- Fabric

**Arm caps**

- Plastic

**Storage end table**

- Paint
- Lux Coatings

# Regard Privacy Screens

**Privacy screens** not only divide space, but also create intimate settings while instilling a sense of visual calm.

**Privacy screens** are standard in frosted tempered glass.

**Attached brackets** are included in shipping.

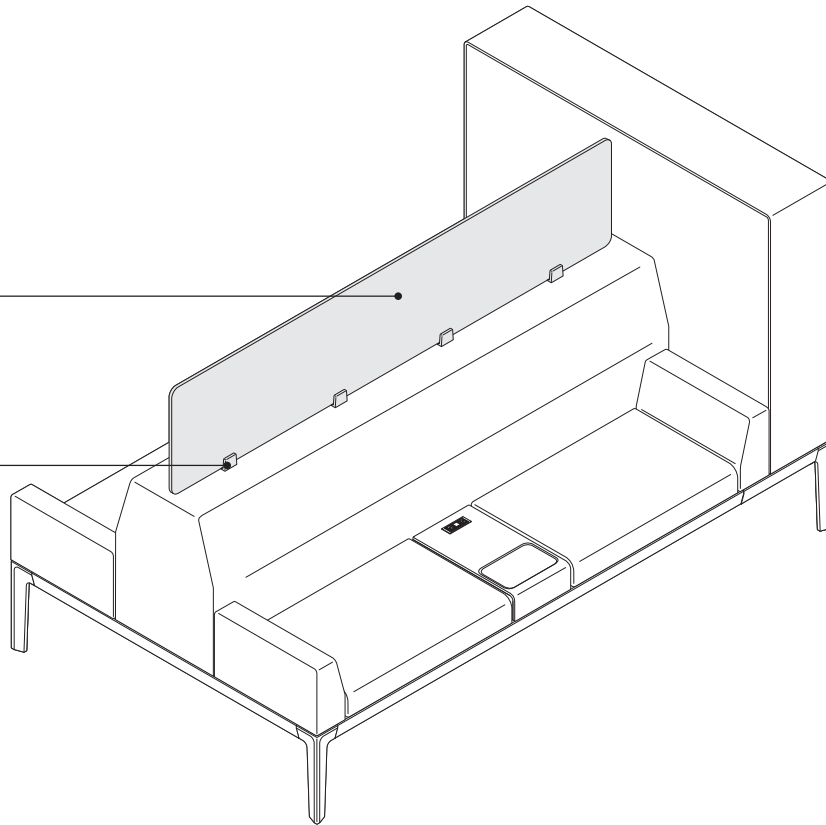

## Actual Dimensions

<b>Depth</b>	39"
<b>Width</b>	33", 38½", 44", 49½", 55", 60½", 66", 71½", 77", 82½", 88"
<b>Height</b>	14"

**Product Details**

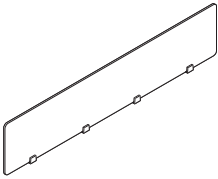

Privacy screens range in size from 33"W to 88"W to match the width of the back.

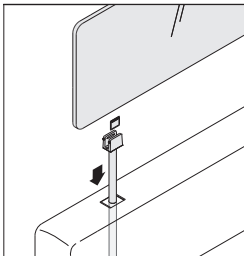

Privacy screen includes glass screen, brackets, supports, and top of cap with holes to accommodate brackets.

**Connections**

Privacy screens attach to the top of seat backs with metal brackets that are included with the screen. Backs must be specified with the screen attachment option.

► See *Application Topics* for specific size requirements.

Screen brackets and stanchions can be specified separately to allow users to supply own screen material.

*Tip: When specifying custom screen materials, screen lengths 33"–55" require two brackets and stanchions and screen lengths 60½"–88" require four brackets and stanchions.*

When using custom screen materials, the installer must attach glass tabs to the screen. Glass connection tabs come with screen brackets and stanchions.

**Application Topics**

**Field-Installed Glass Size Requirements**

Style Number	Maximum Height	Maximum Width	Thickness Range (min-max)	Corner Radius
Standard				
HS4S33G	14"	33"	.350-.400"	1"
HS4S39G	14"	38½"	.350-.400"	1"
HS4S44G	14"	44"	.350-.400"	1"
HS4S50G	14"	49½"	.350-.400"	1"
HS4S55G	14"	55"	.350-.400"	1"
HS4S61G	14"	60½"	.350-.400"	1"
HS4S66G	14"	66"	.350-.400"	1"
HS4S72G	14"	71½"	.350-.400"	1"
HS4S77G	14"	77"	.350-.400"	1"
HS4S83G	14"	81½"	.350-.400"	1"
HS4S88G	14"	88"	.350-.400"	1"

*Tip: Field installed glass should always be tempered. Laminated glass must not be used.*

*Tip: Order connection tabs, 24035701SR, for each field installation screen.*

*Tip: All non-standard screens should be ordered 2" shorter than Steelcase standard. All edges must be rounded and beveled.*

**Surface Materials**

**Screen**

- 6530 Frosted Glass

**Brackets**

- Paint

# Regard Tables

**Tables** are available in three designs to coordinate with Regard seating.

**Tables** are standard in 3/4" thick High-Pressure Laminate or 1 1/4" thick solid surface.

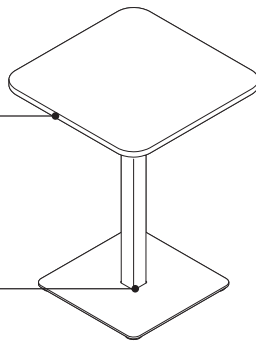
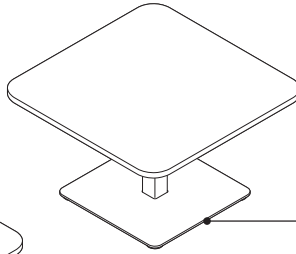
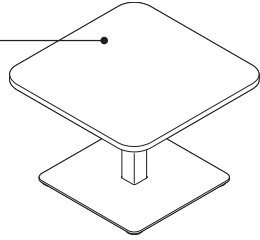

**Edges on laminate table** are finished with 3 mm plastic trim.

**Column and base** are standard in painted steel.

**Glides** are plastic and not adjustable.

## Product Details

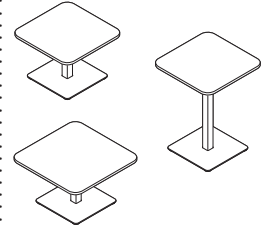

**Tables** include two 15"H square tables and one personal table at the 29" standard worksurface height. Tables are freestanding.

## Application Topics

**26" square table** can be used for turning a 90° corner with single-sided seating.

**Personal table** supports work postures in banquet applications.

## Surface Materials

### Table tops

- High-Pressure Laminate
- Solid surface

### Edges

- 3 mm plastic on laminate table
- Solid surface on solid surface table

### Legs and bases

- Paint

### Glides

- Plastic

## Actual Dimensions

	• Depth	• Width	• Height
Square tables	22" and 26"	22" and 26"	15"
Personal table	22"	22"	29"

# Planters and Planter Shelves

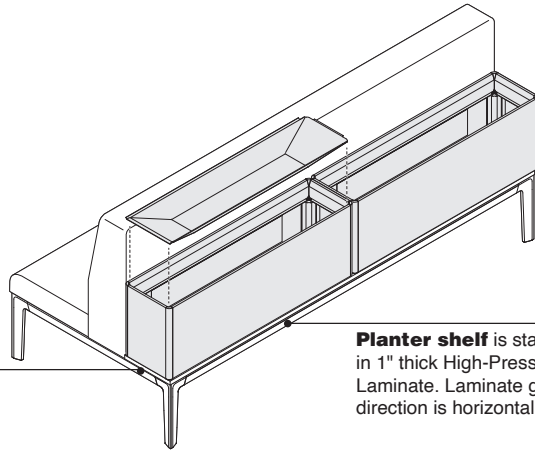

**Edges on planter shelf** are finished with 3 mm plastic trim.

**Planter shelf** is standard in 1" thick High-Pressure Laminate. Laminate grain direction is horizontal.

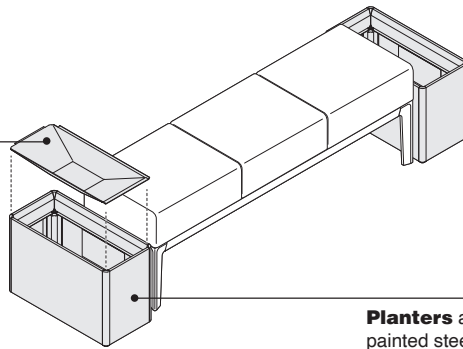

**Liners** are standard in packages of two.

**Planters** are standard in painted steel construction.

## Product Details

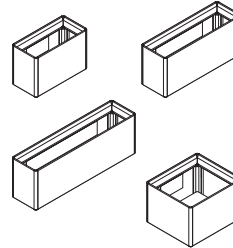

**Planters** are available in four sizes to align with various configurations.

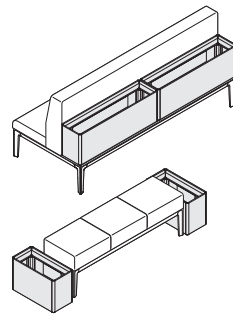

**Planters** can be used with planter frame or on the floor. *Tip: 22"D x 22"W planter is for use on the floor only.*

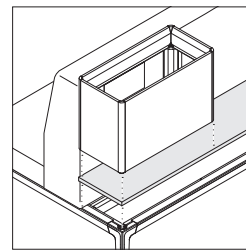

**Planter shelf** must be specified when using the planter frame or planter frame extension. Shelf is ordered separately from frame.

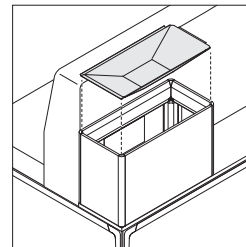

**Liners** are recommended when artificial plants are used to minimize the risk of arbitrary spills (for example, coffee poured into planter).

**Liners** are strongly recommended when planter will be used with live plants.

## Surface Materials

**Planters**

- Paint

**Planter shelf**

- High-Pressure Laminate

**Edges on planter shelf**

- 3 mm plastic on laminate shelf

**Liners**

- Black plastic only

## Shipping

**Planter** ships standard with glides for use on floor. When specified with shelf bracket option, glides are omitted and bracket to attach planter to frame are included.

## Actual Dimensions

	• Depth	• Width	• Height
Rectangular Planters	11"	22", 33", or 44"	14"
Square Planters	22"	22"	14"

# Regard Desk and Media Cabinets

**Desk and media cabinets** are designed to divide space and provide privacy to engage in focused work, conversation, research, or entertainment.

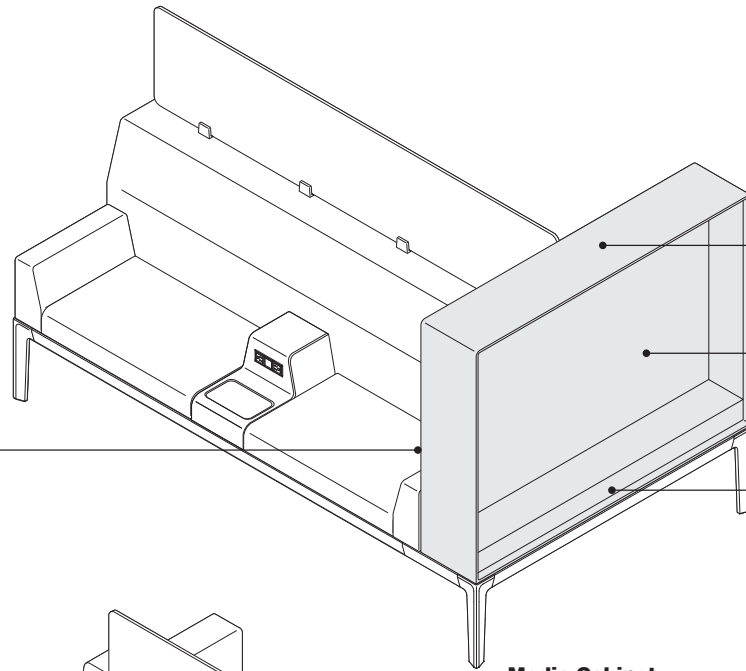

**Shroud** is standard in paint.

**Vertical surfaces** are standard in Low-Pressure Laminate. Laminate grain direction is horizontal.

**Cabinet base** is standard in painted steel and always matches the shroud.

**Back panel** is Low-Pressure Laminate on all cabinets. Laminate grain direction is horizontal.

**Media Cabinet**

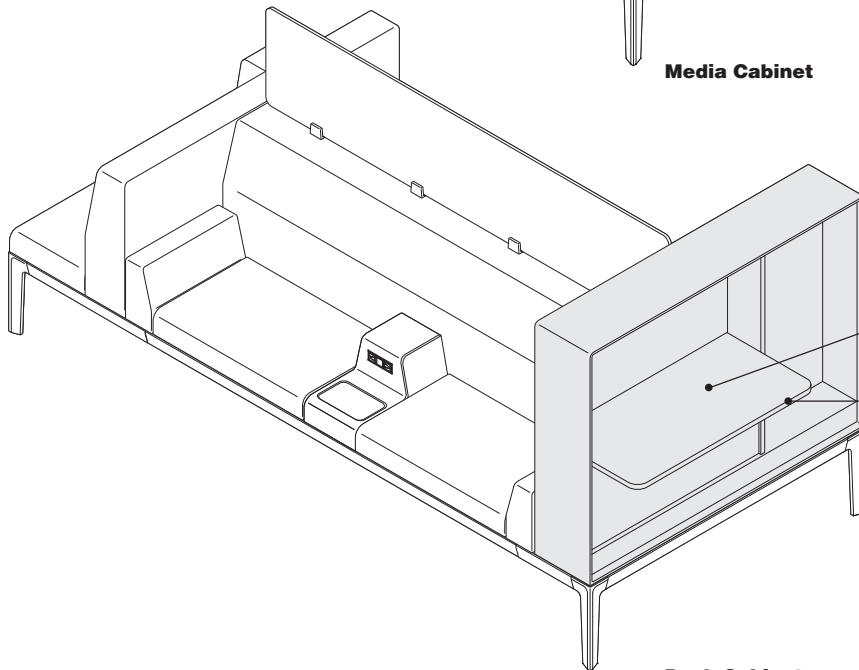

**Worksurface** is available in High-Pressure Laminate or solid surface.

**Edges on laminate worksurface** are finished with 3 mm trim.

**Desk Cabinet**

## Actual Dimensions

	• Depth	• Width	• Height with Frame
Media Cabinet	11"	55"	54"
Desk Cabinets	11"	55"	54"
Desk Cabinet Worksurface	18"	36"	28 <sup>1</sup> / <sub>2</sub> ", 30", and 36"



**Product Details**

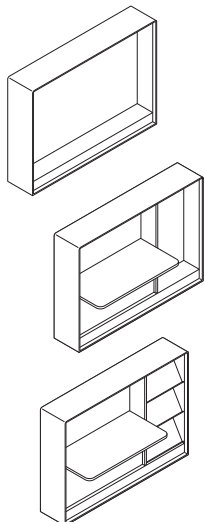

**Desk and media cabinets** are 11"D and 55"W.

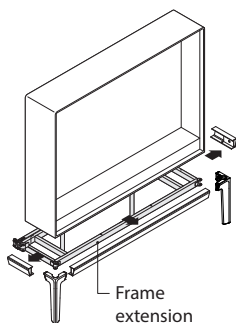

**Desk and media cabinets** can be mounted using an 11" frame extension.

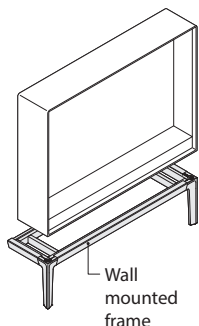

**Desk and media cabinets** can be wall mounted. 11" wall-mounted frame must be ordered separately.

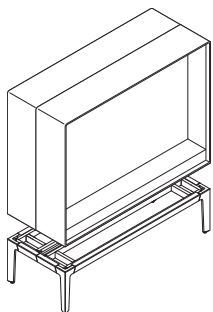

**Freestanding back-to-back cabinet frames** are 22"D and 55"W.

**Wall-mounted desk or media cabinets** do not attach to the wall. Cabinets are mounted to wall-mount frame using provided brackets. Frame attaches to wall at a minimum of 12<sup>2/3</sup>" above the floor with glide adjustment up to 1<sup>1/2</sup>" more.

**Cabinet back panels** can be omitted for wall-mounted applications.

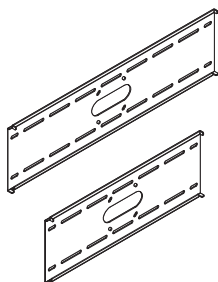

**Monitor brackets** are available in two sizes: small for monitors 32"W or less and large for monitors 32"W–60"W, weighing up to 200 pounds.

**Monitor brackets** will work with all current VESA patterns.

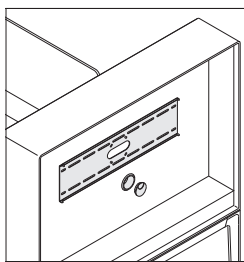

**Monitor bracket option** comes grommet hole, hole is field drilled in the media cabinet to accommodate varying cord locations.

**46" monitor** is recommended in the media cabinet.

**Maximum monitor size** for media cabinet is 60". Inside media cabinet width is 53".

**Monitor bracket option** is not available on the desk cabinet. Monitors are recommended to be placed on the worksurface. Opening above worksurface is 17"H and 36"W.

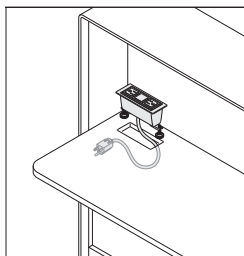

**Power cutout** is available as an option on desk cabinets to provide power to the worksurface area.

**Power cutout** is positioned in the rear left corner of the desk worksurface.

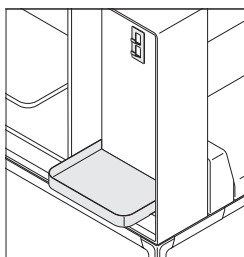

**Coat hook and bag retainer** are available as options on the open desk cabinets only.

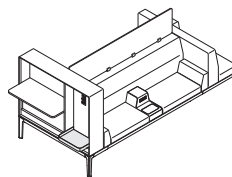

**Coat hook and bag retainer** are always located to the right-hand side of the desk unit as you face the unit.

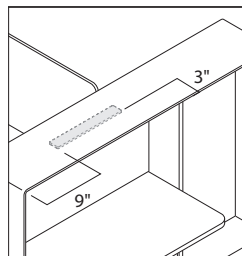

**Optional LED task lighting** can be specified above desk worksurfaces and attaches to the shroud.

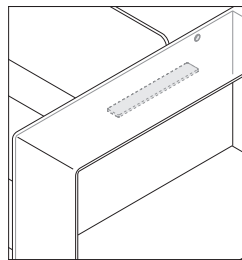

**Grommet and cutout** are included with LED light option for easy cord routing.

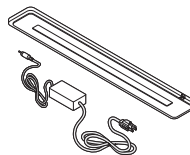

**LED light** includes the lamp and power supply with cord set.

**LED light cord** is 12' in total length with 6' of low voltage cord.

**Power supply** uses a modular cord with standard three prong plug an integrated low voltage cord and connector to attach to light. ▶ See LED shelf light in *Montage Solutions Specification Guide*.

**LED shelf light** is the Steelcase under-storage task light.

▶ See *Montage Solutions Specification Guide* for product details.

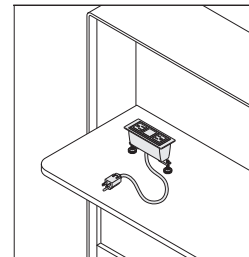

**Power strip** must be specified separately. Over current protection is required in California. ▶ See page 260

**Power cutout** must be specified when mounting drop-in power strip to the worksurface.

**LED light and power strip cords** are routed to the frame between the laminate back panel and the front vertical laminate panel.

**LED lights and work-surface power strip** can be plugged into outlets in the floor, wall, or modular power system.

*Tip: When powering cabinets from the wall, the top of the wall-mounted power module faceplate should be below 11" above the ground to avoid interference with the frame.*

**Surface Materials**

**Worksurface**

- High-Pressure Laminate
- Solid surface

**Edges**

- 3 mm plastic on laminate worksurface
- Solid surface on solid surface worksurface

**Vertical surfaces and back panel**

- Low-Pressure Laminate

**Shroud**

- Paint
- 7275 Seagull
- 7276 Arctic White
- 7277 Sand

**LED Shelf light**

- 6009 Arctic White

# Regard Booth with Table

**Booth with table configuration** is available in two frame sizes with optional convenient power access.

**Shroud** is standard in paint.

**Back panel** is Low-Pressure Laminate. Laminate grain direction is horizontal.

**Vertical surfaces** are standard in Low-Pressure Laminate. Laminate grain direction is horizontal.

**Table column** is standard in paint to match the base frame color selected.

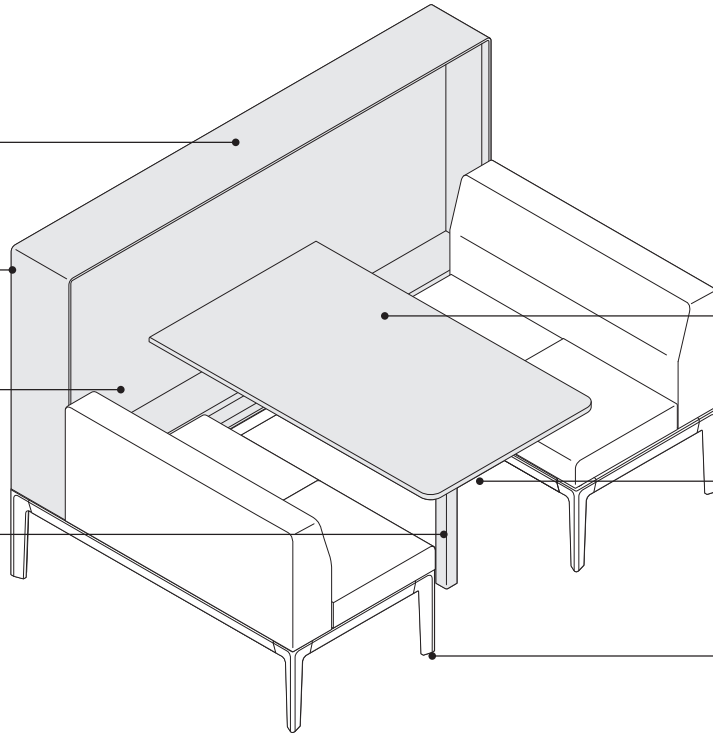

**Table** is available in High-Pressure Laminate or solid surface.

**Edges on laminate table** are finished with 3 mm trim.

**Adjustable glides** are standard on the table column.

## Actual Dimensions

**Table Depth** 44" and 55"

**Table Width** 32"

**Table Height** 28½"

**Shroud Width** 80½"

**Height with Frame** 54"

**Product Details**

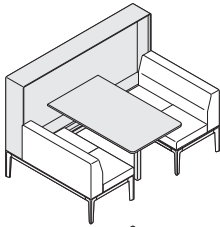

**Booth with table frame** is available in two depths: 44" to accommodate one 33" cushion on either side, or 55" to accommodate two 22" cushions on either side. All booth settings come standard with an 11" deep shroud.

**Table** is available in two sizes to correspond with the 44"D or 55"D frames.

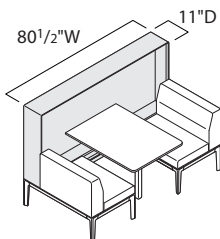

**Booth shroud** is 11"D and 80 1/2"W.

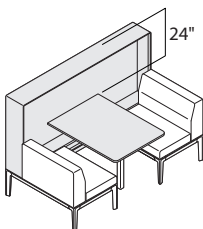

**Opening between** the worksurface and underside of shroud is 24".

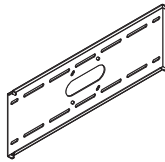

**Monitor bracket** is available for monitors 32"W or smaller. 27"W monitor is recommended.

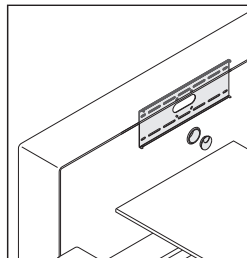

**Monitor bracket option** comes with pre-drilled cord pass through and grommet in the media cabinet. ▶ See page 225

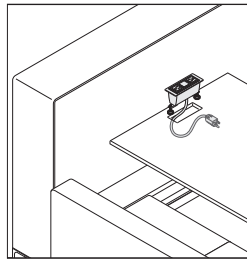

**Power cutout** is available as an option to provide power to the table area.

**Power cutout** is positioned in the center rear of the table.

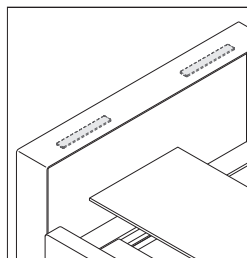

**Optional LED task lighting** can be specified and has two LED lights mounted to the underside of the cabinet shroud.

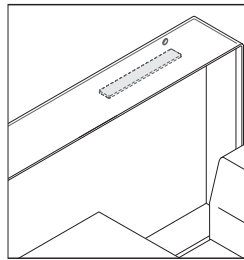

**Grommet and power cutout** are included with LED light option for easy cord routing.

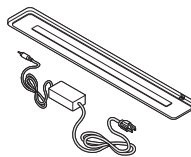

**LED light** includes the lamp and power supply with cord set.

**LED light cord** is 12' in total length with 6' of low voltage cord.

**Power supply** uses a modular cord with standard three prong plug an integrated low voltage cord and connector to attach to light.

**LED shelf light** is the steelcase under-storage task light.

▶ See LED shelf light in *Montage Solutions Specification Guide*.

**Application Topics**

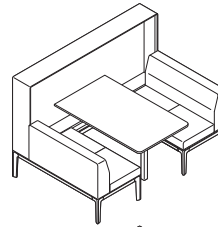

**Booth applications** are freestanding and do not require wall-mounting.

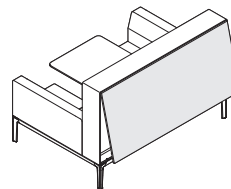
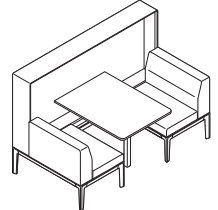

**Booth applications against the wall** allow omitting of back panel as an option.

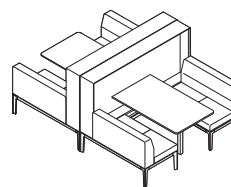

**Booth units** can be placed back to back and do not require additional brackets.

**Booth applications** are completed by ordering the corresponding frame, two backs, and seat cushions.

**Wiring & Cabling**

**Power cutout** must be specified when mounting drop-in power strip to the worksurface.

**Booth cabinets** have 4"W cord chase behind the laminate face for cord management to the wall, floor, or base frame.

**LED light and power strip cords** are routed to the frame between the laminate back panel and the front vertical laminate panel.

**LED lights and work-surface power strip** can be plugged into outlets in the floor, wall, or modular power system.

*Tip: When powering cabinets from the wall, the top of the power module faceplate should be below 11" above the ground to avoid interference with the frame.*

**Surface Materials**

**Table**

- High-Pressure Laminate
- Solid surface

**Edges**

- 3 mm plastic on laminate worksurface
- Solid surface on solid surface worksurface

**Vertical surfaces and back panel**

- Low-Pressure Laminate

**Shroud**

- Paint
- 7275 Seagull
- 7276 Arctic White
- 7277 Sand

**LED Shelf light**

- 6009 Arctic White

# Regard Electrical Components

## Distribution and Access

**Regard** is designed to support technology. Electrical needs can be solved in a variety of ways.

**A modular power system** is available to plug into the power strips. This system can be ordered as a complete kit for each frame size or built up as components if power is being daisy chained from one frame to another, or if two circuits must be specified.

**Users** can access power strips that are incorporated into the contour arms, in-line tables, and desk and booth cabinets, or mounted to the underside of the base frames. These power strips can be plugged into the building, hardwired, or plugged into the modular power system.

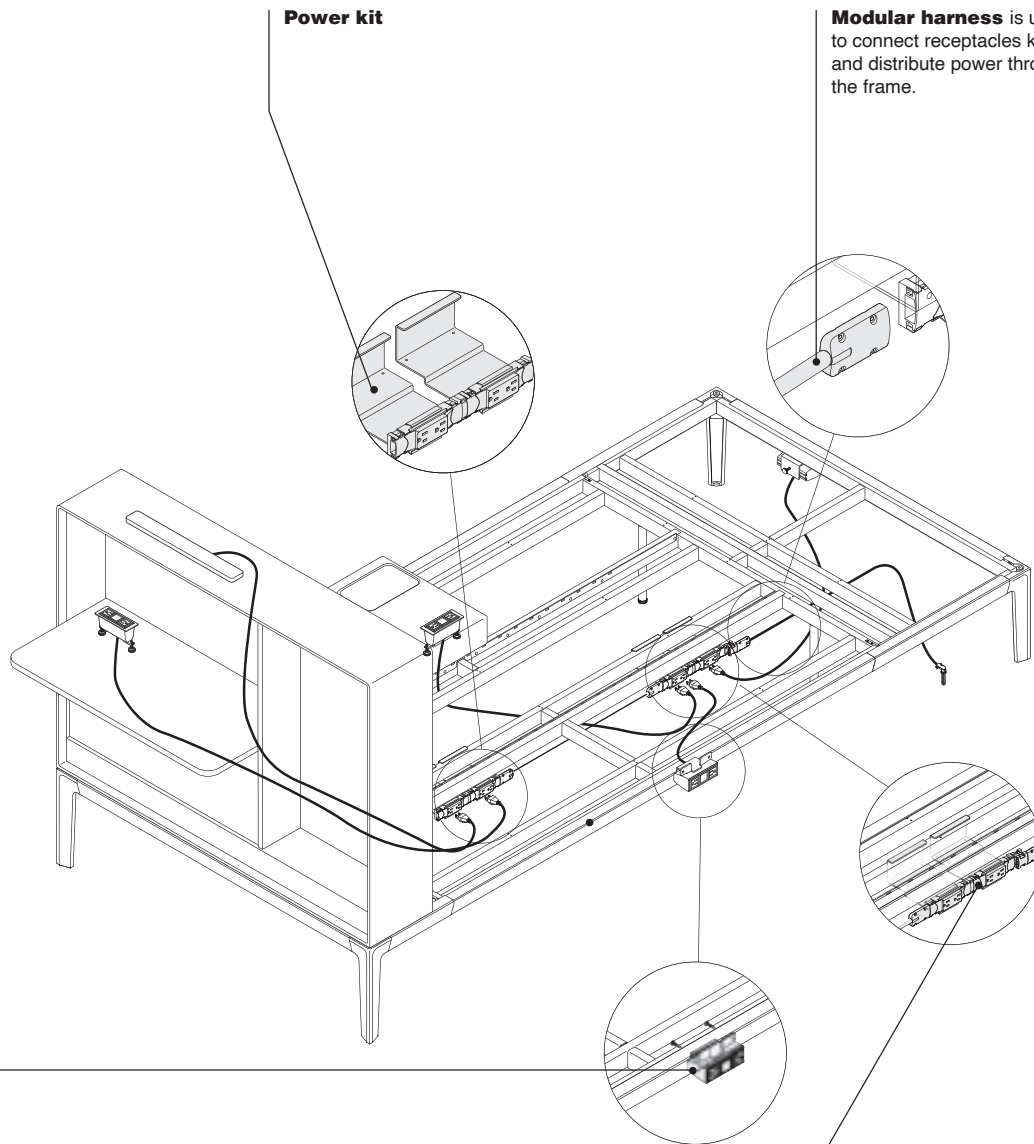

**Power strips** can be placed in worksurfaces, utility arms, and under the frame. They are powered by a modular system.

**Power kits** can be placed on the underside of the frame to collect and distribute power throughout the frame with one building interface. Modular harnesses are used to distribute power through the application.

**Product Details**

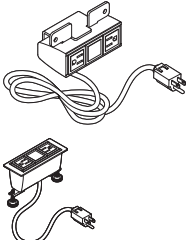

**Power strips** provide user access to outlets and are available in corded or hard-wire option. Power strips are available in drop-in or frame mounted styles. Receptacle options available include standard power, tamper and spill resistant, hospital grade, and USB configurations. All corded options are available with OCP (over current protection) which is a requirement in California. *Tip: As installed, furnishings that feature integrated hospital grade receptacles do not meet Article 517 of the National Electric Code requirements for hospital grade furnishing. These furnishings are not intended to be used in general patient care areas or critical patient care areas.*

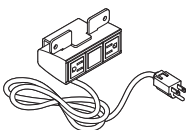

**Corded power strip** can plug into a modular receptacle kit or into a building receptacle. Connection must be accessible.

**Corded power strips** can also be plugged into a modular power system.

**Corded power strips** have a 6'L or 10'L cord and a 15-amp grounded plug. California requires over current protection on corded power strips.



**Hardwire power strips** are available for Chicago and other municipalities that may require it. They include 10' of flexible conduit. California does not require over current protection on hardwire power strips.

**Corded and hardwire power strips** can be mounted at any point along the underside of the frame.

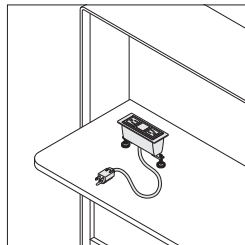

**Drop-in power strips** are for use in the contour arm, in-line table, desk cabinet, and booth cabinet. California requires over current protection on drop-in power strips.

**Drop-in power cut-outs** must be specified to accommodate the drop-in power strips.

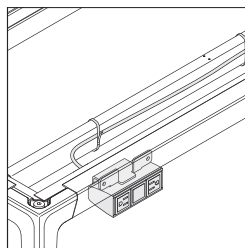

**Power cords and harnesses** can be managed under the frame. Cable ties are included with the harness and kit components. *Tip: Other wire clips and cord managers can be found in the Answer Solutions Specification Guide (32WCP, 999CHT, TS5LEGCLP).*

**Modular power** can either be specified in complete power kits or as a separate component to connect from one base to another, or when two circuits are needed.

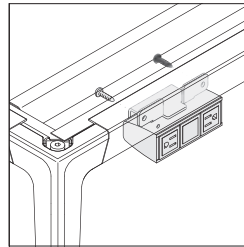

**Modular power** can be mounted at any point along the underside of the frame.

**When the Surround mobile tablet** is installed on the frame, power cannot be mounted to the front edge of the frame. *Tip: Power strips are not recommended in middle of seat cushion.*

**Modular power** can be specified to accommodate multiple power strips.

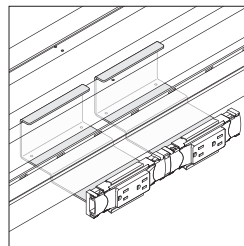

**Power kits** collect and distribute power to power strips throughout the base frame using one building interface.

**Power kits** attach to steel frame with included brackets and face outward.

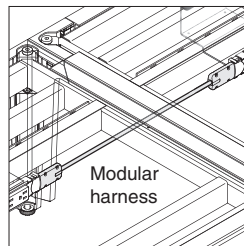

**Modular harnesses** are used to distribute power when power kits are used.

**Modular harnesses** are available to jump from one frame to another. Frames must be ganged together using style number **HS4FG** when jumping power between frames.

**Modular harnesses** are available in lengths from 12" to 42" to accommodate connection of power kits at different ends of the frame or to jump from one frame to another when ganged. Modular harnesses are compatible with one-circuit and two-circuit receptacle kits.

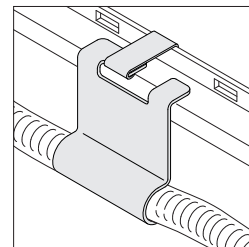

**Power infeeds** include bracket for mounting to the frame and can be attached to either end of the power kits.

**Power infeeds** can connect to power kits or branching connectors only.

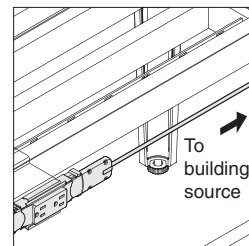

**Hardwire-to-modular power infeeds** bring the power from the building power source to the base frame.

**Hardwire-to-modular power infeed** is available in 9'L. The hardwired end is connected by an electrician to a junction box wherever it is located in the building. The harness is routed to the bottom of the frame and connected to a power kit. Non-PVC is standard.

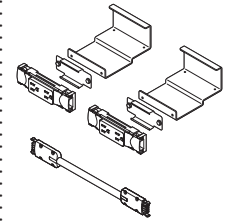

**Power kits** include the necessary receptacle kits, brackets, connectors and harnesses to accommodate specified frame sizes and power module quantity needs.

**Power kits** are single circuit only. Modular power should be ordered as components when two circuits are needed.

**Power kits** do not include base power in which must be specified separately.

**Power kits** are available with one, two, three or four power module options depending on your frame size and power need.

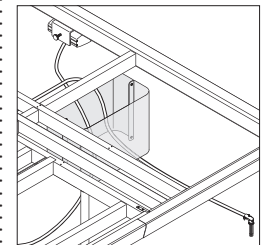

**Vertical cable risers** can be used to hide cords or power conduit coming from the floor to the frame. Vertical risers are bolted to the floor at any location under the frame. Attachment hardware is included.

**Connections**

**Drop-in power strips** are shipped with all hardware included and can be removed without tools.

**Frame-mounted power strips** are mounted to bracket without tool.

**Receptacle kits** include one power module and one bracket that is mounted to the underside of the tube-steel frame.

**Hardwired base power-in** must be secured to the frame with a strain-relief bracket that is included with the base power-in style number.

**Wiring and Cabling**

**All power components** are non PVC.

**All electrical components** are UL listed to the appropriate industry standards in accordance with the National and Canadian Electrical code.

**Local electrical codes vary.** Consult a qualified electrical contractor or engineer for the proper installation of all electrical components.

**Hardwire power** is also available for cities where codes require it.

**Underwriters Laboratory (UL) listed.** These products have been designed to meet U.S. and Canadian national electrical and energy codes and most local building codes. Local electrical codes vary. Consult a qualified electrician or electrical engineer for proper installation of all electrical equipment.

**Surface Materials**

**Power kits**

- 6000 Black

**Frame-mounted power strips**

- Clear anodized aluminum

**Drop-in power strip faceplate**

- Black paint

**Receptacles**

- 6000 Black

# Power Kit Guidelines

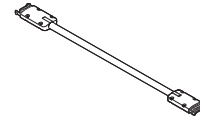
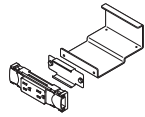

**Power Module  
Quantity**

**In-Line Connector  
Quantity**

**Modular Harness  
Quantity**

## Single Sided Frames

<b>HS4VKS</b>	1		
<b>HS4VKS</b> (2 module option)	2	1	

## Double Sided Frames

<b>HS4VKD44</b>	1		
<b>HS4VKD44</b> (2 module option)	2		1
<b>HS4VKD55</b>	1		
<b>HS4VKD55</b> (2 module option)	2	1	
<b>HS4VKD61</b>	1		
<b>HS4VKD61</b> (2 module option)	2		1
<b>HS4VKD61</b> (3 module option)	3		2
<b>HS4VKD66</b>	1		
<b>HS4VKD66</b> (2 module option)	2		1
<b>HS4VKD66</b> (3 module option)	3		2
<b>HS4VKD72</b>	1		
<b>HS4VKD72</b> (2 module option)	2	1	
<b>HS4VKD72</b> (3 module option)	3	1	1
<b>HS4VKD77</b>	1		
<b>HS4VKD77</b> (2 module option)	2	1	
<b>HS4VKD77</b> (3 module option)	3	1	1
<b>HS4VKD83</b>	1		
<b>HS4VKD83</b> (2 module option)	2	1	
<b>HS4VKD83</b> (3 module option)	3	1	1
<b>HS4VKD88</b>	1		
<b>HS4VKD88</b> (2 module option)	2	1	
<b>HS4VKD88</b> (3 module option)	3	1	1
<b>HS4VKD88</b> (4 module option)	4	2	1

# How to Calculate Power Needs

Use This to Determine How Many Power-Ins You'll Need

**When planning a power network,** you must calculate the amperage requirements of all your electrical components so you can provide sufficient electricity to power them.

**If your usage is not known in advance:**

The National Electrical Code (NEC) allows a maximum of 13 receptacles on each 20-amp circuit. This provides up to 30 receptacles for each 3-circuit power-in.

**If your usage is known in advance:**

Add up the amperage used by each piece of equipment in the workstation. Whenever you reach 60 amps (20 amps times 3 circuits) from items that are likely to be used at the same time, you have reached the limit for a single power-in. Specify another power-in and continue until all equipment is powered.

If the circuits will normally be subject to a continuous load (three or more hours of continuous use, such as lights or computers), the NEC requires that circuit capacity be "de-rated" by 20 percent. Therefore, treat circuits used for continuous loads as if they were rated at 16 amps instead of the regular 20 amps.

Try to anticipate future increases in power requirements and build some excess capacity into your plan.

▶ See table at right for typical and actual amperage usages for components.

To calculate amperage when the wattage of a device is known, divide watts by 120.

Some appliances, such as large copiers, coffee makers, or space heaters require most of the current available on a 20-amp circuit. It is recommended that such devices be supplied with their own receptacle/circuit, directly from the building. This leaves the capacity of the furniture circuits available for the more dynamic requirements of the office equipment.

Local electrical codes vary. Consult a qualified electrical contractor or engineer for the proper planning of electrical circuits in your locale.

**Approximate power consumption for common devices**

• Device	• Wattage	• Amperage	• Voltage	• Number of Devices Supported on Single 20 Amp Circuit
Laptop (Low)	30	0.25	120	64
Laptop (High)	100	0.83	120	19
CPU/Desktop Computer (Low)	65	0.54	120	30
CPU/Desktop Computer (High)	150	1.25	120	13
Monitor (Low)	15	0.13	120	128
Monitor (High)	80	0.67	120	24
Phone	5	0.04	120	384
High Power Tablet	10	0.08	120	192
Lower Power Tablet	45	0.38	120	43
Desktop Printer	40	0.33	120	48
42" LCD Screen	120	1.00	120	16
Projector (Small)	50	0.42	120	38
Projector (Medium)	250	2.08	120	8
Projector (Large)	800	6.67	120	2
Desktop Lamp	20	0.17	120	96
Large Printer/Copier	1600	13.33	120	1
Small Printer/Copier	800	6.67	120	2
Paper Shredder (Small)	250	2.08	120	8
Paper Shredder (Large)	800	6.67	120	2
Desktop Fan	25	0.21	120	77
Standing Fan	125	1.04	120	15
Coffee Maker (Low)	500	4.17	120	4
Coffee Maker (High)	1500	12.50	120	1
Microwave (Low)	600	5.00	120	3
Microwave (High)	1000	8.33	120	2
Refrigerator (Low)	200	1.67	120	10
Refrigerator (High)	1500	12.50	120	1
Vacuum (Low)	200	1.67	120	10
Vacuum (High)	1500	12.50	120	1
Space Heater (Low)	400	3.33	120	5
Space Heater (High)	1500	12.50	120	1
Height-Adjustable Desk (Low Power Consumption)*	200	1.67	120	10
Height-Adjustable Desk (High Power Consumption)*	550	4.58	120	3

*Tip: These calculations are estimations and are meant solely for informational purposes. It is important to conduct proper power planning for each installation to prevent overloading a circuit.*

*\* Refer to the Height-Adjustable Desks Specification Guide for specific product information.*





# Regard Ganging Harness Length Guidelines

**Modular harnesses**

allow power to be extended from one power block to another. Use the guidelines on this page to determine harness length.

▶ Page 261

**Recommended Receptacle Kit Location**

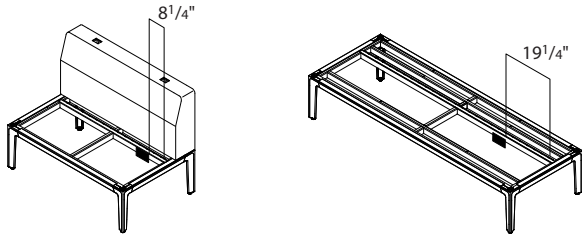

44"-55"W

61"-88"W

## Single-Sided Frames

Frame Width		44"	44"	55"	55"	60½"	60½"	66"	66"	71½"	71½"	77"	77"	82½"
	Power Module Quantity	1	2	1	2	1	2	1	2	1	2	1	2	1
44"	1	18"	18"	18"	18"	30"	30"	30"	30"	30"	30"	30"	30"	30"
44"	2	18"	18"	18"	18"	30"	30"	30"	30"	30"	30"	30"	30"	30"
55"	1	18"	18"	18"	18"	30"	30"	30"	30"	30"	30"	30"	30"	30"
55"	2	18"	18"	18"	18"	30"	30"	30"	30"	30"	30"	30"	30"	30"
60½"	1	30"	30"	30"	30"	42"	42"	42"	42"	42"	42"	42"	42"	42"
60½"	2	30"	30"	30"	30"	42"	42"	42"	42"	42"	42"	42"	42"	42"
66"	1	30"	30"	30"	30"	42"	42"	42"	42"	42"	42"	42"	42"	42"
66"	2	30"	30"	30"	30"	42"	42"	42"	42"	42"	42"	42"	42"	42"
71½"	1	30"	30"	30"	30"	42"	42"	42"	42"	42"	42"	42"	42"	42"
71½"	2	30"	30"	30"	30"	42"	42"	42"	42"	42"	42"	42"	42"	42"
77"	1	30"	30"	30"	30"	42"	42"	42"	42"	42"	42"	42"	42"	42"
77"	2	30"	30"	30"	30"	42"	42"	42"	42"	42"	42"	42"	42"	42"
82½"	1	30"	30"	30"	30"	42"	42"	42"	42"	42"	42"	42"	42"	42"
82½"	2	30"	30"	30"	30"	42"	42"	42"	42"	42"	42"	42"	42"	42"
88"	1	30"	30"	30"	30"	42"	42"	42"	42"	42"	42"	42"	42"	42"
88"	2	30"	30"	30"	30"	42"	42"	42"	42"	42"	42"	42"	42"	42"

82½" 88" 88"

2 1 2

30" 30" 30"

30" 30" 30"

30" 30" 30"

30" 30" 30"

42" 42" 42"

42" 42" 42"

42" 42" 42"

42" 42" 42"

42" 42" 42"

42" 42" 42"

42" 42" 42"

42" 42" 42"

42" 42" 42"

42" 42" 42"

42" 42" 42"

42" 42" 42"

Regard Ganging Harness Length Guidelines, continued

Recommended Receptacle Kit Location

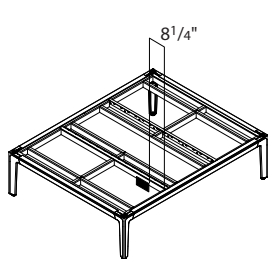

44"-55"W

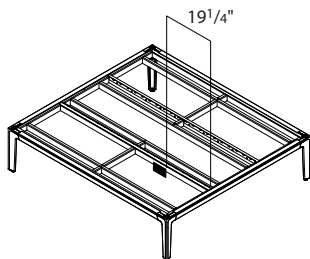

61"-88"W

Double-Sided Frames

Frame Width		44"	44"	55"	55"	60 1/2"	60 1/2"	60 1/2"	66"	66"	66"	71 1/2"	71 1/2"	71 1/2"
	Power Module Quantity	1	2	1	2	1	2	3	1	2	3	1	2	3
44"	1	18"	18"	18"	18"	30"	30"	30"	30"	30"	30"	30"	30"	30"
44"	2	18"	18"	18"	18"	30"	30"	30"	30"	30"	30"	30"	30"	30"
55"	1	18"	18"	18"	18"	30"	30"	30"	30"	30"	30"	30"	30"	30"
55"	2	18"	18"	18"	18"	30"	30"	30"	30"	30"	30"	30"	30"	30"
60 1/2"	1	30"	30"	30"	30"	42"	42"	42"	42"	42"	42"	42"	42"	42"
60 1/2"	2	30"	30"	30"	30"	42"	42"	42"	42"	42"	42"	42"	42"	42"
60 1/2"	3	30"	30"	30"	30"	42"	42"	42"	42"	42"	42"	42"	42"	42"
66"	1	30"	30"	30"	30"	42"	42"	42"	42"	42"	42"	42"	42"	42"
66"	2	30"	30"	30"	30"	42"	42"	42"	42"	42"	42"	42"	42"	42"
66"	3	30"	30"	30"	30"	42"	42"	42"	42"	42"	42"	42"	42"	42"
71 1/2"	1	30"	30"	30"	30"	42"	42"	42"	42"	42"	42"	42"	42"	42"
71 1/2"	2	30"	30"	30"	30"	42"	42"	42"	42"	42"	42"	42"	42"	42"
71 1/2"	3	30"	30"	30"	30"	42"	42"	42"	42"	42"	42"	42"	42"	42"
77"	1	30"	30"	30"	30"	42"	42"	42"	42"	42"	42"	42"	42"	42"
77"	2	30"	30"	30"	30"	42"	42"	42"	42"	42"	42"	42"	42"	42"
77"	3	30"	30"	30"	30"	42"	42"	42"	42"	42"	42"	42"	42"	42"
82 1/2"	1	30"	30"	30"	30"	42"	42"	42"	42"	42"	42"	42"	42"	42"
82 1/2"	2	30"	30"	30"	30"	42"	42"	42"	42"	42"	42"	42"	42"	42"
82 1/2"	3	30"	30"	30"	30"	42"	42"	42"	42"	42"	42"	42"	42"	42"
88"	1	30"	30"	30"	30"	42"	42"	42"	42"	42"	42"	42"	42"	42"
88"	2	30"	30"	30"	30"	42"	42"	42"	42"	42"	42"	42"	42"	42"
88"	3	30"	30"	30"	30"	42"	42"	42"	42"	42"	42"	42"	42"	42"
88"	4	30"	30"	30"	30"	42"	42"	42"	42"	42"	42"	42"	42"	42"



# Regard Base, Bench, Booth, and Wall-Mounted Frames

Standard Includes		Required to Specify
<ul style="list-style-type: none"> <li>▶ Need help? Product details, page 208</li> </ul>	<ul style="list-style-type: none"> <li>• Legs and trim: paint price group 1</li> <li>• Adjustable glides on legs: platinum solid plastic</li> </ul>	<ul style="list-style-type: none"> <li>1 Style number</li> <li>2 Paint color for legs and trim</li> <li>3 Options, if selected (see below)</li> <li>▶ See <i>Surface Materials</i>, page 473.</li> </ul>

Options	U.S. Price	Required to Specify
<b>Surface Materials</b> <ul style="list-style-type: none"> <li>• Paint price group 1</li> <li>• Paint price group 2 for wall-mounted base frame</li> <li>• Paint price group 2 for single-sided, double-sided, bench, and booth base frames</li> <li>• Paint price group 3</li> </ul>	No cost +\$ 41 +\$ 74 +\$146	Specify paint color number. Specify paint color number. Specify paint color number. Specify paint color number. ▶ See <i>Surface Materials</i> , page 473.
<b>Tablet Frame</b> <ul style="list-style-type: none"> <li>• Single-sided frames 77"W–88"W and all double-sided frames</li> <li>• Single-sided frames 44"W–71½"W</li> </ul>	No cost +\$ 68	Specify with tablet frame. Specify with tablet frame.

*Tip: Single-sided frames 77"W-88"W and all double-sided frames are standard with the tablet frame option.*

Specification Information		
Dimensions	Style Number	U.S. Base Price
D W		
·	·	·
·	·	·
·	·	·

## Frames

### Single-Sided

27½"	33"	<b>HS4FS33</b>	\$1182
27½"	44"	<b>HS4FS44</b>	\$1244
27½"	55"	<b>HS4FS55</b>	\$1340
27½"	60½"	<b>HS4FS61</b>	\$1378
27½"	66"	<b>HS4FS66</b>	\$1414
27½"	71½"	<b>HS4FS72</b>	\$1448
27½"	77"	<b>HS4FS77</b>	\$1529
27½"	82½"	<b>HS4FS83</b>	\$1585
27½"	88"	<b>HS4FS88</b>	\$1642

### Double-Sided

55"	44"	<b>HS4FD44</b>	\$1577
55"	55"	<b>HS4FD55</b>	\$1739
55"	60½"	<b>HS4FD61</b>	\$1799
55"	66"	<b>HS4FD66</b>	\$1861
55"	71½"	<b>HS4FD72</b>	\$1922
55"	77"	<b>HS4FD77</b>	\$1984
55"	82½"	<b>HS4FD83</b>	\$2046
55"	88"	<b>HS4FD88</b>	\$2106

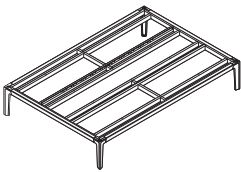
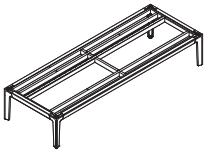

**For Canadian Pricing**  
 Multiply U.S. Price by the Canadian price factor.  
 ▶ See page 1 for details.

▶ **Specification Information, continued on next page**

► Specification Information, continued from previous page

**Specification Information**

Dimensions			Style Number	U.S. Base Price
D	W	H		

**Frames, continued**

**Planter**

37½"	44"	14"	<b>HS4FSP44</b>	\$1543
37½"	55"	14"	<b>HS4FSP55</b>	\$1696
37½"	60½"	14"	<b>HS4FSP61</b>	\$1803
37½"	66"	14"	<b>HS4FSP66</b>	\$1846
37½"	71½"	14"	<b>HS4FSP72</b>	\$2097
37½"	77"	14"	<b>HS4FSP77</b>	\$2166
37½"	82½"	14"	<b>HS4FSP83</b>	\$2278
37½"	88"	14"	<b>HS4FSP88</b>	\$2350

**Bench**

18"	44"	14"	<b>HS4FB44</b>	\$1064
18"	66"	14"	<b>HS4FB66</b>	\$1235

**Booth**

44"	80½"	14"	<b>HS4FC4481</b>	\$2814
55"	80½"	14"	<b>HS4FC5581</b>	\$2989

**Wall-Mounted**

11"	55"	14"	<b>HS4FW1155</b>	\$1231
-----	-----	-----	------------------	--------

**Freestanding Back-to-Back Cabinet**

22"	55"	14"	<b>HS4FD2255</b>	\$1739
-----	-----	-----	------------------	--------

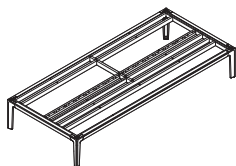

Tip: Planter, bench, booth, and wall-mounted frames are not available with tablet frame option.

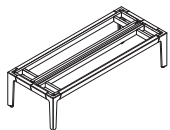
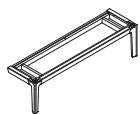
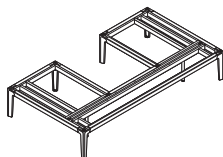
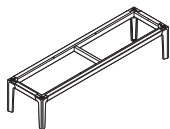

Lounge Seating

 **For Canadian Pricing**  
 Multiply U.S. Price by the Canadian price factor.  
 ► See page 1 for details.

# Regard Frame Extensions

Standard Includes		Required to Specify
<ul style="list-style-type: none"> <li>▶ Need help? Product details, page 208</li> </ul>	<ul style="list-style-type: none"> <li>• Frame extensions: paint price group 1</li> <li>• Adjustable glides on legs: platinum solid plastic</li> </ul>	<ul style="list-style-type: none"> <li>1 Style number</li> <li>2 Paint color for extensions</li> <li>3 Options, if selected (see below)</li> <li>▶ See <i>Surface Materials</i>, page 473.</li> </ul>

*Tip: Extensions can be added to either side of double-sided frames or back of 55"W single-sided frame.*

Options	U.S. Price	Required to Specify
<b>Surface Materials</b>	<ul style="list-style-type: none"> <li>• Paint price group 1: No cost</li> <li>• Paint price group 2 for cabinet and seating frame extensions: +\$ 41</li> <li>• Paint price group 2 for planter frame extensions: +\$ 74</li> <li>• Paint price group 3 for all frame extensions: +\$146</li> </ul>	<ul style="list-style-type: none"> <li>Specify paint color number.</li> <li>Specify paint color number.</li> <li>Specify paint color number.</li> <li>Specify paint color number.</li> </ul>
<b>Tablet Frame</b>	<ul style="list-style-type: none"> <li>• For seating frame extension: +\$ 68</li> </ul>	<ul style="list-style-type: none"> <li>Specify <i>with tablet frame</i>.</li> </ul>

*Tip: Cabinet frame and planter frame extensions are not available with tablet frame option.*

Specification Information			
Dimensions	Style	U.S.	
D W	Number	Base Price	

## Cabinet Frame Extension

11"	55"	<b>HS4FE1155</b>	\$729
:	:	:	:

## Seating Frame Extension

27½"	55"	<b>HS4FE2855</b>	\$972
:	:	:	:

## Planter Frame Extensions

11"	44"	<b>HS4FE1144</b>	\$685
11"	60½"	<b>HS4FE1161</b>	\$774
11"	66"	<b>HS4FE1166</b>	\$816
11"	71½"	<b>HS4FE1172</b>	\$860
11"	77"	<b>HS4FE1177</b>	\$906
11"	82½"	<b>HS4FE1183</b>	\$946
11"	88"	<b>HS4FE1188</b>	\$993
:	:	:	:

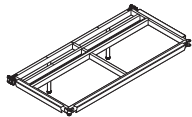
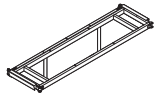

*Tip: Perpendicular seating can only be added using HS4FE2855.*

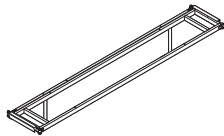

*Tip: Only for use on single-sided frames.*



**For Canadian Pricing**  
 Multiply U.S. Price by the Canadian price factor.  
 ▶ See page 1 for details.



# Regard Frame Bracket



Standard Includes	Required to Specify
<ul style="list-style-type: none"> <li>▶ Need help? Product details, page 210</li> <li>• Ganging bracket: quantity 2</li> </ul>	<ul style="list-style-type: none"> <li>Style number</li> </ul>

## Specification Information

Style Number	U.S. Price
<b>Ganging Bracket</b>	
<b>HS4FG</b>	\$66

 **For Canadian Pricing**  
 Multiply U.S. Price by the Canadian price factor.  
 ▶ See page 1 for details.

# Regard Seat and Bench Cushions

Tip: Contrasting fabrics can be specified on the bench cushions only.

Standard Includes	Required to Specify
<ul style="list-style-type: none"> <li>▶ Need help? Product details, page 212</li> <li>• Seat, bench cushion, bench side panel: fabric</li> <li>• Frame attachment brackets</li> </ul>	<ol style="list-style-type: none"> <li>1 Style number</li> <li>2 Fabric color number for seat or bench cushion</li> <li>3 Fabric color number for bench side panel, if selected</li> <li>4 Options, if selected (see below)</li> </ol> <p>▶ See <i>Surface Materials</i>, page 473.</p>

Options	U.S. Price	Required to Specify
<b>Surface Materials</b> <ul style="list-style-type: none"> <li>• <b>Moisture barrier</b></li> <li>• Moisture barrier</li> </ul>	+\$134 per cushion	Specify with moisture barrier.

## Specification Information

Dimen- sions D W	Style Number	U.S. Base Prices	Fabric	Fabric	Fabric	Fabric	Fabric	Fabric	Fabric	Fabric	Fabric	COM
			Price	Price	Price	Price	Price	Price	Price	Price	Price	
			Group 1	Group 2	Group 3	Group 4	Group 5	Group 6	Group 7	Group 8	Group 9	Group 10

## Seat Cushions

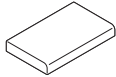

20"	22"	<b>HS4H22</b>	Seat fabric	\$363	\$416	\$443	\$480	\$523	\$ 559	\$ 612	\$ 675	\$ 745	\$ 824	\$389
20"	27 <sup>1</sup> / <sub>2</sub> "	<b>HS4H28</b>	Seat fabric	\$423	\$503	\$543	\$600	\$666	\$ 722	\$ 802	\$ 898	\$1009	\$1127	\$449
20"	33"	<b>HS4H33</b>	Seat fabric	\$438	\$522	\$567	\$624	\$693	\$ 751	\$ 835	\$ 933	\$1052	\$1175	\$464
:	:	:	:	:	:	:	:	:	:	:	:	:	:	:

## Bench Cushion



18"	22"	<b>HS4HB</b>	Seat fabric	\$419	\$475	\$503	\$542	\$587	\$ 625	\$ 682	\$ 747	\$ 822	\$ 905	\$431
			Side fabric	No cost	+\$28	+\$44	+\$63	+\$87	+\$106	+\$135	+\$168	+\$208	+\$252	+\$12
:	:	:	:	:	:	:	:	:	:	:	:	:	:	:



### For Canadian Pricing

Multiply U.S. Price by the Canadian price factor.

▶ See page 1 for details.



# Regard Backs

Tip: Inner and outer fabrics may be contrasting.

Tip: Back fabric patterns may not match seats and arms.

▶ See *Surface Materials*, page 473

Tip: Fabric is applied warp horizontal only.

Tip: Privacy screen attachment option must be specified when mounting a glass screen to a back. Screens are ordered separately.

Standard Includes	Required to Specify
-------------------	---------------------

▶ Need help? Product details, page 214	<ul style="list-style-type: none"> <li>• Inner and outer back: fabric</li> <li>• Frame attachment brackets</li> </ul>	<ul style="list-style-type: none"> <li>1 Style number</li> <li>2 Fabric color number for inner back</li> <li>3 Fabric color number for outer back</li> <li>4 Options, if selected (see below)</li> </ul>
		▶ See <i>Surface Materials</i> , page 473.

Options	U.S. Price	Required to Specify
---------	------------	---------------------

<b>Privacy Screen Attachment</b>	<ul style="list-style-type: none"> <li>• For backs 33" – 60½"</li> <li>• For backs 66" – 88"</li> </ul>	<ul style="list-style-type: none"> <li>+ \$155 per back</li> <li>+ \$186 per back</li> </ul>	<ul style="list-style-type: none"> <li>Specify with screen attachment.</li> <li>Specify with screen attachment.</li> </ul>
----------------------------------	---	--	--

<b>Related Products</b>	• Privacy Screens	▶ Page 251
-------------------------	-------------------	------------

## Specification Information

Dimen- sions D W	Style Number	U.S. Base Prices	Fabric Price										COM
			Group 1	Group 2	Group 3	Group 4	Group 5	Group 6	Group 7	Group 8	Group 9	Group 10	

## Single-Sided

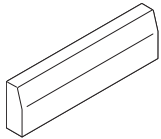

7½" 33"	<b>HS4BS33</b>	Inner fabric	\$ 961	\$1017	\$1044	\$1081	\$1126	\$1165	\$1219	\$1284	\$1358	\$ 1442	\$ 987
		Outer fabric	No cost	+\$ 82	+\$124	+\$182	+\$249	+\$305	+\$386	+\$484	+\$597	+\$ 719	+\$ 26
7½" 44"	<b>HS4BS44</b>	Inner fabric	\$1058	\$1121	\$1155	\$1198	\$1251	\$1292	\$1358	\$1432	\$1517	\$ 1614	\$1084
		Outer fabric	No cost	+\$ 97	+\$143	+\$210	+\$286	+\$352	+\$448	+\$559	+\$691	+\$ 829	+\$ 26
7½" 55"	<b>HS4BS55</b>	Inner fabric	\$1158	\$1232	\$1266	\$1317	\$1375	\$1423	\$1497	\$1581	\$1677	\$ 1784	\$1184
		Outer fabric	No cost	+\$108	+\$162	+\$239	+\$325	+\$397	+\$507	+\$632	+\$782	+\$ 941	+\$ 26
7½" 60½"	<b>HS4BS61</b>	Inner fabric	\$1227	\$1304	\$1340	\$1395	\$1458	\$1507	\$1585	\$1674	\$1776	\$ 1891	\$1253
		Outer fabric	No cost	+\$114	+\$172	+\$252	+\$344	+\$422	+\$537	+\$670	+\$827	+\$ 996	+\$ 26
7½" 66"	<b>HS4BS66</b>	Inner fabric	\$1319	\$1403	\$1448	\$1505	\$1574	\$1632	\$1716	\$1814	\$1933	\$ 2056	\$1345
		Outer fabric	No cost	+\$129	+\$190	+\$280	+\$382	+\$467	+\$595	+\$744	+\$919	+\$1106	+\$ 26

▶ Specification Information, continued on next page



### For Canadian Pricing

Multiply U.S. Price by the Canadian price factor.

▶ See page 1 for details.

► Specification Information, continued from previous page

Specification Information												
Dimen- sions D W	Style Number	U.S. Base Prices	Fabric	Fabric	Fabric	Fabric	Fabric	Fabric	Fabric	Fabric	Fabric	COM
			Price Group 1	Price Group 2	Price Group 3	Price Group 4	Price Group 5	Price Group 6	Price Group 7	Price Group 8	Price Group 9	Price Group 10

Single-Sided, continued

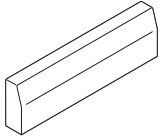

7 1/2" 71 1/2"	<b>HS4BS72</b>	Inner fabric	\$1409	\$1497	\$1543	\$1606	\$1676	\$1737	\$1826	\$1929	\$ 2051	\$ 2184	\$1435
		Outer fabric	No cost	+\$135	+\$201	+\$293	+\$402	+\$489	+\$625	+\$782	+\$ 966	+\$1161	+\$ 26
7 1/2" 77"	<b>HS4BS77</b>	Inner fabric	\$1501	\$1599	\$1646	\$1716	\$1793	\$1860	\$1958	\$2070	\$ 2204	\$ 2348	\$1527
		Outer fabric	No cost	+\$146	+\$220	+\$323	+\$441	+\$538	+\$686	+\$857	+\$1056	+\$1273	+\$ 26
7 1/2" 82 1/2"	<b>HS4BS83</b>	Inner fabric	\$1592	\$1696	\$1745	\$1815	\$1898	\$1967	\$2071	\$2187	\$ 2327	\$ 2475	\$1618
		Outer fabric	No cost	+\$153	+\$231	+\$337	+\$460	+\$562	+\$716	+\$896	+\$1103	+\$1328	+\$ 26
7 1/2" 88"	<b>HS4BS88</b>	Inner fabric	\$1682	\$1793	\$1847	\$1925	\$2016	\$2087	\$2198	\$2327	\$ 2478	\$ 2642	\$1708
		Outer fabric	No cost	+\$165	+\$249	+\$363	+\$497	+\$606	+\$775	+\$968	+\$1194	+\$1438	+\$ 26

Double-Sided

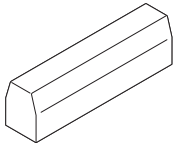

15" 33"	<b>HS4BD33</b>	Inner fabric	\$1195	\$1277	\$1319	\$1377	\$1444	\$1500	\$1581	\$1679	\$ 1792	\$ 1914	\$1221
		Outer fabric	No cost	+\$ 56	+\$ 83	+\$120	+\$165	+\$204	+\$258	+\$323	+\$ 397	+\$ 481	+\$ 26
15" 38 1/2"	<b>HS4BD39</b>	Inner fabric	\$1311	\$1408	\$1454	\$1521	\$1597	\$1663	\$1759	\$1870	\$ 2002	\$ 2140	\$1337
		Outer fabric	No cost	+\$ 63	+\$ 97	+\$140	+\$193	+\$234	+\$300	+\$374	+\$ 459	+\$ 556	+\$ 26
15" 44"	<b>HS4BD44</b>	Inner fabric	\$1415	\$1512	\$1558	\$1625	\$1701	\$1767	\$1863	\$1974	\$ 2106	\$ 2244	\$1441
		Outer fabric	No cost	+\$ 63	+\$ 97	+\$140	+\$193	+\$234	+\$300	+\$374	+\$ 459	+\$ 556	+\$ 26
15" 49 1/2"	<b>HS4BD50</b>	Inner fabric	\$1519	\$1633	\$1691	\$1771	\$1863	\$1941	\$2056	\$2189	\$ 2346	\$ 2515	\$1545
		Outer fabric	No cost	+\$ 77	+\$113	+\$168	+\$231	+\$280	+\$358	+\$447	+\$ 549	+\$ 664	+\$ 26
15" 55"	<b>HS4BD55</b>	Inner fabric	\$1622	\$1751	\$1812	\$1902	\$2004	\$2089	\$2217	\$2366	\$ 2541	\$ 2728	\$1648
		Outer fabric	No cost	+\$ 84	+\$129	+\$186	+\$255	+\$313	+\$397	+\$495	+\$ 614	+\$ 737	+\$ 26
15" 60 1/2"	<b>HS4BD61</b>	Inner fabric	\$1724	\$1853	\$1914	\$2004	\$2106	\$2191	\$2319	\$2468	\$ 2643	\$ 2830	\$1750
		Outer fabric	No cost	+\$ 84	+\$129	+\$186	+\$255	+\$313	+\$397	+\$495	+\$ 614	+\$ 737	+\$ 26

► Specification Information, continued on next page



**For Canadian Pricing**

Multiply U.S. Price by the Canadian price factor.

► See page 1 for details.

Regard Backs, continued

► Specification Information, continued from previous page

Specification Information												
Dimen- sions D W	Style Number	U.S. Base Prices	Fabric	Fabric	Fabric	Fabric	Fabric	Fabric	Fabric	Fabric	Fabric	COM
			Price Group 1	Price Group 2	Price Group 3	Price Group 4	Price Group 5	Price Group 6	Price Group 7	Price Group 8	Price Group 9	Price Group 10

Double-Sided, continued

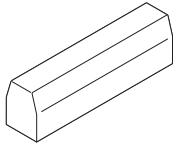

15" 66"	<b>HS4BD66</b>	Inner fabric	\$1826	\$1972	\$2046	\$2149	\$2267	\$2364	\$2512	\$2683	\$ 2882	\$ 3099	\$1852
		Outer fabric	No cost	+\$ 98	+\$145	+\$215	+\$292	+\$359	+\$457	+\$569	+\$ 703	+\$ 847	+\$ 26
15" 71½"	<b>HS4BD72</b>	Inner fabric	\$1929	\$2075	\$2149	\$2252	\$2370	\$2467	\$2615	\$2786	\$ 2985	\$ 3202	\$1955
		Outer fabric	No cost	+\$ 98	+\$145	+\$215	+\$292	+\$359	+\$457	+\$569	+\$ 703	+\$ 847	+\$ 26
15" 77"	<b>HS4BD77</b>	Inner fabric	\$2030	\$2240	\$2346	\$2491	\$2661	\$2804	\$3012	\$3258	\$ 3547	\$ 3856	\$2056
		Outer fabric	No cost	+\$140	+\$210	+\$308	+\$422	+\$514	+\$655	+\$820	+\$1010	+\$1216	+\$ 26
15" 82½"	<b>HS4BD83</b>	Inner fabric	\$2132	\$2349	\$2456	\$2611	\$2784	\$2928	\$3146	\$3397	\$ 3694	\$ 4012	\$2158
		Outer fabric	No cost	+\$144	+\$217	+\$317	+\$434	+\$532	+\$676	+\$844	+\$1043	+\$1256	+\$ 26
15" 88"	<b>HS4BD88</b>	Inner fabric	\$2235	\$2458	\$2571	\$2724	\$2905	\$3055	\$3279	\$3538	\$ 3844	\$ 4172	\$2261
		Outer fabric	No cost	+\$147	+\$222	+\$327	+\$447	+\$546	+\$697	+\$869	+\$1074	+\$1291	+\$ 26



**For Canadian Pricing**





Multiply U.S. Price by the Canadian price factor.

► See page 1 for details.

# Regard Arms

Standard Includes		Required to Specify
▶ Need help? Product details, page 216	<ul style="list-style-type: none"> <li>• Inner and outer arms: fabric</li> <li>• Arm cap, if selected: plastic</li> <li>• Frame attachment brackets</li> </ul>	1 Style number 2 Fabric color number for inner arm 3 Fabric color number for outer arm 4 Plastic color number for arm cap, if selected ▶ See <i>Surface Materials</i> , page 473.

## Specification Information

Single-Sided	Double-Sided	Single-Sided with Plastic Arm Cap					Double-Sided with Plastic Arm Cap					
												
Dimen- sions D W	Style Number	U.S. Prices										COM
		Fabric Price Group 1	Fabric Price Group 2	Fabric Price Group 3	Fabric Price Group 4	Fabric Price Group 5	Fabric Price Group 6	Fabric Price Group 7	Fabric Price Group 8	Fabric Price Group 9	Fabric Price Group 10	

### Single-Sided

20" 5½"	<b>HS4AS6</b>	Inner fabric	\$319	\$344	\$356	\$375	\$ 396	\$ 413	\$ 438	\$ 466	\$ 502	\$ 540	\$331
		Outer fabric	No cost	+\$37	+\$57	+\$84	+\$114	+\$140	+\$179	+\$223	+\$276	+\$334	+\$12
20" 11"	<b>HS4AS11</b>	Inner fabric	\$393	\$418	\$430	\$449	\$ 470	\$ 487	\$ 512	\$ 540	\$ 576	\$ 614	\$405
		Outer fabric	No cost	+\$37	+\$57	+\$84	+\$114	+\$140	+\$179	+\$223	+\$276	+\$334	+\$12

### Double-Sided

20" 5½"	<b>HS4AD6</b>	Inner fabric	\$351	\$376	\$388	\$407	\$ 428	\$ 445	\$ 470	\$ 498	\$ 534	\$ 572	\$363
		Outer fabric	No cost	+\$37	+\$57	+\$84	+\$114	+\$140	+\$179	+\$223	+\$276	+\$334	+\$12
20" 11"	<b>HS4AD11</b>	Inner fabric	\$428	\$453	\$465	\$484	\$ 505	\$ 522	\$ 547	\$ 575	\$ 611	\$ 649	\$440
		Outer fabric	No cost	+\$37	+\$57	+\$84	+\$114	+\$140	+\$179	+\$223	+\$276	+\$334	+\$12

### Single-Sided with Plastic Arm Cap

20" 5½"	<b>HS4AS6C</b>	Inner fabric	\$444	\$456	\$466	\$476	\$ 488	\$ 497	\$ 510	\$ 527	\$ 548	\$ 569	\$456
		Outer fabric	No cost	+\$20	+\$26	+\$37	+\$ 53	+\$ 63	+\$ 82	+\$104	+\$126	+\$152	+\$12
20" 11"	<b>HS4AS11C</b>	Inner fabric	\$542	\$563	\$570	\$583	\$ 599	\$ 614	\$ 630	\$ 654	\$ 679	\$ 707	\$554
		Outer fabric	No cost	+\$24	+\$34	+\$51	+\$ 73	+\$ 85	+\$109	+\$136	+\$168	+\$204	+\$12

### Double-Sided with Plastic Arm Cap

20" 5½"	<b>HS4AD6C</b>	Inner fabric	\$479	\$501	\$510	\$525	\$ 542	\$ 556	\$ 579	\$ 602	\$ 631	\$ 661	\$491
		Outer fabric	No cost	+\$ 9	+\$17	+\$24	+\$ 32	+\$ 39	+\$ 49	+\$ 63	+\$ 78	+\$ 96	+\$12
20" 11"	<b>HS4AD11C</b>	Inner fabric	\$579	\$606	\$620	\$640	\$ 663	\$ 683	\$ 711	\$ 743	\$ 781	\$ 822	\$591
		Outer fabric	No cost	+\$16	+\$23	+\$32	+\$ 44	+\$ 53	+\$ 69	+\$ 84	+\$105	+\$125	+\$12

 **For Canadian Pricing**  
 Multiply U.S. Price by the Canadian price factor.  
 ▶ See page 1 for details.

# Regard Utility Arms

Tip: Contour arm is only to be used between seat cushions.

Tip: In-line table can be used in between seat cushions or on either end of a frame.

Tip: Specify power strip separately.  
▶ See page 260

Standard Includes		Required to Specify
▶ Need help? Product details, page 216	<ul style="list-style-type: none"> <li>Outer arm: fabric</li> <li>Arm cap: plastic</li> <li>Frame attachment brackets</li> </ul>	<ol style="list-style-type: none"> <li>Style number</li> <li>Fabric color number for outer arm</li> <li>Plastic color number for arm cap</li> <li>Options, if selected (see below)</li> </ol> <p>▶ See <i>Surface Materials</i>, page 473.</p>

Options	U.S. Price	Required to Specify
<b>Power Cutout</b> • With power cutout	No cost	Specify with <i>power cutout</i> .

## Specification Information

### Contour Arm



• **Dimensions**  
D W

• **Style Number**

### In-Line Table



• **U.S. Prices**

Fabric Price Group 1	Fabric Price Group 2	Fabric Price Group 3	Fabric Price Group 4	Fabric Price Group 5	Fabric Price Group 6	Fabric Price Group 7	Fabric Price Group 8	Fabric Price Group 9	Fabric Price Group 10	COM
----------------------	----------------------	----------------------	----------------------	----------------------	----------------------	----------------------	----------------------	----------------------	-----------------------	-----

### Contour Arm

20"	11"	<b>HS4AU11</b>	Outer fabric	\$652	\$684	\$699	\$724	\$749	\$769	\$799	\$838	\$883	\$929	\$678
-----	-----	----------------	--------------	-------	-------	-------	-------	-------	-------	-------	-------	-------	-------	-------

### In-Line Table

20"	11"	<b>HS4TL11</b>	Outer fabric	\$521	\$553	\$568	\$593	\$618	\$638	\$668	\$707	\$752	\$798	\$547
-----	-----	----------------	--------------	-------	-------	-------	-------	-------	-------	-------	-------	-------	-------	-------



### For Canadian Pricing

Multiply U.S. Price by the Canadian price factor.

▶ See page 1 for details.



# Regard Storage End Table and Filler

Regard Storage End Table and Filler

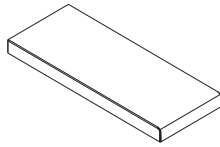

Standard Includes		Required to Specify
▶ Need help? Product details, page 217	<ul style="list-style-type: none"> <li>Table, if selected: paint price group 1</li> <li>Table fillers, if selected: black</li> </ul>	1 Style number 2 Paint color number for storage end table 3 Options, if selected (see below) ▶ See <i>Surface Materials</i> , page 473.

Options	U.S. Price	Required to Specify
<b>Surface Materials</b> <ul style="list-style-type: none"> <li>Storage end table</li> <li>Paint price group 1</li> <li>Paint price group 2</li> <li>Paint price group 3</li> </ul>	No cost No cost +\$60	Specify paint color number. Specify paint color number. Specify paint color number.

Specification Information		
Dimensions	Style	U.S.
D W	Number	Base Price
·	·	·
·	·	·
·	·	·

## Storage End Table

27½"	11"	<b>HS4SET11</b>	\$655
·	·	·	·

## Storage End Table Filler

27½"	11"	<b>HS4T11</b>	\$ 41
·	·	·	·

Tip: Storage filler should be ordered when specifying storage end tables back-to-back. Only one filler required for every two tables.

Tip: Order filler width to match width of storage end table.

Lounge Seating

 **For Canadian Pricing**  
 Multiply U.S. Price by the Canadian price factor.  
 ▶ See page 1 for details.

# Regard Tablet Rails

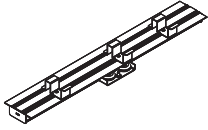

*Tip: Tablet rail must match the length of the frame.*

*Tip: Tablet rails can be specified on each side of a Regard frame or seat extension frame.*

*Tip: Surround mobile tablet is ordered separately.*  
 ▶ Page 435

Standard Includes	Required to Specify
-------------------	---------------------

- Tablet rail: Merle 7360
- Stops

Style number

Specification Information		
Dimensions	Style	U.S.
W	Number	Price

44"	<b>HS4FR44</b>	\$571
55"	<b>HS4FR55</b>	\$571
60½"	<b>HS4FR61</b>	\$571
66"	<b>HS4FR66</b>	\$571
71½"	<b>HS4FR72</b>	\$571
77"	<b>HS4FR77</b>	\$571
82½"	<b>HS4FR83</b>	\$571
88"	<b>HS4FR88</b>	\$571
:	:	:



**For Canadian Pricing**

Multiply U.S. Price by the Canadian price factor.

▶ See page 1 for details.

# Regard Privacy Screens

*Tip: Must specify the privacy screen attachment option for each back, as well as the privacy screen style number. Screens can only be attached when the option is selected on each back.*

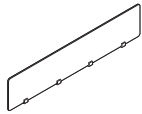

*Tip: Screen width must match width of back width.*

*Tip: When using custom screen materials, screen widths must be ordered 2" less than widths shown at right. All edges must be rounded and beveled.*

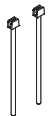

*Tip: Screen brackets and stanchions can be specified separately to allow users to supply own screens.*

*Tip: When specifying custom screen materials, screen lengths 33"–55" require two brackets and stanchions and screen lengths 60½"–88" require four brackets and stanchions.*

*Tip: When using custom screen materials, the installer must attach glass tabs to the screen. Glass connection tabs come with screen brackets and stanchions.*



### For Canadian Pricing

Multiply U.S. Price by the Canadian price factor.

▶ See page 1 for details.

Standard Includes		Required to Specify
▶ Need help? Product details, page 220	<ul style="list-style-type: none"> <li>• Glass screen: 6530 Frosted Glass</li> <li>• Two brackets, 33"W – 55"W: paint</li> <li>• Four brackets, 60½"W – 88"W: paint</li> </ul>	1 Style number 2 Paint color number for brackets ▶ See <i>Surface Materials</i> , page 473.

### Specification Information

Dimensions	Style	U.S.
W H	Number	Price

### Screens with Brackets

33"	14"	<b>HS4S33G</b>	\$ 685
38½"	14"	<b>HS4S39G</b>	\$ 749
44"	14"	<b>HS4S44G</b>	\$ 814
49½"	14"	<b>HS4S50G</b>	\$ 908
55"	14"	<b>HS4S55G</b>	\$ 972
60½"	14"	<b>HS4S61G</b>	\$1039
66"	14"	<b>HS4S66G</b>	\$1102
71½"	14"	<b>HS4S72G</b>	\$1166
77"	14"	<b>HS4S77G</b>	\$1231
82½"	14"	<b>HS4S83G</b>	\$1295
88"	14"	<b>HS4S88G</b>	\$1359

### Screen Brackets and Stanchions

Two brackets and stanchions	<b>HS4SA2</b>	\$ 202
Four brackets and stanchions	<b>HS4SA4</b>	\$ 376

# Regard Tables

Standard Includes	Required to Specify
<ul style="list-style-type: none"> <li>▶ Need help? Product details, page 222</li> <li>• Table top: High-Pressure Laminate, or solid surface</li> <li>• Metal support leg and base: paint</li> <li>• Edges on laminate table, if selected; 3 mm plastic</li> </ul>	<ol style="list-style-type: none"> <li>1 Style number</li> <li>2 Laminate color number for top, if selected</li> <li>3 Solid surface color number for top, if selected</li> <li>4 Plastic color number for laminate table edge, if selected</li> <li>5 Paint color for leg and base</li> <li>6 Options, if selected (see below)</li> </ol> <p>▶ See <i>Surface Materials</i>, page 473.</p>

Tip: Open Line laminate requires a selection of standard edge band finish.

Tip: Table top is 3/4" thick for laminate and 1 1/4" thick for solid surfaces.

Options	U.S. Price	Required to Specify
<b>Surface Materials</b> <ul style="list-style-type: none"> <li>• Steelcase Health laminate</li> <li>• Steelcase laminate</li> <li>• Open Line laminate</li> </ul>	No cost No cost +\$135 plus the cost of laminate	<p>▶ See <i>Surface Materials</i>, page 473.</p> <p>▶ See <i>Surface Materials</i>, page 473.</p> <p>▶ See <i>Surface Materials</i>, page 473.</p>
<b>Paint</b> <ul style="list-style-type: none"> <li>• Paint price group 1</li> <li>• Paint price group 2 for 22"H square tables</li> <li>• Paint price group 2 for 26"H square tables and personal tables</li> <li>• Paint price group 3 for square and personal tables</li> </ul>	No cost +\$ 41 +\$ 74 +\$146	Specify paint color number. Specify paint color number. Specify paint color number. Specify paint color number. ▶ See <i>Surface Materials</i> , page 473.

Specification Information									
Dimensions			Style	U.S. Base Prices					
D	W	H	Number	Laminate	Solid Surface Price Group A	Solid Surface Price Group B	Solid Surface Price Group C	Solid Surface Price Group D	

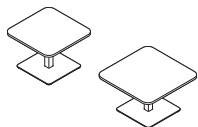

## Square Tables

Laminate									
22"	22"	15"	<b>HS4T2218L</b>	\$1042	N.A.	N.A.	N.A.	N.A.	
26"	26"	15"	<b>HS4T2618L</b>	\$1198	N.A.	N.A.	N.A.	N.A.	
Solid Surface									
22"	22"	15"	<b>HS4T2218S</b>	N.A.	\$1808	\$1854	\$1915	\$2063	
26"	26"	15"	<b>HS4T2618S</b>	N.A.	\$2069	\$2129	\$2201	\$2356	

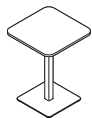

## Personal Tables

Laminate									
22"	22"	29"	<b>HS4T2228L</b>	\$1066	N.A.	N.A.	N.A.	N.A.	
Solid Surface									
22"	22"	29"	<b>HS4T2228S</b>	N.A.	\$1843	\$1889	\$1950	\$2098	

**For Canadian Pricing**  
 Multiply U.S. Price by the Canadian price factor.  
 ▶ See page 1 for details.

# Regard Planters



Standard Includes		Required to Specify
▶ Need help? Product details, page 223	<ul style="list-style-type: none"> <li>Planter: paint price group 1</li> <li>Adjustable glides on planter: platinum solid plastic</li> </ul>	1 Style number 2 Paint color for planter 3 Options, if selected (see below) ▶ See <i>Surface Materials</i> , page 473.

Options	U.S. Price	Required to Specify
<b>Surface Materials</b> <ul style="list-style-type: none"> <li>Paint price group 1</li> <li>Paint price group 2</li> <li>Paint price group 3</li> </ul>	No cost +\$ 74 +\$146	Specify paint color number. Specify paint color number. Specify paint color number.
<b>Shelf Bracket</b> <ul style="list-style-type: none"> <li>Bracket: black paint only</li> </ul>	+\$ 72	Specify with <i>shelf bracket option</i> .

Tip: When mounting to frame, planter must be specified with shelf bracket option.

Specification Information				
Dimensions			Style	U.S.
D	W	H	Number	Base Price
11"	22"	14"	<b>HS4P1122</b>	\$ 959
11"	33"	14"	<b>HS4P1133</b>	\$1066
11"	44"	14"	<b>HS4P1144</b>	\$1135
22"	22"	14"	<b>HS4P2222</b>	\$ 996
:	:	:	:	:

Tip: 22"D x 22"W planter is for use on the floor only.

Lounge Seating

 **For Canadian Pricing**  
 Multiply U.S. Price by the Canadian price factor.  
 ▶ See page 1 for details.

# Regard Planter Shelves

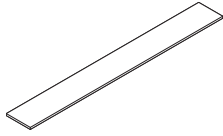

Standard Includes		Required to Specify
<ul style="list-style-type: none"> <li>▶ Need help? Product details, page 223</li> </ul>	<ul style="list-style-type: none"> <li>• Shelf: Steelcase Health laminate or Steelcase laminate</li> <li>• Edge: plastic</li> </ul>	<ol style="list-style-type: none"> <li>1 Style number</li> <li>2 Laminate color number for shelf</li> <li>3 Plastic color number for laminate shelf edge</li> <li>4 Options, if selected (see below)</li> </ol> <ul style="list-style-type: none"> <li>▶ See <i>Surface Materials</i>, page 473.</li> </ul>

Options	U.S. Price	Required to Specify
<b>Surface Materials</b> <ul style="list-style-type: none"> <li>• Steelcase Health laminate</li> <li>• Steelcase laminate</li> <li>• Open Line laminate</li> </ul>	No cost No cost +\$135 plus cost of laminate	<ul style="list-style-type: none"> <li>▶ See <i>Surface Materials</i>, page 473.</li> <li>▶ See <i>Surface Materials</i>, page 473.</li> <li>▶ See <i>Surface Materials</i>, page 473.</li> </ul>

Specification Information			
Dimensions		Style Number	U.S. Base Price
D	W		
11"	44"	<b>HS4LSP44</b>	\$473
11"	55"	<b>HS4LSP55</b>	\$533
11"	60½"	<b>HS4LSP61</b>	\$536
11"	66"	<b>HS4LSP66</b>	\$572
11"	71½"	<b>HS4LSP72</b>	\$576
11"	77"	<b>HS4LSP77</b>	\$644
11"	82½"	<b>HS4LSP83</b>	\$647
11"	88"	<b>HS4LSP88</b>	\$653
:	:	:	:



**For Canadian Pricing**  
 Multiply U.S. Price by the Canadian price factor.  
 ▶ See page 1 for details.

# Regard Planter Liners



*Tip: Liners come in package of two.*

*Tip: Liners are recommended when using artificial plants.*

*Tip: Liners strongly recommended when using live plants.*

Standard Includes	Required to Specify
<ul style="list-style-type: none"> <li>▶ Need help? Product details, page 223</li> <li>• Liner: package of two</li> </ul>	<ul style="list-style-type: none"> <li>Style number</li> </ul>

### Specification Information

Dimensions		Style Number	U.S. Price
D	W		
11"	22"	<b>HS42L1122</b>	\$271
11"	33"	<b>HS42L1133</b>	\$246
11"	44"	<b>HS42L1144</b>	\$266
22"	22"	<b>HS42L2222</b>	\$374
:	:	:	:

Lounge Seating

**For Canadian Pricing**  
 Multiply U.S. Price by the Canadian price factor.  
 ▶ See page 1 for details.

# Regard Desk and Media Cabinets

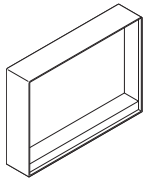

Standard Includes		Required to Specify
<ul style="list-style-type: none"> <li>▶ Need help? Product details, page 224</li> </ul>	<ul style="list-style-type: none"> <li>• Worksurface: laminate or solid surface</li> <li>• Edges on laminate worksurface, if selected: 3 mm plastic</li> <li>• Vertical surfaces: laminate</li> <li>• Back panel, if selected: laminate</li> <li>• Shroud: paint</li> <li>• Display shelves, if selected: paint</li> </ul>	<ol style="list-style-type: none"> <li>1 Style number</li> <li>2 Laminate color number for worksurface, if selected</li> <li>3 Solid surface color number for worksurface, if selected</li> <li>4 Plastic color number for laminate worksurface edges, if selected</li> <li>5 Laminate color number for vertical surfaces and back panel, if selected</li> <li>6 Paint color number for shroud</li> <li>7 Paint color number for display shelves, if selected</li> <li>8 Options, if selected (see below)</li> </ol> <ul style="list-style-type: none"> <li>▶ See <i>Surface Materials</i>, page 473.</li> </ul>

	Options	U.S. Price	Required to Specify
<b>Surface Materials</b>	<b>Laminate</b>		
	<ul style="list-style-type: none"> <li>• Steelcase Health laminate</li> <li>• Steelcase laminate</li> <li>• Open Line laminate</li> </ul>	No cost No cost +\$135 plus the cost of laminate	<ul style="list-style-type: none"> <li>▶ See <i>Surface Materials</i>, page 473.</li> <li>▶ See <i>Surface Materials</i>, page 473.</li> <li>▶ See <i>Surface Materials</i>, page 473.</li> </ul>
	<b>Solid Surface</b>		
	<ul style="list-style-type: none"> <li>• Solid surface price group A</li> <li>• Solid surface price group B</li> <li>• Solid surface price group C</li> <li>• Solid surface price group D</li> </ul>	No cost +\$172 +\$204 +\$228	<ul style="list-style-type: none"> <li>▶ See <i>Surface Materials</i>, page 473.</li> <li>▶ See <i>Surface Materials</i>, page 473.</li> <li>▶ See <i>Surface Materials</i>, page 473.</li> <li>▶ See <i>Surface Materials</i>, page 473.</li> </ul>
<b>Omit Back Panel</b>	<ul style="list-style-type: none"> <li>• Omit back panel</li> </ul>	-\$210	Specify with <i>no back panel</i> .
<b>Monitor Bracket</b>	<ul style="list-style-type: none"> <li>• Small monitor bracket</li> <li>• Large monitor bracket</li> </ul>	+\$171 +\$198	Specify with <i>small monitor bracket</i> . Specify with <i>large monitor bracket</i> .
<b>Power Cutout</b>	<ul style="list-style-type: none"> <li>• With power cutout</li> </ul>	No cost	Specify with <i>power cutout</i> .
<b>Coat Hook and Bag Retainer</b>	<ul style="list-style-type: none"> <li>• Coat hook only with 4799 Platinum</li> </ul>	+\$ 72	Specify with <i>4799 Platinum coat hook</i> .
	<ul style="list-style-type: none"> <li>• Coat hook only with 4750 Champagne</li> </ul>	+\$ 72	Specify with <i>4750 Champagne coat hook</i> .
	<ul style="list-style-type: none"> <li>• Bag retainer only with 4799 Platinum</li> </ul>	+\$210	Specify with <i>4799 Platinum bag retainer</i> .
	<ul style="list-style-type: none"> <li>• Bag retainer only with 4750 Champagne</li> </ul>	+\$210	Specify with <i>4750 Champagne bag retainer</i> .
	<ul style="list-style-type: none"> <li>• Coat hook and bag retainer with 4799 Platinum</li> </ul>	+\$282	Specify with <i>4799 Platinum coat hook and bag retainer</i> .
	<ul style="list-style-type: none"> <li>• Coat hook and bag retainer with 4750 Champagne</li> </ul>	+\$282	Specify with <i>4750 Champagne coat hook and bag retainer</i> .
<b>Lighting</b>	<ul style="list-style-type: none"> <li>• LED lighting</li> </ul>	+\$423	Specify with <i>6009 Arctic White LED lighting</i> .
<b>Related Products</b>	<ul style="list-style-type: none"> <li>• Base frames and frame extensions</li> </ul>		▶ Page 238

Tip: Monitor bracket is available in two sizes for media cabinet only.

Tip: 46"W monitor is recommended for media cabinet.

Tip: Power cutout is available on desk cabinets only.

Tip: Coat hook and bag retainer available on open desk cabinets only.

Tip: LED light is available on desk cabinets only.

Tip: Base frame and frame extensions are ordered separately.



**For Canadian Pricing**  
 Multiply U.S. Price by the Canadian price factor.  
 ▶ See page 1 for details.



**Specification Information**

Dimensions			Style Number	U.S. Base Price
D	W	H		
		Cabinet Height	Worksurface Height	

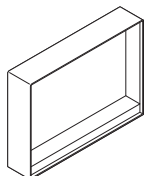

**Media Cabinet**

11"	55"	40"	N.A.	<b>HS4CM</b>	\$4112
-----	-----	-----	------	--------------	--------

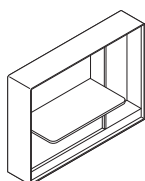

**Open Desk Cabinet**

**Laminate**

11"	55"	40"	28 <sup>1</sup> / <sub>2</sub> "	<b>HS4D1828L</b>	\$4961
11"	55"	40"	30"	<b>HS4D1830L</b>	\$4961
11"	55"	40"	36"	<b>HS4D1836L</b>	\$4961

**Solid Surface**

11"	55"	40"	28 <sup>1</sup> / <sub>2</sub> "	<b>HS4D1828S</b>	\$5604
11"	55"	40"	30"	<b>HS4D1830S</b>	\$5604
11"	55"	40"	36"	<b>HS4D1836S</b>	\$5604

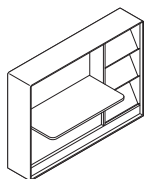

**Desk Cabinet with Display Shelves**

**Laminate**

11"	55"	40"	28 <sup>1</sup> / <sub>2</sub> "	<b>HS4DR1828L</b>	\$5324
11"	55"	40"	30"	<b>HS4DR1830L</b>	\$5324
11"	55"	40"	36"	<b>HS4DR1836L</b>	\$5324

**Solid Surface**

11"	55"	40"	28 <sup>1</sup> / <sub>2</sub> "	<b>HS4DR1828S</b>	\$6113
11"	55"	40"	30"	<b>HS4DR1830S</b>	\$6113
11"	55"	40"	36"	<b>HS4DR1836S</b>	\$6113

Lounge Seating

 **For Canadian Pricing**  
 Multiply U.S. Price by the Canadian price factor.  
 ▶ See page 1 for details.

# Regard Booth with Table

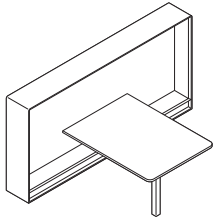

Standard Includes		Required to Specify
<ul style="list-style-type: none"> <li>▶ Need help? Product details, page 226</li> </ul>	<ul style="list-style-type: none"> <li>• Table: laminate or solid surface</li> <li>• Edges on laminate table, if selected: 3 mm plastic</li> <li>• Vertical surfaces: laminate</li> <li>• Back panel, if selected: laminate</li> <li>• Shroud: paint</li> </ul>	<ol style="list-style-type: none"> <li>1 Style number</li> <li>2 Laminate color number for table, if selected</li> <li>3 Solid surface color number for table, if selected</li> <li>4 Plastic color number for laminate table edges, if selected</li> <li>5 Laminate color number for vertical surfaces and back panel, if selected</li> <li>6 Paint color number for shroud</li> <li>7 Options, if selected (see below)</li> </ol> <p>▶ See <i>Surface Materials</i>, page 473.</p>

	Options	U.S. Price	Required to Specify
<b>Surface Materials</b>	<b>Laminate</b>		
	<ul style="list-style-type: none"> <li>• Steelcase Health laminate</li> <li>• Steelcase laminate</li> <li>• Open Line laminate</li> </ul>	No cost No cost +\$135 plus the cost of laminate	<ul style="list-style-type: none"> <li>▶ See <i>Surface Materials</i>, page 473.</li> <li>▶ See <i>Surface Materials</i>, page 473.</li> <li>▶ See <i>Surface Materials</i>, page 473.</li> </ul>
	<b>Solid Surface</b>		
	<ul style="list-style-type: none"> <li>• Solid surface price group A</li> <li>• Solid surface price group B</li> <li>• Solid surface price group C</li> <li>• Solid surface price group D</li> </ul>	No cost +\$172 +\$204 +\$228	<ul style="list-style-type: none"> <li>▶ See <i>Surface Materials</i>, page 473.</li> <li>▶ See <i>Surface Materials</i>, page 473.</li> <li>▶ See <i>Surface Materials</i>, page 473.</li> <li>▶ See <i>Surface Materials</i>, page 473.</li> </ul>
<b>Power Cutout</b>	<ul style="list-style-type: none"> <li>• With power cutout</li> </ul>	No cost	Specify with <i>monitor cutout</i> .
<b>Omit Back Panel</b>	<ul style="list-style-type: none"> <li>• Omit back panel</li> </ul>	-\$210	Specify with <i>no back panel</i> .
<b>Monitor Bracket</b>	<ul style="list-style-type: none"> <li>• Small monitor bracket</li> </ul>	+\$171	Specify with <i>small monitor bracket</i> .
<b>Lighting</b>	<ul style="list-style-type: none"> <li>• LED lighting</li> </ul>	+\$423	Specify with <i>6009 Arctic White LED lighting</i> .
<b>Related Products</b>	<ul style="list-style-type: none"> <li>• Booth frames</li> </ul>		▶ Page 238

Tip: Monitor bracket is available for monitors 32"W or smaller. 27"W monitor is recommended.

Tip: Booth frame is ordered separately.

## Specification Information

Dimensions		Style	U.S.
D	W	Number	Base Price
:	:	:	:
:	:	:	:

### Laminate

44"	80½"	<b>HS4TC4481L</b>	\$5689
55"	80½"	<b>HS4TC5581L</b>	\$5783
:	:	:	:

### Solid Surface

44"	80½"	<b>HS4TC4481S</b>	\$6074
55"	80½"	<b>HS4TC5581S</b>	\$6350
:	:	:	:



**For Canadian Pricing**  
 Multiply U.S. Price by the Canadian price factor.  
 ▶ See page 1 for details.

# Regard Electrical Components

## Hardwire Power Infeed

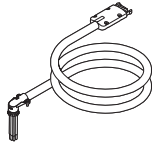

Tip: Vertical cable riser recommended when specifying infeed.

▶ See page 262

Standard Includes	Required to Specify
<ul style="list-style-type: none"> <li>▶ Need help? Product details, page 228</li> <li>• Circuit 1 and 2 hardwired base power-in</li> <li>• Male modular connector</li> <li>• Strain-relief cable clamp</li> </ul>	Style number

Specification Information		
Dimensions	Style Number	U.S. Price
L		
108"	HS4VBPH	\$133

## Power Kits

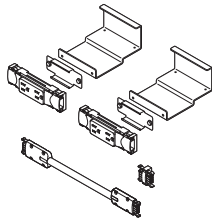

Tip: Power kits are available only with circuit 1. When circuit 2 is required a unique kit is required.

Standard Includes	Required to Specify
<ul style="list-style-type: none"> <li>▶ Need help? Product details, page 228</li> <li>• Single power module: 6000 Black</li> </ul>	1 Style number 2 Options, if selected (see below)

Options	U.S. Price	Required to Specify
<b>Power Modules</b>		
• 2 power modules	Prices below	Specify with 2 power modules.
• 3 power modules	Prices below	Specify with 3 power modules.
• 4 power modules	Prices below	Specify with 4 power modules.

Specification Information			
Dimensions	Style Number	U.S. Base Price	Options
W			(Add \$ to Base Price)
			2 Power Modules : 3 Power Modules : 4 Power Modules

### Single-Sided

	HS4VKS	\$88	+\$124	N.A.	N.A.
--	--------	------	--------	------	------

### Double-Sided

44"	HS4VKD44	\$88	+\$232	N.A.	N.A.
55"	HS4VKD55	\$88	+\$124	N.A.	N.A.
60 1/2"	HS4VKD61	\$88	+\$232	+\$445	N.A.
66"	HS4VKD66	\$88	+\$232	+\$445	N.A.
71 1/2"	HS4VKD72	\$88	+\$124	+\$344	N.A.
77"	HS4VKD77	\$88	+\$124	+\$344	N.A.
82 1/2"	HS4VKD83	\$88	+\$124	+\$344	N.A.
88"	HS4VKD88	\$88	+\$124	+\$344	+\$481



### For Canadian Pricing

Multiply U.S. Price by the Canadian price factor.

▶ See page 1 for details.

**Power Strips**

Standard Includes	Required to Specify
<ul style="list-style-type: none"> <li>▶ Need help? Product details, page 228</li> <li>• Frame-mounted power strip: clear anodized aluminum only</li> <li>• Utility power strip faceplate: paint</li> <li>• Power cord</li> </ul>	<ol style="list-style-type: none"> <li>1 Style number</li> <li>2 Paint color number for utility power strip faceplate, if selected</li> <li>3 Power cord (see below under Required Selections)</li> <li>4 Options, if selected (see below)</li> </ol> <p>▶ See <i>Surface Materials</i>, page 473.</p>

Tip: 10'L cord option available on corded power strips only.

Tip: California requires over current protection on corded power strips.

Tip: California does not require over current protection on hardwire power strips.

Tip: USB/USB configurations are not available.

Tip: 6' and 10' cord options are available with all power configurations.

Tip: As installed, furnishings that feature integrated hospital grade receptacles do not meet Article 517 of the National Electric Code requirements for hospital grade furnishing. These furnishings are not intended to be used in general patient care areas or critical patient care areas.

Tip: Hospital grade receptacles are not available in tamper and spill resistant.

Power Cord	Required Selections	U.S. Price	Required to Specify
	• 6'L Axil Z power cord	No cost	Specify with 6' power cord.
	• 6'L over current protection cord	+\$ 35	
	• 10'L Axil Z power cord	+\$ 61	Specify with 10' power cord.
	• 10'L over current protection cord	+\$ 96	

Power Configuration	Options	U.S. Price	Required to Specify
	• Power/power	No cost	Specify with power/power.
	• Tamper and spill resistant	+\$ 18	Specify with 2 tamper and spill resistant.
	• Hospital grade	+\$ 62	Specify with 2 hospital grade.
	• Power/USB	+\$107	Specify with 1 power/1 USB.
	• Tamper and spill resistant/USB	+\$116	Specify with 1 tamper and spill resistant/1 USB.
	• Hospital grade/USB	+\$137	Specify with 1 hospital grade/1 USB.

Specification Information		
• <b>Dimensions</b>	• <b>Style</b>	• <b>U.S.</b>
• <b>L</b>	• <b>Number</b>	• <b>Base</b>
•	•	• <b>Price</b>
•	•	•
•	•	•

**For Use with Frame Assembly**

Corded		
6'	<b>HS4VPSFC</b>	\$274
Hardwire		
	<b>HS4VPSFH</b>	\$274

**For Use with Utility Arms/Desk/Booth**

Corded		
6'	<b>HS4VPSDC</b>	\$274
Hardwire		
	<b>HS4VPSDH</b>	\$274

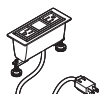
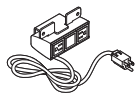

**For Canadian Pricing**  
 Multiply U.S. Price by the Canadian price factor.  
 ▶ See page 1 for details.

## Receptacle Kits

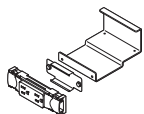

Tip: Receptacle kits are used when adding circuit 2 or when assembling a unique kit.

▶ See power kits, page 259 for standard configurations.

Standard Includes	Required to Specify
-------------------	---------------------

- |  |                                   |
|--|-----------------------------------|
| ▶ Need help?<br>Product details,<br>page 229 | • Single power module: 6000 Black |
|--|-----------------------------------|

Style number

### Specification Information

• Dimensions W	• Style Number	• U.S. Price
-------------------	-------------------	-----------------

#### 1-Circuit

11¾"	<b>HS4VK1</b>	\$88
------	---------------	------

#### 2-Circuit

11¾"	<b>HS4VK2</b>	\$88
------	---------------	------

## Modular Harness

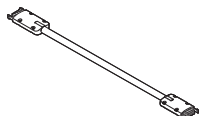

Tip: Modular harness only required when assembling a unique kit.

▶ See power kits, page 259 for standard configurations.

Standard Includes	Required to Specify
-------------------	---------------------

- |  |                           |
|--|---------------------------|
| ▶ Need help?<br>Product details,<br>page 229 | • Non-PVC modular harness |
|--|---------------------------|

Style number

### Specification Information

• Dimensions L	• Style Number	• U.S. Price
-------------------	-------------------	-----------------

12"	<b>HS4VH12</b>	\$121
15"	<b>HS4VH15</b>	\$124
18"	<b>HS4VH18</b>	\$129
21"	<b>HS4VH21</b>	\$132
24"	<b>HS4VH24</b>	\$137
27"	<b>HS4VH27</b>	\$142
30"	<b>HS4VH30</b>	\$146
33"	<b>HS4VH33</b>	\$149
36"	<b>HS4VH36</b>	\$153
39"	<b>HS4VH39</b>	\$157
42"	<b>HS4VH42</b>	\$160



### For Canadian Pricing

Multiply U.S. Price by the Canadian price factor.

▶ See page 1 for details.

## Connectors

Standard Includes	Required to Specify
<ul style="list-style-type: none"> <li>▶ Need help? Product details, page 229</li> <li>• Connector</li> </ul>	<ul style="list-style-type: none"> <li>Style number</li> </ul>

Specification Information		
Style Number	U.S. Price	

In-Line	
<b>HS4VNL</b>	\$35

Branching	
<b>HS4VNB</b>	\$44



## Vertical Cable Riser



*Tip: Vertical cable riser is bolted to the floor and includes attachment hardware. Vertical cable riser is recommended when specifying hardwire power infeed.*

Standard Includes	Required to Specify
<ul style="list-style-type: none"> <li>▶ Need help? Product details, page 229</li> <li>• Cable riser: paint</li> <li>• Attachment hardware</li> </ul>	<ul style="list-style-type: none"> <li>1 Style number</li> <li>2 Paint color number for cable riser</li> <li>▶ See <i>Surface Materials</i>, page 473.</li> </ul>

Specification Information			
Dimensions		Style Number	U.S. Price
D	W		
11 1/8"	6"	<b>HS4VCR</b>	\$235



**For Canadian Pricing**  
 Multiply U.S. Price by the Canadian price factor.  
 ▶ See page 1 for details.

## Cable Clamp



*Tip: Cable clamp is included with hardwire power infeed. Cable clamp can be in used in place of cable ties provided with power kits if required.*

Standard Includes	Required to Specify
<ul style="list-style-type: none"> <li>▶ Need help? Product details, page 229</li> <li>• Cable clamp</li> </ul>	Style number

Specification Information	
• Style • Number	• U.S. • Price
<b>HS4VCC</b>	\$40
•	•
•	•



**For Canadian Pricing**  
Multiply U.S. Price by the Canadian price factor.  
▶ See page 1 for details.

# Node 480 Series by Steelcase

**Node** is a collaborative seating line to accommodate multiple environments including classrooms, clinical settings, and other learning environments. Node supports multiple teaching and learning modes, freedom to change postures and optional storage.

**One piece polypropylene contoured shell** is designed for easy maintenance and cleaning.

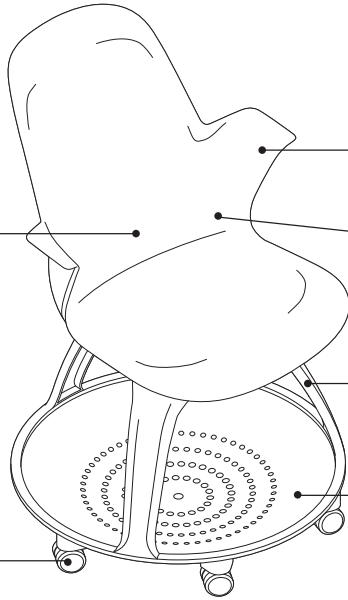

**Arms** are designed to support arms, side-sitting postures, and serve as a backpack hook.

**Flexible and contoured seat shell** supports comfort by allowing many postures.

**360°-swivel mechanism** is standard.

**Backpack storage area** is standard.

**Casters** have hard, dual wheels that roll smoothly on carpets. Soft dual-wheel casters are available for use on hard floors.

**Personal worksurface** moves independently of seat shell and base.

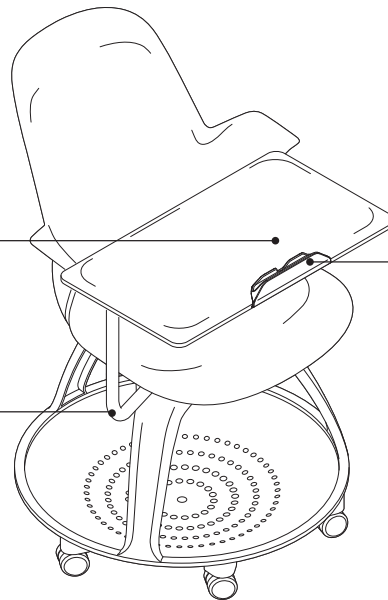

**Tablet stand** is available on all personal worksurfaces and supports tablets and smart phones.

**Personal worksurface** is depth adjustable for large and small users and allows for ingress/egress.

**Personal worksurface** is mounted on the right but appropriate for both right- and left-hand users.

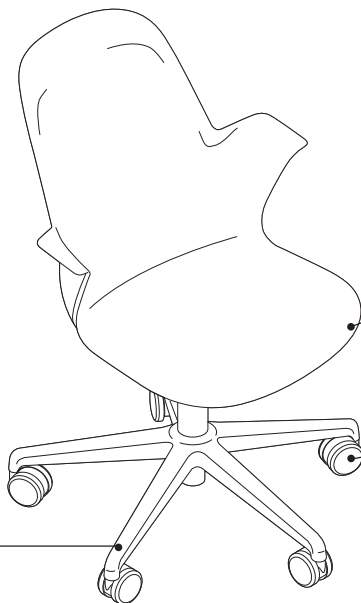

**Seat height** adjusts with a 5¼" range with a pneumatic adjustment mechanisms on five-arm base chairs. Chairs with a personal worksurface adjusts with a 4" range. Stools have a 8½" range. A 7½" range is available as an option.

**Hard, dual wheel casters** are standard for use on carpets. Soft, dark grey treaded, dual-wheel roll-control casters are available for use on hard floors or mats.

*Tip: Do not roll the chair across asphalt during installation as this may damage the casters.*

**Five-arm base** is standard.



**Contoured and flexible seat shell** supports comfort by allowing many postures.

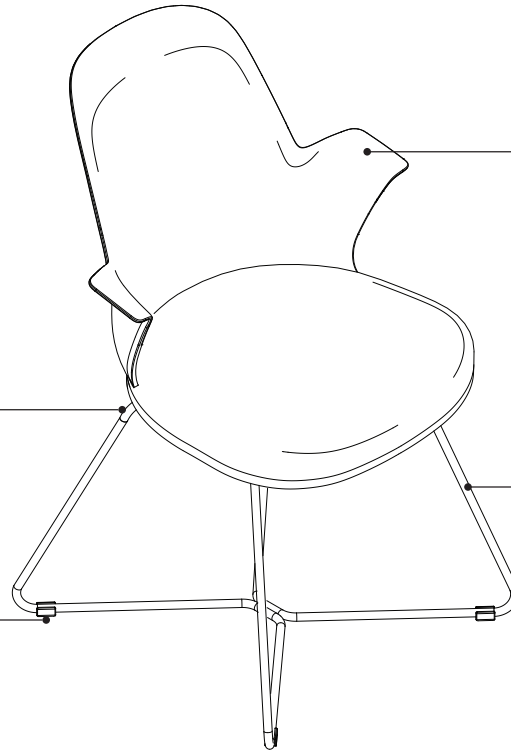

**The arms** are designed to support arms, side-sitting postures, and serve as a backpack hook.

**The seat bracket** can be customized with accent paint or PerfectMatch paint.

**Durable, steel wire frame** is lightweight.

**Hard glides** are standard. Soft, felt glides are available as an option.

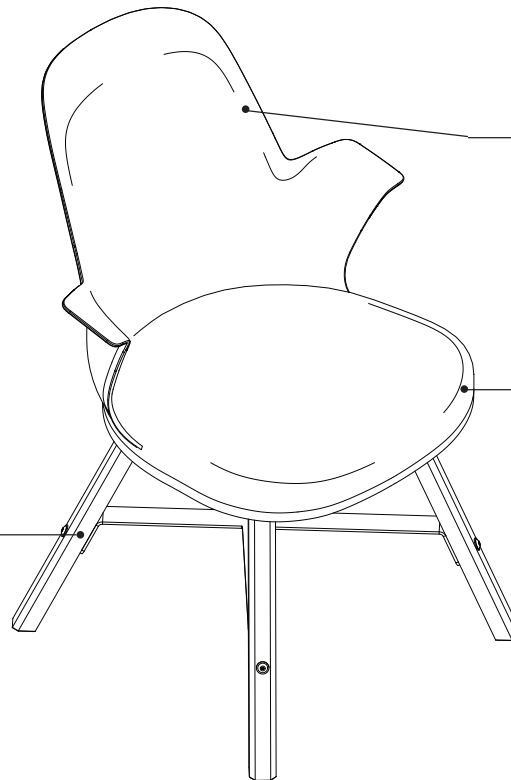

**One piece polypropylene contoured shell** is designed for easy maintenance and cleaning.

**Optional seat cushion** is available for extended comfort.

**Node wood legs** are solid maple wood with a polyethylene glide.

Node 480 Series by Steelcase, continued

**Product Details**

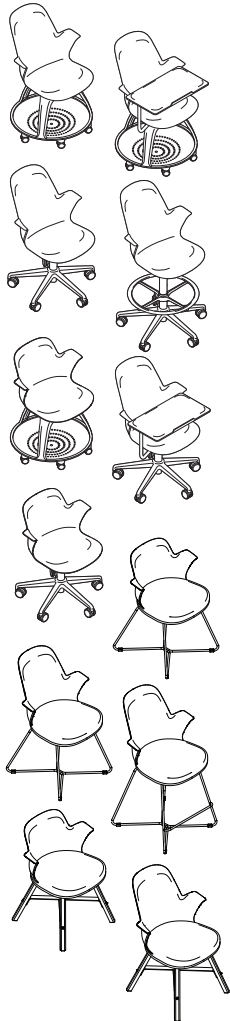

**Chairs and stools** are available with high-back and mid-back shells. Chairs are available with a tripod base, tripod base with personal worksurface five-arm base with pneumatic adjustment, and five-arm base with pneumatic adjustment with personal worksurface. X base is available in chair and stool height. Wood base is available in chair height only.

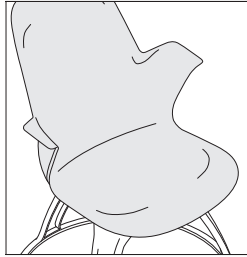

**Flexing seat shell and arms** promotes movement and supports multiple postures. Integrated arms support user's arms, side posture, and act as a backpack hook.

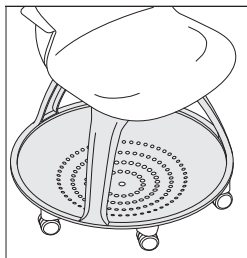

**Tripod base** reclaims the space under the seat. The space is 1.7 cu/ft. and allows for backpacks or personal belongings to be stored, and serves as a footrest.

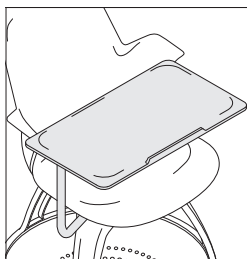

**Personal worksurface** is mounted on user's right, and designed to accommodate left- and right-handed users. It is 12"D x 22 1/4"W and features a safety stop to help prevent belongings and laptops from easily sliding off back edge.

**Node tripod, with or without worksurface, and Node five-arm base chairs with worksurface** ships standard unassembled and cartoned with the seat shell separated from the base. This allows for shipment in a smaller carton. Five-arm base chairs without worksurface and stools ship two to a carton. Assembly by a qualified Steelcase dealer installer is required. Node X base and wood base ship fully assembled. Assembly instructions are available at [www.steelcase.com](http://www.steelcase.com). No tools required for assembly.

**Adjustment Features**

**360° fixed height swivel mechanism on tripod base models** allows students to remain oriented to instructor, presentation materials, and other students.

**360° adjustable height swivel mechanism** is standard on five-arm base models.

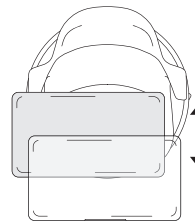

**Personal worksurface depth adjustment range** is 7 1/4" to 15". Measurement is from lumbar to worksurface.

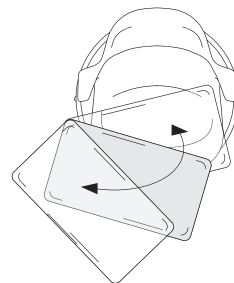

**Personal worksurface pivot range** is 48°.

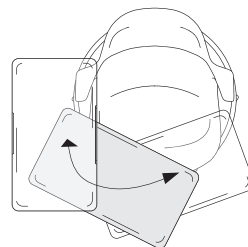

**Personal worksurface center pivot** is 100°. The center pivot range is measured from the closest position to the furthest position from the user.

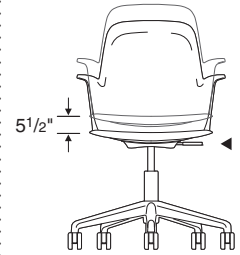

**Seat height** adjusts pneumatically. To lower, pull lever up while seated. To raise, pull lever up and keep your weight off the chair. Range of adjustability is 5 1/4" from 16"H to 21 3/16"H, a 3 3/4" range (17 1/8"H to 20 3/4"H) is available on chairs with a worksurface. Stools are standard with an 8 1/2" range of adjustability (23 1/16"H to 31 3/8"H). A 7 1/2" range of adjustability (18 1/2"H to 26 7/16"H) is available as an option.

**Glides** are available as an option. Glides ship assembled on the chair or stool and maintain same height as casters.

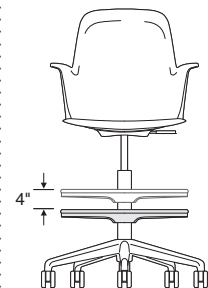

**Foot ring height on stools** adjusts by first lifting ring and rotating it counterclockwise to unlock. Then raise or lower ring up to 4" to desired position before rotating it clockwise to lock. The foot ring has a diameter of 20".

**Soft, dual-wheel roll-control casters for hard floors** are available on five-arm base chairs and stools only.

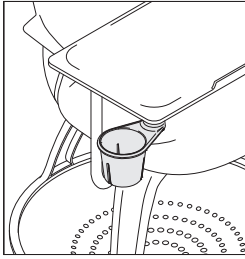

**Cup holder** is available as an option on Node chairs with personal worksurfaces. It is retractable under the worksurface when not in use.

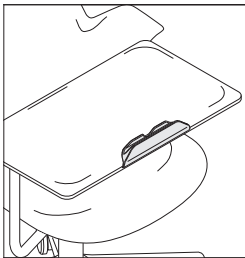

**Tablet stand** is available on Node chairs with personal worksurfaces. The stand supports tablets and smart phones in both portrait and landscape positions, making content easy to view and freeing up space on the worksurface for other materials. It can be field or factory installed.

*Tip: Devices are not secure in tablet stand when Node is moved.*

## Surface Materials

► See surface materials on page 473 for specific availability or refer to the *Surface Materials Reference Manual* for further information.

### Seat shell

#### Price Group 1

##### Plastics

- 6009 Arctic White
- 6059 Sterling Dark Solid
- 6205 Black
- 6249 Platinum Solid
- 6259 Midnight
- 6332 Citron
- 6333 Picasso
- 6334 Flash
- 6335 Wasabi
- 6336 Jazz
- 6337 Element
- 6338 Chili
- 6527 Merle

#### Price Group 2

##### Signature plastics

- 6BD1 Aubergine
- 6BD2 Peacock
- 6BD3 Jungle
- 6BD5 Honey
- 6BD6 Lagoon
- 6BD7 Saffron
- 6BE5 Olivine
- 6BE6 Sea Salt

### Tripod Base

- 6249 Platinum Solid
- 6295 Near Black
- 6337 Element

### Five-arm Base

- 6205 Black
- 6249 Platinum Solid
- 6337 Element

### X Base

- Paint
- Accent paint
- PerfectMatch paint
- Coatings
- Lux Coatings

### Wood Base

#### Base

- V1AC Natural Cherry
- V1AM Clear Maple
- V1CC Medium Amber Cherry
- V1EW Dark Walnut

#### Bracket

- Paint
- Accent paint
- PerfectMatch paint

### Personal Worksurface

- 6053 Seagull
- 6249 Platinum Solid
- 6295 Near Black
- 6337 Element

### Paint for Metal

- 0835 Black
- 4750 Champagne Metallic
- 4799 Platinum

### Casters

- Black

### Glides

- Black plastic (five-arm base)
- Sterling Dark Solid (tripod base)
- Hard, clear (X base)
- Polyethylene (wood base)

### Cup Holder

- Sterling Dark Solid

### Tablet Stand

- Sterling Dark Solid

### Fire Code Seating

**(FCS) option** is available. Order through the Steelcase Supplemental Catalog (SPS).

## Dimensions

► Page 272

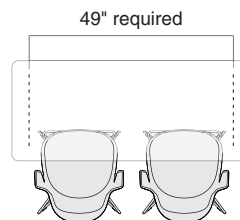

**The backpack storage area and overall chair width** require 23<sup>3</sup>/<sub>4</sub>" of continuous floor space when used with tables. The minimum distance between table bases is 49" to allow two chairs to be pushed under the worksurface. This does not apply to five-arm base models.

# Planning with Node by Steelcase

## For Classroom Environments

**Pedagogy, technology and space**, when carefully considered and intentionally designed, can establish new protocols for advanced learning solutions.

### Planning Tips

- 1 Illustrate multiple modes for each drawing to:
  - a) ensure enough space is available for each reconfiguration
  - b) allow the user to understand what's possible
  - c) ensure that sight lines are maintained when the furniture is moved
  - d) confirm that jurisdictional codes are followed for each layout (eg: International Building Code, American Disability Act, etc.)
- 2 Give permission to act differently by including wall guard and enough space to move, supporting simultaneous multi-modal activities.
- 3 Provide both analogue and digital tools in the solution such as whiteboards, personal whiteboards, interactive whiteboards or media:scape.
- 4 Address the needs of classroom and personal storage for both students and teachers. Incorporate this information into each mode to ensure space is adequate.
- 5 Include zones for mentoring, assessment, and/or coaching for teacher-to-student and/or student-to-student interaction.
- 6 Annotate the drawings with design principles to confirm they are being addressed.

#### Lecture Mode

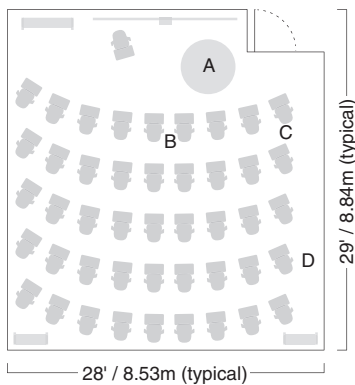

#### Group Mode

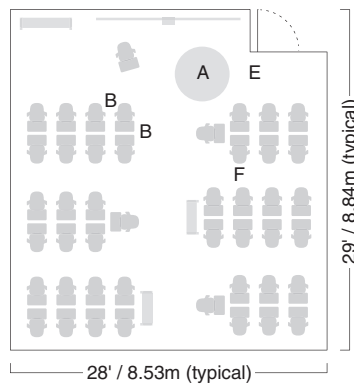

#### Discussion Mode

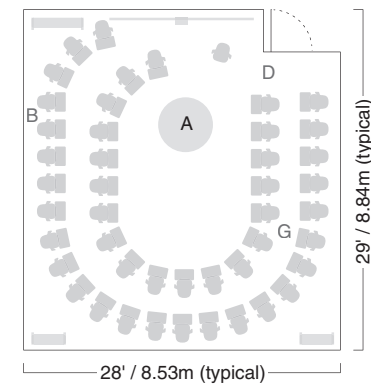

This example: 18\* sq. ft. or 1.68 sq. meters per person. \*For K-12 applications, See Table 1004.1.1 Maximum Floor Area Allowances per Occupant, 2009 International Building Code.

- A** — 60"/1.52m (ADA)
- B** — 12"/0.3m
- C** — 18"-24"/0.46-0.61m (aisle)
- D** — 36"/0.91m (egress)
- E** — 60"/1.52m (egress)
- F** — 38"/0.97m (aisle)
- G** — 18"-36"/0.46-0.91m (aisle)



# Planning with Node by Steelcase

## For Healthcare Environments

**Clinicians, patients, family, technology, and space** should be carefully considered and intentionally designed to create impactful and meaningful healthcare experiences.

### Planning Tips

- 1 Demonstrate ability for a clinician to perform three key behaviors:
  - a) input information using a mobile device.
  - b) share information with the patient and family member.
  - c) connect with patient by moving surface aside for physical exam
- 2 Encourage customers to think differently about the other objects within the exam space to encourage collaboration and mutual participation with all participants.
- 3 Provide both analogue and digital capabilities for both teaching and learning with the clinician, patient, and family member.
- 4 Optimize real estate by considering a chair-based exam for many exam room applications.

### Retail Exam Space

#### Wellbeing Hub

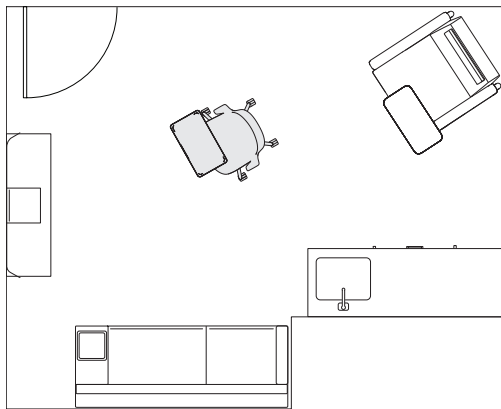

**Room Dimensions:** 13'11" x 11'3"

Wellbeing hubs offers a blended space to perform a physical exam and consultative experience.

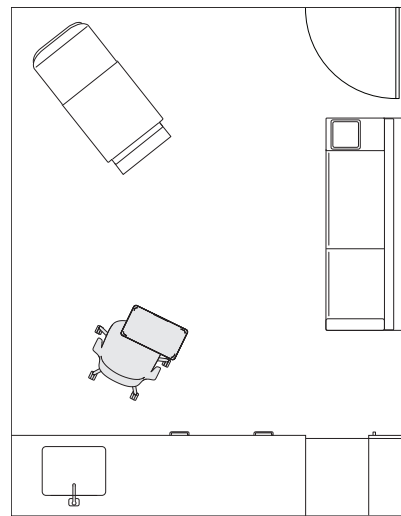

**Room Dimensions:** 9'6" x 12'

Retail exam spaces maximize real estate by accommodating the physical exam, consultative experience, and clinician work area.

▶ See *Table 1004.1.1 Maximum Floor Area Allowances per Occupant, 2009 International Building Code.*

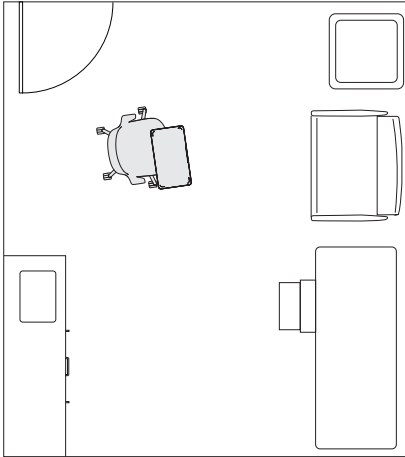
**Planning Tips, continued****Pediatric Exam Space**

**Room Dimensions:** 11'6" x 10'

Pediatric exam spaces are about building trust and connection by accommodating clinicians, parents, and children with a more consultative experience.

▶ See *Table 1004.1.1 Maximum Floor Area Allowances per Occupant, 2009 International Building Code.*

# Dimensions

Node 480 Series by Steelcase

Features	Overall Depth	Width	Height	Seat Depth	Seat Width	Seat Height from Floor	Width Between Arms	Arm to Floor
<b>Node 480 Series</b>								
<b>Tripod Base Collaborative Chair</b>								
	25"	23 <sup>3</sup> / <sub>4</sub> "	35"	16 <sup>1</sup> / <sub>2</sub> "	19 <sup>1</sup> / <sub>2</sub> "	18 <sup>1</sup> / <sub>4</sub> "	20 <sup>1</sup> / <sub>8</sub> "	26 <sup>3</sup> / <sub>4</sub> "
<b>Five-Arm Base Collaborative Chair</b>								
	24 <sup>3</sup> / <sub>4</sub> "	25 <sup>3</sup> / <sub>4</sub> "	32 <sup>5</sup> / <sub>8</sub> " to 37 <sup>3</sup> / <sub>4</sub> "	16 <sup>1</sup> / <sub>2</sub> "	19 <sup>1</sup> / <sub>2</sub> "	15 <sup>5</sup> / <sub>8</sub> " to 20 <sup>3</sup> / <sub>4</sub> "	20 <sup>1</sup> / <sub>8</sub> "	24 <sup>1</sup> / <sub>8</sub> " to 29 <sup>1</sup> / <sub>4</sub> "
<b>Tripod Base Mid-Back Collaborative Chair</b>								
	23 <sup>3</sup> / <sub>4</sub> "	23 <sup>3</sup> / <sub>4</sub> "	31 <sup>1</sup> / <sub>4</sub> "	15 <sup>1</sup> / <sub>2</sub> "	19 <sup>1</sup> / <sub>4</sub> "	18 <sup>1</sup> / <sub>4</sub> "	20 <sup>1</sup> / <sub>8</sub> "	26 <sup>3</sup> / <sub>4</sub> "
<b>Five-Arm Base Mid-Back Collaborative Chair</b>								
	23 <sup>1</sup> / <sub>2</sub> "	25 <sup>3</sup> / <sub>4</sub> "	28 <sup>7</sup> / <sub>8</sub> " to 34"	15 <sup>1</sup> / <sub>2</sub> "	19 <sup>1</sup> / <sub>4</sub> "	15 <sup>5</sup> / <sub>8</sub> " to 20 <sup>3</sup> / <sub>4</sub> "	20 <sup>1</sup> / <sub>8</sub> "	24 <sup>1</sup> / <sub>8</sub> " to 29 <sup>1</sup> / <sub>4</sub> "
<b>Five-Arm Base Stool</b>								
	24 <sup>3</sup> / <sub>4</sub> "	25 <sup>3</sup> / <sub>4</sub> "	40 <sup>7</sup> / <sub>8</sub> " to 48 <sup>1</sup> / <sub>4</sub> "	16 <sup>1</sup> / <sub>2</sub> "	19 <sup>1</sup> / <sub>2</sub> "	23 <sup>5</sup> / <sub>8</sub> " to 31 <sup>3</sup> / <sub>8</sub> "	20 <sup>1</sup> / <sub>8</sub> "	27" to 35"
<b>Five-Arm Base Mid-Back Stool</b>								
	23 <sup>1</sup> / <sub>2</sub> "	25 <sup>3</sup> / <sub>4</sub> "	37 <sup>1</sup> / <sub>8</sub> " to 44 <sup>1</sup> / <sub>2</sub> "	15 <sup>1</sup> / <sub>2</sub> "	19 <sup>1</sup> / <sub>4</sub> "	23 <sup>5</sup> / <sub>8</sub> " to 31 <sup>3</sup> / <sub>8</sub> "	20 <sup>1</sup> / <sub>8</sub> "	27" to 35"

\*Personal worksurface height from floor on tripod base chairs is 28<sup>1</sup>/<sub>2</sub>".  
 \*Personal worksurface height from floor on five-arm base chairs is 27<sup>3</sup>/<sub>16</sub>" to 30<sup>13</sup>/<sub>16</sub>".  
 \*Personal worksurface measures 22<sup>1</sup>/<sub>2</sub>"W x 12"D and has a depth adjustment range of 7<sup>1</sup>/<sub>4</sub>" to 15".

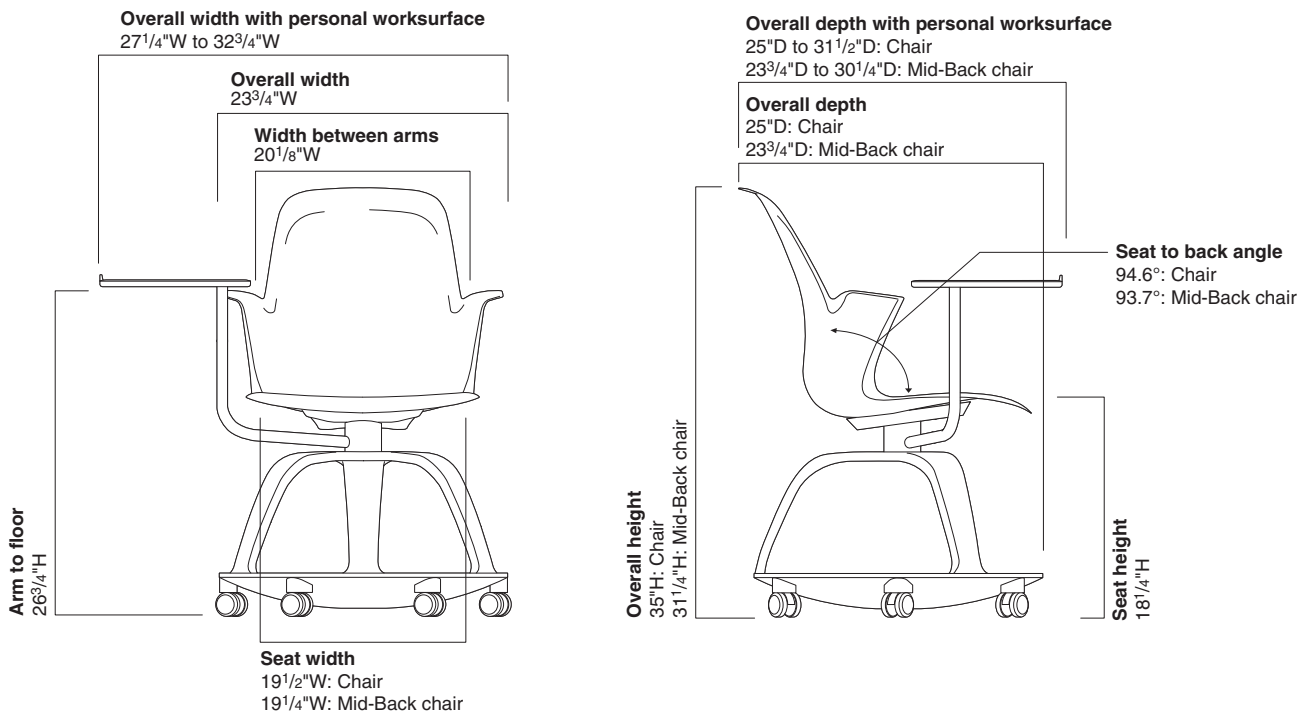



- Angle Between Seat and Back

**Tripod Base Collaborative Chair**

94.6°

**Five-Arm Base Collaborative Chair**

94.6°

**Tripod Base Mid-Back Collaborative Chair**

93.7°

**Five-Arm Base Mid-Back Collaborative Chair**

93.7°

**Five-Arm Base Stool**

94.6°

**Five-Arm Base Mid-Back Stool**

93.7°

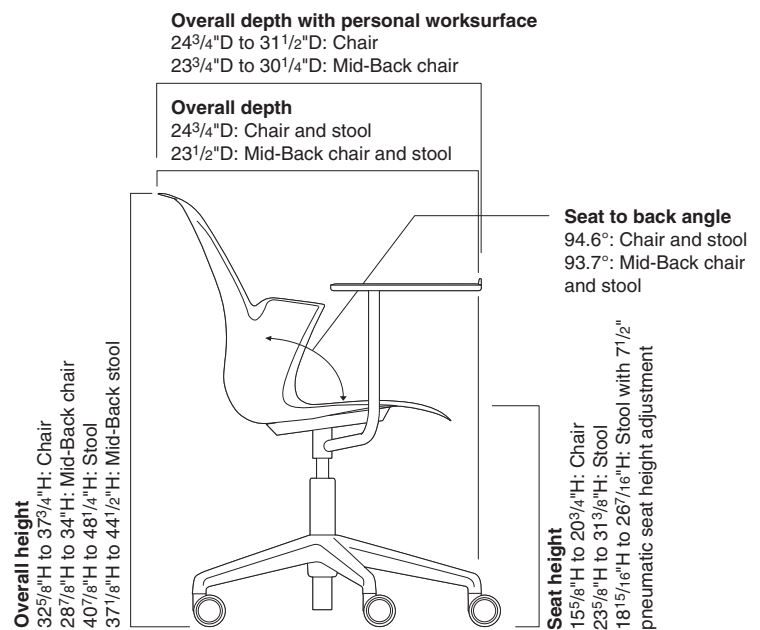
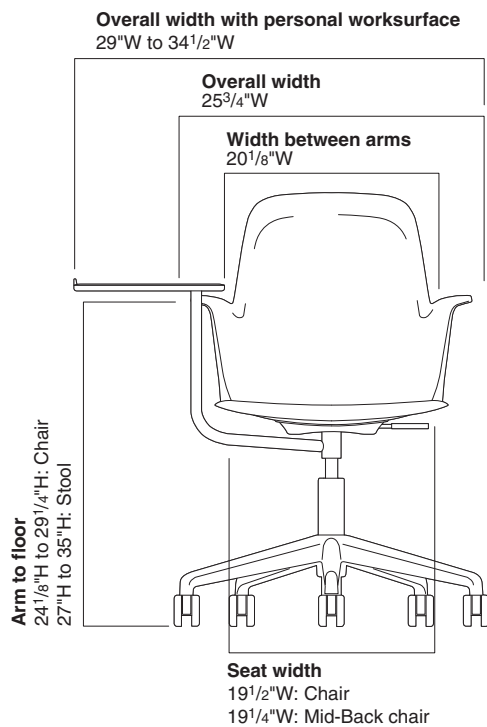

Dimensions, Node 480 Series, continued

Features	Overall Depth	Width	Height	Seat Depth	Seat Width	Seat Height from Floor	Width Between Arms	Arm to Floor
<b>Node 480 Series, continued</b>								
<b>Node X Base Chair</b>								
	24 <sup>3</sup> / <sub>4</sub> "	23 <sup>3</sup> / <sub>4</sub> "	34 <sup>3</sup> / <sub>4</sub> "	16 <sup>1</sup> / <sub>2</sub> "	19 <sup>1</sup> / <sub>2</sub> "	17 <sup>13</sup> / <sub>16</sub> "	20 <sup>1</sup> / <sub>8</sub> "	26 <sup>1</sup> / <sub>4</sub> "
<b>Node X Base Stool</b>								
	24 <sup>3</sup> / <sub>4</sub> "	23 <sup>3</sup> / <sub>4</sub> "	45 <sup>13</sup> / <sub>16</sub> "	16 <sup>1</sup> / <sub>2</sub> "	19 <sup>1</sup> / <sub>4</sub> "	28 <sup>1</sup> / <sub>16</sub> "	20 <sup>1</sup> / <sub>8</sub> "	37 <sup>1</sup> / <sub>4</sub> "
<b>Node X Base Mid-Back</b>								
	23 <sup>1</sup> / <sub>2</sub> "	23 <sup>3</sup> / <sub>4</sub> "	30 <sup>15</sup> / <sub>16</sub> "	15 <sup>1</sup> / <sub>2</sub> "	19 <sup>1</sup> / <sub>4</sub> "	17 <sup>13</sup> / <sub>16</sub> "	20 <sup>1</sup> / <sub>8</sub> "	26 <sup>1</sup> / <sub>4</sub> "
<b>Node X Base Mid-Back Stool</b>								
	23 <sup>1</sup> / <sub>2</sub> "	23 <sup>3</sup> / <sub>4</sub> "	41 <sup>7</sup> / <sub>8</sub> "	15 <sup>1</sup> / <sub>2</sub> "	19 <sup>1</sup> / <sub>4</sub> "	28 <sup>1</sup> / <sub>16</sub> "	20 <sup>1</sup> / <sub>8</sub> "	37 <sup>1</sup> / <sub>4</sub> "
<b>Node Wood Base Chair</b>								
	24 <sup>3</sup> / <sub>4</sub> "	23 <sup>3</sup> / <sub>4</sub> "	34 <sup>7</sup> / <sub>8</sub> "	16 <sup>1</sup> / <sub>2</sub> "	19 <sup>1</sup> / <sub>2</sub> "	18 <sup>1</sup> / <sub>8</sub> "	20 <sup>1</sup> / <sub>8</sub> "	26 <sup>1</sup> / <sub>4</sub> "
<b>Node Wood Base Mid-Back</b>								
	23 <sup>1</sup> / <sub>2</sub> "	23 <sup>3</sup> / <sub>4</sub> "	31 <sup>1</sup> / <sub>8</sub> "	15 <sup>1</sup> / <sub>2</sub> "	19 <sup>1</sup> / <sub>4</sub> "	18 <sup>1</sup> / <sub>8</sub> "	20 <sup>1</sup> / <sub>8</sub> "	26 <sup>1</sup> / <sub>4</sub> "

\*Personal worksurface height from floor on tripod base chairs is 28<sup>1</sup>/<sub>2</sub>".  
 \*Personal worksurface height from floor on five-arm base chairs is 27<sup>3</sup>/<sub>16</sub>" to 30<sup>13</sup>/<sub>16</sub>".  
 \*Personal worksurface measures 22<sup>1</sup>/<sub>2</sub>"W x 12"D and has a depth adjustment range of 7<sup>1</sup>/<sub>4</sub>" to 15".

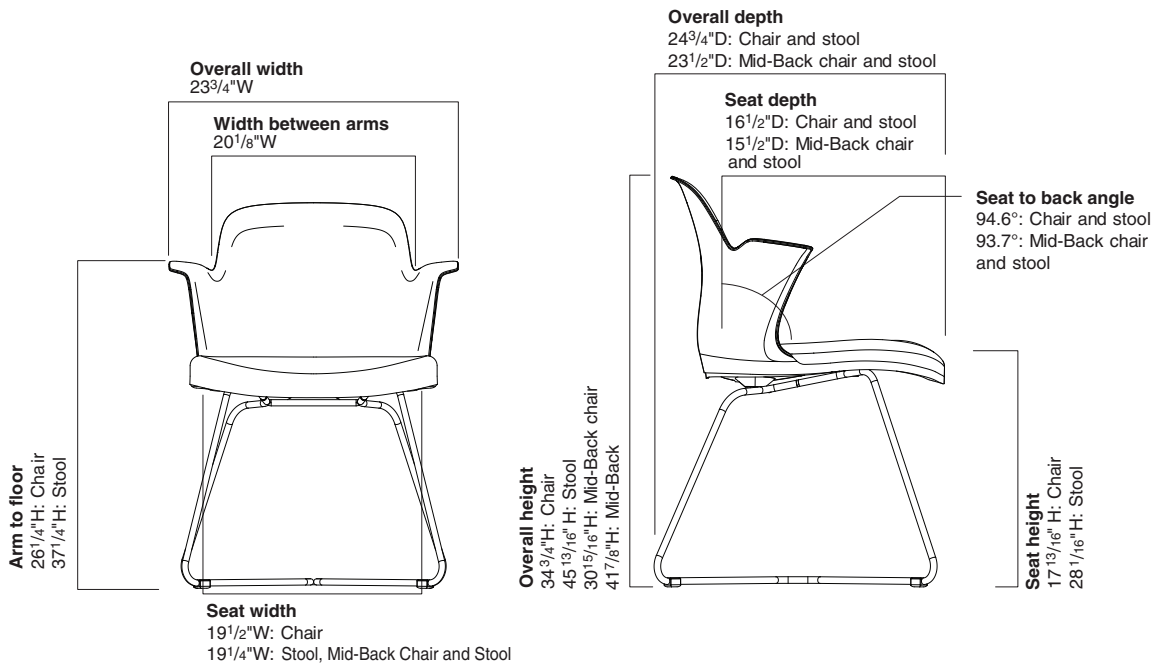

• Angle  
• Between  
• Seat and  
• Back

**Node X Base Chair**

94.6°

**Node X Base Stool**

94.6°

**Node X Base Mid-Back**

93.7°

**Node X Base Mid-Back Stool**

93.7°

**Node Wood Base Chair**

94.6°

**Node Wood Base Mid-Back**

93.7°

.

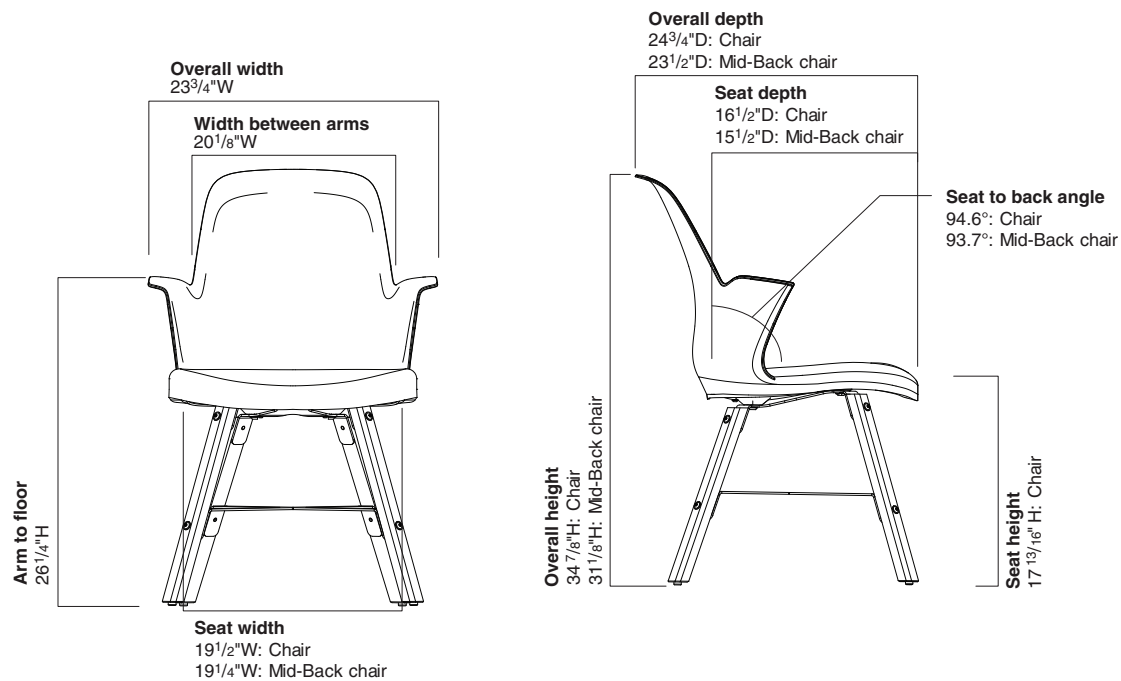

# Node 480 Series Collaborative Chairs by Steelcase

With Tripod Base



Standard Includes		Required to Specify
<ul style="list-style-type: none"> <li>▶ Need help? Product details, page 264</li> </ul>	<ul style="list-style-type: none"> <li>• Seat shell: plastic</li> <li>• Tripod base: plastic</li> <li>• Storage tray: sterling dark solid</li> <li>• Metal components: 0835 Black paint</li> <li>• Swivel seat</li> <li>• Worksurface, if selected: plastic</li> <li>• Hard casters</li> </ul>	<ol style="list-style-type: none"> <li>1 Style number</li> <li>2 Plastic color number for seat shell</li> <li>3 Plastic color number for tripod base</li> <li>4 Paint color number for metal components</li> <li>5 Plastic color number for personal worksurface, if selected</li> <li>6 Options, if selected (see below)</li> </ol> <ul style="list-style-type: none"> <li>▶ See <i>Surface Materials</i>, page 473.</li> </ul>

Options	U.S. Price	Required to Specify	
<b>Surface Materials</b>			
<b>Platinum or Champagne Metallic metal components</b>			
• On 480110	+\$ 12	Specify with 4799 Platinum or 4750 Champagne Metallic.	
• On 480120	+\$ 34	Specify with 4799 Platinum or 4750 Champagne Metallic.	
<b>Seat shell</b>			
• Plastic price group 1	No cost	Specify color number. ▶ See <i>Surface Materials</i> , page 473.	
• Plastic price group 2	+\$ 39	Specify color number. ▶ See <i>Surface Materials</i> , page 473.	
<b>Cushion</b>			
• Price group 1	No cost	Specify fabric color number.	
• Price group 2	+\$ 12	Specify fabric color number.	
• Price group 3	+\$ 36	Specify fabric color number.	
• Price group 4	+\$ 49	Specify fabric color number.	
• Price group 5	+\$ 60	Specify fabric color number.	
• Price group 6	+\$ 75	Specify fabric color number.	
• Price group 7	+\$ 88	Specify fabric color number.	
• Price group 8	+\$109	Specify fabric color number.	
• Price group 9	+\$135	Specify fabric color number.	
• Price group 10	+\$155	Specify fabric color number.	
• Steelcase Leather	+\$132	Specify leather color number.	
• Select Surfaces leather price group 1	+\$132	▶ See <i>Surface Materials Reference Manual</i> .	
• Elmosoft Leather	+\$153	Specify Elmosoft leather color number.	
• Select Surfaces leather price group 2	+\$153	▶ See <i>Surface Materials Reference Manual</i> .	
• Vinyl	+\$ 12	Specify vinyl color number.	
• Customer's Own Material	+\$ 53	▶ See <i>Surface Materials Reference Manual</i> .	
• Customer's Own Leather	+\$ 53	▶ See <i>Surface Materials Reference Manual</i> .	
<b>Cushion</b>	• Cushion	+\$170	Specify with cushion top.
<b>Cup Holder</b>	• On 480120	+\$ 50	Specify with cup holder.
<b>Tablet Stand</b>	• On 480120	+\$ 50	Specify with tablet stand.
<b>Casters</b>	• Soft, dark grey treaded, dual-wheel roll-control casters	+\$ 46	Specify with soft roll-control casters.
<b>Glides</b>	• Glides: sterling dark solid	+\$ 36	Specify with glides.

Tip: Fire Code Seating (FCS) option is available with certain plastic color choices only. Add suffix **F** to style number and order through the Steelcase Supplemental Catalog (SPS).

Tip: Cup holder is available on Node models with personal worksurface only.

▶ Detailed dimensions, page 272



**For Canadian Pricing**

Multiply U.S. Price by the Canadian price factor.

▶ See page 1 for details.

**Specification Information**

Style Number	U.S. Base Price
--------------	-----------------

**Without Personal Worksurface**

480110	\$652
--------	-------

**With Personal Worksurface**

480120	\$982
--------	-------

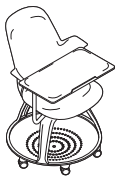

**For Canadian Pricing**

Multiply U.S. Price by the Canadian price factor.

▶ See page 1 for details.

# Node 480 Series Collaborative Chairs by Steelcase

With Five-Arm Base



Standard Includes		Required to Specify
▶ Need help? Product details, page 264	<ul style="list-style-type: none"> <li>• Seat shell: plastic</li> <li>• Five-arm base: plastic</li> <li>• Metal components: 0835 Black paint</li> <li>• Swivel seat</li> <li>• 5¼" pneumatic seat-height adjustment</li> <li>• Hard casters</li> </ul>	<ol style="list-style-type: none"> <li>1 Style number</li> <li>2 Plastic color number for seat shell</li> <li>3 Plastic color number for five-arm base</li> <li>4 Options, if selected (see below)</li> </ol> <p>▶ See <i>Surface Materials</i>, page 473.</p>

Options	U.S. Price	Required to Specify
<b>Surface Materials</b>	<b>Seat shell</b>	
	• Plastic price group 1	No cost
	• Plastic price group 2	+\$ 39
	<b>Cushion</b>	
	• Price group 1	No cost
	• Price group 2	+\$ 12
	• Price group 3	+\$ 36
	• Price group 4	+\$ 49
	• Price group 5	+\$ 60
	• Price group 6	+\$ 75
	• Price group 7	+\$ 88
	• Price group 8	+\$109
	• Price group 9	+\$135
	• Price group 10	+\$155
	• Steelcase Leather	+\$132
	• Select Surfaces leather price group 1	+\$132
	• Elmosoft Leather	+\$153
	• Select Surfaces leather price group 2	+\$153
	• Vinyl	+\$ 12
	• Customer's Own Material	+\$ 53
	• Customer's Own Leather	+\$ 53
<b>Base</b>	• Platinum on 480130	+\$ 48
	• Element on 480130	+\$ 48
	• Platinum on 480150	+\$ 53
	• Element on 480150	+\$ 53
<b>Cushion</b>	• Cushion	+\$170
<b>Cup Holder</b>	• On 480150	+\$ 50
<b>Tablet Stand</b>	• On 480150	+\$ 50
<b>Casters</b>	• Soft, dark grey treaded, dual-wheel roll-control casters for use on hard floors	+\$ 36
<b>Glides</b>	• Glides: black plastic	+\$ 36

Tip: Fire Code Seating (FCS) option is available with certain plastic color choices only. Add suffix **F** to style number and order through the Steelcase Supplemental Catalog (SPS).

Tip: Metal components will match plastic color for base.

Tip: Cup holder is available on Node models with personal worksurface only.

▶ Detailed dimensions, page 272



**For Canadian Pricing**  
Multiply U.S. Price by the Canadian price factor.  
▶ See page 1 for details.

**Specification Information**

Style Number	U.S. Base Price
--------------	-----------------

**Without Personal Worksurface**

480130	\$597
--------	-------

**With Personal Worksurface**

480150	\$982
--------	-------



**For Canadian Pricing**

Multiply U.S. Price by the Canadian price factor.

▶ See page 1 for details.

# Node 480 Series Mid-Back Collaborative Chairs by Steelcase

With Tripod Base



Standard Includes		Required to Specify
<ul style="list-style-type: none"> <li>▶ Need help? Product details, page 264</li> </ul>	<ul style="list-style-type: none"> <li>• Seat shell: plastic</li> <li>• Tripod base: plastic</li> <li>• Storage tray: sterling dark solid</li> <li>• Metal components: 0835 Black paint</li> <li>• Swivel seat</li> <li>• Worksurface, if selected: plastic</li> <li>• Hard casters</li> </ul>	<ol style="list-style-type: none"> <li>1 Style number</li> <li>2 Plastic color number for seat shell</li> <li>3 Plastic color number for tripod base</li> <li>4 Paint color number for metal components</li> <li>5 Plastic color number for personal work-surface, if selected</li> <li>6 Options, if selected (see below)</li> </ol> <p>▶ See <i>Surface Materials</i>, page 473.</p>

Options	U.S. Price	Required to Specify	
<b>Surface Materials</b>			
<b>Platinum or Champagne Metallic metal components</b>			
• On 480210	+\$ 12	Specify with 4799 Platinum or 4750 Champagne Metallic.	
• On 480220	+\$ 34	Specify with 4799 Platinum or 4750 Champagne Metallic.	
<b>Seat shell</b>			
• Plastic price group 1	No cost	Specify color number. ▶ See <i>Surface Materials</i> , page 473.	
• Plastic price group 2	+\$ 39	Specify color number. ▶ See <i>Surface Materials</i> , page 473.	
<b>Cushion</b>			
• Price group 1	No cost	Specify fabric color number.	
• Price group 2	+\$ 12	Specify fabric color number.	
• Price group 3	+\$ 36	Specify fabric color number.	
• Price group 4	+\$ 49	Specify fabric color number.	
• Price group 5	+\$ 60	Specify fabric color number.	
• Price group 6	+\$ 75	Specify fabric color number.	
• Price group 7	+\$ 88	Specify fabric color number.	
• Price group 8	+\$109	Specify fabric color number.	
• Price group 9	+\$135	Specify fabric color number.	
• Price group 10	+\$155	Specify fabric color number.	
• Steelcase Leather	+\$132	Specify leather color number.	
• Select Surfaces leather price group 1	+\$132	▶ See <i>Surface Materials Reference Manual</i> .	
• Elmosoft Leather	+\$153	Specify Elmosoft leather color number.	
• Select Surfaces leather price group 2	+\$153	▶ See <i>Surface Materials Reference Manual</i> .	
• Vinyl	+\$ 12	Specify vinyl color number.	
• Customer's Own Material	+\$ 53	▶ See <i>Surface Materials Reference Manual</i> .	
• Customer's Own Leather	+\$ 53	▶ See <i>Surface Materials Reference Manual</i> .	
<b>Cushion</b>	• Cushion	+\$170	Specify with cushion top.
<b>Cup Holder</b>	• On 480220	+\$ 50	Specify with cup holder.
<b>Tablet Stand</b>	• On 480220	+\$ 50	Specify with tablet stand.
<b>Casters</b>	• Soft, dark grey treaded, dual-wheel roll-control casters for use on hard floors	+\$ 46	Specify with soft roll-control casters.
<b>Glides</b>	• Glides: sterling dark solid	+\$ 36	Specify with glides.

Tip: Fire Code Seating (FCS) option is available with certain upholstery fabric choices only. Add suffix **F** to style number and order through the Steelcase Supplemental Catalog (SPS).

Tip: Cup holder is available on Node models with personal worksurfaces only.

▶ Detailed dimensions, page 272



**For Canadian Pricing**  
Multiply U.S. Price by the Canadian price factor.  
▶ See page 1 for details.



**Specification Information**

• <b>Style</b>	• <b>U.S.</b>
• <b>Number</b>	• <b>Base</b>
•	• <b>Price</b>

**Without Personal Worksurface**

<b>480210</b>	\$665
---------------	-------

**With Personal Worksurface**

<b>480220</b>	\$995
---------------	-------



**For Canadian Pricing**

Multiply U.S. Price by the Canadian price factor.

▶ See page 1 for details.

# Node 480 Series Mid-Back Collaborative Chairs by Steelcase

With Five-Arm Base



Standard Includes		Required to Specify
▶ Need help? Product details, page 264	<ul style="list-style-type: none"> <li>• Seat shell: plastic</li> <li>• Five-arm base: plastic</li> <li>• Metal components: 0835 Black paint</li> <li>• Swivel seat</li> <li>• 5¼" pneumatic seat-height adjustment</li> <li>• Hard casters</li> </ul>	<ol style="list-style-type: none"> <li>1 Style number</li> <li>2 Plastic color number for seat shell</li> <li>3 Plastic color number for five-arm base</li> <li>4 Options, if selected (see below)</li> </ol> <p>▶ See <i>Surface Materials</i>, page 473.</p>

Options	U.S. Price	Required to Specify
<b>Surface Materials</b>	<b>Seat shell</b>	
	• Plastic price group 1	No cost
	• Plastic price group 2	+\$ 39
	<b>Cushion</b>	
	• Price group 1	No cost
	• Price group 2	+\$ 12
	• Price group 3	+\$ 36
	• Price group 4	+\$ 49
	• Price group 5	+\$ 60
	• Price group 6	+\$ 75
	• Price group 7	+\$ 88
	• Price group 8	+\$109
	• Price group 9	+\$135
	• Price group 10	+\$155
	• Steelcase Leather	+\$132
	• Select Surfaces leather price group 1	+\$132
	• Elmosoft Leather	+\$153
	• Select Surfaces leather price group 2	+\$153
	• Vinyl	+\$ 12
	• Customer's Own Material	+\$ 53
	• Customer's Own Leather	+\$ 53
<b>Base</b>	• Platinum on 480230	+\$ 48
	• Element on 480230	+\$ 48
	• Platinum on 480250	+\$ 53
	• Element on 480250	+\$ 53
<b>Cushion</b>	• Cushion	+\$170
<b>Cup Holder</b>	• On 480250	+\$ 50
<b>Tablet Stand</b>	• On 480250	+\$ 50
<b>Casters</b>	• Soft, dark grey treaded, dual-wheel roll-control casters for use on hard floors	+\$ 36
<b>Glides</b>	• Glides: black plastic	+\$ 36

Tip: Fire Code Seating (FCS) option is available with certain plastic color choices only. Add suffix **F** to style number and order through the Steelcase Supplemental Catalog (SPS).

Tip: Metal components will match plastic color for base.

Tip: Cup holder is available on Node models with personal worksurface only.

▶ Detailed dimensions, page 272



**For Canadian Pricing**

Multiply U.S. Price by the Canadian price factor.

▶ See page 1 for details.

**Specification Information**

Style Number	U.S. Base Price
--------------	-----------------

**Without Personal Worksurface**

480230	\$597
--------	-------



**With Personal Worksurface**

480250	\$995
--------	-------



**For Canadian Pricing**

Multiply U.S. Price by the Canadian price factor.

▶ See page 1 for details.

# Node 480 Series Collaborative Stool by Steelcase

With Five-Arm Base

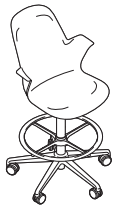

Tip: Metal components will match plastic color for base.

Tip: Fire Code Seating (FCS) option is available with certain plastic color choices only. Add suffix **F** to style number and order through the Steelcase Supplemental Catalog (SPS).

Standard Includes		Required to Specify
<ul style="list-style-type: none"> <li>▶ Need help? Product details, page 264</li> </ul>	<ul style="list-style-type: none"> <li>• Seat shell: plastic</li> <li>• Five-arm base: plastic</li> <li>• Metal components: 0835 Black paint</li> <li>• Swivel seat</li> <li>• 8½" pneumatic seat-height adjustment</li> <li>• Hard casters</li> </ul>	<ol style="list-style-type: none"> <li>1 Style number</li> <li>2 Plastic color number for seat shell</li> <li>3 Plastic color number for five-arm base</li> <li>4 Options, if selected (see below)</li> </ol> <ul style="list-style-type: none"> <li>▶ See <i>Surface Materials</i>, page 473.</li> </ul>

Options	U.S. Price	Required to Specify
<b>Surface Materials</b> <ul style="list-style-type: none"> <li>• Plastic price group 1</li> <li>• Plastic price group 2</li> </ul>	<ul style="list-style-type: none"> <li>No cost</li> <li>+\$ 39</li> </ul>	<ul style="list-style-type: none"> <li>Specify color number.</li> <li>▶ See <i>Surface Materials</i>, page 473</li> <li>Specify color number.</li> <li>▶ See <i>Surface Materials</i>, page 473</li> </ul>
<b>Cushion</b> <ul style="list-style-type: none"> <li>• Price group 1</li> <li>• Price group 2</li> <li>• Price group 3</li> <li>• Price group 4</li> <li>• Price group 5</li> <li>• Price group 6</li> <li>• Price group 7</li> <li>• Price group 8</li> <li>• Price group 9</li> <li>• Price group 10</li> <li>• Steelcase Leather</li> <li>• Select Surfaces leather price group 1</li> <li>• Elmosoft Leather</li> <li>• Select Surfaces leather price group 2</li> <li>• Vinyl</li> <li>• Customer's Own Material</li> <li>• Customer's Own Leather</li> </ul>	<ul style="list-style-type: none"> <li>No cost</li> <li>+\$ 12</li> <li>+\$ 36</li> <li>+\$ 49</li> <li>+\$ 60</li> <li>+\$ 75</li> <li>+\$ 88</li> <li>+\$109</li> <li>+\$135</li> <li>+\$155</li> <li>+\$132</li> <li>+\$132</li> <li>+\$153</li> <li>+\$153</li> <li>+\$ 12</li> <li>+\$ 53</li> <li>+\$ 53</li> </ul>	<ul style="list-style-type: none"> <li>Specify fabric color number.</li> <li>Specify fabric color number.</li> <li>Specify fabric color number.</li> <li>Specify fabric color number.</li> <li>Specify fabric color number.</li> <li>Specify fabric color number.</li> <li>Specify fabric color number.</li> <li>Specify fabric color number.</li> <li>Specify fabric color number.</li> <li>Specify fabric color number.</li> <li>Specify leather color number.</li> <li>▶ See <i>Surface Materials Reference Manual</i>.</li> <li>Specify Elmosoft leather color number.</li> <li>▶ See <i>Surface Materials Reference Manual</i>.</li> <li>Specify vinyl color number.</li> <li>▶ See <i>Surface Materials Reference Manual</i>.</li> <li>▶ See <i>Surface Materials Reference Manual</i>.</li> </ul>
<b>Seat-Height</b> <ul style="list-style-type: none"> <li>• 7½" pneumatic seat-height adjustment</li> </ul>	<ul style="list-style-type: none"> <li>No cost</li> </ul>	<ul style="list-style-type: none"> <li>Specify with 7" pneumatic seat-height adjustment.</li> </ul>
<b>Base</b> <ul style="list-style-type: none"> <li>• Platinum</li> <li>• Element</li> </ul>	<ul style="list-style-type: none"> <li>+\$140</li> <li>+\$140</li> </ul>	<ul style="list-style-type: none"> <li>Specify with 6249 Platinum.</li> <li>Specify with 6337 Element.</li> </ul>
<b>Cushion</b> <ul style="list-style-type: none"> <li>• Cushion</li> </ul>	<ul style="list-style-type: none"> <li>+\$170</li> </ul>	<ul style="list-style-type: none"> <li>Specify with cushion top.</li> </ul>
<b>Casters</b> <ul style="list-style-type: none"> <li>• Soft, dark grey treaded, dual-wheel roll-control casters for use on hard floors</li> </ul>	<ul style="list-style-type: none"> <li>+\$ 36</li> </ul>	<ul style="list-style-type: none"> <li>Specify with soft roll-control casters.</li> </ul>

Specification Information	
Style Number	U.S. Base Price
480140	\$883
:	:

▶ Detailed dimensions, page 272



**For Canadian Pricing**  
 Multiply U.S. Price by the Canadian price factor.  
 ▶ See page 1 for details.

# Node 480 Series Mid-Back Collaborative Stool

by Steelcase

With Five-Arm Base

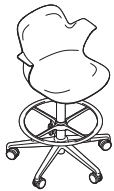

Standard Includes		Required to Specify
<ul style="list-style-type: none"> <li>▶ Need help? Product details, page 264</li> </ul>	<ul style="list-style-type: none"> <li>• Seat shell: plastic</li> <li>• Five-arm base: plastic</li> <li>• Metal components: 0835 Black paint</li> <li>• Swivel seat</li> <li>• 8½" pneumatic seat-height adjustment</li> <li>• Hard casters</li> </ul>	<ol style="list-style-type: none"> <li>1 Style number</li> <li>2 Plastic color number for seat shell</li> <li>3 Plastic color number for five-arm base</li> <li>4 Options, if selected (see below)</li> </ol> <ul style="list-style-type: none"> <li>▶ See <i>Surface Materials</i>, page 473.</li> </ul>

Options	U.S. Price	Required to Specify
<b>Surface Materials</b>	<b>Seat shell</b>	
	<ul style="list-style-type: none"> <li>• Plastic price group 1</li> <li>• Plastic price group 2</li> </ul>	No cost +\$ 39
	<b>Cushion</b>	
	<ul style="list-style-type: none"> <li>• Price group 1</li> <li>• Price group 2</li> <li>• Price group 3</li> <li>• Price group 4</li> <li>• Price group 5</li> <li>• Price group 6</li> <li>• Price group 7</li> <li>• Price group 8</li> <li>• Price group 9</li> <li>• Price group 10</li> <li>• Steelcase Leather</li> <li>• Select Surfaces leather price group 1</li> <li>• Elmosoft Leather</li> <li>• Select Surfaces leather price group 2</li> <li>• Vinyl</li> <li>• Customer's Own Material</li> <li>• Customer's Own Leather</li> </ul>	No cost +\$ 12 +\$ 36 +\$ 49 +\$ 60 +\$ 75 +\$ 88 +\$109 +\$135 +\$155 +\$132 +\$132 +\$153 +\$153 +\$ 12 +\$ 53 +\$ 53
	<b>Seat-Height</b>	
	<ul style="list-style-type: none"> <li>• 7½" pneumatic seat-height adjustment</li> </ul>	No cost Specify with 7" pneumatic seat-height adjustment.
	<b>Base</b>	
	<ul style="list-style-type: none"> <li>• Platinum</li> <li>• Element</li> </ul>	+\$140 +\$140 Specify with 6249 Platinum. Specify with 6337 Element.
	<b>Cushion</b>	
	<ul style="list-style-type: none"> <li>• Cushion</li> </ul>	+\$170 Specify with cushion top.
	<b>Casters</b>	
	<ul style="list-style-type: none"> <li>• Soft, dark grey treaded, dual-wheel roll-control casters for use on hard floors</li> </ul>	+\$ 36 Specify with soft roll-control casters.

Tip: Fire Code Seating (FCS) option is available with certain upholstery fabric choices only. Add suffix **F** to style number and order through the Steelcase Supplemental Catalog (SPS).

Tip: Metal components will match plastic color for base.

Specification Information	
Style Number	U.S. Base Price
480240	\$883

▶ Detailed dimensions, page 272



**For Canadian Pricing**  
 Multiply U.S. Price by the Canadian price factor.  
 ▶ See page 1 for details.

Multi-Purpose Seating

# Node 480 Series X Base Collaborative Chairs

Standard Includes		Required to Specify
<ul style="list-style-type: none"> <li>▶ Need help? Product details, page 264</li> </ul>	<ul style="list-style-type: none"> <li>• Seat shell: plastic</li> <li>• Steel wire frame base: paint price group 1</li> <li>• Standard glides</li> <li>• Ships fully assembled</li> <li>• Meets Cal. 117 requirements</li> </ul>	<ol style="list-style-type: none"> <li>1 Style number</li> <li>2 Paint color number for base</li> <li>3 Plastic color number for shell</li> <li>4 Options, if selected (see below)</li> </ol> <ul style="list-style-type: none"> <li>▶ See <i>Surface Materials</i>, page 473.</li> </ul>

	Options	U.S. Price	Required to Specify
<b>Surface Materials</b>	<b>Base</b>		
	• Paint price group 1	No cost	Specify paint color number.
	• Paint price group 2	+\$ 49	Specify paint color number.
	• Paint price group 3	+\$ 83	Specify paint color number.
	<b>Shell</b>		
	• Plastic price group 1	No cost	Specify plastic color number.
	• Plastic price group 2	+\$ 39	Specify plastic color number.
	<b>Cushion</b>		
	• Price group 1	No cost	Specify fabric color number.
	• Price group 2	+\$ 12	Specify fabric color number.
• Price group 3	+\$ 36	Specify fabric color number.	
• Price group 4	+\$ 49	Specify fabric color number.	
• Price group 5	+\$ 60	Specify fabric color number.	
• Price group 6	+\$ 75	Specify fabric color number.	
• Price group 7	+\$ 88	Specify fabric color number.	
• Price group 8	+\$109	Specify fabric color number.	
• Price group 9	+\$135	Specify fabric color number.	
• Price group 10	+\$155	Specify fabric color number.	
• Steelcase Leather	+\$132	Specify leather color number.	
• Select Surfaces leather price group 1	+\$132	▶ See <i>Surface Materials Reference Manual</i> .	
• Elmosoft Leather	+\$153	Specify Elmosoft leather color number.	
• Select Surfaces leather price group 2	+\$153	▶ See <i>Surface Materials Reference Manual</i> .	
• Vinyl	+\$ 12	Specify vinyl color number.	
• Customer's Own Material	+\$ 53	▶ See <i>Surface Materials Reference Manual</i> .	
• Customer's Own Leather	+\$ 53	▶ See <i>Surface Materials Reference Manual</i> .	
<b>Cushion</b>	• Cushion	+\$170	Specify with <i>cushion top</i> .
<b>Glides</b>	• Soft, felt glides	No cost	Specify with <i>soft, felt glides</i> .

▶ Detailed dimensions, page 273



Specification Information	
• <b>Style Number</b>	• <b>U.S. Base Price</b>
•	•
•	•
•	•

## X Base Chair

480310 \$570

## X Base Mid-Back Chair

480330 \$570

# Node 480 Series X Base Collaborative Stools

Node 480 Series X Base Collaborative Stools

Standard Includes		Required to Specify
<ul style="list-style-type: none"> <li>▶ Need help? Product details, page 264</li> </ul>	<ul style="list-style-type: none"> <li>• Seat shell: plastic</li> <li>• Steel wire frame base: paint price group 1</li> <li>• Standard glides</li> <li>• Ships fully assembled</li> <li>• Meets Cal. 117 requirements</li> </ul>	<ol style="list-style-type: none"> <li>1 Style number</li> <li>2 Paint color number for base</li> <li>3 Plastic color number for shell</li> <li>4 Options, if selected (see below)</li> </ol> <ul style="list-style-type: none"> <li>▶ See <i>Surface Materials</i>, page 473.</li> </ul>

Options	U.S. Price	Required to Specify	
<b>Surface Materials</b>			
<b>Base</b>			
<ul style="list-style-type: none"> <li>• Paint price group 1</li> <li>• Paint price group 2</li> <li>• Paint price group 3</li> </ul>	<ul style="list-style-type: none"> <li>No cost</li> <li>+\$ 49</li> <li>+\$ 83</li> </ul>	<ul style="list-style-type: none"> <li>Specify paint color number.</li> <li>Specify paint color number.</li> <li>Specify paint color number.</li> </ul>	
<b>Shell</b>			
<ul style="list-style-type: none"> <li>• Plastic price group 1</li> <li>• Plastic price group 2</li> </ul>	<ul style="list-style-type: none"> <li>No cost</li> <li>+\$ 39</li> </ul>	<ul style="list-style-type: none"> <li>Specify plastic color number.</li> <li>Specify plastic color number.</li> </ul>	
<b>Cushion</b>			
<ul style="list-style-type: none"> <li>• Price group 1</li> <li>• Price group 2</li> <li>• Price group 3</li> <li>• Price group 4</li> <li>• Price group 5</li> <li>• Price group 6</li> <li>• Price group 7</li> <li>• Price group 8</li> <li>• Price group 9</li> <li>• Price group 10</li> <li>• Steelcase Leather</li> <li>• Select Surfaces leather price group 1</li> <li>• Elmosoft Leather</li> <li>• Select Surfaces leather price group 2</li> <li>• Vinyl</li> <li>• Customer's Own Material</li> <li>• Customer's Own Leather</li> </ul>	<ul style="list-style-type: none"> <li>No cost</li> <li>+\$ 12</li> <li>+\$ 36</li> <li>+\$ 49</li> <li>+\$ 60</li> <li>+\$ 75</li> <li>+\$ 88</li> <li>+\$109</li> <li>+\$135</li> <li>+\$155</li> <li>+\$132</li> <li>+\$132</li> <li>+\$153</li> <li>+\$153</li> <li>+\$ 12</li> <li>+\$ 53</li> <li>+\$ 53</li> </ul>	<ul style="list-style-type: none"> <li>Specify fabric color number.</li> <li>Specify fabric color number.</li> <li>Specify fabric color number.</li> <li>Specify fabric color number.</li> <li>Specify fabric color number.</li> <li>Specify fabric color number.</li> <li>Specify fabric color number.</li> <li>Specify fabric color number.</li> <li>Specify fabric color number.</li> <li>Specify fabric color number.</li> <li>Specify fabric color number.</li> <li>Specify leather color number.</li> <li>▶ See <i>Surface Materials Reference Manual</i>.</li> <li>Specify Elmosoft leather color number.</li> <li>▶ See <i>Surface Materials Reference Manual</i>.</li> <li>Specify vinyl color number.</li> <li>▶ See <i>Surface Materials Reference Manual</i>.</li> <li>▶ See <i>Surface Materials Reference Manual</i>.</li> </ul>	
<b>Cushion</b>	<ul style="list-style-type: none"> <li>• Cushion</li> </ul>	<ul style="list-style-type: none"> <li>+\$170</li> </ul>	<ul style="list-style-type: none"> <li>Specify with <i>cushion top</i>.</li> </ul>
<b>Glides</b>	<ul style="list-style-type: none"> <li>• Soft, felt glides</li> </ul>	<ul style="list-style-type: none"> <li>No cost</li> </ul>	<ul style="list-style-type: none"> <li>Specify with <i>soft, felt glides</i>.</li> </ul>

▶ Detailed dimensions, page 273

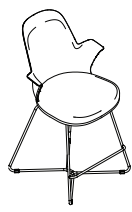

Specification Information	
Style Number	U.S. Base Price

X Base Stool	
480320	\$846

X Base Mid-Back Stool	
480340	\$846

Multi-Purpose Seating

# Node 480 Series Wood Base Collaborative Chairs

Standard Includes		Required to Specify
<ul style="list-style-type: none"> <li>▶ Need help? Product details, page 264</li> </ul>	<ul style="list-style-type: none"> <li>• Seat shell: plastic</li> <li>• Solid maple legs: wood stain</li> <li>• Steel brackets: paint group 1</li> <li>• Standard glides</li> <li>• Ships fully assembled</li> <li>• Meets Cal. 117 requirements</li> </ul>	<ol style="list-style-type: none"> <li>1 Style number</li> <li>2 Plastic color number for shell</li> <li>3 Wood stain color number for legs:                             <ul style="list-style-type: none"> <li>V1AC Natural Cherry</li> <li>V1AM Clear Maple</li> <li>V1CC Medium Amber Cherry</li> <li>V1EW Dark Walnut</li> </ul> </li> <li>4 Paint color number for brackets</li> <li>5 Options, if selected (see below)</li> </ol> <ul style="list-style-type: none"> <li>▶ See <i>Surface Materials</i>, page 473.</li> </ul>

Options	U.S. Price	Required to Specify
<b>Surface Materials</b>		
<b>Shell</b>		
<ul style="list-style-type: none"> <li>• Plastic price group 1</li> <li>• Plastic price group 2</li> </ul>	No cost +\$ 39	Specify plastic color number. Specify plastic color number.
<b>Brackets</b>		
<ul style="list-style-type: none"> <li>• Paint price group 1</li> <li>• Paint price group 2</li> <li>• Paint price group 3</li> </ul>	No cost +\$ 53 +\$ 83	Specify paint color number. Specify paint color number. Specify paint color number.
<b>Cushion</b>		
<ul style="list-style-type: none"> <li>• Price group 1</li> <li>• Price group 2</li> <li>• Price group 3</li> <li>• Price group 4</li> <li>• Price group 5</li> <li>• Price group 6</li> <li>• Price group 7</li> <li>• Price group 8</li> <li>• Price group 9</li> <li>• Price group 10</li> <li>• Steelcase Leather</li> <li>• Select Surfaces leather price group 1</li> <li>• Elmosoft Leather</li> <li>• Select Surfaces leather price group 2</li> <li>• Vinyl</li> <li>• Customer's Own Material</li> <li>• Customer's Own Leather</li> </ul>	No cost +\$ 12 +\$ 36 +\$ 49 +\$ 60 +\$ 75 +\$ 88 +\$109 +\$135 +\$155 +\$132 +\$132 +\$153 +\$153 +\$ 12 +\$ 53 +\$ 53	Specify fabric color number. Specify fabric color number. Specify fabric color number. Specify fabric color number. Specify fabric color number. Specify fabric color number. Specify fabric color number. Specify fabric color number. Specify fabric color number. Specify fabric color number. Specify fabric color number. Specify leather color number. ▶ See <i>Surface Materials Reference Manual</i> .  Specify Elmosoft leather color number. ▶ See <i>Surface Materials Reference Manual</i> .  Specify vinyl color number. ▶ See <i>Surface Materials Reference Manual</i> . ▶ See <i>Surface Materials Reference Manual</i> .
<b>Cushion</b>	<ul style="list-style-type: none"> <li>• Cushion</li> </ul>	+\$170  Specify with cushion top.

▶ Detailed dimensions, page 273



Specification Information	
• <b>Style Number</b>	• <b>U.S. Base Price</b>
.....	.....

## Wood Base Chair

480410 \$1223

## Wood Base Mid-Back Chair

480420 \$1223



# Verge Stool

**Verge stool** is designed to accommodate users in either sitting or perching positions in healthcare, education, and corporate settings. The comfort mechanism absorbs the initial shock and provides an easy transition between sitting and standing.

**Urethane seat** provides a comfortable seat or perch. The comfort mechanism provides approximately 1" travel.

**Foot ring** takes pressure off the user's back and legs.

**Four-leg base** provides a balanced stool.

**Plastic glides** are 1<sup>3</sup>/<sub>4</sub>" diameter to provide a larger footprint with greater stability and to make it slide easier.

**Casters** have soft dual wheels for easy maneuverability on hard surface floors. Casters are available on 21"H stools only.

**31"H stool** is ideal to work with traditional 42" counter height.

**27"H stool** is ideal to use with service counter height in the 36"H range.

**21"H stool** allows for use with standard seated height worksurfaces.  
*Tip: Stool is 19"H when glides are specified.*

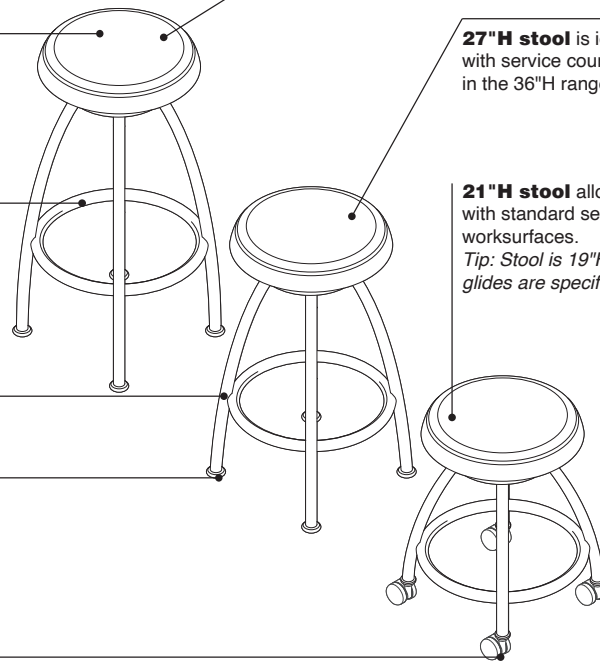

## Surface Materials

### Seat

- Self-skinning urethane in non-metallic steel finish

### Base and foot ring

- Paint
- Accent paint
- Coatings
- Lux Coatings

### Glides

- Plastic in metallic steel finish

### Casters on 21"H stool only

- Soft dual wheels in black

## Programs & Services

For more information on accent paints and Lux Coatings, please refer to the *Surface Materials Reference Manual*.

## Actual Dimensions

<b>Overall width</b>	18 <sup>1</sup> / <sub>5</sub> "
<b>Overall height</b>	19", 21", 27", and 31"
<b>Overall height (seated)</b>	18", 20", 26", and 30"
<b>Foot ring height</b>	5", 7", 8 <sup>1</sup> / <sub>5</sub> ", and 10"

# Verge Stool

Standard Includes		Required to Specify
<ul style="list-style-type: none"> <li>▶ Need help? Product details, page 289</li> </ul>	<ul style="list-style-type: none"> <li>• Seat: self-skimming urethane in 6688 non-metallic steel finish</li> <li>• Four-leg base and foot ring: paint price group 1 and 2</li> <li>• Glides, if selected: plastic in metallic steel finish</li> <li>• Casters, if selected: black</li> </ul>	<ul style="list-style-type: none"> <li>1 Style number</li> <li>2 Paint color number for base and foot ring</li> <li>3 Options, if selected (see below)</li> <li>▶ See <i>Surface Materials</i>, page 473.</li> </ul>

Options	U.S. Price	Required to Specify
<b>Surface Materials</b> <ul style="list-style-type: none"> <li>• Paint price group 1</li> <li>• Paint price group 2</li> <li>• Paint price group 3</li> </ul>	<ul style="list-style-type: none"> <li>No cost</li> <li>No cost</li> <li>+\$51</li> </ul>	<ul style="list-style-type: none"> <li>Specify paint color number.</li> <li>Specify paint color number.</li> <li>Specify paint color number.</li> </ul>

### Specification Information

Dimensions	Style Number	U.S. Base Price
W H		

#### With Glides

18¼"	19"	<b>HS21G</b>	\$600
18¼"	27"	<b>HS27G</b>	\$618
18¼"	31"	<b>HS31G</b>	\$659

#### With Casters

18¼"	21"	<b>HS21C</b>	\$600
------	-----	--------------	-------

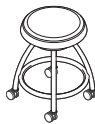
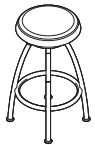

**For Canadian Pricing**  
 Multiply U.S. Price by the Canadian price factor.  
 ▶ See page 1 for details.

# Enea Stacker Chairs by Coalesse

DESIGN JOSEP LLUSCA DESIGN ORIGIN: SPAIN

The Enea stacker has a higher back than most side chairs, providing a greater level of comfort and support. Chairs are available with or without arms.

Back is 33¼"H.

Seat and back are available in polypropylene, wood, or upholstery.

Glides are black polypropylene. Felt glides are optional for use on non-carpeted surfaces are available.

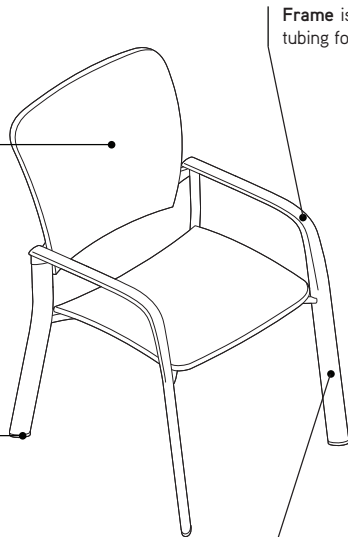

Frame is constructed of steel tubing for increased stability.

4-leg base allows for stacking. Stacking dolly available.

## Product Details

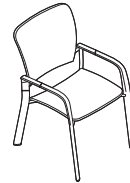
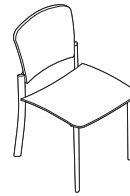

Chairs are available in armless and loop arm versions.

Tip: Ganging and tablet options are not available on armless chairs.



Tablet is available in black powder coat, on left or right side, and measures 11"D x 9"W.

Ganging device option is available to link chairs with arms for evenly spaced rows.

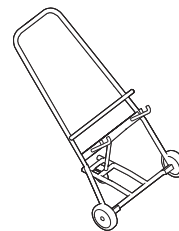

Stacking dolly is available to stack, move, and store chairs. Chairs stack nine high on the dolly. Chairs with tablet stack six high. Unloaded dolly measures 34"D x 26"W x 34"H.

## Surface Materials

► See *Coalesse Surface Materials Reference Guide* for further information.

### Seat and back

- Fabric
- Leather
- Wood
- Polypropylene

### Frame

- Paint

# Enea Stacker Chairs by Coalesse With Arms

DESIGN JACOB LLUSCA DESIGN ORIGIN: SPAIN

*Tip: Due to the design and construction techniques of the Enea Chair only certain textiles can be successfully applied, therefore all COM fabrics must be submitted to Coalesse for approval prior to order acceptance.*

*Tip: Fabrics and leathers will appear loose with comfort wrinkles when upholstered.*

*Tip: For Customer's Own Material or Leather, see necessary requirements, important processing instructions, and ordering information. ▶ See Coalesse Surface Materials Reference Guide.*

*Tip: Contrasting fabric option available on model 3501 only.*

*Tip: Need sketch for ganging.*

*Tip: Models 3501 and 3500 in wood are approved for CAL 133 at no charge.*

*Tip: Tablet is 11"D x 9"W.*

*Tip: Arm chairs stack nine high. Arm chair with tablet stacks six high.*

## Standard Includes

- ▶ Need help? Product details, page 291
- Frame: constructed of steel tubing
- Seat and back: molded nylon, wood, or upholstery (wood is laminated layers of hard maple veneer)

## Required to Specify

- 1 Style number
- 2 Fabric or leather color number for upholstery, if selected
- 3 Plastic or wood finish color number for seat and back, if selected
- 4 Base/frame finish:
  - 4016 White Gloss
  - 4017 Black Gloss
  - 4018 Silver Metallic
- 5 Options, if selected (see below)
  - ▶ See *Coalesse Surface Materials Reference Guide*.

## Options

Options	U.S. Price	Required to Specify
<b>Surface Materials</b>	• Contrasting fabric  • Acrylic backer	+ \$182 per fabric  Add suffix K to the style number and select fabric color number.
	• Chair with upholstered seat and back	+ \$26 Specify with acrylic backer.
	• Chair with upholstered seat and wood back	+ \$10 Specify with acrylic backer. ▶ See <i>Coalesse Surface Materials Reference Guide</i> .
<b>Ganging</b>	• Ganging	+ \$98 Specify with ganging.
<b>Tablet</b>	• Black powder coat	+ \$512 Specify with tablet and specify side as facing.
<b>Felt Glides</b>	• Glides	No cost Specify with felt glides.
<b>Related Products</b>	• Café and conference tables	▶ See <i>Coalesse Tables, Storage, and Accessories Specification Guide</i> .

## Specification Information

Style Number	U.S. Base Prices												Leather Grades:			
	Fabric Grades:												COL	C	E	
	COM	6	7	8	9	10	11	12	13	14						

## Wood Seat and Back Stacker

3500	✕10/24	\$1421	N.A.	N.A.	N.A.	N.A.	N.A.	N.A.	N.A.	N.A.	N.A.	N.A.	N.A.	N.A.	N.A.
------	--------	--------	------	------	------	------	------	------	------	------	------	------	------	------	------



Overall: 22½"D 22½"W 33¾"H  
Inside: 18"D 18"W 15¼"H  
Seat: 18"H  
Arm: 26¾"H

## Upholstered Seat and Back

3501	\$1329	\$1329	\$1345	\$1369	\$1447	\$1494	\$1553	\$1593	\$1661	\$1759	\$1716	\$2026	\$2220
------	--------	--------	--------	--------	--------	--------	--------	--------	--------	--------	--------	--------	--------

COM/yds = 1½, COL/sq ft = 28

▶ Specification Information, continued on next page



Overall: 22½"D 22½"W 33¾"H  
Inside: 18"D 18"W 15¼"H  
Seat: 18"H  
Arm: 26¾"H

✕10/24 = Last order entry  
October 20, 2024

# Enea Stacker Chairs by Coalesse With Arms

DESIGN JACOB LLUSCA DESIGN ORIGIN: SPAIN

► Specification Information, continued from previous page

## Specification Information

Style Number	U.S. Base Prices											Leather Grades:		
	Fabric Grades:											COL	C	E
	COM	6	7	8	9	10	11	12	13	14				



Overall: 22½"D 22½"W 33¼"H  
 Inside: 18"D 18"W 15¼"H  
 Seat: 18"H  
 Arm: 26¾"H

### Upholstered Seat and Wood Back

3502	\$1425	\$1404	\$1412	\$1424	\$1462	\$1485	\$1515	\$1533	\$1570	\$1619	\$1829	\$1968	\$2077
------	--------	--------	--------	--------	--------	--------	--------	--------	--------	--------	--------	--------	--------

COM/yds = ¾, COL/sq ft = 17



Overall: 22½"D 22½"W 33¼"H  
 Inside: 18"D 18"W 15¼"H  
 Seat: 18"H  
 Arm: 26¾"H

### Polypropylene Seat and Back

3503	\$820	N.A.	N.A.	N.A.	N.A.	N.A.	N.A.	N.A.	N.A.	N.A.	N.A.	N.A.	N.A.
------	-------	------	------	------	------	------	------	------	------	------	------	------	------

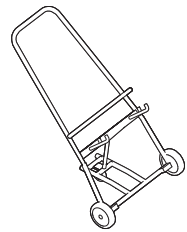

Overall: 34"D 26"W 34"H

### Stacking Dolly

9014S	\$1150	N.A.	N.A.	N.A.	N.A.	N.A.	N.A.	N.A.	N.A.	N.A.	N.A.	N.A.	N.A.
-------	--------	------	------	------	------	------	------	------	------	------	------	------	------



**For Canadian Pricing**  
 Multiply U.S. Price by the  
 Canadian price factor.  
 ► See page 1 for details.

# Enea Stacker Chairs by Coalesse Without Arms

DESIGN JACOB LLUSCA DESIGN ORIGIN: SPAIN

*Tip: CAL 133 for polypropylene is available as a special quote. Polypropylene color will change slightly when FR treatment is applied. Contact Customer Service for availability and pricing. Minimum quantity will apply.*

*Tip: Due to the design and construction techniques of the Enea Chair only certain textiles can be successfully applied, therefore all COM fabrics must be submitted to Coalesse for approval prior to order acceptance.*

*Tip: Armless chairs stack nine high.*

*Tip: Fabrics and leathers will appear loose with comfort wrinkles when upholstered.*

*Tip: For Customer's Own Material or Leather, see necessary requirements, important processing instructions, and ordering information. ▶ See Coalesse Surface Materials Reference Guide.*

*Tip: Contrasting fabric option available on model 3501S only.*

*Tip: No tablet or ganging available on armless models.*



Overall: 22½"D 18"W 33¼"H  
Inside: 18"D 18"W 15¼"H  
Seat: 18"H



Overall: 22½"D 18"W 33¼"H  
Inside: 18"D 18"W 15¼"H  
Seat: 18"H

## Standard Includes

- ▶ Need help? Product details, page 291
- Frame: steel tubing
- Seat and back: molded nylon, wood, or upholstery (wood is laminated layers of hard maple veneer)

## Required to Specify

- 1 Style number
- 2 Fabric or leather color number for upholstery, if selected
- 3 Plastic or wood finish color number for seat and back, if selected
- 4 Base/frame finish:
  - 4016 White Gloss
  - 4017 Black Gloss
  - 4018 Silver Metallic
- 5 Options, if selected (see below)
  - ▶ See *Coalesse Surface Materials Reference Guide*.

## Options

Options	U.S. Price	Required to Specify
<b>Surface Materials</b>		
• Contrasting fabric	+\$182 per fabric	Add suffix K to the style number and select fabric color number.
<b>Acrylic backer</b>		
• Chair with upholstered seat and back	+\$ 26	Specify with acrylic backer.
• Chair with upholstered seat and wood back	+\$ 10	Specify with acrylic backer. ▶ See <i>Coalesse Surface Materials Reference Guide</i> .
<b>Felt Glides</b>		
• Glides	No cost	Specify with felt glides.
<b>Related Products</b>		
• Café and conference tables		▶ See <i>Coalesse Tables, Storage, and Accessories Specification Guide</i> .

## Specification Information

Style Number	U.S. Base Prices														Leather Grades:		
	Fabric Grades:														COL	C	E
COM	6	7	8	9	10	11	12	13	14								

## Wood Seat and Back

3500S	✕10/24	\$1252	N.A.	N.A.	N.A.	N.A.	N.A.	N.A.	N.A.	N.A.	N.A.	N.A.	N.A.	N.A.	N.A.
-------	--------	--------	------	------	------	------	------	------	------	------	------	------	------	------	------

## Upholstered Seat and Back

3501S	\$1157	\$1157	\$1171	\$1192	\$1254	\$1296	\$1344	\$1376	\$1436	\$1519	\$1547	\$1872	\$2055
-------	--------	--------	--------	--------	--------	--------	--------	--------	--------	--------	--------	--------	--------

COM/yds = 1¼, COL/sq ft = 28

▶ Specification Information, continued on next page

✕10/24 = Last order entry  
October 20, 2024

# Enea Stacker Chairs by Coalesse Without Arms

DESIGN JACOB LLUSCA DESIGN ORIGIN: SPAIN

► Specification Information, continued from previous page

## Specification Information

Style Number	U.S. Base Prices											Leather Grades:		
	Fabric Grades:											COL	C	E
	COM	6	7	8	9	10	11	12	13	14				

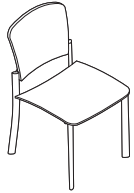

Overall: 22½"D 18"W 33¼"H  
 Inside: 18"D 18"W 15¼"H  
 Seat: 18"H

### Upholstered Seat and Wood Back

3502S	\$1256	\$1235	\$1243	\$1255	\$1293	\$1316	\$1346	\$1364	\$1401	\$1450	\$1671	\$1791	\$1908
COM/yds = ¾, COL/sq ft = 17													



Overall: 22½"D 18"W 33¼"H  
 Inside: 18"D 18"W 15¼"H  
 Seat: 18"H

### Polypropylene Seat and Back

3503S	\$ 765	N.A.	N.A.	N.A.	N.A.	N.A.	N.A.	N.A.	N.A.	N.A.	N.A.	N.A.	N.A.
-------	--------	------	------	------	------	------	------	------	------	------	------	------	------

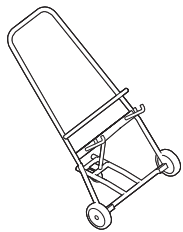

Overall: 34"D 26"W 34"H

### Stacking Dolly

9014S	\$1150	N.A.	N.A.	N.A.	N.A.	N.A.	N.A.	N.A.	N.A.	N.A.	N.A.	N.A.	N.A.
-------	--------	------	------	------	------	------	------	------	------	------	------	------	------

Stackable Seating

 **For Canadian Pricing**  
 Multiply U.S. Price by the  
 Canadian price factor.  
 ► See page 1 for details.

# Move 490 Series by Steelcase

**Move chairs** are guest chairs that also stack. Live dynamic seat, open cantilever arm design, light weight, and strength make Move a logical choice for multipurpose areas. Move's simple design complements a broad range of work settings.

**Arms** are cantilevered and will easily clear the front edge of a worksurface or table. The open cantilever design of the arms allows alternative postures and sitting positions.

**Steel frame** is monochromatic.

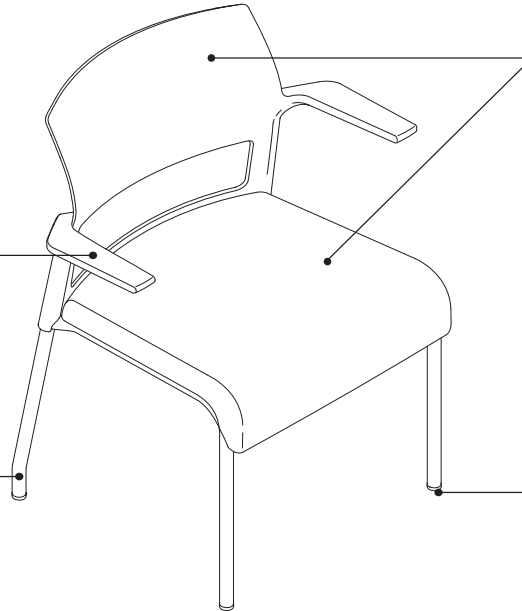

**Seat and back** are available in plastic or with an upholstered cushion.

**Plastic glides** have a hard plastic insert.

**Upholstered back** is available on selected styles.

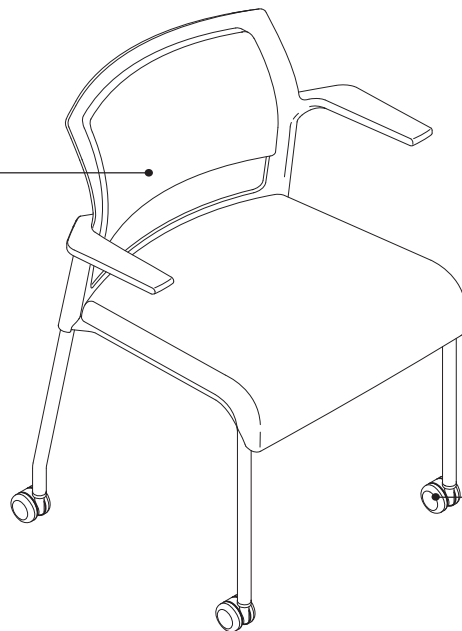

**Casters** have hard, dual wheels that roll smoothly on carpets. Soft, dual-wheel casters are available for use on hard floor or chair mats. Casters are available in black only.

*Tip: Do not roll the chair across asphalt during installation as this may damage the casters.*

## Product Details

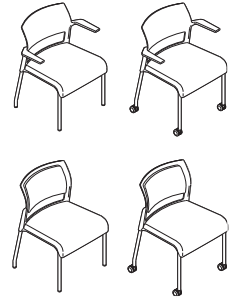

**Chairs and stools** have a leg-base and are available with glides or casters, and with or without arms.

**Stackability for leg base chair models** is five high on the floor. Stools do not stack.

**Plastic glides with stainless steel inserts** are recommended for carpeted surfaces.

**Soft felt glides for use on non-carpeted surfaces** are available as an option.

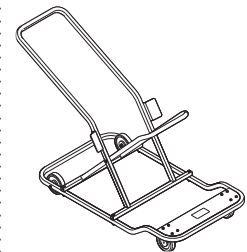

**Transport and storage dolly** is available to stack, move, and store up to 10 chairs.

**Unloaded transport dolly** measures 58 1/2"D x 25 1/2"W x 37 1/2"H.

**Fully loaded transport dolly** measures 58 1/2"D x 25 1/2"W x 58 1/2"H.



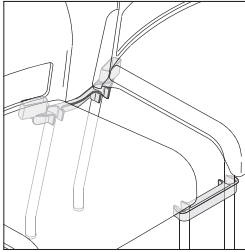

**Ganging and alignment device** is available to link leg-base chairs together in the field for evenly spaced rows. Chairs can be separated easily. Spacing between chairs linked with alignment device is 4" for chairs with no arms and 7" for chairs with arms.



**Move wall saver** is available to prevent the back of the chair from making contact with the wall.

### Surface Materials

► See the *Surface Materials Reference Manual* for further detail about programs and services offered for seating.

### Frame

- 0835 Black Metallic
- 1ATT Cast Shadow
- 4799 Platinum Metallic
- 7239 Midnight
- 4B20 Obsidian
- 4B22 Matte Brass
- 4B23 Burnished Bronze
- 4B24 Night Bronze
- 4B25 Matte Copper
- 4B26 Smoked Mica
- 4B29 Cast Iron

### Arms

- Plastic

### Back shell and seat

- 6009 Arctic White
- 6059 Sterling Dark Solid
- 6205 Black
- 6249 Platinum Solid
- 6259 Midnight
- 6332 Citron
- 6335 Wasabi
- 6336 Jazz
- 6337 Element
- 6338 Chili
- 6BD1 Aubergine
- 6BD3 Jungle
- 6BD5 Honey
- 6BD6 Lagoon
- 6BD7 Saffron
- 6BE1 Ore

### Upholstery

- Fabric
- Fabric with soil retardant treatment (option)
- Leather
- Elmosoft leather
- Select Surfaces leather
- Vinyl

### Casters

- Black only

### Glides

- Plastic with hard plastic inserts come standard on multi-use chairs when specified with glides. Soft glides are available as an option.

### Wall saver

- 6644 Fusion Dark only

### All Steelcase seating with standard upholstery fabrics

complies with requirements of the State of California Technical Bulletin 117-2013. All standard seating is labeled to be in compliance with California 117-2013.

### Programs & Services

► See the *Surface Materials Reference Manual* for further detail about programs and services offered for seating.

### Select Surfaces For information on products within Select Surfaces

, including accent paints, signature plastics, and fabrics from Designtex, Gabriel, Kvadrat, and Pollack, please refer to the *Surface Materials Reference Manual* or visit [www.steelcase.com/selectsurfaces](http://www.steelcase.com/selectsurfaces).

### The Customer's Own Material (COM) Program

offers the opportunity for customers to select fabrics that are not offered through the standard Steelcase surface materials program for use on Steelcase products. Through the COM program, Steelcase will test your materials for application on Steelcase products. Once approved, you can place your order. Steelcase will facilitate the entire ordering process and give you a production schedule. Steelcase will order the COM fabric directly from the textile manufacturer. For up-to-date information regarding fabric test results for all COM fabrics and details regarding yardage requirements for most Seating lines, visit the COM Web site. To locate the COM Web site:

- Visit [www.steelcase.com](http://www.steelcase.com)

**Soil retardants** are treatments that provide long-term soil and stain resistance to a fabric without affecting the shade or the integrity of the fabric. The following Steelcase Textiles are available pre-treated with soil retardant. (You do not need to select the soil-retardant option for these fabrics and incur the upcharge.)

- Jacks
- Link

For information on soil retardant fabrics on Select Surfaces, please refer to the *Surface Materials Reference Manual*. Soil-retardant treatment is available on all other seating fabrics at an additional upcharge per seating unit. To order this option, please select "Soil-Retardant Treatment" under "Optional Accessories."

For soil-retardant treatment on COMs, please select "Soil-Retardant Treatment" under "Optional Accessories." Minimums or additional yardage may be required. Please contact the vendor directly for specific information.

Extended lead times may be necessary for this service.

Contact your Steelcase Solutions Fulfillment Team Representative at 1.888.STEELCASE (1.888.783.3522) or send an email to [lineone@steelcase.com](mailto:lineone@steelcase.com).

### Fire Codes

► See *Surface Materials Reference Manual*.

**Steelcase** offers Fire Code Seating modification (FCS) on some seating models. The most rigorous fire codes in the nation have been developed in California, and the Steelcase FCS modification is designed to meet those codes. Fire Code Seating (FCS) indicates that a product is constructed to meet the strict fire code requirements of high public occupancy areas such as theaters, meeting rooms, and lobbies. The FCS standards will meet the State of California Bureau of Electronic and Appliance Repair, Home Furnishings, and Thermal Insulation Technical Bulletin 133 (Cal TB 133). Boston adopted the California Bureau of Electronic and Appliance Repair, Home Furnishings, and Thermal Insulation Technical Bulletin TB 133 test standard in 1992.

**Local codes** may have special requirements for upholstery.

### Dimensions

► Page 298

### Resources

#### Printed Materials

► Move Brochure (10-0002807)

#### Online Resources

► Product environmental profiles, which provide key environmental attributes and product certifications, can be found by searching for Steelcase at *Origin.build*.

# Dimensions

Move 490 Series

Features	Overall Depth	Width	Height	Seat Depth	Functional Seat Depth	Seat Width	Seat Height from Floor	Back Width	Back Height from Seat
<b>Move 490 Series</b>									
<b>Chair with Arms</b>									
	20¼"	25¾"	31½"	18½"	16⅞"	19"	18½"	19"	15¼"
<b>Plastic Chair with Arms</b>									
	20¼"	25¾"	31½"	18½"	16⅞"	18¼"	18"	19"	15½"
<b>Chair without Arms</b>									
	20¼"	21"	31½"	18½"	16⅞"	19"	18½"	19"	15¼"
<b>Plastic Chair without Arms</b>									
	20¼"	21"	31½"	18½"	16⅞"	18¼"	18"	19"	15½"
<b>Stool with Arms</b>									
	20¼"	25¾"	42½"	18½"	16⅞"	19"	29½"	19"	15¼"
<b>Plastic Stool with Arms</b>									
	20¼"	25¾"	42½"	18½"	16⅞"	18¼"	29"	19"	15½"
<b>Stool without Arms</b>									
	20¼"	21"	42½"	18½"	16⅞"	19"	29½"	19"	15¼"
<b>Plastic Stool without Arms</b>									
	20¼"	21"	42½"	18½"	16⅞"	18¼"	29"	19"	15½"
<b>Perching Stool with Arms</b>									
	20¼"	25¾"	40"	18½"	16⅞"	19"	27"	19"	15¼"
<b>Plastic Perching Stool with Arms</b>									
	20¼"	25¾"	40"	18½"	16⅞"	18¼"	26½"	19"	15½"
<b>Perching Stool without Arms</b>									
	20¼"	21"	40"	18½"	16⅞"	19"	27"	19"	15¼"
<b>Plastic Perching Stool without Arms</b>									
	20¼"	21"	40"	18½"	16⅞"	18¼"	26½"	19"	15½"

Back Lumbar Height	Width Between Arms	Arm to Floor	Arm Height from Seat	Seat Pan Angle	Angle Between Seat and Back
--------------------	--------------------	--------------	----------------------	----------------	-----------------------------

**Chair with Arms**

10"	20½"	25¾"	8¾"	5°	95°
-----	------	------	-----	----	-----

**Plastic Chair with Arms**

10"	20½"	25¾"	8¾"	4°	96°
-----	------	------	-----	----	-----

**Chair without Arms**

10"	N.A.	N.A.	N.A.	5°	95°
-----	------	------	------	----	-----

**Plastic Chair without Arms**

10"	N.A.	N.A.	N.A.	4°	96°
-----	------	------	------	----	-----

**Stool with Arms**

10"	20½"	36¾"	8¾"	5°	95°
-----	------	------	-----	----	-----

**Plastic Stool with Arms**

10"	20½"	25¾"	8¾"	4°	96°
-----	------	------	-----	----	-----

**Stool without Arms**

10"	N.A.	N.A.	N.A.	5°	95°
-----	------	------	------	----	-----

**Plastic Stool without Arms**

10"	N.A.	N.A.	N.A.	4°	96°
-----	------	------	------	----	-----

**Perching Stool with Arms**

10"	20½"	34¼"	8¾"	5°	95°
-----	------	------	-----	----	-----

**Plastic Perching Stool with Arms**

10"	20½"	34¼"	8¾"	4°	96°
-----	------	------	-----	----	-----

**Perching Stool without Arms**

10"	N.A.	N.A.	N.A.	5°	95°
-----	------	------	------	----	-----

**Plastic Perching Stool without Arms**

10"	N.A.	N.A.	N.A.	4°	96°
-----	------	------	------	----	-----

:	:	:	:	:	:
---	---	---	---	---	---

# Move 490 Series Multi-Use Chairs by Steelcase



► Need help?  
Product details,  
page 296

## Standard Includes

- Frame: 0835 Black paint
- Back shell: plastic
- Upholstery, if selected: fabric price group 1
- Arms, if selected: plastic to match back shell
- Glides, if selected: plastic with hard plastic inserts
- Hard, dual-wheel casters, if selected: black

## Required to Specify

- 1 Style number
  - 2 Paint color number for frame
  - 3 Plastic color number for back shell and seat, if selected
  - 4 Fabric color number for upholstery on seat, if selected
  - 5 Options, if selected (see below)
- See *Surface Materials*, page 473.

	Options	U.S. Price	Required to Specify
<b>Surface Materials</b>	<b>Plastic on seat shell</b>		
	• Plastic price group 1	No cost	Specify color number. ► See <i>Surface Materials</i> , page 473.
	• Plastic price group 2	+\$ 33	Specify color number. ► See <i>Surface Materials</i> , page 473.
	<b>Plastic on back shell</b>		
	• Plastic price group 1	No cost	Specify color number. ► See <i>Surface Materials</i> , page 473.
	• Plastic price group 2	+\$ 33	Specify color number. ► See <i>Surface Materials</i> , page 473.
	<b>Upholstery on seat and back</b>		
	• Fabric price group 1	No cost	Specify fabric color number.
	• Fabric price group 2	+\$ 37	Specify fabric color number.
	• Fabric price group 3	+\$ 72	Specify fabric color number.
	• Fabric price group 4	+\$100	Specify fabric color number.
	• Fabric price group 5	+\$125	Specify fabric color number.
	• Fabric price group 6	+\$179	Specify fabric color number.
	• Fabric price group 7	+\$250	Specify fabric color number.
	• Fabric price group 8	+\$332	Specify fabric color number.
	• Fabric price group 9	+\$392	Specify fabric color number.
	• Fabric price group 10	+\$456	Specify fabric color number.
	• Steelcase leather upholstery	+\$258	Specify leather color number.
	• Select Surfaces leather price group 1	+\$258	► See <i>Surface Materials Reference Manual</i> .
	• Elmosoft leather upholstery	+\$301	Specify Elmosoft leather color number.
	• Select Surfaces leather price group 2	+\$301	► See <i>Surface Materials Reference Manual</i> .
	• Customer's Own Material/Vinyl (COM)	No cost	► See <i>Surface Materials Reference Manual</i> .
	• Customer's Own Leather (COL)	No cost	Specify leather color number.
	<b>Contrasting upholstery on seat and back</b>		
	• Contrasting fabrics	+\$ 46	Add suffix <b>K</b> to the style number and specify fabric color numbers.
	<b>Contrasting upholstery on seat</b>		
	• Fabric price group 1	No cost	Specify fabric color number.
	• Fabric price group 2	+\$ 21	Specify fabric color number.
	• Fabric price group 3	+\$ 34	Specify fabric color number.
	• Fabric price group 4	+\$ 49	Specify fabric color number.
	• Fabric price group 5	+\$ 62	Specify fabric color number.
	• Fabric price group 6	+\$ 88	Specify fabric color number.
	• Fabric price group 7	+\$125	Specify fabric color number.
	• Fabric price group 8	+\$165	Specify fabric color number.
	• Fabric price group 9	+\$197	Specify fabric color number.
	• Fabric price group 10	+\$228	Specify fabric color number.
	• Steelcase leather upholstery	+\$130	Specify leather color number.
	• Select Surfaces leather price group 1	+\$130	► See <i>Surface Materials Reference Manual</i> .
	• Elmosoft leather upholstery	+\$150	Specify Elmosoft leather color number.
	• Select Surfaces leather price group 2	+\$150	► See <i>Surface Materials Reference Manual</i> .
	• Customer's Own Material/Vinyl (COM)	No cost	► See <i>Surface Materials Reference Manual</i> .
	• Customer's Own Leather (COL)	No cost	Specify leather color number.

► Detailed dimensions,  
page 298



### For Canadian Pricing

Multiply U.S. Price by the Canadian price factor.

► See page 1 for details.

► Options, continued on next page

## ► Options, continued from previous page

Options	U.S. Price	Required to Specify
<b>Surface Materials, continued</b>	<b>Contrasting upholstery on back</b>	
• Fabric price group 1	No cost	Specify fabric color number.
• Fabric price group 2	+\$ 21	Specify fabric color number.
• Fabric price group 3	+\$ 34	Specify fabric color number.
• Fabric price group 4	+\$ 48	Specify fabric color number.
• Fabric price group 5	+\$ 62	Specify fabric color number.
• Fabric price group 6	+\$ 88	Specify fabric color number.
• Fabric price group 7	+\$125	Specify fabric color number.
• Fabric price group 8	+\$165	Specify fabric color number.
• Fabric price group 9	+\$197	Specify fabric color number.
• Fabric price group 10	+\$228	Specify fabric color number.
• Steelcase leather upholstery	+\$130	Specify leather color number.
• Select Surfaces leather price group 1	+\$130	Specify leather color number.
• Elmosoft leather upholstery	+\$150	Specify leather color number.
• Select Surfaces leather price group 2	+\$150	Specify leather color number.
• Customer's Own Material/Vinyl (COM)	No cost	► See <i>Surface Materials Reference Manual</i> .
• Customer's Own Leather (COL)	No cost	Specify leather color number.
	<b>Fire Code Seating (FCS)</b>	+\$113
	<b>Soil-retardant treatment</b>	+\$ 36
	<b>Frame</b>	
• 7239 Midnight	No cost	Specify with 7239 Midnight.
• 4799 Platinum Metallic	+\$ 85	Specify with 4799 Platinum Metallic.
• 1ATT Cast Shadow	+\$117	Specify with 1ATT Cast Shadow.
• Lux Coatings	+\$117	Specify Lux Coatings color number.
<b>Glides</b>	• Soft felt glides for use on non-carpeted floors	+\$ 7
		Specify with soft glides.
<b>Casters</b>	• Soft, dual-wheel casters for use on hard floors	+\$ 36
		Specify with soft casters.

Tip: Fire Code Seating (FCS) option is available only on models with 6205 Black or 6249 Platinum Solid plastic components.  
► See *Surface Materials Reference Manual*.

## ► Specification Information, on next page



**For Canadian Pricing**  
Multiply U.S. Price by the Canadian price factor.  
► See page 1 for details.

Move 490 Series Multi-Use Chairs by Steelcase, continued

► Options, on previous page

**Specification Information**

Style Number	U.S. Base Price
--------------	-----------------

**Upholstered Seat without Arms**

**With Glides**

<b>490410</b>	\$438
---------------	-------

**With Casters**

<b>490410C</b>	\$514
----------------	-------

**Upholstered Back and Seat without Arms**

**With Glides**

<b>490410U</b>	\$525
----------------	-------

**With Casters**

<b>490410UC</b>	\$601
-----------------	-------

**Plastic Back and Seat without Arms**

**With Glides**

<b>490410P</b>	\$347
----------------	-------

**With Casters**

<b>490410CP</b>	\$423
-----------------	-------

► Specification Information, continued on next page



Tip: Plastic finish number must be specified for both seat and back on plastic styles.



**For Canadian Pricing**

Multiply U.S. Price by the Canadian price factor.

► See page 1 for details.

## ► Specification Information, continued from previous page

## Specification Information

Style Number	U.S. Base Price
--------------	-----------------

## Upholstered Seat with Arms

## With Glides

490412	\$525
--------	-------

## With Casters

490412C	\$601
---------	-------

## Upholstered Back and Seat with Arms

## With Glides

490412U	\$612
---------	-------

## With Casters

490412UC	\$688
----------	-------

## Plastic Back and Seat with Arms

## With Glides

490412P	\$434
---------	-------

## With Casters

490412CP	\$510
----------	-------



Tip: Plastic finish number must be specified for both seat and back on plastic styles.

**For Canadian Pricing**

Multiply U.S. Price by the Canadian price factor.

► See page 1 for details.

# Move 490 Series Multi-Use Stools by Steelcase

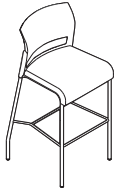

Tip: Move 490 series stools do not stack.

Standard Includes		Required to Specify
<ul style="list-style-type: none"> <li>▶ Need help? Product details, page 296</li> </ul>	<ul style="list-style-type: none"> <li>• Frame: 0835 Black paint</li> <li>• Back shell: plastic</li> <li>• Upholstery, if selected: fabric price group 1</li> <li>• Arms, if selected: plastic to match back shell</li> <li>• Glides, if selected: plastic with hard plastic inserts</li> <li>• Hard, dual-wheel casters, if selected: black</li> </ul>	<ol style="list-style-type: none"> <li>1 Style number</li> <li>2 Plastic color number for back shell</li> <li>3 Plastic color number for seat shell, if selected</li> <li>4 Fabric color number for upholstery on seat, if selected</li> <li>5 Options, if selected (see below)</li> </ol> <ul style="list-style-type: none"> <li>▶ See <i>Surface Materials</i>, page 473.</li> </ul>

Options	U.S. Price	Required to Specify
<b>Surface Materials</b>		
<b>Plastic on seat shell</b>		
• Plastic price group 1	No cost	Specify color number. ▶ See <i>Surface Materials</i> , page 473.
• Plastic price group 2	+\$ 33	Specify color number. ▶ See <i>Surface Materials</i> , page 473.
<b>Plastic on back shell</b>		
• Plastic price group 1	No cost	Specify color number. ▶ See <i>Surface Materials</i> , page 473.
• Plastic price group 2	+\$ 33	Specify color number. ▶ See <i>Surface Materials</i> , page 473.
<b>Upholstery on seat and back</b>		
• Fabric price group 1	No cost	Specify fabric color number.
• Fabric price group 2	+\$ 37	Specify fabric color number.
• Fabric price group 3	+\$ 72	Specify fabric color number.
• Fabric price group 4	+\$100	Specify fabric color number.
• Fabric price group 5	+\$125	Specify fabric color number.
• Fabric price group 6	+\$179	Specify fabric color number.
• Fabric price group 7	+\$250	Specify fabric color number.
• Fabric price group 8	+\$332	Specify fabric color number.
• Fabric price group 9	+\$392	Specify fabric color number.
• Fabric price group 10	+\$456	Specify fabric color number.
• Steelcase leather upholstery	+\$258	Specify leather color number.
• Select Surfaces leather price group 1	+\$258	▶ See <i>Surface Materials Reference Manual</i> .
• Elmosoft leather upholstery	+\$301	Specify Elmosoft leather color number.
• Select Surfaces leather price group 2	+\$301	▶ See <i>Surface Materials Reference Manual</i> .
• Customer's Own Material/Vinyl (COM)	No cost	▶ See <i>Surface Materials Reference Manual</i> .
• Customer's Own Leather (COL)	No cost	Specify leather color number.
<b>Contrasting upholstery on seat and back</b>		
• Contrasting fabrics	+\$ 46	Add suffix <b>K</b> to the style number and specify fabric color numbers.
<b>Contrasting upholstery on seat</b>		
• Fabric price group 1	No cost	Specify fabric color number.
• Fabric price group 2	+\$ 21	Specify fabric color number.
• Fabric price group 3	+\$ 34	Specify fabric color number.
• Fabric price group 4	+\$ 49	Specify fabric color number.
• Fabric price group 5	+\$ 62	Specify fabric color number.
• Fabric price group 6	+\$ 88	Specify fabric color number.
• Fabric price group 7	+\$125	Specify fabric color number.
• Fabric price group 8	+\$165	Specify fabric color number.
• Fabric price group 9	+\$197	Specify fabric color number.
• Fabric price group 10	+\$228	Specify fabric color number.
• Steelcase leather upholstery	+\$130	Specify leather color number.
• Select Surfaces leather price group 1	+\$130	▶ See <i>Surface Materials Reference Manual</i> .
• Elmosoft leather upholstery	+\$150	Specify Elmosoft leather color number.
• Select Surfaces leather price group 2	+\$150	▶ See <i>Surface Materials Reference Manual</i> .
• Customer's Own Material/Vinyl (COM)	No cost	▶ See <i>Surface Materials Reference Manual</i> .
• Customer's Own Leather (COL)	No cost	Specify leather color number.

▶ Detailed dimensions, page 298



### For Canadian Pricing

Multiply U.S. Price by the Canadian price factor.

▶ See page 1 for details.

▶ Options, continued on next page



## ► Options, continued from previous page

Options	U.S. Price	Required to Specify
<b>Surface Materials, continued</b>	<b>Contrasting upholstery on back</b>	
• Fabric price group 1	No cost	Specify fabric color number.
• Fabric price group 2	+\$ 21	Specify fabric color number.
• Fabric price group 3	+\$ 34	Specify fabric color number.
• Fabric price group 4	+\$ 49	Specify fabric color number.
• Fabric price group 5	+\$ 62	Specify fabric color number.
• Fabric price group 6	+\$ 88	Specify fabric color number.
• Fabric price group 7	+\$125	Specify fabric color number.
• Fabric price group 8	+\$165	Specify fabric color number.
• Fabric price group 9	+\$197	Specify fabric color number.
• Fabric price group 10	+\$228	Specify fabric color number.
• Steelcase leather upholstery	+\$130	Specify leather color number.
• Select Surfaces leather price group 1	+\$130	Specify leather color number.
• Elmosoft leather upholstery	+\$150	Specify leather color number.
• Select Surfaces leather price group 2	+\$150	Specify leather color number.
• Customer's Own Material/Vinyl (COM)	No cost	► See <i>Surface Materials Reference Manual</i> .
• Customer's Own Leather (COL)	No cost	Specify leather color number.
	<b>Fire Code Seating (FCS)</b>	+\$113
	<b>Soil-retardant treatment</b>	+\$ 36
	<b>Frame</b>	
• 7239 Midnight	No cost	Specify with 7239 Midnight.
• 4799 Platinum Metallic	+\$ 85	Specify with 4799 Platinum Metallic.
• 1ATT Cast Shadow	+\$117	Specify with 1ATT Cast Shadow.
• Lux Coatings	+\$117	Specify Lux Coatings color number.
<b>Glides</b>	• Soft felt glides for use on non-carpeted floors	+\$ 7
<b>Casters</b>	• Soft, dual-wheel casters for use on hard floors	+\$ 36

## Specification Information

Style Number	U.S. Base Price

## Upholstered Seat without Arms

## With Glides

490710 \$784

## With Casters

490710C \$860



## Upholstered Back and Seat without Arms

## With Glides

490710U \$871

## With Casters

490710UC \$947



## ► Specification Information, continued on next page

► Specification Information, continued from previous page

**Specification Information**

• Style Number	• U.S. Base Price

**Plastic Back and Seat without Arms**

**With Glides**

<b>490710P</b>	\$679
----------------	-------

**With Casters**

<b>490710CP</b>	\$755
-----------------	-------

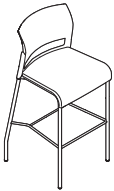

Tip: Plastic finish number must be specified for both seat and back on plastic styles.

**Upholstered Seat with Arms**

**With Glides**

<b>490712</b>	\$871
---------------	-------

**With Casters**

<b>490712C</b>	\$947
----------------	-------

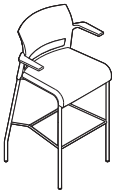

► Specification Information, continued on next page



**For Canadian Pricing**

Multiply U.S. Price by the Canadian price factor.

► See page 1 for details.

## ► Specification Information, continued from previous page

## Specification Information

Style Number	U.S. Base Price

## Upholstered Back and Seat with Arms

## With Glides

<b>490712U</b>	\$ 958
----------------	--------

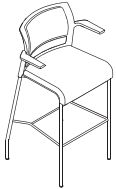

## With Casters

<b>490712UC</b>	\$1034
-----------------	--------

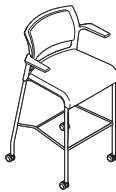

## Plastic Back and Seat with Arms

## With Glides

<b>490712P</b>	\$ 766
----------------	--------

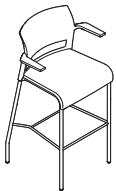

## With Casters

<b>490712CP</b>	\$ 842
-----------------	--------

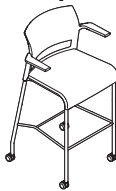

*Tip: Plastic finish number must be specified for both seat and back on plastic styles.*

**For Canadian Pricing**

Multiply U.S. Price by the Canadian price factor.

► See page 1 for details.

# Move 490 Series Perching Stools by Steelcase

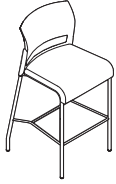

Tip: Move 490 series stools do not stack.

Tip: Fire Code Seating (FCS) option is available only on models with 6205 Black or 6249 Platinum Solid plastic components.  
▶ See *Surface Materials Reference Manual*.

▶ Detailed dimensions, page 298

Standard Includes		Required to Specify	
▶ Need help? Product details, page 296	<ul style="list-style-type: none"> <li>• Frame: 0835 Black paint</li> <li>• Back shell: plastic</li> <li>• Upholstery, if selected: fabric price group 1</li> <li>• Arms, if selected: plastic to match back shell</li> <li>• Glides, if selected: plastic with hard plastic inserts</li> </ul>	<ol style="list-style-type: none"> <li>1 Style number</li> <li>2 Plastic color number for back shell</li> <li>3 Plastic color number for seat shell, if selected</li> <li>4 Fabric color number for upholstery on seat, if selected</li> <li>5 Options, if selected (see below)</li> </ol>	▶ See <i>Surface Materials</i> , page 473.

Options	U.S. Price	Required to Specify	
<b>Surface Materials</b>			
<b>Plastic on seat shell</b>			
• Plastic price group 1	No cost	Specify color number.	▶ See <i>Surface Materials</i> , page 473.
• Plastic price group 2	+\$ 33	Specify color number.	▶ See <i>Surface Materials</i> , page 473.
<b>Plastic on back shell</b>			
• Plastic price group 1	No cost	Specify color number.	▶ See <i>Surface Materials</i> , page 473.
• Plastic price group 2	+\$ 33	Specify color number.	▶ See <i>Surface Materials</i> , page 473.
<b>Upholstery on seat and back</b>			
• Fabric price group 1	No cost	Specify fabric color number.	
• Fabric price group 2	+\$ 37	Specify fabric color number.	
• Fabric price group 3	+\$ 72	Specify fabric color number.	
• Fabric price group 4	+\$100	Specify fabric color number.	
• Fabric price group 5	+\$125	Specify fabric color number.	
• Fabric price group 6	+\$179	Specify fabric color number.	
• Fabric price group 7	+\$250	Specify fabric color number.	
• Fabric price group 8	+\$332	Specify fabric color number.	
• Fabric price group 9	+\$392	Specify fabric color number.	
• Fabric price group 10	+\$456	Specify fabric color number.	
• Steelcase leather upholstery	+\$258	Specify leather color number.	▶ See <i>Surface Materials Reference Manual</i> .
• Select Surfaces leather price group 1	+\$258	Specify Elmosoft leather color number.	▶ See <i>Surface Materials Reference Manual</i> .
• Elmosoft leather upholstery	+\$301	Specify Elmosoft leather color number.	▶ See <i>Surface Materials Reference Manual</i> .
• Select Surfaces leather price group 2	+\$301	Specify leather color number.	▶ See <i>Surface Materials Reference Manual</i> .
• Customer's Own Material/Vinyl (COM)	No cost		
• Customer's Own Leather (COL)	No cost		
<b>Contrasting upholstery on seat and back</b>			
• Contrasting fabrics	+\$ 46	Add suffix <b>K</b> to the style number and specify fabric color numbers.	
<b>Contrasting upholstery on seat</b>			
• Fabric price group 1	No cost	Specify fabric color number.	
• Fabric price group 2	+\$ 21	Specify fabric color number.	
• Fabric price group 3	+\$ 34	Specify fabric color number.	
• Fabric price group 4	+\$ 49	Specify fabric color number.	
• Fabric price group 5	+\$ 62	Specify fabric color number.	
• Fabric price group 6	+\$ 88	Specify fabric color number.	
• Fabric price group 7	+\$125	Specify fabric color number.	
• Fabric price group 8	+\$165	Specify fabric color number.	
• Fabric price group 9	+\$197	Specify fabric color number.	
• Fabric price group 10	+\$228	Specify fabric color number.	
• Steelcase leather upholstery	+\$130	Specify leather color number.	▶ See <i>Surface Materials Reference Manual</i> .
• Select Surfaces leather price group 1	+\$130	Specify Elmosoft leather color number.	▶ See <i>Surface Materials Reference Manual</i> .
• Elmosoft leather upholstery	+\$150	Specify leather color number.	▶ See <i>Surface Materials Reference Manual</i> .
• Select Surfaces leather price group 2	+\$150	Specify leather color number.	▶ See <i>Surface Materials Reference Manual</i> .
• Customer's Own Material/Vinyl (COM)	No cost		
• Customer's Own Leather (COL)	No cost		

▶ Options, continued on next page



## For Canadian Pricing

Multiply U.S. Price by the Canadian price factor.

▶ See page 1 for details.

## ► Options, continued from previous page

Options	U.S. Price	Required to Specify
<b>Surface Materials, continued</b>		
<b>Contrasting upholstery on back</b>		
• Fabric price group 1	No cost	Specify fabric color number.
• Fabric price group 2	+\$ 21	Specify fabric color number.
• Fabric price group 3	+\$ 34	Specify fabric color number.
• Fabric price group 4	+\$ 49	Specify fabric color number.
• Fabric price group 5	+\$ 62	Specify fabric color number.
• Fabric price group 6	+\$ 88	Specify fabric color number.
• Fabric price group 7	+\$125	Specify fabric color number.
• Fabric price group 8	+\$165	Specify fabric color number.
• Fabric price group 9	+\$197	Specify fabric color number.
• Fabric price group 10	+\$228	Specify fabric color number.
• Steelcase leather upholstery	+\$130	Specify leather color number.
• Select Surfaces leather price group 1	+\$130	Specify leather color number.
• Elmosoft leather upholstery	+\$150	Specify leather color number.
• Select Surfaces leather price group 2	+\$150	Specify leather color number.
• Customer's Own Material/Vinyl (COM)	No cost	► See <i>Surface Materials Reference Manual</i> .
• Customer's Own Leather (COL)	No cost	Specify leather color number.
<b>Fire Code Seating (FCS)</b>	+\$113	Add suffix <b>F</b> to the style number.
<b>Soil-retardant treatment</b>	+\$ 36	Specify with <i>soil-retardant treatment</i> .
<b>Frame</b>		
• 7239 Midnight	No cost	Specify with <i>7239 Midnight</i> .
• 4799 Platinum Metallic	+\$ 85	Specify with <i>4799 Platinum Metallic</i> .
• 1ATT Cast Shadow	+\$117	Specify with <i>1ATT Cast Shadow</i> .
• Lux Coatings	+\$117	Specify Lux Coatings color number.
<b>Glides</b>		
• Soft felt glides for use on non-carpeted floors	+\$ 7	Specify with <i>soft glides</i> .

## Specification Information

Style Number	U.S. Base Price
--------------	-----------------

## Upholstered Seat without Arms

490510	\$784
--------	-------

## Upholstered Back and Seat without Arms

490510U	\$871
---------	-------

## Plastic Back and Seat without Arms

490510P	\$679
---------	-------

## ► Specification Information, continued on next page

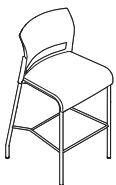
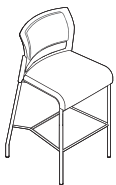
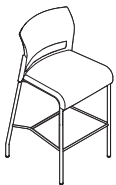

Tip: Plastic finish number must be specified for both seat and back on plastic styles.

► Specification Information, continued from previous page

**Specification Information**

• Style Number	• U.S. Base Price



**Upholstered Seat with Arms**

<b>490512</b>	\$871

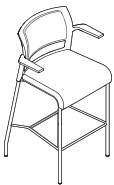

**Upholstered Back and Seat with Arms**

<b>490512U</b>	\$958



**Plastic Back and Seat with Arms**

<b>490512P</b>	\$766

*Tip: Plastic finish number must be specified for both seat and back on plastic styles.*



**For Canadian Pricing**

Multiply U.S. Price by the Canadian price factor.

► See page 1 for details.

## Ganging and Alignment Device

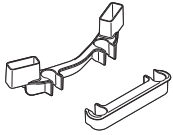

*Tip: One pair is required to align two chairs. The 4" device is used for armless chairs and the 7" device is used for chairs with arms.*

Standard Includes	Required to Specify
-------------------	---------------------

- Alignment device: black plastic only
- Package of two

Style number

Specification Information		
• Style Number	• Width	• U.S. Price

490GA4	4"	\$56
490GA7	7"	\$56

## Transport and Storage Dolly

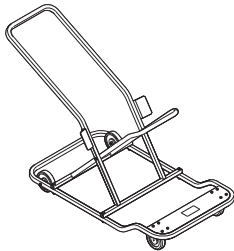

Standard Includes	Required to Specify
-------------------	---------------------

- Transport and storage dolly: black paint only

Style number

Specification Information	
• Style Number	• U.S. Price

490D	\$1104
------	--------

## Wall Saver



*Tip: Wall saver package is for use on Move chair styles only.*

*Tip: One pair is required for each chair.*

Standard Includes	Required to Specify
-------------------	---------------------

- Package of four
- Plastic: 6644 Fusion Dark only

Style number

Specification Information		
• Style Number	• Width	• U.S. Price

490WS	4"	\$76
-------	----	------

 **For Canadian Pricing**  
Multiply U.S. Price by the Canadian price factor.  
▶ See page 1 for details.

# Player 475 Series by Steelcase

**Player** chairs are guest chairs that also stack. Strength features in the back, arms, and back legs make Player a logical choice for high-traffic areas, and its simple, classic design complements a broad range of work settings.

**Arms** slope downward and will easily clear the front edge of a worksurface or table. Arms are available in smooth or textured finish.

**Steel frame** is monochromatic.

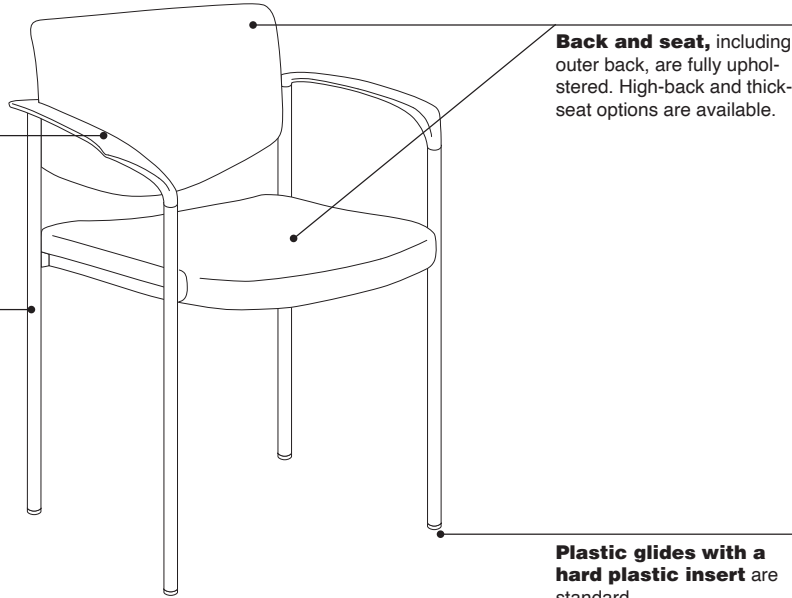

**Back and seat**, including outer back, are fully upholstered. High-back and thick-seat options are available.

**Plastic glides with a hard plastic insert** are standard.

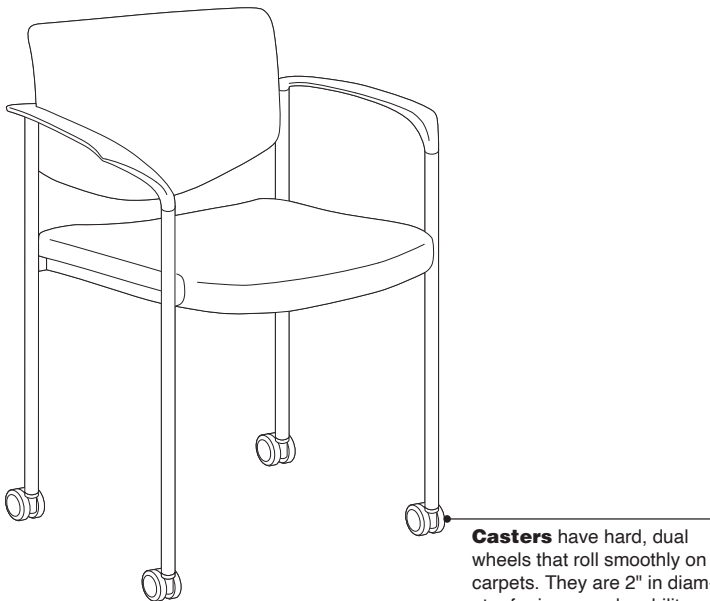

**Casters** have hard, dual wheels that roll smoothly on carpets. They are 2" in diameter for increased mobility. Soft, dual-wheel casters are available for use on hard floor or chair mats. Casters available in black only. *Tip: Do not roll the chair across asphalt during installation as this may damage the casters.*

## Product Details

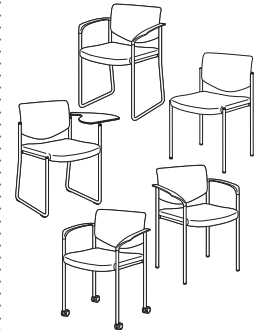

**Chair models** are available with a leg-base or a sled-base. Stools are available with a leg-base. The leg base arms are available with casters. Chairs and stools are available with several features such as arms, tablet arms, high back, and thick seat.

**Stackability** for leg-base models is six high on the floor and eight high on the transport and storage dolly. Leg-base models with casters are not recommended to stack as damage to arms may occur. Sled-base models, stools, and chairs with tablet arms will not stack.

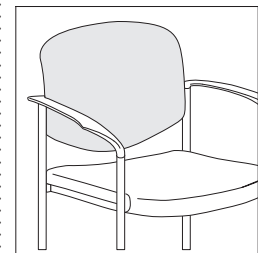

**High-back option**, available on all Player chairs and stools, adds 2½" to back height. Top edge is slightly rounded. Stackability is not affected.



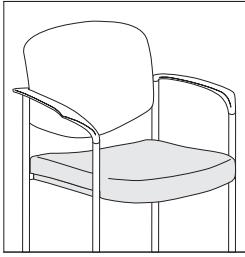

**Thick-seat option**, available on all Player chairs and stools, increases the thickness of the seat cushion by approximately 1/2". Stackability is not affected.

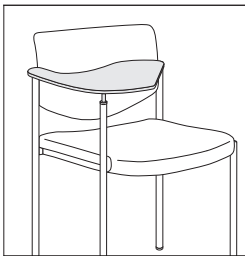

**Tablet arm** is available right hand and left hand and is shipped knocked down (K.D.). Tablet arm tilts for easy entrance and exit from chair. Tablet arm measures 25 1/2" x 13 1/2". Tablet arm is not available to order separately for installation on existing chairs.

**Plastic glides**, with stainless steel inserts on leg-base Player chairs, are recommended for carpeted surfaces only.

**Soft felt glides** are available on Player chairs for non-carpeted surfaces.

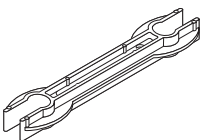

**Alignment device** is available to temporarily link chairs together for evenly spaced rows. Chairs can be unlinked easily. Spacing between chairs linked with alignment device is 5 7/8".

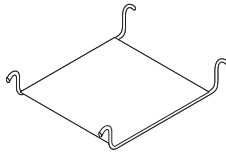

**Ganging device** is available to link chairs on a more permanent basis. It attaches to the chair's side frame. Spacing between chairs linked with the ganging device is approximately 9".

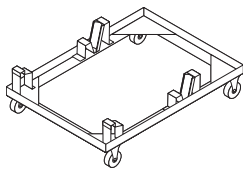

**Transport and storage dolly** is available to stack, move, and store up to eight chairs with or without arms. Without the dolly, chairs will stack up to six high. Sled-base models, stools, and chairs with tablet arms will not stack.

**Fully loaded transport dolly** measures 32 3/4"D x 25 1/2"W x 55 3/4"H.

## Surface Materials

▶ See the *Surface Materials Reference Manual* for further detail about programs and services offered for seating.

## Upholstery

- Fabric
- Fabric with soil-retardant treatment (option)
- Vinyl

## Hard components (arms, frames, and sled base)

- Monochromatic color from list of seating plastic color numbers can be applied to all hard components.

## Arms

- Smooth plastic
- Textured plastic

## Tablet arms

- Laminate

## Casters

- Black only

## Glides

- Plastic with stainless steel inserts

**All Steelcase seating with standard upholstery fabrics** complies with requirements of the State of California Technical Bulletin 117-2013. All standard seating is labeled to be in compliance with California 117-2013.

## Programs & Services

▶ See the *Surface Materials Reference Manual* for further detail about programs and services offered for seating.

## The Customer's Own Material (COM) Program

offers the opportunity for customers to select fabrics that are not offered through the standard Steelcase surface materials program for use on Steelcase products. Through the COM program, Steelcase will test your materials for application on Steelcase products. Once approved, you can place your order. Steelcase will facilitate the entire ordering process and give you a production schedule. Steelcase will order the COM fabric directly from the textile manufacturer. For up-to-date information regarding fabric test results for all COM fabrics and details regarding yardage requirements for most Seating lines, visit the COM Web site. To locate the COM Web site:

- Visit [www.steelcase.com](http://www.steelcase.com)

**Soil retardants** are treatments that provide long-term soil and stain resistance to a fabric without affecting the shade or the integrity of the fabric. The following Steelcase Textiles are available pre-treated with soil retardant. (You do not need to select the soil-retardant option for these fabrics and incur the upcharge.)

- Jacks
- Link

For information on soil retardant fabrics on Select Surfaces, please refer to the *Surface Materials Reference Manual*.

Soil-retardant treatment is available on all other seating fabrics at an additional upcharge per seating unit. To order this option, please select "Soil-Retardant Treatment" under "Optional Accessories."

For soil-retardant treatment on COMs, please select "Soil-Retardant Treatment" under "Optional Accessories." Minimums or additional yardage may be required. Please contact the vendor directly for specific information.

Extended lead times may be necessary for this service.

Contact your Steelcase Solutions Fulfillment Team Representative at 1.888.STEELCASE (1.888.783.3522) or send an email to [lineone@steelcase.com](mailto:lineone@steelcase.com).

## Dimensions

▶ Page 314

## Resources

### Printed Materials

▶ Player Brochure (08-0001468)

### Online Resources

▶ Environmental Profile available at [www.steelcase.com](http://www.steelcase.com)

# Dimensions

## Player 475 Series

Features	Overall Depth	Width	Height	Seat Depth	Functional Seat Depth	Seat Width	Seat Height from Floor	Back Width	Back Height from Seat
<b>Player 475 Series</b>									
<b>Leg-Base Chair with Arms</b>									
	21¼"	25½"	30¼"	19¾"	17½"	18¼"	18¼"	18½"	13¾"
<b>Leg-Base Chair without Arms</b>									
	21¼"	20"	30¼"	19¾"	17½"	18¼"	18¼"	18½"	13¾"
<b>Sled-Base Chair with Arms</b>									
	21¼"	25½"	30¼"	19¾"	17½"	18¼"	18"	18½"	13¾"
<b>Sled-Base Chair without Arms</b>									
	21¼"	20"	30¼"	19¾"	17½"	18¼"	18"	18½"	13¾"
<b>Leg-Base Stool with Arms</b>									
	21¼"	25½"	42"	19¾"	17½"	18¼"	29½"	18½"	13¾"
<b>Leg-Base Stool without Arms</b>									
	21¼"	20"	42"	19¾"	17½"	18¼"	29½"	18½"	13¾"

• Back • Lumbar • Height	• Width • Between • Arms	• Arm • to • Floor	• Arm • Height • from • Seat	• Seat • Pan • Angle	• Angle • Between • Seat and • Back
--------------------------------	--------------------------------	--------------------------	---------------------------------------	----------------------------	--

**Leg-Base Chair with Arms**

7¼"	20½"	25¼"	8¾"	4°	95°
-----	------	------	-----	----	-----

**Leg-Base Chair without Arms**

7¼"	N.A.	N.A.	N.A.	4°	95°
-----	------	------	------	----	-----

**Sled-Base Chair with Arms**

7¼"	20½"	25¼"	8¾"	4°	95°
-----	------	------	-----	----	-----

**Sled-Base Chair without Arms**

7¼"	N.A.	N.A.	N.A.	4°	95°
-----	------	------	------	----	-----

**Leg-Base Stool with Arms**

7¼"	20½"	36½"	8¾"	4°	95°
-----	------	------	-----	----	-----

**Leg-Base Stool without Arms**

7¼"	N.A.	N.A.	N.A.	4°	95°
-----	------	------	------	----	-----

# Player 475 Series Leg-Base Multi-Use Chairs by Steelcase

With Open Arms or without Arms



*Tip: Color choices are limited for chairs with textured plastic arms.*

▶ See *Surface Materials Reference Manual*.

*Tip: To price a chair without contrasting fabrics, add upholstery on seat and upholstery on back prices together.*

Standard Includes		Required to Specify
▶ Need help? Product details, page 312	<ul style="list-style-type: none"> <li>• Frame: monochromatic color</li> <li>• Arms, if selected: plastic color to match frame color</li> <li>• Upholstery: fabric price group 1</li> <li>• Glides, if selected: plastic with hard plastic inserts</li> <li>• Hard composition, dual-wheel casters, if selected; black</li> </ul>	1 Style number 2 Monochromatic color number from seating plastic colors for frame 3 Fabric color number for upholstery 4 Options, if selected (see below) ▶ See <i>Surface Materials</i> , page 473.

Options	U.S. Price	Required to Specify
<b>Surface Materials</b>		
<b>Upholstery on seat</b>		
• Fabric price group 1	No cost	Specify fabric color number.
• Fabric price group 2	+\$ 20	Specify fabric color number.
• Fabric price group 3	+\$ 35	Specify fabric color number.
• Fabric price group 4	+\$ 49	Specify fabric color number.
• Fabric price group 5	+\$ 61	Specify fabric color number.
• Fabric price group 6	+\$ 87	Specify fabric color number.
• Fabric price group 7	+\$125	Specify fabric color number.
• Fabric price group 8	+\$164	Specify fabric color number.
• Fabric price group 9	+\$197	Specify fabric color number.
• Fabric price group 10	+\$228	Specify fabric color number.
• Customer's Own Material/ Vinyl (COM)	+\$ 26	▶ See <i>Surface Materials Reference Manual</i> to specify.
<b>Upholstery on back</b>		
• Fabric price group 1	No cost	Specify fabric color number.
• Fabric price group 2	+\$ 20	Specify fabric color number.
• Fabric price group 3	+\$ 35	Specify fabric color number.
• Fabric price group 4	+\$ 49	Specify fabric color number.
• Fabric price group 5	+\$ 62	Specify fabric color number.
• Fabric price group 6	+\$ 88	Specify fabric color number.
• Fabric price group 7	+\$126	Specify fabric color number.
• Fabric price group 8	+\$164	Specify fabric color number.
• Fabric price group 9	+\$197	Specify fabric color number.
• Fabric price group 10	+\$228	Specify fabric color number.
• Customer's Own Material/ Vinyl (COM)	+\$ 27	▶ See <i>Surface Materials Reference Manual</i> to specify.
<b>Soil-retardant treatment</b>		
• Soil-retardant treatment applied to upholstery fabric	+\$ 36	Specify with soil-retardant treatment.
<b>Platinum</b>		
• Platinum frame	+\$ 85	Specify with 6249 Platinum.
<b>Back and Seat</b>		
• High back	+\$ 60	Specify with high back.
• Thick seat	+\$ 60	Specify with thick seat.
<b>Glides</b>		
• Soft felt glides for use on non-carpeted floors	+\$ 7	Specify with soft glides.
<b>Casters</b>		
• Soft, dual-wheel casters for use on hard floors	+\$ 36	Specify with soft casters.

▶ Detailed dimensions, page 314



## For Canadian Pricing

Multiply U.S. Price by the Canadian price factor.

▶ See page 1 for details.

**Specification Information**

Style Number	U.S. Base Price
--------------	-----------------

**Smooth Plastic Arms**

**With Glides**

<b>475412M</b>	\$626
----------------	-------

**With Casters**

<b>475412MC</b>	\$708
-----------------	-------

**Textured Plastic Arms**

**With Glides**

<b>475415M</b>	\$626
----------------	-------

**With Casters**

<b>475415MC</b>	\$708
-----------------	-------

**Without Arms**

**With Glides**

<b>475410M</b>	\$571
----------------	-------



 **For Canadian Pricing**  
Multiply U.S. Price by the  
Canadian price factor.  
▶ See page 1 for details.

# Player 475 Series Leg-Base Multi-Use Chairs by Steelcase

With Tablet Arm



*Tip: To price a chair with-out contrasting fabrics, add upholstery on seat and upholstery on back prices together.*

Standard Includes	Required to Specify
<ul style="list-style-type: none"> <li>▶ Need help? Product details, page 312</li> <li>• Frame: monochromatic color</li> <li>• Tablet arm: laminate</li> <li>• Upholstery: fabric price group 1</li> <li>• Glides: plastic with hard plastic inserts</li> </ul>	<ol style="list-style-type: none"> <li>1 Style number</li> <li>2 Monochromatic color number from seating plastic colors for frame</li> <li>3 Fabric color number for upholstery</li> <li>4 Laminate color number for tablet arm</li> <li>5 Options, if selected (see below)</li> </ol> <p>▶ See <i>Surface Materials</i>, page 473.</p>

Options	U.S. Price	Required to Specify
<b>Surface Materials</b> <ul style="list-style-type: none"> <li>• Fabric price group 1</li> <li>• Fabric price group 2</li> <li>• Fabric price group 3</li> <li>• Fabric price group 4</li> <li>• Fabric price group 5</li> <li>• Fabric price group 6</li> <li>• Fabric price group 7</li> <li>• Fabric price group 8</li> <li>• Fabric price group 9</li> <li>• Fabric price group 10</li> <li>• Customer's Own Material/ Vinyl (COM)</li> </ul>	<ul style="list-style-type: none"> <li>No cost</li> <li>+\$ 20</li> <li>+\$ 35</li> <li>+\$ 49</li> <li>+\$ 61</li> <li>+\$ 87</li> <li>+\$125</li> <li>+\$164</li> <li>+\$197</li> <li>+\$228</li> <li>+\$ 26</li> </ul>	<ul style="list-style-type: none"> <li>Specify fabric color number.</li> <li>Specify fabric color number.</li> <li>Specify fabric color number.</li> <li>Specify fabric color number.</li> <li>Specify fabric color number.</li> <li>Specify fabric color number.</li> <li>Specify fabric color number.</li> <li>Specify fabric color number.</li> <li>Specify fabric color number.</li> <li>Specify fabric color number.</li> </ul> <p>▶ See <i>Surface Materials Reference Manual</i> to specify.</p>
<b>Upholstery on seat</b> <ul style="list-style-type: none"> <li>• Fabric price group 1</li> <li>• Fabric price group 2</li> <li>• Fabric price group 3</li> <li>• Fabric price group 4</li> <li>• Fabric price group 5</li> <li>• Fabric price group 6</li> <li>• Fabric price group 7</li> <li>• Fabric price group 8</li> <li>• Fabric price group 9</li> <li>• Fabric price group 10</li> <li>• Customer's Own Material/ Vinyl (COM)</li> </ul>	<ul style="list-style-type: none"> <li>No cost</li> <li>+\$ 20</li> <li>+\$ 35</li> <li>+\$ 49</li> <li>+\$ 62</li> <li>+\$ 88</li> <li>+\$126</li> <li>+\$164</li> <li>+\$197</li> <li>+\$228</li> <li>+\$ 27</li> </ul>	<ul style="list-style-type: none"> <li>Specify fabric color number.</li> <li>Specify fabric color number.</li> <li>Specify fabric color number.</li> <li>Specify fabric color number.</li> <li>Specify fabric color number.</li> <li>Specify fabric color number.</li> <li>Specify fabric color number.</li> <li>Specify fabric color number.</li> <li>Specify fabric color number.</li> <li>Specify fabric color number.</li> </ul> <p>▶ See <i>Surface Materials Reference Manual</i> to specify.</p>
<b>Upholstery on back</b> <ul style="list-style-type: none"> <li>• Fabric price group 1</li> <li>• Fabric price group 2</li> <li>• Fabric price group 3</li> <li>• Fabric price group 4</li> <li>• Fabric price group 5</li> <li>• Fabric price group 6</li> <li>• Fabric price group 7</li> <li>• Fabric price group 8</li> <li>• Fabric price group 9</li> <li>• Fabric price group 10</li> <li>• Customer's Own Material/ Vinyl (COM)</li> </ul>	<ul style="list-style-type: none"> <li>No cost</li> <li>+\$ 20</li> <li>+\$ 35</li> <li>+\$ 49</li> <li>+\$ 62</li> <li>+\$ 88</li> <li>+\$126</li> <li>+\$164</li> <li>+\$197</li> <li>+\$228</li> <li>+\$ 27</li> </ul>	<ul style="list-style-type: none"> <li>Specify fabric color number.</li> <li>Specify fabric color number.</li> <li>Specify fabric color number.</li> <li>Specify fabric color number.</li> <li>Specify fabric color number.</li> <li>Specify fabric color number.</li> <li>Specify fabric color number.</li> <li>Specify fabric color number.</li> <li>Specify fabric color number.</li> <li>Specify fabric color number.</li> </ul> <p>▶ See <i>Surface Materials Reference Manual</i> to specify.</p>
<b>Soil-retardant treatment</b> <ul style="list-style-type: none"> <li>• Soil-retardant treatment applied to upholstery fabric</li> </ul>	<ul style="list-style-type: none"> <li>+\$ 36</li> </ul>	<ul style="list-style-type: none"> <li>Specify with <i>soil-retardant treatment</i>.</li> </ul>
<b>Platinum</b> <ul style="list-style-type: none"> <li>• Platinum frame</li> </ul>	<ul style="list-style-type: none"> <li>+\$ 85</li> </ul>	<ul style="list-style-type: none"> <li>Specify with <i>6249 Platinum</i>.</li> </ul>
<b>Back and Seat</b> <ul style="list-style-type: none"> <li>• High back</li> <li>• Thick seat</li> </ul>	<ul style="list-style-type: none"> <li>+\$ 60</li> <li>+\$ 60</li> </ul>	<ul style="list-style-type: none"> <li>Specify with <i>high back</i>.</li> <li>Specify with <i>thick seat</i>.</li> </ul>
<b>Glides</b> <ul style="list-style-type: none"> <li>• Soft felt glides for use on non-carpeted floors</li> </ul>	<ul style="list-style-type: none"> <li>+\$ 7</li> </ul>	<ul style="list-style-type: none"> <li>Specify with <i>soft glides</i>.</li> </ul>

▶ Detailed dimensions, page 314



**For Canadian Pricing**

Multiply U.S. Price by the Canadian price factor.

▶ See page 1 for details.

**Specification Information**

Style Number	U.S. Base Price
--------------	-----------------

**Right-Hand Tablet Arm**

<b>475410MTR</b>	\$890
------------------	-------

**Left-Hand Tablet Arm**

<b>475410MTL</b>	\$890
------------------	-------



**For Canadian Pricing**

Multiply U.S. Price by the Canadian price factor.

▶ See page 1 for details.

# Player 475 Series Sled-Base Multi-Use Chairs by Steelcase

With Open Arms or without Arms



*Tip: Color choices are limited for chairs with textured plastic arms.*

▶ See *Surface Materials Reference Manual*.

*Tip: To price a chair without contrasting fabrics, add upholstery on seat and upholstery on back prices together.*

Standard Includes		Required to Specify
▶ Need help? Product details, page 312	<ul style="list-style-type: none"> <li>• Frame: monochromatic color</li> <li>• Arms, if selected: plastic color to match frame color</li> <li>• Upholstery: fabric price group 1</li> <li>• Glides: stainless steel</li> </ul>	1 Style number 2 Monochromatic color number from seating plastic colors for frame 3 Fabric color number for upholstery 4 Options, if selected (see below) ▶ See <i>Surface Materials</i> , page 473.

Options	U.S. Price	Required to Specify
<b>Surface Materials</b>		
<b>Upholstery on seat</b>		
• Fabric price group 1	No cost	Specify fabric color number.
• Fabric price group 2	+\$ 20	Specify fabric color number.
• Fabric price group 3	+\$ 35	Specify fabric color number.
• Fabric price group 4	+\$ 49	Specify fabric color number.
• Fabric price group 5	+\$ 61	Specify fabric color number.
• Fabric price group 6	+\$ 87	Specify fabric color number.
• Fabric price group 7	+\$125	Specify fabric color number.
• Fabric price group 8	+\$164	Specify fabric color number.
• Fabric price group 9	+\$197	Specify fabric color number.
• Fabric price group 10	+\$228	Specify fabric color number.
• Customer's Own Material/ Vinyl (COM)	+\$ 26	▶ See <i>Surface Materials Reference Manual</i> to specify.
<b>Upholstery on back</b>		
• Fabric price group 1	No cost	Specify fabric color number.
• Fabric price group 2	+\$ 20	Specify fabric color number.
• Fabric price group 3	+\$ 35	Specify fabric color number.
• Fabric price group 4	+\$ 49	Specify fabric color number.
• Fabric price group 5	+\$ 62	Specify fabric color number.
• Fabric price group 6	+\$ 88	Specify fabric color number.
• Fabric price group 7	+\$126	Specify fabric color number.
• Fabric price group 8	+\$164	Specify fabric color number.
• Fabric price group 9	+\$197	Specify fabric color number.
• Fabric price group 10	+\$228	Specify fabric color number.
• Customer's Own Material/ Vinyl (COM)	+\$ 27	▶ See <i>Surface Materials Reference Manual</i> to specify.
<b>Soil-retardant treatment</b>		
• Soil-retardant treatment applied to upholstery fabric	+\$ 36	Specify <i>with soil-retardant treatment</i> .
<b>Platinum</b>		
• Platinum frame	+\$ 85	Specify <i>with 6249 Platinum</i> .
<b>Back and Seat</b>		
• High back	+\$ 60	Specify <i>with high back</i> .
• Thick seat	+\$ 60	Specify <i>with thick seat</i> .
<b>Glides</b>		
• Soft felt glides for use on non-carpeted floors	+\$ 7	Specify <i>with soft glides</i> .

▶ Detailed dimensions, page 314



## For Canadian Pricing

Multiply U.S. Price by the Canadian price factor.

▶ See page 1 for details.



**Specification Information**

Style Number	U.S. Base Price
--------------	-----------------



**Smooth Plastic Arms**

<b>475482M</b>	\$805
----------------	-------



**Textured Plastic Arms**

<b>475485M</b>	\$805
----------------	-------



**Without Arms**

<b>475480M</b>	\$750
----------------	-------



**For Canadian Pricing**

Multiply U.S. Price by the Canadian price factor.

▶ See page 1 for details.

# Player 475 Series Sled-Base Multi-Use Chairs by Steelcase

With Tablet Arm



*Tip: To price a chair without contrasting fabrics, add upholstery on seat and upholstery on back prices together.*

Standard Includes		Required to Specify
<ul style="list-style-type: none"> <li>▶ Need help? Product details, page 312</li> </ul>	<ul style="list-style-type: none"> <li>• Frame: monochromatic color</li> <li>• Tablet arm: laminate</li> <li>• Upholstery: fabric price group 1</li> <li>• Glides: stainless steel</li> </ul>	<ol style="list-style-type: none"> <li>1 Style number</li> <li>2 Monochromatic color number from seating plastic colors for frame</li> <li>3 Fabric color number for upholstery</li> <li>4 Laminate color number for tablet arm</li> <li>5 Options, if selected (see below)</li> </ol> <ul style="list-style-type: none"> <li>▶ See <i>Surface Materials</i>, page 473.</li> </ul>

Options	U.S. Price	Required to Specify
<b>Surface Materials</b>	<b>Upholstery on seat</b> <ul style="list-style-type: none"> <li>• Fabric price group 1 No cost</li> <li>• Fabric price group 2 +\$ 20</li> <li>• Fabric price group 3 +\$ 35</li> <li>• Fabric price group 4 +\$ 49</li> <li>• Fabric price group 5 +\$ 61</li> <li>• Fabric price group 6 +\$ 87</li> <li>• Fabric price group 7 +\$125</li> <li>• Fabric price group 8 +\$164</li> <li>• Fabric price group 9 +\$197</li> <li>• Fabric price group 10 +\$228</li> <li>• Customer's Own Material/ Vinyl (COM) +\$ 26</li> </ul>	<ul style="list-style-type: none"> <li>Specify fabric color number.</li> <li>Specify fabric color number.</li> <li>Specify fabric color number.</li> <li>Specify fabric color number.</li> <li>Specify fabric color number.</li> <li>Specify fabric color number.</li> <li>Specify fabric color number.</li> <li>Specify fabric color number.</li> <li>Specify fabric color number.</li> <li>Specify fabric color number.</li> <li>▶ See <i>Surface Materials Reference Manual</i> to specify.</li> </ul>
	<b>Upholstery on back</b> <ul style="list-style-type: none"> <li>• Fabric price group 1 No cost</li> <li>• Fabric price group 2 +\$ 20</li> <li>• Fabric price group 3 +\$ 35</li> <li>• Fabric price group 4 +\$ 49</li> <li>• Fabric price group 5 +\$ 62</li> <li>• Fabric price group 6 +\$ 88</li> <li>• Fabric price group 7 +\$126</li> <li>• Fabric price group 8 +\$164</li> <li>• Fabric price group 9 +\$197</li> <li>• Fabric price group 10 +\$228</li> <li>• Customer's Own Material/ Vinyl (COM) +\$ 27</li> </ul>	<ul style="list-style-type: none"> <li>Specify fabric color number.</li> <li>Specify fabric color number.</li> <li>Specify fabric color number.</li> <li>Specify fabric color number.</li> <li>Specify fabric color number.</li> <li>Specify fabric color number.</li> <li>Specify fabric color number.</li> <li>Specify fabric color number.</li> <li>Specify fabric color number.</li> <li>Specify fabric color number.</li> <li>▶ See <i>Surface Materials Reference Manual</i> to specify.</li> </ul>
	<b>Soil-retardant treatment</b> <ul style="list-style-type: none"> <li>• Soil-retardant treatment applied to upholstery fabric +\$ 36</li> </ul>	<ul style="list-style-type: none"> <li>Specify with <i>soil-retardant treatment</i>.</li> </ul>
	<b>Platinum</b> <ul style="list-style-type: none"> <li>• Platinum frame +\$ 85</li> </ul>	<ul style="list-style-type: none"> <li>Specify with <i>6249 Platinum</i>.</li> </ul>
<b>Back and Seat</b>	<ul style="list-style-type: none"> <li>• High back +\$ 60</li> <li>• Thick seat +\$ 60</li> </ul>	<ul style="list-style-type: none"> <li>Specify with <i>high back</i>.</li> <li>Specify with <i>thick seat</i>.</li> </ul>
<b>Glides</b>	<ul style="list-style-type: none"> <li>• Soft felt glides for use on non-carpeted floors +\$ 7</li> </ul>	<ul style="list-style-type: none"> <li>Specify with <i>soft glides</i>.</li> </ul>

▶ Detailed dimensions, page 314



### For Canadian Pricing

Multiply U.S. Price by the Canadian price factor.

▶ See page 1 for details.

**Specification Information**

Style Number	U.S. Base Price
--------------	-----------------



**Right-Hand Tablet Arm**

<b>475480MTR</b>	\$1069
------------------	--------



**Left-Hand Tablet Arm**

<b>475480MTL</b>	\$1069
------------------	--------



**For Canadian Pricing**

Multiply U.S. Price by the Canadian price factor.

▶ See page 1 for details.

# Player 475 Series Leg-Base Stools by Steelcase



Tip: Color choices are limited for chairs with textured plastic arms.

▶ See *Surface Materials Reference Manual*.

Tip: To price a chair without contrasting fabrics, add upholstery on seat and upholstery on back prices together.

Standard Includes		Required to Specify
▶ Need help? Product details, page 312	<ul style="list-style-type: none"> <li>Frame: monochromatic color</li> <li>Arms, if selected: plastic color to match frame color</li> <li>Upholstery: fabric price group 1</li> <li>Glides: plastic with inserts</li> </ul>	1 Style number 2 Monochromatic color number from seating plastic colors for frame 3 Fabric color number for upholstery 4 Options, if selected (see below) ▶ See <i>Surface Materials</i> , page 473.

Options	U.S. Price	Required to Specify
<b>Surface Materials</b>		
<b>Upholstery on seat</b>		
• Fabric price group 1	No cost	Specify fabric color number.
• Fabric price group 2	+\$ 20	Specify fabric color number.
• Fabric price group 3	+\$ 35	Specify fabric color number.
• Fabric price group 4	+\$ 49	Specify fabric color number.
• Fabric price group 5	+\$ 61	Specify fabric color number.
• Fabric price group 6	+\$ 87	Specify fabric color number.
• Fabric price group 7	+\$125	Specify fabric color number.
• Fabric price group 8	+\$164	Specify fabric color number.
• Fabric price group 9	+\$197	Specify fabric color number.
• Fabric price group 10	+\$228	Specify fabric color number.
• Customer's Own Material/ Vinyl (COM)	+\$ 26	▶ See <i>Surface Materials Reference Manual</i> to specify.
<b>Upholstery on back</b>		
• Fabric price group 1	No cost	Specify fabric color number.
• Fabric price group 2	+\$ 20	Specify fabric color number.
• Fabric price group 3	+\$ 35	Specify fabric color number.
• Fabric price group 4	+\$ 49	Specify fabric color number.
• Fabric price group 5	+\$ 62	Specify fabric color number.
• Fabric price group 6	+\$ 88	Specify fabric color number.
• Fabric price group 7	+\$126	Specify fabric color number.
• Fabric price group 8	+\$164	Specify fabric color number.
• Fabric price group 9	+\$197	Specify fabric color number.
• Fabric price group 10	+\$228	Specify fabric color number.
• Customer's Own Material/ Vinyl (COM)	+\$ 27	▶ See <i>Surface Materials Reference Manual</i> to specify.
<b>Soil-retardant treatment</b>		
• Soil-retardant treatment applied to upholstery fabric	+\$ 36	Specify with soil-retardant treatment.
<b>Platinum</b>		
• Platinum frame	+\$ 85	Specify with 6249 Platinum.
<b>Back and Seat</b>		
• High back	+\$ 60	Specify with high back.
• Thick seat	+\$ 60	Specify with thick seat.
<b>Glides</b>		
• Soft felt glides for use on non-carpeted floors	+\$ 7	Specify with soft glides.

▶ Detailed dimensions, page 314



### For Canadian Pricing

Multiply U.S. Price by the Canadian price factor.

▶ See page 1 for details.

**Specification Information**

Style Number	U.S. Base Price
--------------	-----------------

**Smooth Plastic Arms**

475712M	\$1075
---------	--------

**Textured Plastic Arms**

475715M	\$1075
---------	--------

**Without Arms**

475710M	\$1020
---------	--------



**For Canadian Pricing**

Multiply U.S. Price by the Canadian price factor.

▶ See page 1 for details.

# Player 475 Series Accessories by Steelcase

## Alignment Device

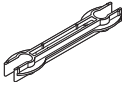

Tip: One pair is required to align two chairs.

Standard Includes		Required to Specify
<ul style="list-style-type: none"> <li>Alignment device: black paint only</li> <li>Package of 5 pairs</li> </ul>		Style number
Specification Information		
Style Number	U.S. Price	
475A	\$121	

## Ganging Device

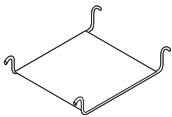

Tip: Use one ganging device for every two chairs.

Standard Includes		Required to Specify
<ul style="list-style-type: none"> <li>Ganging device: black paint only</li> <li>Package of 2</li> </ul>		Style number
Specification Information		
Style Number	U.S. Price	
475G	\$149	

## Transport and Storage Dolly

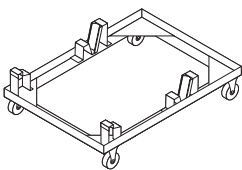

Standard Includes		Required to Specify
<ul style="list-style-type: none"> <li>Transport and storage dolly: black paint only</li> </ul>		Style number
Specification Information		
Style Number	U.S. Price	
475D	\$502	



### For Canadian Pricing

Multiply U.S. Price by the Canadian price factor.

► See page 1 for details.



# Sorrel

**Sorrel seating** offers a broad range of stacking chairs, including chairs with or without arms and a bariatric chair. Easy access chairs are also available. Seating can stand alone or be grouped into ganged configurations.

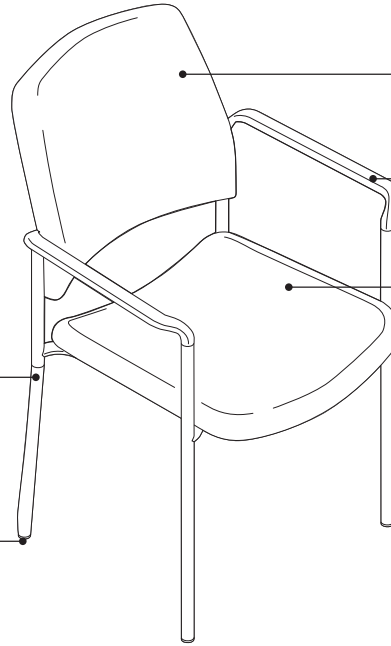

**Back** is available upholstered or with maple wood.

**Arm caps** are plastic.

**Seat cushion** is upholstered.

**Frame and legs** are powder coat painted steel and available with straight or wallsaver legs.

**Plastic glides** are standard. Soft felt glides are available as an option.

## Actual Dimensions

Features	Overall Depth	Width	Height	Seat Depth	Width	Height	Arm Height
<b>Stacking Chairs</b>							
18"W Arm chair*	20"	23½"	36"	18"	18"	18"	26½"
18"W Armless chair*	20"	20¼"	36"	18"	18"	18"	N.A.
22"W Arm chair*	20"	27½"	36"	18"	22"	18"	26½"
22"W Armless chair*	20"	24¼"	36"	18"	22"	18"	N.A.
<b>Bariatric Stacking Arm Chair*</b>	20"	31½"	36"	18"	26"	18"	26½"
<b>Easy Access Arm Chairs</b>							
18"W Easy access chair	20"	23½"	42"	18"	18"	24"	32½"
22"W Easy access chair	20"	27½"	42"	18"	22"	24"	32½"

\*Overall depth of wallsaver styles is 21¼".



## Product Details

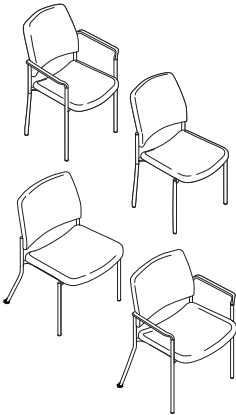

**Stacking chairs** are available with arms or armless and with straight or wallsaver legs. All configurations are available with 18"W and 22"W seats.

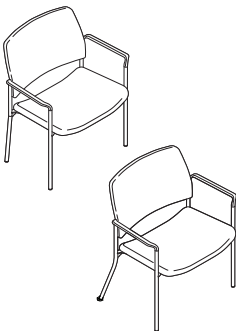

**Bariatric stacking arm chair** is available with a 26" seat width and with straight or wallsaver legs.

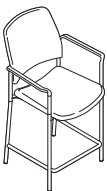

**Easy access chairs** have a 24" seat height and include a foot rest. They are non-stacking with straight legs and available with 18"W and 22"W seats.

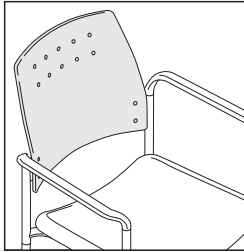

**Wood back** is maple and is available on all chairs.

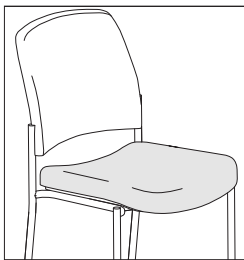

**Thicker seat option**, available on all Sorrel seating, increases the thickness of the seat cushion by approximately 1/2". Stackability is not affected.

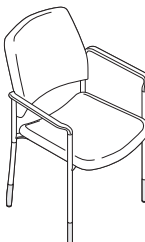

**Leg guards** are available as an option on all chairs and coordinate with the frame finish.

**Soft felt glides** are available as an option for use on non-carpeted surfaces.

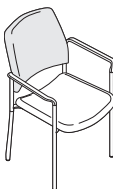

**Different fabrics** can be specified on the seat and back.

**Moisture barrier** is available as an option on seat only.

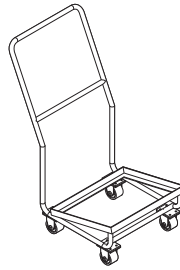

**Two transport and storage dollies** are available. The standard dolly is used to stack, move, and store up to 10 standard 18"W chairs. The bariatric dolly holds up to six bariatric chairs. Dollies do not accommodate wallsaver styles or 22"W chairs. Approximate dimensions for 10 stacked 18"W standard chairs on a dolly are 36"D X 24"W X 71"H.

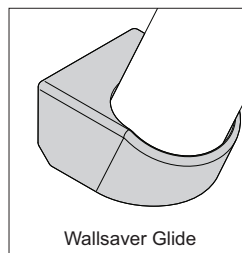

**Wallsaver glide** is designed to protect base trim and flooring.

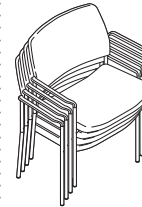
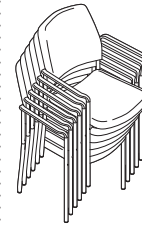

**Stackability on the floor** is six high for 18"W and 22"W standard models and four high for the bariatric chairs. Approximate dimensions are 32"D X 24"W X 53"H for six 18"W stacked standard chairs, 32"D X 28"W X 53"H for six 22"W stacked standard chairs, and 30"D X 32"W X 47"H for four stacked bariatric chairs on the floor.

## Connections

**Ganging brackets** are available to link chairs in the field and must be specified separately.

**When chairs are ganged**, the spacing between the front of the arms is 1" and the spacing between the front legs is 4<sup>3</sup>/<sub>8</sub>". The spacing between the rear legs is 5<sup>3</sup>/<sub>4</sub>".

**All Steelcase Health seating with standard upholstery fabrics** comply with the State of California Technical Bulletin 117-2013.

## Surface Materials

### Seat

- Fabric
- Fabric with moisture barrier (option on seat only)

### Back

- Fabric
- Maple wood

### Arms

- Black plastic
- Grey plastic

### Frame and legs

- Paint

### Dolly

- Black only

### Glides

- Black plastic
- Black with soft felt

### Ganging brackets

- Black
- Merle
- Platinum

### Leg guards

- Black plastisol (when black or merle legs are specified)
- Grey plastisol (when platinum legs are specified)

# Sorrel

## 18" Wide Stacking Chairs

With Arms and Armless

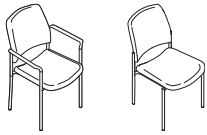

Tip: Different fabrics for the seat and back can be specified. If the fabrics are in different price groups, calculate list price by adding the two price groups together and dividing by two.

Tip: Chairs stack six high alone. Straight leg chairs stack ten high on a dolly.

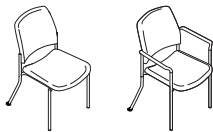

Wallsaver Legs without Arms      Wallsaver Legs with Arms

Tip: Stackability is not affected by thick seat option.

Tip: Leg guard finish will coordinate with frame finish selection.

Standard Includes	Required to Specify
<ul style="list-style-type: none"> <li>Need help? Product details, page 328</li> <li>Seat: fabric</li> <li>Back: fabric or maple wood</li> <li>Arm caps, if selected: plastic</li> <li>Legs and frame: paint</li> <li>Glides: black plastic</li> <li>Ganging brackets, if selected: paint (ordered separately)</li> </ul>	<ol style="list-style-type: none"> <li>Style number</li> <li>Fabric color number for seat</li> <li>Fabric or wood color number for back</li> <li>Plastic color number for arm caps, if selected</li> <li>Paint color number for legs and frame</li> <li>Leg style (see below under Required Selections)</li> <li>Paint color number for ganging brackets, if selected</li> <li>Options, if selected (see below)</li> </ol> <p>▶ See <i>Surface Materials</i>, page 473.</p>

Required Selections	U.S. Price	Required to Specify
<b>Leg Style</b> <ul style="list-style-type: none"> <li>Straight legs</li> <li>Wallsaver legs</li> </ul>	No cost +\$ 25	Specify with <i>straight legs</i> . Specify with <i>wallsaver legs</i> .

Options	U.S. Price	Required to Specify
<b>Surface Materials</b> <ul style="list-style-type: none"> <li>Moisture barrier</li> </ul>	+\$134	Specify with <i>moisture barrier</i> .
<b>Seat</b> <ul style="list-style-type: none"> <li>Thick seat</li> </ul>	+\$ 51	Specify with <i>thick seat</i> .
<b>Leg Guards</b> <ul style="list-style-type: none"> <li>Leg guards</li> </ul>	+\$ 40	Specify with <i>leg guards</i> .
<b>Glides</b> <ul style="list-style-type: none"> <li>Soft felt glides</li> </ul>	+\$ 9	Specify with <i>soft glides</i> .

### Specification Information

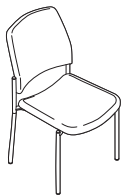

#### Straight Legs

#### U.S. Base Prices

Style Number	Fabric Price Group 1	Fabric Price Group 2	Fabric Price Group 3	Fabric Price Group 4	Fabric Price Group 5	Fabric Price Group 6	Fabric Price Group 7	Fabric Price Group 8	Fabric Price Group 9	Fabric Price Group 10	COM

### 18" Wide Stacking Chair without Arms, With Upholstered Back

SC1060SN	\$447	\$489	\$559	\$601	\$623	\$661	\$697	\$765	\$841	\$957	\$499
----------	-------	-------	-------	-------	-------	-------	-------	-------	-------	-------	-------

### 18" Wide Stacking Chair without Arms, With Wood Back

SC1060SN	\$629	\$650	\$685	\$706	\$717	\$736	\$754	\$788	\$826	\$884	\$655
----------	-------	-------	-------	-------	-------	-------	-------	-------	-------	-------	-------

▶ Specification Information, continued on next page

## ► Specification Information, continued from previous page

## Specification Information



## Straight Legs

## U.S. Base Prices

Style Number	Fabric Price Group 1	Fabric Price Group 2	Fabric Price Group 3	Fabric Price Group 4	Fabric Price Group 5	Fabric Price Group 6	Fabric Price Group 7	Fabric Price Group 8	Fabric Price Group 9	Fabric Price Group 10	COM
--------------	----------------------	----------------------	----------------------	----------------------	----------------------	----------------------	----------------------	----------------------	----------------------	-----------------------	-----

## 18" Wide Stacking Chair with Arms, With Upholstered Back

SC1060SA	\$472	\$514	\$584	\$626	\$648	\$686	\$722	\$790	\$866	\$982	\$524
----------	-------	-------	-------	-------	-------	-------	-------	-------	-------	-------	-------

## 18" Wide Stacking Chair with Arms, With Wood Back

SC1060SA	\$654	\$675	\$710	\$731	\$742	\$761	\$779	\$813	\$851	\$909	\$680
----------	-------	-------	-------	-------	-------	-------	-------	-------	-------	-------	-------

## Specification Information

Style Number	U.S. Price
--------------	------------

## Pair of Ganging Brackets

SC1080	\$64
--------	------

**For Canadian Pricing**

Multiply U.S. Price by the Canadian price factor.

► See page 1 for details.

Sorrel, continued

**22" Wide Stacking Chairs**

With Arms and Armless

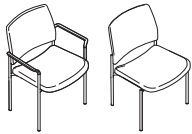

*Tip: Different fabrics for the seat and back can be specified. If the fabrics are in different price groups, calculate list price by adding the two price groups together and dividing by two.*

*Tip: Chairs stack six high alone.*

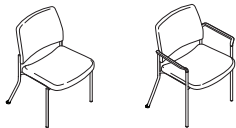

Wallsaver  
Legs without  
Arms

Wallsaver  
Legs with  
Arms

*Tip: Stackability is not affected by thick seat option.*

*Tip: Leg guard finish will coordinate with frame finish selection.*

Standard Includes	Required to Specify
<ul style="list-style-type: none"> <li>▶ Need help? Product details, page 328</li> <li>• Seat: fabric</li> <li>• Back: fabric or maple wood</li> <li>• Arm caps, if selected: plastic</li> <li>• Legs and frame: paint</li> <li>• Glides: black plastic</li> <li>• Ganging brackets, if selected: paint (ordered separately)</li> </ul>	<ol style="list-style-type: none"> <li>1 Style number</li> <li>2 Fabric color number for seat</li> <li>3 Fabric or wood color number for back</li> <li>4 Plastic color number for arm caps, if selected</li> <li>5 Paint color number for legs and frame</li> <li>6 Leg style (see below under Required Selections)</li> <li>7 Paint color number for ganging brackets, if selected</li> <li>8 Options, if selected (see below)</li> </ol> <p>▶ See <i>Surface Materials</i>, page 473.</p>

Required Selections	U.S. Price	Required to Specify
<b>Leg Style</b> <ul style="list-style-type: none"> <li>• Straight legs</li> <li>• Wallsaver legs</li> </ul>	No cost +\$ 25	Specify <i>with straight legs</i> . Specify <i>with wallsaver legs</i> .
Options	U.S. Price	Required to Specify
<b>Surface Materials</b> <ul style="list-style-type: none"> <li>• Moisture barrier</li> </ul>	+\$134	Specify <i>with moisture barrier</i> .
<b>Seat</b> <ul style="list-style-type: none"> <li>• Thick seat</li> </ul>	+\$ 51	Specify <i>with thick seat</i> .
<b>Leg Guards</b> <ul style="list-style-type: none"> <li>• Leg guards</li> </ul>	+\$ 40	Specify <i>with leg guards</i> .
<b>Glides</b> <ul style="list-style-type: none"> <li>• Soft felt glides</li> </ul>	+\$ 9	Specify <i>with soft glides</i> .



**For Canadian Pricing**

Multiply U.S. Price by the Canadian price factor.

▶ See page 1 for details.

## Specification Information



## Straight Legs

## U.S. Base Prices

Style Number	Fabric Price Group 1	Fabric Price Group 2	Fabric Price Group 3	Fabric Price Group 4	Fabric Price Group 5	Fabric Price Group 6	Fabric Price Group 7	Fabric Price Group 8	Fabric Price Group 9	Fabric Price Group 10	COM
--------------	----------------------	----------------------	----------------------	----------------------	----------------------	----------------------	----------------------	----------------------	----------------------	-----------------------	-----

## 22" Wide Stacking Chair without Arms, With Upholstered Back

SC1062SN	\$532	\$580	\$680	\$728	\$758	\$806	\$854	\$940	\$1036	\$1190	\$584
----------	-------	-------	-------	-------	-------	-------	-------	-------	--------	--------	-------

## 22" Wide Stacking Chair without Arms, With Wood Back

SC1062SN	\$714	\$738	\$788	\$812	\$827	\$851	\$875	\$918	\$ 966	\$1043	\$740
----------	-------	-------	-------	-------	-------	-------	-------	-------	--------	--------	-------



## Straight Legs

## U.S. Base Prices

Style Number	Fabric Price Group 1	Fabric Price Group 2	Fabric Price Group 3	Fabric Price Group 4	Fabric Price Group 5	Fabric Price Group 6	Fabric Price Group 7	Fabric Price Group 8	Fabric Price Group 9	Fabric Price Group 10	COM
--------------	----------------------	----------------------	----------------------	----------------------	----------------------	----------------------	----------------------	----------------------	----------------------	-----------------------	-----

## 22" Wide Stacking Chair with Arms, With Upholstered Back

SC1062SA	\$556	\$604	\$704	\$752	\$782	\$830	\$878	\$964	\$1060	\$1214	\$608
----------	-------	-------	-------	-------	-------	-------	-------	-------	--------	--------	-------

## 22" Wide Stacking Chair with Arms, With Wood Back

SC1062SA	\$738	\$762	\$812	\$836	\$851	\$875	\$899	\$942	\$ 990	\$1067	\$764
----------	-------	-------	-------	-------	-------	-------	-------	-------	--------	--------	-------

## Specification Information

Style Number	U.S. Price
--------------	------------

## Pair of Ganging Brackets

SC1080	\$64
--------	------



## For Canadian Pricing

Multiply U.S. Price by the Canadian price factor.

► See page 1 for details.

### Bariatric Stacking Chair



Tip: Different fabrics for the seat and back can be specified. If the fabrics are in different price groups, calculate list price by adding the two price groups together and dividing by two.

Tip: Chairs stack four high alone. Straight leg chairs stack six high on a dolly.



Wallsaver Legs

Tip: Stackability is not affected by thick seat option.

Tip: Leg guard finish will coordinate with frame finish selection.

Standard Includes	Required to Specify
<ul style="list-style-type: none"> <li>▶ Need help? Product details, page 328</li> <li>• Seat: fabric</li> <li>• Back: fabric or maple wood</li> <li>• Arm caps: plastic</li> <li>• Legs and frame: paint</li> <li>• Glides: black plastic</li> <li>• Ganging brackets, if selected: paint (ordered separately)</li> </ul>	<ol style="list-style-type: none"> <li>1 Style number</li> <li>2 Fabric color number for seat</li> <li>3 Fabric or wood color number for back</li> <li>4 Plastic color number for arm caps, if selected</li> <li>5 Paint color number for legs and frame</li> <li>6 Leg style (see below under Required Selections)</li> <li>7 Paint color number for ganging brackets, if selected</li> <li>8 Options, if selected (see below)</li> </ol> <p>▶ See <i>Surface Materials</i>, page 473.</p>

Required Selections	U.S. Price	Required to Specify
<b>Leg Style</b>		
• Straight legs	No cost	Specify with straight legs.
• Wallsaver legs	+\$ 25	Specify with wallsaver legs.

Options	U.S. Price	Required to Specify
<b>Surface Materials</b>		
• Moisture barrier	+\$134	Specify with moisture barrier.
<b>Seat</b>		
• Thick seat	+\$ 51	Specify with thick seat.
<b>Leg Guards</b>		
• Leg guards	+\$ 40	Specify with leg guards.
<b>Glides</b>		
• Soft felt glides	+\$ 9	Specify with soft glides.

#### Specification Information

Style Number	U.S. Base Prices										COM
	Fabric Price Group 1	Fabric Price Group 2	Fabric Price Group 3	Fabric Price Group 4	Fabric Price Group 5	Fabric Price Group 6	Fabric Price Group 7	Fabric Price Group 8	Fabric Price Group 9	Fabric Price Group 10	

#### Bariatric Stacking Chair With Upholstered Back

Style Number	Fabric Price Group 1	Fabric Price Group 2	Fabric Price Group 3	Fabric Price Group 4	Fabric Price Group 5	Fabric Price Group 6	Fabric Price Group 7	Fabric Price Group 8	Fabric Price Group 9	Fabric Price Group 10	COM
SC1065SA	\$651	\$703	\$813	\$867	\$903	\$957	\$1011	\$1101	\$1211	\$1383	\$703

#### Bariatric Stacking Chair With Wood Back

Style Number	Fabric Price Group 1	Fabric Price Group 2	Fabric Price Group 3	Fabric Price Group 4	Fabric Price Group 5	Fabric Price Group 6	Fabric Price Group 7	Fabric Price Group 8	Fabric Price Group 9	Fabric Price Group 10	COM
SC1065SA	\$833	\$859	\$914	\$941	\$959	\$986	\$1013	\$1058	\$1113	\$1199	\$859

#### Specification Information

Style Number	U.S. Price

#### Pair of Ganging Brackets

Style Number	U.S. Price
SC1080	\$64

## 18" Wide Easy Access Chairs

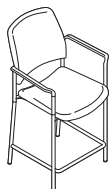

*Tip: Different fabrics for the seat and back can be specified. If the fabrics are in different price groups, calculate list price by adding the two price groups together and dividing by two.*

*Tip: Leg guard finish will coordinate with frame finish selection.*

	Standard Includes	Required to Specify
▶ Need help? Product details, page 329	<ul style="list-style-type: none"> <li>• Seat: fabric</li> <li>• Back: fabric or maple wood</li> <li>• Arm caps: plastic</li> <li>• Legs and frame: paint</li> <li>• Glides: black plastic</li> <li>• Ganging brackets, if selected: paint (ordered separately)</li> </ul>	<ol style="list-style-type: none"> <li>1 Style number</li> <li>2 Fabric color number for seat</li> <li>3 Fabric or wood color number for back</li> <li>4 Plastic color number for arm caps, if selected</li> <li>5 Paint color number for legs and frame</li> <li>6 Paint color number for ganging brackets, if selected</li> <li>7 Options, if selected (see below)</li> </ol> <p>▶ See <i>Surface Materials</i>, page 473.</p>

	Options	U.S. Price	Required to Specify
<b>Surface Materials</b>	• Moisture barrier	+\$134	Specify with moisture barrier.
<b>Seat</b>	• Thick seat	+\$ 51	Specify with thick seat.
<b>Leg Guards</b>	• Leg guards	+\$ 40	Specify with leg guards.
<b>Glides</b>	• Soft felt glides	+\$ 9	Specify with soft glides.

### Specification Information

• Style Number	U.S. Base Prices										• COM
	• Fabric Price Group 1	• Fabric Price Group 2	• Fabric Price Group 3	• Fabric Price Group 4	• Fabric Price Group 5	• Fabric Price Group 6	• Fabric Price Group 7	• Fabric Price Group 8	• Fabric Price Group 9	• Fabric Price Group 10	
•	•	•	•	•	•	•	•	•	•	•	•

### 18" Wide Easy Access Chairs With Upholstered Back

<b>SC1067EA</b>	\$600	\$642	\$712	\$754	\$776	\$814	\$850	\$918	\$994	\$1110	\$652
•	•	•	•	•	•	•	•	•	•	•	•

### 18" Wide Easy Access Chairs With Wood Back

<b>SC1067EA</b>	\$782	\$803	\$838	\$859	\$870	\$889	\$907	\$941	\$979	\$1037	\$808
•	•	•	•	•	•	•	•	•	•	•	•

### Specification Information

• Style Number	• U.S. Price
•	•

### Pair of Ganging Brackets

<b>SC1080</b>	\$64
•	•



#### For Canadian Pricing

Multiply U.S. Price by the Canadian price factor.

▶ See page 1 for details.

## 22" Wide Easy Access Chairs



	Standard Includes	Required to Specify
<p>► Need help? Product details, page 329</p>	<ul style="list-style-type: none"> <li>• Seat: fabric</li> <li>• Back: fabric or maple wood</li> <li>• Arm caps: plastic</li> <li>• Legs and frame: paint</li> <li>• Glides: black plastic</li> <li>• Ganging brackets, if selected: paint (ordered separately)</li> </ul>	<ol style="list-style-type: none"> <li>1 Style number</li> <li>2 Fabric color number for seat</li> <li>3 Fabric or wood color number for back</li> <li>4 Plastic color number for arm caps, if selected,</li> <li>5 Paint color number for legs and frame</li> <li>6 Paint color number for ganging brackets, if selected</li> <li>7 Options, if selected (see below)</li> </ol> <p>► See <i>Surface Materials</i>, page 473.</p>

*Tip: Different fabrics for the seat and back can be specified. If the fabrics are in different price groups, calculate list price by adding the two price groups together and dividing by two.*

*Tip: Leg guard finish will coordinate with frame finish selection.*

	Options	U.S. Price	Required to Specify
<b>Surface Materials</b>	• Moisture barrier	+\$134	Specify with moisture barrier.
<b>Seat</b>	• Thick seat	+\$ 51	Specify with thick seat.
<b>Leg Guards</b>	• Leg guards	+\$ 40	Specify with leg guards.
<b>Glides</b>	• Soft felt glides	+\$ 9	Specify with soft glides.

### Specification Information

Style Number	U.S. Base Prices										COM
	Fabric Price Group 1	Fabric Price Group 2	Fabric Price Group 3	Fabric Price Group 4	Fabric Price Group 5	Fabric Price Group 6	Fabric Price Group 7	Fabric Price Group 8	Fabric Price Group 9	Fabric Price Group 10	

### 22" Wide Easy Access Chairs With Upholstered Back

Style Number	Fabric Price Group 1	Fabric Price Group 2	Fabric Price Group 3	Fabric Price Group 4	Fabric Price Group 5	Fabric Price Group 6	Fabric Price Group 7	Fabric Price Group 8	Fabric Price Group 9	Fabric Price Group 10	COM
SC1069EA	\$686	\$734	\$834	\$882	\$912	\$ 960	\$1008	\$1094	\$1190	\$1344	\$738

### 22" Wide Easy Access Chairs With Wood Back

Style Number	Fabric Price Group 1	Fabric Price Group 2	Fabric Price Group 3	Fabric Price Group 4	Fabric Price Group 5	Fabric Price Group 6	Fabric Price Group 7	Fabric Price Group 8	Fabric Price Group 9	Fabric Price Group 10	COM
SC1069EA	\$868	\$892	\$942	\$966	\$981	\$1005	\$1029	\$1072	\$1120	\$1197	\$894

### Specification Information

Style Number	U.S. Price

### Pair of Ganging Brackets

Style Number	U.S. Price
SC1080	\$64



#### For Canadian Pricing

Multiply U.S. Price by the Canadian price factor.

► See page 1 for details.



## Dolly Carts

	Standard Includes	Required to Specify
▶ Need help? Product details, page 329	<ul style="list-style-type: none"> <li>Dolly frame: black</li> <li>Casters: black only</li> </ul>	Style number

### Specification Information

Dimensions			Style	U.S.
D	W	H	Number	Price

#### Dolly for 18" Wide Stacking Chairs

31 <sup>5</sup> / <sub>8</sub> "	21 <sup>1</sup> / <sub>2</sub> "	43 <sup>1</sup> / <sub>4</sub> "	<b>SC1060D</b>	\$619
----------------------------------	----------------------------------	----------------------------------	----------------	-------

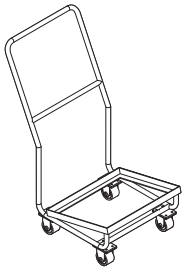

*Tip: Dolly cart can hold 10 18"W straight leg stacked chairs.*

#### Dolly for Bariatric Stacking Chairs

31 <sup>5</sup> / <sub>8</sub> "	29 <sup>1</sup> / <sub>2</sub> "	43 <sup>1</sup> / <sub>4</sub> "	<b>SC1065D</b>	\$690
----------------------------------	----------------------------------	----------------------------------	----------------	-------



*Tip: Dolly cart can hold six straight leg stacked bariatric chairs.*

*Tip: Dolly carts do not accommodate Sorrel wallsaver styles or 22"W stacking chairs.*



#### For Canadian Pricing

Multiply U.S. Price by the Canadian price factor.

▶ See page 1 for details.

# Sorrel Tables

**Sorrel freestanding and ganging tables** coordinate with Sorrel seating.

**High-Pressure Laminate tops** are 3/4" thick and have 3 mm plastic edge.

**Table ganging brackets** are standard with all ganging tables and finished in powder coat paint.

**Legs** are steel and finished with powder coat paint. Legs are included with all tops, except in-line ganging tables.

**Plastic glides** are standard. Soft felt glides available as an option.

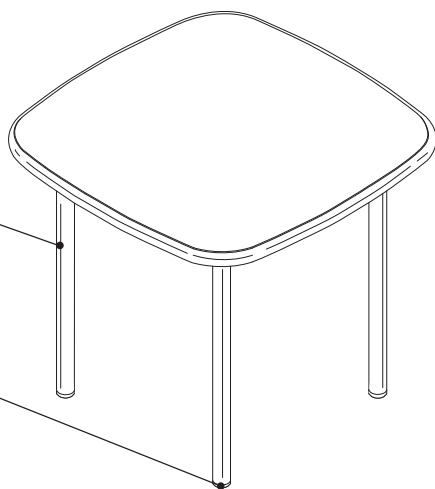
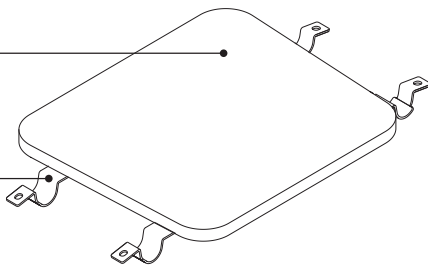

## Product Details



**Freestanding table** is square shaped with rounded corners. It is available in two heights.



**In-line ganging tables** are used to connect two chairs in a straight line configuration. Two widths are available and tables have ganging brackets on both sides.

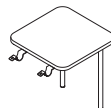
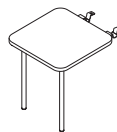

**Ganging end tables** have a square shape and are available in left- and right-hand facing versions. End tables have two legs on one side and ganging brackets on the other.



**Corner ganging table** has a curved back edge and is used to create an L-shape seating configuration. Corner table has one leg in the back and ganging brackets on both sides.



**Power** is available on all ganging tables and includes one standard outlet or two USB ports. Power cord exits through the underside of the table top. Standard outlet power is tamper and spill resistant. Steelcase recommends to check with all local and facility authorities prior to specification and order, to confirm acceptance of proposed product and application.

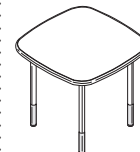

**Leg guards** are available as an option and coordinate with the leg finish.

## Surface Materials

### Top and edges

- High-Pressure Laminate with 3 mm plastic edge

### Legs

- Powder coat paint

### Glides

- Black plastic
- Black with soft felt

### Leg guards

- Black plastisol (when black legs are specified)
- Grey plastisol (when platinum legs are specified)

### Power

- 5U23 Blue Jay
- 6249 Platinum Solid
- 6337 Element
- 6338 Chili
- 6527 Merle

### Power cord

- White
- Black

## Actual Dimensions

Features	Overall Depth	Width	Height
<b>Freestanding Table</b>			
Square Table	18"	18"	16" and 18"
<b>Ganging Table</b>			
In-Line Table	15"	10" and 17"	18"
End Tables	16"	16"	18"
Corner Table	22½"	22½"	18"

# Sorrel Freestanding Table



Tip: Open Line laminate requires a selection of standard edge band finish.

Standard Includes		Required to Specify
<ul style="list-style-type: none"> <li>▶ Need help? Product details, page 338</li> </ul>	<ul style="list-style-type: none"> <li>• Table top and edge: High-Pressure Laminate with 3 mm plastic edge</li> <li>• Round legs: paint</li> <li>• Glides: black plastic</li> </ul>	<ol style="list-style-type: none"> <li>1 Style number</li> <li>2 Table height (see below under Required Selections)</li> <li>3 High-Pressure Laminate color number for top</li> <li>4 Plastic color number for table edge</li> <li>5 Paint color number for legs</li> <li>6 Options, if selected (see below)</li> </ol> <ul style="list-style-type: none"> <li>▶ See <i>Surface Materials</i>, page 473.</li> </ul>

	Required Selections	U.S. Price	Required to Specify
<b>Height</b>	<ul style="list-style-type: none"> <li>• 16"H</li> <li>• 18"H</li> </ul>	No cost +\$ 21	Specify with 16"H. Specify with 18"H.

	Options	U.S. Price	Required to Specify
<b>Surface Materials</b>	<b>Laminate</b> <ul style="list-style-type: none"> <li>• Steelcase Health laminate</li> <li>• Steelcase laminate</li> <li>• Open Line laminate</li> </ul>	No cost No cost +\$135 plus the cost of laminate	<ul style="list-style-type: none"> <li>▶ See <i>Surface Materials</i>, page 473.</li> <li>▶ See <i>Surface Materials</i>, page 473.</li> <li>▶ See <i>Surface Materials</i>, page 473.</li> </ul>

Tip: Leg guard finish will coordinate with frame finish selection.

<b>Leg Guards</b>	<ul style="list-style-type: none"> <li>• Leg guards</li> </ul>	+\$ 40	Specify with leg guards.
<b>Glides</b>	<ul style="list-style-type: none"> <li>• Soft felt glides</li> </ul>	+\$ 9	Specify with soft glides.

Specification Information				
Dimensions			Style Number	U.S. Base Price
D	W	H		
18"	18"	16"	<b>SC10621818</b>	\$445



**For Canadian Pricing**  
 Multiply U.S. Price by the Canadian price factor.  
 ▶ See page 1 for details.

# Sorrel Ganging Tables

Standard Includes	Required to Specify
<ul style="list-style-type: none"> <li>▶ Need help? Product details, page 338</li> <li>• Table top: High-Pressure Laminate with 3 mm plastic edge</li> <li>• Ganging brackets: paint</li> <li>• Leg on end tables and corner table: paint</li> <li>• Glides: black plastic</li> </ul>	<ol style="list-style-type: none"> <li>1 Style number</li> <li>2 In-line table width (see below under Required Selections), if selected</li> <li>3 Paint color number for frame</li> <li>4 High-Pressure Laminate color number for top</li> <li>5 Plastic color number for table edge</li> <li>6 Paint color number for ganging brackets and legs, if selected</li> <li>7 Options, if selected (see below)</li> </ol> <p>▶ See <i>Surface Materials</i>, page 473.</p>

	Required Selections	U.S. Price	Required to Specify
<b>In-Line Table Width</b>	<ul style="list-style-type: none"> <li>• 10"W</li> <li>• 17"W</li> </ul>	No cost +\$104	Specify <i>with 10"W</i> . Specify <i>with 17"W</i> .

	Options	U.S. Price	Required to Specify
<b>Surface Materials</b>	<ul style="list-style-type: none"> <li>• Steelcase Health laminates</li> <li>• Steelcase laminate</li> <li>• Open Line laminate</li> </ul>	No cost No cost +\$135 plus the cost of laminate	<p>▶ See <i>Surface Materials</i>, page 473.</p> <p>▶ See <i>Surface Materials</i>, page 473.</p> <p>▶ See <i>Surface Materials</i>, page 473.</p>

<b>Power</b>	<ul style="list-style-type: none"> <li>• No power</li> <li>• Power</li> <li>• Dual USB</li> </ul>	No cost +\$133 +\$233	Specify <i>with no power</i> . Specify <i>with power</i> and select plastic color number and cord color. Specify <i>with dual USB</i> and select pastic color number and cord color.
--------------	---	-----------------------------	--

<b>Leg Guards</b>	<ul style="list-style-type: none"> <li>• Leg guards</li> </ul>	+\$ 10 per leg	Specify <i>with leg guards</i> .
-------------------	--	----------------	----------------------------------

<b>Glides</b>	<ul style="list-style-type: none"> <li>• Hard glides</li> <li>• Soft felt glides</li> </ul>	No cost +\$ 9	Specify <i>with hard glides</i> . Specify <i>with soft glides</i> .
---------------	---	------------------	--

*Tip: Steelcase recommends to check with all local and facility authorities prior to specification and order of power, to confirm acceptance of proposed product and applications.*

*Tip: Power location is in the back center for all tables.*

*Tip: Leg guards are available on end and corner ganging tables.*

Specification Information				
Dimensions			Style Number	U.S. Base Price
D	W	H		

In-line Table				
15"	10"	18"	<b>SC1050</b>	\$159

## End Tables

Left-Hand Table				
16"	16"	18"	<b>SC1051L</b>	\$314

Right-Hand Table				
16"	16"	18"	<b>SC1051R</b>	\$314

Corner Table				
22½"	22½"	18"	<b>SC1054</b>	\$399

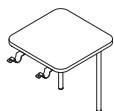

*Tip: Left- and right-hand is determined when facing the seating configuration.*





# Empath Recliners

**Empath recliner seating**

is designed with insight-led features and versatility to create a safer, high quality healthcare experience for both patients and caregivers.

**Seat cushion and back**

are upholstered over contoured molded foam. Elastic web straps in the seat and back, directly connected to tubular welded steel frames, provide additional short and long term comfort and support. Rounded seat and back cushion can also be specified.

**Backrest recline paddles**

control the reclining function of the chair. Paddles are standard on both sides of the chair and are long to ensure easy, intuitive use when upright or fully reclined.

**Bumpers** protect the chair and provide an ending point to the lower arms.

**Footrest control lever**

opens and closes the footrest and operates independently from the backrest recline paddles to provide maximum control and comfort.

**Central lock system**

is standard and features easy activation pedals at the front on both sides of the chair. Press down to set or release.

**Style numbers ending in "S"**

move central lock pedal further back towards the rear of the chair to accommodate sit-to-stand patient transfer lift aids. The location of the central lock in this further back position is 16.2" from the front of the chair to the brake pedal.

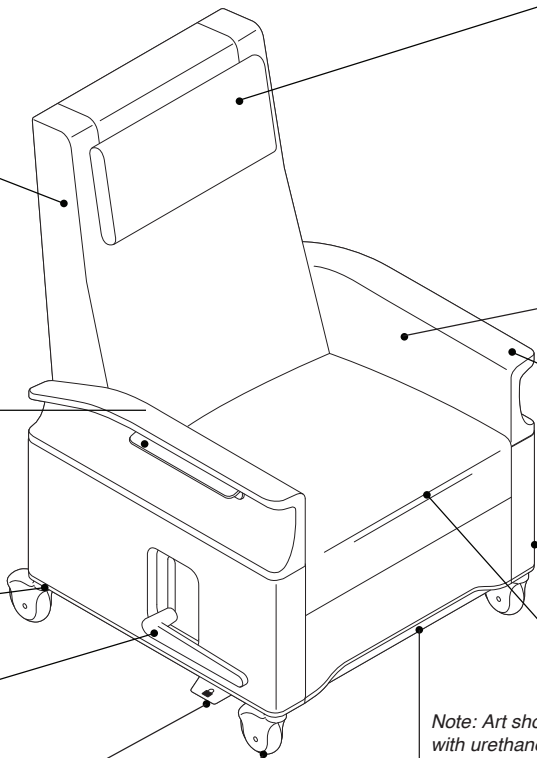

**Adjustable headrest** is optional and is attached to the back with a zipper for easy removal or replacement. It is adjustable and can be flipped over the back when not needed. Headrest is available in two shape styles.

**Flip-down arms** are available on one or both sides to safely and easily assist with patient transfers into or out of the chair.

**Upper arms** are urethane over molded foam and feature integrated hand grips for safe and easy ingress and egress.

**Frame and inner structure** are completely constructed of welded steel for long-term durability.

*Note: Art shown is with urethane arms.*

**Footrest** features a plastic scallop on 23" wide versions and upholstered scallop on 26" wide versions providing comfort where feet and shoes touch most. Scallop also helps facilitate safer exiting of the chair when footrest is closed by allowing heels to go farther underneath.

**Quiet soft casters** are 4" and non-marring and provide quiet, smooth operation. One piece caster housing integrates with the design of the chair and is easy to clean. Optional metal legs are also available.

**Seat cushion** is available in both standard and soft options.

**Actual Dimensions**

Features	Overall			Seat			Arm Height	Fully Reclined Depth	Clearance from floor to the bottom of brake pedal	Distance between front casters
	Depth	Width	Height	Depth	Width	Height				
Reclining chair	31 1/4"	31 5/8" and 34 5/8"	46 5/16"	21"	23" and 26"	20"	26 3/8"	73 3/16"	3.978"	23.842"
Reclining chair with Trendelenburg	31 1/4"	31 5/8" and 34 5/8"	46 5/16"	21"	23" and 26"	20"	26 3/8"	73 3/16"	3.978"	23.842"

*Tip: Seat height with metal legs is 18 1/4". Add 3/4" for adjustability of metal legs.*

**Empath recliners** are also available with fully upholstered arms.

**Backrest recline paddle** controls the recline function of the chair. Paddle is located on the left-side facing arm in a plastic bezel. Another recline paddle can be added through the dual recline paddles option.

**Seat cushion and back** are upholstered over contoured molded foam. Elastic web straps in the seat and back, directly connected to tubular welded steel frames, provide additional short and long term comfort and support. Rounded seat and back cushion can also be specified.

**Flip-down arms** are available on one or both sides to safely and easily assist with patient transfers into or out of the chair.

**Individual locking casters** are standard for Empath recliners with fully upholstered arms. Central lock can be applied to fully upholstered arm recliners.

**Bumpers** protect the chair and provide an ending point to the lower arms.

**Footrest control lever** opens and closes the footrest and operates independently from the backrest recline paddles to provide maximum control and comfort.

**Quiet soft casters** are 4" and non-marring and provide quiet, smooth operation. Optional metal legs are also available.

**Style numbers ending in "S"** move central lock pedal further back towards the rear of the chair to accommodate sit-to-stand patient transfer lift aids. The location of the central lock in this further back position is 16.2" from the front of the chair to the brake pedal.

**Adjustable headrest** is optional and is attached to the back with a zipper for easy removal or replacement. It is adjustable and can be flipped over the back when not needed. Headrest is available in two shape styles.

**Arms** are fully upholstered and available as fixed or flip-down arms.

**Plastic arm caps** are available as an option for increased cleanability on fully upholstered arms.

**Frame and inner structure** are completely constructed of welded steel for long-term durability.

**Seat cushion** is available in both standard and soft options.

*Note: Art shown is with fully upholstered arm.*

**Footrest** features a plastic scallop on 23" wide versions and upholstered scallop on 26" wide versions. Scallop also helps facilitate safer exiting of the chair when footrest is closed by allowing heels to go farther underneath.

**Actual Dimensions**

Features	Overall			Seat			Arm Height	Fully Reclined Depth
	Depth	Width	Height	Depth	Width	Height		
Reclining chair	31 1/4"	31 5/8" and 34 5/8"	46 5/16"	21"	23" and 26"	20"	26 11/16"	73 3/16"
Reclining chair with Trendelenburg	31 1/4"	31 5/8" and 34 5/8"	46 5/16"	21"	23" and 26"	20"	26 11/16"	73 3/16"

*Tip: Seat height with metal legs is 18 1/4". Add 3/4" for adjustability of metal legs.*

Empath Recliners, continued

Product Details

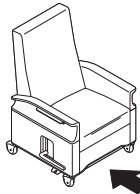

**Left and right for all features and options** are determined when facing the front of the chair.

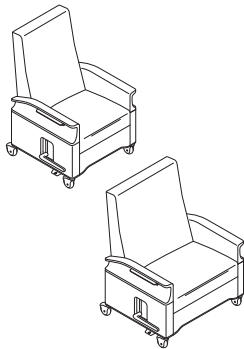

**Two seat widths** are available for all configurations—23"W and 26"W.

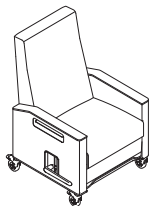

**Empath recliners** are available with fully upholstered arms.

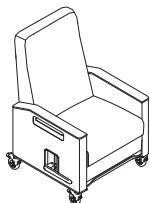

**Empath recliners** are available with a rounded seat and back cushion option. Seat and back must both have rounded corner option selected or both have square corners.

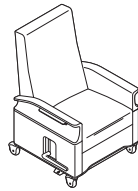

**Back recline mechanism** operates independently from the footrest and features infinite stop positions from upright to full recline.

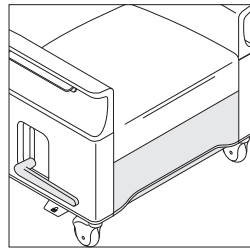

**Footrest lever** is standard on the left side facing arm. For most secure posture, open prior to reclining the back and close after returning back to the upright position.

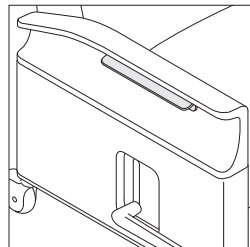

**Backrest recline paddles** are integrated into the urethane arm to provide intuitive and easy use. The paddles are long, providing the right interface whether sitting upright or reclined and are on both sides. Simply squeeze one or the other or both to operate the back recline mechanism.

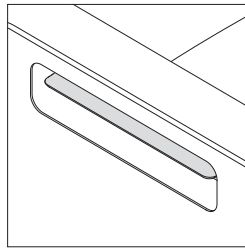

**Backrest recline paddles** are integrated into the fully upholstered arms in a bezel on the left-side facing arm. An additional right-side facing recline paddle can be added for dual recline mechanisms.

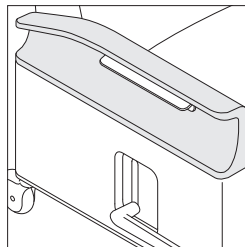

**Upper arms** are urethane over molded foam with aluminum die cast inserts. They feature an integrated grip and the backrest recline paddles. The gentle curve on the inside provides comfort and safety and the long, integrated grip from front to back on the outside provides support, especially when getting in or out of the chair. The arms are cushioned yet supportive, resilient, and easy to clean.

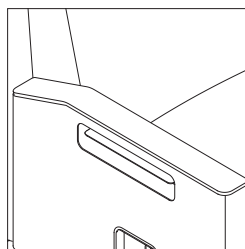

**Upper arms** can also be specified as fully upholstered through a separate style number. These arms are available as fixed, right side facing flip-down, left side facing flip-down, or dual flip-down arms.

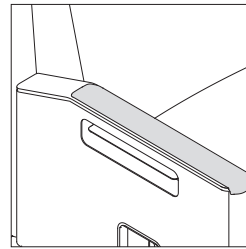

**Fully upholstered arms** can be ordered with or without plastic arm caps that will lay on top of the upholstered section.

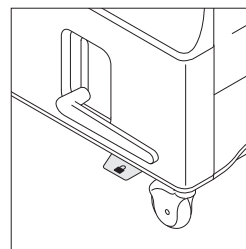

**Central lock system** features easy activation pedals at the front of the chair and on both sides. Use from either side by pushing down to lock and pushing down slightly again to unlock. Easily identify if the chair is secure simply by looking at the pedal and hearing an audible click. When activated, the system locks both the wheel rotation and swivel on three of the four casters to ensure the chair will not inadvertently move.

**Central lock system** comes standard with urethane arm recliners and as an option on fully upholstered arm recliners.

**Style numbers ending in "S"** move central lock pedal further back towards the rear of the chair to accommodate sit-to-stand patient transfer lift aids. The location of the central lock in this further back position is 16.2" from the front of the chair to the brake pedal.

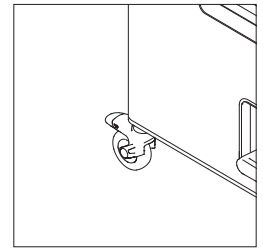

**Individually locking casters** come standard on Empath with fully upholstered arms. Individually locking casters are plastic and available on all chairs with fully upholstered arms. Individually locking casters are not available on Empath with molded urethane upper arms.

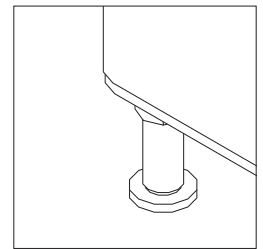

**Metal legs** are an available option and are powder coated aluminum. Metal legs are 4" tall and are adjustable up to 3/4".

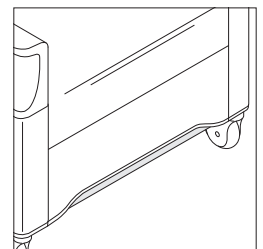

**Footrest** features a plastic scallop on 23" wide versions and upholstered scallop on 26" wide versions providing comfort where feet and shoes touch most. Scallop also helps facilitate safer exiting of the chair when footrest is closed by allowing heels to go farther underneath.



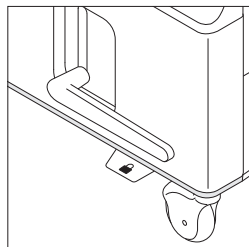

**Bumper along the bottom of the arm panels** acts to protect the chair and provides an ending point to bottom of the chair.

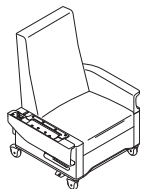

**Flip-down arm** assists with patient transfer into or out of the chair and is available on the left, right, or both sides. Arms self-lock when lifted back to the upright position.

*Tip: IV pole, IV pole holder, and drainage bag is not available on folding Empath fully upholstered arms.*

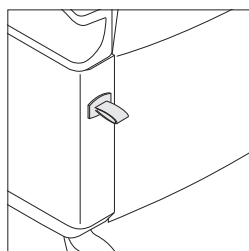

**Flip-down arm release strap** is located on the back of the arm for caregiver operation. Simply pull strap and fold arm down.

*Tip: For urethane arm only.*

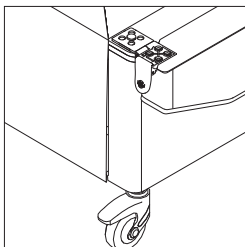

**For fully upholstered arms**, the flip-down arm release is located on the back of the arm for caregiver operation. Press down on release lever and fold arm down.

**When fully upholstered arms** are folded over for patient transport, the transfer surface is molded plastic and fabric to create a snug fit to reduce gapping.



**Urethane Empath arms and fully upholstered Empath arms** use two different tablet arms which are not interchangeable.

Tablet arm on urethane Empath arm swivels 270° when up and folds down to the side of the chair when not needed. Simply rotate up to lock into up position. To lower, press release button on tablet arm and rotate down. Tablet surface is 9<sup>3</sup>/<sub>4</sub>" x 19<sup>3</sup>/<sub>4</sub>" and can be specified on units with at least one fixed arm. Tablet arm location, left or right side (shown), drives the footrest lever placement—footrest lever will be on the arm panel opposite the tablet. Tablet arm adds approximately 2" to the width and 3<sup>1</sup>/<sub>2</sub>" to the depth of the recliner when up and in front position and 4" to both the width and depth when in the down position.

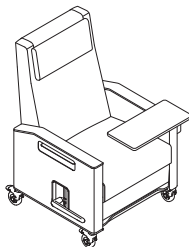

**Tablet arm** on fully upholstered Empath arms swivels 270°. The tablet surface is 9<sup>3</sup>/<sub>4</sub>" x 19<sup>3</sup>/<sub>4</sub>" and is thermoform. The tablet arm can be applied to the right-side facing arm or the left-side facing arm. Footrest lever will be on the left-side facing arm panel. Tablet arm adds approximately 2<sup>3</sup>/<sub>5</sub>" to the width of the recliner. Tablets on fully upholstered Empath arms do not fold down to the side of recline. Tablet arm always remains in upward position.

**Tablets** can only be specified on fixed arms and cannot be specified on fold-down arms.

*Tip: IV pole, IV pole holder, and drainage bag is not available on folding Empath fully upholstered arms.*

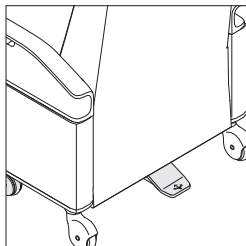

**Directional steering system** helps the chair track straight while in motion, improving control in hallways and around corners. System allows caregivers to turn steering on or off and is independent of central lock. Activation pedal is conveniently located on the back of the recliner. Press down to engage two directional casters. Press down slightly again to disengage, allowing chair to move directly sideways or any other direction required within tight spaces. Directional steering is not available for chairs with metal legs.

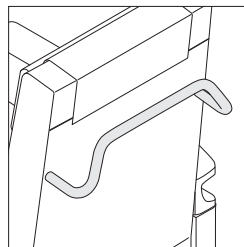

**Push bar** is conveniently located and ergonomically shaped to enhance caregiver grip and maneuverability.

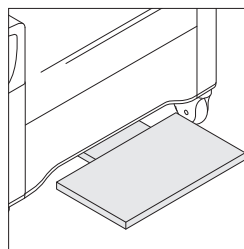

**Pull out footrest** easily slides out from underneath the chair to support a patient's feet while seated.

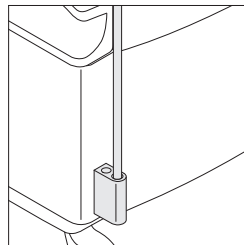

**IV pole** fits into the IV pole holder and is ordered separately. It is 3/4" diameter and height adjustable. The pole features a two loop hanger at the top.

**IV pole holder** is positioned on the back of the arm panel and accommodates 1/2" to 3/4" IV poles. It can be mounted on the left- or right-side facing. IV pole holder option does not include IV pole; it can be ordered separately.

**IV pole holder** is not available on a fully upholstered Empath flip-down arm.

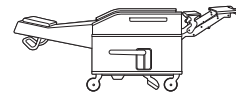

**Trendelenburg** foot is foot activated from either side and allows the caregiver to recline the chair so a patient's feet are above the head.

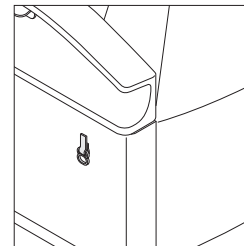

**Drainage bag hanger** accommodates various drainage bags and lays flat when not in use. It is available on all models and can be located in the front, center, or rear of the chair.

*Tip: For all Empath recliners specified before June 2024, the rear location was the standard location.*

**Dual locations (left and right)** are only available for rear location. Center location is limited to one side (right or left), dependent on footrest lever location to avoid interaction. Front location is limited to one side (right or left), dependent on footrest lever location to avoid interaction.

*Tip: Possible interference exists when a drainage bag hanger is specified on the same side as a flip-down arm or the footrest lever and a drainage bag is attached. Care should be exercised in these configurations to help avoid inadvertent damage to the bag. There is no interference between the flip-down arm or footrest lever and drainage bag hanger itself (without a bag attached).*

**Drainage bag holder** is not available on a fully upholstered Empath with flip-down arm.

Empath Recliners, continued

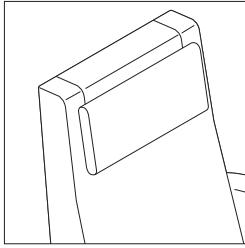

**Square headrest**

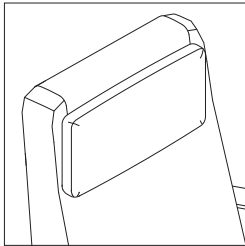

**Round headrest**

**An optional headrest** is available on Empath recliners. The headrest is square or round and can be removed by zipper.

**Both headrest shapes** are available on both square and rounded seat and back cushion styles.

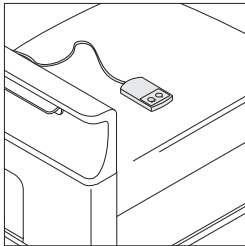

**Heat and massage option** is UL approved. Both functions feature three settings allowing the user to adjust for personal preference. User hand held control pendant has a flexible cord and stores on the side of the back when not in use.

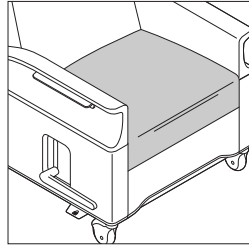

**Seat cushion** is available in standard and soft options. When softer seat is selected, seat foam is approximately 15% softer.

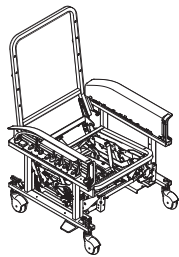

**Frame and inner structure**, including the arm panels, seat pan, back frame, mechanism, and chassis are completely constructed of welded steel for long term durability.

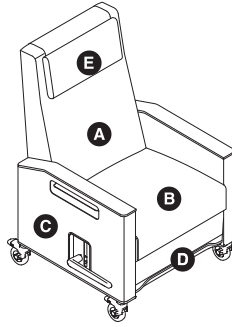
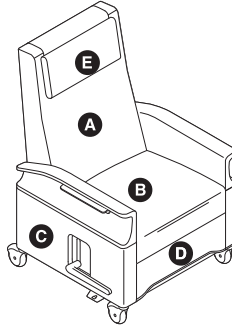

**Up to four different fabrics** can be specified: back (A), seat (B), sides (C), and front (D). The headrest (E) is a separate specifiable option.

**Moisture barrier** is available as an option on the seat only.

**Surface Materials**

**All Steelcase Health seating with standard upholstery fabrics** comply with the State of California Technical Bulletin 117-2013.

**Seat and back**

- Fabric
- Fabric with Moisture Barrier (option on seat only)

**Headrest**

- Fabric

**Urethane upper arms**

- Plastic over molded foam—Sterling Dark or Midnight

**Fully upholstered arms**

- Fabric

**Arm caps for fully upholstered arms**

- Plastic - Sterling Dark or Midnight

**Intermediate transfer arm cap (fully upholstered folding arm only)**

- Plastic - Sterling Dark or Midnight

**Low arm panels (sides)**

- Fabric

**Footrest (front)**

- Fabric

**Bumpers**

- Plastic to match upper arms

**Backrest recline paddles**

- Platinum Solid plastic

**Footrest scallop**

- Plastic to match upper arms on 23"W
- Fabric on 26"W

**Footrest control lever and bezel**

- Platinum Solid plastic

**Central lock pedals**

- Platinum Solid plastic with red visual indicator graphics

**Trendelenburg pedals**

- Platinum Solid plastic with red visual indicator graphics

**Directional steering pedal**

- Platinum Solid plastic with green visual indicator graphics

**Casters**

- Plastic housing color to match upper arms

**Legs**

- Powder coated aluminum in sterling dark, with matching default on casters, arm caps, and bumpers
- Powder coated aluminum in midnight, with matching default on casters, arm caps, and bumpers

**Wheels**

- Grey when Sterling Dark arms are specified
- Black when Midnight arms are specified

**Push bar**

- Platinum Solid paint

**Pull out footrest**

- Black slip-resistant surface

**Tablet arm**

- Thermoform surface
- Platinum Solid powder coated metal arm

**IV pole**

- Stainless steel

**IV pole holder**

- Platinum Solid paint

**Drainage bag hanger**

- Anodized aluminum with black nylon strap

**Shipping**

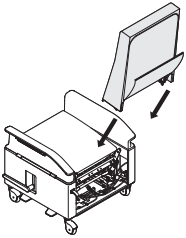

**Empath recliner back** ships uninstalled and requires field assembly. Assembly instructions can be found on [village.steelcase.com](http://village.steelcase.com). Installation requires back to be slid into place and attached with two 7/16" bolts.

**Tablet arm option** ships separately and requires field assembly. Instructions are included in the shipping box or can be found on [village.steelcase.com](http://village.steelcase.com).

# Empath Recliners

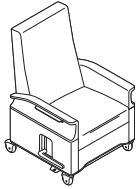

Tip: Left and right for flip-down arms, tablet, drainage bag hanger, and IV pole holder are determined when facing the front of the chair.

Tip: Different fabrics for the seat, back, sides, and front can be specified. If the fabrics are in different price groups, calculate list price by adding the price groups for each surface together and dividing by four. For example, if specifying seat and front fabric both in group 2, sides in group 4, and back in group 6, add the list price in price group 2 twice (seat + front), price group 4 once (sides), and price group 6 (back) once then divide by four.

Tip: Tablet can be located on a fixed arm only. It is not available on dual flip-down arm models. If specified on right flip-down arm models or on the left side facing arm of fixed arm models, the footrest lever will be placed on the right side facing arm panel, opposite the tablet.

Tip: Directional steering, push bar, and pull out footrest are ordered as options.

Tip: IV pole option does not include pole holder (and vice versa). Must order each option separately.

Tip: Possible interference exists when a drainage bag hanger is specified on the same side as a flip-down arm or the footrest lever and a drainage bag is attached. Care should be exercised in these configurations to help avoid inadvertent damage to the bag. There is no interference between the flip-down arm or footrest lever and drainage bag hanger itself (without a bag attached).

Standard Includes	Required to Specify
<ul style="list-style-type: none"> <li>▶ Need help? Product details, page 342</li> <li>• Seat, back, sides, and front: fabric price group 1</li> <li>• Upper arms: plastic over molded foam</li> <li>• 23"W seat</li> <li>• Standard seat</li> <li>• Bumpers: plastic to match upper arms</li> <li>• Footrest scallop:                             <ul style="list-style-type: none"> <li>– Plastic to match upper arms, if 23"W selected</li> <li>– Fabric to match front, if 26"W selected</li> </ul> </li> <li>• Dual backrest recline activation</li> <li>• 4" central locking casters with activation pedals on both sides: housing color to match upper arms</li> <li>• Headrest, if selected: fabric</li> <li>• Recliners for use with sit-to-stand aid: central lock</li> </ul>	<ul style="list-style-type: none"> <li>1 Style number</li> <li>2 Fabric color number for seat, back, sides, and front</li> <li>3 Plastic color number for upper arms</li> <li>4 Options, if selected (see below)</li> <li>▶ See <i>Surface Materials</i>, page 473.</li> </ul>

Options	U.S. Price	Required to Specify
<b>Surface Materials</b> • Moisture barrier on seat	+\$ 270	Specify with moisture barrier.
<b>Seat Foam</b> • Softer seat	No cost	Specify with softer seat.
<b>Seat Width</b> • 26"W	+\$ 881	Specify with 26" seat width.
<b>Adjustable Headrest</b> • Square corners • Round corners	+\$ 267 +\$ 293	Specify with square corners and select fabric color number. Specify with round corners and select fabric color number.
<b>Heat and Massage</b> • Heat only • Heat and massage	+\$1168 +\$1557	Specify with heat. Specify with heat and massage.
<b>Tablet Arm</b> • Flip up tablet arm for non-upholstered arms	+\$ 803	Specify with flip up tablet arm, indicate left or right facing, and select thermoform color number.
<b>Directional Steering</b> • Directional steering	+\$ 536	Specify with directional steering.
<b>Push Bar</b> • Push bar	+\$ 242	Specify with push bar.
<b>Pull Out Footrest</b> • Pull out footrest	+\$ 621	Specify with pull out footrest.
<b>IV Pole Holder</b> • IV pole holder	+\$ 160	Specify with IV pole holder and indicate left or right facing.
<b>IV Pole</b> • IV pole	+\$ 412	Specify with IV pole.
<b>Drainage Bag Hanger</b> • No drainage bag hanger • Drainage bag hanger left side facing rear • Drainage bag hanger right side facing rear • Drainage bag hanger left and right rear • Drainage bag hanger right side facing center • Drainage bag hanger left side facing center • Drainage bag hanger right side facing front • Drainage bag hanger left side facing front	No cost +\$ 78 per hanger +\$ 78 per hanger +\$ 78 per hanger +\$ 78 per hanger +\$ 78 per hanger +\$ 78 per hanger +\$ 78 per hanger +\$ 78 per hanger	Specify no drainage bag hanger. Specify with drainage bag hanger. Specify with drainage bag hanger. Specify with drainage bag hanger. Specify with drainage bag hanger. Specify with drainage bag hanger. Specify with drainage bag hanger. Specify with drainage bag hanger.

▶ Options, continued on next page

► Options, continued from previous page

Options	U.S. Price	Required to Specify
<b>Casters</b> • Central lock	+\$ 971	Specify with central lock.
<b>Seat and Back Cushion</b> • Rounded seat and back cushion	+\$ 93	Specify with rounded corners.
<b>Legs</b> • Metal legs	+\$ 11	Specify with metal legs and select paint finish.

Specification Information

Style Number	U.S. Base Prices										COM
	Fabric Price Group 1	Fabric Price Group 2	Fabric Price Group 3	Fabric Price Group 4	Fabric Price Group 5	Fabric Price Group 6	Fabric Price Group 7	Fabric Price Group 8	Fabric Price Group 9	Fabric Price Group 10	

Recliner

With Fixed Arms

<b>HR223</b>	\$6177	\$6412	\$6645	\$6837	\$7041	\$7157	\$7345	\$7733	\$7985	\$8209	\$6273
--------------	--------	--------	--------	--------	--------	--------	--------	--------	--------	--------	--------



With Left Flip-Down Arm

<b>HR223L</b>	\$6757	\$6992	\$7225	\$7417	\$7621	\$7737	\$7925	\$8313	\$8565	\$8789	\$6853
---------------	--------	--------	--------	--------	--------	--------	--------	--------	--------	--------	--------

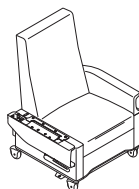

With Right Flip-Down Arm

<b>HR223R</b>	\$6757	\$6992	\$7225	\$7417	\$7621	\$7737	\$7925	\$8313	\$8565	\$8789	\$6853
---------------	--------	--------	--------	--------	--------	--------	--------	--------	--------	--------	--------

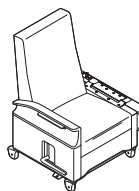

With Dual Flip-Down Arms

<b>HR223D</b>	\$7275	\$7510	\$7743	\$7935	\$8139	\$8255	\$8443	\$8831	\$9083	\$9307	\$7371
---------------	--------	--------	--------	--------	--------	--------	--------	--------	--------	--------	--------

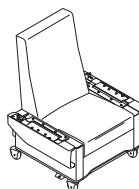

Tip: Central lock is optional on recliners not for use with sit-to-stand aid and upcharge is reflected in base prices.

► Specification Information, continued on next page



**For Canadian Pricing**

Multiply U.S. Price by the Canadian price factor.

► See page 1 for details.

► Specification Information, continued from previous page

Specification Information											
Style Number	U.S. Base Prices										COM
	Fabric Price Group 1	Fabric Price Group 2	Fabric Price Group 3	Fabric Price Group 4	Fabric Price Group 5	Fabric Price Group 6	Fabric Price Group 7	Fabric Price Group 8	Fabric Price Group 9	Fabric Price Group 10	

**Recliner for Use with Sit-to-Stand Aid**

**With Fixed Arms**



<b>HR223S</b>	\$6177	\$6412	\$6645	\$6837	\$7041	\$7157	\$7345	\$7733	\$7985	\$8209	\$6273
---------------	--------	--------	--------	--------	--------	--------	--------	--------	--------	--------	--------

**With Left Flip-Down Arm**

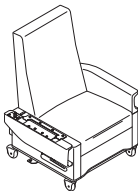

<b>HR223LS</b>	\$6757	\$6992	\$7225	\$7417	\$7621	\$7737	\$7925	\$8313	\$8565	\$8789	\$6853
----------------	--------	--------	--------	--------	--------	--------	--------	--------	--------	--------	--------

**With Right Flip-Down Arm**

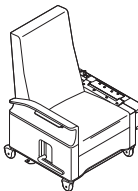

<b>HR223RS</b>	\$6757	\$6992	\$7225	\$7417	\$7621	\$7737	\$7925	\$8313	\$8565	\$8789	\$6853
----------------	--------	--------	--------	--------	--------	--------	--------	--------	--------	--------	--------

**With Dual Flip-Down Arms**

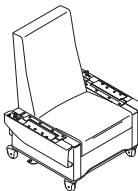

<b>HR223DS</b>	\$7275	\$7510	\$7743	\$7935	\$8139	\$8255	\$8443	\$8831	\$9083	\$9307	\$7371
----------------	--------	--------	--------	--------	--------	--------	--------	--------	--------	--------	--------

Tip: Central lock is required for recliners for use with sit-to-stand aid and upcharge is reflected in base prices.

Tip: Style numbers ending in "S" move central lock pedal further back towards the rear of the chair to accommodate sit-to-stand patient transfer lift aids. The location of the central lock in this further back position is 16.2" from the front of the chair to the brake pedal. Verify dimensions of sit-to-stand aid to ensure fit with Empath.

Tip: Style numbers ending in "S" cannot include directional steering option due to interference with sit-to-stand patient transfer lift aid.

Tip: Style numbers ending in "S" are not available with Trendelenburg.

Tip: Pull out footrest can interfere with sit-to-stand patient transfer lift aids and not recommended to be specified.

► Specification Information, continued on next page



**For Canadian Pricing**

Multiply U.S. Price by the Canadian price factor.

► See page 1 for details.

► Specification Information, continued from previous page

**Specification Information**

Style Number	U.S. Base Prices										COM
	Fabric Price Group 1	Fabric Price Group 2	Fabric Price Group 3	Fabric Price Group 4	Fabric Price Group 5	Fabric Price Group 6	Fabric Price Group 7	Fabric Price Group 8	Fabric Price Group 9	Fabric Price Group 10	

**Recliner with Trendelenburg**

**With Fixed Arms**



<b>HR223T</b>	\$6705	\$6940	\$7173	\$7365	\$7569	\$7685	\$7873	\$8261	\$8513	\$8737	\$6801
---------------	--------	--------	--------	--------	--------	--------	--------	--------	--------	--------	--------

**With Left Flip-Down Arm**

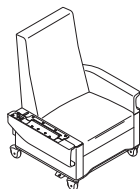

<b>HR223TL</b>	\$7285	\$7520	\$7753	\$7945	\$8149	\$8265	\$8453	\$8841	\$9093	\$9317	\$7381
----------------	--------	--------	--------	--------	--------	--------	--------	--------	--------	--------	--------

**With Right Flip-Down Arm**

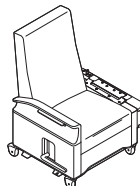

<b>HR223TR</b>	\$7285	\$7520	\$7753	\$7945	\$8149	\$8265	\$8453	\$8841	\$9093	\$9317	\$7381
----------------	--------	--------	--------	--------	--------	--------	--------	--------	--------	--------	--------

**With Dual Flip-Down Arms**

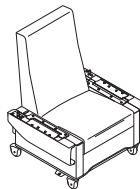

<b>HR223TD</b>	\$7803	\$8038	\$8271	\$8463	\$8667	\$8783	\$8971	\$9359	\$9611	\$9835	\$7899
----------------	--------	--------	--------	--------	--------	--------	--------	--------	--------	--------	--------

# Empath Recliners with Fully Upholstered Arms

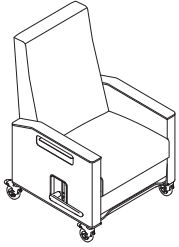

Tip: Left and right for tablet and drainage bag hanger are determined when facing the front of the chair.

Tip: Tablet arm for fully upholstered arm units is not the same as tablet arm for molded urethane arm units.

Tip: Directional steering, push bar, and pull out footrest are ordered as options.

Tip: IV pole option does not include pole holder (and vice versa). Must order each option separately.

Tip: Drainage bag or IV pole holder cannot be specified on a flip-down fully upholstered arm due to interference.

Tip: Central lock is optional on recliners not for use with sit-to-stand aid and upcharge is reflected in base prices.



**For Canadian Pricing**  
Multiply U.S. Price by the Canadian price factor.  
▶ See page 1 for details.

Standard Includes	Required to Specify
<ul style="list-style-type: none"> <li>▶ Need help? Product details, page 342</li> <li>• Seat, back, arms, and front: fabric price group 1</li> <li>• 23"W seat</li> <li>• Standard seat</li> <li>• Bumpers: plastic to match upper arms</li> <li>• Footrest scallop:                             <ul style="list-style-type: none"> <li>– Plastic to match upper arms, if 23"W selected</li> <li>– Fabric to match front, if 26"W selected</li> </ul> </li> <li>• Left-side facing recline activation</li> <li>• Individual locking casters</li> <li>• Headrest, if selected: fabric</li> <li>• Recliners for use with sit-to-stand aid: central lock</li> </ul>	<ol style="list-style-type: none"> <li>1 Style number</li> <li>2 Fabric color number for seat, back, arms, and front</li> <li>3 Options, if selected (see below)                             <ul style="list-style-type: none"> <li>▶ See <i>Surface Materials</i>, page 473.</li> </ul> </li> </ol>

Options	U.S. Price	Required to Specify
<b>Surface Materials</b> <ul style="list-style-type: none"> <li>• <b>Moisture barrier on seat</b> <ul style="list-style-type: none"> <li>• Moisture barrier</li> </ul> </li> <li>• <b>Arm cap</b> <ul style="list-style-type: none"> <li>• Plastic arm cap</li> </ul> </li> </ul>	<ul style="list-style-type: none"> <li>+\$ 270</li> <li>+\$ 144</li> </ul>	<ul style="list-style-type: none"> <li>Specify with moisture barrier.</li> <li>Specify with 6059 Sterling Dark or 6259 Midnight.</li> </ul>
<b>Seat Foam</b> <ul style="list-style-type: none"> <li>• Softer seat</li> </ul>	No cost	Specify with softer seat.
<b>Seat Width</b> <ul style="list-style-type: none"> <li>• 26"W</li> </ul>	+\$ 881	Specify with 26" seat width.
<b>Adjustable Headrest</b> <ul style="list-style-type: none"> <li>• Square corners</li> <li>• Round corners</li> </ul>	<ul style="list-style-type: none"> <li>+\$ 267</li> <li>+\$ 293</li> </ul>	<ul style="list-style-type: none"> <li>Specify with square corners and select fabric color number.</li> <li>Specify with round corners and select fabric color number.</li> </ul>
<b>Heat and Massage</b> <ul style="list-style-type: none"> <li>• Heat only</li> <li>• Heat and massage</li> </ul>	<ul style="list-style-type: none"> <li>+\$1168</li> <li>+\$1557</li> </ul>	<ul style="list-style-type: none"> <li>Specify with heat.</li> <li>Specify with heat and massage.</li> </ul>
<b>Tablet Arm</b> <ul style="list-style-type: none"> <li>• Tablet arm for fully upholstered arms</li> </ul>	+\$ 552	Specify with tablet arm, indicate left or right facing, and select thermoform color number.
<b>Directional Steering</b> <ul style="list-style-type: none"> <li>• Directional steering</li> </ul>	+\$ 536	Specify with directional steering.
<b>Push Bar</b> <ul style="list-style-type: none"> <li>• Push bar</li> </ul>	+\$ 242	Specify with push bar.
<b>Pull Out Footrest</b> <ul style="list-style-type: none"> <li>• Pull out footrest</li> </ul>	+\$ 621	Specify with pull out footrest.
<b>IV Pole Holder</b> <ul style="list-style-type: none"> <li>• IV pole holder</li> </ul>	+\$ 160	Specify with IV pole holder and indicate left or right facing.
<b>IV Pole</b> <ul style="list-style-type: none"> <li>• IV pole</li> </ul>	+\$ 412	Specify with IV pole.
<b>Drainage Bag Hanger</b> <ul style="list-style-type: none"> <li>• Drainage bag hanger</li> </ul>	+\$ 78 per hanger	Specify with drainage bag hanger and indicate left facing, right facing, or both sides.
<b>Casters</b> <ul style="list-style-type: none"> <li>• Central lock</li> </ul>	+\$ 971	Specify with central lock.
<b>Backrest Recline</b> <ul style="list-style-type: none"> <li>• Standard recline</li> <li>• Dual recline</li> </ul>	<ul style="list-style-type: none"> <li>No cost</li> <li>+\$ 125</li> </ul>	<ul style="list-style-type: none"> <li>Specify with standard recline.</li> <li>Specify with dual recline.</li> </ul>
<b>Seat and Back Cushion</b> <ul style="list-style-type: none"> <li>• Rounded seat and back cushion</li> </ul>	+\$ 93	Specify with rounded corners.
<b>Legs</b> <ul style="list-style-type: none"> <li>• Metal legs</li> </ul>	+\$ 11	Specify with metal legs and select paint finish.



**Specification Information**

Style Number	U.S. Base Prices										COM
	Fabric Price Group 1	Fabric Price Group 2	Fabric Price Group 3	Fabric Price Group 4	Fabric Price Group 5	Fabric Price Group 6	Fabric Price Group 7	Fabric Price Group 8	Fabric Price Group 9	Fabric Price Group 10	

**Fully Upholstered Recliner**

**With Fixed Fully Upholstered Arms**

<b>HR223U</b>	\$4399	\$4649	\$4891	\$5087	\$5301	\$5427	\$5619	\$6030	\$6284	\$6520	\$4495
---------------	--------	--------	--------	--------	--------	--------	--------	--------	--------	--------	--------

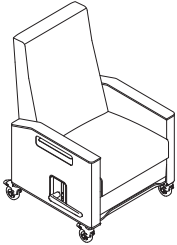

**With Left Flip-Down Arm**

<b>HR223LU</b>	\$5108	\$5343	\$5576	\$5768	\$5972	\$6088	\$6276	\$6664	\$6916	\$7140	\$5204
----------------	--------	--------	--------	--------	--------	--------	--------	--------	--------	--------	--------

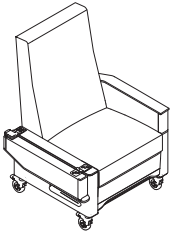

**With Right Flip-Down Arm**

<b>HR223RU</b>	\$5108	\$5343	\$5576	\$5768	\$5972	\$6088	\$6276	\$6664	\$6916	\$7140	\$5204
----------------	--------	--------	--------	--------	--------	--------	--------	--------	--------	--------	--------

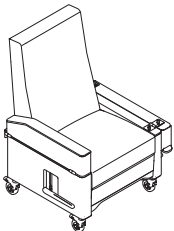

**With Dual Flip-Down Arms**

<b>HR223DU</b>	\$5816	\$6051	\$6284	\$6476	\$6680	\$6796	\$6984	\$7372	\$7624	\$7848	\$5912
----------------	--------	--------	--------	--------	--------	--------	--------	--------	--------	--------	--------

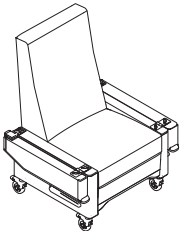

► **Specification Information, continued on next page**

Recliner Seating

 **For Canadian Pricing**  
 Multiply U.S. Price by the Canadian price factor.  
 ► See page 1 for details.

Empath Recliners with Fully Upholstered Arms, continued

► Specification Information, continued from previous page

**Specification Information**

Style Number	U.S. Base Prices										COM
	Fabric Price Group 1	Fabric Price Group 2	Fabric Price Group 3	Fabric Price Group 4	Fabric Price Group 5	Fabric Price Group 6	Fabric Price Group 7	Fabric Price Group 8	Fabric Price Group 9	Fabric Price Group 10	

**Fully Upholstered Recliner for Use with Sit-to-Stand Aid**

**With Fixed Fully Upholstered Arms**

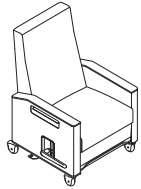

<b>HR223US</b>	\$5370	\$5620	\$5862	\$6058	\$6272	\$6398	\$6590	\$7001	\$7255	\$7491	\$5466
----------------	--------	--------	--------	--------	--------	--------	--------	--------	--------	--------	--------

**With Left Flip-Down Arm**

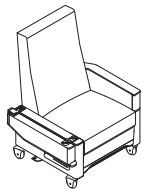

<b>HR223LUS</b>	\$6079	\$6314	\$6547	\$6739	\$6943	\$7059	\$7247	\$7635	\$7887	\$8111	\$6175
-----------------	--------	--------	--------	--------	--------	--------	--------	--------	--------	--------	--------

**With Right Flip-Down Arm**

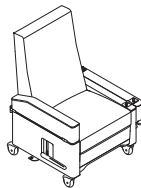

<b>HR223RUS</b>	\$6079	\$6314	\$6547	\$6739	\$6943	\$7059	\$7247	\$7635	\$7887	\$8111	\$6175
-----------------	--------	--------	--------	--------	--------	--------	--------	--------	--------	--------	--------

**With Dual Flip-Down Arms**

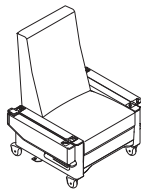

<b>HR223DUS</b>	\$6787	\$7022	\$7255	\$7447	\$7651	\$7767	\$7955	\$8343	\$8595	\$8819	\$6883
-----------------	--------	--------	--------	--------	--------	--------	--------	--------	--------	--------	--------

Tip: Central lock is required for recliners for use with sit-to-stand aid and upcharge is reflected in base prices.

Tip: Style numbers ending in "S" move central lock pedal further back towards the rear of the chair to accommodate sit-to-stand patient transfer lift aids. The location of the central lock in this further back position is 16.2" from the front of the chair to the brake pedal. Verify dimensions of sit-to-stand aid to ensure fit with Empath.

Tip: Style numbers ending in "S" cannot include directional steering option due to interference with sit-to-stand patient transfer lift aid.

Tip: Style numbers ending in "S" are not available with Trendelenburg.

Tip: Pull out footrest can interfere with sit-to-stand patient transfer lift aids and not recommended to be specified.

► Specification Information, continued on next page



**For Canadian Pricing**

Multiply U.S. Price by the Canadian price factor.

► See page 1 for details.

► Specification Information, continued from previous page

Specification Information											
U.S. Base Prices											
Style Number	Fabric Price Group 1	Fabric Price Group 2	Fabric Price Group 3	Fabric Price Group 4	Fabric Price Group 5	Fabric Price Group 6	Fabric Price Group 7	Fabric Price Group 8	Fabric Price Group 9	Fabric Price Group 10	COM

**Fully Upholstered Recliner with Trendelenburg**

**With Fixed Fully Upholstered Arms**

<b>HR223TU</b>	\$4927	\$5177	\$5419	\$5615	\$5829	\$5955	\$6147	\$6558	\$6812	\$7048	\$5023
----------------	--------	--------	--------	--------	--------	--------	--------	--------	--------	--------	--------

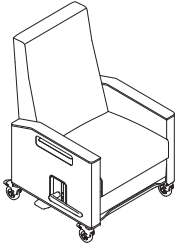

**With Left Flip-Down Arm**

<b>HR223TLU</b>	\$5636	\$5871	\$6104	\$6296	\$6500	\$6616	\$6804	\$7192	\$7444	\$7668	\$5732
-----------------	--------	--------	--------	--------	--------	--------	--------	--------	--------	--------	--------

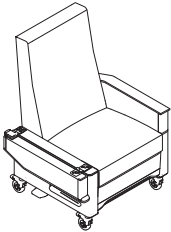

**With Right Flip-Down Arm**

<b>HR223TRU</b>	\$5636	\$5871	\$6104	\$6296	\$6500	\$6616	\$6804	\$7192	\$7444	\$7668	\$5732
-----------------	--------	--------	--------	--------	--------	--------	--------	--------	--------	--------	--------

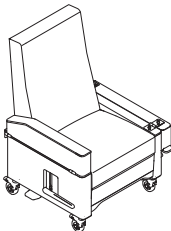

**With Dual Flip-Down Arms**

<b>HR223TDU</b>	\$6344	\$6579	\$6812	\$7004	\$7208	\$7324	\$7512	\$7900	\$8152	\$8376	\$6440
-----------------	--------	--------	--------	--------	--------	--------	--------	--------	--------	--------	--------

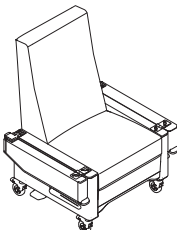

Recliner Seating

 **For Canadian Pricing**  
 Multiply U.S. Price by the Canadian price factor.  
 ► See page 1 for details.

# Mineral Recliners

**Mineral recliner seating** is designed to provide big chair comfort in a compact size.

**Headrest** provides continuous support in the seated position and various reclined postures.

**Seat cushion and back** are upholstered. Elastic web straps, which are connected to the steel frame, provide additional seat and back support.

**Arms panels** are enclosed and upholstered. Arm caps have a beveled front grip to help ease of entry and exit from the chair.

**Backrest recline actuator** controls the reclining function of the chair.

**Footrest control lever** opens and closes the footrest and operates independently from the backrest recline actuator to provide maximum control and comfort.

**Frame** is constructed of welded steel for long-term durability.

**Optional wood legs** are also available.

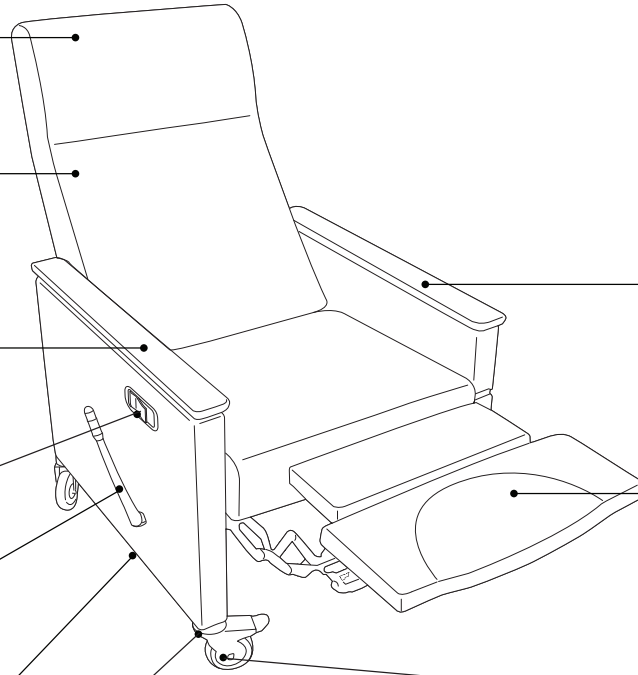

**Fold-down arm** assists with patient transfer to or from another surface.

**Footrest** is scalloped to help prevent feet from slipping off the ends in the raised position and help facilitate exiting the chair in the closed position.

**Casters** are standard and each feature a total lock system to lock both wheel and swivel with easy action.

## Actual Dimensions

Features	Overall			Seat			Arm Height	Fully Reclined Depth
	Depth	Width	Height	Depth	Width	Height		
Reclining chair	30"	29½" and 32½"	46"	18½"	23" and 26"	20½"	26"	69"

**Product Details**

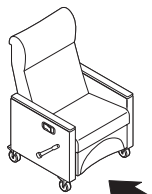

**Left and right for all features and options** are determined when facing the front of the chair.

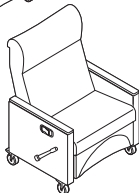

**Two seat widths** are available for all configurations, 23"W and 26"W.



**Back recline** mechanism facilitates a near full flat recline. Pull and hold actuator to recline back and return to upright. Release actuator to keep back at desired position.

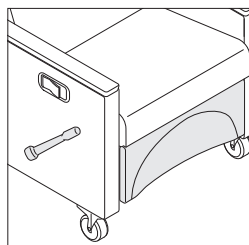

**Footrest lever** is standard on the left side facing arm. For most secure posture, open prior to reclining the back and close after returning the back to the upright position.



**Tablet arm** is 11" x 20" and swivels 270°. It can be mounted on the left or right side (shown) of fixed arm models. If left mount is specified, the recline levers will be positioned on the right side of the unit when facing the front of the chair.

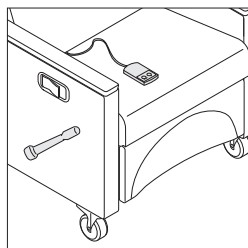

**Heat and massage option** is UL approved. Both functions feature three settings allowing the user to adjust for personal preference. User hand held control pendant has a flexible cord and stores on the side of the back when not in use.

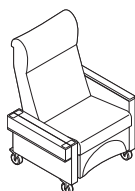

**Fold-down arm** assists with patient transfer to or from another surface. The arm self-locks when lifted into the upright position.

**Flip-down release tab** is located at the back of the arm for easy access and operation.

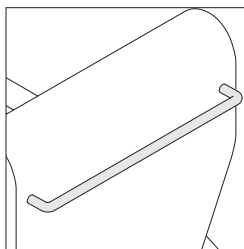

**Push bar** attaches to the back to assist in maneuverability.

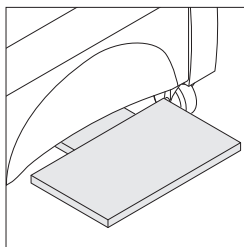

**Pull out foot rest** easily slides out to support a patient's feet while seated.

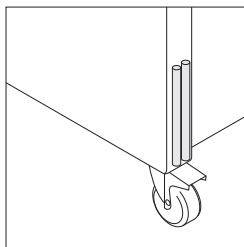

**IV pole holder** is positioned on the back of the arm panel and accommodates 1/2" to 3/4" diameter stainless steel IV poles. It can be mounted on the left or right side.

*Tip: Height adjustable, 3/4" diameter stainless steel IV pole is available through customer service (part 22158701SR).*

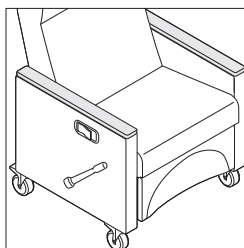

**Arm caps** are available in solid wood or plastisol.

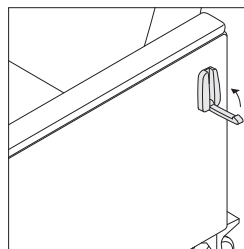

**Drainage bag hanger** accommodates foley bags and other drainage bags and closes flat when not in use. It is best specified on the arm opposite the recline levers but can be mounted on the left or right side. On flip-down arm models, it will be positioned on the opposite arm of the flip-down (controls side).

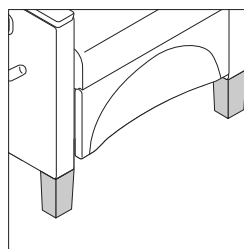

**Wood legs** are available as an option and include non-adjustable plastic glides.

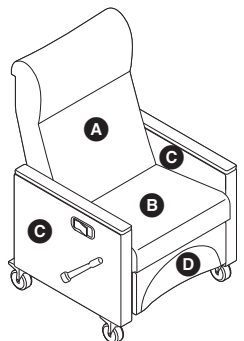

**Up to four different fabrics** can be specified: back (A), seat (B), sides (C), and front (D).

**Moisture barrier** is available as an option on the seat only.

**Surface Materials**

**All Steelcase Health seating with standard upholstery fabrics** comply with the State of California Technical Bulletin 117-2013.

**Seat and back**

- Fabric
- Fabric with Moisture Barrier (option on seat only)

**Arm panels (sides)**

- Fabric

**Footrest (front)**

- Fabric

**Arm caps**

- Wood
- Plastisol (option)

**Tablet arm**

- Thermoform

**Casters**

- 4" non-marring casters: grey only

**Legs**

- Wood (option)

**Push bar**

- Platinum paint

**Pull out foot rest**

- Black slip-resistant surface

**IV pole holder**

- Platinum paint

**Drainage bag hanger**

- Stainless steel

**Shipping**

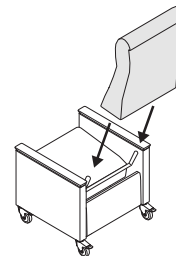

**Mineral recliner back** ships uninstalled and requires field assembly. Assembly instructions can be found on [village.steelcase.com](http://village.steelcase.com). Installation requires back to be slid into place and attached.

# Mineral Recliners



*Tip: Left and right for flip-down arms, tablet arm, IV pole holder, and drainage bag hanger are determined when facing the front of the chair.*

*Tip: Different fabrics for the seat, back, sides, and front can be specified. If the fabrics are in different price groups, calculate list price by adding the price groups for each surface together and dividing by four. For example, if specifying seat and front fabric both in group 2, sides in group 4, and back in group 6, add the list price in price group 2 twice (seat + front), price group 4 once (sides), and price group 6 (back) once then divide by four.*

*Tip: Tablet can only be specified on fixed arm model. If mounted on the left, recline levers will be placed on the right arm panel when facing the front of the chair.*

*Tip: Tablet arm option can be specified in conjunction with the IV pole holder and/or drainage bag hanger.*

*Tip: On flip-down arm models, the IV pole holder and/or drainage bag hanger will be positioned on the arm opposite of the flip-down arm.*

Standard Includes	Required to Specify
<ul style="list-style-type: none"> <li>▶ Need help? Product details, page 356</li> <li>• Seat, back, sides, and front: fabric</li> <li>• Arm caps: wood</li> <li>• 4" non-marring casters: grey</li> </ul>	<ul style="list-style-type: none"> <li>1 Style number</li> <li>2 Fabric color number for seat, back, sides, and front</li> <li>3 Wood color number for arm cap</li> <li>4 Options, if selected (see below)</li> <li>▶ See <i>Surface Materials</i>, page 473.</li> </ul>

Options		U.S. Price	Required to Specify
<b>Surface Materials</b>	<b>Moisture barrier</b>		
	• Moisture barrier	+\$ 270	Specify with moisture barrier.
<b>Seat Width</b>	• 26"W	+\$ 881	Specify with 26"W seat width.
<b>Heat and Massage</b>	• Heat only	+\$1168	Specify with heat.
	• Heat and massage	+\$1557	Specify with heat and massage.
<b>Arm Caps</b>	• Plastisol arm caps	+\$ 154	Specify with plastisol arm caps and select plastic color number.
<b>Tablet Arm</b>	• Tablet arm	+\$ 552	Specify with tablet, indicate left or right facing, and select thermoform color number.
<b>Push Bar</b>	• Push bar	+\$ 242	Specify with push bar.
<b>Pull Out Foot rest</b>	• Pull out foot rest	+\$ 621	Specify with pull out foot rest.
<b>IV Pole Holder</b>	• IV pole holder	+\$ 160	Specify with IV pole holder and for fixed arm model, indicate left or right facing.
<b>Drainage Bag Hanger</b>	• Drainage bag hanger	+\$ 78	Specify with drainage bag hanger and for fixed arm model, indicate left or right facing
<b>Legs</b>	• Casters	No cost	Specify with casters.
	• Legs	No cost	Specify with legs and select wood color number.

**For Canadian Pricing**  
 Multiply U.S. Price by the Canadian price factor.  
 ▶ See page 1 for details.

**Specification Information**

**U.S. Base Prices**

Style Number	Fabric Price Group 1	Fabric Price Group 2	Fabric Price Group 3	Fabric Price Group 4	Fabric Price Group 5	Fabric Price Group 6	Fabric Price Group 7	Fabric Price Group 8	Fabric Price Group 9	Fabric Price Group 10	COM
--------------	----------------------	----------------------	----------------------	----------------------	----------------------	----------------------	----------------------	----------------------	----------------------	-----------------------	-----

**With Fixed Arms**

<b>SC2091</b>	\$4902	\$5126	\$5350	\$5538	\$5726	\$5838	\$6018	\$6398	\$6630	\$6838	\$4998
---------------	--------	--------	--------	--------	--------	--------	--------	--------	--------	--------	--------

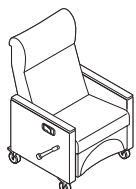

**With Left Flip-Down Arm**

<b>SC2091L</b>	\$5738	\$5962	\$6186	\$6374	\$6562	\$6674	\$6854	\$7234	\$7466	\$7674	\$5834
----------------	--------	--------	--------	--------	--------	--------	--------	--------	--------	--------	--------

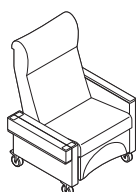

**With Right Flip-Down Arm**

<b>SC2091R</b>	\$5738	\$5962	\$6186	\$6374	\$6562	\$6674	\$6854	\$7234	\$7466	\$7674	\$5834
----------------	--------	--------	--------	--------	--------	--------	--------	--------	--------	--------	--------



 **For Canadian Pricing**  
 Multiply U.S. Price by the Canadian price factor.  
 ▶ See page 1 for details.

# Mitra Recliners

**Mitra recliner seating** is designed to correspond with the energetically curved styling of Mitra arm chairs.

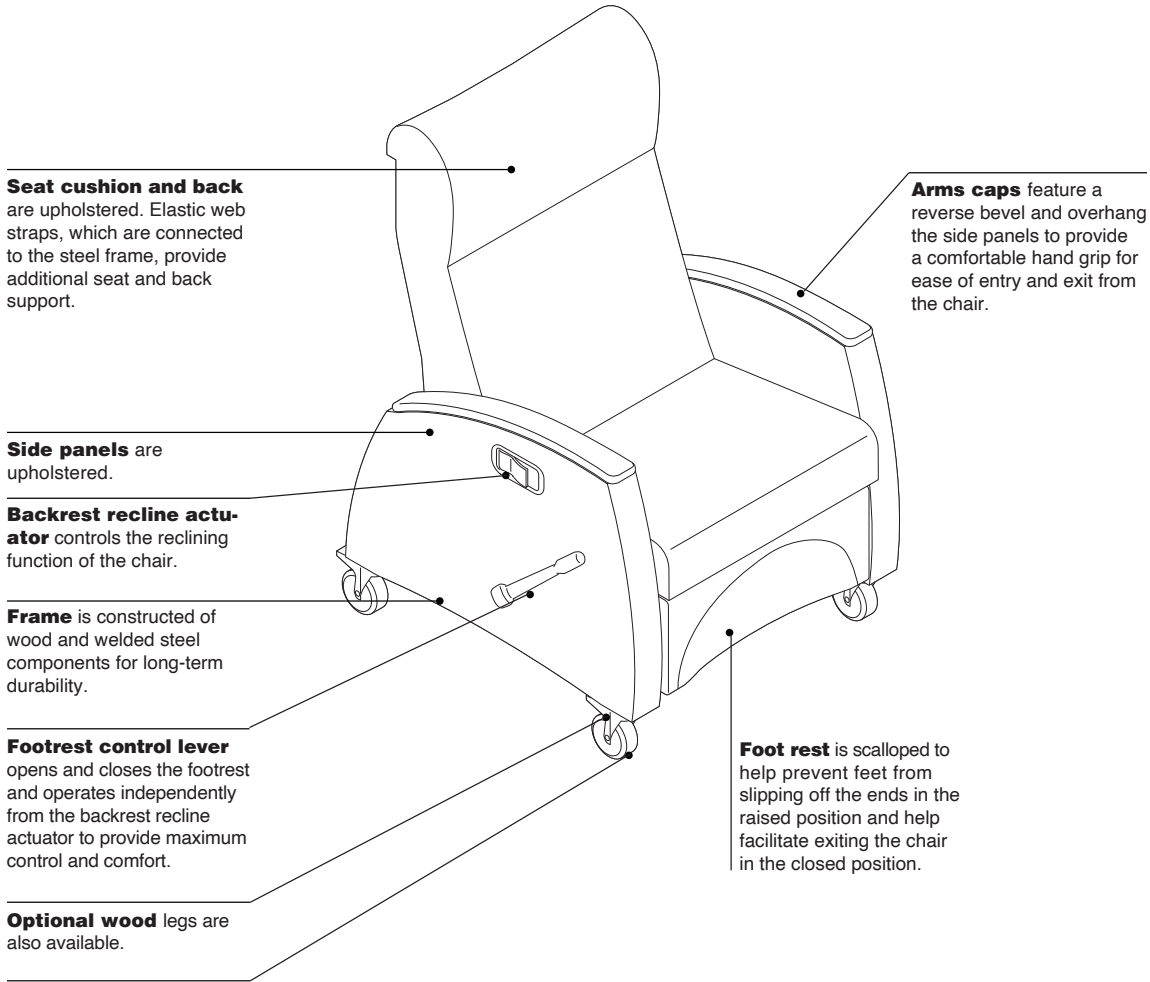

**Casters** are standard and each feature a total lock system to lock both wheel and swivel with easy action.

## Actual Dimensions

Features	Overall			Seat			Arm Height	Fully Reclined Depth
	Depth	Width	Height	Depth	Width	Height		
Reclining chair	32"	31½" and 34½"	46"	18½"	23" and 26"	20½"	27½"	69"



**Product Details**

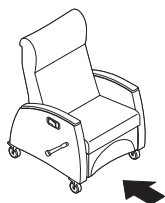

**Left and right for all features and options** are determined when facing the front of the chair.

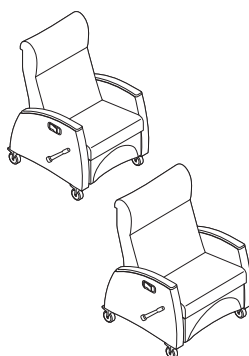

**Two seat widths** are available for the standard mechanism recliner version **SC6091**, 23"W and 26"W. Recliner with Trendelenburg version **SC6091T** is only available in 23"W.

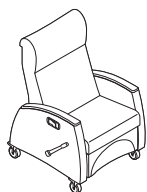

**Back recline mechanism** facilitates a near full flat recline. Pull and hold actuator to recline back and return to upright. Release actuator to keep back at desired position.

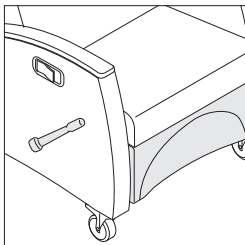

**Footrest lever** is standard on the left side facing arm. For most secure posture, open prior to reclining the back and close after returning the back to the upright position.



**Tablet arm** is 11" x 20" and swivels 270°. It can be mounted on the left or right side (shown). If left mount is specified, the recline levers will be positioned on the right side of the unit when facing the front of the chair.

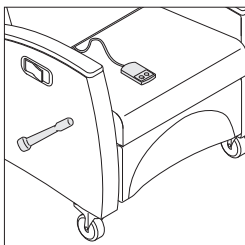

**Heat and massage option** is UL approved. Both functions feature three settings allowing the user to adjust for personal preference. User hand held control pendant has a flexible cord and stores on the side of the back when not in use.

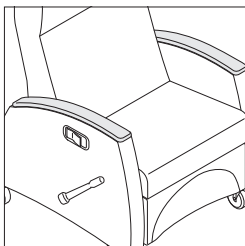

**Arm caps on recliner** are available in solid wood or plastisol.

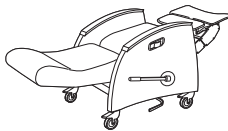

**Trendelenburg** is foot activated from either side and reclines so a patient's feet are above the head.

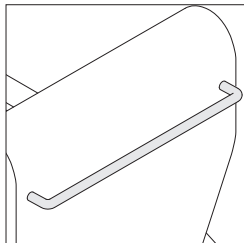

**Push bar** attaches to the back to assist in maneuverability.

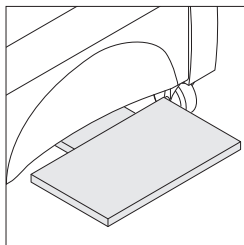

**Pull out foot rest** easily slides out to support a patient's feet while seated.

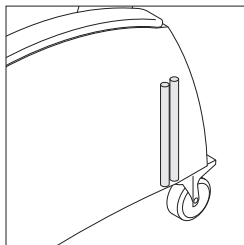

**IV pole holder** is positioned on the arm opposite the recliner levers and accommodates 1/2" to 3/4" diameter IV poles. *Tip: Height adjustable, 3/4" diameter stainless steel IV pole is available through customer service (part 22158701SR).*

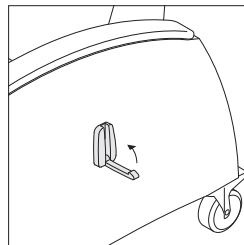

**Drainage bag hanger** accommodates foley bags and other drainage bags and closes flat when not in use. It is positioned on the arm panel opposite the recline levers.

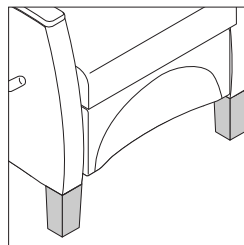

**Wood legs** are available as an option and include non-adjustable plastic glides.

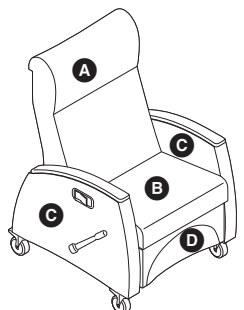

**Up to four different fabrics** can be specified: back (A), seat (B), sides (C), and front (D).

**Moisture barrier** is available as an option on the seat only.

**Surface Materials**

**All Steelcase Health seating with standard upholstery fabrics** comply with the State of California Technical Bulletin 117-2013.

**Seat and back**

- Fabric
- Fabric with Moisture Barrier (option on seat only)

**Arm panels (sides)**

- Fabric

**Footrest (front)**

- Fabric

**Arm caps**

- Maple wood
- Plastisol

**Tablet arm**

- Thermoform

**Casters**

- 4" non-marring casters: grey only

**Legs**

- Wood (option)

**Push bar**

- Platinum paint

**Pull out foot rest**

- Black slip-resistant surface

**IV pole holder**

- Platinum paint

**Drainage bag hanger**

- Stainless steel

**Shipping**

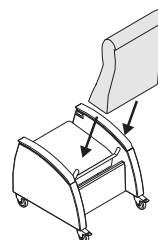

**Mitra recliner back** ships uninstalled and requires field assembly. Assembly instructions can be found on [village.steelcase.com](http://village.steelcase.com). Installation requires back to be slid into place and attached.

# Mitra Recliners

Standard Includes		Required to Specify
▶ Need help? Product details, page 360	<ul style="list-style-type: none"> <li>• Seat, back, sides, and front: fabric</li> <li>• Arm caps: wood</li> <li>• Casters: 4" non-marring casters: grey</li> </ul>	1 Style number 2 Fabric color number for seat, back, sides, and front 3 Wood color number for arm cap 4 Options, if selected (see below) ▶ See <i>Surface Materials</i> , page 473.

Tip: 26"W seat width option is not available on the recliner with Trendelenburg.

Tip: Different fabrics for the seat, back, sides, and front can be specified. If the fabrics are in different price groups, calculate list price by adding the price groups for each surface together and dividing by four. For example, if specifying seat and front fabric both in group 2, sides in group 4, and back in group 6, add the list price in price group 2 twice (seat + front), price group 4 once (sides), and price group 6 (back) once then divide by four.

Tip: If tablet is specified on the left, the recline levers will be positioned on the right arm panel when facing the front of the chair

Tip: Tablet arm option can be specified in conjunction with the IV pole holder and/or drainage bag hanger.

Tip: IV pole holder and/or drainage bag hanger will be positioned on the arm opposite the recline levers.

Options	U.S. Price	Required to Specify
<b>Surface Materials</b>	<b>Moisture barrier</b> • Moisture barrier	+\$ 270 Specify with moisture barrier.
<b>Seat Width</b>	• 26"W	+\$ 881 Specify with 26"W seat width.
<b>Heat and Massage</b>	• Heat only • Heat and massage	+\$1168 +\$1557 Specify with heat. Specify with heat and massage.
<b>Arm Caps</b>	• Plastisol arm caps	+\$ 154 Specify with plastisol arm caps and select plastic color number.
<b>Tablet Arm</b>	• Tablet arm	+\$ 552 Specify with tablet, indicate left or right facing, and select thermoform color number.
<b>Push Bar</b>	• Push bar	+\$ 242 Specify with push bar.
<b>Pull Out Foot rest</b>	• Pull out foot rest	+\$ 621 Specify with pull out foot rest.
<b>IV Pole Holder</b>	• IV pole holder	+\$ 160 Specify with IV pole holder.
<b>Drainage Bag Hanger</b>	• Drainage bag hanger	+\$ 78 Specify with drainage bag hanger.
<b>Legs</b>	• Casters • Legs	No cost No cost Specify with casters. Specify with legs and select wood color number.

Specification Information												
Style Number	U.S. Base Prices										COM	
	Fabric Price Group 1	Fabric Price Group 2	Fabric Price Group 3	Fabric Price Group 4	Fabric Price Group 5	Fabric Price Group 6	Fabric Price Group 7	Fabric Price Group 8	Fabric Price Group 9	Fabric Price Group 10		

Recliner											
<b>SC6091</b>	\$5180	\$5424	\$5672	\$5872	\$6080	\$6200	\$6404	\$6812	\$7068	\$7300	\$5276

Recliner with Trendelenburg											
<b>SC6091T</b>	\$6078	\$6322	\$6570	\$6770	\$6978	\$7098	\$7302	\$7710	\$7966	\$8198	\$6174





# Mitra Sleeper Chair

**Mitra sleeper chairs** are available in a single-seat model and correspond to the curved styling of the Mitra seating family.  
 ▶ See page 365

**Seat cushion and back** are upholstered.

**Side panels** are upholstered.

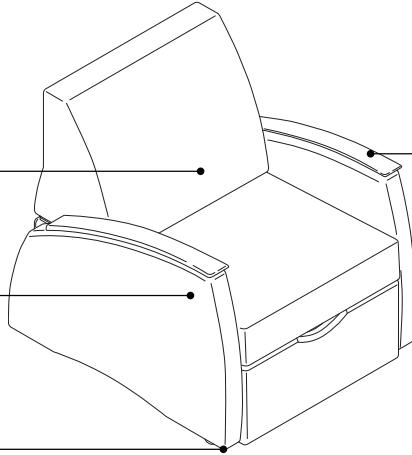

**Arms caps** feature a reverse bevel and overhang the side panels to provide a comfortable hand grip for ease of entry and exit from the chair. Caps are solid maple wood or plastisol.

**Casters** are standard. Rear casters swivel and lock. Front casters are directional and non-locking.

## Product Details

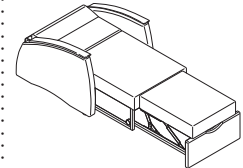
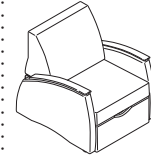

**Mitra** is available in a single-seat model.

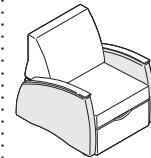

**Different fabrics** can be specified on all sleeper chairs. Back, seat, and front panel fabric will match. Side panel can be specified in a different fabric. Contrasting fabrics to be upholstered different from the standard must be processed through Specials.

**Moisture barrier** is optional. It is applied to the seat only on Mitra sleeper chairs.

## Surface Materials

**All Steelcase Health seating with standard upholstery fabrics** comply with the State of California Technical Bulletin 117-2013.

### Mitra Sleeper Chairs Seat cushion, back, and side panels

- Fabric
- Fabric with moisture barrier (option on seat only)

### Arm caps

- Maple wood
- Plastisol

### Casters

- Black

## Actual Dimensions

Features	Overall Depth	Extended Depth	Width	Height	Seat Depth	Width	Height	Arm Height
----------	---------------	----------------	-------	--------	------------	-------	--------	------------

### Mitra Sleeper Chair

Single-seat sleeper chair	38"	84 1/4"	32 1/4"	36"	21"	26 1/4"	17 3/4"	25 3/4"
---------------------------	-----	---------	---------	-----	-----	---------	---------	---------

# Mitra Sleeper Chair

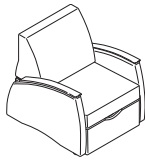

*Tip: Back, seat, and front panel fabric will match. Different fabrics for the center cushions and side panels can be specified. If the fabrics are in different price groups, calculate list price by adding the two price groups together and dividing by two.*

*Tip: Fabrics can only be upholstered in a vertical (top out or down roll) direction because of the size of the center cushions.*

Standard Includes		Required to Specify
<ul style="list-style-type: none"> <li>▶ Need help? Product details, page 364</li> </ul>	<ul style="list-style-type: none"> <li>• Seat, back, and front panel: fabric</li> <li>• Side panels: fabric</li> <li>• Arm caps: maple wood or plastisol</li> <li>• Casters: black</li> </ul>	<ol style="list-style-type: none"> <li>1 Style number</li> <li>2 Fabric color number for seat, back, and front panel</li> <li>3 Fabric color number for side panels</li> <li>4 Wood or plastisol color number for arm caps (see below under Required Selections)</li> <li>5 Options, if selected (see below)</li> </ol> <ul style="list-style-type: none"> <li>▶ See <i>Surface Materials</i>, page 473.</li> </ul>

	Required Selections	U.S. Price	Required to Specify
<b>Arm Caps</b>	• Maple wood	No cost	Specify with <i>wood arm caps</i> and select wood color number.
	• Plastisol	+\$154	Specify with <i>plastisol arm caps</i> and select plastic color number.

	Options	U.S. Price	Required to Specify
<b>Surface Materials</b>	• Moisture barrier	+\$134	Specify with <i>moisture barrier</i> .

Specification Information											
Style Number	U.S. Base Prices										COM
	Fabric Price Group 1	Fabric Price Group 2	Fabric Price Group 3	Fabric Price Group 4	Fabric Price Group 5	Fabric Price Group 6	Fabric Price Group 7	Fabric Price Group 8	Fabric Price Group 9	Fabric Price Group 10	
<b>SC6140S</b>	\$4510	\$4886	\$5254	\$5565	\$5874	\$6060	\$6373	\$6993	\$7379	\$7733	\$4606

 **For Canadian Pricing**  
 Multiply U.S. Price by the Canadian price factor.  
 ▶ See page 1 for details.

# Sieste Sleeper

**Sieste sleeper** complements the Sieste family of chairs. It can be used for seating or folded open for sleeping.

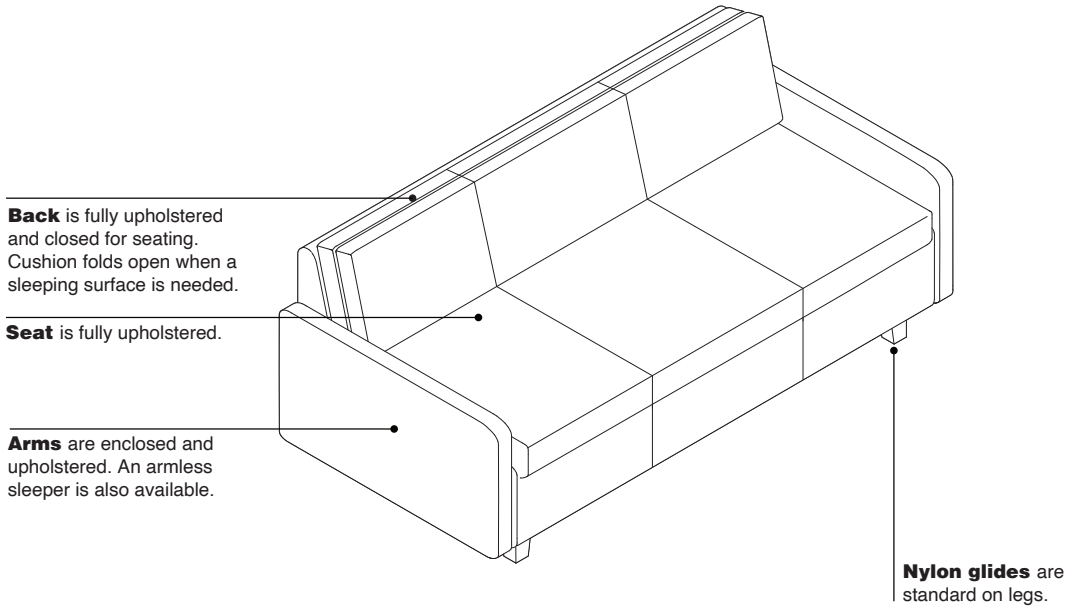

Actual Dimensions								
Features	Overall Depth	Width*	Height	Seat Depth	Width	Seat Height from Floor	Back Height from Seat	Arm Height from Floor
<b>Sleeper with Arms</b>	35"	82", 86", or 90"	33"	21"	76", 80", or 84"	17"	16"	23"
Sleep surface	32"	76", 80", or 84"	21"	N. A.	N. A.	N. A.	N. A.	N. A.
<b>Sleeper with End Panels</b>	35"	78", 82", or 86"	33"	21"	76", 80", or 84"	17"	16"	23"
Sleep surface	32"	76", 80", or 84"	21"	N. A.	N. A.	N. A.	N. A.	N. A.

\*Custom widths also available in one inch increments.

**Product Details**

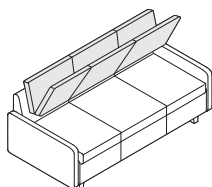

**Back cushion** folds open for a sleeping surface that is protected from sitting exposure. Cushion is securely attached to frame. A standard fitted twin sheet will fit the 76"W sleeper.

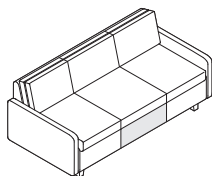

**Storage drawer** is standard on all sleepers to accommodate items such as linens. Drawer can be eliminated as an option.

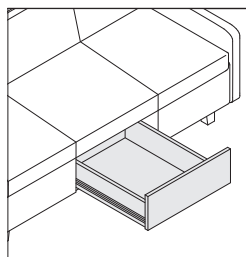

**The inside dimensions of the storage drawer** are 17"D x 24 1/2"W x 5 1/4"H.



**Round bolster** is available for use with the sleeper. Attachment rings on bolster and attachment device on sleeper are available as options. Specify both to attach bolster to sleeper.

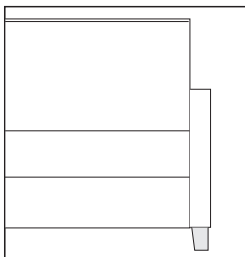

**Outside Position**

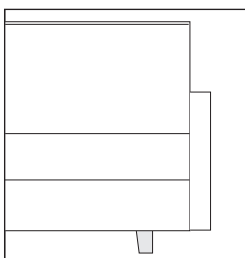

**Underframe Position**

**Legs** are constructed with maple hardwood solids. Two different leg positions are available – outside position or underframe position.

**Casters**, two locking on the front and two non-locking on the back of the sleeper, are available as an option.

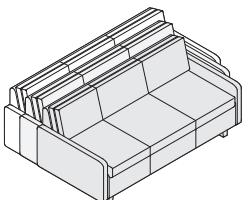

**Customized widths** are also available in one inch increments to help with space limitations or to ensure the perfect fit. Contact Steelcase Health Customer Care at 1.800.342.8462 or customer-care@SteelcaseHealth.com for more information.

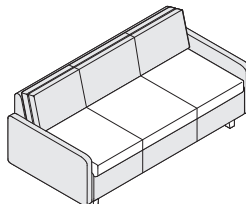

**Different fabrics** can be specified on the seat and back. Fabric on the back will match the fabric on the arm panel and front kick panel. Contrasting fabrics to be upholstered different from the standard must be processed through Specials.

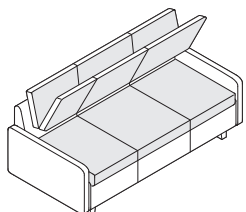

**Moisture barrier** on the seat and back is available as an option.

**Surface Materials**

**All Steelcase Health seating with standard upholstery fabrics** comply with the State of California Technical Bulletin 117-2013.

**Legs**

- Wood

**Seat and back**

- Fabric
- Fabric with moisture barrier (option)

*Note: Certain fabrics and vinyl will appear loose with comfort wrinkles when upholstered. Moisture barrier option may cause additional puddling on seat depending on the specified fabric.*

**Arms**

- Fabric

**Glides**

- Nylon

# Sieste Sleeper

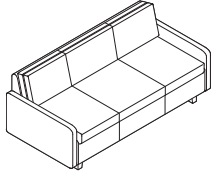

	Standard Includes	Required to Specify
<p>▶ Need help? Product details, page 366</p>	<ul style="list-style-type: none"> <li>• Seat and back: fabric</li> <li>• Legs: wood</li> <li>• Closed arms, if selected: fabric</li> <li>• Nylon glides</li> <li>• Storage drawer</li> <li>• Bolster: fabric</li> </ul>	<ol style="list-style-type: none"> <li>1 Style number</li> <li>2 Fabric color number for seat, back, and bolster, if selected</li> <li>3 Wood color for legs, if selected</li> <li>4 Leg position, if selected</li> <li>5 Options, if selected (see below)</li> </ol> <p>▶ See <i>Surface Materials</i>, page 473.</p>

	Options	U.S. Price	Required to Specify
<b>Surface Materials</b>	<p><b>Moisture barrier</b></p> <ul style="list-style-type: none"> <li>• Moisture barrier</li> </ul>	+\$675	Specify with <i>moisture barrier</i> .
<b>Legs</b>	<ul style="list-style-type: none"> <li>• Legs outside position</li> <li>• Legs underframe position</li> </ul>	No cost No cost	Specify with <i>outside position on legs</i> . Specify with <i>underframe position on legs</i> .
<b>Casters</b>	<ul style="list-style-type: none"> <li>• Casters (two locking and two non-locking)</li> </ul>	+\$368	Specify with <i>casters</i> .
<b>Storage Drawer</b>	<ul style="list-style-type: none"> <li>• Omit storage drawer</li> </ul>	No cost	Specify <i>omit storage drawer</i> .
<b>Attachment Device</b>	<ul style="list-style-type: none"> <li>• Attachment ring on bolster</li> <li>• Attachment device on sleeper</li> </ul>	+\$104 No cost	Specify with <i>attachment ring</i> . Specify with <i>attachment device</i> .

*Tip: Must specify attachment device on sleeper when specifying attachment ring on bolster.*

*Tip: Sleepers are also available in custom widths. See page 367 for more information.*



**For Canadian Pricing**  
Multiply U.S. Price by the Canadian price factor.  
▶ See page 1 for details.



**Specification Information**

Style Number	Overall Width	U.S. Base Prices										COM
		Fabric Price Group 1	Fabric Price Group 2	Fabric Price Group 3	Fabric Price Group 4	Fabric Price Group 5	Fabric Price Group 6	Fabric Price Group 7	Fabric Price Group 8	Fabric Price Group 9	Fabric Price Group 10	

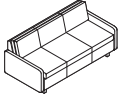

**Sleepers with Arms**

<b>HN26276SA</b>	82"	\$7381	\$7989	\$8591	\$9099	\$ 9601	\$ 9909	\$10,415	\$11,425	\$12,053	\$12,637	\$7475
<b>HN26280SA</b>	86"	\$7742	\$8358	\$8978	\$9490	\$10,008	\$10,314	\$10,824	\$11,856	\$12,492	\$13,092	\$7836
<b>HN26284SA</b>	90"	\$8140	\$8778	\$9418	\$9950	\$10,484	\$10,800	\$11,332	\$12,396	\$13,058	\$13,676	\$8234

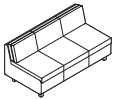

**Sleepers without Arms**

<b>HN26276SP</b>	78"	\$7085	\$7647	\$8213	\$8683	\$ 9151	\$ 9439	\$ 9905	\$10,845	\$11,423	\$11,973	\$7179
<b>HN26280SP</b>	82"	\$7449	\$8023	\$8597	\$9077	\$ 9555	\$ 9843	\$10,323	\$11,279	\$11,873	\$12,429	\$7543
<b>HN26284SP</b>	86"	\$7845	\$8445	\$9035	\$9533	\$10,023	\$10,331	\$10,825	\$11,817	\$12,429	\$13,007	\$7939



**Round Bolster**

<b>HN262A</b>	17½"D	\$ 340	\$ 384	\$ 424	\$ 460	\$ 495	\$ 519	\$ 554	\$ 622	\$ 668	\$ 708	\$ 393
---------------	-------	--------	--------	--------	--------	--------	--------	--------	--------	--------	--------	--------



**For Canadian Pricing**

Multiply U.S. Price by the Canadian price factor.

▶ See page 1 for details.

# Surround Thought Starters and Applications

## Lounge, 104½" Frame Width

Fully Optioned

**104½"W frame** offers a generous sleep surface, multiple seated reclining postures, and connectivity options. An integrated coat hanger and two-tier storage provide organization options.

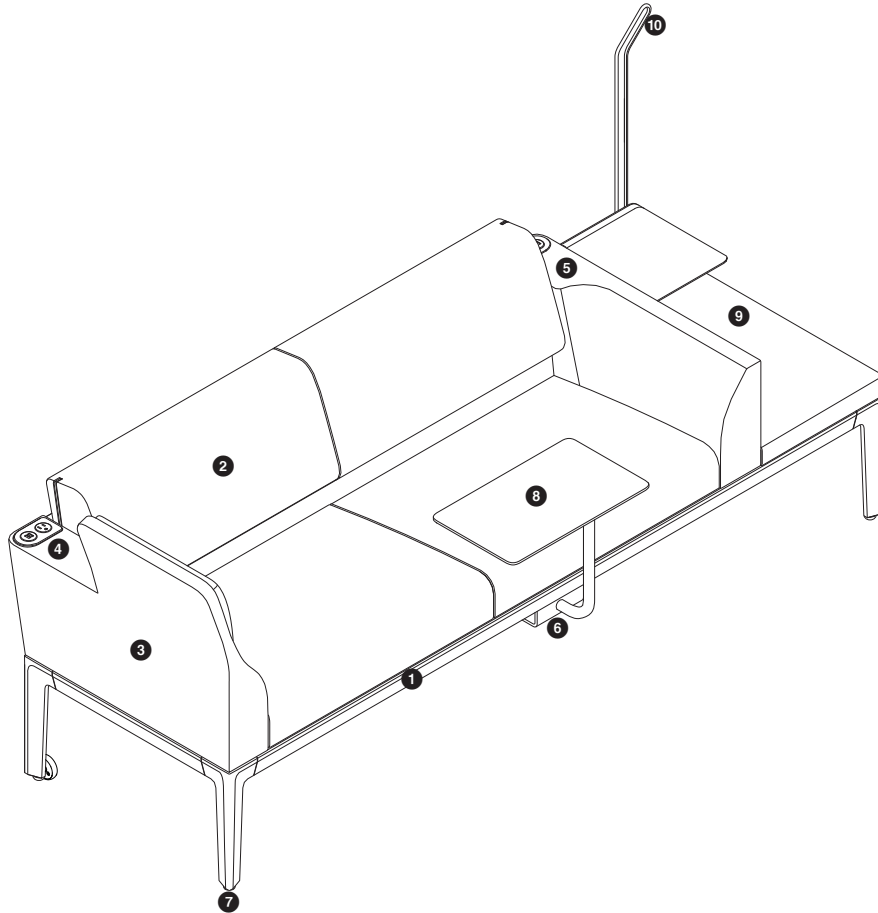

## Lounge, 104½" Frame Width

### Recommended Components

	Quantity	Style Number	Description	Options	Page for Ordering
1	1	<b>HLS105</b>	104½"W Frame		428
2				77"W Seat, Back, and Outer Back	
3				Left Arm, High	
4				Left Arm, One Power/Two USB	
5				Right Arm, Two Power	
6				Tablet Rail	
7				Two Glides and Two Casters	
8	1	<b>HLSMT</b>	Mobile Tablet		433
9	1	<b>HLSSTT</b>	Two-Tier Storage End Table – 16½"W		432
10				Coat Hanger	

**Lounge, 82½" Frame Width**  
High-Recline Arm, Mobile Tablet, and Power

**82½"W frame** accommodates multiple individuals and provides a sleep surface, connectivity, and a personal worksurface option for care partners.

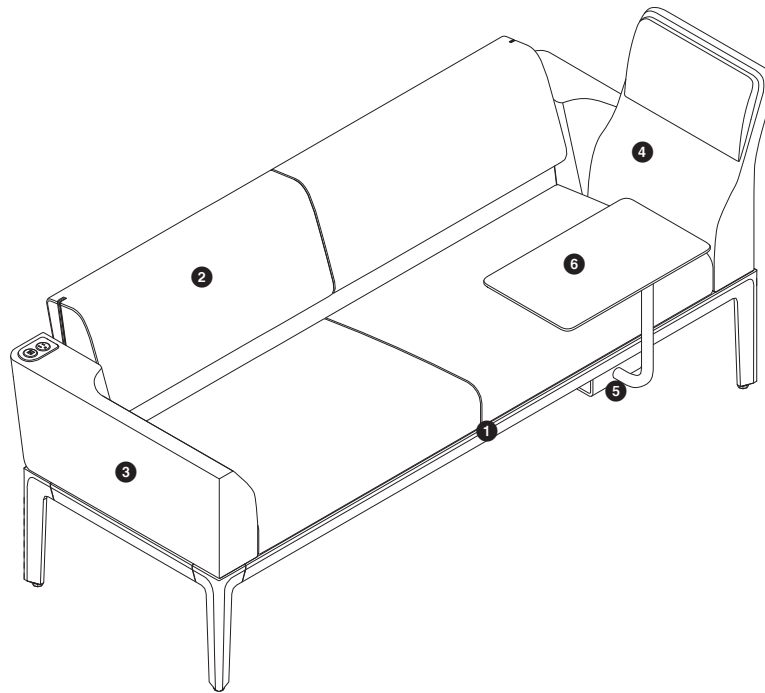

**Lounge, 82½" Frame Width**

**Recommended Components**

	Quantity	Style Number	Description	Options	Page for Ordering
1	1	<b>HLS83</b>	82½"W Frame		412
2				71½"W Seat, Back, and Outer Back	
3				Left Arm, One Power/Two USB	
4				Right Arm, High	
5				Tablet Rail	
6	1	<b>HLSMT</b>	Mobile Tablet		433

**Lounge, 71½" Frame Width**

Single Arm, Storage, Mobile Tablet, and Power

**71½"W frame** accommodates spacious lounge postures. Mobile tablet provides a personal worksurface, and storage is easily accessible for care partners.

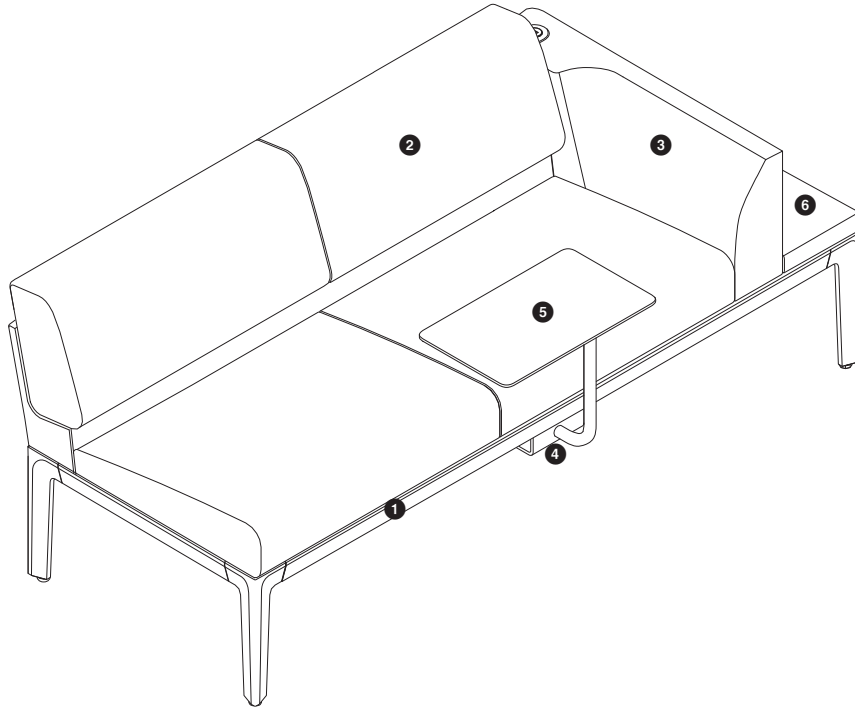

**Lounge, 71½" Frame Width**

**Recommended Components**

	Quantity	Style Number	Description	Options	Page for Ordering
1	1	<b>HLS72</b>	71½"W Frame		404
2				55"W Seat, Back, and Outer Back	
3				Right Arm, Two Power	
4				Tablet Rail	
5	1	<b>HLSMT</b>	Mobile Tablet		433
6	1	<b>HLSET</b>	One-Tier Storage End Table – 11"W		431

**Lounge, 44" Frame Width**  
Two Low Arms, Mobile Tablet, and Power

**44"W frame** provides a comfortable lounge posture, connectivity, and personal worksurface options for users.

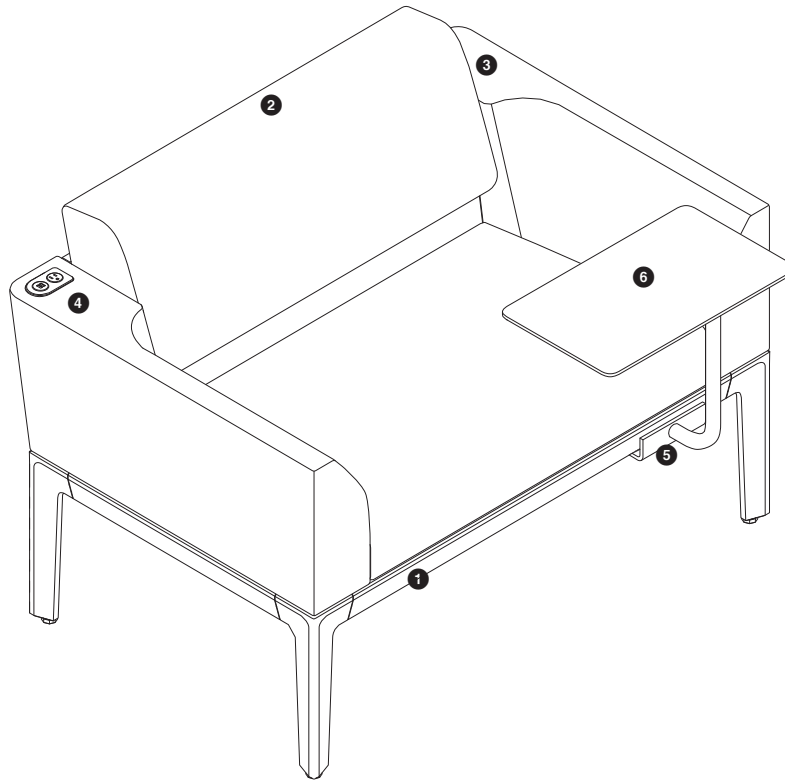

**Lounge, 44" Frame Width**

**Recommended Components**

	Quantity	Style Number	Description	Options	Page for Ordering
1	1	<b>HLS44</b>	44"W Frame		388
2				33"W Seat, Back, and Outer Back	
3				Right Arm	
4				Left Arm, One Power/Two USB	
5				Tablet Rail	
6	1	<b>HLSMT</b>	Mobile Tablet		433

# Surround Configuration Charts

**Surround** is a frame-based modular collection of components designed to maximize the user experience. Each Surround frame can support various combinations of components to accommodate patient room and other various architecture. Product configuration is determined during specification.

*Tip: Understand the dimensions of the architectural space to determine the frame.*

*Tip: Unit weights include one-tier storage where applicable.*

*Tip: Specify the maximum frame dimension to maximize experience and options.*

*Tip: All components must fit within the frame dimension (seat, back, arms, and storage).*

*Tip: Left and right is determined when facing the unit.*

*Tip: Understand the dimensions of the architectural space to accommodate components that may extend outside frame dimensions.*

*Tip: Seat and back must be the same width.*

*Tip: Low arm and high-recline arm are available in left- or right-facing positions.*

*Tip: High-recline arm placed on end of unit extends 3¾" from the frame at the outermost point.*

*Tip: Storage end table can be specified in one- or two-tier option.*

*Tip: Storage end table mounts only to the right or left side of the frame unit.*

*Tip: Two-tier storage requires the specification of an adjacent arm on frame.*

*Tip: Storage cannot be specified adjacent to other storage.*

*Tip: Storage width must match storage size specified on frame.*

*Tip: Power, two front glides and two directional back wheel casters, and mobile tablet can be specified on all units.*

*Tip: Unit weights are approximations and may vary between units.*

44"W Frame				
Seat/Back/Outer Back	Fixed or Sleeper Back	Number of Arms (Positioned on Left and/or Right)	Storage (Positioned on Left or Right)	Weight
33"W	Fixed	N.A.	11"W	130 lb
33"W	Fixed	Two 5½"W	N.A.	145 lb
38½"W	Fixed	One 5½"W	N.A.	139 lb
44"W	Fixed	N.A.	N.A.	130 lb

55"W Frame				
Seat/Back/Outer Back	Fixed or Sleeper Back	Number of Arms (Positioned on Left and/or Right)	Storage (Positioned on Left or Right)	Weight
33"W	Fixed	N.A.	Two 11"W	150 lb
33"W	Fixed	Two 5½"W	11"W	146 lb
38½"W	Fixed	N.A.	16½"W	155 lb
38½"W	Fixed	One 5½"W	11"W	145 lb
44"W	Fixed	N.A.	11"W	155 lb
44"W	Fixed	Two 5½"W	N.A.	166 lb
49½"W	Fixed	One 5½"W	N.A.	151 lb
55"W	Fixed	N.A.	N.A.	150 lb

60½"W Frame				
Seat/Back/Outer Back	Fixed or Sleeper Back	Number of Arms (Positioned on Left and/or Right)	Storage (Positioned on Left or Right)	Weight
33"W	Fixed	N.A.	11"W and 16½"W	160 lb
33"W	Fixed	One 5½"W	Two 11"W	165 lb
33"W	Fixed	Two 5½"W	16½"W	153 lb
38½"W	Fixed	N.A.	Two 11"W	155 lb
38½"W	Fixed	Two 5½"W	11"W	168 lb
38½"W	Fixed	One 5½"W	16½"W	148 lb
44"W	Fixed	N.A.	16½"W	155 lb
44"W	Fixed	One 5½"W	11"W	147 lb
49½"W	Fixed	N.A.	11"W	160 lb
49½"W	Fixed	Two 5½"W	N.A.	174 lb
55"W	Fixed	One 5½"W	N.A.	157 lb
60½"W	Fixed	N.A.	N.A.	160 lb

Tip: Understand the dimensions of the architectural space to determine the frame.

Tip: Specify the maximum frame dimension to maximize experience and options.

Tip: All components must fit within the frame dimension (seat, back, arms, and storage).

Tip: Left and right is determined when facing the unit.

Tip: Understand the dimensions of the architectural space to accommodate components that may extend outside frame dimensions.

Tip: Seat and back must be the same width.

Tip: Low arm and high-recline arm are available in left- or right-facing positions.

Tip: High-recline arm placed on end of unit extends 3¾" from the frame at the outermost point.

Tip: Storage end table can be specified in one- or two-tier option.

Tip: Storage end table mounts only to the right or left side of the frame unit.

Tip: Two-tier storage requires the specification of an adjacent arm on frame.

Tip: Storage cannot be specified adjacent to other storage.

Tip: 71½"W and 77"W seats are standard with a fold-down sleep surface and require two arms.

Tip: 55"W, 60½"W, and 66"W seats can be specified with or without a fold-down sleep surface.

Tip: If a sleep surface is required, an 66"W frame is the smallest frame that can be specified.

Tip: Sleep surface requires the specification of two arms.

Tip: Storage width must match storage size specified on frame.

Tip: Power, two front glides and two directional back wheel casters, and mobile tablet can be specified on all units.

Tip: Unit weights are approximations and may vary between units.

Tip: Unit weights include one-tier storage where applicable.

66" W Frame				
Seat/Back/Outer Back	Fixed or Sleeper Back	Number of Arms (Positioned on Left and/or Right)	Storage (Positioned on Left and/or Right)	Weight
33"W	Fixed	N.A.	Two 16½"W	170 lb
33"W	Fixed	One 5½"W	11"W and 16½"W	175 lb
33"W	Fixed	Two 5½"W	Two 11"W	156 lb
38½"W	Fixed	N.A.	11"W and 16½"W	160 lb
38½"W	Fixed	One 5½"W	Two 11"W	165 lb
38½"W	Fixed	Two 5½"W	16½"W	170 lb
44"W	Fixed	N.A.	Two 11"W	160 lb
44"W	Fixed	Two 5½"W	11"W	171 lb
44"W	Fixed	One 5½"W	16½"W	150 lb
49½"W	Fixed	N.A.	16½"W	160 lb
49½"W	Fixed	One 5½"W	11"W	156 lb
55"W	Fixed	N.A.	11"W	165 lb
55"W	Specify fixed or sleeper	Two 5½"W	N.A.	180 lb
60½"W	Fixed	One 5½"W	N.A.	164 lb
66"W	Fixed	N.A.	N.A.	170 lb

71½" W Frame				
Seat/Back/Outer Back	Fixed or Sleeper Back	Number of Arms (Positioned on Left and/or Right)	Storage (Positioned on Left and/or Right)	Weight
33"W	Fixed	One 5½"W	Two 16½"W	180 lb
33"W	Fixed	Two 5½"W	11"W and 16½"W	158 lb
38½"W	Fixed	N.A.	Two 16½"W	165 lb
38½"W	Fixed	One 5½"W	11"W and 16½"W	165 lb
38½"W	Fixed	Two 5½"W	Two 11"W	156 lb
44"W	Fixed	N.A.	11"W and 16½"W	160 lb
44"W	Fixed	One 5½"W	Two 11"W	167 lb
44"W	Fixed	Two 5½"W	16½"W	173 lb
49½"W	Fixed	N.A.	Two 11"W	170 lb
49½"W	Fixed	Two 5½"W	11"W	179 lb
49½"W	Fixed	One 5½"W	16½"W	156 lb
55"W	Fixed	N.A.	16½"W	160 lb
55"W	Fixed	One 5½"W	11"W	160 lb
60½"W	Fixed	N.A.	11"W	165 lb
60½"W	Specify fixed or sleeper	Two 5½"W	N.A.	188 lb
66"W	Fixed	One 5½"W	N.A.	177 lb

Surround Configuration Charts, continued

Tip: Understand the dimensions of the architectural space to determine the frame.

Tip: Specify the maximum frame dimension to maximize experience and options.

Tip: All components must fit within the frame dimension (seat, back, arms, and storage).

Tip: Left and right is determined when facing the unit.

Tip: Understand the dimensions of the architectural space to accommodate components that may extend outside frame dimensions.

Tip: Seat and back must be the same width.

Tip: Low arm and high-recline arm are available in left- or right-facing positions.

Tip: High-recline arm placed on end of unit extends 3<sup>3</sup>/<sub>4</sub>" from the frame at the outermost point.

Tip: Storage end table can be specified in one- or two-tier option.

Tip: Storage end table mounts only to the right or left side of the frame unit.

Tip: Two-tier storage requires the specification of an adjacent arm on frame.

Tip: Storage cannot be specified adjacent to other storage.

Tip: 71<sup>1</sup>/<sub>2</sub>"W and 77"W seats are standard with a fold-down sleep surface and require two arms.

Tip: 55"W, 60<sup>1</sup>/<sub>2</sub>"W, and 66"W seats can be specified with or without a fold-down sleep surface.

Tip: If a sleep surface is required, a 66"W frame is the smallest frame that can be specified.

Tip: Sleep surface requires the specification of two arms.

Tip: Power, two front glides and two directional back wheel casters, and mobile tablet can be specified on all units.

Tip: Unit weights are approximations and may vary between units.

Tip: Unit weights include one-tier storage where applicable.

77"W Frame				
Seat/Back/Outer Back	Fixed or Sleeper Back	Number of Arms (Positioned on Left and/or Right)	Storage (Positioned on Left and/or Right)	Weight
33"W	Fixed	Two 5 <sup>1</sup> / <sub>2</sub> "W	Two 16 <sup>1</sup> / <sub>2</sub> "W	160 lb
38 <sup>1</sup> / <sub>2</sub> "W	Fixed	One 5 <sup>1</sup> / <sub>2</sub> "W	Two 16 <sup>1</sup> / <sub>2</sub> "W	155 lb
38 <sup>1</sup> / <sub>2</sub> "W	Fixed	Two 5 <sup>1</sup> / <sub>2</sub> "W	11"W and 16 <sup>1</sup> / <sub>2</sub> "W	175 lb
44"W	Fixed	N.A.	Two 16 <sup>1</sup> / <sub>2</sub> "W	170 lb
44"W	Fixed	One 5 <sup>1</sup> / <sub>2</sub> "W	11"W and 16 <sup>1</sup> / <sub>2</sub> "W	175 lb
44"W	Fixed	Two 5 <sup>1</sup> / <sub>2</sub> "W	Two 11"W	176 lb
49 <sup>1</sup> / <sub>2</sub> "W	Fixed	N.A.	11"W and 16 <sup>1</sup> / <sub>2</sub> "W	170 lb
49 <sup>1</sup> / <sub>2</sub> "W	Fixed	One 5 <sup>1</sup> / <sub>2</sub> "W	Two 11"W	175 lb
49 <sup>1</sup> / <sub>2</sub> "W	Fixed	Two 5 <sup>1</sup> / <sub>2</sub> "W	16 <sup>1</sup> / <sub>2</sub> "W	156 lb
55"W	Fixed	N.A.	Two 11"W	160 lb
55"W	Specify fixed or sleeper	Two 5 <sup>1</sup> / <sub>2</sub> "W	11"W	162 lb
55"W	Fixed	One 5 <sup>1</sup> / <sub>2</sub> "W	16 <sup>1</sup> / <sub>2</sub> "W	164 lb
60 <sup>1</sup> / <sub>2</sub> "W	Fixed	N.A.	16 <sup>1</sup> / <sub>2</sub> "W	170 lb
60 <sup>1</sup> / <sub>2</sub> "W	Fixed	One 5 <sup>1</sup> / <sub>2</sub> "W	11"W	169 lb
66"W	Fixed	N.A.	11"W	175 lb
66"W	Specify fixed or sleeper	Two 5 <sup>1</sup> / <sub>2</sub> "W	N.A.	201 lb

82 <sup>1</sup> / <sub>2</sub> "W Frame				
Seat/Back/Outer Back	Fixed or Sleeper Back	Number of Arms (Positioned on Left and/or Right)	Storage (Positioned on Left and/or Right)	Weight
38 <sup>1</sup> / <sub>2</sub> "W	Fixed	Two 5 <sup>1</sup> / <sub>2</sub> "W	Two 16 <sup>1</sup> / <sub>2</sub> "W	177 lb
44"W	Fixed	One 5 <sup>1</sup> / <sub>2</sub> "W	Two 16 <sup>1</sup> / <sub>2</sub> "W	180 lb
44"W	Fixed	Two 5 <sup>1</sup> / <sub>2</sub> "W	11"W and 16 <sup>1</sup> / <sub>2</sub> "W	178 lb
49 <sup>1</sup> / <sub>2</sub> "W	Fixed	N.A.	Two 16 <sup>1</sup> / <sub>2</sub> "W	185 lb
49 <sup>1</sup> / <sub>2</sub> "W	Fixed	One 5 <sup>1</sup> / <sub>2</sub> "W	11"W and 16 <sup>1</sup> / <sub>2</sub> "W	185 lb
49 <sup>1</sup> / <sub>2</sub> "W	Fixed	Two 5 <sup>1</sup> / <sub>2</sub> "W	Two 11"W	184 lb
55"W	Fixed	N.A.	11"W and 16 <sup>1</sup> / <sub>2</sub> "W	190 lb
55"W	Fixed	One 5 <sup>1</sup> / <sub>2</sub> "W	Two 11"W	185 lb
55"W	Specify fixed or sleeper	Two 5 <sup>1</sup> / <sub>2</sub> "W	16 <sup>1</sup> / <sub>2</sub> "W	187 lb
60 <sup>1</sup> / <sub>2</sub> "W	Fixed	N.A.	Two 11"W	190 lb
60 <sup>1</sup> / <sub>2</sub> "W	Specify fixed or sleeper	Two 5 <sup>1</sup> / <sub>2</sub> "W	11"W	192 lb
60 <sup>1</sup> / <sub>2</sub> "W	Fixed	One 5 <sup>1</sup> / <sub>2</sub> "W	16 <sup>1</sup> / <sub>2</sub> "W	171 lb
66"W	Fixed	N.A.	16 <sup>1</sup> / <sub>2</sub> "W	180 lb
66"W	Fixed	One 5 <sup>1</sup> / <sub>2</sub> "W	11"W	183 lb
71 <sup>1</sup> / <sub>2</sub> "W	Sleeper	Two 5 <sup>1</sup> / <sub>2</sub> "W	N.A.	214 lb

\*Configurations with asterisk come in fixed back and sleeper back options.



Tip: Understand the dimensions of the architectural space to determine the frame.

Tip: Specify the maximum frame dimension to maximize experience and options.

Tip: All components must fit within the frame dimension (seat, back, arms, and storage).

Tip: Left and right is determined when facing the unit.

Tip: Understand the dimensions of the architectural space to accommodate components that may extend outside frame dimensions.

Tip: Seat and back must be the same width.

Tip: Low arm and high-recline arm are available in left- or right-facing positions.

Tip: High-recline arm placed on end of unit extends 3¾" from the frame at the outermost point.

Tip: Storage end table can be specified in one- or two-tier option.

Tip: Storage end table mounts only to the right or left side of the frame unit.

Tip: Two-tier storage requires the specification of an adjacent arm on frame.

Tip: Storage cannot be specified adjacent to other storage.

Tip: 71½"W and 77"W seats are standard with a fold-down sleep surface and require two arms.

Tip: 55"W, 60½"W, and 66"W seats can be specified with or without a fold-down sleep surface.

Tip: If a sleep surface is required, an 66"W frame is the smallest frame that can be specified.

Tip: Sleep surface requires the specification of two arms.

Tip: Storage width must match storage size specified on frame.

Tip: Power, two front glides and two directional back wheel casters, and mobile tablet can be specified on all units.

Tip: Unit weights are approximations and may vary between units.

Tip: Unit weights include one-tier storage where applicable.

88" W Frame				
Seat/Back/Outer Back	Fixed or Sleeper Back	Number of Arms (Positioned on Left and/or Right)	Storage (Positioned on Left and/or Right)	Weight
44"W	Fixed	Two 5½"W	Two 16½"W	181 lb
49½"W	Fixed	One 5½"W	Two 16½"W	180 lb
49½"W	Fixed	Two 5½"W	11"W and 16½"W	186 lb
55"W	Fixed	N.A.	Two 16½"W	190 lb
55"W	Fixed	One 5½"W	11"W and 16½"W	185 lb
55"W	Specify fixed or sleeper	Two 5½"W	Two 11"W	191 lb
60½"W	Fixed	N.A.	11"W and 16½"W	193 lb
60½"W	Fixed	One 5½"W	Two 11"W	193 lb
60½"W	Specify fixed or sleeper	Two 5½"W	16½"W	195 lb
66"W	Fixed	N.A.	Two 11"W	200 lb
66"W	Fixed	One 5½"W	16½"W	200 lb
66"W	Specify fixed or sleeper	Two 5½"W	11"W	207 lb
77"W	Sleeper	Two 5½"W	N.A.	235 lb

93½" W Frame				
Seat/Back/Outer Back	Fixed or Sleeper Back	Number of Arms (Positioned on Left and/or Right)	Storage (Positioned on Left and/or Right)	Weight
49½"W	Fixed	Two 5½"W	Two 16½"W	216 lb
55"W	Fixed	One 5½"W	Two 16½"W	218 lb
55"W	Specify fixed or sleeper	Two 5½"W	11"W and 16½"W	221 lb
60½"W	Fixed	N.A.	Two 16½"W	223 lb
60½"W	Fixed	One 5½"W	11"W and 16½"W	223 lb
60½"W	Specify fixed or sleeper	Two 5½"W	Two 11"W	226 lb
66"W	Fixed	N.A.	11"W and 16½"W	230 lb
66"W	Fixed	One 5½"W	Two 11"W	230 lb
66"W	Specify fixed or sleeper	Two 5½"W	16½"W	237 lb
71½"W	Sleeper	Two 5½"W	11"W	248 lb

99" W Frame				
Seat/Back/Outer Back	Fixed or Sleeper Back	Number of Arms (Positioned on Left and/or Right)	Storage (Positioned on Left and/or Right)	Weight
55"W	Specify fixed or sleeper	Two 5½"W	Two 16½"W	225 lb
60½"W	Fixed	One 5½"W	Two 16½"W	228 lb
60½"W	Specify fixed or sleeper	Two 5½"W	11"W and 16½"W	231 lb
66"W	Fixed	N.A.	Two 16½"W	235 lb
66"W	Fixed	One 5½"W	11"W and 16½"W	240 lb
66"W	Specify fixed or sleeper	Two 5½"W	Two 11"W	242 lb
71½"W	Sleeper	Two 5½"W	16½"W	252 lb
77"W	Sleeper	Two 5½"W	11"W	270 lb

Surround Configuration Charts, continued

Tip: Understand the dimensions of the architectural space to determine the frame.

Tip: Specify the maximum frame dimension to maximize experience and options.

Tip: All components must fit within the frame dimension (seat, back, arms, and storage).

Tip: Left and right is determined when facing the unit.

Tip: Understand the dimensions of the architectural space to accommodate components that may extend outside frame dimensions.

Tip: Seat and back must be the same width.

Tip: Low arm and high-recline arm are available in left- or right-facing positions.

Tip: High-recline arm placed on end of unit extends 3¾" from the frame at the outermost point.

Tip: Storage end table can be specified in one- or two-tier option.

Tip: Storage end table mounts only to the right or left side of the frame unit.

Tip: Two-tier storage requires the specification of an adjacent arm on frame.

Tip: Storage cannot be specified adjacent to other storage.

Tip: 71½"W and 77"W seats are standard with a fold-down sleep surface and require two arms.

Tip: 55"W, 60½"W, and 66"W seats can be specified with or without a fold-down sleep surface.

Tip: If a sleep surface is required, an 66"W frame is the smallest frame that can be specified.

Tip: Sleep surface requires the specification of two arms.

Tip: Storage width must match storage size specified on frame.

Tip: Power, two front glides and two directional back wheel casters, and mobile tablet can be specified on all units.

Tip: Unit weights are approximations and may vary between units.

Tip: Unit weights include one-tier storage where applicable.

104½"W Frame				
Seat/Back/Outer Back	Fixed or Sleeper Back	Number of Arms (Positioned on Left and/or Right)	Storage (Positioned on Left and/or Right)	Weight
60½"W	Specify fixed or sleeper	Two 5½"W	Two 16½"W	339 lb
66"W	Fixed	One 5½"W	Two 16½"W	345 lb
66"W	Specify fixed or sleeper	Two 5½"W	11"W and 16½"W	351 lb
71½"W	Sleeper	Two 5½"W	Two 11"W	362 lb
77"W	Sleeper	Two 5½"W	16½"W	379 lb

\*Configurations with asterisk come in fixed back and sleeper back options.

# Surround Height Diagram

## Front View

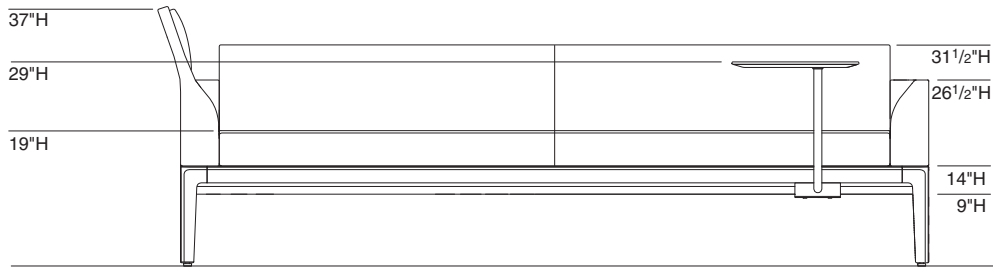

## Rear View

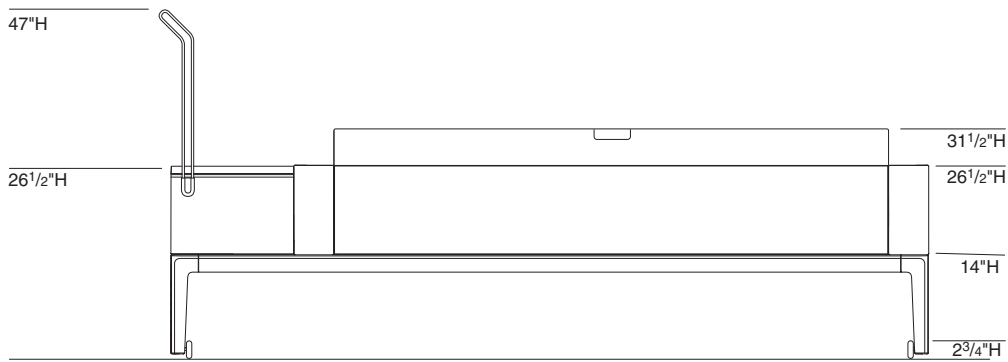

# Surround Lounge

**Units** have a modular design that comes assembled (seat, back, outer back, frame, and arms). Mobile tablet and storage are available and must be specified separately.

**Upholstery for seat, back, outer back, and arms** must be specified separately. They can have different fabrics.

**Short arm, low arm, and high-recline arm** are available in right- or left-facing positions. Specify each arm individually.

**Glides** are standard with frame and have a 1½" adjustment range.

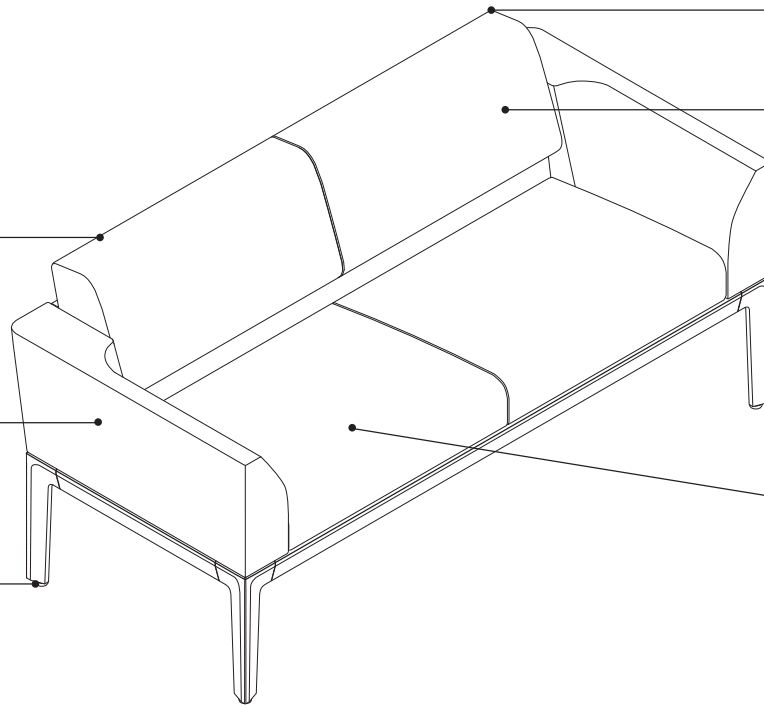

**Structural outer back** extends 3½" behind the frame at its outermost point.

**Back** includes an upholstered structural outer back and upholstered back. Available in sleeper and fixed back.

**Seat cushions** are available in both standard and soft options.

## Actual Dimensions

	Depth	Width	Height
Base Frames	27½"	44"	14"
	27½"	55"	14"
	27½"	60½"	14"
	27½"	66"	14"
	27½"	71½"	14"
	27½"	77"	14"
	27½"	82½"	14"
	27½"	88"	14"
	27½"	93½"	14"
	27½"	99"	14"
	27½"	104½"	14"
Seat, Back, and Outer Back	N.A.	33"	N.A.
	N.A.	38½"	N.A.
	N.A.	44"	N.A.
	N.A.	49½"	N.A.
	N.A.	55"	N.A.
	N.A.	60½"	N.A.
	N.A.	66½"	N.A.
	N.A.	71½"	N.A.
	N.A.	77"	N.A.

**Product Details**

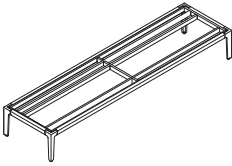

**Frame understructure** is welded, tubular steel.

**Frames** are dynamically tested to 550 pounds and statically tested to 750 pounds in all seating positions.

**Aluminum extrusion trims** span between each corner leg.

**Cast aluminum legs** are attached to steel understructure to provide support and add visual continuity.

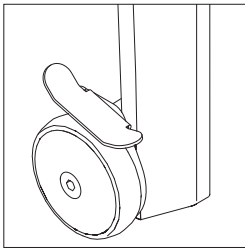

**Mobile option** includes two, locking or non-locking, directional back wheel casters mounted on the frame leg.

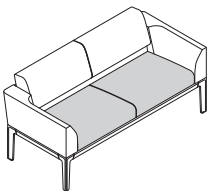

**Seat cushions** offer a contoured design to maximize overall comfort.

**Seat cushions** are available in various widths (see actual dimensions).

**Crumb sweeps** are on all three sides of seat cushions.

**Softer seat cushion option** is available. The softer seat cushion foam option is approximately 15 percent softer than the standard seat cushion foam.

**Seat cushions in widths of 55", 60½", 66", 71½", and 77"** come with a single center seam.

**Seat cushions** have a depth of 18½".

**Seat cushion** is available in standard and soft options.

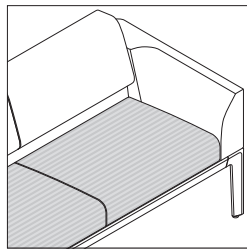

**Fabric** is applied to the seats in the railroad or horizontal direction to remain consistent with the backs.

**Patterned fabrics** will not match between seats, arms, and backs.

**Large, patterned fabrics** should be used selectively and are not recommended for use on all components.

**Contrasting fabrics** are available on seat and back cushions.

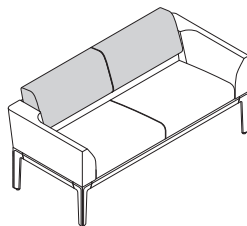

**Back cushions** are available in various widths (see actual dimensions).

**Back cushions in widths of 55", 60½", 66", 71½", and 77"** come with a single center seam.

**Sleeper surface** is standard with back widths of 71½" and 77".

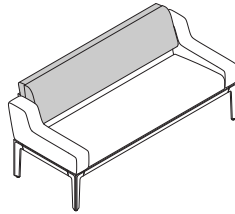

**Sleep surface** is an option with back widths of 55"W, 60½"W, and 66"W.

**Sleep surface** requires the specification of two arms.

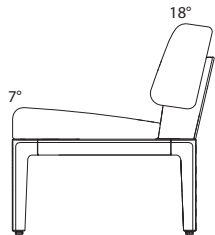

**Seat cushions** have a 7° recline and back cushions have an 18° recline.

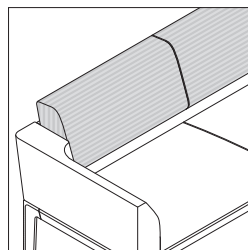

**Fabric** is applied to the backs in the railroad or horizontal direction to remain consistent with the seat cushions.

**Fabric on the top of the back** will match patterns on the front of the back but is applied to waterfall over the ends. Ends will not match top and front of back.

**Contrasting fabrics** are available on back cushions and the structural outer back.

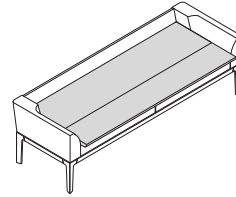

**Sleep surface** folds down in three easy steps and is designed for maximum comfort.

**Sleep surface** has a depth of 28".

**Sleep surface standard material** is an oxford nylon with urethane coating.

**Sleep surface** extends 2" past seat when deployed.

**Sleep surface material** comes standard with moisture barrier.

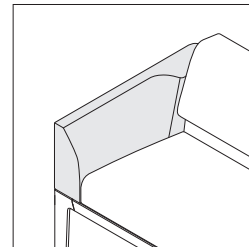

**Low arm** offers wrap-around contour support that supports a lounge posture.

**Low arm dimensions** are 31"D x 5½"W x 12½"H.

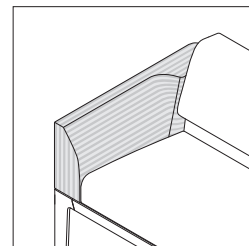

**Contrasting fabrics** are available on low arms and high-recline arms.

*Tip: Thread color that is associated with the more dominant fabric color or surface area will be applied throughout the upholstery.*

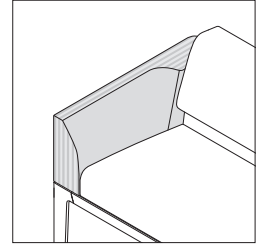

**Fabric on the top of the arm** will not match patterns on inner arm but is applied to waterfall over the ends. Ends will not match top and sides of arm.

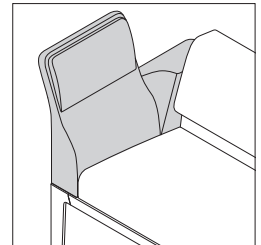

**High-recline arm dimensions** are 31"D x 5½"W x 23"H.

**High-recline arm** supports a natural reclining posture.

**High-recline arm** is standard with an integrated pillow to provide added comfort.

**Contrasting fabrics** are available on high-recline arm and high-recline pillow.

**Patterned fabrics** will not match between high-recline arm and high-recline pillow.

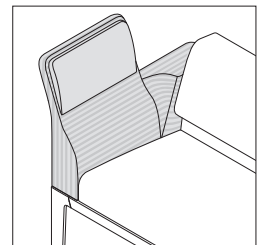

**Fabric on the top of the high-recline arm** will match patterns on inner arm but is applied to waterfall over the ends. Ends will not match top and sides of arm.

Surround Lounge, continued

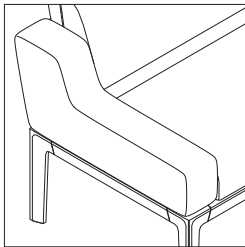

**Short arm dimensions** are 31"D x 51/2"W x 121/2"H.

**Wiring and Cabling**

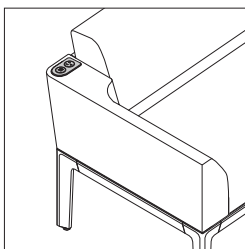

**Power** can be integrated short arms or high-recline arms and offers options for up to four devices.

**Power options** are tamper and spill resistant.

**Power options** include two standard outlets, one standard outlet and two USBs, and four USBs.

**Power outlets** are standard 110V outlets and are not hospital grade. If hospital grade is required, please specify the four USB port power option.

**The USB ports** are USB type A with two amps per port.

**Up to two USB receptacles** (total of four USB ports) may be specified in a unit.

**One-arm units** specified with two standard power outlets will have a 8' power cord that exits the lower center back of the arm specified with power.

**Two-arm units** specified with two standard power outlets in one arm and no power in the other will have a 8' power cord that exits the lower center back of the arm specified with power.

**Two-arm units** specified with two standard power outlets in both arms will have one 8' power cord exiting the back of each arm.

**One or two arm units** specified with any other power option except two standard power outlets will have a 8' power cord exiting the lower center back of the unit.

*Tip: Steelcase recommends to check with all local and facility authorities prior to specification and order, to confirm acceptance of proposed product and applications.*

**Application Topics**

**The dimension of the architectural space** accommodates components that may extend outside frame dimensions.

**All components** must fit within the frame dimension (seat, back, outer back, arms, and storage).

**Seat cushion width specification** determines back cushion and structural outer back widths.

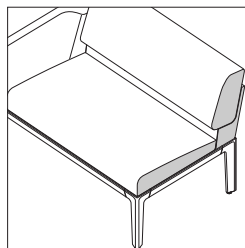

**When only one arm is specified**, the opposite sides of back, outer back, and seat will be upholstered in their respective upholstery.

**If a sleep surface** is required, specify 55"W, 601/2"W, 66"W, 711/2"W, or 77"W seat.

**Sleep surface** is standard with integrated instructions for use.

**Sleep surface** extends 2" past the seat.

**Mobile tablet** can easily be positioned to not interfere with sleep surface during deployment.

**Adding two-tier storage** requires the specification of an adjacent arm.

**Low arm** specified adjacent to storage allows for easier access than high-recline arm.

**Power location and power type in the arm** must be specified.

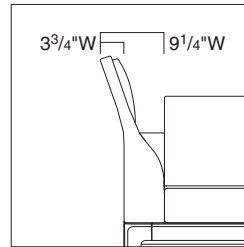

**High-recline arm** placed on end of unit extends 33/4" from the frame at the outermost point.

**High-recline arm** is recommended to be specified to allow reclining posture to face wall containing media, such as a monitor or television.

**Connections**

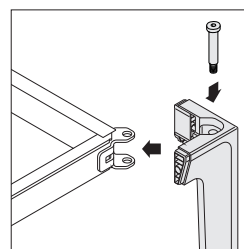

**Cast legs** come assembled to steel frame with bolts at each corner of the frame.

**Surface Materials**

**All Steelcase Health seating with standard upholstery fabrics** comply with the State of California Technical Bulletin 117-2013.

**Frame**

- Paint

**Glides**

- Platinum solid plastic

**Rail (option)**

- Grey paint

**Casters (option)**

- 7360 Merle

**Seat/back/outer back**

- Fabric

**Sleep surface**

- 5031 Light Merle

**Low arm**

- Fabric

**High-recline arm**

- Fabric

**Power (option)**

- 6527 Merle



# Surround Storage End Tables

**Storage end tables** are available in a one- or two-tier option, in two widths: 11"W and 16½"W.

**Storage tray with picture rail** is standard on two-tier end table.

**Adding two-tier storage** requires the specification of an adjacent arm.

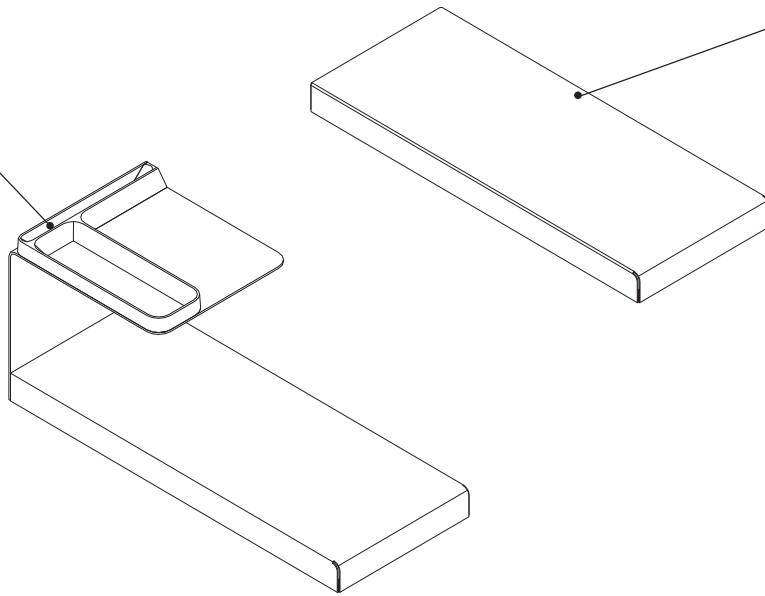

**Storage** is offered in a variety of Steelcase paint finishes.

Actual Dimensions			
	Depth	Width	Height
One-Tier End Table	27½"	11"	2"
	27½"	16½"	2"
Two-Tier End Table	27½"	11"	12½"
	27½"	16½"	12½"



**Product Details**

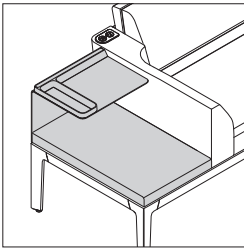

**Two-tier end table** offers coat hanger option.

**Top tier of two-tier end table** has a depth of 12¾".

**Storage tray with picture rail** is standard on two-tier end table.

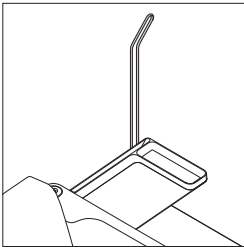

**Coat hanger** is available on the two-tier end table. It provides vertical organization and supports multiple coats.

**Coat hanger** is easily accessible and points away from unit.

**Coat hanger** is a formed continuous loop of 5/16" steel rod.

**Application Topics**

**Storage** mounts only to the right or left end of the frame.

**If a low arm** is specified adjacent to storage, it allows for easier access.

**Short arm** is unable to accommodate two-tier storage.

**Two-tier storage** requires the specification of an adjacent arm. One-tier storage does not.

**Storage width and location** must be specified individually. Storage location is determined when frame is specified.

**Two-tier end table** is available in contrasting finishes.

**Coat hanger** attaches to the back of the two-tier end table on site.

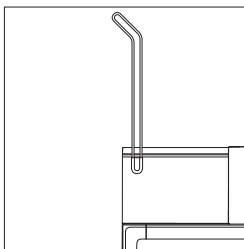

**Coat hanger** extends 2" from the frame at its outermost point.

**Surface Materials**

**Storage**

- Paint
- Coatings
- Lux Coatings

**Storage tray with picture rail**

- 6527 Merle

**Shade (option)**

- White opaque acrylic

**Coat hanger (option)**

- Paint

# Surround Mobile Tablet

**Mobile tablet surface** is designed to accommodate eating, working, entertaining, and writing.

**Mobile tablet surface** is offered in a variety of Steelcase plastic finishes.

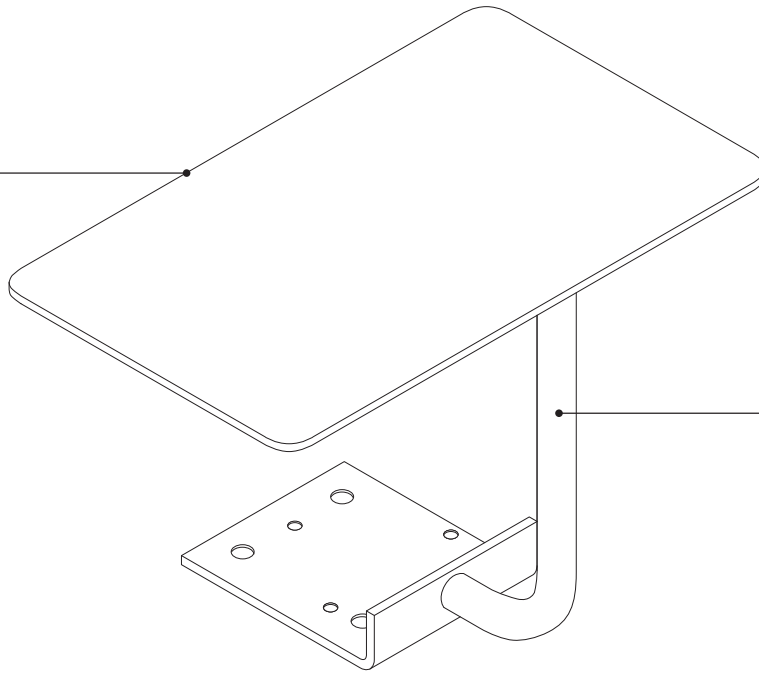

**Tablet arm** is offered in a variety of Steelcase paint finishes.

## Actual Dimensions

	Depth	Width	Height
Mobile Tablet Surface	12"	19½"	7/8"

**Product Details**

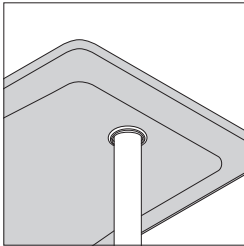

**Tablet surface** pivots 360°.

**Mobile tablet** is injection-molded and vibration-welded to create a barrier against moisture.

**Mobile tablet** is positioned 10" above the seat cushion.

**Tablet surface load capacity** is 100 pounds.

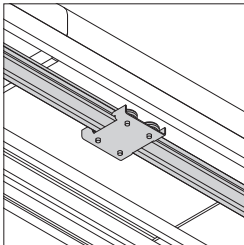

**Tablet rail** is specified on frame. Tablet rail can be added to existing Surround frame in the field.

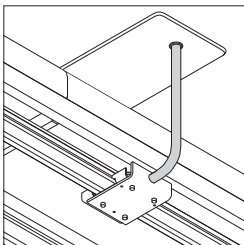

**Tablet arm** slides along the rail the length of the frame.

**Tablet surface** has a safe, yielding failure mode.

**Application Topics**

**Mobile tablet** is ordered separately and attaches to frame on site.

▶ See page 250 for *Regard tablet rail*.

**One tablet rail and mobile tablet** can be specified per unit.

**Tablet rails** have stops to ensure no interference with an adjacent object.

**Additional stops** can be inserted to prevent interference with other objects.

**Tablet rail rollers** are protected, preventing pinch points.

**Surface Materials**

**Surface**

- Plastic

**Tablet arm**

- Paint

# Surround Lounge

44" Frame Width

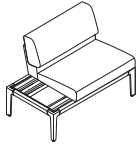

Standard Includes		Required to Specify
<ul style="list-style-type: none"> <li>▶ Need help? Product details, page 380</li> </ul>	<ul style="list-style-type: none"> <li>• Frame: paint price group 1</li> <li>• Seat, back, and outer back: fabric price group 1</li> <li>• Adjustable glides: platinum solid plastic</li> </ul>	<ol style="list-style-type: none"> <li>1 Style number</li> <li>2 Seat, back, and outer back width (see below under Required Selections)</li> <li>3 Paint color number for frame</li> <li>4 Fabric color number for seat, back, and outer back</li> <li>5 Arm position (see below under Required Selections)</li> <li>6 Options, if selected (see below)</li> </ol> <ul style="list-style-type: none"> <li>▶ See <i>Surface Materials</i>, page 473.</li> </ul>

	Required Selections	U.S. Price	Required to Specify
<b>Seat, Back, and Outer Back Width</b>	• 33"W seat, back, and outer back	Price at right	Specify with 33"W seat, back, and outer back.
	• 38½"W seat, back, and outer back	Price at right	Specify with 38½"W seat, back, and outer back.
	• 44"W seat, back, and outer back	Price at right	Specify with 44"W seat, back, and outer back.
<b>Arm Position</b>	• No arms	Prices at right	Specify with no arms.
	• One arm	Prices at right	Specify with arm right- or left-facing.
	• Two arms	Prices at right	Specify with two arms right- and left-facing.

Tip: Left and right determined when facing the unit.

Tip: Understand that standard requires further specification to complete unit.

Tip: For additional specification information, refer to Surround Configuration Charts.

▶ See page 374.

Tip: Fabric upcharges are applied separately for seat, back, and outer back.

	Options	U.S. Price	Required to Specify	
<b>Surface Materials</b>	<b>Frame</b>			
	• Paint price group 1	No cost	Specify paint color number.	
	• Paint price group 2	+\$ 39	Specify paint color number.	
	• Paint price group 3	+\$143	Specify paint color number. ▶ See <i>Surface Materials</i> , page 473.	
	<b>Seat, back, and outer back</b>			
	• Fabric	Prices at right	Specify fabric color number.	
	<b>Arm(s)</b>			
	• Fabric	Prices at right	Specify fabric color number.	
	<b>High arm pillow (if high arm(s) selected)</b>			
	• Fabric	Prices at right	Specify fabric color number.	
	<b>Seat foam</b>			
	• Softer seat	No cost	Specify with softer seat.	
<b>Arm Height(s)</b>	<b>Right</b>			
	• Right arm low	No cost	Specify with right arm low.	
	• Right arm high	+\$197	Specify with right arm high.	
	• Right arm short	+\$131	Specify with right arm short.	
	<b>Left</b>			
	• Left arm low	No cost	Specify with left arm low.	
	• Left arm high	+\$197	Specify with left arm high.	
	• Left arm short	+\$131	Specify with left arm short.	
	<b>Power</b>	<b>Right</b>		
		• Right arm no power	No cost	Specify with right arm no power.
• Right arm two power		+\$493	Specify with right arm two power.	
• Right arm one power, two USB		+\$583	Specify with right arm one power, two USB.	
• Right arm, four USB		+\$583	Specify with right arm, four USB.	
<b>Left</b>				
• Left arm no power		No cost	Specify with left arm no power.	
• Left arm two power		+\$493	Specify with left arm two power.	
• Left arm one power, two USB	+\$583	Specify with left arm one power, two USB.		
	• Left arm, four USB	+\$583	Specify with left arm, four USB.	

Tip: Only four USB ports total may be specified in a unit.



Surround components are not designed for use with international power.



**For Canadian Pricing**  
Multiply U.S. Price by the Canadian price factor.

▶ See page 1 for details.

▶ Options, continued on next page

► Options, continued from previous page

Options	U.S. Price	Required to Specify
<b>Mobility</b>		
• Four glides	No cost	Specify with four glides.
• Two front glides and two rear non-locking casters	+\$ 409	Specify with two front glides and two rear non-locking casters.
• Two front glides and two rear locking casters	+\$ 518	Specify with two front glides and two rear locking casters.
• Two front locking casters and two rear glides	+\$ 518	Specify with two front locking casters and two rear glides.
• Two front non-locking casters and two rear locking casters	+\$ 927	Specify with two front non-locking casters and two rear locking casters.
• Two front locking casters and two rear non-locking casters	+\$ 927	Specify with two front locking casters and two rear non-locking casters.
• Four locking casters	+\$1036	Specify with four locking casters.
<b>Tablet Rail</b>	• Tablet rail	+\$ 571
		Specify with tablet rail.
<b>Related Products</b>	• Mobile tablet	► Page 433

Tip: Mobile tablet is specified separately.  
► See page 433.

**Fabric Upcharges**

Style Number	Width	Fabric Price										COM
		Group 1	Group 2	Group 3	Group 4	Group 5	Group 6	Group 7	Group 8	Group 9	Group 10	
<b>HLS44</b>												
<b>Seat</b>												
33"	No cost	+\$53	+\$ 98	+\$159	+\$233	+\$324	+\$794	+\$1003	+\$1194	+\$1405	+\$17	
38½"	No cost	+\$53	+\$ 98	+\$159	+\$233	+\$324	+\$794	+\$1003	+\$1194	+\$1405	+\$17	
44"	No cost	+\$68	+\$123	+\$203	+\$292	+\$412	+\$873	+\$1126	+\$1354	+\$1602	+\$22	
<b>Back</b>												
33"	No cost	+\$53	+\$ 98	+\$159	+\$233	+\$324	+\$794	+\$1003	+\$1194	+\$1405	+\$17	
38½"	No cost	+\$53	+\$ 98	+\$159	+\$233	+\$324	+\$794	+\$1003	+\$1194	+\$1405	+\$17	
44"	No cost	+\$68	+\$123	+\$203	+\$292	+\$412	+\$873	+\$1126	+\$1354	+\$1602	+\$22	
<b>Outer Back</b>												
33"	No cost	+\$53	+\$ 98	+\$159	+\$233	+\$324	+\$794	+\$1003	+\$1194	+\$1405	+\$17	
38½"	No cost	+\$53	+\$ 98	+\$159	+\$233	+\$324	+\$794	+\$1003	+\$1194	+\$1405	+\$17	
44"	No cost	+\$68	+\$123	+\$203	+\$292	+\$412	+\$873	+\$1126	+\$1354	+\$1602	+\$22	
<b>Arm</b>												
Low	No cost	+\$49	+\$ 69	+\$134	+\$173	+\$203	+\$263	+\$ 352	+\$ 441	+\$ 541	+\$22	
High	No cost	+\$78	+\$106	+\$207	+\$267	+\$374	+\$506	+\$ 605	+\$ 741	+\$ 897	+\$32	
Short	No cost	+\$78	+\$106	+\$207	+\$267	+\$374	+\$506	+\$ 605	+\$ 741	+\$ 897	+\$32	
<b>High Arm Pillow</b>												
Pillow	No cost	+\$49	+\$ 69	+\$134	+\$173	+\$203	+\$263	+\$ 352	+\$ 441	+\$ 541	+\$22	

Tip: Seat, back, and outer back fabrics may be specified in different choices.  
► See Understanding Lounge on page 380.

Tip: Arm fabric and high arm pillow fabric is per arm selected.

Tip: High arm and pillow fabrics may be specified in different choices.  
► See Understanding Lounge on page 380.

► Specification Information, on next page

  
**For Canadian Pricing**  
Multiply U.S. Price by the Canadian price factor.  
► See page 1 for details.

Surround Lounge, 44" Frame Width, continued

► Options, on previous page

**Specification Information**

Style Number	Frame Dimensions		Seat, Back, and Outer Back Width	U.S. Base Prices Low Arms		
	W	D		No arm(s)	One arm	Two arms

**44" Frame Width**

HLS44	44"	27½"	33"	\$2773	N.A.	\$3643
			38½"	N.A.	\$3386	N.A.
			44"	\$3256	N.A.	N.A.
:	:	:	:	:	:	:

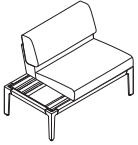

**For Canadian Pricing**

Multiply U.S. Price by the Canadian price factor.

► See page 1 for details.



# Surround Lounge

55" Frame Width

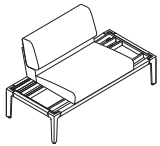

Standard Includes		Required to Specify
<ul style="list-style-type: none"> <li>▶ Need help? Product details, page 380</li> </ul>	<ul style="list-style-type: none"> <li>• Frame: paint price group 1</li> <li>• Seat, back, and outer back: fabric price group 1</li> <li>• Adjustable glides: platinum solid plastic</li> </ul>	<ol style="list-style-type: none"> <li>1 Style number</li> <li>2 Seat, back, and outer back width (see below under Required Selections)</li> <li>3 Paint color number for frame</li> <li>4 Fabric color number for seat, back, and outer back</li> <li>5 Arm position (see below under Required Selections)</li> <li>6 Options, if selected (see below)</li> </ol> <ul style="list-style-type: none"> <li>▶ See <i>Surface Materials</i>, page 473.</li> </ul>

	Required Selections	U.S. Price	Required to Specify
<b>Seat, Back, and Outer Back Width</b>	• 33"W seat, back, and outer back	Price at right	Specify with 33"W seat, back, and outer back.
	• 38 1/2"W seat, back, and outer back	Price at right	Specify with 38 1/2"W seat, back, and outer back.
	• 44"W seat, back, and outer back	Price at right	Specify with 44"W seat, back, and outer back.
	• 49 1/2"W seat, back, and outer back	Price at right	Specify with 49 1/2"W seat, back, and outer back.
	• 55"W seat, back, and outer back	Price at right	Specify with 55"W seat, back, and outer back.

<b>Arm Position</b>	<ul style="list-style-type: none"> <li>• No arms</li> <li>• One arm</li> <li>• Two arms</li> </ul>	Prices at right Prices at right Prices at right	Specify with <i>no arms</i> . Specify with <i>arm right- or left-facing</i> . Specify with <i>two arms right- and left-facing</i> .
---------------------	--	---	---

	Options	U.S. Price	Required to Specify
<b>Surface Materials</b>	<b>Frame</b>		
	• Paint price group 1	No cost	Specify paint color number.
	• Paint price group 2	+\$ 39	Specify paint color number.
	• Paint price group 3	+\$143	Specify paint color number. ▶ See <i>Surface Materials</i> , page 473.
	<b>Seat, back, and outer back</b>		
	• Fabric	Prices at right	Specify fabric color number.
	<b>Arm(s)</b>		
	• Fabric	Prices at right	Specify fabric color number.
	<b>High arm pillow (if high arm(s) selected)</b>		
	• Fabric	Prices at right	Specify fabric color number.
	<b>Seat foam</b>		
	• Softer seat	No cost	Specify with <i>softer seat</i> .

<b>Storage Size(s) and Location(s)</b>	• No storage	No cost	Specify with <i>no storage</i> .
	• 11"W right-facing storage	No cost	Specify with 11"W right-facing storage.
	• 16 1/2"W right-facing storage	No cost	Specify with 16 1/2"W right-facing storage.
	• 11"W left-facing storage	No cost	Specify with 11"W left-facing storage.
	• 16 1/2"W left-facing storage	No cost	Specify with 16 1/2"W left-facing storage.

<b>Storage Type</b>	<b>Right</b>		
	• Right one-tier end table	No cost	Specify with <i>right one-tier end table</i> .
	• Right two-tier end table	No cost	Specify with <i>right two-tier end table</i> .
	<b>Left</b>		
	• Left one-tier end table	No cost	Specify with <i>left one-tier end table</i> .
	• Left two-tier end table	No cost	Specify with <i>left two-tier end table</i> .

▶ Options, continued on next page

Tip: Left and right determined when facing the unit.

Tip: Understand that standard requires further specification to complete unit.

Tip: For additional specification information, refer to Surround Configuration Charts.

▶ See page 374.

Tip: Fabric upcharges are applied separately for seat, back, and outer back.

Tip: Storage is specified separately.

▶ See pages 431–432.

Tip: Storage not available if 49 1/2"W seat, back, and outer back is specified.

Tip: Storage type is only specified when storage size and location is chosen.



**For Canadian Pricing**

Multiply U.S. Price by the Canadian price factor.

▶ See page 1 for details.



► Options, continued from previous page

	Options	U.S. Price	Required to Specify
<b>Arm Height(s)</b>	<b>Right</b>		
	• Right arm low	No cost	Specify with right arm low.
	• Right arm high	+\$ 197	Specify with right arm high.
	• Right arm short	+\$ 131	Specify with right arm short.
	<b>Left</b>		
	• Left arm low	No cost	Specify with left arm low.
	• Left arm high	+\$ 197	Specify with left arm high.
	• Left arm short	+\$ 131	Specify with left arm short.
<b>Power</b>	<b>Right</b>		
	• Right arm no power	No cost	Specify with right arm no power.
	• Right arm two power	+\$ 493	Specify with right arm two power.
	• Right arm one power, two USB	+\$ 583	Specify with right arm one power, two USB.
	• Right arm, four USB	+\$ 583	Specify with right arm, four USB.
	<b>Left</b>		
	• Left arm no power	No cost	Specify with left arm no power.
	• Left arm two power	+\$ 493	Specify with left arm two power.
	• Left arm one power, two USB	+\$ 583	Specify with left arm one power, two USB.
	• Left arm, four USB	+\$ 583	Specify with left arm, four USB.
<b>Mobility</b>	• Four glides	No cost	Specify with four glides.
	• Two front glides and two rear non-locking casters	+\$ 409	Specify with two front glides and two rear non-locking casters.
	• Two front glides and two rear locking casters	+\$ 518	Specify with two front glides and two rear locking casters.
	• Two front locking casters and two rear glides	+\$ 518	Specify with two front locking casters and two rear glides.
	• Two front non-locking casters and two rear locking casters	+\$ 927	Specify with two front non-locking casters and two rear locking casters.
	• Two front locking casters and two rear non-locking casters	+\$ 927	Specify with two front locking casters and two rear non-locking casters.
	• Four locking casters	+\$1036	Specify with four locking casters.
<b>Tablet Rail</b>	• Tablet rail	+\$ 571	Specify with tablet rail.
<b>Related Products</b>	• Storage, one-tier end table		► Page 431
	• Storage, two-tier end table		► Page 432
	• Mobile tablet		► Page 433

► Options, continued on next page



Surround components are not designed for use with international power.

Tip: Only four USB ports total may be specified in a unit.

Tip: Mobile tablet is specified separately.

► See page 433.



**For Canadian Pricing**

Multiply U.S. Price by the Canadian price factor.

► See page 1 for details.

Surround Lounge, 55" Frame Width, continued

► Options, continued from previous page

**Fabric Upcharges**

Style Number	Width	Fabric Price Group 1	Fabric Price Group 2	Fabric Price Group 3	Fabric Price Group 4	Fabric Price Group 5	Fabric Price Group 6	Fabric Price Group 7	Fabric Price Group 8	Fabric Price Group 9	Fabric Price Group 10	COM
<b>HLS55</b>												
<b>Seat</b>												
33"	No cost	+\$53	+\$ 98	+\$159	+\$233	+\$324	+\$794	+\$1003	+\$1194	+\$1405	+\$17	
38½"	No cost	+\$53	+\$ 98	+\$159	+\$233	+\$324	+\$794	+\$1003	+\$1194	+\$1405	+\$17	
44"	No cost	+\$68	+\$123	+\$203	+\$292	+\$412	+\$873	+\$1126	+\$1354	+\$1602	+\$22	
49½"	No cost	+\$78	+\$143	+\$237	+\$346	+\$484	+\$900	+\$1180	+\$1430	+\$1706	+\$24	
55"	No cost	+\$81	+\$147	+\$243	+\$358	+\$500	+\$908	+\$1209	+\$1501	+\$1802	+\$25	
<b>Back</b>												
33"	No cost	+\$53	+\$ 98	+\$159	+\$233	+\$324	+\$794	+\$1003	+\$1194	+\$1405	+\$17	
38½"	No cost	+\$53	+\$ 98	+\$159	+\$233	+\$324	+\$794	+\$1003	+\$1194	+\$1405	+\$17	
44"	No cost	+\$68	+\$123	+\$203	+\$292	+\$412	+\$873	+\$1126	+\$1354	+\$1602	+\$22	
49½"	No cost	+\$78	+\$143	+\$237	+\$346	+\$484	+\$900	+\$1180	+\$1430	+\$1706	+\$24	
55"	No cost	+\$81	+\$147	+\$243	+\$358	+\$500	+\$908	+\$1209	+\$1501	+\$1802	+\$25	
<b>Outer Back</b>												
33"	No cost	+\$53	+\$ 98	+\$159	+\$233	+\$324	+\$794	+\$1003	+\$1194	+\$1405	+\$17	
38½"	No cost	+\$53	+\$ 98	+\$159	+\$233	+\$324	+\$794	+\$1003	+\$1194	+\$1405	+\$17	
44"	No cost	+\$68	+\$123	+\$203	+\$292	+\$412	+\$873	+\$1126	+\$1354	+\$1602	+\$22	
49½"	No cost	+\$78	+\$143	+\$237	+\$346	+\$484	+\$900	+\$1180	+\$1430	+\$1706	+\$24	
55"	No cost	+\$81	+\$147	+\$243	+\$358	+\$500	+\$908	+\$1209	+\$1501	+\$1802	+\$25	
<b>Arm</b>												
Low	No cost	+\$49	+\$ 69	+\$134	+\$173	+\$203	+\$263	+\$ 352	+\$ 441	+\$ 541	+\$22	
High	No cost	+\$78	+\$106	+\$207	+\$267	+\$374	+\$506	+\$ 605	+\$ 741	+\$ 897	+\$68	
Short	No cost	+\$78	+\$106	+\$207	+\$267	+\$374	+\$506	+\$ 605	+\$ 741	+\$ 897	+\$32	
<b>High Arm Pillow</b>												
Pillow	No cost	+\$49	+\$ 69	+\$134	+\$173	+\$203	+\$263	+\$ 352	+\$ 441	+\$ 541	+\$22	

Tip: Seat, back, and outer back fabrics may be specified in different choices. ► See Understanding Lounge on page 380.

Tip: Arm fabric and high arm pillow fabric is per arm selected.

Tip: High arm and pillow fabrics may be specified in different choices. ► See Understanding Lounge on page 380.



**For Canadian Pricing**  
Multiply U.S. Price by the Canadian price factor.  
► See page 1 for details.

**Specification Information**

Style Number	Frame Dimensions		Seat, Back, and Outer Back Width	U.S. Base Prices Low Arms		
	W	D		No arm(s)	One arm	Two arms

**55" Frame Width**

HLS55	55"	27½"	33"	\$3067	\$3502	\$3937
			38½"	\$3245	\$3680	N.A.
			44"	\$3550	N.A.	\$4420
			49½"	N.A.	\$4270	N.A.
			55"	\$4037	N.A.	N.A.

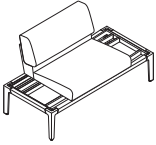

**For Canadian Pricing**  
 Multiply U.S. Price by the Canadian price factor.  
 ▶ See page 1 for details.

# Surround Lounge

60<sup>1</sup>/<sub>2</sub>" Frame Width

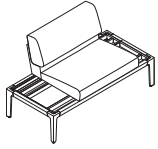

Standard Includes		Required to Specify
<ul style="list-style-type: none"> <li>▶ Need help? Product details, page 380</li> </ul>	<ul style="list-style-type: none"> <li>• Frame: paint price group 1</li> <li>• Seat, back, and outer back: fabric price group 1</li> <li>• Adjustable glides: platinum solid plastic</li> </ul>	<ol style="list-style-type: none"> <li>1 Style number</li> <li>2 Seat, back, and outer back width (see below under Required Selections)</li> <li>3 Paint color number for frame</li> <li>4 Fabric color number for seat, back, and outer back</li> <li>5 Arm position (see below under Required Selections)</li> <li>6 Options, if selected (see below)</li> </ol> <ul style="list-style-type: none"> <li>▶ See <i>Surface Materials</i>, page 473.</li> </ul>

	Required Selections	U.S. Price	Required to Specify
<b>Seat, Back, and Outer Back Width</b>	• 33"W seat, back, and outer back	Price at right	Specify with 33"W seat, back, and outer back.
	• 38 <sup>1</sup> / <sub>2</sub> "W seat, back, and outer back	Price at right	Specify with 38 <sup>1</sup> / <sub>2</sub> "W seat, back, and outer back.
	• 44"W seat, back, and outer back	Price at right	Specify with 44"W seat, back, and outer back.
	• 49 <sup>1</sup> / <sub>2</sub> "W seat, back, and outer back	Price at right	Specify with 49 <sup>1</sup> / <sub>2</sub> "W seat, back, and outer back.
	• 55"W seat, back, and outer back	Price at right	Specify with 55"W seat, back, and outer back.
	• 60 <sup>1</sup> / <sub>2</sub> "W seat, back, and outer back	Price at right	Specify with 60 <sup>1</sup> / <sub>2</sub> "W seat, back, and outer back.
<b>Arm Position</b>	• No arms	Prices at right	Specify with <i>no arms</i> .
	• One arm	Prices at right	Specify with <i>arm right- or left-facing</i> .
	• Two arms	Prices at right	Specify with <i>two arms right- and left-facing</i> .

Tip: Left and right determined when facing the unit.

Tip: Understand that standard requires further specification to complete unit.

Tip: For additional specification information, refer to Surround Configuration Charts.

▶ See page 374.

Tip: Fabric upcharges are applied separately for seat, back, and outer back.

	Options	U.S. Price	Required to Specify
<b>Surface Materials</b>	<b>Frame</b>		
	<ul style="list-style-type: none"> <li>• Paint price group 1</li> <li>• Paint price group 2</li> <li>• Paint price group 3</li> </ul>	No cost +\$ 39 +\$143	Specify paint color number. Specify paint color number. Specify paint color number. ▶ See <i>Surface Materials</i> , page 473.
	<b>Seat, back, and outer back</b>		
	<ul style="list-style-type: none"> <li>• Fabric</li> </ul>	Prices at right	Specify fabric color number.
	<b>Arm(s)</b>		
	<ul style="list-style-type: none"> <li>• Fabric</li> </ul>	Prices at right	Specify fabric color number.
	<b>High arm pillow (if high arm(s) selected)</b>		
	<ul style="list-style-type: none"> <li>• Fabric</li> </ul>	Prices at right	Specify fabric color number.
	<b>Seat foam</b>		
	<ul style="list-style-type: none"> <li>• Softer seat</li> </ul>	No cost	Specify with <i>softer seat</i> .
<b>Storage Size(s) and Location(s)</b>	• No storage	No cost	Specify with <i>no storage</i> .
	• 11"W right-facing storage	No cost	Specify with <i>11"W right-facing storage</i> .
	• 16 <sup>1</sup> / <sub>2</sub> "W right-facing storage	No cost	Specify with <i>16<sup>1</sup>/<sub>2</sub>"W right-facing storage</i> .
	• 11"W left-facing storage	No cost	Specify with <i>11"W left-facing storage</i> .
	• 16 <sup>1</sup> / <sub>2</sub> "W left-facing storage	No cost	Specify with <i>16<sup>1</sup>/<sub>2</sub>"W left-facing storage</i> .
<b>Storage Type</b>	<b>Right</b>		
	• Right one-tier end table	No cost	Specify with <i>right one-tier end table</i> .
	• Right two-tier end table	No cost	Specify with <i>right two-tier end table</i> .
	<b>Left</b>		
	• Left one-tier end table	No cost	Specify with <i>left one-tier end table</i> .
	• Left two-tier end table	No cost	Specify with <i>left two-tier end table</i> .

Tip: Storage is specified separately.

▶ See pages 431–432.

Tip: Storage not available if 55"W seat, back, and outer back is specified.

Tip: Storage type is only specified when storage size and location is chosen.



**For Canadian Pricing**

Multiply U.S. Price by the Canadian price factor.

▶ See page 1 for details.

▶ Options, continued on next page

► Options, continued from previous page

	Options	U.S. Price	Required to Specify
<b>Arm Height(s)</b>	<b>Right</b>		
	• Right arm low	No cost	Specify with right arm low.
	• Right arm high	+\$ 197	Specify with right arm high.
	• Right arm short	+\$ 131	Specify with right arm short.
	<b>Left</b>		
	• Left arm low	No cost	Specify with left arm low.
	• Left arm high	+\$ 197	Specify with left arm high.
	• Left arm short	+\$ 131	Specify with left arm short.
<b>Power</b>	<b>Right</b>		
	• Right arm no power	No cost	Specify with right arm no power.
	• Right arm two power	+\$ 493	Specify with right arm two power.
	• Right arm one power, two USB	+\$ 583	Specify with right arm one power, two USB.
	• Right arm, four USB	+\$ 583	Specify with right arm, four USB.
	<b>Left</b>		
	• Left arm no power	No cost	Specify with left arm no power.
	• Left arm two power	+\$ 493	Specify with left arm two power.
	• Left arm one power, two USB	+\$ 583	Specify with left arm one power, two USB.
	• Left arm, four USB	+\$ 583	Specify with left arm, four USB.
<b>Mobility</b>	• Four glides	No cost	Specify with four glides.
	• Two front glides and two rear non-locking casters	+\$ 409	Specify with two front glides and two rear non-locking casters.
	• Two front glides and two rear locking casters	+\$ 518	Specify with two front glides and two rear locking casters.
	• Two front locking casters and two rear glides	+\$ 518	Specify with two front locking casters and two rear glides.
	• Two front non-locking casters and two rear locking casters	+\$ 927	Specify with two front non-locking casters and two rear locking casters.
	• Two front locking casters and two rear non-locking casters	+\$ 927	Specify with two front locking casters and two rear non-locking casters.
	• Four locking casters	+\$1036	Specify with four locking casters.
<b>Tablet Rail</b>	• Tablet rail	+\$ 571	Specify with tablet rail.
<b>Related Products</b>	• Storage, one-tier end table		► Page 431
	• Storage, two-tier end table		► Page 432
	• Mobile tablet		► Page 433

Tip: Only four USB ports total may be specified in a unit.



Surround components are not designed for use with international power.

Tip: Mobile tablet is specified separately.

► See page 433.

► Options, continued on next page



**For Canadian Pricing**

Multiply U.S. Price by the Canadian price factor.

► See page 1 for details.

Surround Lounge, 60<sup>1</sup>/<sub>2</sub>" Frame Width, continued

► Options, continued from previous page

**Fabric Upcharges**

Style Number	Width	Fabric Price Group 1	Fabric Price Group 2	Fabric Price Group 3	Fabric Price Group 4	Fabric Price Group 5	Fabric Price Group 6	Fabric Price Group 7	Fabric Price Group 8	Fabric Price Group 9	Fabric Price Group 10	COM
<b>HLS61</b>												
<b>Seat</b>												
33"	No cost	+\$53	+\$ 98	+\$159	+\$233	+\$324	+\$794	+\$1003	+\$1194	+\$1405	+\$17	
38 <sup>1</sup> / <sub>2</sub> "	No cost	+\$53	+\$ 98	+\$159	+\$233	+\$324	+\$794	+\$1003	+\$1194	+\$1405	+\$17	
44"	No cost	+\$68	+\$123	+\$203	+\$292	+\$412	+\$873	+\$1126	+\$1354	+\$1602	+\$22	
49 <sup>1</sup> / <sub>2</sub> "	No cost	+\$78	+\$143	+\$237	+\$346	+\$484	+\$900	+\$1180	+\$1430	+\$1706	+\$24	
55"	No cost	+\$81	+\$147	+\$243	+\$358	+\$500	+\$908	+\$1209	+\$1501	+\$1802	+\$25	
60 <sup>1</sup> / <sub>2</sub> "	No cost	+\$92	+\$165	+\$274	+\$397	+\$558	+\$925	+\$1232	+\$1510	+\$1815	+\$27	
<b>Back</b>												
33"	No cost	+\$53	+\$ 98	+\$159	+\$233	+\$324	+\$794	+\$1003	+\$1194	+\$1405	+\$17	
38 <sup>1</sup> / <sub>2</sub> "	No cost	+\$53	+\$ 98	+\$159	+\$233	+\$324	+\$794	+\$1003	+\$1194	+\$1405	+\$17	
44"	No cost	+\$68	+\$123	+\$203	+\$292	+\$412	+\$873	+\$1126	+\$1354	+\$1602	+\$22	
49 <sup>1</sup> / <sub>2</sub> "	No cost	+\$78	+\$143	+\$237	+\$346	+\$484	+\$900	+\$1180	+\$1430	+\$1706	+\$24	
55"	No cost	+\$81	+\$147	+\$243	+\$358	+\$500	+\$908	+\$1209	+\$1501	+\$1802	+\$25	
60 <sup>1</sup> / <sub>2</sub> "	No cost	+\$92	+\$165	+\$274	+\$397	+\$558	+\$925	+\$1232	+\$1510	+\$1815	+\$27	
<b>Outer Back</b>												
33"	No cost	+\$53	+\$ 98	+\$159	+\$233	+\$324	+\$794	+\$1003	+\$1194	+\$1405	+\$17	
38 <sup>1</sup> / <sub>2</sub> "	No cost	+\$53	+\$ 98	+\$159	+\$233	+\$324	+\$794	+\$1003	+\$1194	+\$1405	+\$17	
44"	No cost	+\$68	+\$123	+\$203	+\$292	+\$412	+\$873	+\$1126	+\$1354	+\$1602	+\$22	
49 <sup>1</sup> / <sub>2</sub> "	No cost	+\$78	+\$143	+\$237	+\$346	+\$484	+\$900	+\$1180	+\$1430	+\$1706	+\$24	
55"	No cost	+\$81	+\$147	+\$243	+\$358	+\$500	+\$908	+\$1209	+\$1501	+\$1802	+\$25	
60 <sup>1</sup> / <sub>2</sub> "	No cost	+\$92	+\$165	+\$274	+\$397	+\$558	+\$925	+\$1232	+\$1510	+\$1815	+\$27	
<b>Arm</b>												
Low	No cost	+\$49	+\$ 69	+\$134	+\$173	+\$203	+\$263	+\$ 352	+\$ 441	+\$ 541	+\$22	
High	No cost	+\$78	+\$106	+\$207	+\$267	+\$374	+\$506	+\$ 605	+\$ 741	+\$ 897	+\$32	
Short	No cost	+\$78	+\$106	+\$207	+\$267	+\$374	+\$506	+\$ 605	+\$ 741	+\$ 897	+\$32	
<b>High Arm Pillow</b>												
Pillow	No cost	+\$49	+\$ 69	+\$134	+\$173	+\$203	+\$263	+\$ 352	+\$ 441	+\$ 541	+\$22	

Tip: Seat, back, and outer back fabrics may be specified in different choices. ► See Understanding Lounge on page 380.

Tip: Arm fabric and high arm pillow fabric is per arm selected.

Tip: High arm and pillow fabrics may be specified in different choices. ► See Understanding Lounge on page 380.



**For Canadian Pricing**  
Multiply U.S. Price by the Canadian price factor.  
► See page 1 for details.

**Specification Information**

Style Number	Frame Dimensions		Seat, Back, and Outer Back Width	U.S. Base Prices Low Arms		
	W	D		No arm(s)	One arm	Two arms

**60 1/2" Frame Width**

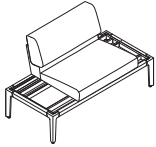

HLS61	60 1/2"	27 1/2"	33"	\$3213	\$3648	\$4083
			38 1/2"	\$3391	\$3826	\$4261
			44"	\$3696	\$4131	N.A.
			49 1/2"	\$3981	N.A.	\$4851
			55"	N.A.	\$4618	N.A.
			60 1/2"	\$4443	N.A.	N.A.

 **For Canadian Pricing**  
 Multiply U.S. Price by the Canadian price factor.  
 ▶ See page 1 for details.

# Surround Lounge

66" Frame Width

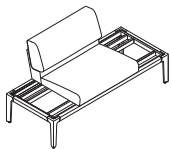

Standard Includes		Required to Specify
<ul style="list-style-type: none"> <li>▶ Need help? Product details, page 380</li> </ul>	<ul style="list-style-type: none"> <li>• Frame: paint price group 1</li> <li>• Seat, back, and outer back: fabric price group 1</li> <li>• Adjustable glides: platinum solid plastic</li> </ul>	<ol style="list-style-type: none"> <li>1 Style number</li> <li>2 Seat, back, and outer back width (see below under Required Selections)</li> <li>3 Sleep surface (see below under Required Selections)</li> <li>4 Paint color number for frame</li> <li>5 Fabric color number for seat, back, and outer back</li> <li>6 Arm position (see below under Required Selections)</li> <li>7 Options, if selected (see below)</li> </ol> <ul style="list-style-type: none"> <li>▶ See <i>Surface Materials</i>, page 473.</li> </ul>

	Required Selections	U.S. Price	Required to Specify
<b>Seat, Back, and Outer Back Width</b>	<ul style="list-style-type: none"> <li>• 33"W seat, back, and outer back</li> <li>• 38½"W seat, back, and outer back</li> <li>• 44"W seat, back, and outer back</li> <li>• 49½"W seat, back, and outer back</li> <li>• 55"W seat, back, and outer back</li> <li>• 60½"W seat, back, and outer back</li> <li>• 66"W seat, back, and outer back</li> </ul>	<p>Price at right</p> <p>Price at right</p> <p>Price at right</p> <p>Price at right</p> <p>Price at right</p> <p>Price at right</p> <p>Price at right</p>	<p>Specify with 33"W seat, back, and outer back.</p> <p>Specify with 38½"W seat, back, and outer back.</p> <p>Specify with 44"W seat, back, and outer back.</p> <p>Specify with 49½"W seat, back, and outer back.</p> <p>Specify with 55"W seat, back, and outer back.</p> <p>Specify with 60½"W seat, back, and outer back.</p> <p>Specify with 66"W seat, back, and outer back.</p>
<b>Sleep Surface</b>	<ul style="list-style-type: none"> <li>• No sleep surface</li> <li>• Sleep surface with 55"W seat, back, and outer back</li> </ul>	<p>No cost</p> <p>+\$735</p>	<p>Specify with no sleep surface.</p> <p>Specify with sleep surface.</p>
<b>Arm Position</b>	<ul style="list-style-type: none"> <li>• No arms</li> <li>• One arm</li> <li>• Two arms</li> </ul>	<p>Prices at right</p> <p>Prices at right</p> <p>Prices at right</p>	<p>Specify with no arms.</p> <p>Specify with arm right- or left-facing.</p> <p>Specify with two arms right- and left-facing.</p>

Tip: Left and right determined when facing the unit.

Tip: Understand that standard requires further specification to complete unit.

Tip: For additional specification information, refer to Surround Configuration Charts.

▶ See page 374.

Tip: Fabric upcharges are applied separately for seat, back, and outer back.

	Options	U.S. Price	Required to Specify
<b>Surface Materials</b>	<ul style="list-style-type: none"> <li>• <b>Frame</b></li> <li>• Paint price group 1</li> <li>• Paint price group 2</li> <li>• Paint price group 3</li> </ul>	<p>No cost</p> <p>+\$ 39</p> <p>+\$143</p>	<p>Specify paint color number.</p> <p>Specify paint color number.</p> <p>Specify paint color number.</p> <p>▶ See <i>Surface Materials</i>, page 473.</p>
	<ul style="list-style-type: none"> <li>• <b>Seat, back, and outer back</b></li> <li>• Fabric</li> </ul>	<p>Prices at right</p>	<p>Specify fabric color number.</p>
	<ul style="list-style-type: none"> <li>• <b>Arm(s)</b></li> <li>• Fabric</li> </ul>	<p>Prices at right</p>	<p>Specify fabric color number.</p>
	<ul style="list-style-type: none"> <li>• <b>High arm pillow (if high arm(s) selected)</b></li> <li>• Fabric</li> </ul>	<p>Prices at right</p>	<p>Specify fabric color number.</p>
	<ul style="list-style-type: none"> <li>• <b>Seat foam</b></li> <li>• Softer seat</li> </ul>	<p>No cost</p>	<p>Specify with softer seat.</p>
<b>Storage Size(s) and Location(s)</b>	<ul style="list-style-type: none"> <li>• No storage</li> <li>• 11"W right-facing storage</li> <li>• 16½"W right-facing storage</li> <li>• 11"W left-facing storage</li> <li>• 16½"W left-facing storage</li> <li>• 11"W left- and 11"W right-facing storage</li> </ul>	<p>No cost</p> <p>No cost</p> <p>No cost</p> <p>No cost</p> <p>No cost</p> <p>No cost</p>	<p>Specify with no storage.</p> <p>Specify with 11"W right-facing storage.</p> <p>Specify with 16½"W right-facing storage.</p> <p>Specify with 11"W left-facing storage.</p> <p>Specify with 16½"W left-facing storage.</p> <p>Specify with 11"W left- and 11"W right-facing storage.</p>

Tip: Storage is specified separately.

▶ See pages 431–432.

Tip: Storage not available if 60½"W seat, back, and outer back is specified.

▶ Options, continued on next page



► Options, continued from previous page

	Options	U.S. Price	Required to Specify
<b>Storage Type</b>	<b>Right</b>		
	• Right one-tier end table	No cost	Specify with right one-tier end table.
	• Right two-tier end table	No cost	Specify with right two-tier end table.
	<b>Left</b>		
	• Left one-tier end table	No cost	Specify with left one-tier end table.
	• Left two-tier end table	No cost	Specify with left two-tier end table.
<b>Arm Height(s)</b>	<b>Right</b>		
	• Right arm low	No cost	Specify with right arm low.
	• Right arm high	+\$ 197	Specify with right arm high.
	• Right arm short	+\$ 131	Specify with right arm short.
	<b>Left</b>		
	• Left arm low	No cost	Specify with left arm low.
• Left arm high	+\$ 197	Specify with left arm high.	
• Left arm short	+\$ 131	Specify with left arm short.	
<b>Power</b>	<b>Right</b>		
	• Right arm no power	No cost	Specify with right arm no power.
	• Right arm two power	+\$ 493	Specify with right arm two power.
	• Right arm one power, two USB	+\$ 583	Specify with right arm one power, two USB.
	• Right arm, four USB	+\$ 583	Specify with right arm, four USB.
	<b>Left</b>		
• Left arm no power	No cost	Specify with left arm no power.	
• Left arm two power	+\$ 493	Specify with left arm two power.	
• Left arm one power, two USB	+\$ 583	Specify with left arm one power, two USB.	
• Left arm, four USB	+\$ 583	Specify with left arm, four USB.	
<b>Mobility</b>	• Four glides	No cost	Specify with four glides.
	• Two front glides and two rear non-locking casters	+\$ 409	Specify with two front glides and two rear non-locking casters.
	• Two front glides and two rear locking casters	+\$ 518	Specify with two front glides and two rear locking casters.
	• Two front locking casters and two rear glides	+\$ 518	Specify with two front locking casters and two rear glides.
	• Two front non-locking casters and two rear locking casters	+\$ 927	Specify with two front non-locking casters and two rear locking casters.
	• Two front locking casters and two rear non-locking casters	+\$ 927	Specify with two front locking casters and two rear non-locking casters.
• Four locking casters	+\$1036	Specify with four locking casters.	
<b>Tablet Rail</b>	• Tablet rail	+\$ 571	Specify with tablet rail.
<b>Related Products</b>	• Storage, one-tier end table		► Page 431
	• Storage, two-tier end table		► Page 432
	• Mobile tablet		► Page 433

Tip: Storage type is only specified when storage size and location is chosen.

Tip: Only four USB ports total may be specified in a unit.



Surround components are not designed for use with international power.

Tip: Mobile tablet is specified separately.

► See page 433.

► Options, continued on next page



**For Canadian Pricing**

Multiply U.S. Price by the Canadian price factor.

► See page 1 for details.

Surround Lounge, 66" Frame Width, continued

► Options, continued from previous page

**Fabric Upcharges**

Style Number	Width	Fabric Price	Fabric Price	Fabric Price	Fabric Price	Fabric Price	Fabric Price	Fabric Price	Fabric Price	Fabric Price	Fabric Price	COM
		Group 1	Group 2	Group 3	Group 4	Group 5	Group 6	Group 7	Group 8	Group 9	Group 10	
<b>HLS66</b>												
<b>Seat</b>												
33"	No cost	+\$ 53	+\$ 98	+\$159	+\$233	+\$324	+\$794	+\$1003	+\$1194	+\$1405	+\$17	
38½"	No cost	+\$ 53	+\$ 98	+\$159	+\$233	+\$324	+\$794	+\$1003	+\$1194	+\$1405	+\$17	
44"	No cost	+\$ 68	+\$123	+\$203	+\$292	+\$412	+\$873	+\$1126	+\$1354	+\$1602	+\$22	
49½"	No cost	+\$ 78	+\$143	+\$237	+\$346	+\$484	+\$900	+\$1180	+\$1430	+\$1706	+\$24	
55"	No cost	+\$ 81	+\$147	+\$243	+\$358	+\$500	+\$908	+\$1209	+\$1501	+\$1802	+\$25	
60½"	No cost	+\$ 92	+\$165	+\$274	+\$397	+\$558	+\$925	+\$1232	+\$1510	+\$1815	+\$27	
66"	No cost	+\$101	+\$183	+\$303	+\$443	+\$618	+\$945	+\$1248	+\$1526	+\$1819	+\$31	
<b>Back</b>												
33"	No cost	+\$ 53	+\$ 98	+\$159	+\$233	+\$324	+\$794	+\$1003	+\$1194	+\$1405	+\$17	
38½"	No cost	+\$ 53	+\$ 98	+\$159	+\$233	+\$324	+\$794	+\$1003	+\$1194	+\$1405	+\$17	
44"	No cost	+\$ 68	+\$123	+\$203	+\$292	+\$412	+\$873	+\$1126	+\$1354	+\$1602	+\$22	
49½"	No cost	+\$ 78	+\$143	+\$237	+\$346	+\$484	+\$900	+\$1180	+\$1430	+\$1706	+\$24	
55"	No cost	+\$ 81	+\$147	+\$243	+\$358	+\$500	+\$908	+\$1209	+\$1501	+\$1802	+\$25	
60½"	No cost	+\$ 92	+\$165	+\$274	+\$397	+\$558	+\$925	+\$1232	+\$1510	+\$1815	+\$27	
66"	No cost	+\$101	+\$183	+\$303	+\$443	+\$618	+\$945	+\$1248	+\$1526	+\$1819	+\$31	
<b>Outer Back</b>												
33"	No cost	+\$ 53	+\$ 98	+\$159	+\$233	+\$324	+\$794	+\$1003	+\$1194	+\$1405	+\$17	
38½"	No cost	+\$ 53	+\$ 98	+\$159	+\$233	+\$324	+\$794	+\$1003	+\$1194	+\$1405	+\$17	
44"	No cost	+\$ 68	+\$123	+\$203	+\$292	+\$412	+\$873	+\$1126	+\$1354	+\$1602	+\$22	
49½"	No cost	+\$ 78	+\$143	+\$237	+\$346	+\$484	+\$900	+\$1180	+\$1430	+\$1706	+\$24	
55"	No cost	+\$ 81	+\$147	+\$243	+\$358	+\$500	+\$908	+\$1209	+\$1501	+\$1802	+\$25	
60½"	No cost	+\$ 92	+\$165	+\$274	+\$397	+\$558	+\$925	+\$1232	+\$1510	+\$1815	+\$27	
66"	No cost	+\$101	+\$183	+\$303	+\$443	+\$618	+\$945	+\$1248	+\$1526	+\$1819	+\$31	
<b>Arm</b>												
Low	No cost	+\$ 49	+\$ 69	+\$134	+\$173	+\$203	+\$263	+\$ 352	+\$ 441	+\$ 541	+\$22	
High	No cost	+\$ 78	+\$106	+\$207	+\$267	+\$374	+\$506	+\$ 605	+\$ 741	+\$ 897	+\$32	
Short	No cost	+\$ 78	+\$106	+\$207	+\$267	+\$374	+\$506	+\$ 605	+\$ 741	+\$ 897	+\$32	
<b>High Arm Pillow</b>												
Pillow	No cost	+\$ 49	+\$ 69	+\$134	+\$173	+\$203	+\$263	+\$ 352	+\$ 441	+\$ 541	+\$22	

Tip: Seat, back, and outer back fabrics may be specified in different choices.  
 ► See Understanding Lounge on page 380.

Tip: Arm fabric and high arm pillow fabric is per arm selected.

Tip: High arm and pillow fabrics may be specified in different choices.  
 ► See Understanding Lounge on page 380.



**For Canadian Pricing**  
 Multiply U.S. Price by the Canadian price factor.  
 ► See page 1 for details.

**Specification Information**

Style Number	Frame Dimensions		Seat, Back, and Outer Back Width	U.S. Base Prices Low Arms		
	W	D		No arm(s)	One arm	Two arms

**66" Frame Width**

<b>HLS66</b>	66"	27½"	33"	\$3357	\$3792	\$4227
			38½"	\$3535	\$3970	\$4405
			44"	\$3840	\$4275	\$4710
			49½"	\$4125	\$4560	N.A.
			55"	\$4327	N.A.	\$5197
			60½"	N.A.	\$5022	N.A.
			66"	\$4855	N.A.	N.A.

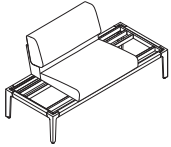

 **For Canadian Pricing**  
 Multiply U.S. Price by the Canadian price factor.  
 ▶ See page 1 for details.

# Surround Lounge

71 1/2" Frame Width

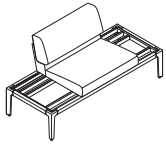

Standard Includes		Required to Specify
<ul style="list-style-type: none"> <li>▶ Need help? Product details, page 380</li> </ul>	<ul style="list-style-type: none"> <li>• Frame: paint price group 1</li> <li>• Seat, back, and outer back: fabric price group 1</li> <li>• Adjustable glides: platinum solid plastic</li> </ul>	<ol style="list-style-type: none"> <li>1 Style number</li> <li>2 Seat, back, and outer back width (see below under Required Selections)</li> <li>3 Sleep surface (see below under Required Selections)</li> <li>4 Paint color number for frame</li> <li>5 Fabric color number for seat, back, and outer back</li> <li>6 Arm position (see below under Required Selections)</li> <li>7 Options, if selected (see below)</li> </ol> <ul style="list-style-type: none"> <li>▶ See <i>Surface Materials</i>, page 473.</li> </ul>

	Required Selections	U.S. Price	Required to Specify
<b>Seat, Back, and Outer Back Width</b>	• 33"W seat, back, and outer back	Price at right	Specify with 33"W seat, back, and outer back.
	• 38 1/2"W seat, back, and outer back	Price at right	Specify with 38 1/2"W seat, back, and outer back.
	• 44"W seat, back, and outer back	Price at right	Specify with 44"W seat, back, and outer back.
	• 49 1/2"W seat, back, and outer back	Price at right	Specify with 49 1/2"W seat, back, and outer back.
	• 55"W seat, back, and outer back	Price at right	Specify with 55"W seat, back, and outer back.
	• 60 1/2"W seat, back, and outer back	Price at right	Specify with 60 1/2"W seat, back, and outer back.
	• 66"W seat, back, and outer back	Price at right	Specify with 66"W seat, back, and outer back.

Tip: When specifying no sleep surface, a fixed back will be received.

<b>Sleep Surface</b>	<ul style="list-style-type: none"> <li>• No sleep surface</li> <li>• Sleep surface with 60 1/2"W seat, back, and outer back</li> </ul>	No cost +\$771	Specify with no sleep surface. Specify with sleep surface.
----------------------	--	-------------------	---

Tip: Left and right determined when facing the unit.

<b>Arm Position</b>	<ul style="list-style-type: none"> <li>• No arms</li> <li>• One arm</li> <li>• Two arms</li> </ul>	Prices at right Prices at right Prices at right	Specify with no arms. Specify with arm right- or left-facing. Specify with two arms right- and left-facing.
---------------------	--	---	---

Tip: Understand that standard requires further specification to complete unit.

	Options	U.S. Price	Required to Specify
<b>Surface Materials</b>	<b>Frame</b>		
	• Paint price group 1	No cost	Specify paint color number.
	• Paint price group 2	+\$ 39	Specify paint color number.
	• Paint price group 3	+\$143	Specify paint color number. ▶ See <i>Surface Materials</i> , page 473.

Tip: For additional specification information, refer to Surround Configuration Charts.  
▶ See page 374.

	<b>Seat, back, and outer back</b>		
	• Fabric	Prices at right	Specify fabric color number.

Tip: Sleep surface requires the specification of two arms.

	<b>Arm(s)</b>		
	• Fabric	Prices at right	Specify fabric color number.

Tip: Fabric upcharges are applied separately for seat, back, and outer back.

	<b>High arm pillow (if high arm(s) selected)</b>		
	• Fabric	Prices at right	Specify fabric color number.

Tip: Storage is specified separately.  
▶ See pages 431–432.

	<b>Seat foam</b>		
	• Softer seat	No cost	Specify with softer seat.

Tip: Storage not available if 66"W seat, back, and outer back is specified.

<b>Storage Size(s) and Location(s)</b>	• No storage	No cost	Specify with no storage.
	• 11"W right-facing storage	No cost	Specify with 11"W right-facing storage.
	• 16 1/2"W right-facing storage	No cost	Specify with 16 1/2"W right-facing storage.
	• 11"W left-facing storage	No cost	Specify with 11"W left-facing storage.
	• 16 1/2"W left-facing storage	No cost	Specify with 16 1/2"W left-facing storage.
	• 11"W left- and 11"W right-facing storage	No cost	Specify with 11"W left- and 11"W right-facing storage.
	• 11"W left- and 16 1/2"W right-facing storage	No cost	Specify with 11"W left- and 16 1/2"W right-facing storage.
	• 16 1/2"W left- and 11"W right-facing storage	No cost	Specify with 16 1/2"W left- and 11"W right-facing storage.

▶ Options, continued on next page

► Options, continued from previous page

	Options	U.S. Price	Required to Specify
<b>Storage Type</b>	<b>Right</b>		
	• Right one-tier end table	No cost	Specify with right one-tier end table.
	• Right two-tier end table	No cost	Specify with right two-tier end table.
	<b>Left</b>		
	• Left one-tier end table	No cost	Specify with left one-tier end table.
	• Left two-tier end table	No cost	Specify with left two-tier end table.
<b>Arm Height(s)</b>	<b>Right</b>		
	• Right arm low	No cost	Specify with right arm low.
	• Right arm high	+\$ 197	Specify with right arm high.
	• Right arm short	+\$ 131	Specify with right arm short.
	<b>Left</b>		
	• Left arm low	No cost	Specify with left arm low.
• Left arm high	+\$ 197	Specify with left arm high.	
• Left arm short	+\$ 131	Specify with left arm short.	
<b>Power</b>	<b>Right</b>		
	• Right arm no power	No cost	Specify with right arm no power.
	• Right arm two power	+\$ 493	Specify with right arm two power.
	• Right arm one power, two USB	+\$ 583	Specify with right arm one power, two USB.
	• Right arm, four USB	+\$ 583	Specify with right arm, four USB.
	<b>Left</b>		
• Left arm no power	No cost	Specify with left arm no power.	
• Left arm two power	+\$ 493	Specify with left arm two power.	
• Left arm one power, two USB	+\$ 583	Specify with left arm one power, two USB.	
• Left arm, four USB	+\$ 583	Specify with left arm, four USB.	
<b>Mobility</b>	• Four glides	No cost	Specify with four glides.
	• Two front glides and two rear non-locking casters	+\$ 409	Specify with two front glides and two rear non-locking casters.
	• Two front glides and two rear locking casters	+\$ 518	Specify with two front glides and two rear locking casters.
	• Two front locking casters and two rear glides	+\$ 518	Specify with two front locking casters and two rear glides.
	• Two front non-locking casters and two rear locking casters	+\$ 927	Specify with two front non-locking casters and two rear locking casters.
	• Two front locking casters and two rear non-locking casters	+\$ 927	Specify with two front locking casters and two rear non-locking casters.
	• Four locking casters	+\$1036	Specify with four locking casters.
<b>Tablet Rail</b>	• Tablet rail	+\$ 571	Specify with tablet rail.
<b>Related Products</b>	• Storage, one-tier end table		► Page 431
	• Storage, two-tier end table		► Page 432
	• Mobile tablet		► Page 433

Tip: Storage type is only specified when storage size and location is chosen.

Tip: Only four USB ports total may be specified in a unit.



Surround components are not designed for use with international power.

Tip: Mobile tablet is specified separately.

► See page 433.

► Options, continued on next page



**For Canadian Pricing**

Multiply U.S. Price by the Canadian price factor.

► See page 1 for details.

Surround Lounge, 71½" Frame Width, continued

► Options, continued from previous page

**Fabric Upcharges**

Style Number	Width	Fabric Price	Fabric Price	Fabric Price	Fabric Price	Fabric Price	Fabric Price	Fabric Price	Fabric Price	Fabric Price	Fabric Price	COM
		Group 1	Group 2	Group 3	Group 4	Group 5	Group 6	Group 7	Group 8	Group 9	Group 10	
<b>HLS72</b>												
<b>Seat</b>												
33"	No cost	+\$ 53	+\$ 98	+\$159	+\$233	+\$324	+\$794	+\$1003	+\$1194	+\$1405	+\$17	
38½"	No cost	+\$ 53	+\$ 98	+\$159	+\$233	+\$324	+\$794	+\$1003	+\$1194	+\$1405	+\$17	
44"	No cost	+\$ 68	+\$123	+\$203	+\$292	+\$412	+\$873	+\$1126	+\$1354	+\$1602	+\$22	
49½"	No cost	+\$ 78	+\$143	+\$237	+\$346	+\$484	+\$900	+\$1180	+\$1430	+\$1706	+\$24	
55"	No cost	+\$ 81	+\$147	+\$243	+\$358	+\$500	+\$908	+\$1209	+\$1501	+\$1802	+\$25	
60½"	No cost	+\$ 92	+\$165	+\$274	+\$397	+\$558	+\$925	+\$1232	+\$1510	+\$1815	+\$27	
66"	No cost	+\$101	+\$183	+\$303	+\$443	+\$618	+\$945	+\$1248	+\$1526	+\$1819	+\$31	
<b>Back</b>												
33"	No cost	+\$ 53	+\$ 98	+\$159	+\$233	+\$324	+\$794	+\$1003	+\$1194	+\$1405	+\$17	
38½"	No cost	+\$ 53	+\$ 98	+\$159	+\$233	+\$324	+\$794	+\$1003	+\$1194	+\$1405	+\$17	
44"	No cost	+\$ 68	+\$123	+\$203	+\$292	+\$412	+\$873	+\$1126	+\$1354	+\$1602	+\$22	
49½"	No cost	+\$ 78	+\$143	+\$237	+\$346	+\$484	+\$900	+\$1180	+\$1430	+\$1706	+\$24	
55"	No cost	+\$ 81	+\$147	+\$243	+\$358	+\$500	+\$908	+\$1209	+\$1501	+\$1802	+\$25	
60½"	No cost	+\$ 92	+\$165	+\$274	+\$397	+\$558	+\$925	+\$1232	+\$1510	+\$1815	+\$27	
66"	No cost	+\$101	+\$183	+\$303	+\$443	+\$618	+\$945	+\$1248	+\$1526	+\$1819	+\$31	
<b>Outer Back</b>												
33"	No cost	+\$ 53	+\$ 98	+\$159	+\$233	+\$324	+\$794	+\$1003	+\$1194	+\$1405	+\$17	
38½"	No cost	+\$ 53	+\$ 98	+\$159	+\$233	+\$324	+\$794	+\$1003	+\$1194	+\$1405	+\$17	
44"	No cost	+\$ 68	+\$123	+\$203	+\$292	+\$412	+\$873	+\$1126	+\$1354	+\$1602	+\$22	
49½"	No cost	+\$ 78	+\$143	+\$237	+\$346	+\$484	+\$900	+\$1180	+\$1430	+\$1706	+\$24	
55"	No cost	+\$ 81	+\$147	+\$243	+\$358	+\$500	+\$908	+\$1209	+\$1501	+\$1802	+\$25	
60½"	No cost	+\$ 92	+\$165	+\$274	+\$397	+\$558	+\$925	+\$1232	+\$1510	+\$1815	+\$27	
66"	No cost	+\$101	+\$183	+\$303	+\$443	+\$618	+\$945	+\$1248	+\$1526	+\$1819	+\$31	
<b>Arm</b>												
Low	No cost	+\$ 49	+\$ 69	+\$134	+\$173	+\$203	+\$263	+\$ 352	+\$ 441	+\$ 541	+\$22	
High	No cost	+\$ 78	+\$106	+\$207	+\$267	+\$374	+\$506	+\$ 605	+\$ 741	+\$ 897	+\$32	
Short	No cost	+\$ 78	+\$106	+\$207	+\$267	+\$374	+\$506	+\$ 605	+\$ 741	+\$ 897	+\$32	
<b>High Arm Pillow</b>												
Pillow	No cost	+\$ 49	+\$ 69	+\$134	+\$173	+\$203	+\$263	+\$ 352	+\$ 441	+\$ 541	+\$22	

Tip: Seat, back, and outer back fabrics may be specified in different choices. ► See Understanding Lounge on page 380.

Tip: Arm fabric and high arm pillow fabric is per arm selected.

Tip: High arm and pillow fabrics may be specified in different choices. ► See Understanding Lounge on page 380.



**For Canadian Pricing**  
Multiply U.S. Price by the Canadian price factor.  
► See page 1 for details.

**Specification Information**

Style Number	Frame Dimensions		Seat, Back, and Outer Back Width	U.S. Base Prices Low Arms		
	W	D		No arm(s)	One arm	Two arms

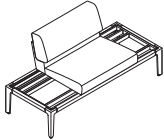

**71½" Frame Width**

HLS72	71½"	27½"	33"	N.A.	\$3940	\$4375
			38½"	\$3683	\$4118	\$4553
			44"	\$3988	\$4423	\$4858
			49½"	\$4273	\$4708	\$5143
			55"	\$4475	\$4910	N.A.
			60½"	\$4735	N.A.	\$5605
			66"	N.A.	\$5438	N.A.

 **For Canadian Pricing**  
 Multiply U.S. Price by the Canadian price factor.  
 ▶ See page 1 for details.

# Surround Lounge

77" Frame Width

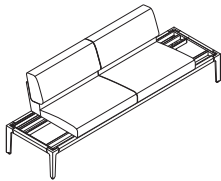

Standard Includes		Required to Specify
<ul style="list-style-type: none"> <li>▶ Need help? Product details, page 380</li> </ul>	<ul style="list-style-type: none"> <li>• Frame: paint price group 1</li> <li>• Seat, back, and outer back: fabric price group 1</li> <li>• Adjustable glides: platinum solid plastic</li> </ul>	<ol style="list-style-type: none"> <li>1 Style number</li> <li>2 Seat, back, and outer back width (see below under Required Selections)</li> <li>3 Sleep surface (see below under Required Selections)</li> <li>4 Paint color number for frame</li> <li>5 Fabric color number for seat, back, and outer back</li> <li>6 Arm position (see below under Required Selections)</li> <li>7 Options, if selected (see below)</li> </ol> <p>▶ See <i>Surface Materials</i>, page 473.</p>

	Required Selections	U.S. Price	Required to Specify
<b>Seat, Back, and Outer Back Width</b>	• 33"W seat, back, and outer back	Price at right	Specify with 33"W seat, back, and outer back.
	• 38 1/2"W seat, back, and outer back	Price at right	Specify with 38 1/2"W seat, back, and outer back.
	• 44"W seat, back, and outer back	Price at right	Specify with 44"W seat, back, and outer back.
	• 49 1/2"W seat, back, and outer back	Price at right	Specify with 49 1/2"W seat, back, and outer back.
	• 55"W seat, back, and outer back	Price at right	Specify with 55"W seat, back, and outer back.
	• 60 1/2"W seat, back, and outer back	Price at right	Specify with 60 1/2"W seat, back, and outer back.
	• 66"W seat, back, and outer back	Price at right	Specify with 66"W seat, back, and outer back.

*Tip: Lounge will have a fixed back when no sleep surface is specified.*

*Tip: Sleep surface requires the specification of two arms.*

*Tip: Left and right determined when facing the unit.*

*Tip: Understand that standard requires further specification to complete unit.*

*Tip: For additional specification information, refer to Surround Configuration Charts.*

▶ See page 374.

*Tip: Fabric upcharges are applied separately for seat, back, and outer back.*

<b>Sleep Surface</b>	• No sleep surface	No cost	Specify with no sleep surface.
	• Sleep surface with 55"W seat, back, and outer back	+\$735	Specify with sleep surface.
	• Sleep surface with 66"W seat, back, and outer back	+\$803	Specify with sleep surface.
<b>Arm Position</b>	• No arms	Prices at right	Specify with no arms.
	• One arm	Prices at right	Specify with arm right- or left-facing.
	• Two arms	Prices at right	Specify with two arms right- and left-facing.

	Options	U.S. Price	Required to Specify
<b>Surface Materials</b>	<b>Frame</b>		
	• Paint price group 1	No cost	Specify paint color number.
	• Paint price group 2	+\$ 39	Specify paint color number.
	• Paint price group 3	+\$143	Specify paint color number. ▶ See <i>Surface Materials</i> , page 473.
	<b>Seat, back, and outer back</b>		
	• Fabric	Prices at right	Specify fabric color number.
	<b>Arm(s)</b>		
	• Fabric	Prices at right	Specify fabric color number.
	<b>High arm pillow (if high arm(s) selected)</b>		
	• Fabric	Prices at right	Specify fabric color number.
	<b>Seat foam</b>		
	• Softer seat	No cost	Specify with softer seat.

▶ Options, continued on next page



### For Canadian Pricing

Multiply U.S. Price by the Canadian price factor.

▶ See page 1 for details.



► Options, continued from previous page

	Options	U.S. Price	Required to Specify	
<b>Storage Size(s) and Location(s)</b>	• No storage	No cost	Specify with no storage.	
	• 11"W right-facing storage	No cost	Specify with 11"W right-facing storage.	
	• 16 1/2"W right-facing storage	No cost	Specify with 16 1/2"W right-facing storage.	
	• 11"W left-facing storage	No cost	Specify with 11"W left-facing storage.	
	• 16 1/2"W left-facing storage	No cost	Specify with 16 1/2"W left-facing storage.	
	• 11"W left- and 11"W right-facing storage	No cost	Specify with 11"W left- and 11"W right-facing storage.	
	• 11"W left- and 16 1/2"W right-facing storage	No cost	Specify with 11"W left- and 16 1/2"W right-facing storage.	
	• 16 1/2"W left- and 11"W right-facing storage	No cost	Specify with 16 1/2"W left- and 11"W right-facing storage.	
	• 16 1/2"W left- and 16 1/2"W right-facing storage	No cost	Specify with 16 1/2"W left- and 16 1/2"W right-facing storage.	
<b>Storage Type</b>	<b>Right</b>			
	• Right one-tier end table	No cost	Specify with right one-tier end table.	
	• Right two-tier end table	No cost	Specify with right two-tier end table.	
	<b>Left</b>			
	• Left one-tier end table	No cost	Specify with left one-tier end table.	
	• Left two-tier end table	No cost	Specify with left two-tier end table.	
<b>Arm Height(s)</b>	<b>Right</b>			
	• Right arm low	No cost	Specify with right arm low.	
	• Right arm high	+\$ 197	Specify with right arm high.	
	• Right arm short	+\$ 131	Specify with right arm short.	
	<b>Left</b>			
	• Left arm low	No cost	Specify with left arm low.	
• Left arm high	+\$ 197	Specify with left arm high.		
• Left arm short	+\$ 131	Specify with left arm short.		
<b>Power</b>	<b>Right</b>			
	• Right arm no power	No cost	Specify with right arm no power.	
	• Right arm two power	+\$ 493	Specify with right arm two power.	
	• Right arm one power, two USB	+\$ 583	Specify with right arm one power, two USB.	
	• Right arm, four USB	+\$ 583	Specify with right arm, four USB.	
	<b>Left</b>			
	• Left arm no power	No cost	Specify with left arm no power.	
	• Left arm two power	+\$ 493	Specify with left arm two power.	
	• Left arm one power, two USB	+\$ 583	Specify with left arm one power, two USB.	
	• Left arm, four USB	+\$ 583	Specify with left arm, four USB.	
	<b>Mobility</b>	• Four glides	No cost	Specify with four glides.
		• Two front glides and two rear non-locking casters	+\$ 409	Specify with two front glides and two rear non-locking casters.
• Two front glides and two rear locking casters		+\$ 518	Specify with two front glides and two rear locking casters.	
• Two front locking casters and two rear glides		+\$ 518	Specify with two front locking casters and two rear glides.	
• Two front non-locking casters and two rear locking casters		+\$ 927	Specify with two front non-locking casters and two rear locking casters.	
• Two front locking casters and two rear non-locking casters		+\$ 927	Specify with two front locking casters and two rear non-locking casters.	
• Four locking casters		+\$1036	Specify with four locking casters.	
<b>Tablet Rail</b>		• Tablet rail	+\$ 571	Specify with tablet rail.
<b>Related Products</b>	• Storage, one-tier end table		► Page 431	
	• Storage, two-tier end table		► Page 432	
	• Mobile tablet		► Page 433	

Tip: Storage is specified separately.

► See pages 431-432.

Tip: Storage type is only specified when storage size and location is chosen.

Tip: Only four USB ports total may be specified in a unit.



Surround components are not designed for use with international power.

Tip: Mobile tablet is specified separately.

► See page 433.



**For Canadian Pricing**

Multiply U.S. Price by the Canadian price factor.

► See page 1 for details.

► Options, continued on next page

Surround Lounge, 77" Frame Width, continued

► Options, continued from previous page

**Fabric Upcharges**

Style Number	Width	Fabric Price Group 1	Fabric Price Group 2	Fabric Price Group 3	Fabric Price Group 4	Fabric Price Group 5	Fabric Price Group 6	Fabric Price Group 7	Fabric Price Group 8	Fabric Price Group 9	Fabric Price Group 10	COM
<b>HLS77</b>												
<b>Seat</b>												
33"	No cost	+\$ 53	+\$ 98	+\$159	+\$233	+\$324	+\$794	+\$1003	+\$1194	+\$1405	+\$17	
38½"	No cost	+\$ 53	+\$ 98	+\$159	+\$233	+\$324	+\$794	+\$1003	+\$1194	+\$1405	+\$17	
44"	No cost	+\$ 68	+\$123	+\$203	+\$292	+\$412	+\$873	+\$1126	+\$1354	+\$1602	+\$22	
49½"	No cost	+\$ 78	+\$143	+\$237	+\$346	+\$484	+\$900	+\$1180	+\$1430	+\$1706	+\$24	
55"	No cost	+\$ 81	+\$147	+\$243	+\$358	+\$500	+\$908	+\$1209	+\$1501	+\$1802	+\$25	
60½"	No cost	+\$ 92	+\$165	+\$274	+\$397	+\$558	+\$925	+\$1232	+\$1510	+\$1815	+\$27	
66"	No cost	+\$101	+\$183	+\$303	+\$443	+\$618	+\$945	+\$1248	+\$1526	+\$1819	+\$31	
<b>Back</b>												
33"	No cost	+\$ 53	+\$ 98	+\$159	+\$233	+\$324	+\$794	+\$1003	+\$1194	+\$1405	+\$17	
38½"	No cost	+\$ 53	+\$ 98	+\$159	+\$233	+\$324	+\$794	+\$1003	+\$1194	+\$1405	+\$17	
44"	No cost	+\$ 68	+\$123	+\$203	+\$292	+\$412	+\$873	+\$1126	+\$1354	+\$1602	+\$22	
49½"	No cost	+\$ 78	+\$143	+\$237	+\$346	+\$484	+\$900	+\$1180	+\$1430	+\$1706	+\$24	
55"	No cost	+\$ 81	+\$147	+\$243	+\$358	+\$500	+\$908	+\$1209	+\$1501	+\$1802	+\$25	
60½"	No cost	+\$ 92	+\$165	+\$274	+\$397	+\$558	+\$925	+\$1232	+\$1510	+\$1815	+\$27	
66"	No cost	+\$101	+\$183	+\$303	+\$443	+\$618	+\$945	+\$1248	+\$1526	+\$1819	+\$31	
<b>Outer Back</b>												
33"	No cost	+\$ 53	+\$ 98	+\$159	+\$233	+\$324	+\$794	+\$1003	+\$1194	+\$1405	+\$17	
38½"	No cost	+\$ 53	+\$ 98	+\$159	+\$233	+\$324	+\$794	+\$1003	+\$1194	+\$1405	+\$17	
44"	No cost	+\$ 68	+\$123	+\$203	+\$292	+\$412	+\$873	+\$1126	+\$1354	+\$1602	+\$22	
49½"	No cost	+\$ 78	+\$143	+\$237	+\$346	+\$484	+\$900	+\$1180	+\$1430	+\$1706	+\$24	
55"	No cost	+\$ 81	+\$147	+\$243	+\$358	+\$500	+\$908	+\$1209	+\$1501	+\$1802	+\$25	
60½"	No cost	+\$ 92	+\$165	+\$274	+\$397	+\$558	+\$925	+\$1232	+\$1510	+\$1815	+\$27	
66"	No cost	+\$101	+\$183	+\$303	+\$443	+\$618	+\$945	+\$1248	+\$1526	+\$1819	+\$31	
<b>Arm</b>												
Low	No cost	+\$49	+\$ 69	+\$134	+\$173	+\$203	+\$263	+\$352	+\$441	+\$541	+\$22	
High	No cost	+\$78	+\$106	+\$207	+\$267	+\$374	+\$506	+\$605	+\$741	+\$897	+\$32	
Short	No cost	+\$78	+\$106	+\$207	+\$267	+\$374	+\$506	+\$605	+\$741	+\$897	+\$32	
<b>High Arm Pillow</b>												
Pillow	No cost	+\$49	+\$ 69	+\$134	+\$173	+\$203	+\$263	+\$352	+\$441	+\$541	+\$22	

Tip: Seat, back, and outer back fabrics may be specified in different choices. ► See Understanding Lounge on page 380.

Tip: Arm fabric and high arm pillow fabric is per arm selected.

Tip: High arm and pillow fabrics may be specified in different choices. ► See Understanding Lounge on page 380.



**For Canadian Pricing**  
Multiply U.S. Price by the Canadian price factor.  
► See page 1 for details.

**Specification Information**

Style Number	Frame Dimensions		Seat, Back, and Outer Back Width	U.S. Base Prices Low Arms		
	W	D		No arm(s)	One arm	Two arms

**77" Frame Width**

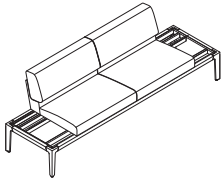

<b>HLS77</b>	77"	27 <sup>1</sup> / <sub>2</sub> "	33"	N.A.	N.A.	\$4523
			38 <sup>1</sup> / <sub>2</sub> "	N.A.	\$4266	\$4701
			44"	\$4136	\$4571	\$5006
			49 <sup>1</sup> / <sub>2</sub> "	\$4421	\$4856	\$5291
			55"	\$4623	\$5058	\$5493
			60 <sup>1</sup> / <sub>2</sub> "	\$4883	\$5318	N.A.
			66"	\$5151	N.A.	\$6021

 **For Canadian Pricing**  
 Multiply U.S. Price by the Canadian price factor.  
 ▶ See page 1 for details.

# Surround Lounge

82½" Frame Width

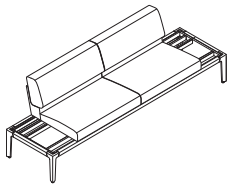

Standard Includes	Required to Specify
<ul style="list-style-type: none"> <li>▶ Need help? Product details, page 380</li> <li>• Frame: paint price group 1</li> <li>• Seat, back, and outer back: fabric price group 1</li> <li>• Sleep surface (if 71½"W seat, back, and outer back selected): 5031 Light Merle</li> <li>• Adjustable glides: platinum solid plastic</li> </ul>	<ol style="list-style-type: none"> <li>1 Style number</li> <li>2 Seat, back, and outer back width (see below under Required Selections)</li> <li>3 Sleep surface (see below under Required Selections)</li> <li>4 Paint color number for frame</li> <li>5 Fabric color number for seat, back, and outer back</li> <li>6 Arm position (see below under Required Selections)</li> <li>7 Options, if selected (see below)</li> </ol> <p>▶ See <i>Surface Materials</i>, page 473.</p>

Required Selections	U.S. Price	Required to Specify	
<b>Seat, Back, and Outer Back Width</b>	• 38½"W seat, back, and outer back	Price at right	Specify with 38½"W seat, back, and outer back.
	• 44"W seat, back, and outer back	Price at right	Specify with 44"W seat, back, and outer back.
	• 49½"W seat, back, and outer back	Price at right	Specify with 49½"W seat, back, and outer back.
	• 55"W seat, back, and outer back	Price at right	Specify with 55"W seat, back, and outer back.
	• 60½"W seat, back, and outer back	Price at right	Specify with 60½"W seat, back, and outer back.
	• 66"W seat, back, and outer back	Price at right	Specify with 66"W seat, back, and outer back.
	• 71½"W seat, back, and outer back	Price at right	Specify with 71½"W seat, back, and outer back.

<b>Sleep Surface</b>	• No sleep surface	No cost	Specify with no sleep surface.
	• Sleep surface with 55"W seat, back, and outer back	+\$735	Specify with sleep surface.
	• Sleep surface with 60½"W seat, back, and outer back	+\$771	Specify with sleep surface.
	• Sleep surface with 71½"W seat, back, and outer back	\$ 834 Included in U.S. Base Price	Specify with sleep surface.

<b>Arm Position</b>	• No arms	Prices at right	Specify with no arms.
	• One arm	Prices at right	Specify with arm right- or left-facing.
	• Two arms	Prices at right	Specify with two arms right- and left-facing.

Options	U.S. Price	Required to Specify	
<b>Surface Materials</b>	<b>Frame</b>		
	• Paint price group 1	No cost	Specify paint color number.
	• Paint price group 2	+\$ 39	Specify paint color number.
	• Paint price group 3	+\$143	Specify paint color number. ▶ See <i>Surface Materials</i> , page 473.
<b>Seat, back, and outer back</b>	• Fabric	Prices at right	Specify fabric color number.
	<b>Arm(s)</b>		
	• Fabric	Prices at right	Specify fabric color number.
<b>High arm pillow (if high arm(s) selected)</b>	• Fabric	Prices at right	Specify fabric color number.
	<b>Seat foam</b>		
	• Softer seat	No cost	Specify with softer seat.

▶ Options, continued on next page

*Tip: When specifying no sleep surface, a fixed back will be received.*

*Tip: Sleep surface is included and the only back available with 71½"W seat, back, and outer back selection.*

*Tip: Sleep surface requires the specification of two arms.*

*Tip: Left and right determined when facing the unit.*

*Tip: Understand that standard requires further specification to complete unit.*

*Tip: For additional specification information, refer to Surround Configuration Charts.*

▶ See page 374.

*Tip: Fabric upcharges are applied separately for seat, back, and outer back.*



**For Canadian Pricing**

Multiply U.S. Price by the Canadian price factor.

▶ See page 1 for details.

► Options, continued from previous page

	Options	U.S. Price	Required to Specify
<b>Storage Size(s) and Location(s)</b>	• No storage	No cost	Specify with no storage.
	• 11"W right-facing storage	No cost	Specify with 11"W right-facing storage.
	• 16 1/2"W right-facing storage	No cost	Specify with 16 1/2"W right-facing storage.
	• 11"W left-facing storage	No cost	Specify with 11"W left-facing storage.
	• 16 1/2"W left-facing storage	No cost	Specify with 16 1/2"W left-facing storage.
	• 11"W left- and 11"W right-facing storage	No cost	Specify with 11"W left- and 11"W right-facing storage.
	• 11"W left- and 16 1/2"W right-facing storage	No cost	Specify with 11"W left- and 16 1/2"W right-facing storage.
	• 16 1/2"W left- and 11"W right-facing storage	No cost	Specify with 16 1/2"W left- and 11"W right-facing storage.
<b>Storage Type</b>	<b>Right</b>		
	• Right one-tier end table	No cost	Specify with right one-tier end table.
	• Right two-tier end table	No cost	Specify with right two-tier end table.
<b>Arm Height(s)</b>	<b>Left</b>		
	• Left one-tier end table	No cost	Specify with left one-tier end table.
	• Left two-tier end table	No cost	Specify with left two-tier end table.
	<b>Right</b>		
	• Right arm low	No cost	Specify with right arm low.
	• Right arm high	+\$ 197	Specify with right arm high.
	• Right arm short	+\$ 131	Specify with right arm short.
<b>Power</b>	<b>Left</b>		
	• Left arm low	No cost	Specify with left arm low.
	• Left arm high	+\$ 197	Specify with left arm high.
	• Left arm short	+\$ 131	Specify with left arm short.
	<b>Right</b>		
	• Right arm no power	No cost	Specify with right arm no power.
	• Right arm two power	+\$ 493	Specify with right arm two power.
	• Right arm one power, two USB	+\$ 583	Specify with right arm one power, two USB.
• Right arm, four USB	+\$ 583	Specify with right arm, four USB.	
<b>Mobility</b>	<b>Left</b>		
	• Left arm no power	No cost	Specify with left arm no power.
	• Left arm two power	+\$ 493	Specify with left arm two power.
	• Left arm one power, two USB	+\$ 583	Specify with left arm one power, two USB.
	• Left arm, four USB	+\$ 583	Specify with left arm, four USB.
	• Four glides	No cost	Specify with four glides.
	• Two front glides and two rear non-locking casters	+\$ 409	Specify with two front glides and two rear non-locking casters.
	• Two front glides and two rear locking casters	+\$ 518	Specify with two front glides and two rear locking casters.
• Two front locking casters and two rear glides	+\$ 518	Specify with two front locking casters and two rear glides.	
• Two front non-locking casters and two rear locking casters	+\$ 927	Specify with two front non-locking casters and two rear locking casters.	
• Two front locking casters and two rear non-locking casters	+\$ 927	Specify with two front locking casters and two rear non-locking casters.	
• Four locking casters	+\$1036	Specify with four locking casters.	
<b>Tablet Rail</b>	• Tablet rail	+\$ 571	Specify with tablet rail.
<b>Related Products</b>	• Storage, one-tier end table		► Page 431
	• Storage, two-tier end table		► Page 432
	• Mobile tablet		► Page 433

Tip: Storage not available if 71 1/2"W seat, back, and outer back is specified.

Tip: Storage is specified separately.  
► See pages 431-432.

Tip: Storage type is only specified when storage size and location is chosen.

Tip: Only four USB ports total may be specified in a unit.



Surround components are not designed for use with international power.

Tip: Mobile tablet is specified separately.  
► See page 433.



**For Canadian Pricing**  
Multiply U.S. Price by the Canadian price factor.  
► See page 1 for details.

► Options, continued on next page

Surround Lounge, 82<sup>1</sup>/<sub>2</sub>" Frame Width, continued

► Options, continued from previous page

**Fabric Upcharges**

Style Number	Width	Fabric Price	Fabric Price	Fabric Price	Fabric Price	Fabric Price	Fabric Price	Fabric Price	Fabric Price	Fabric Price	Fabric Price	COM
		Group 1	Group 2	Group 3	Group 4	Group 5	Group 6	Group 7	Group 8	Group 9	Group 10	
<b>HLS83</b>												
<b>Seat</b>												
38 <sup>1</sup> / <sub>2</sub> "	No cost	+\$ 53	+\$ 98	+\$159	+\$233	+\$324	+\$ 794	+\$1003	+\$1194	+\$1405	+\$17	
44"	No cost	+\$ 68	+\$123	+\$203	+\$292	+\$412	+\$ 873	+\$1126	+\$1354	+\$1602	+\$22	
49 <sup>1</sup> / <sub>2</sub> "	No cost	+\$ 78	+\$143	+\$237	+\$346	+\$484	+\$ 900	+\$1180	+\$1430	+\$1706	+\$24	
55"	No cost	+\$ 81	+\$147	+\$243	+\$358	+\$500	+\$ 908	+\$1209	+\$1501	+\$1802	+\$25	
60 <sup>1</sup> / <sub>2</sub> "	No cost	+\$ 92	+\$165	+\$274	+\$397	+\$558	+\$ 925	+\$1232	+\$1510	+\$1815	+\$27	
66"	No cost	+\$101	+\$183	+\$303	+\$443	+\$618	+\$ 945	+\$1248	+\$1526	+\$1819	+\$31	
71 <sup>1</sup> / <sub>2</sub> "	No cost	+\$117	+\$216	+\$355	+\$518	+\$727	+\$1038	+\$1420	+\$1765	+\$2142	+\$35	
<b>Back</b>												
38 <sup>1</sup> / <sub>2</sub> "	No cost	+\$ 53	+\$ 98	+\$159	+\$233	+\$324	+\$ 794	+\$1003	+\$1194	+\$1405	+\$17	
44"	No cost	+\$ 68	+\$123	+\$203	+\$292	+\$412	+\$ 873	+\$1126	+\$1354	+\$1602	+\$22	
49 <sup>1</sup> / <sub>2</sub> "	No cost	+\$ 78	+\$143	+\$237	+\$346	+\$484	+\$ 900	+\$1180	+\$1430	+\$1706	+\$24	
55"	No cost	+\$ 81	+\$147	+\$243	+\$358	+\$500	+\$ 908	+\$1209	+\$1501	+\$1802	+\$25	
60 <sup>1</sup> / <sub>2</sub> "	No cost	+\$ 92	+\$165	+\$274	+\$397	+\$558	+\$ 925	+\$1232	+\$1510	+\$1815	+\$27	
66"	No cost	+\$101	+\$183	+\$303	+\$443	+\$618	+\$ 945	+\$1248	+\$1526	+\$1819	+\$31	
71 <sup>1</sup> / <sub>2</sub> "	No cost	+\$117	+\$216	+\$355	+\$518	+\$727	+\$1038	+\$1420	+\$1765	+\$2142	+\$35	
<b>Outer Back</b>												
38 <sup>1</sup> / <sub>2</sub> "	No cost	+\$ 53	+\$ 98	+\$159	+\$233	+\$324	+\$ 794	+\$1003	+\$1194	+\$1405	+\$17	
44"	No cost	+\$ 68	+\$123	+\$203	+\$292	+\$412	+\$ 873	+\$1126	+\$1354	+\$1602	+\$22	
49 <sup>1</sup> / <sub>2</sub> "	No cost	+\$ 78	+\$143	+\$237	+\$346	+\$484	+\$ 900	+\$1180	+\$1430	+\$1706	+\$24	
55"	No cost	+\$ 81	+\$147	+\$243	+\$358	+\$500	+\$ 908	+\$1209	+\$1501	+\$1802	+\$25	
60 <sup>1</sup> / <sub>2</sub> "	No cost	+\$ 92	+\$165	+\$274	+\$397	+\$558	+\$ 925	+\$1232	+\$1510	+\$1815	+\$27	
66"	No cost	+\$101	+\$183	+\$303	+\$443	+\$618	+\$ 945	+\$1248	+\$1526	+\$1819	+\$31	
71 <sup>1</sup> / <sub>2</sub> "	No cost	+\$117	+\$216	+\$355	+\$518	+\$727	+\$1038	+\$1420	+\$1765	+\$2142	+\$35	
<b>Arm</b>												
Low	No cost	+\$ 49	+\$ 69	+\$134	+\$173	+\$203	+\$ 263	+\$ 352	+\$ 441	+\$ 541	+\$22	
High	No cost	+\$ 78	+\$106	+\$207	+\$267	+\$374	+\$ 506	+\$ 605	+\$ 741	+\$ 897	+\$32	
Short	No cost	+\$ 78	+\$106	+\$207	+\$267	+\$374	+\$ 506	+\$ 605	+\$ 741	+\$ 897	+\$32	
<b>High Arm Pillow</b>												
Pillow	No cost	+\$ 49	+\$ 69	+\$134	+\$173	+\$203	+\$ 263	+\$ 352	+\$ 441	+\$ 541	+\$22	

Tip: Seat, back, and outer back fabrics may be specified in different choices. ► See Understanding Lounge on page 380.

Tip: Arm fabric and high arm pillow fabric is per arm selected.

Tip: High arm and pillow fabrics may be specified in different choices. ► See Understanding Lounge on page 380.



**For Canadian Pricing**  
Multiply U.S. Price by the Canadian price factor.  
► See page 1 for details.

**Specification Information**

Style Number	Frame Dimensions		Seat, Back, and Outer Back Width	U.S. Base Prices Low Arms		
	W	D		No arm(s)	One arm	Two arms

**82½" Frame Width**

HLS83	82½"	27½"	38½"	N.A.	N.A.	\$4847
			44"	N.A.	\$4717	\$5152
			49½"	\$4567	\$5002	\$5437
			55"	\$4769	\$5204	\$5639
			60½"	\$5029	\$5464	\$5899
			66"	\$5297	\$5732	N.A.
			71½"	N.A.	N.A.	\$6506

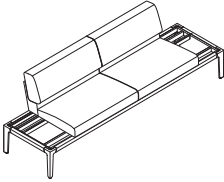

*Tip: Sleep surface upcharge is included in base price for 71½"W seat, back, and outer back.*



**For Canadian Pricing**  
 Multiply U.S. Price by the Canadian price factor.  
 ▶ See page 1 for details.

# Surround Lounge

88" Frame Width

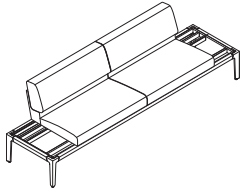

► Need help?  
Product details,  
page 380

### Standard Includes

- Frame: paint price group 1
- Seat, back, and outer back: fabric price group 1
- Sleep surface (if 77"W seat, back, and outer back selected): 5031 Light Merle
- Adjustable glides: platinum solid plastic

### Required to Specify

- 1 Style number
  - 2 Seat, back, and outer back width (see below under Required Selections)
  - 3 Sleep surface (see below under Required Selections)
  - 4 Paint color number for frame
  - 5 Fabric color number for seat, back, and outer back
  - 6 Arm position (see below under Required Selections)
  - 7 Options, if selected (see below)
- See *Surface Materials*, page 473.

	Required Selections	U.S. Price	Required to Specify
<b>Seat, Back, and Outer Back Width</b>	• 44"W seat, back, and outer back	Price at right	Specify with 44"W seat, back, and outer back.
	• 49 <sup>1</sup> / <sub>2</sub> "W seat, back, and outer back	Price at right	Specify with 49 <sup>1</sup> / <sub>2</sub> "W seat, back, and outer back.
	• 55"W seat, back, and outer back	Price at right	Specify with 55"W seat, back, and outer back.
	• 60 <sup>1</sup> / <sub>2</sub> "W seat, back, and outer back	Price at right	Specify with 60 <sup>1</sup> / <sub>2</sub> "W seat, back, and outer back.
	• 66"W seat, back, and outer back	Price at right	Specify with 66"W seat, back, and outer back.
	• 77"W seat, back, and outer back	Price at right	Specify with 77"W seat, back, and outer back.

<b>Sleep Surface</b>	• No sleep surface	No cost	Specify with no sleep surface.
	• Sleep surface with 55"W seat, back, and outer back	+\$735	Specify with sleep surface.
	• Sleep surface with 60 <sup>1</sup> / <sub>2</sub> "W seat, back, and outer back	+\$771	Specify with sleep surface.
	• Sleep surface with 66"W seat, back, and outer back	+\$803	Specify with sleep surface.
	• Sleep surface with 77"W seat, back, and outer back	\$ 868 Included in U.S. Base Price	Specify with sleep surface.

<b>Arm Position</b>	• No arms	Prices at right	Specify with no arms.
	• One arm	Prices at right	Specify with arm right- or left-facing.
	• Two arms	Prices at right	Specify with two arms right- and left-facing.

	Options	U.S. Price	Required to Specify
<b>Surface Materials</b>	<b>Frame</b>		
	• Paint price group 1	No cost	Specify paint color number.
	• Paint price group 2	+\$ 39	Specify paint color number.
	• Paint price group 3	+\$143	Specify paint color number. ► See <i>Surface Materials</i> , page 473.
	<b>Seat, back, and outer back</b>		
	• Fabric	Prices at right	Specify fabric color number.
	<b>Arms</b>		
	• Fabric	Prices at right	Specify fabric color number.
	<b>High arm pillow (if high arm(s) selected)</b>		
	• Fabric	Prices at right	Specify fabric color number.
	<b>Seat foam</b>		
	• Softer seat	No cost	Specify with softer seat.

► Options, continued on next page

*Tip: When specifying no sleep surface, a fixed back will be received.*

*Tip: Sleep surface is included and the only back available with 77"W seat, back, and outer back selection.*

*Tip: Sleep surface requires the specification of two arms.*

*Tip: Left and right determined when facing the unit.*

*Tip: Understand that standard requires further specification to complete unit.*

*Tip: For additional specification information, refer to Surround Configuration Charts.*

► See page 374.

*Tip: Fabric upcharges are applied separately for seat, back, and outer back.*



### For Canadian Pricing

Multiply U.S. Price by the Canadian price factor.

► See page 1 for details.



► Options, continued from previous page

	Options	U.S. Price	Required to Specify
<b>Storage Size(s) and Location(s)</b>	• No storage	No cost	Specify with no storage.
	• 11"W right-facing storage	No cost	Specify with 11"W right-facing storage.
	• 16 1/2"W right-facing storage	No cost	Specify with 16 1/2"W right-facing storage.
	• 11"W left-facing storage	No cost	Specify with 11"W left-facing storage.
	• 16 1/2"W left-facing storage	No cost	Specify with 16 1/2"W left-facing storage.
	• 11"W left- and 11"W right-facing storage	No cost	Specify with 11"W left- and 11"W right-facing storage.
	• 11"W left- and 16 1/2"W right-facing storage	No cost	Specify with 11"W left- and 16 1/2"W right-facing storage.
	• 16 1/2"W left- and 11"W right-facing storage	No cost	Specify with 16 1/2"W left- and 11"W right-facing storage.
	• 16 1/2"W left- and 16 1/2"W right-facing storage	No cost	Specify with 16 1/2"W left- and 16 1/2"W right-facing storage.
	<b>Storage Type</b>	<b>Right</b>	
• Right one-tier end table		No cost	Specify with right one-tier end table.
• Right two-tier end table		No cost	Specify with right two-tier end table.
<b>Left</b>			
• Left one-tier end table		No cost	Specify with left one-tier end table.
• Left two-tier end table		No cost	Specify with left two-tier end table.
<b>Arm Height(s)</b>	<b>Right</b>		
	• Right arm low	No cost	Specify with right arm low.
	• Right arm high	+\$ 197	Specify with right arm high.
	• Right arm short	+\$ 131	Specify with right arm short.
	<b>Left</b>		
	• Left arm low	No cost	Specify with left arm low.
• Left arm high	+\$ 197	Specify with left arm high.	
• Left arm short	+\$ 131	Specify with left arm short.	
<b>Power</b>	<b>Right</b>		
	• Right arm no power	No cost	Specify with right arm no power.
	• Right arm two power	+\$ 493	Specify with right arm two power.
	• Right arm one power, two USB	+\$ 583	Specify with right arm one power, two USB.
	• Right arm, four USB	+\$ 583	Specify with right arm, four USB.
	<b>Left</b>		
	• Left arm no power	No cost	Specify with left arm no power.
	• Left arm two power	+\$ 493	Specify with left arm two power.
	• Left arm one power, two USB	+\$ 583	Specify with left arm one power, two USB.
	• Left arm, four USB	+\$ 583	Specify with left arm, four USB.
<b>Mobility</b>	• Four glides	No cost	Specify with four glides.
	• Two front glides and two rear non-locking casters	+\$ 409	Specify with two front glides and two rear non-locking casters.
	• Two front glides and two rear locking casters	+\$ 518	Specify with two front glides and two rear locking casters.
	• Two front locking casters and two rear glides	+\$ 518	Specify with two front locking casters and two rear glides.
	• Two front non-locking casters and two rear locking casters	+\$ 927	Specify with two front non-locking casters and two rear locking casters.
	• Two front locking casters and two rear non-locking casters	+\$ 927	Specify with two front locking casters and two rear non-locking casters.
	• Four locking casters	+\$1036	Specify with four locking casters.
	<b>Tablet Rail</b>	• Tablet rail	+\$ 571

Tip: Storage is specified separately.

► See pages 431–432.

Tip: Storage not available if 77"W seat, back, and outer back is specified.

Tip: Sleep surface requires the specification of two arms.

Tip: Storage type is only specified when storage size and location is chosen.

Tip: Only four USB ports total may be specified in a unit.



Surround components are not designed for use with international power.

Tip: Mobile tablet is specified separately.

► See page 433.



**For Canadian Pricing**

Multiply U.S. Price by the Canadian price factor.

► See page 1 for details.

► Options, continued on next page

<b>Related Products</b>	• Storage, one-tier end table	► Page 431
	• Storage, two-tier end table	► Page 432
	• Mobile tablet	► Page 433

Surround Lounge, 88" Frame Width, continued

► Options, continued from previous page

**Fabric Upcharges**

Style Number	Width	Fabric Price Group 1	Fabric Price Group 2	Fabric Price Group 3	Fabric Price Group 4	Fabric Price Group 5	Fabric Price Group 6	Fabric Price Group 7	Fabric Price Group 8	Fabric Price Group 9	Fabric Price Group 10	COM
--------------	-------	----------------------	----------------------	----------------------	----------------------	----------------------	----------------------	----------------------	----------------------	----------------------	-----------------------	-----

Tip: Seat, back, and outer back fabrics may be specified in different choices.  
 ► See Understanding Lounge on page 380.

<b>HLS88</b>	<b>Seat</b>											
	44"	No cost	+\$ 68	+\$123	+\$203	+\$292	+\$412	+\$ 873	+\$1126	+\$1354	+\$1602	+\$22
	49½"	No cost	+\$ 78	+\$143	+\$237	+\$346	+\$484	+\$ 900	+\$1180	+\$1430	+\$1706	+\$24
	55"	No cost	+\$ 81	+\$147	+\$243	+\$358	+\$500	+\$ 908	+\$1209	+\$1501	+\$1802	+\$25
	60½"	No cost	+\$ 92	+\$165	+\$274	+\$397	+\$558	+\$ 925	+\$1232	+\$1510	+\$1815	+\$27
	66"	No cost	+\$101	+\$183	+\$303	+\$443	+\$618	+\$ 945	+\$1248	+\$1526	+\$1819	+\$31
	77"	No cost	+\$130	+\$237	+\$388	+\$569	+\$800	+\$1142	+\$1563	+\$1939	+\$2357	+\$39
	<b>Back</b>											
	44"	No cost	+\$ 68	+\$123	+\$203	+\$292	+\$412	+\$ 873	+\$1126	+\$1354	+\$1602	+\$22
	49½"	No cost	+\$ 78	+\$143	+\$237	+\$346	+\$484	+\$ 900	+\$1180	+\$1430	+\$1706	+\$24
	55"	No cost	+\$ 81	+\$147	+\$243	+\$358	+\$500	+\$ 908	+\$1209	+\$1501	+\$1802	+\$25
	60½"	No cost	+\$ 92	+\$165	+\$274	+\$397	+\$558	+\$ 925	+\$1232	+\$1510	+\$1815	+\$27
	66"	No cost	+\$101	+\$183	+\$303	+\$443	+\$618	+\$ 945	+\$1248	+\$1526	+\$1819	+\$31
	77"	No cost	+\$130	+\$237	+\$388	+\$569	+\$800	+\$1142	+\$1563	+\$1939	+\$2357	+\$39
	<b>Outer Back</b>											
	44"	No cost	+\$ 68	+\$123	+\$203	+\$292	+\$412	+\$ 873	+\$1126	+\$1354	+\$1602	+\$22
	49½"	No cost	+\$ 78	+\$143	+\$237	+\$346	+\$484	+\$ 900	+\$1180	+\$1430	+\$1706	+\$24
	55"	No cost	+\$ 81	+\$147	+\$243	+\$358	+\$500	+\$ 908	+\$1209	+\$1501	+\$1802	+\$25
	60½"	No cost	+\$ 92	+\$165	+\$274	+\$397	+\$558	+\$ 925	+\$1232	+\$1510	+\$1815	+\$27
	66"	No cost	+\$101	+\$183	+\$303	+\$443	+\$618	+\$ 945	+\$1248	+\$1526	+\$1819	+\$31
	77"	No cost	+\$130	+\$237	+\$388	+\$569	+\$800	+\$1142	+\$1563	+\$1939	+\$2357	+\$39
	<b>Arm</b>											
	Low	No cost	+\$ 49	+\$ 69	+\$134	+\$173	+\$203	+\$ 263	+\$ 352	+\$ 441	+\$ 541	+\$22
	High	No cost	+\$ 78	+\$106	+\$207	+\$267	+\$374	+\$ 506	+\$ 605	+\$ 741	+\$ 897	+\$32
	Short	No cost	+\$ 78	+\$106	+\$207	+\$267	+\$374	+\$ 506	+\$ 605	+\$ 741	+\$ 897	+\$32
	<b>High Arm Pillow</b>											
	Pillow	No cost	+\$ 49	+\$ 69	+\$134	+\$173	+\$203	+\$ 263	+\$ 352	+\$ 441	+\$ 541	+\$22

Tip: Arm fabric and high arm pillow fabric is per arm selected.

Tip: High arm and pillow fabrics may be specified in different choices.  
 ► See Understanding Lounge on page 380.



**For Canadian Pricing**  
 Multiply U.S. Price by the Canadian price factor.  
 ► See page 1 for details.

**Specification Information**

Style Number	Frame Dimensions		Seat, Back, and Outer Back Width	U.S. Base Prices Low Arms		
	W	D		No arm(s)	One arm	Two arms

**88" Frame Width**

HLS88	88"	27½"	44"	N.A.	N.A.	\$5297
			49½"	N.A.	\$5147	\$5582
			55"	\$4914	\$5349	\$5784
			60½"	\$5174	\$5609	\$6044
			66"	\$5442	\$5877	\$6312
			77"	N.A.	N.A.	\$6937

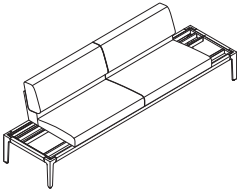

Tip: Sleep surface upcharge is included in base price for 77"W seat, back, and outer back.



**For Canadian Pricing**  
 Multiply U.S. Price by the Canadian price factor.  
 ▶ See page 1 for details.

# Surround Lounge

93 1/2" Frame Width

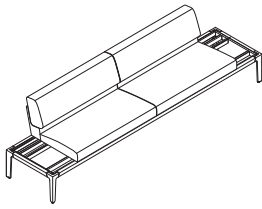

► Need help?  
Product details,  
page 380

### Standard Includes

- Frame: paint price group 1
- Seat, back, and outer back: fabric price group 1
- Sleep surface (if 71 1/2"W seat, back and outer back selected): 5031 Light Merle
- Adjustable glides: platinum solid plastic

### Required to Specify

- 1 Style number
  - 2 Seat, back, and outer back width (see below under Required Selections)
  - 3 Sleep surface (see below under Required Selections)
  - 4 Paint color number for frame
  - 5 Fabric color number for seat, back, and outer back
  - 6 Arm position (see below under Required Selections)
  - 7 Options, if selected (see below)
- See *Surface Materials*, page 473.

	Required Selections	U.S. Price	Required to Specify
<b>Seat, Back, and Outer Back Width</b>	• 49 1/2"W seat, back, and outer back	Prices at right	Specify with 49 1/2"W seat, back, and outer back.
	• 55"W seat, back, and outer back	Prices at right	Specify with 55"W seat, back, and outer back.
	• 60 1/2"W seat, back, and outer back	Prices at right	Specify with 60 1/2"W seat, back, and outer back.
	• 66"W seat, back, and outer back	Prices at right	Specify with 66"W seat, back, and outer back.
	• 71 1/2"W seat, back, and outer back	Prices at right	Specify with 71 1/2"W seat, back, and outer back.

*Tip: When specifying no sleep surface, a fixed back will be received.*

*Tip: Sleep surface is included and the only back available with 71 1/2"W seat, back, and outer back selection.*

*Tip: Sleep surface requires the specification of two arms.*

*Tip: Left and right determined when facing the unit.*

*Tip: Understand that standard requires further specification to complete unit.*

*Tip: For additional specification information, refer to Surround Configuration Charts.*

► See page 374.

*Tip: Fabric upcharges are applied separately for seat, back, and outer back.*

*Tip: Sleep surface requires the specification of two arms.*

<b>Sleep Surface</b>	• No sleep surface	No cost	Specify with no sleep surface.
	• Sleep surface with 55"W seat, back, and outer back	+\$735	Specify with sleep surface.
	• Sleep surface with 60 1/2"W seat, back, and outer back	+\$771	Specify with sleep surface.
	• Sleep surface with 66"W seat, back, and outer back	+\$803	Specify with sleep surface.
	• Sleep surface with 71 1/2"W seat, back, and outer back	\$ 834 Included in U.S. Base Price	Specify with sleep surface.

<b>Arm Position</b>	• No arms	Prices at right	Specify with no arms.
	• One arm	Prices at right	Specify with arm right- or left-facing.
	• Two arms	Prices at right	Specify with two arms right- and left-facing.

	Options	U.S. Price	Required to Specify
<b>Surface Materials</b>	<b>Frame</b>		
	• Paint price group 1	No cost	Specify paint color number.
	• Paint price group 2	+\$ 39	Specify paint color number.
	• Paint price group 3	+\$143	Specify paint color number. ► See <i>Surface Materials</i> , page 473.
	<b>Seat, back, and outer back</b>		
	• Fabric	Prices at right	Specify fabric color number.
	<b>Arms</b>		
	• Fabric	Prices at right	Specify fabric color number.
	<b>High arm pillow (if high arm(s) selected)</b>		
	• Fabric	Prices at right	Specify fabric color number.
	<b>Seat foam</b>		
	• Softer seat	No cost	Specify with softer seat.

► Options, continued on next page



### For Canadian Pricing

Multiply U.S. Price by the Canadian price factor.

► See page 1 for details.

► Options, continued from previous page

	Options	U.S. Price	Required to Specify
<b>Storage Size(s) and Location(s)</b>	• 11"W right-facing storage	No cost	Specify with 11"W right-facing storage.
	• 16 <sup>1</sup> / <sub>2</sub> "W right-facing storage	No cost	Specify with 16 <sup>1</sup> / <sub>2</sub> "W right-facing storage.
	• 11"W left-facing storage	No cost	Specify with 11"W left-facing storage.
	• 16 <sup>1</sup> / <sub>2</sub> "W left-facing storage	No cost	Specify with 16 <sup>1</sup> / <sub>2</sub> "W left-facing storage.
	• 11"W left- and 11"W right-facing storage	No cost	Specify with 11"W left- and 11"W right-facing storage.
	• 16 <sup>1</sup> / <sub>2</sub> "W left- and 11"W right-facing storage	No cost	Specify with 16 <sup>1</sup> / <sub>2</sub> "W left- and 11"W right-facing storage.
	• 11"W left- and 16 <sup>1</sup> / <sub>2</sub> "W right-facing storage	No cost	Specify with 11"W left- and 16 <sup>1</sup> / <sub>2</sub> "W right-facing storage.
	• 16 <sup>1</sup> / <sub>2</sub> "W left- and 16 <sup>1</sup> / <sub>2</sub> "W right-facing storage	No cost	Specify with 16 <sup>1</sup> / <sub>2</sub> "W left- and 16 <sup>1</sup> / <sub>2</sub> "W right-facing storage.
<b>Storage Type</b>	<b>Right</b>		
	• Right one-tier end table	No cost	Specify with right one-tier end table.
	• Right two-tier end table	No cost	Specify with right two-tier end table.
	<b>Left</b>		
• Left one-tier end table	No cost	Specify with left one-tier end table.	
• Left two-tier end table	No cost	Specify with left two-tier end table.	
<b>Arm Height(s)</b>	<b>Right</b>		
	• Right arm low	No cost	Specify with right arm low.
	• Right arm high	+\$ 197	Specify with right arm high.
	• Right arm short	+\$ 131	Specify with right arm short.
	<b>Left</b>		
	• Left arm low	No cost	Specify with left arm low.
	• Left arm high	+\$ 197	Specify with left arm high.
	• Left arm short	+\$ 131	Specify with left arm short.
<b>Power</b>	<b>Right</b>		
	• Right arm no power	No cost	Specify with right arm no power.
	• Right arm two power	+\$ 493	Specify with right arm two power.
	• Right arm one power, two USB	+\$ 583	Specify with right arm one power, two USB.
	• Right arm, four USB	+\$ 583	Specify with right arm, four USB.
	<b>Left</b>		
	• Left arm no power	No cost	Specify with left arm no power.
	• Left arm two power	+\$ 493	Specify with left arm two power.
	• Left arm one power, two USB	+\$ 583	Specify with left arm one power, two USB.
	• Left arm, four USB	+\$ 583	Specify with left arm, four USB.
<b>Mobility</b>	• Four glides	No cost	Specify with four glides.
	• Two front glides and two rear non-locking casters	+\$ 409	Specify with two front glides and two rear non-locking casters.
	• Two front glides and two rear locking casters	+\$ 518	Specify with two front glides and two rear locking casters.
	• Two front locking casters and two rear glides	+\$ 518	Specify with two front locking casters and two rear glides.
	• Two front non-locking casters and two rear locking casters	+\$ 927	Specify with two front non-locking casters and two rear locking casters.
	• Two front locking casters and two rear non-locking casters	+\$ 927	Specify with two front locking casters and two rear non-locking casters.
	• Four locking casters	+\$1036	Specify with four locking casters.
	<b>Tablet Rail</b>	• Tablet rail	+\$ 571
<b>Related Products</b>	• Storage, one-tier end table		► Page 431
	• Storage, two-tier end table		► Page 432
	• Mobile tablet		► Page 433

Tip: Storage is specified separately.

► See pages 431-432.

Tip: Storage type is only specified when storage size and location is chosen.

Tip: Only four USB ports total may be specified in a unit.



Surround components are not designed for use with international power.

Tip: Mobile tablet is specified separately.

► See page 433.



**For Canadian Pricing**

Multiply U.S. Price by the Canadian price factor.

► See page 1 for details.

► Options, continued on next page

Surround Lounge, 93<sup>1</sup>/<sub>2</sub>" Frame Width, continued

► Options, continued from previous page

**Fabric Upcharges**

Style Number	Width	Fabric Price Group 1	Fabric Price Group 2	Fabric Price Group 3	Fabric Price Group 4	Fabric Price Group 5	Fabric Price Group 6	Fabric Price Group 7	Fabric Price Group 8	Fabric Price Group 9	Fabric Price Group 10	COM
<b>HLS94</b>												
<b>Seat</b>												
49 <sup>1</sup> / <sub>2</sub> "	No cost	+\$ 78	+\$143	+\$237	+\$346	+\$484	+\$ 900	+\$1180	+\$1430	+\$1706	+\$24	
55"	No cost	+\$ 81	+\$147	+\$243	+\$358	+\$500	+\$ 908	+\$1209	+\$1501	+\$1802	+\$25	
60 <sup>1</sup> / <sub>2</sub> "	No cost	+\$ 92	+\$165	+\$274	+\$397	+\$558	+\$ 925	+\$1232	+\$1510	+\$1815	+\$27	
66"	No cost	+\$101	+\$183	+\$303	+\$443	+\$618	+\$ 945	+\$1248	+\$1526	+\$1819	+\$31	
71 <sup>1</sup> / <sub>2</sub> "	No cost	+\$117	+\$216	+\$355	+\$518	+\$727	+\$1038	+\$1420	+\$1765	+\$2142	+\$35	
<b>Back</b>												
49 <sup>1</sup> / <sub>2</sub> "	No cost	+\$ 78	+\$143	+\$237	+\$346	+\$484	+\$ 900	+\$1180	+\$1430	+\$1706	+\$24	
55"	No cost	+\$ 81	+\$147	+\$243	+\$358	+\$500	+\$ 908	+\$1209	+\$1501	+\$1802	+\$25	
60 <sup>1</sup> / <sub>2</sub> "	No cost	+\$ 92	+\$165	+\$274	+\$397	+\$558	+\$ 925	+\$1232	+\$1510	+\$1815	+\$27	
66"	No cost	+\$101	+\$183	+\$303	+\$443	+\$618	+\$ 945	+\$1248	+\$1526	+\$1819	+\$31	
71 <sup>1</sup> / <sub>2</sub> "	No cost	+\$117	+\$216	+\$355	+\$518	+\$727	+\$1038	+\$1420	+\$1765	+\$2142	+\$35	
<b>Outer Back</b>												
49 <sup>1</sup> / <sub>2</sub> "	No cost	+\$ 78	+\$143	+\$237	+\$346	+\$484	+\$ 900	+\$1180	+\$1430	+\$1706	+\$24	
55"	No cost	+\$ 81	+\$147	+\$243	+\$358	+\$500	+\$ 908	+\$1209	+\$1501	+\$1802	+\$25	
60 <sup>1</sup> / <sub>2</sub> "	No cost	+\$ 92	+\$165	+\$274	+\$397	+\$558	+\$ 925	+\$1232	+\$1510	+\$1815	+\$27	
66"	No cost	+\$101	+\$183	+\$303	+\$443	+\$618	+\$ 945	+\$1248	+\$1526	+\$1819	+\$31	
71 <sup>1</sup> / <sub>2</sub> "	No cost	+\$117	+\$216	+\$355	+\$518	+\$727	+\$1038	+\$1420	+\$1765	+\$2142	+\$35	
<b>Arm</b>												
Low	No cost	+\$ 49	+\$ 69	+\$134	+\$173	+\$203	+\$ 263	+\$ 352	+\$ 441	+\$ 541	+\$22	
High	No cost	+\$ 78	+\$106	+\$207	+\$267	+\$374	+\$ 506	+\$ 605	+\$ 741	+\$ 897	+\$32	
Short	No cost	+\$ 78	+\$106	+\$207	+\$267	+\$374	+\$ 506	+\$ 605	+\$ 741	+\$ 897	+\$32	
<b>High Arm Pillow</b>												
Pillow	No cost	+\$ 49	+\$ 69	+\$134	+\$173	+\$203	+\$ 263	+\$ 352	+\$ 441	+\$ 541	+\$22	

Tip: Seat, back, and outer back fabrics may be specified in different choices.  
 ► See Understanding Lounge on page 380.

Tip: Arm fabric and high arm pillow fabric is per arm selected.

Tip: High arm and pillow fabrics may be specified in different choices.  
 ► See Understanding Lounge on page 380.

**Specification Information**

Style Number	Frame Dimensions		Seat, Back, and Outer Back Width	U.S. Base Price Low Arms		
	W	D		No arm(s)	One arm	Two arms

**93½" Frame Width**

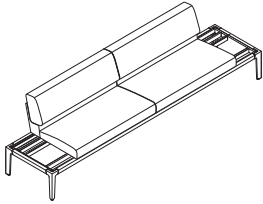

*Tip: Sleep surface upcharge is included in base price for 71½"W seat, back, and outer back.*

<b>HLS94</b>	93½"	27½"	49½"	N.A.	N.A.	\$5730
			55"	N.A.	\$5497	\$5932
			60½"	\$5322	\$5757	\$6192
			66"	\$5590	\$6025	\$6460
			71½"	N.A.	N.A.	\$6799

 **For Canadian Pricing**  
 Multiply U.S. Price by the Canadian price factor.  
 ▶ See page 1 for details.

# Surround Lounge

99" Frame Width

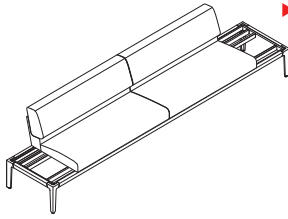

▶ Need help?  
Product details,  
page 380

### Standard Includes

- Frame: paint price group 1
- Seat, back, and outer back: fabric price group 1
- Sleep surface (if 71<sup>1</sup>/<sub>2</sub>"W or 77"W seat, back and outer back selected): 5031 Light Merle
- Adjustable glides: platinum solid plastic

### Required to Specify

- 1 Style number
  - 2 Seat, back, and outer back width (see below under Required Selections)
  - 3 Sleep surface (see below under Required Selections)
  - 4 Paint color number for frame
  - 5 Fabric color number for seat, back, and outer back
  - 6 Arm position (see below under Required Selections)
  - 7 Options, if selected (see below)
- ▶ See *Surface Materials*, page 473.

	Required Selections	U.S. Price	Required to Specify
<b>Seat, Back, and Outer Back Width</b>	• 55"W seat, back, and outer back	Price at right	Specify with 55"W seat, back, and outer back.
	• 60 <sup>1</sup> / <sub>2</sub> "W seat, back, and outer back	Price at right	Specify with 60 <sup>1</sup> / <sub>2</sub> "W seat, back, and outer back.
	• 66"W seat, back, and outer back	Price at right	Specify with 66"W seat, back, and outer back.
	• 71 <sup>1</sup> / <sub>2</sub> "W seat, back, and outer back	Price at right	Specify with 71 <sup>1</sup> / <sub>2</sub> "W seat, back, and outer back.
	• 77"W seat, back, and outer back	Price at right	Specify with 77"W seat, back, and outer back.

*Tip: When specifying no sleep surface, a fixed back will be received.*

*Tip: Sleep surface is included and the only back available with 71<sup>1</sup>/<sub>2</sub>"W or 77"W seat, back, and outer back selection.*

*Tip: Sleep surface requires the specification of two arms.*

*Tip: Left and right determined when facing the unit.*

*Tip: Understand that standard requires further specification to complete unit.*

*Tip: For additional specification information, refer to Surround Configuration Charts.*

▶ See page 374.

*Tip: Fabric upcharges are applied separately for seat, back, and outer back.*

*Tip: Sleep surface requires the specification of two arms.*

<b>Sleep Surface</b>	• No sleep surface	No cost	Specify with <i>no sleep surface</i> .
	• Sleep surface with 55"W seat, back, and outer back	+\$735	Specify with <i>sleep surface</i> .
<b>Arm Position</b>	• Sleep surface with 60 <sup>1</sup> / <sub>2</sub> "W seat, back, and outer back	+\$771	Specify with <i>sleep surface</i> .
	• Sleep surface with 66"W seat, back, and outer back	+\$803	Specify with <i>sleep surface</i> .
	• Sleep surface with 71 <sup>1</sup> / <sub>2</sub> "W seat, back, and outer back	\$ 834 Included in U.S. Base Price	Specify with <i>sleep surface</i> .
<b>Arm Position</b>	• Sleep surface with 77"W seat, back, and outer back	\$ 868 Included in U.S. Base Price	Specify with <i>sleep surface</i> .
	• No arms	Prices at right	Specify with <i>no arms</i> .
<b>Arm Position</b>	• One arm	Prices at right	Specify with <i>arm right- or left-facing</i> .
	• Two arms	Prices at right	Specify with <i>two arms right- and left-facing</i> .

	Options	U.S. Price	Required to Specify
<b>Surface Materials</b>	<b>Frame</b>		
	• Paint price group 1	No cost	Specify paint color number.
	• Paint price group 2	+\$ 39	Specify paint color number.
<b>Surface Materials</b>	• Paint price group 3	+\$143	Specify paint color number.
	<b>Seat, back, and outer back</b>		
<b>Surface Materials</b>	• Fabric	Prices at right	Specify fabric color number.
	<b>Arms</b>		
<b>Surface Materials</b>	• Fabric	Prices at right	Specify fabric color number.
	<b>High arm pillow (if high arm(s) selected)</b>		
<b>Surface Materials</b>	• Fabric	Prices at right	Specify fabric color number.
	<b>Seat foam</b>		
<b>Surface Materials</b>	• Softer seat	No cost	Specify with <i>softer seat</i> .

▶ See *Surface Materials*, page 473.

▶ Options, continued on next page



### For Canadian Pricing

Multiply U.S. Price by the Canadian price factor.

▶ See page 1 for details.



► Options, continued from previous page

	Options	U.S. Price	Required to Specify
<b>Storage Size(s) and Location(s)</b>	• 11"W right-facing storage	No cost	Specify with 11"W right-facing storage.
	• 16 1/2"W right-facing storage	No cost	Specify with 16 1/2"W right-facing storage.
	• 11"W left-facing storage	No cost	Specify with 11"W left-facing storage.
	• 16 1/2"W left-facing storage	No cost	Specify with 16 1/2"W left-facing storage.
	• 11"W left- and 11"W right-facing storage	No cost	Specify with 11"W left- and 11"W right-facing storage.
	• 16 1/2"W left- and 11"W right-facing storage	No cost	Specify with 16 1/2"W left- and 11"W right-facing storage.
	• 11"W left- and 16 1/2"W right-facing storage	No cost	Specify with 11"W left- and 16 1/2"W right-facing storage.
	• 16 1/2"W left- and 16 1/2"W right-facing storage	No cost	Specify with 16 1/2"W left- and 16 1/2"W right-facing storage.
<b>Storage Type</b>	<b>Right</b>		
	• Right one-tier end table	No cost	Specify with right one-tier end table.
	• Right two-tier end table	No cost	Specify with right two-tier end table.
	<b>Left</b>		
• Left one-tier end table	No cost	Specify with left one-tier end table.	
• Left two-tier end table	No cost	Specify with left two-tier end table.	
<b>Arm Height(s)</b>	<b>Right</b>		
	• Right arm low	No cost	Specify with right arm low.
	• Right arm high	+\$ 197	Specify with right arm high.
	• Right arm short	+\$ 131	Specify with right arm short.
	<b>Left</b>		
	• Left arm low	No cost	Specify with left arm low.
	• Left arm high	+\$ 197	Specify with left arm high.
	• Left arm short	+\$ 131	Specify with left arm short.
<b>Power</b>	<b>Right</b>		
	• Right arm no power	No cost	Specify with right arm no power.
	• Right arm two power	+\$ 493	Specify with right arm two power.
	• Right arm one power, two USB	+\$ 583	Specify with right arm one power, two USB.
	• Right arm, four USB	+\$ 583	Specify with right arm, four USB.
	<b>Left</b>		
	• Left arm no power	No cost	Specify with left arm no power.
	• Left arm two power	+\$ 493	Specify with left arm two power.
	• Left arm one power, two USB	+\$ 583	Specify with left arm one power, two USB.
	• Left arm, four USB	+\$ 583	Specify with left arm, four USB.
<b>Mobility</b>	• Four glides	No cost	Specify with four glides.
	• Two front glides and two rear non-locking casters	+\$ 409	Specify with two front glides and two rear non-locking casters.
	• Two front glides and two rear locking casters	+\$ 518	Specify with two front glides and two rear locking casters.
	• Two front locking casters and two rear glides	+\$ 518	Specify with two front locking casters and two rear glides.
	• Two front non-locking casters and two rear locking casters	+\$ 927	Specify with two front non-locking casters and two rear locking casters.
	• Two front locking casters and two rear non-locking casters	+\$ 927	Specify with two front locking casters and two rear non-locking casters.
	• Four locking casters	+\$1036	Specify with four locking casters.
	<b>Tablet Rail</b>	• Tablet rail	+\$ 571
<b>Related Products</b>	• Storage, one-tier end table		► Page 431
	• Storage, two-tier end table		► Page 432
	• Mobile tablet		► Page 433

Tip: Storage is specified separately.

► See pages 431-432.

Tip: Storage type is only specified when storage size and location is chosen.

Tip: Only four USB ports total may be specified in a unit.



Surround components are not designed for use with international power.

Tip: Mobile tablet is specified separately.

► See page 433.



**For Canadian Pricing**

Multiply U.S. Price by the Canadian price factor.

► See page 1 for details.

► Options, continued on next page

Surround Lounge, 99" Frame Width, continued

► Options, continued from previous page

**Fabric Upcharges**

Style Number	Width	Fabric Price	Fabric Price	Fabric Price	Fabric Price	Fabric Price	Fabric Price	Fabric Price	Fabric Price	Fabric Price	Fabric Price	COM
		Group 1	Group 2	Group 3	Group 4	Group 5	Group 6	Group 7	Group 8	Group 9	Group 10	
<b>HLS99</b>												
<b>Seat</b>												
55"	No cost	+\$ 81	+\$147	+\$243	+\$358	+\$500	+\$ 908	+\$1209	+\$1501	+\$1802	+\$25	
60½"	No cost	+\$ 92	+\$165	+\$274	+\$397	+\$558	+\$ 925	+\$1232	+\$1510	+\$1815	+\$27	
66"	No cost	+\$101	+\$183	+\$303	+\$443	+\$618	+\$ 945	+\$1248	+\$1526	+\$1819	+\$31	
71½"	No cost	+\$117	+\$216	+\$355	+\$518	+\$727	+\$1038	+\$1420	+\$1765	+\$2142	+\$35	
77"	No cost	+\$130	+\$237	+\$388	+\$569	+\$800	+\$1142	+\$1563	+\$1939	+\$2357	+\$39	
<b>Back</b>												
55"	No cost	+\$ 81	+\$147	+\$243	+\$358	+\$500	+\$ 908	+\$1209	+\$1501	+\$1802	+\$25	
60½"	No cost	+\$ 92	+\$165	+\$274	+\$397	+\$558	+\$ 925	+\$1232	+\$1510	+\$1815	+\$27	
66"	No cost	+\$101	+\$183	+\$303	+\$443	+\$618	+\$ 945	+\$1248	+\$1526	+\$1819	+\$31	
71½"	No cost	+\$117	+\$216	+\$355	+\$518	+\$727	+\$1038	+\$1420	+\$1765	+\$2142	+\$35	
77"	No cost	+\$130	+\$237	+\$388	+\$569	+\$800	+\$1142	+\$1563	+\$1939	+\$2357	+\$39	
<b>Outer Back</b>												
55"	No cost	+\$ 81	+\$147	+\$243	+\$358	+\$500	+\$ 908	+\$1209	+\$1501	+\$1802	+\$25	
60½"	No cost	+\$ 92	+\$165	+\$274	+\$397	+\$558	+\$ 925	+\$1232	+\$1510	+\$1815	+\$27	
66"	No cost	+\$101	+\$183	+\$303	+\$443	+\$618	+\$ 945	+\$1248	+\$1526	+\$1819	+\$31	
71½"	No cost	+\$117	+\$216	+\$355	+\$518	+\$727	+\$1038	+\$1420	+\$1765	+\$2142	+\$35	
77"	No cost	+\$130	+\$237	+\$388	+\$569	+\$800	+\$1142	+\$1563	+\$1939	+\$2357	+\$39	
<b>Arm</b>												
Low	No cost	+\$ 49	+\$ 69	+\$134	+\$173	+\$203	+\$ 263	+\$ 352	+\$ 441	+\$ 541	+\$22	
High	No cost	+\$ 78	+\$106	+\$207	+\$267	+\$374	+\$ 506	+\$ 605	+\$ 741	+\$ 897	+\$32	
Short	No cost	+\$ 78	+\$106	+\$207	+\$267	+\$374	+\$ 506	+\$ 605	+\$ 741	+\$ 897	+\$32	
<b>High Arm Pillow</b>												
Pillow	No cost	+\$ 49	+\$ 69	+\$134	+\$173	+\$203	+\$ 263	+\$ 352	+\$ 441	+\$ 541	+\$22	

Tip: Seat, back, and outer back fabrics may be specified in different choices. ► See Understanding Lounge on page 380.

Tip: Arm fabric and high arm pillow fabric is per arm selected.

Tip: High arm and pillow fabrics may be specified in different choices. ► See Understanding Lounge on page 380.

**Specification Information**

Style Number	Frame Dimensions		Seat, Back, and Outer Back Width	U.S. Base Prices Low Arms		
	W	D		No arm(s)	One arm	Two arms

**99" Frame Width**

HLS99	99"	27½"	55"	N.A.	N.A.	\$6080
			60½"	N.A.	\$5905	\$6340
			66"	\$5738	\$6173	\$6608
			71½"	N.A.	N.A.	\$6947
			77"	N.A.	N.A.	\$7233

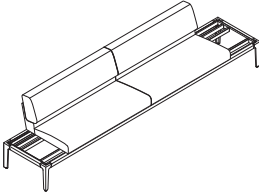

*Tip: Sleep surface upcharge is included in base price for 71½"W and 77"W seat, back, and outer back.*



**For Canadian Pricing**

Multiply U.S. Price by the Canadian price factor.

▶ See page 1 for details.

# Surround Lounge

104<sup>1</sup>/<sub>2</sub>" Frame Width

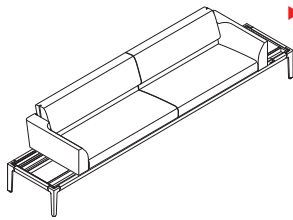

► Need help?  
Product details,  
page 380

### Standard Includes

- Frame: paint price group 1
- Seat, back, and outer back: fabric price group 1
- Sleep surface (if 71<sup>1</sup>/<sub>2</sub>"W or 77"W seat, back and outer back selected): 5031 Light Merle
- Adjustable glides: platinum solid plastic

### Required to Specify

- 1 Style number
  - 2 Seat, back, and outer back width (see below under Required Selections)
  - 3 Sleep surface (see below under Required Selections)
  - 4 Paint color number for frame
  - 5 Fabric color number for seat, back, and outer back
  - 6 Arm position (see below under Required Selections)
  - 7 Options, if selected (see below)
- See *Surface Materials*, page 473.

	Required Selections	U.S. Price	Required to Specify
<b>Seat, Back, and Outer Back Width</b>	• 60 <sup>1</sup> / <sub>2</sub> "W seat, back, and outer back	Price at right	Specify with 60 <sup>1</sup> / <sub>2</sub> "W seat, back, and outer back.
	• 66"W seat, back, and outer back	Price at right	Specify with 66"W seat, back, and outer back.
	• 71 <sup>1</sup> / <sub>2</sub> "W seat, back, and outer back	Price at right	Specify with 71 <sup>1</sup> / <sub>2</sub> "W seat, back, and outer back.
	• 77"W seat, back, and outer back	Price at right	Specify with 77"W seat, back, and outer back.
<b>Sleep Surface</b>	• No sleep surface	No cost	Specify with no sleep surface.
	• Sleep surface with 60 <sup>1</sup> / <sub>2</sub> "W seat, back, and outer back	+\$771	Specify with sleep surface.
	• Sleep surface with 66"W seat, back, and outer back	+\$803	Specify with sleep surface.
	• Sleep surface with 71 <sup>1</sup> / <sub>2</sub> "W seat, back, and outer back	\$ 834 Included in U.S. Base Price	Specify with sleep surface.
	• Sleep surface with 77"W seat, back, and outer back	\$ 868 Included in U.S. Base Price	Specify with sleep surface.
<b>Arm Position</b>	• One arm	Prices at right	Specify with arm right- or left-facing.
	• Two arms	Prices at right	Specify with two arms right- and left-facing.

*Tip: When specifying no sleep surface, a fixed back will be received.*

*Tip: Sleep surface is included and the only back available with 71<sup>1</sup>/<sub>2</sub>"W or 77"W seat, back, and outer back selection.*

*Tip: Sleep surface requires the specification of two arms.*

*Tip: Left and right determined when facing the unit.*

*Tip: Understand that standard requires further specification to complete unit.*

*Tip: For additional specification information, refer to Surround Configuration Charts.*

► See page 374.

*Tip: Fabric upcharges are applied separately for seat, back, and outer back.*

*Tip: Sleep surface requires the specification of two arms.*

	Options	U.S. Price	Required to Specify
<b>Surface Materials</b>	<b>Frame</b>		
	• Paint price group 1	No cost	Specify paint color number.
	• Paint price group 2	+\$ 39	Specify paint color number.
	• Paint price group 3	+\$143	Specify paint color number. ► See <i>Surface Materials</i> , page 473.
	<b>Seat, back, and outer back</b>		
	• Fabric	Prices at right	Specify fabric color number.
	<b>Arms</b>		
	• Fabric	Prices at right	Specify fabric color number.
	<b>High arm pillow (if high arm(s) selected)</b>		
	• Fabric	Prices at right	Specify fabric color number.
	<b>Seat foam</b>		
	• Softer seat	No cost	Specify with softer seat.

► Options, continued on next page



### For Canadian Pricing

Multiply U.S. Price by the Canadian price factor.

► See page 1 for details.

► Options, continued from previous page

	Options	U.S. Price	Required to Specify
<b>Storage Size(s) and Location(s)</b>	• 16 <sup>1</sup> / <sub>2</sub> "W right-facing storage	No cost	Specify with 16 <sup>1</sup> / <sub>2</sub> "W right-facing storage.
	• 11"W left-facing storage	No cost	Specify with 11"W left-facing storage.
	• 16 <sup>1</sup> / <sub>2</sub> "W left-facing storage	No cost	Specify with 16 <sup>1</sup> / <sub>2</sub> "W left-facing storage.
	• 11"W left- and 11"W right-facing storage	No cost	Specify with 11"W left- and 11"W right-facing storage.
	• 16 <sup>1</sup> / <sub>2</sub> "W left- and 11"W right-facing storage	No cost	Specify with 16 <sup>1</sup> / <sub>2</sub> "W left- and 11"W right-facing storage.
	• 11"W left- and 16 <sup>1</sup> / <sub>2</sub> "W right-facing storage	No cost	Specify with 11"W left- and 16 <sup>1</sup> / <sub>2</sub> "W right-facing storage.
	• 16 <sup>1</sup> / <sub>2</sub> "W left- and 16 <sup>1</sup> / <sub>2</sub> "W right-facing storage	No cost	Specify with 16 <sup>1</sup> / <sub>2</sub> "W left- and 16 <sup>1</sup> / <sub>2</sub> "W right-facing storage.
<b>Storage Type</b>	<b>Right</b>		
	• Right one-tier end table	No cost	Specify with right one-tier end table.
	• Right two-tier end table	No cost	Specify with right two-tier end table.
	<b>Left</b>		
• Left one-tier end table	No cost	Specify with left one-tier end table.	
• Left two-tier end table	No cost	Specify with left two-tier end table.	
<b>Arm Height(s)</b>	<b>Right</b>		
	• Right arm low	No cost	Specify with right arm low.
	• Right arm high	+\$ 197	Specify with right arm high.
	• Right arm short	+\$ 131	Specify with right arm short.
	<b>Left</b>		
	• Left arm low	No cost	Specify with left arm low.
• Left arm high	+\$ 197	Specify with left arm high.	
• Left arm short	+\$ 131	Specify with left arm short.	
<b>Power</b>	<b>Right</b>		
	• Right arm no power	No cost	Specify with right arm no power.
	• Right arm two power	+\$ 493	Specify with right arm two power.
	• Right arm one power, two USB	+\$ 583	Specify with right arm one power, two USB.
	• Right arm, four USB	+\$ 583	Specify with right arm, four USB.
	<b>Left</b>		
	• Left arm no power	No cost	Specify with left arm no power.
	• Left arm two power	+\$ 493	Specify with left arm two power.
	• Left arm one power, two USB	+\$ 583	Specify with left arm one power, two USB.
	• Left arm, four USB	+\$ 583	Specify with left arm, four USB.
<b>Mobility</b>	• Four glides	No cost	Specify with four glides.
	• Two front glides and two rear non-locking casters	+\$ 409	Specify with two front glides and two rear non-locking casters.
	• Two front glides and two rear locking casters	+\$ 518	Specify with two front glides and two rear locking casters.
	• Two front locking casters and two rear glides	+\$ 518	Specify with two front locking casters and two rear glides.
	• Two front non-locking casters and two rear locking casters	+\$ 927	Specify with two front non-locking casters and two rear locking casters.
	• Two front locking casters and two rear non-locking casters	+\$ 927	Specify with two front locking casters and two rear non-locking casters.
	• Four locking casters	+\$1036	Specify with four locking casters.
	<b>Tablet Rail</b>	• Tablet rail	+\$ 571
<b>Related Products</b>	• Storage, one-tier end table		► Page 431
	• Storage, two-tier end table		► Page 432
	• Mobile tablet		► Page 433

Tip: Storage is specified separately.

► See pages 431-432.

Tip: Storage type is only specified when storage size and location is chosen.

Tip: Only four USB ports total may be specified in a unit.



Surround components are not designed for use with international power.

Tip: Mobile tablet is specified separately.

► See page 433.



**For Canadian Pricing**

Multiply U.S. Price by the Canadian price factor.

► See page 1 for details.

► Options, continued on next page

Surround Lounge, 104 1/2" Frame Width, continued

► Options, continued from previous page

**Fabric Upcharges**

Style Number	Width	Fabric Price	Fabric Price Group 1	Fabric Price Group 2	Fabric Price Group 3	Fabric Price Group 4	Fabric Price Group 5	Fabric Price Group 6	Fabric Price Group 7	Fabric Price Group 8	Fabric Price Group 9	Fabric Price Group 10	COM
<b>HLS105 Seat</b>													
60 1/2"	No cost	+\$ 92	+\$165	+\$274	+\$397	+\$558	+\$ 925	+\$1232	+\$1510	+\$1815	+\$1815	+\$27	
66"	No cost	+\$101	+\$183	+\$303	+\$443	+\$618	+\$ 945	+\$1248	+\$1526	+\$1819	+\$1819	+\$31	
71 1/2"	No cost	+\$117	+\$216	+\$355	+\$518	+\$727	+\$1038	+\$1420	+\$1765	+\$2142	+\$2142	+\$35	
77"	No cost	+\$130	+\$237	+\$388	+\$569	+\$800	+\$1142	+\$1563	+\$1939	+\$2357	+\$2357	+\$39	
<b>Back</b>													
60 1/2"	No cost	+\$ 92	+\$165	+\$274	+\$397	+\$558	+\$ 925	+\$1232	+\$1510	+\$1815	+\$1815	+\$27	
66"	No cost	+\$101	+\$183	+\$303	+\$443	+\$618	+\$ 945	+\$1248	+\$1526	+\$1819	+\$1819	+\$31	
71 1/2"	No cost	+\$117	+\$216	+\$355	+\$518	+\$727	+\$1038	+\$1420	+\$1765	+\$2142	+\$2142	+\$35	
77"	No cost	+\$130	+\$237	+\$388	+\$569	+\$800	+\$1142	+\$1563	+\$1939	+\$2357	+\$2357	+\$39	
<b>Outer Back</b>													
60 1/2"	No cost	+\$ 92	+\$165	+\$274	+\$397	+\$558	+\$ 925	+\$1232	+\$1510	+\$1815	+\$1815	+\$27	
66"	No cost	+\$101	+\$183	+\$303	+\$443	+\$618	+\$ 945	+\$1248	+\$1526	+\$1819	+\$1819	+\$31	
71 1/2"	No cost	+\$117	+\$216	+\$355	+\$518	+\$727	+\$1038	+\$1420	+\$1765	+\$2142	+\$2142	+\$35	
77"	No cost	+\$130	+\$237	+\$388	+\$569	+\$800	+\$1142	+\$1563	+\$1939	+\$2357	+\$2357	+\$39	
<b>Arm</b>													
Low	No cost	+\$ 49	+\$ 69	+\$134	+\$173	+\$203	+\$ 263	+\$ 352	+\$ 441	+\$ 541	+\$ 541	+\$22	
High	No cost	+\$ 78	+\$106	+\$207	+\$267	+\$374	+\$ 506	+\$ 605	+\$ 741	+\$ 897	+\$ 897	+\$32	
Short	No cost	+\$ 78	+\$106	+\$207	+\$267	+\$374	+\$ 506	+\$ 605	+\$ 741	+\$ 897	+\$ 897	+\$32	
<b>High Arm Pillow</b>													
Pillow	No cost	+\$ 49	+\$ 69	+\$134	+\$173	+\$203	+\$ 263	+\$ 352	+\$ 441	+\$ 541	+\$ 541	+\$22	

Tip: Seat, back, and outer back fabrics may be specified in different choices. ► See Understanding Lounge on page 380.

Tip: Arm fabric and high arm pillow fabric is per arm selected.

Tip: High arm and pillow fabrics may be specified in different choices. ► See Understanding Lounge on page 380.

**Specification Information**

Style Number	Frame Dimensions		Seat, Back, and Outer Back Width	U.S. Base Prices Low Arms		
	W	D		No arm(s)	One arm	Two arms

**104 1/2" Frame Width**

HLS105	104 1/2"	27 1/2"	60 1/2"	N.A.	N.A.	\$6484
			66"	N.A.	\$6317	\$6752
			71 1/2"	N.A.	N.A.	\$7091
			77"	N.A.	N.A.	\$7377

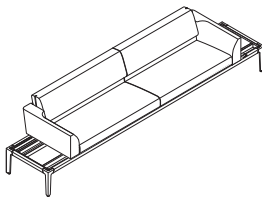

# Surround Storage

## One-Tier End Table

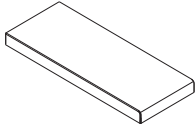

*Tip: Storage width must match storage size specified on frame.*

*Tip: Storage cannot be specified adjacent to other storage.*

Standard Includes		Required to Specify
<ul style="list-style-type: none"> <li>▶ Need help? Product details, page 384</li> </ul>	<ul style="list-style-type: none"> <li>• Table: paint price group 1 and 2</li> </ul>	<ol style="list-style-type: none"> <li>1 Style number</li> <li>2 Table width (see below under Required Selections)</li> <li>3 Storage location (see below under Required Selections)</li> <li>4 Paint color number for table</li> <li>5 Options, if selected (see below)</li> </ol> <ul style="list-style-type: none"> <li>▶ See <i>Surface Materials</i>, page 473.</li> </ul>

	Required Selections	U.S. Price	Required to Specify
<b>Table Width</b>	<ul style="list-style-type: none"> <li>• 11"W</li> <li>• 16<sup>1</sup>/<sub>2</sub>"W</li> </ul>	Price below Price below	Specify with 11"W. Specify with 16 <sup>1</sup> / <sub>2</sub> "W.

<b>Storage Location</b>	<ul style="list-style-type: none"> <li>• Left-facing storage</li> <li>• Right-facing storage</li> </ul>	No cost No cost	Specify with <i>left-facing storage</i> . Specify with <i>right-facing storage</i> .
-------------------------	---	--------------------	---

	Options	U.S. Price	Required to Specify
<b>Surface Materials</b>	<ul style="list-style-type: none"> <li>• Paint price group 1</li> <li>• Paint price group 2</li> <li>• Paint price group 3</li> </ul>	No cost No cost +\$60	Specify paint color number. Specify paint color number. Specify paint color number.

Specification Information		
Style Number	U.S. Base Prices	
	11"W	16 <sup>1</sup> / <sub>2</sub> "W
<b>HLSET</b>	\$655	\$786

 **For Canadian Pricing**  
Multiply U.S. Price by the Canadian price factor.  
▶ See page 1 for details.

# Surround Storage

## Two-Tier End Table

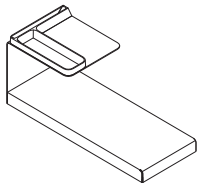

*Tip: Two-tier storage requires the specification of an adjacent low or high recline arm.*

*Tip: Two-tier storage is not able to be specified with short arm.*

*Tip: Storage width must match storage size specified on frame.*

*Tip: Storage location is determined when frame is specified.*

*Tip: Upper storage refers to the entire second tier, and lower storage refers to the bottom tier.*

*Tip: Storage cannot be specified adjacent to other storage.*

Standard Includes		Required to Specify
<ul style="list-style-type: none"> <li>▶ Need help? Product details, page 384</li> </ul>	<ul style="list-style-type: none"> <li>• Table: paint price group 1 and 2</li> <li>• Storage tray with picture rail: 6527 Merle</li> </ul>	<ol style="list-style-type: none"> <li>1 Style number</li> <li>2 Table width (see below under Required Selections)</li> <li>3 Paint color number for table</li> <li>4 Coat hanger (see below under Required Selections)</li> <li>5 Storage location (see below under Required Selections)</li> <li>6 Color scheme (see below under Required Selections)</li> <li>7 Options, if selected (see below)</li> </ol> <p>▶ See <i>Surface Materials</i>, page 473.</p>

	Required Selections	U.S. Price	Required to Specify
<b>Table Width</b>	<ul style="list-style-type: none"> <li>• 11"W</li> <li>• 16<sup>1</sup>/<sub>2</sub>"W</li> </ul>	Price below Price below	Specify <i>with 11"W</i> . Specify <i>with 16<sup>1</sup>/<sub>2</sub>"W</i> .
<b>Coat Hanger</b>	<ul style="list-style-type: none"> <li>• Coat hanger</li> </ul>	+\$131	Specify <i>with coat hanger</i> and select paint color number. ▶ See <i>Surface Materials</i> , page 473.
<b>Storage Location</b>	<ul style="list-style-type: none"> <li>• Left-facing storage</li> <li>• Right-facing storage</li> </ul>	No cost No cost	Specify <i>with left-facing storage</i> . Specify <i>with right-facing storage</i> .
<b>Color Scheme</b>	<ul style="list-style-type: none"> <li>• Contrasting finish</li> </ul>	+\$ 33	Specify <i>with contrasting</i> and select paint color number for upper and lower storage. ▶ See <i>Surface Materials</i> , page 473.

	Options	U.S. Price	Required to Specify
<b>Surface Materials</b>	<ul style="list-style-type: none"> <li>• Paint price group 1</li> <li>• Paint price group 2</li> <li>• Paint price group 3</li> </ul>	No cost No cost +\$ 60	Specify paint color number. Specify paint color number. Specify paint color number.

Specification Information		
• Style Number	U.S. Base Prices	
	• 11"W	• 16 <sup>1</sup> / <sub>2</sub> "W
HLSTTT	\$1834	\$1965



**For Canadian Pricing**  
Multiply U.S. Price by the Canadian price factor.  
▶ See page 1 for details.



# Surround Mobile Tablet

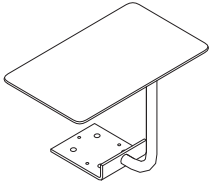

Tip: Tablet arm and tablet attach to the unit on site.

Tip: Tablet rail is specified on the frame.

Tip: Only one tablet rail and mobile tablet can be specified per unit.

Standard Includes		Required to Specify
▶ Need help? Product details, page 386	<ul style="list-style-type: none"> <li>• Tablet surface: plastic</li> <li>• Tablet arm: paint</li> </ul>	1 Style number 2 Plastic color number for tablet surface 3 Paint color number for tablet arm ▶ See <i>Surface Materials</i> , page 473.

Specification Information	
•Style Number	•U.S. Price
HLSMT	\$1723



**For Canadian Pricing**  
 Multiply U.S. Price by the Canadian price factor.  
 ▶ See page 1 for details.

# X-tenz Sleeper Chairs

**X-tenz sleeper chairs** feature a contemporary design and are available in single and double sleeper units.

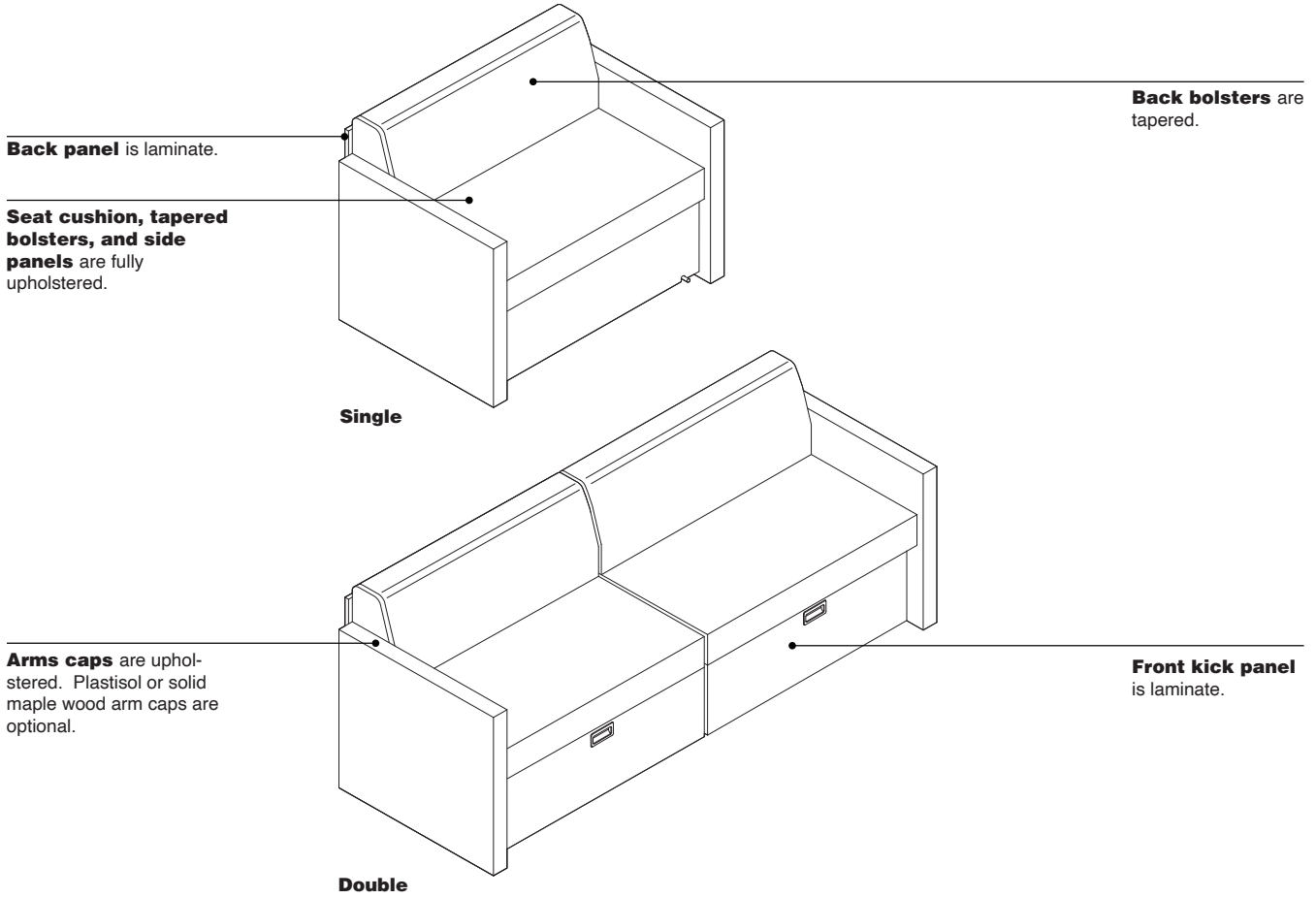

## Actual Dimensions

Features	Overall Depth	Width	Extended Width	Height	Seat Depth with Bolsters	Depth without Bolsters	Height	Mattress Thickness
<b>X-tenz Single Sleeper Chairs</b>								
Sleeper chair with glides	31"	45"	84"	35"	20"	29"	20"	5"
Sleeper chair with casters	31"	45"	84"	35½"	20"	29"	20½"	5"
Sleep surface	27"	80"		14½"				
<b>X-tenz Double Sleeper Chairs</b>								
Sleeper chair with glides	31"	84¾"		35"	20"	29"	20"	5"
Sleep surface when both units are extended	54"	80"		14½"				

\*Height from the floor

Tip: Sleep surface on X-tenz single sleeper chairs is 27"D x 80"W. Height of sleep surface is 14½"H.

Tip: Sleep surface on X-tenz double sleeper chairs when both units are extended is 54"D x 79¾"W. Height of sleep surface is 14½"H.

**Product Details**

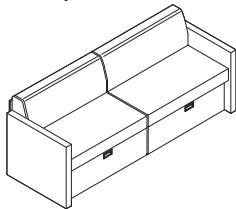
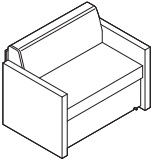

**X-tenz single and X-tenz double units** are standard with tapered bolsters.

**X-tenz single** is available with casters or glides. Caster models feature front locking, rear non-locking swivel casters.

**X-tenz double sleeper chair** is standard with glides.

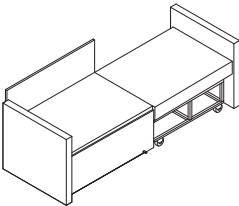

**Rollout section on X-tenz single sleeper chair** pulls to the side to expose the sleeping surface. The rollout section can be specified on either the left or right (shown), based on facing the front of the chair.

**Foot-activated** release allows the rollout section of the sleeper chair to be pulled out.

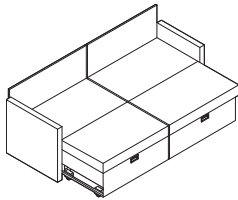

**Rollout section on X-tenz double sleeper chair** pulls forward to expose the sleeping surface.

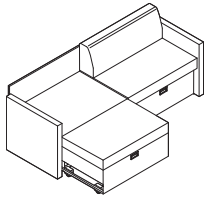

**Lounge position on X-tenz double sleeper chair** pulls forward allowing the two seats to extend independently.

**Directional casters** are standard on the rollout section of sleeper chairs with glides. Swivel casters are standard on the rollout section of single sleeper chairs with casters.

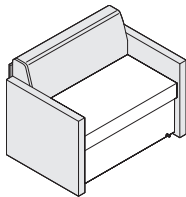

**Different fabrics** can be specified on the seat and back. Back fabric will match the side panel. Contrasting fabrics to be upholstered different from the standard must be processed through Specials.

**Moisture barrier** is optional. It is applied to the seat/mattress only.

**Surface Materials**

**All Steelcase Health seating with standard upholstery fabrics** comply with the State of California Technical Bulletin 117-2013.

**X-tenz Sleeper Chairs Seat cushion, bolsters, and side panels**

- Fabric
- Fabric with moisture barrier (option on seat/mattress only)

**Arm caps**

- Upholstered (standard)
- Maple wood (option)
- Plastisol (option)

**Back panel**

- Laminate

**Front kick panel**

- Laminate

**Glides**

- Black

**Casters**

- Black

**Casters – rollout section**

- Grey on models with glides
- Black on models with casters

# X-tenz Sleeper Chairs

## Single Sleeper Chairs

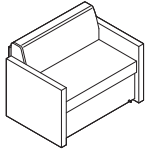

Tip: Specify the rollout section opening to the left or right as you face the front of the sleeper chair.

Tip: Different fabrics for the seat and back can be specified. If the fabrics are in different price groups, calculate list price by adding the two price groups together and dividing by two.

Standard Includes		Required to Specify
<ul style="list-style-type: none"> <li>▶ Need help? Product details, page 434</li> </ul>	<ul style="list-style-type: none"> <li>• Seat cushion and back bolsters: fabric</li> <li>• Arm caps: fabric</li> <li>• Back and front kick panels: laminate</li> <li>• Glides or casters: black only</li> </ul>	<ol style="list-style-type: none"> <li>1 Style number</li> <li>2 Fabric color number for seat cushion and back bolsters</li> <li>3 Laminate color number for back panel and front kick panel</li> <li>4 Options, if selected (see below)</li> </ol> <p>▶ See <i>Surface Materials</i>, page 473.</p>

Options	U.S. Price	Required to Specify
<b>Surface Materials</b> <ul style="list-style-type: none"> <li>• <b>Arm caps</b></li> <li>• Plastisol arm caps</li> <li>• Maple wood arm caps</li> </ul>	<ul style="list-style-type: none"> <li>+\$144</li> <li>+\$225</li> </ul>	<ul style="list-style-type: none"> <li>Specify with <i>plastisol arm caps</i> and select plastic color number.</li> <li>Specify with <i>wood arm caps</i> and select wood color number.</li> </ul>
<ul style="list-style-type: none"> <li>• <b>Moisture barrier on seat/mattress only</b></li> <li>• Moisture barrier</li> </ul>	<ul style="list-style-type: none"> <li>+\$541</li> </ul>	<ul style="list-style-type: none"> <li>Specify with <i>moisture barrier</i>.</li> </ul>

Specification Information											
U.S. Base Prices											
Style Number	Fabric Price Group 1	Fabric Price Group 2	Fabric Price Group 3	Fabric Price Group 4	Fabric Price Group 5	Fabric Price Group 6	Fabric Price Group 7	Fabric Price Group 8	Fabric Price Group 9	Fabric Price Group 10	COM

### With Glides

#### With Rollout Section Opening to the Left

<b>SC8141L</b>	\$4400	\$4868	\$5334	\$5728	\$6116	\$6352	\$6744	\$7522	\$8006	\$8456	\$4494
----------------	--------	--------	--------	--------	--------	--------	--------	--------	--------	--------	--------

#### With Rollout Section Opening to the Right

<b>SC8141R</b>	\$4400	\$4868	\$5334	\$5728	\$6116	\$6352	\$6744	\$7522	\$8006	\$8456	\$4494
----------------	--------	--------	--------	--------	--------	--------	--------	--------	--------	--------	--------

### With Casters

#### With Rollout Section Opening to the Left

<b>SC8141LC</b>	\$4857	\$5325	\$5791	\$6185	\$6573	\$6809	\$7201	\$7979	\$8463	\$8913	\$4951
-----------------	--------	--------	--------	--------	--------	--------	--------	--------	--------	--------	--------

#### With Rollout Section Opening to the Right

<b>SC8141RC</b>	\$4857	\$5325	\$5791	\$6185	\$6573	\$6809	\$7201	\$7979	\$8463	\$8913	\$4951
-----------------	--------	--------	--------	--------	--------	--------	--------	--------	--------	--------	--------



#### For Canadian Pricing

Multiply U.S. Price by the Canadian price factor.

▶ See page 1 for details.

# X-tenz Sleeper Chairs

## Double Sleeper Chairs

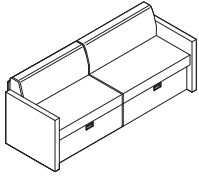

*Tip: Different fabrics for the seat and back can be specified. If the fabrics are in different price groups, calculate list price by adding the two price groups together and dividing by two.*

Standard Includes		Required to Specify
<ul style="list-style-type: none"> <li>▶ Need help? Product details, page 434</li> </ul>	<ul style="list-style-type: none"> <li>• Seat cushion and back bolsters: fabric</li> <li>• Arm caps: fabric</li> <li>• Back and front kick panels: laminate</li> <li>• Glides: black only</li> </ul>	<ol style="list-style-type: none"> <li>1 Style number</li> <li>2 Fabric color number for seat cushion and back bolsters</li> <li>3 Laminate color number for back panel and front kick panel</li> <li>4 Options, if selected (see below)</li> </ol> <p>▶ See <i>Surface Materials</i>, page 473.</p>

Options	U.S. Price	Required to Specify
<b>Surface Materials</b> <ul style="list-style-type: none"> <li>• <b>Arm caps</b></li> </ul>	<ul style="list-style-type: none"> <li>• Plastisol arm caps +\$144</li> <li>• Maple wood arm caps +\$225</li> </ul>	<ul style="list-style-type: none"> <li>Specify with <i>plastisol arm caps</i> and select plastic color number.</li> <li>Specify with <i>wood arm caps</i> and select wood color number.</li> </ul>
<b>Moisture barrier on seat/mattress only</b>		
<ul style="list-style-type: none"> <li>• Moisture barrier</li> </ul>	+\$675	Specify with <i>moisture barrier</i> .

Specification Information											
Style Number	U.S. Base Prices										COM
	Fabric Price Group 1	Fabric Price Group 2	Fabric Price Group 3	Fabric Price Group 4	Fabric Price Group 5	Fabric Price Group 6	Fabric Price Group 7	Fabric Price Group 8	Fabric Price Group 9	Fabric Price Group 10	
<b>SC8241</b>	\$8368	\$9124	\$9878	\$10,508	\$11,138	\$11,516	\$12,144	\$13,404	\$14,186	\$14,912	\$8462



**For Canadian Pricing**  
 Multiply U.S. Price by the Canadian price factor.  
 ▶ See page 1 for details.

# Mesa Lounge

**Mesa lounge seating** adds style to any workspace with its modern form and tapered legs. Modular pieces can easily create common areas of any size.

**Lounge units** can be connected together to create an L- or U-configuration. Two corners can be used together for a two-seat sofa.

**Connector brackets** are standard with all lounges and ottomans.

**Crumbsweep** is provided between seat plus back cushions, between seat cushions, and between seat plus arm cushions.

**Lounge units** are available in two-seat lounge, right- and left-hand chaise lounge, and corner lounge.

**Upholstered seat and back cushions** are attached.

**Tapered legs** are cast aluminum and coated in WE01 Antique Bronze.

**Frame** is a unibody construction with finger jointed plywood.

**Ottoman** can be freestanding or connected to other lounge units.

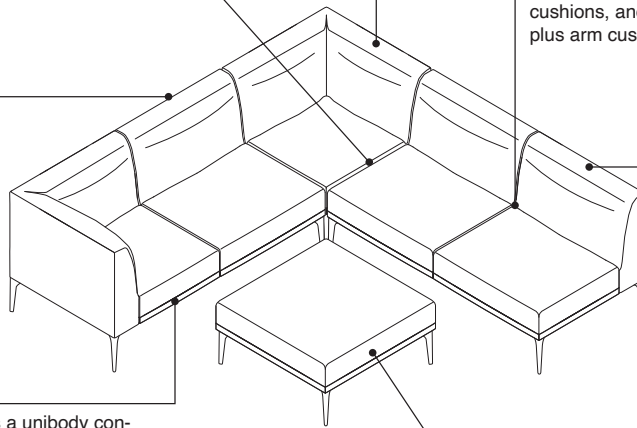

**Product Details**

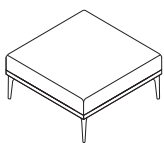
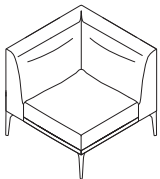
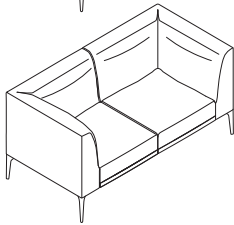
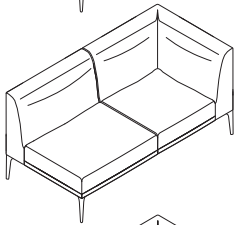
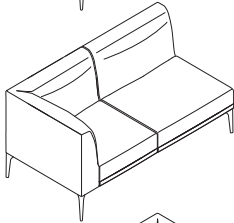
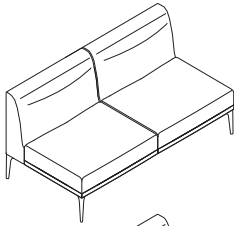

**Lounge seating** features five fully upholstered, complementary models: two-seat lounge, right-hand chaise lounge, left-hand chaise lounge, corner lounge, and ottoman. All models feature a four-leg, cast aluminum base with a powder coat painted finish.

**Mesa units** are tested to a 600 pound dynamic load.

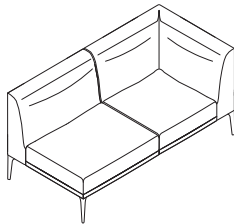
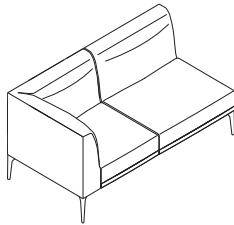

**Chaise lounge** can be specified in a right- or left-hand configuration.  
*Tip: Handedness is determined while in the seated position.*

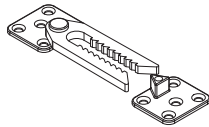

**Integrated ganging device** is included and keeps units aligned.

**Surface Materials**

**Upholstery**

► See *Surface Materials*, page 512 for specific availability.  
*Tip: Contrasting fabric is not available on Mesa.*

Visit <https://srh.steelcase.com/comcalculator.aspx> for Steelcase Textile calculator.

**Legs**

- WE01 Antique Bronze

**Dimensions**

► Page 440

# Dimensions

## Mesa Lounge

• Features	• Overall Depth	Width	Height	• Functional Seat Depth	• Seat Width	• Seat Height from Floor
<b>Mesa</b>						
<b>Lounge Seating</b>						
Two-Seat	32 <sup>1</sup> / <sub>4</sub> "	64 <sup>1</sup> / <sub>4</sub> "	28 <sup>3</sup> / <sub>4</sub> "	22 <sup>3</sup> / <sub>4</sub> "	64 <sup>1</sup> / <sub>4</sub> "	18 <sup>3</sup> / <sub>4</sub> "
Chaise	32 <sup>1</sup> / <sub>4</sub> "	64 <sup>1</sup> / <sub>4</sub> "	28 <sup>3</sup> / <sub>4</sub> "	22 <sup>3</sup> / <sub>4</sub> "	55"	18 <sup>3</sup> / <sub>4</sub> "
Corner	32 <sup>1</sup> / <sub>4</sub> "	32 <sup>1</sup> / <sub>4</sub> "	28 <sup>3</sup> / <sub>4</sub> "	22 <sup>3</sup> / <sub>4</sub> "	22 <sup>3</sup> / <sub>4</sub> "	18 <sup>3</sup> / <sub>4</sub> "
Ottoman	32 <sup>1</sup> / <sub>4</sub> "	32 <sup>1</sup> / <sub>4</sub> "	17 <sup>3</sup> / <sub>4</sub> "	N.A.	N.A.	N.A.
:	:	:	:	:	:	:





# Mesa

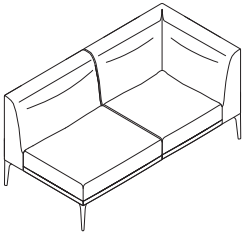

Tip: Contrasting fabric is not available on Mesa lounge seating.

Tip: Handedness is determined while in the seated position.

## Standard Includes

- Fully upholstered non-contrasting lounge: fabric price group 01
- Four leg cast aluminum base: WE01 Antique Bronze
- Ganging brackets: plastic

## Options

Inner Finish	Fabric Customer's Own Material	No cost
	Fabric Price Group 01	No cost
	Fabric Price Group 02	+\$31
	Customer's Own Leather	+\$100
	Fabric Price Group 03	+\$143
	Fabric Price Group 04	+\$278
	Fabric Price Group 05	+\$495
	Fabric Price Group 06	+\$732
	Fabric Price Group 07	+\$1021
	Fabric Price Group 08	+\$1324
	Fabric Price Group 09	+\$1636
	Fabric Price Group 10	+\$1925
	Leather Price Group 01	+\$2106
	Leather Price Group 02	+\$2595
Outer Finish	Fabric Customer's Own Material	No cost
	Fabric Price Group 01	No cost
	Fabric Price Group 02	+\$8
	Fabric Price Group 03	+\$47
	Fabric Price Group 04	+\$94
	Customer's Own Leather	+\$100
	Fabric Price Group 05	+\$165
	Fabric Price Group 06	+\$245
	Fabric Price Group 07	+\$341
	Fabric Price Group 08	+\$443
	Fabric Price Group 09	+\$545
	Fabric Price Group 10	+\$642
	Leather Price Group 01	+\$702
	Leather Price Group 02	+\$865
Leg Finish	Smooth Paint	No cost

## Specification Information

Style Number      Base Price

### Mesa Chaise Lounge - Left Hand

**WEHMESCHLH**      \$5224

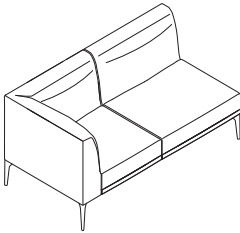

Tip: Contrasting fabric is not available on Mesa lounge seating.

Tip: Handedness is determined while in the seated position.

**Standard Includes**

- Fully upholstered non-contrasting lounge: fabric price group 01
- Four leg cast aluminum base: WE01 Antique Bronze
- Ganging brackets: plastic

**Options**

Inner Finish	Fabric Customer's Own Material	No cost
	Fabric Price Group 01	No cost
	Fabric Price Group 02	+\$31
	Customer's Own Leather	+\$100
	Fabric Price Group 03	+\$143
	Fabric Price Group 04	+\$278
	Fabric Price Group 05	+\$495
	Fabric Price Group 06	+\$732
	Fabric Price Group 07	+\$1021
	Fabric Price Group 08	+\$1324
	Fabric Price Group 09	+\$1636
	Fabric Price Group 10	+\$1925
	Leather Price Group 01	+\$2106
	Leather Price Group 02	+\$2595
Outer Finish	Fabric Customer's Own Material	No cost
	Fabric Price Group 01	No cost
	Fabric Price Group 02	+\$8
	Fabric Price Group 03	+\$47
	Fabric Price Group 04	+\$94
	Customer's Own Leather	+\$100
	Fabric Price Group 05	+\$165
	Fabric Price Group 06	+\$245
	Fabric Price Group 07	+\$341
	Fabric Price Group 08	+\$443
	Fabric Price Group 09	+\$545
	Fabric Price Group 10	+\$642
	Leather Price Group 01	+\$702
	Leather Price Group 02	+\$865
Leg Finish	Smooth Paint	No cost

**Specification Information**

Style Number	Base Price
--------------	------------

**Mesa Chaise Lounge - Right Hand**

<b>WEHMESCHRH</b>	\$5224
-------------------	--------

# Mesa

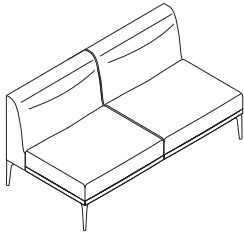

Tip: Contrasting fabric is not available on Mesa lounge seating.

## Standard Includes

- Fully upholstered non-contrasting lounge: fabric price group 01
- Four leg cast aluminum base: WE01 Antique Bronze
- Ganging brackets: plastic

## Options

Inner Finish	Fabric Customer's Own Material	No cost
	Fabric Price Group 01	No cost
	Fabric Price Group 02	+\$27
	Customer's Own Leather	+\$100
	Fabric Price Group 03	+\$133
	Fabric Price Group 04	+\$255
	Fabric Price Group 05	+\$458
	Fabric Price Group 06	+\$676
	Fabric Price Group 07	+\$942
	Fabric Price Group 08	+\$1221
	Fabric Price Group 09	+\$1505
	Fabric Price Group 10	+\$1777
Outer Finish	Leather Price Group 01	+\$1940
	Leather Price Group 02	+\$2389
	Fabric Customer's Own Material	No cost
	Fabric Price Group 01	No cost
	Fabric Price Group 02	+\$8
	Fabric Price Group 03	+\$45
	Fabric Price Group 04	+\$84
	Customer's Own Leather	+\$100
	Fabric Price Group 05	+\$153
	Fabric Price Group 06	+\$225
	Fabric Price Group 07	+\$315
	Fabric Price Group 08	+\$407
Fabric Price Group 09	+\$502	
Fabric Price Group 10	+\$593	
Leg Finish	Leather Price Group 01	+\$646
	Leather Price Group 02	+\$798
Leg Finish	Smooth Paint	No cost

## Specification Information

Style Number	Base Price
--------------	------------

### Mesa Armless Lounge

**WEHMES2SEAT** \$4742

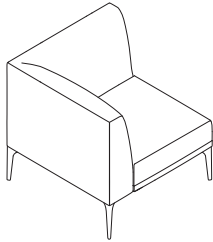

Tip: Contrasting fabric is not available on Mesa lounge seating.

**Standard Includes**

- Fully upholstered non-contrasting lounge: fabric price group 01
- Four leg cast aluminum base: WE01 Antique Bronze
- Ganging brackets: plastic

**Options**

Inner Finish	Fabric Customer's Own Material	No cost
	Fabric Price Group 01	No cost
	Fabric Price Group 02	+\$17
	Fabric Price Group 03	+\$82
	Customer's Own Leather	+\$100
	Fabric Price Group 04	+\$161
	Fabric Price Group 05	+\$286
	Fabric Price Group 06	+\$425
	Fabric Price Group 07	+\$590
	Fabric Price Group 08	+\$765
	Fabric Price Group 09	+\$944
	Fabric Price Group 10	+\$1112
	Leather Price Group 01	+\$1216
	Leather Price Group 02	+\$1500
Outer Finish	Fabric Customer's Own Material	No cost
	Fabric Price Group 01	No cost
	Fabric Price Group 02	+\$4
	Fabric Price Group 03	+\$27
	Fabric Price Group 04	+\$55
	Fabric Price Group 05	+\$97
	Customer's Own Leather	+\$100
	Fabric Price Group 06	+\$141
	Fabric Price Group 07	+\$197
	Fabric Price Group 08	+\$255
	Fabric Price Group 09	+\$315
	Fabric Price Group 10	+\$372
	Leather Price Group 01	+\$405
	Leather Price Group 02	+\$498
Leg Finish	Smooth Paint	No cost

**Specification Information**

Style Number    Base Price

**Mesa Corner Lounge Unit**

**WEHMESC**    \$3083

# Mesa

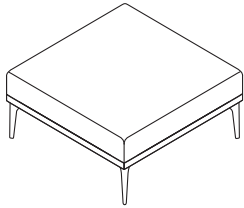

## Standard Includes

- Fully upholstered ottoman: fabric price group 01
- Four leg cast aluminum base: WE01 Antique Bronze
- Ganging brackets: plastic

## Options

Upholstery Finish	Fabric Customer's Own Material	No cost
	Fabric Price Group 01	No cost
	Fabric Price Group 02	+\$12
	Fabric Price Group 03	+\$69
	Fabric Price Group 04	+\$134
	Customer's Own Leather	+\$198
	Fabric Price Group 05	+\$238
	Fabric Price Group 06	+\$352
	Fabric Price Group 07	+\$488
	Fabric Price Group 08	+\$635
	Fabric Price Group 09	+\$784
	Fabric Price Group 10	+\$924
Leather Price Group 01		+\$1008
	Leather Price Group 02	+\$1243
Leg Finish	Smooth Paint	No cost

## Specification Information

Style Number    Base Price

### Mesa Ottoman

**WEHMESO**    \$2107



# Slope

**Simple yet timeless design** allows the Slope family of seating to blend seamlessly into the modern office. A wide range of paint colors and upholstery options ranging from muted to playful add personality.

*Tip: For specification information regarding Slope counter-height stool, Slope bar-height stool, and Slope conference chair see West Elm Work Collection Specification Guide.*

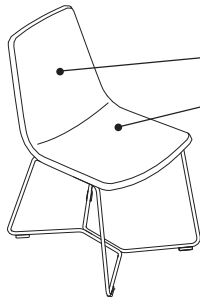

**Seat and back** are always fully upholstered.

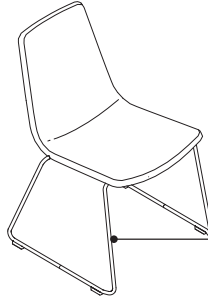

**Stackable base configuration** allows for easier storage and cleaning. Stacking chairs can be stacked up to five high.

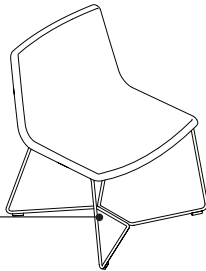

**Wire frame base** is painted and available in a range of standard, accent, and Lux Coatings.

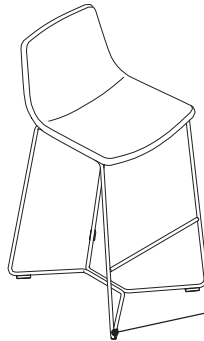

**Glides** are polyethylene for superior durability on carpeted and hard floors. Glides are available in natural or black.

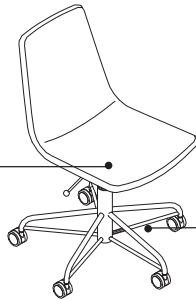

**Seat height** adjusts 4", from 17½"H to 21½"H, with a pneumatic adjustment mechanism.

**Five-star base** is available in hot rolled steel finish only.

## Product Details



Guest chair



Stacking chair



Bariatric guest chair



Counter-height stool



Conference chair



Bar-height stool

**Five-star and wire-frame bases** are available for guest chair and stool.

**Slope wire frame stool** is available in two heights to pair with counter and bar height tables.

**360° adjustable height swivel mechanism** is standard on five-star base models.

**Slope** ships knocked down and the seat must be assembled to the frame on site, with the exception of the stacker with arms and the guest chair with arms which ship fully assembled. All slope styles come in a single carton.

**Arms** are available as an option for bariatric guest, stacking, and conference chair.



**Slope stacking chairs** can be stacked up to five chairs high.

**Slope guest and stacking** are tested to a 300 pound dynamic load.

**Slope bariatric guest** is tested to a 600 pound dynamic load.

## Adjustment Features

Adjustability instructions are included with every swivel-base chair. Instructions can also be found at [www.steelcase.com](http://www.steelcase.com).

### Seat Adjustments

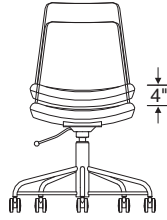

### Conference Chair

**Seat height adjusts** pneumatically. To lower, pull lever up while seated. To raise, pull lever up and keep your weight off the chair.

### Other features

**Soft wheel casters for hard floors on five-star base models** are available for specific applications.

## Surface Materials

### Seat and back upholstery

▶ See *Surface Materials*, page 512 for specific availability.

Visit <https://srh.steelcase.com/comcalculator.aspx> for Steelcase Textile calculator.

### Wire frame base

- Paint
- Accent paint
- Lux Coatings

▶ See *Surface Materials*, page 512

### Wood four-leg and stool base

**Perfect Match**

- 4990 Customiz paint

### Five-star base

- Hot-rolled steel

### Casters

- 6205 Black

### Glides

- Black
- Natural

*Tip: Natural glides are available on 4242 Milk wire frame painted bases only, all other colors will have black glides.*

**All Steelcase seating with standard upholstery fabrics** complies with requirements of the State of California Technical Bulletin 117-2013. All standard seating is labeled to be in compliance with California 117-2013.

## Dimensions

▶ Page 450

# Dimensions

## Slope

Features	Overall Depth	Width	Height	Functional Seat Depth	Seat Width	Seat Height from Floor	Back Width	Back Height from Seat
<b>Slope Seating</b>								
<b>Guest Chair</b>								
	21½"	19¼"	33¼"	17¾"	17¾"	18¾"	16¾"	18¾"
<b>Stacking Chair</b>								
	21½"	19¼"	33¼"	17¾"	17¾"	18¾"	16¾"	18¾"
<b>Bariatric Guest</b>								
	26½"	26½"	28"	21¾"	26½"	18¾"	25¾"	19¼"
<b>Counter Stool</b>								
	21½"	19"	35¾"	17¾"	17¾"	25¼"	16¾"	13"
<b>Bar Stool</b>								
	21½"	19¼"	40"	17¾"	17¾"	29½"	14¼"	13"
<b>Conference Chair</b>								
	21½"	19¼"	32" – 36"	17¾"	17¾"	17½" – 21½"	16¾"	18¾"

\* Overall width does not include the base.  
 Tip: The diameter of the chair with the five-arm base is 25".

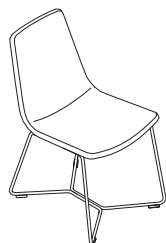

*Tip: Slope guest chair with arms is shipped fully assembled; without arms will require assembly.*

*Tip: Upholstery and paint available on Steelcase Slope. Licensed Slope (stocked) available only in Saddle, Fog, and Aegean Leather with Hot Rolled Steel frame. Exception: Aegean Leather Slope (stocked) frame is defaulted to Antique Brass.*

*Tip: Vertical seam is not recommended in seating for healthcare applications. Vertical seam is required for seating specified in leather. All other fabrics a vertical seam is not offered.*

## Standard Includes

- Fully upholstered seat with back: fabric price group 01
- Wire frame base: paint price group 01
- Glides:
  - Natural
  - Black

## Options

Upholstery Finish	Fabric Customer's Own Material	No cost
	Fabric Price Group 01	No cost
	Fabric Price Group 02	+\$5
	Fabric Price Group 03	+\$31
	Fabric Price Group 04	+\$59
	Fabric Price Group 05	+\$130
	Fabric Price Group 06	+\$153
	Customer's Own Leather	+\$198
	Fabric Price Group 07	+\$214
	Fabric Price Group 08	+\$277
	Fabric Price Group 09	+\$328
Fabric Price Group 10	+\$402	
Leather Price Group 01	+\$440	
Leather Price Group 02	+\$542	
Base Finish	Paint Price Group 01	No cost
	Paint Price Group 02	+\$41
	Paint Price Group 03	+\$83
Vertical Seam	Without Seam	No cost
	With Seam	+\$11
Arm Type	Without Arm	No cost
	With Arm	+\$159
Glides	Black	No cost
	Natural	No cost

## Specification Information

Style Number    Base Price

### Slope Guest Chair

**WEHSLPCG**    \$877

# Slope

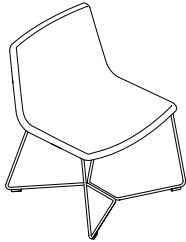

## Standard Includes

- Fully upholstered seat with back: fabric price group 01
- Wire frame base: paint price group 01
- Glides:
  - Natural
  - Black
- Requires assembly

## Options

Upholstery Finish	Fabric Customer's Own Material	No cost
	Fabric Price Group 01	No cost
	Fabric Price Group 02	+\$8
	Fabric Price Group 03	+\$46
	Fabric Price Group 04	+\$87
	Fabric Price Group 05	+\$195
	Customer's Own Leather	+\$198
	Fabric Price Group 06	+\$231
	Fabric Price Group 07	+\$319
	Fabric Price Group 08	+\$415
	Fabric Price Group 09	+\$492
Fabric Price Group 10	+\$601	
Leather Price Group 01	+\$686	
Leather Price Group 02	+\$838	
Base Finish	Paint Price Group 01	No cost
	Paint Price Group 02	+\$41
	Paint Price Group 03	+\$83
Vertical Seam	Without Seam	No cost
	With Seam	+\$11
Arm Type	Without Arm	No cost
	With Arm	+\$159
Glides	Black	No cost
	Natural	No cost

*Tip: Vertical seam is not recommended in seating for healthcare applications. Vertical seam is required for seating specified in leather. All other fabrics a vertical seam is not offered.*

## Specification Information

Style Number	Base Price
--------------	------------

### Slope Bariatric Guest Chair

**WEHSLPCGB** \$1210

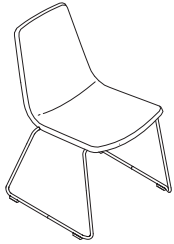

Tip: Slope guest chair with arms is shipped fully assembled; without arms will require assembly.

**Standard Includes**

- Fully upholstered seat with back: fabric price group 01
- Wire frame base: paint price group 01
- Glides:
  - Natural
  - Black

**Options**

Upholstery Finish	Fabric Customer's Own Material	No cost
	Fabric Price Group 01	No cost
	Fabric Price Group 02	+\$5
	Fabric Price Group 03	+\$31
	Fabric Price Group 04	+\$59
	Fabric Price Group 05	+\$130
	Fabric Price Group 06	+\$153
	Customer's Own Leather	+\$198
	Fabric Price Group 07	+\$214
	Fabric Price Group 08	+\$277
	Fabric Price Group 09	+\$328
Fabric Price Group 10	+\$402	
Leather Price Group 01	+\$440	
Leather Price Group 02	+\$542	
Base Finish	Paint Price Group 01	No cost
	Paint Price Group 02	+\$41
	Paint Price Group 03	+\$83
Vertical Seam	Without Seam	No cost
	With Seam	+\$11
Arm Type	Without Arm	No cost
	With Arm	+\$159
Glides	Black	No cost
	Natural	No cost

Tip: Vertical seam is not recommended in seating for healthcare applications. Vertical seam is required for seating specified in leather. All other fabrics a vertical seam is not offered.

**Specification Information**

Style Number    Base Price

**Slope Stacking Guest Chair**

**WEHSLPCS**    \$888

# Sterling

**Sterling** is a family of seating inspired by classic mid-century design. The style and generous sit brings retro-inspired comfort to the office. Hardwood and steel legs or a classic aluminum base and arm options make the Sterling collection relevant across the floor plan. *Tip: For specification information regarding Sterling counter-height stool and Sterling bar-height stool see West Elm Work Collection Specification Guide.*

**Crumbsweep** between back and seat cushion for easy cleaning.

**Optional tilt mechanism** enhances user comfort. Available on the five-star base.

**Casters** have hard, dual-wheels that roll smoothly on carpets. Soft casters for use on hard floors are available as an option.

**Pneumatic cylinder** is always black.

**Glides** are polyethylene for superior durability on carpeted and hard floors.

**Steel legs** are offered in many finishes including Lux Coatings.

**Arms** are optional on guest chair, conference chair, and four-star base chairs. Arms are always upholstered.

**Seat height** adjusts 5", from 16<sup>1</sup>/<sub>2</sub>"H to 21<sup>1</sup>/<sub>2</sub>"H, with a pneumatic adjustment mechanism.

**Five-star base** is aluminum and available polished or in painted finishes.

**In West Elm Designtex fabrics,** armless chairs do not have seams on the seat back.

**Wood leg** is beech hardwood and available in several stain colors.

**In standard Steelcase fabrics, leathers, vinyls, and COM,** seams will be added. The addition of a seam allows a wider range of material types to be upholstered.

**Sterling stools** are fixed and do not swivel.

**Sterling stools** include footrest for added comfort.  
*Tip: The footrest is 8 1/2" from the ground on the counter-height stool and 14 1/4" on the bar-height stool.*

**Glides** are polyethylene for superior durability on carpeted and hard floors.

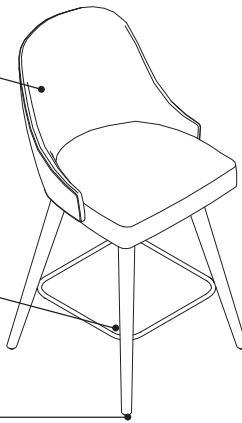

**Sterling four-star chair** comes with 360° swivel and height adjustable mechanism. It does not have an auto-return feature or tilt option.

**Four-star base** is available in polished aluminum only.

**Glides** are polyethylene for superior durability on carpeted and hard floors. Casters are not available.

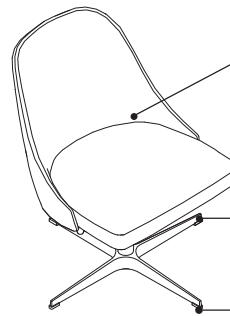

**Product Details**



**Five-star, four-star, and four-leg chairs** are available with and without arms.

**Optional tilt mechanism** is available on five-star chairs and has 10° rearward and 2° forward tilt range. The seat and back always remain in a fixed position relative to each other (i.e. no recline).

**360° adjustable height swivel mechanism** is standard on five-star and four-star base models.

**Sterling chairs** are tested to a 300 pound dynamic load.

**Sterling stools** are fixed and do not swivel.

**Adjustment Features**

Adjustability instructions are included with every swivel-base chair. Instructions can also be found at [www.steelcase.com](http://www.steelcase.com).

**Seat Adjustments**

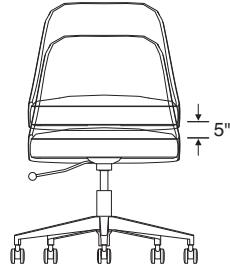

**Seat height** adjusts pneumatically. To lower, pull lever up while seated. To raise, pull lever up and keep your weight off the chair.

**Other features**

**Soft wheel casters for hard floors on five-star base models** are available for specific applications.

**Surface Materials**

**Upholstery**

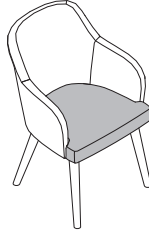

**Optional contrasting fabric** is available between the seat and back/arms.

- Fabric
- Leather
- Vinyl
- Customer's Own Material (COM)

▶ See *Surface Materials*, page 512 for specific availability.

**Wood four-leg and stool base**

- 3901 Customiz stain
- 4990 Customiz paint
- VP01 Light Oak
- VP03 Black Oak
- VP04 Grey Oak
- VP05 White Oak

**Steel four-leg base**

- Paint
  - Accent Paint
  - Lux Coatings
- ▶ See *Surface Materials*, page 512

**Five-star base**

- 0835 Black
- 4242 Milk
- 4B22 Matte Brass
- 4B24 Night Bronze
- 8046 Polished Aluminum

**Four-star base**

- 8046 Polished Aluminum

**Casters and glides**

- 6205 Black

**All Steelcase seating with standard upholstery fabrics** complies with requirements of the State of California Technical Bulletin 117-2013. All standard seating is labeled to be in compliance with California 117-2013.

**Dimensions**

▶ Page 457



# Dimensions

## Sterling

Features	Overall Depth	Width	Height	Functional Seat Depth	Seat Width	Seat Height from Floor	Back Width	Back Height from Seat	Arm Height from Floor
<b>West Elm Work Sterling</b>									
<b>Guest Chairs</b>									
	25½"	26¾"	32⅝"	18⅝"	22"	18½"	21"	15½"	26½"
<b>Guest Chairs—Armless</b>									
	24½"	23½"	32⅝"	18⅝"	22"	18½"	21"	15½"	N.A.
<b>Conference Chairs—Five-Star with Arms</b>									
	25⅞"	26¾"	31¾"	18⅝"	22"	16½"	21"	15½"	25¼"
<b>Conference Chairs—Five-Star Armless</b>									
	24½"	23½"	31¾"	18⅝"	22"	16½"	21"	15½"	N.A.
<b>Counter Height Stool</b>									
	26¼"	26¼"	38"	17"	17½"	26"	19¼"	12⅜"	N.A.
<b>Bar Height Stool</b>									
	26¼"	26¼"	44"	17"	17½"	32"	19¼"	12⅜"	N.A.
<b>Conference Chairs—Four-Star with Arms</b>									
	25⅞"	26¾"	30"	18⅝"	22"	15⅜"	21"	15½"	23½"
<b>Conference Chairs—Four-Star Armless</b>									
	24½"	23½"	30"	18⅝"	22"	15⅜"	21"	15½"	N.A.

\*Overall width does not include the base.

The diameter of the chair with the five-star base is 26".

The diameter of the chair with the four-star base is 26½".

# Sterling

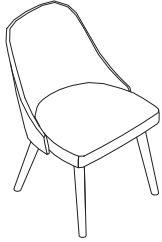

### Standard Includes

- Fully upholstered non-contrasting seat with back: fabric price group 01
- Legs (base): veneer price group 01
- Glides: plastic

### Options

Color Scheme	Non Contrasting	No cost	
	Contrasting	+\$177	
Back Finish	Fabric Customer's Own Material	No cost	
	Fabric Price Group 01	No cost	
	Vinyl Price Group 02	No cost	
	Fabric Price Group 02	+\$5	
	Fabric Price Group 03	+\$36	
	Fabric Price Group 04	+\$74	
	Customer's Own Leather	+\$100	
	Fabric Price Group 05	+\$160	
	Fabric Price Group 06	+\$190	
	Fabric Price Group 07	+\$265	
	Fabric Price Group 08	+\$344	
	Fabric Price Group 09	+\$409	
Seat Finish	Fabric Price Group 10	+\$502	
	Leather Price Group 01	+\$547	
	Leather Price Group 02	+\$675	
	Seat Finish	Fabric Customer's Own Material	No cost
		Fabric Price Group 01	No cost
		Vinyl Price Group 02	No cost
		Fabric Price Group 02	+\$5
		Fabric Price Group 03	+\$31
		Fabric Price Group 04	+\$59
		Customer's Own Leather	+\$100
		Fabric Price Group 05	+\$130
		Fabric Price Group 06	+\$153
Fabric Price Group 07		+\$214	
Fabric Price Group 08		+\$277	
Fabric Price Group 09		+\$328	
Base Finish	Fabric Price Group 10	+\$402	
	Leather Price Group 01	+\$440	
	Leather Price Group 02	+\$542	
Base Finish	Veneer Custom Stain	No cost	
	Veneer Price Group 01	No cost	
	Veneer Price Group 02	+\$41	

### Specification Information

Style Number    Base Price

## Sterling Guest Armless Wood Leg Chair

**WEHMDC4NA**    \$1113

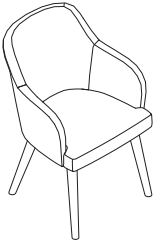

**Standard Includes**

- Fully upholstered non-contrasting seat with back: fabric price group 01
- Legs (base): veneer price group 01
- Glides: plastic

**Options**

Color Scheme	Non Contrasting	No cost	
	Contrasting	+\$177	
Back Finish	Fabric Customer's Own Material	No cost	
	Fabric Price Group 01	No cost	
	Vinyl Price Group 02	No cost	
	Fabric Price Group 02	+\$8	
	Fabric Price Group 03	+\$46	
	Fabric Price Group 04	+\$87	
	Customer's Own Leather	+\$100	
	Fabric Price Group 05	+\$195	
	Fabric Price Group 06	+\$231	
	Fabric Price Group 07	+\$319	
	Fabric Price Group 08	+\$415	
	Fabric Price Group 09	+\$492	
Seat Finish	Fabric Price Group 10	+\$601	
	Leather Price Group 01	+\$659	
	Leather Price Group 02	+\$812	
	Seat Finish	Fabric Customer's Own Material	No cost
		Fabric Price Group 01	No cost
		Vinyl Price Group 02	No cost
		Fabric Price Group 02	+\$5
		Fabric Price Group 03	+\$31
		Fabric Price Group 04	+\$59
		Customer's Own Leather	+\$100
		Fabric Price Group 05	+\$130
		Fabric Price Group 06	+\$153
Fabric Price Group 07		+\$214	
Fabric Price Group 08		+\$277	
Fabric Price Group 09		+\$328	
Base Finish	Fabric Price Group 10	+\$402	
	Leather Price Group 01	+\$440	
	Leather Price Group 02	+\$542	
Base Finish	Veneer Custom Stain	No cost	
	Veneer Price Group 01	No cost	
	Veneer Price Group 02	+\$41	

**Specification Information**

Style Number+Style Number    Base Price

**Sterling Guest with Arm Wood Leg Chair**

**WEHMDC4WA**                      \$1242

# Sterling

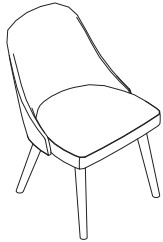

## Standard Includes

- Fully upholstered non-contrasting seat with back: fabric price group 01
- Legs (base): paint
- Glides: plastic

## Options

Color Scheme	Non Contrasting	No cost
	Contrasting	+\$177
Back Finish	Fabric Customer's Own Material	No cost
	Fabric Price Group 01	No cost
	Vinyl Price Group 02	No cost
	Fabric Price Group 02	+\$5
	Fabric Price Group 03	+\$36
	Fabric Price Group 04	+\$74
	Customer's Own Leather	+\$100
	Fabric Price Group 05	+\$160
	Fabric Price Group 06	+\$190
	Fabric Price Group 07	+\$265
	Fabric Price Group 08	+\$344
	Fabric Price Group 09	+\$409
Seat Finish	Fabric Customer's Own Material	No cost
	Fabric Price Group 01	No cost
	Vinyl Price Group 02	No cost
	Fabric Price Group 02	+\$5
	Fabric Price Group 03	+\$31
	Fabric Price Group 04	+\$59
	Customer's Own Leather	+\$100
	Fabric Price Group 05	+\$130
	Fabric Price Group 06	+\$153
	Fabric Price Group 07	+\$214
	Fabric Price Group 08	+\$277
	Fabric Price Group 09	+\$328
Base Finish	Paint Price Group 01	No cost
	Paint Price Group 02	+\$41
	Paint Price Group 03	+\$83

## Specification Information

Style Number      Base Price

### Sterling Guest Armless Metal Leg Chair

**WEHMDC4MNA**    \$1499

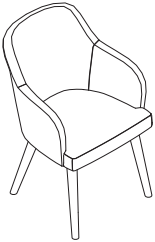

**Standard Includes**

- Fully upholstered non-contrasting seat with back: fabric price group 01
- Legs (base): paint
- Glides: plastic

**Options**

Color Scheme	Non Contrasting	No cost
	Contrasting	+\$177
Back Finish	Fabric Customer's Own Material	No cost
	Fabric Price Group 01	No cost
	Vinyl Price Group 02	No cost
	Fabric Price Group 02	+\$8
	Fabric Price Group 03	+\$46
	Fabric Price Group 04	+\$87
	Customer's Own Leather	+\$100
	Fabric Price Group 05	+\$195
	Fabric Price Group 06	+\$231
	Fabric Price Group 07	+\$319
	Fabric Price Group 08	+\$415
	Fabric Price Group 09	+\$492
Seat Finish	Fabric Customer's Own Material	No cost
	Fabric Price Group 01	No cost
	Vinyl Price Group 02	No cost
	Fabric Price Group 02	+\$5
	Fabric Price Group 03	+\$31
	Fabric Price Group 04	+\$59
	Customer's Own Leather	+\$100
	Fabric Price Group 05	+\$130
	Fabric Price Group 06	+\$153
	Fabric Price Group 07	+\$214
	Fabric Price Group 08	+\$277
	Fabric Price Group 09	+\$328
Base Finish	Paint Price Group 01	No cost
	Paint Price Group 02	+\$41
	Paint Price Group 03	+\$83

**Specification Information**

Style Number      Base Price

**Sterling Guest with Arm Metal Leg Chair**

**WEHMDC4MWA**    \$1628

# Sterling



### Standard Includes

- Fully upholstered non-contrasting seat with back: fabric price group 01
- Five-star adjustable base: paint price group 01
- Hard casters: 6205 Black

### Options

Color Scheme	Non Contrasting	No cost
	Contrasting	+\$177
Back Finish	Fabric Customer's Own Material	No cost
	Fabric Price Group 01	No cost
	Vinyl Price Group 02	No cost
	Fabric Price Group 02	+\$5
	Fabric Price Group 03	+\$36
	Fabric Price Group 04	+\$74
	Customer's Own Leather	+\$100
	Fabric Price Group 05	+\$160
	Fabric Price Group 06	+\$190
	Fabric Price Group 07	+\$265
	Fabric Price Group 08	+\$344
	Fabric Price Group 09	+\$409
Seat Finish	Fabric Price Group 10	+\$502
	Leather Price Group 01	+\$547
	Leather Price Group 02	+\$675
	Fabric Customer's Own Material	No cost
	Fabric Price Group 01	No cost
	Vinyl Price Group 02	No cost
	Fabric Price Group 02	+\$5
	Fabric Price Group 03	+\$31
	Fabric Price Group 04	+\$59
	Customer's Own Leather	+\$100
	Fabric Price Group 05	+\$130
	Fabric Price Group 06	+\$153
Fabric Price Group 07	+\$214	
Fabric Price Group 08	+\$277	
Fabric Price Group 09	+\$328	
Fabric Price Group 10	+\$402	
Leather Price Group 01	+\$440	
Leather Price Group 02	+\$542	
Base Finish	Paint Price Group 01	No cost
	Paint Price Group 02	+\$41
	Paint Price Group 03	+\$83
	Polished Aluminum	+\$126
Caster or Glide	Hard Casters	No cost
	Soft Casters	+\$35
Tilt Mechanism	Without Tilt	No cost
	With Tilt	+\$98

### Specification Information

Style Number      Base Price

## Sterling 5-Star Armless Conference Chair

**WEHMDC5NA**    \$1254



### Standard Includes

- Fully upholstered non-contrasting seat with back: fabric price group 01
- Five-star adjustable base: paint price group 01
- Hard casters: 6205 Black

### Options

Color Scheme	Non Contrasting	No cost	
	Contrasting	+\$177	
Back Finish	Fabric Customer's Own Material	No cost	
	Fabric Price Group 01	No cost	
	Vinyl Price Group 02	No cost	
	Fabric Price Group 02	+\$8	
	Fabric Price Group 03	+\$46	
	Fabric Price Group 04	+\$87	
	Customer's Own Leather	+\$100	
	Fabric Price Group 05	+\$195	
	Fabric Price Group 06	+\$231	
	Fabric Price Group 07	+\$319	
	Fabric Price Group 08	+\$415	
	Fabric Price Group 09	+\$492	
Seat Finish	Fabric Price Group 10	+\$601	
	Leather Price Group 01	+\$659	
	Leather Price Group 02	+\$812	
	Seat Finish	Fabric Customer's Own Material	No cost
		Fabric Price Group 01	No cost
		Vinyl Price Group 02	No cost
		Fabric Price Group 02	+\$5
		Fabric Price Group 03	+\$31
		Fabric Price Group 04	+\$59
		Customer's Own Leather	+\$100
		Fabric Price Group 05	+\$130
		Fabric Price Group 06	+\$153
Fabric Price Group 07		+\$214	
Fabric Price Group 08		+\$277	
Fabric Price Group 09		+\$328	
Base Finish	Fabric Price Group 10	+\$402	
	Leather Price Group 01	+\$440	
	Leather Price Group 02	+\$542	
	Base Finish	Paint Price Group 01	No cost
Paint Price Group 02		+\$41	
Paint Price Group 03		+\$83	
Polished Aluminum		+\$126	
Caster or Glide	Hard Casters	No cost	
	Soft Casters	+\$35	
Tilt Mechanism	Without Tilt	No cost	
	With Tilt	+\$98	

### Specification Information

Style Number      Base Price

## Sterling 5-Star with Arm Conference Chair

**WEHMDC5WA**    \$1369

# Sterling



## Standard Includes

- Fully upholstered non-contrasting seat with back: fabric price group 01
- Four-star base: 8046 Polished Aluminum
- Glides: plastic

## Options

Color Scheme	Non Contrasting	No cost	
	Contrasting	+\$177	
Back Finish	Fabric Customer's Own Material	No cost	
	Fabric Price Group 01	No cost	
	Vinyl Price Group 02	No cost	
	Fabric Price Group 02	+\$5	
	Fabric Price Group 03	+\$36	
	Fabric Price Group 04	+\$74	
	Customer's Own Leather	+\$100	
	Fabric Price Group 05	+\$160	
	Fabric Price Group 06	+\$190	
	Fabric Price Group 07	+\$265	
	Fabric Price Group 08	+\$344	
	Fabric Price Group 09	+\$409	
Seat Finish	Fabric Price Group 10	+\$502	
	Leather Price Group 01	+\$547	
	Leather Price Group 02	+\$675	
	Seat Finish	Fabric Customer's Own Material	No cost
		Fabric Price Group 01	No cost
		Vinyl Price Group 02	No cost
		Fabric Price Group 02	+\$5
		Fabric Price Group 03	+\$31
		Fabric Price Group 04	+\$59
		Customer's Own Leather	+\$100
		Fabric Price Group 05	+\$130
		Fabric Price Group 06	+\$153
Fabric Price Group 07		+\$214	
Fabric Price Group 08		+\$277	
Fabric Price Group 09		+\$328	
Base Finish	Fabric Price Group 10	+\$402	
	Leather Price Group 01	+\$440	
Base Finish	Leather Price Group 02	+\$542	
	Polished Aluminum	No cost	

## Specification Information

Style Number	Base Price
--------------	------------

### Sterling 4-Star Armless Conference Chair

**WEHMDC4CNFNA** \$1046





**Standard Includes**

- Fully upholstered non-contrasting seat with back: fabric price group 01
- Four-star base: 8046 Polished Aluminum
- Glides: plastic

**Options**

Color Scheme	Non Contrasting	No cost
	Contrasting	+\$177
Back Finish	Fabric Customer's Own Material	No cost
	Fabric Price Group 01	No cost
	Vinyl Price Group 02	No cost
	Fabric Price Group 02	+\$8
	Fabric Price Group 03	+\$46
	Fabric Price Group 04	+\$87
	Customer's Own Leather	+\$100
	Fabric Price Group 05	+\$195
	Fabric Price Group 06	+\$231
	Fabric Price Group 07	+\$319
	Fabric Price Group 08	+\$415
	Fabric Price Group 09	+\$492
	Fabric Price Group 10	+\$601
Seat Finish	Leather Price Group 01	+\$659
	Leather Price Group 02	+\$812
	Fabric Customer's Own Material	No cost
	Fabric Price Group 01	No cost
	Vinyl Price Group 02	No cost
	Fabric Price Group 02	+\$5
	Fabric Price Group 03	+\$31
	Fabric Price Group 04	+\$59
	Customer's Own Leather	+\$100
	Fabric Price Group 05	+\$130
	Fabric Price Group 06	+\$153
	Fabric Price Group 07	+\$214
	Fabric Price Group 08	+\$277
Fabric Price Group 09	+\$328	
Fabric Price Group 10	+\$402	
Leather Price Group 01	+\$440	
Leather Price Group 02	+\$542	
Base Finish	Polished Aluminum	No cost

**Specification Information**

Style Number      Base Price

**Sterling 4-Star with Arm Conference Chair**

**WEHMDC4CNFWA**    \$1152

# Sterling



### Standard Includes

- Fully upholstered non-contrasting seat with back: fabric price group 01
- Legs (base): veneer price group 01
- Glides: plastic

### Options

Color Scheme	Non Contrasting	No cost
	Contrasting	+\$177
Back Finish	Fabric Customer's Own Material	No cost
	Fabric Price Group 01	No cost
	Vinyl Price Group 02	No cost
	Fabric Price Group 02	+\$5
	Fabric Price Group 03	+\$36
	Fabric Price Group 04	+\$74
	Customer's Own Leather	+\$100
	Fabric Price Group 05	+\$160
	Fabric Price Group 06	+\$190
	Fabric Price Group 07	+\$265
	Fabric Price Group 08	+\$344
Seat Finish	Fabric Price Group 09	+\$409
	Fabric Price Group 10	+\$502
	Leather Price Group 01	+\$547
	Leather Price Group 02	+\$675
	Fabric Customer's Own Material	No cost
	Fabric Price Group 01	No cost
	Vinyl Price Group 02	No cost
	Fabric Price Group 02	+\$5
	Fabric Price Group 03	+\$31
	Fabric Price Group 04	+\$59
	Customer's Own Leather	+\$100
Fabric Price Group 05	+\$130	
Fabric Price Group 06	+\$153	
Fabric Price Group 07	+\$214	
Fabric Price Group 08	+\$277	
Fabric Price Group 09	+\$328	
Fabric Price Group 10	+\$402	
Leather Price Group 01	+\$440	
Leather Price Group 02	+\$542	
Base Finish	Veneer Custom Stain	No cost
	Veneer Price Group 01	No cost
	Veneer Price Group 02	+\$59

### Specification Information

Style Number      Base Price

## Sterling Counter Height Armless Stool

**WEHMDCSCHNA**    \$1322



**Standard Includes**

- Fully upholstered non-contrasting seat with back: fabric price group 01
- Legs (base): veneer price group 01
- Glides: plastic

**Options**

Color Scheme	Non Contrasting	No cost
	Contrasting	+\$177
Back Finish	Fabric Customer's Own Material	No cost
	Fabric Price Group 01	No cost
	Vinyl Price Group 02	No cost
	Fabric Price Group 02	+\$5
	Fabric Price Group 03	+\$36
	Fabric Price Group 04	+\$74
	Customer's Own Leather	+\$100
	Fabric Price Group 05	+\$160
	Fabric Price Group 06	+\$190
	Fabric Price Group 07	+\$265
	Fabric Price Group 08	+\$344
	Fabric Price Group 09	+\$409
	Fabric Price Group 10	+\$502
Seat Finish	Leather Price Group 01	+\$547
	Leather Price Group 02	+\$675
	Fabric Customer's Own Material	No cost
	Fabric Price Group 01	No cost
	Vinyl Price Group 02	No cost
	Fabric Price Group 02	+\$5
	Fabric Price Group 03	+\$31
	Fabric Price Group 04	+\$59
	Customer's Own Leather	+\$100
	Fabric Price Group 05	+\$130
	Fabric Price Group 06	+\$153
	Fabric Price Group 07	+\$214
	Fabric Price Group 08	+\$277
Fabric Price Group 09	+\$328	
Fabric Price Group 10	+\$402	
Base Finish	Leather Price Group 01	+\$440
	Leather Price Group 02	+\$542
	Veneer Custom Stain	No cost
	Veneer Price Group 01	No cost
	Veneer Price Group 02	+\$59

**Specification Information**

Style Number	Base Price
<b>Sterling Bar Height Armless Stool</b>	
<b>WEHMDCSBHNA</b>	\$1437

# Lucas Seating

**Modern lines** give Lucas a streamlined look, while a wide seat and reclined pitch make it a comfortable spot to sit during long meetings and busy days.

**Lucas** comes standard with arms at a height of 20½".

*Tip: For specification information regarding Lucas Seating see West Elm Work Collection Specification Guide.*

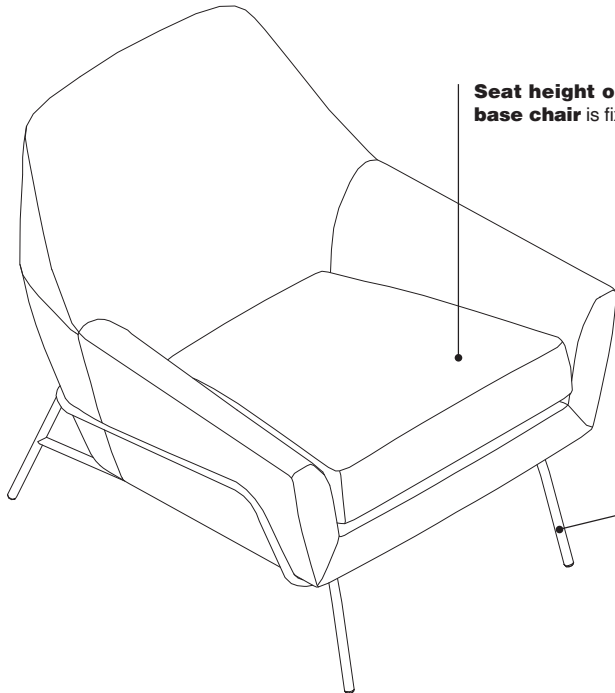

**Seat height on wire base chair** is fixed at 18½".

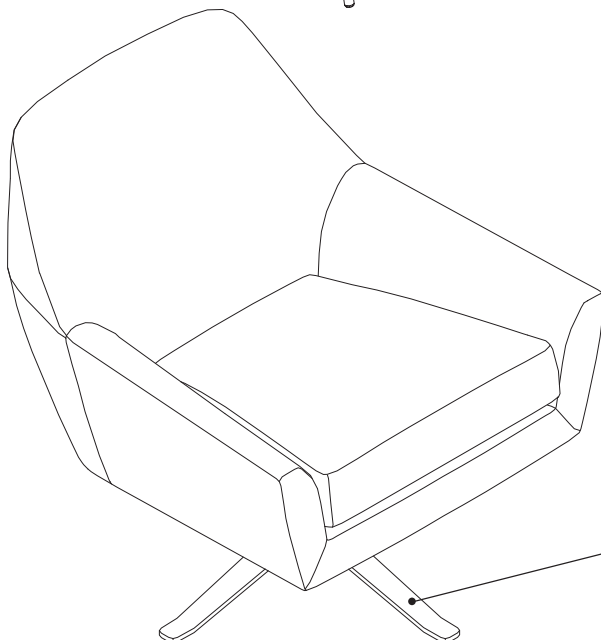

**Swivel base** comes standard in 8046 Polished Aluminum. Swivel is a full 360° without an automatic return.

## Product Details

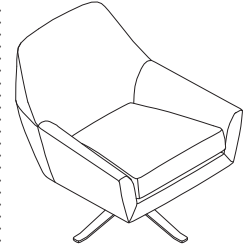

**Cushion** is detachable.

**All product in the Lucas product line** ships fully assembled.

## Surface Materials

**Swivel base** is 8046 Polished Aluminum. The base of the Lucas swivel chair will match the previous style number **WEM3598978**.

**Wire base** is WE05 West Elm Burnished Bronze. The base of the Lucas wire base will match the previous style number **WEM3406073**.

**Contrasting fabric** is not available.

Visit <https://srh.steelcase.com/comcalculator.aspx> for Steelcase Textile calculator.

# Dimensions

## Lucas Seating

Features	Overall Depth	Width	Height	Seat Depth	Seat Width	Seat Height	Arm Height
<b>Lucas Seating</b>							
<b>Wire Base Chair</b>							
	32"	30½"	31"	21"	22"	18½"	20½"
<b>Swivel Base Chair</b>							
	32"	30½"	31"	21"	22"	20¾"	20½"



# Related Products

## Lounge Seating

- Alight Lounge ▶ See *Seating Specification Guide*
- Bix Lounge System ▶ See *Coalesse Seating Specification Guide*
- Bob Lounge ▶ See *Coalesse Seating Specification Guide*
- Brody 488 Series ▶ See *Seating Specification Guide*
- Ripple Benches ▶ See *Coalesse Seating Specification Guide*

## Multi-Purpose Seating

- Enea Lottus Sled Stools ▶ See *Coalesse Seating Specification Guide*
- Scoop ▶ See *Seating Specification Guide*
- Shortcut ▶ See *Seating Specification Guide*

## Stackable Seating

- Max Stacker III 477 Series ▶ See *Seating Specification Guide*

## Task Seating

- Amia 482 Series ▶ See *Seating Specification Guide*
- Cachet 487 Series ▶ See *Seating Specification Guide*
- cobi 434 Series ▶ See *Seating Specification Guide*
- Crew ▶ See *Seating Specification Guide*
- Criterion 453 Series ▶ See *Seating Specification Guide*
- Gesture 442 Series ▶ See *Seating Specification Guide*
- Leap 462 Series ▶ See *Seating Specification Guide*
- Steelcase Series 1 ▶ See *Seating Specification Guide*
- Siento 499 Series ▶ See *Seating Specification Guide*
- Think 465 Series ▶ See *Seating Specification Guide*
- Uno ▶ See *Seating Specification Guide*

## Wood Seating

- Collaboration ▶ See *Seating Specification Guide*
- Kathryn ▶ See *Coalesse Seating Specification Guide*

▶ Refer to product specification guides for complete product and specification information.





---

# Surface Materials

<b>Steelcase Health Surface Materials</b>	<b>474</b>
Color Availability Matrix for Steelcase Health Seating and Tables	<b>478</b>
Wood Veneer Matrix for Steelcase Health Seating and Tables	<b>506</b>
Recommended Worksurface Edge Finishes	<b>508</b>
<b>Steelcase Seating Surface Materials</b>	<b>509</b>
<b>Jenny Lounge Surface Materials</b>	<b>510</b>
<b>West Elm Health Surface Materials</b>	<b>512</b>
<b>Health Upholstery and Color Numbers</b>	<b>516</b>
<b>Steelcase Health Select Surfaces Programs</b>	
Solid Surface	<b>518</b>
Upholstery	<b>518</b>
<b>Fabric Application Direction Guidelines</b>	<b>519</b>

# Steelcase Health Surface Materials

**This listing** includes all the surface material choices that are available for Steelcase and Steelcase Health products in this specification guide.

## Resources

For more information about Steelcase Health surface materials or to get surface material samples, contact Steelcase Health at 1.800.342.8562.

Materials and colors are not available on every product. Refer to the Color Availability Matrices before specifying.

## Plastisol/Urethane

6009 Arctic White  
6053 Seagull  
6059 Sterling Dark  
6161 Graphite  
6162 Taupe  
6205 Black  
6249 Platinum Solid  
6259 Midnight  
6322 Fieldstone  
6527 Merle  
6654 Sand  
6655 Warm White

## Paint

► See *Paint Color Availability Matrix* on page 478 for color availability by product line.

## Steelcase Surfaces

### Price Group 1

#### Smooth Paint

4238 Mocha  
4239 Clay  
4240 Chalk  
4242 Milk  
4858 Seagull

#### Textured Paint

7207 Black  
7225 Sand  
7237 Slate **E**  
7238 Fieldstone  
7239 Midnight  
7241 Arctic White  
7243 Seagull  
7360 Merle

### Price Group 2

#### Smooth Paint

0835 Black  
4700 Warm White

**E** = Established

## Smooth Metallic Paint

4140 Arctic White Gloss  
4743 Mineral Metallic  
4750 Champagne Metallic  
4798 Sterling Metallic  
4799 Platinum Metallic  
4803 Near Black Metallic

## Textured Metallic Paint

7245 Carbon Metallic  
7246 Midnight Metallic

### Price Group 3

Applies to:

- Node 480 Series
- Verge stools
- Leela tables
- Regard frames
- Surround frames

## Accent Paint

1ATG Rose Quartz  
4AV3 Blue Jay  
4AV4 Baltic  
4AX1 Citron  
4AY2 Chili  
4AZ5 Marlin  
4CL1 Dark Olivine  
4CL2 Ice Blue  
4CL3 Aura  
4CL4 Sea Glass  
4CL5 Light Matcha  
4CL6 Terra  
4CL7 Sandstone  
4CL8 Smokey Plum  
4CZ5 Honey  
4CZ6 Lagoon  
4CZ8 Light Peacock

Applies to:

- Embold tables
- Move 490 Series
- Node 480 Series
- Verge stools
- Regard frames and storage\*
- Surround frames and storage

\*Does not include booth frame.

## Coatings

1ATT Cast Shadow

## Lux Coatings

4B20 Obsidian  
4B22 Matte Brass  
4B23 Burnished Bronze  
4B24 Night Bronze  
4B25 Matte Copper  
4B26 Smoked Mica  
4B29 Cast Iron

## Wood

### Steelcase Surfaces

Applies to:

- Tava
- 3456 Clear on Ash  
3457 Almond on Ash  
3460 Dark Rum on Ash  
3461 Shiraz on Ash  
3463 Blonde on Ash  
3464 Clear Cherry on Ash  
3467 Medium Cherry on Ash  
3468 Graphite on Ash  
3469 Clear Walnut on Ash  
3470 Natural Walnut on Ash

## Laminate

### Steelcase Health Laminate

2574 Dark Rum Cherry\*  
2575 Shiraz Cherry\*

### Steelcase Surfaces

#### High-Pressure Laminate

### Price Group 1

Applies to:

- Embold tables
- Regard tables
- Regard media and desk cabinets
- Sieste tables

*Tip: All products may not be available in all colors listed below.*

## Fiber Laminate

2850 Vanadium Fiber  
2854 Vellum Fiber **E**  
2860 Granite Fiber  
2862 Stucco Fiber **E**

## Micro Laminate

2920 Marl Micro  
2921 Gypsum Micro  
2922 Clay Micro

## Patina Laminate

2870 Blonde Bronze Patina  
2873 Instant Iron Patina

## Solid Laminate

2722 Cream **E**  
2730 Arctic White  
2746 Black  
2759 Warm White  
2811 Mist **E**  
2883 Seagull  
2884 Milk  
2885 Dune  
2HAA Persian Salt  
2HAB Rose  
2HAC Indigo  
2HAD Green Citrine  
2HAE Dark Olivine  
2HAF Cloudy  
2HMG Merle  
2HWU Clay  
2HWV Chalk

## Speckle Laminate

2820 Coffee Speckle **E**  
2823 Driftwood Speckle  
2824 Smoke Speckle  
2825 Vanadium Speckle

## Woodgrain Laminate

2406 Clear Cherry **E**  
2409 Clear Maple  
2410 Graphite Walnut  
2412 Natural Cherry  
2422 Medium Cherry  
2511 Winter on Maple  
2535 Virginia Walnut  
2536 Blackwood **E**  
2538 Clear Walnut  
2592 Blonde on Maple **E**  
2714 Natural Walnut **E**  
2HAK Clear Oak  
2HAN Ash Noce  
2HAT Acacia  
2HAW Ash Wenge  
2HBN Bisque Noce  
2HBW Bisque Wenge  
2HCN Clay Noce  
2HCW Clay Wenge  
2HSN Storm Noce  
2HSW Storm Wenge  
2HWA Grey Kingswood  
2HWB Planked Walnut  
2HWD Resolute Walnut  
2HWE Natural Recon  
2HWF Smoked Walnut

### Price Group 2

Applies to:

- Embold tables

## Textured Laminate

2TH2 Fawn Cypress  
2TH4 Saddle Oak  
2TH5 Veranda Teak  
2TH7 Walnut Heights  
2UH1 Reclaimed Aggregate  
2UH2 Reclaimed Gravel  
2UH4 Cement\*  
2UH6 Sheetrock

## Price Group 3

Applies to:

- Embold tables

## Solid Laminate

24H1 Satin White  
24H2 Satin Black  
24H3 Satin Stone  
24H4 Satin Mocha

## Steelcase Melamine

Applies to:

- Regard desk and media cabinets

2409 Clear Maple  
2410 Graphite Walnut  
2412 Natural Cherry  
2511 Winter on Maple  
2535 Virginia Walnut  
2536 Blackwood **E**  
2538 Clear Walnut  
2574 Dark Rum Cherry\*  
2575 Shiraz Cherry\*  
2730 Arctic White  
2883 Seagull  
2885 Dune  
2HAT Acacia  
2HAK Clear Oak  
2LAN Ash Noce  
2LAW Ash Wenge  
2LBN Bisque Noce  
2LBW Bisque Wenge  
2LCN Clay Noce  
2LCW Clay Wenge  
2LSN Storm Noce  
2LSW Storm Wenge

*Tip: Melamine finishes may be represented by HPL or LPL finish codes.*

*\*2574 Dark Rum Cherry, 2575 Shiraz Cherry, and 2UH4 Cement have limited availability, determined by product sizing and/or options.*

## Open Line Laminate (OLL)

Applies to:

- Embold tables
- Jenny
- Regard worksurfaces

This service allows you to order non-standard laminate at an additional fee per unit. See the specification pages for upcharge information.

## Steelcase Health Laminates

that are not called out as standard on Steelcase products will be processed as an Open Line Laminate and Open Line Laminate charges will apply.

High-Pressure Laminate pricing does not include premium or digitally printed patterns from any suppliers. Laminate cost may also vary for basic or standard laminates from other suppliers. Please contact the OLL consultant at 616.475.2426 for pricing. The cost of the laminate will be added to your invoice as a separate line on the acknowledgement.

**When processing orders for Open Line Laminate on Jenny and Regard Worksurfaces**, and specify 2900 in the laminate finish field and enter the OLL manufacturer information.

**Edge bands** must also be specified using the plastic edge band offering.

## Thermoform

Applies to:

- Tablet surface on Cura, Empath, Mineral, and Mitra recliner

- 2030 Arctic White
- 2031 Seagull
- 2032 Dune
- 2035 Ultra White

## Solid Surface

Applies to:

- Aspekt straight arms
- Embold
- Leela table tops
- Mitra guest seating arms
- Regard table tops and desk

## Price Group A

- 2801 Glacier White
- 2973 Linen
- 2975 Bisque
- 2978 Cameo White
- 2979 Silver Grey

## Price Group B

- 2972 Antarctica

## Price Group C

- 2974 Canvas

► See page 518 for additional Select Surfaces solid surfaces

## Plastic

Applies to:

- Node 480 Series

## Price Group 1

- 6009 Arctic White
- 6059 Sterling Dark Solid
- 6205 Black
- 6249 Platinum Solid
- 6259 Midnight
- 6332 Citron
- 6333 Picasso
- 6334 Flash
- 6335 Wasabi
- 6336 Jazz
- 6337 Element
- 6338 Chili
- 6527 Merle
- 6655 Warm White

## Price Group 2

- 6BD1 Aubergine
- 6BD2 Peacock
- 6BD3 Jungle
- 6BD5 Honey
- 6BD6 Lagoon
- 6BD7 Saffron
- 6BE5 Olivine
- 6BE6 Sea Salt

Applies to:

- Radia arm caps
- 6249 Platinum Solid
- 6527 Merle

## Plastic Edge Band

## Steelcase Surfaces

- 6023 Dark Rum Cherry
- 6024 Shiraz Cherry
- 6036 Medium Cherry
- 6041 Natural Walnut **E**
- 6038 Blonde on Maple **E**
- 6231 Graphite Walnut
- 6237 Clear Maple
- 6245 Clear Walnut

Applies to:

- Embold tables
- Regard tables
- Regard media and desk cabinets

*Tip: All products may not be available in all colors listed below.*

- 6000 Black
- 6009 Arctic White
- 6034 Natural Cherry
- 6036 Medium Cherry
- 6037 Winter on Maple
- 6038 Blonde on Maple **E**
- 6041 Natural Walnut **E**
- 6052 Milk
- 6053 Seagull
- 6169 Stone
- 6170 Mocha
- 61AA Persian Salt
- 61AB Rose
- 61AC Indigo
- 61AD Green Citrine
- 61AE Dark Olivine
- 61AF Cloudy
- 6213 Acacia
- 6219 Clear Oak
- 6231 Graphite Walnut
- 6237 Clear Maple
- 6242 Virginia Walnut
- 6243 Blackwood **E**
- 6245 Clear Walnut
- 6249 Platinum Solid
- 6271 Plywood
- 6527 Merle
- 6619 Ice **E**
- 6631 Cream **E**
- 6635 Dawn **E**
- 6636 Mist
- 6654 Sand
- 6655 Warm White
- 6695 Midnight
- 6697 Fog
- 6698 Fieldstone
- 66WA Grey Kingswood
- 66WB Planked Walnut
- 66WD Resolute Walnut
- 66WE Natural Recon
- 66WF Smoked Walnut
- 66WU Clay
- 66WV Chalk
- 6703 Ash Wenge
- 6704 Bisque Wenge
- 6705 Clay Wenge
- 6706 Storm Wenge
- 6707 Ash Noce
- 6708 Bisque Boce
- 6709 Clay Noce
- 6710 Storm Noce

Applies to:

- 3 mm edge on Embold tables
- 1 mm and 3 mm edge on Exchange tables and Folio worksurfaces
- 6T02 Fawn Cypress
- 6T04 Saddle Oak
- 6T05 Veranda Teak
- 6T07 Walnut Heights
- 6T08 Aggregate
- 6T09 Gravel
- 6T10 Cement
- 6T12 Sheetrock

## Urethane

Applies to:

- Verge seat
- 6688 Non metallic steel

## CuraNet

Applies to:

- Cura
- 5081 Ash (Silver Grey)
- 5085 Ebony (Black)
- 5086 Camel
- 5087 Cocoa
- 5088 Aquamarine

## Promessa

Applies to:

- Cura
- UL81 Ash
- UL85 Ebony
- UL86 Camel
- UL87 Cocoa
- UL88 Aquamarine

## Upholstery

► See page 516 for a complete listing of upholstery colors and numbers.

**E** = Established

**Braided Cord Color Matrix**

Applies to:  
• Embold tables

**Braided cord samples** are not available to order. Use matrix below that compares the braided cord finish to the nearest Steelcase finish or Pantone color for color reference purposes.

<b>Finish</b>	<b>Color Reference</b>
9002 Silver	10388 C (Pantone Color)
9003 Fuchsia	PerfectMatch
9004 Marlin	4AZ5 Marlin
9006 Chili	6338 Chili
9007 Sterling	6059 Sterling Dark Solid
9008 Honey	4CZ5 Honey
9009 Black	0835 Black
9010 Light Peacock	4CZ8 Light Peacock
9011 Seagull	4858 Seagull
9012 Merle	6527 Merle
9013 Brass	10362 C (Pantone Color)



# Color Availability Matrix for Steelcase Health Seating and Tables

## Legend

- = Not available
- = Available
- = Available with exceptions
- Ⓢ = Established
- ▶ See specification pages for details.

	Aspekt Seating Frame	Aspekt Straight Arm Cap	Aspekt Wave Arm cap	Aspekt table, footstool, and Bench Frame and Legs	Aspekt Table	Cura Arm Caps	Cura Frame	Cura Tablet	Erbold Arm Caps	Erbold High Back Bracket	Erbold High Back Bracket Cover	Erbold Seating Frame	Erbold Table Frame	Erbold Table Legs	Erbold Adjustable Glides	Erbold Wallsaver Glides	Erbold Tables	Empath Upper Arms	Empath Tablet	Jenny Tables	Leela Arm Caps	Leela Legs	Leela Table Top	
High-Pressure Laminates (HPL)																								
Price Group 1																								
Fiber Laminates																								
2850 Vanadium Fiber	•	•	•	•	•	•	•	•	•	•	•	•	•	•	•	•	•	■	•	•	■	•	•	•
2854 Vellum Fiber Ⓢ	•	•	•	•	•	•	•	•	•	•	•	•	•	•	•	•	•	■	•	•	■	•	•	•
2859 Novell Fiber	•	•	•	•	•	•	•	•	•	•	•	•	•	•	•	•	•	■	•	•	•	•	•	•
2860 Granite Fiber	•	•	•	•	•	•	•	•	•	•	•	•	•	•	•	•	•	■	•	•	■	•	•	•
2861 Coconut Fiber	•	•	•	•	•	•	•	•	•	•	•	•	•	•	•	•	•	■	•	•	•	•	•	•
2862 Stucco Fiber Ⓢ	•	•	•	•	•	•	•	•	•	•	•	•	•	•	•	•	•	■	•	•	■	•	•	•
Micro Laminates																								
2920 Marl Micro	•	•	•	•	•	•	•	•	•	•	•	•	•	•	•	•	•	■	•	•	■	•	•	•
2921 Gypsum Micro	•	•	•	•	•	•	•	•	•	•	•	•	•	•	•	•	•	■	•	•	■	•	•	•
2922 Clay Micro	•	•	•	•	•	•	•	•	•	•	•	•	•	•	•	•	•	■	•	•	■	•	•	•
Patina Laminates																								
2870 Blonde Bronze Patina	•	•	•	•	•	•	•	•	•	•	•	•	•	•	•	•	•	•	•	•	■	•	•	•
2871 Blackened Bronze Patina	•	•	•	•	•	•	•	•	•	•	•	•	•	•	•	•	•	•	•	•	■	•	•	•
2873 Instant Iron Patina	•	•	•	•	•	•	•	•	•	•	•	•	•	•	•	•	•	•	•	•	■	•	•	•
Solid Laminates																								
2722 Cream Ⓢ	•	•	•	•	•	•	•	•	•	•	•	•	•	•	•	•	•	•	•	•	■	•	•	•
2730 Arctic White	•	•	•	•	■	•	•	•	•	•	•	•	•	•	•	•	•	■	•	•	■	•	•	•
2746 Black	•	•	•	•	•	•	•	•	•	•	•	•	•	•	•	•	•	•	•	•	■	•	•	•
2759 Warm White	•	•	•	•	■	•	•	•	•	•	•	•	•	•	•	•	•	■	•	•	■	•	•	•
2811 Mist Ⓢ	•	•	•	•	•	•	•	•	•	•	•	•	•	•	•	•	•	•	•	•	■	•	•	•
2883 Seagull	•	•	•	•	■	•	•	•	•	•	•	•	•	•	•	•	•	■	•	•	■	•	•	•
2884 Milk	•	•	•	•	■	•	•	•	•	•	•	•	•	•	•	•	•	■	•	•	■	•	•	•
2885 Dune	•	•	•	•	■	•	•	•	•	•	•	•	•	•	•	•	•	■	•	•	■	•	•	•
2HAA Persian Salt	•	•	•	•	■	•	•	•	•	•	•	•	•	•	•	•	•	■	•	•	■	•	•	•
2HAB Rose	•	•	•	•	•	•	•	•	•	•	•	•	•	•	•	•	•	■	•	•	■	•	•	•
2HAC Indigo	•	•	•	•	■	•	•	•	•	•	•	•	•	•	•	•	•	■	•	•	■	•	•	•
2HAD Green Citrine	•	•	•	•	■	•	•	•	•	•	•	•	•	•	•	•	•	■	•	•	■	•	•	•
2HAE Dark Olivine	•	•	•	•	■	•	•	•	•	•	•	•	•	•	•	•	•	■	•	•	■	•	•	•
2HAF Cloudy	•	•	•	•	■	•	•	•	•	•	•	•	•	•	•	•	•	■	•	•	■	•	•	•
2HMG Merle	•	•	•	•	■	•	•	•	•	•	•	•	•	•	•	•	•	■	•	•	■	•	•	•
2HWU Clay	•	•	•	•	■	•	•	•	•	•	•	•	•	•	•	•	•	■	•	•	■	•	•	•
2HWV Chalk	•	•	•	•	■	•	•	•	•	•	•	•	•	•	•	•	•	■	•	•	■	•	•	•

**Legend**

- = Not available
- = Available
- = Available with exceptions
- Ⓢ = Established
- ▶ See specification pages for details.

	Mineral Arm Caps	Mineral Tablet Surface	Mitra Seating Frame	Mitra Arm Caps - Guest	Mitra Arm Caps - Lounge	Mitra Arm Caps - Recliner	Mitra Arm Caps - Sleeper	Mitra Table Legs and Bases	Mitra Tables	Mitra Tablet Surface	Outlook Metal Legs	Outlook Wood Legs	Outlook Table	Radia Frame	Radia Arm Caps	Regard Frames	Regard Arm Caps	Regard Storage End Tables	Regard Media and Desk Cabinets	Regard Screen Bracket	Regard Vertical Cable Riser	Regard Power Strip	Regard Booth Table + SQ/ Personal Table (laminated)	Regard SQ/Personal Table
High-Pressure Laminates (HPL)																								
Price Group 1																								
Fiber Laminates																								
2850 Vanadium Fiber	•	•	•	•	•	•	•	•	•	•	•	•	•	•	•	•	•	•	•	•	•	•	•	•
2854 Vellum Fiber Ⓢ	•	•	•	•	•	•	•	•	•	•	•	•	•	•	•	•	•	•	•	•	•	•	■	•
2859 Novell Fiber	•	•	•	•	•	•	•	•	•	•	•	•	•	•	•	•	•	•	•	•	•	•	•	•
2860 Granite Fiber	•	•	•	•	•	•	•	•	•	•	•	•	•	•	•	•	•	•	•	•	•	•	■	•
2861 Coconut Fiber	•	•	•	•	•	•	•	•	•	•	•	•	•	•	•	•	•	•	•	•	•	•	■	•
2862 Stucco Fiber Ⓢ	•	•	•	•	•	•	•	•	•	•	•	•	•	•	•	•	•	•	•	•	•	•	■	•
Micro Laminates																								
2920 Marl Micro	•	•	•	•	•	•	•	•	•	•	•	•	•	•	•	•	•	•	•	•	•	•	■	•
2921 Gypsum Micro	•	•	•	•	•	•	•	•	•	•	•	•	•	•	•	•	•	•	•	•	•	•	■	•
2922 Clay Micro	•	•	•	•	•	•	•	•	•	•	•	•	•	•	•	•	•	•	•	•	•	•	■	•
Patina Laminates																								
2870 Blonde Bronze Patina	•	•	•	•	•	•	•	•	•	•	•	•	•	•	•	•	•	•	•	•	•	•	■	•
2871 Blackened Bronze Patina	•	•	•	•	•	•	•	•	•	•	•	•	•	•	•	•	•	•	•	•	•	•	•	•
2873 Instant Iron Patina	•	•	•	•	•	•	•	•	•	•	•	•	•	•	•	•	•	•	•	•	•	•	■	•
Solid Laminates																								
2722 Cream Ⓢ	•	•	•	•	•	•	•	•	•	•	•	•	•	•	•	•	•	•	•	•	•	•	■	•
2730 Arctic White	•	•	•	•	•	•	•	•	■	•	•	•	•	•	•	•	•	•	•	•	•	•	■	•
2746 Black	•	•	•	•	•	•	•	•	•	•	•	•	•	•	•	•	•	•	•	•	•	•	■	•
2759 Warm White	•	•	•	•	•	•	•	•	■	•	•	•	•	•	•	•	•	•	•	•	•	•	■	•
2811 Mist Ⓢ	•	•	•	•	•	•	•	•	•	•	•	•	•	•	•	•	•	•	•	•	•	•	■	•
2883 Seagull	•	•	•	•	•	•	•	•	■	•	•	•	•	•	•	•	•	•	•	•	•	•	■	•
2884 Milk	•	•	•	•	•	•	•	•	■	•	•	•	•	•	•	•	•	•	•	•	•	•	■	•
2885 Dune	•	•	•	•	•	•	•	•	■	•	•	•	•	•	•	•	•	•	•	•	•	•	■	•
2HAA Persian Salt	•	•	•	•	•	•	•	•	■	•	•	•	•	•	•	•	•	•	•	•	•	•	■	•
2HAB Rose	•	•	•	•	•	•	•	•	■	•	•	•	•	•	•	•	•	•	•	•	•	•	■	•
2HAC Indigo	•	•	•	•	•	•	•	•	■	•	•	•	•	•	•	•	•	•	•	•	•	•	■	•
2HAD Green Citrine	•	•	•	•	•	•	•	•	■	•	•	•	•	•	•	•	•	•	•	•	•	•	■	•
2HAE Dark Olivine	•	•	•	•	•	•	•	•	■	•	•	•	•	•	•	•	•	•	•	•	•	•	■	•
2HAF Cloudy	•	•	•	•	•	•	•	•	■	•	•	•	•	•	•	•	•	•	•	•	•	•	■	•
2HMG Merle	•	•	•	•	•	•	•	•	■	•	•	•	•	•	•	•	•	•	•	•	•	•	■	•
2HWU Clay	•	•	•	•	•	•	•	•	■	•	•	•	•	•	•	•	•	•	•	•	•	•	■	•
2HWV Chalk	•	•	•	•	•	•	•	•	■	•	•	•	•	•	•	•	•	•	•	•	•	•	■	•

Color Availability Matrix for Steelcase Health Seating and Tables, continued

**Legend**

- = Not available
- = Available
- = Available with exceptions
- Ⓢ = Established
- ▶ See specification pages for details.

	Seiste Arm Caps	Sieste Legs	Sieste Sleeper Legs	Sieste Table	Sorrel Seating Frame	Sorrel Seating Backs	Sorrel Table Legs	Sorrel Table	Surround Frame	Surround Mobile Tablet Arm	Surround Tablet Surface	Surround Storage Tables	Surround Storage Tray with Picture Rail	Surround Coat Hanger	Surround Power	Tava Arm and Legs	Verge Base/Foot Ring	X-Tenz Sleeper Arm Caps	X-Tenz
High-Pressure Laminates (HPL)																			
Price Group 1																			
Fiber Laminates																			
2850 Vanadium Fiber	•	•	•	•	•	•	•	•	•	•	•	•	•	•	•	•	•	•	•
2854 Vellum Fiber Ⓢ	•	•	•	•	•	•	•	•	•	•	•	•	•	•	•	•	•	•	•
2859 Novell Fiber	•	•	•	•	•	•	•	•	•	•	•	•	•	•	•	•	•	•	•
2860 Granite Fiber	•	•	•	•	•	•	•	•	•	•	•	•	•	•	•	•	•	•	•
2861 Coconut Fiber	•	•	•	•	•	•	•	•	•	•	•	•	•	•	•	•	•	•	•
2862 Stucco Fiber Ⓢ	•	•	•	•	•	•	•	•	•	•	•	•	•	•	•	•	•	•	•
Micro Laminates																			
2920 Marl Micro	•	•	•	•	•	•	•	•	•	•	•	•	•	•	•	•	•	•	•
2921 Gypsum Micro	•	•	•	•	•	•	•	•	•	•	•	•	•	•	•	•	•	•	•
2922 Clay Micro	•	•	•	•	•	•	•	•	•	•	•	•	•	•	•	•	•	•	•
Patina Laminates																			
2870 Blonde Bronze Patina	•	•	•	•	•	•	•	•	•	•	•	•	•	•	•	•	•	•	•
2871 Blackened Bronze Patina	•	•	•	•	•	•	•	•	•	•	•	•	•	•	•	•	•	•	•
2873 Instant Iron Patina	•	•	•	•	•	•	•	•	•	•	•	•	•	•	•	•	•	•	•
Solid Laminates																			
2722 Cream Ⓢ	•	•	•	•	•	•	•	■	•	•	•	•	•	•	•	•	•	•	•
2730 Arctic White	•	•	•	•	•	•	•	■	•	•	•	•	•	•	•	•	•	•	■
2746 Black	•	•	•	•	•	•	•	■	•	•	•	•	•	•	•	•	•	•	•
2759 Warm White	•	•	•	•	•	•	•	■	•	•	•	•	•	•	•	•	•	•	■
2811 Mist Ⓢ	•	•	•	•	•	•	•	■	•	•	•	•	•	•	•	•	•	•	•
2883 Seagull	•	•	•	•	•	•	•	■	•	•	•	•	•	•	•	•	•	•	■
2884 Milk	•	•	•	•	•	•	•	■	•	•	•	•	•	•	•	•	•	•	■
2885 Dune	•	•	•	•	•	•	•	■	•	•	•	•	•	•	•	•	•	•	■
2HAA Persian Salt	•	•	•	•	•	•	•	■	•	•	•	•	•	•	•	•	•	•	■
2HAB Rose	•	•	•	•	•	•	•	■	•	•	•	•	•	•	•	•	•	•	■
2HAC Indigo	•	•	•	•	•	•	•	■	•	•	•	•	•	•	•	•	•	•	■
2HAD Green Citrine	•	•	•	•	•	•	•	■	•	•	•	•	•	•	•	•	•	•	■
2HAE Dark Olivine	•	•	•	•	•	•	•	■	•	•	•	•	•	•	•	•	•	•	■
2HAF Cloudy	•	•	•	•	•	•	•	■	•	•	•	•	•	•	•	•	•	•	■
2HMG Merle	•	•	•	•	•	•	•	■	•	•	•	•	•	•	•	•	•	•	•
2HWU Clay	•	•	•	•	•	•	•	■	•	•	•	•	•	•	•	•	•	•	■
2HWV Chalk	•	•	•	•	•	•	•	■	•	•	•	•	•	•	•	•	•	•	■



**Legend**

- = Not available
- = Available
- = Available with exceptions
- Ⓢ = Established
- ▶ See specification pages for details.

	Aspekt Seating Frame	Aspekt Straight Arm Cap	Aspekt Wave Arm cap	Aspekt table, footstool, and Bench Frame and Legs	Aspekt Table	Cura Arm Caps	Cura Frame	Cura Tablet	Embold Arm Caps	Embold High Back Bracket	Embold High Back Bracket Cover	Embold Seating Frame	Embold Table Frame	Embold Table Legs	Embold Adjustable Glides	Embold Wallsaver Glides	Embold Tables	Empath Upper Arms	Empath Tablet	Jenny Tables	Leela Arm Caps	Leela Legs	Leela Table Top
High-Pressure Laminates (HPL)																							
Price Group 1																							
Speckle Laminates																							
2820 Coffee Speckle Ⓢ	•	•	•	•	•	•	•	•	•	•	•	•	•	•	•	•	•	•	•	■	•	•	•
2823 Driftwood Speckle	•	•	•	•	•	•	•	•	•	•	•	•	•	•	•	•	•	•	•	■	•	•	•
2824 Smoke Speckle	•	•	•	•	•	•	•	•	•	•	•	•	•	•	•	•	•	•	•	■	•	•	•
2825 Vanadium Speckle	•	•	•	•	•	•	•	•	•	•	•	•	•	•	•	•	•	•	•	■	•	•	•
Woodgrain Laminates																							
2406 Clear Cherry Ⓢ	•	•	•	•	■	•	•	•	•	•	•	•	•	•	•	•	■	•	•	■	•	•	•
2409 Clear Maple	•	•	•	•	■	•	•	•	•	•	•	•	•	•	•	•	■	•	•	■	•	•	•
2410 Graphite Walnut	•	•	•	•	■	•	•	•	•	•	•	•	•	•	•	•	■	•	•	■	•	•	•
2412 Natural Cherry	•	•	•	•	•	•	•	•	•	•	•	•	•	•	•	•	■	•	•	■	•	•	•
2422 Medium Cherry	•	•	•	•	■	•	•	•	•	•	•	•	•	•	•	•	■	•	•	■	•	•	•
2511 Winter On Maple	•	•	•	•	■	•	•	•	•	•	•	•	•	•	•	•	■	•	•	■	•	•	•
2535 Virginia Walnut	•	•	•	•	■	•	•	•	•	•	•	•	•	•	•	•	■	•	•	■	•	•	•
2536 Blackwood Ⓢ	•	•	•	•	■	•	•	•	•	•	•	•	•	•	•	•	■	•	•	■	•	•	•
2538 Clear Walnut	•	•	•	•	■	•	•	•	•	•	•	•	•	•	•	•	■	•	•	■	•	•	•
2539 Warm Oak	•	•	•	•	•	•	•	•	•	•	•	•	•	•	•	•	■	•	•	■	•	•	•
2574 Dark Rum Cherry	•	•	•	•	■	•	•	•	•	•	•	•	•	•	•	•	■	•	•	■	•	•	•
2575 Shiraz Cherry	•	•	•	•	■	•	•	•	•	•	•	•	•	•	•	•	■	•	•	■	•	•	•
2592 Blonde On Maple Ⓢ	•	•	•	•	■	•	•	•	•	•	•	•	•	•	•	•	■	•	•	■	•	•	•
2714 Natural Walnut Ⓢ	•	•	•	•	■	•	•	•	•	•	•	•	•	•	•	•	•	•	•	■	•	•	•
2HAK Clear Oak	•	•	•	•	■	•	•	•	•	•	•	•	•	•	•	•	■	•	•	■	•	•	•
2HAN Ash Noce	•	•	•	•	■	•	•	•	•	•	•	•	•	•	•	•	■	•	•	■	•	•	•
2HAT Acacia	•	•	•	•	■	•	•	•	•	•	•	•	•	•	•	•	■	•	•	■	•	•	•
2HAW Ash Wenge	•	•	•	•	■	•	•	•	•	•	•	•	•	•	•	•	■	•	•	■	•	•	•
2HBN Bisque Noce	•	•	•	•	■	•	•	•	•	•	•	•	•	•	•	•	■	•	•	■	•	•	•
2HBW Bisque Wenge	•	•	•	•	■	•	•	•	•	•	•	•	•	•	•	•	■	•	•	■	•	•	•
2HCN Clay Noce	•	•	•	•	■	•	•	•	•	•	•	•	•	•	•	•	■	•	•	■	•	•	•
2HCW Clay Wenge	•	•	•	•	■	•	•	•	•	•	•	•	•	•	•	•	■	•	•	■	•	•	•
2HSN Storm Noce	•	•	•	•	■	•	•	•	•	•	•	•	•	•	•	•	■	•	•	■	•	•	•
2HSW Storm Wenge	•	•	•	•	■	•	•	•	•	•	•	•	•	•	•	•	■	•	•	■	•	•	•
2HWA Grey Kingswood	•	•	•	•	■	•	•	•	•	•	•	•	•	•	•	•	■	•	•	■	•	•	•
2HWB Planked Walnut	•	•	•	•	■	•	•	•	•	•	•	•	•	•	•	•	■	•	•	■	•	•	•
2HWD Resolute Walnut	•	•	•	•	■	•	•	•	•	•	•	•	•	•	•	•	■	•	•	■	•	•	•
2HWE Natural Recon	•	•	•	•	■	•	•	•	•	•	•	•	•	•	•	•	■	•	•	■	•	•	•
2HWF Smoked Walnut	•	•	•	•	■	•	•	•	•	•	•	•	•	•	•	•	•	•	•	■	•	•	•

# Color Availability Matrix for Steelcase Health Seating and Tables, continued

## Legend

- = Not available
- = Available
- = Available with exceptions
- Ⓢ = Established
- ▶ See specification pages for details.

	Mineral Arm Caps	Mineral Tablet Surface	Mitra Seating Frame	Mitra Arm Caps - Guest	Mitra Arm Caps - Lounge	Mitra Arm Caps - Recliner	Mitra Arm Caps - Sleeper	Mitra Table Legs and Bases	Mitra Tables	Mitra Tablet Surface	Outlook Metal Legs	Outlook Wood Legs	Outlook Table	Radia Frame	Radia Arm Caps	Regard Frames	Regard Arm Caps	Regard Storage End Tables	Regard Media and Desk Cabinets	Regard Screen Bracket	Regard Vertical Cable Riser	Regard Power Strip	Regard Booth Table + SQ / Personal Table (laminated)	Regard SQ/Personal Table
High-Pressure Laminates (HPL)																								
Price Group 1																								
Speckle Laminates																								
2820 Coffee Speckle Ⓢ	•	•	•	•	•	•	•	•	•	•	•	•	•	•	•	•	•	•	•	•	•	•	■	•
2823 Driftwood Speckle	•	•	•	•	•	•	•	•	•	•	•	•	•	•	•	•	•	•	•	•	•	•	■	•
2824 Smoke Speckle	•	•	•	•	•	•	•	•	•	•	•	•	•	•	•	•	•	•	•	•	•	•	■	•
2825 Vanadium Speckle	•	•	•	•	•	•	•	•	•	•	•	•	•	•	•	•	•	•	•	•	•	•	■	•
Woodgrain Laminates																								
2406 Clear Cherry Ⓢ	•	•	•	•	•	•	•	•	■	•	•	•	■	•	•	•	•	•	•	•	•	•	■	•
2409 Clear Maple	•	•	•	•	•	•	•	•	■	•	•	•	■	•	•	•	•	•	•	•	•	•	■	•
2410 Graphite Walnut	•	•	•	•	•	•	•	•	■	•	•	•	■	•	•	•	•	•	•	•	•	•	■	•
2412 Natural Cherry	•	•	•	•	•	•	•	•	■	•	•	•	■	•	•	•	•	•	•	•	•	•	■	•
2422 Medium Cherry	•	•	•	•	•	•	•	•	■	•	•	•	■	•	•	•	•	•	•	•	•	•	■	•
2511 Winter On Maple	•	•	•	•	•	•	•	•	■	•	•	•	■	•	•	•	•	•	•	•	•	•	■	•
2535 Virginia Walnut	•	•	•	•	•	•	•	•	■	•	•	•	■	•	•	•	•	•	•	•	•	•	■	•
2536 Blackwood Ⓢ	•	•	•	•	•	•	•	•	■	•	•	•	■	•	•	•	•	•	•	•	•	•	■	•
2538 Clear Walnut	•	•	•	•	•	•	•	•	■	•	•	•	■	•	•	•	•	•	•	•	•	•	■	•
2539 Warm Oak	•	•	•	•	•	•	•	•	■	•	•	•	■	•	•	•	•	•	•	•	•	•	■	•
2574 Dark Rum Cherry	•	•	•	•	•	•	•	•	■	•	•	•	■	•	•	•	•	•	•	•	•	•	■	•
2575 Shiraz Cherry	•	•	•	•	•	•	•	•	■	•	•	•	■	•	•	•	•	•	•	•	•	•	■	•
2592 Blonde On Maple Ⓢ	•	•	•	•	•	•	•	•	■	•	•	•	■	•	•	•	•	•	•	•	•	•	■	•
2714 Natural Walnut Ⓢ	•	•	•	•	•	•	•	•	■	•	•	•	■	•	•	•	•	•	•	•	•	•	■	•
2HAK Clear Oak	•	•	•	•	•	•	•	•	■	•	•	•	■	•	•	•	•	•	•	•	•	•	■	•
2HAN Ash Noce	•	•	•	•	•	•	•	•	■	•	•	•	■	•	•	•	•	•	•	•	•	•	■	•
2HAT Acacia	•	•	•	•	•	•	•	•	■	•	•	•	■	•	•	•	•	•	•	•	•	•	■	•
2HAW Ash Wenge	•	•	•	•	•	•	•	•	■	•	•	•	■	•	•	•	•	•	•	•	•	•	■	•
2HBN Bisque Noce	•	•	•	•	•	•	•	•	■	•	•	•	■	•	•	•	•	•	•	•	•	•	■	•
2HBW Bisque Wenge	•	•	•	•	•	•	•	•	■	•	•	•	■	•	•	•	•	•	•	•	•	•	■	•
2HCN Clay Noce	•	•	•	•	•	•	•	•	■	•	•	•	■	•	•	•	•	•	•	•	•	•	■	•
2HCW Clay Wenge	•	•	•	•	•	•	•	•	■	•	•	•	■	•	•	•	•	•	•	•	•	•	■	•
2HSN Storm Noce	•	•	•	•	•	•	•	•	■	•	•	•	■	•	•	•	•	•	•	•	•	•	■	•
2HSW Storm Wenge	•	•	•	•	•	•	•	•	■	•	•	•	■	•	•	•	•	•	•	•	•	•	■	•
2HWA Grey Kingswood	•	•	•	•	•	•	•	•	■	•	•	•	■	•	•	•	•	•	•	•	•	•	■	•
2HWB Planked Walnut	•	•	•	•	•	•	•	•	■	•	•	•	■	•	•	•	•	•	•	•	•	•	■	•
2HWD Resolute Walnut	•	•	•	•	•	•	•	•	■	•	•	•	■	•	•	•	•	•	•	•	•	•	■	•
2HWE Natural Recon	•	•	•	•	•	•	•	•	■	•	•	•	■	•	•	•	•	•	•	•	•	•	■	•
2HWF Smoked Walnut	•	•	•	•	•	•	•	•	■	•	•	•	■	•	•	•	•	•	•	•	•	•	■	•

**Legend**

- = Not available
- = Available
- = Available with exceptions
- Ⓢ = Established
- ▶ See specification pages for details.

	Seiste Arm Caps	Sieste Legs	Sieste Sleeper Legs	Sieste Table	Sorrel Seating Frame	Sorrel Seating Backs	Sorrel Table Legs	Sorrel Table	Surround Frame	Surround Mobile Tablet Arm	Surround Tablet Surface	Surround Storage Tables	Surround Storage Tray with Picture Rail	Surround Coat Hanger	Surround Power	Tava Arm and Legs	Verge Base/Foot Ring	X-Tenz Sleeper Arm Caps	X-Tenz
High-Pressure Laminates (HPL)																			
Price Group 1																			
Speckle Laminates																			
2820 Coffee Speckle Ⓢ	•	•	•	•	•	•	•	•	•	•	•	•	•	•	•	•	•	•	•
2823 Driftwood Speckle	•	•	•	•	•	•	•	•	•	•	•	•	•	•	•	•	•	•	•
2824 Smoke Speckle	•	•	•	•	•	•	•	•	•	•	•	•	•	•	•	•	•	•	•
2825 Vanadium Speckle	•	•	•	•	•	•	•	•	•	•	•	•	•	•	•	•	•	•	•
Woodgrain Laminates																			
2406 Clear Cherry Ⓢ	•	•	•	•	•	•	•	■	•	•	•	•	•	•	•	•	•	•	■
2409 Clear Maple	•	•	•	•	•	•	•	■	•	•	•	•	•	•	•	•	•	•	■
2410 Graphite Walnut	•	•	•	•	•	•	•	■	•	•	•	•	•	•	•	•	•	•	■
2412 Natural Cherry	•	•	•	•	•	•	•	■	•	•	•	•	•	•	•	•	•	•	■
2422 Medium Cherry	•	•	•	•	•	•	•	■	•	•	•	•	•	•	•	•	•	•	■
2511 Winter On Maple	•	•	•	•	•	•	•	■	•	•	•	•	•	•	•	•	•	•	■
2535 Virginia Walnut	•	•	•	•	•	•	•	■	•	•	•	•	•	•	•	•	•	•	■
2536 Blackwood Ⓢ	•	•	•	•	•	•	•	■	•	•	•	•	•	•	•	•	•	•	■
2538 Clear Walnut	•	•	•	•	•	•	•	■	•	•	•	•	•	•	•	•	•	•	■
2539 Warm Oak	•	•	•	•	•	•	•	■	•	•	•	•	•	•	•	•	•	•	■
2574 Dark Rum Cherry	•	•	•	■	•	•	•	■	•	•	•	•	•	•	•	•	•	•	■
2575 Shiraz Cherry	•	•	•	■	•	•	•	■	•	•	•	•	•	•	•	•	•	•	■
2592 Blonde On Maple Ⓢ	•	•	•	•	•	•	•	■	•	•	•	•	•	•	•	•	•	•	■
2714 Natural Walnut Ⓢ	•	•	•	•	•	•	•	•	■	•	•	•	•	•	•	•	•	•	■
2HAK Clear Oak	•	•	•	•	•	•	•	■	•	•	•	•	•	•	•	•	•	•	■
2HAN Ash Noce	•	•	•	•	•	•	•	■	•	•	•	•	•	•	•	•	•	•	■
2HAT Acacia	•	•	•	•	•	•	•	■	•	•	•	•	•	•	•	•	•	•	■
2HAW Ash Wenge	•	•	•	•	•	•	•	■	•	•	•	•	•	•	•	•	•	•	■
2HBN Bisque Noce	•	•	•	•	•	•	•	■	•	•	•	•	•	•	•	•	•	•	■
2HBW Bisque Wenge	•	•	•	•	•	•	•	■	•	•	•	•	•	•	•	•	•	•	■
2HCN Clay Noce	•	•	•	•	•	•	•	■	•	•	•	•	•	•	•	•	•	•	■
2HCW Clay Wenge	•	•	•	•	•	•	•	■	•	•	•	•	•	•	•	•	•	•	■
2HSN Storm Noce	•	•	•	•	•	•	•	■	•	•	•	•	•	•	•	•	•	•	■
2HSW Storm Wenge	•	•	•	•	•	•	•	■	•	•	•	•	•	•	•	•	•	•	■
2HWA Grey Kingswood	•	•	•	•	•	•	•	■	•	•	•	•	•	•	•	•	•	•	■
2HWB Planked Walnut	•	•	•	•	•	•	•	■	•	•	•	•	•	•	•	•	•	•	■
2HWD Resolute Walnut	•	•	•	•	•	•	•	■	•	•	•	•	•	•	•	•	•	•	■
2HWE Natural Recon	•	•	•	•	•	•	•	■	•	•	•	•	•	•	•	•	•	•	■
2HWF Smoked Walnut	•	•	•	•	•	•	•	■	•	•	•	•	•	•	•	•	•	•	■

Color Availability Matrix for Steelcase Health Seating and Tables, continued

**Legend**

- = Not available
- = Available
- = Available with exceptions
- ▶ See specification pages for details.

	Aspekt Seating Frame	Aspekt Straight Arm Cap	Aspekt Wave Arm cap	Aspekt table, footstool, and Bench Frame and Legs	Aspekt Table	Cura Arm Caps	Cura Frame	Cura Tablet	Embold Arm Caps	Embold High Back Bracket	Embold High Back Bracket Cover	Embold Seating Frame	Embold Table Frame	Embold Table Legs	Embold Adjustable Glides	Embold Wallsaver Glides	Embold Tables	Empath Upper Arms	Empath Tablet	Jenny Tables	Leela Arm Caps	Leela Legs	Leela Table Top
High-Pressure Laminates (HPL)																							
Price Group 2																							
Textured Laminate																							
2TH2 Fawn Cypress	•	•	•	•	•	•	•	•	•	•	•	•	•	•	•	•	•	•	•	•	•	•	•
2TH4 Saddle Oak	•	•	•	•	•	•	•	•	•	•	•	•	•	•	•	•	•	•	•	•	•	•	•
2TH5 Veranda Teak	•	•	•	•	•	•	•	•	•	•	•	•	•	•	•	•	•	•	•	•	•	•	•
2TH7 Walnut Heights	•	•	•	•	•	•	•	•	•	•	•	•	•	•	•	•	•	•	•	•	•	•	•
2UH1 Reclaimed Aggregate	•	•	•	•	•	•	•	•	•	•	•	•	•	•	•	•	•	•	•	•	•	•	•
2UH2 Reclaimed Gravel	•	•	•	•	•	•	•	•	•	•	•	•	•	•	•	•	•	•	•	•	•	•	•
2UH4 Cement	•	•	•	•	•	•	•	•	•	•	•	•	•	•	•	•	•	•	•	•	•	•	•
2UH6 Sheetrock	•	•	•	•	•	•	•	•	•	•	•	•	•	•	•	•	•	•	•	•	•	•	•
High-Pressure Laminates (HPL)																							
Price Group 3																							
24H1 Satin White	•	•	•	•	•	•	•	•	•	•	•	•	•	•	•	•	•	•	•	•	■	•	•
24H2 Satin Black	•	•	•	•	•	•	•	•	•	•	•	•	•	•	•	•	•	•	•	•	■	•	•
24H3 Satin Stone	•	•	•	•	•	•	•	•	•	•	•	•	•	•	•	•	•	•	•	•	■	•	•
24H4 Satin Mocha	•	•	•	•	•	•	•	•	•	•	•	•	•	•	•	•	•	•	•	•	■	•	•
High-Pressure Laminates (HPL)																							
Select Surfaces Price Grade B																							
Formica																							
118-58 Finnish Oak	•	•	•	•	•	•	•	•	•	•	•	•	•	•	•	•	•	•	•	•	•	•	•
459-58 Brite White	•	•	•	•	•	•	•	•	•	•	•	•	•	•	•	•	•	•	•	•	•	•	•
464-58 Graystone	•	•	•	•	•	•	•	•	•	•	•	•	•	•	•	•	•	•	•	•	•	•	•
503-58 Stone Grafix	•	•	•	•	•	•	•	•	•	•	•	•	•	•	•	•	•	•	•	•	•	•	•
515-58 Graphite Grafix	•	•	•	•	•	•	•	•	•	•	•	•	•	•	•	•	•	•	•	•	•	•	•
5904-58 Wild Cherry	•	•	•	•	•	•	•	•	•	•	•	•	•	•	•	•	•	•	•	•	•	•	•
6402-58 Thermo Walnut	•	•	•	•	•	•	•	•	•	•	•	•	•	•	•	•	•	•	•	•	•	•	•
7197-58 Dover White	•	•	•	•	•	•	•	•	•	•	•	•	•	•	•	•	•	•	•	•	•	•	•
7284-58 Figured Annigre	•	•	•	•	•	•	•	•	•	•	•	•	•	•	•	•	•	•	•	•	•	•	•
756-58 Natural Maple	•	•	•	•	•	•	•	•	•	•	•	•	•	•	•	•	•	•	•	•	•	•	•
758-58 Blossom Cherrywood	•	•	•	•	•	•	•	•	•	•	•	•	•	•	•	•	•	•	•	•	•	•	•
7739-58 Cocoa Maple	•	•	•	•	•	•	•	•	•	•	•	•	•	•	•	•	•	•	•	•	•	•	•
7759-58 Select Cherry	•	•	•	•	•	•	•	•	•	•	•	•	•	•	•	•	•	•	•	•	•	•	•
7813-58 Cardboard Solidz	•	•	•	•	•	•	•	•	•	•	•	•	•	•	•	•	•	•	•	•	•	•	•
7919-60 Amber Cherry	•	•	•	•	•	•	•	•	•	•	•	•	•	•	•	•	•	•	•	•	•	•	•
837-58 Graphite	•	•	•	•	•	•	•	•	•	•	•	•	•	•	•	•	•	•	•	•	•	•	•

**Legend**

- = Not available
- = Available
- = Available with exceptions
- ▶ See specification pages for details.

	Mineral Arm Caps	Mineral Tablet Surface	Mitra Seating Frame	Mitra Arm Caps - Guest	Mitra Arm Caps - Lounge	Mitra Arm Caps - Recliner	Mitra Arm Caps - Sleeper	Mitra Table Legs and Bases	Mitra Tables	Mitra Tablet Surface	Outlook Metal Legs	Outlook Wood Legs	Outlook Table	Radia Frame	Radia Arm Caps	Regard Frames	Regard Arm Caps	Regard Storage End Tables	Regard Media and Desk Cabinets	Regard Screen Bracket	Regard Vertical Cable Riser	Regard Power Strip	Regard Booth Table + SQ/Personal Table (laminated)	Regard SQ/Personal Table
High-Pressure Laminates (HPL) Price Group 2																								
Textured Laminate																								
2TH2 Fawn Cypress	•	•	•	•	•	•	•	•	•	•	•	•	•	•	•	•	•	•	•	•	•	•	•	•
2TH4 Saddle Oak	•	•	•	•	•	•	•	•	•	•	•	•	•	•	•	•	•	•	•	•	•	•	•	•
2TH5 Veranda Teak	•	•	•	•	•	•	•	•	•	•	•	•	•	•	•	•	•	•	•	•	•	•	•	•
2TH7 Walnut Heights	•	•	•	•	•	•	•	•	•	•	•	•	•	•	•	•	•	•	•	•	•	•	•	•
2UH1 Reclaimed Aggregate	•	•	•	•	•	•	•	•	•	•	•	•	•	•	•	•	•	•	•	•	•	•	•	•
2UH2 Reclaimed Gravel	•	•	•	•	•	•	•	•	•	•	•	•	•	•	•	•	•	•	•	•	•	•	•	•
2UH4 Cement	•	•	•	•	•	•	•	•	•	•	•	•	•	•	•	•	•	•	•	•	•	•	•	•
2UH6 Sheetrock	•	•	•	•	•	•	•	•	•	•	•	•	•	•	•	•	•	•	•	•	•	•	•	•
High-Pressure Laminates (HPL) Price Group 3																								
24H1 Satin White	•	•	•	•	•	•	•	•	•	•	•	•	•	•	•	•	•	•	•	•	•	•	•	•
24H2 Satin Black	•	•	•	•	•	•	•	•	•	•	•	•	•	•	•	•	•	•	•	•	•	•	•	•
24H3 Satin Stone	•	•	•	•	•	•	•	•	•	•	•	•	•	•	•	•	•	•	•	•	•	•	•	•
24H4 Satin Mocha	•	•	•	•	•	•	•	•	•	•	•	•	•	•	•	•	•	•	•	•	•	•	•	•
High-Pressure Laminates (HPL) Select Surfaces Price Grade B																								
Formica																								
118-58 Finnish Oak	•	•	•	•	•	•	•	•	•	•	•	•	•	•	•	•	•	•	•	•	•	•	•	•
459-58 Brite White	•	•	•	•	•	•	•	•	•	•	•	•	•	•	•	•	•	•	•	•	•	•	•	•
464-58 Graystone	•	•	•	•	•	•	•	•	•	•	•	•	•	•	•	•	•	•	•	•	•	•	•	•
503-58 Stone Grafix	•	•	•	•	•	•	•	•	•	•	•	•	•	•	•	•	•	•	•	•	•	•	•	•
515-58 Graphite Grafix	•	•	•	•	•	•	•	•	•	•	•	•	•	•	•	•	•	•	•	•	•	•	•	•
5904-58 Wild Cherry	•	•	•	•	•	•	•	•	•	•	•	•	•	•	•	•	•	•	•	•	•	•	•	•
6402-58 Thermo Walnut	•	•	•	•	•	•	•	•	•	•	•	•	•	•	•	•	•	•	•	•	•	•	•	•
7197-58 Dover White	•	•	•	•	•	•	•	•	•	•	•	•	•	•	•	•	•	•	•	•	•	•	•	•
7284-58 Figured Annigre	•	•	•	•	•	•	•	•	•	•	•	•	•	•	•	•	•	•	•	•	•	•	•	•
756-58 Natural Maple	•	•	•	•	•	•	•	•	•	•	•	•	•	•	•	•	•	•	•	•	•	•	•	•
758-58 Blossom Cherrywood	•	•	•	•	•	•	•	•	•	•	•	•	•	•	•	•	•	•	•	•	•	•	•	•
7739-58 Cocoa Maple	•	•	•	•	•	•	•	•	•	•	•	•	•	•	•	•	•	•	•	•	•	•	•	•
7759-58 Select Cherry	•	•	•	•	•	•	•	•	•	•	•	•	•	•	•	•	•	•	•	•	•	•	•	•
7813-58 Cardboard Solidz	•	•	•	•	•	•	•	•	•	•	•	•	•	•	•	•	•	•	•	•	•	•	•	•
7919-60 Amber Cherry	•	•	•	•	•	•	•	•	•	•	•	•	•	•	•	•	•	•	•	•	•	•	•	•
837-58 Graphite	•	•	•	•	•	•	•	•	•	•	•	•	•	•	•	•	•	•	•	•	•	•	•	•

Color Availability Matrix for Steelcase Health Seating and Tables, continued

**Legend**

- = Not available
- = Available
- = Available with exceptions
- ▶ See specification pages for details.

	Seiste Arm Caps	Sieste Legs	Sieste Sleeper Legs	Sieste Table	Sorrel Seating Frame	Sorrel Seating Backs	Sorrel Table Legs	Sorrel Table	Surround Frame	Surround Mobile Tablet Arm	Surround Tablet Surface	Surround Storage Tables	Surround Storage Tray with Picture Rail	Surround Coat Hanger	Surround Power	Tava Arm and Legs	Verge Base/Foot Ring	X-Tenz Sleeper Arm Caps	X-Tenz
High-Pressure Laminates (HPL)																			
Price Group 2																			
Textured Laminate																			
2TH2 Fawn Cypress	•	•	•	•	•	•	•	•	•	•	•	•	•	•	•	•	•	•	•
2TH4 Saddle Oak	•	•	•	•	•	•	•	•	•	•	•	•	•	•	•	•	•	•	•
2TH5 Veranda Teak	•	•	•	•	•	•	•	•	•	•	•	•	•	•	•	•	•	•	•
2TH7 Walnut Heights	•	•	•	•	•	•	•	•	•	•	•	•	•	•	•	•	•	•	•
2UH1 Reclaimed Aggregate	•	•	•	•	•	•	•	•	•	•	•	•	•	•	•	•	•	•	•
2UH2 Reclaimed Gravel	•	•	•	•	•	•	•	•	•	•	•	•	•	•	•	•	•	•	•
2UH4 Cement	•	•	•	•	•	•	•	•	•	•	•	•	•	•	•	•	•	•	•
2UH6 Sheetrock	•	•	•	•	•	•	•	•	•	•	•	•	•	•	•	•	•	•	•
High-Pressure Laminates (HPL)																			
Price Group 3																			
24H1 Satin White	•	•	•	•	•	•	•	•	•	•	•	•	•	•	•	•	•	•	•
24H2 Satin Black	•	•	•	•	•	•	•	•	•	•	•	•	•	•	•	•	•	•	•
24H3 Satin Stone	•	•	•	•	•	•	•	•	•	•	•	•	•	•	•	•	•	•	•
24H4 Satin Mocha	•	•	•	•	•	•	•	•	•	•	•	•	•	•	•	•	•	•	•
High-Pressure Laminates (HPL)																			
Select Surfaces Price Grade B																			
Formica																			
118-58 Finnish Oak	•	•	•	•	•	•	•	•	•	•	•	•	•	•	•	•	•	•	•
459-58 Brite White	•	•	•	•	•	•	•	•	•	•	•	•	•	•	•	•	•	•	•
464-58 Graystone	•	•	•	•	•	•	•	•	•	•	•	•	•	•	•	•	•	•	•
503-58 Stone Grafix	•	•	•	•	•	•	•	•	•	•	•	•	•	•	•	•	•	•	•
515-58 Graphite Grafix	•	•	•	•	•	•	•	•	•	•	•	•	•	•	•	•	•	•	•
5904-58 Wild Cherry	•	•	•	•	•	•	•	•	•	•	•	•	•	•	•	•	•	•	•
6402-58 Thermo Walnut	•	•	•	•	•	•	•	•	•	•	•	•	•	•	•	•	•	•	•
7197-58 Dover White	•	•	•	•	•	•	•	•	•	•	•	•	•	•	•	•	•	•	•
7284-58 Figured Annigre	•	•	•	•	•	•	•	•	•	•	•	•	•	•	•	•	•	•	•
756-58 Natural Maple	•	•	•	•	•	•	•	•	•	•	•	•	•	•	•	•	•	•	•
758-58 Blossom Cherrywood	•	•	•	•	•	•	•	•	•	•	•	•	•	•	•	•	•	•	•
7739-58 Cocoa Maple	•	•	•	•	•	•	•	•	•	•	•	•	•	•	•	•	•	•	•
7759-58 Select Cherry	•	•	•	•	•	•	•	•	•	•	•	•	•	•	•	•	•	•	•
7813-58 Cardboard Solidz	•	•	•	•	•	•	•	•	•	•	•	•	•	•	•	•	•	•	•
7919-60 Amber Cherry	•	•	•	•	•	•	•	•	•	•	•	•	•	•	•	•	•	•	•
837-58 Graphite	•	•	•	•	•	•	•	•	•	•	•	•	•	•	•	•	•	•	•

**Legend**

- = Not available
- = Available
- = Available with exceptions
- ▶ See specification pages for details.

	Aspekt Seating Frame	Aspekt Straight Arm Cap	Aspekt Wave Arm cap	Aspekt table, footstool, and Bench Frame and Legs	Aspekt Table	Cura Arm Caps	Cura Frame	Cura Tablet	Embold Arm Caps	Embold High Back Bracket	Embold High Back Bracket Cover	Embold Seating Frame	Embold Table Frame	Embold Table Legs	Embold Adjustable Glides	Embold Wallsaver Glides	Embold Tables	Empath Upper Arms	Empath Tablet	Jenny Tables	Leela Arm Caps	Leela Legs	Leela Table Top
High-Pressure Laminates (HPL)																							
Select Surfaces Price Grade B																							
Formica																							
8751-58 Mojave	•	•	•	•	•	•	•	•	•	•	•	•	•	•	•	•	•	•	•	•	•	•	•
9011-58 Zebrano	•	•	•	•	•	•	•	•	•	•	•	•	•	•	•	•	•	•	•	•	•	•	•
909-58 Black	•	•	•	•	•	•	•	•	•	•	•	•	•	•	•	•	•	•	•	•	•	•	•
912-58 Storm	•	•	•	•	•	•	•	•	•	•	•	•	•	•	•	•	•	•	•	•	•	•	•
918-58 Neutral White	•	•	•	•	•	•	•	•	•	•	•	•	•	•	•	•	•	•	•	•	•	•	•
920-58 Almond	•	•	•	•	•	•	•	•	•	•	•	•	•	•	•	•	•	•	•	•	•	•	•
9237-58 Sand Maple	•	•	•	•	•	•	•	•	•	•	•	•	•	•	•	•	•	•	•	•	•	•	•
9238-58 Chelsea Maple	•	•	•	•	•	•	•	•	•	•	•	•	•	•	•	•	•	•	•	•	•	•	•
9240-58 Cherry Heartwood	•	•	•	•	•	•	•	•	•	•	•	•	•	•	•	•	•	•	•	•	•	•	•
9242-58 Gull Grey	•	•	•	•	•	•	•	•	•	•	•	•	•	•	•	•	•	•	•	•	•	•	•
9243-58 Zen Grey	•	•	•	•	•	•	•	•	•	•	•	•	•	•	•	•	•	•	•	•	•	•	•
927-58 Folkstone	•	•	•	•	•	•	•	•	•	•	•	•	•	•	•	•	•	•	•	•	•	•	•
933-58 Mission White	•	•	•	•	•	•	•	•	•	•	•	•	•	•	•	•	•	•	•	•	•	•	•
949-58 White	•	•	•	•	•	•	•	•	•	•	•	•	•	•	•	•	•	•	•	•	•	•	•
961-58 Fog	•	•	•	•	•	•	•	•	•	•	•	•	•	•	•	•	•	•	•	•	•	•	•
Wilsonart																							
10745-60 Fonthill Pear	•	•	•	•	•	•	•	•	•	•	•	•	•	•	•	•	•	•	•	•	•	•	•
10776-60 Kensington Maple	•	•	•	•	•	•	•	•	•	•	•	•	•	•	•	•	•	•	•	•	•	•	•
1500-60 Grey	•	•	•	•	•	•	•	•	•	•	•	•	•	•	•	•	•	•	•	•	•	•	•
1572-60 Antique White	•	•	•	•	•	•	•	•	•	•	•	•	•	•	•	•	•	•	•	•	•	•	•
1573-60 Frosty White	•	•	•	•	•	•	•	•	•	•	•	•	•	•	•	•	•	•	•	•	•	•	•
4142-60 Grey Glace	•	•	•	•	•	•	•	•	•	•	•	•	•	•	•	•	•	•	•	•	•	•	•
4622-60 Grey Nebula	•	•	•	•	•	•	•	•	•	•	•	•	•	•	•	•	•	•	•	•	•	•	•
4623-60 Graphite Nebula	•	•	•	•	•	•	•	•	•	•	•	•	•	•	•	•	•	•	•	•	•	•	•
4841-60 Desert Zephyr	•	•	•	•	•	•	•	•	•	•	•	•	•	•	•	•	•	•	•	•	•	•	•
4879-38 Steel Mesh	•	•	•	•	•	•	•	•	•	•	•	•	•	•	•	•	•	•	•	•	•	•	•
4882-38 Oiled Soapstone	•	•	•	•	•	•	•	•	•	•	•	•	•	•	•	•	•	•	•	•	•	•	•
7012-58 Amber Maple	•	•	•	•	•	•	•	•	•	•	•	•	•	•	•	•	•	•	•	•	•	•	•
7039-60 Windsor Mahogany	•	•	•	•	•	•	•	•	•	•	•	•	•	•	•	•	•	•	•	•	•	•	•
7040-60 Figured Mahogany	•	•	•	•	•	•	•	•	•	•	•	•	•	•	•	•	•	•	•	•	•	•	•
7054-60 Wild Cherry	•	•	•	•	•	•	•	•	•	•	•	•	•	•	•	•	•	•	•	•	•	•	•
7110-60 Montana Walnut	•	•	•	•	•	•	•	•	•	•	•	•	•	•	•	•	•	•	•	•	•	•	•

Color Availability Matrix for Steelcase Health Seating and Tables, continued

**Legend**

- = Not available
- = Available
- = Available with exceptions
- ▶ See specification pages for details.

	Mineral Arm Caps	Mineral Tablet Surface	Mitra Seating Frame	Mitra Arm Caps - Guest	Mitra Arm Caps - Lounge	Mitra Arm Caps - Recliner	Mitra Arm Caps - Sleeper	Mitra Table Legs and Bases	Mitra Tables	Mitra Tablet Surface	Outlook Metal Legs	Outlook Wood Legs	Outlook Table	Radia Frame	Radia Arm Caps	Regard Frames	Regard Arm Caps	Regard Storage End Tables	Regard Media and Desk Cabinets	Regard Screen Bracket	Regard Vertical Cable Riser	Regard Power Strip	Regard Booth Table + SQ/ Personal Table (laminated)	Regard SQ/Personal Table
High-Pressure Laminates (HPL)																								
Select Surfaces Price Grade B																								
Formica																								
8751-58 Mojave	•	•	•	•	•	•	•	•	•	•	•	•	•	•	•	•	•	•	•	•	•	•	•	•
9011-58 Zebrano	•	•	•	•	•	•	•	•	•	•	•	•	•	•	•	•	•	•	•	•	•	•	•	•
909-58 Black	•	•	•	•	•	•	•	•	•	•	•	•	•	•	•	•	•	•	•	•	•	•	•	•
912-58 Storm	•	•	•	•	•	•	•	•	•	•	•	•	•	•	•	•	•	•	•	•	•	•	•	•
918-58 Neutral White	•	•	•	•	•	•	•	•	•	•	•	•	•	•	•	•	•	•	•	•	•	•	•	•
920-58 Almond	•	•	•	•	•	•	•	•	•	•	•	•	•	•	•	•	•	•	•	•	•	•	•	•
9237-58 Sand Maple	•	•	•	•	•	•	•	•	•	•	•	•	•	•	•	•	•	•	•	•	•	•	•	•
9238-58 Chelsea Maple	•	•	•	•	•	•	•	•	•	•	•	•	•	•	•	•	•	•	•	•	•	•	•	•
9240-58 Cherry Heartwood	•	•	•	•	•	•	•	•	•	•	•	•	•	•	•	•	•	•	•	•	•	•	•	•
9242-58 Gull Grey	•	•	•	•	•	•	•	•	•	•	•	•	•	•	•	•	•	•	•	•	•	•	•	•
9243-58 Zen Grey	•	•	•	•	•	•	•	•	•	•	•	•	•	•	•	•	•	•	•	•	•	•	•	•
927-58 Folkstone	•	•	•	•	•	•	•	•	•	•	•	•	•	•	•	•	•	•	•	•	•	•	•	•
933-58 Mission White	•	•	•	•	•	•	•	•	•	•	•	•	•	•	•	•	•	•	•	•	•	•	•	•
949-58 White	•	•	•	•	•	•	•	•	•	•	•	•	•	•	•	•	•	•	•	•	•	•	•	•
961-58 Fog	•	•	•	•	•	•	•	•	•	•	•	•	•	•	•	•	•	•	•	•	•	•	•	•
Wilsonart																								
10745-60 Fonthill Pear	•	•	•	•	•	•	•	•	•	•	•	•	•	•	•	•	•	•	•	•	•	•	•	•
10776-60 Kensington Maple	•	•	•	•	•	•	•	•	•	•	•	•	•	•	•	•	•	•	•	•	•	•	•	•
1500-60 Grey	•	•	•	•	•	•	•	•	•	•	•	•	•	•	•	•	•	•	•	•	•	•	•	•
1572-60 Antique White	•	•	•	•	•	•	•	•	•	•	•	•	•	•	•	•	•	•	•	•	•	•	•	•
1573-60 Frosty White	•	•	•	•	•	•	•	•	•	•	•	•	•	•	•	•	•	•	•	•	•	•	•	•
4142-60 Grey Glace	•	•	•	•	•	•	•	•	•	•	•	•	•	•	•	•	•	•	•	•	•	•	•	•
4622-60 Grey Nebula	•	•	•	•	•	•	•	•	•	•	•	•	•	•	•	•	•	•	•	•	•	•	•	•
4623-60 Graphite Nebula	•	•	•	•	•	•	•	•	•	•	•	•	•	•	•	•	•	•	•	•	•	•	•	•
4841-60 Desert Zephyr	•	•	•	•	•	•	•	•	•	•	•	•	•	•	•	•	•	•	•	•	•	•	•	•
4879-38 Steel Mesh	•	•	•	•	•	•	•	•	•	•	•	•	•	•	•	•	•	•	•	•	•	•	•	•
4882-38 Oiled Soapstone	•	•	•	•	•	•	•	•	•	•	•	•	•	•	•	•	•	•	•	•	•	•	•	•
7012-58 Amber Maple	•	•	•	•	•	•	•	•	•	•	•	•	•	•	•	•	•	•	•	•	•	•	•	•
7039-60 Windsor Mahogany	•	•	•	•	•	•	•	•	•	•	•	•	•	•	•	•	•	•	•	•	•	•	•	•
7040-60 Figured Mahogany	•	•	•	•	•	•	•	•	•	•	•	•	•	•	•	•	•	•	•	•	•	•	•	•
7054-60 Wild Cherry	•	•	•	•	•	•	•	•	•	•	•	•	•	•	•	•	•	•	•	•	•	•	•	•
7110-60 Montana Walnut	•	•	•	•	•	•	•	•	•	•	•	•	•	•	•	•	•	•	•	•	•	•	•	•



**Legend**

- = Not available
- = Available
- = Available with exceptions
- ▶ See specification pages for details.

	Seiste Arm Caps	Sieste Legs	Sieste Sleeper Legs	Sieste Table	Sorrel Seating Frame	Sorrel Seating Backs	Sorrel Table Legs	Sorrel Table	Surround Frame	Surround Mobile Tablet Arm	Surround Tablet Surface	Surround Storage Tables	Surround Storage Tray with Picture Rail	Surround Coat Hanger	Surround Power	Tava Arm and Legs	Verge Base/Foot Ring	X-Tenz Sleeper Arm Caps	X-Tenz
High-Pressure Laminates (HPL)																			
Select Surfaces Price Grade B																			
Formica																			
8751-58 Mojave	•	•	•	•	•	•	•	•	•	•	•	•	•	•	•	•	•	•	•
9011-58 Zebrano	•	•	•	•	•	•	•	•	•	•	•	•	•	•	•	•	•	•	•
909-58 Black	•	•	•	•	•	•	•	•	•	•	•	•	•	•	•	•	•	•	•
912-58 Storm	•	•	•	•	•	•	•	•	•	•	•	•	•	•	•	•	•	•	•
918-58 Neutral White	•	•	•	•	•	•	•	•	•	•	•	•	•	•	•	•	•	•	•
920-58 Almond	•	•	•	•	•	•	•	•	•	•	•	•	•	•	•	•	•	•	•
9237-58 Sand Maple	•	•	•	•	•	•	•	•	•	•	•	•	•	•	•	•	•	•	•
9238-58 Chelsea Maple	•	•	•	•	•	•	•	•	•	•	•	•	•	•	•	•	•	•	•
9240-58 Cherry Heartwood	•	•	•	•	•	•	•	•	•	•	•	•	•	•	•	•	•	•	•
9242-58 Gull Grey	•	•	•	•	•	•	•	•	•	•	•	•	•	•	•	•	•	•	•
9243-58 Zen Grey	•	•	•	•	•	•	•	•	•	•	•	•	•	•	•	•	•	•	•
927-58 Folkstone	•	•	•	•	•	•	•	•	•	•	•	•	•	•	•	•	•	•	•
933-58 Mission White	•	•	•	•	•	•	•	•	•	•	•	•	•	•	•	•	•	•	•
949-58 White	•	•	•	•	•	•	•	•	•	•	•	•	•	•	•	•	•	•	•
961-58 Fog	•	•	•	•	•	•	•	•	•	•	•	•	•	•	•	•	•	•	•
Wilsonart																			
10745-60 Fonthill Pear	•	•	•	•	•	•	•	•	•	•	•	•	•	•	•	•	•	•	•
10776-60 Kensington Maple	•	•	•	•	•	•	•	•	•	•	•	•	•	•	•	•	•	•	•
1500-60 Grey	•	•	•	•	•	•	•	•	•	•	•	•	•	•	•	•	•	•	•
1572-60 Antique White	•	•	•	•	•	•	•	•	•	•	•	•	•	•	•	•	•	•	•
1573-60 Frosty White	•	•	•	•	•	•	•	•	•	•	•	•	•	•	•	•	•	•	•
4142-60 Grey Glace	•	•	•	•	•	•	•	•	•	•	•	•	•	•	•	•	•	•	•
4622-60 Grey Nebula	•	•	•	•	•	•	•	•	•	•	•	•	•	•	•	•	•	•	•
4623-60 Graphite Nebula	•	•	•	•	•	•	•	•	•	•	•	•	•	•	•	•	•	•	•
4841-60 Desert Zephyr	•	•	•	•	•	•	•	•	•	•	•	•	•	•	•	•	•	•	•
4879-38 Steel Mesh	•	•	•	•	•	•	•	•	•	•	•	•	•	•	•	•	•	•	•
4882-38 Oiled Soapstone	•	•	•	•	•	•	•	•	•	•	•	•	•	•	•	•	•	•	•
7012-58 Amber Maple	•	•	•	•	•	•	•	•	•	•	•	•	•	•	•	•	•	•	•
7039-60 Windsor Mahogany	•	•	•	•	•	•	•	•	•	•	•	•	•	•	•	•	•	•	•
7040-60 Figured Mahogany	•	•	•	•	•	•	•	•	•	•	•	•	•	•	•	•	•	•	•
7054-60 Wild Cherry	•	•	•	•	•	•	•	•	•	•	•	•	•	•	•	•	•	•	•
7110-60 Montana Walnut	•	•	•	•	•	•	•	•	•	•	•	•	•	•	•	•	•	•	•

# Color Availability Matrix for Steelcase Health Seating and Tables, continued

## Legend

- = Not available
- = Available
- = Available with exceptions
- ▶ See specification pages for details.

	Aspekt Seating Frame	Aspekt Straight Arm Cap	Aspekt Wave Arm cap	Aspekt table, footstool, and Bench Frame and Legs	Aspekt Table	Cura Arm Caps	Cura Frame	Cura Tablet	Embold Arm Caps	Embold High Back Bracket	Embold High Back Bracket Cover	Embold Seating Frame	Embold Table Frame	Embold Table Legs	Embold Adjustable Glides	Embold Wallsaver Glides	Embold Tables	Empath Upper Arms	Empath Tablet	Jenny Tables	Leela Arm Caps	Leela Legs	Leela Table Top
Wilsonart, cont.																							
7122-60 Empire Mahogany	•	•	•	•	•	•	•	•	•	•	•	•	•	•	•	•	•	•	•	•	•	•	•
7806-60 Bannister Oak	•	•	•	•	•	•	•	•	•	•	•	•	•	•	•	•	•	•	•	•	•	•	•
7850-60 Beigewood	•	•	•	•	•	•	•	•	•	•	•	•	•	•	•	•	•	•	•	•	•	•	•
7909-60 Fusion Maple	•	•	•	•	•	•	•	•	•	•	•	•	•	•	•	•	•	•	•	•	•	•	•
7922-60 Brighton Walnut	•	•	•	•	•	•	•	•	•	•	•	•	•	•	•	•	•	•	•	•	•	•	•
7924-60 Biltmore Cherry	•	•	•	•	•	•	•	•	•	•	•	•	•	•	•	•	•	•	•	•	•	•	•
7925-60 Monticello Maple	•	•	•	•	•	•	•	•	•	•	•	•	•	•	•	•	•	•	•	•	•	•	•
7929-60 Huntington Maple	•	•	•	•	•	•	•	•	•	•	•	•	•	•	•	•	•	•	•	•	•	•	•
7933-60 Cafelle	•	•	•	•	•	•	•	•	•	•	•	•	•	•	•	•	•	•	•	•	•	•	•
7935-60 Shaker Cherry	•	•	•	•	•	•	•	•	•	•	•	•	•	•	•	•	•	•	•	•	•	•	•
7936-60 Williamsburg Cherry	•	•	•	•	•	•	•	•	•	•	•	•	•	•	•	•	•	•	•	•	•	•	•
7937-38 River Cherry	•	•	•	•	•	•	•	•	•	•	•	•	•	•	•	•	•	•	•	•	•	•	•
7941-38 Tan Echo	•	•	•	•	•	•	•	•	•	•	•	•	•	•	•	•	•	•	•	•	•	•	•
7942-60 Cocobala	•	•	•	•	•	•	•	•	•	•	•	•	•	•	•	•	•	•	•	•	•	•	•
7945-38 Xanadu	•	•	•	•	•	•	•	•	•	•	•	•	•	•	•	•	•	•	•	•	•	•	•
7946-60 Brazilwood	•	•	•	•	•	•	•	•	•	•	•	•	•	•	•	•	•	•	•	•	•	•	•
7949-38 Asian Night	•	•	•	•	•	•	•	•	•	•	•	•	•	•	•	•	•	•	•	•	•	•	•
7952-38 Asian Sand	•	•	•	•	•	•	•	•	•	•	•	•	•	•	•	•	•	•	•	•	•	•	•
7960-38 Studio Teak	•	•	•	•	•	•	•	•	•	•	•	•	•	•	•	•	•	•	•	•	•	•	•
7964-38 Skyline Walnut	•	•	•	•	•	•	•	•	•	•	•	•	•	•	•	•	•	•	•	•	•	•	•
7980-38 Zebra wood	•	•	•	•	•	•	•	•	•	•	•	•	•	•	•	•	•	•	•	•	•	•	•
7993-38 Florence Walnut	•	•	•	•	•	•	•	•	•	•	•	•	•	•	•	•	•	•	•	•	•	•	•
8200-60 White Driftwood	•	•	•	•	•	•	•	•	•	•	•	•	•	•	•	•	•	•	•	•	•	•	•
8207-60 Branded Oak	•	•	•	•	•	•	•	•	•	•	•	•	•	•	•	•	•	•	•	•	•	•	•
8210-38 Portico Teak	•	•	•	•	•	•	•	•	•	•	•	•	•	•	•	•	•	•	•	•	•	•	•
8211-38 Phantom Pearl	•	•	•	•	•	•	•	•	•	•	•	•	•	•	•	•	•	•	•	•	•	•	•
8212-38 Phantom Ecru	•	•	•	•	•	•	•	•	•	•	•	•	•	•	•	•	•	•	•	•	•	•	•
8214-38 Phantom Charcoal	•	•	•	•	•	•	•	•	•	•	•	•	•	•	•	•	•	•	•	•	•	•	•
D30-60 Natural Almond	•	•	•	•	•	•	•	•	•	•	•	•	•	•	•	•	•	•	•	•	•	•	•
D315-60 Platinum	•	•	•	•	•	•	•	•	•	•	•	•	•	•	•	•	•	•	•	•	•	•	•
D327-60 Pepperdust	•	•	•	•	•	•	•	•	•	•	•	•	•	•	•	•	•	•	•	•	•	•	•
D381-60 Fashion Grey	•	•	•	•	•	•	•	•	•	•	•	•	•	•	•	•	•	•	•	•	•	•	•
D427-60 Linen	•	•	•	•	•	•	•	•	•	•	•	•	•	•	•	•	•	•	•	•	•	•	•
D439-60 Wallaby	•	•	•	•	•	•	•	•	•	•	•	•	•	•	•	•	•	•	•	•	•	•	•
D495-60 Coffee Bean	•	•	•	•	•	•	•	•	•	•	•	•	•	•	•	•	•	•	•	•	•	•	•
D90-60 Northsea	•	•	•	•	•	•	•	•	•	•	•	•	•	•	•	•	•	•	•	•	•	•	•
D91-60 Slate Grey	•	•	•	•	•	•	•	•	•	•	•	•	•	•	•	•	•	•	•	•	•	•	•
D92-60 Dove Grey	•	•	•	•	•	•	•	•	•	•	•	•	•	•	•	•	•	•	•	•	•	•	•
D96-60 Shadow	•	•	•	•	•	•	•	•	•	•	•	•	•	•	•	•	•	•	•	•	•	•	•

**Legend**

- = Not available
- = Available
- = Available with exceptions
- ▶ See specification pages for details.

	Mineral Arm Caps	Mineral Tablet Surface	Mitra Seating Frame	Mitra Arm Caps - Guest	Mitra Arm Caps - Lounge	Mitra Arm Caps - Recliner	Mitra Arm Caps - Sleeper	Mitra Table Legs and Bases	Mitra Tables	Mitra Tablet Surface	Outlook Metal Legs	Outlook Wood Legs	Outlook Table	Radia Frame	Radia Arm Caps	Regard Frames	Regard Arm Caps	Regard Storage End Tables	Regard Media and Desk Cabinets	Regard Screen Bracket	Regard Vertical Cable Riser	Regard Power Strip	Regard Booth Table + SQ/ Personal Table (laminated)	Regard SQ/Personal Table
Wilsonart, cont.																								
7122-60 Empire Mahogany	•	•	•	•	•	•	•	•	•	•	•	•	•	•	•	•	•	•	•	•	•	•	•	•
7806-60 Bannister Oak	•	•	•	•	•	•	•	•	•	•	•	•	•	•	•	•	•	•	•	•	•	•	•	•
7850-60 Beigewood	•	•	•	•	•	•	•	•	•	•	•	•	•	•	•	•	•	•	•	•	•	•	•	•
7909-60 Fusion Maple	•	•	•	•	•	•	•	•	•	•	•	•	•	•	•	•	•	•	•	•	•	•	•	•
7922-60 Brighton Walnut	•	•	•	•	•	•	•	•	•	•	•	•	•	•	•	•	•	•	•	•	•	•	•	•
7924-60 Biltmore Cherry	•	•	•	•	•	•	•	•	•	•	•	•	•	•	•	•	•	•	•	•	•	•	•	•
7925-60 Monticello Maple	•	•	•	•	•	•	•	•	•	•	•	•	•	•	•	•	•	•	•	•	•	•	•	•
7929-60 Huntington Maple	•	•	•	•	•	•	•	•	•	•	•	•	•	•	•	•	•	•	•	•	•	•	•	•
7933-60 Cafelle	•	•	•	•	•	•	•	•	•	•	•	•	•	•	•	•	•	•	•	•	•	•	•	•
7935-60 Shaker Cherry	•	•	•	•	•	•	•	•	•	•	•	•	•	•	•	•	•	•	•	•	•	•	•	•
7936-60 Williamsburg Cherry	•	•	•	•	•	•	•	•	•	•	•	•	•	•	•	•	•	•	•	•	•	•	•	•
7937-38 River Cherry	•	•	•	•	•	•	•	•	•	•	•	•	•	•	•	•	•	•	•	•	•	•	•	•
7941-38 Tan Echo	•	•	•	•	•	•	•	•	•	•	•	•	•	•	•	•	•	•	•	•	•	•	•	•
7942-60 Cocobala	•	•	•	•	•	•	•	•	•	•	•	•	•	•	•	•	•	•	•	•	•	•	•	•
7945-38 Xanadu	•	•	•	•	•	•	•	•	•	•	•	•	•	•	•	•	•	•	•	•	•	•	•	•
7946-60 Brazilwood	•	•	•	•	•	•	•	•	•	•	•	•	•	•	•	•	•	•	•	•	•	•	•	•
7949-38 Asian Night	•	•	•	•	•	•	•	•	•	•	•	•	•	•	•	•	•	•	•	•	•	•	•	•
7952-38 Asian Sand	•	•	•	•	•	•	•	•	•	•	•	•	•	•	•	•	•	•	•	•	•	•	•	•
7960-38 Studio Teak	•	•	•	•	•	•	•	•	•	•	•	•	•	•	•	•	•	•	•	•	•	•	•	•
7964-38 Skyline Walnut	•	•	•	•	•	•	•	•	•	•	•	•	•	•	•	•	•	•	•	•	•	•	•	•
7980-38 Zebrawood	•	•	•	•	•	•	•	•	•	•	•	•	•	•	•	•	•	•	•	•	•	•	•	•
7993-38 Florence Walnut	•	•	•	•	•	•	•	•	•	•	•	•	•	•	•	•	•	•	•	•	•	•	•	•
8200-60 White Driftwood	•	•	•	•	•	•	•	•	•	•	•	•	•	•	•	•	•	•	•	•	•	•	•	•
8207-60 Branded Oak	•	•	•	•	•	•	•	•	•	•	•	•	•	•	•	•	•	•	•	•	•	•	•	•
8210-38 Portico Teak	•	•	•	•	•	•	•	•	•	•	•	•	•	•	•	•	•	•	•	•	•	•	•	•
8211-38 Phantom Pearl	•	•	•	•	•	•	•	•	•	•	•	•	•	•	•	•	•	•	•	•	•	•	•	•
8212-38 Phantom Ecru	•	•	•	•	•	•	•	•	•	•	•	•	•	•	•	•	•	•	•	•	•	•	•	•
8214-38 Phantom Charcoal	•	•	•	•	•	•	•	•	•	•	•	•	•	•	•	•	•	•	•	•	•	•	•	•
D30-60 Natural Almond	•	•	•	•	•	•	•	•	•	•	•	•	•	•	•	•	•	•	•	•	•	•	•	•
D315-60 Platinum	•	•	•	•	•	•	•	•	•	•	•	•	•	•	•	•	•	•	•	•	•	•	•	•
D327-60 Pepperdust	•	•	•	•	•	•	•	•	•	•	•	•	•	•	•	•	•	•	•	•	•	•	•	•
D381-60 Fashion Grey	•	•	•	•	•	•	•	•	•	•	•	•	•	•	•	•	•	•	•	•	•	•	•	•
D427-60 Linen	•	•	•	•	•	•	•	•	•	•	•	•	•	•	•	•	•	•	•	•	•	•	•	•
D439-60 Wallaby	•	•	•	•	•	•	•	•	•	•	•	•	•	•	•	•	•	•	•	•	•	•	•	•
D495-60 Coffee Bean	•	•	•	•	•	•	•	•	•	•	•	•	•	•	•	•	•	•	•	•	•	•	•	•
D90-60 Northsea	•	•	•	•	•	•	•	•	•	•	•	•	•	•	•	•	•	•	•	•	•	•	•	•
D91-60 Slate Grey	•	•	•	•	•	•	•	•	•	•	•	•	•	•	•	•	•	•	•	•	•	•	•	•
D92-60 Dove Grey	•	•	•	•	•	•	•	•	•	•	•	•	•	•	•	•	•	•	•	•	•	•	•	•
D96-60 Shadow	•	•	•	•	•	•	•	•	•	•	•	•	•	•	•	•	•	•	•	•	•	•	•	•

Color Availability Matrix for Steelcase Health Seating and Tables, continued

**Legend**

- = Not available
- = Available
- = Available with exceptions
- ▶ See specification pages for details.

	Seiste Arm Caps	Seiste Legs	Sieste Sleeper Legs	Sieste Table	Sorrel Seating Frame	Sorrel Seating Backs	Sorrel Table Legs	Sorrel Table	Surround Frame	Surround Mobile Tablet Arm	Surround Tablet Surface	Surround Storage Tables	Surround Storage Tray with Picture Rail	Surround Coat Hanger	Surround Power	Tava Arm and Legs	Verge Base/Foot Ring	X-Tenz Sleeper Arm Caps	X-Tenz
Wilsonart, cont.																			
7122-60 Empire Mahogany	•	•	•	•	•	•	•	•	•	•	•	•	•	•	•	•	•	•	•
7806-60 Bannister Oak	•	•	•	•	•	•	•	•	•	•	•	•	•	•	•	•	•	•	•
7850-60 Beigewood	•	•	•	•	•	•	•	•	•	•	•	•	•	•	•	•	•	•	•
7909-60 Fusion Maple	•	•	•	•	•	•	•	•	•	•	•	•	•	•	•	•	•	•	•
7922-60 Brighton Walnut	•	•	•	•	•	•	•	•	•	•	•	•	•	•	•	•	•	•	•
7924-60 Biltmore Cherry	•	•	•	•	•	•	•	•	•	•	•	•	•	•	•	•	•	•	•
7925-60 Monticello Maple	•	•	•	•	•	•	•	•	•	•	•	•	•	•	•	•	•	•	•
7929-60 Huntington Maple	•	•	•	•	•	•	•	•	•	•	•	•	•	•	•	•	•	•	•
7933-60 Cafelle	•	•	•	•	•	•	•	•	•	•	•	•	•	•	•	•	•	•	•
7935-60 Shaker Cherry	•	•	•	•	•	•	•	•	•	•	•	•	•	•	•	•	•	•	•
7936-60 Williamsburg Cherry	•	•	•	•	•	•	•	•	•	•	•	•	•	•	•	•	•	•	•
7937-38 River Cherry	•	•	•	•	•	•	•	•	•	•	•	•	•	•	•	•	•	•	•
7941-38 Tan Echo	•	•	•	•	•	•	•	•	•	•	•	•	•	•	•	•	•	•	•
7942-60 Cocobala	•	•	•	•	•	•	•	•	•	•	•	•	•	•	•	•	•	•	•
7945-38 Xanadu	•	•	•	•	•	•	•	•	•	•	•	•	•	•	•	•	•	•	•
7946-60 Brazilwood	•	•	•	•	•	•	•	•	•	•	•	•	•	•	•	•	•	•	•
7949-38 Asian Night	•	•	•	•	•	•	•	•	•	•	•	•	•	•	•	•	•	•	•
7952-38 Asian Sand	•	•	•	•	•	•	•	•	•	•	•	•	•	•	•	•	•	•	•
7960-38 Studio Teak	•	•	•	•	•	•	•	•	•	•	•	•	•	•	•	•	•	•	•
7964-38 Skyline Walnut	•	•	•	•	•	•	•	•	•	•	•	•	•	•	•	•	•	•	•
7980-38 Zebrawood	•	•	•	•	•	•	•	•	•	•	•	•	•	•	•	•	•	•	•
7993-38 Florence Walnut	•	•	•	•	•	•	•	•	•	•	•	•	•	•	•	•	•	•	•
8200-60 White Driftwood	•	•	•	•	•	•	•	•	•	•	•	•	•	•	•	•	•	•	•
8207-60 Branded Oak	•	•	•	•	•	•	•	•	•	•	•	•	•	•	•	•	•	•	•
8210-38 Portico Teak	•	•	•	•	•	•	•	•	•	•	•	•	•	•	•	•	•	•	•
8211-38 Phantom Pearl	•	•	•	•	•	•	•	•	•	•	•	•	•	•	•	•	•	•	•
8212-38 Phantom Ecu	•	•	•	•	•	•	•	•	•	•	•	•	•	•	•	•	•	•	•
8214-38 Phantom Charcoal	•	•	•	•	•	•	•	•	•	•	•	•	•	•	•	•	•	•	•
D30-60 Natural Almond	•	•	•	•	•	•	•	•	•	•	•	•	•	•	•	•	•	•	•
D315-60 Platinum	•	•	•	•	•	•	•	•	•	•	•	•	•	•	•	•	•	•	•
D327-60 Pepperdust	•	•	•	•	•	•	•	•	•	•	•	•	•	•	•	•	•	•	•
D381-60 Fashion Grey	•	•	•	•	•	•	•	•	•	•	•	•	•	•	•	•	•	•	•
D427-60 Linen	•	•	•	•	•	•	•	•	•	•	•	•	•	•	•	•	•	•	•
D439-60 Wallaby	•	•	•	•	•	•	•	•	•	•	•	•	•	•	•	•	•	•	•
D495-60 Coffee Bean	•	•	•	•	•	•	•	•	•	•	•	•	•	•	•	•	•	•	•
D90-60 Northsea	•	•	•	•	•	•	•	•	•	•	•	•	•	•	•	•	•	•	•
D91-60 Slate Grey	•	•	•	•	•	•	•	•	•	•	•	•	•	•	•	•	•	•	•
D92-60 Dove Grey	•	•	•	•	•	•	•	•	•	•	•	•	•	•	•	•	•	•	•
D96-60 Shadow	•	•	•	•	•	•	•	•	•	•	•	•	•	•	•	•	•	•	•

**Legend**

- = Not available
- = Available
- = Available with exceptions
- ⓔ = Established
- ▶ See specification pages for details.

	Aspekt Seating Frame	Aspekt Straight Arm Cap	Aspekt Wave Arm cap	Aspekt table, footstool, and Bench Frame and Legs	Aspekt Table	Cura Arm Caps	Cura Frame	Cura Tablet	Embold Arm Caps	Embold High Back Bracket	Embold High Back Bracket Cover	Embold Seating Frame	Embold Table Frame	Embold Table Legs	Embold Adjustable Glides	Embold Wallsaver Glides	Embold Tables	Empath Upper Arms	Empath Tablet	Jenny Tables	Leela Arm Caps	Leela Legs	Leela Table Top
<b>Low-Pressure Laminates (LPL)</b>																							
<b>Solid Laminates</b>																							
247L Black	•	•	•	•	•	•	•	•	•	•	•	•	•	•	•	•	•	•	•	•	•	•	•
2L30 Arctic White	•	•	•	•	•	•	•	•	•	•	•	•	•	•	•	•	•	•	•	•	•	•	•
2L83 Seagull	•	•	•	•	•	•	•	•	•	•	•	•	•	•	•	•	•	•	•	•	•	•	•
2L84 Milk	•	•	•	•	•	•	•	•	•	•	•	•	•	•	•	•	•	•	•	•	•	•	•
2L85 Dune	•	•	•	•	•	•	•	•	•	•	•	•	•	•	•	•	•	•	•	•	•	•	•
2LMG Merle	•	•	•	•	•	•	•	•	•	•	•	•	•	•	•	•	•	•	•	•	•	•	•
<b>Woodgrain Laminates</b>																							
24L0 Graphite Walnut	•	•	•	•	•	•	•	•	•	•	•	•	•	•	•	•	•	•	•	•	•	•	•
2574 Dark Rum Cherry	•	•	•	•	•	•	•	•	•	•	•	•	•	•	•	•	•	•	•	•	•	•	•
2575 Shiraz Cherry	•	•	•	•	•	•	•	•	•	•	•	•	•	•	•	•	•	•	•	•	•	•	•
25L1 Winter On Maple	•	•	•	•	•	•	•	•	•	•	•	•	•	•	•	•	•	•	•	•	•	•	•
25L5 Virginia Walnut	•	•	•	•	•	•	•	•	•	•	•	•	•	•	•	•	•	•	•	•	•	•	•
25L6 Blackwood ⓔ	•	•	•	•	•	•	•	•	•	•	•	•	•	•	•	•	•	•	•	•	•	•	•
25L8 Clear Walnut	•	•	•	•	•	•	•	•	•	•	•	•	•	•	•	•	•	•	•	•	•	•	•
26L1 Natural Cherry	•	•	•	•	•	•	•	•	•	•	•	•	•	•	•	•	•	•	•	•	•	•	•
2L09 Clear Maple	•	•	•	•	•	•	•	•	•	•	•	•	•	•	•	•	•	•	•	•	•	•	•
2LAK Clear Oak	•	•	•	•	•	•	•	•	•	•	•	•	•	•	•	•	•	•	•	•	•	•	•
2LAN Ash Noce	•	•	•	•	•	•	•	•	•	•	•	•	•	•	•	•	•	•	•	•	•	•	•
2LAT Acacia	•	•	•	•	•	•	•	•	•	•	•	•	•	•	•	•	•	•	•	•	•	•	•
2LAW Ash Wenge	•	•	•	•	•	•	•	•	•	•	•	•	•	•	•	•	•	•	•	•	•	•	•
2LBN Bisque Noce	•	•	•	•	•	•	•	•	•	•	•	•	•	•	•	•	•	•	•	•	•	•	•
2LBW Bisque Wenge	•	•	•	•	•	•	•	•	•	•	•	•	•	•	•	•	•	•	•	•	•	•	•
2LCN Clay Noce	•	•	•	•	•	•	•	•	•	•	•	•	•	•	•	•	•	•	•	•	•	•	•
2LCW Clay Wenge	•	•	•	•	•	•	•	•	•	•	•	•	•	•	•	•	•	•	•	•	•	•	•
2LSN Storm Noce	•	•	•	•	•	•	•	•	•	•	•	•	•	•	•	•	•	•	•	•	•	•	•
2LSW Storm Wenge	•	•	•	•	•	•	•	•	•	•	•	•	•	•	•	•	•	•	•	•	•	•	•
<b>Thermoform</b>																							
2030 Arctic White	•	•	•	•	•	•	•	■	•	•	•	•	•	•	•	•	•	•	■	•	•	•	•
2031 Seagull	•	•	•	•	•	•	•	■	•	•	•	•	•	•	•	•	•	•	■	•	•	•	•
2032 Dune	•	•	•	•	•	•	•	■	•	•	•	•	•	•	•	•	•	•	■	•	•	•	•
2035 Ultra White	•	•	•	•	•	•	•	■	•	•	•	•	•	•	•	•	•	•	■	•	•	•	•
2069 Dark Rum Cherry	•	•	•	•	•	•	•	•	•	•	•	•	•	•	•	•	•	•	•	•	•	•	•
2070 Shiraz Cherry	•	•	•	•	•	•	•	•	•	•	•	•	•	•	•	•	•	•	•	•	•	•	•
6775 Sand	•	•	•	•	•	•	•	•	•	•	•	•	•	•	•	•	•	•	•	•	•	•	•

# Color Availability Matrix for Steelcase Health Seating and Tables, continued

## Legend

- = Not available
- = Available
- = Available with exceptions
- Ⓢ = Established
- ▶ See specification pages for details.

	Mineral Arm Caps	Mineral Tablet Surface	Mitra Seating Frame	Mitra Arm Caps - Guest	Mitra Arm Caps - Lounge	Mitra Arm Caps - Recliner	Mitra Arm Caps - Sleeper	Mitra Table Legs and Bases	Mitra Tables	Mitra Tablet Surface	Outlook Metal Legs	Outlook Wood Legs	Outlook Table	Radia Frame	Radia Arm Caps	Regard Frames	Regard Arm Caps	Regard Storage End Tables	Regard Media and Desk Cabinets	Regard Screen Bracket	Regard Vertical Cable Riser	Regard Power Strip	Regard Booth Table + SQ/ Personal Table (laminate)	Regard SQ/Personal Table
Low-Pressure Laminates (LPL)																								
Solid Laminates																								
247L Black	•	•	•	•	•	•	•	•	•	•	•	•	•	•	•	•	•	•	•	•	•	•	•	•
2L30 Arctic White	•	•	•	•	•	•	•	•	•	•	•	•	•	•	•	•	•	•	•	•	•	•	•	•
2L83 Seagull	•	•	•	•	•	•	•	•	•	•	•	•	•	•	•	•	•	•	•	•	•	•	•	•
2L84 Milk	•	•	•	•	•	•	•	•	•	•	•	•	•	•	•	•	•	•	•	•	•	•	•	•
2L85 Dune	•	•	•	•	•	•	•	•	•	•	•	•	•	•	•	•	•	•	•	•	•	•	•	•
2LMG Merle	•	•	•	•	•	•	•	•	•	•	•	•	•	•	•	•	•	•	•	•	•	•	•	•
Woodgrain Laminates																								
24L0 Graphite Walnut	•	•	•	•	•	•	•	•	•	•	•	•	•	•	•	•	•	•	•	•	•	•	•	•
2574 Dark Rum Cherry	•	•	•	•	•	•	•	•	•	•	•	•	•	•	•	•	•	•	•	•	•	•	•	•
2575 Shiraz Cherry	•	•	•	•	•	•	•	•	•	•	•	•	•	•	•	•	•	•	•	•	•	•	•	•
25L1 Winter On Maple	•	•	•	•	•	•	•	•	•	•	•	•	•	•	•	•	•	•	•	•	•	•	•	•
25L5 Virginia Walnut	•	•	•	•	•	•	•	•	•	•	•	•	•	•	•	•	•	•	•	•	•	•	•	•
25L6 Blackwood Ⓢ	•	•	•	•	•	•	•	•	•	•	•	•	•	•	•	•	•	•	•	•	•	•	•	•
25L8 Clear Walnut	•	•	•	•	•	•	•	•	•	•	•	•	•	•	•	•	•	•	•	•	•	•	•	•
26L1 Natural Cherry	•	•	•	•	•	•	•	•	•	•	•	•	•	•	•	•	•	•	•	•	•	•	•	•
2L09 Clear Maple	•	•	•	•	•	•	•	•	•	•	•	•	•	•	•	•	•	•	•	•	•	•	•	•
2LAK Clear Oak	•	•	•	•	•	•	•	•	•	•	•	•	•	•	•	•	•	•	•	•	•	•	•	•
2LAN Ash Noce	•	•	•	•	•	•	•	•	•	•	•	•	•	•	•	•	•	•	•	•	•	•	•	•
2LAT Acacia	•	•	•	•	•	•	•	•	•	•	•	•	•	•	•	•	•	•	•	•	•	•	•	•
2LAW Ash Wenge	•	•	•	•	•	•	•	•	•	•	•	•	•	•	•	•	•	•	•	•	•	•	•	•
2LBN Bisque Noce	•	•	•	•	•	•	•	•	•	•	•	•	•	•	•	•	•	•	•	•	•	•	•	•
2LBW Bisque Wenge	•	•	•	•	•	•	•	•	•	•	•	•	•	•	•	•	•	•	•	•	•	•	•	•
2LCN Clay Noce	•	•	•	•	•	•	•	•	•	•	•	•	•	•	•	•	•	•	•	•	•	•	•	•
2LCW Clay Wenge	•	•	•	•	•	•	•	•	•	•	•	•	•	•	•	•	•	•	•	•	•	•	•	•
2LSN Storm Noce	•	•	•	•	•	•	•	•	•	•	•	•	•	•	•	•	•	•	•	•	•	•	•	•
2LSW Storm Wenge	•	•	•	•	•	•	•	•	•	•	•	•	•	•	•	•	•	•	•	•	•	•	•	•
Thermoform																								
2030 Arctic White	•	■	•	•	•	•	•	•	•	■	•	•	•	•	•	•	•	•	•	•	•	•	•	•
2031 Seagull	•	■	•	•	•	•	•	•	•	■	•	•	•	•	•	•	•	•	•	•	•	•	•	•
2032 Dune	•	■	•	•	•	•	•	•	•	■	•	•	•	•	•	•	•	•	•	•	•	•	•	•
2035 Ultra White	•	■	•	•	•	•	•	•	•	■	•	•	•	•	•	•	•	•	•	•	•	•	•	•
2069 Dark Rum Cherry	•	•	•	•	•	•	•	•	•	•	•	•	•	•	•	•	•	•	•	•	•	•	•	•
2070 Shiraz Cherry	•	•	•	•	•	•	•	•	•	•	•	•	•	•	•	•	•	•	•	•	•	•	•	•
6775 Sand	•	•	•	•	•	•	•	•	•	•	•	•	•	•	•	•	•	•	•	•	•	•	•	•

**Legend**

- = Not available
- = Available
- = Available with exceptions
- Ⓢ = Established
- ▶ See specification pages for details.

	Seiste Arm Caps	Sieste Legs	Sieste Sleeper Legs	Sieste Table	Sorrel Seating Frame	Sorrel Seating Backs	Sorrel Table Legs	Sorrel Table	Surround Frame	Surround Mobile Tablet Arm	Surround Tablet Surface	Surround Storage Tables	Surround Storage Tray with Picture Rail	Surround Coat Hanger	Surround Power	Tava Arm and Legs	Verge Base/Foot Ring	X-Tenz Sleeper Arm Caps	X-Tenz
Low-Pressure Laminates (LPL)																			
Solid Laminates																			
247L Black	•	•	•	•	•	•	•	•	•	•	•	•	•	•	•	•	•	•	•
2L30 Arctic White	•	•	•	•	•	•	•	•	•	•	•	•	•	•	•	•	•	•	•
2L83 Seagull	•	•	•	•	•	•	•	•	•	•	•	•	•	•	•	•	•	•	•
2L84 Milk	•	•	•	•	•	•	•	•	•	•	•	•	•	•	•	•	•	•	•
2L85 Dune	•	•	•	•	•	•	•	•	•	•	•	•	•	•	•	•	•	•	•
2LMG Merle	•	•	•	•	•	•	•	•	•	•	•	•	•	•	•	•	•	•	•
Woodgrain Laminates																			
24L0 Graphite Walnut	•	•	•	•	•	•	•	•	•	•	•	•	•	•	•	•	•	•	•
2574 Dark Rum Cherry	•	•	•	•	•	•	•	•	•	•	•	•	•	•	•	•	•	•	•
2575 Shiraz Cherry	•	•	•	•	•	•	•	•	•	•	•	•	•	•	•	•	•	•	•
25L1 Winter On Maple	•	•	•	•	•	•	•	•	•	•	•	•	•	•	•	•	•	•	•
25L5 Virginia Walnut	•	•	•	•	•	•	•	•	•	•	•	•	•	•	•	•	•	•	•
25L6 Blackwood Ⓢ	•	•	•	•	•	•	•	•	•	•	•	•	•	•	•	•	•	•	•
25L8 Clear Walnut	•	•	•	•	•	•	•	•	•	•	•	•	•	•	•	•	•	•	•
26L1 Natural Cherry	•	•	•	•	•	•	•	•	•	•	•	•	•	•	•	•	•	•	•
2L09 Clear Maple	•	•	•	•	•	•	•	•	•	•	•	•	•	•	•	•	•	•	•
2LAK Clear Oak	•	•	•	•	•	•	•	•	•	•	•	•	•	•	•	•	•	•	•
2LAN Ash Noce	•	•	•	•	•	•	•	•	•	•	•	•	•	•	•	•	•	•	•
2LAT Acacia	•	•	•	•	•	•	•	•	•	•	•	•	•	•	•	•	•	•	•
2LAW Ash Wenge	•	•	•	•	•	•	•	•	•	•	•	•	•	•	•	•	•	•	•
2LBN Bisque Noce	•	•	•	•	•	•	•	•	•	•	•	•	•	•	•	•	•	•	•
2LBW Bisque Wenge	•	•	•	•	•	•	•	•	•	•	•	•	•	•	•	•	•	•	•
2LCN Clay Noce	•	•	•	•	•	•	•	•	•	•	•	•	•	•	•	•	•	•	•
2LCW Clay Wenge	•	•	•	•	•	•	•	•	•	•	•	•	•	•	•	•	•	•	•
2LSN Storm Noce	•	•	•	•	•	•	•	•	•	•	•	•	•	•	•	•	•	•	•
2LSW Storm Wenge	•	•	•	•	•	•	•	•	•	•	•	•	•	•	•	•	•	•	•
Thermoform																			
2030 Arctic White	•	•	•	•	•	•	•	•	•	•	•	•	•	•	•	•	•	•	•
2031 Seagull	•	•	•	•	•	•	•	•	•	•	•	•	•	•	•	•	•	•	•
2032 Dune	•	•	•	•	•	•	•	•	•	•	•	•	•	•	•	•	•	•	•
2035 Ultra White	•	•	•	•	•	•	•	•	•	•	•	•	•	•	•	•	•	•	•
2069 Dark Rum Cherry	•	•	•	•	•	•	•	•	•	•	•	•	•	•	•	•	•	•	•
2070 Shiraz Cherry	•	•	•	•	•	•	•	•	•	•	•	•	•	•	•	•	•	•	•
6775 Sand	•	•	•	•	•	•	•	•	•	•	•	•	•	•	•	•	•	•	•

Color Availability Matrix for Steelcase Health Seating and Tables, continued

**Legend**

- = Not available
- = Available
- = Available with exceptions
- Ⓢ = Established
- ▶ See specification pages for details.

	Aspekt Seating Frame	Aspekt Straight Arm Cap	Aspekt Wave Arm cap	Aspekt table, footstool, and Bench Frame and Legs	Aspekt Table	Cura Arm Caps	Cura Frame	Cura Tablet	Embold Arm Caps	Embold High Back Bracket	Embold High Back Bracket Cover	Embold Seating Frame	Embold Table Frame	Embold Table Legs	Embold Adjustable Glides	Embold Wallsaver Glides	Embold Tables	Empath Upper Arms	Empath Tablet	Jenny Tables	Leela Arm Caps	Leela Legs	Leela Table Top
<b>Paint (Price Group 1)</b>																							
<b>Smooth Paint</b>																							
4238 Mocha	•	•	•	•	•	•	•	•	•	•	•	■	•	•	•	•	•	•	•	•	•	•	•
4239 Clay	•	•	•	•	•	•	•	•	•	•	•	■	•	•	•	•	•	•	•	•	•	•	•
4240 Chalk	•	•	•	•	•	•	•	•	•	•	•	■	•	•	•	•	•	•	•	•	•	•	•
4242 Milk	•	•	•	•	•	•	•	•	•	•	•	■	•	•	•	•	•	•	•	•	•	•	•
<b>Metal And Accessory Paint</b>																							
4710 Low Gloss Black	•	•	•	•	•	•	•	•	•	•	•	•	•	•	•	•	•	•	•	•	•	•	•
9201 Polished Chrome	•	•	•	•	•	•	•	•	•	•	•	•	•	•	•	•	•	•	•	•	•	•	•
9211 Nickel	•	•	•	•	•	•	•	•	•	•	•	•	•	•	•	•	•	•	•	•	•	•	•
9212 Silver	•	•	•	•	•	•	•	•	•	•	•	•	•	•	•	•	•	•	•	•	•	•	•
<b>Textured Paint</b>																							
7207 Black	■	•	•	■	•	•	■	•	•	•	•	•	•	•	•	•	•	•	•	•	•	■	■
7225 Sand	•	•	•	•	•	•	■	•	•	•	•	•	•	•	•	•	•	•	•	•	•	•	■
7237 Slate Ⓢ	•	•	•	•	•	•	•	•	•	•	•	•	•	•	•	•	•	•	•	•	•	•	■
7238 Fieldstone	•	•	•	•	•	•	•	•	•	•	•	•	•	•	•	•	•	•	•	•	•	•	■
7239 Midnight	•	•	•	•	•	•	•	•	•	•	•	•	•	•	•	•	•	•	•	•	•	•	■
7241 Arctic White	•	•	•	•	•	•	•	•	•	•	•	•	•	•	•	•	•	•	•	•	•	•	■
7243 Seagull	•	•	•	•	•	•	•	•	•	•	•	•	•	•	•	•	•	•	•	•	•	•	■
7250 Sterling Dark Solid	•	•	•	•	•	•	•	•	•	•	•	•	•	•	•	•	•	•	•	•	•	•	•
7277 Sand Textured	•	•	•	•	•	•	•	•	•	•	•	•	•	•	•	•	•	•	•	•	•	•	•
7360 Merle	■	•	•	■	•	•	•	•	•	■	■	■	■	■	•	•	•	•	•	•	•	■	•
<b>Paint (Price Group 2)</b>																							
0835 Black	•	•	•	•	•	•	•	•	•	•	■	•	•	•	•	•	•	•	•	•	•	•	•
4700 Warm White	•	•	•	•	•	•	•	•	•	•	•	■	•	•	•	•	•	•	•	•	•	•	•
<b>Smooth Metallic Paint</b>																							
4140 Arctic White Gloss	•	•	•	•	•	•	•	•	•	•	•	■	■	■	•	•	•	•	•	•	•	•	•
4743 Mineral Metallic	•	•	•	•	•	•	•	•	•	•	•	•	•	•	•	•	•	•	•	•	•	•	•
4750 Champagne Metallic	■	•	•	■	•	•	■	•	•	•	•	■	■	■	•	•	•	•	•	•	•	■	•
4798 Sterling Metallic	•	•	•	•	•	•	•	•	•	■	■	■	■	■	•	•	•	•	•	•	•	•	•
4799 Platinum Metallic	■	•	•	■	•	•	■	•	•	■	■	■	■	■	•	•	•	•	•	•	•	■	•
4858 Seagull	•	•	•	•	•	•	•	•	•	•	•	■	•	■	•	•	•	•	•	•	•	•	•
4803 Near Black Metallic	•	•	•	•	•	•	•	•	•	■	■	■	•	■	•	•	•	•	•	•	•	•	•
<b>Textured Metallic Paint</b>																							
7245 Carbon Metallic	•	•	•	•	•	•	•	•	•	•	•	■	■	■	•	•	•	•	•	•	•	•	•
7246 Midnight Metallic	•	•	•	•	•	•	•	•	•	•	•	•	•	•	•	•	•	•	•	•	•	•	•



**Legend**

- = Not available
- = Available
- = Available with exceptions
- Ⓢ = Established
- ▶ See specification pages for details.

	Mineral Arm Caps	Mineral Tablet Surface	Mitra Seating Frame	Mitra Arm Caps - Guest	Mitra Arm Caps - Lounge	Mitra Arm Caps - Recliner	Mitra Arm Caps - Sleeper	Mitra Table Legs and Bases	Mitra Tables	Mitra Tablet Surface	Outlook Metal Legs	Outlook Wood Legs	Outlook Table	Radia Frame	Radia Arm Caps	Regard Frames	Regard Arm Caps	Regard Storage End Tables	Regard Media and Desk Cabinets	Regard Screen Bracket	Regard Vertical Cable Riser	Regard Power Strip	Regard Booth Table + SQ/ Personal Table (laminated)	Regard SQ/Personal Table	
<b>Paint (Price Group 1)</b>																									
<b>Smooth Paint</b>																									
4238 Mocha	•	•	•	•	•	•	•	•	•	•	•	•	•	■	•	■	•	•	•	•	•	•	•	■	■
4239 Clay	•	•	•	•	•	•	•	•	•	•	•	•	•	■	•	■	•	•	•	•	•	•	•	■	■
4240 Chalk	•	•	•	•	•	•	•	•	•	•	•	•	•	■	•	■	•	•	•	•	•	•	•	■	■
4242 Milk	•	•	•	•	•	•	•	•	•	•	•	•	•	■	•	■	•	•	•	•	•	•	•	■	■
<b>Metal And Accessory Paint</b>																									
4710 Low Gloss Black	•	•	•	•	•	•	•	•	•	•	•	•	•	■	•	•	•	•	•	•	•	•	•	•	•
9201 Polished Chrome	•	•	•	•	•	•	•	•	•	•	•	•	•	•	•	•	•	•	•	•	•	•	•	•	•
9211 Nickel	•	•	•	•	•	•	•	•	•	•	•	•	•	■	•	•	•	•	•	•	•	•	•	•	•
9212 Silver	•	•	•	•	•	•	•	•	•	•	•	•	•	■	•	•	•	•	•	•	•	•	•	•	•
<b>Textured Paint</b>																									
7207 Black	•	•	•	•	•	•	•	•	•	•	■	•	•	■	•	■	•	•	•	•	•	•	•	■	■
7225 Sand	•	•	•	•	•	•	•	•	•	•	•	•	•	■	•	■	•	■	•	■	•	•	•	■	■
7237 Slate Ⓢ	•	•	•	•	•	•	•	•	•	•	•	•	•	■	•	■	•	•	•	•	•	•	•	■	■
7238 Fieldstone	•	•	•	•	•	•	•	•	•	•	•	•	•	■	•	■	•	•	•	•	■	■	■	■	■
7239 Midnight	•	•	•	•	•	•	•	•	•	•	•	•	•	■	•	■	•	•	•	•	•	•	•	■	■
7241 Arctic White	•	•	•	•	•	•	•	•	•	•	•	•	•	■	•	■	•	■	■	■	•	•	•	■	■
7243 Seagull	•	•	•	•	•	•	•	•	•	•	•	•	•	■	•	•	•	■	■	•	•	•	■	■	
7250 Sterling Dark Solid	•	•	•	•	•	•	•	•	•	•	•	•	•	■	•	•	•	•	•	•	•	•	•	•	•
7277 Sand Textured	•	•	•	•	•	•	•	•	•	•	•	•	•	■	•	•	•	•	■	•	•	•	•	•	•
7360 Merle	•	•	•	•	•	•	•	•	•	•	■	•	•	■	•	■	•	■	•	■	■	■	■	■	■
<b>Paint (Price Group 2)</b>																									
0835 Black	•	•	•	•	•	•	•	•	•	•	•	•	•	■	•	■	•	•	•	■	•	•	■	■	
4700 Warm White	•	•	•	•	•	•	•	•	•	•	•	•	•	■	•	■	•	•	•	•	•	•	•	■	■
<b>Smooth Metallic Paint</b>																									
4140 Arctic White Gloss	•	•	•	•	•	•	•	•	•	•	•	•	•	■	•	■	•	•	•	•	•	•	•	■	■
4743 Mineral Metallic	•	•	•	•	•	•	•	•	•	•	•	•	•	■	•	■	•	•	•	•	•	•	•	■	■
4750 Champagne Metallic	•	•	•	•	•	•	•	•	•	■	•	•	•	■	•	■	•	•	•	•	■	■	■	■	■
4798 Sterling Metallic	•	•	•	•	•	•	•	•	•	•	•	•	•	■	•	■	•	•	•	•	•	•	•	■	■
4799 Platinum Metallic	•	•	•	•	•	•	•	•	•	■	•	•	•	■	•	■	•	•	•	■	■	■	■	■	■
4858 Seagull	•	•	•	•	•	•	•	•	•	•	•	•	•	■	•	•	•	•	•	•	•	•	•	■	■
4803 Near Black Metallic	•	•	•	•	•	•	•	•	•	•	•	•	•	■	•	■	•	•	•	•	•	•	•	■	■
<b>Textured Metallic Paint</b>																									
7245 Carbon Metallic	•	•	•	•	•	•	•	•	•	•	•	•	•	■	•	■	•	■	•	•	•	•	•	■	■
7246 Midnight Metallic	•	•	•	•	•	•	•	•	•	•	•	•	•	■	•	■	•	•	•	•	•	•	•	■	■

Color Availability Matrix for Steelcase Health Seating and Tables, continued

**Legend**

- = Not available
- = Available
- = Available with exceptions
- Ⓢ = Established
- ▶ See specification pages for details.

	Seiste Arm Caps	Sieste Legs	Sieste Sleeper Legs	Sieste Table	Sorrel Seating Frame	Sorrel Seating Backs	Sorrel Table Legs	Sorrel Table	Surround Frame	Surround Mobile Tablet Arm	Surround Tablet Surface	Surround Storage Tables	Surround Storage Tray with Picture Rail	Surround Coat Hanger	Surround Power	Tava Arm and Legs	Verge Base/Foot Ring	X-Tenz Sleeper Arm Caps	X-Tenz
<b>Paint (Price Group 1)</b>																			
<b>Smooth Paint</b>																			
4238 Mocha	•	•	•	•	■	•	•	•	■	•	•	•	•	•	•	•	•	■	•
4239 Clay	•	•	•	•	■	•	•	•	■	•	•	•	•	•	•	•	•	■	•
4240 Chalk	•	•	•	•	■	•	•	•	■	•	•	•	•	•	•	•	•	■	•
4242 Milk	•	•	•	•	•	•	•	•	■	•	•	•	•	•	•	•	•	■	•
<b>Metal And Accessory Paint</b>																			
4710 Low Gloss Black	•	•	•	•	•	•	•	•	•	•	•	•	•	•	•	•	•	•	•
9201 Polished Chrome	•	•	•	•	•	•	•	•	•	•	•	•	•	•	•	•	•	•	•
9211 Nickel	•	•	•	•	•	•	•	•	•	•	•	•	•	•	•	•	•	•	•
9212 Silver	•	•	•	•	•	•	•	•	•	•	•	•	•	•	•	•	•	•	•
<b>Textured Paint</b>																			
7207 Black	•	•	•	•	■	•	■	•	■	■	•	■	•	■	•	•	•	■	•
7225 Sand	•	•	•	•	•	•	•	•	■	•	•	•	•	•	•	•	•	■	•
7237 Slate Ⓢ	•	•	•	•	•	•	•	•	■	•	•	•	•	•	•	•	•	■	•
7238 Fieldstone	•	•	•	•	•	•	•	•	■	•	•	•	•	•	•	•	•	■	•
7239 Midnight	•	•	•	•	•	•	•	•	■	•	•	•	•	•	•	•	•	■	•
7241 Arctic White	•	•	•	•	■	•	•	•	■	■	•	■	•	■	•	•	•	■	•
7243 Seagull	•	•	•	•	■	•	•	•	■	■	•	■	•	■	•	•	•	■	•
7250 Sterling Dark Solid	•	•	•	•	•	•	•	•	•	•	•	•	•	•	•	•	•	•	•
7277 Sand Textured	•	•	•	•	•	•	•	•	•	•	•	•	•	•	•	•	•	•	•
7360 Merle	•	•	•	•	■	•	•	•	■	•	•	•	•	•	•	•	•	■	•
<b>Paint (Price Group 2)</b>																			
0835 Black	•	•	•	•	•	•	•	•	■	•	•	•	•	•	•	•	•	■	•
4700 Warm White	•	•	•	•	•	•	•	•	■	•	•	•	•	•	•	•	•	■	•
<b>Smooth Metallic Paint</b>																			
4140 Arctic White Gloss	•	•	•	•	•	•	•	•	■	•	•	•	•	•	•	•	•	■	•
4743 Mineral Metallic	•	•	•	•	•	•	•	•	■	•	•	•	•	•	•	•	•	■	•
4750 Champagne Metallic	•	•	•	•	■	•	•	•	■	•	•	•	•	•	•	•	•	■	•
4798 Sterling Metallic	•	•	•	•	•	•	•	•	■	•	•	•	•	•	•	•	•	■	•
4799 Platinum Metallic	•	•	•	•	■	•	■	•	■	•	•	•	•	•	•	•	•	■	•
4858 Seagull	•	•	•	•	•	•	•	•	•	•	•	•	•	•	•	•	•	•	•
4803 Near Black Metallic	•	•	•	•	■	•	•	•	■	•	•	•	•	•	•	•	•	■	•
<b>Textured Metallic Paint</b>																			
7245 Carbon Metallic	•	•	•	•	•	•	•	•	■	■	•	■	•	■	•	•	•	■	•
7246 Midnight Metallic	•	•	•	•	•	•	•	•	■	•	•	•	•	•	•	•	•	■	•

**Legend**

- = Not available
- = Available
- = Available with exceptions
- ▶ See specification pages for details.

	Aspekt Seating Frame	Aspekt Straight Arm Cap	Aspekt Wave Arm cap	Aspekt table, footstool, and Bench Frame and Legs	Aspekt Table	Cura Arm Caps	Cura Frame	Cura Tablet	Embold Arm Caps	Embold High Back Bracket	Embold High Back Bracket Cover	Embold Seating Frame	Embold Table Frame	Embold Table Legs	Embold Adjustable Glides	Embold Wallsaver Glides	Embold Tables	Empath Upper Arms	Empath Tablet	Jenny Tables	Leela Arm Caps	Leela Legs	Leela Table Top
Plastisol/Urethane																							
6009 Arctic White	•	•	•	•	•	•	•	•	•	•	•	•	•	•	•	•	•	•	•	•	•	•	•
6053 Seagull	•	•	•	•	•	•	•	•	•	•	•	•	•	•	•	•	•	•	•	•	•	•	•
6059 Sterling Dark	•	■	•	•	•	■	•	•	•	•	•	•	•	•	•	•	•	■	•	•	•	•	•
6160 Grey	•	•	•	•	•	•	•	•	•	•	•	•	•	•	•	•	•	•	•	•	•	•	•
6161 Graphite	•	•	■	•	•	•	•	•	•	•	•	•	•	•	•	•	•	•	•	•	•	•	•
6162 Taupe	•	•	■	•	•	•	•	•	•	•	•	•	•	•	•	•	•	•	•	•	•	•	•
6205 Black	•	■	■	•	•	•	•	•	•	•	•	•	•	•	■	•	•	•	•	•	•	•	•
6249 Platinum Solid	•	■	•	•	•	•	•	•	•	•	•	•	•	•	•	•	•	•	•	•	•	•	•
6259 Midnight	•	•	•	•	•	•	•	•	•	•	•	•	•	•	•	•	•	■	•	•	•	•	•
6322 Fieldstone	•	•	•	•	•	•	•	•	•	•	•	•	•	•	•	•	•	•	•	•	•	•	•
6527 Merle	•	■	•	•	•	•	•	■	•	•	•	•	•	•	•	■	•	•	•	•	•	•	•
6654 Sand	•	•	•	•	•	•	•	•	•	•	•	•	•	•	•	•	•	•	•	•	•	•	•
Other Paint Options																							
Accent Paint	•	•	•	•	•	•	•	•	•	•	•	•	•	•	•	•	•	•	•	•	•	•	•
Lux Coatings	•	•	•	•	•	•	•	•	•	•	•	■	•	•	•	•	•	•	•	•	•	•	■

Color Availability Matrix for Steelcase Health Seating and Tables, continued

**Legend**

- = Not available
- = Available
- = Available with exceptions
- ▶ See specification pages for details.

	Mineral Arm Caps	Mineral Tablet Surface	Mitra Seating Frame	Mitra Arm Caps - Guest	Mitra Arm Caps - Lounge	Mitra Arm Caps - Recliner	Mitra Arm Caps - Sleeper	Mitra Table Legs and Bases	Mitra Tables	Mitra Tablet Surface	Outlook Metal Legs	Outlook Wood Legs	Outlook Table	Radia Frame	Radia Arm Caps	Regard Frames	Regard Arm Caps	Regard Storage End Tables	Regard Media and Desk Cabinets	Regard Screen Bracket	Regard Vertical Cable Riser	Regard Power Strip	Regard Booth Table + SQ/ Personal Table (laminated)	Regard SQ/Personal Table
Plastisol/Urethane																								
6009 Arctic White	•	•	•	•	•	•	•	•	•	•	•	•	•	•	•	•	•	•	•	•	•	•	•	•
6053 Seagull	•	•	•	•	•	•	•	•	•	•	•	•	•	•	•	•	•	•	•	•	•	•	•	•
6059 Sterling Dark	•	•	•	■	•	•	•	•	•	•	•	•	•	•	•	•	•	•	•	•	•	•	•	•
6160 Grey	•	•	•	•	•	•	•	•	•	•	•	•	•	•	•	•	•	•	•	•	•	•	•	•
6161 Graphite	■	•	•	•	■	■	■	•	•	•	•	•	•	•	•	•	•	•	•	•	•	•	•	•
6162 Taupe	■	•	•	•	■	■	■	•	•	•	•	•	•	•	•	•	•	•	•	•	•	•	•	•
6205 Black	■	•	•	■	■	■	■	•	•	•	•	•	•	•	•	•	•	•	•	•	•	•	•	•
6249 Platinum Solid	•	•	•	■	•	•	•	•	•	•	•	•	•	•	■	■	■	•	•	•	•	•	•	•
6259 Midnight	•	•	•	•	•	•	•	•	•	•	•	•	•	•	•	•	•	•	•	•	•	•	•	•
6322 Fieldstone	•	•	•	•	•	•	•	•	•	•	•	•	•	•	•	•	■	•	•	•	•	•	•	•
6527 Merle	•	•	•	■	•	•	•	•	•	•	•	•	•	■	■	■	•	•	•	•	•	•	•	•
6654 Sand	•	•	•	•	•	•	•	•	•	•	•	•	•	■	■	•	•	•	•	•	•	•	•	•
Other Paint Options																								
Accent Paint	•	•	•	•	•	•	•	•	•	•	•	•	•	■	•	■	•	•	•	•	•	•	•	•
Lux Coatings	•	•	•	•	•	•	•	•	•	•	•	•	•	■	•	■	•	■	•	•	•	•	•	•

**Legend**

- = Not available
- = Available
- = Available with exceptions
- ▶ See specification pages for details.

	Seiste Arm Caps	Sieste Legs	Sieste Sleeper Legs	Sieste Table	Sorrel Seating Frame	Sorrel Seating Backs	Sorrel Table Legs	Sorrel Table	Surround Frame	Surround Mobile Tablet Arm	Surround Tablet Surface	Surround Storage Tables	Surround Storage Tray with Picture Rail	Surround Coat Hanger	Surround Power	Tava Arm and Legs	Verge Base/Foot Ring	X-Tenz Sleeper Arm Caps	X-Tenz
Plastisol/Urethane																			
6009 Arctic White	•	•	•	•	•	•	•	•	•	•	■	•	•	•	•	•	•	•	•
6053 Seagull	•	•	•	•	•	•	•	•	•	•	■	•	•	•	•	•	•	•	•
6059 Sterling Dark	•	•	•	•	•	•	•	•	•	•	•	•	•	•	•	•	•	•	•
6160 Grey	•	•	•	•	■	•	•	•	•	•	•	•	•	•	•	•	•	•	•
6161 Graphite	•	•	•	•	•	•	•	•	•	•	•	•	•	•	•	•	•	■	•
6162 Taupe	•	•	•	•	•	•	•	•	•	•	•	•	•	•	•	•	•	■	•
6205 Black	■	•	•	•	■	•	•	•	•	•	•	•	•	•	•	■	•	■	•
6249 Platinum Solid	•	•	•	•	•	•	•	•	•	•	•	•	•	•	•	•	•	•	•
6259 Midnight	•	•	•	•	•	•	•	•	•	•	•	•	•	•	•	•	•	•	•
6322 Fieldstone	•	•	•	•	•	•	•	•	•	•	•	•	•	•	•	•	•	•	•
6527 Merle	•	•	•	•	•	•	•	•	•	•	■	•	■	•	■	•	•	•	•
6654 Sand	•	•	•	•	•	•	•	•	•	•	•	•	•	•	•	•	•	•	•
Other Paint Options																			
Accent Paint	•	•	•	•	•	•	•	•	■	•	•	•	•	•	•	•	■	•	•
Lux Coatings	•	•	•	•	■	•	•	•	■	•	•	■	•	•	•	•	■	•	•

Color Availability Matrix for Steelcase Health Seating and Tables, continued

**Legend**

- = Not available
- = Available
- = Available with exceptions
- ▶ See specification pages for details.

	Aspekt Seating Frame	Aspekt Straight Arm Cap	Aspekt Wave Arm cap	Aspekt table, footstool, and Bench Frame and Legs	Aspekt Table	Cura Arm Caps	Cura Frame	Cura Tablet	Embold Arm Caps	Embold High Back Bracket	Embold High Back Bracket Cover	Embold Seating Frame	Embold Table Frame	Embold Table Legs	Embold Adjustable Glides	Embold Wallsaver Glides	Embold Tables	Empath Upper Arms	Empath Tablet	Jenny Tables	Leela Arm Caps	Leela Legs	Leela Table Top
Solid Surface																							
Price Group A																							
2801 Glacier White	•	■	•	■	•	•	•	•	•	•	•	•	•	•	•	•	■	•	•	•	•	•	■
2973 Linen	•	■	•	■	•	•	•	•	•	•	•	•	•	•	•	•	■	•	•	•	•	•	■
2975 Bisque	•	■	•	■	•	•	•	•	•	•	•	•	•	•	•	•	■	•	•	•	•	•	■
2978 Cameo White	•	■	•	■	•	•	•	•	•	•	•	•	•	•	•	•	■	•	•	•	•	•	■
2979 Silver Grey	•	■	•	■	•	•	•	•	•	•	•	•	•	•	•	•	■	•	•	•	•	•	•
Price Group B																							
2972 Antarctica	•	■	•	■	•	•	•	•	•	•	•	•	•	•	•	•	■	•	•	•	•	•	■
Price Group C																							
2974 Canvas	•	■	•	■	•	•	•	•	•	•	•	•	•	•	•	•	■	•	•	•	•	•	■
Fusion																							
Price Group 1																							
6526 Mulberry Tissue	•	•	•	•	•	•	•	•	•	•	•	•	•	•	•	•	•	•	•	•	•	•	•
Price Group 3																							
6523 Desert Stalk	•	•	•	•	•	•	•	•	•	•	•	•	•	•	•	•	•	•	•	•	•	•	•
Price Group 4																							
6525 Sheer Leaf Medium	•	•	•	•	•	•	•	•	•	•	•	•	•	•	•	•	•	•	•	•	•	•	•

**Legend**

- = Not available
- = Available
- = Available with exceptions
- ▶ See specification pages for details.

	Mineral Arm Caps	Mineral Tablet Surface	Mitra Seating Frame	Mitra Arm Caps - Guest	Mitra Arm Caps - Lounge	Mitra Arm Caps - Recliner	Mitra Arm Caps - Sleeper	Mitra Table Legs and Bases	Mitra Tables	Mitra Tablet Surface	Outlook Metal Legs	Outlook Wood Legs	Outlook Table	Radia Frame	Radia Arm Caps	Regard Frames	Regard Arm Caps	Regard Storage End Tables	Regard Media and Desk Cabinets	Regard Screen Bracket	Regard Vertical Cable Riser	Regard Power Strip	Regard Booth Table + SQ/ Personal Table (laminated)	Regard SQ/Personal Table
<b>Solid Surface</b>																								
<b>Price Group A</b>																								
<b>2801</b> Glacier White	•	•	•	■	•	•	•	•	•	•	•	•	•	•	•	•	•	•	•	•	•	•	•	■
<b>2973</b> Linen	•	•	•	■	•	•	•	•	•	•	•	•	•	•	•	•	•	•	•	•	•	•	•	■
<b>2975</b> Bisque	•	•	•	■	•	•	•	•	•	•	•	•	•	•	•	•	•	•	•	•	•	•	•	■
<b>2978</b> Cameo White	•	•	•	■	•	•	•	•	•	•	•	•	•	•	•	•	•	•	•	•	•	•	•	■
<b>2979</b> Silver Grey	•	•	•	■	•	•	•	•	•	•	•	•	•	•	•	•	•	•	•	•	•	•	•	■
<b>Price Group B</b>																								
<b>2972</b> Antarctica	•	•	•	■	•	•	•	•	•	•	•	•	•	•	•	•	•	•	•	•	•	•	•	■
<b>Price Group C</b>																								
<b>2974</b> Canvas	•	•	•	■	•	•	•	•	•	•	•	•	•	•	•	•	•	•	•	•	•	•	•	■
<b>Fusion</b>																								
<b>Price Group 1</b>																								
<b>6526</b> Mulberry Tissue	•	•	•	•	•	•	•	•	•	•	•	•	•	•	•	•	•	•	•	•	•	•	•	•
<b>Price Group 3</b>																								
<b>6523</b> Desert Stalk	•	•	•	•	•	•	•	•	•	•	•	•	•	•	•	•	•	•	•	•	•	•	•	•
<b>Price Group 4</b>																								
<b>6525</b> Sheer Leaf Medium	•	•	•	•	•	•	•	•	•	•	•	•	•	•	•	•	•	•	•	•	•	•	•	•

Color Availability Matrix for Steelcase Health Seating and Tables, continued

**Legend**

- = Not available
- = Available
- = Available with exceptions
- ▶ See specification pages for details.

	Seiste Arm Caps	Sieste Legs	Sieste Sleeper Legs	Sieste Table	Sorrel Seating Frame	Sorrel Seating Backs	Sorrel Table Legs	Sorrel Table	Surround Frame	Surround Mobile Tablet Arm	Surround Tablet Surface	Surround Storage Tables	Surround Storage Tray with Picture Rail	Surround Coat Hanger	Surround Power	Tava Arm and Legs	Verge Base/Foot Ring	X-Tenz Sleeper Arm Caps	X-Tenz
Solid Surface																			
Price Group A																			
<b>2801</b> Glacier White	•	•	•	•	•	•	•	•	•	•	•	•	•	•	•	•	•	•	•
<b>2973</b> Linen	•	•	•	•	•	•	•	•	•	•	•	•	•	•	•	•	•	•	•
<b>2975</b> Bisque	•	•	•	•	•	•	•	•	•	•	•	•	•	•	•	•	•	•	•
<b>2978</b> Cameo White	•	•	•	•	•	•	•	•	•	•	•	•	•	•	•	•	•	•	•
<b>2979</b> Silver Grey	•	•	•	•	•	•	•	•	•	•	•	•	•	•	•	•	•	•	•
Price Group B																			
<b>2972</b> Antarctica	•	•	•	•	•	•	•	•	•	•	•	•	•	•	•	•	•	•	•
Price Group C																			
<b>2974</b> Canvas	•	•	•	•	•	•	•	•	•	•	•	•	•	•	•	•	•	•	•
Fusion																			
Price Group 1																			
<b>6526</b> Mulberry Tissue	•	•	•	•	•	•	•	•	•	•	•	•	•	•	•	•	•	•	•
Price Group 3																			
<b>6523</b> Desert Stalk	•	•	•	•	•	•	•	•	•	•	•	•	•	•	•	•	•	•	•
Price Group 4																			
<b>6525</b> Sheer Leaf Medium	•	•	•	•	•	•	•	•	•	•	•	•	•	•	•	•	•	•	•





# Wood Veneer Matrix for Steelcase Health Seating and Tables

## Legend

- = Not available
- = Available
- = Available with exceptions
- ▶ See specification pages for details.

		Wood									
		3062	3402	3412	3422	3522	3579	3580	3592	3702	3712
		Graphite Walnut	Clear Cherry	Natural Cherry <sup>E</sup>	Medium Cherry	Clear Maple	Dark Rum Cherry	Shiraz Cherry	Blonde on Maple	Clear Walnut	Natural Walnut
<b>Aspekt</b>	Seating Frame	•	•	•	•	•	•	•	•	•	•
	Arm Caps	■	■	•	■	■	■	■	■	■	■
	Table Legs	•	•	•	•	•	•	•	•	•	•
	Table Top	•	•	•	•	•	•	•	•	•	•
<b>Cura</b>	Arm Caps	■	■	•	■	■	■	■	■	■	■
	Frame	•	•	•	•	•	•	•	•	•	•
<b>Embold</b>	Arm Caps	■	■	•	■	■	■	■	•	■	■
	High Back Bracket	•	•	•	•	•	•	•	•	•	•
	High Back Bracket Cover	•	•	•	•	•	•	•	•	•	•
	Seating Frame	■	■	•	■	■	■	■	•	■	■
	Table Frame	•	•	•	•	•	•	•	•	•	•
	Table Legs	■	■	•	■	■	■	■	•	■	■
<b>Empath</b>	Upper Arms	•	•	•	•	•	•	•	•	•	•
	Tablet Surface	•	•	•	•	•	•	•	•	•	•
<b>Leela</b>	Arm Caps	■	■	•	■	■	■	■	•	■	■
	Legs	•	•	•	•	•	•	•	•	•	•
	Table Top	•	•	•	•	•	•	•	•	•	•
<b>Mineral</b>	Arm Caps	■	■	•	■	■	■	■	■	■	■
	Tablet Surface	•	•	•	•	•	•	•	•	•	•
<b>Mitra</b>	Seating Frame	■	■	•	■	■	■	■	■	■	■
	Arm Caps	■	■	•	■	■	■	■	■	■	■
	Table Legs and Bases	■	■	•	■	■	■	■	■	■	■
	Table Top	•	•	•	•	•	•	•	•	•	•
	Tablet Surface	•	•	•	•	•	•	•	•	•	•

<sup>E</sup> = Established

**Legend**

- = Not available
- = Available
- = Available with exceptions
- ▶ See specification pages for details.

		Wood																		
		3062	3402	3422	3456	3457	3460	3461	3463	3464	3467	3468	3469	3470	3522	3579	3580	3592	3702	3712
		Graphite Walnut	Clear Cherry	Medium Cherry	Clear on Ash	Almond on Ash	Dark Rum on Ash	Shiraz on Ash	Blonde on Ash	Clear Cherry on Ash	Medium Cherry on Ash	Graphite on Ash	Clear Walnut on Ash	Natural Walnut on Ash	Clear Maple	Dark Rum Cherry	Shiraz Cherry	Blonde on Maple	Clear Walnut	Natural Walnut
<b>Outlook Tables</b>	Table Top	•	•	•	•	•	•	•	•	•	•	•	•	•	•	•	•	•	•	•
	Metal Legs	•	•	•	•	•	•	•	•	•	•	•	•	•	•	•	•	•	•	•
	Wood Legs	■	■	■	•	•	•	•	•	•	•	•	•	•	■	■	■	■	■	■
<b>Sieste</b>	Arm Caps	■	■	■	•	•	•	•	•	•	•	•	•	•	■	■	■	■	■	■
	Legs	■	■	■	•	•	•	•	•	•	•	•	•	•	■	■	■	■	■	■
	Table Top	■	■	■	•	•	•	•	•	•	•	•	•	•	■	■	■	■	■	■
<b>Sieste Sleeper</b>	Legs	■	■	■	•	•	•	•	•	•	•	•	•	•	■	■	■	■	■	■
<b>Sorrel</b>	Seating Frame	•	•	•	•	•	•	•	•	•	•	•	•	•	•	•	•	•	•	•
	Seating Backs	■	■	■	•	•	•	•	•	•	•	•	•	•	■	■	■	■	■	■
	Table Legs	•	•	•	•	•	•	•	•	•	•	•	•	•	•	•	•	•	•	•
	Table Tops	•	•	•	•	•	•	•	•	•	•	•	•	•	•	•	•	•	•	•
<b>Tava</b>	Arm and Legs	•	•	•	■	■	■	■	■	■	■	■	■	■	•	•	•	•	•	•
	Bench Body and Table Tops	•	•	•	•	•	•	•	•	•	•	•	•	•	•	•	•	•	•	•
<b>Verge</b>	Base/Foot Ring	•	•	•	•	•	•	•	•	•	•	•	•	•	•	•	•	•	•	•
<b>X-tenz Sleeper</b>	Arm Caps	■	■	■	•	•	•	•	•	•	•	•	•	•	■	■	■	■	■	■
	Frame	•	•	•	•	•	•	•	•	•	•	•	•	•	•	•	•	•	•	•

# Recommended Worksurface Edge Finishes

## Recommended Edge Colors

### Edges

The recommended edge color will complement the laminate color you specify. Edge color is specified separately.

Steelcase Health Laminate Color	Recommended 3 mm Edge Color
<b>Fiber</b>	
<b>2574</b> Dark Rum Cherry	<b>6023</b> Dark Rum Cherry
<b>2575</b> Shiraz Cherry	<b>6024</b> Shiraz Cherry
<b>2850</b> Vanadium Fiber	<b>6654</b> Sand
<b>2854</b> Vellum Fiber <b>E</b>	<b>6655</b> Warm White
<b>2860</b> Granite Fiber	<b>6000</b> Black
<b>2862</b> Stucco Fiber <b>E</b>	<b>6053</b> Seagull
<b>Micro</b>	
<b>2920</b> Marl Micro	<b>6053</b> Seagull
<b>2921</b> Gypsum Micro	<b>6654</b> Sand
<b>2922</b> Clay Micro	<b>6654</b> Sand
<b>Patina</b>	
<b>2870</b> Blonde Bronze Patina	<b>6654</b> Sand
<b>2873</b> Instant Iron Patina	<b>6527</b> Merle
<b>Solid</b>	
<b>24H1</b> Satin White	<b>6009</b> Arctic White
<b>24H2</b> Satin Black	<b>6000</b> Black
<b>24H3</b> Satin Stone	<b>6169</b> Stone
<b>24H4</b> Satin Mocha	<b>6170</b> Mocha
<b>2722</b> Cream <b>E</b>	<b>6631</b> Cream <b>E</b>
<b>2730</b> Arctic White	<b>6697</b> Fog
<b>2746</b> Black	<b>6000</b> Black
<b>2759</b> Warm White	<b>6655</b> Warm White
<b>2811</b> Mist <b>E</b>	<b>6636</b> Mist
<b>2883</b> Seagull	<b>6053</b> Seagull
<b>2884</b> Milk	<b>6052</b> Milk
<b>2885</b> Dune	<b>6654</b> Sand
<b>2HAA</b> Persian Salt	<b>61AA</b> Persian Salt
<b>2HAB</b> Rose	<b>61AB</b> Rose
<b>2HAC</b> Indigo	<b>61AC</b> Indigo
<b>2HAD</b> Green Citrine	<b>61AD</b> Green Citrine
<b>2HAE</b> Dark Olivine	<b>61AE</b> Dark Olivine
<b>2HAF</b> Cloudy	<b>61AF</b> Cloudy
<b>2HMG</b> Merle	<b>6527</b> Merle
<b>2HWU</b> Clay	<b>66WU</b> Clay
<b>2HWV</b> Chalk	<b>66WV</b> Chalk
<b>Speckle</b>	
<b>2820</b> Coffee Speckle <b>E</b>	<b>6631</b> Cream <b>E</b>
<b>2823</b> Driftwood Speckle	<b>6631</b> Cream <b>E</b>
<b>2824</b> Smoke Speckle	<b>6636</b> Mist
<b>2825</b> Vanadium Speckle	<b>6619</b> Ice <b>E</b>

**E** = Established

Steelcase Health Laminate Color	Recommended 3 mm Edge Color
<b>Textured</b>	
<b>2TH2</b> Fawn Cypress	<b>6T02</b> Fawn Cypress
<b>2TH4</b> Saddle Oak	<b>6T04</b> Saddle Oak
<b>2TH5</b> Veranda Teak	<b>6T05</b> Veranda Teak
<b>2TH7</b> Walnut Heights	<b>6T07</b> Walnut Heights
<b>2UH1</b> Reclaimed Aggregate	<b>6T08</b> Aggregate
<b>2UH2</b> Reclaimed Gravel	<b>6T09</b> Gravel
<b>2UH4</b> Cement	<b>6T10</b> Cement
<b>2UH6</b> Sheetrock	<b>6T12</b> Sheetrock
<b>Woodgrain</b>	
<b>2406</b> Clear Cherry <b>E</b>	<b>6234</b> Clear Cherry
<b>2409</b> Clear Maple	<b>6237</b> Clear Maple
<b>2410</b> Graphite Walnut	<b>6231</b> Graphite Walnut
<b>2412</b> Natural Cherry	<b>6034</b> Natural Cherry
<b>2422</b> Medium Cherry	<b>6036</b> Medium Cherry
<b>2511</b> Winter on Maple	<b>6037</b> Winter on Maple
<b>2538</b> Clear Walnut	<b>6245</b> Clear Walnut
<b>2592</b> Blonde on Maple <b>E</b>	<b>6038</b> Blonde on Maple <b>E</b>
<b>2714</b> Natural Walnut <b>E</b>	<b>6041</b> Natural Walnut <b>E</b>
<b>2HAK</b> Clear Oak	<b>6219</b> Clear Oak
<b>2HAN</b> Ash Noce	<b>6707</b> Ash Noce
<b>2HAT</b> Acacia	<b>6213</b> Acacia
<b>2HAW</b> Ash Wenge	<b>6703</b> Ash Wenge
<b>2HBN</b> Bisque Noce	<b>6708</b> Bisque Noce
<b>2HBW</b> Bisque Wenge	<b>6705</b> Bisque Wenge
<b>2HCN</b> Clay Noce	<b>6709</b> Clay Noce
<b>2HCW</b> Clay Wenge	<b>6706</b> Clay Wenge
<b>2HSN</b> Storm Noce	<b>6710</b> Storm Noce
<b>2HSW</b> Storm Wenge	<b>6704</b> Storm Wenge
<b>2HWA</b> Grey Kingswood	<b>66WA</b> Grey Kingswood
<b>2HWB</b> Planked Walnut	<b>66WB</b> Planked Walnut
<b>2HWD</b> Resolute Walnut	<b>66WD</b> Resolute Walnut
<b>2HWE</b> Natural Recon	<b>66WE</b> Natural Recon
<b>2HWF</b> Smoked Walnut	<b>66WF</b> Smoked Walnut

**This listing** includes all the surface material choices that are available for the products in this specification guide.

## Resources

For more information about surface materials, refer to the following resources:

**Additional surface materials specification tools** are available to assist you in the specification process—the Surface Materials Binders.

## Surface Materials Binders

- include:
- Surface Materials Reference Manual
  - A complete set of swatch cards for hard surfaces, vertical surface fabrics, and seating upholstery

Materials and colors are not available on every product. Refer to the Color Availability and Upholstery Matrices before specifying.

## Plastic

- 6009 Arctic White
- 6053 Seagull
- 6059 Sterling Dark Solid
- 6160 Grey
- 6205 Black
- 6249 Platinum Solid
- 6259 Midnight
- 6268 Navy
- 6295 Near Black
- 6296 Sterling
- 6332 Citron
- 6333 Picasso
- 6334 Flash
- 6335 Wasabi
- 6336 Jazz
- 6337 Element
- 6338 Chili
- 6527 Merle
- 6654 Sand
- 6655 Warm White

## Seating Coating

- 7000 Black

## Paint

- 0835 Black
- 4799 Platinum Metallic
- 7239 Midnight

## Metal

- 8046 Polished Aluminum
- 9201 Polished Chrome

## Laminate

- 2406 Clear Cherry **E**
- 2409 Clear Maple
- 2410 Graphite Walnut
- 2412 Natural Cherry
- 2422 Medium Cherry
- 2511 Winter on Maple
- 2535 Virginia Walnut
- 2536 Blackwood **E**
- 2538 Clear Walnut
- 2714 Natural Walnut **E**
- 2722 Cream
- 2730 Arctic White
- 2746 Black
- 2759 Warm White
- 2811 Mist **E**
- 2883 Seagull
- 2884 Milk
- 2885 Dune
- 2HAA Persian Salt
- 2HAB Rose
- 2HAC Indigo
- 2HAD Green Citrine
- 2HAE Dark Olivine
- 2HAF Cloudy
- 2HAK Clear Oak
- 2HAN Ash Noce
- 2HAT Acacia
- 2HAW Ash Wenge
- 2HBN Bisque Noce
- 2HBW Bisque Wenge
- 2HCN Clay Noce
- 2HCW Clay Wenge
- 2HSN Storm Noce
- 2HSW Storm Wenge

## Elmosoft Leather

- L110 Maritime Blue
- L111 Midnight Blue
- L112 Ebony
- L113 Gunmetal
- L114 Mica
- L115 Dove Grey
- L116 Plum Pleasure
- L122 Truffle
- L128 Red Birch
- L133 Espresso
- L134 Ruby
- L135 Scarlet
- L138 Bourbon
- L139 Cinder
- L140 Garnet
- L143 Pecan
- L144 Chamois
- L146 Russet
- L147 Saddle
- L151 White
- L709 Sugar
- L711 Parchment
- L717 Cameo
- L730 Hunter
- L743 Forest Green
- L747 Cigar
- L749 Beaver
- L750 Bluffstone
- L752 Oxblood
- L755 Peanut Butter
- L758 Mustard
- L762 Canvas
- L763 Macadamia
- L768 Tropical
- L769 Mauve
- L770 Cadet
- L772 Timberwolf
- L773 Chalice
- L774 Oil
- L775 Coyote

## 3D Knit

- 5054 Canary
- 5059 Sailor
- 5064 Licorice
- 5065 Coconut
- 5066 Malt
- 5067 Root Beer
- 5089 Royal Blue
- 5090 Wasabi
- 5092 Graphite
- 5093 Nickel
- 5094 Tangerine
- 5095 Scarlet
- 5096 Turmeric/Honey
- 5097 Concord
- 5098 Blue Jay
- 5560 Aubergine
- 5561 Peacock
- 5562 Jungle
- 5563 Merlot
- 5564 Lagoon
- 5565 Saffron

## Upholstery

▶ See page 516 for a complete listing of upholstery colors and numbers.

▶ Check the COM database for specific product and fabric approvals.

**E** = Established

# Jenny Lounge Surface Materials

## Paint

Applies to:

- Jenny tablet arm
- 7207 Black

## Plastic

Applies to:

- Jenny tablet arm
- Jenny end table
- Jenny coffee table
- 6205 Black

Applies to:

- Jenny end table edge band
- Jenny coffee table edge band

6000 Black	6527 Merle
6009 Arctic White	6619 Ice <b>E</b>
6034 Natural Cherry	6631 Cream <b>E</b>
6036 Medium Cherry	6635 Dawn <b>E</b>
6037 Winter on Maple	6636 Mist
6038 Blonde on Maple <b>E</b>	6654 Sand
6041 Natural Walnut <b>E</b>	6655 Warm White
6052 Milk	6695 Midnight
6053 Seagull	6697 Fog
6169 Stone	6698 Fieldstone
6170 Mocha	66WA Grey Kingswood
61AA Persian Salt	66WB Planked Walnut
61AB Rose	66WD Resolute Walnut
61AC Indigo	66WE Natural Recon
61AD Green Citrine	66WF Smoked Walnut
61AE Dark Olivine	66WU Clay
61AF Cloudy	66WV Chalk
6213 Acacia	6703 Ash Wenge
6219 Clear Oak	6704 Storm Wenge
6231 Graphite Walnut	6705 Bisque Wenge
6237 Clear Maple	6706 Clay Wenge
6242 Virginia Walnut	6707 Ash Noce
6243 Blackwood <b>E</b>	6708 Bisque Noce
6245 Clear Walnut	6709 Clay Noce
6249 Platinum Solid	6710 Storm Noce

## Laminate

### Steelcase Surfaces

#### Low-Pressure Laminate

Applies to:

- Jenny tablet arm
- Jenny end table
- Jenny coffee table

#### Fiber Laminate

2L50 Vanadium Fiber LPL

#### Solid Laminate

247L Black V2 LPL  
2L30 Arctic White LPL  
2L83 Seagull LPL  
2L85 Dune LPL

#### Woodgrain Laminate

25L1 Winter on Maple LPL  
25L5 Virginia Walnut LPL  
25L6 Blackwood LPL **E**  
25L8 Clear Walnut LPL  
267L Marbled Cherry V2 LPL **E**  
26L1 Natural Cherry V2 LPL  
2L09 Clear Maple LPL  
2LAK Clear Oak LPL  
2LAN Ash Noce LPL  
2LAT Acacia LPL  
2LAW Ash Wenge LPL  
2LBN Bisque Noce LPL  
2LBW Bisque Wenge LPL  
2LCN Clay Noce LPL  
2LCW Clay Wenge LPL  
2LSN Storm Noce LPL  
2LSW Storm Wenge LPL  
2LWA Grey Kingswood LPL  
2LWB Planked Walnut LPL  
2LWD Resolute Walnut LPL  
2LWF Smoked Walnut LPL  
2LWG Natural Recon LPL  
2TL2 Fawn Cypress LPL

### Steelcase Surfaces

#### High-Pressure Laminate

Applies to:

- Jenny tablet arm
- Jenny end table
- Jenny coffee table

#### Fiber Laminate

2850 Vanadium Fiber  
2854 Vellum Fiber **E**  
2860 Granite Fiber  
2862 Stucco Fiber **E**

#### Micro Laminate

2920 Marl Micro  
2921 Gypsum Micro  
2922 Clay Micro

#### Patina Laminate

2870 Blonde Bronze Patina  
2873 Instant Iron Patina

#### Solid Laminate

2722 Cream **E**  
2730 Arctic White  
2746 Black  
2759 Warm White  
2811 Mist **E**  
2883 Seagull  
2884 Milk  
2885 Dune  
2HAA Persian Salt  
2HAB Rose  
2HAC Indigo  
2HAD Green Citrine  
2HAE Dark Olivine  
2HAF Cloudy  
2HWU Clay  
2HWW Chalk

#### Speckle Laminate

2820 Coffee Speckle **E**  
2823 Driftwood Speckle  
2824 Smoke Speckle  
2825 Vanadium Speckle

#### Woodgrain Laminate

2406 Clear Cherry **E**  
2409 Clear Maple  
2410 Graphite Walnut  
2412 Natural Cherry  
2422 Medium Cherry  
2511 Winter on Maple  
2535 Virginia Walnut  
2536 Blackwood **E**  
2538 Clear Walnut  
2592 Blonde on Maple **E**  
2714 Natural Walnut **E**  
2HAK Clear Oak  
2HAN Ash Noce  
2HAT Acacia  
2HAW Ash Wenge  
2HBN Bisque Noce  
2HBW Bisque Wenge  
2HCN Clay Noce  
2HCW Clear Wenge  
2HSN Storm Noce  
2HSW Storm Wenge  
2HWA Grey Kingswood  
2HWB Planked Walnut  
2HWD Resolute Walnut  
2HWE Natural Recon  
2HWF Smoked Walnut

*Tip: Some wood veneer finishes and woodgrain laminates share the same name. Because of the difference in materials, veneers and laminates of the same name are not an exact match but do coordinate with each other.*

Applies to:

- Jenny end table
- Jenny coffee table

#### Textured Laminate

2TH2 Fawn Cypress  
2TH4 Saddle Oak  
2TH5 Veranda Teak  
2TH7 Walnut Heights

### Custom Surfaces

#### Open Line Laminate (OLL)

When processing orders for Open Line laminate, specify 2900 in the laminate finish field and enter the OLL manufacturer information. Enter the required edge finish as you would a standard laminate.

High-Pressure Laminate pricing does not include premium or digitally printed patterns from any suppliers. Laminate cost may also vary for basic or standard laminates from other suppliers. Please contact the OLL consultant at 616.475.2426 for pricing. The cost of the laminate will be added to your invoice as a separate line on the acknowledgement.

**Edge color** for Open Line laminate must be determined by the dealer and customer before orders can be entered. Specify appropriate 2K finish number.

#### Laminate Approval and Material Requirements

To confirm whether a particular laminate has already been tested for use on a specific Steelcase product or to determine material square foot requirements:

- Visit [www.steelcase.com](http://www.steelcase.com)

**For additional information**, refer to the *Steelcase Surface Materials Reference Manual*.

**E** = Established

### Wood

Applies to:

- Jenny wood legs
- Jenny wood arm
- 3412 Natural Cherry **E**
- 3522 Clear Maple
- 3762 Dark Walnut

*Tip: Due to natural variations in wood, finished products may vary in color, texture and grain.*

### Leather

- T802 Black
- L305 Brown Leather

### Upholstery

▶ See *Surface Materials Reference Manual* for a complete listing of upholstery colors and numbers.

▶ Check the COM database for specific product and fabric approvals.

**E** = Established

# West Elm Health Surface Materials

## Paint

Applies to:  
• Slope

## Steelcase Surfaces

### Price Group 1

#### Smooth Paint

4238 Mocha  
4239 Clay  
4240 Chalk  
4242 Milk Smooth  
4710 Low Gloss Black

#### Textured Paint

7207 Black  
7225 Sand  
7237 Slate **E**  
7238 Fieldstone  
7239 Midnight  
7241 Arctic White  
7243 Seagull  
7250 Sterling Dark Solid  
7360 Merle

### Price Group 2

#### Smooth Paint

0835 Black  
4700 Warm White

#### Smooth Metallic Paint

4743 Mineral Metallic  
4750 Champagne Metallic  
4798 Sterling Metallic  
4799 Platinum Metallic  
4803 Near Black Metallic

#### Textured Metallic Paint

7245 Carbon Metallic  
7246 Midnight Metallic

### Price Group 3

#### Accent Paints

1ATG Rose Quartz  
4AV3 Blue Jay  
4AV4 Baltic  
4AX1 Citron  
4AY2 Chili  
4AZ5 Marlin  
4CL1 Dark Olivine  
4CL2 Ice Blue  
4CL3 Aura  
4CL4 Sea Glass  
4CL5 Light Matcha  
4CL6 Terra  
4CL7 Sandstone  
4CL8 Smokey Plum  
4CZ5 Honey  
4CZ6 Lagoon

#### Coatings

1ATT Cast Shadow

#### Lux Coatings

4B20 Obsidian  
4B22 Matte Brass  
4B23 Burnished Bronze  
4B24 Night Bronze  
4B25 Matte Copper  
4B26 Smoked Mica  
4B29 Cast Iron

## Accessory Paint

Applies to:  
• Slope

## Steelcase Surfaces

Not every paint color is available on every product.  
4140 Arctic White Gloss  
4144 Black Gloss

## Upholstery

Not all fabrics are available on all products. See the COM database for specific product and fabric availability.

### Price Group 1

#### Buzz2

5F03 Tomato  
5F04 Red **E**  
5F05 Burgundy  
5F06 Sky **E**  
5F07 Blue  
5F08 Navy  
5F15 Stone  
5F16 Grey  
5F17 Black  
5G50 Dunegrass  
5G51 Sable  
5G55 Pumpkin  
5G57 Rouge  
5G59 Meadow  
5G61 Cyan  
5G62 Atlantic  
5G63 Crocus  
5G64 Alpine  
5G65 Tornado

#### Era

5ER0 Cobalt  
5ER1 Harbor  
5ER2 Blue Nickel  
5ER3 Pistachio  
5ER4 Canary  
5ER5 Comet  
5ER6 Truffle  
5ER7 Saffron  
5ER8 Pink Lemonade  
5ER9 Onyx  
5ES0 Scarlet  
5ES1 Lentil  
5ES2 Oatmeal  
5ES3 Persimmon  
5ES4 Sprout  
5ES5 Blue Mint  
5ES6 Royal Blue  
5ES7 Night Owl  
5ET1 Rose Quartz  
5ET3 Olivine  
5EU2 Electric Indigo  
5EU3 Green Citrine  
5EU4 Storm Cloud

#### Jacks

5B61 Taupe **E**  
5B63 Camel **E**  
5B64 Pewter **E**  
5B70 Midnight **E**

## Link

5A24 Blue  
5A25 Navy  
5A27 Black

## New Black

5J10 New Black: Bruce  
5J11 New Black: Henry  
*Tip: New Black upholstery has color numbers in both price group 1 and price group 2.*

### Price Group 2

#### Chainmail

5551 Space  
5552 Silver Dollar  
5553 Volcano  
5555 Tricycle  
5559 Lagoon

#### Cogent: Connect

5S15 Coconut  
5S16 Turmeric/Honey  
5S17 Tangerine  
5S18 Scarlet  
5S19 Concord  
5S21 Blue Jay  
5S23 Wasabi  
5S24 Nickel  
5S25 Graphite  
5S26 Licorice  
5S27 Malt  
5S28 Root Beer  
5S93 Indigo/Blueprint  
5S94 Lizard/Jungle  
5S95 Sailor  
5S96 Quicksilver  
5S99 Lipstick/Merlot  
5SD0 Royal Blue  
5SD1 Aubergine  
5SD2 Peacock  
5SD3 Lagoon  
5SD4 Saffron  
5SD5 Citrine  
5SD6 Rose Quartz  
5SD7 Sea Salt  
5SF3 Storm Cloud  
5SF4 Olivine

#### Dovetail by Designtex

5H39 Light Mocha  
5H40 Pebble  
5H41 Warm White  
5H42 Sandstone  
5H43 Honeycomb  
5H44 Terra  
5H45 Honeydew  
5H46 Denim  
5H47 Storm  
5H48 Ice Blue  
5H49 Aura  
5H50 Darkest Grey

## Foundation\*\*\*

5875 Black  
5876 Navy  
5877 Foggy Night  
5878 Sailor  
5879 Ivory  
5880 Seal  
5881 Peat  
5882 New Sand  
5883 Cranberry  
5884 Spring  
5885 Honey  
5886 Folkstone  
5887 Pebble  
5888 Oregano

## New Black

5J08 New Black: Jack  
5J09 New Black: James  
5J12 New Black: Harley  
*Tip: New Black upholstery has color numbers in both price group 1 and price group 2.*

## Nitelights

5F66 Stone  
5F67 Moon

## SoftNext

5H27 Obsidian  
5H28 Foggy Night  
5H29 Greystone  
5H30 Mocha  
5H31 Clay  
5H32 Sandstone  
5H33 Chalk  
5H34 Midnight  
5H35 Blue Mica  
5H36 Jade  
5H37 Burnt Umber  
5H38 Cinnabar

### Price Group 3

#### Billiard Multi-Use by Designtex

5H11 Poppy  
5H12 Tangelo  
5H13 Citrine/Citron  
5H14 Avocado  
5H16 Indigo  
5H17 Mallard\*  
5H18 Teak  
5H19 Cumulus  
5H20 Pewter  
5H21 Gunmetal  
5H22 Ink  
5H23 Rose Quartz\*\*\*\*  
5H24 Sea Salt\*\*\*\*  
5H25 Storm Cloud\*\*\*\*  
5H26 Olivine\*\*\*

\* Only available on Mesa  
\*\* Only available on Slope  
\*\*\* Only available on Sterling  
\*\*\*\* Available on Slope and Sterling  
**E** = Established



**Gaja**

- 5W40 Black
- 5W41 Pepper
- 5W42 Pearl Grey
- 5W43 Crimson
- 5W44 Ink
- 5W45 Night Blue
- 5W48 Sepia
- 5W51 Camellia Red
- 5W52 Emerald
- 5W53 Snow Pea
- 5W54 Olive
- 5W56 Maroon
- 5W57 Black Raspberry
- 5W58 Spruce
- 5W60 Deep Blue
- 5W61 Chili Pepper

**Redeem**

- TM50 Brick
- TM52 Cinnamon
- TM55 Water
- TM58 Mallard
- TM60 Greyhound
- TM62 Iceberg
- TM63 Chestnut
- TM64 Granite
- TM66 Barnwood

**Retrieve**

- TM31 Lake
- TM32 Gala
- TM37 Submarine
- TM40 Quarry
- TM42 Shadow
- TM43 Seal

**Price Group 4**

**Grade In Cloud Velvet\*\*\*\***

- WE70 Light Mocha
- WE71 Black Indigo
- WE72 Slate

**Grade In Tweed Multi\*\*\*\***

- WE73 Medium Grey
- WE74 Medium Blue
- WE75 Light Grey

\* Only available on Mesa  
 \*\* Only available on Slope  
 \*\*\* Only available on Sterling  
 \*\*\*\* Available on Slope and Sterling  
 E = Established

**Price Group 5**

**Bo Peep**

- 5G67 Bone
- 5G72 Honey Mustard
- 5G73 Marmalade
- 5G74 Picnic
- 5G75 Pinot
- 5G76 Bloom
- 5G77 Grapevine
- 5G79 Artichoke
- 5G80 Serpent
- 5G81 Carolina
- 5G82 Blue Bonnet
- 5G83 Nautical
- 5G84 Gravel
- 5G85 Sharkskin
- 5G86 Kohl

**Silk**

- 5L31 Dijon
- 5L32 Seaweed
- 5L33 Boysenberry
- 5L35 Marina
- 5L36 Heather Blue
- 5L37 Blue Raspberry
- 5L38 Cauldron
- 5L39 Flaxen

**Remix**

- RE01 Rust
- RE03 Pebble
- RE04 Dark Chocolate
- RE06 Linen Beige
- RE08 Concrete Grey
- RE09 Sky Blue
- RE10 Blue Jean
- RE11 Ivy Green
- RE13 Night Blue

**Price Group 6**

**Brisa**

- BR01 Black Onyx
- BR04 Truffle
- BR06 Ash
- BR07 Sage
- BR08 Celery
- BR09 Sterling Blue
- BR10 Night Navy
- BR11 Cambridge Blue
- BR12 Abyss
- BR14 Pompeian Red
- BR16 Cinnabar
- BR18 New Sand
- BR20 White
- BR21 Moccasin
- BR22 Buckskin
- BR24 Mineral
- BR25 Skyway
- BR26 Iron
- BR27 Stormy
- BR28 Esmeralda
- BR29 Seaweed
- BR30 Bone
- BR31 Caramel
- BR32 Bridle
- BR33 Moon

**Price Group 7**

**Steelcut Trio**

- TR01 Mist Grey
- TR02 Stone Grey
- TR03 Cassonade Beige
- TR04 Nutmeg Beige
- TR06 Licorice Black
- TR11 Ice Blue
- TR15 Brown Frost

**Leather Price Group**

- Applies to:
- Mesa
  - Sterling
- L107 Black E
  - L207 Mahogany E
  - L220 Soapstone E
  - L221 Rocky E

Applies to:

- Mesa
- Slope
- Sterling

**Elmosoft Leather**

- L110 Maritime Blue
- L111 Midnight Blue
- L112 Ebony
- L113 Gunmetal
- L114 Mica
- L115 Dove Grey
- L116 Plum Pleasure
- L122 Truffle
- L128 Red Birch
- L133 Espresso
- L134 Ruby
- L135 Scarlet
- L138 Bourbon
- L140 Garnet
- L143 Pecan
- L144 Chamois
- L146 Russet
- L147 Saddle
- L151 White
- L709 Sugar
- L711 Parchment
- L717 Cameo
- L723 Storm
- L730 Hunter
- L743 Forest Green
- L747 Cigar
- L749 Beaver
- L750 Bluffstone
- L752 Oxblood
- L755 Peanut Butter
- L758 Mustard
- L762 Canvas
- L763 Macadamia
- L768 Tropical
- L769 Mauve
- L770 Cadet
- L772 Timberwolf
- L773 Chalice
- L774 Oil
- L775 Coyote

**Select Surfaces**

**For information on products within Select Surfaces,** including accent paints and fabrics from Designtex, Gabriel, Kvadrat, and Pollack, please refer to the *Surface Materials Reference Manual* or visit [steelcase.com/surface-materials](http://steelcase.com/surface-materials) under the Select Surfaces section.

**Custom Surfaces**

**Price Group COM (Customer's Own Material)**

**Fabric Approval and Yardage**  
 To confirm whether a particular COM material has already been tested for use on a specific Steelcase or Steelcase Health product or to determine actual yardage requirements:  
 • Visit [www.steelcase.com](http://www.steelcase.com)

**For additional information regarding Customer's Own Material,** call 1.888.STEELCASE (1.888.783.3522) or send an e-mail to [lineone@steelcase.com](mailto:lineone@steelcase.com).

**For Steelcase Health products,** call 1.800.342.8562.

**Steelcase Health Select Surfaces Program: Upholstery**

**Steelcase Health Select Surfaces Program Partners:**

- Architex
- Arc-Com
- CF Stinson
- Designtex
- Mayer
- Momentum
- Ultrafabrics

**A collection of textiles** are available as part of a Select Surfaces Program. The collection from the leading suppliers in the market consists of high-performance textiles that meet the demands of healthcare environments. Note that not all fabrics can be applied to all seating products. Refer to the Steelcase COM database for the most current application information.

To order these fabrics, enter the finish code which corresponds with the fabric price group.

Price Group	Finish Code
1	59DA
2	59DB
3	59DC
4	59DD
5	59DE
6	59DF
7	59DG
8	59DH
9	59DJ
10	59DK

Applies to:

- Mesa
- Sterling

**Leather**

Price Group	Finish Code
1	59LA
2	59LB

Applies to:

- Slope
  - Sterling
- 59DB Birdseye  
 59DC Brushed Flannel  
 59DC Crossweave  
 59DC Gamut  
 59DC Tweed Multi  
 59DD Union Cloth  
 59DE Fomo  
 59DE Linen Like  
 59DF Bark Cloth  
 59DF Tack Cloth  
 59DF Tiny Herringbone  
 59DF W  
 59DF Big Texture  
 59DF Boucle Dot  
 59DF Distressed Texture  
 59DG Starburst  
 59DG Bead  
 59DH Hatchmark

Then enter the fabric information in the Special Fabric Information pop up window.

Fabric application direction must be specified.

▶ See page 519 for *Fabric Application Direction Guidelines* to ensure fabric is specified in the correct direction.

For a comprehensive list of patterns and price grades in Steelcase Health offering, visit [steelcasehealth.com/resources/grade-in](https://steelcasehealth.com/resources/grade-in).



# Health Upholstery and Color Numbers

## Upholstery

Not all fabrics are available on all products. See the COM database for specific product and fabric availability.

## Price Group 1

### Buzz2

- 5F03 Tomato
- 5F04 Red **E**
- 5F05 Burgundy
- 5F06 Sky **E**
- 5F07 Blue
- 5F08 Navy
- 5F15 Stone
- 5F16 Grey
- 5F17 Black
- 5G50 Dunegrass
- 5G51 Sable
- 5G55 Pumpkin
- 5G57 Rouge
- 5G59 Meadow
- 5G61 Cyan
- 5G62 Atlantic
- 5G63 Crocus
- 5G64 Alpine
- 5G65 Tornado

### Era

- 5ER0 Cobalt
- 5ER1 Harbor
- 5ER2 Blue Nickel
- 5ER3 Pistachio
- 5ER4 Canary
- 5ER5 Comet
- 5ER6 Truffle
- 5ER7 Saffron
- 5ER8 Pink Lemonade
- 5ER9 Onyx
- 5ES0 Scarlet
- 5ES1 Lentil
- 5ES2 Oatmeal
- 5ES3 Persimmon
- 5ES4 Sprout
- 5ES5 Blue Mint
- 5ES6 Royal Blue
- 5ES7 Night Owl
- 5ET1 Rose Quartz
- 5ET3 Olivine
- 5EU2 Electric Indigo
- 5EU3 Green Citrine
- 5EU4 Storm Cloud

### Jacks

- 5B61 Taupe **E**
- 5B63 Camel **E**
- 5B64 Pewter **E**
- 5B70 Midnight **E**

## Link

- 5A24 Blue
- 5A25 Navy
- 5A27 Black

## New Black

- 5J10 New Black: Bruce
  - 5J11 New Black: Henry
- Tip: New Black upholstery has color numbers in both price group 1 and price group 2.*

## Price Group 2

### Chainmail

- 5551 Space
- 5552 Silver Dollar
- 5553 Volcano
- 5555 Tricycle
- 5559 Lagoon

### Cogent: Connect

- 5S15 Coconut
- 5S16 Turmeric/Honey
- 5S17 Tangerine
- 5S18 Scarlet
- 5S19 Concord
- 5S21 Blue Jay
- 5S23 Wasabi
- 5S24 Nickel
- 5S25 Graphite
- 5S26 Licorice
- 5S27 Malt
- 5S28 Root Beer
- 5S93 Indigo/Blueprint
- 5S94 Lizard/Jungle
- 5S95 Sailor
- 5S96 Quicksilver
- 5S99 Lipstick/Merlot
- 5SD0 Royal Blue
- 5SD1 Aubergine
- 5SD2 Peacock
- 5SD3 Lagoon
- 5SD4 Saffron
- 5SD5 Citrine
- 5SD6 Rose Quartz
- 5SD7 Sea Salt
- 5SF3 Storm Cloud
- 5SF4 Olivine

### Dovetail by Designtex

- 5H39 Light Mocha
- 5H40 Pebble
- 5H41 Warm White
- 5H42 Sandstone
- 5H43 Honeycomb
- 5H44 Terra
- 5H45 Honeydew
- 5H46 Denim
- 5H47 Storm
- 5H48 Ice Blue
- 5H49 Aura
- 5H50 Darkest Grey

## Foundation

- 5875 Black
- 5876 Navy
- 5877 Foggy Night
- 5878 Sailor
- 5879 Ivory
- 5880 Seal
- 5881 Peat
- 5882 New Sand
- 5883 Cranberry
- 5884 Spring
- 5885 Honey
- 5886 Folkstone
- 5887 Pebble
- 5888 Oregano

## New Black

- 5J08 New Black: Jack
  - 5J09 New Black: James
  - 5J12 New Black: Harley
- Tip: New Black upholstery has color numbers in both price group 1 and price group 2.*

## Nitelights

- 5F66 Stone
- 5F67 Moon

## SoftNext

- 5H27 Obsidian
- 5H28 Foggy Night
- 5H29 Greystone
- 5H30 Mocha
- 5H31 Clay
- 5H32 Sandstone
- 5H33 Chalk
- 5H34 Midnight
- 5H35 Blue Mica
- 5H36 Jade
- 5H37 Burnt Umber
- 5H38 Cinnabar

## Stand In

- 5621 Sleet
- 5622 Lunar
- 5623 Cyclone
- 5624 Eclipse
- 5625 Powder
- 5626 Chardonnay
- 5627 Graham
- 5628 Sediment
- 5629 Allspice
- 5630 Apple
- 5631 Lava
- 5632 Cayenne
- 5633 Plantain
- 5634 Parsley
- 5635 Scallion
- 5636 Atlantis
- 5691 Orca
- 5740 Burlap
- 5741 Porter
- 5742 Tusk
- 5743 Putty
- 5744 Blueberry
- 5745 Chartreuse
- 5746 Mango
- 5747 Sedona
- 5748 Juniper
- 5749 Peanut

## Price Group 3

### Billiard Multi-Use by Designtex

- 5H11 Poppy
- 5H12 Tangelo
- 5H13 Citrine/Citron
- 5H14 Avocado
- 5H16 Indigo
- 5H17 Mallard
- 5H18 Teak
- 5H19 Cumulus
- 5H20 Pewter
- 5H21 Gunmetal
- 5H22 Ink
- 5H23 Rose Quartz
- 5H24 Sea Salt
- 5H25 Storm Cloud
- 5H26 Olivine

### Gaja

- 5W40 Black
- 5W41 Pepper
- 5W42 Pearl Grey
- 5W43 Crimson
- 5W44 Ink
- 5W45 Night Blue
- 5W48 Sepia
- 5W51 Camellia Red
- 5W52 Emerald
- 5W53 Snow Pea
- 5W54 Olive
- 5W56 Maroon
- 5W57 Black Raspberry
- 5W58 Spruce
- 5W60 Deep Blue
- 5W61 Chili Pepper

### Redeem

- TM50 Brick
- TM52 Cinnamon
- TM55 Water
- TM58 Mallard
- TM60 Greyhound
- TM62 Iceberg
- TM63 Chestnut
- TM64 Granite
- TM66 Barnwood

## Retrieve

- TM31 Lake
- TM32 Gala
- TM37 Submarine
- TM40 Quarry
- TM42 Shadow
- TM43 Seal

## Price Group 5

### Bo Peep

- 5G67 Bone
- 5G72 Honey Mustard
- 5G73 Marmalade
- 5G74 Picnic
- 5G75 Pinot
- 5G76 Bloom
- 5G77 Grapevine
- 5G79 Artichoke
- 5G80 Serpent
- 5G81 Carolina
- 5G82 Blue Bonnet
- 5G83 Nautical
- 5G84 Gravel
- 5G85 Sharkskin
- 5G86 Kohl

### Silk

- 5L31 Dijon
- 5L32 Seaweed
- 5L33 Boysenberry
- 5L35 Marina
- 5L36 Heather Blue
- 5L37 Blue Raspberry
- 5L38 Cauldron
- 5L39 Flaxen

### Remix

- RE01 Rust
- RE03 Pebble
- RE04 Dark Chocolate
- RE06 Linen Beige
- RE08 Concrete Grey
- RE09 Sky Blue
- RE10 Blue Jean
- RE11 Ivy Green
- RE13 Night Blue

**E** = Established

**Price Group 6**

**Brisa**

- BR01 Black Onyx
- BR04 Truffle
- BR06 Ash
- BR07 Sage
- BR08 Celery
- BR09 Sterling Blue
- BR10 Night Navy
- BR11 Cambridge Blue
- BR12 Abyss
- BR14 Pompeian Red
- BR16 Cinnabar
- BR18 New Sand
- BR20 White
- BR21 Moccasin
- BR22 Buckskin
- BR24 Mineral
- BR25 Skyway
- BR26 Iron
- BR27 Stormy
- BR28 Esmeralda
- BR29 Seaweed
- BR30 Bone
- BR31 Caramel
- BR32 Bridle
- BR33 Moon

**Price Group 7**

**Steelcut Trio**

- TR01 Mist Grey
- TR02 Stone Grey
- TR03 Cassonade Beige
- TR04 Nutmeg Beige
- TR06 Licorice Black
- TR11 Ice Blue
- TR15 Brown Frost
- TR18 Coastal Oasis
- TR19 Deep Sea

**Leather Price Group**

- L107 Black **E**
- L207 Mahogany **E**
- L220 Soapstone **E**
- L221 Rocky **E**
- L500 Camel
- L503 Navy

**Select Surfaces**

**For information on products within Select Surfaces,** including accent paints and fabrics from Designtex, Gabriel, Kvadrat, and Pollack, please refer to the *Surface Materials Reference Manual* or visit [steelcase.com/surface-materials](http://steelcase.com/surface-materials) under the Select Surfaces section.

**E** = Established

**Custom Surfaces**

**Price Group COM (Customer's Own Material)**

**Fabric Approval and Yardage**

To confirm whether a particular COM material has already been tested for use on a specific Steelcase or Steelcase Health product or to determine actual yardage requirements:

- Visit [www.steelcase.com](http://www.steelcase.com)

**For additional information regarding Customer's Own Material,** call

1.888.STEELCASE (1.888.783.3522) or send an e-mail to [lineone@steelcase.com](mailto:lineone@steelcase.com).

**For Steelcase Health products,** call 1.800.342.8562.

# Steelcase Health Select Surfaces Programs

## Steelcase Health Select Surfaces Program: Solid Surface

A collection of solid surfaces are available as part of a Select Surfaces Program. The collection is from the solid surface offering. Samples can be ordered through [corian.com](http://corian.com)

These solid surfaces are Select Surfaces for Embold tables, Regard, Tava, and Leela products only. The collection on these pages is not Select Surfaces for other Steelcase brands or product lines.

Aspekt straight arm, Embold seating, and Mitra guest seating arm caps are available in all standard Steelcase Health solid surface finishes and Select Surfaces for the colors indicated with an asterisk.

To order these solid surfaces, enter the finish code which corresponds with the solid surface price group.

Price Group	Finish Code
<b>A</b>	<b>29DA</b>
<b>B</b>	<b>29DB</b>
<b>C</b>	<b>29DC</b>
<b>D</b>	<b>29DD</b>

Then enter the solid surface information in the Special Solid Surface Information pop up window. If prompted, enter the finish code CORIAN0001 based on the solid surface supplier.

## Solid Surface

### Solid Surface Offering

#### Price Group A

Vanilla

#### Price Group B

Abalone  
Arctic Ice  
Aurora  
Canyon\*  
Designer White  
Dove  
Elegant Gray\*  
Glacier Ice  
Matterhorn  
Modern White  
Neutral Concrete\*  
Platinum  
Sahara  
Sandstone  
Savannah  
Silt\*

#### Price Group C

Ash Concrete\*  
Carbon Concrete  
Concrete\*  
Cosmos Prima  
Deep Cloud\*  
Deep Espresso  
Deep Night Sky\*  
Deep Nocturne\*  
Deep Titanium\*  
Doeskin  
Hazelnut  
Lava Rock  
Rice Paper  
Sand Storm  
Sandalwood  
Serene Sage  
Silver Birch\*  
Silverite  
Venaro White  
Weathered Concrete  
Whisper  
White Jasmine  
Willow

## Price Group D

Arrowroot  
Clam Shell  
Dune Prima  
Gray Onyx  
Juniper  
Natural Gray  
Rain Cloud  
Rosemary  
Sagebrush  
Sorrel  
Witch Hazel

\*Available on Aspekt straight arm, Embold seating, and Mitra guest seating arm caps.

## Standard Steelcase Health Solid Surface finishes:

### Price Group A

2801 Glacier White  
2973 Linen  
2975 Bisque  
2978 Cameo White  
2979 Silver Grey

### Price Group B

2972 Antarctica

### Price Group C

2974 Canvas

## Steelcase Health Select Surfaces Program: Upholstery

### Steelcase Health Select Surfaces Program Partners:

Architex  
Arc-Com  
CF Stinson  
Designtex  
Mayer  
Momentum  
Ultrafabrics

### A collection of textiles

are available as part of a Select Surfaces Program. The collection from the leading suppliers in the market consists of high-performance textiles that meet the demands of healthcare environments. Note that not all fabrics can be applied to all seating products. Refer to the Steelcase COM database for the most current application information.

To order these fabrics, enter the finish code which corresponds with the fabric price group.

Price Group	Finish Code
<b>2</b>	<b>59DB</b>
<b>3</b>	<b>59DC</b>
<b>4</b>	<b>59DD</b>
<b>5</b>	<b>59DE</b>
<b>6</b>	<b>59DF</b>
<b>7</b>	<b>59DG</b>
<b>8</b>	<b>59DH</b>
<b>9</b>	<b>59DJ</b>
<b>10</b>	<b>59DK</b>

Then enter the fabric information in the Special Fabric Information pop up window.

Fabric application direction must be specified.

► See page 519 for *Fabric Application Direction Guidelines* to ensure fabric is specified in the correct direction.

For a comprehensive list of patterns and price grades in Steelcase Health offering, visit [steelcasehealth.com/resources/grade-in](http://steelcasehealth.com/resources/grade-in).

## What is the issue?

Some textiles are simple and look the same regardless of how you apply them to a product. Other fabrics are patterned, textured, or have luster that will have a distinctly different appearance applied in a different direction on a chair. Because of these differences, and the fact that there are limits to how some fabrics can be applied to Steelcase Health products, it is important to understand fabric application direction when ordering a product to avoid being disappointed.

## Talking about direction

Fabrics come on rolls. The long yarns that run down the length of the roll are called the “warp” yarns. These yarns are used to define the direction you are viewing the fabric as it is applied to a chair. Fabric directionality is determined by how the fabric comes off the roll.



It is NOT determined by the way the pattern looks on the product. For example, the image below shows the fabric applied warped horizontal although the stripes appear vertical.

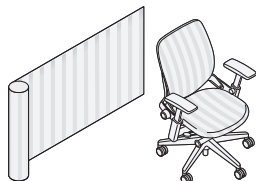

## Terminology

Steelcase uses the terms warped horizontal and warped vertical. There are other terms within the industry that are used that have the same meaning:

- Warped horizontal is also referred to as: railroaded or across roll
- Warped vertical is also referred to as: woven way, down roll, or top out

## Why is it important?

Dealers must specify fabric application direction when ordering COMs and Steelcase Health Select Surfaces fabrics. We require the dealer to specify the direction because we do not know which way customers want to see a pattern on the furniture. Therefore, it is critical to know how the pattern is run on the roll to ensure that Steelcase Health builds and ships each order to the customer's expectation each and every time.



## How do I know which way the fabric comes off the roll?

Most textile companies will swatch their fabrics in a warp vertical (woven way, down roll) direction. Some exceptions might be made to address patterns especially with stripes. Typically, when a fabric is swatched in a warp horizontal (railroad or across roll) direction, the direction is noted on the swatch card or fabric sample. If in doubt of a fabric direction, we encourage you to contact the textile vendor for clarification.

## Vinyl

Vinyl generally only passes on Steelcase Health product in a horizontal or across roll direction. This is due to physical properties of the material. If a vinyl is applied in the opposite direction, too much stretch in the material can compromise the overall aesthetics of the final upholstery. If a patterned vinyl is being specified and the vinyl must be run in a vertical direction, pre-approval must be arranged through Steelcase Health. Steelcase Health will consider the request and a decision will be made based on the specific vinyl and product combination. Contact Steelcase Health's Customer Care line.

## Required Action Steps before Specifying

1. Verify by using Steelcase's COM website that the fabric is approved on the product.
2. Verify the direction that the fabric can be applied. Occasionally a fabric is only approved in one direction.
3. Confirm with the customer how they want the fabric to look on the furniture.
4. Confirm using the swatch card or vendor's website the direction the sample is shown.
5. Now you're ready to place the order.





---

# Resources

<b>Style Number Index</b>	<b>522</b>
---------------------------	------------

# Style Number Index

Style Number	Page	Description
<b>3500</b>	292	Enea Arm Chair
<b>3500S</b>	294	Enea Armless
<b>3501</b>	292	Enea Arm Chair
<b>3501S</b>	294	Enea Armless
<b>3502</b>	293	Enea Arm Chair
<b>3502S</b>	295	Enea Armless
<b>3503</b>	293	Enea Arm Chair
<b>3503S</b>	295	Enea Armless
<b>45-T1300H</b>	165	Circa Freestanding Table
<b>45-T1300HER</b>	165	Circa Ganging Table
<b>45-T1300HG</b>	165	Circa Ganging Table
<b>45-T1300LER</b>	165	Circa Ganging Table
<b>45-T1300LG</b>	165	Circa Ganging Table
<b>45-T1815H</b>	164	Circa Freestanding Table
<b>45-T1815HER</b>	164	Circa Ganging Table
<b>45-T1815HG</b>	164	Circa Ganging Table
<b>45-T1815LER</b>	164	Circa Ganging Table
<b>45-T1815LG</b>	164	Circa Ganging Table
<b>45-T28HER</b>	165	Circa Ganging Table
<b>45-T3730HER</b>	165	Circa Ganging Table
<b>45-T3730HG</b>	165	Circa Ganging Table
<b>45-T3730LER</b>	164	Circa Ganging Table
<b>45-T3730LG</b>	164	Circa Ganging Table
<b>45-T42RD</b>	166	Circa Freestanding Table
<b>451-2500</b>	158	Circa Straight Seat Chair
<b>451-3730FI</b>	157	Circa 30° Inside Wedge Armless Seat
<b>451-3730FO</b>	156	Circa 30° Outside Wedge Seat
<b>451-5000</b>	158	Circa Straight Loveseat
<b>451-7460FI</b>	157	Circa 60° Inside Wedge Loveseat
<b>451-7460FO</b>	157	Circa 60° Outside Wedge Loveseat
<b>451-A1800ER</b>	160	Circa Straight Armrest
<b>451-A1800G</b>	160	Circa Straight Armrest
<b>451-A1815FIER</b>	161	Circa 15° Inside Armrest
<b>451-A1815FIG</b>	161	Circa 15° Inside Armrest
<b>451-A1815FOER</b>	161	Circa 15° Outside Armrest
<b>451-A1815FOG</b>	161	Circa 15° Outside Armrest
<b>451-A3730FIER</b>	161	Circa 30° Inside Armrest
<b>451-A3730FIG</b>	161	Circa 30° Inside Armrest
<b>451-A3730FOER</b>	162	Circa 30° Outside Armrest
<b>451-A3730FOG</b>	162	Circa 30° Outside Armrest
<b>451-B42RD</b>	162	Circa Round Ottoman
<b>451-B5000</b>	158	Circa Straight Bench
<b>451-B7460FI</b>	157	Circa 60° Inside Wedge Bench
<b>451-B7460FO</b>	157	Circa 60° Outside Wedge Bench
<b>451-GANGPKG</b>	158, 162	Circa Ganging Kit
<b>475410M</b>	317	Player 475 Leg-Base Multi-Purp Chair
<b>475410MTL</b>	319	Player 475 Leg-Base Multi-Purp Chair
<b>475410MTR</b>	319	Player 475 Leg-Base Multi-Purp Chair
<b>475412M</b>	317	Player 475 Leg-Base Multi-Purp Chair
<b>475412MC</b>	317	Player 475 Leg-Base Multi-Purp Chair
<b>475415M</b>	317	Player 475 Leg-Base Multi-Purp Chair
<b>475415MC</b>	317	Player 475 Leg-Base
<b>475480M</b>	321	Player 475 Sled-Base
<b>475480MTL</b>	323	Player 475 Sled-Base
<b>475480MTR</b>	323	Player 475 Sled-Base

Style Number	Page	Description
<b>475482M</b>	321	Player 475 Sled-Base
<b>475485M</b>	321	Player 475 Sled-Base
<b>475710M</b>	325	Player 475 Leg-Base Stool
<b>475712M</b>	325	Player 475 Leg-Base Stool
<b>475715M</b>	325	Player 475 Leg-Base Stool
<b>475A</b>	326	Player 475 Alignment Device
<b>475D</b>	326	Player 475 Transport/Strg Dolly
<b>475G</b>	326	Player 475 Ganging Device
<b>480110</b>	277	Node 480 Series Work Chair
<b>480120</b>	277	Node 480 Series Work Chair
<b>480130</b>	279	Node 480 Series Collaborative Chair
<b>480140</b>	284	Node 480 Series Collaborative Stool
<b>480150</b>	279	Node 480 Series Collaborative Chair
<b>480210</b>	281	Node 480 Series MidBk Collab Chair
<b>480220</b>	281	Node 480 Series MidBk Collab Chair
<b>480230</b>	283	Node 480 Series MidBk Collab Chair
<b>480240</b>	285	Node 480 Series MidBk Collab Stool
<b>480250</b>	283	Node 480 Series MidBk Collab Chair
<b>480310</b>	286	Node 480 Series Collaborative Chair
<b>480320</b>	287	Node 480 Series Collaborative Stool
<b>480330</b>	286	Node 480 Series Collaborative Chair
<b>480340</b>	287	Node 480 Series Collaborative Stool
<b>480410</b>	288	Node 480 Series Collaborative Chair
<b>480420</b>	288	Node 480 Series Collaborative Chair
<b>490410</b>	302	Move 490
<b>490410C</b>	302	Move 490
<b>490410CP</b>	302	Move 490
<b>490410P</b>	302	Move 490
<b>490410U</b>	302	Move 490
<b>490410UC</b>	302	Move 490
<b>490412</b>	303	Move 490
<b>490412C</b>	303	Move 490
<b>490412CP</b>	303	Move 490
<b>490412P</b>	303	Move 490
<b>490412U</b>	303	Move 490
<b>490412UC</b>	303	Move 490
<b>490510</b>	309	Move 490 Perching Stool
<b>490510P</b>	309	Move 490 Perching Stool
<b>490510U</b>	309	Move 490 Perching Stool
<b>490512</b>	310	Move 490 Perching Stool
<b>490512P</b>	310	Move 490 Perching Stool
<b>490512U</b>	310	Move 490 Perching Stool
<b>490710</b>	305	Move 490
<b>490710C</b>	305	Move 490
<b>490710CP</b>	306	Move 490
<b>490710P</b>	306	Move 490
<b>490710U</b>	305	Move 490
<b>490710UC</b>	305	Move 490
<b>490712</b>	306	Move 490
<b>490712C</b>	306	Move 490
<b>490712CP</b>	307	Move 490
<b>490712P</b>	307	Move 490
<b>490712U</b>	307	Move 490
<b>490712UC</b>	307	Move 490
<b>490D</b>	311	Move Transport/Storage Dolly

Style Number	Page	Description	Style Number	Page	Description
<b>490GA4</b>	311	Move Ganging/Alignment Device	<b>HN240B30</b>	135	Sieste Bariatric
<b>490GA7</b>	311	Move Ganging/Alignment Device	<b>HN24T1H</b>	136	Sieste Table
<b>490WS</b>	311	Wall Saver	<b>HN24T1L</b>	136	Sieste Table
<b>9014S</b>	293, 295	Stacking Dolly	<b>HN26276SA</b>	369	Sieste Sleeper
<b>HLS105</b>	430	Surround Lounge, 104½" Frame Width	<b>HN26276SP</b>	369	Sieste Sleeper
<b>HLS44</b>	389-390	Surround Lounge, 44" Frame Width	<b>HN26280SA</b>	369	Sieste Sleeper
<b>HLS55</b>	394-395	Surround Lounge, 55" Frame Width	<b>HN26280SP</b>	369	Sieste Sleeper
<b>HLS61</b>	398-399	Surround Lounge, 60½" Frame Width	<b>HN26284SA</b>	369	Sieste Sleeper
<b>HLS66</b>	402-403	Surround Lounge, 66" Frame Width	<b>HN26284SP</b>	369	Sieste Sleeper
<b>HLS72</b>	406-407	Surround Lounge, 71½" Frame Width	<b>HN262A</b>	369	Sieste Bolster
<b>HLS77</b>	410-411	Surround Lounge, 77" Frame Width	<b>HR223</b>	349	Empath Recliner
<b>HLS83</b>	414-415	Surround Lounge, 82½" Frame Width	<b>HR223D</b>	349	Empath Recliner
<b>HLS88</b>	418-419	Surround Lounge, 88" Frame Width	<b>HR223DS</b>	350	Empath Recliner
<b>HLS94</b>	422-423	Surround Lounge, 93½" Frame Width	<b>HR223DU</b>	353	Empath Recliner w/Fully Upholstered Arm
<b>HLS99</b>	426-427	Surround Lounge, 99" Frame Width	<b>HR223DUS</b>	354	Empath Recliner
<b>HLSET</b>	431	Surround Storage, One-Tier End Table	<b>HR223L</b>	349	Empath Recliner
<b>HLSMT</b>	433	Surround, Mobile Tablet	<b>HR223LS</b>	350	Empath Recliner
<b>HLSTTT</b>	432	Surround Storage, Two-Tier End Table	<b>HR223LU</b>	353	Empath Recliners w/Fully Upholstered Arm
<b>HN2300EMM</b>	66	Cura Chair	<b>HR223LUS</b>	354	Empath Recliner
<b>HN2300MM</b>	66	Cura Chair	<b>HR223R</b>	349	Empath Recliner
<b>HN2301EMM</b>	67	Cura Chair	<b>HR223RS</b>	350	Empath Recliner
<b>HN2301MM</b>	67	Cura Chair	<b>HR223RU</b>	353	Empath Recliner w/Fully Upholstered Arm
<b>HN2305EMM</b>	64	Cura Chair	<b>HR223RUS</b>	354	Empath Recliner
<b>HN2305HL</b>	67	Cura Ottoman	<b>HR223S</b>	350	Empath Recliner
<b>HN2305HS</b>	67	Cura Ottoman	<b>HR223T</b>	351	Empath Recliner
<b>HN2305MM</b>	64	Cura Chair	<b>HR223TD</b>	351	Empath Recliner
<b>HN2306EMM</b>	65	Cura Chair	<b>HR223TDU</b>	355	Empath Recliner w/Fully Upholstered Arm
<b>HN2306MM</b>	65	Cura Chair	<b>HR223TL</b>	351	Empath Recliner
<b>HN2310EML</b>	66	Cura Chair	<b>HR223TLU</b>	355	Empath Recliner w/Fully Upholstered Arm
<b>HN2310EMLSB</b>	66	Cura Chair	<b>HR223TR</b>	351	Empath Recliner
<b>HN2310EMU</b>	66	Cura Chair	<b>HR223TRU</b>	355	Empath Recliner w/Fully Upholstered Arm
<b>HN2310EMUSB</b>	66	Cura Chair	<b>HR223TU</b>	355	Empath Recliner
<b>HN2310ML</b>	66	Cura Chair	<b>HR223U</b>	353	Empath Recliner
<b>HN2310MLSB</b>	66	Cura Chair	<b>HR223US</b>	354	Empath Recliner
<b>HN2310MU</b>	66	Cura Chair	<b>HS1B21C</b>	148	Tava Bench
<b>HN2310MUSB</b>	66	Cura Chair	<b>HS1B42C</b>	148	Tava Bench
<b>HN2311EML</b>	67	Cura Chair	<b>HS1B56C</b>	148	Tava Bench
<b>HN2311EMU</b>	67	Cura Chair	<b>HS1B56T1C</b>	148	Tava Bench
<b>HN2311ML</b>	67	Cura Chair	<b>HS1B70C</b>	148	Tava Bench
<b>HN2311MU</b>	67	Cura Chair	<b>HS1B70T1C</b>	148	Tava Bench
<b>HN2315EML</b>	64	Cura Chair	<b>HS1B70T2C</b>	148	Tava Bench
<b>HN2315EMLSB</b>	65	Cura Chair	<b>HS1C1</b>	142	Tava Single-Seat Guest Chair
<b>HN2315EMU</b>	64	Cura Chair	<b>HS1C130</b>	144	Tava Guest Bariatric Chair
<b>HN2315EMUSB</b>	65	Cura Chair	<b>HS1C140</b>	144	Tava Guest Bariatric Chair
<b>HN2315ML</b>	64	Cura Chair	<b>HS1C2</b>	142	Tava Two-Seat Guest Chair
<b>HN2315MLSB</b>	65	Cura Chair	<b>HS1CA2</b>	143	Tava Two-Seat Guest Chair
<b>HN2315MU</b>	64	Cura Chair	<b>HS1CA3</b>	143	Tava Three-Seat Guest Chair
<b>HN2315MUSB</b>	65	Cura Chair	<b>HS1CAU2</b>	143	Tava Two-Seat Guest Chair
<b>HN2316EML</b>	65	Cura Chair	<b>HS1CAU3</b>	143	Tava Three-Seat Guest Chair
<b>HN2316EMU</b>	65	Cura Chair	<b>HS1CU1</b>	142	Tava Single-Seat Guest Chair
<b>HN2316ML</b>	65	Cura Chair	<b>HS1CU130</b>	144	Tava Guest Bariatric Chair
<b>HN2316MU</b>	65	Cura Chair	<b>HS1CU140</b>	144	Tava Guest Bariatric Chair
<b>HN240</b>	134	Sieste Lounge	<b>HS1CU2</b>	142	Tava Two-Seat Guest Chair
<b>HN2402</b>	134	Sieste Loveseat	<b>HS1L1</b>	146	Tava Chair Lounge
<b>HN2403</b>	134	Sieste Sofa	<b>HS1L130</b>	147	Tava Bariatric Lounge

Style Number Index, continued

Style Number	Page	Description
<b>HS1L140</b>	147	Tava Bariatric Lounge
<b>HS1L2</b>	146	Tava Loveseat
<b>HS1L3</b>	146	Tava Sofa
<b>HS1P1</b>	145	Tava High-back Chair
<b>HS1PU1</b>	145	Tava Highback Chair
<b>HS1T1418C</b>	150	Tava Freestanding Table
<b>HS1T2115C</b>	150	Tava Freestanding Table
<b>HS1T2118C</b>	150	Tava Freestanding Table
<b>HS1T4215C</b>	150	Tava Freestanding Table
<b>HS21C</b>	290	Verge Stool with Casters
<b>HS21G</b>	290	Verge Stool with Glides
<b>HS27G</b>	290	Verge Stool with Glides
<b>HS2L121</b>	106	Leela Lounge Chair
<b>HS2L124</b>	106	Leela Single-Seat Chair
<b>HS2L130</b>	107	Leela Bariatric Lounge
<b>HS2L140</b>	107	Leela Bariatric Lounge
<b>HS2L2</b>	106	Leela Loveseat Chair
<b>HS2L3</b>	106	Leela Sofa Chair
<b>HS2T212121C</b>	108	Leela Freestanding Table
<b>HS2T212121S</b>	108	Leela Freestanding Table
<b>HS2T422116C</b>	108	Leela Freestanding Table
<b>HS2T422116S</b>	108	Leela Freestanding Table
<b>HS31G</b>	290	Verge Stool with Glides
<b>HS42L1122</b>	255	Regard Planter Liners
<b>HS42L1133</b>	255	Regard Planter Liners
<b>HS42L1144</b>	255	Regard Planter Liners
<b>HS42L2222</b>	255	Regard Planter Liners
<b>HS4AD11</b>	247	Regard Arm
<b>HS4AD11C</b>	247	Regard Arm
<b>HS4AD6</b>	247	Regard Arm
<b>HS4AD6C</b>	247	Regard Arm
<b>HS4AS11</b>	247	Regard Arm
<b>HS4AS11C</b>	247	Regard Arm
<b>HS4AS6</b>	247	Regard Arm
<b>HS4AS6C</b>	247	Regard Arm
<b>HS4AU11</b>	248	Regard Contour Arm
<b>HS4BD33</b>	245	Regard Back
<b>HS4BD39</b>	245	Regard Back
<b>HS4BD44</b>	245	Regard Back
<b>HS4BD50</b>	245	Regard Back
<b>HS4BD55</b>	245	Regard Back
<b>HS4BD61</b>	245	Regard Back
<b>HS4BD66</b>	246	Regard Back
<b>HS4BD72</b>	246	Regard Back
<b>HS4BD77</b>	246	Regard Back
<b>HS4BD83</b>	246	Regard Back
<b>HS4BD88</b>	246	Regard Back
<b>HS4BS33</b>	244	Regard Back
<b>HS4BS44</b>	244	Regard Back
<b>HS4BS55</b>	244	Regard Back
<b>HS4BS61</b>	244	Regard Back
<b>HS4BS66</b>	244	Regard Back
<b>HS4BS72</b>	245	Regard Back
<b>HS4BS77</b>	245	Regard Back
<b>HS4BS83</b>	245	Regard Back

Style Number	Page	Description
<b>HS4BS88</b>	245	Regard Back
<b>HS4CM</b>	257	Regard Media Cabinet
<b>HS4D1828L</b>	257	Regard Desk Cabinet
<b>HS4D1828S</b>	257	Regard Desk Cabinet
<b>HS4D1830L</b>	257	Regard Desk Cabinet
<b>HS4D1830S</b>	257	Regard Desk Cabinet
<b>HS4D1836L</b>	257	Regard Desk Cabinet
<b>HS4D1836S</b>	257	Regard Desk Cabinet
<b>HS4DR1828L</b>	257	Regard Desk Cabinet
<b>HS4DR1828S</b>	257	Regard Desk Cabinet
<b>HS4DR1830L</b>	257	Regard Desk Cabinet
<b>HS4DR1830S</b>	257	Regard Desk Cabinet
<b>HS4DR1836L</b>	257	Regard Desk Cabinet
<b>HS4DR1836S</b>	257	Regard Desk Cabinet
<b>HS4FB44</b>	239	Regard Bench Frame
<b>HS4FB66</b>	239	Regard Bench Frame
<b>HS4FC4481</b>	239	Regard Booth Frame
<b>HS4FC5581</b>	239	Regard Booth Frame
<b>HS4FD2255</b>	239	Regard Desk Cabinet
<b>HS4FD44</b>	238	Regard Frame
<b>HS4FD55</b>	238	Regard Frame
<b>HS4FD61</b>	238	Regard Frame
<b>HS4FD66</b>	238	Regard Frame
<b>HS4FD72</b>	238	Regard Frame
<b>HS4FD77</b>	238	Regard Frame
<b>HS4FD83</b>	238	Regard Frame
<b>HS4FD88</b>	238	Regard Frame
<b>HS4FE1144</b>	240	Planter Frame Extension
<b>HS4FE1155</b>	240	Regard Frame Extension
<b>HS4FE1161</b>	240	Planter Frame Extension
<b>HS4FE1166</b>	240	Planter Frame Extension
<b>HS4FE1172</b>	240	Planter Frame Extension
<b>HS4FE1177</b>	240	Planter Frame Extension
<b>HS4FE1183</b>	240	Planter Frame Extension
<b>HS4FE1188</b>	240	Planter Frame Extension
<b>HS4FE2855</b>	240	Regard Frame Extension
<b>HS4FG</b>	241	Regard Frame Bracket
<b>HS4FR44</b>	250	Regard Tablet Rail
<b>HS4FR55</b>	250	Regard Tablet Rail
<b>HS4FR61</b>	250	Regard Tablet Rail
<b>HS4FR66</b>	250	Regard Tablet Rail
<b>HS4FR72</b>	250	Regard Tablet Rail
<b>HS4FR77</b>	250	Regard Tablet Rail
<b>HS4FR83</b>	250	Regard Tablet Rail
<b>HS4FR88</b>	250	Regard Tablet Rail
<b>HS4FS33</b>	238	Regard Frame
<b>HS4FS44</b>	238	Regard Frame
<b>HS4FS55</b>	238	Regard Frame
<b>HS4FS61</b>	238	Regard Frame
<b>HS4FS66</b>	238	Regard Frame
<b>HS4FS72</b>	238	Regard Frame
<b>HS4FS77</b>	238	Regard Frame
<b>HS4FS83</b>	238	Regard Frame
<b>HS4FS88</b>	238	Regard Frame
<b>HS4FSP44</b>	239	Planter Frame

Style Number	Page	Description	Style Number	Page	Description
<b>HS4FSP55</b>	239	Planter Frame	<b>HS4VH18</b>	261	Regard Modular Harness
<b>HS4FSP61</b>	239	Planter Frame	<b>HS4VH21</b>	261	Regard Modular Harness
<b>HS4FSP66</b>	239	Planter Frame	<b>HS4VH24</b>	261	Regard Modular Harness
<b>HS4FSP72</b>	239	Planter Frame	<b>HS4VH27</b>	261	Regard Modular Harness
<b>HS4FSP77</b>	239	Planter Frame	<b>HS4VH30</b>	261	Regard Modular Harness
<b>HS4FSP83</b>	239	Planter Frame	<b>HS4VH33</b>	261	Regard Modular Harness
<b>HS4FSP88</b>	239	Planter Frame	<b>HS4VH36</b>	261	Regard Modular Harness
<b>HS4FW1155</b>	239	Regard Wall-Mounted Frame	<b>HS4VH39</b>	261	Regard Modular Harness
<b>HS4H22</b>	242	Regard Cushion	<b>HS4VH42</b>	261	Regard Modular Harness
<b>HS4H28</b>	242	Regard Cushion	<b>HS4VK1</b>	261	Regard Receptacle Kit
<b>HS4H33</b>	242	Regard Cushion	<b>HS4VK2</b>	261	Regard Receptacle Kit
<b>HS4HB</b>	242	Regard Cushion	<b>HS4VKD44</b>	259	Regard Power Kit
<b>HS4LSP44</b>	254	Regard Planter Shelf	<b>HS4VKD55</b>	259	Regard Power Kit
<b>HS4LSP55</b>	254	Regard Planter Shelf	<b>HS4VKD61</b>	259	Regard Power Kit
<b>HS4LSP61</b>	254	Regard Planter Shelf	<b>HS4VKD66</b>	259	Regard Power Kit
<b>HS4LSP66</b>	254	Regard Planter Shelf	<b>HS4VKD72</b>	259	Regard Power Kit
<b>HS4LSP72</b>	254	Regard Planter Shelf	<b>HS4VKD77</b>	259	Regard Power Kit
<b>HS4LSP77</b>	254	Regard Planter Shelf	<b>HS4VKD83</b>	259	Regard Power Kit
<b>HS4LSP83</b>	254	Regard Planter Shelf	<b>HS4VKD88</b>	259	Regard Power Kit
<b>HS4LSP88</b>	254	Regard Planter Shelf	<b>HS4VKS</b>	259	Regard Power Kit
<b>HS4P1122</b>	253	Regard Planter	<b>HS4VNB</b>	262	Regard Connector
<b>HS4P1133</b>	253	Regard Planter	<b>HS4VNL</b>	262	Regard Connector
<b>HS4P1144</b>	253	Regard Planter	<b>HS4VPSDC</b>	260	Regard Power Strip
<b>HS4P2222</b>	253	Regard Planter	<b>HS4VPSDH</b>	260	Regard Power Strip
<b>HS4S33G</b>	251	Regard Privacy Screen	<b>HS4VPSFC</b>	260	Regard Power Strip
<b>HS4S39G</b>	251	Regard Privacy Screen	<b>HS4VPSFH</b>	260	Regard Power Strip
<b>HS4S44G</b>	251	Regard Privacy Screen	<b>HSBARM</b>	102	Embold Midarm
<b>HS4S50G</b>	251	Regard Privacy Screen	<b>HSBB32</b>	89	Embold Single Bariatric Seat 32"W
<b>HS4S55G</b>	251	Regard Privacy Screen	<b>HSBE21</b>	98	Embold Easy Access Seat 21"W
<b>HS4S61G</b>	251	Regard Privacy Screen	<b>HSBE32</b>	98	Embold Easy Access Seat 32"W
<b>HS4S66G</b>	251	Regard Privacy Screen	<b>HSBL43</b>	91	Embold Loveseat
<b>HS4S72G</b>	251	Regard Privacy Screen	<b>HSBLEG</b>	103	Embold Midleg
<b>HS4S77G</b>	251	Regard Privacy Screen	<b>HSBLEGP</b>	103	Embold Midleg and Support Plate
<b>HS4S83G</b>	251	Regard Privacy Screen	<b>HSBM66</b>	94	Embold Multiple Seat 66"W
<b>HS4S88G</b>	251	Regard Privacy Screen	<b>HSBM88</b>	94	Embold Multiple Seat 88"W
<b>HS4SA2</b>	251	Regard Screen Brackets and Stanchions	<b>HSBM88C</b>	95	Embold Multiple Seat Bariatric 88"W
<b>HS4SA4</b>	251	Regard Screen Brackets and Stanchions	<b>HSBS21</b>	88	Embold Single Seat 21"W
<b>HS4SET11</b>	249	Regard;Tbl-End,Stg appl,11½"W	<b>HSBS24</b>	88	Embold Single Seat 24"W
<b>HS4T11</b>	249	Regard;Strg end tbl,Filler,11W	<b>HSBT20</b>	101	Embold Circular Table
<b>HS4T2218L</b>	252	Regard Table	<b>HSBT3219</b>	101	Embold Rounded Rectangle Table
<b>HS4T2218S</b>	252	Regard Table	<b>HSBT4220</b>	101	Embold Racetrack Table
<b>HS4T2228L</b>	252	Regard Table	<b>HSP20A</b>	127	Radia Single Chair
<b>HS4T2228S</b>	252	Regard Table	<b>HSP20HA</b>	130	Radia High-Back Chair
<b>HS4T2618L</b>	252	Regard Table	<b>HSP20N</b>	126	Radia Armless Chair
<b>HS4T2618S</b>	252	Regard Table	<b>HSP30A</b>	128	Radia Bariatric Chair
<b>HS4TC4481L</b>	258	Regard Booth with Table	<b>HSP42A</b>	129	Radia Loveseat
<b>HS4TC4481S</b>	258	Regard Booth with Table	<b>HSPGB</b>	131	Radia Ganging Bracket
<b>HS4TC5581L</b>	258	Regard Booth with Table	<b>HTT181821W</b>	122	Outlook Freestanding Table
<b>HS4TC5581S</b>	258	Regard Booth with Table	<b>HTT242021P</b>	122	Outlook Freestanding Table
<b>HS4TL11</b>	248	Regard In-Line Table Arm	<b>HTT242021W</b>	122	Outlook Freestanding Table
<b>HS4VBPH</b>	259	Regard Hardwire Power Infeed	<b>HTT24R21W</b>	122	Outlook Freestanding Table
<b>HS4VCC</b>	263	Regard Cable Clamp	<b>HTT262621P</b>	122	Outlook Freestanding Table
<b>HS4VCR</b>	262	Regard Vertical Cable Riser	<b>HTT262621W</b>	122	Outlook Freestanding Table
<b>HS4VH12</b>	261	Regard Modular Harness	<b>SC1050</b>	340	Sorrel Ganging Table
<b>HS4VH15</b>	261	Regard Modular Harness	<b>SC1051L</b>	340	Sorrel Ganging Table

Style Number Index, continued

Style Number	Page	Description
<b>SC1051R</b>	340	Sorrel Ganging Table
<b>SC1054</b>	340	Sorrel Ganging Table
<b>SC1060D</b>	337	Stackable Sorrel Dolly Cart
<b>SC1060SA</b>	331	Sorrel 18"W Stacking Chair
<b>SC1060SN</b>	330	Sorrel 18"W Stacking Chair
<b>SC10621818</b>	339	Sorrel Table
<b>SC1062SA</b>	333	Sorrel 22"W Stacking Chair
<b>SC1062SN</b>	333	Sorrel 22"W Stacking Chair
<b>SC1065D</b>	337	Stackable Sorrel Dolly Cart
<b>SC1065SA</b>	334	Sorrel Bariatric Stacking Chair
<b>SC1067EA</b>	335	Sorrel 18"W Easy Access Chair
<b>SC1069EA</b>	336	Sorrel 22"W Easy Access Chairs
<b>SC1080</b>	331, 333-336	Pair Ganging Brackets
<b>SC2091</b>	359	Mineral Recliner
<b>SC2091L</b>	359	Mineral Recliner
<b>SC2091R</b>	359	Mineral Recliner
<b>SC27DT18D</b>	123	Freestanding and Interconnecting Tbl
<b>SC27DT24D</b>	123	Freestanding and Interconnecting Tbl
<b>SC4007</b>	57	Aspekt Easy Access Arm Chair
<b>SC4009</b>	35, 37, 39-40, 50-53	Aspekt Set Ganging Brackets
<b>SC4010</b>	50	Aspekt Single-Seat Chair
<b>SC4020</b>	51	Aspekt Two-Seat Chair
<b>SC4030</b>	52	Aspekt Three-Seat Chair
<b>SC4043</b>	46, 58	Aspekt Bench
<b>SC4045</b>	47, 58	Aspekt Footstool
<b>SC4050</b>	60	Aspekt Ganging Table
<b>SC4051L</b>	60	Aspekt Ganging Table
<b>SC4051R</b>	60	Aspekt Ganging Table
<b>SC4053</b>	60	Aspekt Ganging Table
<b>SC4054</b>	60	Aspekt Ganging Table
<b>SC4055</b>	61	Aspekt FS Table
<b>SC4057</b>	61	Aspekt FS Table
<b>SC4058</b>	61	Aspekt FS Table
<b>SC4060</b>	53	Aspekt Bariatric Arm Chair
<b>SC4062</b>	54	Aspekt Bariatric Wave Arm Chair
<b>SC4063</b>	55	Aspekt Bariatric Wave Arm Chair
<b>SC4085</b>	56	Aspekt High-Back Chair
<b>SC4207</b>	45	Aspekt Easy Access Arm Chair
<b>SC4210</b>	34	Aspekt Single-Seat Chair
<b>SC4220</b>	37	Aspekt Two-Seat Chair
<b>SC4230</b>	39	Aspekt Three-Seat Chair
<b>SC4260</b>	40	Aspekt Bariatric Arm Chair
<b>SC4262</b>	43	Aspekt Bariatric Straight Arm Chair
<b>SC4263</b>	43	Aspekt Bariatric Straight Arm Chair
<b>SC4285</b>	44	Aspekt High-Back Chair
<b>SC6010A</b>	112	Mitra Guest Seating
<b>SC6026A</b>	112	Mitra Guest Seating
<b>SC6055</b>	118	Mitra FS Table
<b>SC6056</b>	118	Mitra FS Table
<b>SC6057</b>	118	Mitra FS Table
<b>SC6058</b>	118	Mitra FS Table
<b>SC6060A</b>	113	Mitra Bariatric Seating
<b>SC6067EA</b>	115	Mitra Easy Access Chair
<b>SC6085A</b>	114	Mitra High-Back Chair

Style Number	Page	Description
<b>SC6091</b>	362	Mitra Recliner
<b>SC6091T</b>	362	Mitra Recliner with Trendelenburg
<b>SC6110L</b>	116	Mitra Lounge Chair
<b>SC6120L</b>	116	Mitra Lounge Chair
<b>SC6130L</b>	116	Mitra Lounge Chair
<b>SC6140S</b>	365	Mitra Sleeper Chair
<b>SC6158</b>	119	Mitra Freestanding Table
<b>SC8141L</b>	436	X-tenz Sleeper Chair
<b>SC8141LC</b>	436	X-tenz Sleeper Chair
<b>SC8141R</b>	436	X-tenz Sleeper Chair
<b>SC8141RC</b>	436	X-tenz Sleeper Chair
<b>SC8241</b>	437	X-tenz Sleeper Chair
<b>TS31401</b>	175	Jenny Chair
<b>TS31401C</b>	175	Jenny Chair
<b>TS31401CH</b>	175	Jenny Chair
<b>TS31401CT</b>	175	Jenny Chair
<b>TS31401H</b>	175	Jenny Chair
<b>TS31401T</b>	175	Jenny Chair
<b>TS31402</b>	177	Jenny Chair
<b>TS31402C</b>	177	Jenny Chair
<b>TS31403</b>	180	Jenny Chair
<b>TS31403C</b>	180	Jenny Chair
<b>TS31403CH</b>	180	Jenny Chair
<b>TS31403CT</b>	180	Jenny Chair
<b>TS31403H</b>	180	Jenny Chair
<b>TS31403T</b>	180	Jenny Chair
<b>TS31404</b>	180	Jenny Chair
<b>TS31404C</b>	180	Jenny Chair
<b>TS31404CH</b>	180	Jenny Chair
<b>TS31404CT</b>	180	Jenny Chair
<b>TS31404H</b>	180	Jenny Chair
<b>TS31404T</b>	180	Jenny Chair
<b>TS31405</b>	191	Jenny Ottoman
<b>TS31405C</b>	191	Jenny Ottoman
<b>TS31406</b>	183	Jenny Chair
<b>TS31406C</b>	183	Jenny Chair
<b>TS31407</b>	185	Jenny Chair
<b>TS31407C</b>	185	Jenny Chair
<b>TS31408</b>	189	Jenny Chair
<b>TS31409</b>	187	Jenny Chair
<b>TS31410</b>	191	Alight Ganging Kit
<b>TS31412</b>	193	Club Low
<b>TS31413</b>	195	Round Low
<b>TS31415H</b>	196	Jenny Occasional Table
<b>TS31415L</b>	196	Jenny Occasional Table
<b>TS31416H</b>	196	Jenny Occasional Table
<b>TS31416L</b>	196	Jenny Occasional Table
<b>TS31426</b>	183	Jenny Chair
<b>TS31426C</b>	183	Jenny Chair
<b>TS31428</b>	189	Jenny Chair
<b>TS31438</b>	189	Jenny Chair
<b>WEHMDC4CNFNA</b>	464	Sterling – Health Conference Chair
<b>WEHMDC4CNFWA</b>	465	Sterling – Health Conference Chair
<b>WEHMDC4MNA</b>	460	Sterling—Health Guest Chair
<b>WEHMDC4MWA</b>	461	Sterling—Health Guest Chair

<b>Style Number</b>	<b>Page</b>	<b>Description</b>
<b>WEHMDC4NA</b>	458	Sterling – Health Guest Chair
<b>WEHMDC4WA</b>	459	Sterling – Health Guest Chair
<b>WEHMDC5NA</b>	462	Sterling – Health Conference Chair
<b>WEHMDC5WA</b>	463	Sterling – Health Conference Chair
<b>WEHMDCSBHNA</b>	467	Sterling Bar-Height Stool
<b>WEHMDCSCHNA</b>	466	Sterling Counter-Height Stool
<b>WEHMES2SEAT</b>	444	Mesa – Health Armless Lounge
<b>WEHMESC</b>	445	Mesa – Health Corner Lounge
<b>WEHMESCHLH</b>	442	Mesa – Health Two-Seat Chaise LH
<b>WEHMESCHRH</b>	443	Mesa – Health Two-Seat Chaise RH
<b>WEHMESO</b>	446	Mesa – Health Ottoman
<b>WEHSLPCG</b>	451	Slope – Health Guest Chair
<b>WEHSLPCGB</b>	452	Slope – Health Bariatric Guest Chair
<b>WEHSLPCS</b>	453	Slope – Health Stacking Guest Chair

# Trademark List

™/® The following is a non-exhaustive list of trademarks and registered trademarks for products of Steelcase Inc. or one of its related corporate entities: Agree, Airtouch, Alight, Amia, Answer, Aspekt, Avenir, Await, B-Free, Ballet, Bassline, Bindu, Bivi, Bix, Bottomline, Brody, Buoy, Cachet, Campfire, Capa, CF Series, CG\_1, Chord, Circa, Clipper, Cobi, Collaboration, Convene, Coupe, Cura, Currency, dash, Divisio, Duo, E-Table 2, Edge Series, Elbrook, Elective Elements, Embold, Empath, Everwall, Exponents, Folio, FrameOne, Gesture, Groupwork, Host, Hosu, i2i, Jenny, Kart, Kathryn, Kick, Lagunitas, Leap, Leela, LessThanFive, LiveBack, LiveSeat, Mackinac, Marien152, Max-Stacker, media:scape, Migration, Millbrae, Mineral, Mitra, Montage, Montara650, MoreThanFive, Move, Node, Ocular, Ology, Opus, Paperflo, Passerelle, Player, Pocket, Potrero415, QiVi, Radia, Regard, Relay, Reply, Ripple, Roam, Sarto, Scoop, Sebastopol, Senti Series, Senza, Shortcut, Sidewalk, Siento, Sieste, SILQ, Soffio, Sorrel, SOTO, Steelcase Eclipse, Steelcase Flex, Steelcase Karman, Steelcase Relay, Steelcase Rise, Steelcase Series, Surround, SW\_1, Switch, Sync, Tava, Tenor, Think, Thoughtful, Thread, Together, Train, Trees, Turnstone, Umami, Underscore, V.I.A., Verb, Verge, Verlay, Victor2, Visalia, WorkValet, and X-tenz.

™/® The following are trademarks or registered trademarks of AMQ Solutions, LLC: 3F, Activ, Amobi, Bixby, Bodi, Cluvo, Concur, Embank, FL-X, Iline, Jaku, Kinex, Personality Plus, Revi, S-Series, Siya, Tektis, Tizu, Uptake, and Zilo.

™/® The following are trademarks or registered trademarks of Orangebox Ltd., Cardiff, UK: Air3, Aspect, Avi, Away from the Desk, Border, Campers & Dens, Coppice, Cubb, Kirm, On the QT, Ramsey, Skomer, Sully, Track-B, and Vale.

™/® The following are trademarks or registered trademarks of Viccarbe Habitat, S.L.: Aleta, Cambio, Designed in The Sun, Foro, Funda, Holy Day, Kelly, Last Minute, Noha, Savina, Sistema, Sistema, Viable, and Wrapp.

® The following are registered brands of Steelcase Inc. and its family of companies: Steelcase, AMQ, Coalesse, Designtex, Halcon, Orangebox, Smith System, and Viccarbe.

® The following registered trademarks are under license from AWI Licensing Company, Dover, DE: SoundScapes, DuraBrite, BioBlock, and Armstrong.

® The following registered trademarks are under license from Byrne Electrical, Rockford, MI: Interport, Mini-Port, Axil Z, and Ellora.

® The following is a registered trademark of DuPont, Wilmington, DE: Corian.

® The following is a registered trademark of Genlyte Thomas Company, Louisville, KY: Lightolier.

® The following is a registered trademark of Hilti Corporation, FL-9494 Schaan, Principality of Liechtenstein: Hilti.

® The following is a registered trademark of Leviton Manufacturing Company, Little Neck, NY: Decora.

® The following is a registered trademark of Mechanical Plastics Corp, Elmsford, NY: Toggler.

® The following is a registered trademark of Microsoft Corporation, Redmond, WA: Microsoft.

® The following are registered trademarks of Orangebox Ltd., Cardiff, UK: Orangebox.

® The following is a registered trademark of Panduit Corporation, Lockport, IL: Panduit.

® The following is a registered trademark of Trav (Press), Cuneo, Italy: Assisa.

® The following is a registered trademark of Virtual Ink, Boston, MA: mimioActive.

® The following registered trademarks are under license from Wilkhahn Furniture Products: Avera, Senzo, Versal, and Wilkhahn FS.

® The following are registered trademarks of Polyvision Corp: Flow, Motif, Polyvision, Sans, and Serif.

® The following is a registered trademark of Wilsonart International, Temple, TX: Chemsurf.

® The following is a registered trademark of Wiremold, West Hartford, CT: Wiremold.

® The following is a registered trademark of EMU Group S.P.A., Perugia, Italy: EMU.

® The following is a registered trademark of Security People, Inc.: Digilock.

® The following are registered trademarks of Natural Capital Partners Europe Limited: CarbonNeutral and the CarbonNeutral Certified logo.

™ The following is a trademark of Microsoft Corporation, Redmond, WA: Windows.

™ The following is a trademark of Rodman Industries, Inc., Oconomowoc, WI: ResinCore1.

™ The following is a trademark of Ultrafabrics, LLC, Elmsford, NY: Ultraleather.

™ The following trademarks are under license from Wilkhahn Furniture products: Cana, Linus, Logon, Picto, Range, Stitz, Thema, Timetable, and Tubis.

™ The following trademarks are under license from Walter Knoll: Andoo, Bob, Lazlo, Lox, Ribbon, and Together.

™ The following trademarks are under license from PP Mobler: Bar and Flag Halyard.

™ The following trademarks are under license from Carl Hansen: Elbow, Paddle, Shell, Wing, and Wishbone.

™ The following trademarks are under license from Cambridge Sound Management, LLC Cambridge, MA: QtPro Soundmasking, Qt Quiet Technology, and Sonet Qt.

™ The following is a trademark of Electri-Cable Assemblies, Shelton, CT: Interact.

™ The following is a trademark of Clestra Hauserman: IRYS.

™ The following is a trademark of Wiesner-Hager Möbel GmbH: Nooi.

™ The following are trademarks of Polyvision: Accord, a3, e3, Boundri, and Nota.

™ The following is a trademark of Bostock Company, Inc: SnapCab.

™ The following is a trademark of Williams-Sonoma, Inc: West Elm.

™ The following is a trademark of Elena Marquina Testor: nanimarquina.

™ The following is a trademark of Forbo International SA: Forbo.

Trademarks used herein are the property of Steelcase Inc. or their respective owners.