

Seating Specification Guide

Availability

Electronic price list updated with release 200.K (U.S.) and 156.K (Canada), dated February 26, 2024.

All specifications subject to change without notice. Reference the electronic catalog/Hedberg for current pricing.

Transitional products in this specification guide are **maintained for existing customers only** and are likely to be phased out over time. These products are indicated with a . Products that are scheduled to be culled are indicated with an , followed by the last order entry date.

Surface Materials

The surface materials team has announced the launch of the Finish Library, found at www.steelcase.com/finishlibrary/.

► For a list of all trademarks, refer to the last page of this specification guide. © 2024 Steelcase Inc.

Ten Tips: How to Get The Most Out of This Book	2
Seating	5
Steel Seating Statement of Line	6
Basics of Ergonomic Seating	21
Basics of Adjustability	24
Additional Resources	30
Surface Materials	633
Wood Seating	683
Resources	703



For Canadian Pricing

Canadian factor can be found at www.steelcase.com/CADpricing/. Calculate in the following order to avoid rounding errors:

- Multiply the base price and each option by the Canadian factor.
- Round each to the nearest dollar.
- Add base and options for total list price.

Ten Tips: How to Get the Most Out of This Book

Tip 1

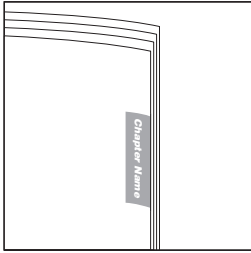

Watch the tabs on the right-hand edges of the pages. They'll always indicate which chapter you are in.

Tip 2

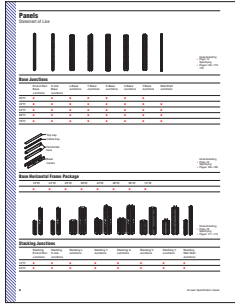

Use the Statement of Line pages for an overview of the available components, their sizes, and page references for additional information. Each *Understanding* chapter includes a statement of line after the table of contents.

Tip 3



Find cross references by looking for page numbers flagged with an arrow.

Tip 4

Study the product detail pages in the *Understanding* section to learn everything an expert knows about specific products. Each product detail page in this section contains the following features, where applicable:

- Product Drawing
- Actual Dimensions
- Product Details
- Connections
- Wiring and Cabling
- Surface Materials
- Application Topics

Product Drawing shows you what the product looks like and points out important features.

Product Details gives specific information on the product and how it is used.

Connections describes how the product is assembled or how it attaches to another product.

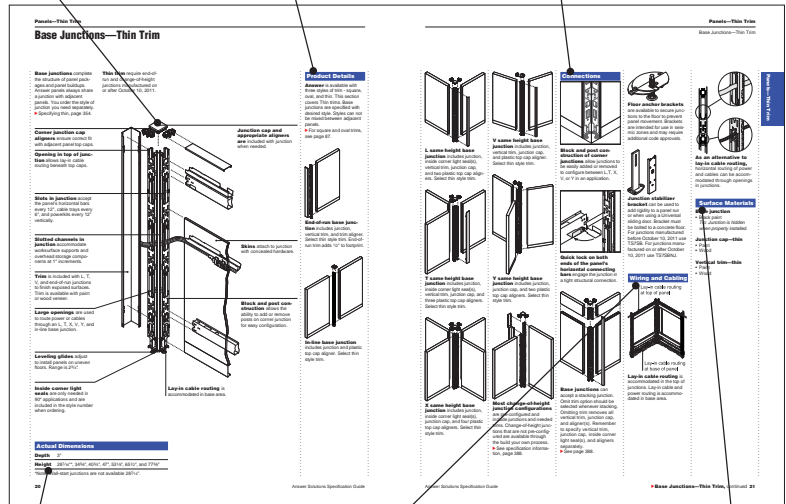

Actual Dimensions table lists the dimensions of the product.

Wiring and Cabling details the power and cable-management and cable routing capabilities of the product.

Surface Materials lists what material is used for each part of the product.

Tip 5

Refer to the specifying pages for all the information needed to order a product. Each product specifying page contains a variety of elements to help you complete a specification:

- Product Drawing
- Standard Includes
- Required to Specify
- Options
- Related Products
- Specification Information
- Dimensions
- Style Number
- Price

Standard Includes (under the red or dark grey band) provides a list of what comes standard with the product.

Required to Specify (under the red or dark grey band) itemizes the information that you must provide to order the standard product and the preferred sequence for specification.

Specification Information (under the teal or light grey band) provides product dimensions, style numbers, and prices for the standard product and any surface material choices that are available.

Product Drawing shows you what the product looks like.

Standard Includes

- Standard 18-gauge steel (18-gauge aluminum) seat frame
- Base trim with no backrests (on 18-gauge seat frame)
- Base trim with backrests (18-gauge seat frame)
- Standard 18-gauge steel (18-gauge aluminum) seat frame

Options

Options	Unit Price	Required to Specify
18-gauge steel	18.00	Specify per seat
18-gauge aluminum	18.00	Specify per seat
18-gauge steel	18.00	Specify per seat
18-gauge aluminum	18.00	Specify per seat

Required to Specify

Options	Unit Price	Required to Specify
18-gauge steel	18.00	Specify per seat
18-gauge aluminum	18.00	Specify per seat
18-gauge steel	18.00	Specify per seat
18-gauge aluminum	18.00	Specify per seat

Specification Information

Style Number	Unit Price	Option
18-gauge steel	18.00	Specify per seat
18-gauge aluminum	18.00	Specify per seat
18-gauge steel	18.00	Specify per seat
18-gauge aluminum	18.00	Specify per seat

Options (under the black band) lists all the options that apply to the product, their price, and what is required to specify.

Related Products provide specification information for products that are directly related.

Tip 6

Required to Specify

Specify with *Customiz Stain*

Italic typeface on specifying pages usually identifies wording that you should use in your order.

Tip 7

To determine how many skins are needed to complete a panel, consult the table at the right.

Tip: Remember to order skins for both sides of the panel buildup.

Watch for tips throughout the text that give you explanations and helpful instructions.

Tip 8

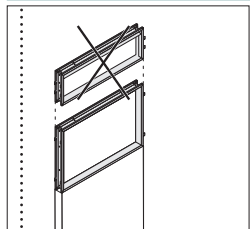

Learn what you cannot do by looking for drawings crossed out with an "X."

Tip 9

Use the surface materials listings in the Surface Materials section of this book to find surface material color numbers.

Tip 10

Style Number	Page
TS7042BL	131
TS7042S	130
TS7048BL	131
TS7048S	130
TS7060BL	131
TS7060S	130
TS7072BL	131

Refer to the style number index when you need to find the page that has more details about the product.



Seating



Statement of Line

6

Work Chairs

Gesture 442 Series	31
Leap 462 Series	47
Steelcase Karman	73
Think 465 Series	87
Amia 482 Series	119
Steelcase Series 2	151
Steelcase Series 1	179
Reply 466 Series	209
Siento 499 Series	241

Multi-Use Seating

Tenor	197
Reply 466 Series	209
Kart Series	229
Shortcut	323
Cachet 487 Series	345
Player 475 Series	361
Simple	377
Move 490 Series	387
Scoop	405
Nooi	409
Max-Stacker III 477 Series	427
Buoy	435

Collaborative Seating

SILQ 418 Series	249
QiVi 428 Series	263
cobi 434 Series	275
Node 480 Series	285
Flex Perch Stool	321

Lounge Seating

Brody 488 Series	439
Umami	467
Campfire	529
B-Free	557
Jenny	587
i2i 416 Series	621
Alight	627

Statement of Line

Work Chairs

Gesture 442 Series

Understanding
▶ Page 32
Specifying
▶ Pages 40–44



Leap 462 Series

Understanding
▶ Page 48
Specifying
▶ Pages 54–70

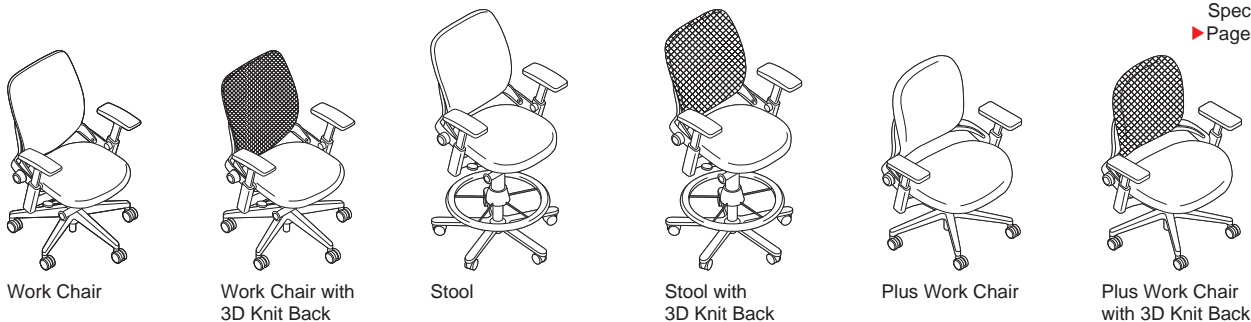

Steelcase Karman

Understanding
▶ Page 74
Specifying
▶ Pages 82–84

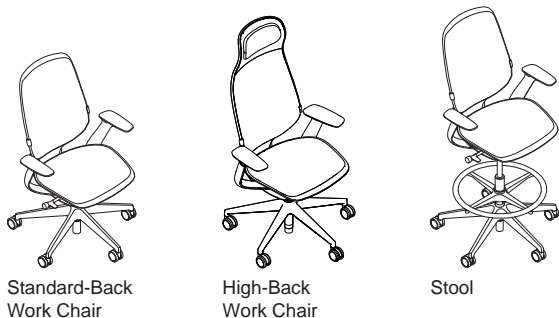

Think 465 Series

Understanding
▶ Page 88
Specifying
▶ Pages 100–116

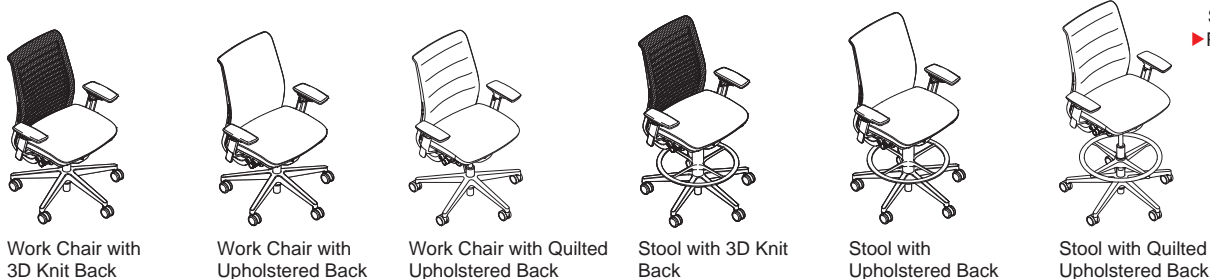

Work Chairs, continued

Amia 482 Series

Understanding
 ▶ Page 120
 Specifying
 ▶ Pages 128–148

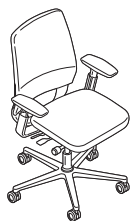

Work Chair with Sewn Leather Upholstery on Seat, Back, and Arms



Work Chair with Upholstery on Seat and Back



Work Chair with 3D Knit on Back, Upholstery on Seat



Work Chair with Air Back and 3D Microknit, Upholstery on Seat



Work Chair with Air Back, Upholstery on Seat



Stool with Upholstery on Seat and Back



Stool with 3D Knit on Back, Upholstery on Seat

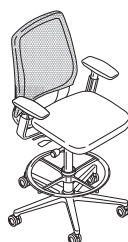

Stool with Air Back and 3D Microknit, Upholstery on Seat



Stool with Air Back, Upholstery on Seat

Steelcase Series 2

Understanding
 ▶ Page 152
 Specifying
 ▶ Pages 160–177



Work Chair with Air Back, Upholstery on Seat and Back



Work Chair with Air Back and 3D Microknit, Upholstery on Seat



Work Chair with Air Back, Upholstery on Seat



Stool with Air Back, Upholstery on Seat and Back

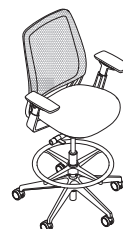

Stool with Air Back and 3D Microknit, Upholstery on Seat



Stool with Air Back, Upholstery on Seat

Steelcase Series 1

Understanding
 ▶ Page 180
 Specifying
 ▶ Pages 188–196



Work Chair with 3D MicroKnit Back



Work Chair with Back



Stool with 3D MicroKnit Back



Stool with Air Back

Work Chairs, continued

Tenor

Understanding
▶ Page 198
Specifying
▶ Pages 201–204

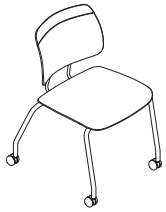

Tenor Chair



Tenor Chair with
Foot Bar

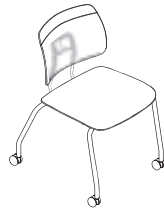

Tenor Chair with
Bag Hook

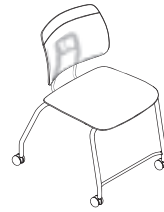

Tenor Chair with
Bag Hook and
Foot Bar

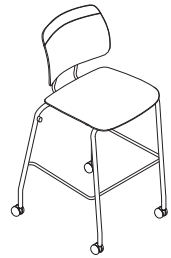

Tenor Stool

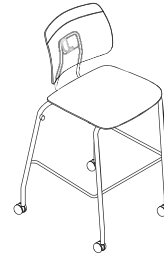

Tenor Stool with
Bag Hook

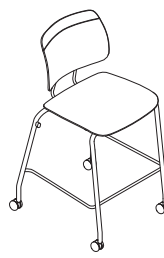

Tenor Perching
Stool

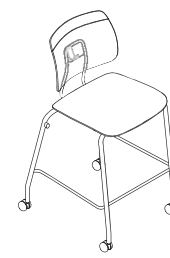

Perching Stool
with Bag Hook

Reply 466 Series

Understanding
▶ Page 210
Specifying
▶ Pages 216 and 218



Work Chair
with Mesh Back



Work Chair

Work Chairs, continued

Siento

Understanding
▶ Page 242
Specifying
▶ Pages 244–246



High-Back
Desk Chair with
Fixed T-Arms



High-Back
Desk Chair with
Enclosed Arms



High-Back
Desk Chair with
Adjustable T-Arms



Mid-Back
Desk Chair with
Fixed T-Arms

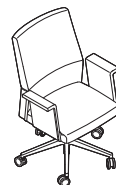

Mid-Back
Desk Chair with
Enclosed Arms



Mid-Back
Desk Chair with
Adjustable T-Arms

Cachet 487 Series

Understanding
▶ Page 346
Specifying
▶ Pages 350 and 354



Swivel-Base
Work Chair



Swivel-Base Stool

SILQ 418 Series

Understanding
▶ Page 250
Specifying
▶ Pages 258–260



SILQ Collaborative
Chair with Arms



SILQ Collaborative
Chair Armless



SILQ Collaborative
Stool with Arms



SILQ Collaborative
Stool Armless

Work Chairs, continued

QiVi 428 Series

Understanding
▶ Page 264
Specifying
▶ Pages 270–272

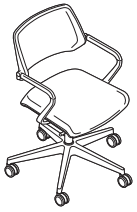

Collaborative Chair
with Arms



Collaborative Stool

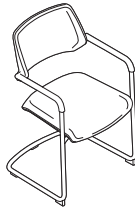

Sled-Base Chair

Collaborative Seating

cobi 434 Series

Understanding
▶ Page 276
Specifying
▶ Pages 280–282



Collaborative
Chair with Arms



Collaborative
Chair without Arms

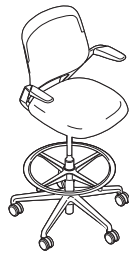

Collaborative
Stool with Arms

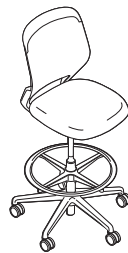

Collaborative
Stool without Arms

Collaborative Seating, continued

Node 480 Series

Understanding
 ▶ Page 286
 Specifying
 ▶ Pages 298–310



Collaborative Mid-Back Chair

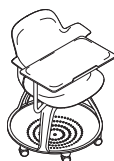

Collaborative Mid-Back Chair with Personal Workspace



Collaborative Mid-Back Chair with Swivel-Base



Collaborative Mid-Back Chair with Swivel-Base and Personal Workspace



Collaborative Mid-Back Stool with Swivel-Base



Collaborative Chair

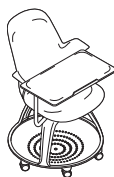

Collaborative Chair with Personal Workspace



Collaborative Chair with Swivel-Base



Collaborative Chair with Swivel-Base and Personal Workspace

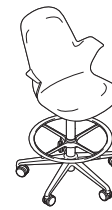

Collaborative Stool with Swivel-Base



Collaborative Mid-Back Chair with X Base



Collaborative Chair with X Base



Collaborative Mid-Back Stool with X Base



Collaborative Stool with X Base



Collaborative Mid-Back Chair with Wood Base



Collaborative Chair with Wood Base

Collaborative Seating, continued

Flex Perch Stool

Understanding
▶ Page 312
Specifying
▶ Page 321



Multi-Use Seating

Reply Series

Understanding
▶ Page 210
Specifying
▶ Pages 220–226



Leg-Base Multi-Use Chair with Mesh Back with Arms

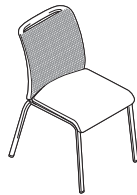

Leg-Base Multi-Use Chair with Mesh Back without Arms



Leg-Base Multi-Use Chair with Standard Upholstery with Arms



Leg-Base Multi-Use Chair with Standard Upholstery without Arms



Sled-Base Multi-Use Chair with Mesh Back with Arms

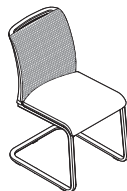

Sled-Base Multi-Use Chair with Mesh Back without Arms



Sled-Base Multi-Use Chair with Standard Upholstery with Arms



Sled-Base Multi-Use Chair with Standard Upholstery without Arms

*Chairs are available with casters.

Kart Nesting Chairs

Understanding
▶ Page 230
Specifying
▶ Page 234



with Arms



Armless

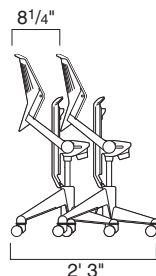

Nested

Multi-Use Seating, continued

Kart Stools with Casters

Understanding
 ▶ Page 230
 Specifying
 ▶ Page 238



with Arms



Armless

Cachet 487 Series

Understanding
 ▶ Page 346
 Specifying
 ▶ Page 352



Leg-Base
 Multi-Use Chair
 without Arms



Leg-Base
 Multi-Use Chair
 with Flip-Up Arms

Shortcut

Understanding
 ▶ Pages 324–332
 Specifying
 ▶ Pages 336–342



Multi-Purpose
 Chair

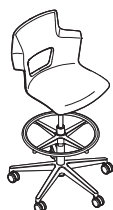

Multi-Purpose
 Stool



Multi-Purpose
 Chair with Personal
 Workspace



X Base Chair



X Base Stool



Wood Chair

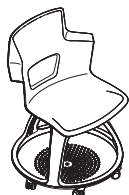

Chair with Tripod
 Base

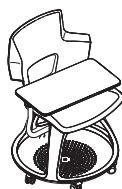

Chair with Tripod
 Base and Personal
 Workspace

Statement of Line, continued

Multi-Use Seating, continued

Player 475 Series

Understanding
 ▶ Page 362
 Specifying
 ▶ Pages 366–374



Leg-Base*
 Multi-Use Chair
 without Arms



Leg-Base*
 Multi-Use Chair
 with Arms



Sled-Base
 Multi-Use Chair
 without Arms



Sled-Base
 Multi-Use Chair
 with Arms



Stool with Arms



Stool
 without Arms

*Player leg-base chair models also stack.

Simple

Understanding
 ▶ Page 378
 Specifying
 ▶ Pages 380–386



Chair

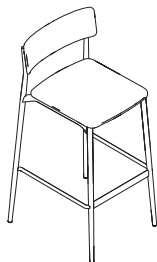

Stool



Lounge



Seat Cushion



Back Cushion

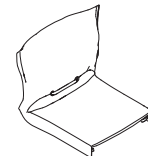

Relaxed Slipcover



Tailored Slipcover

Move 490 Series

Understanding
 ▶ Page 388
 Specifying
 ▶ Pages 392–400



Multi-Use Chair
 without Arms



Multi-Use Chair
 without Arms with
 Casters



Multi-Use Chair
 with Arms



Multi-Use Chair
 with Arms and
 Casters

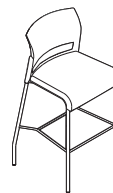

Stool without Arms

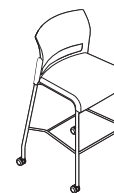

Stool without Arms
 with Casters



Stool with Arms



Stool with Arms
 with Casters

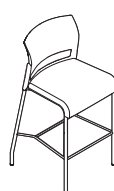

Perching Stool
 without Arms



Perching Stool with
 Arms

Multi-Use Seating, continued

Scoop

Understanding
 ▶ Page 406
 Specifying
 ▶ Page 408

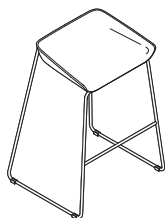

Stool

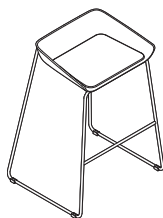

Stool with Upholstered Seat

Nooi

Understanding
 ▶ Page 410
 Specifying
 ▶ Pages 418–426



Frame-Linking Chair, Armless



Frame-Linking Chair with Arms



Sled-Base Chair, Armless



4-Leg Chair, Armless



4-Leg Chair with Arms

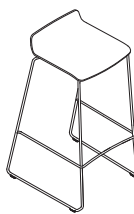

Stool, Bar-Height



Stool, Café-Height

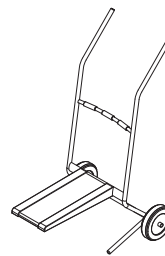

Transport Dolly

Max-Stacker III 477 Series

Understanding
 ▶ Page 428
 Specifying
 ▶ Page 432



Stackable Chair

Buoy

Understanding
 ▶ Page 436
 Specifying
 ▶ Page 438



Lounge Seating

Brody 488 Series

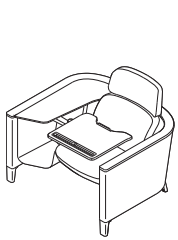

Brody WorkLounge
 Understanding
 ▶ Page 440
 Specifying
 ▶ Page 456

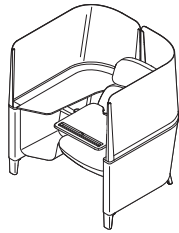

Brody Privacy Lounge
 Understanding
 ▶ Page 440
 Specifying
 ▶ Page 458

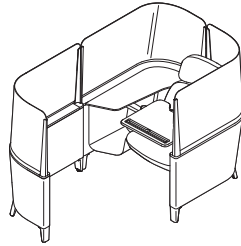

Brody Privacy Lounge with Extension
 Understanding
 ▶ Page 440
 Specifying
 ▶ Page 460

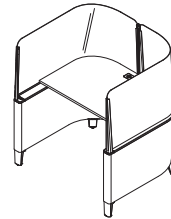

Brody Privacy Desk
 Understanding
 ▶ Page 450
 Specifying
 ▶ Page 462

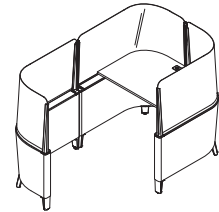

Brody Privacy Desk with Extension
 Understanding
 ▶ Page 450
 Specifying
 ▶ Page 464

Umami

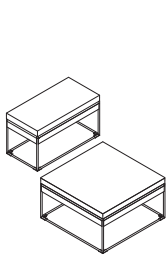

Single Platform
 Understanding
 ▶ Page 468
 Specifying
 ▶ Page 492

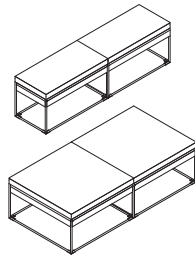

Double Platform
 Understanding
 ▶ Page 468
 Specifying
 ▶ Page 496

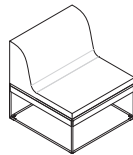

Single, Straight Lounge
 Understanding
 ▶ Page 468
 Specifying
 ▶ Page 500

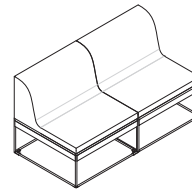

Double, Straight Lounge
 Understanding
 ▶ Page 468
 Specifying
 ▶ Page 502

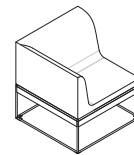

One Arm, Single Lounge
 Understanding
 ▶ Page 468
 Specifying
 ▶ Page 504

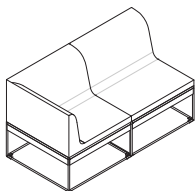

One Arm, Double Lounge
 Understanding
 ▶ Page 468
 Specifying
 ▶ Page 506

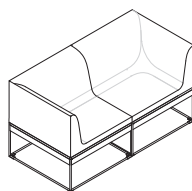

Two Arm, Double Lounge
 Understanding
 ▶ Page 468
 Specifying
 ▶ Page 508

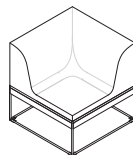

Corner, Single Lounge
 Understanding
 ▶ Page 468
 Specifying
 ▶ Page 510

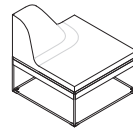

Left arm position

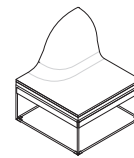

Right arm position

End Cap
 Understanding
 ▶ Page 468
 Specifying
 ▶ Page 512

Lounge Seating, continued

Umami, continued

**Standard Screen**

Understanding
 ▶ Page 482
 Specifying
 ▶ Page 514

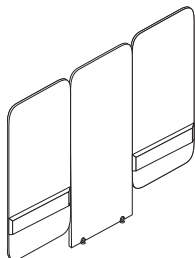
**Standard Spanner Screen**

Understanding
 ▶ Page 482
 Specifying
 ▶ Page 520

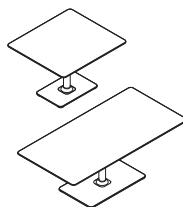
**Lagunitas Work Tables**

Specifying
 ▶ Page 526

**Lagunitas Personal Tables**

Specifying
 ▶ Page 528

Campfire

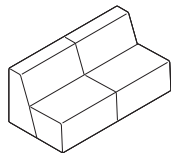
**Big Lounge**

Understanding
 ▶ Page 534
 Specifying
 ▶ Pages 538–540

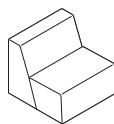
**Half Lounge**

Understanding
 ▶ Page 534
 Specifying
 ▶ Pages 541–543

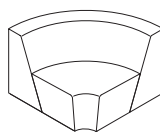
**90° Inside Corner Lounge**

Understanding
 ▶ Page 534
 Specifying
 ▶ Pages 544–546

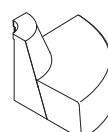
**90° Outside Corner Lounge**

Understanding
 ▶ Page 534
 Specifying
 ▶ Pages 544–546

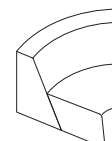
**60° Inside Corner Lounge**

Understanding
 ▶ Page 534
 Specifying
 ▶ Pages 548–550

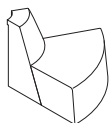
**60° Outside Corner Lounge**

Understanding
 ▶ Page 534
 Specifying
 ▶ Pages 548–550

**Ottoman**

Understanding
 ▶ Page 534
 Specifying
 ▶ Page 552

**Pouf**

Understanding
 ▶ Page 534
 Specifying
 ▶ Page 553

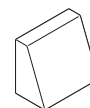
**Wedge**

Understanding
 ▶ Page 534
 Specifying
 ▶ Page 554

Accessories

**Footrest**

Understanding
 ▶ Page 537
 Specifying
 ▶ Page 555

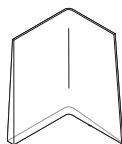
**Screens**

Understanding
 ▶ Page 537
 Specifying
 ▶ Page 555

Lounge Seating, continued

B-Free

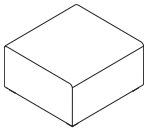

Large Cubes
Understanding
▶ Page 558
Specifying
▶ Page 574

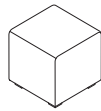

Small Cube
Understanding
▶ Page 558
Specifying
▶ Page 575

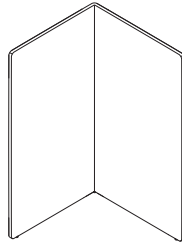

Screens
Understanding
▶ Page 558
Specifying
▶ Page 577

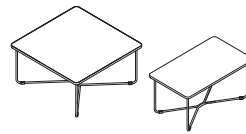

Occasional Tables
Understanding
▶ Page 558
Specifying
▶ Page 579

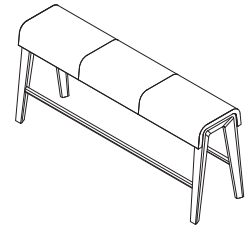

Large Beam, Wood and Aluminum Legs
Understanding
▶ Page 560
Specifying
▶ Pages 580 and 581

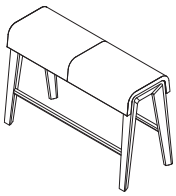

Small Beam, Wood and Aluminum Legs
Understanding
▶ Page 560
Specifying
▶ Pages 582 and 583

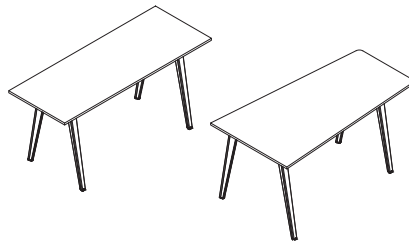

Standing-Height Tables
Understanding
▶ Page 564
Specifying
▶ Pages 584 and 586

Lounge Seating, continued

Jenny Lounge

Tip: Jenny Armless lounge chairs shown comprise full statement of line.

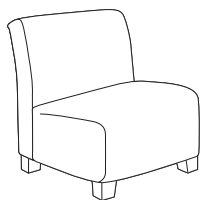

Armless Lounge Chair
Understanding
▶ Page 588
Specifying
▶ Page 594

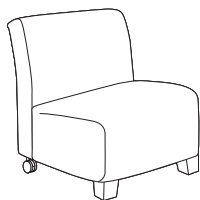

Armless Lounge Chair with Casters
Understanding
▶ Page 588
Specifying
▶ Page 594

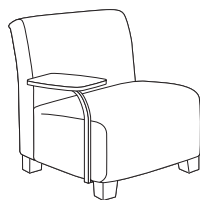

Armless Lounge Chair with Tablet Arm
Understanding
▶ Page 588
Specifying
▶ Page 594

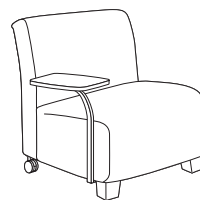

Armless Lounge Chair with Casters and Tablet Arm
Understanding
▶ Page 588
Specifying
▶ Page 594

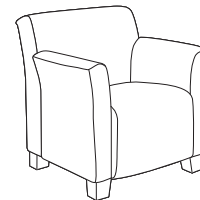

***Lounge Chair with Arms**
Understanding
▶ Page 588
Specifying
▶ Page 598

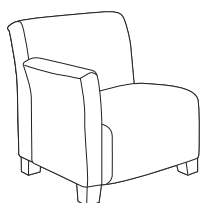

***Lounge Chair with Arm Right**
Understanding
▶ Page 588
Specifying
▶ Page 602

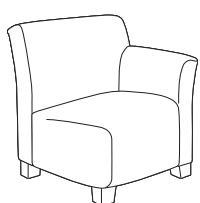

***Lounge Chair with Arm Left**
Understanding
▶ Page 588
Specifying
▶ Page 602

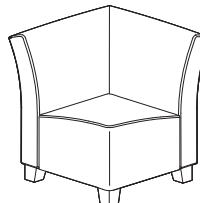

***Corner Lounge Chair**
Understanding
▶ Page 588
Specifying
▶ Page 606

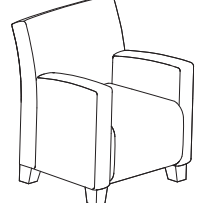

***Club Lounge Chair**
Understanding
▶ Page 588
Specifying
▶ Page 608

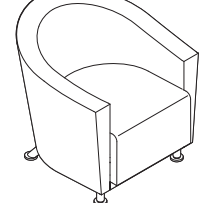

Round Lounge Chair
Understanding
▶ Page 588
Specifying
▶ Page 610

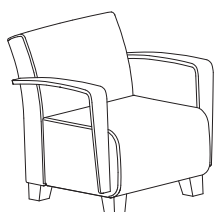

Lounge Chair with Wood Arms
Understanding
▶ Page 588
Specifying
▶ Page 612

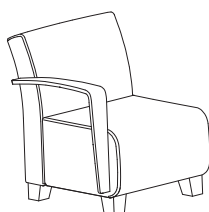

Lounge Chair with Wood Arm Right
Understanding
▶ Page 588
Specifying
▶ Page 612

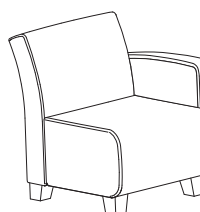

Lounge Chair with Wood Arm Left
Understanding
▶ Page 588
Specifying
▶ Page 612

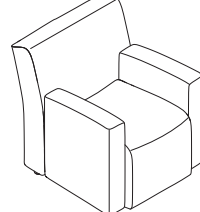

Club Low Lounge Chair
Understanding
▶ Page 588
Specifying
▶ Page 616

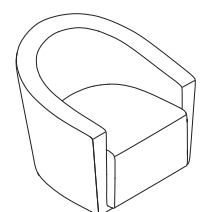

Round Low Lounge Chair
Understanding
▶ Page 588
Specifying
▶ Page 618

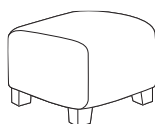

Ottoman
Understanding
▶ Page 588
Specifying
▶ Page 614

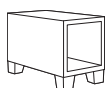

End Table
Understanding
▶ Page 588
Specifying
▶ Page 620

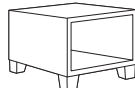

Coffee Table
Understanding
▶ Page 588
Specifying
▶ Page 620

*See specifying pages for availability of casters and tablet arm.

Lounge Seating, continued

i2i 416 Series



Collaborative Lounge Chair



Collaborative Lounge Chair with Tablet Arm

Understanding
▶ Page 622
Specifying
▶ Page 626

Alight Lounge

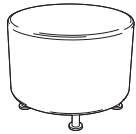

Round Ottoman

Understanding
▶ Page 628
Specifying
▶ Page 631

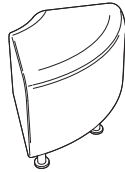

Corner Ottoman

Understanding
▶ Page 628
Specifying
▶ Page 631

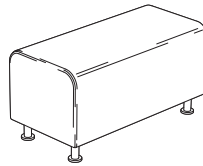

Bench Ottoman

Understanding
▶ Page 628
Specifying
▶ Page 631



End Table

Understanding
▶ Page 628
Specifying
▶ Page 632



Coffee Table

Understanding
▶ Page 628
Specifying
▶ Page 632

Basics of Ergonomic Seating

A well-designed, ergonomically advanced chair that allows a full range of healthy postures throughout the day and can contribute to worker wellness and productivity.

Neck is straight or slightly forward.

Shoulders are relaxed so arms hang naturally.

Back has full contact with the backrest (sit all the way back in your chair).

Elbows and forearms can rest comfortably on the arms of your chair, or on worksurfaces.

Lower back fits into curved lumbar support.

Tension is adjusted so backrest reclines easily, yet provides smooth, even support, and encourages postural change.

If worksurfaces and keyboard support are not height-adjustable, raise your chair's seat height to achieve the appropriate relationship to your tasks. If this leaves your feet dangling above the floor, use a footrest.

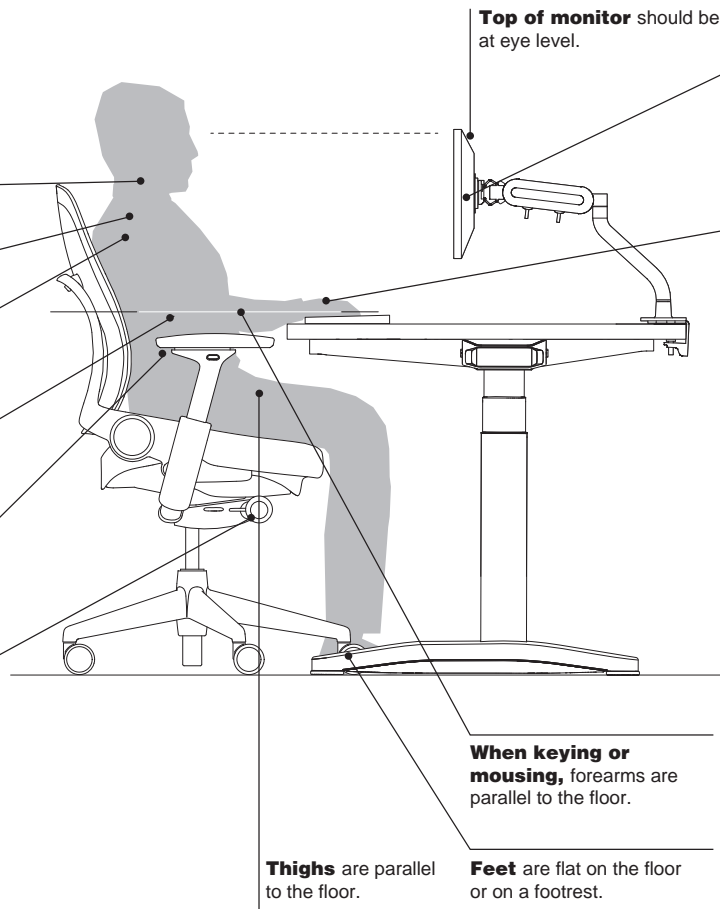

Top of monitor should be at eye level.

Screen is 20 to 30 inches from the eyes. Screen is at eye level slightly lower and directly in front of worker so head is not turned.

Wrists should be straight when keying or mousing, not bent up or down.

ANSI/BIFMA is the American National Standards Institute/Business and Institutional Furniture Manufacturer's Association. All Steelcase furniture meets or exceeds ANSI/BIFMA standards for structural quality. Gesture, Leap, Think, Amia, and Series 1 work chairs, as well as Gesture stool, are all tested and warranted for users up to 400 pounds. Steelcase Karman is tested and warranted for users up to 350 pounds. All other Steelcase brand work chairs are tested and warranted for users 300 pounds and under. Collaborative chairs tested and warranted for users 300 pounds and under are: QiVi, cobī, i2i, and Node. Multi-use chairs are tested and warranted for users 300 pounds and under: Move, Max Stack III, and Player (armless only). All Steelcase Seating products also follow the ergonomic guidelines established in BIFMA G1-2013.

When keying or mousing, forearms are parallel to the floor.

Thighs are parallel to the floor.

Feet are flat on the floor or on a footrest.

CAUTION

Regularly inspect for damaged or broken parts and loose fasteners (screws, etc.). If any of these conditions exist, remove from service immediately. Repairs are to be made using only factory authorized parts and methods. Hard wheel casters must be used on carpeted surfaces only. Use on hard surfaces, including floor mats, will affect chair stability. For information on furniture which requires service, call Steelcase toll free at 1.888.783.3522. Failure to follow these instructions could result in property damage or personal injury.

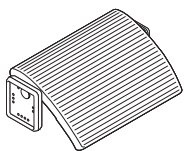

Basics of Ergonomic Seating, continued

BIFMA G1-2013 Ergonomic Guidelines

	BIFMA G1-2013 Requirement	Gesture	Leap	Leap Plus	Steelcase Karman	Think
Seat Height	14 ⁸ / ₁₀ "–20 ² / ₁₀ "	16"–21"	15 ¹ / ₂ "–20 ¹ / ₂ "	15 ¹ / ₂ "–19 ¹ / ₂ "	15 ¹³ / ₁₆ " to 20 ⁷ / ₁₆ "	16 ¹ / ₂ "–21 ¹ / ₂ "
		14 ¹ / ₂ "–18 ¹ / ₄ " (low opt)	14 ¹ / ₂ "–17 ¹ / ₂ " * (low opt)		14 ¹ / ₈ " to 18" (low opt)	15"–19" (low opt)
		17"–22 ¹ / ₂ " (high opt)	17"–24" (high opt)		20 ¹ / ₄ " to 27 ⁵ / ₈ " (high opt)	18"–25" (high opt)
						14 ¹ / ₂ "–17 ¹ / ₂ " *
Fixed Seat Depth	16 ³ / ₁₀ " maximum	N.A.	N.A.	N.A.	16 ³ / ₁₀ "	N.A.
Adjustable Seat Depth (if available)	Range must include 16 ³ / ₁₀ "	15 ³ / ₄ "–18 ¹ / ₂ "	15 ³ / ₄ "–18 ³ / ₄ "	16 ³ / ₄ "–18 ³ / ₄ "	Fixed	15 ¹ / ₂ "–18"
Seat Width	19 ² / ₁₀ " minimum if larger than 19 ² / ₁₀ ", the percentile of users supported should be stated	20" 90th percentile female	19 ¹ / ₄ " 90th percentile female	22 ³ / ₄ " 99th percentile female	19 ¹ / ₄ " 90th percentile female	20 ¹ / ₄ " 90th percentile female
Seat Pan Angle	0° to 4° Must include some part of the range if adjustable	1° Passive	–1° to 3° Passive	0 to 4°	–1° to 7°	2° to 6° Passive
Angle Between Seat Back and Seat Pan	Fixed: >90° Adjustable: range minimum of 15° within 90° and 120°	98° to 125°	96° to 120°	97° to 114°	97° to 112°	98° to 116°
Lumbar Support	5 ⁹ / ₁₀ " to 9 ⁸ / ₁₀ " Within this range	5 ¹ / ₄ "–9 ¹ / ₄ "	5 ¹ / ₄ "–10 ¹ / ₄ "	6 ¹ / ₂ "–11 ¹ / ₂ "	4" to 7 ¹ / ₂ "	6"–10 ¹ / ₄ "
		Adjustable	Adjustable	Adjustable	Adjustable	Adjustable
			Adjustable lumbar and lower back firmness control	Adjustable lumbar and lower back firmness control		
Backrest Width	14 ² / ₁₀ " Minimum at lumbar	16 ¹ / ₄ "	18"	20"	15 ³ / ₈ "	18"
Back Height From Seat (mid back and high back)	13 ⁹ / ₁₀ " minimum	24 ¹ / ₁₆ "	25"	24 ¹ / ₂ "	25"	22 ³ / ₄ "
Distance Between Arm Rests	Fixed: 19 ⁴ / ₁₀ " minimum	Fixed: 19"			Fixed: 20 ¹ / ₂ "	Fixed: 20"
	Adjustable: include 19 ⁴ / ₁₀ "	Adjustable: 10 ¹ / ₄ "–22 ¹ / ₂ "	Adjustable: 15"–20"	Adjustable: 19 ³ / ₄ "–24 ³ / ₄ "	1D: 19 ³ / ₈ " to 20 ¹ / ₈ " 4D: 17 ¹ / ₂ " to 22 ¹ / ₈ "	Adjustable: 16 ¹ / ₂ "–21 ¹ / ₄ "
Arm Height	7 ⁷ / ₁₀ "–11 ⁴ / ₁₀ "	7 ¹ / ₄ "–11 ¹ / ₂ "	7"–11"	7 ¹ / ₄ "–11 ¹ / ₄ "	Fixed 7 ³ / ₄ "	7"–11"
			Adjustable		1D: 7 ¹ / ₂ " to 11 ¹ / ₂ " 4D: 7 ¹ / ₂ " to 11 ¹ / ₂ "	Adjustable
Weight Limit	300 pounds	400 pounds	400 pounds	500 pounds	350 pounds	400 pounds

* Specials: Extra small cylinder option

	Amia	Series 2	Series 1	Reply	Siento
	16"-21"	16½"-21½"	16½"-21½"	16"-21"	16"-21"
	15"-19" (low opt)	14¾"-18" (low opt)	14¾"-17¾" (low opt)		Fixed: 18" (opt)
	17"-24" (high opt)	17½"-22" (high opt)	17¼"-22" (high opt)		14½"-17½" *
	14½"-17½" *				
	N.A.	N.A.	N.A.	16¾"	17½"
	15½"-18½"	Plastic & 3D Microknit AirBack: 15"-17¾"	15½"-17¾"	Mesh: 16½"-18"	N.A.
		Upholstered Back: 14½"-17¼"		Upholstered: 15½"-17"	
	19¾" 90th percentile female	20" 90th percentile female	19½" 90th percentile female	18½"	21" 90th percentile female
	-3° to 3° Passive	0° to 1.7° Passive	0° to 2° Passive	2° to 13°	-2° to 0° Passive
	100° to 120°	99½° to 119°	100° to 122°	Mesh: 97° to 115° Upholstered: 97° to 113°	100° to 114°
	6¼"-10" Adjustable	8½"-9¾" Adjustable	6½"-8¾" Adjustable	Mesh: 6"-10" Adjustable	9½" Fixed
	18⅞"	18⅞"	17¼"	17½"	20¾"
	25"	22½"	21½"	Mesh: 22⅝" Upholstered: 23¼"-25¾"	31½" (high back with headrest) 30" (high back) 24" (mid back)
		Fixed: 20"		Fixed: 18½"	Fixed: 20½"
	Adjustable: 15"-19½"	Adjustable: 15⅞"-20⅛"	Adjustable: 16"-20"	Adjustable: 15¾"-19"	Adjustable: 12¾"-19" *
	7"-11" Adjustable	7½"-11½" Adjustable	6½"-11½" Adjustable	7 ¼"-11" Adjustable	Fixed: 8" Adjustable: 6⅔"-9⅞" *
	400 pounds	400 pounds	400 pounds	300 pounds	300 pounds

Basics of Adjustability

Steelcase chairs offer varying levels of adjustability to meet the needs of many types of users. Adjustable chairs may offer one or more of these features:

Mechanisms



Natural-glide feature causes the seat to slide forward as the user reclines, keeping the user within his or her vision and reach zone (462).



Advanced swivel-tilt feature incorporates a no front-rise design that allows the seat to remain level even when the user leans back (453).



Synchro-tilt feature means the chair back and seat are synchronized to move in a 2:1 ratio. When the user leans back, the seat rises only half as much, allowing the user's feet to remain flat on the floor (499, 466, 482).



Advanced synchro-tilt allows the chair back and seat to move in a 2.8:1 ratio. As the user leans back the seat rises slightly to keep the user's feet on the floor (442).



Weight-activated feature allows for an amount of recline resistance that is directly proportional to the user's weight. The natural-glide feature keeps the user within vision and reach zone (434, 465).



Balanced Action Rocker (BAR) mechanism allows users to recline as the seat flexes. BAR relies on physics to let any user, regardless of posture, height, or weight, find the most comfortable position (487).



Dual-swivel feature allows the back and seat to swivel independently as well as together (416).



360°-swivel feature allows micromovement to stay engaged at fixed height (428, 480).

Seat Adjustments



Pneumatic height adjustment allows the user to remain seated while adjusting the seat height by way of a control button or lever (all work chairs).



Passive seat edge angle allows front edge of seat to drop down while seat angle remains unchanged (442, 462, 499, 465, 482).



Seat angle adjustment allows the user to change the angle of the seat to a forward position (453).



Seat depth adjustment allows the user to slide the seat forward or back (442, 462, 453, 465, 466, 482).



Gliding seat automatically glides forward and back adjusting to the natural movement of the user's body (428).

Back Adjustments



Lumbar height affords additional lower back support. Grasp lumbar handles and slide up or down to adjust (442, 462, 453, 465, 466, 482).



Lower back firmness changes the amount of firmness user feels in lower back (462).



Upper back tension feature provides an increasing amount of force that increases as the user reclines (462).



Back tension adjustment allows the user to control the amount of resistance felt when leaning back in the chair (all chairs except 487).



Pivoting back automatically follows the natural motion of the user's back as they recline (428).



Your Preference back control includes four settings—weight-activated, boosted, mid-back stop, and upright—that allow for personal preference and work styles (465).



Headrest adjustment allows the user to support head and neck in upright or reclined posture (442, 462, 465, 499).



Variable back stop allows the user to lock the back upright or to preset the range of recline (442, 462, 453).



Upright back lock allows the user to lock the backrest in a full upright position or release it for full recline (466, 482, 499, Kart).



Multi-position back lock allows users to recline the back to the desired angle and lock it in place (466).



Back height adjustment allows the user to raise or lower the chair back (453, 466).



Core equalizer connects the back and seat to the advanced synchro-tilt and allows appropriate amount of lumbar support in any angle of recline (442).

Arm Adjustments



Arm height adjustment allows the user to move the arms up or down independently (442, 462, 453, 465, 466, 482, 499).



Arm width adjustment allows the user to move the arms in or out independently (442, 462, 453, 465, 466, 482, 499).



Arm pivot adjustments allows the user to position arm rests as appropriate for the task being performed (442, 462, 453, 465, 466, 482, 499).



Arm depth adjustment allows users to get closer to their work by chair arms moving out of the way (442, 462, 465, 466, 482, 499).

Other Features



Foot ring height can be adjusted up or down for user comfort. Cannot be done from seated position (434, 442, 462, 453, 465, 482, 487, Kart).

Basics of Adjustability, continued

Work Chair Adjustability Features						
	Gesture 442 Series ▶ Page 31	Leap 462 Series ▶ Page 47	Leap Plus 462 Series ▶ Page 47	Steelcase Karman ▶ Page 73	Think 465 Series ▶ Page 87	Amia 482 Series ▶ Page 47
Mechanisms						
Natural glide		•	•			
Weight-activated				•	•	
Advanced swivel-tilt						
Synchro-tilt						•
Advanced Synchro-tilt	•					
Seat Adjustments						
Pneumatic height	•	•	•	•	•	•
Passive seat edge angle	•	•	•	•	•	•
Seat angle						
Seat depth	•	•	•		•	•
Back Adjustments						
Lumbar height	•	•	•	•	•	•
Lower back firmness		•	•			
Upper back tension		•	•			
Back tension	•			•	•	•
Variable back stop	•	•	•	•	•	
Upright back lock	•	•	•	•	•	•
Multi-position back lock						
Core equalizer	•					
Back height						
Arm Adjustments						
Arm height	•	•	•	•	•	•
Arm width	•	•	•	•	•	•
Arm pivot	•	•	•	•	•	•
Arm depth	•	•	•	•	•	•
Other Features						
Foot ring height (stool)	•	•		•	•	•
Headrest	•	•				

*See product understanding pages for additional details.

Work Chair Adjustability Features				
	Steelcase Series 2 ▶ Page 151	Steelcase Series 1 ▶ Page 47	Reply 466 Series ▶ Page 209	Siento 499 Series ▶ Page 241
Mechanisms				
Natural glide				
Weight-activated	●	●		
Advanced swivel-tilt				
Synchro-tilt			●	●
Advanced Synchro-tilt				
Seat Adjustments				
Pneumatic height	●	●	●	●
Passive seat edge angle				●
Seat angle	●	●	●	
Seat depth	●	●	●	
Back Adjustments				
Lumbar height	●	●	● *	
Lower back firmness				
Upper back tension				
Back tension	●	●	●	●
Variable back stop				
Upright back lock	●	●	●	●
Multi-position back lock			●	
Core equalizer				
Back height			● *	
Arm Adjustments				
Arm height	●	●	●	● *
Arm width	●	●	●	● *
Arm pivot	●	●	●	● *
Arm depth	●	●	●	● *
Other Features				
Foot ring height (stool)	●	●		
Headrest	●	● **		● *

*See product understanding pages for additional details.

**Ordered separately as an accessory

Basics of Adjustability, continued

Collaborative/Multi-Use Adjustability Features						
	Cachet 487 Series ▶ Page 345	SILQ 418 Series ▶ Page 249	Qivi 428 Series ▶ Page 263	cobi 434 Series ▶ Page 275	i2i 416 Series ▶ Page 621	Node 480 Series ▶ Page 285
Mechanisms						
Advanced swivel-tilt						
Balanced Action Rocker (BAR)	•					
Weight-activated		•		•		
Dual-swivel					•	
360°-swivel			•			•
Seat Adjustments						
Pneumatic height		•	•	•	•	
Gliding seat			•			
Back Adjustments						
Back tension						
Upright back lock						
Self adjusting	•	•	•	•	•	
Pivoting back			•			

CarbonNeutral Product Certification



CarbonNeutral.com

To be a CarbonNeutral product, the emissions of each chair are measured, calculated and third-party verified across every stage of the chair's lifecycle. The amount of carbon emissions from manufacturing that can't be avoided are offset by investing in trusted projects that focus on emissions avoidance and removal, and social good. Through the investment of these projects, the carbon emissions of these chair options equal zero.

The following product lines have CarbonNeutral product certification options:

- Gesture
- Leap
- Think
- Steelcase Karman
- Amia + Amia Air
- Steelcase Series 2
- Steelcase Series 1

Exceptions (CarbonNeutral product Certification unavailable):

- Leap Plus
- Amia + Amia Air Stools

Additional Resources

Steelcase seating is supported with an array of informational materials, tools, and software to help you plan efficiently.

Product brochures and planning tools can be ordered through your Steelcase area office by calling 1.800.784.0358 or through the Marketing Resources website at village.steelcase.com.

Printed Materials

Surface Materials Reference Manual

This publication provides:

- An explanation of the surface materials and their categories
- "Available on" matrices
- Vertical surface fabric and seating upholstery selection listing
- Technical data for surface materials
- Surface material care and cleaning instructions

Planning Tools

Quick Ship Guide

This handbook describes all Steelcase and Coalesse products that are available for Rapid2 (ships in 2 days), Rapid5 (ships in 5–7 days), or Coalesse Rapid10 (ships in 10 days).

Computer Tools

Digital Publications

You can access these digital publications at www.steelcase.com or village.steelcase.com.

Electronic Catalog

Accurate sales quotations and purchase orders for Steelcase products are created with specification software that uses Steelcase Electronic Catalog data. Use the data to specify and price style numbers and options for every Steelcase product. The data is updated bimonthly by Steelcase and provided to software programs including: the Hedberg Business System, SmartTools – Steelcase's design and specification software (for more information on SmartTools, please email SmartTools@steelcase.com), the ProjectMatrix Project-Symbols libraries, as well as 20-20 CAP Studio.

Furniture Symbol

Graphic Data

Steelcase creates 2D and 3D furniture symbols (with attributes) for planning and initially specifying Steelcase products. This data is incorporated into several add-on software packages that work in either a Microstation or an AutoCAD drafting environment.

More Information

For more information about these and other software tools to help you plan effective work environments, email fsl@steelcase.com.

Seating Product

Training

Basic training for Steelcase seating products is available through the Steelcase University website at village.steelcase.com.

Support

Steelcase Capabilities

Steelcase products are distributed, installed, and serviced through a network of more than 600 dealers worldwide. Steelcase is also represented with offices and corporate showrooms in 26 U.S. cities, 4 Canadian cities, and in France, Germany, Great Britain, and Japan. Every Steelcase product meets our exceptionally high standards of quality and durability and comes with the Steelcase assurance of excellence in service.

For ordering or product

assistance, please call your local dealer, the Steelcase Solutions Resource Team, or the Steelcase Solutions Fulfillment Team at 1.888.STEELCASE (1.888.783.3522) or send an email to lineone@steelcase.com.

Call the Steelcase Solutions Resource Team prior to placing an order, when working on a bid, or when you need information about product applications and specifications.

Call the Steelcase Solutions Fulfillment Team if you have submitted an order to Steelcase and you need to speak to your Solutions Fulfillment Team Representative about the order. Also call if you have any post-shipment quality concerns or service parts questions.

For warranty information, please go to <http://www.steelcase.com/warranty/>.

Outside the U.S.A., Canada, Mexico, Puerto Rico, and the U.S. Virgin Islands, call 1.616.247.2500.

For information about Steelcase, the name of your nearest Steelcase dealer, or for product literature, call 1.800.333.9939 or visit our website: www.steelcase.com.

Sustainability

At Steelcase, we believe business can be a force for good. We create long-lasting products that are better for people and better for the planet. Our products and operations use life cycle thinking to meet our commitment to reducing climate change. This commitment is reinforced by practices such as designing to minimize global warming and other life cycle impacts, ensuring material health, and enabling end-of-use strategies.

To learn more at a corporate level, visit: www.steelcase.com/discover/steelcase/esg-overview/environmental/ProductEnvironmentalProfiles, which provide key environmental attributes such as recycled content, embodied carbon and recyclability, as well as product certifications can be found by searching for Steelcase at Origin.build.

Understanding and Specifying Gesture 442 Series Work Chairs

Work Chairs

Highly adjustable task seating offers maximum personalization for fit and comfort for a range of duration and use. By making a series of simple adjustments, you can customize the chair to your body, preferences, and tasks. These chairs provide continuous, stable, comfort, and can be quickly adjusted to support you in upright, and reclining work postures.

- Gesture 442 Series
- Leap 462 Series
- Think 465 Series
- Amia 482 Series
- Reply 466 Series

Adjustability Features

- See page 26 for a comparison to other chairs.

Gesture 442 Series

Mechanisms

Advanced Synchro-tilt ●

Seat Adjustments

Pneumatic height ●

Passive seat edge angle ●

Seat angle ●

Seat depth ●

Back Adjustments

Back tension ●

Core equalizer ●

Lumbar height ●

Variable back stop ●

Arm Adjustments

Arm height ●

Arm width ●

Arm pivot ●

Arm depth ●

Other Features

Foot ring height (stool) ●

Headrest ●

Product Details

Gesture 442 Series	32
Gesture Upholstery	37
Dimensions	38

Specifying

Gesture 442 Series Work Chairs	40
Gesture 442 Series Work Chair with Headrest	42
Gesture 442 Series Stools	44
Gesture Coat Hanger	46

Gesture 442 Series



Now available as a CarbonNeutral product, making sure our commitment to a more sustainable future helps yours too.

Gesture is a new sitting experience that is designed for the interface between user and technology, inspired by the movement of the human body, and created for the way we work today.

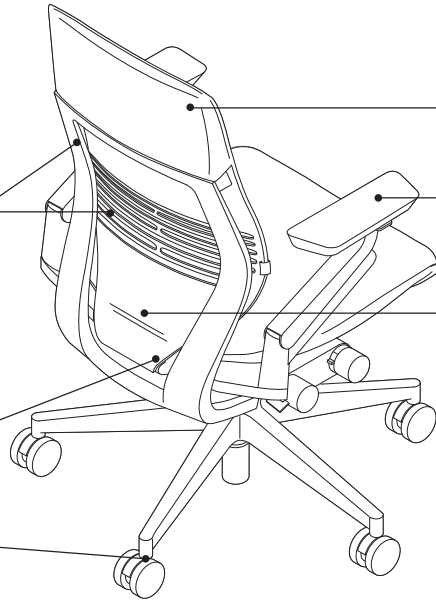

Back frame, back shell, seat perimeter, arms, and base are standard in black/black or dark/dark color schemes. Polished aluminum base, dark/light, or light/light color schemes are available as options.

Core equalizer provides just the right amount of lumbar support in any angle of recline.

Casters have hard, dual wheels that roll smoothly on carpets. They are 2 1/2" for increased mobility. Soft, dark grey treaded, dual-wheel roll-control casters are available for use on hard floors or mats. Glides are also available as an option.

Tip: Do not roll the chair across asphalt during installation as this may damage the casters.

Variable back stop with four positions is standard.

Back tension requires only 3 1/2 complete turns and accommodates a broader range of users by allowing user to change the rate of increase in force as the chair reclines.

Pneumatic adjustment mechanism is standard. It adjusts with a 5" range. A 3 3/4" low-range pneumatic seat-height adjustment and a 5 1/2" high-range pneumatic seat-height adjustment are available as options on chairs. Stools have an 8" range.

Seat depth adjusts 2 3/4" to accommodate various leg lengths.

Wrapped upper back upholstery design is available.

360° arm enables 360° of motion to give arm support where it is needed with one release.

3D LiveBack moves with the shape of the user's spine as sitting positions change.

Outer back and outer seat are plastic.

Arm depth can retract 2 1/8" to allow user to get closer to worksurface and into tight corners.

Soft arm caps independently pivot 15° inward and 15° outward to accommodate individual user preferences.

Arm width can adjust parallel from 10 1/4" to 22 1/2" for forearm and elbow support.

Arm height can adjust 4 1/4" for arm and elbow support.

Passive seat edge angle allows the front edge of the seat to flex 1 1/2" to relieve pressure under the user's thighs.

Seat perimeter is made of flexible elastomer that provides comfort to larger users and allows alternative postures.

Five-star base is plastic, a polished aluminum base is available as an option.

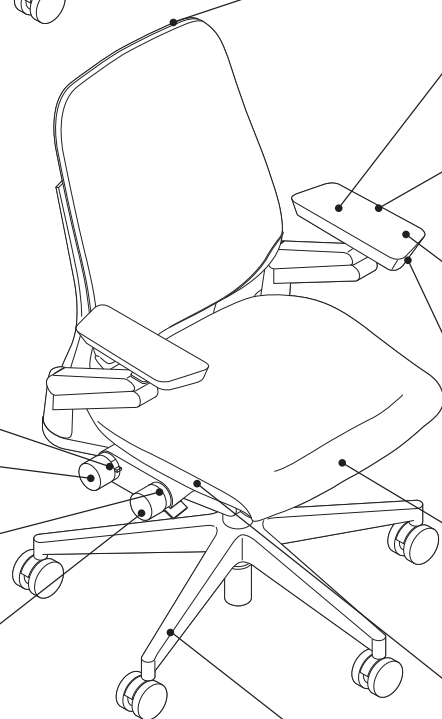

Product Details

Adjustability instructions are included with every chair. Instructions can also be found at www.steelcase.com.

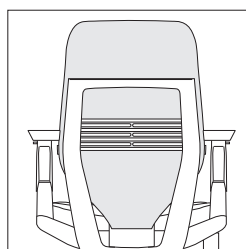

3D LiveBack allows the back to move and conform laterally, sagittally, and torsionally to support individual users.

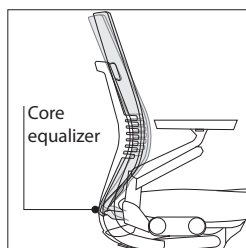

The core equalizer is powered by a torsional spring that adjusts with the angle of the seat and back to provide less lumbar support in a deep recline and more lumbar support in an upright posture.

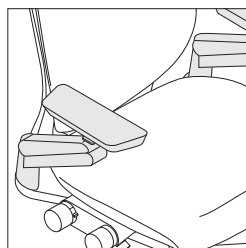

Rectilinear arms with soft caps are standard.

Product Weight

- Gesture chair: 58 pounds

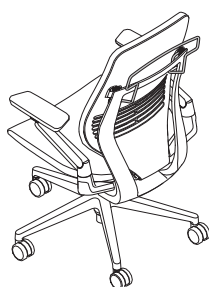

Coat hanger is field installed. It is offered in one finish, 7360 Merle. The coat hanger supports up to 10 pounds and is not intended to hold bags or backpacks. Not available on: stool models or wrapped back models (including wrapped back with headrest models).



CarbonNeutral product Gesture helps organizations achieve their carbon emissions goals. Add **CN** to the end of the style number to specify Gesture with CarbonNeutral product certification.

Adjustment Features

Seat Adjustments

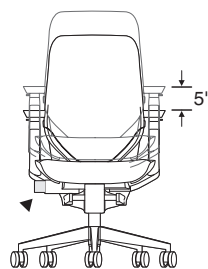

Seat height adjusts pneumatically. To lower, hold handle up while seated. To raise, hold handle up and keep weight off the chair. Range of adjustability is 5", from 16"H to 21"H, and is standard on work chairs. An optional 5 1/2" high-range of adjustability (17"H to 22 1/2"H) and a 3 3/4" low-range (14 1/2"H to 18 1/4"H) are available as an option. Stools are standard with an 8 1/4" range of adjustability (24"H to 32 1/4"H).

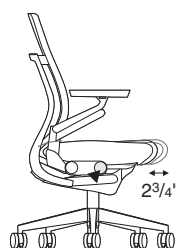

Seat depth adjusts 2 3/4" (15 3/4" to 18 1/2") by rotating dial while seated for an easy fine-tuned fit. This feature is standard on work chairs and stools.

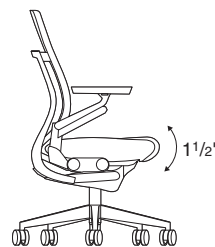

Passive seat edge angle flexes 1 1/2", relieving pressure under the user's thighs. This feature is standard on all work chairs and stools.

Flexible side edges. Comfort goes all the way to edges and requires no adjustment. Perfect for large users and has the ability to side sit.

Adaptive bolstering. The seat has air pockets carefully placed beneath the foam to give consistent comfort and support to a range of users.

Back Adjustments

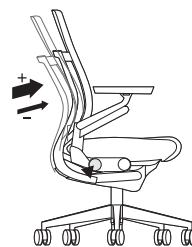

Back tension. Turn the knob forward for more resistance and backward for less resistance. Adjust back tension for appropriate amount of resistance.

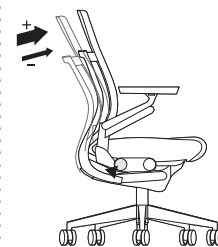

Variable back stop. To lock backrest in upright position, lean forward and flip lever down. Flip lever up to unlock for full-range motion. There are four settings to give just the right angle of recline.

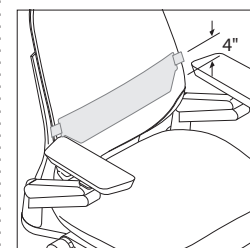

Lumbar height adjusts 4" (5 1/4" to 9 1/4") from seat by grabbing exposed tabs and sliding the lumbar support up or down. This feature is optional on work chairs and stools.

Gesture 442 Series, continued

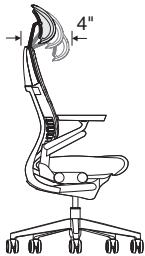
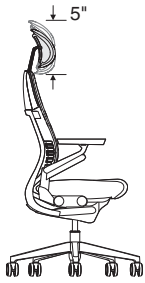

Headrest adjusts 5" vertically and measures 8"H x 10 1/2"W. It tilts 4° forward and the cushion rotates 90°. Plastic shell on the headrest is available in black, merle, or seagull and will match the plastic back shell. Upholstery can match or contrast the seat and back material. It is not available to order separately for installation on existing Gesture chairs. Headrest is available on stools as a special only.

Arm Adjustments

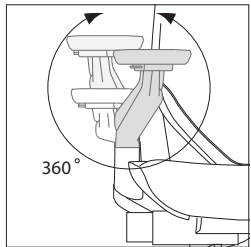

360°-arm. One release enables 360° of motion to give arms support where it is needed. To adjust arm cap position, grasp arm caps and slide in any direction. The 360° provide a great dimensional range for large users and many postures, and ensures proper support when using a range of technology, mobile or fixed.

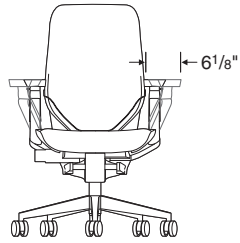

Arm width adjusts parallel 6 1/8" per arm for a total range of 10 1/4" to 22 1/2" between arms.

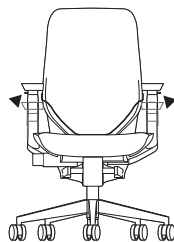

Arm height adjusts independently 4 1/4" (7 1/4"H to 11 1/2"H) to relieve upper back and shoulder fatigue.

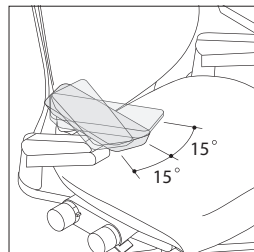

Arms pivot independently 15° inward and 15° outward. Grasp arm and push front to left or right.

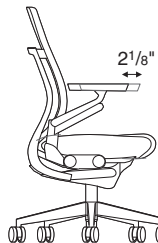

Arm depth adjusts 2 1/8" to enable user to get closer to worksurface.

Other features

Cartoned request on dealer purchase order forces Gesture chairs to ship knocked down in three pieces; the seat and back, the base, and the pneumatic cylinder. This allows for shipment in a smaller carton. Assembly by a qualified dealer installer is required. Assembly instructions are included. This does not apply to Gesture stools. No additional tools are required for assembly.



Armless models are also available.

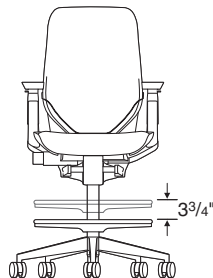

Column and foot ring on stools adjusts by first lifting ring and rotating it counterclockwise to unlock. Then raise or lower ring up to 3 3/4" to desired position before rotating it clockwise to lock.

Surface Materials

▶ See surface materials on page 634 for specific availability or refer to the *Surface Materials Reference Manual* for further information.

Open slats in the back shell will appear as a matching color to the back surface material if specified with Cogent:Connect or 3D Knit. Slats will appear as black if any other seating material is specified.

Upholstery

- Fabric
- Fabric with soil-retardant treatment (option)
- 3D Knit (back and headrest only)
- Leather
- Elmosoft leather
- Select Surfaces leather
- Vinyl
- COM
- COL

Hard components

(back frame, outer back, arm retainer, and base)

- 4799 Platinum
 - 6053 Seagull
 - 6205 Black
 - 6527 Merle
 - 7250 Sterling Dark
 - 8046 Polished Aluminum
- ▶ See color scheme matrix.

Headrest shell is determined by the color scheme.

- 6053 Seagull
- 6205 Black
- 6527 Merle

Stool footring finish is determined by the color scheme.

- 0835 Black (Black/Black, Dark/Dark)
- 4799 Platinum Metallic (Dark/Light, Light/Light)

Arm caps

- Black
- Leather

Coat hanger

- 7360 Merle

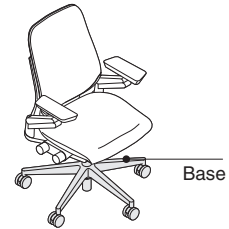

Polished aluminum base is available.

All Steelcase seating with standard upholstery fabrics complies with requirements of the State of California Technical Bulletin 117-2013. All standard seating is labeled to be in compliance with California 117-2013.

Programs & Services

► See the *Surface Materials Reference Manual* for further detail about programs and services offered for seating.

The Customer's Own Material (COM)

Program offers the opportunity for customers to select fabrics that are not offered through the standard Steelcase surface materials program for use on Steelcase products. Through the COM program, Steelcase will test your materials for application on Steelcase products. Once approved, you can place your order. Steelcase will facilitate the entire ordering process and give you a production schedule. Steelcase will order the COM fabric directly from the textile manufacturer. For up-to-date information regarding fabric test results for all COM fabrics and details regarding yardage requirements for most Seating lines, visit the COM website. To locate the COM website:

- Visit www.steelcase.com

Soil retardants are treatments that provide long-term soil and stain resistance to a fabric without affecting the shade or the integrity of the fabric. The following Steelcase Textiles are available pre-treated with soil retardant. (You do not need to select the soil-retardant option for these fabrics and incur the upcharge.)

- Jacks
- Link

For information on soil retardant fabrics on Select Surfaces, please refer to the *Surface Materials Reference Manual*.

Soil-retardant treatment is available on all other seating fabrics at an additional upcharge per seating unit. To order this option, please select "Soil-Retardant Treatment" under "Optional Accessories."

For soil-retardant treatment on COMs, please select "Soil-Retardant Treatment" under "Optional Accessories." Minimums or additional yardage may be required. Please contact the vendor directly for specific information. Extended lead times may be necessary for this service.

Contact your Steelcase Solutions Fulfillment Team Representative at 1.888.STEELCASE (1.888.783.3522) or send an email to lineone@steelcase.com.

Dimensions

- Page 38

Resources

Online Resources

- Interactive User Guide available on www.steelcase.com
- Model sales conversation available on village.steelcase.com
- Adjustability video available on www.steelcase.com
- Product Environmental Profiles, which provide key environmental attributes and product certifications can be found by searching for Steelcase at *Origin.build*.

Gesture 442 Series, continued

Color Scheme Matrix						
Color Scheme	Back Frame	Back Shell /Headrest	Seat Perimeter	Arms	Base	Cylinder
Black/Black	Molded Black-6205	Molded Black-6205	Molded Black-6205	Molded Black-6205	Molded Black-6205 or optional Polished Aluminum-8046	Painted Black-0835
Dark/Dark	Painted Sterling Dark Textured-7250	Molded Merle-6527	Molded Merle-6527	Molded Merle-6527	Painted Sterling Dark Textured-7250 or optional Polished Aluminum-8046	Painted Black-0835
Dark/Light	Painted Platinum Metallic-4799	Molded Merle-6527	Molded Merle-6527	Molded Merle-6527	Painted Platinum Metallic-4799 or optional Polished Aluminum-8046	Painted Platinum Metallic-4799
Light/Light	Painted Platinum Metallic-4799	Molded Seagull -6053	Molded Seagull -6053	Molded Merle-6527	Painted Platinum Metallic-4799 or optional Polished Aluminum-8046	Painted Platinum Metallic-4799

Tip: To enhance Gesture visuals and reduce environmental impact, effective summer 2024, Dark/Light and Light/Light color schemes will ship with 0835 Black painted cylinders.

Gesture Upholstery

What Is It?

Fabric, leather, or vinyl-covered back and seat, 3D Knit back.

Standard upholstery design

Cogent: Connect

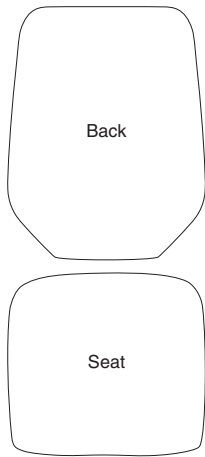

Stitched upholstery design

Leather, Vinyl, and All Other Fabrics

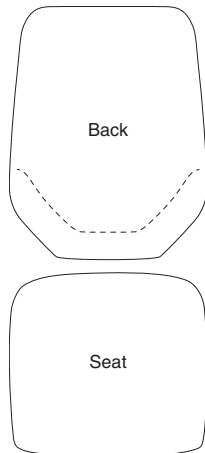

Chairs with headrest only

Leather, Vinyl, and All Other Fabrics

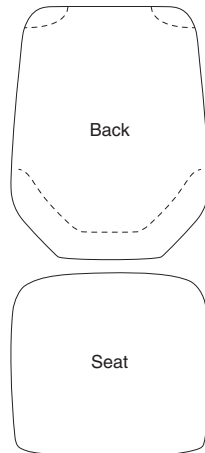

3D Knit on Back only

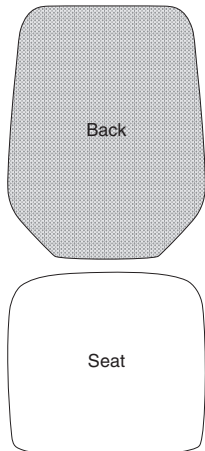

Stitched seams are included on the back cushion of the following:

- Leather
- Upholstery
- Customer's Own Leather (COL)
- Vinyl
- Select Customer's Own Material/Vinyl (COM)

Pattern alignment at the lumbar seam cannot be guaranteed.

Open slats in the back shell will appear as a matching color to the back surface material if specified with Cogent:Connect or 3D Knit. Slats will appear as black if any other seating material is specified.

Additional stitched seams in the upper left and right corner of the back cushion on Gesture chairs with headrest are included of the following:

- Leather
- Upholstery
- Customer's Own Leather (COL)
- Vinyl
- Select Customer's Own Material/Vinyl (COM)

Tip: Fabrics that show a distinct pattern or texture may demonstrate an undesirable contrast at the upper left and right corners of the top of the back.

3D Knit back is made up of three layers: the 3D Knit, a solid fabric that matches the 3D Knit color, and the polyurethane cushion that provides exceptional comfort. The seat on these models can be specified with Cogent: Connect fabric colors to match the 3D Knit color, or in any other material.

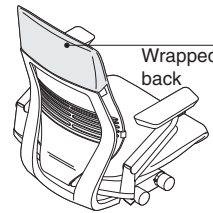
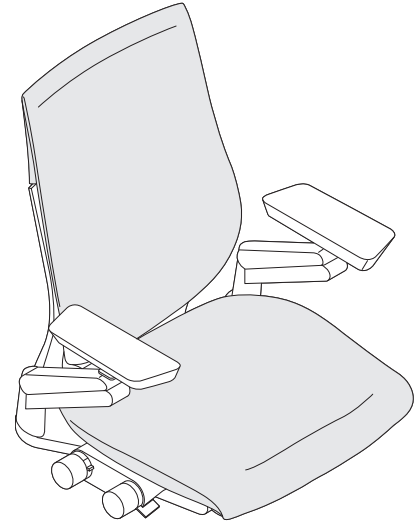

Wrapped upper back is upholstered to the top of the back frame.

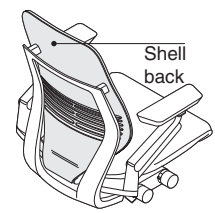

Plastic shell back is fully exposed.

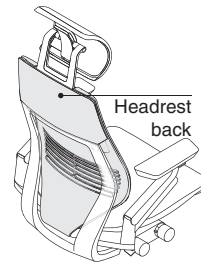

Headrest chair back is upholstered to the top of the back frame.

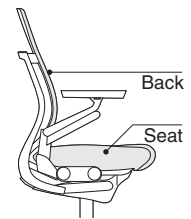

Seat and back cushions can be removed and replaced if damaged.

Dimensions

Gesture 442 Series

Features	Overall Depth	Width	Height	Seat Depth	Functional Seat Depth	Seat Width	Seat Height from Floor	Ring Height from Floor	Back Width	Back Height from Seat
Gesture 442 Series										
Work Chairs										
Adjustable Seat Depth	21" to 23 ⁵ / ₈ "	22 ³ / ₈ " to 34 ⁵ / ₈ "	39 ¹ / ₄ " to 44 ¹ / ₄ "	18 ¹ / ₄ "	15 ³ / ₄ " to 18 ¹ / ₂ "	20"*	16" to 21" (14 ¹ / ₂ " to 18 ¹ / ₄ ", 17" to 22 ¹ / ₂ " optional)	N.A.	16 ¹ / ₄ "	24 ¹ / ₁₆ "
Work Chair with Headrest										
Adjustable Seat Depth	21" to 23 ⁵ / ₈ "	22 ³ / ₈ " to 34 ⁵ / ₈ "	47" to 57"	18 ¹ / ₄ "	15 ³ / ₄ " to 18 ¹ / ₂ "	20"*	16" to 21" (14 ¹ / ₂ " to 18 ¹ / ₄ ", 17" to 22 ¹ / ₂ " optional)	N.A.	16 ¹ / ₄ "	25 ³ / ₈ "
Stools										
Adjustable Seat Depth	21" to 23 ⁵ / ₈ "	22 ³ / ₈ " to 34 ⁵ / ₈ "	47 ³ / ₈ " to 55 ⁵ / ₈ "	18 ¹ / ₄ "	15 ³ / ₄ " to 18 ¹ / ₂ "	20"*	24" to 32 ¹ / ₄ "	10 ¹ / ₄ " to 14"	16 ¹ / ₄ "	24 ¹ / ₁₆ "

Dimensions were measured with BIFMA CMD (chair-measuring device).

*Seat width at the front of the cushion is 18¹/₄"W.

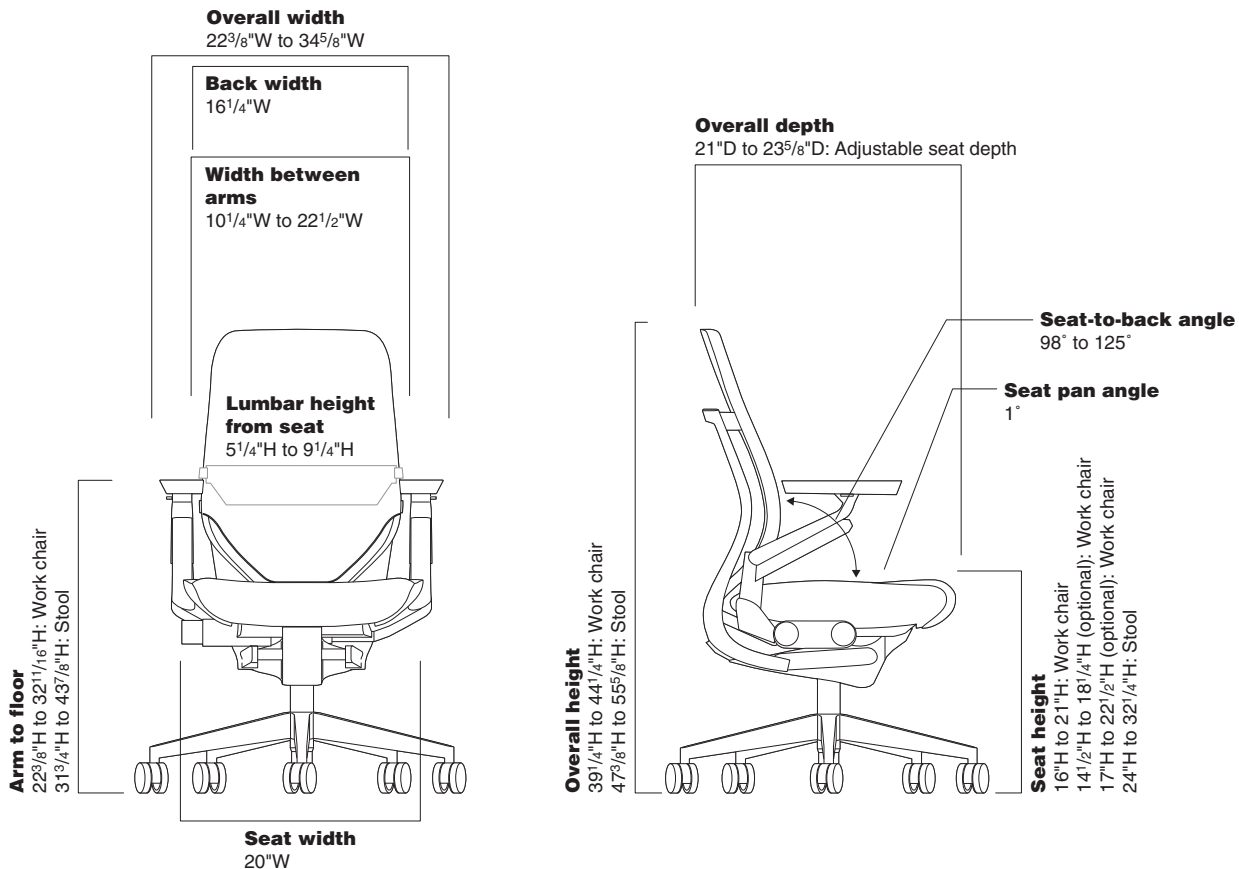

• Back Lumbar Height	• Lumbar Flex Zone	• Width Between Arms	• Arm to Floor	• Arm Height from Seat	• Arm Cap Pivot Range	• Seat Pan Angle	• Angle Between Seat and Back
----------------------	--------------------	----------------------	----------------	------------------------	-----------------------	------------------	-------------------------------

9¼"	4"	10¼" to 22½"	23⅜" to 32⅛"	7¼" to 11½"	15° inward, 15° outward	1°	98° to 125°
-----	----	--------------	--------------	-------------	-------------------------	----	-------------

9¼"	4"	10¼" to 22½"	23⅜" to 32⅛"	7¼" to 11½"	15° inward, 15° outward	1°	98° to 125°
-----	----	--------------	--------------	-------------	-------------------------	----	-------------

9¼"	4"	10¼" to 22½"	31¼" to 43⅞"	7¼" to 11½"	15° inward, 15° outward	1°	98° to 125°
-----	----	--------------	--------------	-------------	-------------------------	----	-------------

:	:	:	:	:	:	:	:
---	---	---	---	---	---	---	---

Gesture 442 Series

Gesture 442 Series Work Chairs

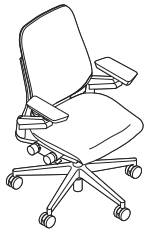

Tip: For more information regarding color schemes, see page 35.

Tip: Seat and back will be a matching textile unless 3D Knit is specified.

► Detailed dimensions, page 38



For Canadian Pricing
Multiply U.S. Price by the Canadian price factor.
► See page 1 for details.

Standard Includes		Required to Specify
► Need help? Product details, page 32	<ul style="list-style-type: none"> 5" pneumatic seat-height adjustment (16"-21") 360° independent height-, width-, pivot-, and depth-adjustable arms and soft arm caps: black plastic Frame, seat shell, outer back, and five-arm base: plastic 2¾" seat depth adjustment Standard upholstery design on seat: fabric price group 1 Shell back chair, if selected: fabric price group 1 Wrapped back chair, if selected: fabric price group 1 3D Knit on back only, if selected 2½" diameter, hard-composition, dual-wheel casters: black 	<ol style="list-style-type: none"> Style number Plastic color scheme for frame, seat shell, outer back, and base (see below under Required Selections) Fabric color number for upholstery on seat and back, if selected 3D Knit color number for upholstery on back, if selected Options, if selected (see below) <p>► See <i>Surface Materials</i>, page 634.</p>

Required Selections	U.S. Price	Required to Specify
Color Scheme		
• Black/Black	No cost	Specify with <i>black/black</i> color scheme.
• Dark/Dark	+\$ 65	Specify with <i>dark/dark</i> color scheme.
• Dark/Light	+\$ 65	Specify with <i>dark/light</i> color scheme.
• Light/Light	+\$ 65	Specify with <i>light/light</i> color scheme.

Options	U.S. Price	Required to Specify
Surface Materials		
Contrasting	+\$ 46	Specify with <i>contrasting</i> .
Upholstery on seat		
• Fabric price group 1	No cost	Specify fabric color number.
• Fabric price group 2	+\$ 12	Specify fabric color number.
• Fabric price group 3	+\$ 37	Specify fabric color number.
• Fabric price group 4	+\$ 51	Specify fabric color number.
• Fabric price group 5	+\$ 61	Specify fabric color number.
• Fabric price group 6	+\$ 76	Specify fabric color number.
• Fabric price group 7	+\$ 92	Specify fabric color number.
• Fabric price group 8	+\$112	Specify fabric color number.
• Fabric price group 9	+\$137	Specify fabric color number.
• Fabric price group 10	+\$159	Specify fabric color number.
• Steelcase leather upholstery	+\$457	Specify leather color number.
• Select Surfaces leather price group 1	+\$457	► See <i>Surface Materials Reference Manual</i> .
• Elmosoft leather upholstery	+\$537	Specify Elmosoft leather color number.
• Select Surfaces leather price group 2	+\$537	► See <i>Surface Materials Reference Manual</i> .
• Steelcase vinyl	+\$ 12	Specify vinyl color number.
• Customer's Own Material/Vinyl (COM-Sewn)	No cost	► See <i>Surface Materials Reference Manual</i> .
• Customer's Own Leather (COL-Sewn)	+\$198	Specify leather color number.
Upholstery on back		
• Fabric price group 1	No cost	Specify fabric color number.
• Fabric price group 2	+\$ 12	Specify fabric color number.
• Fabric price group 3	+\$ 37	Specify fabric color number.
• Fabric price group 4	+\$ 51	Specify fabric color number.
• Fabric price group 5	+\$ 61	Specify fabric color number.
• Fabric price group 6	+\$ 76	Specify fabric color number.
• Fabric price group 7	+\$ 92	Specify fabric color number.
• Fabric price group 8	+\$112	Specify fabric color number.
• Fabric price group 9	+\$137	Specify fabric color number.
• Fabric price group 10	+\$159	Specify fabric color number.
• 3D Knit	+\$ 85	Specify 3D Knit fabric color number.
• Steelcase leather upholstery	+\$457	Specify leather color number.
• Select Surfaces leather price group 1	+\$457	► See <i>Surface Materials Reference Manual</i> .
• Elmosoft leather upholstery	+\$537	Specify Elmosoft leather color number.
• Select Surfaces leather price group 2	+\$537	► See <i>Surface Materials Reference Manual</i> .
• Steelcase vinyl	+\$ 12	Specify vinyl color number.
• Customer's Own Material/Vinyl (COM-Sewn)	No cost	► See <i>Surface Materials Reference Manual</i> .
• Customer's Own Leather (COL-Sewn)	+\$198	Specify leather color number.
Soil-retardant treatment	+\$ 36	Specify with <i>soil-retardant</i> treatment.

► Options, continued on next page

► Options, continued from previous page

Options	U.S. Price	Required to Specify
Surface Materials, continued	Polished aluminum base package	
• Polished aluminum base on chairs	+\$205	Specify with polished aluminum base.
Arms		
• 360° independent height-, width-, pivot-, and depth-adjustable arms with leather arm caps	+\$240	Specify with 360° independent height-, width-, pivot-, and depth-adjustable arms and select leather color number.
• 360° independent height-, width-, pivot-, and depth-adjustable arms with Elmosoft leather arm caps	+\$281	Specify with 360° independent height-, width-, pivot-, and depth-adjustable arms and select Elmosoft leather color number.
• Armless	-\$401	Specify without arms.
Seat Height		
• 3 ³ / ₄ " low-range pneumatic seat-height adjustment (14 ¹ / ₂ " to 18 ¹ / ₄ ")	+\$ 85	Specify with low-range pneumatic seat-height adjustment.
• 5 ¹ / ₂ " high-range pneumatic seat-height adjustment (17" to 22 ¹ / ₂ ")	+\$ 85	Specify with high-range pneumatic seat-height adjustment.
Lumbar	• Adjustable lumbar support	+\$ 47
		Specify with adjustable lumbar height.
Casters	• Soft, dark grey treaded, dual-wheel roll-control casters for use on hard floors	+\$ 36
		Specify with soft roll-control casters.
Glides	• Glides: plastic	+\$ 36
		Specify with glides.
CarbonNeutral Product	• CarbonNeutral product certification	+\$ 35
		Add suffix CN to the end of the style number.

Gesture 442 Series

Specification Information

Style Number	U.S. Base Price

Wrapped Back Chair

442A40	\$2278
---------------	--------

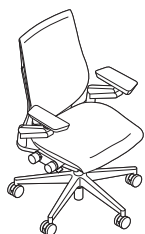

Tip: Coat hanger cannot be used on Gesture wrapped back chair.

Shell Back Chair

442A30	\$2239
---------------	--------



For Canadian Pricing
Multiply U.S. Price by the Canadian price factor.
► See page 1 for details.

Gesture 442 Series Work Chair with Headrest

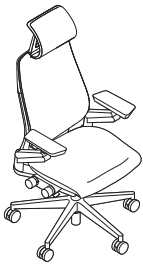

Tip: For more information regarding color schemes, see page 35.

Tip: Headrest upholstery can match or contrast the seat and back upholstery.

Tip: Seat and back will be a matching textile unless 3D Knit is specified.

► Detailed dimensions, page 38



For Canadian Pricing
Multiply U.S. Price by the Canadian price factor.
► See page 1 for details.

Standard Includes		Required to Specify
► Need help? Product details, page 32	<ul style="list-style-type: none"> 5" pneumatic seat-height adjustment (16"-21") 360° independent height-, width-, pivot-, and depth-adjustable arms and soft arm caps: black plastic Frame, seat shell, outer back, and five-arm base: plastic 2¾" seat depth adjustment Standard upholstery design on seat: fabric price group 1 Adjustable headrest, standard upholstery 3D Knit on back and headrest only, if selected 2½" diameter, hard-composition, dual-wheel casters: black 	<ol style="list-style-type: none"> Style number Plastic color scheme for frame, seat shell, outer back, headrest, and base (see below under Required Selections) Fabric color number for upholstery on seat and back, if selected Fabric color number for upholstery on headrest 3D Knit color number for upholstery on back, if selected Options, if selected (see below) <p>► See <i>Surface Materials</i>, page 634.</p>

Required Selections	U.S. Price	Required to Specify
Color Scheme		
• Black/Black	No cost	Specify with black/black color scheme.
• Dark/Dark	+\$ 65	Specify with dark/dark color scheme.
• Dark/Light	+\$ 65	Specify with dark/light color scheme.
• Light/Light	+\$ 65	Specify with light/light color scheme.

Options	U.S. Price	Required to Specify
Surface Materials		
Contrasting		
• Contrasting fabrics	+\$ 46	Specify with contrasting.
Upholstery on seat		
• Fabric price group 1	No cost	Specify fabric color number.
• Fabric price group 2	+\$ 12	Specify fabric color number.
• Fabric price group 3	+\$ 37	Specify fabric color number.
• Fabric price group 4	+\$ 51	Specify fabric color number.
• Fabric price group 5	+\$ 61	Specify fabric color number.
• Fabric price group 6	+\$ 76	Specify fabric color number.
• Fabric price group 7	+\$ 92	Specify fabric color number.
• Fabric price group 8	+\$112	Specify fabric color number.
• Fabric price group 9	+\$137	Specify fabric color number.
• Fabric price group 10	+\$159	Specify fabric color number.
• Steelcase leather upholstery	+\$457	Specify leather color number.
• Select Surfaces leather price group 1	+\$457	► See <i>Surface Materials Reference Manual</i> .
• Elmosoft leather upholstery	+\$537	Specify Elmosoft leather color number.
• Select Surfaces leather price group 2	+\$537	► See <i>Surface Materials Reference Manual</i> .
• Steelcase vinyl	+\$ 12	Specify vinyl color number.
• Customer's Own Material/Vinyl (COM-Sewn)	No cost	► See <i>Surface Materials Reference Manual</i> .
• Customer's Own Leather (COL-Sewn)	+\$198	Specify leather color number.
Upholstery on back		
• Fabric price group 1	No cost	Specify fabric color number.
• Fabric price group 2	+\$ 12	Specify fabric color number.
• Fabric price group 3	+\$ 37	Specify fabric color number.
• Fabric price group 4	+\$ 51	Specify fabric color number.
• Fabric price group 5	+\$ 61	Specify fabric color number.
• Fabric price group 6	+\$ 76	Specify fabric color number.
• Fabric price group 7	+\$ 92	Specify fabric color number.
• Fabric price group 8	+\$112	Specify fabric color number.
• Fabric price group 9	+\$137	Specify fabric color number.
• Fabric price group 10	+\$159	Specify fabric color number.
• 3D Knit	+\$ 85	Specify 3D Knit fabric color number.
• Steelcase leather upholstery	+\$457	Specify leather color number.
• Select Surfaces leather price group 1	+\$457	► See <i>Surface Materials Reference Manual</i> .
• Elmosoft leather upholstery	+\$537	Specify Elmosoft leather color number.
• Select Surfaces leather price group 2	+\$537	► See <i>Surface Materials Reference Manual</i> .
• Steelcase vinyl	+\$ 12	Specify vinyl color number.
• Customer's Own Material/Vinyl (COM-Sewn)	No cost	► See <i>Surface Materials Reference Manual</i> .
• Customer's Own Leather (COL-Sewn)	+\$198	Specify leather color number.
Soil-retardant treatment	+\$ 36	Specify with soil-retardant treatment.

► Options, continued on next page

► Options, continued from previous page

Options	U.S. Price	Required to Specify	
Surface Materials, continued	Polished aluminum base package		
• Polished aluminum base on chairs	+\$205	Specify with <i>polished aluminum base</i> .	
Arms			
• 360° independent height-, width-, pivot-, and depth-adjustable arms with leather arm caps	+\$240	Specify with <i>360° independent height-, width-, pivot-, and depth-adjustable arms</i> and select leather color number.	
• 360° independent height-, width-, pivot-, and depth-adjustable arms with Elmosoft leather arm caps	+\$281	Specify with <i>360° independent height-, width-, pivot-, and depth-adjustable arms</i> and select Elmosoft leather color number.	
• Armless	-\$401	Specify <i>without arms</i> .	
Seat Height			
• 3 ³ / ₄ " low-range pneumatic seat-height adjustment (14 ¹ / ₂ " to 18 ¹ / ₄ ")	+\$ 85	Specify with <i>low-range pneumatic seat-height adjustment</i> .	
• 5 ¹ / ₂ " high-range pneumatic seat-height adjustment (17" to 22 ¹ / ₂ ")	+\$ 85	Specify with <i>high-range pneumatic seat-height adjustment</i> .	
Lumbar	• Adjustable lumbar support	+\$ 47	Specify with <i>adjustable lumbar height</i> .
Casters	• Soft, dark grey treaded, dual-wheel roll-control casters for use on hard floors	+\$ 36	Specify with <i>soft roll-control casters</i> .
Glides	• Glides: plastic	+\$ 36	Specify with <i>glides</i> .
CarbonNeutral Product	• CarbonNeutral product certification	+\$ 35	Add suffix CN to the end of the style number.

Specification Information

Style Number	U.S. Base Price
442A50	\$2656

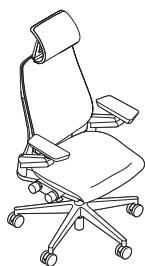

Tip: Coat hanger cannot be used on Gesture chair with headrest.

**For Canadian Pricing**

Multiply U.S. Price by the Canadian price factor.

► See page 1 for details.

Gesture 442 Series Stools

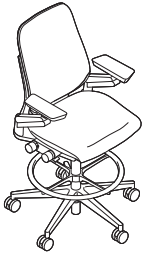

Tip: For more information regarding color schemes, see page 35.

Tip: Seat and back will be a matching textile unless 3D Knit is specified.

► Detailed dimensions, page 38



For Canadian Pricing
Multiply U.S. Price by the Canadian price factor.
► See page 1 for details.

Standard Includes		Required to Specify
► Need help? Product details, page 32	<ul style="list-style-type: none"> • 8¼" pneumatic seat-height adjustment (24"-32¼") • 360° independent height-, width-, pivot-, and depth-adjustable arms and soft arm caps: black plastic • Frame, seat shell, outer back, and five-arm base: plastic • 2¾" seat depth adjustment • Column and 4" adjustable foot ring • Standard upholstery design on seat: fabric price group 1 • Shell back stool, if selected: fabric price group 1 • Wrapped back stool, if selected: fabric price group 1 • 3D Knit on back only, if selected • 2½" diameter, hard-composition, dual-wheel casters: black 	<ol style="list-style-type: none"> 1 Style number 2 Plastic color scheme for frame, seat shell, outer back, and base (see below under Required Selections) 3 Fabric color number for upholstery on seat and back, if selected 4 3D Knit color number for upholstery on back, if selected 5 Options, if selected (see below) <p>► See <i>Surface Materials</i>, page 634.</p>

Required Selections	U.S. Price	Required to Specify
Color Scheme		
• Black/Black	No cost	Specify with <i>black/black</i> color scheme.
• Dark/Dark	+\$ 65	Specify with <i>dark/dark</i> color scheme.
• Dark/Light	+\$ 65	Specify with <i>dark/light</i> color scheme.
• Light/Light	+\$ 65	Specify with <i>light/light</i> color scheme.

Options	U.S. Price	Required to Specify
Surface Materials		
Contrasting		
• Contrasting fabrics	+\$ 46	Specify with <i>contrasting</i> .
Upholstery on seat		
• Fabric price group 1	No cost	Specify fabric color number.
• Fabric price group 2	+\$ 12	Specify fabric color number.
• Fabric price group 3	+\$ 37	Specify fabric color number.
• Fabric price group 4	+\$ 51	Specify fabric color number.
• Fabric price group 5	+\$ 61	Specify fabric color number.
• Fabric price group 6	+\$ 76	Specify fabric color number.
• Fabric price group 7	+\$ 92	Specify fabric color number.
• Fabric price group 8	+\$112	Specify fabric color number.
• Fabric price group 9	+\$137	Specify fabric color number.
• Fabric price group 10	+\$159	Specify fabric color number.
• Steelcase leather upholstery	+\$457	Specify leather color number.
• Select Surfaces leather price group 1	+\$457	► See <i>Surface Materials Reference Manual</i> .
• Elmosoft leather upholstery	+\$537	Specify Elmosoft leather color number.
• Select Surfaces leather price group 2	+\$537	► See <i>Surface Materials Reference Manual</i> .
• Steelcase vinyl	+\$ 12	Specify vinyl color number.
• Customer's Own Material/Vinyl (COM-Sewn)	No cost	► See <i>Surface Materials Reference Manual</i> .
• Customer's Own Leather (COL-Sewn)	+\$198	Specify leather color number.
Upholstery on back		
• Fabric price group 1	No cost	Specify fabric color number.
• Fabric price group 2	+\$ 12	Specify fabric color number.
• Fabric price group 3	+\$ 37	Specify fabric color number.
• Fabric price group 4	+\$ 51	Specify fabric color number.
• Fabric price group 5	+\$ 61	Specify fabric color number.
• Fabric price group 6	+\$ 76	Specify fabric color number.
• Fabric price group 7	+\$ 92	Specify fabric color number.
• Fabric price group 8	+\$112	Specify fabric color number.
• Fabric price group 9	+\$137	Specify fabric color number.
• Fabric price group 10	+\$159	Specify fabric color number.
• 3D Knit	+\$ 85	Specify 3D knit fabric color number.
• Steelcase leather upholstery	+\$457	Specify leather color number.
• Select Surfaces leather price group 1	+\$457	► See <i>Surface Materials Reference Manual</i> .
• Elmosoft leather upholstery	+\$537	Specify Elmosoft leather color number.
• Select Surfaces leather price group 2	+\$537	► See <i>Surface Materials Reference Manual</i> .
• Steelcase vinyl	+\$ 12	Specify vinyl color number.
• Customer's Own Material/Vinyl (COM-Sewn)	No cost	► See <i>Surface Materials Reference Manual</i> .
• Customer's Own Leather (COL-Sewn)	+\$198	Specify leather color number.
Soil-retardant treatment	+\$ 36	Specify with <i>soil-retardant</i> treatment.

► Options, continued on next page

► Options, continued from previous page

Options	U.S. Price	Required to Specify	
Surface Materials, continued	Polished aluminum base package		
• Polished aluminum base on chairs	+\$205	Specify with <i>polished aluminum base</i> .	
Arms			
• 360° independent height-, width-, pivot-, and depth-adjustable arms with leather arm caps	+\$240	Specify with <i>360° independent height-, width-, pivot-, and depth-adjustable arms</i> and select leather color number.	
• 360° independent height-, width-, pivot-, and depth-adjustable arms with Elmosoft leather arm caps	+\$281	Specify with <i>360° independent height-, width-, pivot-, and depth-adjustable arms</i> and select Elmosoft leather color number.	
• Armless	-\$401	Specify <i>without arms</i> .	
Lumbar	• Adjustable lumbar support	+\$ 47	Specify with <i>adjustable lumbar height</i> .
Casters	• Soft, dark grey treaded, dual-wheel roll-control casters for use on hard floors	+\$ 36	Specify with <i>soft roll-control casters</i> .
Glides	• Glides: plastic	+\$ 36	Specify with <i>glides</i> .
CarbonNeutral Product	• CarbonNeutral product certification	+\$ 35	Add suffix CN to the end of the style number.

Specification Information

Style Number	U.S. Base Price
.....

Wrapped Back Stool

442B40	\$2612
.....

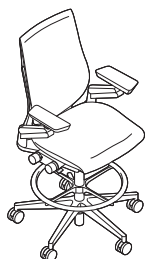

Shell Back Stool

442B30	\$2573
.....

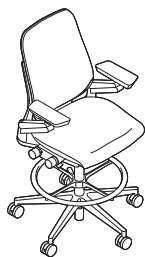

Tip: Coat hanger cannot be used on Gesture stools.



For Canadian Pricing
Multiply U.S. Price by the Canadian price factor.
► See page 1 for details.

Gesture Coat Hanger



Tip: Coat hanger cannot be used on Gesture stools or wrapped back chairs (including wrapped back with headrest).

Tip: Stand alone add on accessories are not available with CarbonNeutral product certification.

Standard Includes	Required to Specify
<ul style="list-style-type: none"> ▶ Need help? Product details, page 32 • Coat hanger: 7360 Merle paint 	<ul style="list-style-type: none"> Style number

Specification Information	
• Style Number	• U.S. Price
442COATHANGER	\$97

▶ Detailed dimensions, page 38



For Canadian Pricing
 Multiply U.S. Price by the Canadian price factor.
 ▶ See page 1 for details.

Understanding and Specifying Leap 462 Series Work Chairs

Work Chairs

Highly adjustable task seating offers maximum personalization for fit and comfort for a range of duration and use. By making a series of simple adjustments, you can customize the chair to your body, preferences, and tasks. These chairs provide continuous, stable, comfort, and can be quickly adjusted to support you in upright, and reclining work postures.

- Gesture 442 Series
- Leap 462 Series
- Think 465 Series
- Amia 482 Series
- Reply 466 Series

Adjustability Features

► See page 26 for a comparison to other chairs.

	Leap 462 Series	Leap Plus
Mechanisms		
Natural glide	●	●
Seat Adjustments		
Pneumatic height	●	●
Passive seat edge angle	●	
Seat depth	●	●
Back Adjustments		
Lumbar height	●	●
Lower back firmness	●	●
Upper back tension	●	●
Variable back stop	●	●
Arm Adjustments		
Arm height	●	●
Arm width	●	●
Arm pivot	●	●
Arm depth	●	●
Other Features		
Foot ring height (stool)	●	

Product Details

Leap 462 Series	48
Leap Upholstery	51
Dimensions	52

Specifying

Work Chairs

Upholstery on Back and Seat	54
3D Knit on Back with Upholstery on Seat	58

Stools

Upholstery on Back and Seat	60
3D Knit on Back with Upholstery on Seat	64

Plus Work Chairs

Upholstery on Back and Seat	66
3D Knit on Back and Upholstery on Seat	70

Leap Coat Hanger

	72
--	----

Leap 462 Series



Now available as a **CarbonNeutral product**, making sure our commitment to a more sustainable future helps yours too.

Leap is a high-performance chair for customers who place the highest value on ergonomics, health, and productivity.

Outer back and outer seat are plastic.

LiveBack moves with the shape of the user's spine as sitting positions change.

Lumbar height adjusts 5" to provide additional lower back support. It is standard on all chairs, but may be omitted.

Arm height can adjust independently within a 4" range to help relieve upper back and shoulder fatigue.

Seat depth adjusts within a 3" range to accommodate users of varying leg lengths. Seat depth is standard on all models.

Five-star base is available in plastic or polished aluminum.

Casters have hard, dual-wheels that roll smoothly on carpets. They are 2½" for increased mobility. Soft, dark grey treaded, dual-wheel roll-control casters are available for use on hard floors or mats. Stools are standard with 2" hard casters. Soft casters are available as an option.

Tip: Do not roll the chair across asphalt during installation as this may damage the casters.

Arm depth can retract 3" to allow user to get closer to worksurface and into tight corners.

Arm width can adjust 4½" overall to provide forearm support.

Arm caps can pivot 30° in and out to accommodate individual user preferences.

Passive seat edge angle allows the front edge of the seat to flex 1½" to relieve pressure under the user's thighs.

Lower back firmness changes the amount of firmness user feels in lower back. Requires only two complete turns.

Upper back force requires only five complete turns and accommodates a broader range of users by allowing user to change the rate of increase in force as the user reclines.

Variable back stop with five positions is standard.

Seat height adjusts within a 5" range with a pneumatic adjustment mechanism. A 7" range is available as an option. Stools have an 8" range.

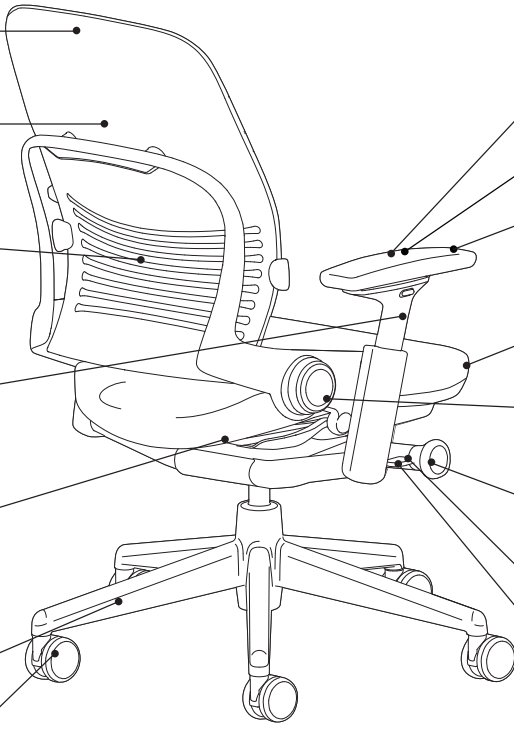

Product Details

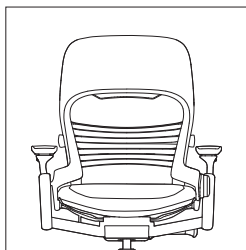

Parallel slats in the Live-Back shell provide extensive flexibility to allow back to conform to individual users.

Leap Plus offers the benefits and functionality of the standard Leap chair, including LiveBack Technology, to users weighing up to 500 pounds.

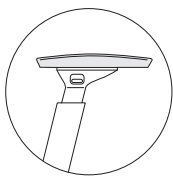

Rectilinear arms with soft caps are standard.

Models are standard with adjustable seats that include seat depth and passive seat edge angle.

Adjustability instructions are included with every chair. Fully adjustable arm models include instructions under the arm cap. Instructions can also be found at www.steelcase.com

Controls under the seat include tactile braille designators.



Coat hanger is field installed. It is offered in one finish, 0835 Black. The coat hanger supports up to 10 pounds and is not intended to hold bags or backpacks. The coat hanger cannot be used on stool models.

Cartoned request on your dealer purchase order means Leap chairs will ship knocked down with the chair base separated from the rest of the chair. This allows for shipment in a smaller carton. Assembly instructions are included. This does not apply to Leap stools or Leap Plus.

Uncartoned request on your dealer purchase order means Leap chairs will ship fully assembled.

Product Weight

- Leap chair: 46.7 pounds
- Leap Plus chair: 60.2 pounds



CarbonNeutral.com

CarbonNeutral product Leap helps organizations achieve their carbon emissions goals. Add **CN** to the end of the style number to specify Leap with CarbonNeutral product certification.

Adjustment Features

Seat Adjustments

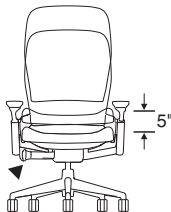

Seat height adjusts pneumatically. To lower, hold handle up while seated. To raise, hold handle up and keep your weight off the chair. Range of adjustability is 5", from 15½"H to 20½"H, and is standard on work chairs. A 7" range of adjustability (17"H to 24"H) is available as an option. Stools are standard with an 8" range of adjustability (22"H to 30"H). Leap Plus is standard with a 4" range of adjustability (15½"H to 19½"H). A 5" range (17½"H to 22½"H) is available as an option.

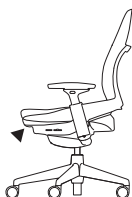

Passive seat edge angle flexes 1½", relieving pressure under the user's thighs. This feature is standard on all work chairs and stools.

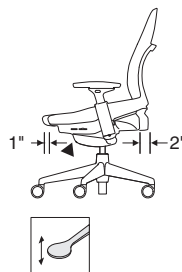

Seat depth adjusts 3" (15¾"-18¾") by pulling handle up. Slide seat forward or back to accommodate various leg lengths. Release handle to lock. This feature is standard on work chairs and stools. Seat depth adjustment range for Leap Plus is 2" (16¾"-18¾").

Back Adjustments

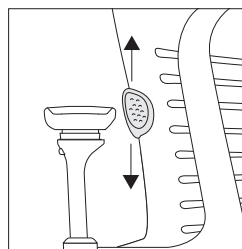

Lumbar height adjusts 5" (5¼" to 10¼" from seat, 6½" to 11½" on Plus chairs) by grabbing exposed tabs and sliding the lumbar support up or down. This feature is standard on work chairs and stools, but may be omitted.

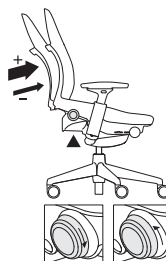

Lower back firmness adjusts by turning knob two complete turns. Forward increases firmness. Backward decreases firmness. This feature is standard on work chairs and stools.

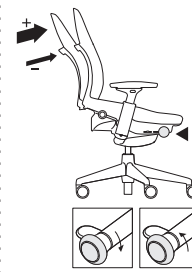

Upper back force adjusts by turning knob five complete turns. Turn knob forward to increase rate of tension; backward to decrease. This feature is standard on work chairs and stools.

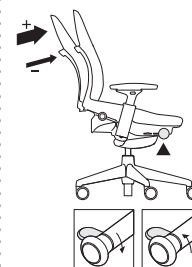

Variable back stop. Rotate handle up or down to set recline angle. Lean back to desired back angle. Five stops are available. This feature is standard on work chairs and stools. *Tip: To stop in upright position, remove weight from back and rotate lever up.*

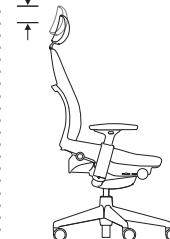

Headrest (option) adjusts 2¼" vertically and adds 6¾" to 9" to the overall height. Plastic shell on the headrest is available in black only. Upholstery is available to match the seat material or black vinyl only. Headrest is not available on stools or Plus models.

Leap 462 Series, continued

Arm Adjustments

Rectilinear height-, width-, pivot-, and depth-adjustable arms come standard on all arm models of chairs and stools.

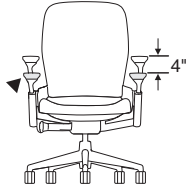

Arm height adjusts independently within a range of 4" (7"–11" from the seat, 7¼"–11¼" on Plus models). Push button on outside and under arm cap in while moving arms up or down. Releasing buttons locks arms in position.

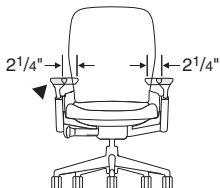

Arm width adjusts 2¼" each independently on chairs with this option. Grasp arm and move in or out.

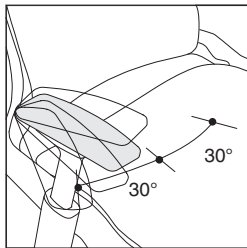

Arms pivot independently 30° inward and outward. Grasp arm and push front to left or right.

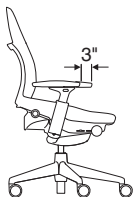

Arm depth adjusts approximately 3" to enable user to get closer to worksurface.

Other Features

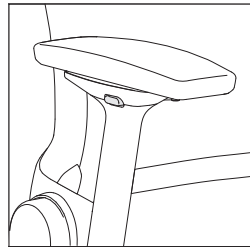

Height-only adjustable arm is also available and adjusts 4".



Armless models are also available.

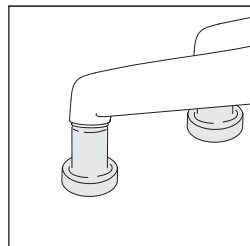

Glides are available as an option, except on chairs with polished aluminum package. Glides ship with chair or stool for field installation and maintain same height as casters.

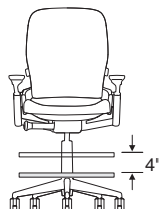

Foot ring height on stools adjusts by first lifting ring and rotating it counter-clockwise to unlock. Then raise or lower ring up to 4" to desired position before rotating it clockwise to lock.

Soft-wheel casters for hard floors are available for specific applications.

Surface Materials

▶ See surface materials on page 634 for specific availability or refer to the *Surface Materials Reference Manual* for further information.

Upholstery

- Fabric
- Fabric with soil-retardant treatment (option)
- 3D Knit (back only)
- Leather
- Elmosoft leather
- Select Surfaces leather
- Vinyl
- COM
- COL

Hard components

- (ribbon back frame, outer back, arm retainer, and base)
- 6205 Black
 - 6249 Platinum
 - 6259 Midnight

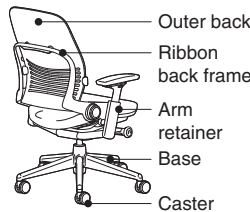

Polished aluminum package is available on black chairs only. Polished aluminum is applied to ribbon back frame, base, and casters. Stools and Plus models are not available with this package.

Arms

- Black only

Column and foot ring on stools

- 7207 Black only

Coat hanger

- 0835 Black

All Steelcase seating with standard upholstery fabrics complies with requirements of the State of California Technical Bulletin 117-2013. All standard seating is labeled to be in compliance with California 117-2013.

Programs & Services

▶ See the *Surface Materials Reference Manual* for further detail about programs and services offered for seating.

The Customer's Own Material (COM) Program

offers the opportunity for customers to select fabrics that are not offered through the standard Steelcase surface materials program for use on Steelcase products. Through the COM program, Steelcase will test your materials for application on Steelcase products. Once approved, you can place your order. Steelcase will facilitate the entire ordering process and give you a production schedule.

Steelcase will order the COM fabric directly from the textile manufacturer. For up-to-date information regarding fabric test results for all COM fabrics and details regarding yardage requirements for most Seating lines, visit the COM website. To locate the COM website:

- Visit www.steelcase.com
- Soil retardants** are treatments that provide long-term soil and stain resistance to a fabric without affecting the shade or the integrity of the fabric. The following Steelcase Textiles are available pre-treated with soil retardant. (You do not need to select the soil-retardant option for these fabrics and incur the upcharge.)

- Jacks
- Link

For information on soil retardant fabrics on Select Surfaces, please refer to the *Surface Materials Reference Manual*.

Soil-retardant treatment is available on all other seating fabrics at an additional upcharge per seating unit. To order this option, please select "Soil-Retardant Treatment" under "Optional Accessories."

For soil-retardant treatment on COMs, please select "Soil-Retardant Treatment" under "Optional Accessories." Minimums or additional yardage may be required. Please contact the vendor directly for specific information.

Extended lead times may be necessary for this service.

Contact your Steelcase Solutions Fulfillment Team Representative at 1.888.STEELCASE (1.888.783.3522) or send an email to lineone@steelcase.com.

Local codes may have special requirements for upholstery.

Dimensions

▶ Page 52

Resources

Printed Materials

- ▶ Leap Brochure (11-0002334)
- ▶ Humantech Case Study (03-0003715)
- ▶ Leap Productivity and Health Impact Study (03-0003716)

Online Resources

- ▶ Interactive User Guide available on www.steelcase.com
- ▶ Leap mini-site (download) available on village.steelcase.com or viewable on www.steelcase.com.
- ▶ Model sales conversation available on village.steelcase.com
- ▶ Leap User Guide available on www.steelcase.com
- ▶ Adjustability video available on www.steelcase.com
- ▶ Leap White Paper Packet available on village.steelcase.com
- ▶ Product Environmental Profiles, which provide key environmental attributes and product certifications can be found by searching for Steelcase at *Origin.build*.

Leap Upholstery

What Is It?

Fabric, leather, or vinyl-covered back and seat, 3D Knit back.

Fabric

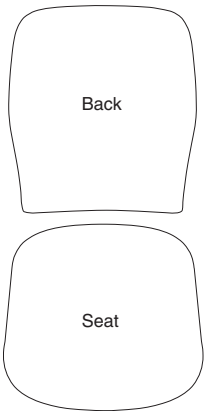

Leather, Vinyl, and Select Fabrics

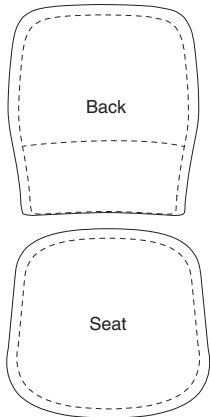

3D Knit Back

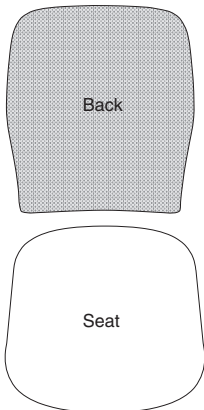

Stitched seams are included on the back cushion and seat cushion of the following:

- Leather
- Customer's Own Leather (COL)
- Vinyl
- Select Customer's Own Material/Vinyl (COM)

Pattern alignment at the lumbar seam cannot be guaranteed.

3D Knit back is made up of three layers: the 3D Knit, a solid fabric that matches the 3D Knit color, and the polyester cushion that provides exceptional comfort. The seat on these models can be specified with Cogent: Connect fabric colors to match the 3D Knit color, or in any other material.

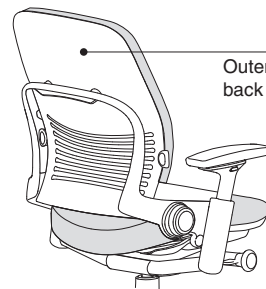

Plastic outer back is fully exposed.

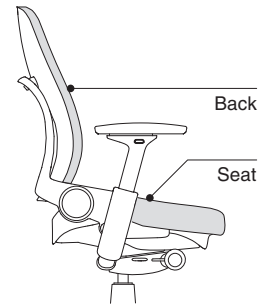

Seat and back cushions can be removed and replaced if damaged.

Dimensions

Leap 462 Series

Features	Overall Depth	Width	Height	Seat Depth	Functional Seat Depth	Seat Width	Seat Height from Floor	Ring Height from Floor	Back Width	Back Height from Seat
Leap 462 Series										
Work Chairs										
Adjustable Seat Depth	21 ³ / ₄ " to 24 ³ / ₄ "	27"	38 ¹ / ₂ " to 43 ¹ / ₂ "	19"	15 ³ / ₄ " to 18 ³ / ₄ "	19 ¹ / ₄ "	15 ¹ / ₂ " to 20 ¹ / ₂ "	N.A.	18"	25"
Stools										
Adjustable Seat Depth	21 ³ / ₄ " to 24 ³ / ₄ "	27"	46" to 54"	19"	15 ³ / ₄ " to 18 ³ / ₄ "	19 ¹ / ₄ "	22" to 30"	6" to 18"	18"	25"
Plus Work Chairs										
Adjustable Seat Depth	21 ³ / ₄ " to 24 ³ / ₄ "	31 ³ / ₄ "	38 ³ / ₄ " to 42 ¹ / ₂ "	20 ¹ / ₂ "	16 ³ / ₄ " to 18 ³ / ₄ "	22 ³ / ₄ "	15 ¹ / ₂ " to 19 ¹ / ₂ "	N.A.	20"	24 ¹ / ₂ "

Dimensions were measured with BIFMA CMD (chair-measuring device).

****Arm width adjustment for Leap** is 15"–20". Arm pivot adjustment adds 2¹/₄" to the minimum width providing a total of 12³/₄"–20" of width between the arms.

****Arm width adjustment for Leap Plus** is 19³/₄"–24³/₄". Arm pivot adjustment adds 2¹/₄" to the minimum width providing a total of 17¹/₂"–24³/₄" of width between the arms.

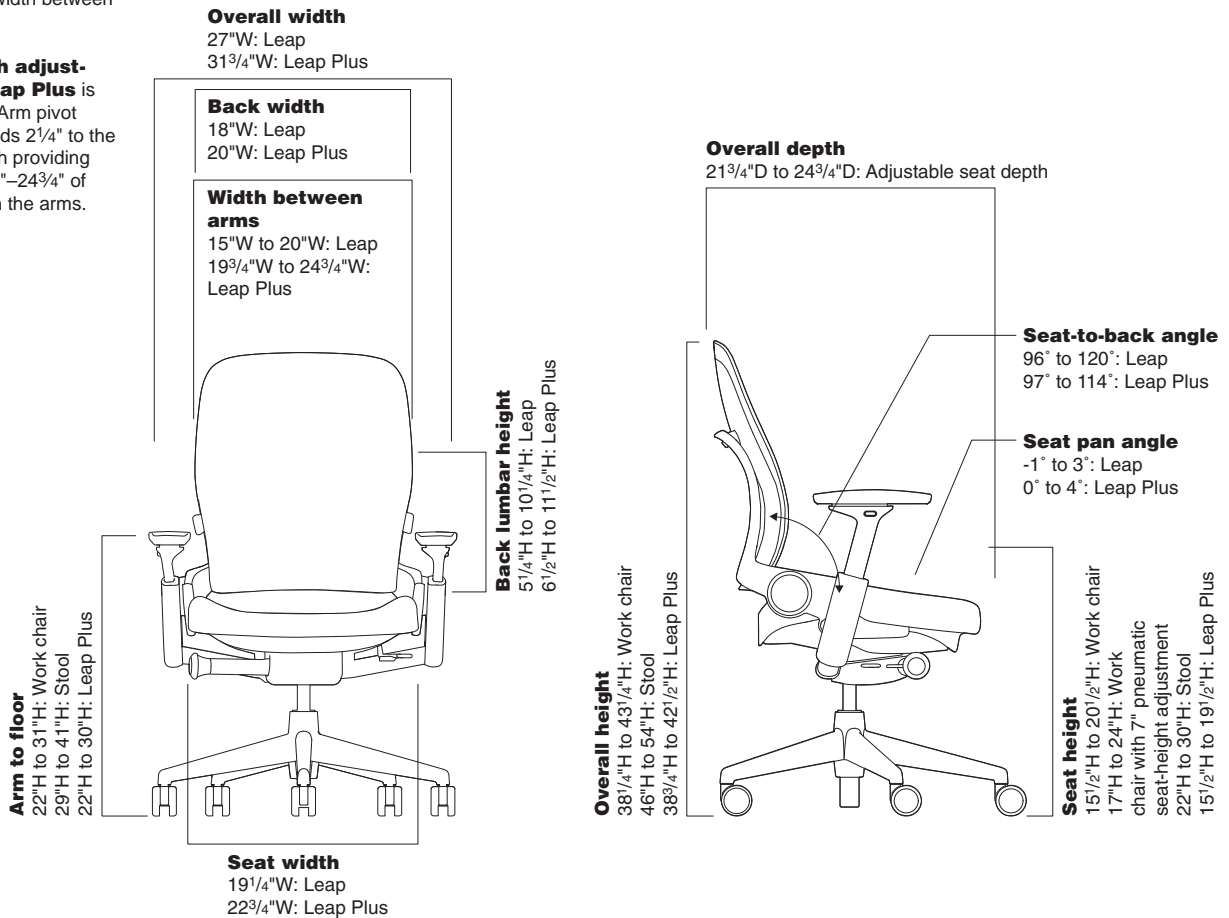

• Back Lumbar Height	• Lumbar Flex Zone	• Width Between Arms	• Arm to Floor	• Arm Height from Seat	• Arm Cap Pivot Range	• Seat Pan Angle	• Angle Between Seat and Back	• Headrest Height Adjustment Range
Work Chairs								
5¼" to 10¼"	5¼" to 10¼"	15" to 20"***	22" to 31"	7" to 11"	30°	-1° to 3°	96° to 120°	2¼"
Stools								
5¼" to 10¼"	5¼" to 10¼"	12¾" to 20"***	29" to 41"	7" to 11"	30°	-1° to 3°	96° to 120°	N.A.
Plus Work Chairs								
6½" to 11½"	11¼" to 16¼"	17½" to 24¾"***	22" to 30"	7¼" to 11¼"	30"	0° to 4°	97° to 114°	N.A.

Leap 462 Series

Leap 462 Series Work Chair

Upholstery on Back and Seat



Standard Includes	Required to Specify
<ul style="list-style-type: none"> ▶ Need help? Product details, page 48 • Upper back force • 5" pneumatic seat-height adjustment • Variable back stop • Lower back firmness • Rectilinear independent height-, width-, pivot-, and depth- adjustable arms and soft arm caps, if selected: black plastic • Frame, seat shell, outer back, and five-arm base: plastic • 3" seat depth adjustment • Passive seat edge angle • Adjustable lumbar • Standard upholstery design: fabric price group 1 • 2½"-diameter, hard-composition, dual-wheel casters: black 	<ol style="list-style-type: none"> 1 Style number 2 Plastic color for frame, seat shell, outer back, and base 3 Fabric color number for upholstery on seat and back 4 Options, if selected (see below) <p>▶ See <i>Surface Materials</i>, page 634.</p>

Options	U.S. Price	Required to Specify
Surface Materials		
Upholstery on seat and back		
• Fabric price group 1	No cost	Specify fabric color number.
• Fabric price group 2	+\$ 37	Specify fabric color number.
• Fabric price group 3	+\$ 72	Specify fabric color number.
• Fabric price group 4	+\$ 100	Specify fabric color number.
• Fabric price group 5	+\$ 125	Specify fabric color number.
• Fabric price group 6	+\$ 154	Specify fabric color number.
• Fabric price group 7	+\$ 179	Specify fabric color number.
• Fabric price group 8	+\$ 223	Specify fabric color number.
• Fabric price group 9	+\$ 276	Specify fabric color number.
• Fabric price group 10	+\$ 312	Specify fabric color number.
• Steelcase leather upholstery	+\$ 920	Add suffix S to the style number and specify leather color number.
• Select Surfaces leather price group 1	+\$ 920	Add suffix S to the style number and specify Select Surfaces leather price group 1.
• Elmosoft leather upholstery	+\$1082	▶ See <i>Surface Materials Reference Manual</i> . Add suffix S to the style number and specify Elmosoft leather color number.
• Select Surfaces leather price group 2	+\$1082	Add suffix S to the style number and specify Select Surfaces leather price group 2.
• Steelcase vinyl	+\$ 37	▶ See <i>Surface Materials Reference Manual</i> . Add suffix S to the style number and specify vinyl color number.
• Customer's Own Material (COM)	No cost	▶ See <i>Surface Materials Reference Manual</i> to specify.
• Customer's Own Leather (COL)	+\$ 404	Add suffix S to the style number and specify leather color number.
Sewn upholstery		
• Sewn upholstery on chair	+\$ 113	Add suffix S to the style number.
Contrasting upholstery on seat and back		
• Contrasting fabrics	+\$ 46	Add suffix K to the style number and specify fabric color numbers.
Contrasting upholstery on seat		
• Fabric price group 1	No cost	Specify fabric color number.
• Fabric price group 2	+\$ 21	Specify fabric color number.
• Fabric price group 3	+\$ 34	Specify fabric color number.
• Fabric price group 4	+\$ 48	Specify fabric color number.
• Fabric price group 5	+\$ 62	Specify fabric color number.
• Fabric price group 6	+\$ 77	Specify fabric color number.
• Fabric price group 7	+\$ 88	Specify fabric color number.
• Fabric price group 8	+\$ 111	Specify fabric color number.
• Fabric price group 9	+\$ 137	Specify fabric color number.
• Fabric price group 10	+\$ 154	Specify fabric color number.

▶ **Options, continued on next page**

Tip: Leather and vinyl upcharges are in addition to sewn upholstery upcharge.

Tip: Select COMs require sewn application with an additional upcharge. Specify with an **S** suffix.

Tip: Suffixes other than **K** for contrasting fabric, will be added in alphabetical order when specifying options. The contrasting fabric suffix, **K**, will always follow **S**.

▶ Detailed dimensions, page 52



For Canadian Pricing
Multiply U.S. Price by the Canadian price factor.
▶ See page 1 for details.

► Options, continued from previous page

	Options	U.S. Price	Required to Specify
Surface Materials, continued	Contrasting upholstery on seat, continued		
	• Steelcase leather upholstery	+\$460	Add suffix S to the style number and specify leather color number.
	• Select Surfaces leather price group 1	+\$460	Add suffix S to the style number and specify leather color number.
	• Elmosoft leather upholstery	+\$542	Add suffix S to the style number and specify leather color number.
	• Select Surfaces leather price group 2	+\$542	Add suffix S to the style number and specify leather color number.
	• Steelcase vinyl	+\$ 21	Add suffix S to the style number and specify vinyl color number.
	• Customer's Own Material (COM)	No cost	► See <i>Surface Materials Reference Manual</i> .
	• Customer's Own Leather (COL)	+\$202	Add suffix S to the style number and specify leather color number.
	Contrasting upholstery on back		
	• Fabric price group 1	No cost	Specify fabric color number.
• Fabric price group 2	+\$ 21	Specify fabric color number.	
• Fabric price group 3	+\$ 34	Specify fabric color number.	
• Fabric price group 4	+\$ 48	Specify fabric color number.	
• Fabric price group 5	+\$ 62	Specify fabric color number.	
• Fabric price group 6	+\$ 78	Specify fabric color number.	
• Fabric price group 7	+\$ 88	Specify fabric color number.	
• Fabric price group 8	+\$112	Specify fabric color number.	
• Fabric price group 9	+\$137	Specify fabric color number.	
• Fabric price group 10	+\$155	Specify fabric color number.	
• Steelcase leather upholstery	+\$460	Add suffix S to the style number and specify leather color number.	
• Select Surfaces leather price group 1	+\$460	Add suffix S to the style number and specify leather color number.	
• Elmosoft leather upholstery	+\$543	Add suffix S to the style number and specify leather color number.	
• Select Surfaces leather price group 2	+\$543	Add suffix S to the style number and specify leather color number.	
• Steelcase vinyl	+\$ 21	Add suffix S to the style number and specify vinyl color number.	
• Customer's Own Material (COM)	No cost	► See <i>Surface Materials Reference Manual</i> .	
• Customer's Own Leather (COL)	+\$204	Add suffix S to the style number and specify leather color number.	
Soil-retardant treatment		+\$ 36	Specify with soil-retardant treatment.
Polished aluminum package			
• Polished aluminum package on chairs with arms and 6205 Black frame finish		+\$691	Add suffix C to the style number.
Platinum/Midnight			
• On frame, base, arm retainer, and outer back		+\$ 65	Specify with 6249 Platinum or with 6259 Midnight.
Arms	• Height-adjustable arms, soft arm caps	-\$132	Specify with height-adjustable arms.
	• Armless	-\$415	Specify without arms.
Seat Height	• 7" pneumatic seat-height adjustment	+\$ 85	Specify with 7" pneumatic seat-height adjustment.
Headrest	• Headrest	+\$340	Specify with headrest.
Lumbar	• Without lumbar	-\$ 84	Specify without lumbar.

Tip: Leather and vinyl upcharges are in addition to sewn upholstery upcharge.

Tip: Select COMs require sewn application with an additional upcharge. Specify with an **S** suffix.

Tip: Plastic shell on headrest is available in black only.



For Canadian Pricing
Multiply U.S. Price by the Canadian price factor.
► See page 1 for details.

Leap 462 Series Work Chair, Upholstery on Back and Seat, continued

► Options, continued from previous page

	Options	U.S. Price	Required to Specify
Casters	• Soft, dark grey treaded, dual-wheel roll-control casters for use on hard floors	+\$36	Specify <i>with soft roll-control casters</i> .
Glides	• Glides: plastic	+\$36	Specify <i>with glides</i> .
CarbonNeutral Product	• CarbonNeutral product certification	+\$35	Add suffix CN to the end of the style number.

Tip: Glides are not available on chairs with polished aluminum package.

Specification Information



Style Number	U.S. Base Price
46216179	\$2222



For Canadian Pricing
 Multiply U.S. Price by the Canadian price factor.
 ► See page 1 for details.

Leap 462 Series Work Chair

3D Knit on Back with Upholstery on Seat



► Need help?
Product details,
page 48

Standard Includes

- Upper back force
- 5" pneumatic seat-height adjustment
- Variable back stop
- Lower back firmness
- Rectilinear independent height-, width-, pivot-, and depth- adjustable arms and soft arm caps, if selected: black plastic
- Frame, seat shell, outer back, and five-arm base: plastic
- 3" seat depth adjustment
- Passive seat edge angle
- Adjustable lumbar
- 3D Knit on back only
- Standard upholstery design on seat: Fabric price group 1
- 2½"-diameter, hard-composition, dual-wheel casters: black

Required to Specify

- 1 Style number
 - 2 Plastic color for frame, seat shell, outer back, and base
 - 3 3D Knit color for back
 - 4 Fabric color number for upholstery on seat
 - 5 Options, if selected (see below)
- See *Surface Materials*, page 634.

Tip: Always add suffixes in alphabetical order when specifying options to Leap seating.

Tip: Leather and vinyl upcharges are in addition to sewn upholstery upcharge.

*Tip: Select COMs require sewn application with an additional upcharge. Specify with an **S** suffix.*

Tip: Glides are not available on chairs with polished aluminum package.

► Detailed dimensions, page 52

	Options	U.S. Price	Required to Specify
Surface Materials	Upholstery		
	• Fabric price group 1	No cost	Specify fabric color number.
	• Fabric price group 2	+\$ 21	Specify fabric color number.
	• Fabric price group 3	+\$ 34	Specify fabric color number.
	• Fabric price group 4	+\$ 48	Specify fabric color number.
	• Fabric price group 5	+\$ 62	Specify fabric color number.
	• Fabric price group 6	+\$ 77	Specify fabric color number.
	• Fabric price group 7	+\$ 88	Specify fabric color number.
	• Fabric price group 8	+\$111	Specify fabric color number.
	• Fabric price group 9	+\$137	Specify fabric color number.
• Fabric price group 10	+\$154	Specify fabric color number.	
• Steelcase leather upholstery	+\$460	Specify fabric color number. Add suffix S to the style number and specify leather color number.	
• Select Surfaces leather price group 1	+\$460	Add suffix S to the style number and specify Select Surfaces leather price group 1. ► See <i>Surface Materials Reference Manual</i> .	
• Elmosoft leather upholstery	+\$542	Add suffix S to the style number and specify Elmosoft leather color number.	
• Select Surfaces leather price group 2	+\$542	Add suffix S to the style number and specify Select Surfaces leather price group 2. ► See <i>Surface Materials Reference Manual</i> .	
• Steelcase vinyl	+\$ 21	Add suffix S to the style number and specify vinyl color number. ► See <i>Surface Materials Reference Manual</i> to specify.	
• Customer's Own Material (COM)	No cost	Add suffix S to the style number and specify leather color number.	
• Customer's Own Leather (COL)	+\$202		
	Soil-retardant treatment	+\$ 36	Specify <i>with soil-retardant treatment</i> .
	Sewn upholstery		
	• Sewn upholstery on chair	+\$ 58	Add suffix S to the style number.
	Polished aluminum package		
	• Polished aluminum package on chairs with arms and 6205 Black frame finish	+\$691	Add suffix C to the style number.
	Platinum/Midnight		
	• On frame, base, arm retainer, and outer back	+\$ 65	Specify <i>with 6249 Platinum or with 6259 Midnight</i> .

► Options, continued on next page



For Canadian Pricing

Multiply U.S. Price by the Canadian price factor.

► See page 1 for details.

► Options, continued from previous page

	Options	U.S. Price	Required to Specify
Arms	• Height-adjustable arms, soft arm caps	-\$132	Specify <i>with height-adjustable arms</i> .
	• Armless	-\$415	Specify <i>without arms</i> .
Seat Height	• 7" pneumatic seat-height adjustment	+\$ 85	Specify <i>with 7" pneumatic seat-height adjustment</i> .
Headrest	• Headrest	+\$340	Specify <i>with headrest</i> .
Lumbar	• Without lumbar	-\$ 84	Specify <i>without lumbar</i> .
Casters	• Soft, dark grey treaded, dual-wheel roll-control casters for use on hard floors	+\$ 36	Specify <i>with soft roll-control casters</i> .
Glides	• Glides: plastic	+\$ 36	Specify <i>with glides</i> .
CarbonNeutral Product	• CarbonNeutral product certification	+\$ 35	Add suffix CN to the end of the style number.

Tip: Plastic shell on headrest is available in black only.

Specification Information



• Style Number	• U.S. Base Price
46216189	\$2307

Leap 462 Series

 **For Canadian Pricing**
Multiply U.S. Price by the Canadian price factor.
► See page 1 for details.

Leap 462 Series Stool

Upholstery on Back and Seat

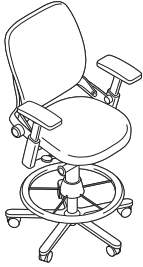

Standard Includes	Required to Specify
<ul style="list-style-type: none"> ▶ Need help? Product details, page 48 • Upper back force • 8" pneumatic seat-height adjustment • Variable back stop • Lower back firmness • Passive seat edge angle • Rectilinear independent height-, width-, pivot-, and depth-adjustable arms and soft arm caps, if selected: black plastic • Frame, seat shell, outer back, and five-arm base: plastic • 3" seat depth adjustment • Column and 4" adjustable foot ring: black • Standard upholstery design: fabric price group 1 • 2"-diameter, hard-composition, dual-wheel casters: black 	<ol style="list-style-type: none"> 1 Style number 2 Plastic color for frame, seat shell, outer back, and base 3 Fabric color number for upholstery on seat and back 4 Options, if selected (see below) <ul style="list-style-type: none"> ▶ See <i>Surface Materials</i>, page 634.

Options	U.S. Price	Required to Specify
<p>Surface Materials</p> <p>Upholstery on seat and back</p> <ul style="list-style-type: none"> • Fabric price group 1 No cost • Fabric price group 2 +\$ 37 • Fabric price group 3 +\$ 72 • Fabric price group 4 +\$ 100 • Fabric price group 5 +\$ 125 • Fabric price group 6 +\$ 154 • Fabric price group 7 +\$ 179 • Fabric price group 8 +\$ 223 • Fabric price group 9 +\$ 276 • Fabric price group 10 +\$ 312 • Steelcase leather upholstery +\$ 920 • Select Surfaces leather price group 1 +\$ 920 • Elmosoft leather upholstery +\$1082 • Select Surfaces leather price group 2 +\$1082 • Steelcase vinyl +\$ 37 • Customer's Own Material (COM) No cost • Customer's Own Leather (COL) +\$ 404 <p>Platinum/Midnight</p> <ul style="list-style-type: none"> • On frame, base, arm retainer, and outer back +\$ 65 <p>Sewn upholstery</p> <ul style="list-style-type: none"> • Sewn upholstery on chair +\$ 113 <p>Contrasting upholstery on seat and back</p> <ul style="list-style-type: none"> • Contrasting fabrics +\$ 46 		<p>Specify fabric color number.</p> <p>Specify fabric color number.</p> <p>Specify fabric color number.</p> <p>Specify fabric color number.</p> <p>Specify fabric color number.</p> <p>Specify fabric color number.</p> <p>Specify fabric color number.</p> <p>Specify fabric color number.</p> <p>Specify fabric color number.</p> <p>Specify fabric color number.</p> <p>Specify fabric color number.</p> <p>Add suffix S to the style number and specify leather color number.</p> <p>Add suffix S to the style number and specify Select Surfaces leather price group 1.</p> <p>▶ See <i>Surface Materials Reference Manual</i>. Add suffix S to the style number and specify Elmosoft leather color number.</p> <p>Add suffix S to the style number and specify Select Surfaces leather price group 2.</p> <p>▶ See <i>Surface Materials Reference Manual</i>. Add suffix S to the style number and specify vinyl color number.</p> <p>▶ See <i>Surface Materials Reference Manual</i> to specify.</p> <p>Add suffix S to the style number and specify leather color number.</p> <hr/> <p>Specify with 6249 <i>Platinum</i> or with 6259 <i>Midnight</i>.</p> <hr/> <p>Add suffix S to the style number.</p> <hr/> <p>Add suffix K to the style number and specify fabric color numbers.</p>

▶ Options, continued on next page

Tip: Leather and vinyl upcharges are in addition to sewn upholstery upcharge.

Tip: Select COMs require sewn application with an additional upcharge. Specify with an **S** suffix.

Tip: Suffixes other than **K** for contrasting fabric, will be added in alphabetical order when specifying options. The contrasting fabric suffix, **K**, will always follow **S**.

▶ Detailed dimensions, page 52



For Canadian Pricing

Multiply U.S. Price by the Canadian price factor.

▶ See page 1 for details.

► Options, continued from previous page

	Options	U.S. Price	Required to Specify
Surface Materials, continued	Contrasting upholstery on seat		
	• Fabric price group 1	No cost	Specify fabric color number.
	• Fabric price group 2	+\$ 21	Specify fabric color number.
	• Fabric price group 3	+\$ 34	Specify fabric color number.
	• Fabric price group 4	+\$ 48	Specify fabric color number.
	• Fabric price group 5	+\$ 62	Specify fabric color number.
	• Fabric price group 6	+\$ 77	Specify fabric color number.
	• Fabric price group 7	+\$ 88	Specify fabric color number.
	• Fabric price group 8	+\$111	Specify fabric color number.
	• Fabric price group 9	+\$137	Specify fabric color number.
	• Fabric price group 10	+\$154	Specify fabric color number.
	• Steelcase leather upholstery	+\$460	Add suffix S to the style number and specify leather color number.
	• Select Surfaces leather price group 1	+\$460	Add suffix S to the style number and specify leather color number.
	• Elmosoft leather upholstery	+\$542	Add suffix S to the style number and specify leather color number.
• Select Surfaces leather price group 2	+\$542	Add suffix S to the style number and specify leather color number.	
• Steelcase vinyl	+\$ 21	Add suffix S to the style number and specify vinyl color number.	
• Customer's Own Material (COM)	No cost	► See <i>Surface Materials Reference Manual</i> .	
• Customer's Own Leather (COL)	+\$202	Add suffix S to the style number and specify leather color number.	
	Contrasting upholstery on back		
	• Fabric price group 1	No cost	Specify fabric color number.
	• Fabric price group 2	+\$ 21	Specify fabric color number.
	• Fabric price group 3	+\$ 34	Specify fabric color number.
	• Fabric price group 4	+\$ 49	Specify fabric color number.
	• Fabric price group 5	+\$ 62	Specify fabric color number.
	• Fabric price group 6	+\$ 78	Specify fabric color number.
	• Fabric price group 7	+\$ 88	Specify fabric color number.
	• Fabric price group 8	+\$112	Specify fabric color number.
	• Fabric price group 9	+\$137	Specify fabric color number.
	• Fabric price group 10	+\$155	Specify fabric color number.
	• Steelcase leather upholstery	+\$460	Add suffix S to the style number and specify leather color number.
	• Select Surfaces leather price group 1	+\$460	Add suffix S to the style number and specify leather color number.
	• Elmosoft leather upholstery	+\$543	Add suffix S to the style number and specify leather color number.
• Select Surfaces leather price group 2	+\$543	Add suffix S to the style number and specify leather color number.	
• Steelcase vinyl	+\$ 21	Add suffix S to the style number and specify vinyl color number.	
• Customer's Own Material (COM)	No cost	► See <i>Surface Materials Reference Manual</i> .	
• Customer's Own Leather (COL)	+\$204	Add suffix S to the style number and specify leather color number.	
	Soil-retardant treatment	+\$ 36	Specify with soil-retardant treatment.
Arms	• Height-adjustable arms, soft arm caps	-\$132	Specify with height-adjustable arms.
	• Armless	-\$415	Specify without arms.
Lumbar	• Without lumbar	-\$ 84	Specify without lumbar.
Casters	• Soft, dark grey treaded, dual-wheel roll-control casters for use on hard floors	+\$ 36	Specify with soft roll-control casters.

► Options, continued on next page

Tip: Leather and vinyl upcharges are in addition to sewn upholstery upcharge.

Tip: Select COMs require sewn application with an additional upcharge. Specify with an **S** suffix.



For Canadian Pricing
Multiply U.S. Price by the Canadian price factor.
► See page 1 for details.

Leap 462 Series Stool, Upholstery on Back and Seat, continued

► Options, continued from previous page

	Options	U.S. Price	Required to Specify
Glides	• Glides: plastic	+\$36	Specify <i>with glides</i> .
CarbonNeutral Product	• CarbonNeutral product certification	+\$35	Add suffix CN to the end of the style number.

Specification Information

Tip: Coat hanger cannot be used on Leap stools.



• Style Number	• U.S. Base Price
46267179	\$2561



For Canadian Pricing
 Multiply U.S. Price by the Canadian price factor.
 ► See page 1 for details.

Leap 462 Series Stool

3D Knit on Back with Upholstery on Seat



► Need help?
Product details,
page 48

Standard Includes

- Upper back force
- 8" pneumatic seat-height adjustment
- Variable back stop
- Lower back firmness
- Passive seat edge angle
- Rectilinear independent height-, width-, pivot-, and depth-adjustable arms and soft arm caps, if selected: black plastic
- Frame, seat shell, outer back, and five-arm base: plastic
- Column and 4" adjustable foot ring: black
- 3D Knit on back only
- 3" seat depth adjustment
- Adjustable lumbar
- Standard upholstery design on seat: fabric price group 1
- 2"-diameter, hard-composition, dual-wheel casters: black

Required to Specify

- 1 Style number
- 2 Plastic color for frame, seat shell, outer back, and base
- 3 3D Knit color for back
- 4 Fabric color number for upholstery on seat
- 5 Options, if selected (see below)
 - See *Surface Materials*, page 634.

Tip: Always add suffixes in alphabetical order when specifying options to Leap seating.

Tip: Leather and vinyl upcharges are in addition to sewn upholstery upcharge.

*Tip: Select COMs require sewn application with an additional upcharge. Specify with an **S** suffix.*

Options		U.S. Price	Required to Specify
Surface Materials	Upholstery		
	• Fabric price group 1	No cost	Specify fabric color number.
	• Fabric price group 2	+\$ 21	Specify fabric color number.
	• Fabric price group 3	+\$ 34	Specify fabric color number.
	• Fabric price group 4	+\$ 48	Specify fabric color number.
	• Fabric price group 5	+\$ 62	Specify fabric color number.
	• Fabric price group 6	+\$ 77	Specify fabric color number.
	• Fabric price group 7	+\$ 88	Specify fabric color number.
	• Fabric price group 8	+\$111	Specify fabric color number.
	• Fabric price group 9	+\$137	Specify fabric color number.
• Fabric price group 10	+\$154	Specify fabric color number.	
• Steelcase leather upholstery	+\$460	Add suffix S to the style number and specify leather color number.	
• Select Surfaces leather price group 1	+\$460	Add suffix S to the style number and specify Select Surfaces leather price group 1.	
• Elmosoft leather upholstery	+\$542	► See <i>Surface Materials Reference Manual</i> . Add suffix S to the style number and specify Elmosoft leather color number.	
• Select Surfaces leather price group 2	+\$542	Add suffix S to the style number and specify Select Surfaces leather price group 2.	
• Steelcase vinyl	+\$ 21	► See <i>Surface Materials Reference Manual</i> . Add suffix S to the style number and specify vinyl color number.	
• Customer's Own Material (COM)	No cost	► See <i>Surface Materials Reference Manual</i> to specify.	
• Customer's Own Leather (COL)	+\$202	Add suffix S to the style number and specify leather color number.	
Soil-retardant treatment		+\$ 36	Specify <i>with soil-retardant treatment</i> .
Sewn upholstery			
• Sewn upholstery on chair	+\$ 58	Add suffix S to the style number.	
Platinum/Midnight			
• On frame, base, arm retainer, and outer back	+\$ 65	Specify <i>with 6249 Platinum or with 6259 Midnight</i> .	
Arms	• Height-adjustable arms, soft arm caps	-\$132	Specify <i>with height-adjustable arms</i>
	• Armless	-\$415	Specify <i>without arms</i> .
Lumbar	• Without lumbar	-\$ 84	Specify <i>without lumbar</i> .

► Options, continued on next page

► Detailed dimensions, page 52



For Canadian Pricing
Multiply U.S. Price by the Canadian price factor.
► See page 1 for details.

► Options, continued from previous page

Options	U.S. Price	Required to Specify
Casters <ul style="list-style-type: none"> Soft, dark grey treaded, dual-wheel roll-control casters for use on hard floors 	+\$36	Specify with soft roll-control casters.
Glides <ul style="list-style-type: none"> Glides: plastic 	+\$36	Specify with glides.
CarbonNeutral Product <ul style="list-style-type: none"> CarbonNeutral product certification 	+\$35	Add suffix CN to the end of the style number.

Specification Information

Tip: Coat hanger cannot be used on Leap stools.



Style Number	U.S. Base Price
46267189	\$2646

Leap 462 Series

For Canadian Pricing
 Multiply U.S. Price by the Canadian price factor.
 ► See page 1 for details.

Leap Plus 462 Series Work Chair

Upholstery on Back and Seat



► Need help? Product details, page 48

Standard Includes

- Upper back force
- 4" pneumatic seat-height adjustment
- Variable back stop
- Lower back firmness
- Rectilinear independent height-, width-, pivot-, and depth- adjustable arms and soft arm caps, if selected: black plastic
- Frame, seat shell, outer back, and five-arm base: plastic
- 2" seat depth adjustment
- Adjustable lumbar
- Standard upholstery design: fabric price group 1
- 2½"-diameter, hard-composition, dual-wheel casters: black

Required to Specify

- 1 Style number
 - 2 Plastic color for frame, seat shell, outer back, and base
 - 3 Fabric color number for upholstery on seat and back
 - 4 Options, if selected (see below)
- See *Surface Materials*, page 634.

Tip: Leather and vinyl upcharges are in addition to sewn upholstery upcharge.

Tip: Select COMs require sewn application with an additional upcharge. Specify with an **S** suffix.

Tip: Suffixes other than **K** for contrasting fabric, will be added in alphabetical order when specifying options. The contrasting fabric suffix, **K**, will always be at the end of the style number.

► Detailed dimensions, page 52



For Canadian Pricing
Multiply U.S. Price by the Canadian price factor.
► See page 1 for details.

	Options	U.S. Price	Required to Specify
Surface Materials	Upholstery on seat and back		
	• Fabric price group 1	No cost	Specify fabric color number.
	• Fabric price group 2	+\$ 37	Specify fabric color number.
	• Fabric price group 3	+\$ 72	Specify fabric color number.
	• Fabric price group 4	+\$ 100	Specify fabric color number.
	• Fabric price group 5	+\$ 125	Specify fabric color number.
	• Fabric price group 6	+\$ 154	Specify fabric color number.
	• Fabric price group 7	+\$ 179	Specify fabric color number.
	• Fabric price group 8	+\$ 223	Specify fabric color number.
	• Fabric price group 9	+\$ 276	Specify fabric color number.
• Fabric price group 10	+\$ 312	Specify fabric color number.	
• Steelcase leather upholstery	+\$ 920	Add suffix S to the style number and specify leather color number.	
• Select Surfaces leather price group 1	+\$ 920	Add suffix S to the style number and specify Select Surfaces leather price group 1. ► See <i>Surface Materials Reference Manual</i> .	
• Elmosoft leather upholstery	+\$1082	Add suffix S to the style number and specify Elmosoft leather color number.	
• Select Surfaces leather price group 2	+\$1082	Add suffix S to the style number and specify Select Surfaces leather price group 2. ► See <i>Surface Materials Reference Manual</i> .	
• Steelcase vinyl	+\$ 37	Add suffix S to the style number and specify vinyl color number. ► See <i>Surface Materials Reference Manual</i> to specify.	
• Customer's Own Material (COM)	No cost	Add suffix S to the style number and specify leather color number.	
• Customer's Own Leather (COL)	+\$ 404		
	Sewn upholstery		
• Sewn upholstery on chair	+\$ 113	Add suffix S to the style number.	
	Contrasting upholstery on seat and back		
• Contrasting fabrics	+\$ 46	Add suffix K to the style number and specify fabric color numbers.	
	Contrasting upholstery on seat		
• Fabric price group 1	No cost	Specify fabric color number.	
• Fabric price group 2	+\$ 21	Specify fabric color number.	
• Fabric price group 3	+\$ 34	Specify fabric color number.	
• Fabric price group 4	+\$ 48	Specify fabric color number.	
• Fabric price group 5	+\$ 62	Specify fabric color number.	
• Fabric price group 6	+\$ 77	Specify fabric color number.	
• Fabric price group 7	+\$ 88	Specify fabric color number.	
• Fabric price group 8	+\$ 111	Specify fabric color number.	
• Fabric price group 9	+\$ 137	Specify fabric color number.	
• Fabric price group 10	+\$ 154	Specify fabric color number.	

► Options, continued on next page

► Options, continued from previous page

	Options	U.S. Price	Required to Specify
Surface Materials, continued	Contrasting upholstery on seat, continued		
	• Steelcase leather upholstery	+\$460	Add suffix S to the style number and specify leather color number.
	• Select Surfaces leather price group 1	+\$460	Add suffix S to the style number and specify leather color number.
	• Elmosoft leather upholstery	+\$542	Add suffix S to the style number and specify leather color number.
	• Select Surfaces leather price group 2	+\$542	Add suffix S to the style number and specify leather color number.
	• Steelcase vinyl	+\$ 21	Add suffix S to the style number and specify vinyl color number.
	• Customer's Own Material (COM)	No cost	► See <i>Surface Materials Reference Manual</i> .
	• Customer's Own Leather (COL)	+\$ 202	Add suffix S to the style number and specify leather color number.
	Contrasting upholstery on back		
	• Fabric price group 1	No cost	Specify fabric color number.
• Fabric price group 2	+\$ 21	Specify fabric color number.	
• Fabric price group 3	+\$ 34	Specify fabric color number.	
• Fabric price group 4	+\$ 49	Specify fabric color number.	
• Fabric price group 5	+\$ 62	Specify fabric color number.	
• Fabric price group 6	+\$ 78	Specify fabric color number.	
• Fabric price group 7	+\$ 88	Specify fabric color number.	
• Fabric price group 8	+\$112	Specify fabric color number.	
• Fabric price group 9	+\$137	Specify fabric color number.	
• Fabric price group 10	+\$155	Specify fabric color number.	
• Steelcase leather upholstery	+\$460	Add suffix S to the style number and specify leather color number.	
• Select Surfaces leather price group 1	+\$460	Add suffix S to the style number and specify leather color number.	
• Elmosoft leather upholstery	+\$543	Add suffix S to the style number and specify leather color number.	
• Select Surfaces leather price group 2	+\$543	Add suffix S to the style number and specify leather color number.	
• Steelcase vinyl	+\$ 21	Add suffix S to the style number and specify vinyl color number.	
• Customer's Own Material (COM)	No cost	► See <i>Surface Materials Reference Manual</i> .	
• Customer's Own Leather (COL)	+\$204	Add suffix S to the style number and specify leather color number.	
Soil-retardant treatment			
	+\$ 36	Specify with soil-retardant treatment.	
Platinum/Midnight			
• On frame, base, arm retainer, and outer back	+\$ 65	Specify with 6249 Platinum or with 6259 Midnight.	
Arms	• Height-adjustable arms, soft arm caps	-\$132	Specify with height-adjustable arms.
	• Armless	-\$415	Specify without arms.
Seat Height	• 5" pneumatic seat-height adjustment	+\$ 85	Specify with 5" pneumatic seat-height adjustment.
Lumbar	• Without lumbar	-\$ 84	Specify without lumbar.
Casters	• Soft, dark grey treaded, dual-wheel roll-control casters for use on hard floors	+\$ 36	Specify with soft roll-control casters.
Glides	• Glides: plastic	+\$ 36	Specify with glides.

► Specification Information, on next page

Tip: Leather and vinyl upcharges are in addition to sewn upholstery upcharge.

Tip: Select COMs require sewn application with an additional upcharge. Specify with an **S** suffix.



For Canadian Pricing
Multiply U.S. Price by the Canadian price factor.
► See page 1 for details.

Leap Plus 462 Series Work Chair, Upholstery on Back and Seat, continued

► Options, on previous page

Specification Information



• Style • Number	• U.S. • Base • Price
46296179	\$3335



For Canadian Pricing

Multiply U.S. Price by the Canadian price factor.

► See page 1 for details.

Leap Plus 462 Series Work Chair

3D Knit on Back with Upholstery on Seat



▶ Need help?
Product details,
page 48

Standard Includes

- Upper back force
- 4" pneumatic seat-height adjustment
- Variable back stop
- Lower back firmness
- Rectilinear independent height-, width-, pivot-, and depth- adjustable arms and soft arm caps, if selected: black plastic
- Frame, seat shell, outer back, and five-arm base: plastic
- 2" seat depth adjustment
- Adjustable lumbar
- 3D Knit on back only
- Standard upholstery design on seat: Fabric price group 1
- 2½"-diameter, hard-composition, dual-wheel casters: black

Required to Specify

- 1 Style number
 - 2 Plastic color for frame, seat shell, outer back, and base
 - 3 3D Knit color for back
 - 4 Fabric color number for upholstery on seat
 - 5 Options, if selected (see below)
- ▶ See *Surface Materials*, page 634.

Tip: Always add suffixes in alphabetical order when specifying options to Leap seating.

Tip: Leather and vinyl upcharges are in addition to sewn upholstery upcharge.

*Tip: Select COMs require sewn application with an additional upcharge. Specify with an **S** suffix.*

	Options	U.S. Price	Required to Specify
Surface Materials	Upholstery		
	• Fabric price group 1	No cost	Specify fabric color number.
	• Fabric price group 2	+\$ 21	Specify fabric color number.
	• Fabric price group 3	+\$ 34	Specify fabric color number.
	• Fabric price group 4	+\$ 48	Specify fabric color number.
	• Fabric price group 5	+\$ 62	Specify fabric color number.
	• Fabric price group 6	+\$ 77	Specify fabric color number.
	• Fabric price group 7	+\$ 88	Specify fabric color number.
	• Fabric price group 8	+\$111	Specify fabric color number.
	• Fabric price group 9	+\$137	Specify fabric color number.
	• Fabric price group 10	+\$154	Specify fabric color number.
	• Steelcase leather upholstery	+\$460	Add suffix S to the style number and specify leather color number.
	• Select Surfaces leather price group 1	+\$460	Add suffix S to the style number and specify Select Surfaces leather price group 1. ▶ See <i>Surface Materials Reference Manual</i> .
• Elmosoft leather upholstery	+\$542	Add suffix S to the style number and specify Elmosoft leather color number.	
• Select Surfaces leather price group 2	+\$542	Add suffix S to the style number and specify Select Surfaces leather price group 2. ▶ See <i>Surface Materials Reference Manual</i> .	
• Steelcase vinyl	+\$ 21	Add suffix S to the style number and specify vinyl color number. ▶ See <i>Surface Materials Reference Manual</i> to specify.	
• Customer's Own Material (COM)	No cost	Add suffix S to the style number and specify leather color number.	
• Customer's Own Leather (COL)	+\$202		
	Soil-retardant treatment	+\$ 36	Specify with soil-retardant treatment.
	Sewn upholstery		
	• Sewn upholstery on chair	+\$ 58	Add suffix S to the style number.
	Platinum/Midnight		
	• On frame, base, arm retainer, and outer back	+\$ 65	Specify with 6249 Platinum or with 6259 Midnight.
Arms	• Height-adjustable arms, soft arm caps	-\$132	Specify with height-adjustable arms.
	• Armless	-\$415	Specify without arms.

▶ Options, continued on next page

▶ Detailed dimensions, page 52



For Canadian Pricing

Multiply U.S. Price by the Canadian price factor.

▶ See page 1 for details.

► Options, continued from previous page

	Options	U.S. Price	Required to Specify
Seat Height	• 5" pneumatic seat-height adjustment	+\$85	Specify with 5" pneumatic seat-height adjustment.
Lumbar	• Without lumbar	-\$84	Specify without lumbar.
Casters	• Soft, dark grey treaded, dual-wheel roll-control casters for use on hard floors	+\$36	Specify with soft roll-control casters.
Glides	• Glides: plastic	+\$36	Specify with glides.

Specification Information



• Style Number	• U.S. Base Price
46296189	\$3420

Leap 462 Series



For Canadian Pricing
Multiply U.S. Price by the Canadian price factor.
► See page 1 for details.

Leap Coat Hanger

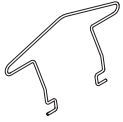

Tip: The coat hanger cannot be used on Leap stools.

Tip: Stand alone add on accessories are not available with CarbonNeutral product certification.

Standard Includes	Required to Specify
<ul style="list-style-type: none"> ▶ Need help? Product details, page 32 • Coat hanger: 0835 Black paint 	<ul style="list-style-type: none"> Style number

Specification Information	
• Style Number	• U.S. Price
462COATHANGER	\$104

▶ Detailed dimensions, page 38



For Canadian Pricing

Multiply U.S. Price by the Canadian price factor.

▶ See page 1 for details.

Understanding and Specifying Steelcase Karman Work Chairs

Product Details

Steelcase Karman	74
Dimensions	80

Specifying

Standard-Back Work Chair

Steelcase Karman Standard-Back Work Chair with Intermix Performance Textile	82
---	----

Stool

Steelcase Karman Work Stool with Intermix Performance Textile	83
---	----

High-Back Work Chair

Steelcase Karman High-Back Work Chair with Intermix Performance Textile	84
---	----

Accessories

85

Steelcase Karman



Now available as a CarbonNeutral product, making sure our commitment to a more sustainable future helps yours too.

Steelcase Karman design relies more on physics than mechanism – intuitively responding to your movement and weight while providing effortless comfort. Its proprietary performance textile, Intermix, creates support that never sags or feels stiff for people of all shapes and sizes.

Back frame and seat shell are flexible, encouraging healthy user movement.

Lumbar height adjusts over 3 1/2" to provide additional lower back support and is available as an option.

Arm caps can pivot independently 28° in and 24° out to accommodate individual user preferences.

Arm depth can retract 2" to allow user to get closer to the worksurface and into tight corners.

Comfort dial back control provides four settings for the user's personal preference and work style.

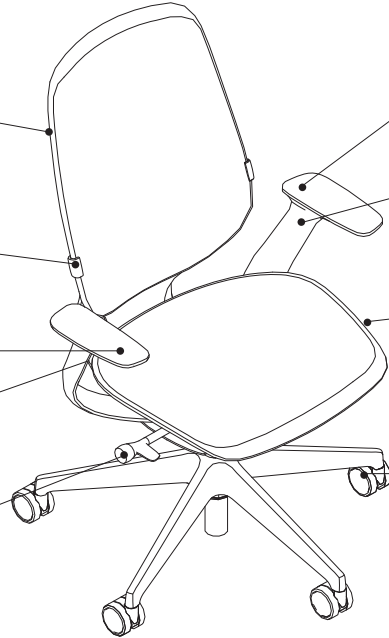

Arm width adjusts 4 5/8" overall to support forearms in neutral position.

Arm height can adjust independently within a 4" range to help relieve upper back and shoulder fatigue.

Seat height adjusts within a 5" range with a pneumatic adjustment mechanism. A 4" or 7" range is available as an option. Stools have a 8" range.

Casters have hard, dual-wheels that roll smoothly on carpets. They are 2 1/2" for increased mobility. Soft, dark grey treaded, dual-wheel roll-control casters are available for use on hard floors or mats. Glides are also available as an option.
Tip: Do not roll the chair across asphalt during installation as this may damage the casters.

Product Details

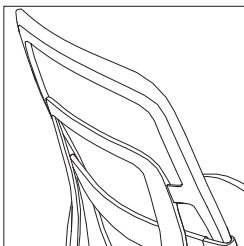

LiveBack technology allows the backrest to flex and contour to mimic the natural movement of the spine and reinforce a healthy posture.

Patented hybrid seat

Suspension seat with integrated cushioning provides maximum comfort right where you need it most.

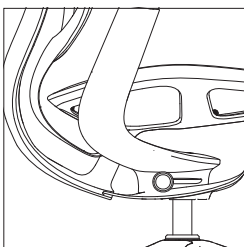

Advanced weight-activated mechanism with a natural fluid motion keeps users oriented to their work.

Organic movement is achieved with this advanced weight-activated mechanism that responds automatically to your body with appropriate support as you sit and change postures in every direction.

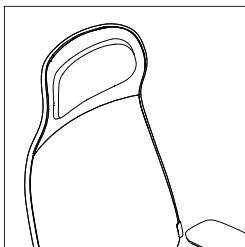

Available in standard-back and high-back configurations. High-back features an adjustable neck support pillow standard, allowing users to gently support their neck and head during recline. Neck support pillow adjusts 3" vertically, and measures 5³/₄"H x 10"W. Pillow follows Intermix selection of the seat and back configuration, and is field serviceable only on high-back chairs that were originally specified with a neck support pillow. Pillow is not able to be installed on existing Steelcase Karman chairs that did not originally have a neck support pillow specified.

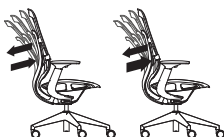

Weight-activated setting

Boosted setting



Mid-back stop recline setting

Upright back stop setting

Comfort dial has four settings that allow for the user's personal preference and work style: (1) weight-activated setting; (2) boosted tension setting that has approximately 20% more resistance than your body is providing; (3) mid-stop recline setting; and (4) an upright lock setting.

Comfort edge on the back and seat frames

The ultra-light back and seat frames flex to eliminate hard edges and pressure points on your legs and body and comfort edge allows users to lean back or sit sideways.

Proprietary Intermix

The versatility from the Intermix proprietary weave process results in three variations:

Intermix is classic and translucent with a more traditional mesh look and feel.

Intermix Shift is color-shifting and provocative with a dynamic visual that changes with light and viewing angle.

Intermix Opaque is luxurious and residential with the hand-feel of upholstery.

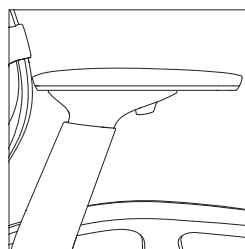

Rectilinear arms with soft caps are standard.

Uncartoned request on your dealer purchase order means Steelcase Karman chairs will ship fully assembled.

Cartoned request on your dealer purchase order means Steelcase Karman will ship knocked down with the chair base and pneumatic cylinder separated from the rest of the chair. This allows for shipment in a smaller carton. Assembly by a qualified dealer installer is required.

Tip: Assembly instructions are included.



CarbonNeutral.com

CarbonNeutral product Karman helps organizations achieve their carbon emissions goals. Add **CN** to the end of the style number to specify Karman with CarbonNeutral product certification.

Adjustment Features

Adjustability instructions are included with every chair.

Seat Adjustments

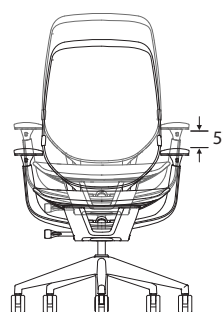

Seat height adjusts pneumatically. To lower, hold handle up while seated. To raise, hold handle up and keep your weight off the chair. Standard range of adjustability is 5" from 16"H to 21"H. A short 4" range of adjustability (14"H to 18"H) and a tall 7" range of adjustability (21"H to 28"H) are available as options. An 8" range of adjustability (21"H to 29"H) is available on stools.

Back Adjustments

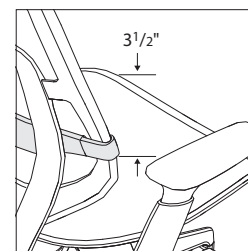

Lumbar height adjusts 3¹/₂" (4" to 7¹/₂" from seat) by grabbing exposed tabs and sliding the lumbar support up or down.

Lumbar is available as an option or as a field installed accessory. When ordered initially, the lumbar ships assembled to the chair. When ordered at a later date, the lumbar ships in its own carton and is easily field installed.

Arm Adjustments

4D arms have fully adjustable armrests that raise up and down, pivot in and out, and shift in all directions letting your arms and shoulders fall naturally into place.

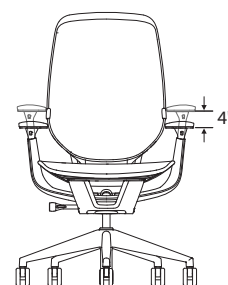

Arm height adjusts independently within a range of 4". Push button on outside and under arm cap in while moving arms up or down. Releasing buttons locks arms in position.

Steelcase Karman , continued

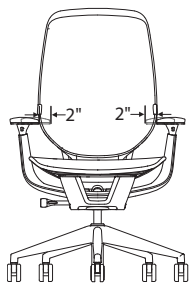

Arm width can be adjusted 2" each, 4" overall. Grasp arm cap and move in or out.

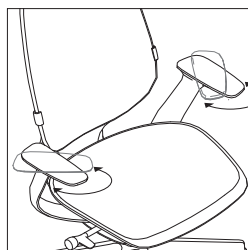

Arms pivot independently, 28° inward and 24° outward. Grasp arm and push front to left or right.

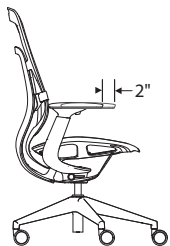

Arm depth adjusts by sliding arm caps back 2". Friction-fit keeps arms in position.

Other Features

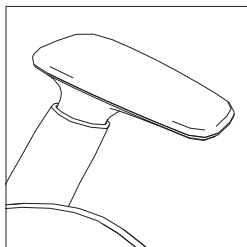

Height-only adjustable arm is also available and adjusts 4".



Fixed arm models are also available in plastic and polished aluminum finishes.

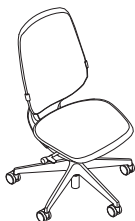

Armless models are also available.

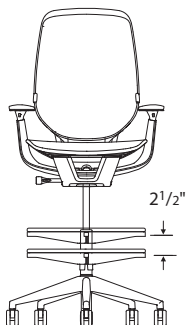

Foot ring height on stools adjusts by rotating it counterclockwise to unlock. Then raise or lower ring to desired position before rotating it clockwise to lock. The foot ring has a diameter of 20".

Soft dual-wheel roll-control casters feature an internal brake that activates when the chair is not under load to reduce shifting when user stands up.

Hubless hard wheel casters, hubless soft roll control wheel casters, and hard glides are available as options.

Steelcase Karman Finish Options

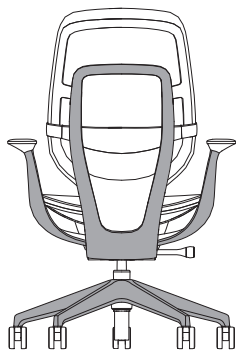
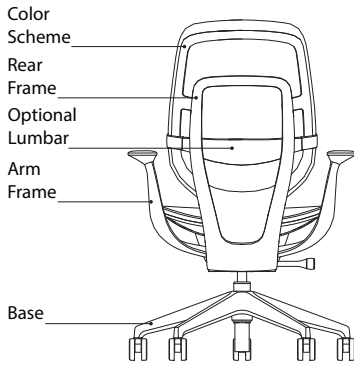

Rear Frame + Arm Frame + Base

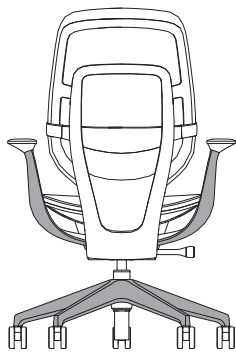

Arm Frame + Base

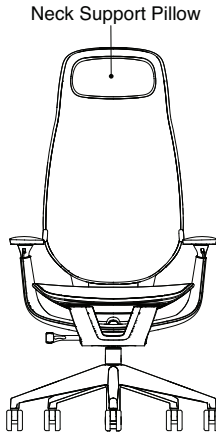

High-Back Work Chair + Neck Support Pillow

Proprietary Textile

Intermix

- KR07 Platinum
- KR08 Black
- KR09 Baltic
- KR10 Bright Peacock
- KR11 Merlot

Intermix Shift

- KR12 Red/ Blue
- KR13 Blue/Gold

Intermix Opaque

- KR14 Seagull
- KR15 Platinum
- KR16 Bronze
- KR17 Black
- KR18 Baltic
- KR19 Peacock
- KR20 Merlot

Hard components

Note: Finishes are determined by color scheme, see page 78 for color scheme matrix.

Color scheme

- Platinum Solid
- Black
- Seagull
- Merle

Rear frame

- 6205 Black
- 7190 Platinum Solid
- 7243 Seagull
- 7360 Merle
- 4B20 Obsidian
- 4B22 Matte Brass
- 4B23 Burnished Bronze
- 4B24 Night Bronze
- 4B25 Matte Copper
- 4B26 Smoked Mica
- 4B29 Cast Iron

Base

- 6205 Black
- 7190 Platinum Solid
- 7243 Seagull
- 7360 Merle
- 8046 Polished Aluminum
- 4B20 Obsidian
- 4B22 Matte Brass
- 4B23 Burnished Bronze
- 4B24 Night Bronze
- 4B25 Matte Copper
- 4B26 Smoked Mica
- 4B29 Cast Iron

Note: if short cylinder is specified, Lux Coatings paints cannot be applied to base. If the extended cylinder is specified, all base finishes are available.

Arm frame

- 7190 Platinum Solid
- 7207 Black
- 7243 Seagull
- 7360 Merle
- 8046 Polished Aluminum
- 4B20 Obsidian
- 4B22 Matte Brass
- 4B23 Burnished Bronze
- 4B24 Night Bronze
- 4B25 Matte Copper
- 4B26 Smoked Mica
- 4B29 Cast Iron

Arm caps, casters, cylinder, and stool ring

- 6059 Sterling Dark
- 6205 Black

Note: When short and extended cylinders are specified, cylinder color will always be 6205 black.

Lumbar

- 6053 Seagull
- 6205 Black
- 6249 Platinum Solid
- 6527 Merle

Coat hanger

- 6059 Sterling Dark
- 6205 Black

All Steelcase Karman with standard Intermix complies with requirements of the state of California. Technical Bulletin 117-2013. All chairs are labeled to be in compliance with California 117-2013.

Color Scheme Matrix

Steelcase Karman

Frame Package Color Scheme Matrix

Color Scheme	Rear Frame	Lower Shell*	Arm Frame	Back Shell*	Seat Shell*	Lumbar**
Platinum Solid	7190 Platinum Solid	7190 Platinum Solid	7190 Platinum Solid	6249 Platinum Solid	6249 Platinum Solid	6249 Platinum Solid
Black	7207 Black	7207 Black	7207 Black	6205 Black	6205 Black	6205 Black
Seagull	7243 Seagull	7243 Seagull	7243 Seagull	6053 Seagull	6059 Sterling Dark	6053 Seagull
Merle	7360 Merle	7360 Merle	7360 Merle	6527 Merle	6527 Merle	6527 Merle

- Tip: Lux Coatings are available as an option on one of the two following combinations: rear frame, arm frame, and base or arm frame and base.*
- Tip: Color scheme selection determines finishes for all other non-specifiable components (arm cap, back and seat frame, lumbar, cylinder, foot ring, and caster color).*
- Tip: If Lux Coatings are selected for frame finish, the same Lux Coatings finish will be applied to the rear frame, arm frame, and base.*
- Tip: Polished aluminum is available as an option on base and arm frame specified separately, and cannot be combined with Lux Coatings.*
- Tip: If short or extended cylinder is selected, cylinder will always be Black 6205 Lux Coatings cannot be specified.*
- * Denotes components that are not specifiable, they default based on color scheme selected. Seagull color scheme comes standard with contrasting sterling dark comfort edges. Black, merle, and platinum come standard with coordinating comfort edge.*
- ** Unless ordered as a separate style: **419LUMBAR, 419COATHANGER.***

Base	Cylinder*	Arm Caps*	Casters*	Comfort Edge	Coat Hanger**
7190 Platinum Solid	6205 Black	6205 Black	6205 Black	7190 Platinum Solid	6205 Black
6205 Black	6205 Black	6205 Black	6205 Black	6205 Black	6205 Black
7243 Seagull	6059 Sterling	6059 Sterling Dark	6059 Sterling Dark	6059 Sterling Dark	6059 Sterling Dark
7360 Merle	6205 Black	6205 Black	6205 Black	7360 Merle	6205 Black

Note: Seagull color scheme comes standard with contrasting sterling dark comfort edges. Black, merle, and platinum come standard with coordinating comfort edges, matching color scheme selections.

Dimensions

Steelcase Karman

Steelcase Karman								
Features	Overall Depth	Overall Width	Overall Height	Seat height (from floor)	Fixed Seat Depth	Fixed Seat Width	Functional Seat Depth	Ring Height from Floor
Standard-back work chair	26 ¹ / ₈ "	26 ¹ / ₈ "	39 ¹ / ₈ " to 43 ¹ / ₂ "	15 ¹³ / ₁₆ " to 20 ⁷ / ₁₆ "	16 ³ / ₁₀ "	19 ¹ / ₄ "	N.A.	N.A.
			37 ⁵ / ₈ " to 41 ¹ / ₂ " (low opt)	14 ¹ / ₈ " to 18" (low opt)				
			43 ³ / ₄ " to 50 ¹ / ₈ " (high opt)	20 ¹ / ₄ " to 27 ⁵ / ₈ " (high opt)				
High-back work chair	26 ¹ / ₈ "	26 ¹ / ₈ "	46 ³ / ₄ " to 51 ¹ / ₈ "	15 ¹³ / ₁₆ " to 20 ⁷ / ₁₆ "	16 ³ / ₁₀ "	19 ¹ / ₄ "	N.A.	N.A.
			45 ¹ / ₄ " to 49 ¹ / ₈ " (low opt)	14 ¹ / ₈ " to 18" (low opt)				
			51 ³ / ₈ " to 57 ³ / ₄ " (high opt)	20 ¹ / ₄ " to 27 ⁵ / ₈ " (high opt)				
Stool	26 ¹ / ₈ "	26 ¹ / ₈ "	45 ¹ / ₈ " to 52 ³ / ₈ "	21 ⁵ / ₈ " to 28 ⁷ / ₈ "	16 ³ / ₁₀ "	19 ¹ / ₄ "	N.A.	11 ¹ / ₂ " to 13"

Note: The Steelcase Karman chair complies with current BIFMA G1 Ergonomic Guidelines, listed above.

Back Width	Back Height from Seat	Back Lumbar Height	Width between Arms	Arm Height from Seat	Seat Pan Angle	Angle between Seat and Back	Weight Limit
15 ³ / ₈ "	25"	4" to 7 ¹ / ₂ " adjustable	Fixed: 20 ¹ / ₂ " 1D: 19 ³ / ₈ " to 20 ¹ / ₈ " 4D: 17 ¹ / ₂ " to 11 ¹ / ₈ "	Fixed: 7 ³ / ₄ " 1D: 7 ¹ / ₂ " to 11 ¹ / ₂ " 4D: 7 ¹ / ₂ " to 11 ¹ / ₂ "	-1° to 7°	-97° to -112°	350-lbs
15 ³ / ₈ "	32 ⁵ / ₈ "	4" to 7 ¹ / ₂ " adjustable	Fixed: 20 ¹ / ₂ " 1D: 19 ³ / ₈ " to 20 ¹ / ₈ " 4D: 17 ¹ / ₂ " to 11 ¹ / ₈ "	Fixed: 7 ³ / ₄ " 1D: 7 ¹ / ₂ " to 11 ¹ / ₂ " 4D: 7 ¹ / ₂ " to 11 ¹ / ₂ "	-1° to 7°	-97° to -112°	350-lbs
15 ³ / ₈ "	25"	4" to 7 ¹ / ₂ " adjustable	Fixed: 20 ¹ / ₂ " 1D: 19 ³ / ₈ " to 20 ¹ / ₈ " 4D: 17 ¹ / ₂ " to 22 ¹ / ₈ "	Fixed: 7 ³ / ₄ " 1D: 7 ¹ / ₂ " to 11 ¹ / ₂ " 4D: 7 ¹ / ₂ " to 11 ¹ / ₂ "	-1° to 7°	-97° to -112°	350-lbs

Note: The Steelcase Karman chair complies with current BIFMA G1 Ergonomic Guidelines, listed above.

Steelcase Karman Work Chair with Intermix Performance Textile

Standard Height Back with Performance Intermix on Seat and Back



Tip: For more information regarding color schemes, see page 78.

Tip: Leather, vinyl, Customer's Own Material (COM), and Customer's Own Leather (COL) are not available on Steelcase Karman.

Tip: Rear frame, arm frame, and base finish matches color scheme unless Lux Coatings frame is selected.

Tip: If Lux Coatings is selected, rear frame, arm frame, and base will match.

Tip: Polished aluminum base and arms are not available if Lux Coatings is chosen for frame finish.

Tip: Intermix selection is applied on both seat and back and must be the same on both.

Tip: Soil-retardant treatment not available.

Tip: Hard casters are recommended for use on soft flooring (i.e., carpet). Soft casters are recommended for use on hard flooring (i.e., hardwood) to help prevent scuffs and damage.

Standard Includes		Required to Specify
<ul style="list-style-type: none"> ▶ Need help? Product details, page 74 	<ul style="list-style-type: none"> 5" pneumatic seat-height adjustment (16"-21") Passive seat edge angle Frame, seat shell, and five-arm plastic base: textured paint 4D arms, rectilinear, height-,width-, pivot-, and depth-adjustable arms Intermix price group 1 on seat and back 2½"-diameter, hard dual-wheeled casters: black 	<ol style="list-style-type: none"> 1 Style number 2 Color scheme (see below under Required Selections) 3 Intermix color for seat and back 4 Options, if selected (see below) <ul style="list-style-type: none"> ▶ See <i>Surface Materials</i>, page 634.

Required Selections	U.S. Price	Required to Specify
Color Scheme		
<ul style="list-style-type: none"> Black Merle Platinum Seagull 	<ul style="list-style-type: none"> No cost No cost No cost No cost 	<ul style="list-style-type: none"> Specify with 6205 Black. Specify with 7360 Merle. Specify with 7190 Platinum. Specify with 7243 Seagull.

Options	U.S. Price	Required to Specify
Surface Materials		
Intermix on seat and back		
<ul style="list-style-type: none"> Intermix price group 1 Intermix Shift price group 2 Intermix Opaque price group 3 	<ul style="list-style-type: none"> No cost +\$ 36 +\$ 68 	<ul style="list-style-type: none"> Specify Intermix color number. Specify Intermix Shift color number. Specify Intermix Opaque color number.
Rear frame		
<ul style="list-style-type: none"> Lux Coatings 	<ul style="list-style-type: none"> +\$ 49 	<ul style="list-style-type: none"> Specify Lux Coatings color number.
Base		
<ul style="list-style-type: none"> Lux Coatings Polished aluminum base 	<ul style="list-style-type: none"> +\$131 +\$186 	<ul style="list-style-type: none"> Specify Lux Coatings color number. Specify with polished aluminum base.
Arms		
<ul style="list-style-type: none"> Lux Coatings 	<ul style="list-style-type: none"> +\$ 85 	<ul style="list-style-type: none"> Specify Lux Coatings color number.
Arms		
<ul style="list-style-type: none"> Height-adjustable arms Fixed arms Armless Polished aluminum fixed arms 	<ul style="list-style-type: none"> -\$ 71 -\$144 -\$367 +\$100 	<ul style="list-style-type: none"> Specify with height-adjustable arms. Specify with fixed arms. Specify without arms. Specify with polished aluminum fixed arms.
Lumbar		
<ul style="list-style-type: none"> Adjustable lumbar support 	<ul style="list-style-type: none"> +\$ 93 	<ul style="list-style-type: none"> Specify with adjustable lumbar.
Seat Height		
<ul style="list-style-type: none"> 4" low-range pneumatic seat-height adjustment (14"-18") 7" high-range pneumatic seat-height adjustment (20"-27") 	<ul style="list-style-type: none"> +\$ 82 +\$ 82 	<ul style="list-style-type: none"> Specify with low-range cylinder. Specify with high-range cylinder.
Casters		
<ul style="list-style-type: none"> Soft, dark grey treaded, dual-wheel roll-control casters for use on hard floors Hard, black interior/black treaded hubless casters for use on soft floors Soft, black interior/dark grey treaded hubless casters, for use on hard floors 	<ul style="list-style-type: none"> +\$ 36 +\$140 +\$179 	<ul style="list-style-type: none"> Specify with soft casters. Specify with hard, hubless casters. Specify with soft, hubless casters.
Glides		
<ul style="list-style-type: none"> Glides: plastic 	<ul style="list-style-type: none"> +\$ 36 	<ul style="list-style-type: none"> Specify with glides.
Coat Hanger		
<ul style="list-style-type: none"> Field-installed coat hanger 	<ul style="list-style-type: none"> +\$ 45 	<ul style="list-style-type: none"> Specify with coat hanger.
CarbonNeutral Product		
<ul style="list-style-type: none"> CarbonNeutral product certification 	<ul style="list-style-type: none"> +\$ 35 	<ul style="list-style-type: none"> Add suffix CN to the end of the style number.

Specification Information

Style Number	U.S. Base Price
419A000	\$1744



For Canadian Pricing
 Multiply U.S. Price by the Canadian price factor.
 ▶ See page 1 for details.

Steelcase Karman Work Stool with Intermix Performance Textile

Steelcase Karman Work Stool with Intermix Performance Textile

Standard Height Back with Performance Intermix on Seat and Back

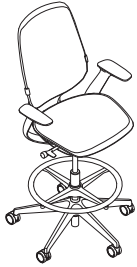

Tip: For more information regarding color schemes, see page 78.

Tip: Leather, vinyl, Customer's Own Material (COM), and Customer's Own Leather (COL) are not available on seat and back.

Tip: Frame finish matches color scheme unless Lux Coatings frame is selected.

Tip: If Lux Coatings frame is selected, arm frame and base will match.

Tip: Polished aluminum base and arms are not available if Lux Coatings is chosen for frame finish.

Tip: Soil-retardant treatment not available.

Tip: Hard casters are recommended for use on soft flooring (i.e., carpet). Soft casters are recommended for use on hard flooring (i.e., hardwood) to help prevent scuffs and damage.

Standard Includes		Required to Specify
▶ Need help? Product details, page 74	<ul style="list-style-type: none"> 8" pneumatic seat-height adjustment (21"-29") Passive seat edge angle Frame, seat shell, and five-arm plastic base: textured paint 4D arms, rectilinear, height-, width-, pivot-, and depth-adjustable arms Intermix price group 1 on seat and back 2 1/2"-diameter, hard dual-wheeled casters: black 	<ol style="list-style-type: none"> Style number Color scheme (see below under Required Selections) Intermix color for seat and back Options, if selected (see below) <ul style="list-style-type: none"> ▶ See <i>Surface Materials</i>, page 634.

Required Selections	U.S. Price	Required to Specify
Color Scheme		
<ul style="list-style-type: none"> Black Merle Platinum Seagull 	<ul style="list-style-type: none"> No cost No cost No cost No cost 	<ul style="list-style-type: none"> Specify with 6205 Black. Specify with 7360 Merle. Specify with 7190 Platinum. Specify with 7243 Seagull.

Options	U.S. Price	Required to Specify
Surface Materials		
Intermix on seat and back		
<ul style="list-style-type: none"> Intermix price group 1 Intermix Shift price group 2 Intermix Opaque price group 3 	<ul style="list-style-type: none"> No cost +\$ 36 +\$ 68 	<ul style="list-style-type: none"> Specify Intermix color number. Specify Intermix Shift color number. Specify Intermix Opaque color number.
Rear frame		
<ul style="list-style-type: none"> Lux Coatings 	<ul style="list-style-type: none"> +\$ 49 	<ul style="list-style-type: none"> Specify Lux Coatings color number.
Base		
<ul style="list-style-type: none"> Lux Coatings Polished aluminum base 	<ul style="list-style-type: none"> +\$131 +\$186 	<ul style="list-style-type: none"> Specify Lux Coatings color number. Specify with polished aluminum base.
Arms		
<ul style="list-style-type: none"> Lux Coatings 	<ul style="list-style-type: none"> +\$ 85 	<ul style="list-style-type: none"> Specify Lux Coatings color number.
Arms		
<ul style="list-style-type: none"> Height-adjustable arms Fixed arms Armless Polished aluminum fixed arms 	<ul style="list-style-type: none"> -\$ 71 -\$144 -\$367 +\$100 	<ul style="list-style-type: none"> Specify with height-adjustable arms. Specify with fixed arms. Specify without arms. Specify with polished aluminum fixed arms.
Lumbar		
<ul style="list-style-type: none"> Adjustable lumbar support 	<ul style="list-style-type: none"> +\$ 93 	<ul style="list-style-type: none"> Specify with adjustable lumbar.
Casters		
<ul style="list-style-type: none"> Soft, dark grey treaded, dual-wheel roll-control casters for use on hard floors Hard, black interior/black treaded hubless casters for use on soft floors Soft, black interior/dark grey treaded hubless casters, for use on hard floors 	<ul style="list-style-type: none"> +\$ 36 +\$140 +\$179 	<ul style="list-style-type: none"> Specify with soft casters. Specify with hard, hubless casters. Specify with soft, hubless casters.
Glides		
<ul style="list-style-type: none"> Glides: plastic 	<ul style="list-style-type: none"> +\$ 36 	<ul style="list-style-type: none"> Specify with glides.
Coat Hanger		
<ul style="list-style-type: none"> Field-installed coat hanger 	<ul style="list-style-type: none"> +\$ 45 	<ul style="list-style-type: none"> Specify with coat hanger.
CarbonNeutral Product		
<ul style="list-style-type: none"> CarbonNeutral product certification 	<ul style="list-style-type: none"> +\$ 35 	<ul style="list-style-type: none"> Add suffix CN to the end of the style number.

Specification Information	
Style Number	U.S. Base Price
419B000	\$1994

 **For Canadian Pricing**
 Multiply U.S. Price by the Canadian price factor.
 ▶ See page 1 for details.

Steelcase Karman High-Back Work Chair with Intermix Performance Textile

High-Back with Performance Intermix on Seat and Back

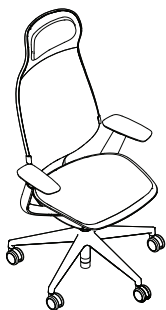

Tip: For more information regarding color schemes, see page 78.

Tip: Leather, vinyl, Customer's Own Material (COM), and Customer's Own Leather (COL) are not available on Steelcase Karman.

Tip: Rear frame, arm frame, and base finish matches color scheme unless Lux Coatings frame is selected.

Tip: If Lux Coatings is selected, rear frame, arm frame, and base will match.

Tip: Polished aluminum base and arms are not available if Lux Coatings is chosen for frame finish.

Tip: Intermix selection is applied on both seat and back and must be the same on both.

Tip: Neck support pillow follows intermix selection of the seat and back, and is field serviceable only on high-back chairs that were originally specified with a neck support pillow. Pillow is not able to be specified on existing Steelcase Karman chairs that did not originally have a neck support pillow.

Tip: Soil-retardant treatment not available.

Tip: Hard casters are recommended for use on soft flooring (i.e., carpet). Soft casters are recommended for use on hard flooring (i.e., hardwood) to help prevent scuffs and damage.



For Canadian Pricing

Multiply U.S. Price by the Canadian price factor.

▶ See page 1 for details.

Standard Includes		Required to Specify
-------------------	--	---------------------

▶ Need help? Product details, page 74	<ul style="list-style-type: none"> 5" pneumatic seat-height adjustment (16"-21") Passive seat edge angle Frame, seat shell, and five-arm plastic base: textured paint 4D arms, rectilinear, height-, width-, pivot-, and depth-adjustable arms High-back with adjustable neck support pillow Intermix price group 1 on seat, back, and neck support pillow 2½"-diameter, hard dual-wheeled casters: black 	<ol style="list-style-type: none"> Style number Color scheme (see below under Required Selections) Intermix color for seat and back Options, if selected (see below) <ul style="list-style-type: none"> ▶ See <i>Surface Materials</i>, page 634.
---------------------------------------	--	---

Required Selections	U.S. Price	Required to Specify
---------------------	------------	---------------------

Color Scheme	<ul style="list-style-type: none"> Black Platinum Seagull Merle 	<ul style="list-style-type: none"> No cost No cost No cost No cost 	<ul style="list-style-type: none"> Specify with 6205 Black. Specify with 7190 Platinum. Specify with 7243 Seagull. Specify with 7360 Merle.
---------------------	---	--	---

Options	U.S. Price	Required to Specify
---------	------------	---------------------

Surface Materials	Intermix on seat, back, and neck support pillow	<ul style="list-style-type: none"> Intermix price group 1 Intermix Shift price group 2 Intermix Opaque price group 3 	<ul style="list-style-type: none"> No cost +\$ 36 +\$ 68 	<ul style="list-style-type: none"> Specify Intermix color number. Specify Intermix Shift color number. Specify Intermix Opaque color number.
	Rear frame	<ul style="list-style-type: none"> Lux Coatings 	<ul style="list-style-type: none"> +\$ 49 	<ul style="list-style-type: none"> Specify Lux Coatings color number.
	Base	<ul style="list-style-type: none"> Lux Coatings Polished aluminum base 	<ul style="list-style-type: none"> +\$131 +\$186 	<ul style="list-style-type: none"> Specify Lux Coatings color number. Specify with polished aluminum base.
	Arms	<ul style="list-style-type: none"> Lux Coatings 	<ul style="list-style-type: none"> +\$ 85 	<ul style="list-style-type: none"> Specify Lux Coatings color number.
Arms	<ul style="list-style-type: none"> Height-adjustable arms Fixed arms Armless Polished aluminum fixed arms 	<ul style="list-style-type: none"> -\$ 71 -\$144 -\$367 +\$100 	<ul style="list-style-type: none"> Specify with height-adjustable arms. Specify with fixed arms. Specify without arms. Specify with polished aluminum fixed arms. 	
Lumbar	<ul style="list-style-type: none"> Adjustable lumbar support 	<ul style="list-style-type: none"> +\$ 93 	<ul style="list-style-type: none"> Specify with adjustable lumbar. 	
Seat Height	<ul style="list-style-type: none"> 4" low-range pneumatic seat-height adjustment (14"-18") 7" high-range pneumatic seat-height adjustment (20"-27") 	<ul style="list-style-type: none"> +\$ 82 +\$ 82 	<ul style="list-style-type: none"> Specify with low-range cylinder. Specify with high-range cylinder. 	
Casters	<ul style="list-style-type: none"> Soft, dark grey treaded, dual-wheel roll-control casters for use on hard floors Hard, black interior/black treaded hubless casters for use on soft floors Soft, black interior/dark grey treaded hubless casters, for use on hard floors 	<ul style="list-style-type: none"> +\$ 36 +\$140 +\$179 	<ul style="list-style-type: none"> Specify with soft casters. Specify with hard, hubless casters. Specify with soft, hubless casters. 	
Glides	<ul style="list-style-type: none"> Glides: plastic 	<ul style="list-style-type: none"> +\$ 36 	<ul style="list-style-type: none"> Specify with glides. 	
Coat Hanger	<ul style="list-style-type: none"> Field-installed coat hanger 	<ul style="list-style-type: none"> +\$ 45 	<ul style="list-style-type: none"> Specify with coat hanger. 	
Neck Support Pillow	<ul style="list-style-type: none"> No neck support pillow 	<ul style="list-style-type: none"> -\$ 50 	<ul style="list-style-type: none"> Specify with no neck support pillow. 	
CarbonNeutral Product	<ul style="list-style-type: none"> CarbonNeutral product certification 	<ul style="list-style-type: none"> +\$ 35 	<ul style="list-style-type: none"> Add suffix CN to the end of the style number. 	

Specification Information

Style Number	U.S. Base Price
419A500	\$2044

Steelcase Karman Accessories

Steelcase Karman Lumbar



Tip: Lumbar is retrofittable and applicable on all chair and stool styles.

Tip: Stand alone add on accessories are not available with CarbonNeutral product certification.

Standard Includes	Required to Specify
<ul style="list-style-type: none"> ▶ Need help? Product details, page 74 • Adjustable lumbar 	<ul style="list-style-type: none"> 1 Style number 2 Color scheme (see below under Required Selections)

Required Selections	U.S. Price	Required to Specify
Color Scheme <ul style="list-style-type: none"> • Black • Merle • Platinum • Seagull 	<ul style="list-style-type: none"> No cost No cost No cost 	<ul style="list-style-type: none"> Specify with 6205 Black. Specify with 7360 Merle. Specify with 7190 Platinum. Specify with 7243 Seagull.

Specification Information	
Style Number	U.S. Price
419LUMBAR	\$93

Steelcase Karman Coat Hanger

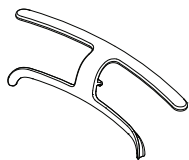

Tip: Coat hanger is retrofittable and applicable on all chair and stool styles.

Tip: Stand alone add on accessories are not available with CarbonNeutral product certification.

Standard Includes	Required to Specify
<ul style="list-style-type: none"> ▶ Need help? Product details, page 74 • Field-installed coat hanger 	<ul style="list-style-type: none"> 1 Style number 2 Color scheme (see below under Required Selections)

Required Selections	U.S. Price	Required to Specify
Color Scheme <ul style="list-style-type: none"> • Sterling dark • Black 	<ul style="list-style-type: none"> No cost No cost 	<ul style="list-style-type: none"> Specify with 6059 Sterling Dark. Specify with 6205 Black.

Specification Information	
Style Number	U.S. Price
419COATHANGER	\$65

Steelcase Karman

 **For Canadian Pricing**
Multiply U.S. Price by the Canadian price factor.
▶ See page 1 for details.



Understanding and Specifying Think 465 Series Work Chairs

Product Details

Think 465 Series	88
Think 465 Finish Options and Locations	92
Think Color Scheme Matrix	94
Think Upholstery	96
Dimensions	98

Specifying

Work Chairs

3D Knit Back with Upholstery on Seat	100
Upholstered Back with Upholstery on Seat	102
Quilted Upholstered Back with Upholstery on Seat	106

Stools

3D Knit Back with Upholstery on Seat	110
Upholstered Back with Upholstery on Seat	112
Quilted Upholstered Back with Upholstery on Seat	116

Work Chairs

Highly adjustable task seating offers maximum personalization for fit and comfort for a range of duration and use. By making a series of simple adjustments, you can customize the chair to your body, preferences, and tasks. These chairs provide continuous, stable, comfort, and can be quickly adjusted to support you in upright, and reclining work postures.

- Gesture 442 Series
- Leap 462 Series
- Think 465 Series
- Amia 482 Series
- Reply 466 Series

Adjustability Features

► See page 26 for a comparison to other chairs. **Think 465 Series**

Mechanisms

Weight-activated ●

Seat Adjustments

Pneumatic height ●

Passive seat edge angle ●

Seat depth ●

Back Adjustments

Lumbar height ●

Arm Adjustments

Arm height ●

Arm width ●

Arm pivot ●

Arm depth ●

Other Features

Foot ring height (stool) ●

Think 465 Series



Now available as a CarbonNeutral product, making sure our commitment to a more sustainable future helps yours too.

Think's award-winning design re-imagined what an office chair could do, and how sustainable it could be. Designed for hybrid workers and their unique needs, it's smart and simple, weight activated, controls allow anyone, anywhere to get comfortable and to get to work. With beauty to match brains, this icon of sustainable design serves up a breadth of style choice that is warm, tailored, and sophisticated.

Back style choice:

- 3D Knit
- Upholstered
- Quilted upholstered

Lumbar height adjusts over 4 1/4" to provide additional lower back support and is available as an option.

Arm caps can pivot independently 30° in and 30° out to accommodate individual user preferences.

Back frame and seat shell are plastic.

Comfort dial back control provides four settings for the user's personal preference and work style.

Seat height adjusts within a 5" range with a pneumatic adjustment mechanism. A 3" or 7" range is available as an option. Stools have a 10" range.

Seat depth adjusts within a 2 1/2" range to accommodate users of varying leg lengths.

Casters have hard, dual-wheels that roll smoothly on carpets. They are 2 1/2" for increased mobility. Soft, dark grey treaded, dual-wheel roll-control casters are available for use on hard floors or mats. Glides are also available as an option.

Tip: Do not roll the chair across asphalt during installation as this may damage the casters.



LiveBack Flexor System conforms to your spine to provide flexibility and support.

Arm width adjusts 4 1/2" overall to support forearms in neutral position.

Arm height can adjust independently within a 4" range to help relieve upper back and shoulder fatigue.

Arm depth can retract 3" to allow user to get closer to the worksurface and into tight corners.

Passive seat edge angle allows the front edge of the seat to flex 1 1/2" to relieve pressure under the user's thighs.

Five-star base is available in plastic or polished aluminum.

Product Details

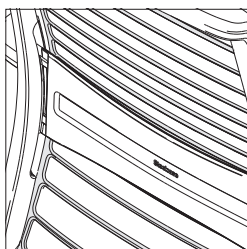

LiveBack Flexor System conforms to your spine to provide flexibility and support.

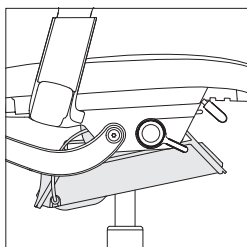

Advanced weight-activated mechanism with a natural fluid motion keeps users oriented to their work.

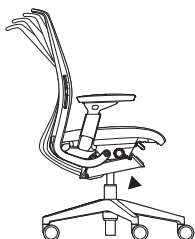

Comfort dial has four settings that allow for the user's personal preference and work style.

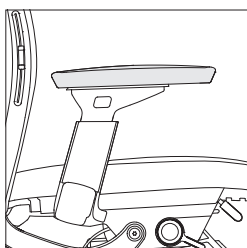

Rectilinear arms with soft caps are standard.

Cartoned request on your dealer purchase order means Think chairs will ship knocked down with the chair base and pneumatic cylinder separated from the rest of the chair. This allows for shipment in a smaller carton. Assembly by a qualified dealer installer is required. *Tip: Assembly instructions are included.*

Uncartoned request on your dealer purchase order means Think chairs will ship fully assembled.

Product Weight

- Think upholstered chair: 34.5 pounds
- Think 3D Microknit chair: 35.6 pounds



CarbonNeutral.com

CarbonNeutral product

Think helps organizations achieve their carbon emissions goals. Add **CN** to the end of the style number to specify Think with CarbonNeutral product certification.

Adjustment Features

Adjustability instructions are included with every chair.

Seat Adjustments

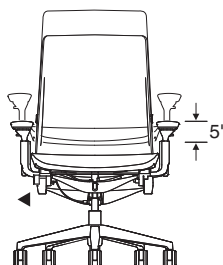

Seat height adjusts pneumatically. To lower, hold handle up while seated. To raise, hold handle up and keep your weight off the chair. Standard range of adjustability is 5" from 16½"H to 21½"H. A 3" range of adjustability (15"H to 18"H), and a 7" range of adjustability (18"H to 25"H) is available as an option. A 10" range of adjustability (22½"H to 32½"H) is available on stools.

Passive seat edge angle relieves pressure under the user's thighs. The passive front seat edge helps properly support the angle of the user's leg and thigh without compromising pelvic support. The front seat edge angle flexes 1½".

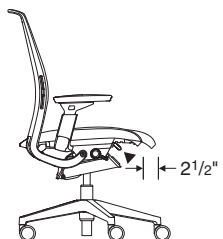

Seat depth adjusts 2½" (15½"–18") by pulling handle up. Slide seat forward or back to accommodate various leg lengths. Release handle to lock.

Back Adjustments

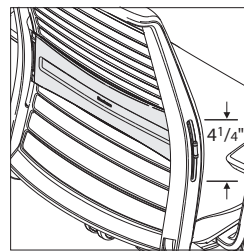

Lumbar height adjusts 4¼" (6" to 10¼" from seat) by grabbing exposed tabs and sliding the lumbar support up or down. Fixed lumbar height is available as an option on work chairs and stools. The fixed lumbar is positioned 8" from the seat. The adjustment handles are replaced with inserts that fill the lumbar slot in the back frame.



Weight-activated setting

Boosted setting



Mid-back stop recline setting

Upright back stop setting

Comfort dial has four settings that allow for the user's personal preference and work style: (1) weight-activated setting; (2) boosted setting that has approximately 20% more resistance than your body is providing; (3) mid-stop recline setting; and (4) an upright setting.

Arm Adjustments

Rectilinear height-, width-, pivot-, and depth-adjustable arms come standard on all arm models of chairs and stools.

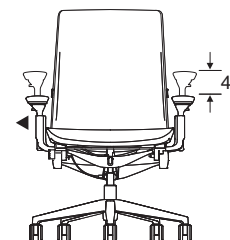

Arm height adjusts independently within a range of 4" (7"–11" from the seat). Push button on outside and under arm cap in while moving arms up or down. Releasing buttons locks arms in position.

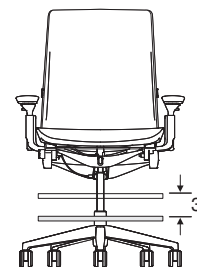

Foot ring height on stools adjusts by rotating it counterclockwise to unlock. Then raise or lower ring to desired position before rotating it clockwise to lock. The foot ring has a diameter of 20".

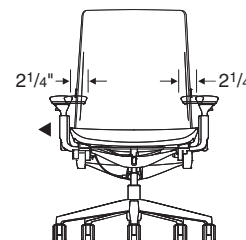

Arm width can be adjusted 2¼" each, 4½" overall. Grasp arm cap and move in or out.

Think 465 Series, continued

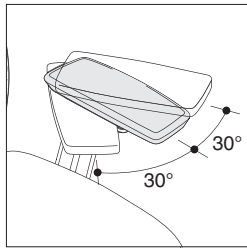

Arms pivot independently, 30° inward and outward. Grasp arm and push front to left or right.

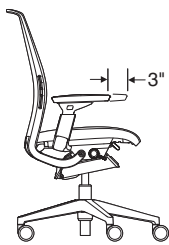

Arm depth adjusts by sliding arm caps back 3". Friction-fit mechanism keeps arms in position.

Other Features

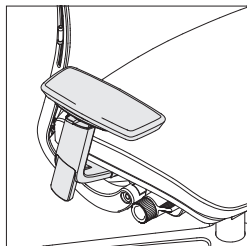

Height-only adjustable arm is also available and adjusts 4".

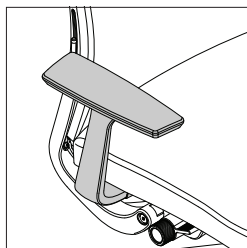

Fixed arm available.



Armless models are also available.



Headrest (option) adjusts 4" vertically and 2½" horizontally (front-to-back) to support the head and neck of the user in both upright and recline postures. The plastic stalk and underside of the headrest will coordinate to match the frame color specified: black, platinum, or seagull. The foam pad of the headrest will always be black. Headrest is not available on stools. Whether ordered initially or at a later date, the headrest ships in its own carton and must be field installed.

Think headrest frame will match frame color specified. Headrest cushion is always black and made of a self skinning urethane.



Coat hanger (option) is field installed. The color will coordinate with the frame of the chair, but will not match the frame exactly. The coat hanger supports up to 10 pounds and is not intended to hold bags or backpacks. This option is not available on stools.

Note: Merle monochromatic color scheme receives 6205 black coat hanger.

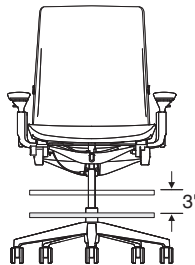

Foot ring height on stools adjusts by rotating it counterclockwise to unlock. Then raise or lower ring to desired position before rotating it clockwise to lock. The foot ring has a diameter of 20".

Soft dual-wheel roll-control casters feature an internal brake that activates when the chair is not under load to reduce shifting when user stands up.

All seat cushions have a unique sewn construction that is included in the price of the chair.



Stitch detail across the lumbar region of the back cushion is required on some models with an upholstered backrest. To ensure optimum performance of the Integrated LiveBack System, all Steelcase Select Surfaces, COMs, Leathers, Vinyls, and some standard fabrics will require this sewn detail. The stitch detail is included in the price of the chair.

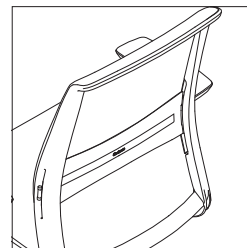

Fabric outer back cover is available on quilted upholstered and upholstered back styles. The fabric back cover conceals the horizontal flexors while keeping the lumbar visible.

Outer back cover fabric defaults to match the specified seat back fabric.

All Steelcase seating with standard upholstery fabrics complies with requirements of the State of California Technical Bulletin 117-2013. All standard seating is labeled to be in compliance with California 117-2013.

Programs & Services

► See *Surface Materials Reference Manual* for further detail about programs and services offered for seating.

The Customer's Own Material (COM) Program

offers the opportunity for customers to select fabrics that are not offered through the standard Steelcase surface materials program for use on Steelcase products. Through the COM program, Steelcase will test your materials for application on Steelcase products. Once approved, you can place your order. Steelcase will facilitate the entire ordering process and give you a production schedule. Steelcase will order the COM fabric directly from the textile manufacturer. For up-to-date information regarding fabric test results for all COM fabrics and details regarding yardage requirements for most seating lines, visit the COM website. To locate the COM website:

- Visit www.steelcase.com

Soil retardants are treatments that provide long-term soil and stain resistance to a fabric without affecting the shade or the integrity of the fabric. The following Steelcase Textiles are available pre-treated with soil retardant. (You do not need to select the soil-retardant option for these fabrics and incur the upcharge.)

- Jacks
- Link

For information on soil retardant fabrics on Select Surfaces, please refer to the *Surface Materials Reference Manual*.

Soil-retardant treatment is available on all other seating fabrics at an additional upcharge per seating unit. To order this option, please select "Soil-Retardant Treatment" under "Optional Accessories."

For soil-retardant treatment on COMs, please select "Soil-Retardant Treatment" under "Optional Accessories." Minimums or additional yardage may be required. Please contact the vendor directly for specific information.

Extended lead times may be necessary for this service.

Contact your Steelcase Solutions Fulfillment Team Representative at 1.888.STEELCASE (1.888.783.3522) or send an email to line-one@steelcase.com.

Local codes may have special requirements for upholstery.

Dimensions

▶ Page 98

Think 465 Finish Options and Locations

3D Knit Back Chair

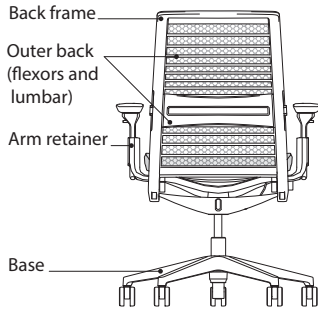

Quilted Upholstered and Upholstered Back Chairs

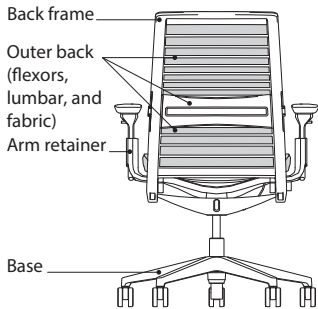

Upholstery

- Fabric
- Fabric with soil-retardant treatment (option)
- 3D Knit (back only)
- Select Surfaces leather*
- Elmosoft leather*
- Leather*
- Vinyl*
- Customer's Own Material (COM)
- Customer's Own Leather (COL)*

*Upholstered back and seats only

Hard Components

Note: finishes are determined by color scheme, see page 94 for color scheme matrix.

Back frame, arm retainer, and base

- 6205 Black
- 7360 Merle
- 7190 Platinum Solid
- 4799 Platinum Metallic
- 7243 Seagull
- Lux Coatings

Outer back is determined by color scheme/frame package:

Monochromatic Color Schemes

Frame/arm retainer/base and outer back match

- 6205 Black and 6205 Black
- 7360 Merle and 6527 Merle
- 7190 Platinum Solid and 6249 Platinum
- 4799 Platinum Metallic and 6249 Platinum
- 7243 Seagull and 6053 Seagull

Contrasting Color Schemes

Frame/arm retainer/base and outer back contrast

- 4799 Platinum Metallic and 6527 Merle
- 7243 Seagull and 6527 Merle

Pneumatic cylinders, mechanism, and stool foot ring:

- 4710 Low Gloss Black

Adjustment handles, arm pads, arm stalk, outer seat shell, inner seat shell, casters, and glides

- 6205 Black

Lux Applications

- Base
- Arm retainer and base
- Frame, arm retainer, and base

Think 465 Lux Finish Options and Locations

Lux on Base

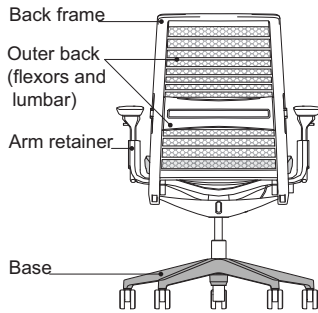

Lux on Arm Retainer and Base

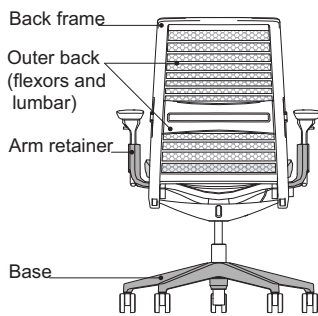

Lux on Frame, Arm Retainer, and Base

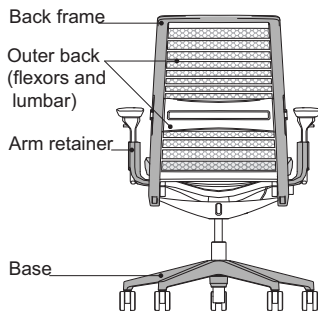

Lux Applications

- Base
- Arm retainer and base
- Frame, arm retainer, and base

Lux Finishes

- 4B20 Obsidian
- 4B22 Matte Brass
- 4B23 Burnished Bronze
- 4B24 Night Bronze
- 4B25 Matte Copper
- 4B26 Smoked Mica
- 4B29 Cast Iron

When Lux on base only is selected, specify frame finish:

Note: outer back will match frame finish.

Frame:

- 6205 Black
- 7360 Merle
- 7190 Platinum Solid
- 7243 Seagull

When Lux on arm retainer and base is selected, specify frame finish:

Note: outer back will match frame finish.

Frame:

- 6205 Black
- 7360 Merle
- 7190 Platinum Solid
- 7243 Seagull

When Lux on frame, arm retainer, and base is selected, specify outer back finish:

Outer back:

- 6205 Black
- 6527 Merle
- 6249 Platinum Solid
- 6053 Seagull

Think Color Scheme Matrix

Frame Package Color Scheme Matrix

Color Scheme	Back Frame	Outer Back (flexors and lumbar)	Arm Retainer	Mechanism
Monochromatic Color Schemes				
Black	6205 Black	6205 Black	6205 Black	Black
Merle	7360 Merle	6527 Merle	7360 Merle	Black
Platinum Solid	7190 Platinum Solid	6249 Platinum	7190 Platinum Solid	Black
Platinum Metallic	4799 Platinum Metallic	6249 Platinum	4799 Platinum Metallic	Black
Seagull	7243 Seagull	6053 Seagull	7243 Seagull	Black
Contrasting Color Schemes				
Platinum Metallic	4799 Platinum Metallic	6527 Merle	4799 Platinum Metallic	Black
Seagull	7243 Seagull	6527 Merle	7243 Seagull	Black

Tip: Lux Coatings are available as an option in one of the three applications: base only, arms & base, frame, arms, base

Tip: The mechanism, cylinder, and foot ring are always black.

Tip: Polished aluminum is available on base for all color schemes but cannot be combined with Lux Coatings applications.

• Cylinder	• Base	• Headrest (optional)	• Coat Hanger (optional)
Black	6205 Black	6205 Black	6205 Black
Black	7360 Merle	6527 Merle	6205 Black
Black	7190 Platinum Solid	6249 Platinum	6249 Platinum
Black	4799 Platinum Metallic	6249 Platinum	6249 Platinum
Black	7243 Seagull	6053 Seagull	6053 Seagull
Black	4799 Platinum Metallic	6249 Platinum	6249 Platinum
Black	7243 Seagull	6053 Seagull	6053 Seagull

Think Upholstery

What Is It?

Fabric, leather, or vinyl-covered back and seat, 3D Knit back.

3D Knit on Back only

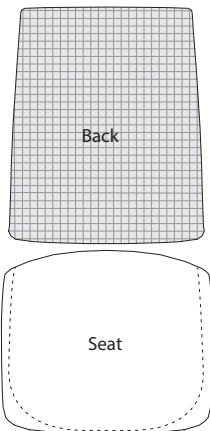

3D Knit back

Upholstered Back: Standard Fabrics

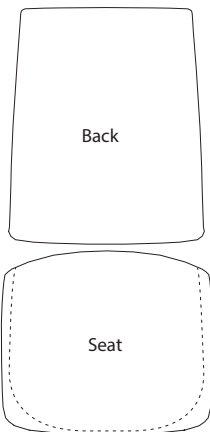

Upholstered Back: Leather, Vinyl, and Select Other Fabrics

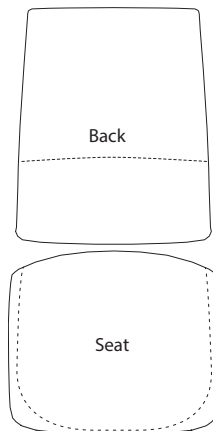

Stitched seams are included on the back cushion and seat cushion of the following:

- Leather
- Vinyl
- Some upholstery
- Customer's Own Material (COM)
- Customer's Own Leather (COL)

Pattern alignment at the lumbar seam cannot be guaranteed.

Quilted Upholstered Back: Fabrics

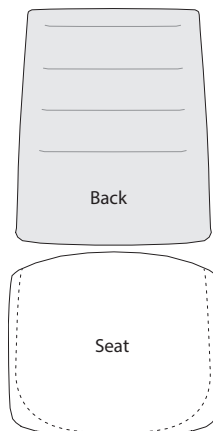

Quilted back styles feature horizontal stitching detail.

Tip: Plaid and striped fabrics are not available on Think quilted back styles.

3D Knit Back



Upholstered Back



Quilted Upholstered Back



Back flexors are fully exposed.

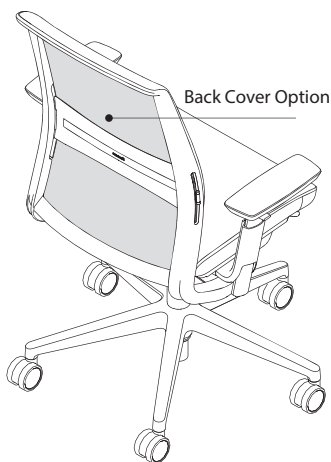

Optional fabric back cover (on quilted upholstered and upholstered back styles) conceals back flexors.

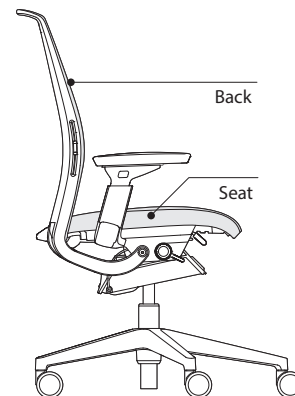

Seat and back assemblies can be removed and replaced if damaged.

Dimensions

Think 465 Series

• Features	• Overall Depth	Width	Height	• Seat Depth	• Functional Seat Depth	• Seat Width	• Seat Height from Floor	• Ring Height from Floor	• Back Width	• Back Height from Seat	• Lumbar Height from Seat
------------	-----------------	-------	--------	--------------	-------------------------	--------------	--------------------------	--------------------------	--------------	-------------------------	---------------------------

Think 465 Series

Chairs

Arms	22" to 24 ¹ / ₄ "	28 ¹ / ₂ "	37 ¹ / ₄ " to 42"	18 ¹ / ₂ "	15 ¹ / ₂ " to 18"	20 ¹ / ₄ "	16 ¹ / ₂ " to 21 ¹ / ₂ " (15" to 18", 18" to 25" optional)	N.A.	18"	22 ³ / ₄ "	6" to 10 ¹ / ₄ "
------	---	----------------------------------	---	----------------------------------	---	----------------------------------	---	------	-----	----------------------------------	--

Stools

Arms	22" to 24 ¹ / ₄ "	28 ¹ / ₂ "	44" to 53 ³ / ₄ "	18 ¹ / ₂ "	15 ¹ / ₂ " to 18"	20 ¹ / ₄ "	22 ¹ / ₂ " to 32 ¹ / ₂ "	10" to 13"	18"	22 ³ / ₄ "	6" to 10 ¹ / ₄ "
------	---	----------------------------------	---	----------------------------------	---	----------------------------------	--	------------	-----	----------------------------------	--

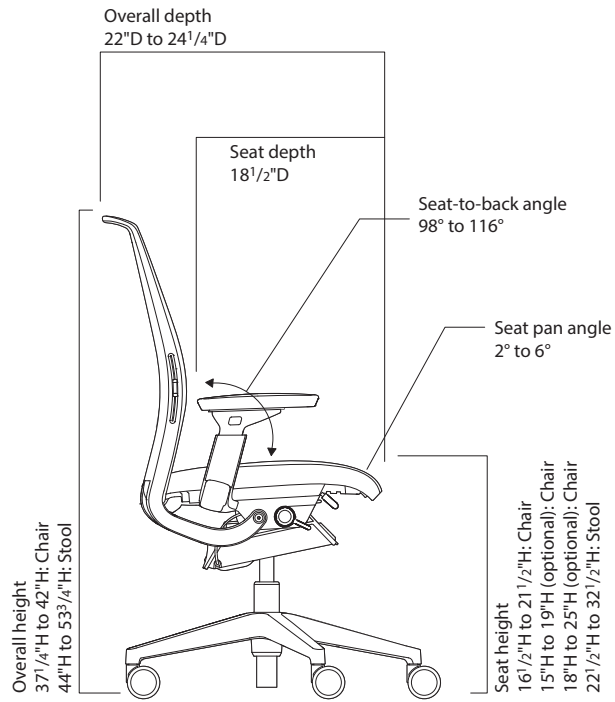
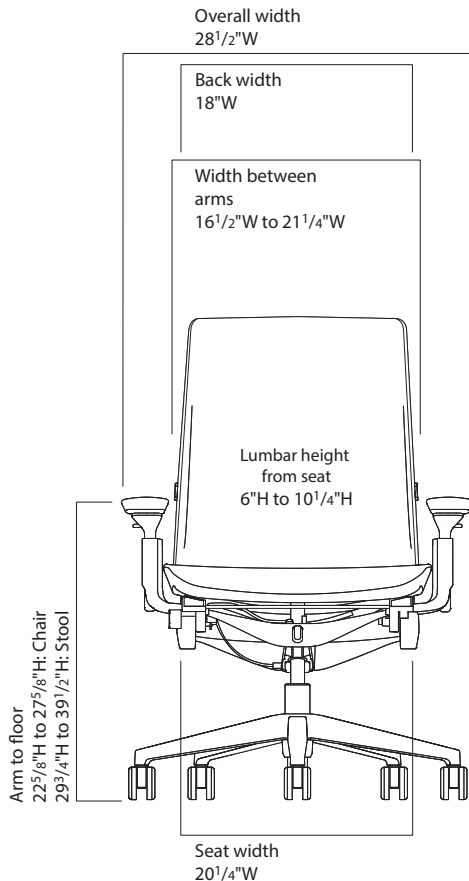

• Width • Between • Adjustable • Arms	• Width • Between • Fixed • Arms	• Arm • to • Floor	• Arm • Height • from • Seat	• Arm • Height • from Seat • for Fixed • Arms	• Arm Cap • Pivot • Range	• Angle • Between • Seat and • Back	• Seat • Pan • Angle	• Headrest • Height • Adjustment • Range
--	---	--------------------------	---------------------------------------	---	---------------------------------	--	----------------------------	---

16½" to 21¼" 14" to 21¼" (including pivot)	20½"	22⅝" to 27⅝"	7" to 11"	8¼"	30° inward, 30° outward	98° to 116°	2° to 6°	4"
--	------	--------------	-----------	-----	----------------------------	-------------	----------	----

16½" to 21¼" 14" to 21¼" (including pivot)	20½"	29¾" to 39½"	7" to 11"	8¼"	30° inward, 30° outward	98° to 116°	2° to 6°	N.A.
--	------	--------------	-----------	-----	----------------------------	-------------	----------	------

: : : : : : : :

Think 465 Series Work Chair

3D Knit Back with Upholstery on Seat



	Standard Includes	Required to Specify
<p>▶ Need help? Product details, page 88</p>	<ul style="list-style-type: none"> • 5" pneumatic seat-height adjustment (16½"-21½") • Passive seat edge angle • Frame, seat shell, and five-arm plastic base: black • 2½" seat depth adjustment • Rectilinear height-, width-, pivot-, and depth-adjustable arms • Adjustable lumbar • 3D Knit on back • Standard upholstery design on seat: fabric price group 1 • 2½"-diameter, hard-composition, dual-wheel casters: black 	<ol style="list-style-type: none"> 1 Style number 2 Color scheme: monochromatic, contrasting, or Lux (see below under Required Selections) 3 Finish color for frame, base, and arm retainer 4 3D Knit color for back 5 Fabric color number for upholstery on seat 6 Options, if selected (see below) <p>▶ See <i>Surface Materials</i>, page 634.</p>

	Required Selections	U.S. Price	Required to Specify
Color Scheme/ Frame Package	Monochromatic		
	<ul style="list-style-type: none"> • Black • Merle • Platinum Solid • Platinum Metallic • Seagull 	<p>No cost</p> <p>+\$ 68</p> <p>+\$ 68</p> <p>+\$ 68</p> <p>+\$ 68</p>	<p>Specify with 6205 Black.</p> <p>Specify with 7360 Merle.</p> <p>Specify with 7190 Platinum Solid.</p> <p>Specify with 4799 Platinum Metallic.</p> <p>Specify with 7243 Seagull.</p>
	Contrasting		
	<ul style="list-style-type: none"> • Platinum Metallic • Seagull 	<p>+\$ 68</p> <p>+\$ 68</p>	<p>Specify with 4799 Platinum.</p> <p>Specify with 7243 Seagull.</p>
	Lux		
	<ul style="list-style-type: none"> • Frame, arms, and base • Arms and base • Base only 	<p>See below</p> <p>See below</p> <p>See below</p>	<p>Specify with Lux application: frame, arms, and base.</p> <p>Specify with Lux application: arms and base.</p> <p>Specify with Lux application: base.</p>

	Options	U.S. Price	Required to Specify
Surface Materials	Upholstery on seat		
	<ul style="list-style-type: none"> • Fabric price group 1 • Fabric price group 2 • Fabric price group 3 • Fabric price group 4 • Fabric price group 5 • Fabric price group 6 • Fabric price group 7 • Fabric price group 8 • Fabric price group 9 • Fabric price group 10 • Steelcase leather upholstery • Select Surfaces leather price group 1 • Elmosoft leather upholstery • Select Surfaces leather price group 2 • Customer's Own Material (COM) 	<p>No cost</p> <p>+\$ 12</p> <p>+\$ 35</p> <p>+\$ 48</p> <p>+\$ 61</p> <p>+\$ 76</p> <p>+\$ 84</p> <p>+\$111</p> <p>+\$136</p> <p>+\$154</p> <p>+\$238</p> <p>+\$238</p> <p>+\$279</p> <p>+\$279</p> <p>No cost</p>	<p>Specify fabric color number.</p> <p>Specify fabric color number.</p> <p>Specify fabric color number.</p> <p>Specify fabric color number.</p> <p>Specify fabric color number.</p> <p>Specify fabric color number.</p> <p>Specify fabric color number.</p> <p>Specify fabric color number.</p> <p>Specify fabric color number.</p> <p>Specify fabric color number.</p> <p>Specify fabric color number.</p> <p>Specify leather color number.</p> <p>▶ See <i>Surface Materials Reference Manual</i>. Specify Elmosoft leather color number.</p> <p>▶ See <i>Surface Materials Reference Manual</i>.</p> <p>▶ See <i>Surface Materials Reference Manual</i>.</p>
	Frame		
	<ul style="list-style-type: none"> • Lux 	<p>+\$ 50</p>	<p>Specify with Lux Coating and select color number.</p>
	Arms		
	<ul style="list-style-type: none"> • Lux 	<p>+\$ 40</p>	<p>Specify with Lux Coating and select color number.</p>

▶ Options, continued on next page

 **For Canadian Pricing**
 Multiply U.S. Price by the Canadian price factor.
 ▶ See page 1 for details.

► Options, continued from previous page

	Options	U.S. Price	Required to Specify
Surface Materials, continued	Base		
	• Lux	+\$ 70	Specify with <i>Lux Coating</i> and select color number.
	• Polished aluminum base	+\$205	Specify with <i>aluminum base</i> .
	Soil-retardant treatment	+\$ 36	Specify with <i>soil-retardant treatment</i> .
Arms	• Height-adjustable arms	-\$ 72	Specify with <i>height-adjustable arms</i> .
	• Fixed arms	-\$144	Specify with <i>fixed arms</i> .
	• Armless	-\$367	Specify <i>without arms</i> .
Seat Height	• 3" low-range pneumatic seat-height adjustment (15"–18")	+\$ 85	Specify with <i>low-range pneumatic seat-height adjustment</i> .
	• 7" high-range pneumatic seat-height adjustment (18"–25")	+\$ 85	Specify with <i>high-range pneumatic seat-height adjustment</i> .
Coat Hanger	• Coat hanger	+\$ 45	Specify with <i>coat hanger</i> .
Headrest	• Headrest	+\$247	Specify with <i>headrest</i> .
Lumbar	• Fixed lumbar support	-\$ 84	Specify with <i>fixed lumbar height</i> .
Casters	• Soft, dark grey treaded, dual-wheel roll-control casters for use on hard floors	+\$ 36	Specify with <i>soft roll-control casters</i> .
Glides	• Glides: plastic	+\$ 36	Specify with <i>glides</i> .
CarbonNeutral Product	• CarbonNeutral product certification	+\$ 35	Add suffix CN to the end of the style number.

Tip: Coat hanger option is not available on chairs with headrest.

Tip: Plastic shell on headrest is available in black only.
► Detailed dimensions, page 98

Specification Information

Style Number	U.S. Base Price
465A300	\$1794



Think 465 Series

 **For Canadian Pricing**
Multiply U.S. Price by the Canadian price factor.
► See page 1 for details.

Think 465 Series Work Chair

Upholstered Back with Upholstery on Seat



	Standard Includes	Required to Specify
▶ Need help? Product details, page 88	<ul style="list-style-type: none"> 5" pneumatic seat-height adjustment (16½"–21½") Passive seat edge angle Frame, seat shell, and five-arm plastic base: black 2½" seat depth adjustment Rectilinear height-, width-, pivot-, and depth-adjustable arms Adjustable lumbar Standard upholstery design: fabric price group 1 2½"-diameter, hard-composition, dual-wheel casters: black 	<ol style="list-style-type: none"> Style number Color scheme: monochromatic, contrasting, or Lux (see below under Required Selections) Finish color for frame, base, and arm retainer Fabric color number for upholstery on seat and back Outer back cover (see below under Required Selections) Options, if selected (see below) <p>▶ See <i>Surface Materials</i>, page 634.</p>

	Required Selections	U.S. Price	Required to Specify
Color Scheme/ Frame Package	Monochromatic		
	<ul style="list-style-type: none"> Black Merle Platinum Solid Platinum Metallic Seagull 	<ul style="list-style-type: none"> No cost +\$ 68 +\$ 68 +\$ 68 +\$ 68 	<ul style="list-style-type: none"> Specify with 6205 Black. Specify with 7360 Merle. Specify with 7190 Platinum Solid. Specify with 4799 Platinum Metallic. Specify with 7243 Seagull.
	Contrasting		
	<ul style="list-style-type: none"> Platinum Metallic Seagull 	<ul style="list-style-type: none"> +\$ 68 +\$ 68 	<ul style="list-style-type: none"> Specify with 4799 Platinum. Specify with 7243 Seagull.
	Lux		
	<ul style="list-style-type: none"> Frame, arms, and base Arms and base Base only 	<ul style="list-style-type: none"> See below See below See below 	<ul style="list-style-type: none"> Specify with Lux application: frame, arms, and base. Specify with Lux application: arms and base. Specify with Lux application: base.
Outer Back Cover	<ul style="list-style-type: none"> No fabric back cover Fabric back cover 	<ul style="list-style-type: none"> No cost +\$ 68 	<ul style="list-style-type: none"> Specify with no fabric back cover. Specify with fabric back cover.

	Options	U.S. Price	Required to Specify	
Surface Materials	Upholstery on seat and back			
	<ul style="list-style-type: none"> Fabric price group 1 Fabric price group 2 Fabric price group 3 Fabric price group 4 Fabric price group 5 Fabric price group 6 Fabric price group 7 Fabric price group 8 Fabric price group 9 Fabric price group 10 Steelcase leather upholstery Select Surfaces leather price group 1 Elmosoft leather upholstery Select Surfaces leather price group 2 Customer's Own Material (COM) Customer's Own Leather (COL) 	<ul style="list-style-type: none"> No cost +\$ 33 +\$ 72 +\$ 99 +\$123 +\$154 +\$176 +\$223 +\$273 +\$313 +\$488 +\$488 +\$566 +\$566 No cost No cost 	<ul style="list-style-type: none"> Specify fabric color number. Specify fabric color number. Specify fabric color number. Specify fabric color number. Specify fabric color number. Specify fabric color number. Specify fabric color number. Specify fabric color number. Specify fabric color number. Specify fabric color number. Specify leather color number. ▶ See <i>Surface Materials Reference Manual</i>. Specify Elmosoft leather color number. ▶ See <i>Surface Materials Reference Manual</i>. ▶ See <i>Surface Materials Reference Manual</i>. ▶ See <i>Surface Materials Reference Manual</i>. 	
	Contrasting			
	<ul style="list-style-type: none"> Contrasting fabrics 	<ul style="list-style-type: none"> +\$ 46 	<ul style="list-style-type: none"> Specify with contrasting. 	

▶ Options, continued on next page



For Canadian Pricing

Multiply U.S. Price by the Canadian price factor.

▶ See page 1 for details.

► Options, continued from previous page

Options	U.S. Price	Required to Specify
Surface Materials, continued		
Upholstery on seat		
• Fabric price group 1	No cost	Specify fabric color number.
• Fabric price group 2	+\$ 21	Specify fabric color number.
• Fabric price group 3	+\$ 37	Specify fabric color number.
• Fabric price group 4	+\$ 51	Specify fabric color number.
• Fabric price group 5	+\$ 62	Specify fabric color number.
• Fabric price group 6	+\$ 78	Specify fabric color number.
• Fabric price group 7	+\$ 92	Specify fabric color number.
• Fabric price group 8	+\$112	Specify fabric color number.
• Fabric price group 9	+\$137	Specify fabric color number.
• Fabric price group 10	+\$159	Specify fabric color number.
• Steelcase leather upholstery	+\$250	Specify leather color number.
• Select Surfaces leather price group 1	+\$250	► See <i>Surface Materials Reference Manual</i> .
• Elmosoft leather upholstery	+\$287	Specify Elmosoft leather color number.
• Select Surfaces leather price group 2	+\$287	► See <i>Surface Materials Reference Manual</i> .
• Customer's Own Material (COM)	No cost	► See <i>Surface Materials Reference Manual</i> .
Upholstery on back		
• Fabric price group 1	No cost	Specify fabric color number.
• Fabric price group 2	+\$ 21	Specify fabric color number.
• Fabric price group 3	+\$ 37	Specify fabric color number.
• Fabric price group 4	+\$ 51	Specify fabric color number.
• Fabric price group 5	+\$ 62	Specify fabric color number.
• Fabric price group 6	+\$ 78	Specify fabric color number.
• Fabric price group 7	+\$ 92	Specify fabric color number.
• Fabric price group 8	+\$112	Specify fabric color number.
• Fabric price group 9	+\$137	Specify fabric color number.
• Fabric price group 10	+\$159	Specify fabric color number.
• Steelcase leather upholstery	+\$250	Specify leather color number.
• Select Surfaces leather price group 1	+\$250	► See <i>Surface Materials Reference Manual</i> .
• Elmosoft leather upholstery	+\$287	Specify Elmosoft leather color number.
• Select Surfaces leather price group 2	+\$287	► See <i>Surface Materials Reference Manual</i> .
• Customer's Own Material (COM)	No cost	► See <i>Surface Materials Reference Manual</i> .
• Customer's Own Leather (COL)	No cost	► See <i>Surface Materials Reference Manual</i> .
Upholstery on optional back cover		
• Fabric price group 1	No cost	Specify fabric color number.
• Fabric price group 2	+\$ 19	Specify fabric color number.
• Fabric price group 3	+\$ 33	Specify fabric color number.
• Fabric price group 4	+\$ 46	Specify fabric color number.
• Fabric price group 5	+\$ 56	Specify fabric color number.
• Fabric price group 6	+\$ 70	Specify fabric color number.
• Fabric price group 7	+\$ 83	Specify fabric color number.
• Fabric price group 8	+\$101	Specify fabric color number.
• Fabric price group 9	+\$123	Specify fabric color number.
• Fabric price group 10	+\$143	Specify fabric color number.
• Steelcase leather upholstery	+\$225	Specify leather color number.
• Select Surfaces leather price group 1	+\$225	► See <i>Surface Materials Reference Manual</i> .
• Elmosoft leather upholstery	+\$258	Specify Elmosoft leather color number.
• Select Surfaces leather price group 2	+\$258	► See <i>Surface Materials Reference Manual</i> .
• Customer's Own Material (COM)	No cost	► See <i>Surface Materials Reference Manual</i> .
• Customer's Own Leather (COL)	No cost	► See <i>Surface Materials Reference Manual</i> .
Frame		
• Lux	+\$ 50	Specify <i>with Lux Coating</i> and select color number.
Arms		
• Lux	+\$ 40	Specify <i>with Lux Coating</i> and select color number.
Base		
• Lux	+\$ 70	Specify <i>with Lux Coating</i> and select color number.
• Polished aluminum base	+\$205	Specify <i>with aluminum base</i> .

Tip: Back cover fabric defaults to match the seat back fabric specified.



For Canadian Pricing
Multiply U.S. Price by the Canadian price factor.
► See page 1 for details.

► Options, continued on next page

Think 465 Series Work Chair, Upholstered Back with Upholstery on Seat, continued

► Options, continued from previous page

	Options	U.S. Price	Required to Specify
Surface Materials, continued	Soil-retardant treatment	+\$ 36	Specify with soil-retardant treatment.
Arms	<ul style="list-style-type: none"> • Height-adjustable arms • Fixed arms • Armless 	-\$ 72 -\$144 -\$367	Specify with height-adjustable arms. Specify with fixed arms. Specify without arms.
Seat Height	<ul style="list-style-type: none"> • 3" low-range pneumatic seat-height adjustment (15"–18") • 7" high-range pneumatic seat-height adjustment (18"–25") 	+\$ 85 +\$ 85	Specify with low-range pneumatic seat-height adjustment. Specify with high-range pneumatic seat-height adjustment.
Coat Hanger	• Coat hanger	+\$ 45	Specify with coat hanger.
Headrest	• Headrest	+\$247	Specify with headrest.
Lumbar	• Fixed lumbar support	-\$ 84	Specify with fixed lumbar height.
Casters	• Soft, dark grey treaded, dual-wheel roll-control casters for use on hard floors	+\$ 36	Specify with soft roll-control casters.
Glides	• Glides: plastic	+\$ 36	Specify with glides.
CarbonNeutral Product	• CarbonNeutral product certification	+\$ 35	Add suffix CN to the end of the style number.

Tip: Coat hanger option is not available on chairs with headrest.

Tip: Plastic shell on headrest is available in black only.

► Detailed dimensions, page 98

Specification Information	
Style Number	U.S. Base Price
465A000	\$1709



For Canadian Pricing

Multiply U.S. Price by the Canadian price factor.

► See page 1 for details.

► Options, continued from previous page

	Options	U.S. Price	Required to Specify
Surface Materials, continued	Contrasting upholstery on back		
	• Fabric price group 1	No cost	Specify fabric color number.
	• Fabric price group 2	+\$ 21	Specify fabric color number.
	• Fabric price group 3	+\$ 37	Specify fabric color number.
	• Fabric price group 4	+\$ 51	Specify fabric color number.
	• Fabric price group 5	+\$ 62	Specify fabric color number.
	• Fabric price group 6	+\$ 78	Specify fabric color number.
	• Fabric price group 7	+\$ 92	Specify fabric color number.
	• Fabric price group 8	+\$112	Specify fabric color number.
	• Fabric price group 9	+\$137	Specify fabric color number.
	• Fabric price group 10	+\$159	Specify fabric color number.
	• Customer's Own Material (COM)	No cost	► See <i>Surface Materials Reference Manual</i> .
	Upholstery on optional back cover		
	• Fabric price group 1	No cost	Specify fabric color number.
	• Fabric price group 2	+\$ 19	Specify fabric color number.
	• Fabric price group 3	+\$ 33	Specify fabric color number.
	• Fabric price group 4	+\$ 46	Specify fabric color number.
	• Fabric price group 5	+\$ 56	Specify fabric color number.
	• Fabric price group 6	+\$ 70	Specify fabric color number.
	• Fabric price group 7	+\$ 83	Specify fabric color number.
	• Fabric price group 8	+\$101	Specify fabric color number.
	• Fabric price group 9	+\$123	Specify fabric color number.
	• Fabric price group 10	+\$143	Specify fabric color number.
	• Customer's Own Material (COM)	No cost	► See <i>Surface Materials Reference Manual</i> .
	Frame		
	• Lux	+\$ 50	Specify <i>with Lux Coating</i> and select color number.
	Arms		
	• Lux	+\$ 40	Specify <i>with Lux Coating</i> and select color number.
	Base		
	• Lux	+\$ 70	Specify <i>with Lux Coating</i> and select color number.
	• Polished aluminum base	+\$205	Specify <i>with aluminum base</i> .
	Soil-retardant treatment	+\$ 36	Specify <i>with soil-retardant treatment</i> .
	Arms		
	• Height-adjustable arms	-\$ 72	Specify <i>with height-adjustable arms</i> .
	• Fixed arms	-\$144	Specify <i>with fixed arms</i> .
	• Armless	-\$367	Specify <i>without arms</i> .
	Seat Height		
	• 3" low-range pneumatic seat-height adjustment (15"–18")	+\$ 85	Specify <i>with low-range pneumatic seat-height adjustment</i> .
	• 7" high-range pneumatic seat-height adjustment (18"–25")	+\$ 85	Specify <i>with high-range pneumatic seat-height adjustment</i> .
	Coat Hanger		
	• Coat hanger	+\$ 45	Specify <i>with coat hanger</i> .
	Headrest		
	• Headrest	+\$247	Specify <i>with headrest</i> .
	Lumbar		
	• Fixed lumbar support	-\$84	Specify <i>with fixed lumbar height</i> .

Tip: Back cover fabric defaults to match the seat back fabric specified.

Tip: Plastic shell on headrest is available in black only.

Tip: Headrest and coat hanger can not be attached to a Think chair simultaneously.

► Options, continued on next page

**For Canadian Pricing**

Multiply U.S. Price by the Canadian price factor.

► See page 1 for details.

Think 465 Series Work Chair, Quilted Upholstered Back with Upholstery on Seat, continued

► Options, on previous page

	Options	U.S. Price	Required to Specify
Casters	• Soft, dark grey treaded, dual-wheel roll-control casters for use on hard floors	+\$36	Specify <i>with soft roll-control casters</i> .
Glides	• Glides: plastic	+\$36	Specify <i>with glides</i> .

Specification Information

Style Number	U.S. Base Price
465A000Q	\$1735



► Detailed dimensions, page 98



For Canadian Pricing

Multiply U.S. Price by the Canadian price factor.

► See page 1 for details.

Think 465 Series Stool

3D Knit Back with Upholstery on Seat



	Standard Includes	Required to Specify
▶ Need help? Product details, page 88	<ul style="list-style-type: none"> • 10" pneumatic seat-height adjustment (22½"-32½") • Passive seat edge angle • Frame, seat shell, and five-arm base: black • 2½" seat depth adjustment • Rectilinear height-, width-, pivot-, and depth-adjustable arms • Column and adjustable foot ring: black • Adjustable lumbar • 3D Knit on back • Standard upholstery design on seat: fabric price group 1 • 2½"-diameter, hard-composition, dual-wheel casters: black 	<ol style="list-style-type: none"> 1 Style number 2 Color scheme: monochromatic, contrasting, or Lux (see below under Required Selections) 3 Finish color for frame, base, and arm retainer 4 3D Knit color for back 5 Fabric color number for upholstery on seat 6 Options, if selected (see below) <p>▶ See <i>Surface Materials</i>, page 634.</p>

	Required Selections	U.S. Price	Required to Specify
Color Scheme/ Frame Package	Monochromatic		
	<ul style="list-style-type: none"> • Black • Merle • Platinum Solid • Platinum Metallic • Seagull 	<ul style="list-style-type: none"> No cost +\$ 68 +\$ 68 +\$ 68 +\$ 68 	<ul style="list-style-type: none"> Specify with 6205 Black. Specify with 7360 Merle. Specify with 7190 Platinum Solid. Specify with 4799 Platinum Metallic. Specify with 7243 Seagull.
	Contrasting		
	<ul style="list-style-type: none"> • Platinum Metallic • Seagull 	<ul style="list-style-type: none"> +\$ 68 +\$ 68 	<ul style="list-style-type: none"> Specify with 4799 Platinum. Specify with 7243 Seagull.
	Lux		
	<ul style="list-style-type: none"> • Frame, arms, and base • Arms and base • Base only 	<ul style="list-style-type: none"> See below See below See below 	<ul style="list-style-type: none"> Specify with Lux application: frame, arms, and base. Specify with Lux application: arms and base. Specify with Lux application: base.

	Options	U.S. Price	Required to Specify	
Surface Materials	Upholstery on seat			
	<ul style="list-style-type: none"> • Fabric price group 1 • Fabric price group 2 • Fabric price group 3 • Fabric price group 4 • Fabric price group 5 • Fabric price group 6 • Fabric price group 7 • Fabric price group 8 • Fabric price group 9 • Fabric price group 10 • Steelcase leather upholstery • Select Surfaces leather price group 1 • Elmosoft leather upholstery • Select Surfaces leather price group 2 • Customer's Own Material (COM) 	<ul style="list-style-type: none"> No cost +\$ 12 +\$ 35 +\$ 48 +\$ 61 +\$ 76 +\$ 84 +\$111 +\$136 +\$154 +\$238 +\$238 +\$279 +\$279 No cost 	<ul style="list-style-type: none"> Specify fabric color number. Specify fabric color number. Specify fabric color number. Specify fabric color number. Specify fabric color number. Specify fabric color number. Specify fabric color number. Specify fabric color number. Specify fabric color number. Specify fabric color number. Specify leather color number. ▶ See <i>Surface Materials Reference Manual</i>. Specify Elmosoft leather color number. ▶ See <i>Surface Materials Reference Manual</i>. ▶ See <i>Surface Materials Reference Manual</i>. 	
	Frame			
	<ul style="list-style-type: none"> • Lux 	<ul style="list-style-type: none"> +\$ 50 	<ul style="list-style-type: none"> Specify with Lux Coating and select color number. 	
	Arms			
	<ul style="list-style-type: none"> • Lux 	<ul style="list-style-type: none"> +\$ 40 	<ul style="list-style-type: none"> Specify with Lux Coating and select color number. 	
	Base			
	<ul style="list-style-type: none"> • Lux • Polished aluminum base 	<ul style="list-style-type: none"> +\$ 70 +\$205 	<ul style="list-style-type: none"> Specify with Lux Coating and select color number. Specify with aluminum base. 	

▶ Detailed dimensions, page 98

 **For Canadian Pricing**
 Multiply U.S. Price by the Canadian price factor.
 ▶ See page 1 for details.

▶ Options, continued on next page

► Options, continued from previous page

Options		U.S. Price	Required to Specify
Surface Materials, continued	Soil-retardant treatment	+\$ 36	Specify with soil-retardant treatment.
	Arms	<ul style="list-style-type: none"> • Height-adjustable arms -\$ 72 • Fixed arms -\$144 • Armless -\$367 	Specify with height-adjustable arms. Specify with fixed arms. Specify without arms.
Lumbar	<ul style="list-style-type: none"> • Fixed lumbar support 	-\$ 84	Specify with fixed lumbar height.
Casters	<ul style="list-style-type: none"> • Soft, dark grey treaded, dual-wheel roll-control casters for use on hard floors 	+\$ 36	Specify with soft roll-control casters.
Glides	<ul style="list-style-type: none"> • Glides: plastic 	+\$ 36	Specify with glides.
CarbonNeutral Product	<ul style="list-style-type: none"> • CarbonNeutral product certification 	+\$ 35	Add suffix CN to the end of the style number.

Specification Information

Style Number	U.S. Base Price
465B300	\$2144



Think 465 Series

 **For Canadian Pricing**
 Multiply U.S. Price by the Canadian price factor.
 ► See page 1 for details.

Think 465 Series Stool

Upholstered Back with Upholstery on Seat



	Standard Includes	Required to Specify
▶ Need help? Product details, page 88	<ul style="list-style-type: none"> • 10" pneumatic seat-height adjustment (22½"-32½") • Passive seat edge angle • Frame, seat shell, and five-arm base: black • 2½" seat depth adjustment • Rectilinear height-, width-, pivot-, and depth-adjustable arms • Column and adjustable foot ring: black • Adjustable lumbar • Standard upholstery design: fabric price group 1 • 2½"-diameter, hard-composition, dual-wheel casters: black 	<ol style="list-style-type: none"> 1 Style number 2 Color scheme: monochromatic, contrasting, or Lux (see below under Required Selections) 3 Finish color for frame, base, and arm retainer 4 Fabric color number for upholstery on seat and back 5 Outer back cover (see below under Required Selections) 6 Options, if selected (see below) <p>▶ See <i>Surface Materials</i>, page 634.</p>

	Required Selections	U.S. Price	Required to Specify
Color Scheme/ Frame Package	Monochromatic		
	<ul style="list-style-type: none"> • Black • Merle • Platinum Solid • Platinum Metallic • Seagull 	No cost +\$ 68 +\$ 68 +\$ 68 +\$ 68	Specify with 6205 Black. Specify with 7360 Merle. Specify with 7190 Platinum Solid. Specify with 4799 Platinum Metallic. Specify with 7243 Seagull.
	Contrasting		
	<ul style="list-style-type: none"> • Platinum Metallic • Seagull 	+\$ 68 +\$ 68	Specify with 4799 Platinum. Specify with 7243 Seagull.
	Lux		
	<ul style="list-style-type: none"> • Frame, arms, and base • Arms and base • Base only 	See below See below See below	Specify with Lux application: frame, arms, and base. Specify with Lux application: arms and base. Specify with Lux application: base.
Outer Back Cover	<ul style="list-style-type: none"> • No fabric back cover • Fabric back cover 	See below +\$ 65	Specify with no fabric back cover. Specify with fabric back cover.

	Options	U.S. Price	Required to Specify
Surface Materials	Upholstery on seat and back		
	<ul style="list-style-type: none"> • Fabric price group 1 • Fabric price group 2 • Fabric price group 3 • Fabric price group 4 • Fabric price group 5 • Fabric price group 6 • Fabric price group 7 • Fabric price group 8 • Fabric price group 9 • Fabric price group 10 • Steelcase leather upholstery • Select Surfaces leather price group 1 • Elmosoft leather upholstery • Select Surfaces leather price group 2 • Customer's Own Material (COM) • Customer's Own Leather (COL) 	No cost +\$ 33 +\$ 72 +\$ 99 +\$123 +\$154 +\$176 +\$223 +\$273 +\$313 +\$488 +\$488 +\$566 +\$566 No cost No cost	Specify fabric color number. Specify fabric color number. Specify fabric color number. Specify fabric color number. Specify fabric color number. Specify fabric color number. Specify fabric color number. Specify fabric color number. Specify fabric color number. Specify fabric color number. Specify leather color number. ▶ See <i>Surface Materials Reference Manual</i> . Specify Elmosoft leather color number. ▶ See <i>Surface Materials Reference Manual</i> . ▶ See <i>Surface Materials Reference Manual</i> . ▶ See <i>Surface Materials Reference Manual</i> .
	Contrasting		
	<ul style="list-style-type: none"> • Contrasting fabrics 	+\$ 46	Specify with contrasting.

▶ Detailed dimensions, page 98

▶ Options, continued on next page



For Canadian Pricing

Multiply U.S. Price by the Canadian price factor.

▶ See page 1 for details.

► Options, continued from previous page

Options	U.S. Price	Required to Specify
Surface Materials, Continued		
Upholstery on seat		
• Fabric price group 1	No cost	Specify fabric color number.
• Fabric price group 2	+\$ 12	Specify fabric color number.
• Fabric price group 3	+\$ 35	Specify fabric color number.
• Fabric price group 4	+\$ 48	Specify fabric color number.
• Fabric price group 5	+\$ 61	Specify fabric color number.
• Fabric price group 6	+\$ 76	Specify fabric color number.
• Fabric price group 7	+\$ 84	Specify fabric color number.
• Fabric price group 8	+\$111	Specify fabric color number.
• Fabric price group 9	+\$136	Specify fabric color number.
• Fabric price group 10	+\$154	Specify fabric color number.
• Steelcase leather upholstery	+\$238	Specify leather color number.
• Select Surfaces leather price group 1	+\$238	► See <i>Surface Materials Reference Manual</i> .
• Elmosoft leather upholstery	+\$279	Specify Elmosoft leather color number.
• Select Surfaces leather price group 2	+\$279	► See <i>Surface Materials Reference Manual</i> .
• Customer's Own Material (COM)	No cost	► See <i>Surface Materials Reference Manual</i> .
Upholstery on back		
• Fabric price group 1	No cost	Specify fabric color number.
• Fabric price group 2	+\$ 21	Specify fabric color number.
• Fabric price group 3	+\$ 37	Specify fabric color number.
• Fabric price group 4	+\$ 51	Specify fabric color number.
• Fabric price group 5	+\$ 62	Specify fabric color number.
• Fabric price group 6	+\$ 78	Specify fabric color number.
• Fabric price group 7	+\$ 92	Specify fabric color number.
• Fabric price group 8	+\$112	Specify fabric color number.
• Fabric price group 9	+\$137	Specify fabric color number.
• Fabric price group 10	+\$159	Specify fabric color number.
• Steelcase leather upholstery	+\$250	Specify leather color number.
• Select Surfaces leather price group 1	+\$250	► See <i>Surface Materials Reference Manual</i> .
• Elmosoft leather upholstery	+\$287	Specify Elmosoft leather color number.
• Select Surfaces leather price group 2	+\$287	► See <i>Surface Materials Reference Manual</i> .
• Customer's Own Material (COM)	No cost	► See <i>Surface Materials Reference Manual</i> .
• Customer's Own Leather (COL)	No cost	► See <i>Surface Materials Reference Manual</i> .
Upholstery on optional back cover		
• Fabric price group 1	No cost	Specify fabric color number.
• Fabric price group 2	+\$ 19	Specify fabric color number.
• Fabric price group 3	+\$ 33	Specify fabric color number.
• Fabric price group 4	+\$ 46	Specify fabric color number.
• Fabric price group 5	+\$ 56	Specify fabric color number.
• Fabric price group 6	+\$ 70	Specify fabric color number.
• Fabric price group 7	+\$ 83	Specify fabric color number.
• Fabric price group 8	+\$101	Specify fabric color number.
• Fabric price group 9	+\$123	Specify fabric color number.
• Fabric price group 10	+\$143	Specify fabric color number.
• Steelcase leather upholstery	+\$225	Specify leather color number.
• Select Surfaces leather price group 1	+\$225	► See <i>Surface Materials Reference Manual</i> .
• Elmosoft leather upholstery	+\$258	Specify Elmosoft leather color number.
• Select Surfaces leather price group 2	+\$258	► See <i>Surface Materials Reference Manual</i> .
• Customer's Own Material (COM)	No cost	► See <i>Surface Materials Reference Manual</i> .
• Customer's Own Leather (COL)	No cost	► See <i>Surface Materials Reference Manual</i> .
Frame		
• Lux	+\$ 50	Specify with <i>Lux Coating</i> and select color number.
Arms		
• Lux	+\$ 40	Specify with <i>Lux Coating</i> and select color number.

Tip: Back cover fabric defaults to match the seat back fabric specified.

**For Canadian Pricing**

Multiply U.S. Price by the Canadian price factor.

► See page 1 for details.

Think 465 Series Stool, Upholstery on Back and Seat, continued

► Options, on previous page

	Options	U.S. Price	Required to Specify
Surface Materials, continued	Base		
	• Lux	+\$ 70	Specify with <i>Lux Coating</i> and select color number.
	• Polished aluminum base	+\$205	Specify with <i>aluminum base</i> .
	Soil-retardant treatment	+\$ 36	Specify with <i>soil-retardant treatment</i> .
Arms	• Height-adjustable arms	-\$ 72	Specify with <i>height-adjustable arms</i> .
	• Fixed arms	-\$144	Specify with <i>fixed arms</i> .
	• Armless	-\$367	Specify <i>without arms</i> .
Lumbar	• Fixed lumbar support	-\$ 84	Specify with <i>fixed lumbar height</i> .
Casters	• Soft, dark grey treaded, dual-wheel roll-control casters for use on hard floors	+\$ 36	Specify with <i>soft roll-control casters</i> .
Glides	• Glides: plastic	+\$ 36	Specify with <i>glides</i> .
CarbonNeutral Product	• CarbonNeutral product certification	+\$ 35	Add suffix CN to the end of the style number.

► Specification Information, on next page

Specification Information	
• Style Number	• U.S. Base Price
465B000	\$2059



► Detailed dimensions, page 98



For Canadian Pricing

Multiply U.S. Price by the Canadian price factor.

► See page 1 for details.

► Options, continued from previous page

	Options	U.S. Price	Required to Specify
Surface Materials, continued	Contrasting upholstery on back		
	• Fabric price group 1	No cost	Specify fabric color number.
	• Fabric price group 2	+\$ 21	Specify fabric color number.
	• Fabric price group 3	+\$ 37	Specify fabric color number.
	• Fabric price group 4	+\$ 51	Specify fabric color number.
	• Fabric price group 5	+\$ 62	Specify fabric color number.
	• Fabric price group 6	+\$ 78	Specify fabric color number.
	• Fabric price group 7	+\$ 92	Specify fabric color number.
	• Fabric price group 8	+\$112	Specify fabric color number.
	• Fabric price group 9	+\$137	Specify fabric color number.
	• Fabric price group 10	+\$159	Specify fabric color number.
	• Customer's Own Material (COM)	No cost	► See <i>Surface Materials Reference Manual</i> .
		Upholstery on optional back cover	
	• Fabric price group 1	No cost	Specify fabric color number.
	• Fabric price group 2	+\$ 19	Specify fabric color number.
	• Fabric price group 3	+\$ 33	Specify fabric color number.
	• Fabric price group 4	+\$ 46	Specify fabric color number.
	• Fabric price group 5	+\$ 56	Specify fabric color number.
	• Fabric price group 6	+\$ 70	Specify fabric color number.
	• Fabric price group 7	+\$ 83	Specify fabric color number.
	• Fabric price group 8	+\$101	Specify fabric color number.
	• Fabric price group 9	+\$123	Specify fabric color number.
	• Fabric price group 10	+\$143	Specify fabric color number.
	• Customer's Own Material (COM)	No cost	► See <i>Surface Materials Reference Manual</i> .
	Frame		
	• Lux	+\$ 50	Specify <i>with Lux Coating</i> and select color number.
	Arms		
	• Lux	+\$ 40	Specify <i>with Lux Coating</i> and select color number.
	Base		
	• Lux	+\$ 70	Specify <i>with Lux Coating</i> and select color number.
	• Polished aluminum base	+\$205	Specify <i>with aluminum base</i> .
	Soil-retardant treatment		
		+\$ 36	Specify <i>with soil-retardant treatment</i> .
Arms	• Height-adjustable arms	-\$ 72	Specify <i>with height-adjustable arms</i> .
	• Fixed arms	-\$144	Specify <i>with fixed arms</i> .
	• Armless	-\$367	Specify <i>without arms</i> .
Lumbar	• Fixed lumbar support	-\$ 84	Specify <i>with fixed lumbar height</i> .
Casters	• Soft, dark grey treaded, dual-wheel roll-control casters for use on hard floors	+\$ 36	Specify <i>with soft roll-control casters</i> .
Glides	• Glides: plastic	+\$ 36	Specify <i>with glides</i> .

Tip: Back cover fabric defaults to match the seat back fabric specified.

Think 465 Series

Specification Information	
• Style Number	• U.S. Base Price
465B000Q	\$2085



► Detailed dimensions, page 98



Understanding and Specifying Amia 482 Series Work Chairs

Product Details

Amia 482 Series	120
Amia Upholstery	124
Dimensions	126

Specifying

Work Chairs

Sewn Leather Upholstery on Seat, Back, and Arm Caps	128
Upholstery on Seat and Back	130
3D Knit on Back with Upholstery on Seat	134
Air Back with 3D Microknit and Upholstery on Seat	136
Air Back with Upholstery on Seat	138

Stools

Upholstery on Seat and Back	140
3D Knit on Back with Upholstery on Seat	144
Air Back with 3D Microknit and Upholstery on Seat	146
Air Back with Upholstery on Seat	148

Work Chairs

Highly adjustable task seating offers maximum personalization for fit and comfort for a range of duration and use. By making a series of simple adjustments, you can customize the chair to your body, preferences, and tasks. These chairs provide continuous, stable, comfort, and can be quickly adjusted to support you in upright, and reclining work postures.

- Gesture 442 Series
- Leap 462 Series
- Think 465 Series
- Amia 482 Series
- Reply 466 Series

Adjustability Features

▶ See page 26 for a comparison to other chairs. **Amia 482 Series**

Mechanisms

Syncrotilt ●

Seat Adjustments

Pneumatic height ●

Passive seat edge angle ●

Seat depth ●

Back Adjustments

Lumbar height ●

Back tension ●

Back lock ●

Arm Adjustments

Arm height ●

Arm width ●

Arm pivot ●

Arm depth ●

Other Features

Foot ring height (stool) ●

Amia 482 Series



Now available as a CarbonNeutral product, making sure our commitment to a more sustainable future helps yours too.

Amia effortlessly combines timeless, sophisticated design with high-performing ergonomics at an attainable price point. Amia can be personalized with different back designs expressed through upholstery, 3D Microknit, and plastic Air Back design combinations.

Outer back and outer seat are plastic. Fully upholstered outer back is available.

LiveLumbar system offers a dialed in spring force in the lumbar region that actively supports the lower back.

Arm height can adjust independently within a 4" range to help relieve upper back and shoulder fatigue.

Seat depth adjusts within a 3" range.

Five-star base is standard.

Casters have hard, dual-wheels that roll smoothly on carpets. They are 2 1/2" for increased mobility. Soft, dark grey treaded, dual-wheel roll-control casters are available for use on hard floors or mats. Stools are standard with 2" hard casters. Soft casters are available as an option.

Tip: Do not roll the chair across asphalt during installation as this may damage the casters.

Air LiveBack technology works through an innovative, geometric plastic design that flexes in two dimensions as the user moves to create a responsive, personalized comfort and fit.

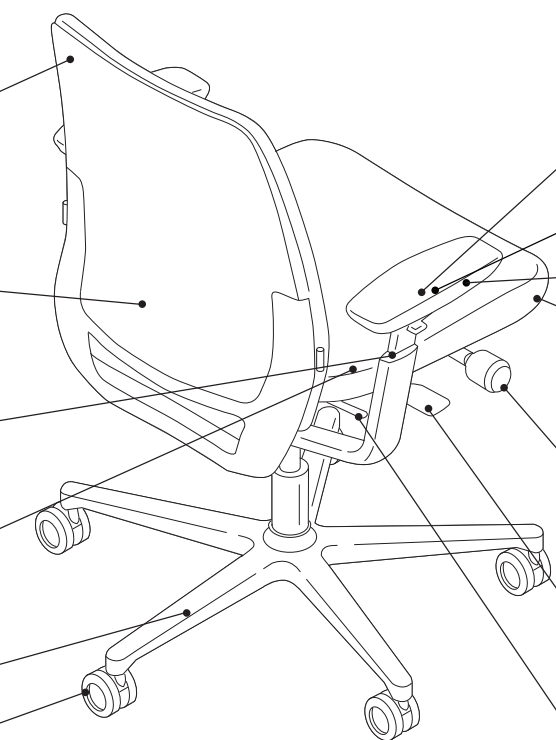

Arm depth can be adjusted approximately 3", enabling individuals to get closer to their work.

Arm width can adjust 4 1/2" overall to provide forearm support.

Arm caps can pivot 30° in and out to accommodate individual user preferences.

Passive seat edge angle allows the front edge of the seat to flex 1 1/2", relieving pressure behind the thighs.

Back tension accommodates a broader range of users by allowing user to change the rate of increase, or decrease, in force as the user reclines.

Seat height adjusts within a 5" range with a pneumatic adjustment mechanism. Stools have an 8" range.

Upright back lock allows the user to lock the back in a full upright position, or release it for full-tilt motion.

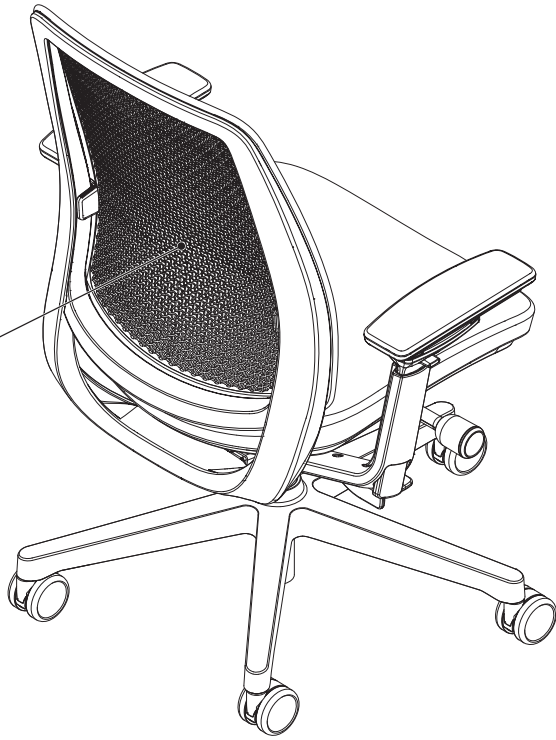

Product Details

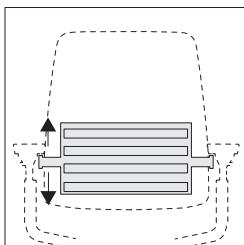

LiveLumbar system allows the user to experience continuous back support with dialed in spring force that can be adjusted to match the user's anatomy. Available on standard Amia chairs.

Integrated LiveBack automatically creates flexibility and movement in the backrest to ensure dynamic back support as you recline. A height adjustable lumbar is also available on the Amia Air with 3D Microknit.

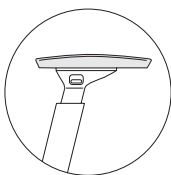

Rectilinear arms with soft caps are standard.

Models are standard with adjustable seats that include seat depth and passive seat edge angle.

Adjustability instructions are included with every chair. Instructions can also be found at www.steelcase.com

Cartoned request on your dealer purchase order means Amia chairs will ship knocked down with the chair back separated from the rest of the chair. This allows for shipment in a smaller carton. Assembly by a qualified dealer installer is required. Assembly instructions are included. This does not apply to Amia stools.

Uncartoned request on your dealer purchase order means Amia chairs will ship fully assembled.

Product Weight

- Amia (plastic back): 48.4 pounds
- Amia Air: 46.4 pounds



CarbonNeutral.com

CarbonNeutral product

Amia helps organizations achieve their carbon emissions goals. Add **CN** to the end of the style number to specify Amia with CarbonNeutral product certification.

Adjustment Features

Seat Adjustments

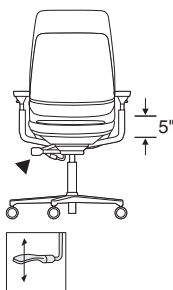

Seat height adjusts pneumatically. To lower, hold handle up while seated. To raise, hold handle up and keep your weight off the chair. Range of adjustability is 5" from 16"H to 21"H, and is standard on work chairs. A lower range of adjustability (15"H to 19"H) is available as an option. A higher range of adjustability (17"H to 24"H) is available as an option. An 8" range of adjustability (23"H to 31"H) is available on stools.

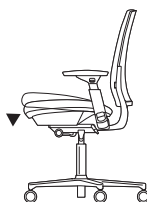

Passive seat edge angle flexes, relieving pressure under the user's thighs. The front flexes 1½". This feature is standard on all work chairs and stools.

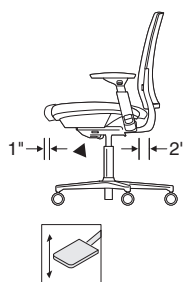

Seat depth adjusts 3" (15½"–18½") by pulling handle up. Slide seat forward or back to accommodate various leg lengths. Release handle to lock. This feature is standard on work chairs and stools.

Back Adjustments

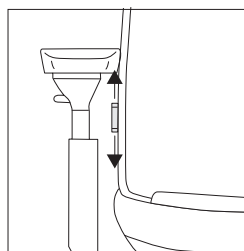

Lumbar height adjusts ¾" (6¼" to 10" from seat) by grabbing exposed tabs and sliding the lumbar support up or down. This feature is standard on work chairs and stools.

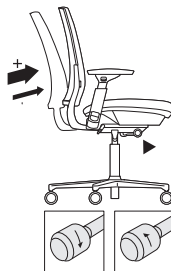

Back tension adjusts by turning knob forward to increase back tension, backward to decrease back tension. This feature is standard on work chairs and stools.

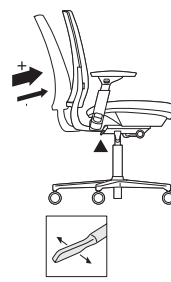

Upright back lock. To release, lean forward and pull toward back. To lock, lean forward and push toward front.

Arm Adjustments

Rectilinear height-, width-, pivot-, and depth-adjustable arms come standard on all arm models of chairs and stools.

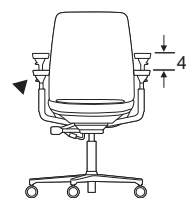

Arm height adjusts independently within a range of 4" (7"–11" from the seat). Push button on outside and under arm cap in while moving arms up or down. Releasing buttons locks arms in position.

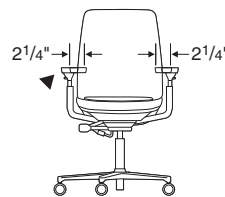

Arm width adjusts 2¼" each independently on chairs with this option. Grasp arm and move in or out.

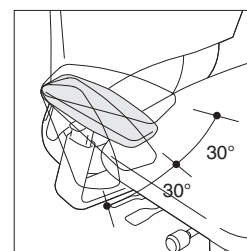

Arms pivot independently 30° inward and outward. Grasp arm and push front to left or right.

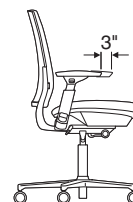

Arm depth adjusts approximately 3" to enable user to get closer to worksurface.

Other Features

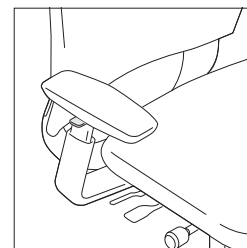

Height-only adjustable arm is also available and adjusts 4".



Armless models are also available.

Amia 482 Series, continued

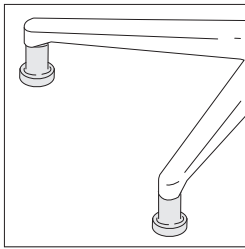

Glides are available as an option. Glides ship with chair or stool for field installation and maintain same height as casters.

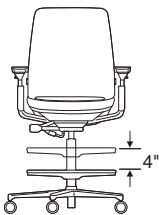

Foot ring height on stools adjusts by first lifting ring and rotating it counter-clockwise to unlock. Then raise or lower ring up to 4" to desired position before rotating it clockwise to lock. The foot ring has a diameter of 20".

Soft-wheel casters for hard floors are available for specific applications.

Surface Materials

▶ See surface materials on page 634 for specific availability or refer to the *Surface Materials Reference Manual* for further information.

Upholstery

- Fabric
- Fabric with soil-retardant treatment (option)
- 3D Knit (back only)
- 3D Microknit (Amia back only)
- Leather
- Elmosoft leather
- Select Surfaces leather
- Vinyl
- Customer's Own Leather (COL)
- Select Customer's Own Material/Vinyl (COM)

Amia hard components

- Outer back frame, arm, holsters, and base
- 6205 Black plastic (Black color scheme)
 - 7250 Sterling dark paint (Merle color scheme)
 - 4799 Platinum metallic paint (Platinum color scheme)
 - 7243 Seagull paint (Seagull color scheme)

- Outer back shell and outer seat shell
- 6205 Black plastic (Black color scheme)
 - 6527 Merle Plastic (Merle color scheme)
 - 6249 Platinum Plastic (Platinum color scheme)
 - 6053 Seagull Plastic (Seagull color scheme)

Amia Air hard components

- Outer back frame, arm, holsters, and base
- 6205 Black plastic (Black color scheme)
 - 7250 Sterling dark paint (Merle color scheme)
 - 4799 Platinum metallic paint (Platinum color scheme)
 - 7243 Seagull paint (Seagull color scheme)

- Inner back frame and lumbar, and outer seat shell
- 6205 Black plastic (Black color scheme)
 - 6527 Merle Plastic (Merle color scheme)
 - 6527 Merle Plastic (Platinum color scheme)
 - 6527 Merle Plastic (Seagull color scheme)

Outer back

- Fully upholstered

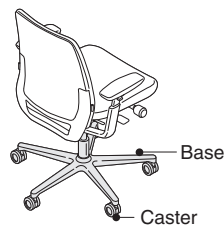

Polished aluminum base and casters are available on chairs only. Polished aluminum casters approved to 225 pounds only. Stools are not available with this base.

Arm caps

- Black
- Leather

Column and foot ring on stools

- 7207 Black only

All Steelcase seating with standard upholstery fabrics complies with requirements of the State of California Technical Bulletin 117-2013. All standard seating is labeled to be in compliance with California 117-2013.

Programs & Services

▶ See the *Surface Materials Reference Manual* for further detail about programs and services offered for seating.

The Customer's Own Material (COM) Program

offers the opportunity for customers to select fabrics that are not offered through the standard Steelcase surface materials program for use on Steelcase products. Through the COM program, Steelcase will test your materials for application on Steelcase products. Once approved, you can place your order. Steelcase will facilitate the entire ordering process and give you a production schedule. Steelcase will order the COM fabric directly from the textile manufacturer. For up-to-date information regarding fabric test results for all COM fabrics and details regarding yardage requirements for most Seating lines, visit the COM website:
• Visit www.steelcase.com

Soil retardants are treatments that provide long-term soil and stain resistance to a fabric without affecting the shade or the integrity of the fabric. The following Steelcase Textiles are available pre-treated with soil retardant. (You do not need to select the soil-retardant option for these fabrics and incur the upcharge.)

- Jacks
- Link

For information on soil retardant fabrics on Select Surfaces, please refer to the *Surface Materials Reference Manual*.

Soil-retardant treatment is available on all other seating fabrics at an additional upcharge per seating unit. To order this option, please select "Soil-Retardant Treatment" under "Optional Accessories."

For soil-retardant treatment on COMs, please select "Soil-Retardant Treatment" under "Optional Accessories." Minimums or additional yardage may be required. Please contact the vendor directly for specific information.

Soil-retardant treatment is available on all other seating fabrics at an additional upcharge per seating unit. To order this option, please select "Soil-Retardant Treatment" under "Optional Accessories."

For soil-retardant treatment on COMs, please select "Soil-Retardant Treatment" under "Optional Accessories." Minimums or additional yardage may be required. Please contact the vendor directly for specific information.

Extended lead times may be necessary for this service.

Contact your Steelcase Solutions Fulfillment Team Representative at 1.888.STEELCASE (1.888.783.3522) or send an email to lineone@steelcase.com.

Local codes may have special requirements for upholstery.

Dimensions

▶ Page 126

Resources

Printed Materials

- ▶ Amia Brochure (11-0002073)
- ▶ Amia User Guide (07-0006468)
- ▶ Amia LiveLumbar card (08-0000111)
- ▶ Innovation Seating Brochure (04-0011870)
- ▶ Alive Seating Story
- ▶ Amia Air Cut Sheet (18-0005529)

Online Resources

- ▶ Interactive User Guide available on www.steelcase.com
- ▶ Amia Model Sales Presentation DVD
- ▶ Amia Design Story video available on www.steelcase.com
- ▶ Adjustability video available on www.steelcase.com
- ▶ Product Environmental Profiles, which provide key environmental attributes and product certifications can be found by searching for Steelcase at *Origin.build*.

Color Scheme Matrix

Amia Color Scheme	Outer Back Shell	Outer Back Frame	Arm Holsters	Outer Seat Shell	Base
Black	Black plastic-6205	Black plastic-6205	Black plastic-6205	Black plastic-6205	Black plastic-6205
Merle	Merle plastic-6527	Sterling Dark paint-7250	Sterling Dark paint-7250	Merle plastic-6527	Sterling Dark paint-7250
Platinum	Platinum plastic-6249	Platinum Metallic paint-4799	Platinum Metallic paint-4799	Platinum plastic-6249	Platinum Metallic paint-4799
Seagull	Platinum plastic-6249	Seagull paint-7243	Seagull paint-7243	Platinum plastic-6249	Seagull paint-7243

Amia Air Color Scheme	Inner Back Frame and Lumbar	Outer Back Frame	Arm Holsters	Outer Seat Shell	Base
Black	Black plastic-6205	Black plastic-6205	Black plastic-6205	Black plastic-6205	Black plastic-6205
Merle	Merle plastic-6527	Sterling Dark paint-7250	Sterling Dark paint-7250	Merle plastic-6527	Sterling Dark paint-7250
Platinum	Merle plastic-6527	Platinum Metallic paint-4799	Platinum Metallic paint-4799	Merle plastic-6527	Platinum Metallic paint-4799
Seagull	Merle plastic-6527	Seagull paint-7243	Seagull paint-7243	Merle plastic-6527	Seagull paint-7243

Amia Upholstery

What Is It?

Fabric, leather, or vinyl-covered back and seat, 3D Knit back

Fabric



Back

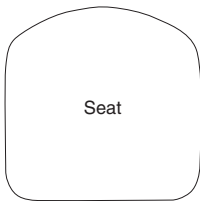

Seat

3D Knit and 3D Microknit Back



Back

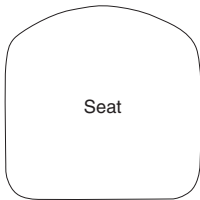

Seat

3D Knit back is made up of three layers: the 3D Knit, a solid fabric that matches the 3D Knit color, and the polyester cushion that provides exceptional comfort. The seat on these models can be specified to match the 3D Knit color or in any other material.

3D Microknit back upholstery

is applied directly over plastic air back. A Cogent: Connect fabric can be specified on the seat to color match the 3D Microknit, except seagull. The 3D Microknit can be specified to match or contrast the air back.

Leather, Vinyl, and Select Fabrics

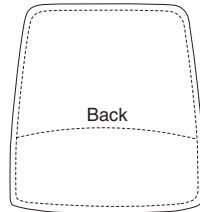

Back

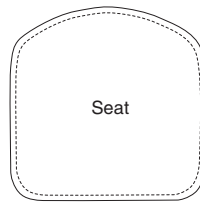

Seat

Stitched seams are included on the back cushion and seat cushion of the following:

- Leather
- Elmosoft leather
- Select Surfaces leather
- Customer's Own Leather (COL)
- Vinyl
- Select Customer's Own Material/Vinyl (COM)
- Select Fabrics

Pattern alignment at the lumbar seam cannot be guaranteed.

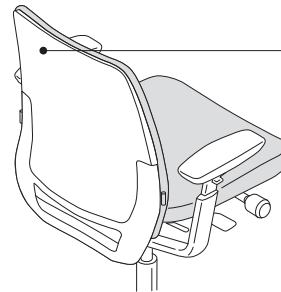
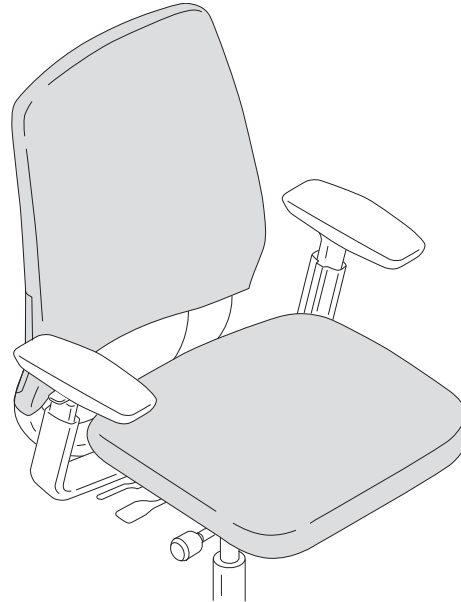

Outer back

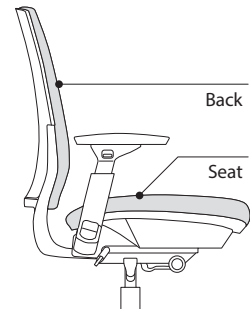

Back

Seat

Plastic outer back is fully exposed. Fully upholstered outer back is available.

Seat and back cushions can be removed and replaced if damaged.

Dimensions

Amia 482 Series

Features	Overall Depth	Width	Height	Seat Depth	Functional Seat Depth	Seat Width	Seat Height from Floor	Ring Height from Floor	Back Width
Amia 482 Series									
Work Chairs									
Adjustable Seat Depth	21¾" to 24¾"	26⅝"	37¼" to 42½"	18½"	15½" to 18½"	19⅜"	16" to 21"	N.A.	18⅞"
Stools									
Adjustable Seat Depth	21¾" to 24¾"	26⅝"	44¼" to 52½"	18½"	15½" to 18½"	19⅜"	23" to 31"	10¼" to 14¼"	18⅞"

Dimensions were measured with BIFMA CMD (chair-measuring device).

Arm width adjustment

is 15"–19½". Arm pivot adjustment adds 2¾" to the width providing a total of 12¼"–20½" of width between the arms.

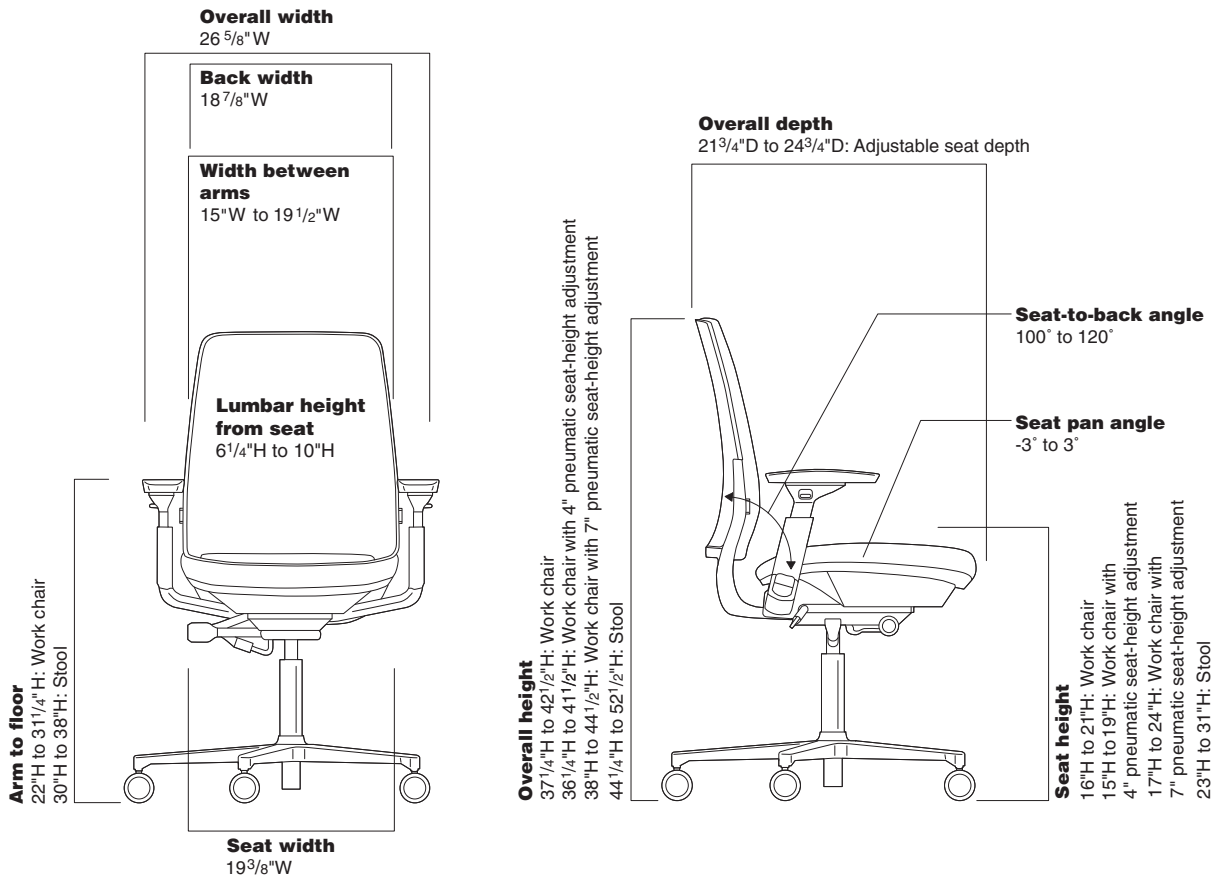

• Back Height from Seat	• Back Lumbar Height	• Lumbar Flex Zone	• Width Between Arms	• Arm to Floor	• Arm Height from Seat	• Arm Cap Pivot Range	• Seat Pan Angle	• Angle Between Seat and Back
25"	6¼" to 10"	5¼" to 10¼"	15" to 19½"	22" to 32¼"	7" to 11"	30°	-3° to 3°	100° to 120°
25"	6¼" to 10"	5¼" to 10¼"	15" to 19½"	22" to 32¼"	7" to 11"	30°	-3° to 3°	100° to 120°
:	:	:	:	:	:	:	:	:

Amia 482 Series Work Chair

Sewn Leather Upholstery on Seat, Back, and Arm Caps

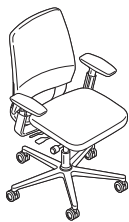

	Standard Includes	Required to Specify
▶ Need help? Product details, page 120	<ul style="list-style-type: none"> • Synchro-tilt mechanism • 5" pneumatic seat-height adjustment • Upright back lock • Rectilinear independent height-, width-, pivot-, and depth-adjustable arms • Frame and arms: platinum • 3" seat depth adjustment • Five-star base: polished aluminum • Passive seat edge angle • Adjustable lumbar • Fully upholstered outer back, seat, and arm caps: leather • Sewn upholstery design • 2½"-diameter, hard-composition, dual-wheel casters: polished aluminum 	<ol style="list-style-type: none"> 1 Style number 2 Leather color number for upholstery on back, seat, and arm caps 3 Options, if selected (see below) <p>▶ See <i>Surface Materials</i>, page 634.</p>

	Options	U.S. Price	Required to Specify
Surface Materials	Upholstery		
	• Elmosoft leather upholstery	+\$120	Specify Elmosoft leather color number.
	• Select Surfaces leather price group 2	+\$120	▶ See <i>Surface Materials Reference Manual</i> .
	• Customer's Own Leather (COL)	No cost	Specify leather color number.
	Soil-retardant treatment	+\$ 36	Specify with soil-retardant treatment.
	Frame and arms		
	• Black plastic	-\$ 65	Specify with 6205 Black.
Base	• Plastic base	-\$305	Specify with plastic base.
Arms	• Height-adjustable arms, soft arm caps	-\$131	Specify with height-adjustable arms.
Seat Height	• 4" pneumatic seat-height adjustment	+\$ 85	Specify with 4" pneumatic seat-height adjustment.
	• 7" pneumatic seat-height adjustment	+\$ 85	Specify with 7" pneumatic seat-height adjustment.
Casters	Polished aluminum base		
	• Soft, dual-wheel casters for use on hard floors: polished aluminum	+\$ 36	Specify with soft polished aluminum casters.
	• Hard, dual-wheel casters for use on soft floors: plastic	-\$ 86	Specify with hard plastic casters.
	• Soft, dark grey treaded, dual-wheel roll-control casters for use on hard floors: plastic	-\$ 52	Specify with soft plastic casters.
	Plastic base		
	• Soft, dark grey treaded, dual-wheel roll-control casters for use on hard floors: plastic	+\$ 36	Specify with soft roll-control casters.
Glides	Polished aluminum base		
	• Glides: plastic	-\$ 52	Specify with glides.
	Plastic base		
	• Glides: plastic	+\$ 36	Specify with glides.
CarbonNeutral Product	• CarbonNeutral product certification	+\$ 35	Add suffix CN to the end of the style number.

Tip: Plastic base available with plastic casters only.

Tip: Polished aluminum casters are available on a polished aluminum base only.

▶ Detailed dimensions, page 126



For Canadian Pricing
Multiply U.S. Price by the Canadian price factor.
▶ See page 1 for details.

Specification Information

Style Number	U.S. Base Price
4821410LS	\$3154

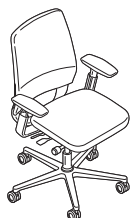

For Canadian Pricing
Multiply U.S. Price by the
Canadian price factor.
▶ See page 1 for details.

Amia 482 Series Work Chair

Upholstery on Seat and Back



Tip: Frame packages include outer back shell, outer back frame, arm holsters, outer seat shell, and base.

Tip: When merle, platinum, or seagull are selected as frame packages, the outer seat shell and inner back frame default to 6527 Merle plastic.

*Tip: Suffixes other than **K** for contrasting fabric, will be added in alphabetical order when specifying options. The contrasting fabric suffix, **K**, will always follow **S** or **SU**.*

Tip: Leather and vinyl upcharges are in addition to sewn upholstery upcharge.

Standard Includes		Required to Specify
<ul style="list-style-type: none"> ▶ Need help? Product details, page 120 	<ul style="list-style-type: none"> • Frame package color scheme: black • Synchro-tilt mechanism • 5" pneumatic seat-height adjustment • Upright back lock • Rectilinear independent height-, width-, pivot-, and depth-adjustable arms and soft arm caps: black plastic • 3" seat depth adjustment • Passive seat edge angle • Adjustable lumbar • Standard upholstery design: fabric price group 1 • 2½"-diameter, hard-composition, dual-wheel casters: black 	<ol style="list-style-type: none"> 1 Style number 2 Frame package color scheme (see below under Required Selections) 3 Fabric color number for upholstery on seat and back 4 Options, if selected (see below) <ul style="list-style-type: none"> ▶ See <i>Surface Materials</i>, page 634.

Required Selections	U.S. Price	Required to Specify
Frame Package Color Scheme <ul style="list-style-type: none"> • Black • Merle • Platinum • Seagull 	<ul style="list-style-type: none"> No cost +\$ 65 +\$ 65 +\$ 65 	<ul style="list-style-type: none"> Specify with 6205 Black. Specify with 6527 Merle. Specify with 6249 Platinum. Specify with 6053 Seagull.

Options	U.S. Price	Required to Specify
Surface Materials		
Upholstery on seat and back <ul style="list-style-type: none"> • Fabric price group 1 • Fabric price group 2 • Fabric price group 3 • Fabric price group 4 • Fabric price group 5 • Fabric price group 6 • Fabric price group 7 • Fabric price group 8 • Fabric price group 9 • Fabric price group 10 • Steelcase leather upholstery 	<ul style="list-style-type: none"> No cost +\$ 37 +\$ 72 +\$100 +\$125 +\$154 +\$179 +\$223 +\$276 +\$312 +\$413 	<ul style="list-style-type: none"> Specify fabric color number. Specify fabric color number. Specify fabric color number. Specify fabric color number. Specify fabric color number. Specify fabric color number. Specify fabric color number. Specify fabric color number. Specify fabric color number. Specify fabric color number. Specify fabric color number. Add suffix S to the style number and specify leather color number. Add suffix S to the style number and specify Select Surfaces leather price group 1. ▶ See <i>Surface Materials Reference Manual</i>. Add suffix S to the style number and specify Elmosoft leather color number. Add suffix S to the style number and specify Select Surfaces leather price group 2. ▶ See <i>Surface Materials Reference Manual</i>. Add suffix S to the style number and specify vinyl color number.
<ul style="list-style-type: none"> • Select Surfaces leather price group 1 	<ul style="list-style-type: none"> +\$413 	
<ul style="list-style-type: none"> • Elmosoft leather upholstery 	<ul style="list-style-type: none"> +\$492 	
<ul style="list-style-type: none"> • Select Surfaces leather price group 2 	<ul style="list-style-type: none"> +\$492 	
<ul style="list-style-type: none"> • Steelcase vinyl 	<ul style="list-style-type: none"> +\$ 37 	
Contrasting upholstery on seat and back <ul style="list-style-type: none"> • Contrasting fabrics 	<ul style="list-style-type: none"> +\$ 46 	<ul style="list-style-type: none"> Add suffix K to the style number and specify fabric color numbers.
Sewn upholstery <ul style="list-style-type: none"> • Sewn upholstery on chair 	<ul style="list-style-type: none"> +\$113 	<ul style="list-style-type: none"> Add suffix S to the style number.

▶ Options, continued on next page

▶ Detailed dimensions, page 126



For Canadian Pricing
 Multiply U.S. Price by the Canadian price factor.
 ▶ See page 1 for details.

► Options, continued from previous page

	Options	U.S. Price	Required to Specify
Surface Materials, continued	Contrasting upholstery on seat		
	• Fabric price group 1	No cost	Specify fabric color number.
	• Fabric price group 2	+\$ 21	Specify fabric color number.
	• Fabric price group 3	+\$ 34	Specify fabric color number.
	• Fabric price group 4	+\$ 48	Specify fabric color number.
	• Fabric price group 5	+\$ 62	Specify fabric color number.
	• Fabric price group 6	+\$ 77	Specify fabric color number.
	• Fabric price group 7	+\$ 88	Specify fabric color number.
	• Fabric price group 8	+\$111	Specify fabric color number.
	• Fabric price group 9	+\$137	Specify fabric color number.
	• Fabric price group 10	+\$154	Specify fabric color number.
	• Steelcase leather upholstery	+\$206	Add suffix S to the style number and specify leather color number.
	• Select Surfaces leather price group 1	+\$206	Add suffix S to the style number and specify leather color number.
	• Elmosoft leather upholstery	+\$246	Add suffix S to the style number and specify leather color number.
	• Select Surfaces leather price group 2	+\$246	Add suffix S to the style number and specify leather color number.
• Customer's Own Material (COM)	No cost	► See <i>Surface Materials Reference Manual</i>	
	Contrasting upholstery on back		
	• Fabric price group 1	No cost	Specify fabric color number.
	• Fabric price group 2	+\$ 21	Specify fabric color number.
	• Fabric price group 3	+\$ 34	Specify fabric color number.
	• Fabric price group 4	+\$ 49	Specify fabric color number.
	• Fabric price group 5	+\$ 62	Specify fabric color number.
	• Fabric price group 6	+\$ 78	Specify fabric color number.
	• Fabric price group 7	+\$ 88	Specify fabric color number.
	• Fabric price group 8	+\$112	Specify fabric color number.
	• Fabric price group 9	+\$137	Specify fabric color number.
	• Fabric price group 10	+\$155	Specify fabric color number.
	• Steelcase leather upholstery	+\$207	Add suffix S to the style number and specify leather color number.
	• Select Surfaces leather price group 1	+\$207	Add suffix S to the style number and specify leather color number.
	• Elmosoft leather upholstery	+\$246	Add suffix S to the style number and specify leather color number.
	• Select Surfaces leather price group 2	+\$246	Add suffix S to the style number and specify leather color number.
	• Customer's Own Material (COM)	No cost	► See <i>Surface Materials Reference Manual</i>
	Soil-retardant treatment	+\$ 36	Specify with soil-retardant treatment.
	Fully upholstered		
	• Fully upholstered with fabric	+\$191	Add suffix U to the style number.
	• Fully upholstered with leather	+\$304	Add suffix SU to the style number.
	• Steelcase leather fully upholstered outer back	+\$676	Add suffix SU to the style number and specify leather color number.
	• Select Surfaces leather price group 1 fully upholstered outer back	+\$676	Add suffix SU to the style number and specify Select Surfaces leather price group 1.
			► See <i>Surface Materials Reference Manual</i>
	• Elmosoft leather fully upholstered outer back	+\$795	Add suffix SU to the style number and specify Elmosoft leather color number.
	• Select Surfaces leather price group 2 fully upholstered outer back	+\$795	Add suffix SU to the style number and specify Select Surfaces leather price group 2.
			► See <i>Surface Materials Reference Manual</i>
	• Customer's Own Leather (COL) fully upholstered outer back	No cost	Add suffix SU to the style number. ► See <i>Surface Materials Reference Manual</i> to specify.

Tip: Suffixes other than **K** for contrasting fabric, will be added in alphabetical order when specifying options. The contrasting fabric suffix, **K**, will always follow **S** or **SU**.

Tip: Leather and vinyl upcharges are in addition to sewn upholstery upcharge.

Tip: To get leather on a fully upholstered chair, you will need to add both the fully upholstered with leather upcharge and the upcharge for the leather itself.

► Options, continued on next page



For Canadian Pricing
Multiply U.S. Price by the Canadian price factor.
► See page 1 for details.

Amia 482 Series Work Chair, Upholstery on Seat and Back, continued

► Options, continued from previous page

	Options	U.S. Price	Required to Specify
Base	<ul style="list-style-type: none"> Polished aluminum base 	+\$219	Specify with polished aluminum base.
Arms	<ul style="list-style-type: none"> Height-adjustable arms, soft arm caps 	-\$131	Specify with height-adjustable arms.
	<ul style="list-style-type: none"> Armless 	-\$304	Specify without arms.
Seat Height	<ul style="list-style-type: none"> 4" pneumatic seat-height adjustment 	+\$ 85	Specify with 4" pneumatic seat-height adjustment.
	<ul style="list-style-type: none"> 7" pneumatic seat-height adjustment 	+\$ 85	Specify with 7" pneumatic seat-height adjustment.
Casters	<ul style="list-style-type: none"> Soft, dark grey treaded, dual-wheel roll-control casters for use on hard floors 	+\$ 36	Specify with soft roll-control casters.
	<ul style="list-style-type: none"> Hard, polished aluminum casters on polished aluminum base for use on soft floors 	+\$ 86	Specify with hard polished aluminum casters.
	<ul style="list-style-type: none"> Soft, polished aluminum casters on polished aluminum base for use on hard floors 	+\$122	Specify with soft polished aluminum casters.
Glides	<ul style="list-style-type: none"> Glides: plastic 	+\$ 36	Specify with glides.
CarbonNeutral Product	<ul style="list-style-type: none"> CarbonNeutral product certification 	+\$ 35	Add suffix CN to the end of the style number.

Specification Information

Style Number	U.S. Base Price
4821410	\$1548



For Canadian Pricing

Multiply U.S. Price by the Canadian price factor.

► See page 1 for details.

Amia 482 Series Work Chair

3D Knit on Back with Upholstery on Seat



Tip: Frame packages include outer back shell, outer back frame, arm holsters, outer seat shell, and base.

Tip: Always add suffixes in alphabetical order with the exception of **CN**. **CN** should be at the end of the style number when specifying options to Amia seating.

Tip: Leather and vinyl upcharges are in addition to sewn upholstery upcharge.

► Detailed dimensions, page 126

 **For Canadian Pricing**
Multiply U.S. Price by the Canadian price factor.
► See page 1 for details.

Standard Includes		Required to Specify
► Need help? Product details, page 120	<ul style="list-style-type: none"> • Frame package color scheme: black • Synchro-tilt mechanism • 5" pneumatic seat-height adjustment • Upright back lock • Rectilinear independent height-, width-, pivot-, and depth-adjustable arms and soft arm caps: black plastic • 3" seat depth adjustment • Passive seat edge angle • Height-adjustable lumbar • 3D Knit on back only • Standard upholstery design on seat: fabric price group 1 • 2½"-diameter, hard-composition, dual-wheel casters: black 	<ol style="list-style-type: none"> 1 Style number 2 Frame package color scheme (see below under Required Selections) 3 3D Knit color for back 4 Fabric color number for upholstery on seat 5 Options, if selected (see below) <p>► See <i>Surface Materials</i>, page 634.</p>

Required Selections	U.S. Price	Required to Specify
Frame Package Color Scheme		
• Black	No cost	Specify with 6205 Black.
• Merle	+\$ 65	Specify with 6527 Merle.
• Platinum	+\$ 65	Specify with 6249 Platinum.
• Seagull	+\$ 65	Specify with 6053 Seagull.

Options	U.S. Price	Required to Specify
Surface Materials		
Upholstery		
• Fabric price group 1	No cost	Specify fabric color number.
• Fabric price group 2	+\$ 21	Specify fabric color number.
• Fabric price group 3	+\$ 34	Specify fabric color number.
• Fabric price group 4	+\$ 48	Specify fabric color number.
• Fabric price group 5	+\$ 62	Specify fabric color number.
• Fabric price group 6	+\$ 77	Specify fabric color number.
• Fabric price group 7	+\$ 88	Specify fabric color number.
• Fabric price group 8	+\$111	Specify fabric color number.
• Fabric price group 9	+\$137	Specify fabric color number.
• Fabric price group 10	+\$154	Specify fabric color number.
• Steelcase leather upholstery	+\$206	Specify fabric color number. Add suffix S to the style number and specify leather color number.
• Select Surfaces leather price group 1	+\$206	Add suffix S to the style number and specify Select Surfaces leather price group 1. ► See <i>Surface Materials Reference Manual</i> .
• Elmosoft leather upholstery	+\$246	Add suffix S to the style number and specify Elmosoft leather color number.
• Select Surfaces leather price group 2	+\$246	Add suffix S to the style number and specify Select Surfaces leather price group 2. ► See <i>Surface Materials Reference Manual</i> .
• Steelcase vinyl	+\$ 21	Add suffix S to the style number and specify vinyl color number. ► See <i>Surface Materials Reference Manual</i> to specify.
• Customer's Own Material (COM)	No cost	Add suffix S to the style number and specify leather color number.
• Customer's Own Leather (COL)	No cost	Add suffix S to the style number and specify leather color number.
Soil-retardant treatment	+\$ 36	Specify with soil-retardant treatment.
Sewn upholstery		
• Sewn upholstery on chair	+\$ 58	Add suffix S to the style number.
Base		
• Polished aluminum base	+\$219	Specify with polished aluminum base.

► Options, continued on next page

► Options, continued from previous page

	Options	U.S. Price	Required to Specify
Arms	• Height-adjustable arms, soft arm caps	-\$131	Specify with height-adjustable arms.
	• Armless	-\$304	Specify without arms.
Seat Height	• 4" pneumatic seat-height adjustment	+\$ 85	Specify with 4" pneumatic seat-height adjustment.
	• 7" pneumatic seat-height adjustment	+\$ 85	Specify with 7" pneumatic seat-height adjustment.
Casters	• Soft, dark grey treaded, dual-wheel roll-control casters for use on hard floors	+\$ 36	Specify with soft roll-control casters.
	• Hard, polished aluminum casters on polished aluminum base for use on soft floors	+\$ 86	Specify with hard polished aluminum casters.
	• Soft, polished aluminum casters on polished aluminum base for use on hard floors	+\$122	Specify with soft polished aluminum casters.
Glides	• Glides: plastic	+\$ 36	Specify with glides.
CarbonNeutral Product	• CarbonNeutral product certification	+\$ 35	Add suffix CN to the end of the style number.

Specification Information

Style Number	U.S. Base Price
4821418	\$1634



For Canadian Pricing
Multiply U.S. Price by the Canadian price factor.
► See page 1 for details.

Amia 482 Series Work Chair

Air Back with 3D Microknit and Upholstery on Seat



Tip: Amia Air frame packages include inner back frame and lumbar, outer back frame, arm holsters, outer seat shell, and base.

Tip: When merle, platinum, or seagull are selected as frame packages, the outer seat shell and inner back frame default to 6527 Merle plastic.

Tip: Leather and vinyl upcharges are in addition to sewn upholstery upcharge.

Tip: To specify a non-contrasting seat back, the air back plastic color finish and 3D Microknit color finish must be the same.

► Detailed dimensions, page 126



For Canadian Pricing
Multiply U.S. Price by the Canadian price factor.
► See page 1 for details.

Standard Includes		Required to Specify
► Need help? Product details, page 120	<ul style="list-style-type: none"> • Frame package color scheme: black • Synchro-tilt mechanism • 5" pneumatic seat-height adjustment • Upright back lock • Rectilinear independent height-, width-, pivot-, and depth-adjustable arms and soft arm caps: black plastic • 3" seat depth adjustment • Passive seat edge angle • Air back with integrated Air LiveBack technology: plastic price groups 1 and 2 • Height-adjustable lumbar • 3D Microknit on back only • Standard upholstery design on seat: fabric price group 1 • 2½"-diameter, hard-composition, dual-wheel casters: black 	<ol style="list-style-type: none"> 1 Style number 2 Frame package color scheme (see below under Required Selections) 3 Fabric color number for upholstery on seat 4 Air back plastic color number 5 3D Microknit color number for back 6 Options, if selected (see below) <p>► See <i>Surface Materials</i>, page 634.</p>

	Required Selections	U.S. Price	Required to Specify
Frame Package Color Scheme	<ul style="list-style-type: none"> • Black • Merle • Platinum • Seagull 	<p>No cost</p> <p>+\$ 65</p> <p>+\$ 65</p> <p>+\$ 65</p>	<p>Specify with 6205 Black.</p> <p>Specify with 6527 Merle.</p> <p>Specify with 6249 Platinum.</p> <p>Specify with 6053 Seagull.</p>

	Options	U.S. Price	Required to Specify
Surface Materials	<p>Upholstery</p> <ul style="list-style-type: none"> • Fabric price group 1 • Fabric price group 2 • Fabric price group 3 • Fabric price group 4 • Fabric price group 5 • Fabric price group 6 • Fabric price group 7 • Fabric price group 8 • Fabric price group 9 • Fabric price group 10 • Steelcase leather upholstery • Select Surfaces leather price group 1 • Elmosoft leather upholstery • Select Surfaces leather price group 2 • Steelcase vinyl • Customer's Own Material (COM) • Customer's Own Leather (COL) <p>Soil-retardant treatment</p> <p>Sewn upholstery</p> <ul style="list-style-type: none"> • Sewn upholstery on chair 	<p>No cost</p> <p>+\$ 21</p> <p>+\$ 34</p> <p>+\$ 48</p> <p>+\$ 62</p> <p>+\$ 77</p> <p>+\$ 88</p> <p>+\$111</p> <p>+\$137</p> <p>+\$154</p> <p>+\$206</p> <p>+\$206</p> <p>+\$246</p> <p>+\$246</p> <p>+\$ 21</p> <p>No cost</p> <p>No cost</p> <p>+\$ 36</p> <p>+\$ 58</p>	<p>Specify fabric color number.</p> <p>Specify fabric color number.</p> <p>Specify fabric color number.</p> <p>Specify fabric color number.</p> <p>Specify fabric color number.</p> <p>Specify fabric color number.</p> <p>Specify fabric color number.</p> <p>Specify fabric color number.</p> <p>Specify fabric color number.</p> <p>Specify fabric color number.</p> <p>Specify fabric color number.</p> <p>Add suffix S to the style number and specify leather color number.</p> <p>Add suffix S to the style number and specify Select Surfaces leather price group 1.</p> <p>► See <i>Surface Materials Reference Manual</i>. Add suffix S to the style number and specify Elmosoft leather color number.</p> <p>Add suffix S to the style number and specify Select Surfaces leather price group 2.</p> <p>► See <i>Surface Materials Reference Manual</i>. Add suffix S to the style number and specify vinyl color number.</p> <p>► See <i>Surface Materials Reference Manual</i> to specify. Add suffix S to the style number and specify leather color number.</p> <p>Specify with soil-retardant treatment.</p> <p>Add suffix S to the style number.</p>

Base	<ul style="list-style-type: none"> • Polished aluminum base 	+\$219	Specify with polished aluminum base.
Arms	<ul style="list-style-type: none"> • Height-adjustable arms, soft arm caps • Armless 	<p>-\$131</p> <p>-\$304</p>	<p>Specify with height-adjustable arms.</p> <p>Specify without arms.</p>

► Options, continued on next page

► Options, continued from previous page

	Options	U.S. Price	Required to Specify
Lumbar	• No lumbar	–\$ 35	Specify <i>with no lumbar</i> .
Seat Height	• 4" pneumatic seat-height adjustment	+\$ 85	Specify <i>with 4" pneumatic seat-height adjustment</i> .
	• 7" pneumatic seat-height adjustment	+\$ 85	Specify <i>with 7" pneumatic seat-height adjustment</i> .
Casters	• Soft, dark grey treaded, dual-wheel roll-control casters for use on hard floors	+\$ 36	Specify <i>with soft roll-control casters</i> .
	• Hard, polished aluminum casters on polished aluminum base for use on soft floors	+\$ 86	Specify <i>with hard polished aluminum casters</i> .
	• Soft, polished aluminum casters on polished aluminum base for use on hard floors	+\$122	Specify <i>with soft polished aluminum casters</i> .
Glides	• Glides: plastic	+\$ 36	Specify <i>with glides</i> .
CarbonNeutral Product	• CarbonNeutral product certification	+\$ 35	Add suffix CN to the end of the style number.

Specification Information

Style Number	U.S. Base Price
4821414	\$1396



For Canadian Pricing
Multiply U.S. Price by the
Canadian price factor.
► See page 1 for details.

Amia 482 Series Work Chair

Air Back with Upholstery on Seat



Tip: Frame packages include outer back shell, outer back frame, arm holsters, outer seat shell, and base.

Tip: When merle, platinum, or seagull are selected as frame packages, the outer seat shell and inner back frame default to 6527 Merle plastic.

Tip: Leather and vinyl upcharges are in addition to sewn upholstery upcharge.

► Detailed dimensions, page 126



For Canadian Pricing
Multiply U.S. Price by the Canadian price factor.
► See page 1 for details.

Standard Includes		Required to Specify
► Need help? Product details, page 120	<ul style="list-style-type: none"> • Frame package color scheme: black • Synchro-tilt mechanism • 5" pneumatic seat-height adjustment • Upright back lock • Rectilinear independent height-, width-, pivot-, and depth-adjustable arms and soft arm caps: black plastic • 3" seat depth adjustment • Passive seat edge angle • Air back with integrated Air LiveBack technology: plastic price groups 1 and 2 • Standard upholstery design on seat: fabric price group 1 • 2½"-diameter, hard-composition, dual-wheel casters: black 	<ol style="list-style-type: none"> 1 Style number 2 Frame package color scheme (see below under Required Selections) 3 Fabric color number for upholstery on seat 4 Air back plastic color number 5 Options, if selected (see below) <p>► See <i>Surface Materials</i>, page 634.</p>

	Required Selections	U.S. Price	Required to Specify
Frame Package Color Scheme	<ul style="list-style-type: none"> • Black • Merle • Platinum • Seagull 	<p>No cost</p> <p>+\$ 65</p> <p>+\$ 65</p> <p>+\$ 65</p>	<p>Specify with 6205 Black.</p> <p>Specify with 6527 Merle.</p> <p>Specify with 6249 Platinum.</p> <p>Specify with 6053 Seagull.</p>

	Options	U.S. Price	Required to Specify
Surface Materials	<p>Upholstery</p> <ul style="list-style-type: none"> • Fabric price group 1 • Fabric price group 2 • Fabric price group 3 • Fabric price group 4 • Fabric price group 5 • Fabric price group 6 • Fabric price group 7 • Fabric price group 8 • Fabric price group 9 • Fabric price group 10 • Steelcase leather upholstery <p>• Select Surfaces leather price group 1</p> <p>• Elmosoft leather upholstery</p> <p>• Select Surfaces leather price group 2</p> <p>• Steelcase vinyl</p> <p>• Customer's Own Material (COM)</p> <p>• Customer's Own Leather (COL)</p>	<p>No cost</p> <p>+\$ 21</p> <p>+\$ 34</p> <p>+\$ 48</p> <p>+\$ 62</p> <p>+\$ 77</p> <p>+\$ 88</p> <p>+\$111</p> <p>+\$137</p> <p>+\$154</p> <p>+\$206</p> <p>+\$206</p> <p>+\$246</p> <p>+\$246</p> <p>+\$ 21</p> <p>No cost</p> <p>No cost</p> <p>+\$ 36</p> <p>+\$ 58</p>	<p>Specify fabric color number.</p> <p>Specify fabric color number.</p> <p>Specify fabric color number.</p> <p>Specify fabric color number.</p> <p>Specify fabric color number.</p> <p>Specify fabric color number.</p> <p>Specify fabric color number.</p> <p>Specify fabric color number.</p> <p>Specify fabric color number.</p> <p>Specify fabric color number.</p> <p>Specify fabric color number.</p> <p>Specify fabric color number.</p> <p>Specify fabric color number.</p> <p>Add suffix S to the style number and specify leather color number.</p> <p>Add suffix S to the style number and specify Select Surfaces leather price group 1.</p> <p>► See <i>Surface Materials Reference Manual</i>. Add suffix S to the style number and specify Elmosoft leather color number.</p> <p>Add suffix S to the style number and specify Select Surfaces leather price group 2.</p> <p>► See <i>Surface Materials Reference Manual</i>. Add suffix S to the style number and specify vinyl color number.</p> <p>► See <i>Surface Materials Reference Manual</i> to specify.</p> <p>Add suffix S to the style number and specify leather color number.</p> <p>Specify with soil-retardant treatment.</p> <p>Add suffix S to the style number.</p>
Base	<ul style="list-style-type: none"> • Polished aluminum base 	<p>+\$219</p>	<p>Specify with polished aluminum base.</p>
Arms	<ul style="list-style-type: none"> • Height-adjustable arms, soft arm caps • Armless 	<p>-\$131</p> <p>-\$304</p>	<p>Specify with height-adjustable arms.</p> <p>Specify without arms.</p>

► Options, continued on next page

► Options, continued from previous page

	Options	U.S. Price	Required to Specify
Seat Height	• 4" pneumatic seat-height adjustment	+\$ 85	Specify with 4" pneumatic seat-height adjustment.
	• 7" pneumatic seat-height adjustment	+\$ 85	Specify with 7" pneumatic seat-height adjustment.
Casters	• Soft, dark grey treaded, dual-wheel roll-control casters for use on hard floors	+\$ 36	Specify with soft roll-control casters.
	• Hard, polished aluminum casters on polished aluminum base for use on soft floors	+\$ 86	Specify with hard polished aluminum casters.
	• Soft, polished aluminum casters on polished aluminum base for use on hard floors	+\$122	Specify with soft polished aluminum casters.
Glides	• Glides: plastic	+\$ 36	Specify with glides.
CarbonNeutral Product	• CarbonNeutral product certification	+\$ 35	Add suffix CN to the end of the style number.

Specification Information

Style Number	U.S. Base Price
4821412	\$1319



For Canadian Pricing
Multiply U.S. Price by the Canadian price factor.
► See page 1 for details.

Amia 482 Series Stool

Upholstery on Seat and Back



Tip: Frame packages include outer back shell, outer back frame, arm holsters, outer seat shell, and base.

*Tip: Suffixes other than **K** for contrasting fabric, will be added in alphabetical order when specifying options. The contrasting fabric suffix, **K**, will always be at the end of the style number.*

Tip: Leather and vinyl upcharges are in addition to sewn upholstery upcharge.

Standard Includes		Required to Specify
<ul style="list-style-type: none"> ▶ Need help? Product details, page 120 	<ul style="list-style-type: none"> • Frame package color scheme: black • Synchro-tilt mechanism • 8" pneumatic seat-height adjustment • Upright back lock • Passive seat edge angle • Rectilinear independent height-, width-, pivot-, and depth-adjustable arms and soft arm caps: black plastic • 3" seat depth adjustment • Column and 4" adjustable foot ring: black • Standard upholstery design: fabric price group 1 • 2"-diameter, hard-composition, dual-wheel casters: black • Adjustable lumbar 	<ol style="list-style-type: none"> 1 Style number 2 Frame package color scheme (see below under Required Selections) 3 Fabric color number for upholstery on seat and back 4 Options, if selected (see below) <ul style="list-style-type: none"> ▶ See <i>Surface Materials</i>, page 634.

Required Selections	U.S. Price	Required to Specify
Frame Package Color Scheme <ul style="list-style-type: none"> • Black • Merle • Platinum • Seagull 	<ul style="list-style-type: none"> No cost +\$ 65 +\$ 65 +\$ 65 	<ul style="list-style-type: none"> Specify with 6205 <i>Black</i>. Specify with 6527 <i>Merle</i>. Specify with 6249 <i>Platinum</i>. Specify with 6053 <i>Seagull</i>.

Options	U.S. Price	Required to Specify
Surface Materials		
Upholstery on seat and back <ul style="list-style-type: none"> • Fabric price group 1 • Fabric price group 2 • Fabric price group 3 • Fabric price group 4 • Fabric price group 5 • Fabric price group 6 • Fabric price group 7 • Fabric price group 8 • Fabric price group 9 • Fabric price group 10 • Steelcase leather upholstery • Select Surfaces leather price group 1 • Elmosoft leather upholstery • Select Surfaces leather price group 2 • Steelcase vinyl • Customer's Own Material (COM) • Customer's Own Leather (COL) 	<ul style="list-style-type: none"> No cost +\$ 37 +\$ 72 +\$100 +\$125 +\$154 +\$179 +\$223 +\$276 +\$312 +\$413 +\$413 +\$492 +\$492 +\$ 36 No cost No cost 	<ul style="list-style-type: none"> Specify fabric color number. Specify fabric color number. Specify fabric color number. Specify fabric color number. Specify fabric color number. Specify fabric color number. Specify fabric color number. Specify fabric color number. Specify fabric color number. Specify fabric color number. Add suffix S to the style number and specify leather color number. Add suffix S to the style number and specify Select Surfaces leather price group 1. ▶ See <i>Surface Materials Reference Manual</i>. Add suffix S to the style number and specify Elmosoft leather color number. Add suffix S to the style number and specify Select Surfaces leather price group 2. ▶ See <i>Surface Materials Reference Manual</i>. Add suffix S to the style number and specify vinyl color number. ▶ See <i>Surface Materials Reference Manual</i> to specify. Add suffix S to the style number and specify leather color number.
Sewn upholstery <ul style="list-style-type: none"> • Sewn upholstery on chair 	<ul style="list-style-type: none"> +\$113 	<ul style="list-style-type: none"> Add suffix S to the style number.
Contrasting upholstery on seat and back <ul style="list-style-type: none"> • Contrasting fabrics 	<ul style="list-style-type: none"> +\$ 46 	<ul style="list-style-type: none"> Add suffix K to the style number and specify fabric color numbers.

▶ Options, continued on next page

▶ Detailed dimensions, page 126



For Canadian Pricing

Multiply U.S. Price by the Canadian price factor.

▶ See page 1 for details.

► Options, continued from previous page

	Options	U.S. Price	Required to Specify
Surface Materials, continued	Contrasting upholstery on seat		
	• Fabric price group 1	No cost	Specify fabric color number.
	• Fabric price group 2	+\$ 21	Specify fabric color number.
	• Fabric price group 3	+\$ 34	Specify fabric color number.
	• Fabric price group 4	+\$ 48	Specify fabric color number.
	• Fabric price group 5	+\$ 62	Specify fabric color number.
	• Fabric price group 6	+\$ 77	Specify fabric color number.
	• Fabric price group 7	+\$ 88	Specify fabric color number.
	• Fabric price group 8	+\$111	Specify fabric color number.
	• Fabric price group 9	+\$137	Specify fabric color number.
• Fabric price group 10	+\$154	Specify fabric color number.	
• Steelcase leather upholstery	+\$206	Specify fabric color number. Add suffix S to the style number and specify leather color number.	
• Select Surfaces leather price group 1	+\$206	Specify fabric color number. Add suffix S to the style number and specify leather color number.	
• Elmosoft leather upholstery	+\$246	Specify fabric color number. Add suffix S to the style number and specify leather color number.	
• Select Surfaces leather price group 2	+\$246	Specify fabric color number. Add suffix S to the style number and specify leather color number.	
• Customer's Own Material (COM)	No cost	Specify fabric color number. Add suffix S to the style number and specify leather color number. ► See <i>Surface Materials Reference Manual</i>	
	Contrasting upholstery on back		
	• Fabric price group 1	No cost	Specify fabric color number.
	• Fabric price group 2	+\$ 21	Specify fabric color number.
	• Fabric price group 3	+\$ 34	Specify fabric color number.
	• Fabric price group 4	+\$ 49	Specify fabric color number.
	• Fabric price group 5	+\$ 62	Specify fabric color number.
	• Fabric price group 6	+\$ 78	Specify fabric color number.
	• Fabric price group 7	+\$ 88	Specify fabric color number.
	• Fabric price group 8	+\$112	Specify fabric color number.
	• Fabric price group 9	+\$137	Specify fabric color number.
	• Fabric price group 10	+\$155	Specify fabric color number.
	• Steelcase leather upholstery	+\$207	Specify fabric color number. Add suffix S to the style number and specify leather color number.
	• Select Surfaces leather price group 1	+\$207	Specify fabric color number. Add suffix S to the style number and specify leather color number.
	• Elmosoft leather upholstery	+\$246	Specify fabric color number. Add suffix S to the style number and specify leather color number.
	• Select Surfaces leather price group 2	+\$246	Specify fabric color number. Add suffix S to the style number and specify leather color number.
	• Customer's Own Material (COM)	No cost	Specify fabric color number. Add suffix S to the style number and specify leather color number. ► See <i>Surface Materials Reference Manual</i>
	Soil-retardant treatment	+\$ 36	Specify with soil-retardant treatment.
	Fully upholstered		
	• Fully upholstered with fabric	+\$191	Add suffix U to the style number.
	• Fully upholstered with leather	+\$304	Add suffix SU to the style number.
	• Steelcase leather fully upholstered outer back	+\$676	Add suffix SU to the style number and specify leather color number.
	• Select Surfaces leather price group 1 fully upholstered outer back	+\$676	Add suffix SU to the style number and specify Select Surfaces leather price group 1. ► See <i>Surface Materials Reference Manual</i>
	• Elmosoft leather fully upholstered outer back	+\$795	Add suffix SU to the style number and specify Elmosoft leather color number.
	• Select Surfaces leather price group 2 fully upholstered outer back	+\$795	Add suffix SU to the style number and specify Select Surfaces leather price group 2. ► See <i>Surface Materials Reference Manual</i>
	• Customer's Own Leather (COL) fully upholstered outer back	No cost	Add suffix SU to the style number. ► See <i>Surface Materials Reference Manual</i> to specify.

Tip: Suffixes other than **K** for contrasting fabric, will be added in alphabetical order when specifying options. The contrasting fabric suffix, **K**, will always be at the end of the style number.

Tip: Leather and vinyl upcharges are in addition to sewn upholstery upcharge.

Tip: To get leather on a fully upholstered chair, you will need to add both the fully upholstered with leather upcharge and the upcharge for the leather itself.

► Options, continued on next page

**For Canadian Pricing**

Multiply U.S. Price by the Canadian price factor.

► See page 1 for details.

Amia 482 Series Stool, Upholstery on Seat and Back, continued

► Options, continued from previous page

	Options	U.S. Price	Required to Specify
Arms	• Height-adjustable arms, soft arm caps	-\$131	Specify <i>with height-adjustable arms</i> . Specify <i>without arms</i> .
	• Armless	-\$304	
Casters	• Soft, dark grey treaded, dual-wheel roll-control casters for use on hard floors	+\$ 36	Specify <i>with soft roll-control casters</i> .
Glides	• Glides: plastic	+\$ 36	Specify <i>with glides</i> .

Specification Information

• Style Number	• U.S. Base Price
4827410	\$1837
•	•

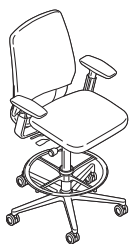

 **For Canadian Pricing**
 Multiply U.S. Price by the Canadian price factor.
 ► See page 1 for details.

Amia 482 Series Stool

3D Knit on Back with Upholstery on Seat



Tip: Frame packages include outer back shell, outer back frame, arm holsters, outer seat shell, and base.

Tip: Always add suffixes in alphabetical order when specifying options to Amia seating.

Tip: Leather and vinyl upcharges are in addition to sewn upholstery upcharge.

► Detailed dimensions, page 126

 **For Canadian Pricing**
Multiply U.S. Price by the Canadian price factor.
► See page 1 for details.

Standard Includes		Required to Specify
► Need help? Product details, page 120	<ul style="list-style-type: none"> • Frame package color scheme: black • Synchro-tilt mechanism • 8" pneumatic seat-height adjustment • Upright back lock • Passive seat edge angle • Rectilinear independent height-, width-, pivot-, and depth-adjustable arms and soft arm caps: black plastic • 3" seat depth adjustment • Column and 4" adjustable foot ring: black • 3D Knit on back only • Standard upholstery design on seat: fabric price group 1 • 2"-diameter, hard-composition, dual-wheel casters: black • Adjustable lumbar 	<ol style="list-style-type: none"> 1 Style number 2 Frame package color scheme (see below under Required Selections) 3 3D Knit color for back 4 Fabric color number for upholstery on seat 5 Options, if selected (see below) <p>► See <i>Surface Materials</i>, page 634.</p>

	Required Selections	U.S. Price	Required to Specify
Frame Package Color Scheme	<ul style="list-style-type: none"> • Black • Merle • Platinum • Seagull 	<p>No cost</p> <p>+\$ 65</p> <p>+\$ 65</p> <p>+\$ 65</p>	<p>Specify with 6205 Black.</p> <p>Specify with 6527 Merle.</p> <p>Specify with 6249 Platinum.</p> <p>Specify with 6053 Seagull.</p>

	Options	U.S. Price	Required to Specify
Surface Materials	<p>Upholstery</p> <ul style="list-style-type: none"> • Fabric price group 1 • Fabric price group 2 • Fabric price group 3 • Fabric price group 4 • Fabric price group 5 • Fabric price group 6 • Fabric price group 7 • Fabric price group 8 • Fabric price group 9 • Fabric price group 10 • Steelcase leather upholstery • Select Surfaces leather price group 1 • Elmosoft leather upholstery • Select Surfaces leather price group 2 • Steelcase vinyl • Customer's Own Material (COM) • Customer's Own Leather (COL) 	<p>No cost</p> <p>+\$ 21</p> <p>+\$ 34</p> <p>+\$ 48</p> <p>+\$ 62</p> <p>+\$ 77</p> <p>+\$ 88</p> <p>+\$111</p> <p>+\$137</p> <p>+\$154</p> <p>+\$206</p> <p>+\$206</p> <p>+\$246</p> <p>+\$246</p> <p>+\$ 21</p> <p>No cost</p> <p>No cost</p>	<p>Specify fabric color number.</p> <p>Specify fabric color number.</p> <p>Specify fabric color number.</p> <p>Specify fabric color number.</p> <p>Specify fabric color number.</p> <p>Specify fabric color number.</p> <p>Specify fabric color number.</p> <p>Specify fabric color number.</p> <p>Specify fabric color number.</p> <p>Specify fabric color number.</p> <p>Specify fabric color number.</p> <p>Add suffix S to the style number and specify leather color number.</p> <p>Add suffix S to the style number and specify Select Surfaces leather price group 1.</p> <p>► See <i>Surface Materials Reference Manual</i>. Add suffix S to the style number and specify Elmosoft leather color number.</p> <p>Add suffix S to the style number and specify Select Surfaces leather price group 2.</p> <p>► See <i>Surface Materials Reference Manual</i>. Add suffix S to the style number and specify vinyl color number.</p> <p>► See <i>Surface Materials Reference Manual</i> to specify.</p> <p>Add suffix S to the style number and specify leather color number.</p>
	Soil-retardant treatment	+\$ 36	Specify with soil-retardant treatment.
	Sewn upholstery		
	• Sewn upholstery on chair	+\$ 58	Add suffix S to the style number.
Arms	<ul style="list-style-type: none"> • Height-adjustable arms, soft arm caps • Armless 	<p>-\$131</p> <p>-\$304</p>	<p>Specify with height-adjustable arms.</p> <p>Specify without arms.</p>

► Options, continued on next page

► Options, continued from previous page

Options	U.S. Price	Required to Specify
Casters <ul style="list-style-type: none"> Soft, dark grey treaded, dual-wheel roll-control casters for use on hard floors 	+\$36	Specify with soft roll-control casters.
Glides <ul style="list-style-type: none"> Glides: plastic 	+\$36	Specify with glides.

Specification Information

Style Number	U.S. Base Price
4827418	\$1923



Amia 482 Series

For Canadian Pricing
 Multiply U.S. Price by the Canadian price factor.
 ► See page 1 for details.

Specification Information

Style Number	U.S. Base Price
4827414	\$1685

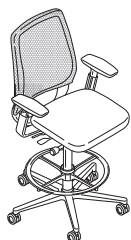

Amia 482 Series

For Canadian Pricing
Multiply U.S. Price by the
Canadian price factor.
▶ See page 1 for details.

Specification Information

Style Number	U.S. Base Price
4827412	\$1608



For Canadian Pricing
Multiply U.S. Price by the
Canadian price factor.
▶ See page 1 for details.



Understanding and Specifying Steelcase Series 2

Product Details

Steelcase Series 2	152
Steelcase Series 2 Upholstery	156
Dimensions	158

Specifying

Work Chair

Air Back with Upholstery on Seat and Back	160
Air Back with 3D Microknit and Upholstery on Seat	164
Air Back with Upholstery on Seat	166

Stool

Air Back with Upholstery on Seat and Back	168
Air Back with 3D Microknit and Upholstery on Seat	172
Air Back with Upholstery on Seat	174

Accessories

176

Steelcase Series 2



Now available as a CarbonNeutral product, making sure our commitment to a more sustainable future helps yours too.

Steelcase Series 2

is the attainable, high-performing task chair that can be personalized with extensive style choices. Its backrest signals comfort and sophisticated support, while the slim profile and light scale look can help optimize any space. The back features an innovative geometric design that flexes in two dimensions to provide continuous support for the spine.

Back frame and seat shell

are plastic. Fabric back cover and quilted back are available as options on fully upholstered versions.

Lumbar height adjusts 3¾".

Air LiveBack technology

works through an innovative geometric design that flexes in two dimensions as the user moves to create responsive, personalized comfort and fit.

Seat height adjusts within a 5" range with a pneumatic adjustment mechanism. Short or tall range are available as options. Stools have a 7¾" range.

Comfort dial provides three settings for the user's personal preference and work style.

Casters have hard, dual-wheels that roll smoothly on carpets. They are 2½" for increased mobility. Soft, dual-wheel roll-control casters are available as an option for use on hard floors or chair mats. Glides are also available as an option.

Tip: Do not roll the chair across asphalt during installation as this may damage the casters.

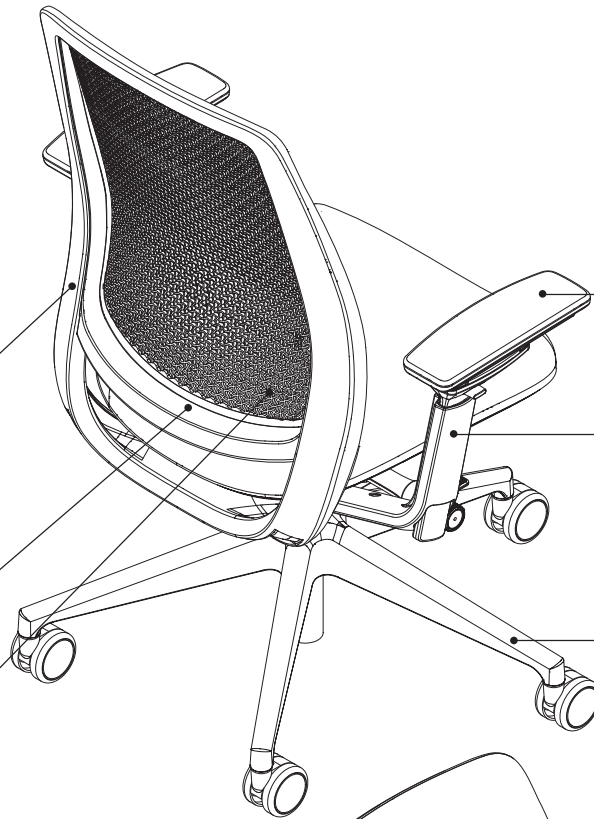

Arm width adjusts 2¼" in each direction.

Arm height can adjust independently within a 4" range to help relieve upper back and shoulder fatigue.

Five-star base is available in plastic or polished aluminum.

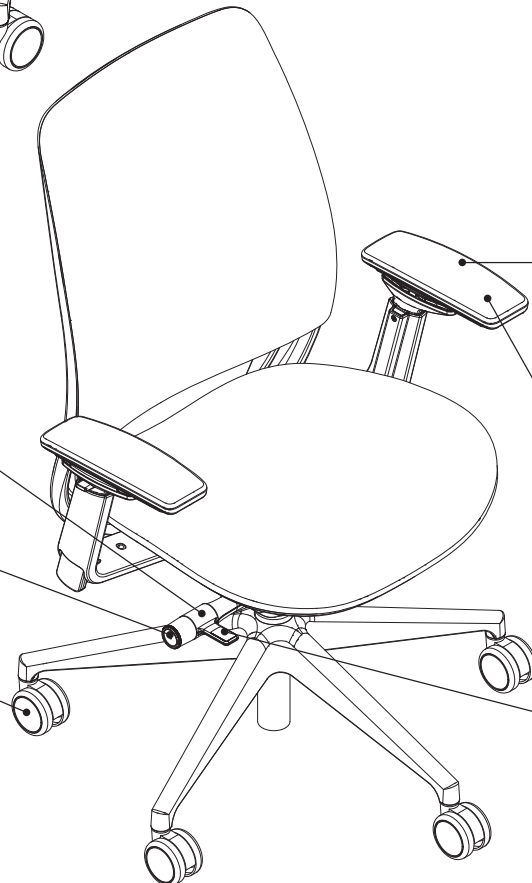

Arm depth can be adjusted approximately 3".

Arm caps can pivot 30° inwardly and outwardly.

Seat depth adjusts within a 2¾" range.

Product Details

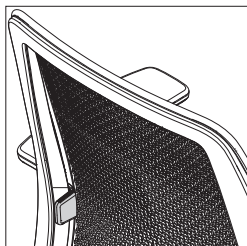

Integrated LiveBack automatically creates the flexibility and movement in the backrest to ensure dynamic back support during recline. Height-adjustable lumbar comes standard on Steelcase Series 2.

Steelcase Series 2 is available in four back types: plastic air back, 3D Microknit, fully upholstered, and quilted upholstery. A fabric back cover is also available on fully upholstered versions.

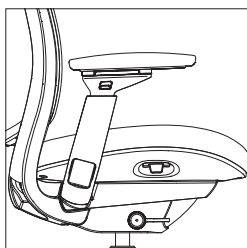

Advanced weight-activated mechanism with a natural fluid motion keeps users oriented to their work.

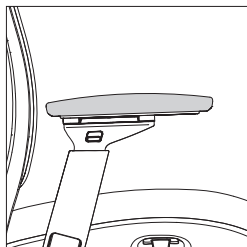

Rectilinear arms with soft caps are standard.

Uncartoned request on your dealer purchase order means Steelcase Series 2 chairs will ship blanket wrapped and fully assembled. *Tip: Select cartoned if a box is preferred, cartoned chairs will ship unassembled.*

Cartoned request on the dealer purchase order means Steelcase Series 2 chairs will ship knocked down in four pieces. This allows for shipment in a smaller carton. Assembly does not require tools. Assembly instructions are included.

Product Weight

- Series 2 upholstered chair: 37.4 pounds
- Series 2 3D Microknit chair: 36.1 pounds
- Series 2 AirBack chair: 35.8 pounds



CarbonNeutral.com

CarbonNeutral product Series 2 helps organizations achieve their carbon emissions goals. Add **CN** to the end of the style number to specify Series 2 with CarbonNeutral product certification.

Adjustment Features

Adjustability instructions are included with every chair.

Seat Adjustments

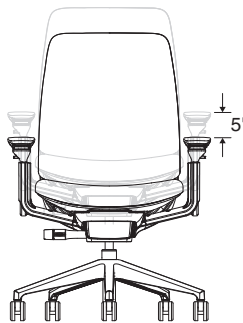

Seat height adjusts pneumatically. To lower, hold handle up while seated. To raise, hold handle up and keep your weight off the chair. Standard range of adjustability is 5" from 16½"H to 21½"H. A short 3¼" range of adjustability (14¾" to 18") and a tall 4¾" range of adjustability (17¼" to 22") is available as an option. A 7¾" range of adjustability (23" to 30¾") is available on stools.

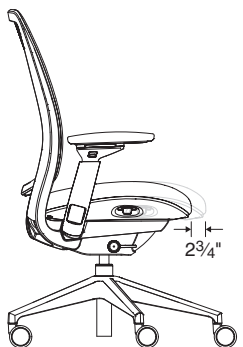

Seat depth adjusts 2¾" by pulling handle up. Slide seat forward or back to accommodate various leg lengths. Release handle to lock. This feature is standard on Steelcase Series 2 work chairs and stools.

Back Adjustments

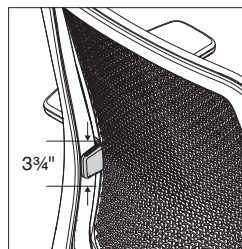

Lumbar height adjusts 3¾" (6¼" to 10" from seat) by grabbing exposed tabs and sliding the lumbar support up or down. This feature is standard on Steelcase Series 2 work chairs and stools.

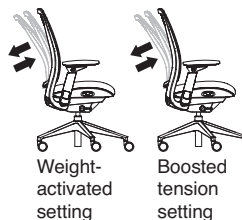

Comfort dial has three settings: (1) weight-activated setting; (2) boosted tension setting that has more resistance than your body is providing; and (3) an upright back lock setting.



Headrest adjusts 3¼" vertically to support the head and neck of the user in both upright and recline postures. The plastic stalk and underside of the headrest will coordinate to match the frame color specified: black, seagull, or sterling dark. The foam pad of the headrest is available in all upholstery currently approved on seat and back.

Arm Adjustments

Rectilinear height-, width-, pivot-, and depth-adjustable arms come standard on all arm models of chairs and stools.

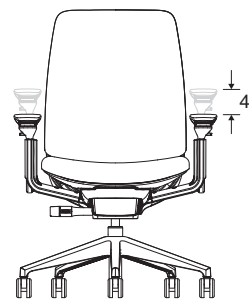

Arm height adjusts independently within a range of 4" (7½"–11½" from the seat). Push button on outside and under arm cap in while moving arms up or down. Releasing buttons locks arms in position.

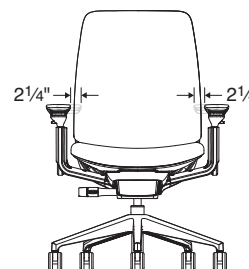

Arm width adjusts 2¼" in each direction.

Steelcase Series 2, continued

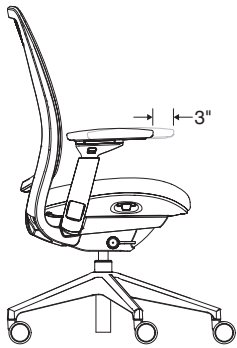

Arm depth adjusts approximately 3" to enable user to get closer to worksurface.

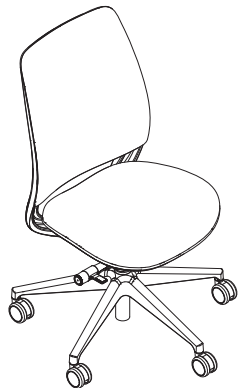

Armless models are also available.

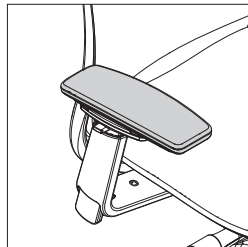

Arms pivot independently, 30° inward and outward. Grasp arm and push front to left or right.

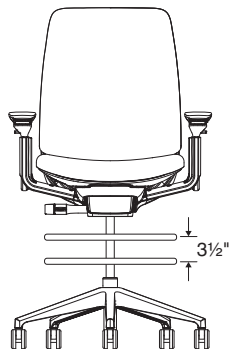

Foot ring height on stools adjusts by rotating it counterclockwise to unlock. Then raise or lower ring to desired position before rotating it clockwise to lock. The foot ring has a diameter of 20".

Hard, dual-wheeled casters are standard. Soft, dual-wheel roll-control casters are available as an option. Glides are also available as an option.

Soft dual-wheel roll-control casters feature an internal brake that activates when the chair is not under load to reduce shifting when user stands up.

Coat hanger (option) is field installed. The color will coordinate with the frame of the chair but will not match the frame exactly. The coat hanger is not intended to hold bags or backpacks.

Other Features

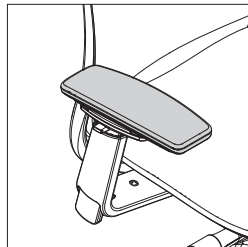

Height-only adjustable arm is also available and adjusts 4 1/2".

Surface Materials

Upholstery

- Fabric
- Fabric with soil-retardant treatment (option)
- 3D Microknit (back and headrest only)
- Select Surfaces leather
- Elmosoft leather
- Leather
- Vinyl
- Customer's Own Leather (COL)
- Customer's Own Material/Vinyl (COM)

Hard components

- Back frame, outer back, back shell, seat shell, arm retainer, stool ring, headrest, and coat hanger
- 6053 Seagull
 - 6205 Black
 - 7250 Sterling Dark

Base

- 6053 Seagull
- 6205 Black
- 7250 Sterling Dark
- 8046 Polished Aluminum

Pneumatic cylinders

- 6205 Black

Seat shell is determined by the frame finish.

- 6053 Seagull
- 6205 Black
- 7250 Sterling Dark

Arms

- 6205 Black

All Steelcase seating with standard upholstery fabrics complies with requirements of the State of California Technical Bulletin 117-2013. All standard seating is labeled to be in compliance with California 117-2013.

Programs & Services

▶ See *Surface Materials Reference Manual* for further detail about programs and services offered for seating.

The Customer's Own Material (COM) Program

offers the opportunity for customers to select fabrics that are not offered through the standard Steelcase surface materials program for use on Steelcase products. Through the COM program, Steelcase will test your materials for application on Steelcase products. Once approved, you can place your order. Steelcase will facilitate the entire ordering process and give you a production schedule. Steelcase will order the COM fabric directly from the textile manufacturer. For up-to-date information regarding fabric test results for all COM fabrics and details regarding yardage requirements for most seating lines, visit the COM website. To locate the COM website:

- Visit www.steelcase.com

Soil retardants are treatments that provide long-term soil and stain resistance to a fabric without affecting the shade or the integrity of the fabric. The following Steelcase Textiles are available pre-treated with soil retardant. (You do not need to select the soil-retardant option for these fabrics and incur the upcharge.)

- Jacks
- Link

For information on soil retardant fabrics on Select Surfaces, please refer to the *Surface Materials Reference Manual*.

Soil-retardant treatment is available on all other seating fabrics at an additional upcharge per seating unit. To order this option, please select "Soil-Retardant Treatment" under "Optional Accessories."

For soil-retardant treatment on COMs, please select "Soil-Retardant Treatment" under "Optional Accessories." Minimums or additional yardage may be required. Please contact the vendor directly for specific information.

Extended lead times may be necessary for this service.

Contact your Steelcase Solutions Fulfillment Team Representative at 1.888.STEELCASE (1.888.783.3522) or send an email to lineone@steelcase.com.

Frame Package Color Scheme Matrix

Color Scheme	Inner Back Frame	Outer Back Frame	Arm Holster	Outer Seat Shell	Base
Black	6205 Black plastic	6205 Black plastic	6205 Black plastic	6205 Black plastic	6205 Black plastic
Sterling Dark	6527 Merle plastic	7250 Sterling Dark paint	7250 Sterling Dark paint	6059 Sterling Dark plastic	7250 Sterling Dark paint
Seagull	6527 Merle plastic	7243 Seagull paint	7243 Seagull paint	6053 Seagull plastic	7243 Seagull paint (6205 Black plastic and 7250 Sterling Dark paint are also available)

Tip: Polished aluminum is available on base for all color schemes with an upcharge.

Steelcase Series 2 Upholstery

What Is It?

Fabric, leather, or vinyl-covered back and seat, 3D Microknit back

Fabric, Leather, and Vinyl

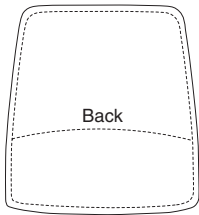

Back

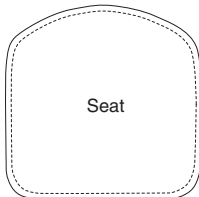

Seat

Stitched seams will be included on all upholstery types, except for select fabrics.

Pattern alignment at the lumbar seam cannot be guaranteed.

Tip: Headrest will include stitched seams in fabrics, leather, and vinyl.

Microknit Back

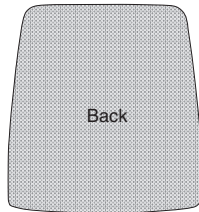

Back

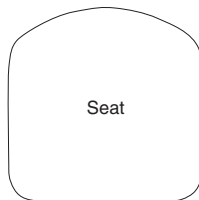

Seat

3D Microknit back upholstery is applied directly over plastic air back. A Cogent: Connect fabric can be specified on the seat to color match the 3D Microknit, except seagull. The 3D Microknit can be specified to match or contrast the air back.

Tip: 3D Microknit back has no stitched seams. Upholstery seams on seat are driven by specified seat fabric.

Tip: Headrest will include stitched seams in 3D Microknit.

Cogent: Connect and Select Fabrics

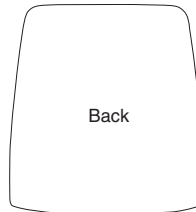

Back

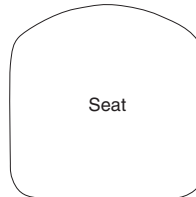

Seat

Cogent: Connect and select Customer's Own Material (COM) do not have stitched seams.

Tip: Headrest will include stitched seams in Cogent: Connect.

Quilted Back



Back

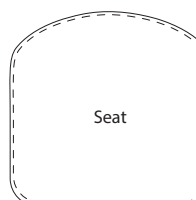

Seat

Quilted back is available as an option on fully upholstered versions. Quilted back option features horizontal stitching detail.

Tip: Stitched seams are included on all upholstery types when "quilted back" is selected.

Tip: Headrest will include stitched seams in fabrics, leather, and vinyl.



Plastic Air LiveBack is fully visible and available in several colors.

Fabric back cover is available as an option on fully upholstered styles.

Tip: Fabric back cover is only available in Cogent: Connect and Era.

Seat and back cushions can be removed and replaced if damaged.

Dimensions

Steelcase Series 2

Features	Overall Depth	Width	Height	Seat Depth	Functional Seat Depth	Seat Width	Seat Height from Floor	Ring Height from Floor	Back Width	Back Height from Seat
----------	---------------	-------	--------	------------	-----------------------	------------	------------------------	------------------------	------------	-----------------------

Steelcase Series 2

Chair

Arms	19 1/4" to 22"	27"	38" to 42 1/2"	Adjustable 2 3/4"	Plastic + 3D Microknit AirBack: 15"-17 3/4" Upholstered back: 14 1/2"-17 1/4"	20"	16 1/2"-21 1/2" (14 3/4"-18", 17 1/4"-22" optional)	N.A.	18 7/8"	22 1/2"
------	----------------	-----	----------------	-------------------	--	-----	--	------	---------	---------

Stool

Arms	19 1/4" to 22"	27"	44 1/2" to 52"	Adjustable 2 3/4"	14" to 17 3/4"	20"	23" to 30 3/4"	11 1/2" to 15"	18 7/8"	22 1/2"
------	----------------	-----	----------------	-------------------	----------------	-----	----------------	----------------	---------	---------

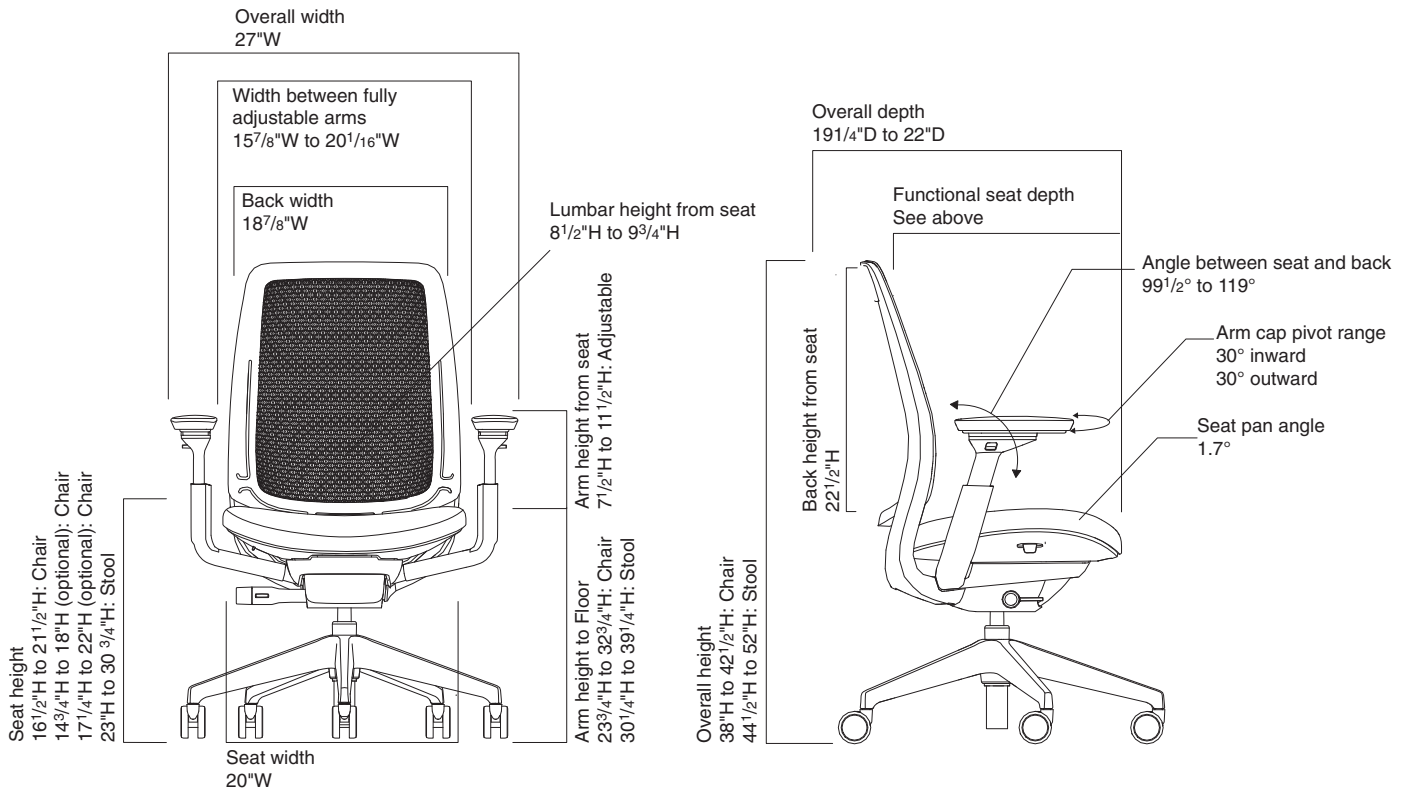

Lumbar Height from Seat	Width Between Adjustable Arms	Width Between Height-Adjustable Arms	Arm to Floor	Arm Height from Seat	Arm Cap Pivot Range	Angle Between Seat and Back	Seat Pan Angle	Headrest Height Adjustment Range
-------------------------	-------------------------------	--------------------------------------	--------------	----------------------	---------------------	-----------------------------	----------------	----------------------------------

8½" to 9¾"	15⅞" to 20⅙"	20"	23¾" to 32¾"	7½" to 11½"	30° outward 30° inward	99½° to 119°	1.7°	3¼"
------------	--------------	-----	--------------	-------------	---------------------------	--------------	------	-----

8½" to 9¾"	15⅞" to 20⅙"	20"	30¼" to 39¼"	7½" to 11½"	30° outward 30° inward	99½° to 119°	1.7°	3¼"
------------	--------------	-----	--------------	-------------	---------------------------	--------------	------	-----

Steelcase Series 2 Work Chair

Air Back with Upholstery on Seat and Back



Tip: Steelcase Series 2 frame packages include inner back frame, lumbar, outer back frame, arm holsters, outer seat shell, and base.

▶ See *Frame Package Color Scheme Matrix*, page 155.

Tip: When quilted back is selected, sewn seat is defaulted.

Tip: When back cover is selected, air back plastic color is automatically black because air back is not visible.

Standard Includes		Required to Specify
▶ Need help? Product details, page 153	<ul style="list-style-type: none"> 5" pneumatic seat-height adjustment (16½"-21½") Frame package color scheme: black Base: 6205 Black plastic Standard upholstery design on seat and back: fabric price group 1 Air back with integrated Air LiveBack technology: plastic price groups 1 and 2 Rectilinear independent height-, width-, pivot-, and depth-adjustable arms and soft arm caps: black plastic 2½" seat depth adjustment Height-adjustable lumbar 2½" diameter, hard-composition, dual-wheel casters: black only 	<ol style="list-style-type: none"> Style number Frame package color scheme (see below under Required Selections) Back cover (see below under Required Selections) Quilted back (see below under Required Selections) Plastic color number for base Fabric color number for upholstery on seat and back Air back plastic color number, if selected Options, if selected (see below)

Required Selections	U.S. Price	Required to Specify
Frame Package Color Scheme <ul style="list-style-type: none"> Black Seagull Sterling dark 	No cost +\$ 63 +\$ 63	Specify <i>with black</i> . Specify <i>with seagull</i> . Specify <i>with sterling dark</i> .
Back Cover <ul style="list-style-type: none"> No back cover Fabric back cover 	No cost +\$ 41	Specify <i>with no back cover</i> . Specify <i>with fabric back cover</i> and select Cogent: Connect or Era fabric color number.
Quilted Back (Back Stitch Detail) <ul style="list-style-type: none"> No back quilting Quilted back 	No cost +\$ 26	Specify <i>with no stitch detail</i> . Specify <i>with quilted stitching</i> .

Options	U.S. Price	Required to Specify
Surface Materials <ul style="list-style-type: none"> Upholstery on seat and back Fabric price group 1 Fabric price group 2 Fabric price group 3 Fabric price group 4 Fabric price group 5 Fabric price group 6 Fabric price group 7 Fabric price group 8 Fabric price group 9 Fabric price group 10 Steelcase leather upholstery Select Surfaces leather price group 1 Elmosoft leather upholstery Select Surfaces leather price group 2 Vinyl Customer's Own Material (COM) Customer's Own Leather (COL) 	No cost +\$ 41 +\$ 70 +\$ 98 +\$126 +\$157 +\$183 +\$227 +\$279 +\$316 +\$421 +\$421 +\$504 +\$504 +\$ 41 No cost No cost	Specify fabric color number. Specify fabric color number. Specify fabric color number. Specify fabric color number. Specify fabric color number. Specify fabric color number. Specify fabric color number. Specify fabric color number. Specify fabric color number. Specify fabric color number. Specify fabric color number. Specify leather color number. ▶ See <i>Surface Materials Reference Manual</i> . Specify Elmosoft leather color number. ▶ See <i>Surface Materials Reference Manual</i> . Specify vinyl color number. ▶ See <i>Surface Materials Reference Manual</i> . ▶ See <i>Surface Materials Reference Manual</i> .
Contrasting upholstery on seat and back <ul style="list-style-type: none"> Contrasting fabrics 	+\$ 46	Specify <i>with contrasting fabrics</i> .

▶ Options, continued on next page



For Canadian Pricing
 Multiply U.S. Price by the Canadian price factor.
 ▶ See page 1 for details.

► Options, continued from previous page

Options	U.S. Price	Required to Specify
Surface Materials, continued		
Contrasting upholstery on seat		
• Fabric price group 1	No cost	Specify fabric color number.
• Fabric price group 2	+\$ 21	Specify fabric color number.
• Fabric price group 3	+\$ 35	Specify fabric color number.
• Fabric price group 4	+\$ 49	Specify fabric color number.
• Fabric price group 5	+\$ 63	Specify fabric color number.
• Fabric price group 6	+\$ 78	Specify fabric color number.
• Fabric price group 7	+\$ 92	Specify fabric color number.
• Fabric price group 8	+\$113	Specify fabric color number.
• Fabric price group 9	+\$140	Specify fabric color number.
• Fabric price group 10	+\$158	Specify fabric color number.
• Steelcase leather upholstery	+\$210	Specify leather color number.
• Select Surfaces leather price group 1	+\$210	► See <i>Surface Materials Reference Manual</i> .
• Elmosoft leather upholstery	+\$252	Specify Elmosoft leather color number.
• Select Surfaces leather price group 2	+\$252	► See <i>Surface Materials Reference Manual</i> .
• Vinyl	+\$ 21	Specify vinyl color number.
• Customer's Own Material (COM)	No cost	► See <i>Surface Materials Reference Manual</i> .
• Customer's Own Leather (COL)	No cost	► See <i>Surface Materials Reference Manual</i> .
Contrasting upholstery on back		
• Fabric price group 1	No cost	Specify fabric color number.
• Fabric price group 2	+\$ 21	Specify fabric color number.
• Fabric price group 3	+\$ 35	Specify fabric color number.
• Fabric price group 4	+\$ 49	Specify fabric color number.
• Fabric price group 5	+\$ 63	Specify fabric color number.
• Fabric price group 6	+\$ 78	Specify fabric color number.
• Fabric price group 7	+\$ 92	Specify fabric color number.
• Fabric price group 8	+\$113	Specify fabric color number.
• Fabric price group 9	+\$140	Specify fabric color number.
• Fabric price group 10	+\$158	Specify fabric color number.
• Steelcase leather upholstery	+\$210	Specify leather color number.
• Select Surfaces leather price group 1	+\$210	► See <i>Surface Materials Reference Manual</i> .
• Elmosoft leather upholstery	+\$252	Specify Elmosoft leather color number.
• Select Surfaces leather price group 2	+\$252	► See <i>Surface Materials Reference Manual</i> .
• Vinyl	+\$ 21	Specify vinyl color number.
• Customer's Own Material (COM)	No cost	► See <i>Surface Materials Reference Manual</i> .
• Customer's Own Leather (COL)	No cost	► See <i>Surface Materials Reference Manual</i> .
Upholstery on headrest		
• 3D Microknit	No cost	Specify fabric color number.
• Fabric price group 1	No cost	Specify fabric color number.
• Fabric price group 2	+\$ 3	Specify fabric color number.
• Fabric price group 3	+\$ 9	Specify fabric color number.
• Fabric price group 4	+\$ 16	Specify fabric color number.
• Fabric price group 5	+\$ 20	Specify fabric color number.
• Fabric price group 6	+\$ 23	Specify fabric color number.
• Fabric price group 7	+\$ 25	Specify fabric color number.
• Fabric price group 8	+\$ 33	Specify fabric color number.
• Fabric price group 9	+\$ 41	Specify fabric color number.
• Fabric price group 10	+\$ 47	Specify fabric color number.
• Steelcase leather upholstery	+\$ 74	Specify leather color number.
• Select Surfaces leather price group 1	+\$ 74	► See <i>Surface Materials Reference Manual</i> .
• Elmosoft leather upholstery	+\$ 84	Specify Elmosoft leather color number.
• Select Surfaces leather price group 2	+\$ 84	► See <i>Surface Materials Reference Manual</i> .
• Vinyl	+\$ 3	Specify vinyl color number.
• Customer's Own Material (COM)	No cost	► See <i>Surface Materials Reference Manual</i> .
• Customer's Own Leather (COL)	No cost	► See <i>Surface Materials Reference Manual</i> .
Soil-retardant treatment	+\$ 36	Specify with soil-retardant treatment.

► Options, continued on next page

**For Canadian Pricing**

Multiply U.S. Price by the Canadian price factor.

► See page 1 for details.

Steelcase Series 2 Work Chair, Air Back with Upholstery on Seat and Back, continued

► Options, continued from previous page

Tip: Base finish matches frame finish, unless seagull frame is selected, then black or sterling dark bases are also available.

Tip: Order black base on seagull frame for lowest maintenance.

Tip: Headrest and coat hanger can not be attached to a Steelcase Series 2 chair simultaneously.

	Options	U.S. Price	Required to Specify
Base	• Black	No cost	Specify with 6205 Black base.
	• Seagull	No cost	Specify with 7243 Seagull base.
	• Sterling dark	No cost	Specify with 7250 Sterling Dark Solid base.
	• Polished aluminum	+\$190	Specify with 8046 Polished Aluminum base.
Headrest	• Headrest	+\$160	Specify with headrest.
Coat Hanger	• Coat hanger	+\$ 45	Specify with coat hanger.
Lumbar	• No lumbar	-\$ 34	Specify with no lumbar.
Arms	• Height-only adjustable arms, soft arm caps	-\$131	Specify with height-only adjustable arms.
	• Armless	-\$302	Specify without arms.
Seat Height	• 3¼" short-range pneumatic seat-height adjustment	+\$ 82	Specify with short-range pneumatic seat-height adjustment.
	• 4¾" tall-range pneumatic seat-height adjustment	+\$ 82	Specify with tall-range pneumatic seat-height adjustment.
Casters	• Soft, dual-wheel roll-control casters for use on hard floors	+\$ 36	Specify with soft roll-control casters.
Glides	• Plastic glides	+\$ 36	Specify with glides.
CarbonNeutral Product	• CarbonNeutral product certification	+\$ 35	Add suffix CN to the end of the style number.

Specification Information

Style Number	U.S. Base Price
436UPH	\$1271



 **For Canadian Pricing**
 Multiply U.S. Price by the Canadian price factor.
 ► See page 1 for details.

Steelcase Series 2 Work Chair

Air Back with 3D Microknit and Upholstery on Seat



Tip: Plastic air back will match 3D Microknit unless contrasting is specified.

Tip: Steelcase Series 2 frame packages include inner back frame, lumbar, outer back frame, arm holsters, outer seat shell, and base.

▶ See Frame Package Color Scheme Matrix, page 155.

Standard Includes		Required to Specify
▶ Need help? Product details, page 153	<ul style="list-style-type: none"> 5" pneumatic seat-height adjustment (16½"–21½") Frame package color scheme: black Base: 6205 Black plastic Back: 3D Microknit only Air back with integrated Air LiveBack technology: plastic price groups 1 and 2 Standard upholstery design on seat: fabric price group 1 Rectilinear independent height-, width-, pivot-, and depth-adjustable arms: black plastic 2½" seat depth adjustment Height-adjustable lumbar 2½"-diameter, hard-composition, dual-wheel casters: black only 	<ol style="list-style-type: none"> Style number Back color scheme (see below under Required Selections) Frame package color scheme (see below under Required Selections) Plastic color number for base 3D Microknit color number for back Air back plastic color number Fabric color number for upholstery on seat Options, if selected (see below)

Required Selections	U.S. Price	Required to Specify
Back Color Scheme <ul style="list-style-type: none"> Non-contrasting outer back Contrasting outer back 	No cost +\$ 16	Specify with non-contrasting outer back. Specify with contrasting outer back.
Frame Package Color Scheme <ul style="list-style-type: none"> Black Seagull Sterling dark 	No cost +\$ 63 +\$ 63	Specify with black. Specify with seagull. Specify with sterling dark.

Options	U.S. Price	Required to Specify
Surface Materials		
Upholstery on seat <ul style="list-style-type: none"> Fabric price group 1 Fabric price group 2 Fabric price group 3 Fabric price group 4 Fabric price group 5 Fabric price group 6 Fabric price group 7 Fabric price group 8 Fabric price group 9 Fabric price group 10 Steelcase leather upholstery Select Surfaces leather price group 1 Elmosoft leather upholstery Select Surfaces leather price group 2 Vinyl Customer's Own Material (COM) Customer's Own Leather (COL) 	No cost +\$ 21 +\$ 35 +\$ 49 +\$ 63 +\$ 78 +\$ 92 +\$113 +\$140 +\$158 +\$210 +\$210 +\$252 +\$252 No cost No cost	Specify fabric color number. Specify fabric color number. Specify fabric color number. Specify fabric color number. Specify fabric color number. Specify fabric color number. Specify fabric color number. Specify fabric color number. Specify fabric color number. Specify fabric color number. Specify leather color number. ▶ See Surface Materials Reference Manual. Specify Elmosoft leather color number. ▶ See Surface Materials Reference Manual. Specify vinyl color number. ▶ See Surface Materials Reference Manual. ▶ See Surface Materials Reference Manual.
Upholstery on headrest <ul style="list-style-type: none"> 3D Microknit Fabric price group 1 Fabric price group 2 Fabric price group 3 Fabric price group 4 Fabric price group 5 Fabric price group 6 Fabric price group 7 Fabric price group 8 Fabric price group 9 Fabric price group 10 Steelcase leather upholstery Select Surfaces leather price group 1 Elmosoft leather upholstery Select Surfaces leather price group 2 Vinyl Customer's Own Material (COM) Customer's Own Leather (COL) 	No cost No cost +\$ 3 +\$ 9 +\$ 16 +\$ 20 +\$ 23 +\$ 25 +\$ 33 +\$ 41 +\$ 47 +\$ 74 +\$ 74 +\$ 84 +\$ 84 +\$ 3 No cost No cost	Specify fabric color number. Specify fabric color number. Specify fabric color number. Specify fabric color number. Specify fabric color number. Specify fabric color number. Specify fabric color number. Specify fabric color number. Specify fabric color number. Specify fabric color number. Specify leather color number. ▶ See Surface Materials Reference Manual. Specify Elmosoft leather color number. ▶ See Surface Materials Reference Manual. Specify vinyl color number. ▶ See Surface Materials Reference Manual. ▶ See Surface Materials Reference Manual.
Soil-retardant treatment	+\$ 36	Specify with soil-retardant treatment.

▶ Options, continued on next page



For Canadian Pricing
Multiply U.S. Price by the Canadian price factor.
▶ See page 1 for details.

► Options, continued from previous page

	Options	U.S. Price	Required to Specify
Base	• Black	No cost	Specify with 6205 Black base.
	• Seagull	No cost	Specify with 7243 Seagull base.
	• Sterling dark	No cost	Specify with 7250 Sterling Dark Solid base.
	• Polished aluminum	+\$190	Specify with 8046 Polished Aluminum base.
Headrest	• Headrest	+\$160	Specify with headrest.
Coat Hanger	• Coat hanger	+\$ 45	Specify with coat hanger.
Lumbar	• No lumbar	-\$ 34	Specify with no lumbar.
Arms	• Height-only adjustable arms, soft arm caps	-\$131	Specify with height-only adjustable arms.
	• Armless	-\$302	Specify without arms.
Seat Height	• 3¼" short-range pneumatic seat-height adjustment	+\$ 82	Specify with short-range pneumatic seat-height adjustment.
	• 4¾" tall-range pneumatic seat-height adjustment	+\$ 82	Specify with tall-range pneumatic seat-height adjustment.
Casters	• Soft, dual-wheel roll-control casters for use on hard floors	+\$ 36	Specify with soft roll-control casters.
Glides	• Plastic glides	+\$ 36	Specify with glides.
CarbonNeutral Product	• CarbonNeutral product certification	+\$ 35	Add suffix CN to the end of the style number.

Tip: Base finish matches frame finish, unless seagull frame is selected, then black or sterling dark bases are also available.

Tip: Order black base on seagull frame for lowest maintenance.

Tip: Headrest and coat hanger can not be attached to a Steelcase Series 2 chair simultaneously.

Specification Information

Style Number	U.S. Base Price
436AIR3D	\$1204



 **For Canadian Pricing**
Multiply U.S. Price by the Canadian price factor.
► See page 1 for details.

Steelcase Series 2 Work Chair

Air Back with Upholstery on Seat



Tip: Steelcase Series 2 frame packages include inner back frame, lumbar, outer back frame, arm holsters, outer seat shell, and base.

▶ See *Frame Package Color Scheme Matrix*, page 155.

Standard Includes		Required to Specify
▶ Need help? Product details, page 153	<ul style="list-style-type: none"> 5" pneumatic seat-height adjustment (16½"–21½") Frame package color scheme: black Base: 6205 Black plastic Rectilinear independent height-, width-, pivot-, and depth-adjustable arms and soft arm caps: black plastic 2½" seat depth adjustment Air back with integrated Air LiveBack technology: plastic price groups 1 and 2 Standard upholstery design on seat: fabric price group 1 2½"-diameter, hard-composition, dual-wheel casters: black only 	<ol style="list-style-type: none"> Style number Frame package color scheme (see below under Required Selections) Plastic color number for base Air back plastic color number Fabric color number for upholstery on seat Options, if selected (see below)

Required Selections	U.S. Price	Required to Specify
Frame Package Color Scheme		
• Black	No cost	Specify with <i>black</i> .
• Seagull	+\$ 63	Specify with <i>seagull</i> .
• Sterling dark	+\$ 63	Specify with <i>sterling dark</i> .

Options	U.S. Price	Required to Specify
Surface Materials		
Upholstery on seat		
• Fabric price group 1	No cost	Specify fabric color number.
• Fabric price group 2	+\$ 21	Specify fabric color number.
• Fabric price group 3	+\$ 35	Specify fabric color number.
• Fabric price group 4	+\$ 49	Specify fabric color number.
• Fabric price group 5	+\$ 63	Specify fabric color number.
• Fabric price group 6	+\$ 78	Specify fabric color number.
• Fabric price group 7	+\$ 92	Specify fabric color number.
• Fabric price group 8	+\$113	Specify fabric color number.
• Fabric price group 9	+\$140	Specify fabric color number.
• Fabric price group 10	+\$158	Specify fabric color number.
• Steelcase leather upholstery	+\$210	Specify leather color number.
• Select Surfaces leather price group 1	+\$210	▶ See <i>Surface Materials Reference Manual</i> . Specify Elmosoft leather color number.
• Elmosoft leather upholstery	+\$252	▶ See <i>Surface Materials Reference Manual</i> . Specify vinyl color number.
• Select Surfaces leather price group 2	+\$252	▶ See <i>Surface Materials Reference Manual</i> . Specify vinyl color number.
• Vinyl	+\$ 21	
• Customer's Own Material (COM)	No cost	
• Customer's Own Leather (COL)	No cost	
Upholstery on headrest		
• 3D Microknit	No cost	Specify fabric color number.
• Fabric price group 1	No cost	Specify fabric color number.
• Fabric price group 2	+\$ 3	Specify fabric color number.
• Fabric price group 3	+\$ 9	Specify fabric color number.
• Fabric price group 4	+\$ 16	Specify fabric color number.
• Fabric price group 5	+\$ 20	Specify fabric color number.
• Fabric price group 6	+\$ 23	Specify fabric color number.
• Fabric price group 7	+\$ 25	Specify fabric color number.
• Fabric price group 8	+\$ 33	Specify fabric color number.
• Fabric price group 9	+\$ 41	Specify fabric color number.
• Fabric price group 10	+\$ 47	Specify fabric color number.
• Steelcase leather upholstery	+\$ 74	Specify leather color number.
• Select Surfaces leather price group 1	+\$ 74	▶ See <i>Surface Materials Reference Manual</i> . Specify Elmosoft leather color number.
• Elmosoft leather upholstery	+\$ 84	▶ See <i>Surface Materials Reference Manual</i> . Specify vinyl color number.
• Select Surfaces leather price group 2	+\$ 84	▶ See <i>Surface Materials Reference Manual</i> . Specify vinyl color number.
• Vinyl	+\$ 3	
• Customer's Own Material (COM)	No cost	
• Customer's Own Leather (COL)	No cost	
Soil-retardant treatment	+\$ 36	Specify with <i>soil-retardant treatment</i> .

▶ Options, continued on next page



For Canadian Pricing

Multiply U.S. Price by the Canadian price factor.

▶ See page 1 for details.

► Options, continued from previous page

Tip: Base finish matches frame finish, unless seagull frame is selected, then black or sterling dark bases are also available.

Tip: Order black base on seagull frame for lowest maintenance.

Tip: Headrest and coat hanger can not be attached to a Steelcase Series 2 chair simultaneously.

Options	U.S. Price	Required to Specify
Base <ul style="list-style-type: none"> Black Seagull Sterling dark Polished aluminum 	No cost No cost No cost +\$190	Specify with 6205 Black base. Specify with 7243 Seagull base. Specify with 7250 Sterling Dark Solid base. Specify with 8046 Polished Aluminum base.
Headrest <ul style="list-style-type: none"> Headrest 	+\$160	Specify with headrest.
Coat Hanger <ul style="list-style-type: none"> Coat hanger 	+\$ 45	Specify with coat hanger.
Arms <ul style="list-style-type: none"> Height-only adjustable arms, soft arm caps Armless 	-\$131 -\$302	Specify with height-only adjustable arms. Specify without arms.
Seat Height <ul style="list-style-type: none"> 3¼" short-range pneumatic seat-height adjustment 4¾" tall-range pneumatic seat-height adjustment 	+\$ 82 +\$ 82	Specify with short-range pneumatic seat-height adjustment. Specify with tall-range pneumatic seat-height adjustment.
Casters <ul style="list-style-type: none"> Soft, dual-wheel roll-control casters for use on hard floors 	+\$ 36	Specify with soft roll-control casters.
Glides <ul style="list-style-type: none"> Plastic glides 	+\$ 36	Specify with glides.
CarbonNeutral Product <ul style="list-style-type: none"> CarbonNeutral product certification 	+\$ 35	Add suffix CN to the end of the style number.

Specification Information

Style Number	U.S. Base Price
436AIR	\$1137



 **For Canadian Pricing**
 Multiply U.S. Price by the Canadian price factor.
 ► See page 1 for details.

Steelcase Series 2 Stool

Air Back with Upholstery on Seat and Back

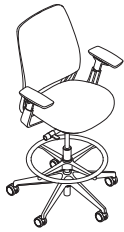

Standard Includes		Required to Specify
<ul style="list-style-type: none"> ▶ Need help? Product details, page 153 	<ul style="list-style-type: none"> • 7³/₄" pneumatic seat-height adjustment (23"-30³/₄" • Frame package color scheme: black • Base: 6205 Black plastic • Standard upholstery design on seat and back: fabric price group 1 • Air back with integrated live Air LiveBack technology: plastic price groups 1 and 2 • Rectilinear independent height-, width-, pivot-, and depth-adjustable arms and soft arm caps: black plastic • 2¹/₂" seat depth adjustment • Height-adjustable lumbar • Column and adjustable foot ring: black paint • 2¹/₂" diameter, hard-composition, dual-wheel casters: black only 	<ol style="list-style-type: none"> 1 Style number 2 Frame package color scheme (see below under Required Selections) 3 Plastic color number for base 4 Back cover (see below under Required Selections) 5 Quilted back (see below under Required Selections) 6 Fabric color number for upholstery on seat and back 7 Air back plastic color number, if selected 8 Options, if selected (see below)

Tip: Steelcase Series 2 frame packages include inner back frame, lumbar, outer back frame, arm holsters, outer seat shell, and base.

▶ See *Frame Package Color Scheme Matrix*, page 155.

Tip: When quilted back is selected, sewn seat is defaulted.

Tip: When back cover is selected, air back plastic color is automatically black because air back is not visible.

	Required Selections	U.S. Price	Required to Specify
Frame Package Color Scheme	<ul style="list-style-type: none"> • Black • Seagull • Sterling dark 	<p>No cost</p> <p>+\$ 63</p> <p>+\$ 63</p>	<p>Specify with <i>black</i>.</p> <p>Specify with <i>seagull</i>.</p> <p>Specify with <i>sterling dark</i>.</p>
Back Cover	<ul style="list-style-type: none"> • No back cover • Fabric back cover 	<p>No cost</p> <p>+\$ 41</p>	<p>Specify with <i>no back cover</i>.</p> <p>Specify with <i>fabric back cover</i> and select Cogent: Connect or Era fabric color number.</p>
Quilted Back (Back Stitch Detail)	<ul style="list-style-type: none"> • No back quilting • Quilted back 	<p>No cost</p> <p>+\$ 26</p>	<p>Specify with <i>no stitch detail</i>.</p> <p>Specify with <i>quilted stitching</i>.</p>

	Options	U.S. Price	Required to Specify
Surface Materials	<p>Upholstery on seat and back</p> <ul style="list-style-type: none"> • Fabric price group 1 • Fabric price group 2 • Fabric price group 3 • Fabric price group 4 • Fabric price group 5 • Fabric price group 6 • Fabric price group 7 • Fabric price group 8 • Fabric price group 9 • Fabric price group 10 • Steelcase leather upholstery • Select Surfaces leather price group 1 • Elmosoft leather upholstery • Select Surfaces leather price group 2 • Vinyl • Customer's Own Material (COM) • Customer's Own Leather (COL) <p>Contrasting upholstery on seat and back</p> <ul style="list-style-type: none"> • Contrasting fabrics 	<p>No cost</p> <p>+\$ 41</p> <p>+\$ 70</p> <p>+\$ 98</p> <p>+\$126</p> <p>+\$157</p> <p>+\$183</p> <p>+\$227</p> <p>+\$279</p> <p>+\$316</p> <p>+\$421</p> <p>+\$421</p> <p>+\$504</p> <p>+\$504</p> <p>+\$ 41</p> <p>No cost</p> <p>No cost</p> <p>+\$ 46</p>	<p>Specify fabric color number.</p> <p>Specify fabric color number.</p> <p>Specify fabric color number.</p> <p>Specify fabric color number.</p> <p>Specify fabric color number.</p> <p>Specify fabric color number.</p> <p>Specify fabric color number.</p> <p>Specify fabric color number.</p> <p>Specify fabric color number.</p> <p>Specify fabric color number.</p> <p>Specify fabric color number.</p> <p>Specify leather color number.</p> <p>▶ See <i>Surface Materials Reference Manual</i>. Specify Elmosoft leather color number.</p> <p>▶ See <i>Surface Materials Reference Manual</i>. Specify vinyl color number.</p> <p>▶ See <i>Surface Materials Reference Manual</i>.</p> <p>▶ See <i>Surface Materials Reference Manual</i>.</p> <p>Specify with <i>contrasting fabrics</i>.</p>

▶ Options, continued on next page



For Canadian Pricing
 Multiply U.S. Price by the Canadian price factor.
 ▶ See page 1 for details.

► Options, continued from previous page

Options	U.S. Price	Required to Specify
Surface Materials, continued		
Contrasting upholstery on seat		
• Fabric price group 1	No cost	Specify fabric color number.
• Fabric price group 2	+\$ 21	Specify fabric color number.
• Fabric price group 3	+\$ 35	Specify fabric color number.
• Fabric price group 4	+\$ 49	Specify fabric color number.
• Fabric price group 5	+\$ 63	Specify fabric color number.
• Fabric price group 6	+\$ 78	Specify fabric color number.
• Fabric price group 7	+\$ 92	Specify fabric color number.
• Fabric price group 8	+\$113	Specify fabric color number.
• Fabric price group 9	+\$140	Specify fabric color number.
• Fabric price group 10	+\$158	Specify fabric color number.
• Steelcase leather upholstery	+\$210	Specify leather color number.
• Select Surfaces leather price group 1	+\$210	► See <i>Surface Materials Reference Manual</i> .
• Elmosoft leather upholstery	+\$252	Specify Elmosoft leather color number.
• Select Surfaces leather price group 2	+\$252	► See <i>Surface Materials Reference Manual</i> .
• Vinyl	+\$ 21	Specify vinyl color number.
• Customer's Own Material (COM)	No cost	► See <i>Surface Materials Reference Manual</i> .
• Customer's Own Leather (COL)	No cost	► See <i>Surface Materials Reference Manual</i> .
Contrasting upholstery on back		
• Fabric price group 1	No cost	Specify fabric color number.
• Fabric price group 2	+\$ 21	Specify fabric color number.
• Fabric price group 3	+\$ 35	Specify fabric color number.
• Fabric price group 4	+\$ 49	Specify fabric color number.
• Fabric price group 5	+\$ 63	Specify fabric color number.
• Fabric price group 6	+\$ 78	Specify fabric color number.
• Fabric price group 7	+\$ 92	Specify fabric color number.
• Fabric price group 8	+\$113	Specify fabric color number.
• Fabric price group 9	+\$140	Specify fabric color number.
• Fabric price group 10	+\$158	Specify fabric color number.
• Steelcase leather upholstery	+\$210	Specify leather color number.
• Select Surfaces leather price group 1	+\$210	► See <i>Surface Materials Reference Manual</i> .
• Elmosoft leather upholstery	+\$252	Specify Elmosoft leather color number.
• Select Surfaces leather price group 2	+\$252	► See <i>Surface Materials Reference Manual</i> .
• Vinyl	+\$ 21	Specify vinyl color number.
• Customer's Own Material (COM)	No cost	► See <i>Surface Materials Reference Manual</i> .
• Customer's Own Leather (COL)	No cost	► See <i>Surface Materials Reference Manual</i> .
Upholstery on headrest		
• 3D Microknit	No cost	Specify fabric color number.
• Fabric price group 1	No cost	Specify fabric color number.
• Fabric price group 2	+\$ 3	Specify fabric color number.
• Fabric price group 3	+\$ 9	Specify fabric color number.
• Fabric price group 4	+\$ 16	Specify fabric color number.
• Fabric price group 5	+\$ 20	Specify fabric color number.
• Fabric price group 6	+\$ 23	Specify fabric color number.
• Fabric price group 7	+\$ 25	Specify fabric color number.
• Fabric price group 8	+\$ 33	Specify fabric color number.
• Fabric price group 9	+\$ 41	Specify fabric color number.
• Fabric price group 10	+\$ 47	Specify fabric color number.
• Steelcase leather upholstery	+\$ 74	Specify leather color number.
• Select Surfaces leather price group 1	+\$ 74	► See <i>Surface Materials Reference Manual</i> .
• Elmosoft leather upholstery	+\$ 84	Specify Elmosoft leather color number.
• Select Surfaces leather price group 2	+\$ 84	► See <i>Surface Materials Reference Manual</i> .
• Vinyl	+\$ 3	Specify vinyl color number.
• Customer's Own Material (COM)	No cost	► See <i>Surface Materials Reference Manual</i> .
• Customer's Own Leather (COL)	No cost	► See <i>Surface Materials Reference Manual</i> .
Soil-retardant treatment	+\$ 36	Specify with soil-retardant treatment.

► Options, continued on next page

**For Canadian Pricing**

Multiply U.S. Price by the Canadian price factor.

► See page 1 for details.

Steelcase Series 2 Stool, Air Back with Upholstery on Seat and Back, continued

► Options, continued from previous page

	Options	U.S. Price	Required to Specify
Base	• Black	No cost	Specify with 6205 Black base.
	• Seagull	No cost	Specify with 7243 Seagull base.
	• Sterling dark	No cost	Specify with 7250 Sterling Dark Solid base.
	• Polished aluminum base	+\$190	Specify with 8046 Polished Aluminum base.
Headrest	• Headrest	+\$160	Specify with headrest.
Coat Hanger	• Coat hanger	+\$ 45	Specify with coat hanger.
Lumbar	• No lumbar	-\$ 34	Specify with no lumbar.
Arms	• Height-only adjustable arms, soft arm caps	-\$131	Specify with height-only adjustable arms.
	• Armless	-\$302	Specify without arms.
Casters	• Soft, dual-wheel roll-control casters for use on hard floors	+\$ 36	Specify with soft roll-control casters.
Glides	• Plastic glides	+\$ 36	Specify with glides.
CarbonNeutral Product	• CarbonNeutral product certification	+\$ 35	Add suffix CN to the end of the style number.

Tip: Base finish matches frame finish, unless seagull frame is selected, then black or sterling dark bases are also available.

Tip: Order black base on seagull frame for lowest maintenance.

Tip: Headrest and coat hanger can not be attached to a Steelcase Series 2 chair simultaneously.

Specification Information

• Style Number	• U.S. Base Price
436UPHSTOOL	\$1524

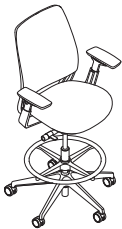

For Canadian Pricing

Multiply U.S. Price by the Canadian price factor.

► See page 1 for details.

Steelcase Series 2 Stool

Air Back with 3D Microknit and Upholstery on Seat

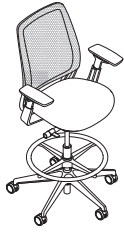

Tip: Plastic air back will match 3D Microknit unless contrasting is specified.

Tip: Steelcase Series 2 frame packages include inner back frame, lumbar, outer back frame, arm holsters, outer seat shell, and base.

► See Frame Package Color Scheme Matrix, page 155.

 **For Canadian Pricing**
Multiply U.S. Price by the Canadian price factor.
► See page 1 for details.

Standard Includes		Required to Specify
► Need help? Product details, page 153	<ul style="list-style-type: none"> 7³/₄" pneumatic seat-height adjustment (23"-30³/₄") Frame package color scheme: black Base: 6205 Black plastic Back: 3D Microknit only Air back with integrated Air LiveBack technology: plastic price groups 1 and 2 Standard upholstery design on seat: fabric price group 1 Rectilinear independent height-, width-, pivot-, and depth-adjustable arms and soft arm caps: black plastic 2¹/₂" seat depth adjustment Height-adjustable lumbar Column and adjustable foot ring: black paint 2¹/₂"-diameter, hard-composition, dual-wheel casters: black only 	<ol style="list-style-type: none"> Style number Back color scheme (see below under Required Selections) Frame package color scheme (see below under Required Selections) Plastic color number for base 3D Microknit color number for back Air back plastic color number. Fabric color number for upholstery on seat Options, if selected (see below)

Required Selections	U.S. Price	Required to Specify
Back Color Scheme <ul style="list-style-type: none"> Non-contrasting outer back Contrasting outer back 	No cost +\$ 16	Specify with non-contrasting outer back. Specify with contrasting outer back.
Frame Package Color Scheme <ul style="list-style-type: none"> Black Seagull Sterling dark 	No cost +\$ 63 +\$ 63	Specify with black. Specify with seagull. Specify with sterling dark.

Options	U.S. Price	Required to Specify
Surface Materials		
Upholstery on seat <ul style="list-style-type: none"> Fabric price group 1 Fabric price group 2 Fabric price group 3 Fabric price group 4 Fabric price group 5 Fabric price group 6 Fabric price group 7 Fabric price group 8 Fabric price group 9 Fabric price group 10 Steelcase leather upholstery Select Surfaces leather price group 1 Elmosoft leather upholstery Select Surfaces leather price group 2 Vinyl Customer's Own Material (COM) Customer's Own Leather (COL) 	No cost +\$ 21 +\$ 35 +\$ 49 +\$ 63 +\$ 78 +\$ 92 +\$113 +\$140 +\$158 +\$210 +\$210 +\$252 +\$252 +\$ 21 No cost No cost	Specify fabric color number. Specify fabric color number. Specify fabric color number. Specify fabric color number. Specify fabric color number. Specify fabric color number. Specify fabric color number. Specify fabric color number. Specify fabric color number. Specify fabric color number. Specify fabric color number. Specify leather color number. ► See Surface Materials Reference Manual. Specify Elmosoft leather color number. ► See Surface Materials Reference Manual. Specify vinyl color number. ► See Surface Materials Reference Manual. ► See Surface Materials Reference Manual.
Upholstery on headrest <ul style="list-style-type: none"> 3D Microknit Fabric price group 1 Fabric price group 2 Fabric price group 3 Fabric price group 4 Fabric price group 5 Fabric price group 6 Fabric price group 7 Fabric price group 8 Fabric price group 9 Fabric price group 10 Steelcase leather upholstery Select Surfaces leather price group 1 Elmosoft leather upholstery Select Surfaces leather price group 2 Vinyl Customer's Own Material (COM) Customer's Own Leather (COL) 	No cost No cost +\$ 3 +\$ 9 +\$ 16 +\$ 20 +\$ 23 +\$ 25 +\$ 33 +\$ 41 +\$ 47 +\$ 74 +\$ 74 +\$ 84 +\$ 84 +\$ 3 No cost No cost	Specify fabric color number. Specify fabric color number. Specify fabric color number. Specify fabric color number. Specify fabric color number. Specify fabric color number. Specify fabric color number. Specify fabric color number. Specify fabric color number. Specify fabric color number. Specify fabric color number. Specify leather color number. ► See Surface Materials Reference Manual. Specify Elmosoft leather color number. ► See Surface Materials Reference Manual. Specify vinyl color number. ► See Surface Materials Reference Manual. ► See Surface Materials Reference Manual.
Soil-retardant treatment	+\$ 36	Specify with soil-retardant treatment.

► Options, continued on next page

► Options, continued from previous page

Options	U.S. Price	Required to Specify
Base <ul style="list-style-type: none"> Black Seagull Sterling dark Polished aluminum 	No cost No cost No cost +\$190	Specify with 6205 Black base. Specify with 7243 Seagull base. Specify with 7250 Sterling Dark Solid base. Specify with 8046 Polished Aluminum base.
Headrest <ul style="list-style-type: none"> Headrest 	+\$160	Specify with headrest.
Coat Hanger <ul style="list-style-type: none"> Coat hanger 	+\$ 45	Specify with coat hanger.
Lumbar <ul style="list-style-type: none"> No lumbar 	-\$ 34	Specify with no lumbar.
Arms <ul style="list-style-type: none"> Height-only adjustable arms, soft arm caps Armless 	-\$131 -\$302	Specify with height-only adjustable arms. Specify without arms.
Casters <ul style="list-style-type: none"> Soft, dual-wheel roll-control casters for use on hard floors 	+\$ 36	Specify with soft roll-control casters.
Glides <ul style="list-style-type: none"> Plastic glides 	+\$ 36	Specify with glides.
CarbonNeutral Product <ul style="list-style-type: none"> CarbonNeutral product certification 	+\$ 35	Add suffix CN to the end of the style number.

Tip: Base finish matches frame finish, unless seagull frame is selected, then black or sterling dark bases are also available.

Tip: Order black base on seagull frame for lowest maintenance.

Tip: Headrest and coat hanger can not be attached to a Steelcase Series 2 chair simultaneously.

Specification Information

Style Number	U.S. Base Price
436AIR3DSTOOL	\$1458



For Canadian Pricing
 Multiply U.S. Price by the Canadian price factor.
 ► See page 1 for details.

Steelcase Series 2 Stool

Air Back with Upholstery on Seat



Tip: Steelcase Series 2 frame packages include inner back frame, lumbar, outer back frame, arm holsters, outer seat shell, and base.

▶ See *Frame Package Color Scheme Matrix*, page 155.

Tip: Stool ring is always black for lower cleaning maintenance.

Standard Includes		Required to Specify
▶ Need help? Product details, page 153	<ul style="list-style-type: none"> 7³/₄" pneumatic seat-height adjustment (23"-30³/₄") Frame package color scheme: black Base: 6205 Black plastic Rectilinear independent height-, width-, pivot-, and depth-adjustable arms and soft arm caps: black plastic 2¹/₂" seat depth adjustment Column and adjustable foot ring: black paint Air back with integrated live Air LiveBack technology: plastic price groups 1 and 2 Standard upholstery design on seat: fabric price group 1 2¹/₂"-diameter, hard-composition, dual-wheel casters: black only 	<ol style="list-style-type: none"> 1 Style number 2 Frame package color scheme (see below under Required Selections) 3 Plastic color number for base 4 Air back plastic color number 5 Fabric color number for upholstery on seat 6 Options, if selected (see below)

Required Selections	U.S. Price	Required to Specify
Frame Package Color Scheme		
• Black	No cost	Specify <i>with black</i> .
• Seagull	+\$ 63	Specify <i>with seagull</i> .
• Sterling dark	+\$ 63	Specify <i>with sterling dark</i> .

Options	U.S. Price	Required to Specify
Surface Materials		
Upholstery on seat		
• Fabric price group 1	No cost	Specify fabric color number.
• Fabric price group 2	+\$ 21	Specify fabric color number.
• Fabric price group 3	+\$ 35	Specify fabric color number.
• Fabric price group 4	+\$ 49	Specify fabric color number.
• Fabric price group 5	+\$ 63	Specify fabric color number.
• Fabric price group 6	+\$ 78	Specify fabric color number.
• Fabric price group 7	+\$ 92	Specify fabric color number.
• Fabric price group 8	+\$113	Specify fabric color number.
• Fabric price group 9	+\$140	Specify fabric color number.
• Fabric price group 10	+\$158	Specify fabric color number.
• Steelcase leather upholstery	+\$210	Specify leather color number.
• Select Surfaces leather price group 1	+\$210	▶ See <i>Surface Materials Reference Manual</i> .
• Elmosoft leather upholstery	+\$252	Specify Elmosoft leather color number.
• Select Surfaces leather price group 2	+\$252	▶ See <i>Surface Materials Reference Manual</i> .
• Vinyl	+\$ 21	Specify vinyl color number.
• Customer's Own Material (COM)	No cost	▶ See <i>Surface Materials Reference Manual</i> .
• Customer's Own Leather (COL)	No cost	▶ See <i>Surface Materials Reference Manual</i> .

Upholstery on headrest		
• 3D Microknit	No cost	Specify fabric color number.
• Fabric price group 1	No cost	Specify fabric color number.
• Fabric price group 2	+\$ 3	Specify fabric color number.
• Fabric price group 3	+\$ 9	Specify fabric color number.
• Fabric price group 4	+\$ 16	Specify fabric color number.
• Fabric price group 5	+\$ 20	Specify fabric color number.
• Fabric price group 6	+\$ 23	Specify fabric color number.
• Fabric price group 7	+\$ 25	Specify fabric color number.
• Fabric price group 8	+\$ 33	Specify fabric color number.
• Fabric price group 9	+\$ 41	Specify fabric color number.
• Fabric price group 10	+\$ 47	Specify fabric color number.
• Steelcase leather upholstery	+\$ 74	Specify leather color number.
• Select Surfaces leather price group 1	+\$ 74	▶ See <i>Surface Materials Reference Manual</i> .
• Elmosoft leather upholstery	+\$ 84	Specify Elmosoft leather color number.
• Select Surfaces leather price group 2	+\$ 84	▶ See <i>Surface Materials Reference Manual</i> .
• Vinyl	+\$ 3	Specify vinyl color number.
• Customer's Own Material (COM)	No cost	▶ See <i>Surface Materials Reference Manual</i> .
• Customer's Own Leather (COL)	No cost	▶ See <i>Surface Materials Reference Manual</i> .

Soil-retardant treatment	+\$ 36	Specify <i>with soil-retardant treatment</i> .
---------------------------------	--------	--

▶ Options, continued on next page



For Canadian Pricing

Multiply U.S. Price by the Canadian price factor.

▶ See page 1 for details.

► Options, continued from previous page

Options	U.S. Price	Required to Specify
Base		
• Black	No cost	Specify with 6205 Black base.
• Seagull	No cost	Specify with 7243 Seagull base.
• Sterling dark	No cost	Specify with 7250 Sterling Dark Solid base.
• Polished aluminum	+\$190	Specify with 8046 Polished Aluminum base.
Headrest		
• Headrest	+\$160	Specify with headrest.
Coat Hanger		
• Coat hanger	+\$ 45	Specify with coat hanger.
Arms		
• Height-only adjustable arms, soft arm caps	-\$131	Specify with height-only adjustable arms.
• Armless	-\$302	Specify without arms.
Casters		
• Soft, dual-wheel roll-control casters for use on hard floors	+\$ 36	Specify with soft roll-control casters.
Glides		
• Plastic glides	+\$ 36	Specify with glides.
CarbonNeutral Product		
• CarbonNeutral product certification	+\$ 35	Add suffix CN to the end of the style number.

Tip: Base finish matches frame finish, unless seagull frame is selected, then black or sterling dark bases are also available.

Tip: Order black base on seagull frame for lowest maintenance.

Tip: Headrest and coat hanger can not be attached to a Steelcase Series 2 chair simultaneously.

Specification Information

Style Number	U.S. Base Price
436AIRSTOOL	\$1390



 **For Canadian Pricing**
Multiply U.S. Price by the Canadian price factor.
► See page 1 for details.

Steelcase Series 2 Accessories

Series 2 Coat Hanger



Standard Includes	Required to Specify
<ul style="list-style-type: none"> ▶ Need help? Product details, page 180 • Coat hanger color scheme: black 	<ul style="list-style-type: none"> 1 Style number 2 Coat hanger color scheme (see below under Required Selections)

Tip: Headrest and coat hanger can not be attached to a Steelcase Series 2 chair simultaneously.

Tip: Stand alone add on accessories are not available with CarbonNeutral product certification.

Required Selections	U.S. Price	Required to Specify
Coat Hanger Color Scheme <ul style="list-style-type: none"> • Black • Seagull • Sterling dark 	<ul style="list-style-type: none"> No cost No cost No cost 	<ul style="list-style-type: none"> Specify <i>with black</i>. Specify <i>with seagull</i>. Specify <i>with sterling dark</i>.

Specification Information	
• Style Number	• U.S. Price
436COATHANGER	\$45
•	•



For Canadian Pricing
 Multiply U.S. Price by the Canadian price factor.
 ▶ See page 1 for details.

Series 2 Headrest



Tip: Headrest and coat hanger can not be attached to a Steelcase Series 2 chair simultaneously.

Tip: Stand alone add on accessories are not available with CarbonNeutral product certification.

Standard Includes	Required to Specify
-------------------	---------------------

- | | |
|--|---|
| <ul style="list-style-type: none"> • Headrest: fabric price group 1 | <ol style="list-style-type: none"> 1 Style number 2 Headrest frame color scheme (see below under Required Selections) 3 Fabric color number for headrest 4 Options, if selected |
|--|---|

Required Selections	U.S. Price	Required to Specify
---------------------	------------	---------------------

Headrest Frame Color Scheme <ul style="list-style-type: none"> • Black • Seagull • Sterling dark 	No cost No cost No cost	Specify <i>with black</i> . Specify <i>with seagull</i> . Specify <i>with sterling dark</i> .
--	-------------------------------	---

Options	U.S. Price	Required to Specify
---------	------------	---------------------

Surface Materials	Upholstery <ul style="list-style-type: none"> • 3D Microknit • Fabric price group 1 • Fabric price group 2 • Fabric price group 3 • Fabric price group 4 • Fabric price group 5 • Fabric price group 6 • Fabric price group 7 • Fabric price group 8 • Fabric price group 9 • Fabric price group 10 • Steelcase leather upholstery • Select Surfaces leather price group 1 • Elmosoft leather upholstery • Select Surfaces leather price group 2 • Vinyl • Customer's Own Material (COM) • Customer's Own Leather (COL) 	No cost No cost +\$ 3 +\$ 9 +\$16 +\$20 +\$23 +\$25 +\$33 +\$41 +\$47 +\$74 +\$74 +\$84 +\$84 +\$ 3 No cost No cost	Specify fabric color number. Specify fabric color number. Specify fabric color number. Specify fabric color number. Specify fabric color number. Specify fabric color number. Specify fabric color number. Specify fabric color number. Specify fabric color number. Specify fabric color number. Specify leather color number. ▶ See <i>Surface Materials Reference Manual</i> . Specify Elmosoft leather color number. ▶ See <i>Surface Materials Reference Manual</i> . Specify vinyl color number. ▶ See <i>Surface Materials Reference Manual</i> . ▶ See <i>Surface Materials Reference Manual</i> .
	Soil-retardant treatment	+\$ 9	Specify <i>with soil-retardant treatment</i> .

Specification Information	
Style Number	U.S. Base Price

436HEADREST	\$160
-------------	-------

For Canadian Pricing
 Multiply U.S. Price by the Canadian price factor.
 ▶ See page 1 for details.



Understanding and Specifying Steelcase Series 1 Work Chairs

Product Details

Steelcase Series 1	180
Steelcase Series 1 Upholstery	184
Dimensions	186

Specifying

Work Chair

3D Microknit Back with Standard Upholstery on Seat	188
Air Back with Standard Upholstery on Seat	179

Stool

3D Microknit Back with Standard Upholstery on Seat	192
Air Back with Standard Upholstery on Seat	193

Accessories

196

Work Chairs

Highly adjustable task seating offers maximum personalization for fit and comfort for a range of duration and use. By making a series of simple adjustments, you can customize the chair to your body, preferences, and tasks. These chairs provide continuous, stable, comfort, and can be quickly adjusted to support you in upright, and reclining work postures.

- Gesture 442 Series
- Leap 462 Series
- Think 465 Series
- Amia 482 Series
- Reply 466 Series

Adjustability Features

► See page 26 for a comparison to other chairs. **Steelcase Series 1**

Mechanisms

Weight-activated ●

Seat Adjustments

Pneumatic height ●

Seat depth ●

Back Adjustments

Lumbar height ●

Arm Adjustments

Arm height ●

Arm width ●

Arm pivot ●

Arm depth ●

Other Features

Foot ring height (stool) ●

Steelcase Series 1



Now available as a CarbonNeutral product, making sure our commitment to a more sustainable future helps yours too.

Essential ergonomics –

Steelcase Series 1 provides essential ergonomics at a great value, complete with our signature quality. This exceptional entry point into high-performance seating is characterized by space efficiency, weight-activated controls, and a supportive seat.

Back frame and seat shell are plastic.

Lumbar height adjusts over 2 1/4" to provide additional lower back support.

Arm caps can pivot independently 40° inward and 40° outward to accommodate individual user preferences.

Seat height adjusts within a 5" range with a pneumatic adjustment mechanism. Short or tall range is available as an option. Stools have a 7 3/4" range.

Comfort dial back control provides three settings for the user's personal preference and work style.

Casters have hard, dual-wheels that roll smoothly on carpets. They are 2 1/2" for increased mobility. Soft, dual-wheel roll-control casters are available as an option for use on hard floors or chair mats. Glides are also available as an option.

Tip: Do not roll the chair across asphalt during installation as this may damage the casters.

Arm height can adjust independently within a 5" range to help relieve upper back and shoulder fatigue.

Arm width adjusts 4" overall to support forearms in neutral position.

Arm depth can retract 2" to allow user to get closer to the worksurface and into tight corners.

Seat depth adjusts within a 2 1/4" range to accommodate users of varying leg lengths.

Five-star base is available in paint, plastic, or polished aluminum.

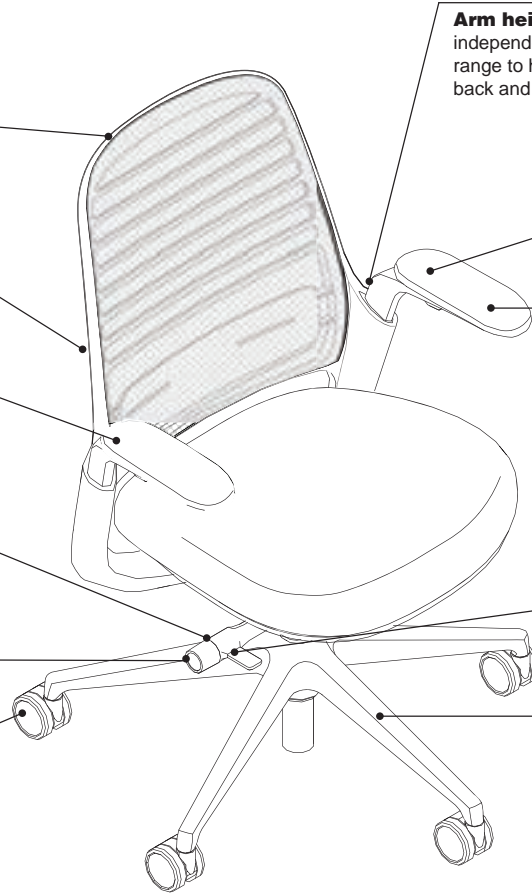

Product Details

Steelcase Series 1 is available in two back designs: 3D microknit (with lumbar and back flexors) and the polypropylene air back.

3D Microknit Back

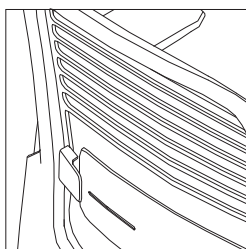

LiveBack Flexor System conforms to and mimics the spine to provide flexibility and continuous lower-back support. An additional adjustable lumbar for extra support comes standard.

Air Back

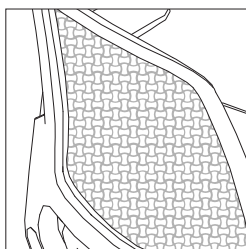

Air LiveBack technology specially engineered geometric wave pattern in the polypropylene back flexes in two dimensions to encourage movement and posture changes while providing the spine with responsive support.

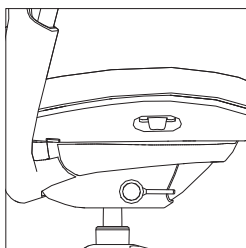

Advanced weight-activated mechanism with a natural fluid motion keeps users oriented to their work.

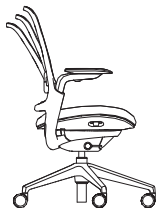

Comfort dial has three settings that allow for the user's personal preference and work style.

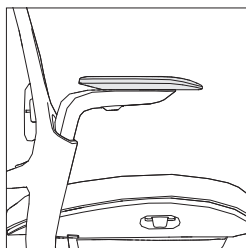

Pill-shaped arms with soft caps are standard.

Uncartoned request on your dealer purchase order means Steelcase Series 1 chairs will ship fully assembled.

Cartoned request on the dealer purchase order means Steelcase Series 1 chairs will ship knocked down in seven pieces. This allows for shipment in a smaller carton. Assembly does not require tools.

Tip: Assembly instructions are included on the box.

Product Weight

- Series 1 chair: 29.2 pounds



CarbonNeutral.com
CarbonNeutral product Series 1 helps organizations achieve their carbon emissions goals. Add **CN** to the end of the style number to specify Series 1 with CarbonNeutral product certification.

Adjustment Features

Adjustability instructions are included with every chair.

Seat Adjustments

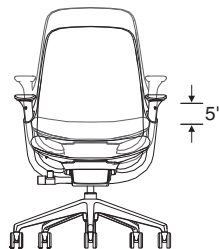

Seat height adjusts pneumatically. To lower, hold handle up while seated. To raise, hold handle up and keep your weight off the chair. Standard range of adjustability is 5" from 16½"H to 21½"H. A short 3" range of adjustability (14¾" to 17¾") and a tall 4¾" range of adjustability (17¼" to 22") is available as an option. A 7¾" range of adjustability (23" to 30¾") is available on stools.

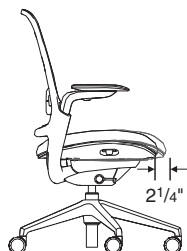

Seat depth adjusts 2¼" (15½"–17¾") by pulling handle up. Slide seat forward or back to accommodate various leg lengths. Release handle to lock.

Back Adjustments

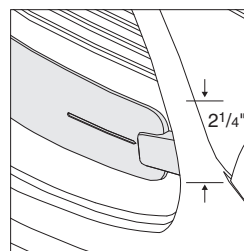

Lumbar height (3D microknit back) adjusts 2¼" (6½" to 8¾" from seat) by grabbing exposed tabs and sliding the lumbar support up or down.

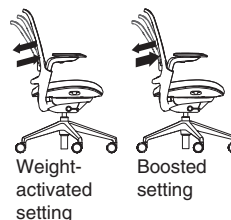

Weight-activated setting

Boosted setting



Upright setting

Comfort dial has three settings: (1) weight-activated setting; (2) boosted setting that has more resistance than your body is providing; and (3) an upright back lock setting.

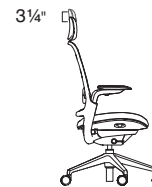

Headrest adjusts ¾" vertically to support the head and neck of the user in both upright and recline postures. The plastic stalk and underside of the headrest will coordinate to match the frame color specified: black or seagull. The foam pad of the headrest is available in 3D Microknit. The headrest may be ordered as an option and must be field installed or as its own style number which ships in its own carton and must be field installed.

Arm Adjustments

Rectilinear height-, width-, pivot-, and depth-adjustable arms come standard on all arm models of chairs and stools.

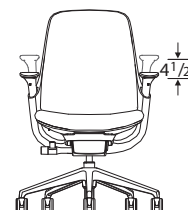

Arm height adjusts independently within a range of 4½" (6½"–11" from the seat). Push button on outside and under arm cap in while moving arms up or down. Releasing buttons locks arms in position.

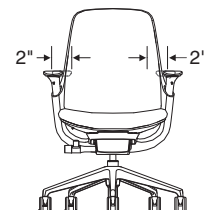

Arm width can be adjusted 2" each, 4" overall. Grasp arm cap and move in or out.

Steelcase Series 1, continued

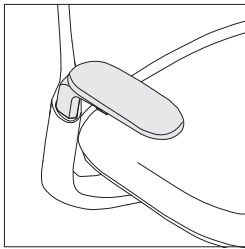

Arms pivot independently, 40° inward and outward. Grasp arm and push front to left or right.

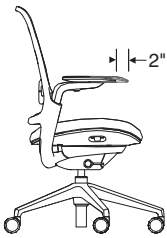

Arm depth adjusts by sliding arm caps back 2". Friction-fit mechanism keeps arms in position.

Other Features

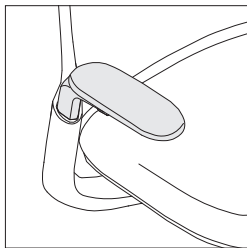

Height-only adjustable arm is also available and adjusts 4½".



Armless models are also available.

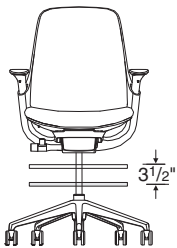

Foot ring height on stools adjusts by rotating it counterclockwise to unlock. Then raise or lower ring to desired position before rotating it clockwise to lock. The foot ring has a diameter of 20".

Soft dual-wheel roll-control casters feature an internal brake that activates when the chair is not under load to reduce shifting when user stands up.

Coat hanger (option) is field installed. The color will coordinate with the frame of the chair but will not match the frame exactly. The coat hanger supports up to ten pounds and is not intended to hold bags or backpacks.

Surface Materials

▶ See *Surface Materials Reference Manual* for further information.

Upholstery

- Fabric*
- Fabric with soil-retardant treatment (option)
- 3D Microknit (back and headrest only)
- Elmosoft leather
- Select Surfaces leather
- Leather
- Vinyl
- Customer's Own Leather (COL)
- Customer's Own Material (COM)

Air Back

- 6205 Black
- 6053 Seagull
- 6249 Platinum Solid
- 6BD6 Lagoon
- 6BD7 Saffron

Hard components

Back frame, seat shell, arm retainer, stool ring, headrest, and hanger

- 6053 Seagull
- 6205 Black*

Base

- 6205 Black*
- 7243 Seagull
- 8046 Polished Aluminum

Pneumatic cylinders

- 6205 Black*

Flexors and lumbar finishes are determined by the 3D Microknit color unless specified as contrasting.

Seat shell is determined by the frame finish.

- 6053 Seagull
- 6205 Black*

Arms

- 6059 Sterling Dark (on seagull chair)
- 6205 Black (on black chair)*

All Steelcase seating with standard upholstery fabrics complies with requirements of the State of California Technical Bulletin 117-2013. All standard seating is labeled to be in compliance with California 117-2013.

Programs & Services

▶ See *Surface Materials Reference Manual* for further detail about programs and services offered for seating.

The Customer's Own Material (COM) Program

offers the opportunity for customers to select fabrics that are not offered through the standard Steelcase surface materials program for use on Steelcase products. Through the COM program, Steelcase will test your materials for application on Steelcase products. Once approved, you can place your order. Steelcase will facilitate the entire ordering process and give you a production schedule. Steelcase will order the COM fabric directly from the textile manufacturer. For up-to-date information regarding fabric test results for all COM fabrics and details regarding yardage requirements for most seating lines, visit the COM website. To locate the COM website:

- Visit www.steelcase.com

Soil retardants are treatments that provide long-term soil and stain resistance to a fabric without affecting the shade or the integrity of the fabric. The following Steelcase Textiles are available pre-treated with soil retardant. (You do not need to select the soil-retardant option for these fabrics and incur the upcharge.)

- Jacks
- Link

For information on soil retardant fabrics on Select Surfaces, please refer to the *Surface Materials Reference Manual*.

Soil-retardant treatment is available on all other seating fabrics at an additional upcharge per seating unit. To order this option, please select "Soil-Retardant Treatment" under "Optional Accessories."

For soil-retardant treatment on COMs, please select "Soil-Retardant Treatment" under "Optional Accessories." Minimums or additional yardage may be required. Please contact the vendor directly for specific information.

Extended lead times may be necessary for this service.

Contact your Steelcase Solutions Fulfillment Team Representative at 1.888.STEELCASE (1.888.783.3522) or send an email to line-one@steelcase.com.

Dimensions

▶ Page 186

Steelcase Series 1 Upholstery

What Is It?

3D Microknit Back

Back

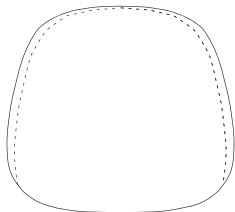
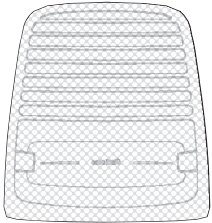

Seat

Fabric, leather, or vinyl-covered seat; 3D Microknit back only

Stitched seams are included on the seat cushion of the following:

- Leather
- Vinyl
- Upholstery
- Select Customer's Own Material/ Vinyl (COM)

Tip: There are no stitching seams in Cogent:Connect.

Air Back

Back

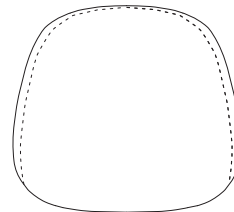
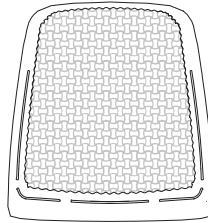

Seat

Fabric, leather, or vinyl-covered seat.

Stitched seams are included on the seat cushion of the following:

- Leather
- Vinyl
- Upholstery
- Select Customer's Own Material/ Vinyl (COM)

Tip: There are no stitching seams in Cogent:Connect.

A Cogent: Connect fabric can be specified on the seat to color match the 3D Microknit, except seagull.

Tip: 3D Microknit back has no stitched seams. Upholstery seams on seat are driven by specified seat fabric.

A Cogent: Connect fabric can be specified on the seat to color match the Air Back colors, except seagull and platinum solid. Cogent: Connect in nickel coordinates with platinum solid.

Tip: Upholstery seams on seat are driven by specified seat fabric.

What Is It?

Series 1 3D Microknit Back (with lumbar and back flexors)

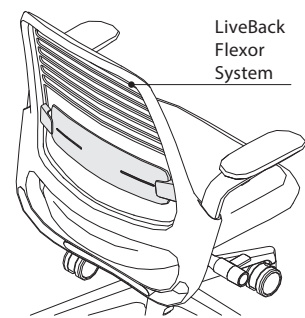

Back flexors are fully exposed. Lumbar and flexor colors always match. Lumbar and flexors will also match the 3D Microknit fabric unless contrasting outer back is selected.

Exception: Eight 3D microknit colors are only available with contrasting outer back (3D microknit is a different color than the lumbar and flexors): Seagull, Honey, Saffron, Merlot, Aubergine, Lagoon, Peacock, and Jungle.

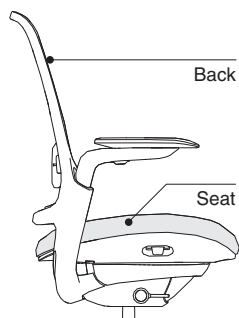

Seat and back assemblies can be removed and replaced if damaged.

Series 1 Air Back

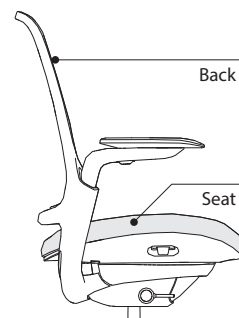
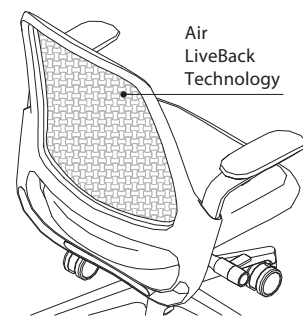
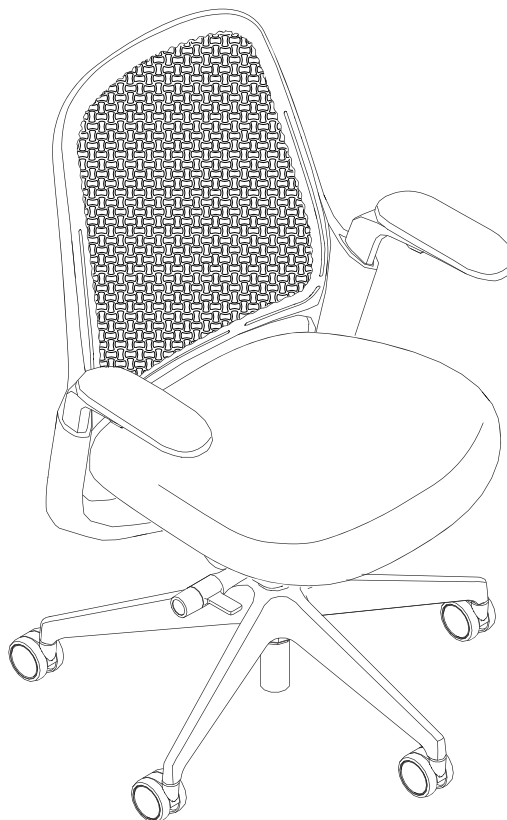

Seat and back assemblies can be removed and replaced if damaged.

Dimensions

Steelcase Series 1

Features	Overall Depth	Width	Height	Seat Depth	Functional Seat Depth	Seat Width	Seat Height from Floor	Ring Height from Floor	Back Width	Back Height from Seat	Lumbar Height from Seat
----------	---------------	-------	--------	------------	-----------------------	------------	------------------------	------------------------	------------	-----------------------	-------------------------

Steelcase Series 1

Chair

Arms	21" to 23 ³ / ₄ "	23 ¹ / ₂ " to 27"	36 ¹ / ₂ " to 41 ¹ / ₄ "	18 ¹ / ₂ "	15 ¹ / ₂ " to 17 ³ / ₄ "	19 ¹ / ₂ "	16 ¹ / ₂ " to 21 ¹ / ₂ " (14 ³ / ₄ " to 17 ³ / ₄ ", 17 ¹ / ₄ " to 22" optional)	N.A.	17 ¹ / ₄ "	21 ¹ / ₂ "	6 ¹ / ₂ " to 8 ³ / ₄ "
------	---	---	--	----------------------------------	--	----------------------------------	---	------	----------------------------------	----------------------------------	--

Stool

Arms	21" to 23 ³ / ₄ "	23 ¹ / ₂ " to 27"	42 ¹ / ₄ " to 50"	18 ¹ / ₂ "	15 ¹ / ₂ " to 17 ³ / ₄ "	19 ¹ / ₂ "	23" to 30 ³ / ₄ "	11 ¹ / ₂ " to 15"	17 ¹ / ₄ "	21 ¹ / ₂ "	6 ¹ / ₂ " to 8 ³ / ₄ "
------	---	---	---	----------------------------------	--	----------------------------------	---	---	----------------------------------	----------------------------------	--

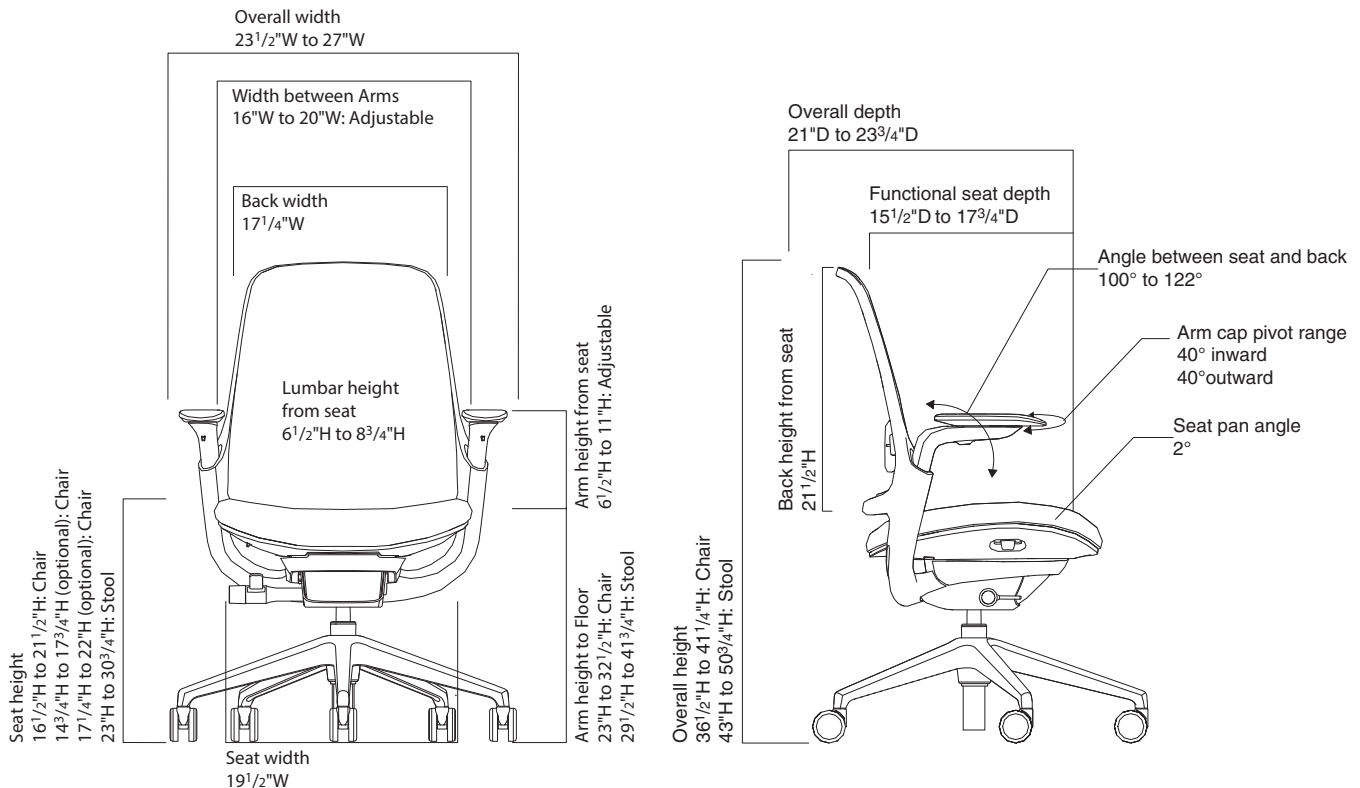

• Width • Between • Adjustable • Arms	• Width • Between • Height- • Adjustable • Arms	• Arm • to • Floor	• Arm • Height • from • Seat	• Arm Cap • Pivot • Range	• Angle • Between • Seat and • Back	• Seat • Pan • Angle	• Headrest • Height • Adjustment • Range
16" to 20½"	19"	23" to 32½"	6½" to 11"	40° outward 40° inward	100° to 122°	2°	3¼"
16" to 20½"	19"	29½" to 41¾"	6½" to 11"	40° outward 40° inward	100° to 122°	2°	3¼"

Steelcase Series 1 Work Chair

3D Microknit Back with Standard Upholstery on Seat



Tip: When ordering seagull frame the arms are 6059 Sterling Dark Solid. When ordering black frame, arms are black.

Tip: 3D Microknit, lumbar, and back flexors colors match unless contrasting outer back is selected.

Tip: Eight additional 3D Microknit colors are available when contrasting outer back is selected.

Tip: Base finish matches frame finish, unless seagull frame is selected, then black base is also available.

Tip: Order black base on seagull frame for lowest maintenance.

Tip: A headrest and a coat hanger cannot be attached on a Steelcase Series 1 chair simultaneously.

► Detailed dimensions, page 94

Standard Includes		Required to Specify
► Need help? Product details, page 180	<ul style="list-style-type: none"> 5" pneumatic seat-height adjustment (16½"–21½") Frame: plastic Base: paint or plastic 2¼" seat depth adjustment Pill height-, width-, pivot-, and depth-adjustable arms Adjustable lumbar Back: 3D Microknit on back Standard upholstery design on seat: fabric price group 1 2½"-diameter, hard-composition, dual-wheel casters: black only 	<ol style="list-style-type: none"> Style number Frame (see below under Required Selections) 3D Microknit color number for back Plastic color number for outer back, if contrasting outer back is selected Fabric color number for upholstery on seat Plastic color number for base: 6205 Black (black and seagull frame) 7243 Seagull (seagull frame only) Options, if selected (see below) <p>► See <i>Surface Materials</i>, page 634.</p>

Required Selections	U.S. Price	Required to Specify
Frame		
<ul style="list-style-type: none"> Black color scheme Seagull color scheme 	No cost +\$ 46	Specify with 6205 Black. Specify with 6053 Seagull.

Options	U.S. Price	Required to Specify
Surface Materials		
Upholstery on seat		
<ul style="list-style-type: none"> Fabric price group 1 Fabric price group 2 Fabric price group 3 Fabric price group 4 Fabric price group 5 Fabric price group 6 Fabric price group 7 Fabric price group 8 Fabric price group 9 Fabric price group 10 Steelcase leather upholstery Select Surfaces leather price group 1 Elmosoft leather upholstery Select Surfaces leather price group 2 Customer's Own Material (COM) 	No cost +\$ 12 +\$ 35 +\$ 48 +\$ 61 +\$ 76 +\$ 84 +\$111 +\$136 +\$154 +\$238 +\$238 +\$279 +\$279 No cost	Specify fabric color number. Specify fabric color number. Specify fabric color number. Specify fabric color number. Specify fabric color number. Specify fabric color number. Specify fabric color number. Specify fabric color number. Specify fabric color number. Specify fabric color number. Specify fabric color number. Specify leather color number. ► See <i>Surface Materials Reference Manual</i> . Specify Elmosoft leather color number. ► See <i>Surface Materials Reference Manual</i> . ► See <i>Surface Materials Reference Manual</i> .
Soil-retardant treatment	+\$ 36	Specify with soil-retardant treatment.
Back color scheme		
<ul style="list-style-type: none"> Contrasting outer back 	+\$ 16	Specify with contrasting outer back and select plastic color number.
Arms		
<ul style="list-style-type: none"> Height-only adjustable Armless 	–\$ 12 –\$ 87	Specify with height-only adjustable. Specify without arms.
Base		
<ul style="list-style-type: none"> Black Polished aluminum base 	No cost +\$182	Specify with black base. Specify with aluminum base.
Headrest	+\$160	Specify with headrest.
Coat Hanger	+\$ 45	Specify with coat hanger.
Lumbar		
<ul style="list-style-type: none"> Adjustable lumbar Fixed lumbar 	No cost No cost	Specify with adjustable lumbar. Specify with fixed lumbar.
Seat Height		
<ul style="list-style-type: none"> 3¼" short-range pneumatic seat-height adjustment 4¾" tall-range pneumatic seat-height adjustment 	+\$ 82 +\$ 82	Specify with short-range pneumatic seat-height adjustment. Specify with tall-range pneumatic seat-height adjustment.
Casters	+\$ 36	Specify with soft roll-control casters.
Glides	+\$ 36	Specify with glides.
CarbonNeutral Product	+\$ 35	Add suffix CN to the end of the style number.

Specification Information

Style Number	U.S. Base Price
435A00	\$987

Steelcase Series 1



For Canadian Pricing
Multiply U.S. Price by the
Canadian price factor.
▶ See page 1 for details.

Steelcase Series 1 Work Chair

Air Back with Standard Upholstery on Seat



Standard Includes		Required to Specify
<ul style="list-style-type: none"> ▶ Need help? Product details, page 180 	<ul style="list-style-type: none"> 5" pneumatic seat-height adjustment (16½"–21½") Frame: plastic Base: plastic 2¼" seat depth adjustment Pill height-, width-, pivot-, and depth-adjustable arms Back: air back with integrated Air LiveBack technology: plastic groups 1 and 2 Standard upholstery design on seat: fabric price group 1 2½"-diameter, hard-composition, dual-wheel casters: black only 	<ol style="list-style-type: none"> Style number Frame (see below under Required Selections) Plastic color number for air back Fabric color number for upholstery on seat Plastic color number for base: <ul style="list-style-type: none"> 7243 Seagull (seagull frame only) 6205 Black (black and seagull frame) Options, if selected (see below) <ul style="list-style-type: none"> ▶ See <i>Surface Materials</i>, page 634.

	Required Selections	U.S. Price	Required to Specify
Frame	<ul style="list-style-type: none"> Black color scheme Seagull color scheme 	No cost +\$ 46	Specify with 6205 Black. Specify with 6053 Seagull.

	Options	U.S. Price	Required to Specify
Surface Materials	Upholstery on seat <ul style="list-style-type: none"> Fabric price group 1 Fabric price group 2 Fabric price group 3 Fabric price group 4 Fabric price group 5 Fabric price group 6 Fabric price group 7 Fabric price group 8 Fabric price group 9 Fabric price group 10 Steelcase leather upholstery Select Surfaces leather price group 1 Elmosoft leather upholstery Select Surfaces leather price group 2 Customer's Own Material (COM) 	No cost +\$ 12 +\$ 35 +\$ 48 +\$ 61 +\$ 76 +\$ 84 +\$111 +\$136 +\$154 +\$238 +\$238 +\$279 +\$279 No cost	Specify fabric color number. Specify fabric color number. Specify fabric color number. Specify fabric color number. Specify fabric color number. Specify fabric color number. Specify fabric color number. Specify fabric color number. Specify fabric color number. Specify fabric color number. Specify leather color number. Specify leather color number. Specify leather color number. Specify leather color number. Specify fabric color number.
	Plastic Air Back <ul style="list-style-type: none"> Black Platinum Solid Seagull Lagoon Saffron 	No cost No cost No cost No cost No cost	Specify plastic color 6205 Black. Specify plastic color 6249 Platinum Solid. Specify plastic color 6053 Seagull. Specify plastic color 6BD6 Lagoon. Specify plastic color 6BD7 Saffron.
	Soil-retardant treatment	+\$ 36	Specify with soil-retardant treatment.
Arms	<ul style="list-style-type: none"> Height-only adjustable Armless 	–\$ 12 –\$ 87	Specify with height-only adjustable arms. Specify without arms.
Base	<ul style="list-style-type: none"> Plastic base Polished aluminum base 	No cost +\$182	Specify plastic color number. Specify with aluminum base.
Headrest	<ul style="list-style-type: none"> Headrest 	+\$160	Specify with headrest.
Coat Hanger	<ul style="list-style-type: none"> Coat hanger 	+\$ 45	Specify with coat hanger.
Seat Height	<ul style="list-style-type: none"> 3¼" low-range pneumatic seat height adjustment 4¾" high-range pneumatic seat height adjustment 	–\$ 82 –\$ 82	Specify with short-range pneumatic seat height adjustment. Specify with tall-range pneumatic seat height adjustment.
Casters	<ul style="list-style-type: none"> Soft, dual-wheel roll-control casters for use on hard floors 	+\$ 36	Specify with soft roll-control casters.
Glides	<ul style="list-style-type: none"> Plastic glides 	+\$ 36	Specify with glides.
CarbonNeutral Product	<ul style="list-style-type: none"> CarbonNeutral product certification 	+\$ 35	Add suffix CN to the end of the style number.

Tip: When ordering seagull frame the arms are 6059 Sterling Dark Solid. When ordering black frame, arms are black.

Tip: Base finish matches frame finish, unless seagull frame is selected, then black base is also available.

Tip: Order black base on seagull frame for lowest maintenance.



For Canadian Pricing
 Multiply U.S. Price by the Canadian price factor.
 ▶ See page 1 for details.

Specification Information

Style Number	U.S. Base Price
435A00AIR	\$903

Steelcase Series 1



For Canadian Pricing
Multiply U.S. Price by the
Canadian price factor.
▶ See page 1 for details.

Steelcase Series 1 Stool

3D Microknit with Standard Upholstery on Seat



	Standard Includes	Required to Specify
▶ Need help? Product details, page 180	<ul style="list-style-type: none"> • 7¾" pneumatic seat-height adjustment (23"-30¾") • Frame: plastic • Base: plastic • 2¼" seat depth adjustment • Pill height-, width-, pivot-, and depth-adjustable arms • Column and adjustable foot ring: black • Adjustable lumbar • Back: 3D Microknit • Standard upholstery design on seat: fabric price group 1 • 2½"-diameter, hard-composition, dual-wheel casters: black only 	<ol style="list-style-type: none"> 1 Style number 2 Frame (see below under Required Selections) 3 3D Microknit color number for back 4 Plastic color number for outer back, if contrasting outer back is selected 5 Fabric color number for upholstery on seat 6 Plastic color number for base: 6053 Seagull (seagull frame only) 6205 Black (black and seagull frame) 7 Options, if selected (see below) <p>▶ See <i>Surface Materials</i>, page 634.</p>

	Required Selections	U.S. Price	Required to Specify
Frame	<ul style="list-style-type: none"> • Black color scheme • Seagull color scheme 	No cost +\$ 46	Specify with 6205 Black. Specify with 6053 Seagull.

	Options	U.S. Price	Required to Specify
Surface Materials	<p>Upholstery on seat</p> <ul style="list-style-type: none"> • Fabric price group 1 • Fabric price group 2 • Fabric price group 3 • Fabric price group 4 • Fabric price group 5 • Fabric price group 6 • Fabric price group 7 • Fabric price group 8 • Fabric price group 9 • Fabric price group 10 • Steelcase leather upholstery • Select Surfaces leather price group 1 • Elmosoft leather upholstery • Select Surfaces leather price group 2 • Customer's Own Material (COM) <p>Soil-retardant treatment</p> <ul style="list-style-type: none"> • Soil-retardant treatment <p>Back color scheme</p> <ul style="list-style-type: none"> • Contrasting outer back 	No cost +\$ 12 +\$ 35 +\$ 48 +\$ 61 +\$ 76 +\$ 84 +\$111 +\$136 +\$154 +\$238 +\$238 +\$279 +\$279 No cost +\$ 36 +\$ 16	Specify fabric color number. Specify fabric color number. Specify fabric color number. Specify fabric color number. Specify fabric color number. Specify fabric color number. Specify fabric color number. Specify fabric color number. Specify fabric color number. Specify fabric color number. Specify fabric color number. Specify leather color number. ▶ See <i>Surface Materials Reference Manual</i> . Specify Elmosoft leather color number. ▶ See <i>Surface Materials Reference Manual</i> . ▶ See <i>Surface Materials Reference Manual</i> . Specify with soil-retardant treatment. Specify with contrasting outer back and select plastic color number.

Arms	<ul style="list-style-type: none"> • Height-only adjustable • Armless 	-\$ 12 -\$ 87	Specify with height-only adjustable. Specify without arms.
Base	<ul style="list-style-type: none"> • Plastic base • Polished aluminum base 	No cost +\$182	Specify plastic color number. Specify with aluminum base.
Headrest	<ul style="list-style-type: none"> • Headrest 	+\$160	Specify with headrest.
Coat Hanger	<ul style="list-style-type: none"> • Coat hanger 	+\$ 45	Specify with coat hanger.
Lumbar	<ul style="list-style-type: none"> • Adjustable lumbar • Fixed lumbar 	No cost No cost	Specify with adjustable lumbar. Specify with fixed lumbar.
Casters	<ul style="list-style-type: none"> • Soft, dual-wheel roll-control casters for use on hard floors 	+\$ 36	Specify with soft roll-control casters.
Glides	<ul style="list-style-type: none"> • Plastic glides 	+\$ 36	Specify with glides.
CarbonNeutral Product	<ul style="list-style-type: none"> • CarbonNeutral product certification 	+\$ 35	Add suffix CN to the end of the style number.

Tip: When ordering seagull frame the arms are 6059 Sterling Dark Solid. When ordering black frame, arms are black.

Tip: 3D Microknit, lumbar, and back flexors colors match unless contrasting outer back is selected.

Tip: Eight additional 3D Microknit colors are available when contrasting outer back is selected.

Tip: Base finish matches frame finish, unless seagull frame is selected, then black base is also available.

Tip: Order black base on seagull frame for lowest maintenance.

Tip: Stool ring is always black for lower cleaning maintenance, even on the seagull frame.

Tip: A headrest and a coat hanger cannot be attached on a Steelcase Series 1 chair simultaneously.

▶ Detailed dimensions, page 94

Specification Information

•Style Number	•U.S. Base Price
435B00	\$1239

Steelcase Series 1



For Canadian Pricing
Multiply U.S. Price by the
Canadian price factor.
▶ See page 1 for details.

Steelcase Series 1 Stool

Air Back with Standard Upholstery on Seat



Tip: When ordering seagull frame the arms are 6059 Sterling Dark Solid. When ordering black frame, arms are black.

Tip: Stool ring is always black for lower cleaning maintenance, even on the seagull frame.

Tip: Base finish matches frame finish, unless seagull frame is selected, then black base is also available.

Tip: Order black base on seagull frame for lowest maintenance.

For Canadian Pricing
 Multiply U.S. Price by the Canadian price factor.
 ▶ See page 1 for details.

Standard Includes		Required to Specify
▶ Need help? Product details, page 180	<ul style="list-style-type: none"> • 7¾" pneumatic seat-height adjustment (23"-30¾") • Frame: plastic • Base: plastic • 2¼" seat depth adjustment • Pill height-, width-, pivot-, and depth-adjustable arms • Column and adjustable foot ring: black • Back: air back with integrated Air LiveBack technology: plastic groups 1 and 2 • Standard upholstery design on seat: fabric price group 1 • 2½"-diameter, hard-composition, dual-wheel casters: black only 	<ol style="list-style-type: none"> 1 Style number 2 Frame (see below under Required Selections) 3 Plastic color number for air back 4 Fabric color number for upholstery on seat 5 Plastic color number for base: <ul style="list-style-type: none"> 7243 Seagull (seagull frame only) 6205 Black (black and seagull frame) 7 Options, if selected (see below) ▶ See <i>Surface Materials</i> , page 634.

Required Selections	U.S. Price	Required to Specify
Frame		
<ul style="list-style-type: none"> • Black color scheme • Seagull color scheme 	No cost +\$ 46	Specify with 6205 Black. Specify with 6053 Seagull.

Options	U.S. Price	Required to Specify
Surface Materials		
Upholstery on seat		
<ul style="list-style-type: none"> • Fabric price group 1 • Fabric price group 2 • Fabric price group 3 • Fabric price group 4 • Fabric price group 5 • Fabric price group 6 • Fabric price group 7 • Fabric price group 8 • Fabric price group 9 • Fabric price group 10 • Steelcase leather upholstery • Select Surfaces leather price group 1 • Elmosoft leather upholstery • Select Surfaces leather price group 2 • Customer's Own Material (COM) 	No cost +\$ 12 +\$ 35 +\$ 48 +\$ 61 +\$ 76 +\$ 84 +\$111 +\$136 +\$154 +\$238 +\$238 +\$279 +\$279 No cost	Specify fabric color number. Specify fabric color number. Specify fabric color number. Specify fabric color number. Specify fabric color number. Specify fabric color number. Specify fabric color number. Specify fabric color number. Specify fabric color number. Specify fabric color number. Specify leather color number. Specify leather color number. Specify leather color number. Specify leather color number. Specify fabric color number.
Air Back		
<ul style="list-style-type: none"> • Black • Platinum Solid • Seagull • Lagoon • Saffron 	No cost No cost No cost No cost No cost	Specify plastic color 6205 Black. Specify plastic color 6249 Platinum Solid. Specify plastic color 6053 Seagull. Specify plastic color 6BD6 Lagoon. Specify plastic color 6BD7 Saffron.
Soil-retardant treatment	+\$ 36	Specify with soil-retardant treatment.
Arms		
<ul style="list-style-type: none"> • Height-only adjustable • Armless 	-\$ 12 -\$ 87	Specify with height-only adjustable arms. Specify without arms.
Base		
<ul style="list-style-type: none"> • Black • Polished aluminum base 	No cost +\$182	Specify with black base. Specify with aluminum base.
Headrest	+\$160	Specify with headrest.
Coat Hanger	+\$ 45	Specify with coat hanger.
Casters	+\$ 36	Specify with soft roll-control casters.
Glides	+\$ 36	Specify with glides.
CarbonNeutral Product	+\$ 35	Add suffix CN to the end of the style number.

Specification Information

Style Number	U.S. Base Price
435B00AIR	\$1154

Steelcase Series 1



For Canadian Pricing
Multiply U.S. Price by the
Canadian price factor.
▶ See page 1 for details.

Steelcase Series 1 Accessories

Steelcase Series 1 Headrest

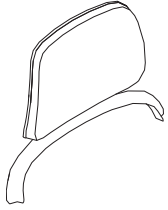

Tip: A headrest and a coat hanger cannot be attached on a Steelcase Series 1 chair simultaneously.

Tip: Stand alone add on accessories are not available with CarbonNeutral product certification.

Standard Includes	Required to Specify
-------------------	---------------------

- | | | |
|--|--|--|
| <ul style="list-style-type: none"> ▶ Need help? Product details, page 180 | <ul style="list-style-type: none"> • Headrest frame: plastic • Headrest: 3D Microknit • 3" adjustment range | <ul style="list-style-type: none"> 1 Style number 2 Plastic color number for frame: <ul style="list-style-type: none"> 6053 Seagull 6205 Black 3 3D Microknit color number for headrest <ul style="list-style-type: none"> ▶ See <i>Surface Materials</i>, page 634. |
|--|--|--|

Specification Information	
---------------------------	--

Style Number	U.S. Price
435HEADREST	\$160

Steelcase Series 1 Coat Hanger

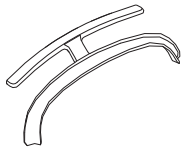

Tip: A headrest and a coat hanger cannot be attached on a Steelcase Series 1 chair simultaneously.

Tip: Stand alone add on accessories are not available with CarbonNeutral product certification.

Standard Includes	Required to Specify
-------------------	---------------------

- | | |
|--|---|
| <ul style="list-style-type: none"> • Coat hanger: plastic | <ul style="list-style-type: none"> 1 Style number 2 Plastic color number for coat hanger: <ul style="list-style-type: none"> 6053 Seagull 6205 Black |
|--|---|

Specification Information	
---------------------------	--

Style Number	U.S. Price
435COATHANGER	\$45



For Canadian Pricing
 Multiply U.S. Price by the Canadian price factor.
 ▶ See page 1 for details.

Understanding and Specifying Tenor

Multi-Use Seating

Product Details		
Tenor		198
Dimensions		200
Specifying		
Chairs		201
Stools		205

Tenor

Tenor chairs and stools are designed for comfort, mobility, stackability, and tailorability. Everything you need in multipurpose seating and perfectly suited for any learning or corporate environment.

Optional steel bag hook is simple and intuitive to use.

A non-directional seat pan is not only comfortable, but allows the user to move their bodies to follow the flow of learning.

Steel frame is available in any of the Steelcase paints, including Lux Coatings.

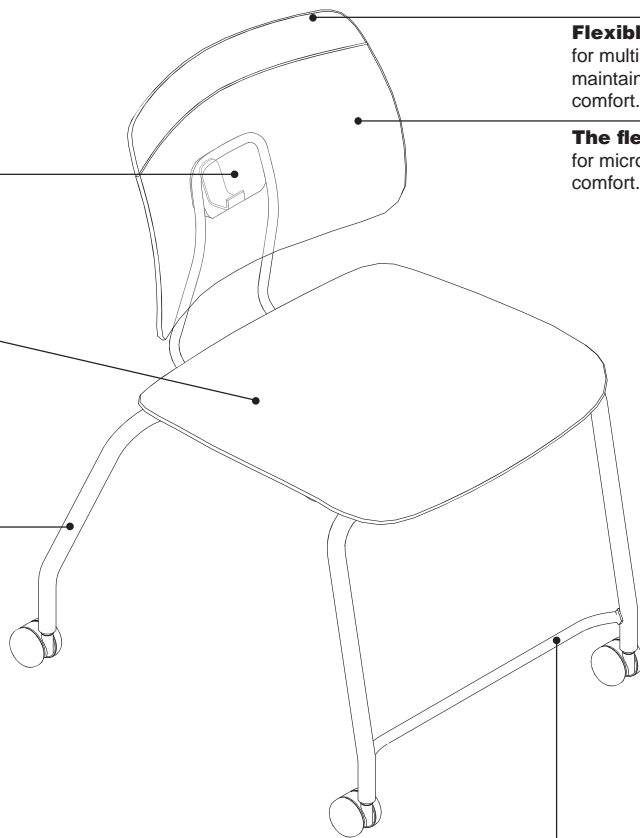

Flexible top edge allows for multiple postures while maintaining support and comfort.

The flex back allows for micro-movements and comfort.

The Tenor chair offers an optional comfort footbar to support propping of legs. A footbar is standard on Tenor stools.

Product Details

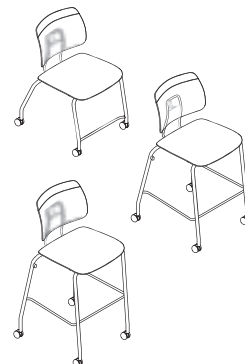

Tenor chairs and stools come in a four-leg stacking base and are available with hard nylon glides, hard steel glides, soft felt glides, hard casters, and soft casters. Chairs stack six high. Stools stack two-high.

Tenor is designed as a wall-saver, it will not cause damage to walls if contact is made.

Tenor ships fully assembled.

Tenor chair is 18.1–19.5 pounds depending on options chosen.

Tenor chairs are tested to 400 pounds maximum weight capacity.

Tenor stools are tested to 300 pounds maximum weight capacity.

Tenor has a finished bottom cover without any pinch points and bumpers for stacking.

Warranty

Limited Lifetime Warranty.

Surface Materials

▶ See surface materials on page 634 for specific availability or refer to the *Surface Materials Reference Manual* for further information.

**Back and Seat Shell
Price Group 1**

Plastic

- 6009 Arctic White
- 6059 Sterling Dark Solid
- 6205 Black
- 6249 Platinum Solid
- 6335 Wasabi
- 6336 Jazz
- 6338 Chili
- 6527 Merle

Price Group 2

Plastic

- 6BD2 Peacock
- 6BD5 Honey
- 6BD6 Lagoon
- 6BD7 Saffron
- 6BE5 Olivine
- 6BE6 Sea Salt

Tip: Bottom cover and top edge will default to coordinate with finish of seat and back shell.

Frame

- Paint
- Accessory paint
- Accent paint
- PerfectMatch paint
- Lux Coatings

Casters (soft and hard)

- Black

Glides

- Steel
- Black nylon
- Gray felt

Programs & Services

▶ See the *Surface Materials Reference Manual* for further detail about programs and services offered for seating.

Dimensions

▶ Page 200

Resources

▶ www.steelcase.com/products/classroom-chairs/tenor/

Dimensions

Tenor

• Features	• Overall Depth	Seat Width	Seat Height from Floor	• Overall Height
Tenor				
Multipurpose Seating				
Tenor Chair	21 ³ / ₄ "	17 ⁵ / ₈ "	18"	32"
Tenor Stool	21 ³ / ₄ "	17 ⁵ / ₈ "	29"	43"
Tenor Perching Stool	21 ³ / ₄ "	17 ⁵ / ₈ "	26"	40"

Tenor Chair

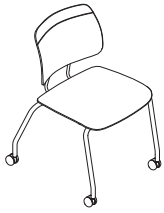

Tip: Tenor chairs can stack six high on the floor.

Tip: Soft felt glides are for use on non-carpeted floors. Black soft casters are for use on hard floors.

Tip: Tenor is designed as a wall-saver, it will not cause damage to walls if contact is made.

Standard Includes		Required to Specify
<ul style="list-style-type: none"> ▶ Need help? Product details, page 198 	<ul style="list-style-type: none"> • Seat and back: plastic price group 1 • Steel frame: paint price group 1 • Standard hard casters: black • Ships fully assembled 	<ol style="list-style-type: none"> 1 Style number 2 Plastic color number for back and seat shell 3 Paint color number for frame 4 Options, if selected (see below) <p>▶ See <i>Surface Materials</i>, page 634.</p>

Options	U.S. Price	Required to Specify
Surface Materials		
Plastic on back and seat shell		
• Plastic price group 1	No cost	Specify plastic color number.
• Plastic price group 2	+\$ 56	Specify plastic color number.
Paint on frame		
• Paint price group 1	No cost	Specify paint color number.
• Paint price group 2	+\$ 74	Specify paint color number.
• Paint price group 3	+\$100	Specify paint color number.
Glides and Casters		
• Black nylon glides	No cost	Specify <i>with nylon glides</i> .
• Steel glides	No cost	Specify <i>with steel glides</i> .
• Soft felt glides	+\$ 7	Specify <i>with soft felt glides</i> .
• Black soft casters	+\$ 36	Specify <i>with black soft casters</i> .

Specification Information				
Dimensions			Style Number	U.S. Base Price
D	W	H		
21 ³ / ₄ "	17 ⁵ / ₈ "	18"	SLC0	\$439

Tenor

 **For Canadian Pricing**
 Multiply U.S. Price by the Canadian price factor.
 ▶ See page 1 for details.

Tenor Chair

with Foot Bar

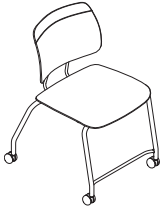

Tip: Tenor chairs can stack six high on the floor.

Tip: Soft felt glides are for use on non-carpeted floors. Black soft casters are for use on hard floors.

Tip: Tenor is designed as a wall-saver, it will not cause damage to walls if contact is made.

Standard Includes		Required to Specify
<ul style="list-style-type: none"> ▶ Need help? Product details, page 198 	<ul style="list-style-type: none"> • Seat and back: plastic price group 1 • Steel frame: paint price group 1 • Standard hard casters: black • Foot bar • Ships fully assembled 	<ol style="list-style-type: none"> 1 Style number 2 Plastic color number for back and seat shell 3 Paint color number for frame 4 Options, if selected (see below) <p>▶ See <i>Surface Materials</i>, page 634.</p>

Options	U.S. Price	Required to Specify
Surface Materials <ul style="list-style-type: none"> • Plastic on back and seat shell • Plastic price group 1 • Plastic price group 2 	No cost +\$ 56	Specify plastic color number. Specify plastic color number.
<ul style="list-style-type: none"> • Paint on frame • Paint price group 1 • Paint price group 2 • Paint price group 3 	No cost +\$ 74 +\$100	Specify paint color number. Specify paint color number. Specify paint color number.
Glides and Casters <ul style="list-style-type: none"> • Black nylon glides • Steel glides • Soft felt glides • Black soft casters 	No cost No cost +\$ 7 +\$ 36	Specify <i>with nylon glides</i> . Specify <i>with steel glides</i> . Specify <i>with soft felt glides</i> . Specify <i>with black soft casters</i>

Specification Information				
Dimensions			Style Number	U.S. Base Price
D	W	H		
21 ³ / ₄ "	17 ⁵ / ₈ "	18"	SLCF	\$450



For Canadian Pricing
 Multiply U.S. Price by the Canadian price factor.
 ▶ See page 1 for details.

Tenor Chair

with Bag Hook



Tip: Tenor chairs can stack six high on the floor.

Tip: Soft felt glides are for use on non-carpeted floors. Black soft casters are for use on hard floors.

Tip: Tenor is designed as a wall-saver, it will not cause damage to walls if contact is made.

Standard Includes		Required to Specify
<ul style="list-style-type: none"> ▶ Need help? Product details, page 198 	<ul style="list-style-type: none"> • Seat and back: plastic price group 1 • Steel frame: paint price group 1 • Standard hard casters: black • Bag hook • Ships fully assembled 	<ol style="list-style-type: none"> 1 Style number 2 Plastic color number for back and seat shell 3 Paint color number for frame 4 Options, if selected (see below) <p>▶ See <i>Surface Materials</i>, page 634.</p>

Options	U.S. Price	Required to Specify
Surface Materials <ul style="list-style-type: none"> • Plastic on back and seat shell • Plastic price group 1 • Plastic price group 2 	<ul style="list-style-type: none"> No cost +\$ 56 	<ul style="list-style-type: none"> Specify plastic color number. Specify plastic color number.
<ul style="list-style-type: none"> • Paint on frame • Paint price group 1 • Paint price group 2 • Paint price group 3 	<ul style="list-style-type: none"> No cost +\$ 74 +\$100 	<ul style="list-style-type: none"> Specify paint color number. Specify paint color number. Specify paint color number.
Glides and Casters <ul style="list-style-type: none"> • Black nylon glides • Steel glides • Soft felt glides • Black soft casters 	<ul style="list-style-type: none"> No cost No cost +\$ 7 +\$ 36 	<ul style="list-style-type: none"> Specify <i>with nylon glides</i>. Specify <i>with steel glides</i>. Specify <i>with soft felt glides</i>. Specify <i>with black soft casters</i>.

Specification Information				
Dimensions			Style Number	U.S. Base Price
D	W	H		
21 ³ / ₄ "	17 ⁵ / ₈ "	18"	SLCH	\$459

Tenor

 **For Canadian Pricing**
 Multiply U.S. Price by the Canadian price factor.
 ▶ See page 1 for details.

Tenor Chair

with Bag Hook and Foot Bar



Tip: Tenor chairs can stack six high on the floor.

Tip: Soft felt glides are for use on non-carpeted floors. Black soft casters are for use on hard floors.

Tip: Tenor is designed as a wall-saver, it will not cause damage to walls if contact is made.

Standard Includes		Required to Specify
<ul style="list-style-type: none"> ▶ Need help? Product details, page 198 	<ul style="list-style-type: none"> • Seat and back: plastic price group 1 • Steel frame: paint price group 1 • Standard hard casters: black • Bag hook • Foot bar • Ships fully assembled 	<ol style="list-style-type: none"> 1 Style number 2 Plastic color number for back and seat shell 3 Paint color number for frame 4 Options, if selected (see below) <ul style="list-style-type: none"> ▶ See <i>Surface Materials</i>, page 634.

Options	U.S. Price	Required to Specify
Surface Materials <ul style="list-style-type: none"> • Plastic on back and seat shell <ul style="list-style-type: none"> • Plastic price group 1 • Plastic price group 2 • Paint on frame <ul style="list-style-type: none"> • Paint price group 1 • Paint price group 2 • Paint price group 3 	<ul style="list-style-type: none"> No cost +\$ 56 No cost +\$ 74 +\$100 	<ul style="list-style-type: none"> Specify plastic color number. Specify plastic color number. Specify paint color number. Specify paint color number. Specify paint color number.
Glides and Casters <ul style="list-style-type: none"> • Black nylon glides • Steel glides • Soft felt glides • Black soft casters 	<ul style="list-style-type: none"> No cost No cost +\$ 7 +\$ 36 	<ul style="list-style-type: none"> Specify <i>with nylon glides</i>. Specify <i>with steel glides</i>. Specify <i>with soft felt glides</i>. Specify <i>with black soft casters</i>.

Specification Information				
Dimensions			Style Number	U.S. Base Price
D	W	H		
21 ³ / ₄ "	17 ⁵ / ₈ "	18"	SLCFH	\$470



For Canadian Pricing
 Multiply U.S. Price by the Canadian price factor.
 ▶ See page 1 for details.

Tenor Stool

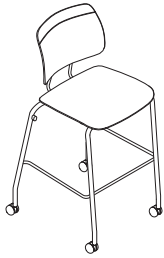

Tip: Tenor stools can stack two high on the floor.

Tip: Soft felt glides are for use on non-carpeted floors. Black soft casters are for use on hard floors.

Tip: Tenor is designed as a wall-saver, it will not cause damage to walls if contact is made.

Standard Includes		Required to Specify
<ul style="list-style-type: none"> ▶ Need help? Product details, page 198 	<ul style="list-style-type: none"> • Steel frame: paint price group 1 • Seat and back: plastic price group 1 • Standard hard casters: black • Ships fully assembled 	<ul style="list-style-type: none"> 1 Style number 2 Paint color number for frame 3 Plastic color number for back and seat shell 4 Options, if selected (see below) ▶ See <i>Surface Materials</i>, page 634.

Options	U.S. Price	Required to Specify
Surface Materials <ul style="list-style-type: none"> • Plastic on back and seat shell <ul style="list-style-type: none"> • Plastic price group 1 • Plastic price group 2 • Paint on frame <ul style="list-style-type: none"> • Paint price group 1 • Paint price group 2 • Paint price group 3 	<ul style="list-style-type: none"> No cost +\$ 56 No cost +\$ 74 +\$100 	<ul style="list-style-type: none"> Specify plastic color number. Specify plastic color number. Specify paint color number. Specify paint color number. Specify paint color number.
Glides <ul style="list-style-type: none"> • Black nylon glides • Steel glides • Soft felt glides 	<ul style="list-style-type: none"> No cost No cost +\$ 7 	<ul style="list-style-type: none"> Specify <i>with nylon glides</i>. Specify <i>with steel glides</i>. Specify <i>with soft felt glides</i>.
Casters <ul style="list-style-type: none"> • Black soft casters 	<ul style="list-style-type: none"> +\$ 36 	<ul style="list-style-type: none"> Specify <i>with black soft casters</i>.
Related Products <ul style="list-style-type: none"> • Tenor chair 		<ul style="list-style-type: none"> ▶ Page 201

Specification Information				
Dimensions			Style Number	U.S. Base Price
D	W	H		
21 ³ / ₄ "	17 ⁵ / ₈ "	29"	SLSB	\$667

Tenor

 **For Canadian Pricing**
 Multiply U.S. Price by the Canadian price factor.
 ▶ See page 1 for details.

Tenor Stool

with Bag Hook

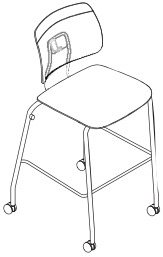

Tip: Tenor stools can stack two high on the floor.

Tip: Soft felt glides are for use on non-carpeted floors. Black soft casters are for use on hard floors.

Tip: Tenor is designed as a wall-saver, it will not cause damage to walls if contact is made.

Standard Includes		Required to Specify
<ul style="list-style-type: none"> ▶ Need help? Product details, page 198 	<ul style="list-style-type: none"> • Steel frame: paint price group 1 • Seat and back: plastic price group 1 • Standard hard casters: black • Ships fully assembled 	<ol style="list-style-type: none"> 1 Style number 2 Paint color number for frame 3 Plastic color number for back and seat shell 4 Options, if selected (see below) <ul style="list-style-type: none"> ▶ See <i>Surface Materials</i>, page 634.

Options	U.S. Price	Required to Specify
Surface Materials <ul style="list-style-type: none"> • Plastic on back and seat shell <ul style="list-style-type: none"> • Plastic price group 1 • Plastic price group 2 • Paint on frame <ul style="list-style-type: none"> • Paint price group 1 • Paint price group 2 • Paint price group 3 	<ul style="list-style-type: none"> No cost +\$ 56 No cost +\$ 74 +\$100 	<ul style="list-style-type: none"> Specify plastic color number. Specify plastic color number. Specify paint color number. Specify paint color number. Specify paint color number.
Glides <ul style="list-style-type: none"> • Black nylon glides • Steel glides • Soft felt glides 	<ul style="list-style-type: none"> No cost No cost +\$ 7 	<ul style="list-style-type: none"> Specify <i>with nylon glides</i>. Specify <i>with steel glides</i>. Specify <i>with soft felt glides</i>.
Casters <ul style="list-style-type: none"> • Black soft casters 	<ul style="list-style-type: none"> +\$ 36 	<ul style="list-style-type: none"> Specify <i>with black soft casters</i>.
Related Products <ul style="list-style-type: none"> • Tenor chair 		<ul style="list-style-type: none"> ▶ Page 201

Specification Information				
• Dimensions			• Style Number	• U.S. Base Price
D	W	H		
21¾"	17⅝"	29"	SLSBH	\$687



For Canadian Pricing
 Multiply U.S. Price by the Canadian price factor.
 ▶ See page 1 for details.

Tenor Perching Stool

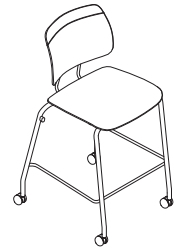

Tip: Tenor stools can stack two high on the floor.

Tip: Soft felt glides are for use on non-carpeted floors. Black soft casters are for use on hard floors.

Tip: Tenor is designed as a wall-saver, it will not cause damage to walls if contact is made.

Standard Includes		Required to Specify	
<ul style="list-style-type: none"> ▶ Need help? Product details, page 198 	<ul style="list-style-type: none"> • Steel frame: paint price group 1 • Seat and back: plastic price group 1 • Standard hard casters: black • Ships fully assembled 	<ol style="list-style-type: none"> 1 Style number 2 Paint color number for frame 3 Plastic color number for back and seat shell 4 Options, if selected (see below) 	<ul style="list-style-type: none"> ▶ See <i>Surface Materials</i>, page 634.

Options	U.S. Price	Required to Specify	
Surface Materials	Plastic on back and seat shell		
	<ul style="list-style-type: none"> • Plastic price group 1 • Plastic price group 2 	No cost +\$ 56	Specify plastic color number. Specify plastic color number.
	Paint on frame		
	<ul style="list-style-type: none"> • Paint price group 1 • Paint price group 2 • Paint price group 3 	No cost +\$ 74 +\$100	Specify paint color number. Specify paint color number. Specify paint color number.
Glides	<ul style="list-style-type: none"> • Black nylon glides • Steel glides • Soft felt glides 	No cost No cost +\$ 7	Specify <i>with nylon glides</i> . Specify <i>with steel glides</i> . Specify <i>with soft felt glides</i> .
Casters	<ul style="list-style-type: none"> • Black soft casters 	+ \$ 36	Specify <i>with black soft casters</i> .
Related Products	<ul style="list-style-type: none"> • Tenor chair 		▶ Page 201

Specification Information				
Dimensions			Style Number	U.S. Base Price
D	W	H		
21 ³ / ₄ "	17 ⁵ / ₈ "	26"	SLSC	\$650

 **For Canadian Pricing**
 Multiply U.S. Price by the Canadian price factor.
 ▶ See page 1 for details.



Tenor Perching Stool

with Bag Hook

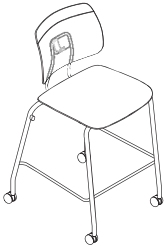

Tip: Tenor stools can stack two high on the floor.

Tip: Soft felt glides are for use on non-carpeted floors. Black soft casters are for use on hard floors.

Tip: Tenor is designed as a wall-saver, it will not cause damage to walls if contact is made.

Standard Includes		Required to Specify
<ul style="list-style-type: none"> ▶ Need help? Product details, page 198 	<ul style="list-style-type: none"> • Steel frame: paint price group 1 • Seat and back: plastic price group 1 • Standard hard casters: black • Ships fully assembled 	<ol style="list-style-type: none"> 1 Style number 2 Paint color number for frame 3 Plastic color number for back and seat shell 4 Options, if selected (see below) <ul style="list-style-type: none"> ▶ See <i>Surface Materials</i>, page 634.

Options	U.S. Price	Required to Specify
Surface Materials <ul style="list-style-type: none"> • Plastic on back and seat shell <ul style="list-style-type: none"> • Plastic price group 1 • Plastic price group 2 • Paint on frame <ul style="list-style-type: none"> • Paint price group 1 • Paint price group 2 • Paint price group 3 	<ul style="list-style-type: none"> No cost +\$ 56 No cost +\$ 74 +\$100 	<ul style="list-style-type: none"> Specify plastic color number. Specify plastic color number. Specify paint color number. Specify paint color number. Specify paint color number.
Glides <ul style="list-style-type: none"> • Black nylon glides • Steel glides • Soft felt glides 	<ul style="list-style-type: none"> No cost No cost +\$ 7 	<ul style="list-style-type: none"> Specify <i>with nylon glides</i>. Specify <i>with steel glides</i>. Specify <i>with soft felt glides</i>.
Casters <ul style="list-style-type: none"> • Black soft casters 	<ul style="list-style-type: none"> +\$ 36 	<ul style="list-style-type: none"> Specify <i>with black soft casters</i>.
Related Products <ul style="list-style-type: none"> • Tenor chair 		<ul style="list-style-type: none"> ▶ Page 201

Specification Information

• Dimensions			• Style Number	• U.S. Base Price
D	W	H		
21¾"	17⅝"	26"	SLSCH	\$670



For Canadian Pricing

Multiply U.S. Price by the Canadian price factor.

▶ See page 1 for details.

Understanding and Specifying Reply 466 Series Work Chairs/ Multi-Use Seating

Product Details

Reply 466 Series	210
Dimensions	214

Specifying

Swivel-Base Work Chairs	216
Leg-Base Multi-Use Chairs	220
Sled-Base Multi-Use Chairs	224

Work Chairs

Highly adjustable task seating offers maximum personalization for fit and comfort for a range of duration and use. By making a series of simple adjustments, you can customize the chair to your body, preferences, and tasks. These chairs provide continuous, stable, comfort, and can be quickly adjusted to support you in upright, and reclining work postures.

- Gesture 442 Series
- Leap 462 Series
- Think 465 Series
- Amia 482 Series
- Reply 466 Series

Adjustability Features

▶ See page 26 for a comparison to other chairs. **Reply 466 Series**

Mechanisms

Synchro-tilt ●

Seat Adjustments

Pneumatic height ●

Seat depth ●

Back Adjustments

Back height ●

Lumbar height ●

Multi-position back lock ●

Arm Adjustments

Arm height ●

Arm pivot ●

Arm depth ●

Reply 466 Series

Reply is a global family of value-friendly seating designed with unexpected extras.

Back frame and seat shell are plastic.

Back height adjustment on upholstered chairs allows you to raise or lower chair back from a seated position to support your lower back.

Five-star base is plastic, a polished aluminum base is available as an option.

Arm tube matches the frame finish.

Exception: The height-, width-, pivot-, depth-adjustable arm (maintenance width adjustment) is only available in black.

Arm support is coordinated to match the base finish.

Exception: The height-, width-, pivot-, depth-adjustable arm (maintenance width adjustment) is only available in black. Arm support color is always platinum metallic paint 4799 when the 6053 Seagull frame is selected.

Dual-wheel with roll-control casters may be used on soft and hard flooring surfaces.

Back handle on mesh back chairs provides a convenient handhold to easily move the chair.

Arms, when specified, have a textured plastic arm cap.

Lumbar height adjusts 4" to provide additional lower back support and is available as an option on mesh back chairs only.

Arm depth can retract 3" to allow user to get closer to the worksurface and into tight corners.

Arm height can adjust independently within a 3³/₄" range to help relieve upper back and shoulder fatigue.

Arm caps can pivot independently 18° in and 4° out to accommodate individual user preferences.

Arm width adjusts 1" per arm for a total of 2" overall width adjustment.

Multi-position back lock allows user to recline the back to the desired angle and lock it in place.

Seat depth adjusts within a 1¹/₂" range to accommodate users of varying leg lengths.

Seat height adjusts within a 5" range with a pneumatic adjustment mechanism.

Tilt tension adjustment allows you to control the amount of resistance needed for reclining.

Casters have hard, dual-wheels that roll smoothly on carpets. They are 2¹/₂" for increased mobility. Soft, dark grey treaded, dual-wheel roll-control casters are available for use on hard floors or mats.

Tip: Do not roll the chair across asphalt during installation as this may damage the casters.

Plastic glides are standard. Optional soft glides are available.

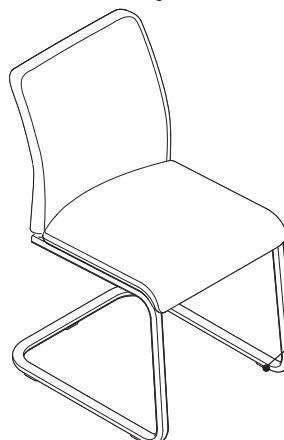
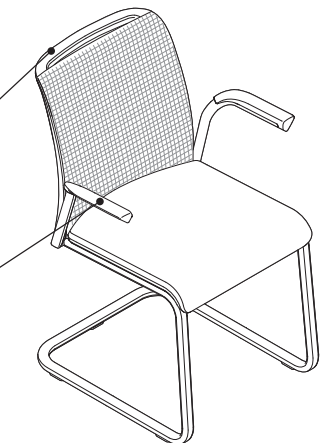
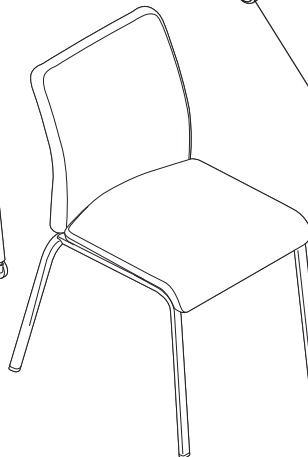
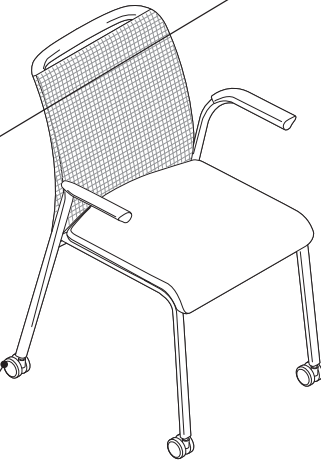

Product Details



Synchro-tilt mechanism with a natural fluid motion on work chairs keeps users oriented to their work.

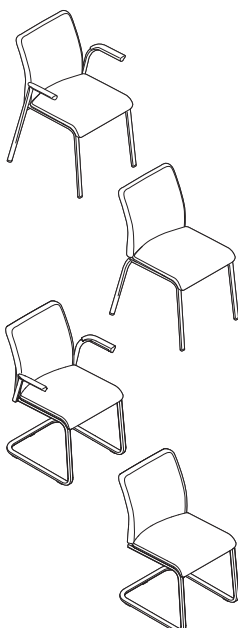

Fixed-height multi-use chairs are available with or without arms.

Cartoned shipment of Reply work chairs is standard. Reply work chairs ship knocked down in a single carton consisting of two components: the base, pneumatic, mechanism, and seat (built up as one component), and the back with the attachment knob. This allows for shipment in a smaller carton. Leg-base multi-use chairs ship two to a carton, when applicable. Assembly by a qualified dealer installer is required for work chairs. Assembly instructions are included. No additional tools are required for assembly.

Uncartoned request means Reply work chairs will ship fully assembled and blanket wrapped.

Stacking density for leg-base multi-use chairs is six on the floor. Arms and casters do not impact the ability to stack.

Adjustment Features

Adjustability instructions are included with every swivel-base chair. Instructions can also be found at www.steelcase.com.

Seat Adjustments

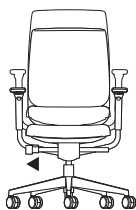

Seat height adjusts pneumatically. To lower, hold handle up while seated. To raise, hold handle up and keep your weight off the chair. Range of adjustability is 5", from 16"H to 21"H.

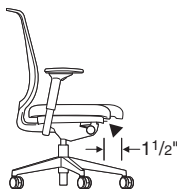

Seat depth adjusts 1½" by pulling handle up. Slide seat forward or back to accommodate various leg lengths. Release handle to lock. Seat depth is a standard feature on work chairs.

Back Adjustments

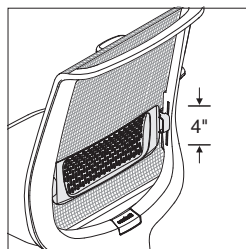

Lumbar height adjusts 4" (6" to 10" from seat) by grabbing exposed tabs and sliding the lumbar support up or down. Available as an option on mesh work chairs only.

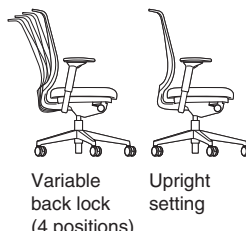

Variable back lock (4 positions)

Upright setting

Multiple position back lock allows users to recline the back to the desired angle and lock it in place. To lock, recline to desired angle and push back lock handle down. To release, lean forward, lift the handle and apply pressure to the back to disengage the lock.

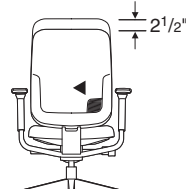

Back height adjusts 2½" (23"–25½") by pressing and holding the control button on the right side of the back, and sliding the back support up or down. Release the control button to lock. This feature is standard on work chairs with upholstered (non-mesh) backs only.

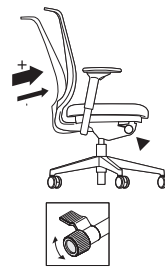

Back tension adjusts by turning knob forward to increase back tension, backward to decrease back tension. This feature is standard on all work chairs.

Arm Adjustments

Height-, pivot-, and depth-adjustable arms are available as an option on Reply task chairs.

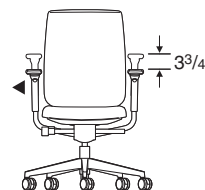

Arm height adjusts independently within a range of 3¾" (7½"–11¼" from the seat). Push button on outside and under arm cap in while moving arms up or down. Releasing buttons locks arms in position.

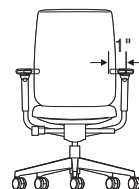

Width maintenance arms adjust 1" each independently on chairs with this option. To adjust, loosen the screw under the arm tube and move to desired position and tighten.

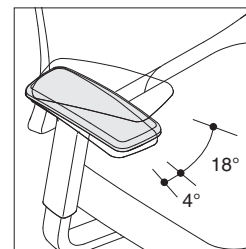

Arms pivot 18° inward and 4° outward on models with adjustable pivot arms. Grasp arm and push front to left or right.



Arm depth adjusts approximately 3" to enable user to get closer to worksurface.

Other Features

Height-only adjustable arm is also available and adjusts 3¾".

Soft, dark grey treaded, dual-wheel roll-control casters are available as an option for use on hard floors or mats.

Dual-wheel roll-control casters for use on soft and hard flooring surfaces come standard on leg-base multi-use chairs when specified with casters.

Hard glides come standard on multi-use chairs when specified with glides. Soft glides are available as an option.

Reply 466 Series, continued

Surface Materials

► See surface materials on page 634 for specific availability or refer to the *Surface Materials Reference Manual* for further information.

Upholstery

- Fabric
- Fabric with soil-retardant treatment (option)
- Mesh (back only)
- Leather
- Elmosoft leather
- Select Surfaces leather
- Vinyl

Chair with mesh back and swivel base

Arm cap assembly, 4D arms, and mechanism:

- 6205 Black

Frame and arm tube match:

- 6205 Black or 6053 Seagull

Swivel base and arm support coordinate:

- 6205 Black base with 6205 Black arm support
- 4799 Platinum Metallic base with 4799 Platinum Metallic arm support
- 8046 Polished Aluminum base with 4799 Platinum Metallic arm support

Exception: 6053 Seagull frame receives 4799 Platinum Metallic arm support.

Chair with upholstered back and swivel base

Outer back, arm cap assembly, 4D arms, and mechanism:

- 6205 Black

Frame and arm tube:

- 6205 black only

Swivel base and arm support coordinate based on base color:

- 6205 Black base with 6205 Black arm support
- 4799 Platinum Metallic base with 4799 Platinum Metallic arm support
- 8046 Polished Aluminum base with 4799 Platinum

Metallic arm support Height-, width-, pivot-, depth-adjustable arms (maintenance width adjustment):

- Arm tube and support only available in 6205 Black

Chair with multi-use leg-base (outer back, and arm caps)

- 6205 Black

Chair with leg-base or sled-base (metal frame)

- 4799 Platinum
- 7207 Black

Castors

- 6205 Black

Glides

Chair with multi-use leg-base

- 6205 Black

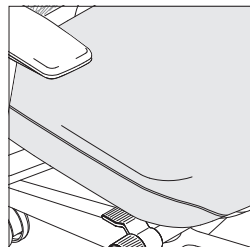
**Sewn-upholstery models**

feature a stitch detail on the sides of the seat and back cushions. Task chairs have an additional stitch across the lumbar region of the back cushion.

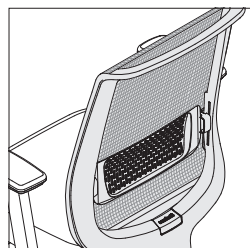
Swivel-Base Models

Mesh back on swivel-base models are available with a height-adjustable lumbar option to enhance back support.

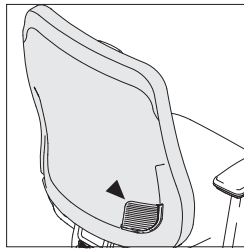
**Upholstered back on swivel-base models**

feature a back-height adjustment that allows you to raise or lower the chair back from a seated position to support your lower back.

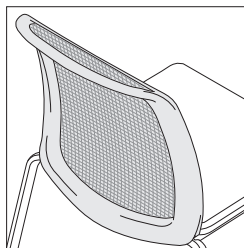
Leg-Base and Sled-Base Models

Mesh back frame with handle on leg-base models provides a convenient handhold to easily move the chair.

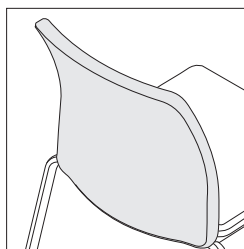

Upholstered backrest on leg-base models features a plastic outer shell.

All Steelcase seating with standard upholstery fabrics complies with requirements of the State of California Technical Bulletin 117-2013. All standard seating is labeled to be in compliance with California 117-2013.

Programs & Services

► See *Surface Materials Reference Manual* for further detail about programs and services offered for seating.

The Customer's Own Material (COM) Program

offers the opportunity for customers to select fabrics that are not offered through the standard Steelcase surface materials program for use on Steelcase products. Through the COM program, Steelcase will test your materials for application on Steelcase products. Once approved, you can place your order. Steelcase will facilitate the entire ordering process and give you a production schedule. Steelcase will order the COM fabric directly from the textile manufacturer. For up-to-date information regarding fabric test results for all COM fabrics and details regarding yardage requirements for most Seating lines, visit the COM website. To locate the COM website:

- Visit www.steelcase.com

Soil retardants are treatments that provide long-term soil and stain resistance to a fabric without affecting the shade or the integrity of the fabric. The following Steelcase Textiles are available pre-treated with soil retardant. (You do not need to select the soil-retardant option for these fabrics and incur the upcharge.)

- Jacks
- Link

For information on soil retardant fabrics on Select Surfaces, please refer to the *Surface Materials Reference Manual*.

Soil-retardant treatment is available on all other seating fabrics at an additional upcharge per seating unit. To order this option, please select "Soil-Retardant Treatment" under "Optional Accessories."

For soil-retardant treatment on COMs, please select "Soil-Retardant Treatment" under "Optional Accessories." Minimums or additional yardage may be required. Please contact the vendor directly for specific information.

Extended lead times may be necessary for this service.

Contact your Steelcase Solutions Fulfillment Team Representative at 1.888.STEELCASE (1.888.783.3522) or send an email to lineone@steelcase.com.

Dimensions

► Page 214

Resources**Printed Materials**

- Reply Product Brochure (10-0002941)
- Reply User Guide (10-0002805)

Audiovisual Materials

- Adjustability video available on www.steelcase.com

Online Resources

- Product Environmental Profiles, which provide key environmental attributes and product certifications can be found by searching for Steelcase at *Origin.build*.

Mesh Back Chair Color Scheme Matrix

Frame Color	Arm Cap	Arm Tube	Arm Support (Height-adjustable arms and Height-, pivot-, depth-adjustable arms)	Base
Black 6205	Black 6205	Black 6205	Black 6205, Platinum Metallic Paint 4799	Black 6205, Platinum Metallic Paint 4799, Polished Aluminum 8046
Seagull 6053	Black 6205	Seagull 6053	Platinum Metallic Paint 4799	Black 6205, Platinum Metallic Paint 4799, Polished Aluminum 8046

* For black frame mesh chairs, arm support color is driven by base color (black base chair receives black arm supports, platinum metallic and polished aluminum bases receive platinum metallic arm supports)

* For seagull frame mesh chairs, arm support color is Platinum Metallic Paint 4799

* Arm tube and arm support color for height-, width-, pivot-, depth-adjustable (maintenance width adjustment) arm is only available in black

Upholstered Back Chair Color Scheme Matrix

Outer Back Frame	Arm Cap	Arm Tube	Arm Support (Height-adjustable arms and Height pivot depth adjustable arms)	Base
Black 6205	Black 6205	Black 6205	Black 6205, Platinum Metallic Paint 4799	Black 6205, Platinum Metallic Paint 4799, Polished Aluminum 8046

* Arm support color is driven by base color (black base chair receives black arm supports, platinum metallic and polished aluminum bases receive platinum metallic arm supports)

* Arm tube and arm support color for height-, width-, pivot-, depth-adjustable (maintenance width adjustment) arm is only available in black

Dimensions

Reply 466 Series

Features	Overall Depth	Width	Height	Seat Depth	Functional Seat Depth	Seat Width	Seat Height from Floor	Back Width	Back Height from Seat	Lumbar Height from Seat
Reply 466 Series										
Swivel-Base Work Chairs										
Mesh Back	24" to 25"	26"	37 ³ / ₄ " to 42 ³ / ₄ "	16 ⁷ / ₈ "	16 ¹ / ₂ " to 18"	18 ¹ / ₂ "	16" to 21"	17 ¹ / ₂ "	22 ⁵ / ₈ "	6" to 10"
Upholstered Back and Seat	21 ¹ / ₈ " to 22 ¹ / ₂ "	26"	39 ¹ / ₄ " to 46 ³ / ₄ "	16 ⁷ / ₈ "	15 ¹ / ₂ " to 17"	18 ¹ / ₂ "	16" to 21"	17 ¹ / ₂ "	23 ¹ / ₄ " to 25 ³ / ₄ "	N.A.
Leg-Base Multi-Use Chairs										
Mesh Back	23"	23 ¹ / ₄ **	34***	17 ¹ / ₂ "	16"	17 ³ / ₄ "	19***	16 ¹ / ₂ "	17"	9 ¹ / ₂ "
Upholstered	23"	23 ¹ / ₄ **	33***	17 ¹ / ₂ "	17"	17 ³ / ₄ "	19***	16 ³ / ₄ "	17"	8"
Sled-Base Multi-Use Chairs										
Mesh Back	23 ¹ / ₂ "	23 ¹ / ₄ "	33 ¹ / ₂ "	17 ¹ / ₂ "	16"	17 ³ / ₄ "	18 ¹ / ₂ "	16 ¹ / ₂ "	17"	9 ¹ / ₂ "
Upholstered	23 ¹ / ₂ "	23 ¹ / ₄ "	32 ¹ / ₂ "	17 ¹ / ₂ "	17"	17 ³ / ₄ "	18 ¹ / ₂ "	16 ³ / ₄ "	17"	8"

*Armless models are 1¹/₄" narrower.

**Dimension is 1/2" less when specified with glides.

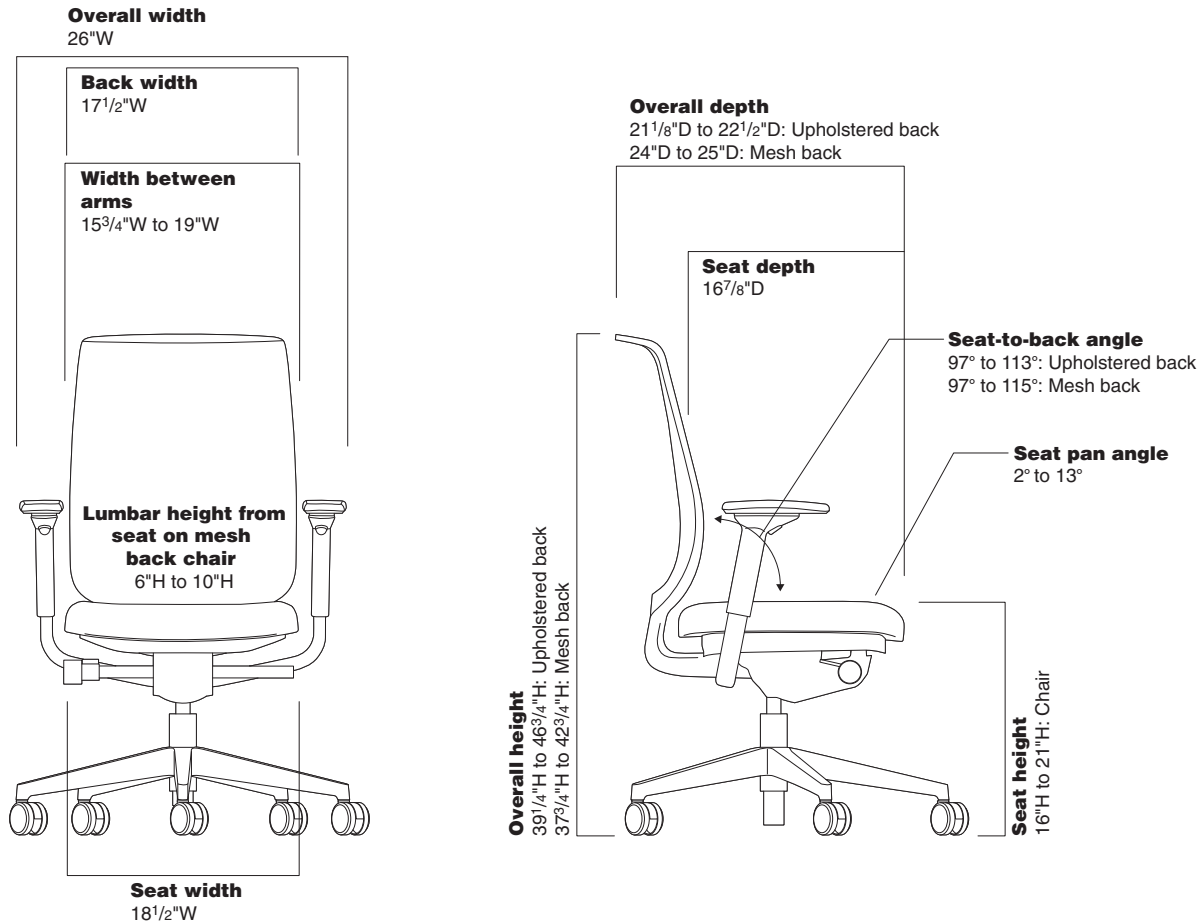

• Width Between Arms	• Arm Height to Floor	• Arm Height from Seat	• Arm Cap Pivot Range	• Angle Between Seat and Back	• Seat Pan Angle
15¾" to 19"	23¼" to 32"	7¼" to 11"	18° inward, 4° outward	97° to 115°	2° to 13°
15¾" to 19"	23¼" to 32"	7¼" to 11"	18° inward, 4° outward	97° to 113°	2° to 13°
19½"	26¾"***	9"	N.A.	98°	6°
19½"	26¾"***	9"	N.A.	98°	6°
19½"	26¼"	9"	N.A.	98°	6°
19½"	26¼"	9"	N.A.	98°	6°

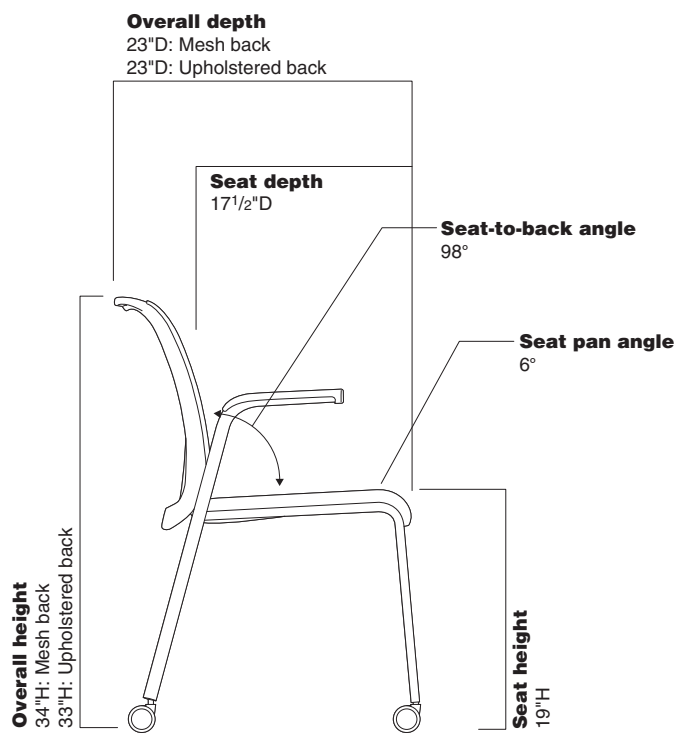
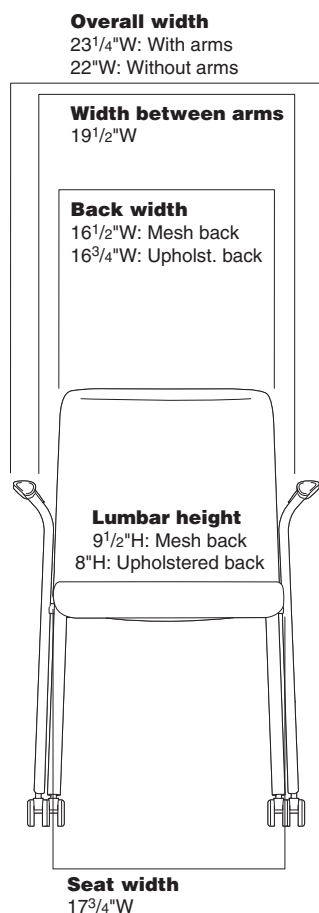

Reply 466 Series Swivel-Base Work Chair

Mesh Back with Standard Upholstery on Seat



Tip: Arms are not included with Reply unless you specify one of the arm options.

Tip: Always add suffixes in alphabetical order when specifying options to Reply seating.

Tip: Leather and vinyl upcharges are in addition to sewn upholstery upcharge.

► Detailed dimensions, page 214

Tip: Height-, width-, pivot-, depth-adjustable arms are maintenance width adjustable in 6205 Black only (tube and support).

Tip: Frame color determines matching arm tube color.

Tip: Base and arm support colors coordinate and are driven by base color: 6205 Black base with 6205 Black arm support. 4799 Platinum Metallic base with 4799 Platinum Metallic arm support. 8046 Polished Aluminum base with 4799 Platinum Metallic arm support. Exception: 6053 Seagull frame receives 4799 Platinum Metallic arm support.

Standard Includes		Required to Specify
► Need help? Product details, page 210	<ul style="list-style-type: none"> • Synchro-tilt mechanism • 5" pneumatic seat-height adjustment (16"-21") • Multi-position back lock • Outer back, seat shell, and five-arm plastic base: plastic • 1½" seat depth adjustment • Mesh on back • Standard upholstery design on seat: fabric price group 1 • 2½"-diameter, hard-composition, dual-wheel casters: black 	<ol style="list-style-type: none"> 1 Style number 2 Plastic color number for frame, arm tube, and base; if specified 3 Mesh color number for back 4 Fabric color number for upholstery on seat 5 Options, if selected (see below) <p>► See <i>Surface Materials</i>, page 634.</p>

Options	U.S. Price	Required to Specify
Surface Materials <ul style="list-style-type: none"> • Fabric price group 1 • Fabric price group 2 • Fabric price group 3 • Fabric price group 4 • Fabric price group 5 • Fabric price group 6 • Fabric price group 7 • Fabric price group 8 • Fabric price group 9 • Fabric price group 10 • Steelcase leather upholstery • Select Surfaces leather price group 1 • Elmosoft leather upholstery • Select Surfaces leather price group 2 • Steelcase vinyl • Customer's Own Material (COM) • Customer's Own Leather (COL) 	<ul style="list-style-type: none"> No cost +\$ 21 +\$ 34 +\$ 48 +\$ 62 +\$ 77 +\$ 88 +\$111 +\$137 +\$154 +\$204 +\$204 +\$245 +\$245 +\$ 21 No cost No cost 	<ul style="list-style-type: none"> Specify fabric color number. Specify fabric color number. Specify fabric color number. Specify fabric color number. Specify fabric color number. Specify fabric color number. Specify fabric color number. Specify fabric color number. Specify fabric color number. Specify fabric color number. Specify fabric color number. Add suffix S to the style number and specify leather color number. Add suffix S to the style number and specify Select Surfaces leather price group 1. ► See <i>Surface Materials Reference Manual</i>. Add suffix S to the style number and specify Elmosoft leather color number. Add suffix S to the style number and specify Select Surfaces leather price group 2. ► See <i>Surface Materials Reference Manual</i>. Add suffix S to the style number and specify vinyl color number. ► See <i>Surface Materials Reference Manual</i> to specify. Add suffix S to the style number and specify leather color number.
Soil-retardant treatment <ul style="list-style-type: none"> • Sewn upholstery on chair 	<ul style="list-style-type: none"> +\$ 36 +\$ 58 	<ul style="list-style-type: none"> Specify <i>with soil-retardant treatment</i>. Add suffix S to the style number.
Arms <ul style="list-style-type: none"> • Height-adjustable arms, soft arm caps • Height-, pivot-, depth-adjustable arms • Height-, width-, pivot-, depth-adjustable arms (maintenance width adjustment) 	<ul style="list-style-type: none"> +\$146 +\$218 +\$277 	<ul style="list-style-type: none"> Specify <i>with height-adjustable arms</i>. Specify <i>with height-, pivot-, depth-adjustable arms</i>. Specify <i>with height-, width-, pivot-, depth-adjustable arms</i>.
Frame <ul style="list-style-type: none"> • Black • Seagull 	<ul style="list-style-type: none"> No cost +\$ 65 	<ul style="list-style-type: none"> Specify <i>with 6205 Black</i>. Specify <i>with 6053 Seagull</i>.
Base <ul style="list-style-type: none"> • Black • Platinum • Polished aluminum 	<ul style="list-style-type: none"> No cost +\$ 66 +\$220 	<ul style="list-style-type: none"> Specify <i>with 6205 Black</i>. Specify <i>with 4799 Platinum</i>. Specify <i>with aluminum base</i>.
Lumbar Height <ul style="list-style-type: none"> • 4" travel for additional lumbar support 	<ul style="list-style-type: none"> +\$ 61 	<ul style="list-style-type: none"> Specify <i>with adjustable lumbar height</i>.
Casters <ul style="list-style-type: none"> • Soft, dark grey treaded, dual-wheel roll-control casters for use on hard floors 	<ul style="list-style-type: none"> +\$ 36 	<ul style="list-style-type: none"> Specify <i>with soft roll-control casters</i>.

Specification Information

Style Number	U.S. Base Price
466160MT	\$1077



Reply 466 Series



For Canadian Pricing
Multiply U.S. Price by the
Canadian price factor.
▶ See page 1 for details.

Reply 466 Series Swivel-Base Work Chair

Standard Upholstery on Back and Seat



Tip: Arms are not included with Reply unless you specify one of the arm options.

Tip: Leather and vinyl upcharges are in addition to sewn upholstery upcharge.

► Detailed dimensions, page 214



For Canadian Pricing

Multiply U.S. Price by the Canadian price factor.

► See page 1 for details.

Standard Includes	Required to Specify
<ul style="list-style-type: none"> ► Need help? Product details, page 210 • Synchro-tilt mechanism • 5" pneumatic seat-height adjustment (16"-21") • Multi-position back lock • Outer back, seat shell, and five-arm plastic base: plastic • 1½" seat depth adjustment • 2¼" back-height adjustment • Standard upholstery design on back and seat: fabric price group 1 • 2½"-diameter, hard-composition, dual-wheel casters: black 	<ol style="list-style-type: none"> 1 Style number 2 Plastic color number for base, and arm tube; if specified 3 Fabric color number for upholstery on back and seat 4 Options, if selected (see below) <p>► See <i>Surface Materials</i>, page 634.</p>

Options	U.S. Price	Required to Specify
Surface Materials		
Upholstery on seat and back		
• Fabric price group 1	No cost	Specify fabric color number.
• Fabric price group 2	+\$ 37	Specify fabric color number.
• Fabric price group 3	+\$ 72	Specify fabric color number.
• Fabric price group 4	+\$100	Specify fabric color number.
• Fabric price group 5	+\$125	Specify fabric color number.
• Fabric price group 6	+\$154	Specify fabric color number.
• Fabric price group 7	+\$179	Specify fabric color number.
• Fabric price group 8	+\$223	Specify fabric color number.
• Fabric price group 9	+\$276	Specify fabric color number.
• Fabric price group 10	+\$312	Specify fabric color number.
• Steelcase leather upholstery	+\$405	Add suffix S to the style number and specify leather color number.
• Select Surfaces leather price group 1	+\$405	Add suffix S to the style number and specify Select Surfaces leather price group 1.
• Elmosoft leather upholstery	+\$489	► See <i>Surface Materials Reference Manual</i> . Add suffix S to the style number and specify Elmosoft leather color number.
• Select Surfaces leather price group 2	+\$489	Add suffix S to the style number and specify Select Surfaces leather price group 2.
• Steelcase vinyl	+\$ 37	► See <i>Surface Materials Reference Manual</i> . Add suffix S to the style number and specify vinyl color number.
• Customer's Own Material (COM)	No cost	► See <i>Surface Materials Reference Manual</i> to specify.
• Customer's Own Leather (COL)	No cost	Add suffix S to the style number and specify leather color number.
Sewn upholstery		
• Sewn upholstery on chair	+\$110	Add suffix S to the style number.
Contrasting upholstery on seat and back		
• Contrasting fabrics	+\$ 46	Add suffix K to the style number and specify fabric color numbers.
Contrasting upholstery on seat		
• Fabric price group 1	No cost	Specify fabric color number.
• Fabric price group 2	+\$ 21	Specify fabric color number.
• Fabric price group 3	+\$ 34	Specify fabric color number.
• Fabric price group 4	+\$ 48	Specify fabric color number.
• Fabric price group 5	+\$ 62	Specify fabric color number.
• Fabric price group 6	+\$ 77	Specify fabric color number.
• Fabric price group 7	+\$ 88	Specify fabric color number.
• Fabric price group 8	+\$111	Specify fabric color number.
• Fabric price group 9	+\$137	Specify fabric color number.
• Fabric price group 10	+\$154	Specify fabric color number.
• Steelcase leather upholstery	+\$204	Add suffix S to the style number and specify leather color number.
• Select Surfaces leather price group 1	+\$204	Add suffix S to the style number and specify leather color number.
• Elmosoft leather upholstery	+\$245	Add suffix S to the style number and specify leather color number.

► **Options, continued on next page**

► Options, continued from previous page

Options	U.S. Price	Required to Specify
Surface Materials, continued		
Contrasting upholstery on seat, continued		
• Select Surfaces leather price group 2	+\$245	Add suffix S to the style number and specify leather color number. Add suffix S to the style number and specify vinyl color number. ► See <i>Surface Materials Reference Manual</i> . Add suffix S to the style number and specify leather color number.
• Steelcase vinyl	+\$ 21	
• Customer's Own Material (COM)	No cost	
• Customer's Own Leather (COL)	No cost	
Contrasting upholstery on back		
• Fabric price group 1	No cost	Specify fabric color number. Specify fabric color number. Specify fabric color number. Specify fabric color number. Specify fabric color number. Specify fabric color number. Specify fabric color number. Specify fabric color number. Specify fabric color number. Specify fabric color number. Add suffix S to the style number and specify leather color number. Add suffix S to the style number and specify leather color number. Add suffix S to the style number and specify leather color number. Add suffix S to the style number and specify vinyl color number. Add suffix S to the style number and specify vinyl color number. ► See <i>Surface Materials Reference Manual</i> . Add suffix S to the style number and specify leather color number.
• Fabric price group 2	+\$ 21	
• Fabric price group 3	+\$ 34	
• Fabric price group 4	+\$ 49	
• Fabric price group 5	+\$ 62	
• Fabric price group 6	+\$ 78	
• Fabric price group 7	+\$ 88	
• Fabric price group 8	+\$112	
• Fabric price group 9	+\$137	
• Fabric price group 10	+\$155	
• Steelcase leather upholstery	+\$204	
• Select Surfaces leather price group 1	+\$204	
• Elmosoft leather upholstery	+\$246	
• Select Surfaces leather price group 2	+\$246	
• Steelcase vinyl	+\$ 21	
• Customer's Own Material (COM)	No cost	
• Customer's Own Leather (COL)	No cost	
Soil-retardant treatment		
	+\$ 36	Specify with <i>soil-retardant treatment</i> .
Platinum		
• On base, and arm tube	+\$ 66	Specify with <i>4799 Platinum</i> .
Arms		
• Height-adjustable arms, soft arm caps	+\$146	Specify with <i>height-adjustable arms</i> . Specify with <i>height-, pivot-, depth-adjustable arms</i> . Specify with <i>height-, width-, pivot-, depth-adjustable arms</i> .
• Height-, pivot-, depth-adjustable arms	+\$218	
• Height-, width-, pivot-, depth-adjustable arms (maintenance width adjustment)	+\$277	
Base		
• Polished aluminum base	+\$220	Specify with <i>aluminum base</i> .
Casters		
• Soft, dark grey treaded, dual-wheel roll-control casters for use on hard floors	+\$ 36	Specify with <i>soft roll-control casters</i> .

Reply 466 Series

Tip: Leather and vinyl upcharges are in addition to sewn upholstery upcharge.

Tip: Height-, width-, pivot-, depth-adjustable arms are maintenance width adjustable in 6205 Black only (tube and support).

Tip: 6205 Black outer back color determines matching 6205 Black arm tube color.

Tip: Base and arm support colors coordinate and are driven by base color: 6205 Black base with 6205 Black arm support. 4799 Platinum Metallic base with 4799 Platinum Metallic arm support. 8046 Polished Aluminum base with 4799 Platinum Metallic arm support.

Specification Information

Style Number	U.S. Base Price
466160MP	\$1025



Reply 466 Series Leg-Base Multi-Use Chairs

Mesh Back with Standard Upholstery on Seat

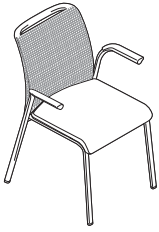

Tip: Leather and vinyl upcharges are in addition to sewn upholstery upcharge.

Tip: Casters or glides must be selected to complete specification of chair.

► Detailed dimensions, page 214

 **For Canadian Pricing**
Multiply U.S. Price by the Canadian price factor.
► See page 1 for details.

Standard Includes	Required to Specify
<ul style="list-style-type: none"> ► Need help? Product details, page 210 • Frame: paint • Mesh on back • Standard upholstery design on seat: fabric price group 1 • Arm caps, if selected: black 	<ol style="list-style-type: none"> 1 Style number 2 Paint color number for metal frame, and arms; if specified 3 Mesh color number for back 4 Fabric color number for upholstery on seat 5 Options, if selected (see below) <p>► See <i>Surface Materials</i>, page 634.</p>

Options	U.S. Price	Required to Specify
Surface Materials		
Upholstery on seat		
• Fabric price group 1	No cost	Specify fabric color number.
• Fabric price group 2	+\$ 21	Specify fabric color number.
• Fabric price group 3	+\$ 34	Specify fabric color number.
• Fabric price group 4	+\$ 48	Specify fabric color number.
• Fabric price group 5	+\$ 62	Specify fabric color number.
• Fabric price group 6	+\$ 77	Specify fabric color number.
• Fabric price group 7	+\$ 88	Specify fabric color number.
• Fabric price group 8	+\$111	Specify fabric color number.
• Fabric price group 9	+\$137	Specify fabric color number.
• Fabric price group 10	+\$154	Specify fabric color number.
• Steelcase leather upholstery	+\$204	Add suffix S to the style number and specify leather color number.
• Select Surfaces leather price group 1	+\$204	Add suffix S to the style number and specify Select Surfaces leather price group 1.
		► See <i>Surface Materials Reference Manual</i> .
• Elmosoft leather upholstery	+\$245	Add suffix S to the style number and specify Elmosoft leather color number.
• Select Surfaces leather price group 2	+\$245	Add suffix S to the style number and specify Select Surfaces leather price group 2.
		► See <i>Surface Materials Reference Manual</i> .
• Steelcase vinyl	+\$ 21	Add suffix S to the style number and specify vinyl color number.
• Customer's Own Material (COM)	No cost	► See <i>Surface Materials Reference Manual</i> to specify.
• Customer's Own Leather (COL)	No cost	Add suffix S to the style number and specify leather color number.
Soil-retardant treatment		
	+\$ 36	Specify <i>with soil-retardant treatment</i> .
Sewn upholstery		
• Sewn upholstery on chair	+\$ 58	Add suffix S to the style number.
Frame		
• Platinum on frame	+\$ 66	Specify <i>with 4799 Platinum frame</i> .
Casters		
• Dual-wheel roll-control casters	+\$ 75	Specify <i>with dual-wheel roll-control casters</i> .
Glides		
• Hard glides for use on carpeted floors	No cost	Specify <i>with hard glides</i> .
• Soft glides for use on non-carpeted floors	+\$ 7	Specify <i>with soft glides</i> .

Specification Information

With Arms



Without Arms



•Style •Number	•U.S. Base •Price	•Style •Number	•U.S. Base •Price
466452MT	\$869	466450MT	\$783

Reply 466 Series



For Canadian Pricing
Multiply U.S. Price by the
Canadian price factor.
▶ See page 1 for details.

Reply 466 Series Leg-Base Multi-Use Chairs

Standard Upholstery on Back and Seat



Tip: Leather and vinyl upcharges are in addition to sewn upholstery upcharge.

► Detailed dimensions, page 214



For Canadian Pricing

Multiply U.S. Price by the Canadian price factor.

► See page 1 for details.

Standard Includes		Required to Specify
► Need help? Product details, page 210	<ul style="list-style-type: none"> • Frame: paint • Standard upholstery design on seat and back: fabric price group 1 • Arm caps, if selected: black 	<ol style="list-style-type: none"> 1 Style number 2 Paint color number for metal frame, and arms; if specified 3 Fabric color number for upholstery on seat and back 4 Options, if selected (see below) <p>► See <i>Surface Materials</i>, page 634.</p>

Options	U.S. Price	Required to Specify
Surface Materials		
Upholstery on seat and back		
• Fabric price group 1	No cost	Specify fabric color number.
• Fabric price group 2	+\$ 37	Specify fabric color number.
• Fabric price group 3	+\$ 72	Specify fabric color number.
• Fabric price group 4	+\$100	Specify fabric color number.
• Fabric price group 5	+\$125	Specify fabric color number.
• Fabric price group 6	+\$154	Specify fabric color number.
• Fabric price group 7	+\$179	Specify fabric color number.
• Fabric price group 8	+\$223	Specify fabric color number.
• Fabric price group 9	+\$276	Specify fabric color number.
• Fabric price group 10	+\$312	Specify fabric color number.
• Steelcase leather upholstery	+\$405	Specify fabric color number.
• Select Surfaces leather price group 1	+\$405	Add suffix S to the style number and specify leather color number. Add suffix S to the style number and specify Select Surfaces leather price group 1.
• Elmosoft leather upholstery	+\$489	► See <i>Surface Materials Reference Manual</i> . Add suffix S to the style number and specify Elmosoft leather color number.
• Select Surfaces leather price group 2	+\$489	Add suffix S to the style number and specify Select Surfaces leather price group 2.
• Steelcase vinyl	+\$ 37	► See <i>Surface Materials Reference Manual</i> . Add suffix S to the style number and specify vinyl color number.
• Customer's Own Material (COM)	No cost	► See <i>Surface Materials Reference Manual</i> to specify.
• Customer's Own Leather (COL)	No cost	Add suffix S to the style number and specify leather color number.
Soil-retardant treatment	+\$ 36	Specify <i>with soil-retardant treatment</i> .
Sewn upholstery		
• Sewn upholstery on chair	+\$119	Add suffix S to the style number.
Contrasting upholstery on seat and back		
• Contrasting fabrics	+\$ 46	Add suffix K to the style number and specify fabric color numbers.
Contrasting upholstery on seat		
• Fabric price group 1	No cost	Specify fabric color number.
• Fabric price group 2	+\$ 21	Specify fabric color number.
• Fabric price group 3	+\$ 34	Specify fabric color number.
• Fabric price group 4	+\$ 48	Specify fabric color number.
• Fabric price group 5	+\$ 62	Specify fabric color number.
• Fabric price group 6	+\$ 77	Specify fabric color number.
• Fabric price group 7	+\$ 88	Specify fabric color number.
• Fabric price group 8	+\$111	Specify fabric color number.
• Fabric price group 9	+\$137	Specify fabric color number.
• Fabric price group 10	+\$154	Specify fabric color number.
• Steelcase leather upholstery	+\$204	Specify fabric color number.
• Select Surfaces leather price group 1	+\$204	Add suffix S to the style number and specify leather color number.
• Elmosoft leather upholstery	+\$245	Add suffix S to the style number and specify leather color number.

► Options, continued on next page

► Options, continued from previous page

Options	U.S. Price	Required to Specify	
Surface Materials, continued			
Contrasting upholstery on seat, continued			
• Select Surfaces leather price group 2	+\$245	Add suffix S to the style number and specify leather color number. Add suffix S to the style number and specify vinyl color number. ► See <i>Surface Materials Reference Manual</i> . Add suffix S to the style number and specify leather color number.	
• Steelcase vinyl	+\$ 21		
• Customer's Own Material (COM)	No cost		
• Customer's Own Leather (COL)	No cost		
Contrasting upholstery on back			
• Fabric price group 1	No cost	Specify fabric color number. Specify fabric color number. Specify fabric color number. Specify fabric color number. Specify fabric color number. Specify fabric color number. Specify fabric color number. Specify fabric color number. Specify fabric color number. Specify fabric color number. Add suffix S to the style number and specify leather color number. Add suffix S to the style number and specify leather color number. Add suffix S to the style number and specify leather color number. Add suffix S to the style number and specify leather color number. Add suffix S to the style number and specify vinyl color number. ► See <i>Surface Materials Reference Manual</i> . Add suffix S to the style number and specify leather color number.	
• Fabric price group 2	+\$ 21		
• Fabric price group 3	+\$ 34		
• Fabric price group 4	+\$ 49		
• Fabric price group 5	+\$ 62		
• Fabric price group 6	+\$ 78		
• Fabric price group 7	+\$ 88		
• Fabric price group 8	+\$112		
• Fabric price group 9	+\$137		
• Fabric price group 10	+\$155		
• Steelcase leather upholstery	+\$204		
• Select Surfaces leather price group 1	+\$204		
• Elmosoft leather upholstery	+\$246		
• Select Surfaces leather price group 2	+\$246		
• Steelcase vinyl	+\$ 21		
• Customer's Own Material (COM)	No cost		
• Customer's Own Leather (COL)	No cost		
Soil-retardant treatment		+\$ 36	Specify with soil-retardant treatment.
Frame			
• Platinum on frame	+\$ 66		Specify with 4799 Platinum frame.
Casters			
• Dual-wheel roll-control casters	+\$ 75		Specify with dual-wheel roll-control casters.
Glides			
• Hard glides for use on carpeted floors	No cost		Specify with hard glides.
• Soft glides for use on non-carpeted floors	+\$ 7		Specify with soft glides.

Tip: Leather and vinyl upcharges are in addition to sewn upholstery upcharge.

Tip: Casters or glides must be selected to complete specification of chair.

Reply 466 Series

Specification Information

With Arms



• Style Number
• U.S. Base Price

466452MH \$783

Without Arms



• Style Number
• U.S. Base Price

466450MH \$697



For Canadian Pricing
Multiply U.S. Price by the Canadian price factor.
► See page 1 for details.

Reply 466 Series Sled-Base Multi-Use Chairs

Mesh Back with Standard Upholstery on Seat



Standard Includes	Required to Specify
<ul style="list-style-type: none"> ▶ Need help? Product details, page 210 • Frame: paint • Mesh on back • Standard upholstery design on seat: fabric price group 1 • Arm caps, if selected: black 	<ol style="list-style-type: none"> 1 Style number 2 Paint color number for metal frame, and arms; if specified 3 Mesh color number for back 4 Fabric color number for upholstery on seat 5 Options, if selected (see below) <p>▶ See <i>Surface Materials</i>, page 634.</p>

Options	U.S. Price	Required to Specify
Surface Materials		
Upholstery on seat		
• Fabric price group 1	No cost	Specify fabric color number.
• Fabric price group 2	+\$ 21	Specify fabric color number.
• Fabric price group 3	+\$ 34	Specify fabric color number.
• Fabric price group 4	+\$ 48	Specify fabric color number.
• Fabric price group 5	+\$ 62	Specify fabric color number.
• Fabric price group 6	+\$ 77	Specify fabric color number.
• Fabric price group 7	+\$ 88	Specify fabric color number.
• Fabric price group 8	+\$111	Specify fabric color number.
• Fabric price group 9	+\$137	Specify fabric color number.
• Fabric price group 10	+\$154	Specify fabric color number.
• Steelcase leather upholstery	+\$204	Specify fabric color number.
• Select Surfaces leather price group 1	+\$204	Add suffix S to the style number and specify leather color number. Add suffix S to the style number and specify Select Surfaces leather price group 1.
• Elmosoft leather upholstery	+\$245	▶ See <i>Surface Materials Reference Manual</i> . Add suffix S to the style number and specify Elmosoft leather color number.
• Select Surfaces leather price group 2	+\$245	Add suffix S to the style number and specify Select Surfaces leather price group 2.
• Steelcase vinyl	+\$ 21	▶ See <i>Surface Materials Reference Manual</i> . Add suffix S to the style number and specify vinyl color number.
• Customer's Own Material (COM)	No cost	▶ See <i>Surface Materials Reference Manual</i> to specify.
• Customer's Own Leather (COL)	No cost	Add suffix S to the style number and specify leather color number.
• Customer's Own Material/Vinyl (COM-Sewn)	No cost	Add suffix S to the style number and specify vinyl color number.
Soil-retardant treatment		
	+\$ 36	Specify <i>with soil-retardant treatment</i> .
Sewn upholstery		
• Sewn upholstery on chair	+\$ 58	Add suffix S to the style number.
Frame		
• Platinum on frame	+\$ 66	Specify <i>with 4799 Platinum frame</i> .
Glides		
• Hard glides for use on carpeted floors	No cost	Specify <i>with hard glides</i> .
• Soft glides for use on non-carpeted floors	+\$ 7	Specify <i>with soft glides</i> .

Tip: Leather and vinyl upcharges are in addition to sewn upholstery upcharge.

Tip: Glides must be selected to complete specification of the chair.

▶ Detailed dimensions, page 214



For Canadian Pricing

Multiply U.S. Price by the Canadian price factor.

▶ See page 1 for details.

Specification Information

With Arms



**•Style
Number**

**•U.S.
Base
Price**

466482MT \$921

Without Arms



**•Style
Number**

**•U.S.
Base
Price**

466480MT \$835

Reply 466 Series

Reply 466 Series Sled-Base Multi-Use Chairs

Standard Upholstery on Back and Seat

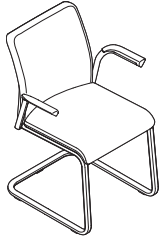

Tip: Leather and vinyl upcharges are in addition to sewn upholstery upcharge.

► Detailed dimensions, page 214



For Canadian Pricing
Multiply U.S. Price by the Canadian price factor.
► See page 1 for details.

Standard Includes		Required to Specify
► Need help? Product details, page 210	<ul style="list-style-type: none"> • Frame: paint • Standard upholstery design on seat and back: fabric price group 1 • Arm caps, if selected: black 	<ol style="list-style-type: none"> 1 Style number 2 Paint color number for metal frame, and arms; if specified 3 Fabric color number for upholstery on seat and back 4 Options, if selected (see below) <p>► See <i>Surface Materials</i>, page 634.</p>

Options	U.S. Price	Required to Specify
Surface Materials		
Upholstery on seat and back		
• Fabric price group 1	No cost	Specify fabric color number.
• Fabric price group 2	+\$ 37	Specify fabric color number.
• Fabric price group 3	+\$ 72	Specify fabric color number.
• Fabric price group 4	+\$100	Specify fabric color number.
• Fabric price group 5	+\$125	Specify fabric color number.
• Fabric price group 6	+\$154	Specify fabric color number.
• Fabric price group 7	+\$179	Specify fabric color number.
• Fabric price group 8	+\$223	Specify fabric color number.
• Fabric price group 9	+\$276	Specify fabric color number.
• Fabric price group 10	+\$312	Specify fabric color number.
• Steelcase leather upholstery	+\$405	Specify fabric color number.
• Select Surfaces leather price group 1	+\$405	Add suffix S to the style number and specify leather color number. Add suffix S to the style number and specify Select Surfaces leather price group 1.
• Elmosoft leather upholstery	+\$489	► See <i>Surface Materials Reference Manual</i> . Add suffix S to the style number and specify Elmosoft leather color number.
• Select Surfaces leather price group 2	+\$489	Add suffix S to the style number and specify Select Surfaces leather price group 2.
• Steelcase vinyl	+\$ 37	► See <i>Surface Materials Reference Manual</i> . Add suffix S to the style number and specify vinyl color number.
• Customer's Own Material (COM)	No cost	► See <i>Surface Materials Reference Manual</i> to specify.
• Customer's Own Leather (COL)	No cost	Add suffix S to the style number and specify leather color number.
Sewn upholstery		
• Sewn upholstery on chair	+\$119	Add suffix S to the style number.
Contrasting upholstery on seat and back		
• Contrasting fabrics	+\$ 46	Add suffix K to the style number and specify fabric color numbers.
Contrasting upholstery on seat		
• Fabric price group 1	No cost	Specify fabric color number.
• Fabric price group 2	+\$ 21	Specify fabric color number.
• Fabric price group 3	+\$ 34	Specify fabric color number.
• Fabric price group 4	+\$ 48	Specify fabric color number.
• Fabric price group 5	+\$ 62	Specify fabric color number.
• Fabric price group 6	+\$ 77	Specify fabric color number.
• Fabric price group 7	+\$ 88	Specify fabric color number.
• Fabric price group 8	+\$111	Specify fabric color number.
• Fabric price group 9	+\$137	Specify fabric color number.
• Fabric price group 10	+\$154	Specify fabric color number.
• Steelcase leather upholstery	+\$204	Specify fabric color number.
• Select Surfaces leather price group 1	+\$204	Add suffix S to the style number and specify leather color number.
• Elmosoft leather upholstery	+\$245	Add suffix S to the style number and specify leather color number.

► Options, continued on next page

► Options, continued from previous page



Options	U.S. Price	Required to Specify
Surface Materials, continued		
Contrasting upholstery on seat, continued		
• Select Surfaces leather price group 2	+\$245	Add suffix S to the style number and specify leather color number. Add suffix S to the style number and specify vinyl color number. ► See <i>Surface Materials Reference Manual</i> . Add suffix S to the style number and specify leather color number.
• Steelcase vinyl	+\$ 21	
• Customer's Own Material (COM)	No cost	
• Customer's Own Leather (COL)	No cost	
Contrasting upholstery on back		
• Fabric price group 1	No cost	Specify fabric color number. Specify fabric color number. Specify fabric color number. Specify fabric color number. Specify fabric color number. Specify fabric color number. Specify fabric color number. Specify fabric color number. Specify fabric color number. Specify fabric color number. Add suffix S to the style number and specify leather color number. Add suffix S to the style number and specify leather color number. Add suffix S to the style number and specify leather color number. Add suffix S to the style number and specify leather color number. Add suffix S to the style number and specify vinyl color number. ► See <i>Surface Materials Reference Manual</i> . Add suffix S to the style number and specify leather color number.
• Fabric price group 2	+\$ 21	
• Fabric price group 3	+\$ 34	
• Fabric price group 4	+\$ 49	
• Fabric price group 5	+\$ 62	
• Fabric price group 6	+\$ 78	
• Fabric price group 7	+\$ 88	
• Fabric price group 8	+\$112	
• Fabric price group 9	+\$137	
• Fabric price group 10	+\$155	
• Steelcase leather upholstery	+\$204	
• Select Surfaces leather price group 1	+\$204	
• Elmosoft leather upholstery	+\$246	
• Select Surfaces leather price group 2	+\$246	
• Steelcase vinyl	+\$ 21	
• Customer's Own Material (COM)	No cost	
• Customer's Own Leather (COL)	No cost	
Soil-retardant treatment	+\$ 36	Specify with soil-retardant treatment.
Frame		
• Platinum on frame	+\$ 66	Specify with 4799 Platinum frame.
Glides		
• Hard glides for use on carpeted floors	No cost	Specify with hard glides.
• Soft glides for use on non-carpeted floors	+\$ 7	Specify with soft glides.

Tip: Leather and vinyl upcharges are in addition to sewn upholstery upcharge.

Tip: Glides must be selected to complete specification of the chair.

Reply 466 Series

Specification Information

With Arms		Without Arms	
			
• Style Number	• U.S. Base Price	• Style Number	• U.S. Base Price
466482MH	\$835	466480MH	\$749

 **For Canadian Pricing**
Multiply U.S. Price by the Canadian price factor.
► See page 1 for details.



Understanding and Specifying Kart Series Multi-Use Seating

Product Details

Kart Series	230
Dimensions	232

Specifying

Nesting Chairs	234
Stools	238

Kart Series

Kart seating collection offers solutions for classrooms, cafeterias, training rooms, and multipurpose rooms.



Seat height adjusts within a 5" range with a pneumatic adjustment mechanism.

Casters have hard, dual wheels that roll smoothly on carpets. Soft, dark grey treaded, dual-wheel roll-control casters are available for use on hard floors or mats.

Tip: Do not roll the chair across asphalt during installation as this may damage the casters.

Arms, glides, and back-seat connection will always be black.

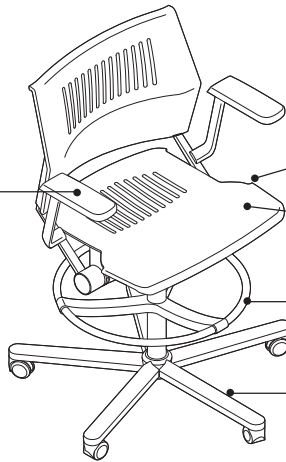

Flip the seat on the nesting chairs and eight Kart chairs can nest in the space of two and a half.

Tilt tension adjustment allows you to control the amount of resistance needed for reclining.

Four-arm base is standard on nesting chairs.

Back lock mechanism allow users to lock the back in an upright position.

Stools do not nest.

Adjustable 19" diameter chrome foot ring.

The stool has a five-star base.

Product Details



Nesting chairs and stools with casters are available with or without arms.

Kart is available non-upholstered, upholstered seat only, or upholstered seat and back.

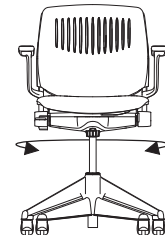

360° swivel motion is locked when in nesting mode (seat up and engaged with base).

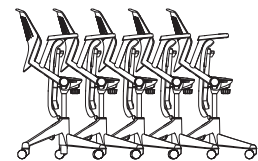

Nesting chairs have the ability to nest five chairs in a space of 4'6", or 54". Each additional chair adds 7" to the overall nesting length.

Kart chairs and stools come standard uncartoned. There is an option to have Kart cartoned.

Adjustment Features

Adjustability instructions are included with every swivel-base chair. Instructions can also be found at www.steelcase.com.

Seat Adjustments

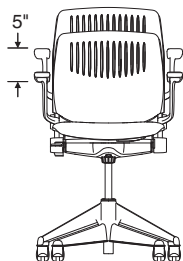

Seat height adjusts pneumatically. To lower, hold handle up while seated. To raise, hold handle up and keep your weight off the chair. Range of adjustability is 5".

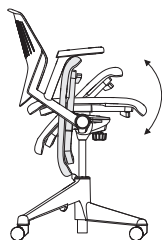

Seat flips on nesting chairs. Pull the lever under the seat toward the front of the chair and tip the seat up. As the seat releases, the pneumatic lift activates and pushes the chair to its full height position. To lock, spin the chair until the seat engages with the base tooth.



Tilt Tension. To loosen, turn control knob counter-clockwise. To tighten, turn control knob clockwise.

Back Adjustments

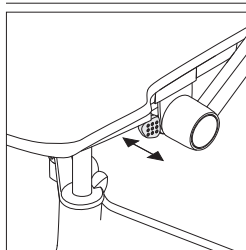

Forward back lock on nesting and stool with casters. Lean forward, pull triangular knob out until it stops.

Foot Ring Adjustments

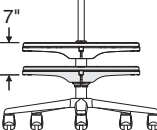
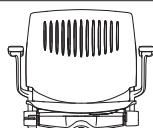

19" chrome foot ring adjusts 8½"H to 15½"H by rotating it left or right.

Other Features

Hard dual-wheel casters for use on soft floors come standard on nesting chairs as well as stools with casters.

Soft dual-wheel casters for hard floors on nesting or five-arm base stools are available for specific applications.

Surface Materials

▶ See surface materials on page 634 for specific availability or refer to the *Surface Materials Reference Manual* for further information.

Fabric and leathers will appear loose with comfort wrinkles when upholstered.

Back frame and seat shell are plastic on all Kart models.

Upholstery

- Fabric
- Leather
- Elmosoft Leather

Hard Components

(Base, back supports, and arm support bar)

- Aluminum with paint

(Rub strips, yoke strips, non-upholstered seat, and back)

- Plastic

(Café stool steel frame)

- Paint

Arm Caps

- Black plastic

Foot Ring

- Chrome

Casters

- Black only

Glides

- Standard on café stool and optional on nesting and stools with casters.

Extra Foam

- Available on nesting and stools with casters.

Programs & Services

▶ See the *Surface Materials Reference Manual* for further detail about programs and services offered for seating.

The Customer's Own Material (COM) Program

offers the opportunity for customers to select fabrics that are not offered through the standard Steelcase surface materials program for use on Steelcase products. Through the COM program, Steelcase will test your materials for application on Steelcase products. Once approved, you can place your order. Steelcase will facilitate the entire ordering process and give you a production schedule. Steelcase will order the COM fabric directly from the textile manufacturer. For up-to-date information regarding fabric test results for all COM fabrics and details regarding yardage requirements for most Seating lines, visit the COM website. To locate the COM website:

- Visit www.steelcase.com

Dimensions

▶ Page 232

Resources

Printed Materials

▶ Kart Brochure

Online Resources

▶ Product Environmental Profiles, which provide key environmental attributes and product certifications can be found by searching for Steelcase at *Origin.build*.

Dimensions

Kart Series

Features	Overall Depth	Width	Height	Seat Depth	Seat Width	Seat Height from Floor	Ring Height from Floor	Back Width	Width Between Arms
Kart									
Nesting Chairs									
With arms	22½"	24½"	38"	17¾"	19"	16" to 21"	N.A.	18"	19½"
Without arms	22½"	24½"	38"	17¾"	19"	16" to 21"	N.A.	18"	N.A.
Stools with Casters									
With arms	22½"	24½"	44"	17¾"	19"	21" to 28½"	8½" to 15½"	18"	19½"
Without arms	22½"	24½"	44"	17¾"	19"	21" to 28½"	8½" to 15½"	18"	N.A.

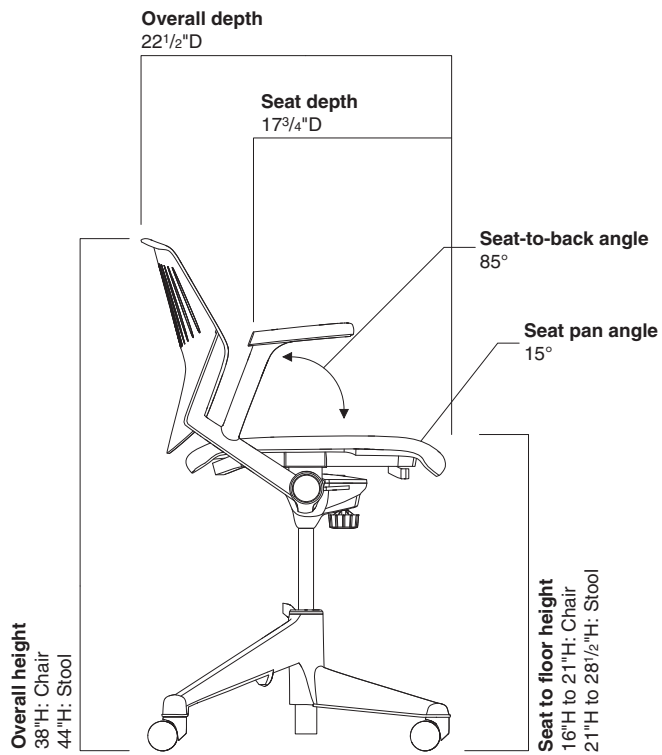
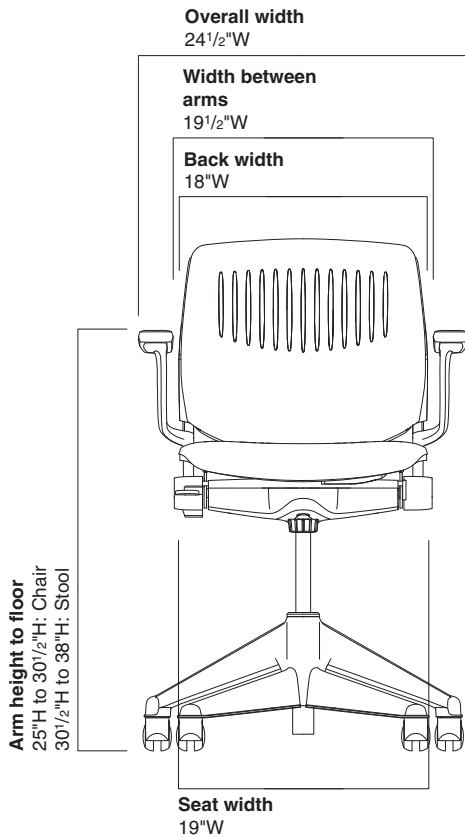

Kart Nesting Chairs



Tip: Fabrics and leathers will appear loose with comfort wrinkles when upholstered.

Tip: For Customer's Own Material or Leather, see necessary requirements, important processing instructions, and ordering information.

▶ See *Surface Materials Reference Manual*.

Standard Includes	Required to Specify
<ul style="list-style-type: none"> ▶ Need help? Product details, page 230 • Four-prong Kart nesting base with nylon base tooth: die-cast aluminum with powder coat • Rub strips: injection-molded black polypropylene • Yoke strips: injection-molded black polypropylene • Hard, dual-wheel casters for use on carpet: black plastic • Seat and back: black or gray textured contoured, injection-molded glass-filled Polyurethane • Upholstered seat or upholstered seat and back, if selected: molded urethane foam over injection-molded polypropylene inner shell(s) • Folding seat with self-aligning features • Back supports: one-piece die-cast aluminum • Arms, if selected: die-cast aluminum support bar with black, molded, self-skinning polyurethane arm cap • Pneumatic height adjustment • Tilt tension adjustment • Zero front rise • Forward back lock 	<ol style="list-style-type: none"> 1 Style number 2 Powder coat color number for base 3 Plastic color number for seat and back 4 Fabric or leather color number for upholstery, if selected 5 Options, if selected (see below) <p>▶ See <i>Surface Materials</i>, page 634.</p>

Surface Materials	Options	U.S. Price	Required to Specify
	Non-upholstered chair		
	• Plastic	No cost	Specify plastic color number.
	Upholstery on seat and back		
	• Fabric price group 1	No cost	Specify fabric color number.
	• Fabric price group 2	+\$ 31	Specify fabric color number.
	• Fabric price group 3	+\$ 73	Specify fabric color number.
	• Fabric price group 4	+\$102	Specify fabric color number.
	• Fabric price group 5	+\$124	Specify fabric color number.
	• Fabric price group 6	+\$150	Specify fabric color number.
	• Fabric price group 7	+\$181	Specify fabric color number.
	• Fabric price group 8	+\$225	Specify fabric color number.
	• Fabric price group 9	+\$263	Specify fabric color number.
	• Fabric price group 10	+\$317	Specify fabric color number.
	• Steelcase leather upholstery	+\$150	Specify leather color number.
	• Elmosoft leather upholstery	+\$301	Specify Elmosoft leather color number.
	• Customer's Own Material (COM)	+\$ 60	▶ See <i>Surface Materials Reference Manual</i> to specify.
	• Customer's Own Leather (COL)	No cost	▶ See <i>Surface Materials Reference Manual</i> to specify.
	Contrasting upholstery on seat and back		
	• Contrasting fabrics	+\$ 46	Add suffix K to the style number and specify fabric color numbers.
	Contrasting upholstery on seat		
	• Fabric price group 1	No cost	Specify fabric color number.
	• Fabric price group 2	+\$ 16	Specify fabric color number.
	• Fabric price group 3	+\$ 34	Specify fabric color number.
	• Fabric price group 4	+\$ 49	Specify fabric color number.
	• Fabric price group 5	+\$ 61	Specify fabric color number.
	• Fabric price group 6	+\$ 76	Specify fabric color number.
	• Fabric price group 7	+\$ 92	Specify fabric color number.
	• Fabric price group 8	+\$112	Specify fabric color number.
	• Fabric price group 9	+\$132	Specify fabric color number.
	• Fabric price group 10	+\$159	Specify fabric color number.
	• Steelcase leather upholstery	+\$ 76	Specify leather color number.
	• Elmosoft leather upholstery	+\$147	Specify leather color number.
	• Customer's Own Material/ Vinyl (COM)	+\$ 28	▶ See <i>Surface Materials Reference Manual</i> to specify.
	• Customer's Own Leather (COL)	No cost	▶ See <i>Surface Materials Reference Manual</i> to specify.

▶ Detailed dimensions, page 232



For Canadian Pricing

Multiply U.S. Price by the Canadian price factor.

▶ See page 1 for details.

▶ **Options, continued on next page**

► Options, continued from previous page

Options	U.S. Price	Required to Specify
Surface Materials, continued Contrasting upholstery on back <ul style="list-style-type: none"> Fabric price group 1 Fabric price group 2 Fabric price group 3 Fabric price group 4 Fabric price group 5 Fabric price group 6 Fabric price group 7 Fabric price group 8 Fabric price group 9 Fabric price group 10 Steelcase leather upholstery Elmosoft leather upholstery Customer's Own Material/ Vinyl (COM) Customer's Own Leather (COL) 	<ul style="list-style-type: none"> No cost +\$ 16 +\$ 35 +\$ 51 +\$ 62 +\$ 76 +\$ 92 +\$112 +\$133 +\$159 +\$ 76 +\$150 +\$ 31 No cost 	<ul style="list-style-type: none"> Specify fabric color number. Specify fabric color number. Specify fabric color number. Specify fabric color number. Specify fabric color number. Specify fabric color number. Specify fabric color number. Specify fabric color number. Specify fabric color number. Specify fabric color number. Specify leather color number. Specify leather color number. See <i>Surface Materials Reference Manual</i> to specify. See <i>Surface Materials Reference Manual</i> to specify.
Casters <ul style="list-style-type: none"> Soft, dark grey treaded, dual-wheel roll-control casters for use on hard floors 	<ul style="list-style-type: none"> +\$ 62 	<ul style="list-style-type: none"> Specify with soft roll-control casters.
Extra Foam <ul style="list-style-type: none"> Extra foam 	<ul style="list-style-type: none"> +\$108 	<ul style="list-style-type: none"> Specify with extra foam.
Glide <ul style="list-style-type: none"> Glide 	<ul style="list-style-type: none"> +\$ 53 	<ul style="list-style-type: none"> Specify with glides.
Related Products <ul style="list-style-type: none"> Pouch and leash 		<ul style="list-style-type: none"> ► Page 236

Specification Information

Style Number	U.S. Base Price
--------------	-----------------

Non-Upholstered with Arms

126A101	\$1313
---------	--------

Non-Upholstered without Arms

126A100	\$1197
---------	--------

Upholstered Seat with Arms

126A201S	\$1583
----------	--------

► Specification Information, continued on next page



For Canadian Pricing
 Multiply U.S. Price by the Canadian price factor.
 ► See page 1 for details.

Kart Nesting Chairs, continued

► Specification Information, continued from previous page

Specification Information

Style Number	U.S. Base Price
--------------	-----------------



Upholstered Seat without Arms

126A200S	\$1467
----------	--------



Upholstered Seat and Back with Arms

126A201	\$1641
---------	--------



Upholstered Seat and Back without Arms

126A200	\$1525
---------	--------

Pouch and Leash for Use on Kart Nesting Chairs



Standard Includes	Required to Specify
-------------------	---------------------

- Leash to retain up to 10 nested chairs
- Pouch to store leash
- Pouch attaches to bottom of seat

Style number

Specification Information

Style Number	U.S. Price
--------------	------------

126900	\$108
--------	-------



For Canadian Pricing

Multiply U.S. Price by the Canadian price factor.

► See page 1 for details.

Kart Stools

with Casters



Tip: Stools do not nest.

Tip: Fabrics and leathers will appear loose with comfort wrinkles when upholstered.

Tip: For Customer's Own Material or Leather, see necessary requirements, important processing instructions, and ordering information. ▶ See *Surface Materials Reference Manual*.

▶ Detailed dimensions, page 232



For Canadian Pricing
Multiply U.S. Price by the Canadian price factor.
▶ See page 1 for details.

Standard Includes	Required to Specify
<ul style="list-style-type: none"> ▶ Need help? Product details, page 230 • Five-prong base with 25" span: one-piece die-cast aluminum with powder coat color • Telescoping hub cover: black plastic • Adjustable 19" diameter chrome foot ring • Hard, dual-wheel casters for use on carpet: black • Seat and back: black or gray textured contoured, injection-molded glass-filled polypropylene • Upholstered seat or upholstered seat and back, if selected: molded urethane foam over injection-molded polypropylene inner shell(s) • Back supports: one-piece die-cast aluminum • Arms, if selected: die-cast aluminum support bar with black, molded, self-skinning polyurethane arm cap • Pneumatic height adjustment • Tilt tension adjustment • Zero front rise • Forward back lock 	<ol style="list-style-type: none"> 1 Style number 2 Powder coat color number for base 3 Plastic color number for seat and back 4 Fabric or leather color number for upholstery, if selected 5 Options, if selected (see below) <p>▶ See <i>Surface Materials</i>, page 634.</p>

Surface Materials	Options	U.S. Price	Required to Specify
	Non-upholstered stool		
	• Plastic	No cost	Specify plastic color number.
	Upholstery on seat and back		
	• Fabric price group 1	No cost	Specify fabric color number.
	• Fabric price group 2	+\$ 31	Specify fabric color number.
	• Fabric price group 3	+\$ 73	Specify fabric color number.
	• Fabric price group 4	+\$102	Specify fabric color number.
	• Fabric price group 5	+\$124	Specify fabric color number.
	• Fabric price group 6	+\$150	Specify fabric color number.
	• Fabric price group 7	+\$181	Specify fabric color number.
	• Fabric price group 8	+\$225	Specify fabric color number.
	• Fabric price group 9	+\$263	Specify fabric color number.
	• Fabric price group 10	+\$317	Specify fabric color number.
	• Steelcase leather upholstery	+\$150	Specify leather color number.
	• Elmosoft leather upholstery	+\$301	Specify Elmosoft leather color number.
	• Customer's Own Material (COM)	+\$ 60	▶ See <i>Surface Materials Reference Manual</i> to specify.
	• Customer's Own Leather (COL)	No cost	▶ See <i>Surface Materials Reference Manual</i> to specify.
	Contrasting upholstery on seat and back		
	• Contrasting fabrics	+\$ 46	Add suffix K to the style number and specify fabric color numbers.
	Contrasting upholstery on seat		
	• Fabric price group 1	No cost	Specify fabric color number.
	• Fabric price group 2	+\$ 16	Specify fabric color number.
	• Fabric price group 3	+\$ 34	Specify fabric color number.
	• Fabric price group 4	+\$ 49	Specify fabric color number.
	• Fabric price group 5	+\$ 61	Specify fabric color number.
	• Fabric price group 6	+\$ 76	Specify fabric color number.
	• Fabric price group 7	+\$ 92	Specify fabric color number.
	• Fabric price group 8	+\$112	Specify fabric color number.
	• Fabric price group 9	+\$132	Specify fabric color number.
	• Fabric price group 10	+\$159	Specify fabric color number.
	• Steelcase leather upholstery	+\$ 76	Specify leather color number.
	• Elmosoft leather upholstery	+\$147	Specify leather color number.
	• Customer's Own Material/ Vinyl (COM)	+\$ 28	▶ See <i>Surface Materials Reference Manual</i> to specify.
	• Customer's Own Leather (COL)	No cost	▶ See <i>Surface Materials Reference Manual</i> to specify.

▶ Options, continued on next page

► Options, continued from previous page

Options	U.S. Price	Required to Specify
Surface Materials, continued	Contrasting upholstery on back	
	• Fabric price group 1	No cost
	• Fabric price group 2	+\$ 16
	• Fabric price group 3	+\$ 35
	• Fabric price group 4	+\$ 51
	• Fabric price group 5	+\$ 62
	• Fabric price group 6	+\$ 76
	• Fabric price group 7	+\$ 92
	• Fabric price group 8	+\$112
	• Fabric price group 9	+\$133
	• Fabric price group 10	+\$159
	• Steelcase leather upholstery	+\$ 76
	• Elmosoft leather upholstery	+\$150
	• Customer's Own Material/ Vinyl (COM)	+\$ 31
	• Customer's Own Leather (COL)	No cost
		Specify fabric color number. Specify fabric color number. Specify fabric color number. Specify fabric color number. Specify fabric color number. Specify fabric color number. Specify fabric color number. Specify fabric color number. Specify fabric color number. Specify fabric color number. Specify leather color number. See <i>Surface Materials Reference Manual</i> to specify. See <i>Surface Materials Reference Manual</i> to specify.
Casters	• Soft, dark grey treaded, dual-wheel roll-control casters for use on hard floors	+\$ 62
		Specify with soft roll-control casters.
Extra Foam	• Extra foam	+\$108
		Specify with extra foam.
Glide	• Glide	+\$ 53
		Specify with glides.

Specification Information

Style Number	U.S. Base Price

Non-Upholstered with Arms

126B101ST	\$1550



Non-Upholstered without Arms

126B100ST	\$1434



Upholstered Seat with Arms

126B201SST	\$1820



► Specification Information, continued on next page

**For Canadian Pricing**

Multiply U.S. Price by the Canadian price factor.

► See page 1 for details.

► Specification Information, continued from previous page

Specification Information

Style Number	U.S. Base Price
--------------	-----------------

Upholstered Seat without Arms

126B200SST	\$1704
------------	--------

Upholstered Seat and Back with Arms

126B201ST	\$1878
-----------	--------

Upholstered Seat and Back without Arms

126B200ST	\$1762
-----------	--------



For Canadian Pricing

Multiply U.S. Price by the Canadian price factor.

► See page 1 for details.

Understanding and Specifying Siento 499 Series Work Chairs

Product Details

Siento 499 Series	242
-------------------	-----

Specifying

Design Package High-Back Executive Chair	244
Executive Desk Chairs	246

Adjustability Features

- ▶ See page 26 for a comparison to other chairs.
- Siento 499 Series**

Mechanisms

Synchro-tilt	●
--------------	---

Seat Adjustments

Pneumatic height	●
------------------	---

Passive seat edge angle	●
-------------------------	---

Back Adjustments

Back tension	●
--------------	---

Upright back lock	●
-------------------	---

Siento 499 Series

Siento desk chairs, designed in collaboration with Jorge Pensi, merge remarkable ergonomic comfort with a slim and sophisticated executive form.

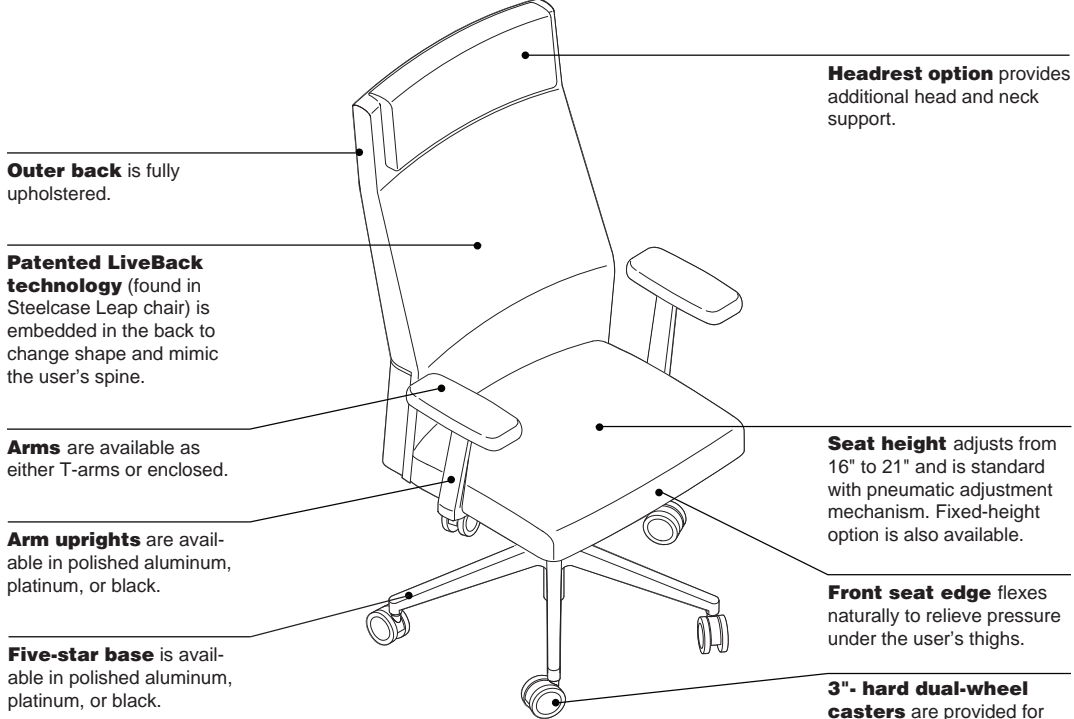

Outer back is fully upholstered.

Patented LiveBack technology (found in Steelcase Leap chair) is embedded in the back to change shape and mimic the user's spine.

Arms are available as either T-arms or enclosed.

Arm uprights are available in polished aluminum, platinum, or black.

Five-star base is available in polished aluminum, platinum, or black.

Headrest option provides additional head and neck support.

Seat height adjusts from 16" to 21" and is standard with pneumatic adjustment mechanism. Fixed-height option is also available.

Front seat edge flexes naturally to relieve pressure under the user's thighs.

3"- hard dual-wheel casters are provided for use on carpet. Soft dark grey treaded, dual-wheel roll-casters are available for use on hard floors or mats. *Tip: Do not roll the chair across asphalt during installation as this may damage the casters.*

Adjustability Features

- Pneumatic seat-height
- Upright back lock
- Back tension control
- Synchro-tilt mechanism

Product Details



High-back and mid-back desk chairs are available.



Arms are available as T-arms or enclosed. Fixed T-arms are available in urethane or fully upholstered. Adjustable T-arms are available in urethane or fully upholstered. Enclosed arms are always fully upholstered.

All Siento chairs comply with ANSI/HFS and BIFMA standards.

Adjustment Features

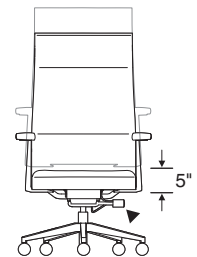

Seat height adjusts pneumatically. To lower, hold handle up while seated. To raise, hold handle up and keep your weight off the chair. Standard range of adjustability is 5" from 16"H to 21"H.

Actual Dimensions

	High-Back Desk Chairs with Headrest	High-Back Desk Chairs without Headrest	Mid-Back Desk Chairs
Overall depth	26"	26"	26"
Overall width—outside of T-arms	27½"	27½"	27½"
Overall width—outside of enclosed arms	29½"	29½"	29½"
Overall height	46¾"–51¾"	46"–51"	40"–45"
Seat depth	17½"	17½"	17½"
Seat width	21"	21"	21"
Back height from seat	31½"	30"	24"
Width between arms	20½"	20½"	20½"
Arm height from seat	8"	8"	8"
Angle between back and seat	100° to 114°	100° to 114°	100° to 114°

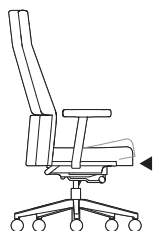

Seat edge flexes, relieving pressure under the user's thighs.

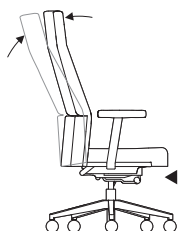

Upright back lock. Flick switch forward to lock; flick switch back to tilt.



Back tension control adjusts by turning knob. Turn knob forward to increase rate of tension, backward to decrease.

Synchro-tilt mechanism provides synchronized back movement while feet remain flat on the floor.

Height-, width-, pivot-, and depth-adjustable arms are available on select models of chairs.

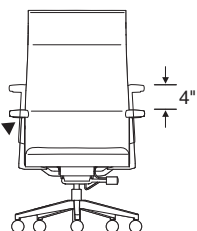

Arm height adjusts independently within a range of 4" (7"–11" from the seat). Push button on outside and under arm cap in while moving arms up or down. Releasing buttons locks arms in position.

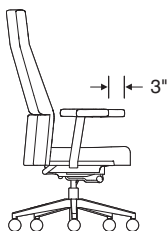

Arm depth adjusts by sliding arm caps back 3". Friction-fit mechanism keeps arms in position.

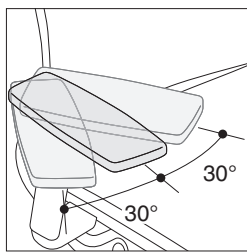

Arms pivot independently, 30° inward and outward

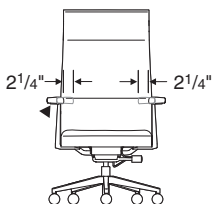

Arm width can be adjusted 2 1/4" each, 4 1/2" overall. Grasp arm cap and move in or out.

Surface Materials

Upholstery

- Fabric
- Fabric with soil-retardant treatment (option)
- Elmosoft leather
- Select Surfaces leather
- COM
- COL

Arms

- Black urethane T-arms
- Upholstered T-arms
- Enclosed upholstered arms

Column

- Black only

Base

- 0835 Black
- 4799 Platinum
- 8046 Polished Aluminum

Casters

- Black wheels with black body on black or platinum base
- Black wheels with polished aluminum body on polished aluminum base

All Steelcase seating with standard upholstery fabrics complies with requirements of the State of California Technical Bulletin 117-2013. All standard seating is labeled to be in compliance with California 117-2013.

Programs & Services

► See the *Surface Materials Reference Manual* for further detail about programs and services offered for seating.

The Customer's Own Material (COM & COL) Program

offers the opportunity for customers to select fabrics and leather that are not offered through the standard Steelcase surface materials program for use on Steelcase products. Avoid pattern fabrics and heavily grained leathers. Through the COM & COL program, Steelcase will test your materials for application on Steelcase products. Once approved, you can place your order. Steelcase will facilitate the entire ordering process and give you a production schedule. Steelcase will order the COM & COL fabric and leather directly from the textile manufacturer. For up-to-date information regarding fabric test results for all COM & COL fabrics and details regarding yardage requirements for most Seating lines, visit the COM website: www.steelcase.com

Soil retardants are treatments that provide long-term soil and stain resistance to a fabric without affecting the shade or the integrity of the fabric. The following Steelcase Textiles are available pre-treated with soil retardant. (You do not need to select the soil-retardant option for these fabrics and incur the upcharge.)

- Jacks
- Link

For information on soil retardant fabrics on Select Surfaces, please refer to the *Surface Materials Reference Manual*.

Soil-retardant treatment is available on all other seating fabrics at an additional upcharge per seating unit. To order this option, please select "Soil-Retardant Treatment" under "Optional Accessories."

For soil-retardant treatment on COMs, please select "Soil-Retardant Treatment" under "Optional Accessories." Minimums or additional yardage may be required. Please contact the vendor directly for specific information.

Extended lead times may be necessary for this service.

Contact your Steelcase Solutions Fulfillment Team Representative at 1.888.STEELCASE (1.888.783.3522) or send an e-mail to lineone@steelcase.com.

Local codes may have special requirements for upholstery.

Resources

Siento Brochure

Form number 06-0001282

Online Resources

- Siento User Guide available on www.steelcase.com
- Product Environmental Profiles, which provide key environmental attributes and product certifications can be found by searching for Steelcase at Origin.build.

Siento 499 Series Design Package High-Back Executive Chair



Tip: This design package allows you to obtain the pre-selected features at a lower price than if specifying as a standard model number.

Tip: Options or substitutions are not available on this design package.

Standard Includes	Required to Specify
-------------------	---------------------

- | | | |
|--|---|--|
| <ul style="list-style-type: none"> ▶ Need help? Product details, page 242 | <ul style="list-style-type: none"> • Back tension control • 5" pneumatic seat-height adjustment • Upright back lock • Fully upholstered outer back • Front seat edge flex • LiveBack Technology • T-arms: upholstered • Headrest • Upholstery: Elmosoft leather • Five-star base and arm supports: 8046 Polished Aluminum • Column: black only • 3"-diameter, hard composition, dual-wheel aluminum casters: black wheels with polished aluminum body | <ul style="list-style-type: none"> 1 Style number 2 Elmosoft leather color number ▶ See <i>Surface Materials</i>, page 634. |
|--|---|--|

Specification Information	
Style Number	U.S. Price

499SIENTO 	\$5001
---	--------

▶ Detailed dimensions, page 242



For Canadian Pricing

Multiply U.S. Price by the Canadian price factor.

▶ See page 1 for details.

 = Transitional product

Siento 499 Series Executive Desk Chairs



Tip: When a black or platinum painted base is specified, the casters will be black. When a polished aluminum base is specified, the casters will have black wheels with polished aluminum body.

Standard Includes	Required to Specify
<ul style="list-style-type: none"> ▶ Need help? Product details, page 242 • Back tension control • 5" pneumatic seat-height adjustment • Upright back lock • Front seat edge flex • LiveBack Technology • Fully upholstered outer back • Adjustable arms, if selected: soft black urethane • T-arms, if selected: soft black urethane • Enclosed arms, if selected: fully upholstered • Upholstery: fabric price group 1 • Five-star base and arm supports: paint or Polished Aluminum • Column: black only • 3"-diameter, hard-composition, dual-wheel casters: black 	<ul style="list-style-type: none"> 1 Style number 2 Paint color number for base and arm supports 3 Fabric color number for upholstery 4 Options, if selected (see below) ▶ See <i>Surface Materials</i>, page 634.

Options	U.S. Price	Required to Specify
Surface Materials		
Upholstery on seat and back		
• Fabric price group 1	No cost	Specify fabric color number.
• Fabric price group 2	+\$ 37	Specify fabric color number.
• Fabric price group 3	+\$ 72	Specify fabric color number.
• Fabric price group 4	+\$ 100	Specify fabric color number.
• Fabric price group 5	+\$ 125	Specify fabric color number.
• Fabric price group 6	+\$ 154	Specify fabric color number.
• Fabric price group 7	+\$ 179	Specify fabric color number.
• Fabric price group 8	+\$ 223	Specify fabric color number.
• Fabric price group 9	+\$ 276	Specify fabric color number.
• Fabric price group 10	+\$ 312	Specify fabric color number.
• Customer's Own Material (COM)	+\$ 55	▶ See <i>Surface Materials Reference Manual</i> . Add suffix S to the style number and specify leather color number.
• Customer's Own Leather (COL)	+\$ 55	Add suffix S to the style number and specify leather color number.
• Steelcase leather upholstery	+\$ 863	Add suffix S to the style number and specify Select Surfaces leather price group 1.
• Select Surfaces leather price group 1	+\$ 863	▶ See <i>Surface Materials Reference Manual</i> . Add suffix S to the style number and specify Elmosoft leather color number.
• Elmosoft leather	+\$1210	▶ See <i>Surface Materials</i> , page 634.
• Select Surfaces leather price group 2	+\$1210	Add suffix S to the style number and specify Select Surfaces leather price group 2.
• Sewn upholstery	No cost	▶ See <i>Surface Materials Reference Manual</i> . Add suffix S to the style number.
Contrasting upholstery on seat and back		
• Contrasting fabrics	+\$ 46	Add suffix K to the style number and specify fabric color numbers.
Contrasting upholstery on seat		
• Fabric price group 1	No cost	Specify fabric color number.
• Fabric price group 2	+\$ 21	Specify fabric color number.
• Fabric price group 3	+\$ 34	Specify fabric color number.
• Fabric price group 4	+\$ 48	Specify fabric color number.
• Fabric price group 5	+\$ 62	Specify fabric color number.
• Fabric price group 6	+\$ 77	Specify fabric color number.
• Fabric price group 7	+\$ 88	Specify fabric color number.
• Fabric price group 8	+\$ 111	Specify fabric color number.
• Fabric price group 9	+\$ 137	Specify fabric color number.
• Fabric price group 10	+\$ 154	Specify fabric color number.

▶ Options, continued on next page

▶ Detailed dimensions, page 242



For Canadian Pricing

Multiply U.S. Price by the Canadian price factor.

▶ See page 1 for details.

 = Transitional product

► Options, continued from previous page

	Options	U.S. Price	Required to Specify	
Surface Materials, continued	Contrasting upholstery on seat, continued			
	• Steelcase leather upholstery	+\$432	Add suffix S to the style number and specify leather color number.	
	• Select Surfaces leather price group 1	+\$432	Add suffix S to the style number and specify leather color number.	
	• Elmosoft leather upholstery	+\$603	Add suffix S to the style number and specify leather color number.	
	• Select Surfaces leather price group 2	+\$603	Add suffix S to the style number and specify leather color number.	
	• Sewn upholstery	No cost	Add suffix S to the style number.	
	• Customer's Own Material (COM)	+\$ 26	► See <i>Surface Materials Reference Manual</i> to specify.	
	• Customer's Own Leather (COL)	+\$ 26	Add suffix S to the style number and specify leather color number.	
		Contrasting upholstery on back		
		• Fabric price group 1	No cost	Specify fabric color number.
	• Fabric price group 2	+\$ 21	Specify fabric color number.	
	• Fabric price group 3	+\$ 34	Specify fabric color number.	
	• Fabric price group 4	+\$ 49	Specify fabric color number.	
	• Fabric price group 5	+\$ 62	Specify fabric color number.	
	• Fabric price group 6	+\$ 78	Specify fabric color number.	
	• Fabric price group 7	+\$ 88	Specify fabric color number.	
	• Fabric price group 8	+\$112	Specify fabric color number.	
	• Fabric price group 9	+\$137	Specify fabric color number.	
	• Fabric price group 10	+\$155	Specify fabric color number.	
	• Steelcase leather upholstery	+\$433	Add suffix S to the style number and specify leather color number.	
	• Select Surfaces leather price group 1	+\$433	Add suffix S to the style number and specify leather color number.	
	• Elmosoft leather upholstery	+\$603	Add suffix S to the style number and specify leather color number.	
	• Select Surfaces leather price group 2	+\$603	Add suffix S to the style number and specify leather color number.	
	• Sewn upholstery	No cost	Add suffix S to the style number.	
	• Customer's Own Material (COM)	+\$ 27	See <i>Surface Materials Reference Manual</i> to specify.	
	• Customer's Own Leather (COL)	+\$ 27	Add suffix S to the style number and specify leather color number.	
	Soil-retardant treatment	+\$ 36	Specify <i>with soil-retardant treatment</i> .	
	T-arms			
	• Fully upholstered T-arms	+\$146	Specify <i>with fully upholstered T-arms</i> .	
	Base and casters			
	• 0835 Black base and black casters	No cost	Specify <i>with 0835 Black base</i> .	
	• 4799 Platinum base and black casters	+\$129	Specify <i>with 4799 Platinum base</i> .	
Seat Height	• 18" fixed seat height	No cost	Specify <i>with fixed seat height</i> .	
Headrest	• Headrest on high-back chairs only	+\$190	Specify <i>with headrest</i> .	
Casters	• Soft, dark grey treaded, dual-wheel roll-control casters for use on hard floors	+\$ 36	Specify <i>with soft roll-control casters</i> .	

Tip: Fully upholstered option is available on fixed T-arm style numbers only.

Tip: When the standard polished aluminum base is specified along with adjustable T-arms, you must specify the finish for arm uprights in either 6205 Black or 6249 Platinum.

Tip: When base and adjustable T-arms are specified in 4799 Platinum, the arm upright will be in 4799 Platinum and the lower section of the arm will be in 6205 Black.

► Specification Information, on next page

**For Canadian Pricing**



Multiply U.S. Price by the Canadian price factor.

► See page 1 for details.







Siento 499 Series Executive Desk Chairs, continued



► Options, on previous page

Specification Information







	Fixed T-Arms		Enclosed Upholstered Arms		Adjustable T-Arms	
						
• Description	• Style Number	• U.S. Base Price	• Style Number	• U.S. Base Price	• Style Number	• U.S. Base Price

High-Back Chairs

Painted Base	499211 	\$2964	499212 	\$3353	499213 	\$3423
Polished Aluminum Base	499221 	\$3550	499222 	\$3939	499223 	\$4009

	Fixed T-Arms		Enclosed Upholstered Arm		Adjustable T-Arms	
						
• Description	• Style Number	• U.S. Base Price	• Style Number	• U.S. Base Price	• Style Number	• U.S. Base Price

Mid-Back Chairs

Painted Base	499111 	\$2769	499112 	\$3158	499113 	\$3228
Polished Aluminum Base	499121 	\$3355	499122 	\$3744	499123 	\$3814



For Canadian Pricing

Multiply U.S. Price by the Canadian price factor.

► See page 1 for details.

 = Transitional product

Understanding and Specifying SILQ 418 Series

Product Details

SILQ 418 Series	250
SILQ Upholstery	254
Dimensions	256

Specifying

Collaborative Chair	258
Collaborative Stool	260

Collaborative chairs

Collaborative seating promotes comfort for long periods of time and promotes movement, offers automatic and intuitive adjustments, and supports multiple postures.

- SILQ 418 Series
- QiVi 428 Series
- cobo 434 Series
- Node 480 Series

Adjustability Features

▶ See page 26 for a comparison to other chairs

SILQ 418 Series

Mechanisms

360°-swivel ●

Seat Adjustments

Pneumatic height ●

Other Features

Foot ring height (stool) ●

SILQ 418 Series

SILQ is a breakthrough in seating design that combines innovation, artistry, and performance to create a personal experience by responding to the unique movements of your body.

Fabric is applied in the warp vertical direction.

Fixed arms are painted plastic. Arm caps are molded plastic. An armless option is available. Polished aluminum is available as an option.

Seat height adjusts $4\frac{5}{8}$ " from $16\frac{1}{4}$ "H to $20\frac{7}{8}$ "H with a pneumatic adjustment mechanism.

Casters have hard, dual-wheels that roll smoothly on carpets. They are $2\frac{1}{2}$ " for increased mobility. Soft, dual-wheel, roll control casters are an option available for use on hard floors or chair mats. Hard hubless casters, and soft hubless casters are also available as an option.

Tip: Do not roll the chair across asphalt during installation as this may damage the casters.

Upper back shell is molded plastic.

Lower shell is painted plastic.

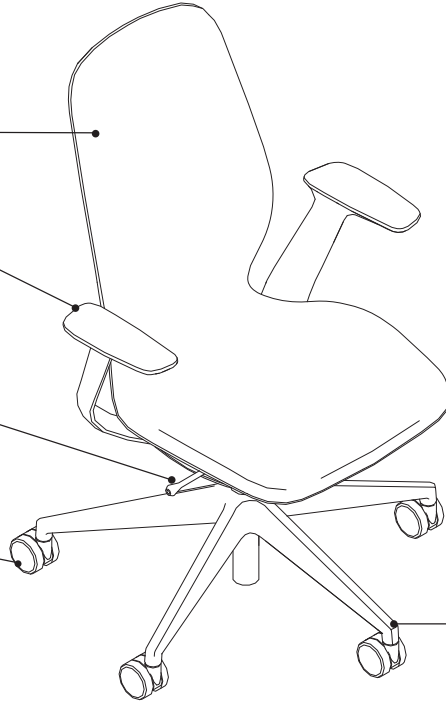

Five-star base is painted or plastic.

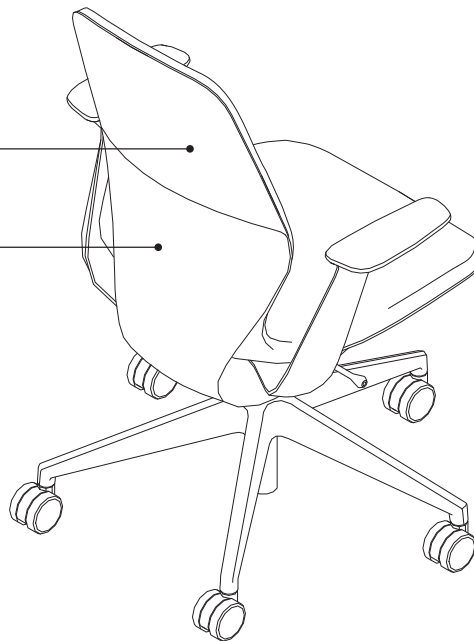

Product Details



Five-star base chairs and stools are available with and without arms. Five-star bases are also available with casters or glides.

Product Weight

- SILQ chair: 29.8 pounds

Adjustment Features

Adjustability instructions are included with every chair. Instructions can also be found at www.steelcase.com.

Seat Adjustments

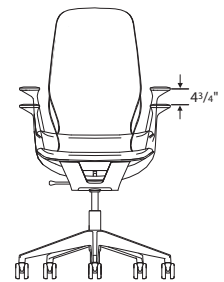

Seat height adjusts pneumatically. To lower, pull lever up while seated. To raise, pull lever up and keep your weight off the chair.

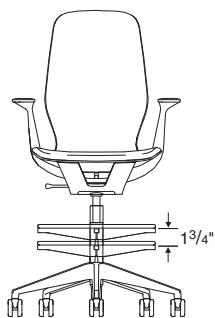

Foot ring height on stools adjusts by first lifting ring and rotating it counterclockwise to unlock. Then raise or lower ring up to 1³/₄" to desired position before rotating it clockwise to lock. The foot ring has a diameter of 20".

Back Adjustments

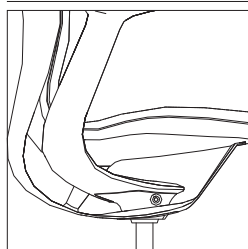

Weight activated compliant system responds to the natural movements of the user's body.

Other features

Hard and soft, hubless roll control wheel casters and hard glides are available as options on the five-arm base.

Cartoned request on dealer purchase order forces SILQ chairs to ship knocked down in three pieces; the seat and back, the base, and the pneumatic cylinder. This request forces SILQ stools to ship knocked down in four pieces; the seat and back, the base, the pneumatic cylinder, and the foot ring. Assembly by a qualified dealer installer is required. Assembly instructions are included.

Surface Materials

► See surface materials on page 634 for specific availability or refer to the *Surface Materials Reference Manual* for further information.

Upholstery

- Fabric
 - Fabric with soil-retardant treatment (option)
- See SILQ Resources on Village for list of approved fabrics (<https://village.steelcase.com/docs/DOC-49519>)
- Tip: Fabric on the SILQ 418 Series will only be applied in the warp vertical/down roll direction. This includes all standard Steelcase fabrics, Select Surfaces, and COMs.*
- See *Fabric Application Direction Guidelines*, page 644.

Solid, non-pattern fabrics are recommended. Steelcase will not pattern match fabrics which have a distinct repeating pattern (stripes, vertical repeats, etc). This includes pattern matching on the single unit but also pattern matching from one component to another. If pattern matching is of concern it is recommended to use one of the standard Steelcase fabrics, vinyls, or non-patterned COM.

Hard Components

Upper Shell

- 6053 Seagull
- 6249 Platinum Solid
- 6527 Merle

Lower Shell

- 4140 Arctic White Gloss
- 4144 Gloss Black
- 7245 Carbon Metallic
- 7360 Merle

Arms

- 7243 Seagull
- 7250 Sterling Dark
- 7360 Merle
- 8406 Polished Aluminum
- 4B20 Obsidian
- 4B22 Matte Brass
- 4B23 Burnished Bronze
- 4B24 Night Bronze
- 4B25 Matte Copper
- 4B26 Smoked Mica
- 4B29 Cast Iron

Base

- 4140 Arctic White Gloss
- 6205 Black
- 7243 Seagull
- 7360 Merle
- 8406 Polished Aluminum
- 4B20 Obsidian
- 4B22 Matte Brass
- 4B23 Burnished Bronze
- 4B24 Night Bronze
- 4B25 Matte Copper
- 4B26 Smoked Mica
- 4B29 Cast Iron

Tip: See next page for Color Scheme Matrix.

All Steelcase seating with standard upholstery fabrics

complies with requirements of the State of California Technical Bulletin 117-2013. All standard seating is labeled to be in compliance with California 117-2013.

Programs & Services

► See the *Surface Materials Reference Manual* for further detail about programs and services offered for seating.

The Customer's Own Material (COM) Program

offers the opportunity for customers to select fabrics that are not offered through the standard Steelcase surface materials program for use on Steelcase products. Through the COM program, Steelcase will test your materials for application on Steelcase products. Once approved, you can place your order. Steelcase will facilitate the entire ordering process and give you a production schedule. Steelcase will order the COM fabric directly from the textile manufacturer. For up-to-date information regarding fabric test results for all COM fabrics and details regarding yardage requirements for most Seating lines, visit the COM website. To locate the COM website:

- Visit www.steelcase.com

Soil retardants are treatments that provide long-term soil and stain resistance to a fabric without affecting the shade or the integrity of the fabric. The following Steelcase Textiles are available pre-treated with soil retardant. (You do not need to select the soil-retardant option for these fabrics and incur the upcharge.)

- Jacks
- Link

For information on soil retardant fabrics on Select Surfaces, please refer to the *Surface Materials Reference Manual*.

Soil-retardant treatment is available on all other seating fabrics at an additional upcharge per seating unit. To order this option, please select "Soil-Retardant Treatment" under "Optional Accessories."

For soil-retardant treatment on COMs, please select "Soil-Retardant Treatment" under "Optional Accessories." Minimums or additional yardage may be required. Please contact the vendor directly for specific information.

Extended lead times may be necessary for this service.

Contact your Steelcase Solutions Fulfillment Team Representative at 1.888.STEELCASE (1.888.783.3522) or send an email to lineone@steelcase.com.

Local codes may have special requirements for upholstery.

SILQ 418 Series, continued

Color Scheme Matrix

Color Scheme	Upper Back Shell	Lower Back Shell	Arms	Base
Platinum/Merle	Molded Plastic–Platinum Solid 6249	Painted–Textured Merle 7360	Painted–Textured Sterling Dark Solid 7250	Molded Plastic–Black 6205
Seagull/Merle	Molded Plastic–Seagull 6053	Painted–Textured Merle 7360	Painted–Textured Sterling Dark Solid 7250	Painted–Textured Merle 7360
Seagull/Carbon Metallic	Molded Plastic–Seagull 6053	Painted–Textured Carbon Metallic 7245	Painted–Textured Seagull 7243	Painted–Textured Seagull 7243
Merle/Merle	Molded Plastic–Merle 6527	Painted–Textured Merle 7360	Painted–Textured Sterling Dark Solid 7250	Painted–Textured Merle 7360
Merle/Gloss Black	Molded Plastic–Merle 6527	Painted–Gloss Black 4144	Painted–Textured Sterling Dark Solid 7250	Molded Plastic–Black 6205
Seagull/Arctic White Gloss	Molded Plastic–Seagull 6053	Painted–Arctic White Gloss 4140	Painted–Textured Seagull 7243	Painted–Arctic White Gloss 4140

- Tip: Polished aluminum and Lux Coatings are available as options on arms and base.*
- Tip: The polished aluminum arm can be specified with the standard base color.*
- Tip: The polished aluminum base can be specified with the standard arm color.*
- Tip: A polished aluminum arm cannot be combined with a Lux Coatings base.*
- Tip: If a Lux Coatings finish is selected on the arm, the same Lux Coatings finish must be selected on the base.*
- Tip: If a Lux Coatings finish is selected, the arm caps will be 6205 black plastic.*

Foot Ring (Stools)	Arm Caps	Casters	Cylinder
Plastic–Black 6205	Black 6205	Black 6205	Black 6205
Plastic–Black 6205	Black 6205	Black 6205	Black 6205
Painted–Sterling Dark Solid 7250	Sterling Dark Solid 6059	Sterling Dark Solid 6059	Painted–Sterling Dark Solid 7250
Plastic–Black 6205	Plastic–Black 6205	Plastic–Black 6205	Black 6205
Plastic–Black 6205	Black 6205	Black 6205	Black 6205
Painted–Sterling Dark Solid 7250	Sterling Dark Solid 6059	Sterling Dark Solid 6059	Painted–Sterling Dark Solid 7250

SILQ Upholstery

What Is It?

Fabric, leather, or vinyl-covered back and seat.

Tip: Fabrics on SILQ 418 Series will only be applied in the warp vertical/down roll direction. This fabric application is the opposite direction of the rest of the Steelcase seating portfolio.

Standard upholstery design

Cogent: Connect

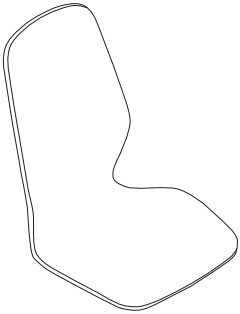

Sewn upholstery design

Vinyl and All Other Fabrics

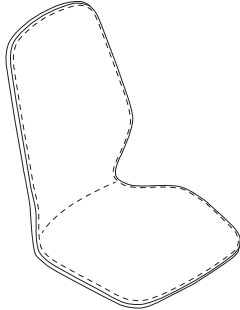

Stitched seams are included across the waist of the chair and along the edges of the chair.

- Upholstery
- Vinyl
- Select Customer's Own Material/Vinyl (COM)

Leather upholstery design

Leather

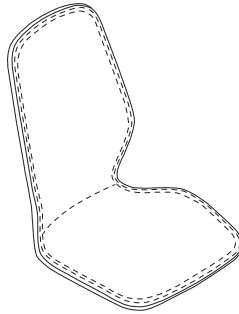

Stitched seams on leather include a single seam across the waist of the chair and a double seam along the edges of the chair.

- Leather
- Select Customer's Own Leather (COL)



Dimensions

SILQ 418 Series

Features	Overall Depth	Width	Height	Seat Depth	Functional Seat Depth	Seat Width	Seat Height from Floor	Ring Height from Floor	Back Width	Back Height from Seat
SILQ 418 Series										
Collaborative Chairs										
	23½"	25½"	37½"-42¼"	16¾"	16¾"	18¾"	16¼"-20⅞"	N.A.	14"	23⅞"

Stools

	23½"	25½"	44½"-52"	16¾"	16¾"	18¾"	22⅞"-30⅞"	11¼"-13"	14"	23⅞"
--	------	------	----------	------	------	------	-----------	----------	-----	------

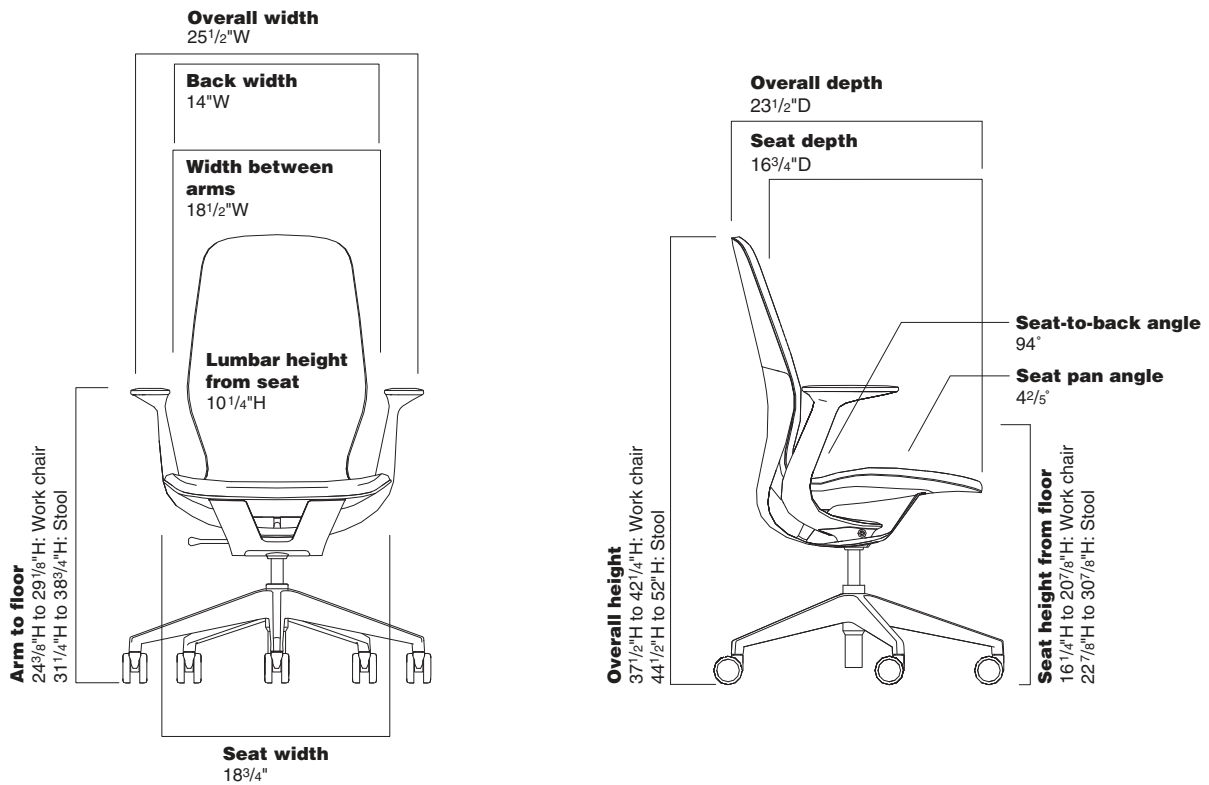

• Back • Lumbar • Height	• Width • Between • Arms	• Arm • to • Floor	• Arm • Height • from • Seat	• Seat • Pan • Angle	• Angle • Between • Seat and • Back
--------------------------------	--------------------------------	--------------------------	---------------------------------------	----------------------------	--

10¼"	18½"	24¾"–29½"	9¼"	4⅔°	94°
------	------	-----------	-----	-----	-----

10¼"	18½"	31¼"–38¾"	9¼"	4⅔°	94°
------	------	-----------	-----	-----	-----

:	:	:	:	:	:
---	---	---	---	---	---

SILQ 418 Series Collaborative Chair



Standard Includes		Required to Specify
▶ Need help? Product details, page 250	<ul style="list-style-type: none"> • 45/8" pneumatic seat-height adjustment (161/4" – 207/8") • Fixed arms: textured paint • Upper back shell and arm caps: plastic • Lower back shell: textured paint • Five-star base: plastic or paint • Standard upholstery design on seat: fabric price group 1 • 21/2"-diameter, hard-composition, dual-wheel casters: black 	<ol style="list-style-type: none"> 1 Style number 2 Fabric color number for upholstery on seat 3 Plastic color number for upper back shell and arm caps 4 Paint color number for lower back shell 5 Paint color number for arms 6 Plastic or paint color number for base 7 Options, if selected (see below) <p>▶ See <i>Surface Materials</i>, page 634.</p>

Tip: Fabric on the SILQ 418 Series will only be applied in the warp vertical/down roll direction. This includes all standard Steelcase fabrics, *Select Surfaces*, and COMs. ▶ See *Fabric Application Direction Guidelines*, page 644.

Tip: Leather and vinyl upcharges are in addition to sewn upholstery upcharge.

Options	U.S. Price	Required to Specify
Surface Materials	Upholstery on seat	
	• Fabric price group 1	No cost
	• Fabric price group 2	+\$ 37
	• Fabric price group 3	+\$ 72
	• Fabric price group 4	+\$100
	• Fabric price group 5	+\$125
	• Fabric price group 6	+\$154
	• Fabric price group 7	+\$179
	• Fabric price group 8	+\$223
	• Fabric price group 9	+\$276
	• Fabric price group 10	+\$312
	• Sewn upholstery	+\$140
	• Steelcase leather upholstery	+\$368
	• Select Surfaces leather price group 1	+\$368
	• Elmosoft leather	+\$446
	• Select Surfaces leather price group 2	+\$446
	• Steelcase vinyl	+\$ 37
	• Customer's Own Material (COM)	No cost
	• Customer's Own Leather (COL)	No cost
	Soil-retardant treatment	+\$ 36
Stitch	• White	No cost
	• Light	No cost
	• Dark	No cost
Upper Back Shell	• 6053 Seagull	No cost
	• 6249 Platinum Solid	No cost
	• 6527 Merle	No cost
Lower Back Shell	• 4140 Arctic White Gloss	+\$434
	• 4144 Black Gloss	+\$434
	• 7245 Carbon Metallic	No cost
	• 7360 Merle	No cost
Arms	• Armless	-\$ 86
	• Lux Coatings	+\$ 86
	• Polished aluminum	+\$125

▶ Options, continued on next page

Tip: Stitch selection will default to a contrast stitch on standard leathers.

Tip: Lower back shell and other component finishes have limited selections based on the upper back shell finish selection. ▶ See *color scheme matrix*, page 252.

Tip: Armless models cannot be modified to have arms after purchase. Conversely, chairs ordered with arms cannot be removed in the field after purchase.

► Options, continued from previous page

Options	U.S. Price	Required to Specify
Base		
• Lux Coatings	+\$138	Specify Lux Coatings color number.
• Polished aluminum	+\$185	Specify <i>with polished aluminum</i> .
Casters		
• Soft, dark grey treaded, dual-wheel roll-control casters for use on hard floors	+\$ 36	Specify <i>with soft casters</i> .
• Hard, black interior/black treaded hubless casters for use on soft floors	+\$140	Specify <i>with hard, hubless casters</i> .
• Soft, black interior/dark grey treaded roll-control hubless casters for use on hard floors	+\$179	Specify <i>with soft, hubless casters</i> .
Glides		
• Glides	+\$ 36	Specify <i>with glides</i> .

Specification Information

Style Number	U.S. Base Price
418A000	\$1390



► Detailed dimensions, page 256



For Canadian Pricing

Multiply U.S. Price by the Canadian price factor.

► See page 1 for details.

SILQ 418 Series Collaborative Stool



Standard Includes		Required to Specify
▶ Need help? Product details, page 250	<ul style="list-style-type: none"> 8" pneumatic seat-height adjustment (22⁷/₈" – 30⁷/₈") Fixed arms: textured paint Upper back shell and arm caps: plastic Lower back shell: textured paint Five-star base: plastic or paint Standard upholstery design on seat: fabric price group 1 Adjustable foot ring: plastic color 2"-diameter, hard-composition, dual-wheel casters: black 	<ol style="list-style-type: none"> Style number Fabric color number for upholstery on seat Plastic color number for upper back shell and arm caps Paint color number for lower back shell Paint color number for arms Plastic or paint color number for base Plastic color number for foot ring Options, if selected (see below) <p>▶ See <i>Surface Materials</i>, page 634.</p>

Tip: Fabric on the SILQ 418 Series will only be applied in the warp vertical/down roll direction. This includes all standard Steelcase fabrics, *Select Surfaces*, and COMs. ▶ See *Fabric Application Direction Guidelines*, page 644.

Tip: Leather and vinyl upcharges are in addition to sewn upholstery upcharge.

Options	U.S. Price	Required to Specify
Surface Materials <ul style="list-style-type: none"> Fabric price group 1 Fabric price group 2 Fabric price group 3 Fabric price group 4 Fabric price group 5 Fabric price group 6 Fabric price group 7 Fabric price group 8 Fabric price group 9 Fabric price group 10 Sewn upholstery 	<ul style="list-style-type: none"> No cost +\$ 37 +\$ 72 +\$100 +\$125 +\$154 +\$179 +\$223 +\$276 +\$312 +\$140 	<ul style="list-style-type: none"> Specify fabric color number. Specify fabric color number. Specify fabric color number. Specify fabric color number. Specify fabric color number. Specify fabric color number. Specify fabric color number. Specify fabric color number. Specify fabric color number. Specify fabric color number. Specify fabric color number. Add suffix S to the style number and specify fabric color number. Add suffix S to the style number and specify leather color number Add suffix S to the style number and specify leather color number. ▶ See <i>Surface Materials Reference Manual</i>. Add suffix S to the style number and specify Elmosoft leather color number. Add suffix S to the style number and specify leather color number. ▶ See <i>Surface Materials Reference Manual</i>. Add suffix S to the style number and specify vinyl color number. ▶ See <i>Surface Materials Reference Manual</i>. Add suffix S to style number and specify leather color number. ▶ See <i>Surface Materials Reference Manual</i>.
<ul style="list-style-type: none"> Steelcase leather upholstery Select Surfaces leather price group 1 Elmosoft leather Select Surfaces leather price group 2 Steelcase vinyl Customer's Own Material (COM) Customer's Own Leather (COL) 	<ul style="list-style-type: none"> +\$368 +\$368 +\$446 +\$446 +\$ 37 No cost No cost 	<ul style="list-style-type: none"> ▶ See <i>Surface Materials Reference Manual</i>. ▶ See <i>Surface Materials Reference Manual</i>. ▶ See <i>Surface Materials Reference Manual</i>. ▶ See <i>Surface Materials Reference Manual</i>.
Soil-retardant treatment	<ul style="list-style-type: none"> +\$ 36 	<ul style="list-style-type: none"> Specify with soil-retardant treatment.
Stitch <ul style="list-style-type: none"> White Light Dark 	<ul style="list-style-type: none"> No cost No cost No cost 	<ul style="list-style-type: none"> Specify white stitch. Specify light stitch. Specify dark stitch.
Upper Back Shell <ul style="list-style-type: none"> 6053 Seagull 6249 Platinum Solid 6527 Merle 	<ul style="list-style-type: none"> No cost No cost No cost 	<ul style="list-style-type: none"> Specify with 6053 Seagull. Specify with 6249 Platinum Solid. Specify with 6527 Merle.
Lower Back Shell <ul style="list-style-type: none"> 4140 Arctic White Gloss 4144 Black Gloss 7245 Carbon Metallic 7360 Merle 	<ul style="list-style-type: none"> +\$434 +\$434 No cost No cost 	<ul style="list-style-type: none"> Specify with 4140 Arctic White Gloss. Specify with 4144 Black Gloss. Specify with 7245 Carbon Metallic. Specify with 7360 Merle.
Arms <ul style="list-style-type: none"> Armless Lux Coatings Polished aluminum 	<ul style="list-style-type: none"> -\$ 86 +\$ 86 +\$125 	<ul style="list-style-type: none"> Specify without arms. Specify Lux Coatings color number. Specify with polished aluminum.

▶ Options, continued on next page

Tip: Stitch selection will default to a contrast stitch on standard leathers.

Tip: Lower back shell and other component finishes have limited selections based on the upper back shell finish selection. ▶ See color scheme matrix, page 252.

Tip: Armless models cannot be modified to have arms after purchase. Conversely, chairs ordered with arms cannot be removed in the field after purchase.

► Options, continued from previous page

Options	U.S. Price	Required to Specify
Base		
• Lux Coatings	+\$138	Specify Lux Coatings color number.
• Polished aluminum	+\$185	Specify <i>with polished aluminum</i> .
Casters		
• Soft, dark grey treaded, dual-wheel roll-control casters for use on hard floors	+\$ 36	Specify <i>with soft casters</i> .
• Hard, black interior/black treaded hubless casters for use on soft floors	+\$140	Specify <i>with hard, hubless casters</i> .
• Soft, black interior/dark grey treaded roll-control hubless casters for use on hard floors	+\$179	Specify <i>with soft, hubless casters</i> .
Glides		
• Glides	+\$ 36	Specify <i>with glides</i> .

Specification Information

Style Number	U.S. Base Price
418B000	\$1676

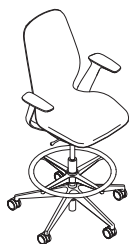

► Detailed dimensions, page 256



For Canadian Pricing
Multiply U.S. Price by the Canadian price factor.
► See page 1 for details.



Understanding and Specifying QiVi 428 Series

Product Details

QiVi 428 Series	264
Dimensions	268

Specifying

Collaborative Chair	270
Collaborative Stool	271
Sled-Base Multi-Use Chairs	272

Collaborative chairs

Collaborative seating promotes comfort for long periods of time and promotes movement, offers automatic and intuitive adjustments, and supports multiple postures.

- QiVi 428 Series
- cobî 434 Series
- Node 480 Series

Adjustability Features

▶ See page 26 for a comparison to other chairs

QiVi 428 Series

Mechanisms

360°-swivel ●

Seat Adjustments

Pneumatic height ●

Gliding seat ●

Back Adjustments

Self adjusting ●

Pivoting back ●

Other Features

Foot ring height (stool) ●

QiVi 428 Series

QiVi is a family of seating, inspired by collaboration and designed to encourage movement and support various postures. With its pivoting backrest and gliding seat, QiVi adjusts automatically to provide comfort for extended periods of time.

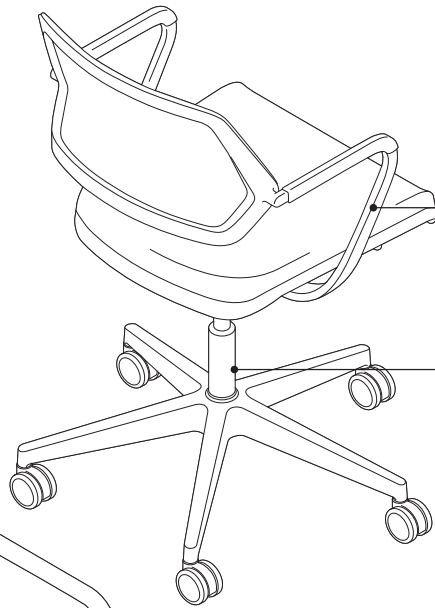

Arms are painted aluminum with a soft touch painted plastic arm cap. Polished aluminum arms are available as an option.

Seat height adjusts 4½" from 17½"H to 22"H with a pneumatic adjustment mechanism.

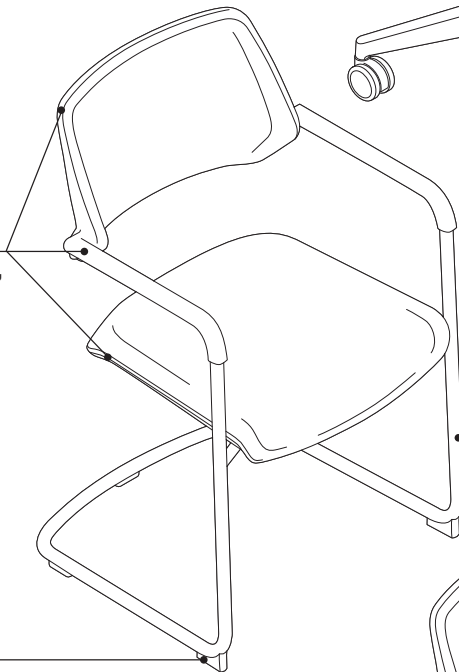

Back frame, seat shell, and arm caps are plastic and will always coordinate finish color.

Frame is painted steel with a soft touch painted plastic arm cap. Polished chrome is available as an option.

Pivoting back rotates 15° automatically, encouraging movement and sitting in multiple postures.

Hard plastic glides are standard, soft glides are available as an option.

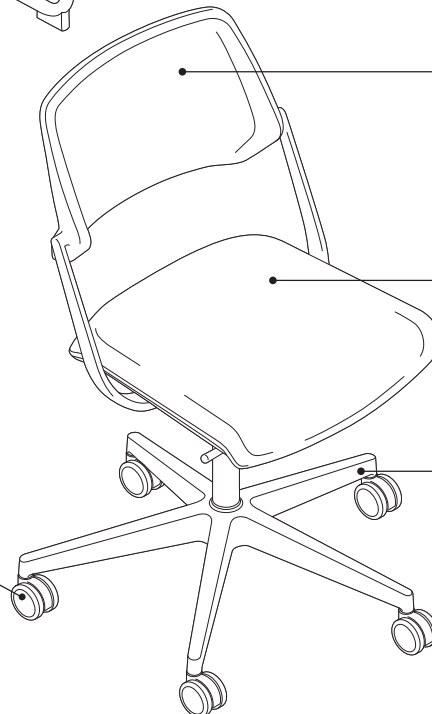

Gliding seat has a 1" range. Movement is automatic and follows the user as they shift postures. A fixed seat is available as an option.

Five-star base is standard in plastic. Painted and polished aluminum base are available as options.

Casters have hard, dual-wheels that roll smoothly on carpets. They are 2½" for increased mobility. Soft, dark grey treaded, dual-wheel roll-control casters are available for use on hard floors or mats. Stools are standard with 2" hard casters. Soft casters are available as an option.

Tip: Do not roll the chair across asphalt during installation as this may damage the casters.

Product Details



Five-star base chairs and stools are available with and without arms.

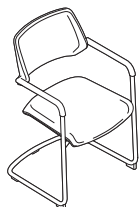

Sled-base is available with arms only.

360° adjustable height swivel mechanism is standard on five-star base models.

QiVi ships standard assembled and uncartoned. Cartoned shipment is available as an option.

Stacking density for sled-base stacking chairs is three on the floor. Bases on the stacking chairs have a slight bend at the front of each leg.

Product Weight

- QiVi chair: 16.4 pounds

Adjustment Features

Adjustability instructions are included with every swivel-base chair. Instructions can also be found at www.steelcase.com.

Seat Adjustments

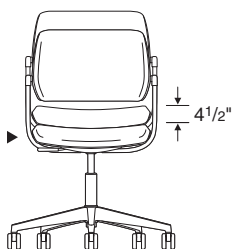

Seat height adjusts pneumatically. To lower, pull lever up while seated. To raise, pull lever up and keep your weight off the chair.

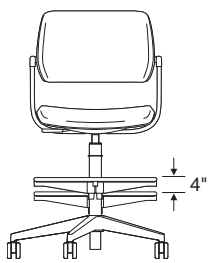

Foot ring height on stools adjusts by first lifting ring and rotating it counter-clockwise to unlock. Then raise or lower ring up to 4" to desired position before rotating it clockwise to lock. The foot ring has a diameter of 20".

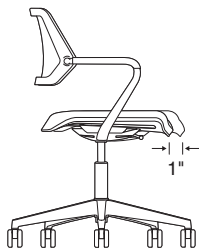

Gliding seat automatically glides forward and back, adjusting to the natural motion of your body. The seat glides within a 1" range and returns to a neutral position when the user leaves the seat. The gliding seat is a standard feature, a fixed seat option is available.

Back Adjustments

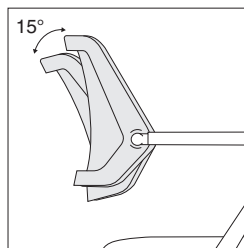

Pivoting back automatically follows the natural motion of your back as you recline, encouraging movement and supporting multiple postures. The backrest pivot range is 15° and will return to the neutral position when the user is not applying pressure to the back.

Other features

Soft wheel casters for hard floors on five-star base models are available for specific applications.

Hard glides come standard on sled base chairs, soft glides are available as an option.

Surface Materials

▶ See surface materials on page 634 for specific availability or refer to the *Surface Materials Reference Manual* for further information.

Back Upholstery

- QiVi Net (back only)
- QN01 Wasabi
- QN02 Licorice
- QN03 Tangerine
- QN04 Graphite
- QN05 Malt
- QN06 Coconut
- QN07 Scarlet
- QN08 Blue Jay
- QN10 Aubergine
- QN11 Peacock
- QN12 Jungle
- QN13 Merlot
- QN14 Honey
- QN15 Lagoon
- QN16 Saffron

Seat Upholstery

- Cogent: Connect fabric
- Fabric
- Fabric with soil-retardant treatment (option)
- Leather
- Elmosoft Leather
- Select Surfaces leather
- Vinyl
- COM
- COL

Tip: Some Steelcase seating fabrics are available with and without a stitched detail on the seat. See seating upholstery matrix for details.

Base

- Coatings
- 1ATT Cast Shadow

- Lux Coatings
- 4B20 Obsidian
- 4B22 Matte Brass
- 4B23 Burnished Bronze
- 4B24 Night Bronze
- 4B25 Matte Copper
- 4B26 Smoked Mica
- 4B29 Cast Iron

Plastic components

Back frame, seat shell, and arm caps

- 6009 Arctic White
- 6205 Black
- 6249 Platinum

Tip: Only one finish can be selected for all three plastic components.

Base, frame, and arms

- 6205 Black
- 7241 Textured Arctic White
- 4799 Platinum Metallic
- 8046 Polished Aluminum (five-arm only)
- 9201 Polished Chrome (sled only)

Casters and glides

- 6205 Black

Foot ring on stools

- 6205 Black
- 6249 Platinum
- 7241 Arctic White

Tip: Foot ring and cylinder on stool will coordinate to match the base color.

All Steelcase seating with standard upholstery fabrics

complies with requirements of the State of California Technical Bulletin 117-2013. All standard seating is labeled to be in compliance with California 117-2013.

Programs & Services

▶ See the *Surface Materials Reference Manual* for further detail about programs and services offered for seating.

The Customer's Own Material (COM) Program

offers the opportunity for customers to select fabrics that are not offered through the standard Steelcase surface materials program for use on Steelcase products. Through the COM program, Steelcase will test your materials for application on Steelcase products. Once approved, you can place your order. Steelcase will facilitate the entire ordering process and give you a production schedule. Steelcase will order the COM fabric directly from the textile manufacturer. For up-to-date information regarding fabric test results for all COM fabrics and details regarding yardage requirements for most Seating lines, visit the COM website. To locate the COM website:

- Visit www.steelcase.com

Soil retardants are treatments that provide long-term soil and stain resistance to a fabric without affecting the shade or the integrity of the fabric. The following Steelcase Textiles are available pre-treated with soil retardant. (You do not need to select the soil-retardant option for these fabrics and incur the upcharge.)

- Jacks
- Link

For information on soil retardant fabrics on Select Surfaces, please refer to the *Surface Materials Reference Manual*.

Soil-retardant treatment is available on all other seating fabrics at an additional upcharge per seating unit. To order this option, please select "Soil-Retardant Treatment" under "Optional Accessories."

For soil-retardant treatment on COMs, please select "Soil-Retardant Treatment" under "Optional Accessories." Minimums or additional yardage may be required. Please contact the vendor directly for specific information.

Extended lead times may be necessary for this service.

Contact your Steelcase Solutions Fulfillment Team Representative at 1.888.STEELCASE (1.888.783.3522) or send an email to lineone@steelcase.com.

Local codes may have special requirements for upholstery.

Dimensions

- ▶ Page 268

Resources

Printed Materials

- ▶ QiVi Brochure (13-0000592)
- ▶ QiVi User Guide (13-0000217)

Online Resources

- ▶ QiVi technical animation available on SteelcaseTV YouTube channel
- ▶ QiVi Commercial available on SteelcaseTV YouTube channel
- ▶ Product Environmental Profiles, which provide key environmental attributes and product certifications can be found by searching for Steelcase at *Origin.build*.

Dimensions

QiVi 428 Series

Features	Overall Depth	Width	Height	Seat Depth	Functional Seat Depth	Seat Width	Seat Height from Floor	Ring Height from Floor	Back Width	Back Height from Seat
QiVi 428 Series										
Collaborative Chairs										
	22 ¹ / ₁₆ "	*22 ¹ / ₂ "	33 ¹ / ₄ "–38 ¹ / ₈ "	19 ⁷ / ₈ "	18 ¹ / ₂ "	18 ¹ / ₂ "	17 ¹ / ₂ "–22"	N.A.	18"	16 ¹ / ₂ "
Sled-Base Chairs										
	22 ¹ / ₈ "	22 ¹ / ₁₆ "	34"	19 ⁷ / ₈ "	18 ¹ / ₂ "	18 ¹ / ₂ "	18 ¹ / ₂ "	N.A.	18"	16 ¹ / ₂ "
Stools										
	22 ¹ / ₁₆ "	*22 ¹ / ₂ "	38 ¹ / ₄ "–46 ¹ / ₂ "	19 ⁷ / ₈ "	18 ¹ / ₂ "	18 ¹ / ₂ "	22"–30 ¹ / ₄ "	10 ¹ / ₂ "–14 ¹ / ₂ "	18"	16 ¹ / ₂ "

*Overall width does not include the base.
The diameter of the chair with the five-star base is 26".

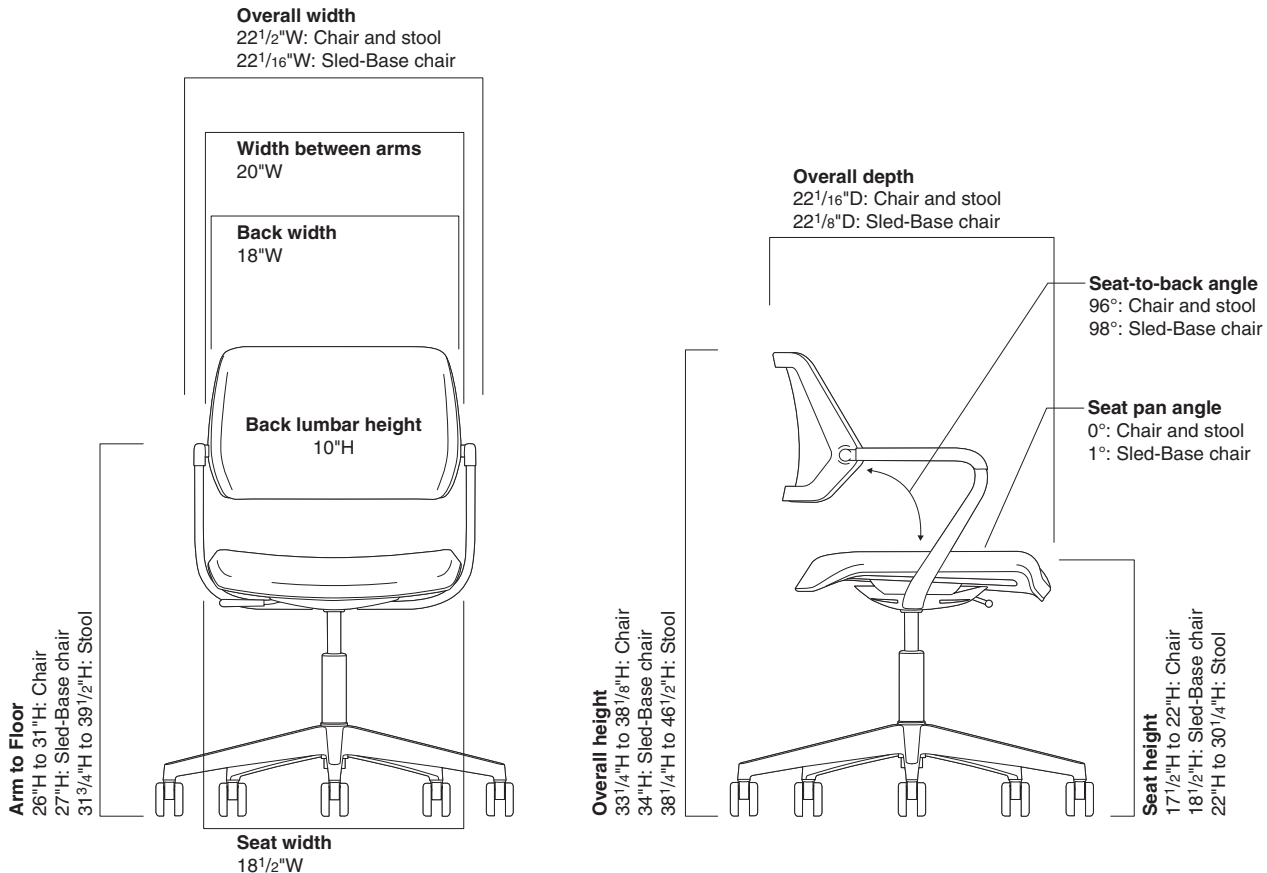

• Back • Lumbar • Height	• Width • Between • Arms	• Arm • to • Floor	• Arm • Height • from • Seat	• Seat • Pan • Angle	• Angle • Between • Seat and • Back
--------------------------------	--------------------------------	--------------------------	---------------------------------------	----------------------------	--

10"	20"	26"-31"	8½"	0°	96°
-----	-----	---------	-----	----	-----

10"	20"	27"	8½"	1°	98°
-----	-----	-----	-----	----	-----

10"	20"	31¾"-39½"	8½"	0°	96°
-----	-----	-----------	-----	----	-----

:	:	:	:	:	:
---	---	---	---	---	---

QiVi 428 Series Collaborative Chair



► Need help?
Product details,
page 264

Standard Includes

- 4½" pneumatic seat-height adjustment (17½" to 22")
- Arms, if selected: 6205 black plastic to match base
- Seat shell, outer back, and soft touch arm caps: plastic
- Five-star base: 6205 black plastic
- QiVi Net upholstery on back
- 15° pivoting backrest
- Standard upholstery design on seat: fabric price group 1
- 1" gliding seat
- 2½"-diameter, hard-composition, dual-wheel casters: black

Required to Specify

- 1 Style number
 - 2 Plastic color number for base
 - 3 Plastic color number for seat shell, outer back shell, and arm caps, if selected
 - 4 QiVi Net color number for upholstery on back
 - 5 Fabric color number for upholstery on seat
 - 6 Options, if selected (see below)
- See *Surface Materials*, page 634.

Tip: Always add suffixes in alphabetical order when specifying options to QiVi seating.

Tip: Leather and vinyl upcharges are in addition to sewn upholstery upcharge.

	Options	U.S. Price	Required to Specify
Surface Materials	Upholstery on seat		
	• Fabric price group 1	No cost	Specify fabric color number.
	• Fabric price group 2	No cost	Specify fabric color number.
	• Fabric price group 3	+\$ 37	Specify fabric color number.
	• Fabric price group 4	+\$ 51	Specify fabric color number.
	• Fabric price group 5	+\$ 61	Specify fabric color number.
	• Fabric price group 6	+\$ 76	Specify fabric color number.
	• Fabric price group 7	+\$ 92	Specify fabric color number.
	• Fabric price group 8	+\$112	Specify fabric color number.
	• Fabric price group 9	+\$137	Specify fabric color number.
• Fabric price group 10	+\$159	Specify fabric color number.	
• Steelcase leather upholstery	+\$258	Add suffix S to the style number and specify leather color number.	
• Select Surfaces leather price group 1	+\$258	Add suffix S to the style number and specify Select Surfaces leather price group 1.	
• Elmosoft leather upholstery	+\$301	► See <i>Surface Materials Reference Manual</i> . Add suffix S to the style number and specify Elmosoft leather color number.	
• Select Surfaces leather price group 2	+\$301	Add suffix S to the style number and specify Select Surfaces leather price group 2.	
• Sewn upholstery	+\$ 58	► See <i>Surface Materials Reference Manual</i> . Add suffix S to the style number.	
• Steelcase vinyl	No cost	Add suffix S to the style number and specify vinyl color number.	
• Customer's Own Material (COM)	No cost	► See <i>Surface Materials Reference Manual</i> . Add suffix S to the style number and specify leather color number.	
• Customer's Own Leather (COL)	No cost		
	Soil-retardant treatment	+\$ 36	Specify <i>with soil-retardant treatment</i> .
Base	• Arctic white	+\$ 85	Specify <i>with 6009 Arctic White</i> .
	• Platinum metallic	+\$ 85	Specify <i>with 4799 Platinum Metallic</i> .
	• Polished aluminum	+\$195	Specify <i>with polished aluminum</i> .
	• Cast Shadow	+\$300	Specify <i>with 1ATT Cast Shadow</i> .
	• Lux Coatings	+\$300	Specify Lux Coatings color number.
Arms	• Armless	-\$ 96	Specify <i>without arms</i> .
Gliding Seat	• Fixed seat	-\$ 49	Specify <i>with fixed seat</i> .
Casters	• Soft, dark grey treaded, dual-wheel roll-control casters for use on hard floors	+\$ 36	Specify <i>with soft roll-control casters</i> .

► Detailed dimensions,
page 268



For Canadian Pricing
Multiply U.S. Price by the
Canadian price factor.
► See page 1 for details.

Specification Information

Style Number	U.S. Base Price
428510	\$1252

QiVi 428 Series Collaborative Stool



Standard Includes		Required to Specify
▶ Need help? Product details, page 264	<ul style="list-style-type: none"> • 8¼" pneumatic seat-height adjustment (22" to 30¼") • Arms, if selected: 6205 black plastic to match base • Seat shell, outer back, and soft touch arm caps: plastic • Five-star base: 6205 black plastic • QiVi Net upholstery on back • 15° pivoting backrest • Standard upholstery design on seat: Fabric price group 1 • 1" gliding seat • Adjustable foot ring: plastic color • 2"-diameter, hard-composition, dual-wheel casters: black 	<ol style="list-style-type: none"> 1 Style number 2 Plastic color number for base and foot ring 3 Plastic color number for seat shell, outer back shell, and arm caps, if selected 4 QiVi Net color number for upholstery on back 5 Fabric color number for upholstery on seat 6 Options, if selected (see below) <p>▶ See <i>Surface Materials</i>, page 634.</p>

Tip: Always add suffixes in alphabetical order when specifying options to QiVi seating.

Tip: Leather and vinyl upcharges are in addition to sewn upholstery upcharge.

Options	U.S. Price	Required to Specify
Surface Materials		
Upholstery on seat		
• Fabric price group 1	No cost	Specify fabric color number.
• Fabric price group 2	No cost	Specify fabric color number.
• Fabric price group 3	+\$ 37	Specify fabric color number.
• Fabric price group 4	+\$ 51	Specify fabric color number.
• Fabric price group 5	+\$ 61	Specify fabric color number.
• Fabric price group 6	+\$ 76	Specify fabric color number.
• Fabric price group 7	+\$ 92	Specify fabric color number.
• Fabric price group 8	+\$112	Specify fabric color number.
• Fabric price group 9	+\$137	Specify fabric color number.
• Fabric price group 10	+\$159	Specify fabric color number.
• Steelcase leather upholstery	+\$258	Specify fabric color number. Add suffix S to the style number and specify leather color number.
• Select Surfaces leather price group 1	+\$258	Add suffix S to the style number and specify Select Surfaces leather price group 1.
• Elmosoft leather upholstery	+\$301	▶ See <i>Surface Materials Reference Manual</i> . Add suffix S to the style number and specify Elmosoft leather color number.
• Select Surfaces leather price group 2	+\$301	Add suffix S to the style number and specify Select Surfaces leather price group 2.
• Sewn upholstery	+\$ 58	▶ See <i>Surface Materials Reference Manual</i> . Add suffix S to the style number.
• Steelcase vinyl	No cost	Add suffix S to the style number and specify vinyl color number.
• Customer's Own Material (COM)	No cost	▶ See <i>Surface Materials Reference Manual</i> . Add suffix S to the style number and specify leather color number.
• Customer's Own Leather (COL)	No cost	
Soil-retardant treatment	+\$ 36	Specify with soil-retardant treatment.
Base		
• Arctic white	+\$ 85	Specify with 6009 Arctic White.
• Platinum metallic	+\$ 85	Specify with 4799 Platinum Metallic.
• Cast Shadow	+\$300	Specify with 1ATT Cast Shadow.
• Lux Coatings	+\$300	Specify Lux Coatings color number.
Arms		
• Armless	-\$ 96	Specify without arms.
Gliding Seat		
• Fixed seat	-\$ 49	Specify with fixed seat.
Casters		
• Soft, dark grey treaded, dual-wheel roll-control casters for use on hard floors	+\$ 36	Specify with soft roll-control casters.

▶ Detailed dimensions, page 268



For Canadian Pricing
Multiply U.S. Price by the Canadian price factor.
▶ See page 1 for details.

Specification Information	
Style Number	U.S. Base Price
428710	\$1754

QiVi 428 Series Sled-Base Multi-Use Chairs

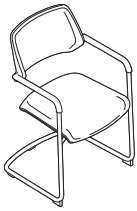

	Standard Includes	Required to Specify
▶ Need help? Product details, page 264	<ul style="list-style-type: none"> • Frame: 6205 black plastic to match base • Base, seat shell, outer back, and soft touch arm caps: plastic • QiVi Net upholstery on back • 15° pivoting backrest • Standard upholstery design on seat: fabric price group 1 • 1" gliding seat 	<ol style="list-style-type: none"> 1 Style number 2 Plastic color number for base 3 Plastic color number for, seat shell, outer back shell, and arm caps, if selected 4 QiVi Net color number for upholstery on back 5 Fabric color number for upholstery on seat 6 Options, if selected (see below) <p>▶ See <i>Surface Materials</i>, page 634.</p>

	Options	U.S. Price	Required to Specify
Surface Materials	Upholstery on seat		
	• Fabric price group 1	No cost	Specify fabric color number.
	• Fabric price group 2	No cost	Specify fabric color number.
	• Fabric price group 3	+\$ 37	Specify fabric color number.
	• Fabric price group 4	+\$ 51	Specify fabric color number.
	• Fabric price group 5	+\$ 61	Specify fabric color number.
	• Fabric price group 6	+\$ 76	Specify fabric color number.
	• Fabric price group 7	+\$ 92	Specify fabric color number.
	• Fabric price group 8	+\$112	Specify fabric color number.
	• Fabric price group 9	+\$137	Specify fabric color number.
• Fabric price group 10	+\$159	Specify fabric color number.	
• Steelcase leather upholstery	+\$258	Add suffix S to the style number and specify leather color number.	
• Select Surfaces leather price group 1	+\$258	Add suffix S to the style number and specify Select Surfaces leather price group 1.	
• Elmosoft leather upholstery	+\$301	▶ See <i>Surface Materials Reference Manual</i> . Add suffix S to the style number and specify Elmosoft leather color number.	
• Select Surfaces leather price group 2	+\$301	Add suffix S to the style number and specify Select Surfaces leather price group 2.	
• Sewn upholstery	+\$ 58	▶ See <i>Surface Materials Reference Manual</i> . Add suffix S to the style number.	
• Steelcase vinyl	No cost	Add suffix S to the style number and specify vinyl color number.	
• Customer's Own Material (COM)	No cost	▶ See <i>Surface Materials Reference Manual</i> . Add suffix S to the style number and specify leather color number.	
• Customer's Own Leather (COL)	No cost		
	Soil-retardant treatment	+\$ 36	Specify <i>with soil-retardant treatment</i> .
Base	• Arctic white	+\$ 85	Specify <i>with 6009 Arctic White</i> .
	• Platinum metallic	+\$ 85	Specify <i>with 4799 Platinum Metallic</i> .
	• Cast Shadow	+\$172	Specify <i>with 1ATT Cast Shadow</i> .
	• Lux Coatings	+\$172	Specify Lux Coatings color number.
	• Polished chrome	+\$233	Specify <i>with polished chrome</i> .
Gliding Seat	• Fixed seat	-\$ 49	Specify <i>with fixed seat</i> .
	Glides		
	• Hard glides for use on carpeted floors	No cost	Specify <i>with hard glides</i> .
	• Soft glides for use on non-carpeted floors	+\$ 7	Specify <i>with soft glides</i> .

Tip: Always add suffixes in alphabetical order when specifying options to QiVi seating.

Tip: Leather and vinyl upcharges are in addition to sewn upholstery upcharge.

▶ Detailed dimensions, page 268



For Canadian Pricing

Multiply U.S. Price by the Canadian price factor.

▶ See page 1 for details.

Specification Information

Style Number	U.S. Base Price
--------------	-----------------

Sled-Base

428310	\$1021
--------	--------

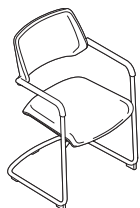

Stacking Sled-Base

428910	\$1021
--------	--------

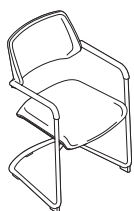

 **For Canadian Pricing**
Multiply U.S. Price by the
Canadian price factor.
▶ See page 1 for details.



Understanding and Specifying cobi 434 Series Collaborative Chairs

Product Details

cobi 434 Series	276
Dimensions	278

Specifying

Collaborative Chairs	280
Swivel-Base Stools	282

Collaborative chairs

Collaborative seating promotes comfort for long periods of time and promotes movement, offers automatic and intuitive adjustments, and supports multiple postures.

- QiVi 428 Series
- cobi 434 Series
- Node 480 Series

Adjustability Features

- ▶ See page 26 for a comparison to other chairs

cobi 434 Series

Mechanisms

Weight-activated	●
------------------	---

Seat Adjustments

Pneumatic height	●
------------------	---

Back Adjustments

Self adjusting	●
----------------	---

Other Features

Foot ring height (stool)	●
--------------------------	---

cobi 434 Series

cobi is collaborative seating for teams that helps people move freely, change postures, and stay energized and comfortable.

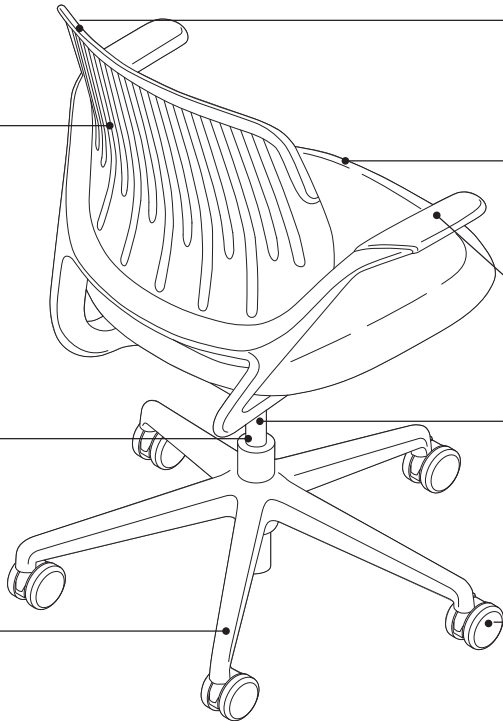

Flexing fingers in back offer support while moving and conforming to the user.

Weight-activated mechanism provides support by automatically responding to the users movements.

Five-star base is standard.

Flexible top edge allows for multiple postures while maintaining support and comfort.

Flexible seat edge on all 3-sides supports multiple postures while relieving thigh pressure.

Arms are constructed of a soft durable rubber compound.

Seat height adjusts with a 5" range from 15½"H to 20½"H with a pneumatic adjustment mechanism.

Casters have hard, dual-wheels that roll smoothly on carpets. They are 2½" for increased mobility. Soft, dark grey treaded, dual-wheel roll-control casters are available for use on hard floors or mats. Stools are standard with 2" hard casters. Soft casters are available as an option. *Tip: Do not roll the chair across asphalt during installation as this may damage the casters.*

Product Details



Chairs and stools are available with or without arms.



Weight-activated mechanism provides individual support without a tension control by intuitively sensing and supporting the users center of gravity.

cobi ships standard assembled and uncartoned. A cartoned request on a dealer purchase order forces cobi chairs to ship unassembled with the chair seat, back, and cylinder separated from the base. This allows for shipment in a smaller carton. Assembly by a qualified dealer installer is required. Assembly instructions are included. No additional tools are required for assembly.

Product Weight

- Cobi chair: 26.3 pounds

Adjustment Features

Seat Adjustments

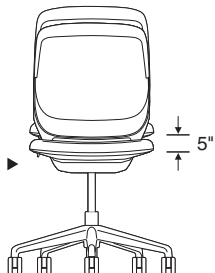

Seat height adjusts

pneumatically. To lower, pull lever up while seated. To raise, pull lever up and keep your weight off the chair.

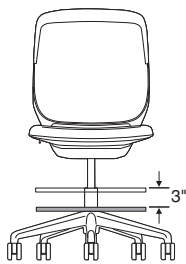

Foot ring height on stools

adjusts by first lifting ring and rotating it counter-clockwise to unlock. Then raise or lower ring up to 3" to desired position before rotating it clockwise to lock. The foot ring has a diameter of 20".

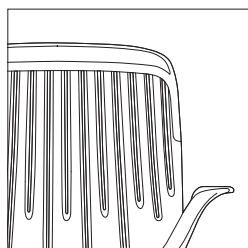

Flexing fingers in back promote movement and provide support for a wide range of postures.

Soft roll-control caster option

features an internal brake that activates when the chair is not under load to reduce shifting when user stands up.

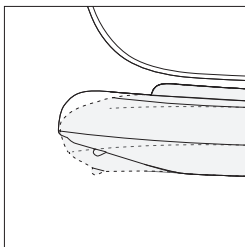

Flexing seat edge on all 3-sides supports multiple postures while relieving thigh pressure.

Surface Materials

▶ See surface materials on page 634 for specific availability or refer to the *Surface Materials Reference Manual* for further information.

Back Upholstery

- Connect 3D (back only)

Seat Upholstery

- Cogent: Connect (seat only)
- Fabric
- Fabric with soil-retardant treatment (option)
- Leather
- Elmosoft leather
- Select Surfaces leather
- Vinyl
- COM
- COL

All seat upholstery except standard Cogent: Connect requires a sewn application. Specify with an **S** suffix.

Outer Back

- 6009 Arctic White
- 6205 Black
- 6249 Platinum
- 6295 Near Black

Arm Caps, Top Edge, and Casters

- 6205 Black
- 6249 Platinum

Tip: Frame, base, and cylinder will default to match outer back color.

Tip: If black or near black are specified on the outer back, the arm caps, top edge, and casters will be 6205 black. If platinum or arctic white are specified on the outer back, the arm caps, top edge, and casters will be 6249 platinum.

Glides

- Black plastic

Foot ring on stools

- 4799 Platinum Metallic
- 6205 Black

Tip: Foot ring on stool will coordinate to match outer back color. For example, the 4799 Platinum Metallic foot ring coordinates with the 6249 Platinum Solid outer back color scheme and 4799 Platinum Metallic base.

All Steelcase seating with standard upholstery fabrics

complies with requirements of the State of California Technical Bulletin 117-2013. All standard seating is labeled to be in compliance with California 117-2013.

Programs & Services

▶ See the *Surface Materials Reference Manual* for further detail about programs and services offered for seating.

The Customer's Own Material (COM) Program

offers the opportunity for customers to select fabrics that are not offered through the standard Steelcase surface materials program for use on Steelcase products. Through the COM program, Steelcase will test your materials for application on Steelcase products. Once approved, you can place your order. Steelcase will facilitate the entire ordering process and give you a production schedule. Steelcase will order the COM fabric directly from the textile manufacturer. For up-to-date information regarding fabric test results for all COM fabrics and details regarding yardage requirements for most Seating lines, visit the COM website:

- Visit www.steelcase.com

Soil retardants are treatments that provide long-term soil and stain resistance to a fabric without affecting the shade or the integrity of the fabric. The following Steelcase Textiles are available pre-treated with soil retardant. (You do not need to select the soil-retardant option for these fabrics and incur the upcharge.)

- Jacks
- Link

For information on soil retardant fabrics on Select Surfaces, please refer to the *Surface Materials Reference Manual*.

Soil-retardant treatment is available on all other seating fabrics at an additional upcharge per seating unit. To order this option, please select "Soil-Retardant Treatment" under "Optional Accessories."

For soil-retardant treatment on COMs, please select "Soil-Retardant Treatment" under "Optional Accessories." Minimums or additional yardage may be required. Please contact the vendor directly for specific information.

Extended lead times may be necessary for this service.

Contact your Steelcase Solutions Fulfillment Team Representative at 1.888.STEELCASE (1.888.783.3522) or send an email to lineone@steelcase.com.

Local codes may have special requirements for upholstery.

Dimensions

▶ Page 278

Resources

Printed Materials

- ▶ cobi Brochure (09-000049)
- ▶ cobi User Guide (10-0002706)

Online Resources

- ▶ Come Together (PDF) available on www.steelcase.com
- ▶ Collaborative Seating Design video available on www.steelcase.com
- ▶ Product Environmental Profiles, which provide key environmental attributes and product certifications can be found by searching for Steelcase at Origin.build.

Dimensions

cobi 434 Series

Features	Overall Depth	Width	Height	Seat Depth	Functional Seat Depth	Seat Width	Seat Height from Floor	Ring Height from Floor	Back Width	Back Height from Seat
cobi 434 Series										
Collaborative Chairs										
	23 ¹ / ₄ "	24 ³ / ₄ "	34"-39"	19 ¹ / ₂ "	17 ⁷ / ₈ "	18 ³ / ₄ "	15 ¹ / ₂ "-20 ¹ / ₂ "	N.A.	18"	19 ¹ / ₂ "
Stools										
	23 ¹ / ₄ "	24 ³ / ₄ "	40"-50"	19 ¹ / ₂ "	17 ⁷ / ₈ "	18 ³ / ₄ "	21"-31"	11 ¹ / ₄ "-14 ¹ / ₄ "	18"	19 ¹ / ₂ "

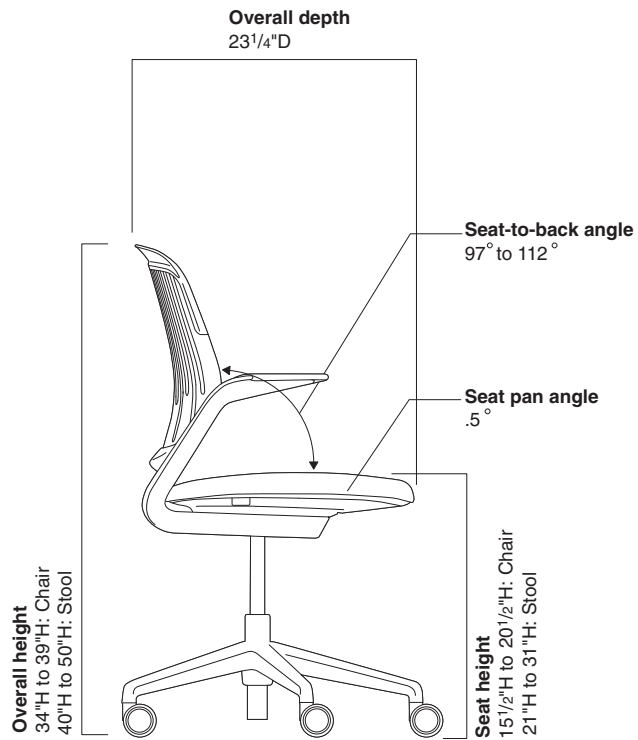
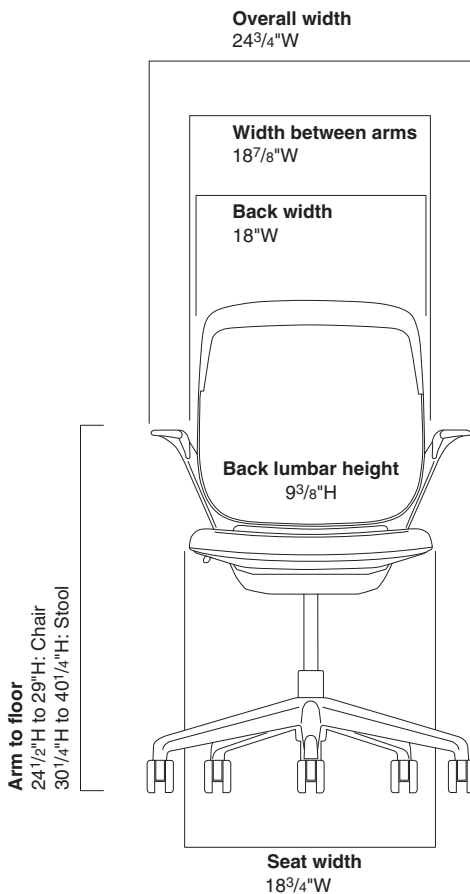

• Back • Lumbar • Height	• Width • Between • Arms	• Arm • to • Floor	• Arm • Height • from • Seat	• Seat • Pan • Angle	• Angle • Between • Seat and • Back
--------------------------------	--------------------------------	--------------------------	---------------------------------------	----------------------------	--

cobi 434 Series

9 ³ / ₈ "	18 ⁷ / ₈ "	24 ¹ / ₄ "–29"	8 ⁷ / ₈ "	.5°	97°–112°
---------------------------------	----------------------------------	--------------------------------------	---------------------------------	-----	----------

9 ³ / ₈ "	18 ⁷ / ₈ "	30 ¹ / ₄ "–40 ¹ / ₄ "	8 ⁷ / ₈ "	.5°	97°–112°
---------------------------------	----------------------------------	---	---------------------------------	-----	----------

:	:	:	:	:	:
---	---	---	---	---	---

cobi 434 Series Collaborative Chairs



▶ Need help?
Product details,
page 276

Standard Includes

- Weight-activated mechanism
- 5" pneumatic seat-height adjustment
- Fixed arms, if selected: plastic to match outer back
- Back upholstery: Connect 3D
- Seat upholstery: Cogent: Connect
- Frame, outer back, and five-star base: Black
- 2½"-diameter, hard composition, dual-wheel casters: black plastic

Required to Specify

- 1 Style number
 - 2 Plastic color number for outer back
 - 3 Connect 3D color number for back
 - 4 Cogent: Connect color number for upholstery on seat
 - 5 Options, if selected (see below)
- ▶ See *Surface Materials*, page 634.

*Tip: All seat upholstery except standard Cogent: Connect requires a sewn application. Specify with an **S** suffix.*

Tip: Always add suffixes in alphabetical order when specifying options to cobi seating.

Tip: Leather and vinyl upcharges are in addition to sewn upholstery upcharge.

	Options	U.S. Price	Required to Specify
Surface Materials	Upholstery		
	• Fabric price group 1	No cost	Add suffix S to the style number and specify fabric color number.
	• Fabric price group 2	No cost	Add suffix S to the style number and specify fabric color number.
	• Fabric price group 3	+\$ 37	Add suffix S to the style number and specify fabric color number.
	• Fabric price group 4	+\$ 51	Add suffix S to the style number and specify fabric color number.
	• Fabric price group 5	+\$ 61	Add suffix S to the style number and specify fabric color number.
	• Fabric price group 6	+\$ 76	Add suffix S to the style number and specify fabric color number.
	• Fabric price group 7	+\$ 92	Add suffix S to the style number and specify fabric color number.
	• Fabric price group 8	+\$112	Add suffix S to the style number and specify fabric color number.
	• Fabric price group 9	+\$137	Add suffix S to the style number and specify fabric color number.
	• Fabric price group 10	+\$159	Add suffix S to the style number and specify fabric color number.
	• Steelcase leather upholstery	+\$258	Add suffix S to the style number and specify leather color number.
	• Select Surfaces leather price group 1	+\$258	Add suffix S to the style number and specify Select Surfaces leather price group 1.
	• Elmosoft leather upholstery	+\$301	▶ See <i>Surface Materials Reference Manual</i> . Add suffix S to the style number and specify Elmosoft leather color number.
	• Select Surfaces leather price group 2	+\$301	Add suffix S to the style number and specify Select Surfaces leather price group 2.
• Sewn Upholstery	+\$ 58	▶ See <i>Surface Materials Reference Manual</i> . Add suffix S to the style number and specify fabric color number.	
• Steelcase vinyl	No cost	Add suffix S to the style number and specify vinyl color number.	
• Customer's Own Material (COM)	No cost	Add suffix S to the style number and specify fabric color number.	
• Customer's Own Leather (COL)	No cost	Add suffix S to the style number and specify leather color number.	
	Soil-retardant treatment	+\$ 36	Specify with soil-retardant treatment.
	Outer back		
	• Arctic white	+\$126	Specify with 6009 Arctic White.
	• Platinum	+\$126	Specify with 6249 Platinum.
	• Near black	+\$126	Specify with 6295 Near Black.
	Casters	• Soft, dark grey treaded, dual-wheel roll-control casters for use on hard floors	+\$ 36 Specify with soft roll-control casters.
	Glides	• Glides: black plastic	+\$ 36 Specify with glides.

▶ Detailed dimensions,
page 278



For Canadian Pricing
Multiply U.S. Price by the
Canadian price factor.
▶ See page 1 for details.

Specification Information

**Arms with
Soft Arm Caps**



Without Arms



Style Number	U.S. Base	Style Number	U.S. Base Price
434111	\$1106	434110	\$1020



For Canadian Pricing
Multiply U.S. Price by the
Canadian price factor.
▶ See page 1 for details.

cobi 434 Series Swivel-Base Stools

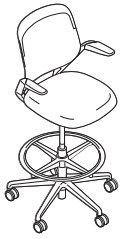

► Need help?
Product details,
page 276

Standard Includes

- Weight-activated mechanism
- 10" pneumatic seat-height adjustment
- Fixed arms, if selected: plastic to match outer back
- Adjustable foot ring: black
- Back upholstery: Connect 3D
- Seat upholstery: Cogent: Connect
- Frame, outer back, and five-star base: black
- 2½"-diameter, hard composition, dual-wheel casters: black plastic

Required to Specify

- 1 Style number
 - 2 Plastic color number for outer back
 - 3 Connect 3D color number for back
 - 4 Cogent: Connect color number for upholstery on seat
 - 5 Options, if selected (see below)
- See *Surface Materials*, page 634.

*Tip: All seat upholstery except standard Cogent: Connect requires a sewn application. Specify with an **S** suffix.*

Tip: Always add suffixes in alphabetical order when specifying options to cobi seating.

Tip: Leather and vinyl upcharges are in addition to sewn upholstery upcharge.

► Detailed dimensions,
page 278



For Canadian Pricing
Multiply U.S. Price by the
Canadian price factor.
► See page 1 for details.

	Options	U.S. Price	Required to Specify
Surface Materials	Upholstery		
	• Fabric price group 1	No cost	Add suffix S to the style number and specify fabric color number.
	• Fabric price group 2	No cost	Add suffix S to the style number and specify fabric color number.
	• Fabric price group 3	+\$ 37	Add suffix S to the style number and specify fabric color number.
	• Fabric price group 4	+\$ 51	Add suffix S to the style number and specify fabric color number.
	• Fabric price group 5	+\$ 61	Add suffix S to the style number and specify fabric color number.
	• Fabric price group 6	+\$ 76	Add suffix S to the style number and specify fabric color number.
	• Fabric price group 7	+\$ 92	Add suffix S to the style number and specify fabric color number.
	• Fabric price group 8	+\$112	Add suffix S to the style number and specify fabric color number.
	• Fabric price group 9	+\$137	Add suffix S to the style number and specify fabric color number.
	• Fabric price group 10	+\$159	Add suffix S to the style number and specify fabric color number.
	• Steelcase leather upholstery	+\$258	Add suffix S to the style number and specify leather color number.
	• Select Surfaces leather price group 1	+\$258	Add suffix S to the style number and specify Select Surfaces leather price group 1.
	• Elmosoft leather upholstery	+\$301	► See <i>Surface Materials Reference Manual</i> . Add suffix S to the style number and specify Elmosoft leather color number.
• Select Surfaces leather price group 2	+\$301	Add suffix S to the style number and specify Select Surfaces leather price group 2.	
• Sewn Upholstery	+\$ 58	► See <i>Surface Materials Reference Manual</i> . Add suffix S to the style number and specify fabric color number.	
• Steelcase vinyl	No cost	Add suffix S to the style number and specify vinyl color number.	
• Customer's Own Material/Vinyl (COM)	No cost	Add suffix S to the style number and specify fabric color number.	
• Customer's Own Leather (COL)	No cost	Add suffix S to the style number and specify leather color number.	
	Soil-retardant treatment	+\$ 36	Specify <i>with soil-retardant treatment</i> .
	Outer back		
	• Arctic white	+\$196	Specify <i>with 6009 Arctic White</i> .
	• Platinum	+\$196	Specify <i>with 6249 Platinum</i> .
	• Near black	+\$196	Specify <i>with 6295 Near Black</i> .
Casters	• Soft, dark grey treaded, dual-wheel roll-control casters for use on hard floors	+\$ 36	Specify <i>with soft roll-control casters</i> .
Glides	• Glides: black plastic	+\$ 36	Specify <i>with glides</i> .

Specification Information

**Arms with
Soft Arm Caps**



• Style
• Number

434711

• U.S.
• Base
• Price

\$1541

Without Arms

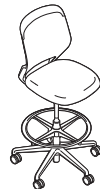

• Style
• Number

434710

• U.S.
• Base
• Price

\$1455



For Canadian Pricing

Multiply U.S. Price by the
Canadian price factor.

▶ See page 1 for details.



Understanding and Specifying Node 480 Series Collaborative Chairs

Product Details

Node 480 Series	286
Planning with Node	290
Dimensions	294

Specifying

Collaborative Chairs	298
Mid-Back Collaborative Chairs	302
Collaborative Stool	306
Mid-Back Collaborative Stool	307
X Base Collaborative Chairs	308
X Base Collaborative Stools	309
Wood Base Collaborative Chairs	310

Collaborative Chairs

Collaborative seating promotes comfort for long periods of time and promotes movement, offers automatic and intuitive adjustments, and supports multiple postures.

- QiVi 428 Series
- cobī 434 Series
- Node 480 Series

Adjustability Features

▶ See page 26 for a comparison to other chairs

Node 480 Series

Mechanisms

360°-swivel



Node 480 Series

Node is a collaborative seating line that accommodates multiple environments including classrooms, clinical settings, and other learning environments. Node supports multiple teaching and learning modes, freedom to change postures, and optional storage.

One piece polypropylene contoured shell is designed for easy maintenance and cleaning.

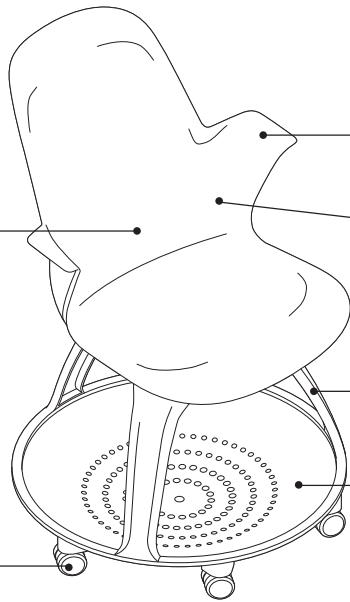

Arms are designed to support arms, side-sitting postures, and serve as a backpack hook.

Flexible and contoured seat shell supports comfort by allowing many postures.

360°-swivel mechanism is standard.

Backpack storage area is standard.

Casters have hard, dual wheels that roll smoothly on carpets. Soft dual-wheel casters are available for use on hard floors.

Tip: Do not roll the chair across asphalt during installation as this may damage the casters.

Personal worksurface moves independently of seat shell and base.

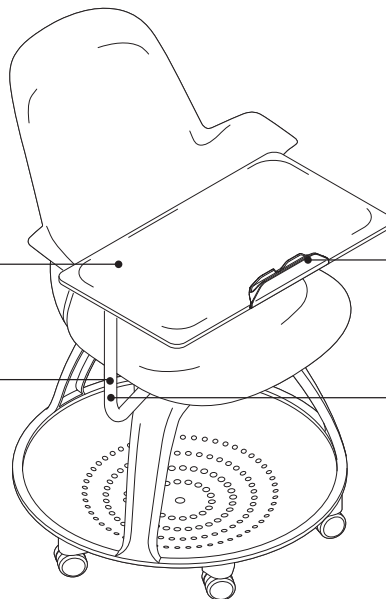

Tablet stand is available on all personal worksurfaces and supports tablets and smart phones.

Personal worksurface is depth adjustable for large and small users and allows for ingress/egress.

Personal worksurface is mounted on the right but appropriate for both right- and left-hand users.

Seat height adjusts with a 5 1/4" range with a pneumatic adjustment mechanisms on five-star base chairs. Chairs with a personal worksurface or Share-Surface adjusts with a 4" range. Stools have a 8 1/2" range. A 7 1/2" range is available as an option.

Five-star base is standard.

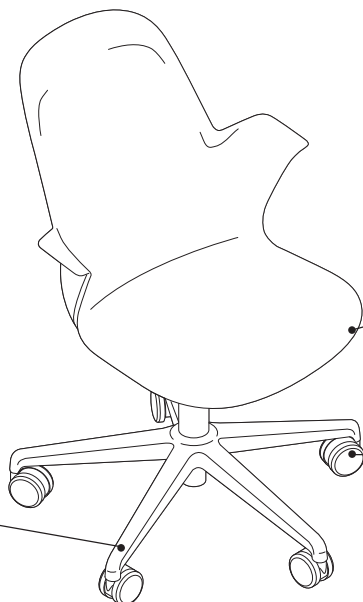

Hard, dual wheel casters are standard for use on carpets. Soft, dark grey treaded, dual-wheel roll-control casters are available for use on hard floors or mats.

Contoured and flexible seat shell supports comfort by allowing many postures.

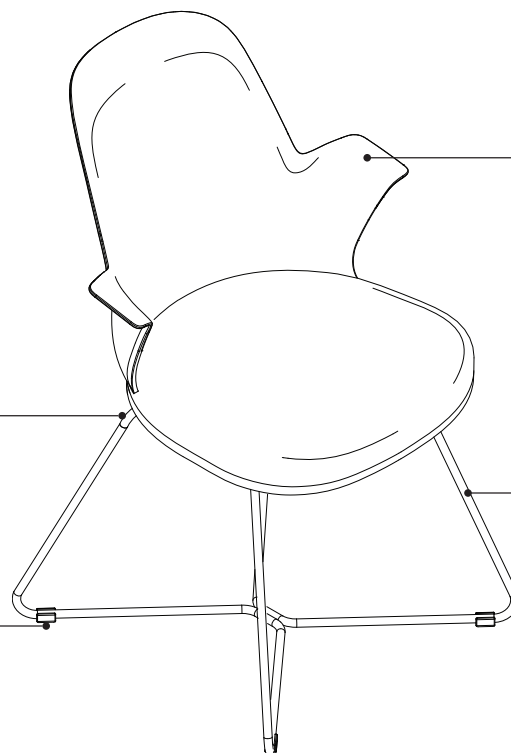

The arms are designed to support arms, side-sitting postures, and serve as a backpack hook.

The seat bracket can be customized with accent paint or PerfectMatch paint.

Durable, steel wire frame is lightweight.

Hard glides are standard. Soft, felt glides are available as an option.

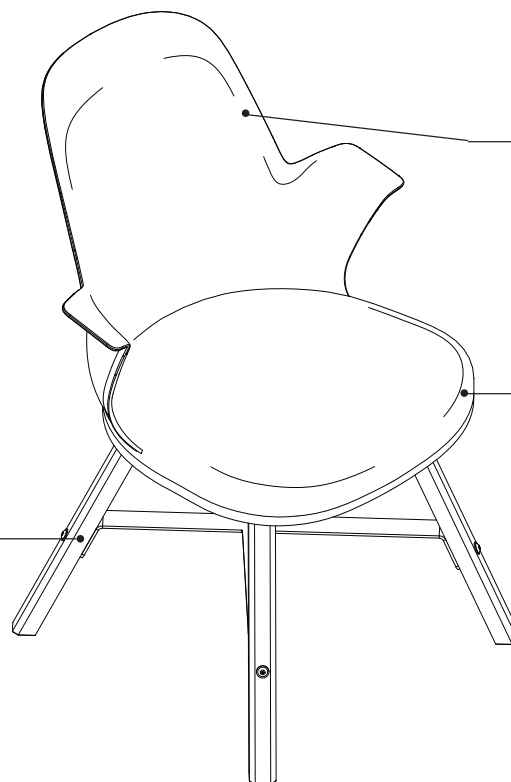

One piece polypropylene contoured shell is designed for easy maintenance and cleaning.

Optional seat cushion is available for extended comfort.

Node wood legs are solid maple wood with a polyethylene glide.

Node 480 Series, continued

Product Details

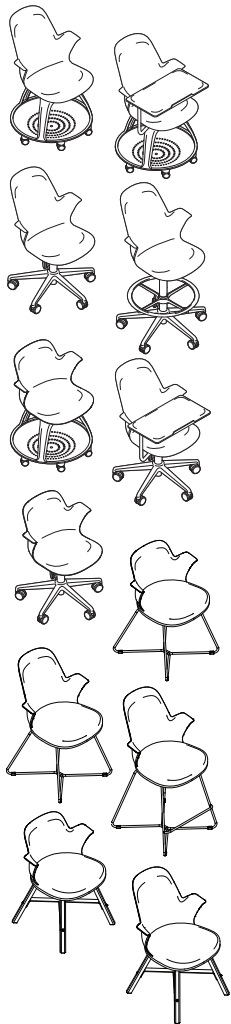

Chairs and stools are available with high-back and mid-back shells. Chairs are available with a tripod base, tripod base with personal workspace, five-star base with pneumatic adjustment, and five-star base with pneumatic adjustment with personal workspace. X base is available in chair and stool height. Wood base is available in chair height only.

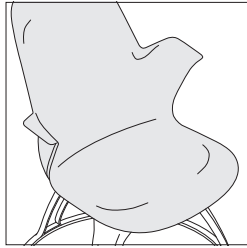

Flexing seat shell and arms promotes movement and supports multiple postures. Integrated arms support user's arms, side posture, and act as a backpack hook.

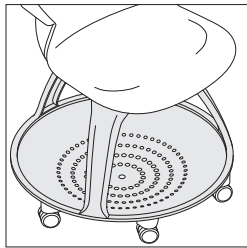

Tripod base reclaims the space under the seat. The space is 1.7 cu/ft. and allows for backpacks or personal belongings to be stored, and serves as a footrest.

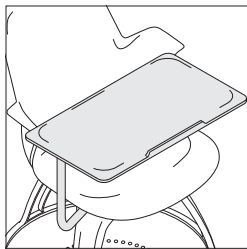

Personal workspace is mounted on user's right, and designed to accommodate left- and right-handed users. It is 12"D x 22 1/4"W and features a safety stop to help prevent belongings and laptops from easily sliding off back edge. It is designed to be level when in use and may appear to have a slight upward angle when not in use.

Node tripod, with or without workspace, and Node five-star base chairs with workspace ships standard unassembled and cartoned with the seat shell separated from the base. This allows for shipment in a smaller carton. Five-star base chairs without workspace and stools ship two to a carton. Assembly by a qualified Steelcase dealer installer is required. Node X base and wood base ship fully assembled. Assembly instructions are available at www.steelcase.com. No tools required for assembly.

Adjustment Features

360° fixed height swivel mechanism on tripod base models allows students to remain oriented to instructor, presentation materials, and other students.

360° adjustable height swivel mechanism is standard on five-star base models.

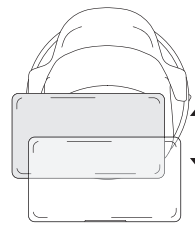

Personal workspace depth adjustment range is 7 1/4" to 15".

Measurement is from lumbar to workspace.

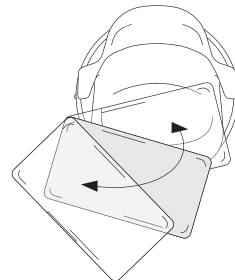

Personal workspace pivot range is 48°.

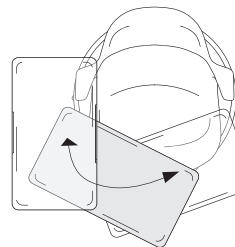

Personal workspace center pivot is 100°. The center pivot range is measured from the closest position to the furthest position from the user.

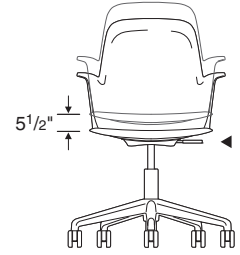

Seat height adjusts pneumatically. To lower, pull lever up while seated. To raise, pull lever up and keep your weight off the chair. Range of adjustability is 5 1/4" from 16"H to 21 3/16"H, a 3 3/4" range (17 1/8"H to 20 3/4"H) is available on chairs with a workspace. Stools are standard with an 8 1/2" range of adjustability (23 1/16"H to 31 3/8"H). A 7 1/2" range of adjustability (18 1/2"H to 26 7/16"H) is available as an option.

Glides are available as an option. Glides ship assembled on the chair and maintain same height as casters. Glides are not available on stools.

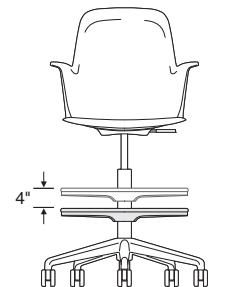

Foot ring height on stools adjusts by first lifting ring and rotating it counterclockwise to unlock. Then raise or lower ring up to 4" to desired position before rotating it clockwise to lock. The foot ring has a diameter of 20".

Soft, dual-wheel roll-control casters for hard floors are available on five-star base chairs and stools only.

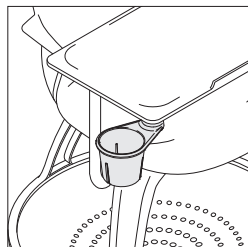

Cup holder is available as an option on Node chairs with personal worksurfaces. It is retractable under the worksurface when not in use.

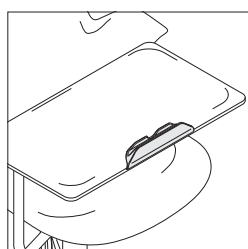

Tablet stand is available on Node chairs with personal worksurfaces. The stand supports tablets and smart phones in both portrait and landscape positions, making content easy to view and freeing up space on the worksurface for other materials. It can be field or factory installed.

Tip: Devices are not secure in tablet stand when Node is moved.

Surface Materials

► See surface materials on page 634 for specific availability or refer to the *Surface Materials Reference Manual* for further information.

Seat Shell

Price Group 1

Plastics

- 6009 Arctic White
- 6059 Sterling Dark Solid
- 6205 Black
- 6249 Platinum Solid
- 6259 Midnight
- 6332 Citron
- 6333 Picasso
- 6334 Flash
- 6335 Wasabi
- 6336 Jazz
- 6337 Element
- 6338 Chili Red
- 6527 Merle

Price Group 2

Signature Plastics

- 6BD1 Aubergine
- 6BD2 Peacock
- 6BD5 Honey
- 6BD6 Lagoon
- 6BD7 Saffron
- 6BE5 Olivine
- 6BE6 Sea Salt

Tripod Base

- 6249 Platinum Solid
- 6295 Near Black
- 6337 Element

Five-star Base

- 6205 Black
- 6249 Platinum Solid
- 6337 Element

X Base

- Paint
- Accent paint
- PerfectMatch paint
- Coatings
- Lux Coatings

Wood Base

Base

- V1AC Natural Cherry
- V1AM Clear Maple
- V1CC Medium Amber Cherry
- V1EW Dark Walnut

Bracket

- Paint
- Accent paint
- PerfectMatch paint

Personal Worksurface

- 6053 Seagull
- 6249 Platinum Solid
- 6295 Near Black
- 6337 Element

Paint for Metal

- 0835 Black
- 4750 Champagne Metallic
- 4799 Platinum Metallic

Casters

- Black

Glides

- Black plastic (five-star base)
- Sterling Dark Solid (tripod base)
- Hard, clear (X base)
- Polyethylene (wood base)

Cup Holder

- Sterling Dark Solid

Tablet Stand

- Sterling Dark Solid

Seat Cushion

- Upholstery
- Leather
- Elmosoft Leather
- Select Surface Leather
- COM (Customer's Own Material)
- COL (Customer's Own Leather)

Dimensions

► Page 294

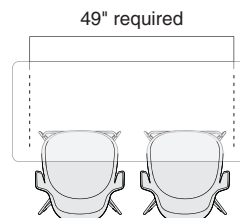

The backpack storage area and overall chair width require 23³/₄" of continuous floor space when used with tables. The minimum distance between table bases is 49" to allow two chairs to be pushed under the worksurface. This does not apply to five-star basemodels.

Planning with Node

For Classroom Environments

Pedagogy, technology and space, when carefully considered and intentionally designed, can establish new protocols for advanced learning solutions.

Planning Tips

- 1 Illustrate multiple modes for each drawing to:
 - a) ensure enough space is available for each reconfiguration
 - b) allow the user to understand what's possible
 - c) ensure that sight lines are maintained when the furniture is moved
 - d) confirm that jurisdictional codes are followed for each layout (eg: International Building Code, American Disability Act, etc.)
- 2 Give permission to act differently by including wall guard and enough space to move, supporting simultaneous multi-modal activities.
- 3 Provide both analogue and digital tools in the solution such as whiteboards, personal whiteboards, interactive whiteboards or media:scape.
- 4 Address the needs of classroom and personal storage for both students and teachers. Incorporate this information into each mode to ensure space is adequate.
- 5 Include zones for mentoring, assessment, and/or coaching for teacher-to-student and/or student-to-student interaction.
- 6 Annotate the drawings with design principles to confirm they are being addressed.

Lecture Mode

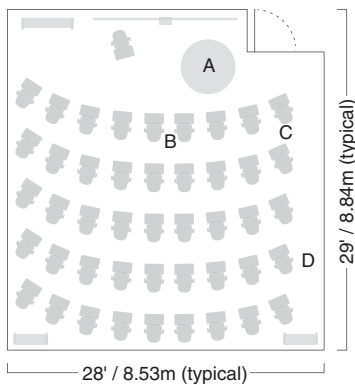

Group Mode

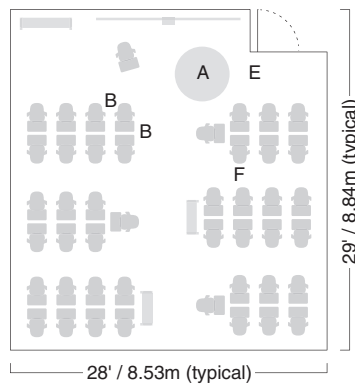

Discussion Mode

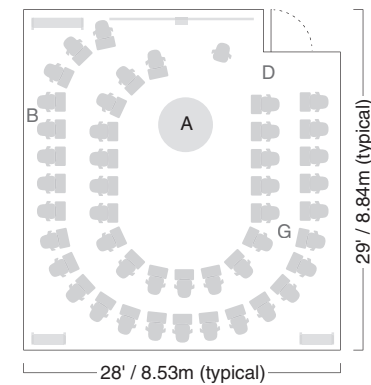

This example: 18* sq. ft. or 1.68 sq. meters per person. *For K-12 applications, See Table 1004.1.1 Maximum Floor Area Allowances per Occupant, 2009 International Building Code.

- A** — 60"/1.52m (ADA)
- B** — 12"/0.3m
- C** — 18"-24"/0.46-0.61m (aisle)
- D** — 36"/0.91m (egress)
- E** — 60"/1.52m (egress)
- F** — 38"/0.97m (aisle)
- G** — 18"-36"/0.46-0.91m (aisle)

Planning with Node

For Healthcare Environments

Clinicians, patients, family, technology, and space should be carefully considered and intentionally designed to create impactful and meaningful healthcare experiences.

Planning Tips

- 1 Demonstrate ability for a clinician to perform three key behaviors:
 - a) input information using a mobile device
 - b) share information with the patient and family member
 - c) connect with patient by moving surface aside for physical exam
- 2 Encourage customers to think differently about other objects within the exam space to encourage collaboration and mutual participation with all participants.
- 3 Provide both analogue and digital capabilities for teaching and learning with the clinician, patient, and family member.
- 4 Optimize real estate by considering a chair-based exam for many exam room applications.

Wellbeing Hub

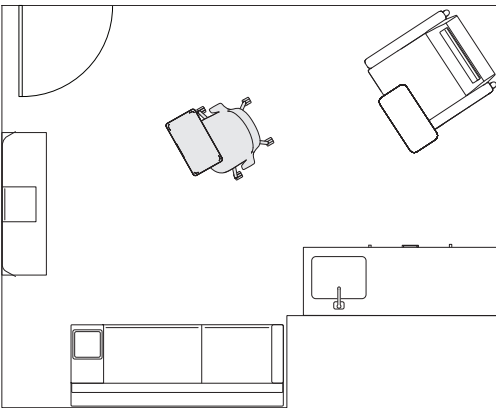

Room Dimensions: 13'11" x 11'3"

Wellbeing hubs offers a blended space to perform a physical exam and consultative experience.

Retail Exam Space

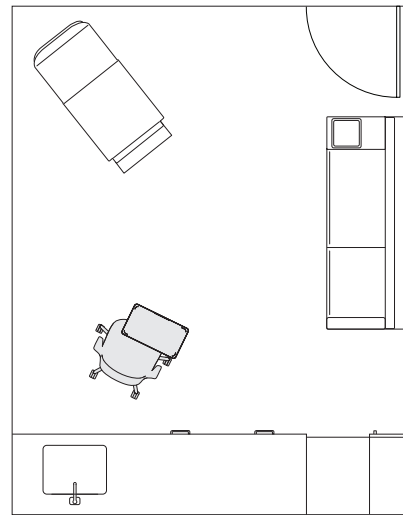

Room Dimensions: 9'6" x 12'

Retail exam spaces maximize real estate by accommodating the physical exam, consultative experience, and clinician work area.

► See *Table 1004.1.1 Maximum Floor Area Allowances per Occupant, 2009 International Building Code.*

Planning Tips, continued

Pediatric Exam Space

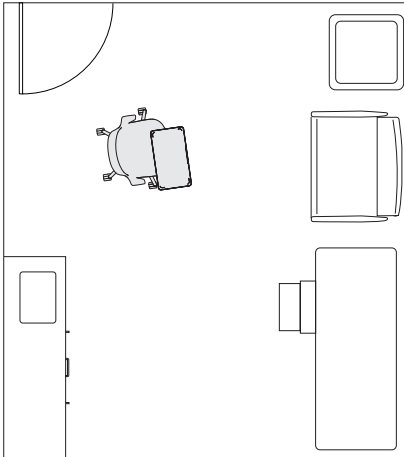

Room Dimensions: 11'6" x 10'

Pediatric exam spaces are about building trust and connection by accommodating clinicians, parents, and children with a more consultative experience.

▶ See *Table 1004.1.1 Maximum Floor Area Allowances per Occupant, 2009 International Building Code.*

Dimensions

Node 480 Series

Features	Overall Depth	Width	Height	Seat Depth	Seat Width	Seat Height from Floor	Ring Height from Floor	Width Between Arms
Node 480 Series								
Tripod Base Collaborative Chair								
	25"	23 ³ / ₄ "	35"	16 ¹ / ₂ "	19 ¹ / ₂ "	18 ¹ / ₄ "	N.A.	20 ¹ / ₈ "
Five-Star Base Collaborative Chair								
	24 ³ / ₄ "	25 ³ / ₄ "	32 ⁵ / ₈ " to 37 ³ / ₄ "	16 ¹ / ₂ "	19 ¹ / ₂ "	15 ⁵ / ₈ " to 20 ³ / ₄ "	N.A.	20 ¹ / ₈ "
Tripod Base Mid-Back Collaborative Chair								
	23 ³ / ₄ "	23 ³ / ₄ "	31 ¹ / ₄ "	15 ¹ / ₂ "	19 ¹ / ₄ "	18 ¹ / ₄ "	N.A.	20 ¹ / ₈ "
Five-Star Base Mid-Back Collaborative Chair								
	23 ¹ / ₂ "	25 ³ / ₄ "	28 ⁷ / ₈ " to 34"	15 ¹ / ₂ "	19 ¹ / ₄ "	15 ⁵ / ₈ " to 20 ³ / ₄ "	N.A.	20 ¹ / ₈ "
Five-Star Base Stool								
	24 ³ / ₄ "	25 ³ / ₄ "	40 ⁷ / ₈ " to 48 ¹ / ₄ "	16 ¹ / ₂ "	19 ¹ / ₂ "	23 ⁵ / ₈ " to 31 ³ / ₈ "	11 ¹ / ₂ " to 15 ¹ / ₂ "	20 ¹ / ₈ "
Five-Star Base Mid-Back Stool								
	23 ¹ / ₂ "	25 ³ / ₄ "	37 ¹ / ₈ " to 44 ¹ / ₂ "	15 ¹ / ₂ "	19 ¹ / ₄ "	23 ⁵ / ₈ " to 31 ³ / ₈ "	11 ¹ / ₂ " to 15 ¹ / ₂ "	20 ¹ / ₈ "

*Personal worksurface height from floor on tripod base chairs is 28¹/₂".

*Personal worksurface height from floor on five-star base chairs is 27³/₁₆" to 30¹³/₁₆".

*Personal worksurface measures 22¹/₂"W x 12"D and has a depth adjustment range of 7¹/₄" to 15".

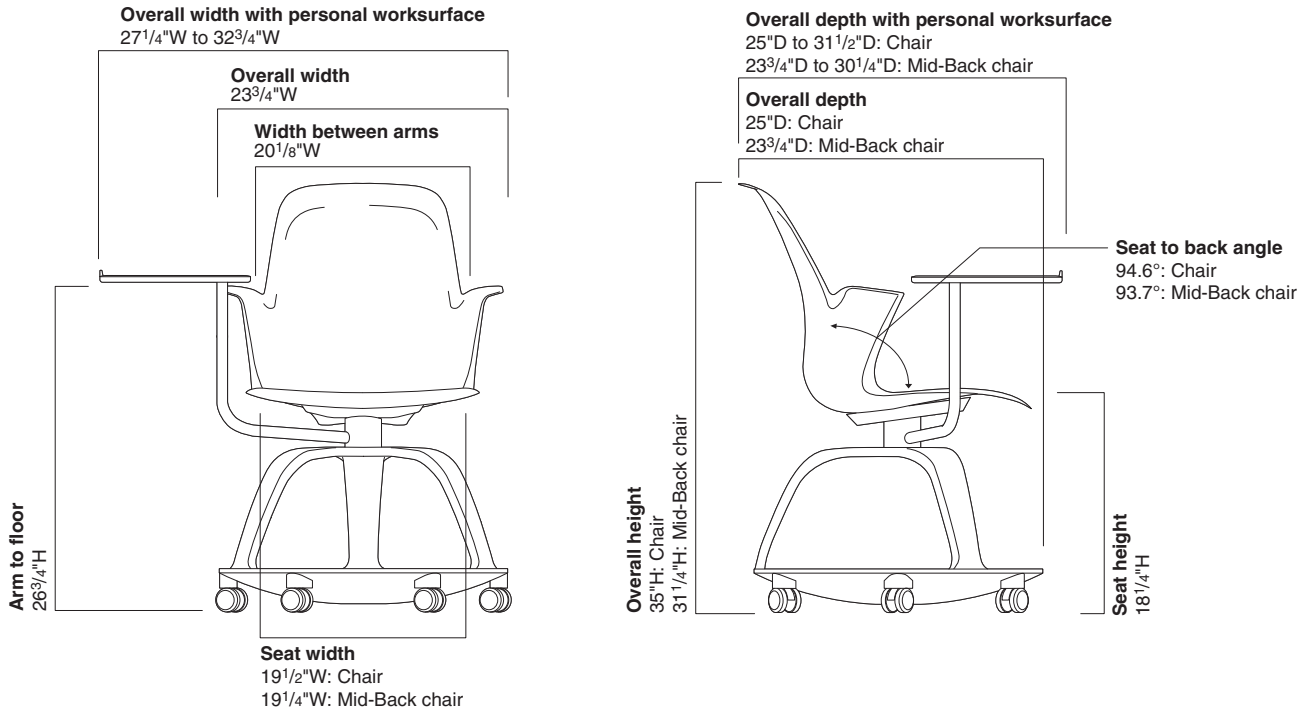

· Arm to Floor
· Angle Between Seat and Back

26 ³ / ₄ "	94.6°
24 ¹ / ₈ " to 29 ¹ / ₄ "	94.6°
26 ³ / ₄ "	93.7°
24 ¹ / ₈ " to 29 ¹ / ₄ "	93.7°
27" to 35"	94.6°
27" to 35"	93.7°

Node 480 Series

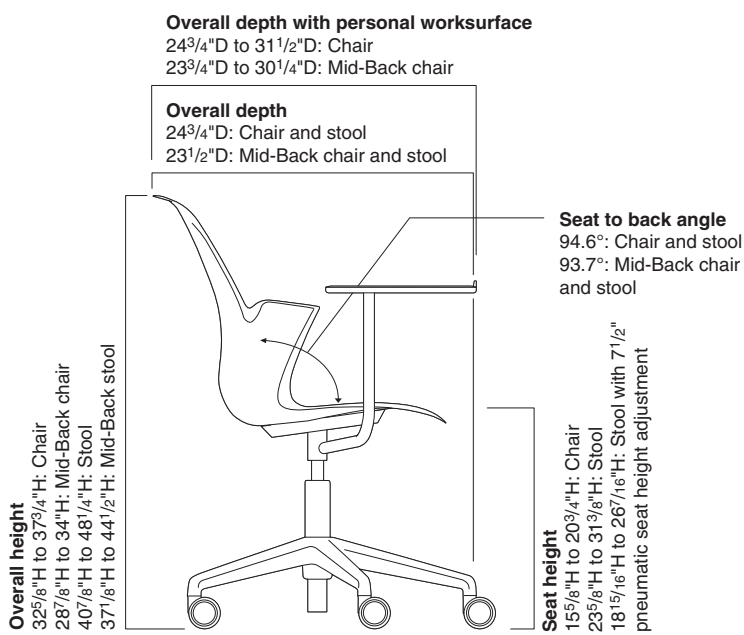
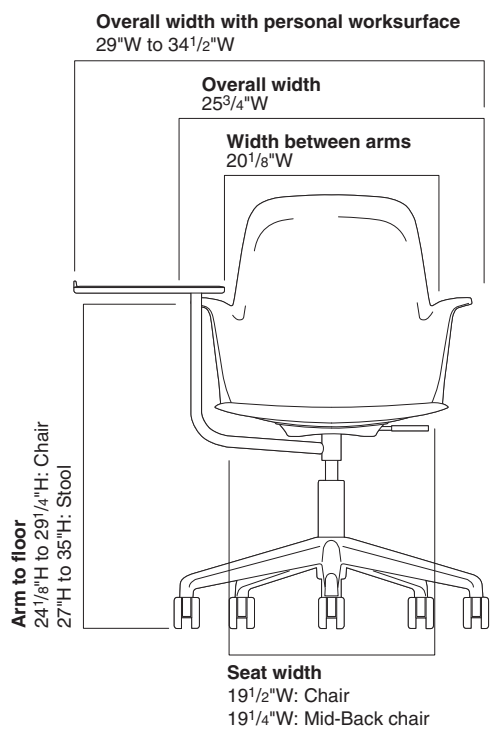

Steel Seating

Dimensions, Node 480 Series, continued

Features	Overall Depth	Width	Height	Seat Depth	Seat Width	Seat Height from Floor	Width Between Arms	Arm to Floor
Node 480 Series, continued								
Node X Base Chair								
	24 ³ / ₄ "	23 ³ / ₄ "	34 ³ / ₄ "	16 ¹ / ₂ "	19 ¹ / ₂ "	17 ¹³ / ₁₆ "	20 ¹ / ₈ "	26 ¹ / ₄ "
Node X Base Stool								
	24 ³ / ₄ "	23 ³ / ₄ "	45 ¹³ / ₁₆ "	16 ¹ / ₂ "	19 ¹ / ₄ "	28 ¹ / ₁₆ "	20 ¹ / ₈ "	37 ¹ / ₄ "
Node X Base Mid-Back								
	23 ¹ / ₂ "	23 ³ / ₄ "	30 ¹⁵ / ₁₆ "	15 ¹ / ₂ "	19 ¹ / ₄ "	17 ¹³ / ₁₆ "	20 ¹ / ₈ "	26 ¹ / ₄ "
Node X Base Mid-Back Stool								
	23 ¹ / ₂ "	23 ³ / ₄ "	41 ⁷ / ₈ "	15 ¹ / ₂ "	19 ¹ / ₄ "	28 ¹ / ₁₆ "	20 ¹ / ₈ "	37 ¹ / ₄ "
Node Wood Base Chair								
	24 ³ / ₄ "	23 ³ / ₄ "	34 ⁷ / ₈ "	16 ¹ / ₂ "	19 ¹ / ₂ "	18 ¹ / ₈ "	20 ¹ / ₈ "	26 ¹ / ₄ "
Node Wood Base Mid-Back								
	23 ¹ / ₂ "	23 ³ / ₄ "	31 ¹ / ₈ "	15 ¹ / ₂ "	19 ¹ / ₄ "	18 ¹ / ₈ "	20 ¹ / ₈ "	26 ¹ / ₄ "

*Personal worksurface height from floor on tripod base chairs is 28¹/₂".
 *Personal worksurface height from floor on five-star base chairs is 27³/₁₆" to 30¹³/₁₆".
 *Personal worksurface measures 22¹/₂"W x 12"D and has a depth adjustment range of 7¹/₄" to 15".

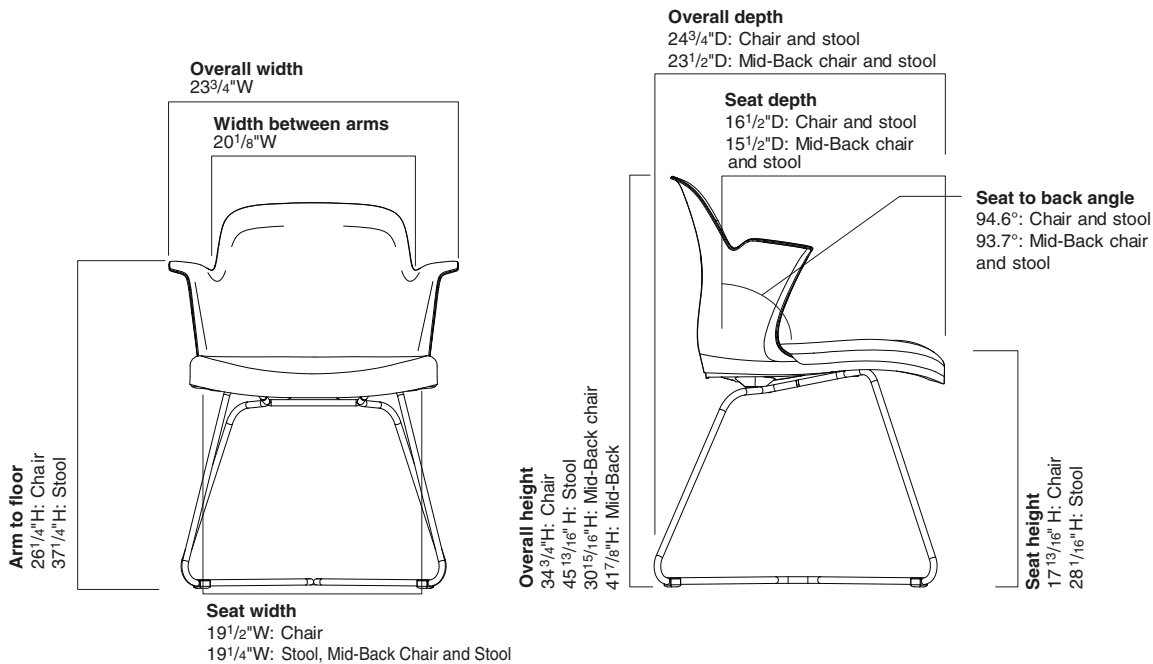

• Angle
Between
Seat and
Back

94.6°

94.6°

93.7°

93.7°

94.6°

93.7°

:

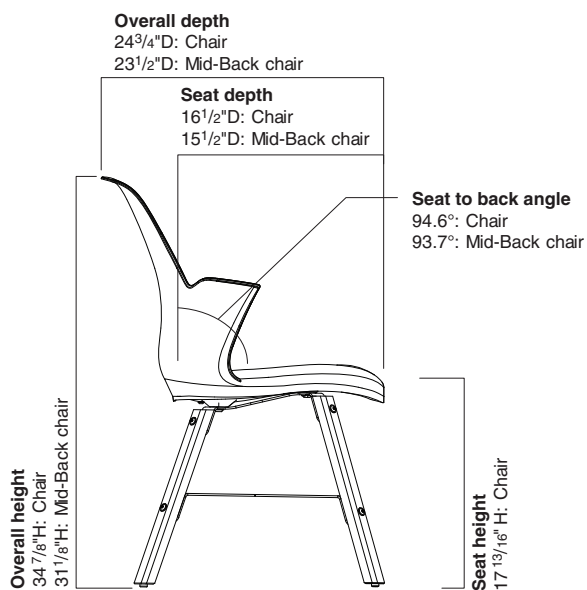
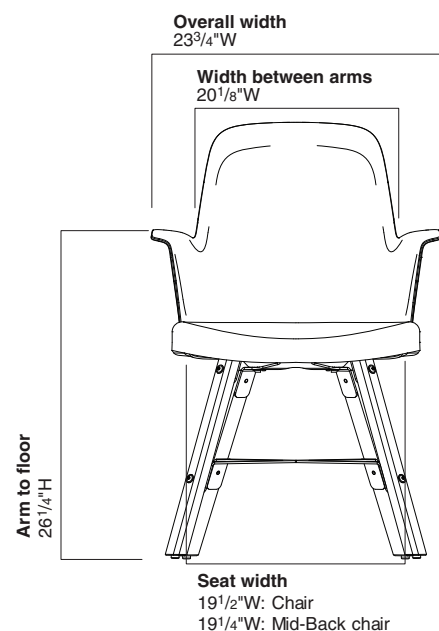

Node 480 Series Collaborative Chairs

With Tripod Base



	Standard Includes	Required to Specify
▶ Need help? Product details, page 286	<ul style="list-style-type: none"> • Seat shell: plastic • Tripod base: plastic • Storage tray: sterling dark solid • Metal components: 0835 Black paint • Swivel seat • Worksurface, if selected: plastic • Hard casters 	<ol style="list-style-type: none"> 1 Style number 2 Plastic color number for seat shell 3 Plastic color number for tripod base 4 Paint color number for metal components 5 Plastic color number for personal worksurface, if selected 6 Options, if selected (see below) <p>▶ See <i>Surface Materials</i>, page 634.</p>

	Options	U.S. Price	Required to Specify
Surface Materials	Platinum or Champagne Metallic metal components		
	<ul style="list-style-type: none"> • On 480110 • On 480120 	<ul style="list-style-type: none"> +\$ 12 +\$ 34 	<ul style="list-style-type: none"> Specify with 4799 Platinum or 4750 Champagne Metallic. Specify with 4799 Platinum or 4750 Champagne Metallic.
	Seat shell		
	<ul style="list-style-type: none"> • Plastic price group 1 • Plastic price group 2 	<ul style="list-style-type: none"> No cost +\$ 39 	<ul style="list-style-type: none"> Specify color number. ▶ See <i>Surface Materials</i>, page 634. Specify color number. ▶ See <i>Surface Materials</i>, page 634.
	Cushion		
	<ul style="list-style-type: none"> • Price group 1 • Price group 2 • Price group 3 • Price group 4 • Price group 5 • Price group 6 • Price group 7 • Price group 8 • Price group 9 • Price group 10 • Steelcase Leather • Select Surfaces leather price group 1 • Elmosoft Leather • Select Surfaces leather price group 2 • Customer's Own Material • Customer's Own Leather 	<ul style="list-style-type: none"> No cost +\$ 12 +\$ 36 +\$ 49 +\$ 60 +\$ 75 +\$ 88 +\$109 +\$135 +\$155 +\$132 +\$132 +\$153 +\$153 +\$ 53 +\$ 53 	<ul style="list-style-type: none"> Specify fabric color number. Specify fabric color number. Specify fabric color number. Specify fabric color number. Specify fabric color number. Specify fabric color number. Specify fabric color number. Specify fabric color number. Specify fabric color number. Specify fabric color number. Specify leather color number. ▶ See <i>Surface Materials Reference Manual</i>. Specify Elmosoft leather color number. ▶ See <i>Surface Materials Reference Manual</i>. ▶ See <i>Surface Materials Reference Manual</i>. ▶ See <i>Surface Materials Reference Manual</i>.
	Cushion	<ul style="list-style-type: none"> • Cushion 	<ul style="list-style-type: none"> +\$170 Specify with cushion top.
	Cup Holder	<ul style="list-style-type: none"> • On 480120 	<ul style="list-style-type: none"> +\$ 50 Specify with cup holder.
	Tablet Stand	<ul style="list-style-type: none"> • On 480120 	<ul style="list-style-type: none"> +\$ 50 Specify with tablet stand.
	Casters	<ul style="list-style-type: none"> • Soft casters 	<ul style="list-style-type: none"> +\$ 46 Specify with soft casters.
	Glides	<ul style="list-style-type: none"> • Glides: sterling dark solid 	<ul style="list-style-type: none"> +\$ 36 Specify with glides.

Tip: Cup holder is available on Node models with personal worksurface only.

▶ Detailed dimensions, page 294



For Canadian Pricing
 Multiply U.S. Price by the Canadian price factor.
 ▶ See page 1 for details.

Specification Information

Style Number	U.S. Base Price
--------------	-----------------

Without Personal Worksurface

480110	\$652
---------------	-------



With Personal Worksurface

480120	\$982
---------------	-------

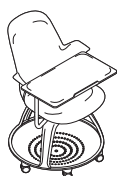

Node 480 Series

► Detailed dimensions, page 294

 **For Canadian Pricing**
Multiply U.S. Price by the Canadian price factor.
► See page 1 for details.

Node 480 Series Collaborative Chairs

With Five-Star Base



Standard Includes		Required to Specify
<ul style="list-style-type: none"> ▶ Need help? Product details, page 286 	<ul style="list-style-type: none"> • Seat shell: plastic • Five-star base: plastic • Metal components: 0835 Black paint • Swivel seat • 5¼" pneumatic seat-height adjustment • Hard casters 	<ol style="list-style-type: none"> 1 Style number 2 Plastic color number for seat shell 3 Plastic color number for five-star base 4 Options, if selected (see below) <ul style="list-style-type: none"> ▶ See <i>Surface Materials</i>, page 634.

Options	U.S. Price	Required to Specify
Surface Materials <ul style="list-style-type: none"> • Seat shell • Plastic price group 1 • Plastic price group 2 	<ul style="list-style-type: none"> No cost +\$ 39 	<ul style="list-style-type: none"> Specify plastic color number. ▶ See <i>Surface Materials</i>, page 634. Specify color number. ▶ See <i>Surface Materials</i>, page 634.
<ul style="list-style-type: none"> • Cushion • Price group 1 • Price group 2 • Price group 3 • Price group 4 • Price group 5 • Price group 6 • Price group 7 • Price group 8 • Price group 9 • Price group 10 • Steelcase Leather • Select Surfaces leather price group 1 • Elmosoft Leather • Select Surfaces leather price group 2 • Customer's Own Material • Customer's Own Leather 	<ul style="list-style-type: none"> No cost +\$ 12 +\$ 36 +\$ 49 +\$ 60 +\$ 75 +\$ 88 +\$109 +\$135 +\$155 +\$132 +\$132 +\$153 +\$153 +\$ 53 +\$ 53 	<ul style="list-style-type: none"> Specify fabric color number. Specify fabric color number. Specify fabric color number. Specify fabric color number. Specify fabric color number. Specify fabric color number. Specify fabric color number. Specify fabric color number. Specify fabric color number. Specify fabric color number. Specify fabric color number. Specify leather color number. ▶ See <i>Surface Materials Reference Manual</i>. Specify Elmosoft leather color number. ▶ See <i>Surface Materials Reference Manual</i>. ▶ See <i>Surface Materials Reference Manual</i>. ▶ See <i>Surface Materials Reference Manual</i>.
Base <ul style="list-style-type: none"> • Platinum on 480130 • Element on 480130 • Platinum on 480150 • Element on 480150 	<ul style="list-style-type: none"> +\$ 48 +\$ 48 +\$ 53 +\$ 53 	<ul style="list-style-type: none"> Specify with 6249 Platinum. Specify with 6337 Element. Specify with 6249 Platinum. Specify with 6337 Element.
Cushion <ul style="list-style-type: none"> • Cushion 	<ul style="list-style-type: none"> +\$170 	<ul style="list-style-type: none"> Specify with cushion top.
Cup Holder <ul style="list-style-type: none"> • On 480150 	<ul style="list-style-type: none"> +\$ 50 	<ul style="list-style-type: none"> Specify with cup holder.
Tablet Stand <ul style="list-style-type: none"> • On 480150 	<ul style="list-style-type: none"> +\$ 50 	<ul style="list-style-type: none"> Specify with tablet stand.
Casters <ul style="list-style-type: none"> • Soft, dark grey treaded, dual-wheel roll-control casters for use on hard floors 	<ul style="list-style-type: none"> +\$ 36 	<ul style="list-style-type: none"> Specify with soft roll-control casters.
Glides <ul style="list-style-type: none"> • Glides: black plastic 	<ul style="list-style-type: none"> +\$ 36 	<ul style="list-style-type: none"> Specify with glides.

Tip: Metal components will match plastic color for base.

Tip: Cup holder is available on Node models with personal worksurface only.

▶ Detailed dimensions, page 294



For Canadian Pricing

Multiply U.S. Price by the Canadian price factor.

▶ See page 1 for details.

Specification Information

Style Number	U.S. Base Price
--------------	-----------------

Without Personal Worksurface

480130	\$597
--------	-------

With Personal Worksurface

480150	\$982
--------	-------



Node 480 Series

► Detailed dimensions, page 294



For Canadian Pricing
Multiply U.S. Price by the Canadian price factor.
► See page 1 for details.

Node 480 Series Mid-Back Collaborative Chairs

With Tripod Base



	Standard Includes	Required to Specify
▶ Need help? Product details, page 286	<ul style="list-style-type: none"> • Seat shell: plastic • Tripod base: plastic • Storage tray: sterling dark solid • Metal components: 0835 Black paint • Swivel seat • Worksurface, if selected: plastic • Hard casters 	<ol style="list-style-type: none"> 1 Style number 2 Plastic color number for seat shell 3 Plastic color number for tripod base 4 Paint color number for metal components 5 Plastic color number for personal work-surface, if selected 6 Options, if selected (see below) <p>▶ See <i>Surface Materials</i>, page 634.</p>

	Options	U.S. Price	Required to Specify
Surface Materials	<p>Platinum or Champagne Metallic metal components</p> <ul style="list-style-type: none"> • On 480210 • On 480220 	<p>+\$ 12</p> <p>+ \$ 34</p>	<p>Specify with 4799 Platinum or 4750 Champagne Metallic.</p> <p>Specify with 4799 Platinum or 4750 Champagne Metallic.</p>
	<p>Seat shell</p> <ul style="list-style-type: none"> • Plastic price group 1 • Plastic price group 2 	<p>No cost</p> <p>+ \$ 39</p>	<p>Specify plastic color number.</p> <p>▶ See <i>Surface Materials</i>, page 634.</p> <p>Specify color number.</p> <p>▶ See <i>Surface Materials</i>, page 634.</p>
	<p>Cushion</p> <ul style="list-style-type: none"> • Price group 1 • Price group 2 • Price group 3 • Price group 4 • Price group 5 • Price group 6 • Price group 7 • Price group 8 • Price group 9 • Price group 10 • Steelcase Leather • Select Surfaces leather price group 1 • Elmosoft Leather • Select Surfaces leather price group 2 • Customer's Own Material • Customer's Own Leather 	<p>No cost</p> <p>+ \$ 12</p> <p>+ \$ 36</p> <p>+ \$ 49</p> <p>+ \$ 60</p> <p>+ \$ 75</p> <p>+ \$ 88</p> <p>+ \$109</p> <p>+ \$135</p> <p>+ \$155</p> <p>+ \$132</p> <p>+ \$132</p> <p>+ \$153</p> <p>+ \$153</p> <p>+ \$ 53</p> <p>+ \$ 53</p>	<p>Specify fabric color number.</p> <p>Specify fabric color number.</p> <p>Specify fabric color number.</p> <p>Specify fabric color number.</p> <p>Specify fabric color number.</p> <p>Specify fabric color number.</p> <p>Specify fabric color number.</p> <p>Specify fabric color number.</p> <p>Specify fabric color number.</p> <p>Specify fabric color number.</p> <p>Specify fabric color number.</p> <p>Specify leather color number.</p> <p>▶ See <i>Surface Materials Reference Manual</i>.</p> <p>Specify Elmosoft leather color number.</p> <p>▶ See <i>Surface Materials Reference Manual</i>.</p> <p>▶ See <i>Surface Materials Reference Manual</i>.</p> <p>▶ See <i>Surface Materials Reference Manual</i>.</p>
Cushion	<ul style="list-style-type: none"> • Cushion 	<p>+ \$170</p>	<p>Specify with cushion top.</p>
Cup Holder	<ul style="list-style-type: none"> • On 480220 	<p>+ \$ 50</p>	<p>Specify with cup holder.</p>
Tablet Stand	<ul style="list-style-type: none"> • On 480220 	<p>+ \$ 50</p>	<p>Specify with tablet stand.</p>
Casters	<ul style="list-style-type: none"> • Soft, dark grey treaded, dual-wheel roll-control casters for use on hard floors 	<p>+ \$ 46</p>	<p>Specify with soft roll-control casters.</p>
Glides	<ul style="list-style-type: none"> • Glides: sterling dark solid 	<p>+ \$ 36</p>	<p>Specify with glides.</p>

Tip: Cup holder is available on Node models with personal worksurface only.

▶ Detailed dimensions, page 294



For Canadian Pricing

Multiply U.S. Price by the Canadian price factor.

▶ See page 1 for details.

Specification Information

Style Number	U.S. Base Price
--------------	-----------------

Without Personal Worksurface

480210	\$665
---------------	-------

With Personal Worksurface

480220	\$995
---------------	-------



► Detailed dimensions, page 294

 **For Canadian Pricing**
 Multiply U.S. Price by the Canadian price factor.
 ► See page 1 for details.

Node 480 Series Mid-Back Collaborative Chairs

With Five-Star Base



Standard Includes		Required to Specify
<ul style="list-style-type: none"> ▶ Need help? Product details, page 286 	<ul style="list-style-type: none"> • Seat shell: plastic • Five-star base: plastic • Metal components: 0835 Black paint • Swivel seat • 5¼" pneumatic seat-height adjustment • Hard casters 	<ol style="list-style-type: none"> 1 Style number 2 Plastic color number for seat shell 3 Plastic color number for five-star base 4 Options, if selected (see below) <ul style="list-style-type: none"> ▶ See <i>Surface Materials</i>, page 634.

Options	U.S. Price	Required to Specify	
Surface Materials			
Seat shell			
• Plastic price group 1	No cost	Specify plastic color number. ▶ See <i>Surface Materials</i> , page 634.	
• Plastic price group 2	+\$ 39	Specify color number. ▶ See <i>Surface Materials</i> , page 634.	
Cushion			
• Price group 1	No cost	Specify fabric color number.	
• Price group 2	+\$ 12	Specify fabric color number.	
• Price group 3	+\$ 36	Specify fabric color number.	
• Price group 4	+\$ 49	Specify fabric color number.	
• Price group 5	+\$ 60	Specify fabric color number.	
• Price group 6	+\$ 75	Specify fabric color number.	
• Price group 7	+\$ 88	Specify fabric color number.	
• Price group 8	+\$109	Specify fabric color number.	
• Price group 9	+\$135	Specify fabric color number.	
• Price group 10	+\$155	Specify fabric color number.	
• Steelcase Leather	+\$132	Specify leather color number.	
• Select Surfaces leather price group 1	+\$132	▶ See <i>Surface Materials Reference Manual</i> .	
• Elmosoft Leather	+\$153	Specify Elmosoft leather color number.	
• Select Surfaces leather price group 2	+\$153	▶ See <i>Surface Materials Reference Manual</i> .	
• Customer's Own Material	+\$ 53	▶ See <i>Surface Materials Reference Manual</i> .	
• Customer's Own Leather	+\$ 53	▶ See <i>Surface Materials Reference Manual</i> .	
Base			
• Platinum on 480230	+\$ 48	Specify with 6249 Platinum.	
• Element on 480230	+\$ 48	Specify with 6337 Element.	
• Platinum on 480250	+\$ 53	Specify with 6249 Platinum.	
• Element on 480250	+\$ 53	Specify with 6337 Element.	
Cushion	• Cushion	+\$170	Specify with cushion top.
Cup Holder	• On 480250	+\$ 50	Specify with cup holder.
Tablet Stand	• On 480250	+\$ 50	Specify with tablet stand.
Casters	• Soft, dark grey treaded, dual-wheel roll-control casters for use on hard floors	+\$ 36	Specify with soft roll-control casters.
Glides	• Glides: black plastic	+\$ 36	Specify with glides.

Tip: Metal components will match plastic color for base.

Tip: Cup holder is available on Node models with personal worksurface only.

▶ Detailed dimensions, page 294



For Canadian Pricing

Multiply U.S. Price by the Canadian price factor.

▶ See page 1 for details.

Specification Information

Style Number	U.S. Base Price
--------------	-----------------

Without Personal Worksurface

480230	\$597
---------------	-------

With Personal Worksurface

480250	\$995
---------------	-------



Node 480 Series

► Detailed dimensions, page 294



For Canadian Pricing
 Multiply U.S. Price by the Canadian price factor.
 ► See page 1 for details.

Node 480 Series Collaborative Stool

With Five-Star Base

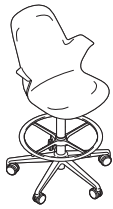

Tip: Metal components will match plastic color for base.

Tip: Metal components will match plastic color for base.

Standard Includes		Required to Specify
<ul style="list-style-type: none"> ▶ Need help? Product details, page 286 	<ul style="list-style-type: none"> • Seat shell: plastic • Five-star base: plastic • Metal components: 0835 Black paint • Swivel seat • 8½" pneumatic seat-height adjustment • Hard casters 	<ol style="list-style-type: none"> 1 Style number 2 Plastic color number for seat shell 3 Plastic color number for five-star base 4 Options, if selected (see below) <ul style="list-style-type: none"> ▶ See <i>Surface Materials</i>, page 634.

Options	U.S. Price	Required to Specify
Surface Materials <ul style="list-style-type: none"> • Seat shell • Plastic price group 1 • Plastic price group 2 	<ul style="list-style-type: none"> No cost +\$ 39 	<ul style="list-style-type: none"> Specify plastic color number. ▶ See <i>Surface Materials</i>, page 634. Specify color number. ▶ See <i>Surface Materials</i>, page 634.
Cushion <ul style="list-style-type: none"> • Price group 1 • Price group 2 • Price group 3 • Price group 4 • Price group 5 • Price group 6 • Price group 7 • Price group 8 • Price group 9 • Price group 10 • Steelcase Leather • Select Surfaces leather price group 1 • Elmosoft Leather • Select Surfaces leather price group 2 • Customer's Own Material • Customer's Own Leather 	<ul style="list-style-type: none"> No cost +\$ 12 +\$ 36 +\$ 49 +\$ 60 +\$ 75 +\$ 88 +\$109 +\$135 +\$155 +\$132 +\$132 +\$153 +\$153 +\$ 53 +\$ 53 	<ul style="list-style-type: none"> Specify fabric color number. Specify fabric color number. Specify fabric color number. Specify fabric color number. Specify fabric color number. Specify fabric color number. Specify fabric color number. Specify fabric color number. Specify fabric color number. Specify fabric color number. Specify leather color number. ▶ See <i>Surface Materials Reference Manual</i>. Specify Elmosoft leather color number. ▶ See <i>Surface Materials Reference Manual</i>. ▶ See <i>Surface Materials Reference Manual</i>. ▶ See <i>Surface Materials Reference Manual</i>.
Seat-Height <ul style="list-style-type: none"> • 7½" pneumatic seat-height adjustment 	<ul style="list-style-type: none"> No cost 	<ul style="list-style-type: none"> Specify with 7" pneumatic seat-height adjustment.
Base <ul style="list-style-type: none"> • Platinum • Element 	<ul style="list-style-type: none"> +\$140 +\$140 	<ul style="list-style-type: none"> Specify with 6249 Platinum. Specify with 6337 Element.
Cushion <ul style="list-style-type: none"> • Cushion 	<ul style="list-style-type: none"> +\$170 	<ul style="list-style-type: none"> Specify with cushion top.
Casters <ul style="list-style-type: none"> • Soft, dark grey treaded, dual-wheel roll-control casters for use on hard floors 	<ul style="list-style-type: none"> +\$ 36 	<ul style="list-style-type: none"> Specify with soft roll-control casters.

Specification Information	
Style Number	U.S. Base Price
480140	\$883

▶ Detailed dimensions, page 294



For Canadian Pricing

Multiply U.S. Price by the Canadian price factor.

▶ See page 1 for details.

Node 480 Series Mid-Back Collaborative Stool

With Five-Star Base

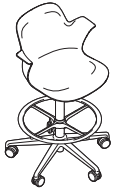

Tip: Metal components will match plastic color for base.

Standard Includes		Required to Specify
▶ Need help? Product details, page 286	<ul style="list-style-type: none"> • Seat shell: plastic • Five-star base: plastic • Metal components: 0835 Black paint • Swivel seat • 8½" pneumatic seat-height adjustment • Hard casters 	<ol style="list-style-type: none"> 1 Style number 2 Plastic color number for seat shell 3 Plastic color number for five-star base 4 Options, if selected (see below) <p>▶ See <i>Surface Materials</i>, page 634.</p>

Options	U.S. Price	Required to Specify
Surface Materials		
Seat shell		
• Plastic price group 1	No cost	Specify plastic color number. ▶ See <i>Surface Materials</i> , page 634.
• Plastic price group 2	+\$ 39	Specify color number. ▶ See <i>Surface Materials</i> , page 634.
Cushion		
• Price group 1	No cost	Specify fabric color number.
• Price group 2	+\$ 12	Specify fabric color number.
• Price group 3	+\$ 36	Specify fabric color number.
• Price group 4	+\$ 49	Specify fabric color number.
• Price group 5	+\$ 60	Specify fabric color number.
• Price group 6	+\$ 75	Specify fabric color number.
• Price group 7	+\$ 88	Specify fabric color number.
• Price group 8	+\$109	Specify fabric color number.
• Price group 9	+\$135	Specify fabric color number.
• Price group 10	+\$155	Specify fabric color number.
• Steelcase Leather	+\$132	Specify leather color number.
• Select Surfaces leather price group 1	+\$132	▶ See <i>Surface Materials Reference Manual</i> .
• Elmosoft Leather	+\$153	Specify Elmosoft leather color number.
• Select Surfaces leather price group 2	+\$153	▶ See <i>Surface Materials Reference Manual</i> .
• Customer's Own Material	+\$ 53	▶ See <i>Surface Materials Reference Manual</i> .
• Customer's Own Leather	+\$ 53	▶ See <i>Surface Materials Reference Manual</i> .
Seat-Height		
• 7½" pneumatic seat-height adjustment	No cost	Specify with 7" pneumatic seat-height adjustment.
Base		
• Platinum	+\$140	Specify with 6249 Platinum.
• Element	+\$140	Specify with 6337 Element.
Cushion		
• Cushion	+\$170	Specify with cushion top.
Casters		
• Soft, dark grey treaded, dual-wheel roll-control casters for use on hard floors	+\$ 36	Specify with soft roll-control casters.

Specification Information	
Style Number	U.S. Base Price
480240	\$883

▶ Detailed dimensions, page 294



For Canadian Pricing
Multiply U.S. Price by the Canadian price factor.
▶ See page 1 for details.

Node 480 Series X Base Collaborative Chairs

Standard Includes		Required to Specify
<ul style="list-style-type: none"> ▶ Need help? Product details, page 286 	<ul style="list-style-type: none"> • Seat shell: plastic • Steel wire frame base: paint price group 1 • Standard glides • Ships fully assembled • Meets Cal. 117 requirements 	<ol style="list-style-type: none"> 1 Style number 2 Paint color number for base 3 Plastic color number for shell 4 Options, if selected (see below) <ul style="list-style-type: none"> ▶ See <i>Surface Materials</i>, page 634.

Options	U.S. Price	Required to Specify	
Surface Materials			
Base			
• Paint price group 1	No cost	Specify paint color number.	
• Paint price group 2	+\$ 49	Specify paint color number.	
• Paint price group 3	+\$ 83	Specify paint color number.	
Shell			
• Plastic price group 1	No cost	Specify plastic color number.	
• Plastic price group 2	+\$ 39	Specify plastic color number.	
Cushion			
• Price group 1	No cost	Specify fabric color number.	
• Price group 2	+\$ 12	Specify fabric color number.	
• Price group 3	+\$ 36	Specify fabric color number.	
• Price group 4	+\$ 49	Specify fabric color number.	
• Price group 5	+\$ 60	Specify fabric color number.	
• Price group 6	+\$ 75	Specify fabric color number.	
• Price group 7	+\$ 88	Specify fabric color number.	
• Price group 8	+\$109	Specify fabric color number.	
• Price group 9	+\$135	Specify fabric color number.	
• Price group 10	+\$155	Specify fabric color number.	
• Steelcase Leather	+\$132	Specify leather color number.	
• Select Surfaces leather price group 1	+\$132	▶ See <i>Surface Materials Reference Manual</i> .	
• Elmosoft Leather	+\$153	Specify Elmosoft leather color number.	
• Select Surfaces leather price group 2	+\$153	▶ See <i>Surface Materials Reference Manual</i> .	
• Customer's Own Material	+\$ 53	▶ See <i>Surface Materials Reference Manual</i> .	
• Customer's Own Leather	+\$ 53	▶ See <i>Surface Materials Reference Manual</i> .	
Cushion	• Cushion	+\$170	Specify <i>with cushion top</i> .
Glides	• Soft, felt glides	No cost	Specify <i>with soft, felt glides</i> .

Specification Information

Style Number	U.S. Base Price
--------------	-----------------

X Base Chair

480310 \$570

.....

.....

.....

.....

.....

.....

.....

.....

.....

.....

.....

.....

.....

.....

.....

.....

.....

.....

.....

.....

.....

.....

.....

X Base Mid-Back Chair

480330 \$570

.....

.....

.....

.....

.....

.....

.....

.....

.....

.....

.....

.....

.....

.....

▶ Detailed dimensions, page 295



Node 480 Series X Base Collaborative Stools

Node 480 Series X Base Collaborative Stools

Standard Includes		Required to Specify
<ul style="list-style-type: none"> ▶ Need help? Product details, page 286 	<ul style="list-style-type: none"> • Seat shell: plastic • Steel wire frame base: paint price group 1 • Standard glides • Ships fully assembled • Meets Cal. 117 requirements 	<ol style="list-style-type: none"> 1 Style number 2 Paint color number for base 3 Plastic color number for shell 4 Options, if selected (see below) <ul style="list-style-type: none"> ▶ See <i>Surface Materials</i>, page 634.

Options	U.S. Price	Required to Specify	
Surface Materials			
Base			
• Paint price group 1	No cost	Specify paint color number.	
• Paint price group 2	+\$ 49	Specify paint color number.	
• Paint price group 3	+\$ 83	Specify paint color number.	
Shell			
• Plastic price group 1	No cost	Specify plastic color number.	
• Plastic price group 2	+\$ 39	Specify plastic color number.	
Cushion			
• Price group 1	No cost	Specify fabric color number.	
• Price group 2	+\$ 12	Specify fabric color number.	
• Price group 3	+\$ 36	Specify fabric color number.	
• Price group 4	+\$ 49	Specify fabric color number.	
• Price group 5	+\$ 60	Specify fabric color number.	
• Price group 6	+\$ 75	Specify fabric color number.	
• Price group 7	+\$ 88	Specify fabric color number.	
• Price group 8	+\$109	Specify fabric color number.	
• Price group 9	+\$135	Specify fabric color number.	
• Price group 10	+\$155	Specify fabric color number.	
• Steelcase Leather	+\$132	Specify leather color number.	
• Select Surfaces leather price group 1		▶ See <i>Surface Materials Reference Manual</i> .	
• Elmosoft Leather	+\$153	Specify Elmosoft leather color number.	
• Select Surfaces leather price group 2	+\$153	▶ See <i>Surface Materials Reference Manual</i> .	
• Customer's Own Material	+\$ 53	▶ See <i>Surface Materials Reference Manual</i> .	
• Customer's Own Leather	+\$ 53	▶ See <i>Surface Materials Reference Manual</i> .	
Cushion	• Cushion	+\$170	Specify <i>with cushion top</i> .
Glides	• Soft, felt glides	No cost	Specify <i>with soft, felt glides</i> .

Node 480 Series

▶ Detailed dimensions, page 295



Specification Information

Style Number	U.S. Base Price
--------------	-----------------

X Base Stool

480320 \$846

X Base Mid-Back Stool

480340 \$846

Node 480 Series Wood Base Collaborative Chairs

Standard Includes		Required to Specify
<ul style="list-style-type: none"> ▶ Need help? Product details, page 286 	<ul style="list-style-type: none"> • Seat shell: plastic • Solid maple legs: wood stain • Steel brackets: paint group 1 • Standard glides • Ships fully assembled • Meets Cal. 117 requirements 	<ol style="list-style-type: none"> 1 Style number 2 Plastic color number for shell 3 Wood stain color number for legs: <ul style="list-style-type: none"> V1AC Natural Cherry V1AM Clear Maple V1CC Medium Amber Cherry V1EW Dark Walnut 4 Paint color number for brackets 5 Options, if selected (see below) <p>▶ See <i>Surface Materials</i>, page 634.</p>

Options	U.S. Price	Required to Specify
Surface Materials Shell <ul style="list-style-type: none"> • Plastic price group 1 • Plastic price group 2 	No cost +\$ 39	Specify plastic color number. Specify plastic color number.
Brackets <ul style="list-style-type: none"> • Paint price group 1 • Paint price group 2 • Paint price group 3 	No cost +\$ 53 +\$ 83	Specify paint color number. Specify paint color number. Specify paint color number.
Cushion <ul style="list-style-type: none"> • Price group 1 • Price group 2 • Price group 3 • Price group 4 • Price group 5 • Price group 6 • Price group 7 • Price group 8 • Price group 9 • Price group 10 • Steelcase Leather • Select Surfaces leather price group 1 • Elmosoft Leather • Select Surfaces leather price group 2 • Customer's Own Material • Customer's Own Leather 	No cost +\$ 12 +\$ 36 +\$ 49 +\$ 60 +\$ 75 +\$ 88 +\$109 +\$135 +\$155 +\$132 +\$132 +\$153 +\$153 +\$ 53 +\$ 53	Specify fabric color number. Specify fabric color number. Specify fabric color number. Specify fabric color number. Specify fabric color number. Specify fabric color number. Specify fabric color number. Specify fabric color number. Specify fabric color number. Specify fabric color number. Specify fabric color number. Specify leather color number. ▶ See <i>Surface Materials Reference Manual</i> . Specify Elmosoft leather color number. ▶ See <i>Surface Materials Reference Manual</i> . ▶ See <i>Surface Materials Reference Manual</i> . ▶ See <i>Surface Materials Reference Manual</i> .
Cushion <ul style="list-style-type: none"> • Cushion 	+\$170	Specify <i>with cushion top</i> .

▶ Detailed dimensions, page 295



Specification Information	
• Style Number	• U.S. Base Price
.....

Wood Base Chair

480410 \$1223

Wood Base Mid-Back Chair

480420 \$1223

Understanding and Specifying Flex Perch Stool

Collaborative Chairs

Product Details

Flex Perch Stool	312
Thought Starters	314
Dimensions	318

Specifying

Collaborative Chairs	321
----------------------	-----

Flex Perch Stool

Flex Perch is a short-term seating solution that nests for easy use and storage in your agile team spaces. Its beautiful design, flexibility, and light weight make it the perfect perching option for stand-ups, team huddles, and working sessions. Pair Flex Perch with your current Flex Collection applications for a seamless integration.

Frame and seat are one molded piece, available in five colors.

Seat is designed with a 7.2° angle, ideal for perching.

Plastic frame is a 4-leg base made with ChemCycled Nylon and available in five colors.

Plastic glides are suitable for hard floors or carpet.

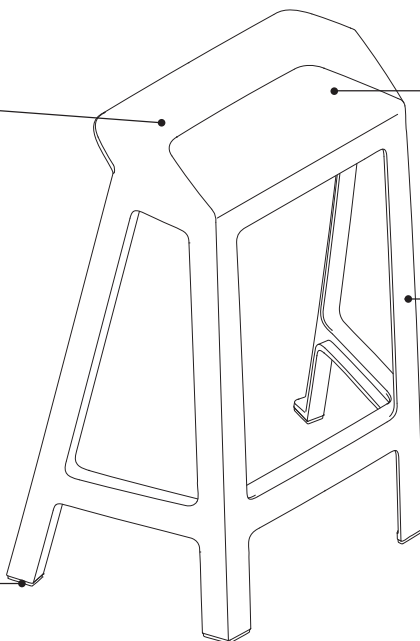

Product Details

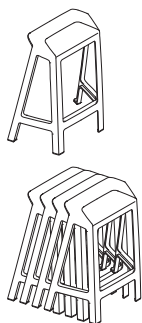

Flex Perch are available in one height option, have a 4-leg base, and come standard with glides. Choose from single or 4-pack.

Seat and frame are molded out of ChemCycled nylon and are 100% recyclable.

One-piece molded design makes it easy for Flex Perch to be cleaned and sanitized. See *Surface Materials Reference Guide* for detailed cleaning instructions.

Continuing to design with sustainability and increasing product recyclability as core principles, color variation such as swirls, lines, and halos may be visible.

Glides are available in one type suitable for both hard floors and carpet. Glides are designed with texture to keep Flex Perch in place during use.

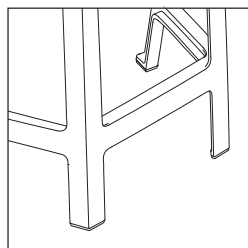

Flex Perch stool can support up to 300 pounds, despite its lightweight of only 8.7 pounds.

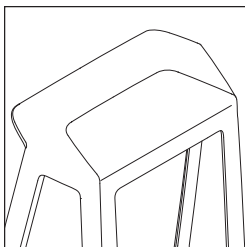

Textured seat provides adequate grip ideal for perching.

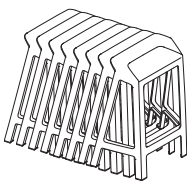

Flex Perch nest on the floor in rows. Make rows as long or as short as you'd like. There is no limit to the number of Flex Perch that can nest.

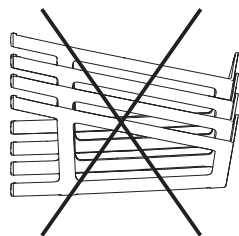

Flex Perch is not intended to be stacked horizontally. Storing or transporting the product in this position could cause scuffing and abrasion. Optimal storage of Flex Perch is nested with glides on the floor.

Surface Materials

Frame and seat

- 6302 Baltic
- 6527 Merle
- 6697 Fog
- 6BD7 Saffron
- 6BE2 Light Peacock

Glides

- Soft plastic glides are made of Thermoplastic Polyurethane and come standard on all models of Flex Perch in 6205 Black.
- Felt glides are unavailable for use with Flex Perch.

Clean promptly to minimize staining. See *Surface Materials Reference Manual* for detailed cleaning instructions.

Programs & Services

► See the *Surface Materials Reference Manual* for further detail about programs and services offered for seating.

Thought Starters

Flex Perch Stool

Team Huddle

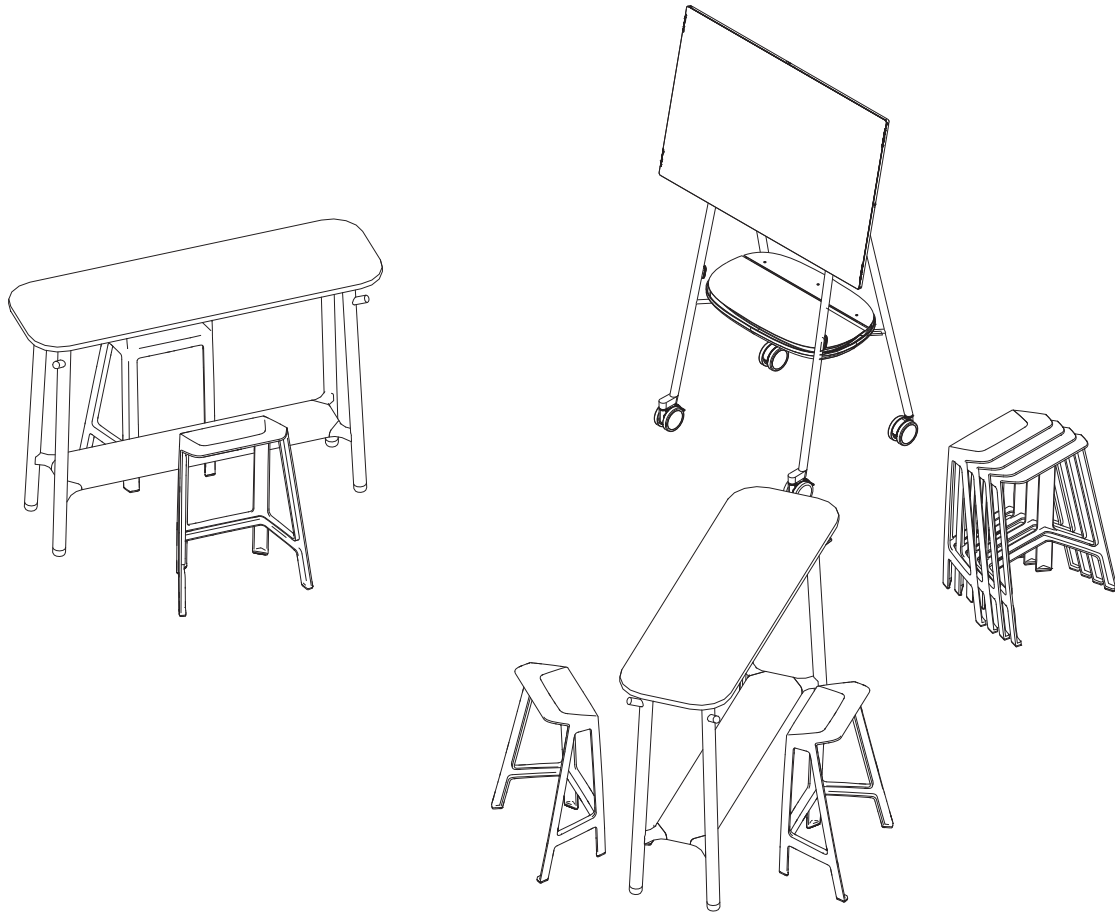

Quantity	Style Number	Description	Options	Page for Ordering
2	FLXPR4	Flex Perch Stool (4-Pack)		▶ Page 321
1	STPM1CART	Steelcase Roam Cart		▶ See <i>Steelcase Roam Specification Guide</i> .
2	FLXWTH	Flex, Standing-Height	29"W	▶ See <i>Flex Collection Specification Guide</i> .

Vertical Collaboration

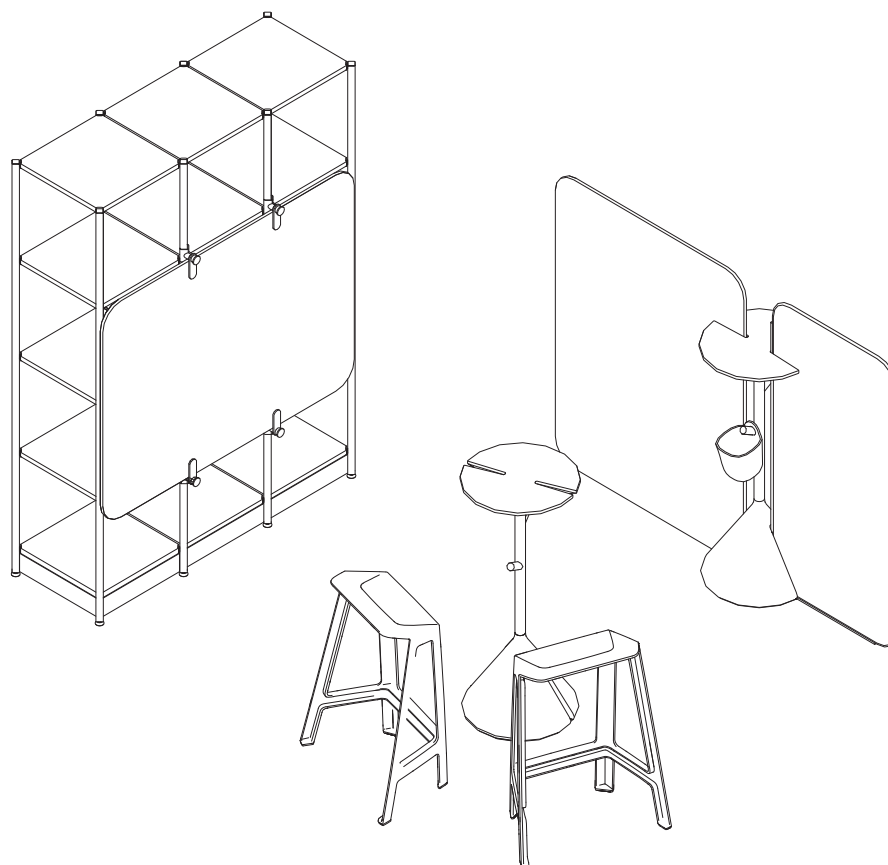

Flex Perch Stool

Quantity	Style Number	Description	Options	Page for Ordering
2	FLXPR1	Flex Perch Stool		▶ Page 321
2	FLXSTAND	Flex, Stand		▶ See <i>Flex Collection Specification Guide</i> .
2	FLXMB	Flex, Markerboard		▶ See <i>Flex Collection Specification Guide</i> .
1	FLXFSRQ	Flex, Freestanding Screen, Rectangle	35 1/2"W	▶ See <i>Flex Collection Specification Guide</i> .
1	FLXAFFRAME	Flex, Frame	1 Wide Frame 4 Units High	▶ See <i>Flex Collection Specification Guide</i> .
2	FLXAFFRAMEEXT	Flex, Frame	1 Wide Frame 4 Units High	▶ See <i>Flex Collection Specification Guide</i> .
1	FLXAFMBRDCLIP	Flex, Mobile Board Clips		▶ See <i>Flex Collection Specification Guide</i> .
1	FLEXCUP	Flex, Cup		▶ See <i>Flex Collection Specification Guide</i> .

Makerspace

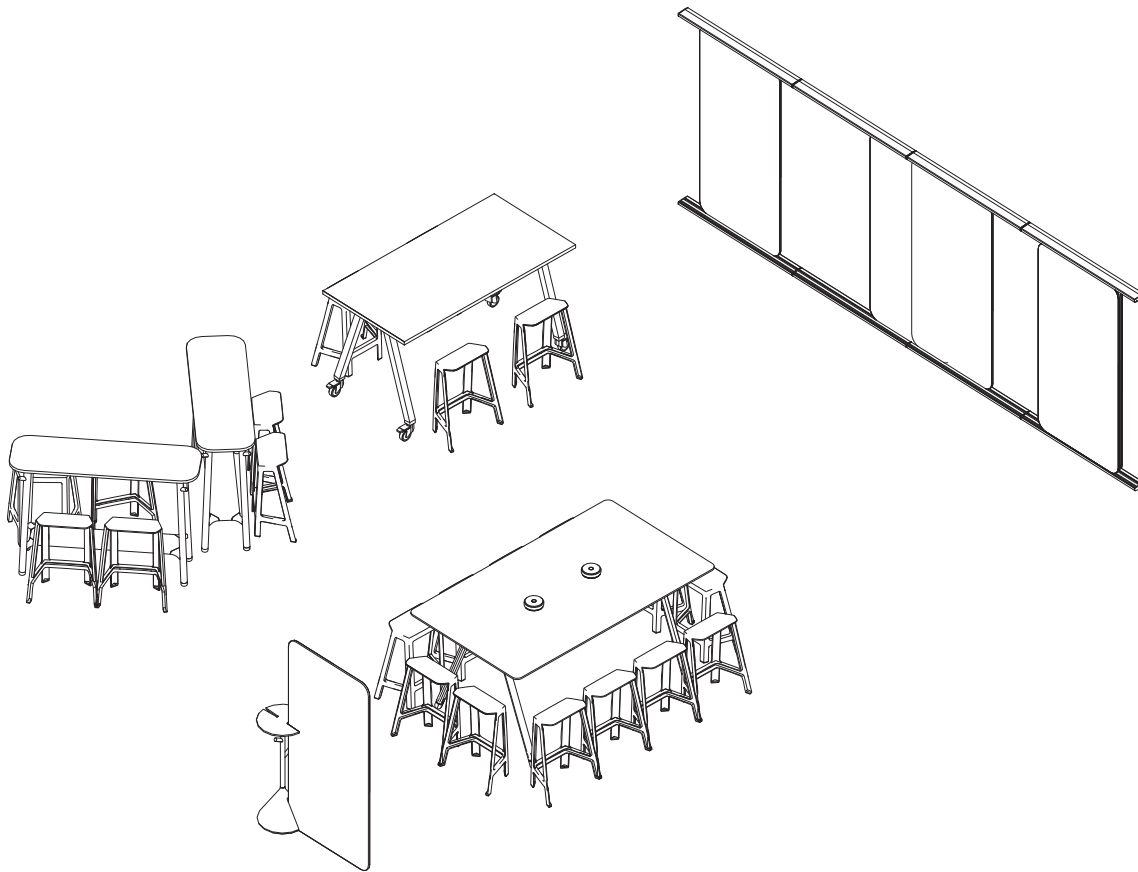

Quantity	Style Number	Description	Options	Page for Ordering
2	FLXPR1	Flex Perch Stool		▶ Page 321
5	FLXPR4	Flex Perch Stool (4-Pack)		▶ Page 321
1	FLXWRPKG	Flex, Wall Rail Package	96"	▶ See <i>Flex Collection Specification Guide</i> .
2	FLXSTAND	Flex, Stand		▶ See <i>Flex Collection Specification Guide</i> .
1	FLXMB	Flex, Markerboard		▶ See <i>Flex Collection Specification Guide</i> .
2	FLXSLIM	Flex, Slim Table		▶ See <i>Flex Collection Specification Guide</i> .
1	25216F	Smith System Planner Studio Rectangle, 40" high fixed casters		▶ See <i>Smith Systems Price List</i> .
1	COFOFRECST	Potrero415 Standing-height rectangular table	48"x120", and 2 PowerPod grommets	▶ See <i>Coalesse Tables, Storage, and Accessories Specification Guide</i> .

Education Transition Space

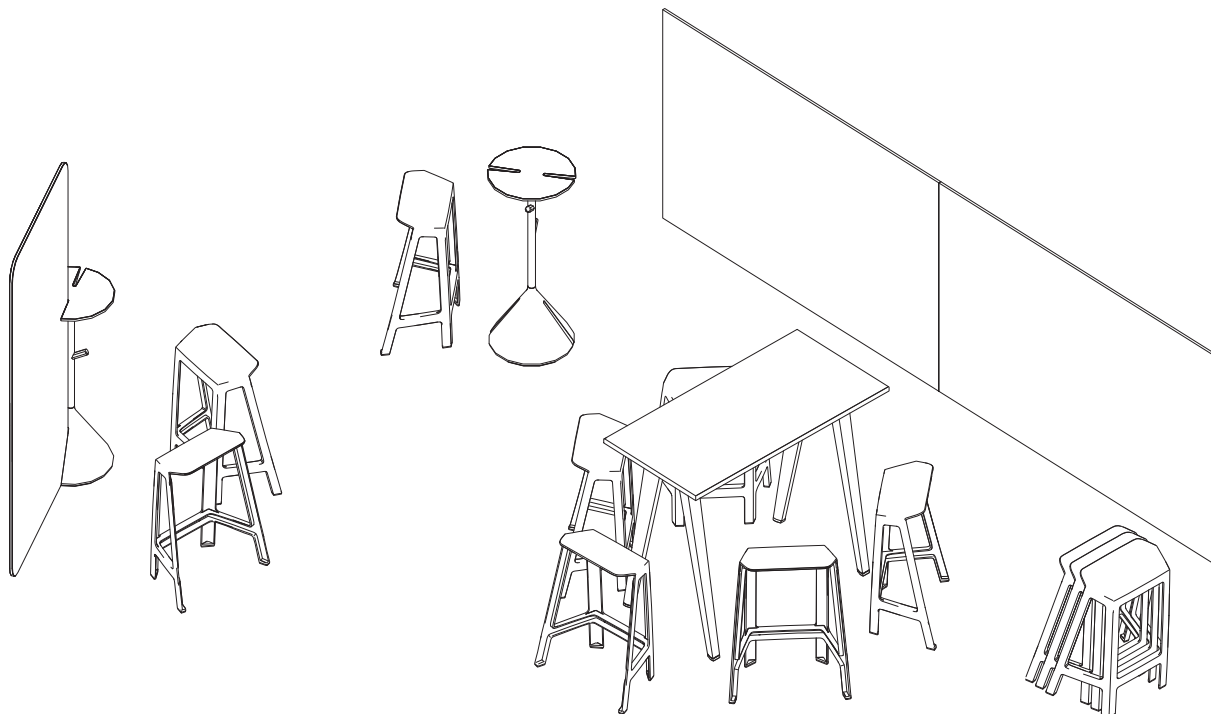

Flex Perch Stool

Quantity	Style Number	Description	Options	Page for Ordering
3	FLXPR1	Flex Perch Stool		▶ Page 321
2	FLXPR4	Flex Perch Stool (4-Pack)		▶ Page 321
2	FLXSTAND	Flex, Stand		▶ See <i>Flex Collection Specification Guide</i> .
1	FLXFSRQ	Flex, Freestanding Screen, Rectangle	30"W	▶ See <i>Flex Collection Specification Guide</i> .
1	N3LRECT	B-Free standing-height table, rectangular table	60"W x 32"D; One end with one power/ one dual USB	▶ Page 584
2	SANS	PolyVision a ³	47" x 72" CeramicSteel Sans	▶ See <i>Collaborative Surfaces Specification Guide</i> .

Dimensions

Flex Perch Stool

	• Overall Depth	• Overall Width	• Overall Height	• Seat Depth	• Seat Width	• Seat Height from floor (Front of seat)	• Seat Height from floor (Back of seat)
Flex Perch Stool	12½"	21½"	28½"	9½"	17½"	26⅝"	28½"

• Seat • Angle	• Footrest • height from floor	• Footrest • height from seat
7.2°	8 ¹ / ₁₆ "	18 ⁹ / ₁₆ "

Nested Dimensions

Flex Perch Stool

Nested Applications

Flex Perch nests on the floor in rows. Rows can be long or short. There is no limit to the number of perches that can nest. To help with spacing this application, the following outline the nesting dimensions of common number of units in an application.

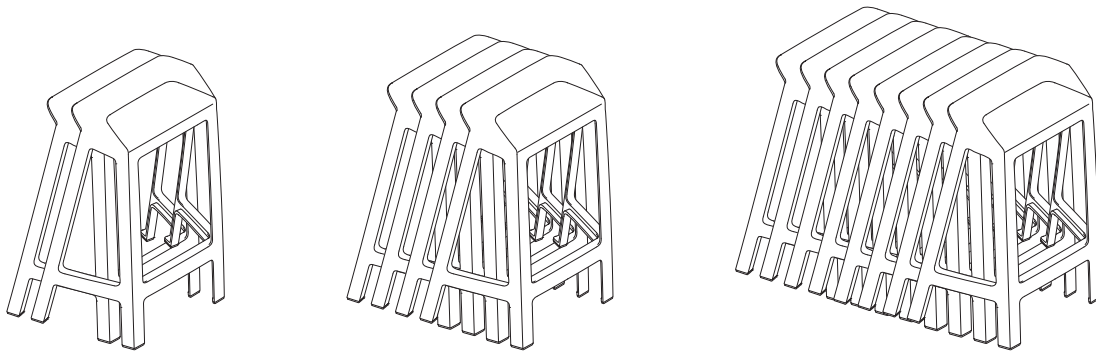

Number of Nested Stools	Overall Width	Overall Depth
1	21½"	12½"
2	21½"	15½"
4	21½"	21½"
8	21½"	33½"
12	21½"	45½"

Flex Perch Stools

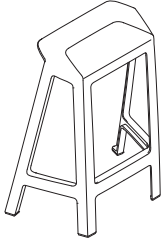

Tip: Perch stools can be nested in rows for easy storage. There is no limit to the number of stools that can be nested together.

Tip: Perch stool is a single molded component. Plastic frame color option applies to both frame and seat.

Tip: Perch stool comes standard with soft plastic glides. No additional glide options are available.

Tip: Glides may scratch hardwood floors. To minimize damage, keep floors and glides clean of dirt and debris.

Standard Includes

- 28 1/8"H perching stool
- Molded plastic frame and seat
- Soft plastic glides

Options

Frame Finish	Plastic - PG1	No cost
	Plastic - PG2	No cost

Specification Information

Style	Prices
Number	

Perch Stool, Quantity 1

FLXPR1	\$450
---------------	-------

Perch Stool, Quantity 4

FLXPR4	\$1478
---------------	--------



Understanding and Specifying Turnstone Shortcut Multi-Use Seating

Product Details

Shortcut Five-Star Base	324
Shortcut Five-Star Base with Personal Worksurface	326
Shortcut X Base and Shortcut Wood	328
Shortcut with Tripod Base	330
Planning with Shortcut	332
Dimensions	334

Specifying

Shortcut Five-Star Base	336
Shortcut Five-Star Base with Personal Worksurface	338
Shortcut X Base	339
Shortcut Wood	341
Shortcut with Tripod Base	342

Shortcut Five-Star Base

Shortcut is a collaborative seating collection that encourages people to move freely, change postures, and stay energized, yet comfortable in many settings.
 ▶ Specifying, pages 336–337

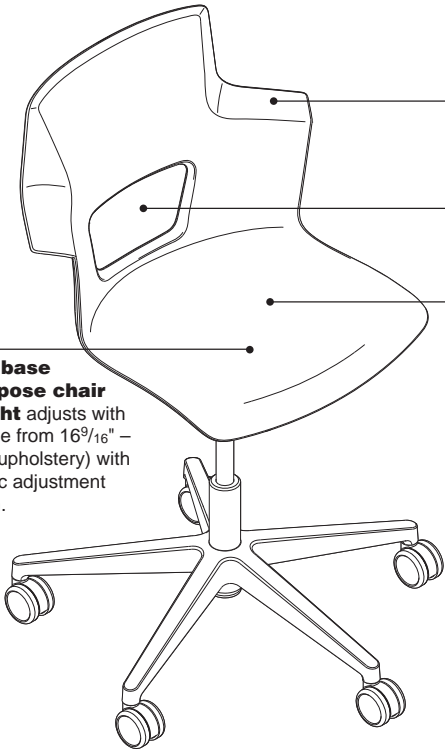

Five-star base multi-purpose chair seat height adjusts with a $4\frac{5}{8}$ " range from $16\frac{9}{16}$ " – $21\frac{3}{16}$ " (no upholstery) with a pneumatic adjustment mechanism.

Five-star base multi-purpose stool seat height adjusts with a $10\frac{3}{16}$ " range from $22\frac{1}{8}$ " – $32\frac{5}{16}$ " (no upholstery) with a pneumatic adjustment mechanism.

Five-star base is standard.

Hard, dual wheeled casters are standard for use on carpets. Soft, roll-control, dual-wheel casters are available for use on hard floors or chair mats.

Abbreviated arms allow users to pull up to a worksurface with ease.

Cut-out provides more flexibility.

The Shortcut shell is made of polypropylene plastic.

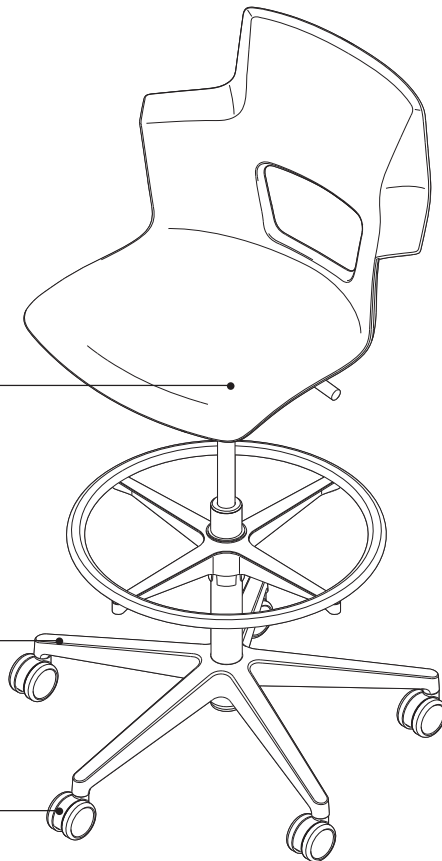

Adjustment Features

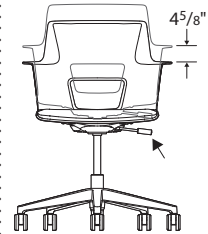

Seat height adjusts with a $4\frac{5}{8}$ " range from $16\frac{9}{16}$ " – $21\frac{3}{16}$ " (no upholstery) with a pneumatic adjustment mechanism.

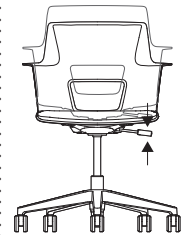

Seat height adjusts pneumatically. To lower, pull lever up while seated. To raise, pull lever up and keep weight off of the chair. Lever is located on the left hand side.

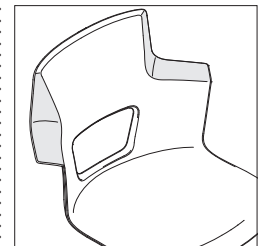

Elbow rests are abbreviated to stay out of the way as the user gets closer to the worksurface and supports a wide range of postures. It is designed to be level when in use and may appear to have slight upward angle when not in use.

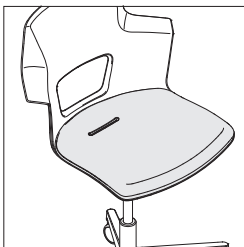

Cushion option is available for extra support and comfort.

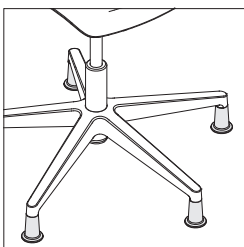

Black glides are available as an option. Glides ship assembled on the chair or stool and maintain the same height as casters.

Soft roll-control caster option features an internal brake that activates when the chair is not under load to reduce shifting when user stands up.

Soft, dual-wheel casters are two-tone, with a merle ring, which makes them easily identifiable.

Surface Materials

► See surface materials on page 634 for specific availability or refer to the *Surface Materials Reference Manual* for further information.

Upholstery

- Fabric
- Leather
- Elmosoft leather
- Select Surfaces leather
- COM (Customer's Own Material)
- COL (Customer's Own Leather)

Hard components

Chair (shell, five-star base)

Shell

- Plastic

Base

- 4140 Arctic White
- 4799 Platinum Metallic
- 6205 Black

Tip: Cylinder paint color defaults to coordinate with base color.

Hard casters

- 6205 Black
- 6249 Platinum Solid

Tip: Casters paint color defaults to coordinate with base color.

Soft casters with 6527

- Merle ring
- 6205 Black
- 6249 Platinum Solid

Tip: Casters paint color defaults to coordinate with base color.

The Shortcut stool foot ring

is defaulted based on the paint color specified, with the exception of 4140 Arctic White, in which case the foot ring is platinum.

All Steelcase seating with standard upholstery fabrics complies with requirements of the State of California Technical Bulletin 117. All standard seating is labeled to be in compliance with California 117.

Programs & Services

Local codes may have special requirements for upholstery.

Dimensions

► Page 334

Shortcut Five-Star Base with Personal Worksurface

► Specifying, page 338

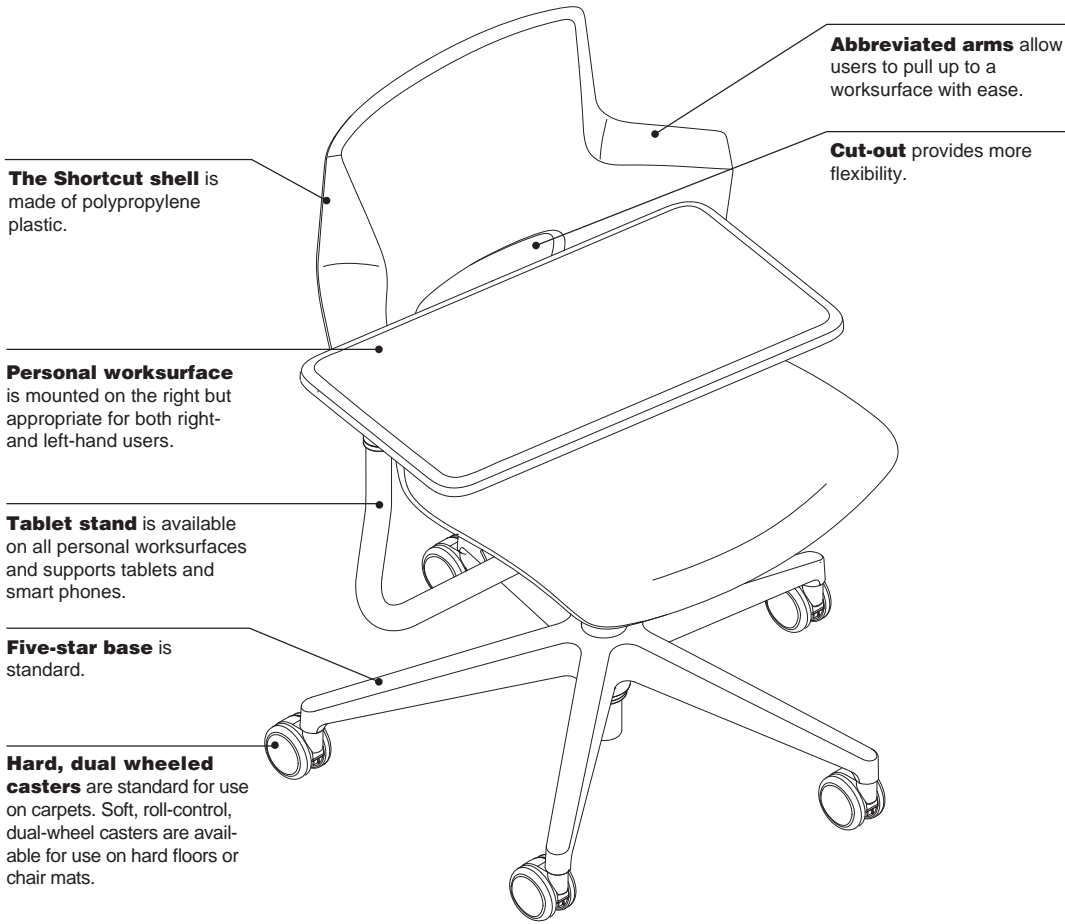

Product Details

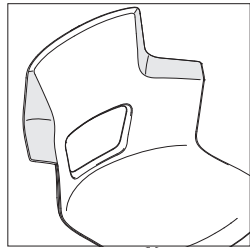

Elbow rests are abbreviated to stay out of the way as the user gets closer to the worksurface and supports a wide range of postures. It is designed to be level when in use and may appear to have slight upward angle when not in use.

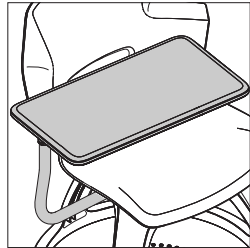

Personal worksurface is mounted on user's right, and designed to accommodate left- and right-handed users. It is 12"D x 22¼"W and features a safety stop to help prevent belongings and laptops from easily sliding off back edge.

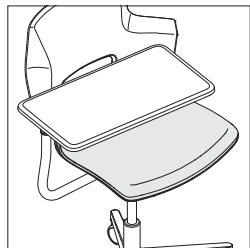

Cushion options are available for extra support and comfort.

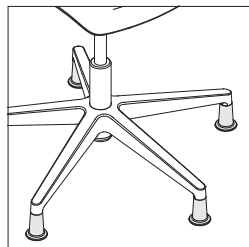

Black glides are available as an option. Glides ship assembled on the chair and maintain the same height as casters.

Soft roll-control caster option features an internal brake that activates when the chair is not under load to reduce shifting when user stands up.

Soft, dual-wheel casters are two-tone, with a merle ring, which makes them easily identifiable.

Adjustment Features

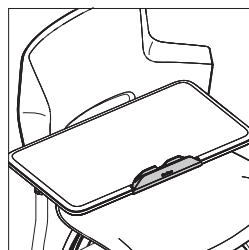

Tablet stand supports tablets and smart phones in both portrait and landscape positions, making content easy to view and freeing up space on the worksurface for other materials.

Tip: Devices are not secure in tablet stand when moved.

Cup holder is available as an option and it is retractable under the worksurface when not in use.

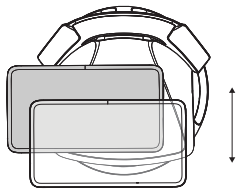

Personal worksurface depth adjustment range is 6" to 16¼". Measurement is from lumbar to worksurface.

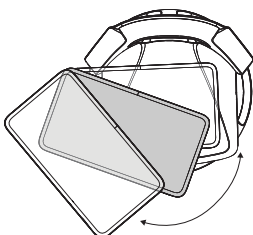

Personal worksurface pivot range is 48°.

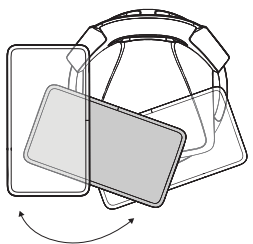

Personal worksurface center pivot is 100°. The center pivot range is measured from the closest position to the furthest position from the user.

Surface Materials

▶ See surface materials on page 634 for specific availability or refer to the *Surface Materials Reference Manual* for further information.

Upholstery

- Fabric
- Leather
- Elmosoft leather
- Select Surfaces leather
- COM (Customer's Own Material)
- COL (Customer's Own Leather)

Hard components

Chair (shell, five-star base)

Shell

- Plastic

Base

- 4140 Arctic White
- 4799 Platinum Metallic
- 6205 Black

Tip: Cylinder paint color defaults to coordinate with base color.

Hard casters

- 6205 Black
- 6249 Platinum Solid

Tip: Casters paint color defaults to coordinate with base color.

Soft casters with 6527

- Merle ring
- 6205 Black
- 6249 Platinum Solid

Tip: Casters paint color defaults to coordinate with base color.

Personal worksurface

- 6053 Seagull
- 6249 Platinum Solid
- 6295 Near Black
- 6337 Element

Tablet stand and cup holder

- Sterling dark solid only

Paint for metal components

- 0835 Black
- 4140 Arctic White
- 4799 Platinum Metallic

All Steelcase seating with standard upholstery fabrics complies with requirements of the State of California Technical Bulletin 117. All standard seating is labeled to be in compliance with California 117.

Programs & Services

Local codes may have special requirements for upholstery.

Dimensions

▶ Page 334

Shortcut X Base and Shortcut Wood

► Specifying, pages 339–340

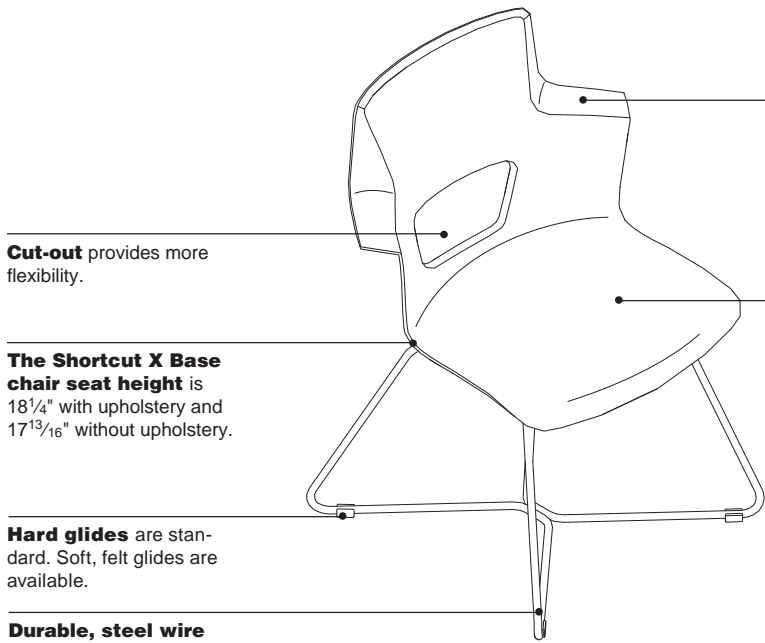

Cut-out provides more flexibility.

The Shortcut X Base chair seat height is 18¹/₄" with upholstery and 17¹³/₁₆" without upholstery.

Hard glides are standard. Soft, felt glides are available.

Durable, steel wire frame is lightweight.

Abbreviated arms allow users to pull up to a work-surface with ease.

The Shortcut shell is made of polypropylene plastic.

Adjustment Features

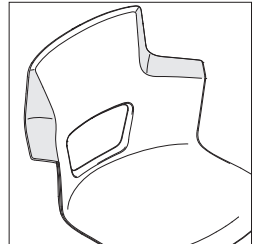

Elbow rests are abbreviated to stay out of the way as the user gets closer to the worksurface and supports a wide range of postures.

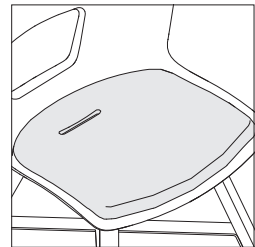

Cushion option is available for extra support and comfort.

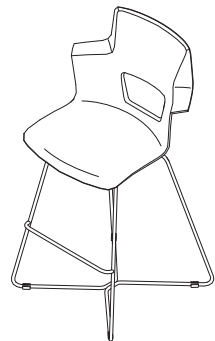

The Shortcut X Base stool seat height is 29³/₈" with upholstery and 28¹/₁₆" without upholstery.

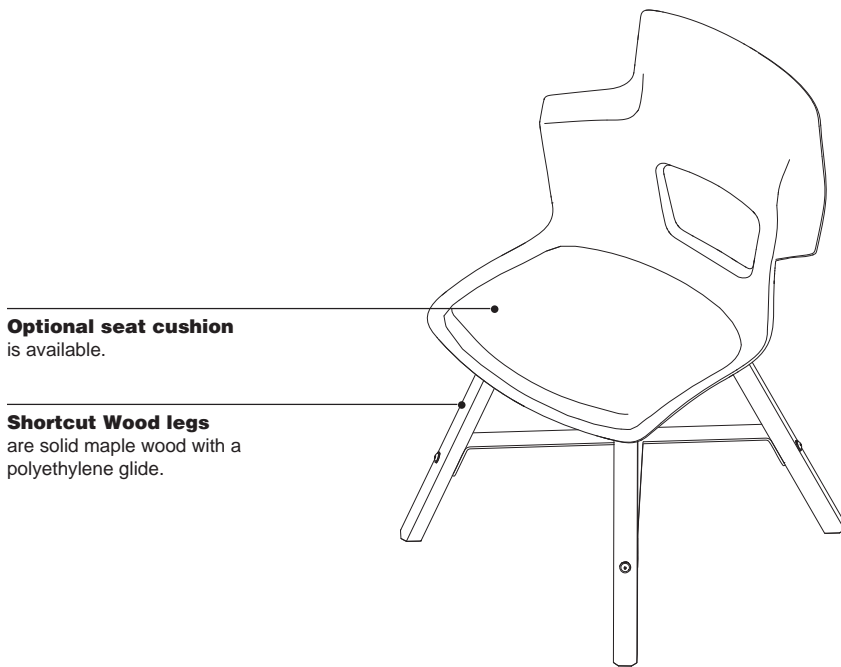

Optional seat cushion is available.

Shortcut Wood legs are solid maple wood with a polyethylene glide.

Surface Materials

▶ See surface materials on page 634 for specific availability or refer to the *Surface Materials Reference Manual* for further information.

Shortcut X Base**Upholstery**

- Fabric
- Leather
- Elmosoft leather
- Select Surfaces leather
- COM (Customer's Own Material)
- COL (Customer's Own Leather)

Shell

- Plastic

Base

- Paint

▶ For Surface Materials matrices for all product lines, see page 648

Shortcut Wood**Upholstery**

- Fabric
- Leather
- Elmosoft leather
- Select Surfaces leather
- COM (Customer's Own Material)
- COL (Customer's Own Leather)

Shell

- Plastic

Legs

- V1AC Natural Cherry
- V1AM Clear Maple
- V1CC Medium Amber Cherry
- V1EW Dark Walnut

Brackets

- Paint
- Accent Paint
- PerfectMatch Paint

All Steelcase seating with standard upholstery fabrics complies with requirements of the State of California Technical Bulletin 117. All standard seating is labeled to be in compliance with California 117.

Programs & Services

Local codes may have special requirements for upholstery.

Dimensions

▶ Page 334

Shortcut with Tripod Base

► Specifying, page 342

Abbreviated arms allow users to pull up to a worksurface with ease.

Cut-out provides more flexibility.

360°-swivel mechanism is standard.

Backpack storage area is standard.

Casters have hard dual wheels that roll smoothly on carpets. Soft dual-wheel casters are available for use on hard floors.

Tablet stand is available on all personal worksurfaces and supports tablets and smart phones.

Personal worksurface moves independently of seat shell and base.

Personal worksurface is mounted on the right but appropriate for both right- and left-hand users.

Personal worksurface is depth adjustable for large and small users and allows for ingress/egress.

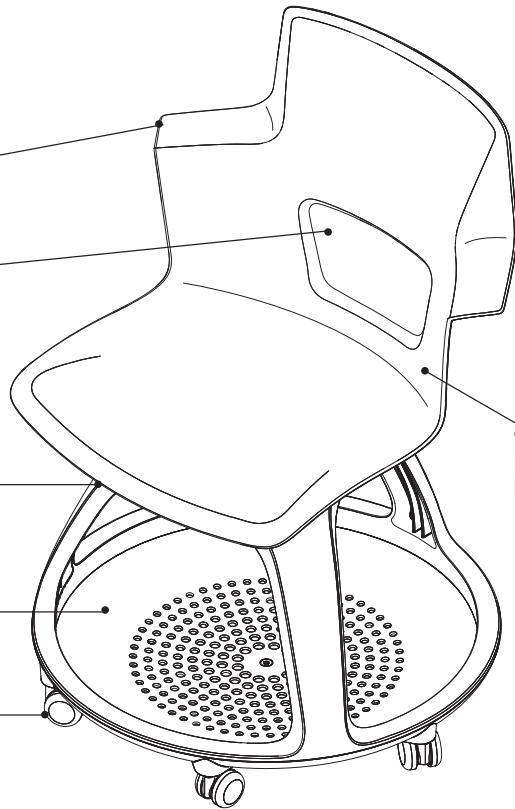

The Shortcut shell is made of polypropylene plastic.

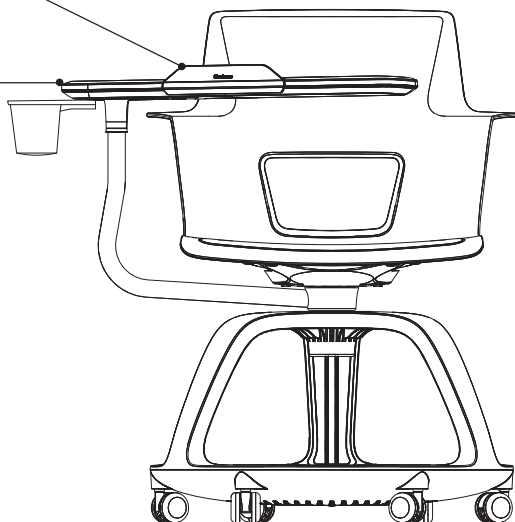

Product Details

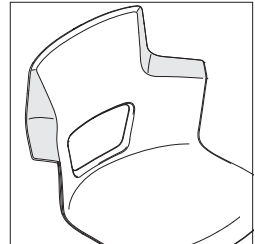

Elbow rests are abbreviated to stay out of the way as the user gets closer to the worksurface and supports a wide range of postures.

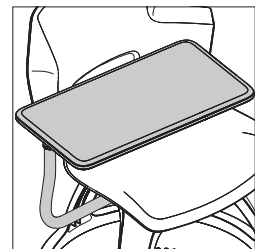

Personal worksurface is mounted on user's right, and designed to accommodate left- and right-handed users. It is 12"D x 22 1/4"W and features a safety stop to help prevent belongings and laptops from easily sliding off back edge.

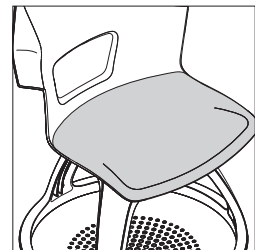

Cushion options are available for extra support and comfort.

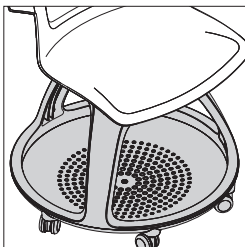

Tripod base reclaims the space under the seat. The space is 1.7 cu/ft and allows for backpack or personal belongings to be stored.

Adjustment Features

360° fixed height swivel mechanism on tripod base models allows students to remain oriented to instructor, presentation materials, and other students.

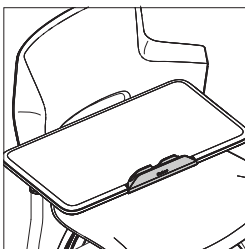

Tablet stand is available on chairs with personal worksurfaces. The stand supports tablets and smart phones in both portrait and landscape positions, making content easy to view and freeing up space on the worksurface for other materials.

Tip: Devices are not secure in tablet stand when moved.

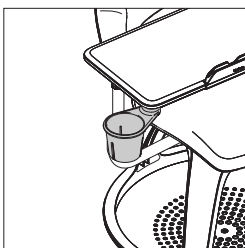

Cup holder is available as an option on Shortcut chairs with personal worksurfaces. It is retractable under the worksurface when not in use.

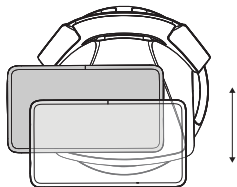

Personal worksurface depth adjustment range is 6" to 16¼". Measurement is from lumbar to worksurface.

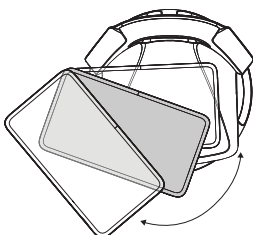

Personal worksurface pivot range is 48°.

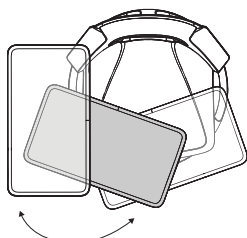

Personal worksurface center pivot is 100°. The center pivot range is measured from the closest position to the furthest position from the user.

Surface Materials

▶ See surface materials on page 634 for specific availability or refer to the *Surface Materials Reference Manual* for further information.

Shell

- Plastic

Upholstery

- Fabric
- Leather
- Elmosoft leather
- Select Surfaces leather
- COM (Customer's Own Material)
- COL (Customer's Own Leather)

Tripod base

- 6249 Platinum Solid
- 6295 Near Black
- 6337 Element

Storage tray/bottom of tripod base

- Sterling dark solid only

Personal worksurface

- 6053 Seagull
- 6249 Platinum Solid
- 6295 Near Black
- 6337 Element

Casters

- Black

Glides

- Sterling dark solid only

Tablet stand and cup holder

- Sterling dark solid only

Paint for metal components

- 0835 Black
- 4140 Arctic White
- 4799 Platinum Metallic

Dimensions

▶ Page 334

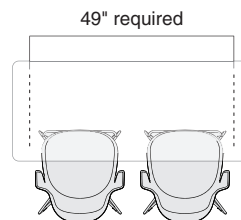

The backpack storage area and overall chair width require 23¾" of continuous floor space when used with tables. The minimum distance between table bases is 49" to allow two chairs to be pushed under the worksurface.

Planning with Shortcut

For Classroom Environments

Pedagogy, technology and space, when carefully considered and intentionally designed, can establish new protocols for advanced learning solutions.

Planning Tips

- 1 Illustrate multiple modes for each drawing to:
 - a) ensure enough space is available for each reconfiguration
 - b) allow the user to understand what's possible
 - c) ensure that sight lines are maintained when the furniture is moved
 - d) confirm that jurisdictional codes are followed for each layout (eg: International Building Code, American Disability Act, etc.)
- 2 Give permission to act differently by including wall guard and enough space to move, supporting simultaneous multi-modal activities.
- 3 Provide both analogue and digital tools in the solution such as whiteboards, personal whiteboards, interactive whiteboards or media:scape.
- 4 Address the needs of classroom and personal storage for both students and teachers. Incorporate this information into each mode to ensure space is adequate.
- 5 Include zones for mentoring, assessment, and/or coaching for teacher-to-student and/or student-to-student interaction.
- 6 Annotate the drawings with design principles to confirm they are being addressed.

Lecture Mode

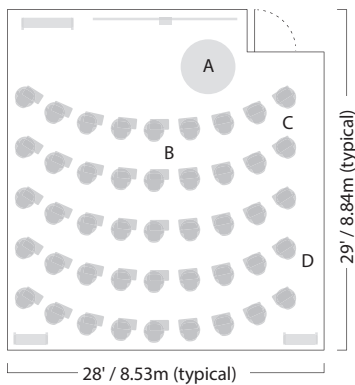

Group Mode

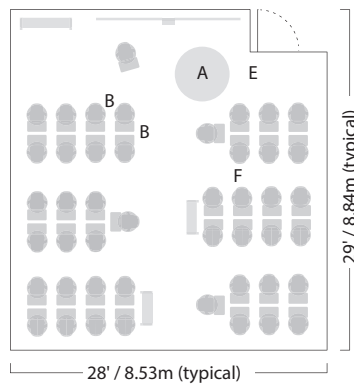

Discussion Mode

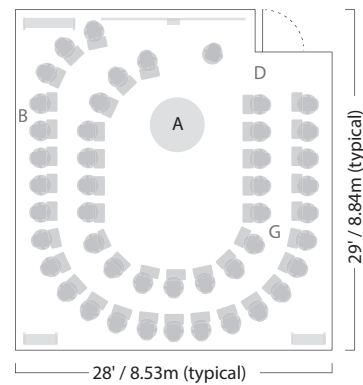

This example: 18* sq. ft. or 1.68 sq. meters per person. *For K-12 applications, See Table 1004.1.1 Maximum Floor Area Allowances per Occupant, 2009 International Building Code.

- A** — 60"/1.52m (ADA)
- B** — 12"/0.3m
- C** — 18"-24"/0.46-0.61m (aisle)
- D** — 36"/0.91m (egress)
- E** — 60"/1.52m (egress)
- F** — 38"/0.97m (aisle)
- G** — 18"-36"/0.46-0.91m (aisle)

Dimensions

Shortcut

Features	Overall Depth	Width	Height	Seat Depth	Seat Width	Seat Height from Floor
----------	---------------	-------	--------	------------	------------	------------------------

Shortcut

Multi-Use Seating

Five-Star Base Chair	24½"	24⅛"	31½"-35⅙"	16⅞"	19⅝"	16⅞"-21⅜"
Five-Star Base Stool	24½"	24⅛"	36⅙"-47"	16⅞"	19⅝"	22⅛"-32⅝"
Five-Star Base with Personal Worksurface	24½"	34½"	31¾"-37¾"	16⅞"	19⅝"	16⅞"-21⅜"
X Base Chair	21½"	24⅛"	33"	16⅞"	19⅝"	17⅓"
X Base Stool	21½"	24⅛"	44"	16⅞"	19⅝"	28⅛"
Wood Chair	27¾"	24⅛"	33"	16⅞"	19⅝"	17⅓"
Chair with Tripod Base	23¾"	25⅙"	33½"	16⅞"	19⅝"	18⅜" (19⅙")
Chair with Tripod Base and Personal Worksurface	31"	34½"	33½"	16⅞"	19⅝"	18⅜" (19⅙")

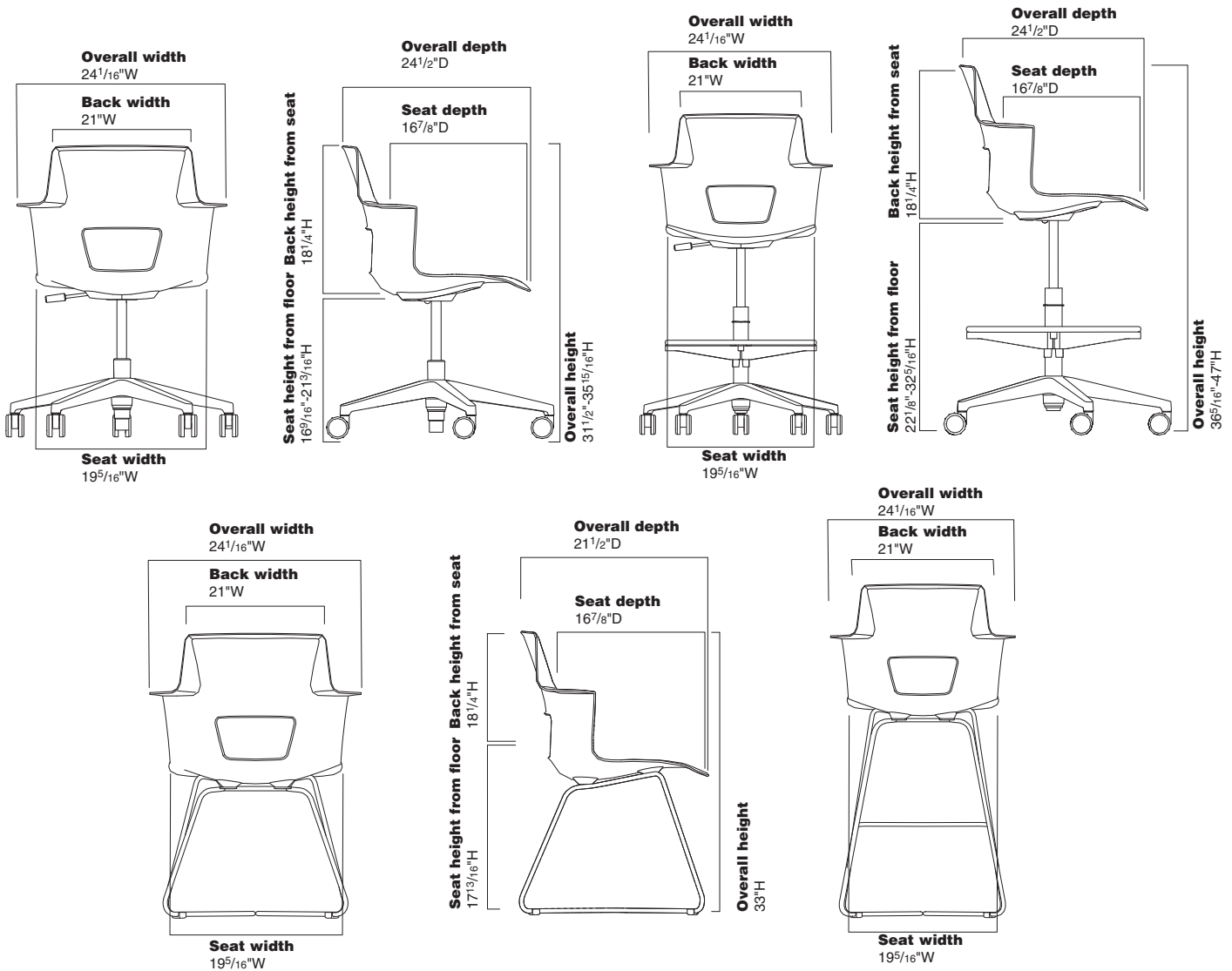

• Back Width	• Back Height from Seat	• Back Lumbar Height	• Seat Pan Angle	• Angle Between Seat and Back	• Width Between Elbow Rest	• Elbow Rest to Floor
21"	18¼"	9¼"	8.3°	within 0–4°	21"	N.A.
21"	18¼"	9¼"	8.3°	within 0–4°	21"	N.A.
21"	18¼"	9¼"	8.3°	within 0–4°	21"	N.A.
21"	18¼"	9¼"	8°	within 0–4°	21"	26¼"
21"	18¼"	9¼"	8°	within 0–4°	21"	37¼"
21"	18¼"	9¼"	5 - 8°	within 0–4°	21"	26¼"
21"	18¼"	9¼"	8.3°	within 0-4°	21"	26¾"
21"	18¼"	9¼"	8.3°	within 0-4°	21"	26¾"

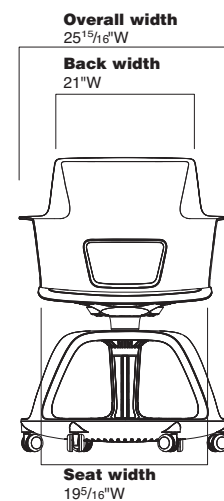
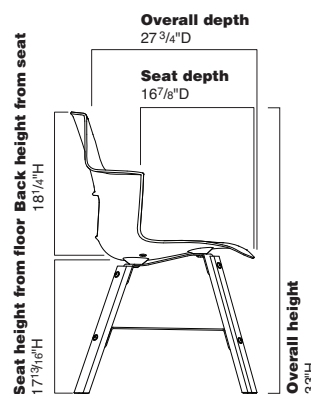
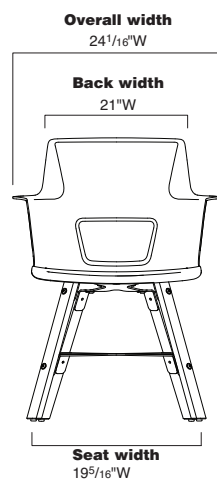
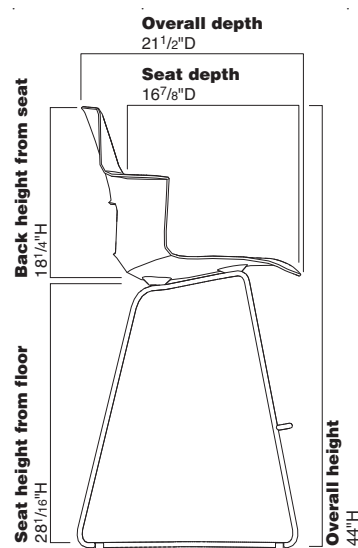

Shortcut

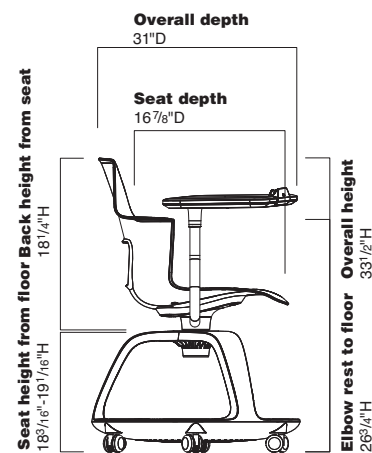
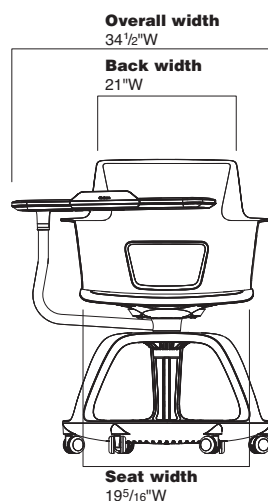
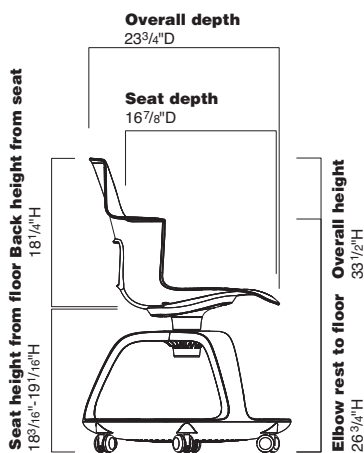

Shortcut

Five-Star Base Chair



Tip: Hard dual-wheel casters are for use on carpet. Use on hard surfaces, including floor mats, will affect chair stability and may result in personal injury.

Tip: Upholstery is only applicable if seat cushion is a selected option.

Tip: Craft in upholstery cautions the use of stripes and patterns on Shortcut. Please use fabric database when specifying.

Tip: Casters default to coordinate with base color.

Standard Includes		Required to Specify
▶ Need help? Product details, page 324	<ul style="list-style-type: none"> • Seat shell: plastic • Five-star base: 6205 Black plastic • Pneumatic seat height • Hard dual-wheel casters: 6205 Black • Shipped ready to assemble • Meets Cal. 117 requirements 	<ol style="list-style-type: none"> 1 Style number 2 Color number for base 3 Plastic color number for shell 4 Options, if selected (see below) <p>▶ See <i>Surface Materials</i>, page 634.</p>

Options		U.S. Price	Required to Specify
Seat Cushion	• Cushion	+\$215	Specify <i>with cushion</i> and specify fabric color number.
Surface Materials	Upholstery		
	<ul style="list-style-type: none"> • Fabric price group 1 • Fabric price group 2 • Fabric price group 3 • Fabric price group 4 • Fabric price group 5 • Fabric price group 6 • Fabric price group 7 • Fabric price group 8 • Fabric price group 9 • Fabric price group 10 • Steelcase leather • Select Surfaces leather price group 1 • Elmosoft leather • Select Surfaces leather price group 2 • Vinyl • Customer's Own Material (COM) 	<ul style="list-style-type: none"> No cost +\$ 16 +\$ 37 +\$ 53 +\$ 62 +\$ 77 +\$ 94 +\$113 +\$140 +\$162 +\$136 +\$136 +\$160 +\$160 +\$ 16 +\$ 56 	<ul style="list-style-type: none"> Specify fabric color number. Specify fabric color number. Specify fabric color number. Specify fabric color number. Specify fabric color number. Specify fabric color number. Specify fabric color number. Specify fabric color number. Specify fabric color number. Specify fabric color number. Specify leather color number. ▶ See <i>Surface Materials Reference Manual</i>. Specify Elmosoft color number. ▶ See <i>Surface Materials Reference Manual</i>. Specify vinyl color number. ▶ See <i>Understanding Customer's Own Material (COM)</i>, page 642. ▶ See <i>Understanding Customer's Own Material (COM)</i>, page 642.
	Base		
	<ul style="list-style-type: none"> • Arctic white gloss • Platinum metallic 	<ul style="list-style-type: none"> +\$ 56 +\$ 56 	<ul style="list-style-type: none"> Specify <i>with 4140 Arctic White Gloss</i>. Specify <i>with 4799 Platinum Metallic</i>.
	Shell		
	<ul style="list-style-type: none"> • Plastic price group 1 • Plastic price group 2 	<ul style="list-style-type: none"> No cost +\$ 53 	<ul style="list-style-type: none"> Specify plastic color number. Specify plastic color number.
Casters	<ul style="list-style-type: none"> • Hard casters • Soft dual-wheel casters for use on hard floors 	<ul style="list-style-type: none"> No cost +\$ 47 	<ul style="list-style-type: none"> Specify <i>with hard casters</i>. Specify <i>with soft casters</i>.
Glides	• Non-marring plastic glides	+\$ 47	Specify <i>with glides</i> .

Specification Information

Style Number	U.S. Base Price
TS31201A	\$647

▶ Detailed dimensions, page 334

For Canadian Pricing
Multiply U.S. Price by the Canadian price factor.
▶ See page 1 for details.

Shortcut

Five-Star Base Stool

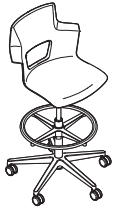

Tip: Hard dual-wheel casters are for use on carpet. Use on hard surfaces, including floor mats, will affect chair stability and may result in personal injury.

Tip: Upholstery is only applicable if seat cushion is a selected option.

Tip: Craft in upholstery cautions the use of stripes and patterns on Shortcut. Please use fabric database when specifying.

Tip: Casters default to coordinate with base color.

Standard Includes		Required to Specify
▶ Need help? Product details, page 324	<ul style="list-style-type: none"> • Seat shell: plastic • Five-star base: 6205 Black plastic • Pneumatic seat height • Hard dual-wheel casters: 6205 Black • Shipped ready to assemble • Meets Cal. 117 requirements 	<ol style="list-style-type: none"> 1 Style number 2 Color number for base 3 Plastic color number for shell 4 Options, if selected (see below) <p>▶ See <i>Surface Materials</i>, page 634.</p>

Options	U.S. Price	Required to Specify
Seat Cushion	• Cushion +\$215	Specify <i>with cushion</i> and specify fabric color number.
Surface Materials	Upholstery <ul style="list-style-type: none"> • Fabric price group 1 No cost • Fabric price group 2 +\$ 16 • Fabric price group 3 +\$ 37 • Fabric price group 4 +\$ 53 • Fabric price group 5 +\$ 62 • Fabric price group 6 +\$ 77 • Fabric price group 7 +\$ 94 • Fabric price group 8 +\$113 • Fabric price group 9 +\$140 • Fabric price group 10 +\$162 • Steelcase leather +\$136 • Select Surfaces leather price group 1 +\$136 • Elmosoft leather +\$160 • Select Surfaces leather price group 2 +\$160 • Vinyl +\$ 16 • Customer's Own Material (COM) +\$ 56 <ul style="list-style-type: none"> • Customer's Own Leather (COL) +\$ 56 	Specify fabric color number. Specify fabric color number. Specify fabric color number. Specify fabric color number. Specify fabric color number. Specify fabric color number. Specify fabric color number. Specify fabric color number. Specify fabric color number. Specify fabric color number. Specify leather color number. ▶ See <i>Surface Materials Reference Manual</i> . Specify Elmosoft color number. ▶ See <i>Surface Materials Reference Manual</i> . Specify vinyl color number. ▶ See <i>Understanding Customer's Own Material (COM)</i> , page 642. ▶ See <i>Understanding Customer's Own Material (COM)</i> , page 642.
	Base <ul style="list-style-type: none"> • Arctic white gloss +\$ 56 • Platinum metallic +\$ 56 	Specify <i>with 4140 Arctic White Gloss</i> . Specify <i>with 4799 Platinum Metallic</i> .
	Shell <ul style="list-style-type: none"> • Plastic price group 1 No cost • Plastic price group 2 +\$ 53 	Specify plastic color number. Specify plastic color number.
Casters	<ul style="list-style-type: none"> • Hard casters No cost • Soft dual-wheel casters for use on hard floors +\$ 47 	Specify <i>with hard casters</i> . Specify <i>with soft casters</i> .
Glides	• Non-marring plastic glides +\$ 47	Specify <i>with glides</i> .

Specification Information	
Style Number	U.S. Base Price

TS31202B	\$916
-----------------	-------

▶ Detailed dimensions, page 334

For Canadian Pricing
 Multiply U.S. Price by the Canadian price factor.
 ▶ See page 1 for details.

Shortcut

Five-Star Base Chair with Personal Worksurface



Tip: Hard dual-wheel casters are for use on carpet. Use on hard surfaces, including floor mats, will affect chair stability and may result in personal injury.

Tip: Upholstery is only applicable if seat cushion is a selected option.

Tip: Craft in upholstery cautions the use of stripes and patterns on Shortcut. Please use fabric database when specifying.

Tip: Metal components include shell bracket and personal worksurface arm that default to match the base finish.

Tip: Casters default to coordinate with base color.

► Detailed dimensions, page 334



For Canadian Pricing
Multiply U.S. Price by the Canadian price factor.
► See page 1 for details.

Standard Includes		Required to Specify
► Need help? Product details, page 326	<ul style="list-style-type: none"> • Seat shell: plastic • Five-star base: 6205 Black plastic • Pneumatic seat height • Hard dual-wheel casters: 6205 Black • Metal components: paint • Swivel seat • Personal Worksurface: plastic • Shipped ready to assemble • Meets Cal. 117 requirements 	<ol style="list-style-type: none"> 1 Style number 2 Color number for base 3 Plastic color number for shell 4 Paint for metal components 5 Plastic color number for Personal Worksurface 6 Options, if selected (see below) <p>► See <i>Surface Materials</i>, page 634.</p>

	Options	U.S. Price	Required to Specify
Seat Cushion	• Cushion	+\$215	Specify <i>with cushion</i> and specify fabric color number.
Surface Materials	<p>Upholstery</p> <ul style="list-style-type: none"> • Fabric price group 1 • Fabric price group 2 • Fabric price group 3 • Fabric price group 4 • Fabric price group 5 • Fabric price group 6 • Fabric price group 7 • Fabric price group 8 • Fabric price group 9 • Fabric price group 10 • Steelcase leather • Select Surfaces leather price group 1 • Elmosoft leather • Select Surfaces leather price group 2 • Vinyl • Customer's Own Material (COM) <p>• Customer's Own Leather (COL)</p> <p>Base</p> <ul style="list-style-type: none"> • Arctic white gloss • Platinum metallic <p>Shell</p> <ul style="list-style-type: none"> • Plastic price group 1 • Plastic price group 2 	<p>No cost</p> <p>+\$ 16</p> <p>+\$ 37</p> <p>+\$ 53</p> <p>+\$ 62</p> <p>+\$ 77</p> <p>+\$ 94</p> <p>+\$113</p> <p>+\$140</p> <p>+\$162</p> <p>+\$136</p> <p>+\$136</p> <p>+\$160</p> <p>+\$160</p> <p>+\$ 16</p> <p>+\$ 56</p> <p>+\$ 56</p> <p>+\$ 56</p> <p>+\$ 56</p>	<p>Specify fabric color number.</p> <p>Specify fabric color number.</p> <p>Specify fabric color number.</p> <p>Specify fabric color number.</p> <p>Specify fabric color number.</p> <p>Specify fabric color number.</p> <p>Specify fabric color number.</p> <p>Specify fabric color number.</p> <p>Specify fabric color number.</p> <p>Specify fabric color number.</p> <p>Specify leather color number.</p> <p>► See <i>Surface Materials Reference Manual</i>.</p> <p>Specify Elmosoft color number.</p> <p>► See <i>Surface Materials Reference Manual</i>.</p> <p>Specify vinyl color number.</p> <p>► See <i>Understanding Customer's Own Material (COM)</i>, page 642.</p> <p>► See <i>Understanding Customer's Own Material (COM)</i>, page 642.</p> <p>Specify <i>with 4140 Arctic White Gloss</i>.</p> <p>Specify <i>with 4799 Platinum Metallic</i>.</p> <p>Specify plastic color number.</p> <p>Specify plastic color number.</p>
Cup Holder	• Cup holder	+\$ 52	Specify <i>with cup holder</i> .
Tablet Stand	• Tablet stand	+\$ 52	Specify <i>with tablet stand</i> .
Casters	<ul style="list-style-type: none"> • Hard casters • Soft dual-wheel casters for use on hard floors 	<p>No cost</p> <p>+\$ 47</p>	<p>Specify <i>with hard casters</i>.</p> <p>Specify <i>with soft casters</i>.</p>
Glides	• Non-marring plastic glides	+\$ 47	Specify <i>with glides</i> .

Specification Information	
Style Number	U.S. Base Price
TS31209A	\$1000

Shortcut

X Base Chair



Tip: Upholstery is only applicable if seat cushion is a selected option.

Tip: Craft in upholstery cautions the use of stripes and patterns on Shortcut. Please use fabric database when specifying.

Standard Includes		Required to Specify
▶ Need help? Product details, page 328	<ul style="list-style-type: none"> • Seat shell: plastic • Steel wire frame base: paint price group 1 • Standard glides • Ships fully assembled • Meets Cal. 117 requirements 	<ol style="list-style-type: none"> 1 Style number 2 Paint color number for base 3 Plastic color number for shell 4 Options, if selected (see below) <p>▶ See <i>Surface Materials</i>, page 634.</p>

Options	U.S. Price	Required to Specify
Seat Cushion	• Cushion +\$215	Specify with soft, felt glides.
Surface Materials	<p>Upholstery</p> <ul style="list-style-type: none"> • Fabric price group 1 No cost • Fabric price group 2 +\$ 16 • Fabric price group 3 +\$ 37 • Fabric price group 4 +\$ 53 • Fabric price group 5 +\$ 62 • Fabric price group 6 +\$ 77 • Fabric price group 7 +\$ 94 • Fabric price group 8 +\$113 • Fabric price group 9 +\$140 • Fabric price group 10 +\$162 • Steelcase leather +\$136 • Select Surfaces leather price group 1 +\$136 • Elmosoft leather +\$160 • Select Surfaces leather price group 2 +\$160 • Vinyl +\$ 16 • Customer's Own Material (COM) +\$ 56 <p>• Customer's Own Leather (COL) +\$ 56</p> <p>Base</p> <ul style="list-style-type: none"> • Paint price group 1 No cost • Paint price group 2 +\$ 56 • Paint price group 3 +\$ 86 <p>Shell</p> <ul style="list-style-type: none"> • Plastic price group 1 No cost • Plastic price group 2 +\$ 53 	<p>Specify fabric color number.</p> <p>Specify fabric color number.</p> <p>Specify fabric color number.</p> <p>Specify fabric color number.</p> <p>Specify fabric color number.</p> <p>Specify fabric color number.</p> <p>Specify fabric color number.</p> <p>Specify fabric color number.</p> <p>Specify fabric color number.</p> <p>Specify leather color number.</p> <p>▶ See <i>Surface Materials Reference Manual</i>.</p> <p>Specify Elmosoft color number.</p> <p>▶ See <i>Surface Materials Reference Manual</i>.</p> <p>Specify vinyl color number.</p> <p>▶ See <i>Understanding Customer's Own Material (COM)</i>, page 642.</p> <p>▶ See <i>Understanding Customer's Own Material (COM)</i>, page 642.</p> <p>Specify paint color number.</p> <p>Specify paint color number.</p> <p>Specify paint color number.</p> <p>Specify plastic color number.</p> <p>Specify plastic color number.</p>
Glides	• Soft, felt glides No cost	Specify with soft, felt glides.

Specification Information	
Style Number	U.S. Base Price
TS31204A	\$582

▶ Detailed dimensions, page 334

For Canadian Pricing
 Multiply U.S. Price by the Canadian price factor.
 ▶ See page 1 for details.



Shortcut

X Base Stool



Tip: Upholstery is only applicable if seat cushion is a selected option.

Tip: Craft in upholstery cautions the use of stripes and patterns on Shortcut. Please use fabric database when specifying.

Standard Includes		Required to Specify
<ul style="list-style-type: none"> ▶ Need help? Product details, page 328 	<ul style="list-style-type: none"> • Seat shell: plastic • Steel wire frame base: paint price group 1 • Standard glides • Ships fully assembled • Meets Cal. 117 requirements 	<ol style="list-style-type: none"> 1 Style number 2 Paint color number for base 3 Plastic color number for shell 4 Options, if selected (see below) <ul style="list-style-type: none"> ▶ See <i>Surface Materials</i>, page 634.

Options	U.S. Price	Required to Specify
Seat Cushion	• Cushion +\$215	Specify <i>with cushion</i> and specify fabric color number.
Surface Materials	Upholstery <ul style="list-style-type: none"> • Fabric price group 1 No cost • Fabric price group 2 +\$ 16 • Fabric price group 3 +\$ 37 • Fabric price group 4 +\$ 53 • Fabric price group 5 +\$ 62 • Fabric price group 6 +\$ 77 • Fabric price group 7 +\$ 94 • Fabric price group 8 +\$113 • Fabric price group 9 +\$140 • Fabric price group 10 +\$162 • Steelcase leather +\$136 • Select Surfaces leather price group 1 +\$136 • Elmosoft leather +\$160 • Select Surfaces leather price group 2 +\$160 • Vinyl +\$ 16 • Customer's Own Material (COM) +\$ 56 <ul style="list-style-type: none"> • Customer's Own Leather (COL) +\$ 56 	Specify fabric color number. Specify fabric color number. Specify fabric color number. Specify fabric color number. Specify fabric color number. Specify fabric color number. Specify fabric color number. Specify fabric color number. Specify fabric color number. Specify fabric color number. Specify fabric color number. Specify leather color number. ▶ See <i>Surface Materials Reference Manual</i> . Specify Elmosoft color number. ▶ See <i>Surface Materials Reference Manual</i> . Specify vinyl color number. ▶ See <i>Understanding Customer's Own Material (COM)</i> , page 642. ▶ See <i>Understanding Customer's Own Material (COM)</i> , page 642.
	Base <ul style="list-style-type: none"> • Paint price group 1 No cost • Paint price group 2 +\$ 56 • Paint price group 3 +\$ 86 	Specify paint color number. Specify paint color number. Specify paint color number.
	Shell <ul style="list-style-type: none"> • Plastic price group 1 No cost • Plastic price group 2 +\$ 53 	Specify plastic color number. Specify plastic color number.
Glides	• Soft, felt glides No cost	Specify <i>with soft, felt glides</i> .

Specification Information	
Style Number	U.S. Base Price
TS31205B	\$863

▶ Detailed dimensions, page 334



For Canadian Pricing
 Multiply U.S. Price by the Canadian price factor.
 ▶ See page 1 for details.

Shortcut

Wood Chair



Standard Includes		Required to Specify
<ul style="list-style-type: none"> ▶ Need help? Product details, page 328 	<ul style="list-style-type: none"> • Seat shell: plastic • Solid maple legs: wood stain • Steel brackets: paint group 1 • Standard glides • Ships fully assembled • Meets Cal. 117 requirements 	<ol style="list-style-type: none"> 1 Style number 2 Plastic color number for shell 3 Wood stain color number for legs: <ul style="list-style-type: none"> V1AC Natural Cherry V1AM Clear Maple VICC Medium Amber Cherry V1EW Dark Walnut 4 Paint color number for brackets 5 Options, if selected (see below) <ul style="list-style-type: none"> ▶ See <i>Surface Materials</i>, page 634.

Options	U.S. Price	Required to Specify
Seat Cushion <ul style="list-style-type: none"> • Cushion 	+\$215	Specify <i>with cushion</i> and specify fabric color number.
Surface Materials	Upholstery <ul style="list-style-type: none"> • Fabric price group 1 No cost • Fabric price group 2 +\$ 16 • Fabric price group 3 +\$ 37 • Fabric price group 4 +\$ 53 • Fabric price group 5 +\$ 62 • Fabric price group 6 +\$ 77 • Fabric price group 7 +\$ 94 • Fabric price group 8 +\$113 • Fabric price group 9 +\$140 • Fabric price group 10 +\$162 • Steelcase leather +\$136 • Select Surfaces leather price group 1 +\$136 • Elmosoft leather +\$160 • Select Surfaces leather price group 2 +\$160 • Vinyl +\$ 16 • Customer's Own Material (COM) +\$ 56 	Specify fabric color number. Specify fabric color number. Specify fabric color number. Specify fabric color number. Specify fabric color number. Specify fabric color number. Specify fabric color number. Specify fabric color number. Specify fabric color number. Specify fabric color number. Specify leather color number. ▶ See <i>Surface Materials Reference Manual</i> . Specify Elmosoft color number. ▶ See <i>Surface Materials Reference Manual</i> . Specify vinyl color number. ▶ See <i>Understanding Customer's Own Material (COM)</i> , page 642. ▶ See <i>Understanding Customer's Own Material (COM)</i> , page 642.
	Shell <ul style="list-style-type: none"> • Plastic price group 1 No cost • Plastic price group 2 +\$ 53 	Specify plastic color number. Specify plastic color number.
	Brackets <ul style="list-style-type: none"> • Paint price group 1 No cost • Paint price group 2 +\$ 56 • Paint price group 3 +\$ 86 	Specify paint color number. Specify paint color number. Specify paint color number.

Related Products <ul style="list-style-type: none"> • Shortcut X Base chair and stool 	▶ Pages 339–340
---	-----------------

Specification Information	
Style Number	U.S. Base Price
TS31206A	\$1232

▶ Detailed dimensions, page 334

 **For Canadian Pricing**
 Multiply U.S. Price by the Canadian price factor.
 ▶ See page 1 for details.

Shortcut

with Tripod Base

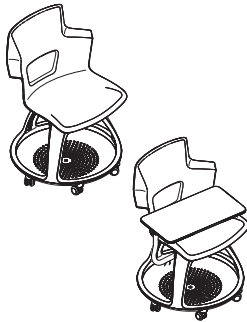

Tip: Metal components include shell bracket and personal worksurface arm if TS31208A is selected.

Tip: Upholstery is only applicable if seat cushion is a selected option.

Tip: Craft in upholstery cautions the use of stripes and patterns on Shortcut. Please use fabric database when specifying.

Tip: Cup Holder and Tablet Stand are only available on Shortcut with a Personal Worksurface.

► Detailed dimensions, page 334

 **For Canadian Pricing**
Multiply U.S. Price by the Canadian price factor.
► See page 1 for details.

Standard Includes		Required to Specify
► Need help? Product details, page 330	<ul style="list-style-type: none"> • Seat shell: plastic • Tripod base: plastic • Metal components: paint • Storage tray: sterling dark solid only • Swivel seat • Personal Worksurface, if TS31208A selected: plastic • Hard casters: black • Ships ready to assemble • Meets Cal. 117 requirements 	<ol style="list-style-type: none"> 1 Style number 2 Plastic color number for shell 3 Plastic color number for tripod base 4 Paint number for metal components: 0835 Black 4140 Arctic White 4799 Platinum Metallic 5 Plastic color number for Personal Worksurface, if selected 6 Options, if selected (see below) <p>► See <i>Surface Materials</i>, page 634.</p>

Options	U.S. Price	Required to Specify
Surface Materials	Upholstery on seat cushion	
	<ul style="list-style-type: none"> • Fabric price group 1 No cost • Fabric price group 2 +\$ 16 • Fabric price group 3 +\$ 37 • Fabric price group 4 +\$ 53 • Fabric price group 5 +\$ 62 • Fabric price group 6 +\$ 77 • Fabric price group 7 +\$ 94 • Fabric price group 8 +\$113 • Fabric price group 9 +\$140 • Fabric price group 10 +\$162 • Steelcase leather +\$136 • Select Surfaces leather price group 1 +\$136 • Elmosoft leather +\$160 • Select Surfaces leather price group 2 +\$160 • Customer's Own Material (COM) +\$ 56 • Vinyl +\$ 16 • Customer's Own Leather (COL) +\$ 56 	Specify fabric color number. Specify fabric color number. Specify fabric color number. Specify fabric color number. Specify fabric color number. Specify fabric color number. Specify fabric color number. Specify fabric color number. Specify fabric color number. Specify fabric color number. Specify fabric color number. Specify leather color number. ► See <i>Surface Materials Reference Manual</i> . Specify Elmosoft color number. ► See <i>Surface Materials Reference Manual</i> . ► See <i>Understanding Customer's Own Material (COM)</i> , page 642. Specify vinyl color number. ► See <i>Understanding Customer's Own Material (COM)</i> , page 642.
	Shell	
	<ul style="list-style-type: none"> • Plastic price group 1 No cost • Plastic price group 2 +\$ 53 	Specify plastic color number. Specify plastic color number.
Seat Cushion	<ul style="list-style-type: none"> • Cushion +\$215 	Specify <i>with cushion</i> and specify fabric color number.
Cup Holder	<ul style="list-style-type: none"> • On TS31208A +\$ 53 	Specify <i>with cup holder</i> .
Tablet Stand	<ul style="list-style-type: none"> • On TS31208A +\$ 53 	Specify <i>with tablet stand</i> .
Casters	<ul style="list-style-type: none"> • Soft, dual-wheel casters for use on hard floors +\$ 47 	Specify <i>with soft casters</i> .
Glides	<ul style="list-style-type: none"> • Glides: sterling dark solid +\$ 37 	Specify <i>with glides</i> .
Related Products	<ul style="list-style-type: none"> • Shortcut Cushions • Shortcut Five-Star Base Chair and Stool • Shortcut X-Base Chair and Stool 	► Page 344 ► Pages 336–337 ► Pages 339–340

Specification Information

Style Number	U.S. Base Price
--------------	-----------------

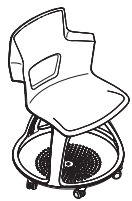

Chair with Tripod Base

TS31207A	\$ 707
-----------------	--------

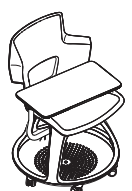

Chair with Tripod Base and Personal Worksurface

TS31208A	\$1036
-----------------	--------

► Detailed dimensions, page 334



For Canadian Pricing
 Multiply U.S. Price by the Canadian price factor.
 ► See page 1 for details.

Shortcut

Cushion



Tip: Cushion can be optioned on when ordering any Shortcut chair or stool, or installed after purchase when ordered separately.

Standard Includes		Required to Specify
<ul style="list-style-type: none"> ▶ Need help? Product details, page 324 	<ul style="list-style-type: none"> • Cushion: fabric price group 1 • Shipped ready to assemble • Meets Cal. 117 requirements 	<ul style="list-style-type: none"> 1 Style number 2 Fabric color number for cushion 3 Options, if selected (see below) ▶ See <i>Surface Materials</i>, page 634.

Surface Materials	Options	U.S. Price	Required to Specify
	Upholstery		
	• Fabric price group 1	No cost	Specify fabric color number.
	• Fabric price group 2	+\$ 16	Specify fabric color number.
	• Fabric price group 3	+\$ 37	Specify fabric color number.
	• Fabric price group 4	+\$ 53	Specify fabric color number.
	• Fabric price group 5	+\$ 62	Specify fabric color number.
	• Fabric price group 6	+\$ 77	Specify fabric color number.
	• Fabric price group 7	+\$ 94	Specify fabric color number.
	• Fabric price group 8	+\$113	Specify fabric color number.
	• Fabric price group 9	+\$140	Specify fabric color number.
	• Fabric price group 10	+\$162	Specify fabric color number.
	• Steelcase leather	+\$136	Specify leather color number.
	• Select Surfaces leather price group 1	+\$136	▶ See <i>Surface Materials Reference Manual</i> .
	• Elmosoft leather	+\$160	Specify Elmosoft color number.
	• Select Surfaces leather price group 2	+\$160	▶ See <i>Surface Materials Reference Manual</i> .
	• Vinyl	+\$ 16	Specify vinyl color number.
	• Customer's Own Material (COM)	+\$ 56	▶ See <i>Understanding Customer's Own Material (COM)</i> , page 642.
	• Customer's Own Leather (COL)	+\$ 56	▶ See <i>Understanding Customer's Own Material (COM)</i> , page 642.

Specification Information	
Style Number	U.S. Base Price
TS31203	\$215

▶ Detailed dimensions, page 334



For Canadian Pricing

Multiply U.S. Price by the Canadian price factor.

▶ See page 1 for details.

Understanding and Specifying Cachet 487 Series Work/Multi-Use Seating

Product Details

Cachet 487 Series	346
Dimensions	348

Specifying

Swivel-Base Work Chairs	350
Leg-Base Multi-Use Chairs	352
Swivel-Base Stools	354
Cushion Upholstery Packages	356
Accessories	360

Work Chairs

Cachet offers basic ergonomic comfort for people who have varied tasks and tend to be in and out of the office during the day. Features include adjustable seat height and a unique Balanced-Action Rocker (BAR) mechanism that allows users to recline easily without a manual adjustment. Also featured is the no front-rise seat—in other words, when you lean back, the front edge of the seat doesn't rise up, lifting your legs off the floor and cutting off circulation.

Adjustability Features

▶ See page 26 for a comparison to other chairs

Cachet 487 Series

Mechanisms

Balanced Action Rocker (BAR)	●
------------------------------	---

Seat Adjustments

Pneumatic height	●
------------------	---

Back Adjustments

Self adjusts	●
--------------	---

Other Features

Foot ring height (stool)	●
--------------------------	---

Cachet 487 Series

Cachet chairs are light-weight, extremely comfortable, multi-use chairs with a unique Balanced-Action Rocker (BAR) mechanism that allows the chair to recline in response to the user's weight.

Flexible, contoured back and seat have parallel slats that conform to individual users.

Nylon injection-molded tubular frame provides strength with minimal weight.

Plastic glides are standard. Optional soft glides are available.

Balanced-action rocker (BAR) mechanism allows every user to fully recline.

Five-star base is standard.

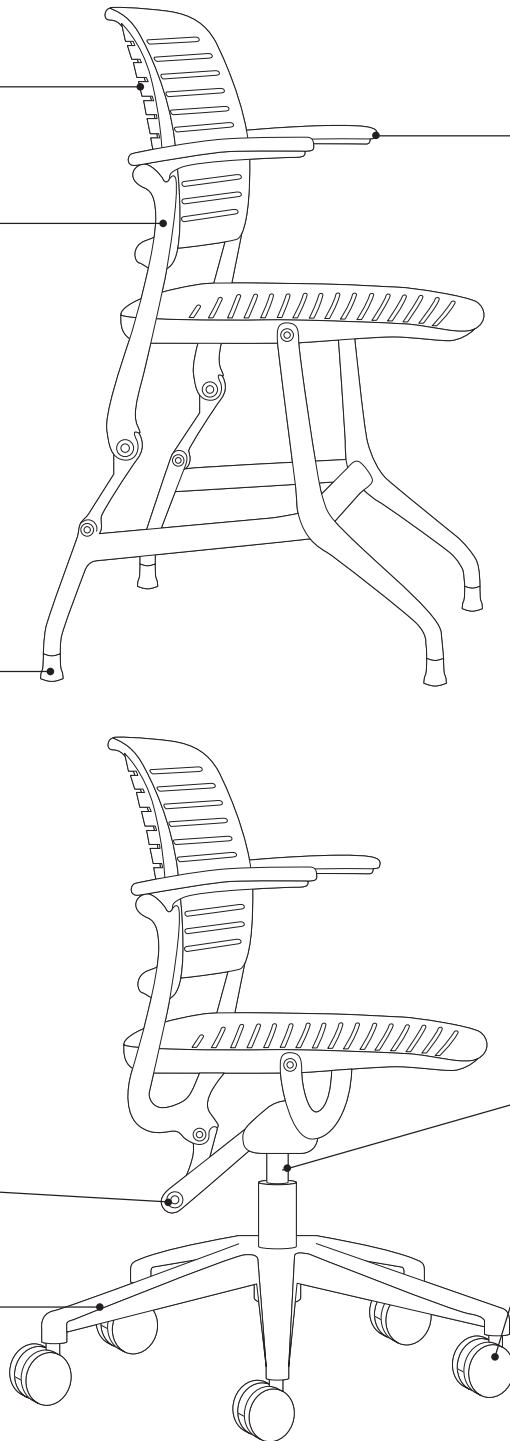

Flip-up arms easily lift to move out of the way or to allow for stacking.

Seat height adjusts within a 5" range (15½"H to 20½"H) with a pneumatic-adjustment mechanism.

Casters have hard, dual-wheels that roll smoothly on carpets. They are 2¾" diameter for increased mobility. Soft, dark grey treaded, dual-wheel roll-control casters are available for use on hard floors and mats.
Tip: Do not roll the chair across asphalt during installation as this may damage the casters.

Product Details



Chair bases are available in three styles—fixed-height four leg, adjustable-height swivel, and adjustable-height stool.

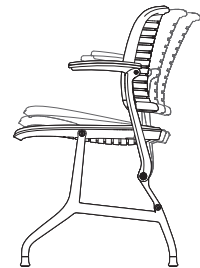

Balanced-action rocker (BAR) mechanism allows the user to recline for optimum comfort.



Upholstered cushions are available for use on chair back and seat. Cushions can be specified for factory installation or ordered separately for field installation. When specified with the chair, cushions are available for seat and back, or seat only. When ordered separately, cushions are available for seat and back, seat only, or back only. The cushions attach to the slats of back and seat.

Tip: You must specify plastic outer back color to match chair.

Soft, dark grey treaded, dual-wheel roll-control casters are available for use on hard floors or mats. Roll-control casters feature an internal brake that activates when the chair is not under load to reduce shifting when user stands up.

Hard plastic glides are standard on leg-base chairs.

Soft felt glides are available as an option for use on non-carpeted surfaces. The soft glide is reversible—soft on one side, hard on the other.

Leg-base chairs stack five high on the floor and 20 high on the dolly. Upholstery does not impact stacking capacity.

Leg-base chairs are available with or without flip-up arms. Chairs with or without arms can be stacked.

Other Features

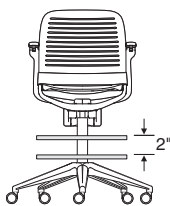

Foot ring height on stools adjusts by first lifting ring and rotating it counterclockwise to unlock. Then raise or lower ring up to 2" to desired position before rotating it clockwise to lock. The foot ring has a diameter of 20".

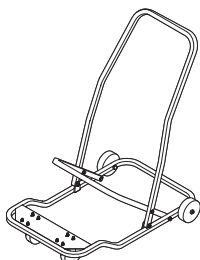

Transport and storage dolly is available to stack, move, and store up to 20 leg-base chairs. Upholstery does not impact stacking capacity. Swivel-base chairs will not stack.

Unloaded transport dolly measures 48"D x 23"W x 38¾"H.

Fully loaded transport dolly measures 51"D x 23"W x 78¾"H.

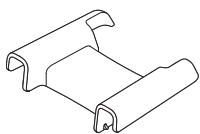

Ganging and alignment device is available to link leg-base chairs together in the field for evenly spaced rows. Chairs can be separated easily. Spacing between chairs linked with alignment device is 2".

Tip: You must specify plastic color of ganging and alignment device to match chairs.

Cachet is recommended for indoor use only.

Surface Materials

► See surface materials on page 634 for specific availability or refer to the *Surface Materials Reference Manual* for further information.

Hard components (frame, flip-up arms, back, seat, and base)

- Swivel and 4-leg chair models available in black and midnight
- Stool available in black only

Upholstery

- Fabric
- Fabric with soil-retardant treatment (option)
- Leather
- Elmosoft leather
- Select Surfaces leather
- Vinyl

Glides

- Color-matched plastic on leg-base chair
- Color-matched soft plastic on leg-base chair (option)

Casters

- Hard, black plastic wheels on swivel-base chair and stool
- Soft, dual-wheel roll-control black plastic wheels (option)

All Steelcase seating with standard upholstery fabrics complies with requirements of the State of California Technical Bulletin 117-2013. All standard seating is labeled to be in compliance with California 117-2013.

Programs & Services

► See the *Surface Materials Reference Manual* for further detail about programs and services offered for seating.

The Customer's Own Material (COM)

Program offers the opportunity for customers to select fabrics that are not offered through the standard Steelcase surface materials program for use on Steelcase products.

Through the COM program, Steelcase will test your materials for application on Steelcase products. Once approved, you can place your order. Steelcase will facilitate the entire ordering process and give you a production schedule. Steelcase will order the COM fabric directly from the textile manufacturer. For up-to-date information regarding fabric test results for all COM fabrics and details regarding yardage requirements for most Seating lines, visit the COM website. To locate the COM website:

- Visit www.steelcase.com

Soil retardants are treatments that provide long-term soil and stain resistance to a fabric without affecting the shade or the integrity of the fabric. The following Steelcase Textiles are available pre-treated with soil retardant. (You do not need to select the soil-retardant option for these fabrics and incur the upcharge.)

- Jacks
- Link

For information on soil retardant fabrics on Select Surfaces, please refer to the *Surface Materials Reference Manual*.

Soil-retardant treatment is available on all other seating fabrics at an additional upcharge per seating unit. To order this option, please select "Soil-Retardant Treatment" under "Optional Accessories."

For soil-retardant treatment on COMs, please select "Soil-Retardant Treatment" under "Optional Accessories." Minimums or additional yardage may be required. Please contact the vendor directly for specific information.

Extended lead times may be necessary for this service.

Contact your Steelcase Solutions Fulfillment Team Representative at 1.888.STEELCASE (1.888.783.3522) or send an email to lineone@steelcase.com.

Local codes may have special requirements for upholstery.

Dimensions

► Page 348

Resources

Printed Materials

► Cachet Product Brochure (08-0001115)

Online Resources

► Product Environmental Profiles, which provide key environmental attributes and product certifications can be found by searching for Steelcase at *Origin.build*.

Dimensions

Cachet 487 Series

Features	Overall Depth	Width	Height	Seat Depth	Functional Seat Depth	Seat Width*	Seat Height from Floor	Ring Height from Floor	Back Width	Back Height from Seat	Back Lumbar Height
----------	---------------	-------	--------	------------	-----------------------	-------------	------------------------	------------------------	------------	-----------------------	--------------------

Cachet 487 Series

Leg-Base Multi-Use Chairs

Fixed-Height	20½"	23"	34¼"	19¾"	16⅞"	16⅜"	17⅝"	N.A.	18½"	18¾"	8"
--------------	------	-----	------	------	------	------	------	------	------	------	----

Swivel-Base Work Chairs

Pneumatic	25"	25"	32⅛"–37⅛"	19¾"	16⅞"	16⅜"	15½"–20½"	N.A.	18½"	18¾"	8"
-----------	-----	-----	-----------	------	------	------	-----------	------	------	------	----

Stools

	25"	25"	39"–46"	19¾"	16⅞"	16⅜"	23"–30"	11¼"–13¼"	18½"	18¾"	8"
--	-----	-----	---------	------	------	------	---------	-----------	------	------	----

* **Seat width dimension** is taken close to the front edge of the seat. The dimension closer to the actual sitting surface is 19".

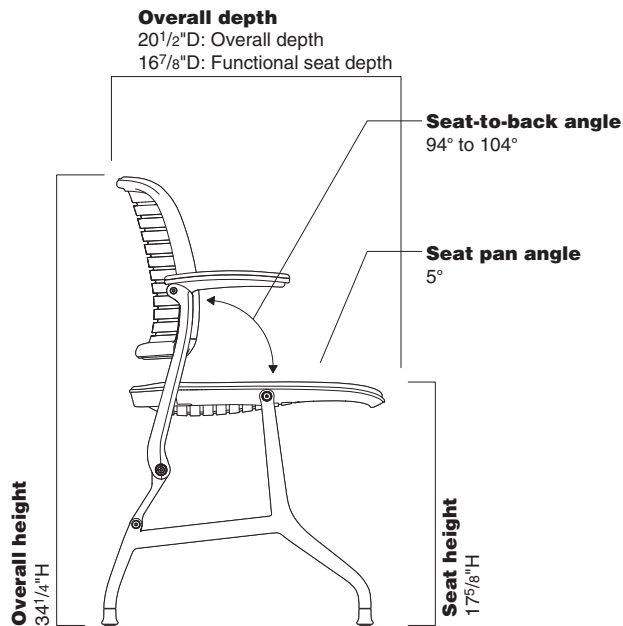
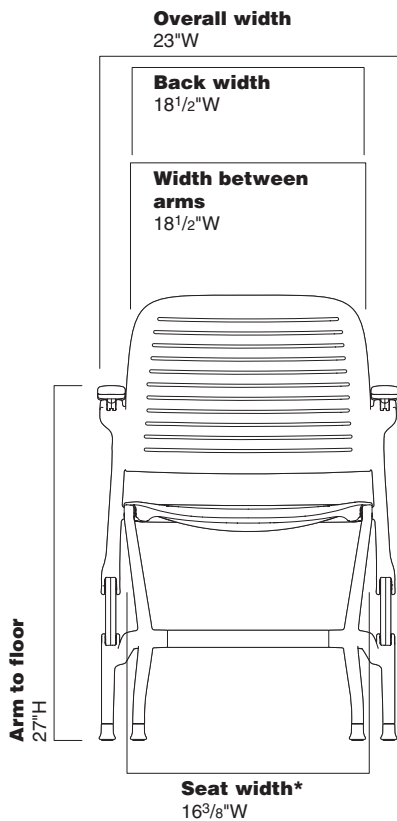

Leg-Base Multi-Use Chair

Width Between Arms	Arm to Floor	Arm Height from Seat	Seat Pan Angle	Angle Between Seat and Back
18½"	27"	10¾"	5°	94°–104°
18½"	25"–30"	10¾"	5°	94°–107°
18½"	33"–40"	10¾"	5°	94°–107°

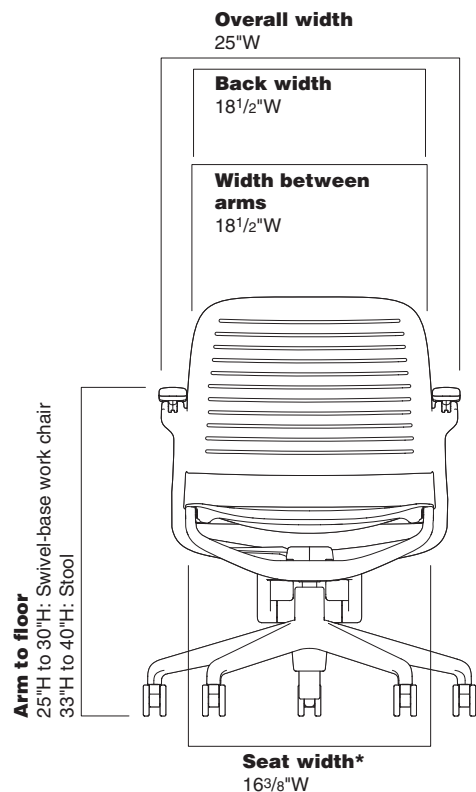

Swivel-Base Work Chair

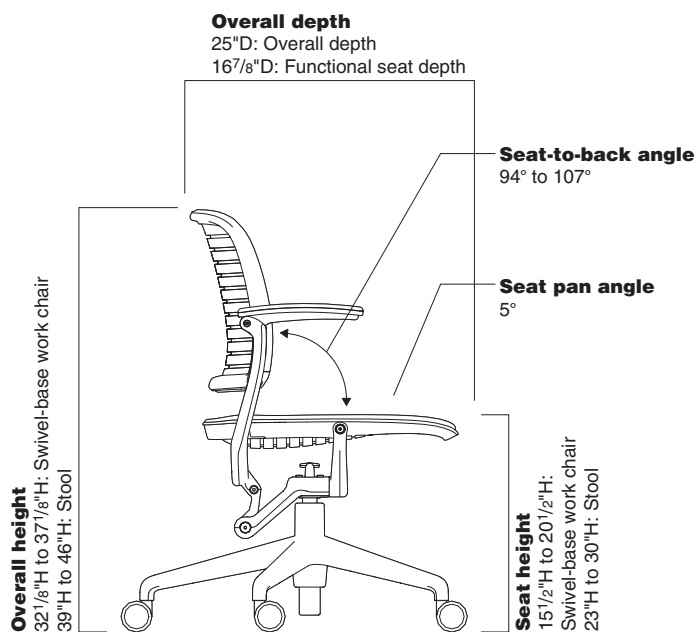

Cachet 487 Series

Cachet 487 Series Swivel-Base Work Chairs



Standard Includes	Required to Specify
<ul style="list-style-type: none"> ▶ Need help? Product details, page 346 Balanced-action rocker (BAR) mechanism Frame, seat, back, flip-up arms, and five-star base: plastic 5" pneumatic seat-height adjustment Upholstery, if selected: fabric price group 1 2³/₈" diameter, hard composition, dual-wheel casters: black plastic 	<ol style="list-style-type: none"> Style number Plastic color number for frame, seat, back, flip-up arms, and five-star base Fabric color number for upholstery on seat and back, or seat, if selected Options, if selected (see below) <ul style="list-style-type: none"> ▶ See <i>Surface Materials</i>, page 634.

Options	U.S. Price	Required to Specify
Surface Materials		
Upholstery on seat and back		
<ul style="list-style-type: none"> Fabric price group 1 Fabric price group 2 Fabric price group 3 Fabric price group 4 Fabric price group 5 Fabric price group 6 Fabric price group 7 Fabric price group 8 Fabric price group 9 Fabric price group 10 Steelcase leather upholstery 	<ul style="list-style-type: none"> No cost +\$ 37 +\$ 72 +\$100 +\$125 +\$154 +\$179 +\$223 +\$276 +\$312 +\$265 	<ul style="list-style-type: none"> Specify fabric color number. Specify fabric color number. Specify fabric color number. Specify fabric color number. Specify fabric color number. Specify fabric color number. Specify fabric color number. Specify fabric color number. Specify fabric color number. Specify fabric color number. Specify fabric color number. Add suffix S to the style number and specify leather color number. Add suffix S to the style number and specify Select Surfaces leather price group 1. ▶ See <i>Surface Materials Reference Manual</i> Add suffix S to the style number and specify Elmosoft leather color number. Add suffix S to the style number and specify Select Surfaces leather price group 2. ▶ See <i>Surface Materials Reference Manual</i> ▶ See <i>Surface Materials Reference Manual</i> to specify. Add suffix S to the style number and specify leather color number. ▶ See <i>Surface Materials Reference Manual</i> to specify.
<ul style="list-style-type: none"> Select Surfaces leather price group 1 	<ul style="list-style-type: none"> +\$265 	
<ul style="list-style-type: none"> Elmosoft leather upholstery 	<ul style="list-style-type: none"> +\$308 	
<ul style="list-style-type: none"> Select Surfaces leather price group 2 	<ul style="list-style-type: none"> +\$308 	
<ul style="list-style-type: none"> Customer's Own Material (COM) 	<ul style="list-style-type: none"> No cost 	
<ul style="list-style-type: none"> Customer's Own Leather (COL) 	<ul style="list-style-type: none"> No cost 	
Contrasting upholstery on seat and back		
<ul style="list-style-type: none"> Contrasting fabrics 	<ul style="list-style-type: none"> +\$ 46 	<ul style="list-style-type: none"> Add suffix K to the style number and specify fabric color numbers.
Contrasting upholstery on seat		
<ul style="list-style-type: none"> Fabric price group 1 Fabric price group 2 Fabric price group 3 Fabric price group 4 Fabric price group 5 Fabric price group 6 Fabric price group 7 Fabric price group 8 Fabric price group 9 Fabric price group 10 Steelcase leather upholstery 	<ul style="list-style-type: none"> No cost +\$ 20 +\$ 33 +\$ 48 +\$ 62 +\$ 77 +\$ 87 +\$ 111 +\$137 +\$154 +\$133 	<ul style="list-style-type: none"> Specify fabric color number. Specify fabric color number. Specify fabric color number. Specify fabric color number. Specify fabric color number. Specify fabric color number. Specify fabric color number. Specify fabric color number. Specify fabric color number. Specify fabric color number. Specify fabric color number. Add suffix S to the style number and specify leather color number. Add suffix S to the style number and specify leather color number. Add suffix S to the style number and specify leather color number. ▶ See <i>Surface Materials Reference Manual</i> to specify. Add suffix S to the style number and specify leather color number.
<ul style="list-style-type: none"> Select Surfaces leather price group 1 	<ul style="list-style-type: none"> +\$133 	
<ul style="list-style-type: none"> Elmosoft leather upholstery 	<ul style="list-style-type: none"> +\$154 	
<ul style="list-style-type: none"> Select Surfaces leather price group 2 	<ul style="list-style-type: none"> +\$154 	
<ul style="list-style-type: none"> Customer's Own Material (COM) 	<ul style="list-style-type: none"> No cost 	
<ul style="list-style-type: none"> Customer's Own Leather (COL) 	<ul style="list-style-type: none"> No cost 	

▶ Detailed dimensions, page 348

 **For Canadian Pricing**
 Multiply U.S. Price by the Canadian price factor.
 ▶ See page 1 for details.

▶ **Options, continued on next page**

► Options, continued from previous page

Options	U.S. Price	Required to Specify
Surface Materials, continued		
Contrasting upholstery on back		
• Fabric price group 1	No cost	Specify fabric color number.
• Fabric price group 2	+\$ 22	Specify fabric color number.
• Fabric price group 3	+\$ 35	Specify fabric color number.
• Fabric price group 4	+\$ 49	Specify fabric color number.
• Fabric price group 5	+\$ 62	Specify fabric color number.
• Fabric price group 6	+\$ 78	Specify fabric color number.
• Fabric price group 7	+\$ 92	Specify fabric color number.
• Fabric price group 8	+\$112	Specify fabric color number.
• Fabric price group 9	+\$137	Specify fabric color number.
• Fabric price group 10	+\$155	Specify fabric color number.
• Steelcase leather upholstery	+\$134	Add suffix S to the style number and specify leather color number.
• Select Surfaces leather price group 1	+\$134	Add suffix S to the style number and specify leather color number.
• Elmosoft leather upholstery	+\$154	Add suffix S to the style number and specify leather color number.
• Select Surfaces leather price group 2	+\$154	Add suffix S to the style number and specify leather color number.
• Customer's Own Material (COM)	No cost	► See <i>Surface Materials Reference Manual</i> to specify.
• Customer's Own Leather (COL)	No cost	Add suffix S to the style number and specify leather color number.
Soil-retardant treatment	+\$ 36	Specify with soil-retardant treatment.
Casters		
• Soft, dark grey treaded, dual-wheel roll-control casters for use on hard floors: black plastic	+\$ 36	Specify with soft roll-control casters.

Specification Information

Without Upholstery



• Style Number
• U.S. Base Price

4871110 \$1107

With Upholstered Seat



• Style Number
• U.S. Base Price

4871210 \$1325

With Upholstered Seat and Back



• Style Number
• U.S. Base Price

4871211 \$1429



For Canadian Pricing
Multiply U.S. Price by the Canadian price factor.
► See page 1 for details.

Cachet 487 Series Leg-Base Multi-Use Chairs T

Without Arms or with Flip-Up Arms



Standard Includes	Required to Specify
<ul style="list-style-type: none"> ▶ Need help? Product details, page 346 Balanced-action rocker (BAR) mechanism Frame, seat, back, and four-leg base: plastic Flip-up arms, if selected: plastic color to match frame, seat, and four-leg base Upholstery, if selected: fabric price group 1 Hard glides: color-matched to frame 	<ol style="list-style-type: none"> Style number Plastic color number for frame, seat, back, four-leg base, and flip-up arms, if selected Fabric color number for upholstery on seat and back, or seat, if selected Options, if selected (see below) <p>▶ See <i>Surface Materials</i>, page 634.</p>

Options	U.S. Price	Required to Specify
<p>Surface Materials</p> <p>Upholstery on seat and back</p> <ul style="list-style-type: none"> Fabric price group 1 Fabric price group 2 Fabric price group 3 Fabric price group 4 Fabric price group 5 Fabric price group 6 Fabric price group 7 Fabric price group 8 Fabric price group 9 Fabric price group 10 Steelcase leather upholstery Select Surfaces leather price group 1 Elmosoft leather upholstery Select Surfaces leather price group 2 Customer's Own Material (COM) Customer's Own Leather (COL) 	<p>No cost</p> <p>+\$ 37</p> <p>+\$ 72</p> <p>+\$100</p> <p>+\$125</p> <p>+\$154</p> <p>+\$179</p> <p>+\$223</p> <p>+\$276</p> <p>+\$312</p> <p>+\$265</p> <p>+\$265</p> <p>+\$308</p> <p>+\$308</p> <p>No cost</p> <p>No cost</p>	<p>Specify fabric color number.</p> <p>Specify fabric color number.</p> <p>Specify fabric color number.</p> <p>Specify fabric color number.</p> <p>Specify fabric color number.</p> <p>Specify fabric color number.</p> <p>Specify fabric color number.</p> <p>Specify fabric color number.</p> <p>Specify fabric color number.</p> <p>Specify fabric color number.</p> <p>Specify fabric color number.</p> <p>Add suffix S to the style number and specify leather color number.</p> <p>Add suffix S to the style number and specify Select Surfaces leather price group 1.</p> <p>▶ See <i>Surface Materials Reference Manual</i></p> <p>Add suffix S to the style number and specify Elmosoft leather color number.</p> <p>Add suffix S to the style number and specify Select Surfaces leather price group 2.</p> <p>▶ See <i>Surface Materials Reference Manual</i></p> <p>▶ See <i>Surface Materials Reference Manual</i> to specify.</p> <p>Add suffix S to the style number and specify leather color number.</p> <p>▶ See <i>Surface Materials Reference Manual</i> to specify.</p>
<p>Contrasting upholstery on seat and back</p> <ul style="list-style-type: none"> Contrasting fabrics 	<p>+\$ 46</p>	<p>Add suffix K to the style number and specify fabric color numbers.</p>
<p>Contrasting upholstery on seat</p> <ul style="list-style-type: none"> Fabric price group 1 Fabric price group 2 Fabric price group 3 Fabric price group 4 Fabric price group 5 Fabric price group 6 Fabric price group 7 Fabric price group 8 Fabric price group 9 Fabric price group 10 Steelcase leather upholstery Select Surfaces leather price group 1 Elmosoft leather upholstery Select Surfaces leather price group 2 Customer's Own Material (COM) Customer's Own Leather (COL) 	<p>No cost</p> <p>+\$ 20</p> <p>+\$ 33</p> <p>+\$ 48</p> <p>+\$ 62</p> <p>+\$ 77</p> <p>+\$ 87</p> <p>+\$111</p> <p>+\$137</p> <p>+\$154</p> <p>+\$133</p> <p>+\$133</p> <p>+\$154</p> <p>+\$154</p> <p>No cost</p> <p>No cost</p>	<p>Specify fabric color number.</p> <p>Specify fabric color number.</p> <p>Specify fabric color number.</p> <p>Specify fabric color number.</p> <p>Specify fabric color number.</p> <p>Specify fabric color number.</p> <p>Specify fabric color number.</p> <p>Specify fabric color number.</p> <p>Specify fabric color number.</p> <p>Specify fabric color number.</p> <p>Specify fabric color number.</p> <p>Add suffix S to the style number and specify leather color number.</p> <p>Add suffix S to the style number and specify leather color number.</p> <p>Add suffix S to the style number and specify leather color number.</p> <p>Add suffix S to the style number and specify leather color number.</p> <p>▶ See <i>Surface Materials Reference Manual</i> to specify.</p> <p>Add suffix S to the style number and specify leather color number.</p>

▶ Detailed dimensions, page 348

For Canadian Pricing
 Multiply U.S. Price by the Canadian price factor.
 ▶ See page 1 for details.

▶ **Options, continued on next page**

T = Transitional product

► Options, continued from previous page

Options	U.S. Price	Required to Specify
Surface Materials, continued		
Contrasting upholstery on back		
• Fabric price group 1	No cost	Specify fabric color number.
• Fabric price group 2	+\$ 22	Specify fabric color number.
• Fabric price group 3	+\$ 35	Specify fabric color number.
• Fabric price group 4	+\$ 49	Specify fabric color number.
• Fabric price group 5	+\$ 62	Specify fabric color number.
• Fabric price group 6	+\$ 78	Specify fabric color number.
• Fabric price group 7	+\$ 92	Specify fabric color number.
• Fabric price group 8	+\$112	Specify fabric color number.
• Fabric price group 9	+\$137	Specify fabric color number.
• Fabric price group 10	+\$155	Specify fabric color number.
• Steelcase leather upholstery	+\$133	Add suffix S to the style number and specify leather color number.
• Select Surfaces leather price group 1	+\$133	Add suffix S to the style number and specify leather color number.
• Elmosoft leather upholstery	+\$154	Add suffix S to the style number and specify leather color number.
• Select Surfaces leather price group 2	+\$154	Add suffix S to the style number and specify leather color number.
• Customer's Own Material (COM)	No cost	► See <i>Surface Materials Reference Manual</i> to specify.
• Customer's Own Leather (COL)	No cost	Add suffix S to the style number and specify leather color number.
Soil-retardant treatment	+\$ 36	Specify with soil-retardant treatment.
Glides		
• Soft felt glides: color matched to frame	+\$ 16	Specify with soft glides.

Specification Information

Without Upholstery



• Style Number
• U.S. Base Price

With Upholstered Seat



• Style Number
• U.S. Base Price

With Upholstered Seat and Back



• Style Number
• U.S. Base Price

Without Arms

4878100 \$665

4878200 \$ 883

4878201 \$ 987

Without Upholstery



• Style Number
• U.S. Base Price

With Upholstered Seat



• Style Number
• U.S. Base Price

With Upholstered Seat and Back



• Style Number
• U.S. Base Price

With Flip-Up Arms

4878110 \$842

4878210 \$1060

4878211 \$1164

= Transitional product

Cachet 487 Series Swivel-Base Stools



Standard Includes	Required to Specify
<ul style="list-style-type: none"> ▶ Need help? Product details, page 346 Balanced-action rocker (BAR) mechanism Frame, seat, back, flip-up arms, and five-star base: black plastic 7¾" pneumatic seat-height adjustment Upholstery, if selected: fabric price group 1 2⅜" diameter, hard composition, dual-wheel casters: black plastic 	<ol style="list-style-type: none"> 1 Style number 2 Fabric color number for upholstery on seat and back, or seat, if selected 3 Options, if selected (see below) <ul style="list-style-type: none"> ▶ See <i>Surface Materials</i>, page 634.

Options	U.S. Price	Required to Specify
Surface Materials		
Upholstery on seat and back		
• Fabric price group 1	No cost	Specify fabric color number.
• Fabric price group 2	+\$ 37	Specify fabric color number.
• Fabric price group 3	+\$ 72	Specify fabric color number.
• Fabric price group 4	+\$100	Specify fabric color number.
• Fabric price group 5	+\$125	Specify fabric color number.
• Fabric price group 6	+\$154	Specify fabric color number.
• Fabric price group 7	+\$179	Specify fabric color number.
• Fabric price group 8	+\$223	Specify fabric color number.
• Fabric price group 9	+\$276	Specify fabric color number.
• Fabric price group 10	+\$312	Specify fabric color number.
• Steelcase leather upholstery	+\$265	Specify fabric color number. Add suffix S to the style number and specify leather color number.
• Select Surfaces leather price group 1	+\$265	Add suffix S to the style number and specify Select Surfaces leather price group 1. ▶ See <i>Surface Materials Reference Manual</i>
• Elmosoft leather upholstery	+\$308	Add suffix S to the style number and specify Elmosoft leather color number.
• Select Surfaces leather price group 2	+\$308	Add suffix S to the style number and specify Select Surfaces leather price group 2. ▶ See <i>Surface Materials Reference Manual</i>
• Customer's Own Material (COM)	No cost	▶ See <i>Surface Materials Reference Manual</i> to specify.
• Customer's Own Leather (COL)	No cost	Add suffix S to the style number and specify leather color number. ▶ See <i>Surface Materials Reference Manual</i> to specify.
Contrasting upholstery on seat and back		
• Contrasting fabrics	+\$ 46	Add suffix K to the style number and specify fabric color numbers.
Contrasting upholstery on seat		
• Fabric price group 1	No cost	Specify fabric color number.
• Fabric price group 2	+\$ 20	Specify fabric color number.
• Fabric price group 3	+\$ 33	Specify fabric color number.
• Fabric price group 4	+\$ 48	Specify fabric color number.
• Fabric price group 5	+\$ 62	Specify fabric color number.
• Fabric price group 6	+\$ 77	Specify fabric color number.
• Fabric price group 7	+\$ 87	Specify fabric color number.
• Fabric price group 8	+\$111	Specify fabric color number.
• Fabric price group 9	+\$137	Specify fabric color number.
• Fabric price group 10	+\$154	Specify fabric color number.
• Steelcase leather upholstery	+\$133	Specify fabric color number. Add suffix S to the style number and specify leather color number.
• Select Surfaces leather price group 1	+\$133	Add suffix S to the style number and specify leather color number.
• Elmosoft leather upholstery	+\$154	Add suffix S to the style number and specify leather color number.
• Select Surfaces leather price group 2	+\$154	Add suffix S to the style number and specify leather color number. ▶ See <i>Surface Materials Reference Manual</i> to specify.
• Customer's Own Material (COM)	No cost	▶ See <i>Surface Materials Reference Manual</i> to specify.
• Customer's Own Leather (COL)	No cost	Add suffix S to the style number and specify leather color number.

▶ Detailed dimensions, page 348



For Canadian Pricing
Multiply U.S. Price by the Canadian price factor.
▶ See page 1 for details.

▶ **Options, continued on next page**

► Options, continued from previous page

Options	U.S. Price	Required to Specify
Surface Materials, continued		
Contrasting upholstery on back		
• Fabric price group 1	No cost	Specify fabric color number.
• Fabric price group 2	+\$ 22	Specify fabric color number.
• Fabric price group 3	+\$ 35	Specify fabric color number.
• Fabric price group 4	+\$ 49	Specify fabric color number.
• Fabric price group 5	+\$ 62	Specify fabric color number.
• Fabric price group 6	+\$ 78	Specify fabric color number.
• Fabric price group 7	+\$ 92	Specify fabric color number.
• Fabric price group 8	+\$112	Specify fabric color number.
• Fabric price group 9	+\$137	Specify fabric color number.
• Fabric price group 10	+\$155	Specify fabric color number.
• Steelcase leather upholstery	+\$134	Add suffix S to the style number and specify leather color number.
• Select Surfaces leather price group 1	+\$134	Add suffix S to the style number and specify leather color number.
• Elmosoft leather upholstery	+\$154	Add suffix S to the style number and specify leather color number.
• Select Surfaces leather price group 2	+\$154	Add suffix S to the style number and specify leather color number.
• Customer's Own Material (COM)	No cost	► See <i>Surface Materials Reference Manual</i> to specify.
• Customer's Own Leather (COL)	No cost	Add suffix S to the style number and specify leather color number.
Soil-retardant treatment	+\$ 36	Specify with soil-retardant treatment.
Casters		
• Soft, dark grey treaded, dual-wheel roll-control casters for use on hard floors: black plastic	+\$ 36	Specify with soft roll-control casters.

Specification Information

Without Upholstery



• Style Number

• U.S. Base Price

4877110 \$1574

With Upholstered Seat



• Style Number

• U.S. Base Price

4877210 \$1792

With Upholstered Seat and Back



• Style Number

• U.S. Base Price

4877211 \$1896



For Canadian Pricing

Multiply U.S. Price by the Canadian price factor.

► See page 1 for details.

Cushion Upholstery Packages

Cushion Upholstery Package for Back and Seat

For Use on Leg-Base, Swivel, and Stool Models

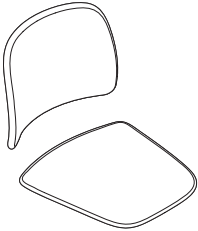

Standard Includes	Required to Specify
-------------------	---------------------

- | | |
|--|--|
| Standard Includes | Required to Specify |
| <ul style="list-style-type: none"> • Package of one seat and one back cushion • Cushion upholstery for seat and back: fabric price group 1 • Outer back: plastic to match chair | <ol style="list-style-type: none"> 1 Style number 2 Fabric color number 3 Specify plastic color of back to match chair 4 Options, if selected (see below) <p>▶ See <i>Surface Materials</i>, page 634.</p> |

Surface Materials	Options	U.S. Price	Required to Specify
-------------------	---------	------------	---------------------

Surface Materials	Options	U.S. Price	Required to Specify
	Upholstery on seat and back		
	• Fabric price group 1	No cost	Specify fabric color number.
	• Fabric price group 2	+\$ 37	Specify fabric color number.
	• Fabric price group 3	+\$ 72	Specify fabric color number.
	• Fabric price group 4	+\$100	Specify fabric color number.
	• Fabric price group 5	+\$125	Specify fabric color number.
	• Fabric price group 6	+\$154	Specify fabric color number.
	• Fabric price group 7	+\$179	Specify fabric color number.
	• Fabric price group 8	+\$223	Specify fabric color number.
	• Fabric price group 9	+\$276	Specify fabric color number.
	• Fabric price group 10	+\$312	Specify fabric color number.
	• Steelcase leather upholstery	+\$265	Add suffix S to the style number and specify leather color number.
	• Select Surfaces leather price group 1	+\$265	Add suffix S to the style number and specify Select Surfaces leather price group 1. ▶ See <i>Surface Materials Reference Manual</i> .
	• Elmosoft leather upholstery	+\$308	Add suffix S to the style number and specify Elmosoft leather color number.
	• Select Surfaces leather price group 2	+\$308	Add suffix S to the style number and specify Select Surfaces leather price group 2. ▶ See <i>Surface Materials Reference Manual</i> .
	• Customer's Own Material (COM)	No cost	▶ See <i>Surface Materials Reference Manual</i> to specify.
	• Customer's Own Leather (COL)	No cost	Add suffix S to the style number and specify leather color number. ▶ See <i>Surface Materials Reference Manual</i> .
	Contrasting upholstery on seat and back		
	• Contrasting fabrics	+\$ 46	Add suffix K to the style number and specify fabric color numbers.

▶ Options, continued on next page



For Canadian Pricing

Multiply U.S. Price by the Canadian price factor.

▶ See page 1 for details.

► Options, continued from previous page

Options	U.S. Price	Required to Specify
Surface Materials, continued		
Contrasting upholstery on seat		
• Fabric price group 1	No cost	Specify fabric color number.
• Fabric price group 2	+\$ 20	Specify fabric color number.
• Fabric price group 3	+\$ 33	Specify fabric color number.
• Fabric price group 4	+\$ 48	Specify fabric color number.
• Fabric price group 5	+\$ 62	Specify fabric color number.
• Fabric price group 6	+\$ 77	Specify fabric color number.
• Fabric price group 7	+\$ 87	Specify fabric color number.
• Fabric price group 8	+\$111	Specify fabric color number.
• Fabric price group 9	+\$137	Specify fabric color number.
• Fabric price group 10	+\$154	Specify fabric color number.
• Steelcase leather upholstery	+\$133	Add suffix S to the style number and specify leather color number.
• Select Surfaces leather price group 1	+\$133	Add suffix S to the style number and specify leather color number.
• Elmosoft leather upholstery	+\$154	Add suffix S to the style number and specify leather color number.
• Select Surfaces leather price group 2	+\$154	Add suffix S to the style number and specify leather color number.
• Customer's Own Material (COM)	No cost	► See <i>Surface Materials Reference Manual</i> to specify.
• Customer's Own Leather (COL)	No cost	Add suffix S to the style number and specify leather color number.
Contrasting upholstery on back		
• Fabric price group 1	No cost	Specify fabric color number.
• Fabric price group 2	+\$ 22	Specify fabric color number.
• Fabric price group 3	+\$ 35	Specify fabric color number.
• Fabric price group 4	+\$ 49	Specify fabric color number.
• Fabric price group 5	+\$ 62	Specify fabric color number.
• Fabric price group 6	+\$ 78	Specify fabric color number.
• Fabric price group 7	+\$ 92	Specify fabric color number.
• Fabric price group 8	+\$112	Specify fabric color number.
• Fabric price group 9	+\$137	Specify fabric color number.
• Fabric price group 10	+\$155	Specify fabric color number.
• Steelcase leather upholstery	+\$134	Add suffix S to the style number and specify leather color number.
• Select Surfaces leather price group 1	+\$134	Add suffix S to the style number and specify leather color number.
• Elmosoft leather upholstery	+\$154	Add suffix S to the style number and specify leather color number.
• Select Surfaces leather price group 2	+\$154	Add suffix S to the style number and specify leather color number.
• Customer's Own Material (COM)	No cost	► See <i>Surface Materials Reference Manual</i> to specify.
• Customer's Own Leather (COL)	No cost	Add suffix S to the style number and specify leather color number.
Soil-retardant treatment	+\$ 36	Specify with soil-retardant treatment.

Specification Information

• Style Number	• U.S. Base Price
•	•
•	•
•	•

Package of 1 Back Cushion and 1 Seat Cushion

487STBK	\$495
•	•
•	•

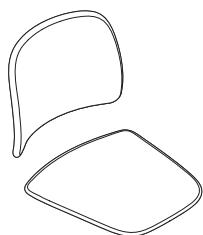

Cachet 487 Series

Cushion Upholstery Packages, continued

Cushion Upholstery Package for Back

For Use on Leg-Base, Swivel, and Stool Models

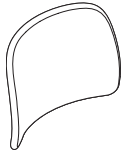

Standard Includes	Required to Specify
<ul style="list-style-type: none"> • One back cushion • Cushion upholstery for back: fabric price group 1 • Outer back: plastic to match chair 	<ol style="list-style-type: none"> 1 Style number 2 Fabric color number for cushion 3 Specify plastic color of back to match chair 4 Options, if selected (see below) <p>▶ See <i>Surface Materials</i>, page 634.</p>

	Options	U.S. Price	Required to Specify
Surface Materials	• Fabric price group 1	No cost	Specify fabric color number.
	• Fabric price group 2	+\$ 22	Specify fabric color number.
	• Fabric price group 3	+\$ 35	Specify fabric color number.
	• Fabric price group 4	+\$ 49	Specify fabric color number.
	• Fabric price group 5	+\$ 62	Specify fabric color number.
	• Fabric price group 6	+\$ 78	Specify fabric color number.
	• Fabric price group 7	+\$ 92	Specify fabric color number.
	• Fabric price group 8	+\$112	Specify fabric color number.
	• Fabric price group 9	+\$137	Specify fabric color number.
	• Fabric price group 10	+\$155	Specify fabric color number.
• Steelcase leather upholstery	+\$134	Add suffix S to the style number and specify leather color number.	
• Select Surfaces leather price group 1	+\$134	Add suffix S to the style number and specify Select Surfaces leather price group 1.	
• Elmosoft leather upholstery	+\$154	▶ See <i>Surface Materials Reference Manual</i> . Add suffix S to the style number and specify Elmosoft leather color number.	
• Select Surfaces leather price group 2	+\$154	Add suffix S to the style number and specify Select Surfaces leather price group 2.	
• Customer's Own Material (COM)	No cost	▶ See <i>Surface Materials Reference Manual</i> .	
• Customer's Own Leather (COL)	No cost	▶ See <i>Surface Materials Reference Manual</i> to specify. Add suffix S to the style number and specify leather color number.	
• Soil-retardant treatment	+\$ 36	▶ See <i>Surface Materials Reference Manual</i> . Specify with soil-retardant treatment.	

Specification Information

Style Number	U.S. Base Price
487BK	\$276
:	:



For Canadian Pricing

Multiply U.S. Price by the Canadian price factor.

▶ See page 1 for details.

Cushion Upholstery Package for Seat

For Use on Leg-Base, Swivel, and Stool Models

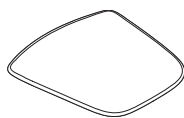

Standard Includes	Required to Specify
<ul style="list-style-type: none"> • One seat cushion • Cushion upholstery for seat: fabric price group 1 	<ol style="list-style-type: none"> 1 Style number 2 Fabric color number for cushion 3 Options, if selected (see below) <p>▶ See <i>Surface Materials</i>, page 634.</p>

Surface Materials	Options	U.S. Price	Required to Specify
	<ul style="list-style-type: none"> • Fabric price group 1 • Fabric price group 2 • Fabric price group 3 • Fabric price group 4 • Fabric price group 5 • Fabric price group 6 • Fabric price group 7 • Fabric price group 8 • Fabric price group 9 • Fabric price group 10 • Steelcase leather upholstery 	<p>No cost</p> <p>+\$ 20</p> <p>+\$ 33</p> <p>+\$ 48</p> <p>+\$ 62</p> <p>+\$ 77</p> <p>+\$ 87</p> <p>+\$111</p> <p>+\$137</p> <p>+\$154</p> <p>+\$133</p>	<p>Specify fabric color number.</p> <p>Specify fabric color number.</p> <p>Specify fabric color number.</p> <p>Specify fabric color number.</p> <p>Specify fabric color number.</p> <p>Specify fabric color number.</p> <p>Specify fabric color number.</p> <p>Specify fabric color number.</p> <p>Specify fabric color number.</p> <p>Specify fabric color number.</p> <p>Add suffix S to the style number and specify leather color number.</p> <p>Add suffix S to the style number and specify Select Surfaces leather price group 1.</p> <p>▶ See <i>Surface Materials Reference Manual</i>.</p> <p>Add suffix S to the style number and specify Elmosoft leather color number.</p> <p>Add suffix S to the style number and specify Select Surfaces leather price group 2.</p> <p>▶ See <i>Surface Materials Reference Manual</i>.</p> <p>▶ See <i>Surface Materials Reference Manual</i> to specify.</p> <p>Add suffix S to the style number and specify leather color number.</p> <p>▶ See <i>Surface Materials Reference Manual</i>. Specify <i>with soil-retardant treatment</i>.</p>
	<ul style="list-style-type: none"> • Select Surfaces leather price group 1 	<p>+\$133</p>	
	<ul style="list-style-type: none"> • Elmosoft leather upholstery 	<p>+\$154</p>	
	<ul style="list-style-type: none"> • Select Surfaces leather price group 2 	<p>+\$154</p>	
	<ul style="list-style-type: none"> • Customer's Own Material (COM) 	<p>No cost</p>	
	<ul style="list-style-type: none"> • Customer's Own Leather (COL) 	<p>No cost</p>	
	<ul style="list-style-type: none"> • Soil-retardant treatment 	<p>+\$ 36</p>	

Specification Information

Style Number	U.S. Base Price
487ST	\$276

Cachet 487 Series

For Canadian Pricing
 Multiply U.S. Price by the Canadian price factor.
 ▶ See page 1 for details.

Cachet 487 Series Accessories

Transport and Storage Dolly T

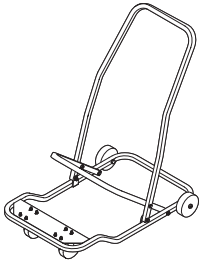

Tip: Transport and storage dolly is for leg-base chairs only.

Standard Includes	Required to Specify
<ul style="list-style-type: none"> ▶ Need help? Product details, page 347 • Transport and storage dolly: black paint only 	Style number

Specification Information	
• Style Number	• U.S. Price
487D T	\$885

Ganging and Alignment Devices T

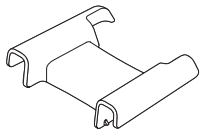

Tip: Ganging and alignment devices are for leg-base chairs only.

Standard Includes	Required to Specify
<ul style="list-style-type: none"> ▶ Need help? Product details, page 347 • Carton of 5 devices: color matched to frame 	<ul style="list-style-type: none"> 1 Style number 2 Plastic color number to match chair ▶ See <i>Surface Materials</i>, page 634.

Specification Information	
• Style Number	• U.S. Price
487G T	\$88



For Canadian Pricing
 Multiply U.S. Price by the Canadian price factor.
 ▶ See page 1 for details.

T = Transitional product

Understanding and Specifying Player 475 Series Multi-Use Seating

Product Details

Player 475 Series	362
Dimensions	364

Specifying

Leg-Base Multi-Use Chairs	366
Sled-Base Multi-Use Chairs	370
Leg-Base Stools	374
Accessories	376

Multi-Use Chairs

Multi-use chairs are suitable for use as occasional seating within team spaces, workstations, offices, or wherever extra seating is required.

- Player 475 Series
- Move 490 Series

Player 475 Series

Player chairs are guest chairs that also stack. Strength features in the back, arms, and back legs make Player a logical choice for high-traffic areas, and its simple, classic design complements a broad range of work settings.

Back and seat, including outer back, are fully upholstered. High-back and thick-seat options are available.

Arms slope downward and will easily clear the front edge of a worksurface or table. Arms are available in smooth or textured finish.

Steel frame is monochromatic.

Plastic glides with a hard plastic insert are standard.

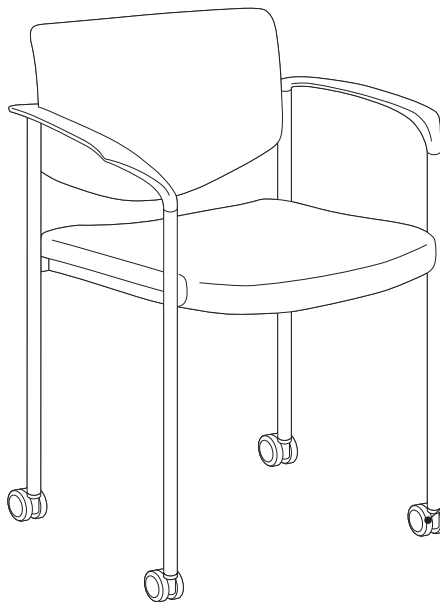
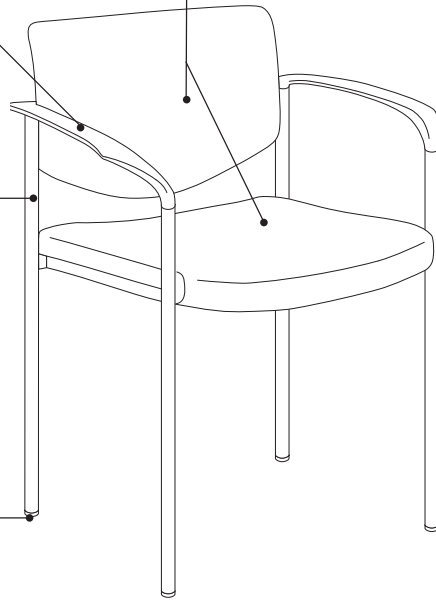

Casters have hard, dual wheels that roll smoothly on carpets. They are 2" in diameter for increased mobility. Soft, dual-wheel casters are available for use on hard floor or chair mats. Casters available in black only. *Tip: Do not roll the chair across asphalt during installation as this may damage the casters.*

Product Details

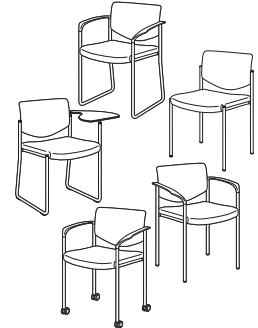

Chair models are available with a leg-base or a sled-base. Stools are available with a leg-base. The leg base arms are available with casters. Chairs and stools are available with several features such as arms, tablet arms, high back, and thick seat.

Stackability for leg-base models is six high on the floor and eight high on the transport and storage dolly. Leg-base models with casters are not recommended to stack as damage to arms may occur. Sled-base models, stools, and chairs with tablet arms will not stack.

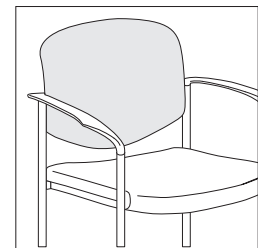

High-back option, available on all Player chairs and stools, adds 2½" to back height. Top edge is slightly rounded. Stackability is not affected.

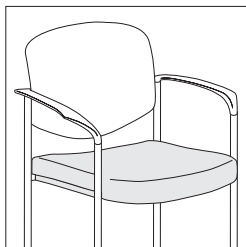

Thick-seat option, available on all Player chairs and stools, increases the thickness of the seat cushion by approximately 1/2". Stackability is not affected.

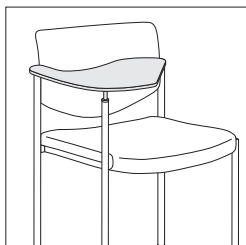

Tablet arm is available right hand and left hand and is shipped knocked down (K.D.). Tablet arm tilts for easy entrance and exit from chair. Tablet arm measures 25 1/2" x 13 1/2". Tablet arm is not available to order separately for installation on existing chairs.

Plastic glides, with hard plastic inserts on leg-base Player chairs, are recommended for carpeted surfaces only.

Soft felt glides are available on Player chairs for non-carpeted surfaces.

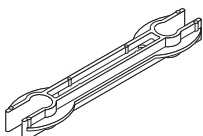

Alignment device is available to temporarily link chairs together for evenly spaced rows. Chairs can be unlinked easily. Spacing between chairs linked with alignment device is 5 7/8".

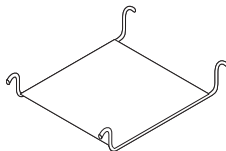

Ganging device is available to link chairs on a more permanent basis. It attaches to the chair's side frame. Spacing between chairs linked with the ganging device is approximately 9".

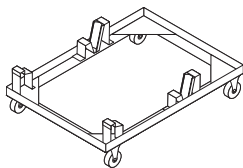

Transport and storage dolly is available to stack, move, and store up to eight chairs with or without arms. Without the dolly, chairs will stack up to six high. Sled-base models, stools, and chairs with tablet arms will not stack.

Fully loaded transport dolly measures 32 3/4"D x 25 1/2"W x 55 3/4"H.

Surface Materials

▶ See surface materials on page 634 for specific availability or refer to the *Surface Materials Reference Manual* for further information.

Upholstery

- Fabric
- Fabric with soil-retardant treatment (option)
- Vinyl

Hard components (arms, frames, and sled base)

- Monochromatic color from list of seating plastic color numbers can be applied to all hard components.

Arms

- Smooth plastic
- Textured plastic

Tablet arms

- Laminated

Casters

- Black only

Glides

- Plastic with hard plastic inserts come standard on leg-base multi-use chairs when specified with glides. Soft glides are available as an option.

All Steelcase seating with standard upholstery fabrics complies with requirements of the State of California Technical Bulletin 117-2013. All standard seating is labeled to be in compliance with California 117-2013.

Programs & Services

▶ See the *Surface Materials Reference Manual* for further detail about programs and services offered for seating.

The Customer's Own Material (COM)

Program offers the opportunity for customers to select fabrics that are not offered through the standard Steelcase surface materials program for use on Steelcase products. Through the COM program, Steelcase will test your materials for application on Steelcase products. Once approved, you can place your order. Steelcase will facilitate the entire ordering process and give you a production schedule. Steelcase will order the COM fabric directly from the textile manufacturer. For up-to-date information regarding fabric test results for all COM fabrics and details regarding yardage requirements for most Seating lines, visit the COM website. To locate the COM website:

- Visit www.steelcase.com

Soil retardants are treatments that provide long-term soil and stain resistance to a fabric without affecting the shade or the integrity of the fabric. The following Steelcase Textiles are available pre-treated with soil retardant. (You do not need to select the soil-retardant option for these fabrics and incur the upcharge.)

- Jacks
- Link

For information on soil retardant fabrics on Select Surfaces, please refer to the *Surface Materials Reference Manual*.

Soil-retardant treatment is available on all other seating fabrics at an additional upcharge per seating unit. To order this option, please select "Soil-Retardant Treatment" under "Optional Accessories."

For soil-retardant treatment on COMs, please select "Soil-Retardant Treatment" under "Optional Accessories." Minimums or additional yardage may be required. Please contact the vendor directly for specific information.

Extended lead times may be necessary for this service.

Contact your Steelcase Solutions Fulfillment Team Representative at 1.888.STEELCASE (1.888.783.3522) or send an email to lineone@steelcase.com.

Dimensions

▶ Page 364

Resources

Printed Materials

▶ Player Brochure (08-0001468)

Online Resources

▶ Product Environmental Profiles, which provide key environmental attributes and product certifications can be found by searching for Steelcase at *Origin.build*.

Dimensions

Player 475 Series

Features	Overall Depth	Width	Height	Seat Depth	Functional Seat Depth	Seat Width	Seat Height from Floor	Footrest Height from Floor	Back Width
Player 475 Series									
Leg-Base Chair with Arms									
	21¼"	25½"	30¼"	19¾"	17½"	18¼"	18¼"	N.A.	18½"
Leg-Base Chair without Arms									
	21¼"	20"	30¼"	19¾"	17½"	18¼"	18¼"	N.A.	18½"
Sled-Base Chair with Arms									
	21¼"	25½"	30¼"	19¾"	17½"	18¼"	18"	N.A.	18½"
Sled-Base Chair without Arms									
	21¼"	20"	30¼"	19¾"	17½"	18¼"	18"	N.A.	18½"
Leg-Base Stool with Arms									
	21¼"	25½"	42"	19¾"	17½"	18¼"	29½"	11⅞"	18½"
Leg-Base Stool without Arms									
	21¼"	20"	42"	19¾"	17½"	18¼"	29½"	11⅞"	18½"

Back Height from Seat	Back Lumbar Height	Width Between Arms	Arm to Floor	Arm Height from Seat	Seat Pan Angle	Angle Between Seat and Back
13 ³ / ₄ "	7 ¹ / ₄ "	20 ¹ / ₂ "	25 ¹ / ₄ "	8 ³ / ₈ "	4°	95°
13 ³ / ₄ "	7 ¹ / ₄ "	N.A.	N.A.	N.A.	4°	95°
13 ³ / ₄ "	7 ¹ / ₄ "	20 ¹ / ₂ "	25 ¹ / ₄ "	8 ³ / ₈ "	4°	95°
13 ³ / ₄ "	7 ¹ / ₄ "	N.A.	N.A.	N.A.	4°	95°
13 ³ / ₄ "	7 ¹ / ₄ "	20 ¹ / ₂ "	36 ¹ / ₂ "	8 ³ / ₈ "	4°	95°
13 ³ / ₄ "	7 ¹ / ₄ "	N.A.	N.A.	N.A.	4°	95°

Player 475 Series Leg-Base Multi-Use Chairs

With Open Arms or without Arms



Tip: Color choices are limited for chairs with textured plastic arms.

▶ Page 658

Tip: To price a chair without contrasting fabrics, add upholstery on seat and upholstery on back prices together.

Standard Includes		Required to Specify
▶ Need help? Product details, page 362	<ul style="list-style-type: none"> • Frame: monochromatic color • Arms, if selected: plastic color to match frame color • Upholstery: fabric price group 1 • Glides, if selected: plastic with hard plastic inserts • Hard composition, dual-wheel casters, if selected; black 	<ol style="list-style-type: none"> 1 Style number 2 Monochromatic color number from seating plastic colors for frame 3 Fabric color number for upholstery 4 Options, if selected (see below) <p>▶ See <i>Surface Materials</i>, page 634.</p>

Options	U.S. Price	Required to Specify
Surface Materials		
Upholstery on seat		
• Fabric price group 1	No cost	Specify fabric color number.
• Fabric price group 2	+\$ 20	Specify fabric color number.
• Fabric price group 3	+\$ 35	Specify fabric color number.
• Fabric price group 4	+\$ 49	Specify fabric color number.
• Fabric price group 5	+\$ 61	Specify fabric color number.
• Fabric price group 6	+\$ 87	Specify fabric color number.
• Fabric price group 7	+\$125	Specify fabric color number.
• Fabric price group 8	+\$164	Specify fabric color number.
• Fabric price group 9	+\$197	Specify fabric color number.
• Fabric price group 10	+\$228	Specify fabric color number.
• Customer's Own Material/ Vinyl (COM)	+\$ 26	▶ See <i>Surface Materials Reference Manual</i> .
Upholstery on back		
• Fabric price group 1	No cost	Specify fabric color number.
• Fabric price group 2	+\$ 20	Specify fabric color number.
• Fabric price group 3	+\$ 35	Specify fabric color number.
• Fabric price group 4	+\$ 49	Specify fabric color number.
• Fabric price group 5	+\$ 62	Specify fabric color number.
• Fabric price group 6	+\$ 88	Specify fabric color number.
• Fabric price group 7	+\$126	Specify fabric color number.
• Fabric price group 8	+\$164	Specify fabric color number.
• Fabric price group 9	+\$197	Specify fabric color number.
• Fabric price group 10	+\$228	Specify fabric color number.
• Customer's Own Material/ Vinyl (COM)	+\$ 27	▶ See <i>Surface Materials Reference Manual</i> .
Soil-retardant treatment	+\$ 36	Specify with soil-retardant treatment.
Platinum		
• Platinum frame	+\$ 85	Specify with 6249 Platinum.
Back and Seat		
• High back	+\$ 60	Specify with high back.
• Thick seat	+\$ 60	Specify with thick seat.
Glides		
• Soft felt glides for use on non-carpeted floors	+\$ 7	Specify with soft glides.
Casters		
• Soft, dual-wheel casters for use on hard floors	+\$ 36	Specify with soft casters.

▶ Detailed dimensions, page 364



For Canadian Pricing

Multiply U.S. Price by the Canadian price factor.

▶ See page 1 for details.

Specification Information

Style Number	U.S. Base Price
--------------	-----------------

Smooth Plastic Arms

With Glides

475412M \$626

.....

With Casters

475412MC \$708

.....

Textured Plastic Arms

With Glides

475415M \$626

.....

With Casters

475415MC \$708

.....

Without Arms

With Glides

475410M \$571

.....



Tip: Player without arms is only available with glides. Casters are not available.

 **For Canadian Pricing**
Multiply U.S. Price by the Canadian price factor.
▶ See page 1 for details.

Specification Information

Style Number	U.S. Base Price
--------------	-----------------

Right-Hand Tablet Arm

475410MTR	\$890
-----------	-------

Left-Hand Tablet Arm

475410MTL	\$890
-----------	-------



 **For Canadian Pricing**
Multiply U.S. Price by the Canadian price factor.
▶ See page 1 for details.

Player 475 Series Sled-Base Multi-Use Chairs

With Open Arms or without Arms



Tip: Color choices are limited for chairs with textured plastic arms.
▶ Page 658

Tip: To price a chair without contrasting fabrics, add upholstery on seat and upholstery on back prices together.

Standard Includes		Required to Specify
▶ Need help? Product details, page 362	<ul style="list-style-type: none"> • Frame: monochromatic color • Arms, if selected: plastic color to match frame color • Upholstery: fabric price group 1 • Glides: plastic with hard plastic inserts 	<ol style="list-style-type: none"> 1 Style number 2 Monochromatic color number from seating plastic colors for frame 3 Fabric color number for upholstery 4 Options, if selected (see below) <p>▶ See <i>Surface Materials</i>, page 634.</p>

Options	U.S. Price	Required to Specify
Surface Materials		
Upholstery on seat		
• Fabric price group 1	No cost	Specify fabric color number.
• Fabric price group 2	+\$ 20	Specify fabric color number.
• Fabric price group 3	+\$ 35	Specify fabric color number.
• Fabric price group 4	+\$ 49	Specify fabric color number.
• Fabric price group 5	+\$ 61	Specify fabric color number.
• Fabric price group 6	+\$ 87	Specify fabric color number.
• Fabric price group 7	+\$125	Specify fabric color number.
• Fabric price group 8	+\$164	Specify fabric color number.
• Fabric price group 9	+\$197	Specify fabric color number.
• Fabric price group 10	+\$228	Specify fabric color number.
• Customer's Own Material/ Vinyl (COM)	+\$ 26	▶ See <i>Surface Materials Reference Manual</i> .
Upholstery on back		
• Fabric price group 1	No cost	Specify fabric color number.
• Fabric price group 2	+\$ 20	Specify fabric color number.
• Fabric price group 3	+\$ 35	Specify fabric color number.
• Fabric price group 4	+\$ 49	Specify fabric color number.
• Fabric price group 5	+\$ 62	Specify fabric color number.
• Fabric price group 6	+\$ 88	Specify fabric color number.
• Fabric price group 7	+\$126	Specify fabric color number.
• Fabric price group 8	+\$164	Specify fabric color number.
• Fabric price group 9	+\$197	Specify fabric color number.
• Fabric price group 10	+\$228	Specify fabric color number.
• Customer's Own Material/ Vinyl (COM)	+\$ 27	▶ See <i>Surface Materials Reference Manual</i> .
Soil-retardant treatment	+\$ 36	Specify with soil-retardant treatment.
Platinum		
• Platinum frame	+\$ 85	Specify with 6249 Platinum.
Back and Seat		
• High back	+\$ 60	Specify with high back.
• Thick seat	+\$ 60	Specify with thick seat.
Glides		
• Soft felt glides for use on non-carpeted floors	+\$ 7	Specify with soft glides.

▶ Detailed dimensions, page 364



For Canadian Pricing

Multiply U.S. Price by the Canadian price factor.

▶ See page 1 for details.

Specification Information

Style Number	U.S. Base Price
--------------	-----------------

Smooth Plastic Arms

475482M	\$805
---------	-------

Textured Plastic Arms

475485M	\$805
---------	-------

Without Arms

475480M	\$750
---------	-------



For Canadian Pricing
Multiply U.S. Price by the
Canadian price factor.
▶ See page 1 for details.

Player 475 Series Sled-Base Multi-Use Chairs

With Tablet Arm



Tip: To price a chair without contrasting fabrics, add upholstery on seat and upholstery on back prices together.

Standard Includes		Required to Specify	
<ul style="list-style-type: none"> ▶ Need help? Product details, page 362 	<ul style="list-style-type: none"> • Frame: monochromatic color • Tablet arm: laminate • Upholstery: fabric price group 1 • Glides: plastic with hard plastic inserts 	<ol style="list-style-type: none"> 1 Style number 2 Monochromatic color number from seating plastic colors for frame 3 Fabric color number for upholstery 4 Laminate color number for tablet arm 5 Options, if selected (see below) 	<ul style="list-style-type: none"> ▶ See <i>Surface Materials</i>, page 634.

Options	U.S. Price	Required to Specify
Surface Materials		
Upholstery on seat		
<ul style="list-style-type: none"> • Fabric price group 1 • Fabric price group 2 • Fabric price group 3 • Fabric price group 4 • Fabric price group 5 • Fabric price group 6 • Fabric price group 7 • Fabric price group 8 • Fabric price group 9 • Fabric price group 10 • Customer's Own Material/ Vinyl (COM) 	<ul style="list-style-type: none"> No cost +\$ 20 +\$ 35 +\$ 49 +\$ 61 +\$ 87 +\$125 +\$164 +\$197 +\$228 +\$ 26 	<ul style="list-style-type: none"> Specify fabric color number. Specify fabric color number. Specify fabric color number. Specify fabric color number. Specify fabric color number. Specify fabric color number. Specify fabric color number. Specify fabric color number. Specify fabric color number. Specify fabric color number. ▶ See <i>Surface Materials Reference Manual</i>.
Upholstery on back		
<ul style="list-style-type: none"> • Fabric price group 1 • Fabric price group 2 • Fabric price group 3 • Fabric price group 4 • Fabric price group 5 • Fabric price group 6 • Fabric price group 7 • Fabric price group 8 • Fabric price group 9 • Fabric price group 10 • Customer's Own Material/ Vinyl (COM) 	<ul style="list-style-type: none"> No cost +\$ 20 +\$ 35 +\$ 49 +\$ 62 +\$ 88 +\$126 +\$164 +\$197 +\$228 +\$ 27 	<ul style="list-style-type: none"> Specify fabric color number. Specify fabric color number. Specify fabric color number. Specify fabric color number. Specify fabric color number. Specify fabric color number. Specify fabric color number. Specify fabric color number. Specify fabric color number. Specify fabric color number. ▶ See <i>Surface Materials Reference Manual</i>.
Soil-retardant treatment	+\$ 36	Specify with soil-retardant treatment.
Platinum		
<ul style="list-style-type: none"> • Platinum frame 	+\$ 85	Specify with 6249 Platinum.
Back and Seat		
<ul style="list-style-type: none"> • High back • Thick seat 	<ul style="list-style-type: none"> +\$ 60 +\$ 60 	<ul style="list-style-type: none"> Specify with high back. Specify with thick seat.
Glides	+\$ 7	Specify with soft glides.

▶ Detailed dimensions, page 364



For Canadian Pricing

Multiply U.S. Price by the Canadian price factor.

▶ See page 1 for details.

Specification Information

Style Number	U.S. Base Price
--------------	-----------------



Right-Hand Tablet Arm

475480MTR	\$1069
-----------	--------



Left-Hand Tablet Arm

475480MTL	\$1069
-----------	--------

 **For Canadian Pricing**
Multiply U.S. Price by the Canadian price factor.
▶ See page 1 for details.

Player 475 Series Leg-Base Stools



Tip: Color choices are limited for chairs with textured plastic arms.
▶ Page 658

Tip: To price a chair without contrasting fabrics, add upholstery on seat and upholstery on back prices together.

Standard Includes		Required to Specify	
▶ Need help? Product details, page 362	<ul style="list-style-type: none"> • Frame: monochromatic color • Arms, if selected: plastic color to match frame color • Upholstery: fabric price group 1 • Glides: plastic with hard plastic inserts 	<ol style="list-style-type: none"> 1 Style number 2 Monochromatic color number from seating plastic colors for frame 3 Fabric color number for upholstery 4 Options, if selected (see below) 	▶ See <i>Surface Materials</i> , page 634.

Options	U.S. Price	Required to Specify	
Surface Materials			
Upholstery on seat			
• Fabric price group 1	No cost	Specify fabric color number.	
• Fabric price group 2	+\$ 20	Specify fabric color number.	
• Fabric price group 3	+\$ 35	Specify fabric color number.	
• Fabric price group 4	+\$ 49	Specify fabric color number.	
• Fabric price group 5	+\$ 61	Specify fabric color number.	
• Fabric price group 6	+\$ 87	Specify fabric color number.	
• Fabric price group 7	+\$125	Specify fabric color number.	
• Fabric price group 8	+\$164	Specify fabric color number.	
• Fabric price group 9	+\$197	Specify fabric color number.	
• Fabric price group 10	+\$228	Specify fabric color number.	
• Customer's Own Material/ Vinyl (COM)	+\$ 26	▶ See <i>Surface Materials Reference Manual</i> .	
Upholstery on back			
• Fabric price group 1	No cost	Specify fabric color number.	
• Fabric price group 2	+\$ 20	Specify fabric color number.	
• Fabric price group 3	+\$ 35	Specify fabric color number.	
• Fabric price group 4	+\$ 49	Specify fabric color number.	
• Fabric price group 5	+\$ 62	Specify fabric color number.	
• Fabric price group 6	+\$ 88	Specify fabric color number.	
• Fabric price group 7	+\$126	Specify fabric color number.	
• Fabric price group 8	+\$164	Specify fabric color number.	
• Fabric price group 9	+\$197	Specify fabric color number.	
• Fabric price group 10	+\$228	Specify fabric color number.	
• Customer's Own Material/ Vinyl (COM)	+\$ 27	▶ See <i>Surface Materials Reference Manual</i> .	
Soil-retardant treatment	+\$ 36	Specify <i>with soil-retardant treatment</i> .	
Platinum			
• Platinum frame	+\$ 85	Specify <i>with 6249 Platinum</i> .	
Back and Seat			
• High back	+\$ 60	Specify <i>with high back</i> .	
• Thick seat	+\$ 60	Specify <i>with thick seat</i> .	
Glides			
• Soft felt glides for use on non-carpeted floors	+\$ 7	Specify <i>with soft glides</i> .	

▶ Detailed dimensions, page 364



For Canadian Pricing
Multiply U.S. Price by the Canadian price factor.
▶ See page 1 for details.

Specification Information

Style Number	U.S. Base Price
--------------	-----------------



Smooth Plastic Arms

475712M	\$1075
----------------	--------



Textured Plastic Arms

475715M	\$1075
----------------	--------



Without Arms

475710M	\$1020
----------------	--------

 **For Canadian Pricing**
Multiply U.S. Price by the Canadian price factor.
▶ See page 1 for details.

Player 475 Series Accessories

Alignment Device

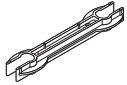

Tip: One pair is required to align two chairs.

Standard Includes		Required to Specify
<ul style="list-style-type: none"> Alignment device: black paint only Package of 5 pairs 		Style number
Specification Information		
Style Number	U.S. Price	
475A	\$121	

Ganging Device

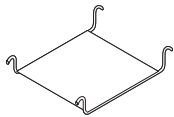

Tip: Use one ganging device for every two chairs.

Standard Includes		Required to Specify
<ul style="list-style-type: none"> Ganging device: black paint only Package of 2 		Style number
Specification Information		
Style Number	U.S. Price	
475G	\$149	

Transport and Storage Dolly

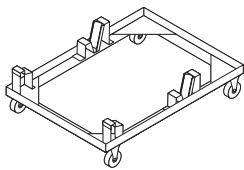

Standard Includes		Required to Specify
<ul style="list-style-type: none"> Transport and storage dolly: black paint only 		Style number
Specification Information		
Style Number	U.S. Price	
475D	\$502	



For Canadian Pricing
 Multiply U.S. Price by the Canadian price factor.
 ▶ See page 1 for details.

Understanding and Specifying Turnstone Simple

Multi-Use Seating



Product Details

Simple	378
--------	-----



Specifying

Simple	380
--------	-----

Simple

Simple chair is a light-weight, stackable seating family with easily changeable cushions and slipcovers providing a range of aesthetics, price points, and comfort.

▶ Specifying, page 380

Chair, stool, and lounge are available in several paints.

Seat and back are made of polypropylene plastic.

Simple Chair is light-weight at 12 pounds and ships fully assembled.

Frame is made of steel with a powder coated finish.

Stacking spacers allow chair, stool, and lounge to be stacked up to four high, with or without cushions or slipcovers.

Simple Stool is light-weight at 17 pounds and ships fully assembled.

Hard glides are standard.

Simple Lounge is light-weight at 17½ pounds and ships fully assembled.

Simple Lounge is a lounge chair designed to have the right recline and pitch to work at a lounge height table.

Simple Lounge polypropylene arm caps, back, and seat match paint color selected.

Actual Dimensions

	Chair	Stool	Lounge
Depth	19 ² / ₃ "	19 ² / ₃ "	20 ⁹ / ₁₆ "
Width	19 ² / ₃ "	19 ² / ₃ "	29 ¹ / ₄ "
Height	31 ⁸ / ₉ "	38 ⁴ / ₇ "	29 ¹⁵ / ₁₆ "
Seat Height	17 ⁵ / ₇ "	29 ¹ / ₂ "	16 ¹ / ₄ "
Weight Limit	275 lbs	275 lbs	275 lbs

Product Details

Frame only



Seat cushion



Seat and back cushion



Relaxed slipcover



Tailored slipcover

Chairs, stools, and lounges are available as shown above.

Seat and back cushion options are available for extra support and comfort. Both are easily removable and replaceable.

Slipcover option provides a range of aesthetics and additional support and comfort. Slipcover is easily removable and replaceable as well.

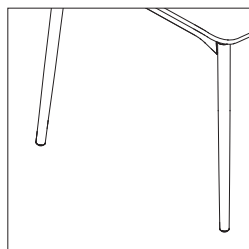

Legs are tapered.

Surface Materials**Chairs, stools, and lounges**

- 7041 Milk Textured
- 7042 Shale Grey
- 7043 Moss
- 7207 Black

Webbing on Relaxed Slipcover

- 5JG0 Black
- 5JG1 Burgundy
- 5JG5 Red
- 5JG7 Green
- 5JG8 Navy

Seat/back cushion and Relaxed/Tailored Slipcovers**Price Group 1**

- Buzz2
- Era
- Jacks
- New Black
- Link

Tip: New Black upholstery has fabric in both price group 1 and price group 2.

Price Group 2

- Chainmail
- Cogent: Connect
- New Black
- Nitelights

Tip: New Black upholstery has fabric in both price group 1 and price group 2.

Price Group 3

- Billiard Multi-Use by Designtex
- Gaja
- Redeem
- Retrieve

Price Group 5

- Bo Peep
- Remix
- Silk

Price Group 6

- Brisa

Price Group 7

- Steelcut Trio

Simple Chair



Tip: Cushions or slipcover can be installed after purchase and are ordered separately.

Tip: Chairs, stools, and lounge can be stacked up to four high with or without cushions and slipcovers.

Standard Includes	Required to Specify
-------------------	---------------------

- | | | |
|--|---|---|
| <ul style="list-style-type: none"> ▶ Need help? Product details, page 378 | <ul style="list-style-type: none"> • Steel frame: paint • Seat and back: plastic, default to match paint color for frame • Standard hard glides • Ships fully assembled | <ul style="list-style-type: none"> 1 Style number 2 Paint color number for chair: <ul style="list-style-type: none"> 7041 Milk Textured 7042 Shale Grey 7043 Moss 7207 Black |
|--|---|---|

Related Products

- | | |
|---|--|
| <ul style="list-style-type: none"> • Simple Stool • Seat Cushion • Back Cushion • Relaxed Slipcover • Tailored Slipcover | <ul style="list-style-type: none"> ▶ Page 381 ▶ Page 383 ▶ Page 384 ▶ Page 385 ▶ Page 386 |
|---|--|

Specification Information				
• Dimensions			• Style	• U.S.
D	W	H	Number	Price

19 ² / ₃ "	19 ² / ₃ "	31 ⁸ / ₉ "	TSAVNCH	\$458
----------------------------------	----------------------------------	----------------------------------	----------------	-------



For Canadian Pricing

Multiply U.S. Price by the Canadian price factor.

▶ See page 1 for details.

Simple Stool

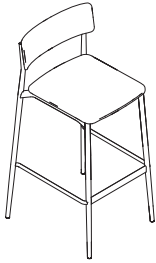

Tip: Cushions or slipcover can be installed after purchase and are ordered separately.

Tip: Chairs, stools, and lounge can be stacked up to four high with or without cushions and slipcovers.

Standard Includes		Required to Specify
▶ Need help? Product details, page 378	<ul style="list-style-type: none"> • Steel frame: paint • Seat and back: plastic, default to match paint color for frame • Standard hard glides • Ships fully assembled 	1 Style number 2 Paint color number for stool: 7041 Milk Textured 7042 Shale Grey 7043 Moss 7207 Black

Related Products	
<ul style="list-style-type: none"> • Simple Chair • Simple Lounge • Seat Cushion • Back Cushion • Relaxed Slipcover • Tailored Slipcover 	<ul style="list-style-type: none"> ▶ Page 380 ▶ Page 382 ▶ Page 383 ▶ Page 384 ▶ Page 385 ▶ Page 386

Specification Information				
Dimensions			Style	U.S.
D	W	H	Number	Price
19 ² / ₃ "	19 ² / ₃ "	38 ⁴ / ₇ "	TSAVNST	\$688

 **For Canadian Pricing**
 Multiply U.S. Price by the Canadian price factor.
 ▶ See page 1 for details.



Simple Lounge

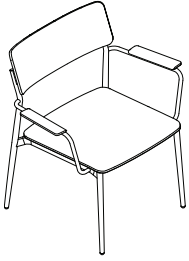

Tip: Simple Lounge can be stacked up to four high with or without cushions and slipcovers.

Standard Includes		Required to Specify
▶ Need help? Product details, page 378	<ul style="list-style-type: none"> • Steel frame: paint • Seat and back: plastic, default to match paint color for frame • Standard hard glides • Ships fully assembled 	1 Style number 2 Paint color number for stool: 7041 Milk Textured 7042 Shale Grey 7043 Moss 7207 Black

Related Products	
<ul style="list-style-type: none"> • Simple Chair • Simple Stool • Seat Cushion • Back Cushion • Relaxed Slipcover • Tailored Slipcover 	<ul style="list-style-type: none"> ▶ Page 380 ▶ Page 381 ▶ Page 383 ▶ Page 384 ▶ Page 385 ▶ Page 386

Specification Information				
• Dimensions			• Style	• U.S.
D	W	H	Number	Price
20 ⁹ / ₁₆ "	29 ¹ / ₄ "	29 ¹⁵ / ₁₆ "	TSAVNLC	\$719



For Canadian Pricing
 Multiply U.S. Price by the Canadian price factor.
 ▶ See page 1 for details.

Simple Seat Cushion

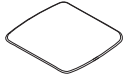

Tip: Seat and back cushions are ordered separately and can be in matching or contrasting fabrics and colors.

Tip: Chairs, stools, and lounge can be stacked up to four high with or without cushions and slipcovers.

Standard Includes		Required to Specify
▶ Need help? Product details, page 379	<ul style="list-style-type: none"> Cushion: fabric price group 1 Shipped ready to assemble 	<ol style="list-style-type: none"> Style number Application (see Required Selections) Fabric color number for cushion Options, if selected (see below) <p>▶ See Surface Materials, page 634.</p>

	Required Selections	U.S. Price	Required to Specify
Application	<ul style="list-style-type: none"> Chair Stool Lounge 	<p>No cost</p> <p>No cost</p> <p>+\$ 12</p>	<p>Specify chair application.</p> <p>Specify stool application.</p> <p>Specify lounge application.</p>

	Options	U.S. Price	Required to Specify
Surface Materials	<ul style="list-style-type: none"> Fabric price group 1 Fabric price group 2 Fabric price group 3 Fabric price group 4 Fabric price group 5 Fabric price group 6 Fabric price group 7 Fabric price group 8 Fabric price group 9 Fabric price group 10 COM 	<p>No cost</p> <p>+\$ 12</p> <p>+\$ 34</p> <p>+\$ 48</p> <p>+\$ 62</p> <p>+\$ 77</p> <p>+\$ 92</p> <p>+\$105</p> <p>+\$125</p> <p>+\$160</p> <p>+\$ 48</p>	<p>Specify fabric color number.</p> <p>Specify fabric color number.</p> <p>Specify fabric color number.</p> <p>Specify fabric color number.</p> <p>Specify fabric color number.</p> <p>Specify fabric color number.</p> <p>Specify fabric color number.</p> <p>Specify fabric color number.</p> <p>Specify fabric color number.</p> <p>Specify fabric color number.</p> <p>Specify fabric color number.</p>

Related Products	<ul style="list-style-type: none"> Simple Chair Simple Stool Simple Lounge Simple Back Cushion Simple Relaxed Slipcover Simple Tailored Slipcover 	<ul style="list-style-type: none"> ▶ Page 380 ▶ Page 381 ▶ Page 382 ▶ Page 384 ▶ Page 385 ▶ Page 386
-------------------------	---	--

Specification Information	
Style Number	U.S. Base Price
TSAVNSC	\$230

 **For Canadian Pricing**
 Multiply U.S. Price by the Canadian price factor.
 ▶ See page 1 for details.



Simple Back Cushion



Tip: Seat and back cushions are ordered separately and can be in matching or contrasting fabrics and colors.

Tip: Chairs, stools, and lounge can be stacked up to four high with or without cushions and slipcovers.

Standard Includes		Required to Specify
<ul style="list-style-type: none"> ▶ Need help? Product details, page 379 	<ul style="list-style-type: none"> • Cushion: fabric price group 1 • Shipped ready to assemble 	<ol style="list-style-type: none"> 1 Style number 2 Application (see Required Selections) 3 Fabric color number for cushion 4 Options, if selected (see below) <ul style="list-style-type: none"> ▶ See Surface Materials, page 634.

	Required Selections	U.S. Price	Required to Specify
Application	<ul style="list-style-type: none"> • Chair • Stool • Lounge 	<ul style="list-style-type: none"> No cost No cost +\$12 	<ul style="list-style-type: none"> Specify chair application. Specify stool application. Specify lounge application.

	Options	U.S. Price	Required to Specify
Surface Materials	<ul style="list-style-type: none"> • Fabric price group 1 • Fabric price group 2 • Fabric price group 3 • Fabric price group 4 • Fabric price group 5 • Fabric price group 6 • Fabric price group 7 • Fabric price group 8 • Fabric price group 9 • Fabric price group 10 • COM 	<ul style="list-style-type: none"> No cost +\$ 5 +\$20 +\$25 +\$32 +\$37 +\$46 +\$53 +\$62 +\$81 +\$25 	<ul style="list-style-type: none"> Specify fabric color number. Specify fabric color number. Specify fabric color number. Specify fabric color number. Specify fabric color number. Specify fabric color number. Specify fabric color number. Specify fabric color number. Specify fabric color number. Specify fabric color number. Specify fabric color number.

Related Products	<ul style="list-style-type: none"> • Simple Chair • Simple Stool • Simple Lounge • Simple Seat Cushion • Simple Relaxed Slipcover • Simple Tailored Slipcover 	<ul style="list-style-type: none"> ▶ Page 380 ▶ Page 381 ▶ Page 382 ▶ Page 383 ▶ Page 385 ▶ Page 386
-------------------------	---	--

Specification Information	
Style Number	U.S. Base Price
TSAVNBC	\$150



For Canadian Pricing
 Multiply U.S. Price by the Canadian price factor.
 ▶ See page 1 for details.

Simple Relaxed Slipcover



Tip: Chairs, stools, and lounge can be stacked up to four high with or without cushions and slipcovers.

Standard Includes	Required to Specify
-------------------	---------------------

<ul style="list-style-type: none"> ▶ Need help? Product details, page 379 	<ul style="list-style-type: none"> • Slipcover: fabric price group 1 • Webbing: fabric • Shipped ready to assemble 	<ol style="list-style-type: none"> 1 Style number 2 Application (see Required Selections) 3 Fabric color number for slipcover 4 Fabric color number for webbing: <ul style="list-style-type: none"> 5JG0 Black 5JG1 Burgundy 5JG5 Red 5JG7 Green 5JG8 Navy 5 Options, if selected (see below) <ul style="list-style-type: none"> ▶ See Surface Materials, page 634.
--	---	--

Required Selections	U.S. Price	Required to Specify
---------------------	------------	---------------------

Application	<ul style="list-style-type: none"> • Chair • Stool • Lounge 	<ul style="list-style-type: none"> No cost No cost +\$ 85 <p>Specify chair application. Specify stool application. Specify lounge application.</p>
--------------------	--	---

Options	U.S. Price	Required to Specify
---------	------------	---------------------

Surface Materials	<ul style="list-style-type: none"> • Fabric price group 1 • Fabric price group 2 • Fabric price group 3 • Fabric price group 4 • Fabric price group 5 • Fabric price group 6 • Fabric price group 7 • Fabric price group 8 • Fabric price group 9 • Fabric price group 10 • COM 	<ul style="list-style-type: none"> No cost +\$ 24 +\$ 59 +\$ 81 +\$105 +\$129 +\$150 +\$173 +\$208 +\$266 +\$ 81 <p>Specify fabric color number. Specify fabric color number. Specify fabric color number. Specify fabric color number. Specify fabric color number. Specify fabric color number. Specify fabric color number. Specify fabric color number. Specify fabric color number. Specify fabric color number. Specify fabric color number.</p>
--------------------------	--	---

Related Products	<ul style="list-style-type: none"> • Simple Chair • Simple Stool • Simple Lounge • Simple Seat Cushion • Simple Back Cushion • Simple Tailored Slipcover 	<ul style="list-style-type: none"> ▶ Page 380 ▶ Page 381 ▶ Page 382 ▶ Page 383 ▶ Page 384 ▶ Page 386
-------------------------	--	--

Specification Information

Style Number	U.S. Base Price
TSAVNS1	\$328

For Canadian Pricing
Multiply U.S. Price by the Canadian price factor.
▶ See page 1 for details.

Simple Tailored Slipcover

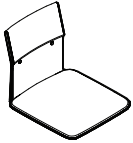

Tip: Chairs, stools, and lounge can be stacked up to four high with or without cushions and slipcovers.

Standard Includes		Required to Specify
<ul style="list-style-type: none"> ▶ Need help? Product details, page 379 	<ul style="list-style-type: none"> • Slipcover: fabric price group 1 • Shipped ready to assemble 	<ol style="list-style-type: none"> 1 Style number 2 Application (see Required Selections) 3 Fabric color number for slipcover 4 Options, if selected (see below) <ul style="list-style-type: none"> ▶ See Surface Materials, page 634.

	Required Selections	U.S. Price	Required to Specify
Application	<ul style="list-style-type: none"> • Chair • Stool • Lounge 	No cost No cost +\$ 85	Specify chair application. Specify stool application. Specify lounge application.

	Options	U.S. Price	Required to Specify
Surface Materials	<ul style="list-style-type: none"> • Fabric price group 1 • Fabric price group 2 • Fabric price group 3 • Fabric price group 4 • Fabric price group 5 • Fabric price group 6 • Fabric price group 7 • Fabric price group 8 • Fabric price group 9 • Fabric price group 10 • COM 	No cost +\$ 22 +\$ 53 +\$ 75 +\$ 96 +\$114 +\$136 +\$158 +\$187 +\$240 +\$ 75	Specify fabric color number. Specify fabric color number. Specify fabric color number. Specify fabric color number. Specify fabric color number. Specify fabric color number. Specify fabric color number. Specify fabric color number. Specify fabric color number. Specify fabric color number.

Related Products	<ul style="list-style-type: none"> • Simple Chair • Simple Stool • Simple Lounge • Simple Seat Cushion • Simple Back Cushion • Simple Relaxed Slipcover 	<ul style="list-style-type: none"> ▶ Page 380 ▶ Page 381 ▶ Page 382 ▶ Page 383 ▶ Page 384 ▶ Page 385
-------------------------	---	--

Specification Information	
Style Number	U.S. Base Price
TSAVNS2	\$294



For Canadian Pricing
 Multiply U.S. Price by the Canadian price factor.
 ▶ See page 1 for details.

Understanding and Specifying Move 490 Series Multi-Use Seating

Product Details

Move 490 Series	388
Dimensions	390

Specifying

Multi-Use Chairs	392
Multi-Use Stools	396
Perching Stools	400
Accessories	403

Multi-Use Chairs

Multi-use chairs are suitable for use as occasional seating within team spaces, workstations, offices, or wherever extra seating is required.

- Player 475 Series
- Move 490 Series

Move 490 Series

Move chairs are guest chairs that also stack. Live dynamic seat, open cantilever arm design, light weight, and strength make Move a logical choice for multipurpose areas. Move's simple design complements a broad range of work settings.

Arms are cantilevered and will easily clear the front edge of a worksurface or table. The open cantilever design of the arms allows alternative postures and sitting positions.

Steel frame is monochromatic.

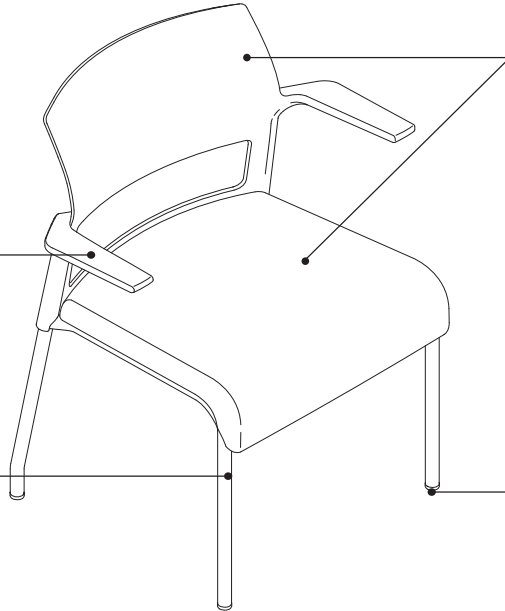

Seat and back are available in plastic or with an upholstered cushion.

Plastic glides have a hard plastic insert.

Upholstered back is available on selected styles.

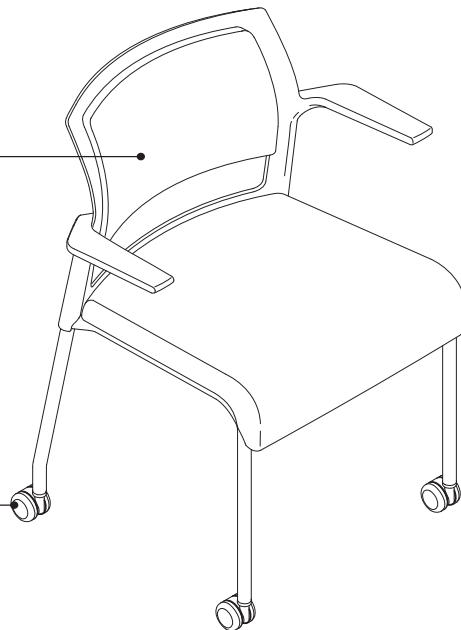

Casters have hard, dual wheels that roll smoothly on carpets. Soft, dual-wheel casters are available for use on hard floor or chair mats. Casters are available in black only.

Tip: Do not roll the chair across asphalt during installation as this may damage the casters.

Product Details

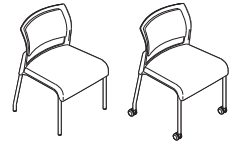
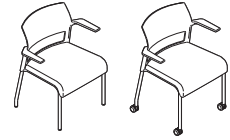

Chairs and stools have a leg-base and are available with glides or casters, and with or without arms.

Stackability for leg base chair models is five high on the floor. Stools do not stack.

Plastic glides with hard plastic inserts are recommended for carpeted surfaces.

Soft felt glides for use on non-carpeted surfaces are available as an option.

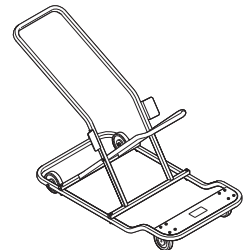

Transport and storage dolly is available to stack, move, and store up to 10 chairs.

Unloaded transport dolly measures 58 1/2"D x 25 1/2"W x 37 1/2"H.

Fully loaded transport dolly measures 58 1/2"D x 25 1/2"W x 58 1/2"H.

Product Weight

- Move chair: 16.4 pounds

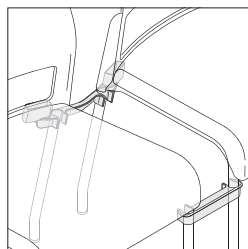

Ganging and alignment device is available to link leg-base chairs together in the field for evenly spaced rows. Chairs can be separated easily. Spacing between chairs linked with alignment device is 4" for chairs with no arms and 7" for chairs with arms.



Move wall saver is available to prevent the back of the chair from making contact with the wall.

Surface Materials

► See surface materials on page 634 for specific availability or refer to the *Surface Materials Reference Manual* for further information.

Frame

- 0835 Black
- 1ATT Cast Shadow
- 4799 Platinum Metallic
- 7239 Midnight
- 4B20 Obsidian
- 4B22 Matte Brass
- 4B23 Burnished Bronze
- 4B24 Night Bronze
- 4B25 Matte Copper
- 4B26 Smoked Mica
- 4B29 Cast Iron

Arms

- Plastic

Back shell and seat

- 6009 Arctic White
- 6059 Sterling Dark Solid
- 6205 Black
- 6249 Platinum Solid
- 6259 Midnight
- 6332 Citron
- 6333 Picasso
- 6334 Flash
- 6335 Wasabi
- 6336 Jazz
- 6337 Element
- 6338 Chili Red
- 6BC2 Purple
- 6BC5 Blue
- 6BC8 Gold
- 6BD1 Aubergine
- 6BD2 Peacock
- 6BD3 Jungle
- 6BD4 Merlot
- 6BD5 Honey
- 6BD6 Lagoon
- 6BD7 Saffron
- 6BD8 Snow
- 6BD9 Carbon Flat
- 6BE1 Ore

Upholstery

- Fabric
- Fabric with soil retardant treatment (option)
- Leather
- ElmoSoft leather
- Select Surfaces leather
- Vinyl

Casters

- Black only

Glides

- Hard glides—Polyethylene
- Soft glides—wool felt
- Plastic with hard plastic inserts come standard on multi-use chairs when specified with glides. Soft glides are available as an option.

Wall saver

- 6644 Fusion Dark only

All Steelcase seating with standard upholstery fabrics

complies with requirements of the State of California Technical Bulletin 117-2013. All standard seating is labeled to be in compliance with California 117-2013.

Programs & Services

► See the *Surface Materials Reference Manual* for further detail about programs and services offered for seating.

Select Surfaces

For information on products within Select Surfaces, including accent paints, Signature plastics, and fabrics from Designtex, Gabriel, Kvadrat, and Pollack, please refer to the *Surface Materials Reference Manual* or visit www.steelcase.com/selectsurfaces.

Custom Surfaces

The Customer's Own Material (COM) Program offers the opportunity for customers to select fabrics that are not offered through the standard Steelcase surface materials program for use on Steelcase products. Through the COM program, Steelcase will test your materials for application on Steelcase products. Once approved, you can place your order. Steelcase will facilitate the entire ordering process and give you a production schedule. Steelcase will order the COM fabric directly from the textile manufacturer. For up-to-date information regarding fabric test results for all COM fabrics and details regarding yardage requirements for most Seating lines, visit the COM website. To locate the COM website:

- Visit www.steelcase.com

Soil retardants are treatments that provide long-term soil and stain resistance to a fabric without affecting the shade or the integrity of the fabric. The following Steelcase Textiles are available pre-treated with soil retardant. (You do not need to select the soil-retardant option for these fabrics and incur the upcharge.)

- Jacks
- Link

For information on soil retardant fabrics on Select Surfaces, please refer to the *Surface Materials Reference Manual*.

Soil-retardant treatment is available on all other seating fabrics at an additional upcharge per seating unit. To order this option, please select "Soil-Retardant Treatment" under "Optional Accessories."

For soil-retardant treatment on COMs, please select "Soil-Retardant Treatment" under "Optional Accessories." Minimums or additional yardage may be required. Please contact the vendor directly for specific information.

Extended lead times may be necessary for this service.

Contact your Steelcase Solutions Fulfillment Team Representative at 1.888.STEELCASE (1.888.783.3522) or send an email to lineone@steelcase.com.

Local codes may have special requirements for upholstery.

Dimensions

► Page 390

Resources

Printed Materials

► Move Brochure (10-0002807)

Online Resources

► Product Environmental Profiles, which provide key environmental attributes and product certifications can be found by searching for Steelcase at *Origin.build*.

Dimensions

Move 490 Series

Features	Overall Depth	Width	Height	Seat Depth	Functional Seat Depth	Seat Width	Seat Height from Floor	Back Width	Back Height from Seat
Move 490 Series									
Chair with Arms									
	20 ¹ / ₄ "	25 ³ / ₄ "	31 ¹ / ₂ "	18 ¹ / ₂ "	16 ⁷ / ₈ "	19"	18 ¹ / ₂ "	19"	15 ¹ / ₄ "
Plastic Chair with Arms									
	20 ¹ / ₄ "	25 ³ / ₄ "	31 ¹ / ₂ "	18 ¹ / ₂ "	16 ⁷ / ₈ "	18 ¹ / ₄ "	18"	19"	15 ¹ / ₂ "
Chair without Arms									
	20 ¹ / ₄ "	21"	31 ¹ / ₂ "	18 ¹ / ₂ "	16 ⁷ / ₈ "	19"	18 ¹ / ₂ "	19"	15 ¹ / ₄ "
Plastic Chair without Arms									
	20 ¹ / ₄ "	21"	31 ¹ / ₂ "	18 ¹ / ₂ "	16 ⁷ / ₈ "	18 ¹ / ₄ "	18"	19"	15 ¹ / ₂ "
Stool with Arms									
	20 ¹ / ₄ "	25 ³ / ₄ "	42 ¹ / ₂ "	18 ¹ / ₂ "	16 ⁷ / ₈ "	19"	29 ¹ / ₂ "	19"	15 ¹ / ₄ "
Plastic Stool with Arms									
	20 ¹ / ₄ "	25 ³ / ₄ "	42 ¹ / ₂ "	18 ¹ / ₂ "	16 ⁷ / ₈ "	18 ¹ / ₄ "	29"	19"	15 ¹ / ₂ "
Stool without Arms									
	20 ¹ / ₄ "	21"	42 ¹ / ₂ "	18 ¹ / ₂ "	16 ⁷ / ₈ "	19"	29 ¹ / ₂ "	19"	15 ¹ / ₄ "
Plastic Stool without Arms									
	20 ¹ / ₄ "	21"	42 ¹ / ₂ "	18 ¹ / ₂ "	16 ⁷ / ₈ "	18 ¹ / ₄ "	29"	19"	15 ¹ / ₂ "
Perching Stool with Arms									
	20 ¹ / ₄ "	25 ³ / ₄ "	40"	18 ¹ / ₂ "	16 ⁷ / ₈ "	19"	27"	19"	15 ¹ / ₄ "
Plastic Perching Stool with Arms									
	20 ¹ / ₄ "	25 ³ / ₄ "	40"	18 ¹ / ₂ "	16 ⁷ / ₈ "	18 ¹ / ₄ "	26 ¹ / ₂ "	19"	15 ¹ / ₂ "
Perching Stool without Arms									
	20 ¹ / ₄ "	21"	40"	18 ¹ / ₂ "	16 ⁷ / ₈ "	19"	27"	19"	15 ¹ / ₄ "
Plastic Perching Stool without Arms									
	20 ¹ / ₄ "	21"	40"	18 ¹ / ₂ "	16 ⁷ / ₈ "	18 ¹ / ₄ "	26 ¹ / ₂ "	19"	15 ¹ / ₂ "

Back Lumbar Height	Width Between Arms	Arm to Floor	Arm Height from Seat	Arm Length	Seat Pan Angle	Angle Between Seat and Back
10"	20½"	25¾"	8¾"	8½"	5°	95°
10"	20½"	25¾"	8¾"	8½"	4°	96°
10"	N.A.	N.A.	N.A.	N.A.	5°	95°
10"	N.A.	N.A.	N.A.	N.A.	4°	96°
10"	20½"	36¾"	8¾"	8½"	5°	95°
10"	20½"	36¾"	8¾"	8½"	4°	96°
10"	N.A.	N.A.	N.A.	N.A.	5°	95°
10"	N.A.	N.A.	N.A.	N.A.	4°	96°
10"	20½"	34¼"	8¾"	8½"	5°	95°
10"	20½"	34¼"	8¾"	8½"	4°	96°
10"	N.A.	N.A.	N.A.	N.A.	5°	95°
10"	N.A.	N.A.	N.A.	N.A.	4°	96°

Move 490 Series Multi-Use Chairs



	Standard Includes	Required to Specify
▶ Need help? Product details, page 388	<ul style="list-style-type: none"> • Frame: 0835 Black paint • Back shell: plastic • Seat shell, if selected: plastic • Upholstery, if selected: fabric price group 1 • Arms, if selected: plastic to match back shell • Glides, if selected: plastic with hard plastic inserts • Hard, dual-wheel casters, if selected: black 	<ol style="list-style-type: none"> 1 Style number 2 Paint color number for frame 3 Plastic color number for back shell 4 Plastic color number for seat shell, if selected 5 Fabric color number for upholstery on seat and back, or seat, if selected 6 Options, if selected (see below) <p>▶ See <i>Surface Materials</i>, page 634.</p>

	Options	U.S. Price	Required to Specify
Surface Materials	Plastic on seat shell		
	<ul style="list-style-type: none"> • Plastic price group 1 • Plastic price group 2 	<p>No cost</p> <p>+\$ 33</p>	<p>Specify color number.</p> <p>▶ See <i>Surface Materials</i>, page 634.</p> <p>Specify color number.</p> <p>▶ See <i>Surface Materials</i>, page 634.</p>
	Plastic on back shell		
	<ul style="list-style-type: none"> • Plastic price group 1 • Plastic price group 2 	<p>No cost</p> <p>+\$ 33</p>	<p>Specify color number.</p> <p>▶ See <i>Surface Materials</i>, page 634.</p> <p>Specify color number.</p> <p>▶ See <i>Surface Materials</i>, page 634.</p>
	Upholstery on seat and back		
	<ul style="list-style-type: none"> • Fabric price group 1 • Fabric price group 2 • Fabric price group 3 • Fabric price group 4 • Fabric price group 5 • Fabric price group 6 • Fabric price group 7 • Fabric price group 8 • Fabric price group 9 • Fabric price group 10 • Steelcase leather upholstery • Select Surfaces leather price group 1 • Elmosoft leather upholstery • Select Surfaces leather price group 2 • Customer's Own Material/Vinyl (COM) • Customer's Own Leather (COL) 	<p>No cost</p> <p>+\$ 37</p> <p>+\$ 72</p> <p>+\$100</p> <p>+\$125</p> <p>+\$179</p> <p>+\$250</p> <p>+\$332</p> <p>+\$392</p> <p>+\$456</p> <p>+\$258</p> <p>+\$258</p> <p>+\$301</p> <p>+\$301</p> <p>No cost</p> <p>No cost</p>	<p>Specify fabric color number.</p> <p>Specify fabric color number.</p> <p>Specify fabric color number.</p> <p>Specify fabric color number.</p> <p>Specify fabric color number.</p> <p>Specify fabric color number.</p> <p>Specify fabric color number.</p> <p>Specify fabric color number.</p> <p>Specify fabric color number.</p> <p>Specify fabric color number.</p> <p>Specify fabric color number.</p> <p>Specify leather color number.</p> <p>▶ See <i>Surface Materials Reference Manual</i>.</p> <p>Specify Elmosoft leather color number.</p> <p>▶ See <i>Surface Materials Reference Manual</i>.</p> <p>▶ See <i>Surface Materials Reference Manual</i>.</p> <p>Specify leather color number.</p>
	Contrasting upholstery on seat and back		
	<ul style="list-style-type: none"> • Contrasting fabrics 	<p>+\$ 46</p>	<p>Add suffix K to the style number and specify fabric color numbers.</p>
	Contrasting upholstery on seat		
	<ul style="list-style-type: none"> • Fabric price group 1 • Fabric price group 2 • Fabric price group 3 • Fabric price group 4 • Fabric price group 5 • Fabric price group 6 • Fabric price group 7 • Fabric price group 8 • Fabric price group 9 • Fabric price group 10 • Steelcase leather upholstery • Select Surfaces leather price group 1 • Elmosoft leather upholstery • Select Surfaces leather price group 2 • Customer's Own Material/Vinyl (COM) • Customer's Own Leather (COL) 	<p>No cost</p> <p>+\$ 21</p> <p>+\$ 34</p> <p>+\$ 49</p> <p>+\$ 62</p> <p>+\$ 88</p> <p>+\$125</p> <p>+\$165</p> <p>+\$197</p> <p>+\$228</p> <p>+\$130</p> <p>+\$130</p> <p>+\$150</p> <p>+\$150</p> <p>No cost</p> <p>No cost</p>	<p>Specify fabric color number.</p> <p>Specify fabric color number.</p> <p>Specify fabric color number.</p> <p>Specify fabric color number.</p> <p>Specify fabric color number.</p> <p>Specify fabric color number.</p> <p>Specify fabric color number.</p> <p>Specify fabric color number.</p> <p>Specify fabric color number.</p> <p>Specify fabric color number.</p> <p>Specify leather color number.</p> <p>▶ See <i>Surface Materials Reference Manual</i>.</p> <p>Specify Elmosoft leather color number.</p> <p>▶ See <i>Surface Materials Reference Manual</i>.</p> <p>▶ See <i>Surface Materials Reference Manual</i>.</p> <p>Specify leather color number.</p>

▶ Detailed dimensions,
page 390

 **For Canadian Pricing**
Multiply U.S. Price by the
Canadian price factor.
▶ See page 1 for details.

▶ Options, continued on next page

► Options, continued from previous page

Options	U.S. Price	Required to Specify	
Surface Materials, continued			
Contrasting upholstery on back			
• Fabric price group 1	No cost	Specify fabric color number.	
• Fabric price group 2	+\$ 21	Specify fabric color number.	
• Fabric price group 3	+\$ 34	Specify fabric color number.	
• Fabric price group 4	+\$ 48	Specify fabric color number.	
• Fabric price group 5	+\$ 62	Specify fabric color number.	
• Fabric price group 6	+\$ 88	Specify fabric color number.	
• Fabric price group 7	+\$125	Specify fabric color number.	
• Fabric price group 8	+\$165	Specify fabric color number.	
• Fabric price group 9	+\$197	Specify fabric color number.	
• Fabric price group 10	+\$228	Specify fabric color number.	
• Steelcase leather upholstery	+\$130	Specify leather color number.	
• Select Surfaces leather price group 1	+\$130	Specify leather color number.	
• Elmosoft leather upholstery	+\$147	Specify leather color number.	
• Select Surfaces leather price group 2	+\$147	Specify leather color number.	
• Customer's Own Material/Vinyl (COM)	No cost	► See <i>Surface Materials Reference Manual</i> .	
• Customer's Own Leather (COL)	No cost	Specify leather color number.	
Soil-retardant treatment	+\$ 36	Specify <i>with soil-retardant treatment</i> .	
Frame			
• 7239 Midnight	No cost	Specify <i>with 7239 Midnight</i> .	
• 4799 Platinum Metallic	+\$ 85	Specify <i>with 4799 Platinum Metallic</i> .	
• 1ATT Cast Shadow	+\$117	Specify <i>with 1ATT Cast Shadow</i> .	
• Lux Coatings	+\$117	Specify Lux Coatings color number.	
Glides	• Soft felt glides for use on non-carpeted floors	+\$ 7	Specify <i>with soft glides</i> .
Casters	• Soft, dual-wheel casters for use on hard floors	+\$ 36	Specify <i>with soft casters</i> .

Specification Information

Style Number	U.S. Base Price

Upholstered Seat without Arms

With Glides

490410	\$438

With Casters

490410C	\$514

► Specification Information, continued on next page



Tip: Plastic finish number must be specified for both seat and back on plastic styles.



For Canadian Pricing
Multiply U.S. Price by the Canadian price factor.
► See page 1 for details.

► Specification Information, continued from previous page

Specification Information

Style Number	U.S. Base Price
--------------	-----------------

Upholstered Back and Seat without Arms

With Glides

490410U	\$525
---------	-------

With Casters

490410UC	\$601
----------	-------

Plastic Back and Seat without Arms

With Glides

490410P	\$347
---------	-------

With Casters

490410CP	\$423
----------	-------

Upholstered Seat with Arms

With Glides

490412	\$525
--------	-------

With Casters

490412C	\$601
---------	-------

► Specification Information, continued on next page



Tip: Plastic finish number must be specified for both seat and back on plastic styles.



For Canadian Pricing

Multiply U.S. Price by the Canadian price factor.

► See page 1 for details.

► Specification Information, continued from previous page

Specification Information

Style Number	U.S. Base Price
--------------	-----------------

Upholstered Back and Seat with Arms

With Glides

490412U	\$612
----------------	-------

With Casters

490412UC	\$688
-----------------	-------

Plastic Back and Seat with Arms

With Glides

490412P	\$434
----------------	-------

With Casters

490412CP	\$510
-----------------	-------



Tip: Plastic finish number must be specified for both seat and back on plastic styles.



For Canadian Pricing
 Multiply U.S. Price by the Canadian price factor.
 ► See page 1 for details.

Move 490 Series Multi-Use Stools

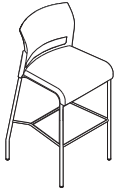

Standard Includes	Required to Specify
<ul style="list-style-type: none"> ▶ Need help? Product details, page 388 • Frame: 0835 Black paint • Back shell: plastic • Seat shell, if selected: plastic • Upholstery, if selected: fabric price group 1 • Arms, if selected: plastic to match back shell • Glides, if selected: plastic with hard plastic inserts • Hard, dual-wheel casters, if selected: black 	<ol style="list-style-type: none"> 1 Style number 2 Paint color number for frame 3 Plastic color number for back shell 4 Plastic color number for seat shell, if selected 5 Fabric color number for upholstery on seat and back, or seat, if selected 6 Options, if selected (see below) <p>▶ See <i>Surface Materials</i>, page 634.</p>

Options	U.S. Price	Required to Specify
<p>Surface Materials</p> <p>Plastic on seat shell</p> <ul style="list-style-type: none"> • Plastic price group 1 • Plastic price group 2 <hr/> <p>Plastic on back shell</p> <ul style="list-style-type: none"> • Plastic price group 1 • Plastic price group 2 <hr/> <p>Upholstery on seat and back</p> <ul style="list-style-type: none"> • Fabric price group 1 • Fabric price group 2 • Fabric price group 3 • Fabric price group 4 • Fabric price group 5 • Fabric price group 6 • Fabric price group 7 • Fabric price group 8 • Fabric price group 9 • Fabric price group 10 • Steelcase leather upholstery • Select Surfaces leather price group 1 • Elmosoft leather upholstery • Select Surfaces leather price group 2 • Customer's Own Material/Vinyl (COM) • Customer's Own Leather (COL) <hr/> <p>Contrasting upholstery on seat and back</p> <ul style="list-style-type: none"> • Contrasting fabrics <hr/> <p>Contrasting upholstery on seat</p> <ul style="list-style-type: none"> • Fabric price group 1 • Fabric price group 2 • Fabric price group 3 • Fabric price group 4 • Fabric price group 5 • Fabric price group 6 • Fabric price group 7 • Fabric price group 8 • Fabric price group 9 • Fabric price group 10 • Steelcase leather upholstery • Select Surfaces leather price group 1 • Elmosoft leather upholstery • Select Surfaces leather price group 2 • Customer's Own Material/Vinyl (COM) • Customer's Own Leather (COL) 	<p>No cost</p> <p>+\$ 33</p> <hr/> <p>No cost</p> <p>+\$ 33</p> <hr/> <p>No cost</p> <p>+\$ 37</p> <p>+\$ 72</p> <p>+\$100</p> <p>+\$125</p> <p>+\$179</p> <p>+\$250</p> <p>+\$332</p> <p>+\$392</p> <p>+\$456</p> <p>+\$258</p> <p>+\$258</p> <p>+\$301</p> <p>+\$301</p> <p>No cost</p> <p>No cost</p> <hr/> <p>+\$ 46</p> <hr/> <p>No cost</p> <p>+\$ 21</p> <p>+\$ 34</p> <p>+\$ 49</p> <p>+\$ 62</p> <p>+\$ 88</p> <p>+\$125</p> <p>+\$165</p> <p>+\$197</p> <p>+\$228</p> <p>+\$130</p> <p>+\$130</p> <p>+\$150</p> <p>+\$150</p> <p>No cost</p> <p>No cost</p>	<p>Specify color number.</p> <p>▶ See <i>Surface Materials</i>, page 634.</p> <p>Specify color number.</p> <p>▶ See <i>Surface Materials</i>, page 634.</p> <hr/> <p>Specify color number.</p> <p>▶ See <i>Surface Materials</i>, page 634.</p> <p>Specify color number.</p> <p>▶ See <i>Surface Materials</i>, page 634.</p> <hr/> <p>Specify fabric color number.</p> <p>Specify fabric color number.</p> <p>Specify fabric color number.</p> <p>Specify fabric color number.</p> <p>Specify fabric color number.</p> <p>Specify fabric color number.</p> <p>Specify fabric color number.</p> <p>Specify fabric color number.</p> <p>Specify fabric color number.</p> <p>Specify leather color number.</p> <p>▶ See <i>Surface Materials Reference Manual</i>.</p> <p>Specify Elmosoft leather color number.</p> <p>▶ See <i>Surface Materials Reference Manual</i>.</p> <p>▶ See <i>Surface Materials Reference Manual</i>.</p> <p>Specify leather color number.</p> <hr/> <p>Add suffix K to the style number and specify fabric color numbers.</p> <hr/> <p>Specify fabric color number.</p> <p>Specify fabric color number.</p> <p>Specify fabric color number.</p> <p>Specify fabric color number.</p> <p>Specify fabric color number.</p> <p>Specify fabric color number.</p> <p>Specify fabric color number.</p> <p>Specify fabric color number.</p> <p>Specify fabric color number.</p> <p>Specify leather color number.</p> <p>▶ See <i>Surface Materials Reference Manual</i>.</p> <p>Specify Elmosoft leather color number.</p> <p>▶ See <i>Surface Materials Reference Manual</i>.</p> <p>▶ See <i>Surface Materials Reference Manual</i>.</p> <p>Specify leather color number.</p>

▶ Detailed dimensions, page 390

For Canadian Pricing
 Multiply U.S. Price by the Canadian price factor.
 ▶ See page 1 for details.

▶ Options, continued on next page

► Options, continued from previous page

Options	U.S. Price	Required to Specify
Surface Materials, continued		
Contrasting upholstery on back		
• Fabric price group 1	No cost	Specify fabric color number.
• Fabric price group 2	+\$ 21	Specify fabric color number.
• Fabric price group 3	+\$ 34	Specify fabric color number.
• Fabric price group 4	+\$ 48	Specify fabric color number.
• Fabric price group 5	+\$ 62	Specify fabric color number.
• Fabric price group 6	+\$ 88	Specify fabric color number.
• Fabric price group 7	+\$125	Specify fabric color number.
• Fabric price group 8	+\$165	Specify fabric color number.
• Fabric price group 9	+\$197	Specify fabric color number.
• Fabric price group 10	+\$227	Specify fabric color number.
• Steelcase leather upholstery	+\$130	Specify leather color number.
• Select Surfaces leather price group 1	+\$130	Specify leather color number.
• Elmosoft leather upholstery	+\$147	Specify leather color number.
• Select Surfaces leather price group 2	+\$147	Specify leather color number.
• Customer's Own Material/Vinyl (COM)	No cost	► See <i>Surface Materials Reference Manual</i> .
• Customer's Own Leather (COL)	No cost	Specify leather color number.
Soil-retardant treatment	+\$ 36	Specify <i>with soil-retardant treatment</i> .
Frame		
• 7239 Midnight	No cost	Specify <i>with 7239 Midnight</i> .
• 4799 Platinum Metallic	+\$ 85	Specify <i>with 4799 Platinum Metallic</i> .
• 1ATT Cast Shadow	+\$117	Specify <i>with 1ATT Cast Shadow</i> .
• Lux Coatings	+\$117	Specify Lux Coatings color number.
Glides	• Soft felt glides for use on non-carpeted floors	+\$ 7 Specify <i>with soft glides</i> .
Casters	• Soft, dual-wheel casters for use on hard floors	+\$ 36 Specify <i>with soft casters</i> .

Specification Information

Style Number	U.S. Base Price
.	.
.	.

Upholstered Seat without Arms

With Glides

490710	\$784
.	.

With Casters

490710C	\$860
.	.

► Specification Information, continued on next page

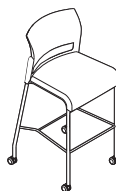
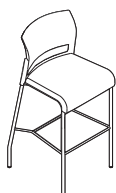

For Canadian Pricing
 Multiply U.S. Price by the Canadian price factor.
 ► See page 1 for details.

Move 490 Series Multi-Use Stools, continued

► Specification Information, continued from previous page

Specification Information

• Style Number	• U.S. Base Price
----------------	-------------------

Upholstered Back and Seat without Arms

With Glides

490710U	\$871
----------------	-------

With Casters

490710UC	\$947
-----------------	-------

Plastic Back and Seat without Arms

With Glides

490710P	\$679
----------------	-------

With Casters

490710CP	\$755
-----------------	-------

Upholstered Seat with Arms

With Glides

490712	\$871
---------------	-------

With Casters

490712C	\$947
----------------	-------

► Specification Information, continued on next page

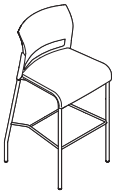
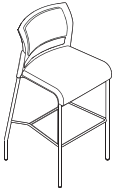

Tip: Plastic finish number must be specified for both seat and back on plastic styles.

► Specification Information, continued from previous page

Specification Information

Style Number	U.S. Base Price
--------------	-----------------

Upholstered Back and Seat with Arms

With Glides

490712U	\$ 958
----------------	--------

With Casters

490712UC	\$1034
-----------------	--------

Plastic Back and Seat with Arms

With Glides

490712P	\$ 766
----------------	--------

With Casters

490712CP	\$ 842
-----------------	--------

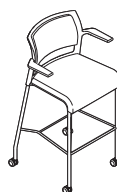
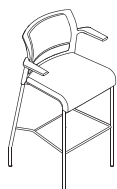

Tip: Plastic finish number must be specified for both seat and back on plastic styles.

For Canadian Pricing
 Multiply U.S. Price by the Canadian price factor.
 ► See page 1 for details.

Move 490 Series Perching Stools

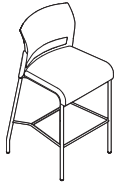

Tip: Move 490 Series stools do not stack.

Standard Includes	Required to Specify
<ul style="list-style-type: none"> ▶ Need help? Product details, page 388 • Frame: 0835 Black paint • Back shell: plastic • Seat shell, if selected: plastic • Upholstery, if selected: fabric price group 1 • Arms, if selected: plastic to match back shell • Glides, if selected: plastic with hard plastic inserts 	<ol style="list-style-type: none"> 1 Style number 2 Paint color number for frame 3 Plastic color number for back shell 4 Plastic color number for seat shell, if selected 5 Fabric color number for upholstery on seat, if selected 6 Options, if selected (see below) <p>▶ See <i>Surface Materials</i>, page 634.</p>

Options	U.S. Price	Required to Specify
Surface Materials		
Plastic on seat shell		
• Plastic price group 1	No cost	Specify color number. ▶ See <i>Surface Materials</i> , page 634.
• Plastic price group 2	+\$ 33	Specify color number. ▶ See <i>Surface Materials</i> , page 634.
Plastic on back shell		
• Plastic price group 1	No cost	Specify color number. ▶ See <i>Surface Materials</i> , page 634.
• Plastic price group 2	+\$ 33	Specify color number. ▶ See <i>Surface Materials</i> , page 634.
Upholstery on seat and back		
• Fabric price group 1	No cost	Specify fabric color number.
• Fabric price group 2	+\$ 37	Specify fabric color number.
• Fabric price group 3	+\$ 72	Specify fabric color number.
• Fabric price group 4	+\$100	Specify fabric color number.
• Fabric price group 5	+\$125	Specify fabric color number.
• Fabric price group 6	+\$179	Specify fabric color number.
• Fabric price group 7	+\$250	Specify fabric color number.
• Fabric price group 8	+\$332	Specify fabric color number.
• Fabric price group 9	+\$392	Specify fabric color number.
• Fabric price group 10	+\$456	Specify fabric color number.
• Steelcase leather upholstery	+\$258	Specify leather color number.
• Select Surfaces leather price group 1	+\$258	▶ See <i>Surface Materials Reference Manual</i> .
• Elmosoft leather upholstery	+\$301	Specify Elmosoft leather color number.
• Select Surfaces leather price group 2	+\$301	▶ See <i>Surface Materials Reference Manual</i> .
• Customer's Own Material/Vinyl (COM)	No cost	▶ See <i>Surface Materials Reference Manual</i> .
• Customer's Own Leather (COL)	No cost	Specify leather color number.
Contrasting upholstery on seat and back		
• Contrasting fabrics	+\$ 46	Add suffix K to the style number and specify fabric color numbers.
Contrasting upholstery on seat		
• Fabric price group 1	No cost	Specify fabric color number.
• Fabric price group 2	+\$ 21	Specify fabric color number.
• Fabric price group 3	+\$ 34	Specify fabric color number.
• Fabric price group 4	+\$ 49	Specify fabric color number.
• Fabric price group 5	+\$ 62	Specify fabric color number.
• Fabric price group 6	+\$ 88	Specify fabric color number.
• Fabric price group 7	+\$125	Specify fabric color number.
• Fabric price group 8	+\$165	Specify fabric color number.
• Fabric price group 9	+\$197	Specify fabric color number.
• Fabric price group 10	+\$228	Specify fabric color number.
• Steelcase leather upholstery	+\$130	Specify leather color number.
• Select Surfaces leather price group 1	+\$130	▶ See <i>Surface Materials Reference Manual</i> .
• Elmosoft leather upholstery	+\$150	Specify Elmosoft leather color number.
• Select Surfaces leather price group 2	+\$150	▶ See <i>Surface Materials Reference Manual</i> .
• Customer's Own Material/Vinyl (COM)	No cost	▶ See <i>Surface Materials Reference Manual</i> .
• Customer's Own Leather (COL)	No cost	Specify leather color number.

▶ Detailed dimensions, page 390

 **For Canadian Pricing**
Multiply U.S. Price by the Canadian price factor.
▶ See page 1 for details.

▶ Options, continued on next page

► Options, continued from previous page

Options	U.S. Price	Required to Specify
Surface Materials, continued		
Contrasting upholstery on back		
• Fabric price group 1	No cost	Specify fabric color number.
• Fabric price group 2	+\$ 21	Specify fabric color number.
• Fabric price group 3	+\$ 34	Specify fabric color number.
• Fabric price group 4	+\$ 48	Specify fabric color number.
• Fabric price group 5	+\$ 62	Specify fabric color number.
• Fabric price group 6	+\$ 88	Specify fabric color number.
• Fabric price group 7	+\$125	Specify fabric color number.
• Fabric price group 8	+\$165	Specify fabric color number.
• Fabric price group 9	+\$197	Specify fabric color number.
• Fabric price group 10	+\$227	Specify fabric color number.
• Steelcase leather upholstery	+\$130	Specify leather color number.
• Select Surfaces leather price group 1	+\$130	Specify leather color number.
• Elmosoft leather upholstery	+\$147	Specify leather color number.
• Select Surfaces leather price group 2	+\$147	Specify leather color number.
• Customer's Own Material/Vinyl (COM)	No cost	► See <i>Surface Materials Reference Manual</i> .
• Customer's Own Leather (COL)	No cost	Specify leather color number.
Soil-retardant treatment	+\$ 36	Specify with soil-retardant treatment.
Frame		
• 7239 Midnight	No cost	Specify with 7239 Midnight.
• 4799 Platinum Metallic	+\$ 85	Specify with 4799 Platinum Metallic.
• 1ATT Cast Shadow	+\$117	Specify with 1ATT Cast Shadow.
• Lux Coatings	+\$117	Specify Lux Coatings color number.
Glides		
• Soft felt glides for use on non-carpeted floors	+\$ 7	Specify with soft glides.

Specification Information

Style Number	U.S. Base Price
--------------	-----------------

Upholstered Seat without Arms

490510 \$784

Upholstered Back and Seat without Arms

490510U \$871

► Specification Information, continued on next page

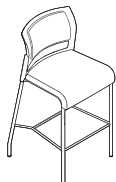

Tip: Plastic finish number must be specified for both seat and back on plastic styles.



For Canadian Pricing
Multiply U.S. Price by the Canadian price factor.
► See page 1 for details.

Move 490 Series Perching Stools, continued

► Specification Information, continued from previous page

Specification Information

Style Number	U.S. Base Price
--------------	-----------------



Plastic Back and Seat without Arms

490510P	\$679
---------	-------



Upholstered Seat with Arms

490512	\$871
--------	-------

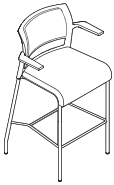

Upholstered Back and Seat with Arms

490512U	\$958
---------	-------



Plastic Back and Seat with Arms

490512P	\$766
---------	-------

Tip: Plastic finish number must be specified for both seat and back on plastic styles.



For Canadian Pricing

Multiply U.S. Price by the Canadian price factor.

► See page 1 for details.

Ganging and Alignment Device

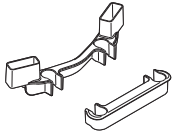

Tip: One pair is required to align two chairs. The 4" device is used for armless chairs and the 7" device is used for chairs with arms.

Standard Includes	Required to Specify
-------------------	---------------------

- | | |
|--|--------------|
| <ul style="list-style-type: none"> Alignment device: black plastic only Package of two | Style number |
|--|--------------|

Specification Information		
Style Number	Width	U.S. Price

490GA4	4"	\$56
490GA7	7"	\$56

Transport and Storage Dolly

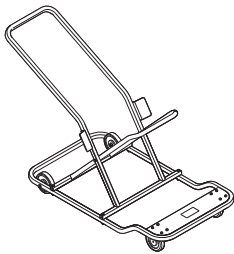

Standard Includes	Required to Specify
-------------------	---------------------

- | | |
|---|--------------|
| <ul style="list-style-type: none"> Transport and storage dolly: black paint only | Style number |
|---|--------------|

Specification Information	
Style Number	U.S. Price

490D	\$1104
------	--------

Wall Saver



Tip: Wall saver package is for use on Move chair styles only.

Tip: One pair is required for each chair.

Standard Includes	Required to Specify
-------------------	---------------------

- | | |
|---|--------------|
| <ul style="list-style-type: none"> Package of four Plastic: 6644 Fusion Dark only | Style number |
|---|--------------|

Specification Information		
Style Number	Width	U.S. Price

490WS	4"	\$76
-------	----	------



For Canadian Pricing
Multiply U.S. Price by the Canadian price factor.
▶ See page 1 for details.



Understanding and Specifying Turnstone Scoop

Multi-Use Seating

Product Details		
Scoop		406
Dimensions		407
Specifying		
Scoop		408

Scoop

Scoop is collaborative seating for teams that helps people move freely, change postures, and stay energized and comfortable.

► Specifying, page 408

Durable wire frame is lightweight and available in multiple finishes.

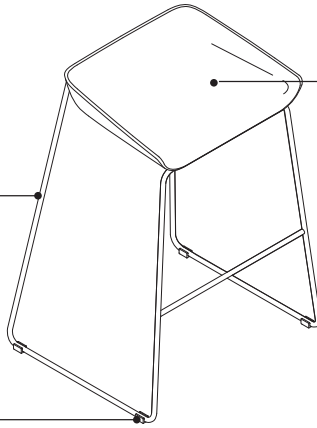

Glides are standard for use on carpets. Soft glides are available for use on hard floors or chair mats.

Seat is constructed of molded plastic and available in several colors.

Upholstered seat is also available.

Product Details

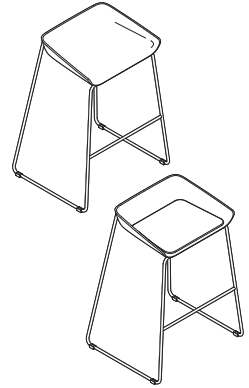

Stools are available with or without upholstered seat.

Surface Materials

► See surface materials on page 634 for specific availability or refer to the *Surface Materials Reference Manual* for further information.

Dimensions

► Page 407

Dimensions

Scoop

Features	Overall Depth	Width	Height	Functional Seat Depth	Seat Width	Seat Height from Floor	Foot Bar Height
Scoop	20 ¹ / ₄ "	23"	33"	13 ¹ / ₂ "	17"	28 ³ / ₄ "	12 ³ / ₄ "

Scoop

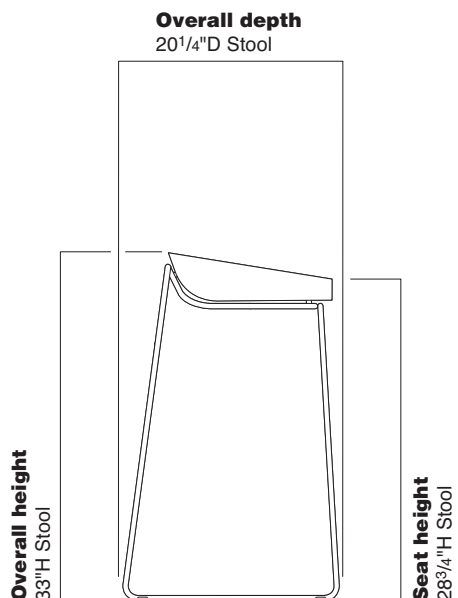
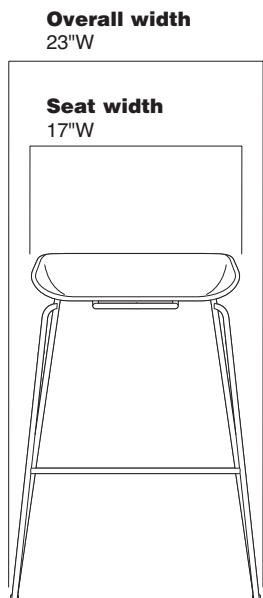

Scoop

Stools

	Standard Includes	Required to Specify
▶ Need help? Product details, page 406	<ul style="list-style-type: none"> • Steel wire frame: paint price group 1 • Seat: plastic price group 1 • Upholstered seat, if selected: fabric price group 1 • Glides • Shipped fully assembled 	<ol style="list-style-type: none"> 1 Style number 2 Paint color number for frame 3 Plastic color number for seat 4 Fabric color number for upholstery, if selected 5 Options, if selected (see below) <p>▶ See <i>Surface Materials</i>, page 634.</p>

	Options	U.S. Price	Required to Specify
Surface Materials	Steel wire frame		
	• Paint price group 1	No cost	Specify paint color number.
	• Paint price group 2	+\$ 56	Specify paint color number.
	• Paint price group 3	+\$ 86	Specify paint color number.
	Seat		
	• Plastic price group 1	No cost	Specify plastic color number.
	• Plastic price group 2	+\$ 53	Specify plastic color number.
	Upholstery		
	• Fabric price group 1	No cost	Specify fabric color number.
	• Fabric price group 2	+\$ 12	Specify fabric color number.
• Fabric price group 3	+\$ 37	Specify fabric color number.	
• Fabric price group 4	+\$ 51	Specify fabric color number.	
• Fabric price group 5	+\$ 61	Specify fabric color number.	
• Fabric price group 6	+\$ 76	Specify fabric color number.	
• Fabric price group 7	+\$ 92	Specify fabric color number.	
• Fabric price group 8	+\$112	Specify fabric color number.	
• Fabric price group 9	+\$137	Specify fabric color number.	
• Fabric price group 10	+\$159	Specify fabric color number.	
• Vinyl	+\$ 12	Specify vinyl color number.	
• Customer's Own Material (COM)	+\$ 23	▶ See <i>Understanding Customer's Own Material (COM)</i> , page 642.	
Glides	• Soft glides	No cost	Specify <i>with soft glides</i> .

▶ Detailed dimensions, page 407

Specification Information	
• Style Number	• U.S. Base Price
•	•
•	•
•	•

Stool	
TS30701	\$507
•	•
•	•

Stool with Upholstered Seat	
TS30702	\$609
•	•
•	•

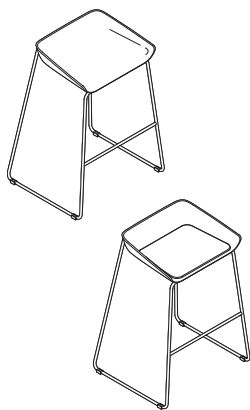

 **For Canadian Pricing**
Multiply U.S. Price by the Canadian price factor.
▶ See page 1 for details.

Understanding and Specifying Nooi

Multi-Use Seating

Product Details

Nooi	410
Thought Starters	412
Dimensions	416

Specifying

Nooi Frame-Linking Chairs	418
Nooi Sled-Base Chair	420
Nooi 4-Leg Base Chairs	422
Nooi Stools	424
Nooi Transport Dolly	426

Multi-Use Chairs

Multi-use chairs are suitable for use as occasional seating within team spaces, workstations, offices, or wherever extra seating is required.

- Player 475 Series
- Move 490 Series

Nooi

Nooi is a seating family of multi-use chairs and stools with various arm, base, and upholstery choices. The sophisticated design features an elegant high-gloss exterior shell and a textured interior shell available in different color combinations, with optional upholstery to make a statement in any space. Nooi's generous, flexible seat shell is calibrated to comfortably support a wide range of users with a beautiful aesthetic. The versatile statement of line provides choice and control in a broad range of collaborative spaces ranging from café's, meeting spaces, and townhalls.

Seat and back are one integrated plastic shell. The interior shell is textured and the exterior shell is high gloss.

Upholstered seat is available as an option on chairs and stools.

Upholstered seat and back is available as an option on chairs.

Glides are available in hard and soft options.

Ganging device integrated into frame-linking chairs and sled-base chairs creates an ingenious interlocking frame system that supports simplistic reconfigurability.

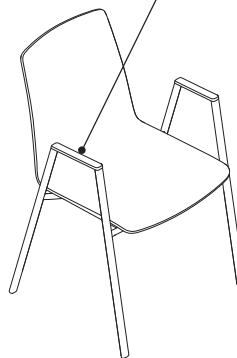
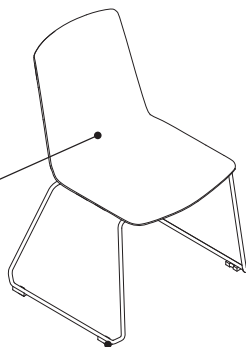

Arms are available on frame-linking chairs and 4-leg base chairs.

Product Details

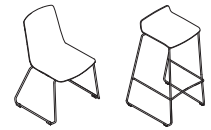

Plastic shell.
Shown: sled-base chair and bar-height stool



Plastic shell with upholstered seat.
Shown: 4-leg chair with arms and cafe-height stool



Plastic shell with upholstered seat and back.
Shown: 4-leg armless chair and frame linking chair with arms

Nooi is available with a plastic seat and back, upholstery on seat and plastic back, or upholstery on seat and back on select styles.

Stackability varies by style number. See specific style number product page for details.

Hard glides are recommended for carpeted surfaces and soft glides are recommended for non-carpeted surfaces.

Product Weight

- Nooi chair: 16.5 pounds

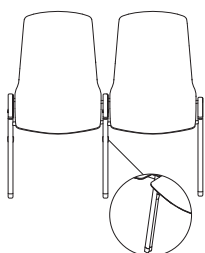

Frame-linking armless chairs

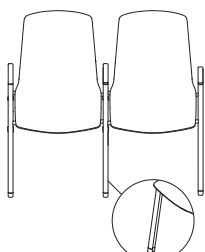

Frame-linking chairs with arms

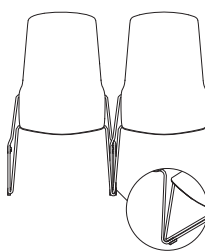

Frame-linking sled-base chairs

Nooi frame-linking armless chair, chair with arms, and sled-base chairs feature an interlocking frame that allows the chairs to gang together.

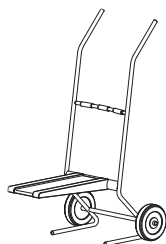

Transport dolly is available to stack and move up to eight chairs. It is meant for transport use only. Chairs should not be stored on the dolly.

Unloaded transport dolly dimensions are 32"D x 30"W x 50"H.

Surface Materials

► See surface materials on page 634 for specific availability or refer to the *Surface Materials Reference Manual* for further information.

Frame

- 0835 Black
- 4242 Milk
- 4799 Platinum Metallic
- 4H04 Chrome

Arm pad cover

- WH95 Black
- WH96 White

Frame cover

- WH95 Black
- WH96 White

Shell

- WH69 White/Light Green
- WH71 White/Mocca Anthracite
- WH72 Black/Black
- WH73 White/White
- WH74 Mocca Anthracite/Mocca Anthracite
- WH75 White/Light Blue
- WH76 White/Yellow
- WH77 White/Terra
- WH78 White/Warm Grey
- WH79 White/Black

Tip: The first color listed for each finish number represents the interior textured shell color. The color listed after the backslash for each finish number represents the exterior high-gloss shell color.

Upholstery

- Fabric
- Fabric with soil retardant treatment (option)
- Leather
- Elmosoft leather
- Select Surfaces leather
- Vinyl

Glides

- Hard glides are recommended for carpeted surfaces and soft glides are recommended for non-carpeted surfaces.

All Steelcase seating with standard upholstery fabrics complies with requirements of the State of California Technical Bulletin 117-2013. All standard seating is labeled to be in compliance with California 117-2013.

Programs & Services

► See the *Surface Materials Reference Manual* for further detail about programs and services offered for seating.

Select Surfaces

For information on products within Select Surfaces, including accent paints, Signature plastics, and fabrics from Designtex, Gabriel, Kvadrat, and Pollack, please refer to the *Surface Materials Reference Manual* or visit www.steelcase.com/selectsurfaces.

Custom Surfaces

The Customer's Own Material (COM) Program offers the opportunity for customers to select fabrics that are not offered through the standard Steelcase surface materials program for use on Steelcase products. Through the COM program, Steelcase will test your materials for application on Steelcase products. Once approved, you can place your order. Steelcase will facilitate the entire ordering process and give you a production schedule. Steelcase will order the COM fabric directly from the textile manufacturer. For up-to-date information regarding fabric test results for all COM fabrics and details regarding yardage requirements for most Seating lines, visit the COM website. To locate the COM website:

- Visit www.steelcase.com

Soil retardants are treatments that provide long-term soil and stain resistance to a fabric without affecting the shade or the integrity of the fabric. The following Steelcase Textiles are available pre-treated with soil retardant. (You do not need to select the soil-retardant option for these fabrics and incur the upcharge.)

- Jacks
- Link

For information on soil retardant fabrics on Select Surfaces, please refer to the *Surface Materials Reference Manual*.

Soil-retardant treatment is available on all other seating fabrics at an additional upcharge per seating unit. To order this option, please select "Soil-Retardant Treatment" under "Optional Accessories."

For soil-retardant treatment on COMs, please select "Soil-Retardant Treatment" under "Optional Accessories." Minimums or additional yardage may be required. Please contact the vendor directly for specific information.

Extended lead times may be necessary for this service.

Contact your Steelcase Solutions Fulfillment Team Representative at 1.888.STEELCASE (1.888.783.3522) or send an email to lineone@steelcase.com.

Local codes may have special requirements for upholstery.

Dimensions

► Page 416

Resources

Printed Materials

► Nooi Brochure (18-0006442)

Online Resources

► Product Environmental Profiles, which provide key environmental attributes and product certifications can be found by searching for Steelcase at *Origin.build*.

Thought Starters

Nooi

Nooi Bar-Height Stools and B-Free Rectangle Table

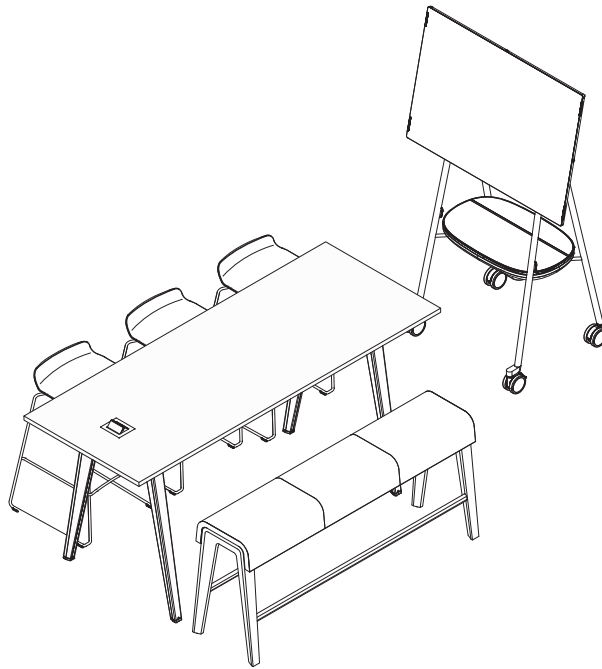

Quantity	Style Number	Description	Options	Page for Ordering
3	WHG6625	Nooi bar-height stool		▶ Page 424
1	N3LBA1600	Large beam, aluminum legs		▶ Page 580
1	N3LRECT	B-Free rectangle table, steel legs	One power module	▶ Page 584
1	STPM1CART	Steelcase Roam cart		▶ See <i>Roam Specification Guide</i>

Nooi Bar-Height Stools and Flex Slim Standing Height Table

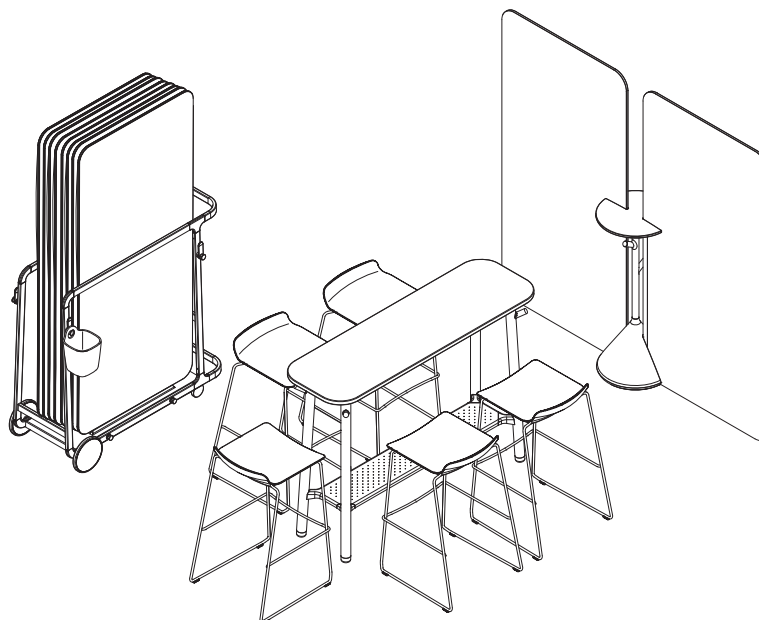

Nooi

Quantity	Style Number	Description	Page for Ordering
5	WHG6625	Nooi bar-height stool	▶ Page 424
1	FLXSLIM	Flex High-Pressure Laminate slim table, standing height	▶ See <i>Steelcase Flex Collection Specification Guide</i>
1	FLXCTBDPKG	Flex board cart package	▶ See <i>Steelcase Flex Collection Specification Guide</i>
1	FLXSTAND	Flex stand	▶ See <i>Steelcase Flex Collection Specification Guide</i>
2	FLXMB	Flex markerboard	▶ See <i>Steelcase Flex Collection Specification Guide</i>

Nooi 4-Leg Base Chair and Verlay Table

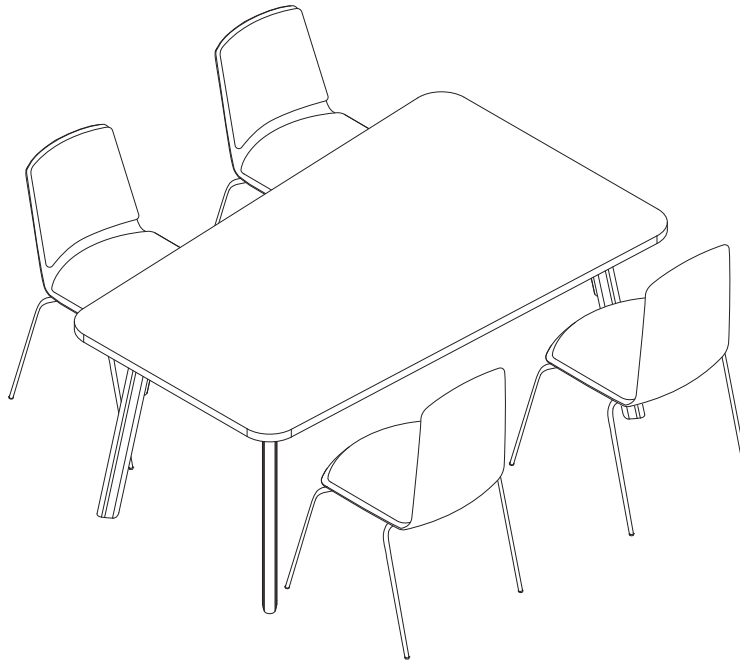

Quantity	Style Number	Description	Options	Page for Ordering
4	WHG6606	Nooi 4-leg base chair, armless	Upholstered seat and back	▶ Page 422
1	VLSTLWL	Verlay seated-height sightline table	Wood group 1 worksurface	▶ See <i>Conference and Collaborative Tables Specification Guide</i>

Nooi Frame-Linking and Stacking

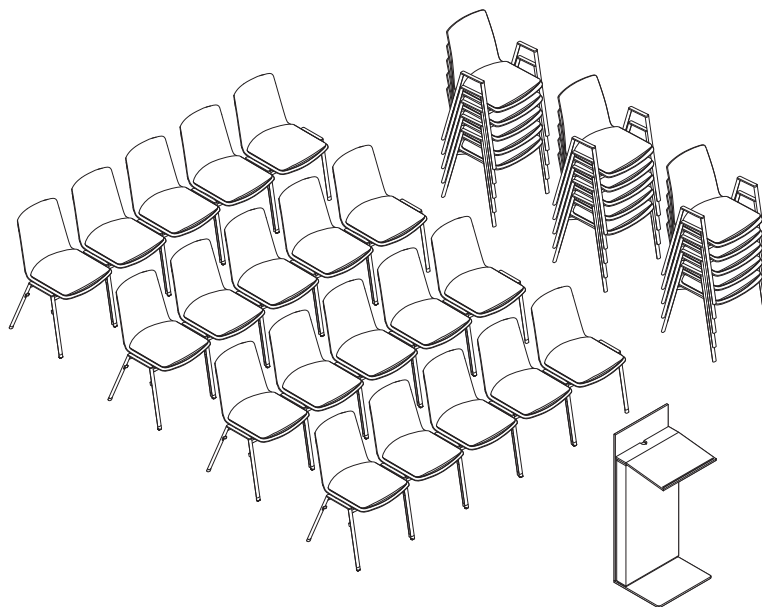

Quantity	Style Number	Description	Page for Ordering
20	WHG6600	Nooi frame-linking chair, armless	▶ Page 418
15	WHG6602	Nooi frame-linking chair with arms	▶ Page 418
1	COCL42	Exponents lectern	▶ See <i>Coalesse Tables Specification Guide</i>

Dimensions

Nooi

• Features	• Overall Depth	• Width	• Height	• Footrest Height	• Seat Depth	• Functional Seat Depth	• Seat Width
Nooi							
Frame-Linking Chair, Armless	22 ¹ / ₂ "	21"	33 ¹ / ₂ "	N.A.	17 ³ / ₁₀ "	17 ³ / ₁₀ "	18"
Frame-Linking Chair with Arms	22 ¹ / ₂ "	21"	33 ¹ / ₂ "	N.A.	17 ³ / ₁₀ "	17 ³ / ₁₀ "	18"
Sled-Base Chair	22 ⁴ / ₅ "	22 ⁹ / ₁₀ "	33"	N.A.	17 ³ / ₁₀ "	17 ³ / ₁₀ "	18 ¹ / ₁₀ "
4-Leg Base Chair, Armless	22 ⁴ / ₅ "	22 ⁹ / ₁₀ "	33"	N.A.	17 ³ / ₁₀ "	17 ³ / ₁₀ "	18 ¹ / ₁₀ "
4-Leg Base Chair with Arms	22 ⁴ / ₅ "	22 ⁹ / ₁₀ "	33"	N.A.	17 ³ / ₁₀ "	17 ³ / ₁₀ "	18 ¹ / ₁₀ "
Bar-Height Stool	21 ¹ / ₂ "	20 ¹ / ₂ "	33 ³ / ₁₀ "	12 ⁴ / ₅ "	17 ³ / ₁₀ "	17 ³ / ₁₀ "	17 ¹ / ₁₀ "
Café-Height Stool	20 ³ / ₁₀ "	20 ³ / ₁₀ "	29"	8 ⁷ / ₁₀ "	17 ³ / ₁₀ "	17 ³ / ₁₀ "	17 ¹ / ₁₀ "

• Features	• Quantity	• Height of Stack	• Depth of Stack
Nooi – Stack Dimensions on Floor			
Nooi Frame-Linking Chair, Armless	15	67 ¹¹ / ₁₆ "	25 ² / ₅ "
Nooi Frame-Linking Chair with Arms	15	76"	23 ²⁹ / ₃₂ "
Nooi Sled-Base Chair	8	47 ¹ / ₅ "	28 ³ / ₅ "
4-Leg Base Chair, Armless	8	46 ²⁹ / ₃₂ "	29 ⁵ / ₁₆ "
4-Leg Base Chair with Arms	8	46 ²⁹ / ₃₂ "	29 ⁵ / ₁₆ "
Nooi Bar-Height Stool	5	40 ² / ₅ "	25 ³ / ₅ "
Nooi Café-Height Stool	5	36 ²⁹ / ₃₂ "	24 ⁴ / ₅ "

• Features	• Quantity	• Height of Stack	• Depth of Stack
Nooi – Stack Dimensions on Dolly			
Nooi Frame-Linking Chair, Armless	8	50 ³ / ₅ "	23 ²⁹ / ₃₂ "
Nooi Frame-Linking Chair with Arms	8	54 ¹¹ / ₁₆ "	23 ¹ / ₅ "
Nooi Sled-Base Chair	8	47 ¹ / ₅ "	28 ³ / ₅ "
4-Leg Base Chair, Armless	8	46 ²⁹ / ₃₂ "	29 ⁵ / ₁₆ "
4-Leg Base Chair with Arms	8	46 ²⁹ / ₃₂ "	29 ⁵ / ₁₆ "

Tip: The Nooi transport dolly is intended for transport use only. Nooi chairs and stools should not be stored on the dolly.

Tip: The Nooi transport dolly is not compatible with the Nooi bar-height stool or the Nooi café-height stool.

• Seat Height from Floor	• Back Width	• Back Height from Seat	• Width Between Arms	• Arm to Floor	• Arm Height from Seat	• Seat Pan Angle	• Angle Between Seat and Back
17 ¹ / ₂ "	15 ¹ / ₁₀ "	17 ³ / ₅ "	N.A.	N.A.	N.A.	27 ⁷ / ₁₀ °	103 ² / ₅ °
17 ¹ / ₂ "	15 ¹ / ₁₀ "	17 ³ / ₅ "	18 ⁸ / ₁₀ "	26 ³ / ₅ "	8 ² / ₅ "	24 ⁴ / ₅ °	103 ¹ / ₂ °
17 ¹ / ₂ "	15 ¹ / ₁₀ "	17 ³ / ₅ "	N.A.	N.A.	N.A.	-1 ¹ / ₅ °	102 ¹ / ₁₀ °
17 ¹ / ₂ "	15 ¹ / ₁₀ "	17 ³ / ₅ "	N.A.	N.A.	N.A.	3 ² / ₅ °	102 ¹ / ₂ °
17 ¹ / ₂ "	15 ¹ / ₁₀ "	17 ³ / ₅ "	18 ¹ / ₂ "	26 ⁴ / ₅ "	8 ⁹ / ₁₀ "	37 ¹ / ₁₀ °	103°
29 ⁴ / ₅ "	15 ² / ₅ "	3 ³ / ₅ "	N.A.	N.A.	N.A.	19 ⁹ / ₁₀ °	100 ⁹ / ₁₀ °
25 ³ / ₅ "	15 ² / ₅ "	3 ³ / ₅ "	N.A.	N.A.	N.A.	19 ⁹ / ₁₀ °	100 ⁹ / ₁₀ °



Nooi Frame-Linking Chairs



Tip: Nooi frame linking chairs can stack 15 high on floor and eight high on transport dolly.

Tip: When specifying the shell color, the first color listed indicates the interior, textured shell color. The color after the backslash indicates the exterior, high-gloss shell color.

Tip: The arms on the frame-linking chair are slightly off-set to allow for interlocking frame linking capability.

Standard Includes		Required to Specify
<ul style="list-style-type: none"> ▶ Need help? Product details, page 410 	<ul style="list-style-type: none"> • Shell: plastic price group 1 • Seat and back: plastic to match shell • Frame color: paint price group 1 • Frame cover, if armless chair is selected: plastic price group 1 • Arm pad cover, if chair with arms is selected: plastic price group 1 	<ol style="list-style-type: none"> 1 Style number 2 Plastic color number for shell 3 Paint color number for frame 4 Plastic color number for frame cover, if selected 5 Plastic color number for arm pad cover, if selected 6 Options, if selected (see below) <p>▶ See <i>Surface Materials</i>, page 634.</p>

Surface Materials	Options	U.S. Price	Required to Specify
	Upholstery version		
	<ul style="list-style-type: none"> • Plastic seat • Upholstered seat and plastic back • Upholstered seat and back 	<p>No cost</p> <p>+\$172</p> <p>+\$349</p>	<p>Specify with <i>plastic seat</i>.</p> <p>Specify with <i>upholstered seat and plastic back</i>.</p> <p>Specify with <i>upholstered seat and back</i>.</p>
	Shell		
	<ul style="list-style-type: none"> • WH69 White/Light Green • WH71 White/Mocca Anthracite • WH72 Black/Black • WH73 White/White • WH74 Mocca Anthracite/Mocca Anthracite • WH75 White/Light Blue • WH76 White/Yellow • WH77 White/Terra • WH78 White/Warm Grey • WH79 White/Black 	<p>No cost</p> <p>No cost</p> <p>No cost</p> <p>No cost</p> <p>No cost</p> <p>No cost</p> <p>No cost</p> <p>No cost</p> <p>No cost</p> <p>No cost</p>	<p>Specify with <i>WH69 White/Light Green</i>.</p> <p>Specify with <i>WG71 White/Mocca Anthracite</i>.</p> <p>Specify with <i>WH72 Black/Black</i>.</p> <p>Specify with <i>WH73 White/White</i>.</p> <p>Specify with <i>WH74 Mocca Anthracite/Mocca Anthracite</i>.</p> <p>Specify with <i>WH75 White/Light Blue</i>.</p> <p>Specify with <i>WH76 White/Yellow</i>.</p> <p>Specify with <i>WH77 White/Terra</i>.</p> <p>Specify with <i>WH78 White/Warm Grey</i>.</p> <p>Specify with <i>WH79 White/Black</i>.</p>
	Upholstery on seat		
	<ul style="list-style-type: none"> • Fabric price group 1 • Fabric price group 2 • Fabric price group 3 • Fabric price group 4 • Fabric price group 5 • Fabric price group 6 • Fabric price group 7 • Fabric price group 8 • Fabric price group 9 • Fabric price group 10 • Steelcase leather upholstery • Select Surfaces leather price group 1 • Elmosoft leather upholstery • Select Surfaces leather price group 2 • Customer's Own Material/Vinyl (COM) • Customer's Own Leather (COL) 	<p>No cost</p> <p>+\$ 21</p> <p>+\$ 34</p> <p>+\$ 49</p> <p>+\$ 62</p> <p>+\$ 88</p> <p>+\$125</p> <p>+\$165</p> <p>+\$197</p> <p>+\$228</p> <p>+\$130</p> <p>+\$130</p> <p>+\$150</p> <p>+\$150</p> <p>No cost</p> <p>No cost</p>	<p>Specify fabric color number.</p> <p>Specify fabric color number.</p> <p>Specify fabric color number.</p> <p>Specify fabric color number.</p> <p>Specify fabric color number.</p> <p>Specify fabric color number.</p> <p>Specify fabric color number.</p> <p>Specify fabric color number.</p> <p>Specify fabric color number.</p> <p>Specify fabric color number.</p> <p>Specify leather color number.</p> <p>▶ See <i>Surface Materials Reference Manual</i>. Specify Elmosoft leather color number.</p> <p>▶ See <i>Surface Materials Reference Manual</i>.</p> <p>▶ See <i>Surface Materials Reference Manual</i>. Specify leather color number.</p>

▶ Options, continued on next page



For Canadian Pricing
 Multiply U.S. Price by the Canadian price factor.
 ▶ See page 1 for details.

► Options, continued from previous page

	Options	U.S. Price	Required to Specify
Surface Materials, continued	Upholstery on back		
	• Fabric price group 1	No cost	Specify fabric color number.
	• Fabric price group 2	+\$ 21	Specify fabric color number.
	• Fabric price group 3	+\$ 34	Specify fabric color number.
	• Fabric price group 4	+\$ 49	Specify fabric color number.
	• Fabric price group 5	+\$ 62	Specify fabric color number.
	• Fabric price group 6	+\$ 88	Specify fabric color number.
	• Fabric price group 7	+\$125	Specify fabric color number.
	• Fabric price group 8	+\$165	Specify fabric color number.
	• Fabric price group 9	+\$197	Specify fabric color number.
	• Fabric price group 10	+\$228	Specify fabric color number.
	• Steelcase leather upholstery	+\$130	Specify leather color number.
	• Select Surfaces leather price group 1	+\$130	► See <i>Surface Materials Reference Manual</i> . Specify Elmosoft leather color number.
	• Elmosoft leather upholstery	+\$150	► See <i>Surface Materials Reference Manual</i> .
	• Select Surfaces leather price group 2	+\$150	► See <i>Surface Materials Reference Manual</i> . Specify leather color number.
• Customer's Own Material/Vinyl (COM)	No cost		
• Customer's Own Leather (COL)	No cost		
	Contrasting upholstery on seat and back		
	• Contrasting fabrics	+\$ 46	Specify with contrasting.
	Soil-retardant treatment	+\$ 36	Specify with soil-retardant treatment.
	Frame color on WHG6600		
	• 4242 Milk	No cost	Specify with 4242 Milk.
	• 0835 Black	+\$ 23	Specify with 0835 Black.
	• 4799 Platinum Metallic	+\$ 23	Specify with 4799 Platinum Metallic.
	• WH04 Chrome	+\$ 73	Specify with WH04 Chrome.
	Frame color on WHG6602		
	• 4242 Milk	No cost	Specify with 4242 Milk.
	• 0835 Black	+\$ 23	Specify with 0835 Black.
	• 4799 Platinum Metallic	+\$ 23	Specify with 4799 Platinum Metallic.
	• WH04 Chrome	+\$107	Specify with WH04 Chrome.
	Frame cover on WHG6600		
	• WH95 Black	No cost	Specify with WH95 Black.
	• WH96 White	No cost	Specify with WH96 White.
	Arm pad cover on WHG6602		
	• WH95 Black	No cost	Specify with WH95 Black.
	• WH96 White	No cost	Specify with WH96 White.
	Glides		
	• Hard	No cost	Specify with hard glides.
	• Soft	No cost	Specify with soft glides.

Tip: Hard glides are recommended for carpeted surfaces and soft glides are recommended for non-carpeted surfaces.

Specification Information

Style Number	U.S. Base Price
WHG6600	\$669
WHG6602	\$737

Frame-Linking Chair, Armless

WHG6600 \$669

Frame-Linking Chair with Arms

WHG6602 \$737

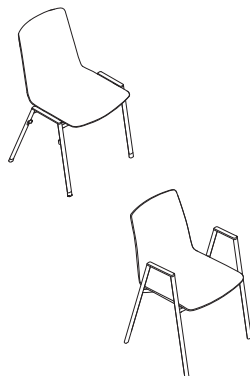

Nooi Sled-Base Chair



Tip: Nooi sled-base chairs can stack eight high on floor and eight high on transport dolly.

Tip: When specifying the shell color, the first color listed indicates the interior, textured shell color. The color after the backslash indicates the exterior, high-gloss shell color.

Standard Includes	Required to Specify
<ul style="list-style-type: none"> ▶ Need help? Product details, page 410 • Shell: plastic price group 1 • Seat and back: plastic to match shell • Frame color: paint price group 1 	<ol style="list-style-type: none"> 1 Style number 2 Plastic color number for shell 3 Paint color number for frame 4 Options, if selected (see below) <ul style="list-style-type: none"> ▶ See <i>Surface Materials</i>, page 634.

Options	U.S. Price	Required to Specify
Surface Materials		
Upholstery version		
• Plastic seat	No cost	Specify with <i>plastic seat</i> .
• Upholstered seat and plastic back	+\$172	Specify with <i>upholstered seat and plastic back</i> .
• Upholstered seat and back	+\$349	Specify with <i>upholstered seat and back</i> .
Shell		
• WH69 White/Light Green	No cost	Specify with <i>WH69 White/Light Green</i> .
• WH71 White/Mocca Anthracite	No cost	Specify with <i>WG71 White/Mocca Anthracite</i> .
• WH72 Black/Black	No cost	Specify with <i>WH72 Black/Black</i> .
• WH73 White/White	No cost	Specify with <i>WH73 White/White</i> .
• WH74 Mocca Anthracite/Mocca Anthracite	No cost	Specify with <i>WH74 Mocca Anthracite/Mocca Anthracite</i> .
• WH75 White/Light Blue	No cost	Specify with <i>WH75 White/Light Blue</i> .
• WH76 White/Yellow	No cost	Specify with <i>WH76 White/Yellow</i> .
• WH77 White/Terra	No cost	Specify with <i>WH77 White/Terra</i> .
• WH78 White/Warm Grey	No cost	Specify with <i>WH78 White/Warm Grey</i> .
• WH79 White/Black	No cost	Specify with <i>WH79 White/Black</i> .
Upholstery on seat		
• Fabric price group 1	No cost	Specify fabric color number.
• Fabric price group 2	+\$ 21	Specify fabric color number.
• Fabric price group 3	+\$ 34	Specify fabric color number.
• Fabric price group 4	+\$ 49	Specify fabric color number.
• Fabric price group 5	+\$ 62	Specify fabric color number.
• Fabric price group 6	+\$ 88	Specify fabric color number.
• Fabric price group 7	+\$125	Specify fabric color number.
• Fabric price group 8	+\$165	Specify fabric color number.
• Fabric price group 9	+\$197	Specify fabric color number.
• Fabric price group 10	+\$228	Specify fabric color number.
• Steelcase leather upholstery	+\$130	Specify leather color number.
• Select Surfaces leather price group 1	+\$130	▶ See <i>Surface Materials Reference Manual</i> . Specify Elmosoft leather color number.
• Elmosoft leather upholstery	+\$150	▶ See <i>Surface Materials Reference Manual</i> .
• Select Surfaces leather price group 2	+\$150	▶ See <i>Surface Materials Reference Manual</i> .
• Customer's Own Material/Vinyl (COM)	No cost	▶ See <i>Surface Materials Reference Manual</i> . Specify leather color number.
• Customer's Own Leather (COL)	No cost	
Upholstery on back		
• Fabric price group 1	No cost	Specify fabric color number.
• Fabric price group 2	+\$ 21	Specify fabric color number.
• Fabric price group 3	+\$ 34	Specify fabric color number.
• Fabric price group 4	+\$ 49	Specify fabric color number.
• Fabric price group 5	+\$ 62	Specify fabric color number.
• Fabric price group 6	+\$ 88	Specify fabric color number.
• Fabric price group 7	+\$125	Specify fabric color number.
• Fabric price group 8	+\$165	Specify fabric color number.
• Fabric price group 9	+\$197	Specify fabric color number.
• Fabric price group 10	+\$228	Specify fabric color number.
• Steelcase leather upholstery	+\$130	Specify leather color number.
• Select Surfaces leather price group 1	+\$130	▶ See <i>Surface Materials Reference Manual</i> . Specify Elmosoft leather color number.
• Elmosoft leather upholstery	+\$150	▶ See <i>Surface Materials Reference Manual</i> .
• Select Surfaces leather price group 2	+\$150	▶ See <i>Surface Materials Reference Manual</i> .
• Customer's Own Material/Vinyl (COM)	No cost	▶ See <i>Surface Materials Reference Manual</i> . Specify leather color number.
• Customer's Own Leather (COL)	No cost	

▶ Options, continued on next page

 **For Canadian Pricing**
Multiply U.S. Price by the Canadian price factor.
▶ See page 1 for details.

► Options, continued from previous page

Options	U.S. Price	Required to Specify
Surface Materials, continued		
Contrasting upholstery on seat and back		
• Contrasting fabrics	+\$46	Specify with <i>contrasting</i> .
Soil-retardant treatment	+\$36	Specify with <i>soil-retardant treatment</i> .
Frame color		
• 4242 Milk	No cost	Specify with <i>4242 Milk</i> .
• 0835 Black	+\$23	Specify with <i>0835 Black</i> .
• 4799 Platinum Metallic	+\$23	Specify with <i>4799 Platinum Metallic</i> .
Glides		
• Hard	No cost	Specify with <i>hard glides</i> .
• Soft	No cost	Specify with <i>soft glides</i> .

Tip: Hard glides are recommended for carpeted surfaces and soft glides are recommended for non-carpeted surfaces.



Specification Information	
Style Number	U.S. Base Price
WHG6604	\$603



 **For Canadian Pricing**
 Multiply U.S. Price by the Canadian price factor.
 ► See page 1 for details.

Nooi 4-Leg Base Chairs



Tip: Nooi 4-leg base chairs can stack eight high on floor and eight high on transport dolly.

Tip: When specifying the shell color, the first color listed indicates the interior, textured shell color. The color after the backslash indicates the exterior, high-gloss shell color.

Standard Includes	Required to Specify
<ul style="list-style-type: none"> ▶ Need help? Product details, page 410 • Shell: plastic price group 1 • Seat and back: plastic to match shell • Frame color: paint price group 1 • Arm pad cover, if chair with arms is selected: plastic price group 1 	<ol style="list-style-type: none"> 1 Style number 2 Plastic color number for shell 3 Paint color number for frame 4 Plastic color number for arm pad cover, if selected 5 Options, if selected (see below) <ul style="list-style-type: none"> ▶ See <i>Surface Materials</i>, page 634.

Options	U.S. Price	Required to Specify
<p>Surface Materials</p> <ul style="list-style-type: none"> • Plastic seat • Upholstered seat and plastic back • Upholstered seat and back 	<p>No cost</p> <p>+\$172</p> <p>+\$349</p>	<p>Specify with <i>plastic seat</i>.</p> <p>Specify with <i>upholstered seat and plastic back</i>.</p> <p>Specify with <i>upholstered seat and back</i>.</p>
<p>Shell</p> <ul style="list-style-type: none"> • WH69 White/Light Green • WH71 White/Mocca Anthracite • WH72 Black/Black • WH73 White/White • WH74 Mocca Anthracite/Mocca Anthracite • WH75 White/Light Blue • WH76 White/Yellow • WH77 White/Terra • WH78 White/Warm Grey • WH79 White/Black 	<p>No cost</p> <p>No cost</p> <p>No cost</p> <p>No cost</p> <p>No cost</p> <p>No cost</p> <p>No cost</p> <p>No cost</p> <p>No cost</p> <p>No cost</p>	<p>Specify with <i>WH69 White/Light Green</i>.</p> <p>Specify with <i>WG71 White/Mocca Anthracite</i>.</p> <p>Specify with <i>WH72 Black/Black</i>.</p> <p>Specify with <i>WH73 White/White</i>.</p> <p>Specify with <i>WH74 Mocca Anthracite/Mocca Anthracite</i>.</p> <p>Specify with <i>WH75 White/Light Blue</i>.</p> <p>Specify with <i>WH76 White/Yellow</i>.</p> <p>Specify with <i>WH77 White/Terra</i>.</p> <p>Specify with <i>WH78 White/Warm Grey</i>.</p> <p>Specify with <i>WH79 White/Black</i>.</p>
<p>Upholstery on seat</p> <ul style="list-style-type: none"> • Fabric price group 1 • Fabric price group 2 • Fabric price group 3 • Fabric price group 4 • Fabric price group 5 • Fabric price group 6 • Fabric price group 7 • Fabric price group 8 • Fabric price group 9 • Fabric price group 10 • Steelcase leather upholstery • Select Surfaces leather price group 1 • Elmosoft leather upholstery • Select Surfaces leather price group 2 • Customer's Own Material/Vinyl (COM) • Customer's Own Leather (COL) 	<p>No cost</p> <p>+\$ 21</p> <p>+\$ 34</p> <p>+\$ 49</p> <p>+\$ 62</p> <p>+\$ 88</p> <p>+\$125</p> <p>+\$165</p> <p>+\$197</p> <p>+\$228</p> <p>+\$130</p> <p>+\$130</p> <p>+\$150</p> <p>+\$150</p> <p>No cost</p> <p>No cost</p>	<p>Specify fabric color number.</p> <p>Specify fabric color number.</p> <p>Specify fabric color number.</p> <p>Specify fabric color number.</p> <p>Specify fabric color number.</p> <p>Specify fabric color number.</p> <p>Specify fabric color number.</p> <p>Specify fabric color number.</p> <p>Specify fabric color number.</p> <p>Specify fabric color number.</p> <p>Specify leather color number.</p> <ul style="list-style-type: none"> ▶ See <i>Surface Materials Reference Manual</i>. Specify Elmosoft leather color number. ▶ See <i>Surface Materials Reference Manual</i>. ▶ See <i>Surface Materials Reference Manual</i>. Specify leather color number.
<p>Upholstery on back</p> <ul style="list-style-type: none"> • Fabric price group 1 • Fabric price group 2 • Fabric price group 3 • Fabric price group 4 • Fabric price group 5 • Fabric price group 6 • Fabric price group 7 • Fabric price group 8 • Fabric price group 9 • Fabric price group 10 • Steelcase leather upholstery • Select Surfaces leather price group 1 • Elmosoft leather upholstery • Select Surfaces leather price group 2 • Customer's Own Material/Vinyl (COM) • Customer's Own Leather (COL) 	<p>No cost</p> <p>+\$ 21</p> <p>+\$ 34</p> <p>+\$ 49</p> <p>+\$ 62</p> <p>+\$ 88</p> <p>+\$125</p> <p>+\$165</p> <p>+\$197</p> <p>+\$228</p> <p>+\$130</p> <p>+\$130</p> <p>+\$150</p> <p>+\$150</p> <p>No cost</p> <p>No cost</p>	<p>Specify fabric color number.</p> <p>Specify fabric color number.</p> <p>Specify fabric color number.</p> <p>Specify fabric color number.</p> <p>Specify fabric color number.</p> <p>Specify fabric color number.</p> <p>Specify fabric color number.</p> <p>Specify fabric color number.</p> <p>Specify fabric color number.</p> <p>Specify fabric color number.</p> <p>Specify leather color number.</p> <ul style="list-style-type: none"> ▶ See <i>Surface Materials Reference Manual</i>. Specify Elmosoft leather color number. ▶ See <i>Surface Materials Reference Manual</i>. ▶ See <i>Surface Materials Reference Manual</i>. Specify leather color number.

▶ Options, continued on next page

 **For Canadian Pricing**
 Multiply U.S. Price by the Canadian price factor.
 ▶ See page 1 for details.

► Options, continued from previous page

Options	U.S. Price	Required to Specify
Surface Materials, continued		
Contrasting upholstery on seat and back		
• Contrasting fabrics	+\$46	Specify with <i>contrasting</i> .
Soil-retardant treatment	+\$36	Specify with <i>soil-retardant treatment</i> .
Frame color		
• 4242 Milk	No cost	Specify with <i>4242 Milk</i> .
• 0835 Black	+\$23	Specify with <i>0835 Black</i> .
• 4799 Platinum Metallic	+\$23	Specify with <i>4799 Platinum Metallic</i> .
• WH04 Chrome	+\$73	Specify with <i>WH04 Chrome</i> .
Arm pad cover on WHG6608		
• WH95 Black	No cost	Specify with <i>WH95 Black</i> .
• WH96 White	No cost	Specify with <i>WH96 White</i> .
Glides		
• Hard	No cost	Specify with <i>hard glides</i> .
• Soft	No cost	Specify with <i>soft glides</i> .

Tip: Hard glides are recommended for carpeted surfaces and soft glides are recommended for non-carpeted surfaces.

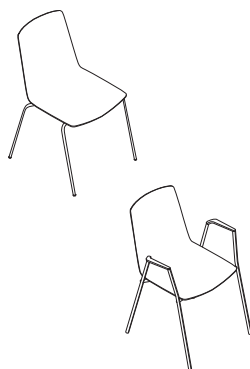

Specification Information

Style Number	U.S. Base Price

4-Leg Base Chair, Armless

WHG6606	\$536
----------------	-------

4-Leg Base Chair with Arms

WHG6608	\$603
----------------	-------

Nooi

 **For Canadian Pricing**
 Multiply U.S. Price by the Canadian price factor.
 ► See page 1 for details.

Nooi Stools

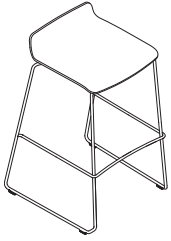

Tip: Nooi café-height stools and bar-height stools can stack five high on floor.

Tip: When specifying the shell color, the first color listed indicates the interior, textured shell color. The color after the backslash indicates the exterior, high-gloss shell color.

Tip: Hard glides are recommended for carpeted surfaces and soft glides are recommended for non-carpeted surfaces.

Standard Includes		Required to Specify
<ul style="list-style-type: none"> ▶ Need help? Product details, page 410 	<ul style="list-style-type: none"> • Shell: plastic price group 1 • Frame color: paint price group 1 	<ol style="list-style-type: none"> 1 Style number 2 Plastic color number for shell 3 Paint color number for frame 4 Options, if selected (see below) <ul style="list-style-type: none"> ▶ See <i>Surface Materials</i>, page 634.

Options	U.S. Price	Required to Specify
Surface Materials		
Upholstery version		
• Plastic seat	No cost	Specify with plastic seat.
• Upholstered seat	+\$172	Specify with upholstered seat.
Shell		
• WH69 White/Light Green	No cost	Specify with WH69 White/Light Green.
• WH71 White/Mocca Anthracite	No cost	Specify with WG71 White/Mocca Anthracite.
• WH72 Black/Black	No cost	Specify with WH72 Black/Black.
• WH73 White/White	No cost	Specify with WH73 White/White.
• WH74 Mocca Anthracite/Mocca Anthracite	No cost	Specify with WH74 Mocca Anthracite/Mocca Anthracite.
• WH75 White/Light Blue	No cost	Specify with WH75 White/Light Blue.
• WH76 White/Yellow	No cost	Specify with WH76 White/Yellow.
• WH77 White/Terra	No cost	Specify with WH77 White/Terra.
• WH78 White/Warm Grey	No cost	Specify with WH78 White/Warm Grey.
• WH79 White/Black	No cost	Specify with WH79 White/Black.
Upholstery on seat		
• Fabric price group 1	No cost	Specify fabric color number.
• Fabric price group 2	+\$ 21	Specify fabric color number.
• Fabric price group 3	+\$ 34	Specify fabric color number.
• Fabric price group 4	+\$ 49	Specify fabric color number.
• Fabric price group 5	+\$ 62	Specify fabric color number.
• Fabric price group 6	+\$ 88	Specify fabric color number.
• Fabric price group 7	+\$125	Specify fabric color number.
• Fabric price group 8	+\$165	Specify fabric color number.
• Fabric price group 9	+\$197	Specify fabric color number.
• Fabric price group 10	+\$228	Specify fabric color number.
• Steelcase leather upholstery	+\$130	Specify leather color number.
• Select Surfaces leather price group 1	+\$130	▶ See <i>Surface Materials Reference Manual</i> .
• Elmosoft leather upholstery	+\$150	Specify Elmosoft leather color number.
• Select Surfaces leather price group 2	+\$150	▶ See <i>Surface Materials Reference Manual</i> .
• Customer's Own Material/Vinyl (COM)	No cost	▶ See <i>Surface Materials Reference Manual</i> .
• Customer's Own Leather (COL)	No cost	Specify leather color number.
Soil-retardant treatment	+\$ 36	Specify with soil-retardant treatment.
Frame color		
• 4242 Milk	No cost	Specify with 4242 Milk.
• 0835 Black	+\$ 23	Specify with 0835 Black.
• 4799 Platinum Metallic	+\$ 23	Specify with 4799 Platinum Metallic.
Glides		
• Hard	No cost	Specify with hard glides.
• Soft	No cost	Specify with soft glides.

 **For Canadian Pricing**
 Multiply U.S. Price by the Canadian price factor.
 ▶ See page 1 for details.

Specification Information

Style Number	U.S. Base Price
--------------	-----------------

Café-Height Stool

WHG6626	\$803
---------	-------

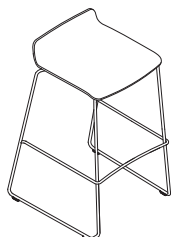

Bar-Height Stool

WHG6625	\$835
---------	-------

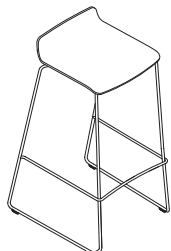

 **For Canadian Pricing**
 Multiply U.S. Price by the Canadian price factor.
 ▶ See page 1 for details.

Nooi Transport Dolly

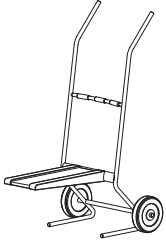

Tip: Nooi transport dolly is intended for transport only. Nooi chairs and stools should not be stored on the dolly.

Tip: Nooi café-height stool and bar-height stool are not compatible with the transportation dolly.

Standard Includes	Required to Specify
<ul style="list-style-type: none"> ▶ Need help? Product details, page 410 • Transport dolly: black paint only 	Style number

Specification Information

Style Number	U.S. Price
WHGDOLLY	\$1097



For Canadian Pricing
 Multiply U.S. Price by the Canadian price factor.
 ▶ See page 1 for details.

Understanding and Specifying Max-Stacker III 477 Series Stackable Chair

Product Details

Max-Stacker III 477 Series	428
Dimensions	430

Specifying

Stackable Chair	432
Accessories	433

Stackable Chairs

Stackable chairs offer flexibility and ease of use in classrooms, auditoriums, or wherever extra seating is required.

- Max-Stacker III 477 Series
- Player 475 Series
- Leg-Base Chairs

Max-Stacker III 477 Series

Max-Stacker III is a stacking chair perfect for high traffic areas. With a new texture and an updated finish offering, it fits into any environment.

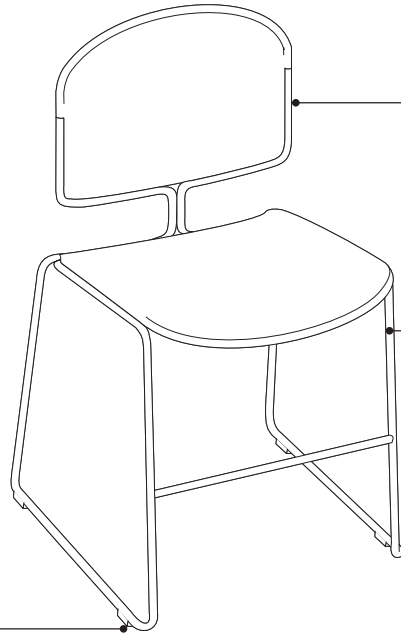

Shell is available in flexible, contoured plastic.

Two-piece wire-rod frame is 7/16" diameter carbon steel for strength and durability.

Plastic glides are standard. Soft felt glides, optional, are recommended for use on non-carpeted floors.

Product Details

Max-Stacker III can stack up to 12 chairs high when stacked on the floor.

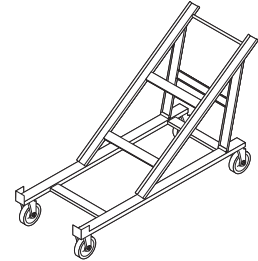

Transport and storage dolly is available to stack, move, and store up to 45 chairs.

Unloaded transport dolly measures 55"D x 22"W x 37½"H.

Fully loaded transport dolly measures 57"D x 22"W x 68½"H.

Without transport dolly stack can be up to 12 chairs high.

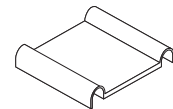

Alignment device is available to temporarily link chairs together in the field for evenly spaced rows. Chairs can be unlinked easily. Spacing between chairs linked with alignment device is 2¼".

Surface Materials

▶ See surface materials on page 634 for specific availability or refer to the *Surface Materials Reference Manual* for further information.

Hard components (frame)

- 4799 Platinum Metallic
- 7000 Black
- 7239 Midnight
- 9201 Polished Chrome

Coatings

- 1ATT Cast Shadow

Lux Coatings

- 4B20 Obsidian
- 4B22 Matte Brass
- 4B23 Burnished Bronze
- 4B24 Night Bronze
- 4B25 Matte Copper
- 4B26 Smoked Mica
- 4B29 Cast Iron

Shell

Price Group 1

Plastics

- 6009 Arctic White
- 6059 Sterling Dark Solid
- 6205 Black
- 6249 Platinum Solid
- 6259 Midnight
- 6332 Citron
- 6335 Wasabi
- 6336 Jazz
- 6337 Element
- 6338 Chili Red
- 6BE1 Ore

Price Group 2

Signature Plastics

- 6BD1 Aubergine
- 6BD5 Honey
- 6BD6 Lagoon
- 6BD7 Saffron

Glides

- Clear plastic
- Soft

Programs & Services

▶ See the *Surface Materials Reference Manual* for further detail about programs and services offered for seating.

Dimensions

▶ Page 430

Resources

Printed Materials

▶ Max-Stacker Brochure (11-0002245)

Online Resources

▶ Product Environmental Profiles, which provide key environmental attributes and product certifications can be found by searching for Steelcase at *Origin.build*.

Dimensions

Max-Stacker III 477 Series

• Features	• Overall • Depth	Width	Height	• Seat • Depth	• Functional • Seat • Depth	• Seat • Width	• Seat • Height • from • Floor	• Back • Width	• Back • Height • from • Seat	• Back • Lumbar • Height
Max-Stacker III 477 Series										
	21½"	20"	30¼"	17¾"	16¾"	18¼"	17½"	18¼"	14¾"	9½"

Tip: Max Stacker III 477 Series stacked twelve high on the floor have the following overall dimensions: 29"D, 20"W, and 37"H.

• Width • Between • Arms	• Arm • to • Floor	• Arm • Height • from • Seat	• Seat • Pan • Angle	• Angle • Between • Seat and • Back
--------------------------------	--------------------------	---------------------------------------	----------------------------	--

N.A.	N.A.	N.A.	8°	93°
------	------	------	----	-----

Max-Stacker III 477 Series Stackable Chair



Standard Includes		Required to Specify
<ul style="list-style-type: none"> ▶ Need help? Product details, page 428 	<ul style="list-style-type: none"> • Frame: 7000 Black paint • Shell: plastic • Glides: plastic 	<ol style="list-style-type: none"> 1 Style number 2 Seating coating color number for frame 3 Plastic color number for shell 4 Options, if selected (see below) <ul style="list-style-type: none"> ▶ See <i>Surface Materials</i>, page 634.

Options	U.S. Price	Required to Specify
Surface Materials	Frame <ul style="list-style-type: none"> • 7239 Midnight • 4799 Platinum Metallic • 9201 Polished Chrome • 1ATT Cast Shadow • Lux Coatings 	<ul style="list-style-type: none"> No cost +\$46 +\$46 +\$82 +\$82
	Shell <ul style="list-style-type: none"> • Plastic price group 1 • Plastic price group 2 	<ul style="list-style-type: none"> No cost +\$41
Glides	<ul style="list-style-type: none"> • Soft glides for use on non-carpeted floors 	<ul style="list-style-type: none"> Specify with 7239 <i>Midnight</i>. Specify with 4799 <i>Platinum Metallic</i>. Specify with 9201 <i>Polished Chrome</i>. Specify with 1ATT <i>Cast Shadow</i>. Specify Lux Coatings color number. ▶ See <i>Surface Materials</i>, page 634.
		<ul style="list-style-type: none"> Specify color number. ▶ See <i>Surface Materials</i>, page 634. Specify color number. ▶ See <i>Surface Materials</i>, page 634.
		<ul style="list-style-type: none"> Specify with <i>soft glides</i>.

Specification Information	
Style Number	U.S. Base Price
477100	\$304

▶ Detailed dimensions, page 430



For Canadian Pricing
 Multiply U.S. Price by the Canadian price factor.
 ▶ See page 1 for details.

Alignment Device

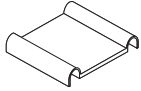

Standard Includes		Required to Specify
<ul style="list-style-type: none"> • Carton of 12 alignment devices: black plastic only 		Style number
Specification Information		
Style Number	U.S. Price	
472G	\$52	

Transport and Storage Dolly

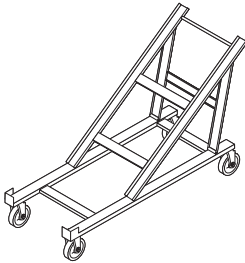

Standard Includes		Required to Specify
<ul style="list-style-type: none"> • Transport and storage dolly: black paint only 		Style number
Specification Information		
Style Number	U.S. Price	
473D	\$778	

Max-Stacker III
477 Series



For Canadian Pricing
Multiply U.S. Price by the Canadian price factor.
▶ See page 1 for details.



Understanding and Specifying Turnstone Buoy

Multi-Use Seating



Product Details

Buoy	436
Dimensions	437



Specifying

Buoy	438
------	-----

Buoy

Buoy is collaborative seating for teams that helps people move freely, change postures, and stay energized and comfortable.
▶ Specifying, page 438

Buoy is 18" in diameter.

Buoy body comes in 16 different colors, is lightweight at 20 lb and ships in a carton fully assembled.

Base is 6527 Merle.

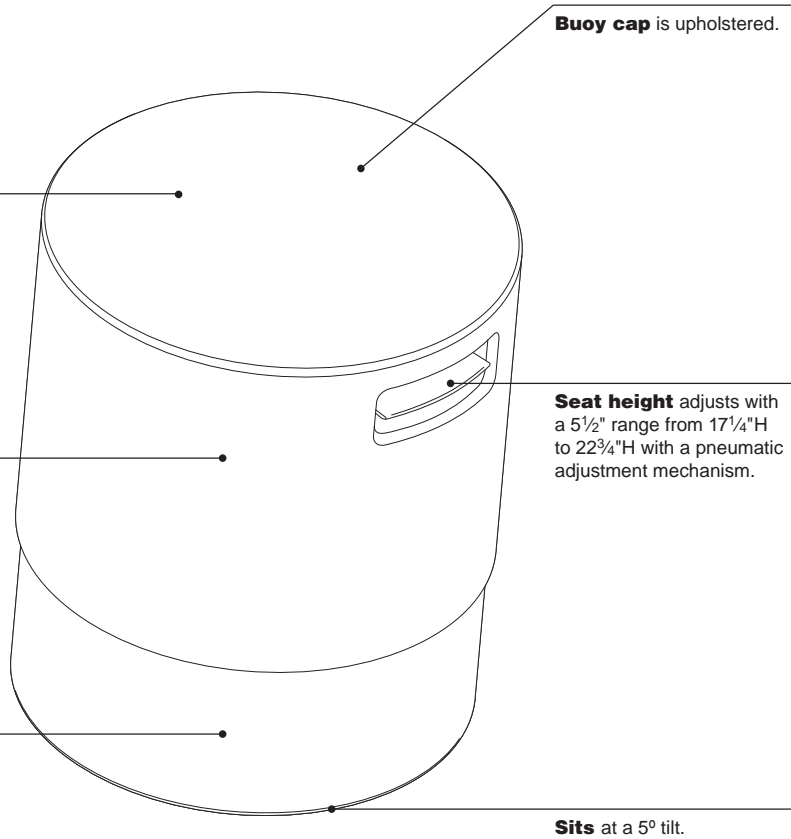

Product Details

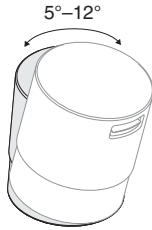

Tilts up to 12° to encourage active sitting.

Adjustment Features

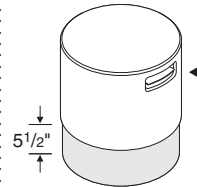

Seat height adjusts pneumatically. To lower, hold handle up while seated. To raise, hold handle up and keep weight off. Range of adjustability is 5½".

Surface Materials

▶ See surface materials on page 634 for specific availability or refer to the *Surface Materials Reference Manual* for further information.

Dimensions

▶ Page 437

Dimensions

Buoy

Features	Overall Depth	Width	Height
Buoy			
Multi-Use Seating			
Buoy	18"	18"	17¼"-22¾"



Buoy



Tip: Not recommended for use on hard floors. May cause scratches.

Standard Includes		Required to Specify
<ul style="list-style-type: none"> ▶ Need help? Product details, page 436 	<ul style="list-style-type: none"> • Body: plastic price group 1 • Base: 6527 Merle • Cap: fabric price group 1 • Pneumatic height adjustment • Ships fully assembled 	<ol style="list-style-type: none"> 1 Style number 2 Fabric color number for cap 3 Plastic color number for body 4 Options, if selected (see below) <ul style="list-style-type: none"> ▶ See <i>Surface Materials</i>, page 634.

Options	U.S. Price	Required to Specify
Surface Materials		
Cap		
• Fabric price group 1	No cost	Specify fabric color number.
• Fabric price group 2	+\$ 41	Specify fabric color number.
• Fabric price group 3	+\$ 57	Specify fabric color number.
• Fabric price group 4	+\$ 81	Specify fabric color number.
• Fabric price group 5	+\$ 96	Specify fabric color number.
• Fabric price group 6	+\$108	Specify fabric color number.
• Fabric price group 7	+\$124	Specify fabric color number.
• Fabric price group 8	+\$135	Specify fabric color number.
• Fabric price group 9	+\$146	Specify fabric color number.
• Fabric price group 10	+\$161	Specify fabric color number.
• COM	+\$ 53	Specify fabric color number.
• Non-upholstered cap: 6527 Merle only	+\$ 41	Specify <i>with non-upholstered cap</i> .
Body		
• Plastic price group 1	No cost	Specify color number.
• Plastic price group 2	+\$ 53	Specify color number.

Specification Information				
• Dimensions			• Style Number	• U.S. Base Price
D	W	H		
18"	18"	17¼"–22¾"	TSBUOY	\$518



For Canadian Pricing
 Multiply U.S. Price by the Canadian price factor.
 ▶ See page 1 for details.

Understanding and Specifying Brody 488 Series Lounge Seating

Product Details

Brody WorkLounge 488 Series	440
Brody WorkLounge Dimensions	446
Brody WorkLounge Application Tips	448
Brody Desk 488 Series	450
Brody Desk Dimensions	453
Brody Desk Application Tips	454

Specifying

Brody WorkLounge	456
Brody Privacy WorkLounge	458
Brody Privacy WorkLounge with Extension	460
Brody Privacy Desk	462
Brody Privacy Desk with Extension	464
Brody Footrest	466

Brody WorkLounge 488 Series

The Brody WorkLounge

is a private workspace designed to be good for the body and good for the brain—providing places to get away without going away. A drop-in destination for focus in a relaxed posture. Brody includes integrating power, ergonomic comfort in the highly-desired lounge posture, personal storage, lighting, privacy screens offering shelter from distractions and safe shielding, and a personal worksurface that keeps technology at eye level, reducing neck and shoulder strain.

Screen alignment clip

ensures privacy screens remain aligned.

Side surface is a laminate surface and creates space to spread work out.

Storage caddy delivers a convenient place to store belongings off the floor and within arm's reach.

Integrated power is easily accessible, so the user can focus on work and not worry about battery level.

Lower surround is upholstery wrapped and creates a barrier around the workspace.

Footrest tethering is available when using a compatible, off-the-shelf standard laptop cable lock with lock slot.

Footrest provides additional support for legs and feet, helping maintain a comfortable, reclined posture. Footrest fits under the seat when not in use.

dash mini LED light integrates seamlessly to deliver adjustable, efficient lighting where it is needed most.

Screens provide shielding from visual distractions and enhance personal privacy and psychological comfort.

Personal worksurface tilts to ergonomically support a user's wrists for keyboarding while also allowing the screen to rise up to eye level, reducing neck strain.

Seat has adaptive bolstering which creates comfort pockets designed to support every user.

Open cavity beneath seat provides storage space for footrest.

Leveling glides on foot adjust 1 1/2" for uneven floors.

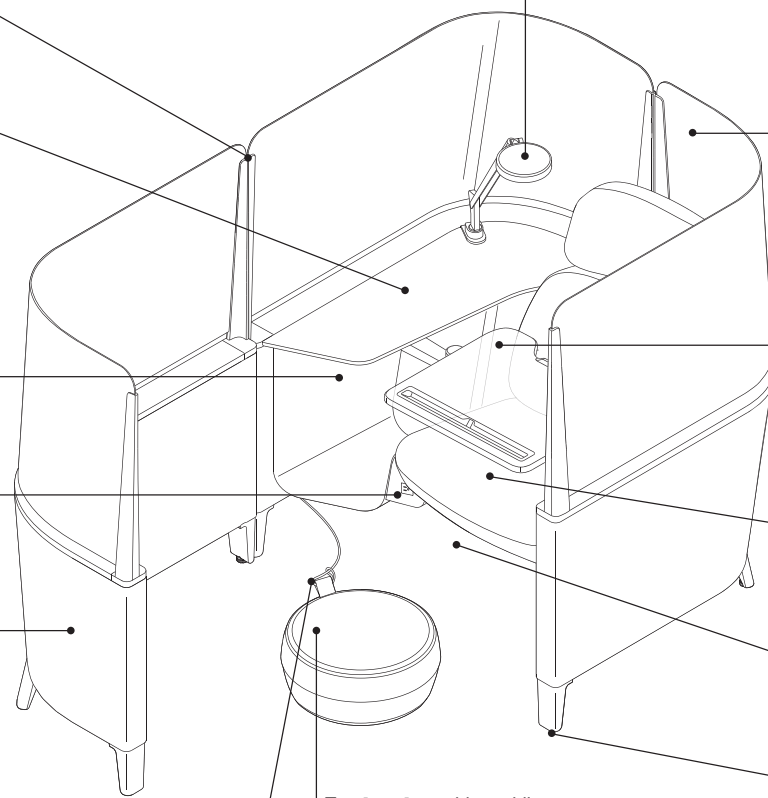

Product Details

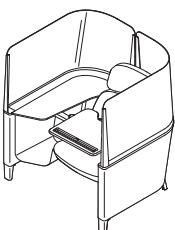
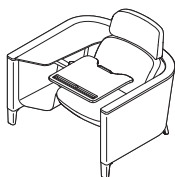

Brody WorkLounge is available with and without screens.

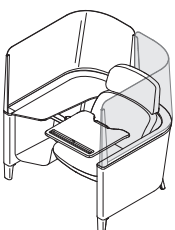

Screens on privacy WorkLounge with extension can only be omitted on the opposite side of where the side surface is located.

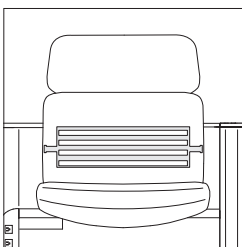

LiveLumbar offers a dialed in spring force in the lumbar region that actively supports the lower back.

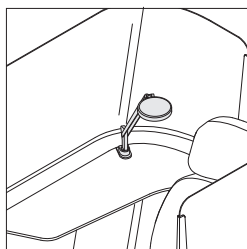

dash mini LED light is available if power has been specified and can be field installed.

dash mini LED light adjusts 19⁷/₈"H from the side surface. The base and head pivot 360°.

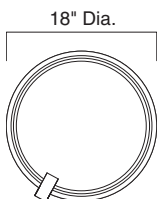

Footrest has plastic base and an overall height of 10"H and a diameter of 18".

Integrated loop on footrest allows for easy repositioning of the footrest in the workspace. It is 1³/₄"W x 2" long and can be used to tether the footrest to the frame.

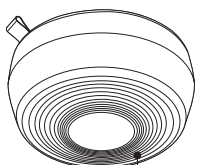

Non-slip surface

Footrest base is domed in the middle, allowing it to move to adapt to user preferences.

Bottom of footrest has a non-slip surface toward the outside to prevent sliding.

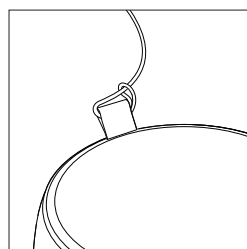
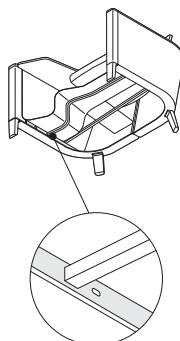

Footrest can be tethered to the frame with a laptop cable lock with lock slot. These can be purchased separately. There are multiple styles available. To complete the tether, use the footrest pull tag and the slot located on the perimeter of the frame.

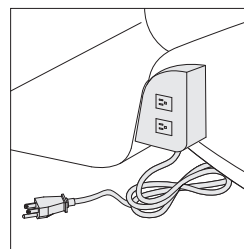

Two NEMA outlets

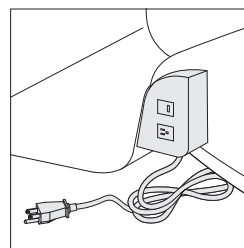

One NEMA, one USB outlet

Power is standard with two three-prong NEMA outlets. It is available with one three-prong NEMA outlet and one USB 2.0 (2.1 amp) outlet as an option. The cord is 10' long and is available with either a standard three-prong NEMA plug for use with standard receptacles or with Steelcase's proprietary Thread low-profile plug for use with one-door and two-door low-profile connectors.

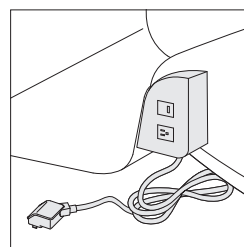

Proprietary low-profile plug can only be used with the Thread system and will not interface with existing receptacles. In order to achieve ADA compliance for connectors in an egress location, we developed our own plug design.

Tip: Always consult your local inspector prior to purchasing the Thread system to ensure all local codes and ordinances are satisfied since local regulations may supersede those spelled out in the National Electric Code.

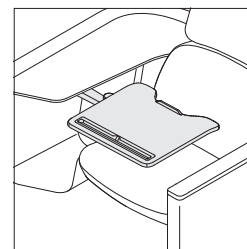

Personal worksurface has a cut out to hold technology like smart phones and tablets. The worksurface measures 16⁵/₈"D x 18¹/₄"W and is 26⁷/₈"H from the floor.

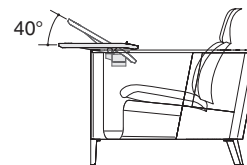

Personal worksurface tilts up to 40-degrees allowing users to bring work to eye level.

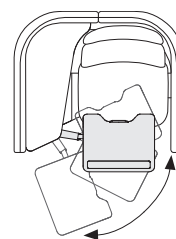

Personal worksurface swivels 125 degrees in and out to allow easy entry and exit.

Brody WorkLounge 488 Series, continued

Surface Materials

► See surface materials on page 634 for specific availability or refer to the *Surface Materials Reference Manual* for further information.

Seat upholstery

- Fabric
- Leather
- Elmosoft Leather
- Select Surfaces leather
- Vinyl
- COL
- COM

Screen

- Acrylic – 6559 Satin Ice
- Buzz2 fabric
- COM

Tip: COM selections are strictly limited. Please reference the COM page at www.steelcase.com to make your selections.

Lower surround upholstery

- Fabric
- COM
- Vinyl

Tip: The standard application direction of fabric on the lower surround is warp horizontal. Standard Steelcase fabrics were designed for this application direction.

Upper footrest

- Fabric
- Leather
- Elmosoft Leather
- Select Surfaces leather
- Plastic
- Vinyl
- COL
- COM

Tip: Consider fabrics appropriate for high-wear environments for the upper footrest.

Lower footrest

- 6053 Seagull
- 6059 Sterling Dark

Trim

- Fabric
- Plastic
- COM

Light

- 4231 Arctic White
- 4710 Low Gloss Black
- 4799 Platinum
- Accent paint (option)

Side surface

- 2410 Graphite Walnut
- 2511 Winter on Maple
- 2535 Virginia Walnut
- 2536 Blackwood
- 2883 Seagull
- 2HAT Acacia

Storage caddy, lower surround trim, seat shell, personal worksurface, personal worksurface arm, screen brackets, power, frame, foot, and back of caddy finishes can be found on the color scheme matrix.

► See page 35

Programs & Services

► See the *Surface Materials Reference Manual* for further detail about programs and services offered for seating.

The Customer's Own Material (COM) Program

offers the opportunity for customers to select fabrics that are not offered through the standard Steelcase surface materials program for use on Steelcase products. Through the COM program, Steelcase will test your materials for application on Steelcase products. Once approved, you can place your order. Steelcase will facilitate the entire ordering process and give you a production schedule. Steelcase will order the COM fabric directly from the textile manufacturer. For up-to-date information regarding fabric test results for all COM fabrics and details regarding yardage requirements for most Seating lines, visit the COM website. To locate the COM website:

- Visit www.steelcase.com

Soil retardants are treatments that provide long-term soil and stain resistance to a fabric without affecting the shade or the integrity of the fabric. The following Steelcase Textiles are available pre-treated with soil retardant. (You do not need to select the soil-retardant option for these fabrics and incur the upcharge.)

- Jacks
- Link

For information on soil retardant fabrics on Select Surfaces, please refer to the *Surface Materials Reference Manual*.

Soil-retardant treatment is available on all other seating fabrics at an additional upcharge per seating unit. To order this option, please select "Soil-Retardant Treatment" under "Optional Accessories."

For soil-retardant treatment on COMs, please select "Soil-Retardant Treatment" under "Optional Accessories." Minimums or additional yardage may be required. Please contact the vendor directly for specific information.

Extended lead times may be necessary for this service.

Contact your Steelcase Solutions Fulfillment Team Representative at 1.888.STEELCASE (1.888.783.3522) or send an email to lineone@steelcase.com.

Dimensions

► Page 446

Resources**Printed Materials**

► Brody WorkLounge Brochure (15-0000167)

Brody WorkLounge 488 Series, continued

Color Scheme Matrix

Color Scheme	Foot	Screen Brackets	Frame	Lower Surround Trim	Seat Shell
Light	Seagull 7243	Seagull 7243	Merle 7360	Seagull 6053	Platinum Solid 6249
Medium	Platinum Metallic 4799	Platinum Metallic 4799	Merle 7360	Platinum Solid 6249	Sterling Dark Solid 6059
Dark	Sterling Dark 7250	Sterling Dark 7250	Merle 7360	Sterling Dark Solid 6059	Sterling Dark Solid 6059
Burnished Bronze	Burnished Bronze 4B23	Burnished Bronze 4B23	Merle 7360	Sterling Dark Solid 6059	Sterling Dark Solid 6059
Matte Brass	Matte Brass 4B22	Matte Brass 4B22	Merle 7360	Sterling Dark Solid 6059	Sterling Dark Solid 6059
Obsidian	Obsidian 4B20	Obsidian 4B20	Merle 7360	Sterling Dark Solid 6059	Sterling Dark Solid 6059

Tip: If an upholstered screen is specified, then the screen clips will always be aluminum.

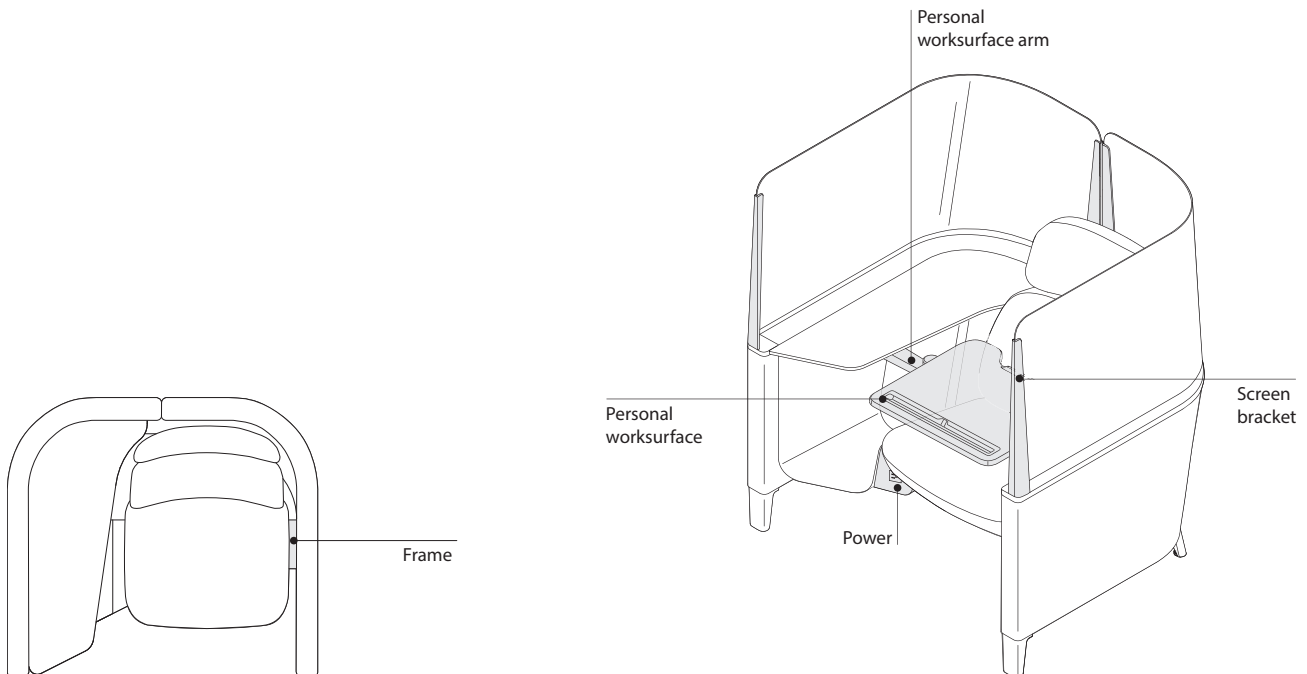

Color Scheme Matrix

Color Scheme	Personal Worksurface	Personal Worksurface Arm	Caddy	Back of Caddy	Power
Light	Seagull 6053	Platinum Metallic 4799	Seagull 6053	Merle 6527	Merle 6527
Medium	Platinum Solid 6249	Platinum Metallic 4799	Merle 6527	Merle 6527	Merle 6527
Dark	Sterling Dark Solid 6059	Sterling Dark 7250	Sterling Dark Solid 6059	Merle 6527	Merle 6527
Burnished Bronze	Sterling Dark Solid 6059	Burnished Bronze 4B23	Sterling Dark Solid 6059	Merle 6527	Merle 6527
Matte Brass	Sterling Dark Solid 6059	Matte Brass 4B22	Sterling Dark Solid 6059	Merle 6527	Merle 6527
Obsidian	Sterling Dark Solid 6059	Obsidian 4B20	Sterling Dark Solid 6059	Merle 6527	Merle 6527

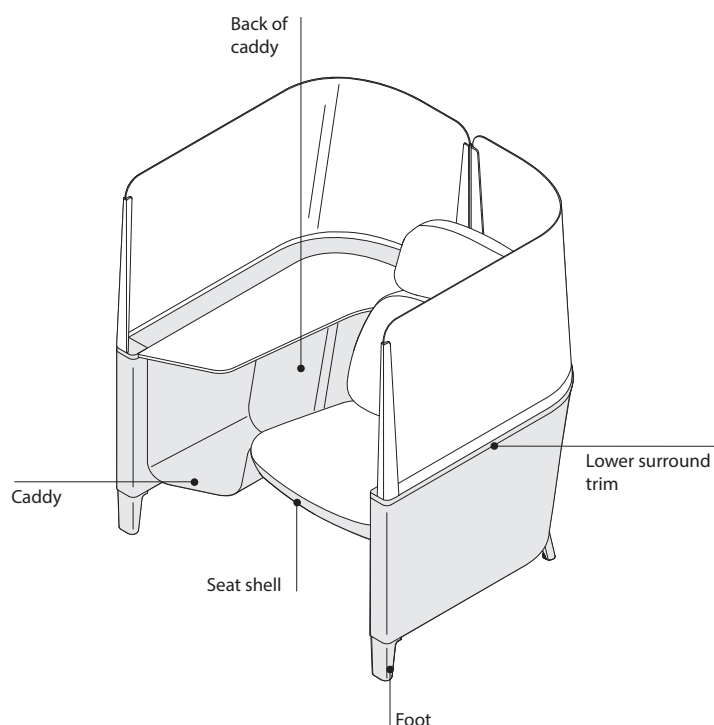

Dimensions

Brody WorkLounge 488 Series

Features	Overall Depth	Width	Height	Seat Depth	Functional Seat Depth	Seat Width	Seat Height from Floor	Back Width	Lumbar Height from Floor	Lower Surround Height from Floor
Brody WorkLounge 488 Series										
WorkLounge	36 ¹ / ₁₀ "	42 ¹³ / ₁₆ "	36"	21 ⁵ / ₈ "	19 ⁷ / ₈ "	22 ⁵ / ₈ "	16 ⁷ / ₈ "	21 ⁷ / ₈ "	18 ³ / ₈ "	25"
Privacy WorkLounge	36 ¹ / ₁₀ "	42 ¹³ / ₁₆ "	48 ¹ / ₂ "	21 ⁵ / ₈ "	19 ⁷ / ₈ "	22 ⁵ / ₈ "	16 ⁷ / ₈ "	21 ⁷ / ₈ "	18 ³ / ₈ "	25"
Privacy WorkLounge with Extension	72 ¹ / ₄ "	42 ¹³ / ₁₆ "	48 ¹ / ₂ "	21 ⁵ / ₈ "	19 ⁷ / ₈ "	22 ⁵ / ₈ "	16 ⁷ / ₈ "	21 ⁷ / ₈ "	18 ³ / ₈ "	25"

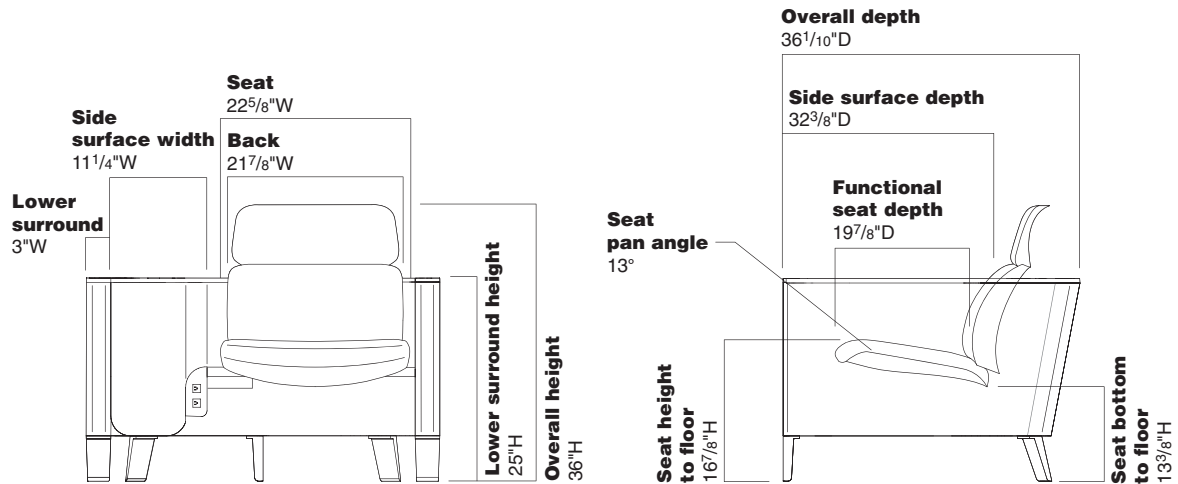

Lower Surround Trim Width	Screen Height	Side Surface Depth	Side Surface Width	Side Surface Height from Floor	Angle Between Seat and Back	Seat Pan Angle	Caddy	Weight Acrylic Screen	Fabric Screen
3"	N.A.	32 ³ / ₈ "	11 ¹ / ₄ "	25"	99°	13°	14 ¹ / ₄ "D x 10"W x 17 ³ / ₈ "H	119 lbs*	119 lbs*
3"	23 ¹ / ₂ "	32 ³ / ₈ "	11 ¹ / ₄ "	25"	99°	13°	14 ¹ / ₄ "D x 10"W x 17 ³ / ₈ "H	135 lbs	161 lbs
3"	23 ¹ / ₂ "	32 ³ / ₈ "	11 ¹ / ₄ "	25"	99°	13°	14 ¹ / ₄ "D x 10"W x 17 ³ / ₈ "H	169 lbs	208 lbs

*WorkLounge does not come with screens.
The WorkLounge base weight is displayed.

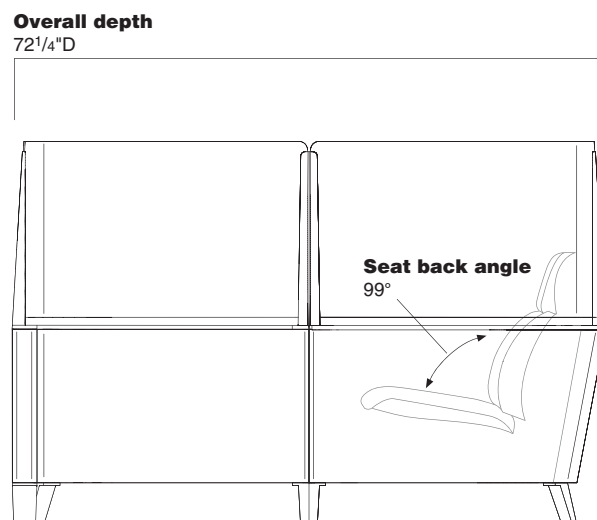
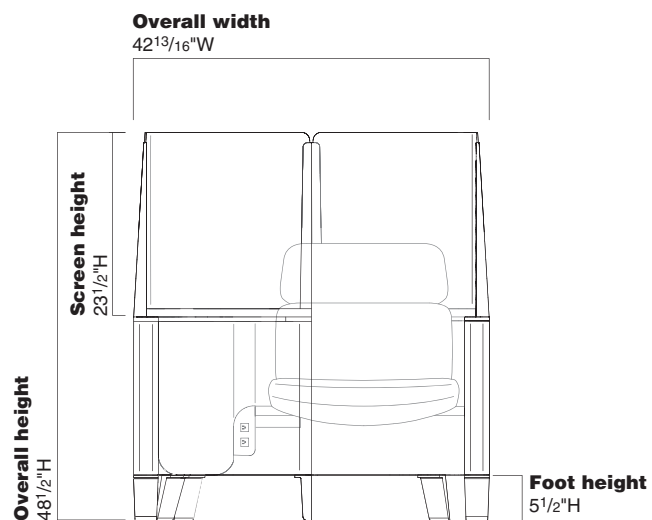

Brody 488 Series

Brody WorkLounge Application Tips

Application Topics

Consider Brody for the following applications across the floorplan:

- Private individual focus area
- At thresholds to the neighborhood
- Along transition paths and in-between spaces
- As supplements to the primary workstation
- Working lounge areas

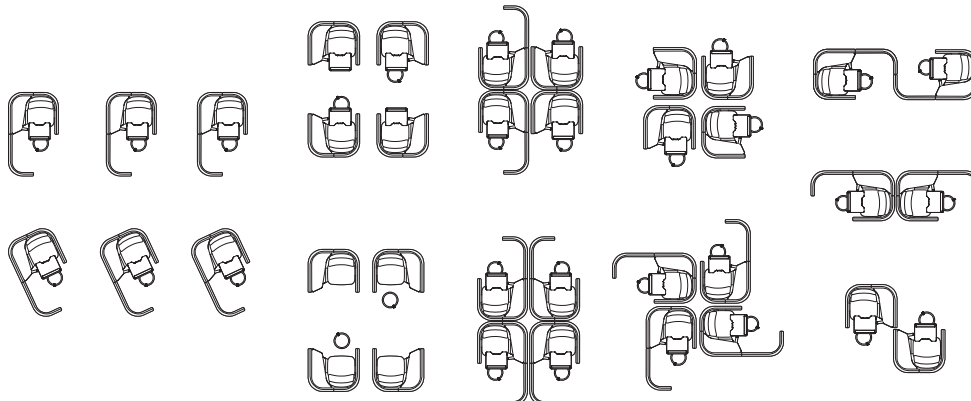

Parallel:
Side-by-Side/Angled

Booth

Clover

Pin Wheel

Yin Yang

Tip: Individual Brody units do not connect with brackets.

Brody Desk 488 Series

Brody is a destination for focus. Every detail has been designed with focus in mind, creating a place where people can escape while still having access to the tools, information, and people they need to be most productive.

Worksurface is available in laminate or veneer and creates space to spread work out.

dash mini LED light is available to provide additional light when needed.

Power is conveniently integrated into the worksurface.

Screens offer additional privacy and shield from distractions.

Lower surround is upholstery wrapped and creates a barrier around the workspace.

Leveling glides on foot adjust 1 $\frac{1}{2}$ " for uneven floors.

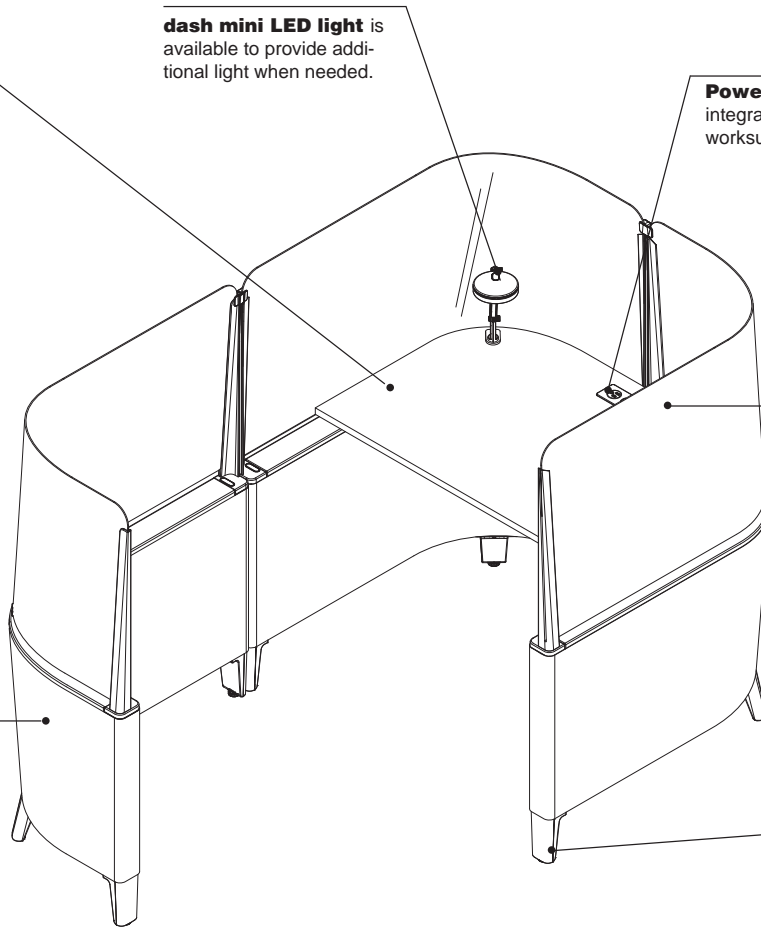

Product Details

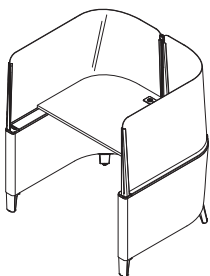

Brody desk always comes standard with screens.

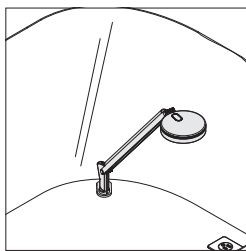

dash mini LED light is available if power has been specified and can be field installed.

dash mini LED light adjusts 19⁷/₈"H from the worksurface. The base and head pivot 360°.

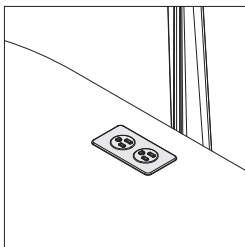

Two NEMA outlets

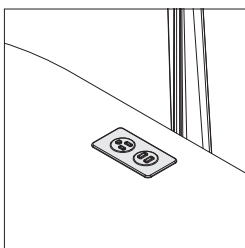

One NEMA, one USB outlet

Power is standard with two three-prong NEMA outlets. It is available with one three-prong NEMA outlet and one USB 2.0 (2.1 amp) outlet as an option. The cord is 10' long and is available with either a standard three-prong NEMA plug for use with standard receptacles or with Steelcase's proprietary Thread low-profile plug for use with one-door and two-door low-profile connectors.

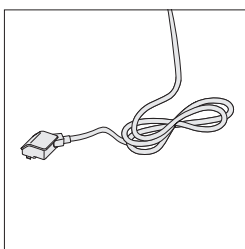

Proprietary low-profile plug can only be used with the Thread system and will not interface with existing receptacles. In order to achieve ADA compliance for connectors in an egress location, we developed our own plug design.

Tip: Always consult your local inspector prior to purchasing the Thread system to ensure all local codes and ordinances are satisfied since local regulations may supersede those spelled out in the National Electric Code.

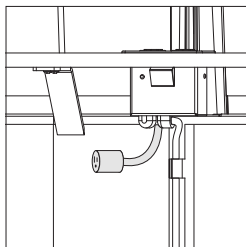

Power includes one convenience outlet standard below the worksurface to power the available dash mini LED light and retain a single power cord out.

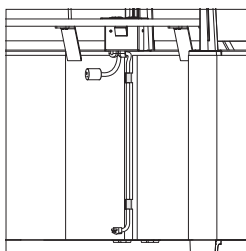

Wire management clips come standard with Brody desk to manage the power cord to the floor.

Surface Materials

► See surface materials on page 634 for specific availability or refer to the *Surface Materials Reference Manual* for further information.

Screen

- Arcylic – 6559 Satin Ice
- Buzz2 fabric
- COM

Tip: COM selections are strictly limited. Please reference the COM page at www.steelcase.com to make your selections.

Lower surround upholstery

- Fabric
- COM
- Vinyl

Tip: The standard application direction of fabric on the lower surround is warp horizontal. Standard Steelcase fabrics were designed for this application direction.

Trim

- Fabric
- Plastic
- COM

Light

- 4231 Arctic White
- 4710 Low Gloss Black
- 4799 Platinum
- Accent paint (option)

Power

- 4799 Platinum Metallic
- 7243 Seagull
- 7250 Sterling Dark Solid

Worksurface

- Laminate
- Veneer

Lower surround trim, screen brackets, frame, and foot finishes can be found on the color scheme matrix.

► See page 452

Programs & Services

► See the *Surface Materials Reference Manual* for further detail about programs and services offered for seating.

The Customer's Own Material (COM) Program

offers the opportunity for customers to select fabrics that are not offered through the standard Steelcase surface materials program for use on Steelcase products. Through the COM program, Steelcase will test your materials for application on Steelcase products. Once approved, you can place your order. Steelcase will facilitate the entire ordering process and give you a production schedule. Steelcase will order the COM fabric directly from the textile manufacturer. For up-to-date information regarding fabric test results for all COM fabrics and details regarding yardage requirements for most Seating lines, visit the COM website. To locate the COM website:

- Visit www.steelcase.com

Dimensions

► Page 453

Color Scheme Matrix

Color Scheme	Foot	Screen Brackets	Frame	Lower Surround Trim
Light	Seagull 7243	Seagull 7243	Merle 7360	Seagull 6053
Medium	Platinum Metallic 4799	Platinum Metallic 4799	Merle 7360	Platinum Solid 6249
Dark	Sterling Dark 7250	Sterling Dark 7250	Merle 7360	Sterling Dark Solid 6059
Burnished Bronze	Burnished Bronze 4B23	Burnished Bronze 4B23	Merle 7360	Sterling Dark Solid 6059
Matte Brass	Matte Brass 4B22	Matte Brass 4B22	Merle 7360	Sterling Dark Solid 6059
Obsidian	Obsidian 4B20	Obsidian 4B20	Merle 7360	Sterling Dark Solid 6059

Tip: If an upholstered screen is specified, then the screen clips will always be aluminum.

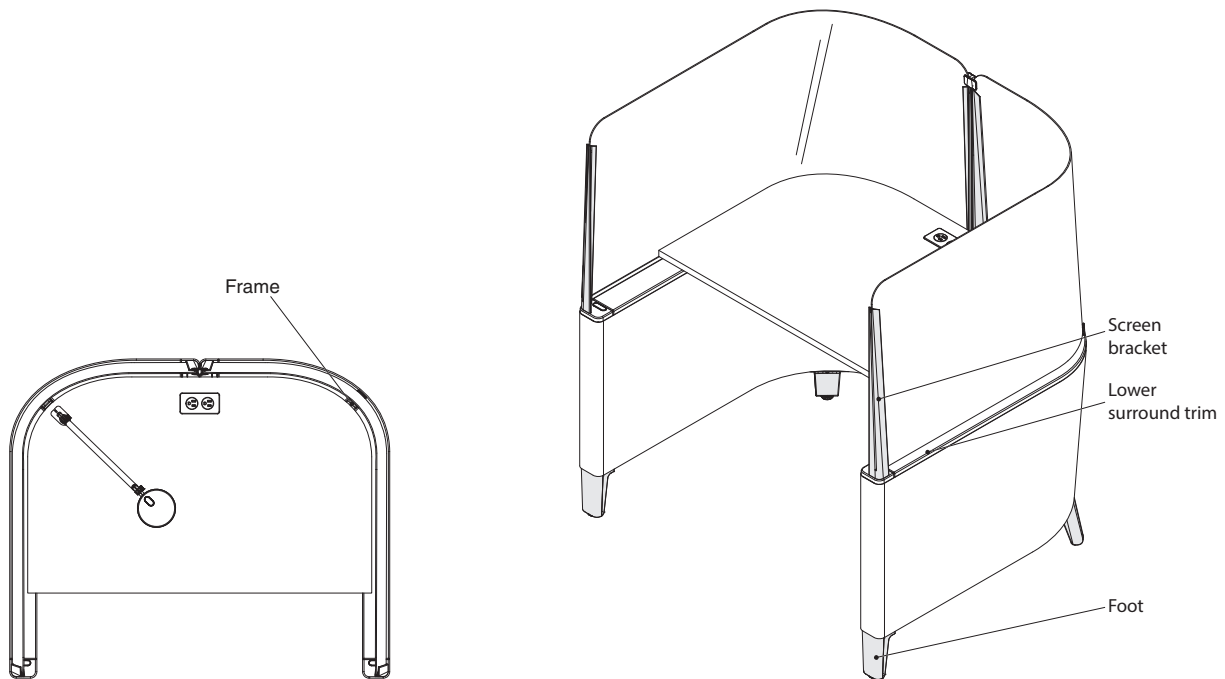

Dimensions

Brody Desk 488 Series

Features	Overall Depth	Width	Height	Lower Surround Trim Width	Screen Height	Worksurface Depth	Worksurface Width	Worksurface Height from Floor
Brody Desk 488 Series								
Privacy Desk	36 ¹ / ₈ "	43"	48 ¹ / ₂ "	3"	23 ¹ / ₂ "	24 ¹ / ₂ "	39"	28 ¹ / ₂ "
Privacy Desk with Extension	72 ¹ / ₄ "	43"	48 ¹ / ₂ "	3"	23 ¹ / ₂ "	24 ¹ / ₂ "	39"	28 ¹ / ₂ "

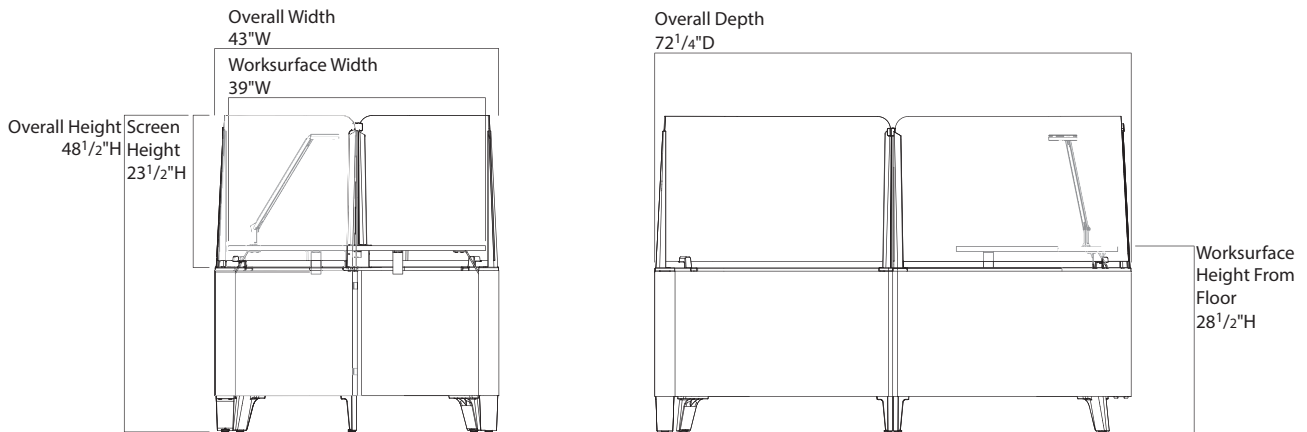
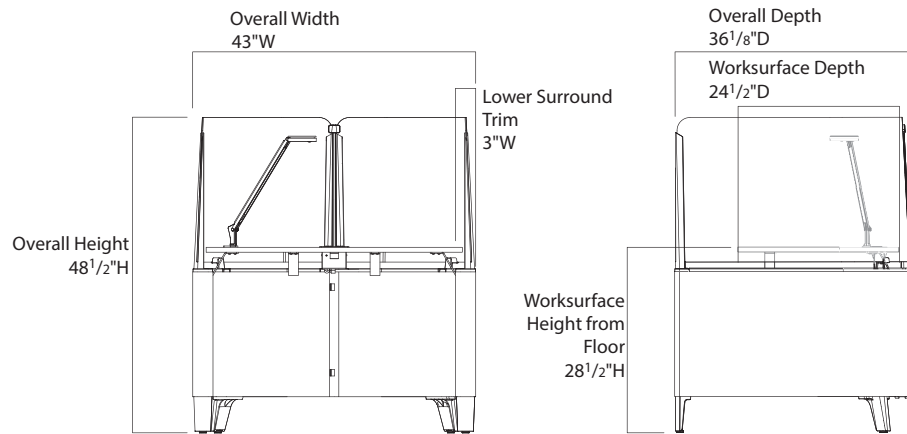

Brody 488 Series

Brody Desk Application Tips

Application Topics

Consider Brody for the following applications across the floorplan:

- Private individual focus areas
- At thresholds to the neighborhoods
- Along transition paths and in-between spaces
- As supplements to the primary workstation

Parallel: Side-by-Side

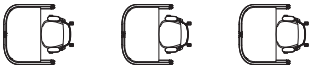

Serpentine

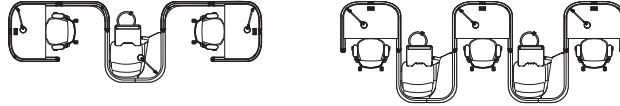

Parallel: Angled



Yin Yang



Tip: Individual Brody units do not connect with brackets.

Brody WorkLounge

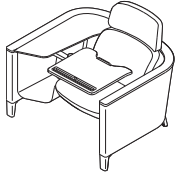

Tip: Illustration above shows right-hand WorkLounge.

Standard Includes	Required to Specify
<ul style="list-style-type: none"> ▶ Need help? Product details, page 440 • Lower surround: fabric price group 1 • Seat: fabric price group 1 • Side surface: laminate • Personal worksurface: plastic defaulted by color scheme • NEMA three prong power outlet: plastic defaulted by color scheme • Caddy: paint defaulted by color scheme 	<ol style="list-style-type: none"> 1 Style number 2 Color scheme (see below under Required Selections) 3 Left- or right-hand configuration (see below under Required Selections) 4 Fabric color number for upholstery on lower surround 5 Fabric color number for upholstery on seat 6 Laminate for side surface 7 Options, if selected (see below) <p>▶ See <i>Surface Materials</i>, page 634.</p>

Tip: For more information regarding color schemes, see page 442.

Color Scheme	WorkLounge	U.S. Price	Required to Specify
	<ul style="list-style-type: none"> • Light • Medium • Dark • Burnished bronze 	<p>No cost</p> <p>No cost</p> <p>No cost</p> <p>+\$423</p>	<p>Specify with <i>light color scheme</i>.</p> <p>Specify with <i>medium color scheme</i>.</p> <p>Specify with <i>dark color scheme</i>.</p> <p>Specify with <i>burnished bronze color scheme</i>.</p>
	<ul style="list-style-type: none"> • Matte brass • Obsidian 	<p>+\$423</p> <p>+\$423</p>	<p>Specify with <i>matte brass color scheme</i>.</p> <p>Specify with <i>obsidian color scheme</i>.</p>

Tip: Handedness is determined by the side surface location. If specified as right-hand, the side surface and storage will be on the user's right (as seated).

Handedness	U.S. Price	Required to Specify
• Left	No cost	Specify with <i>left-hand side surface and storage location</i> .
• Right	No cost	Specify with <i>right-hand side surface and storage location</i> .

Tip: The trim is the top edge of the lower surround. If fabric trim is selected, the upholstery will match the upholstery specified on the lower surround.

Surface Materials	Options	U.S. Price	Required to Specify
	<p>Upholstery on lower surround</p> <ul style="list-style-type: none"> • Fabric price group 1 • Fabric price group 2 • Fabric price group 3 • Fabric price group 4 • Fabric price group 5 • Fabric price group 6 • Fabric price group 7 • Fabric price group 8 • Fabric price group 9 • Fabric price group 10 • Vinyl • Customer's Own Material (COM) 	<p>No cost</p> <p>+\$ 69</p> <p>+\$130</p> <p>+\$182</p> <p>+\$228</p> <p>+\$282</p> <p>+\$324</p> <p>+\$408</p> <p>+\$502</p> <p>+\$571</p> <p>+\$ 69</p> <p>No cost</p>	<p>Specify fabric color number.</p> <p>Specify fabric color number.</p> <p>Specify fabric color number.</p> <p>Specify fabric color number.</p> <p>Specify fabric color number.</p> <p>Specify fabric color number.</p> <p>Specify fabric color number.</p> <p>Specify fabric color number.</p> <p>Specify fabric color number.</p> <p>Specify fabric color number.</p> <p>Specify vinyl color number.</p> <p>▶ See <i>Surface Materials Reference Manual</i>.</p>
	<p>Trim</p> <ul style="list-style-type: none"> • Plastic • Fabric to match lower surround 	<p>No cost</p> <p>+\$362</p>	<p>Specify with <i>plastic trim</i>.</p> <p>Specify with <i>fabric trim</i>.</p>
	<p>Upholstery on trim</p> <ul style="list-style-type: none"> • Fabric price group 1 • Fabric price group 2 • Fabric price group 3 • Fabric price group 4 • Fabric price group 5 • Fabric price group 6 • Fabric price group 7 • Fabric price group 8 • Fabric price group 9 • Fabric price group 10 • Vinyl • Customer's Own Material (COM) 	<p>No cost</p> <p>+\$ 25</p> <p>+\$ 47</p> <p>+\$ 65</p> <p>+\$ 82</p> <p>+\$104</p> <p>+\$118</p> <p>+\$146</p> <p>+\$183</p> <p>+\$207</p> <p>+\$ 25</p> <p>No cost</p>	<p>Specify fabric color number.</p> <p>Specify fabric color number.</p> <p>Specify fabric color number.</p> <p>Specify fabric color number.</p> <p>Specify fabric color number.</p> <p>Specify fabric color number.</p> <p>Specify fabric color number.</p> <p>Specify fabric color number.</p> <p>Specify fabric color number.</p> <p>Specify fabric color number.</p> <p>Specify vinyl color number.</p> <p>▶ See <i>Surface Materials Reference Manual</i>.</p>

▶ Detailed dimensions, page 446

▶ Options, continued on next page



For Canadian Pricing
 Multiply U.S. Price by the Canadian price factor.
 ▶ See page 1 for details.

► Options, continued from previous page

	Options	U.S. Price	Required to Specify
Surface Materials, continued	Upholstery on seat		
	• Fabric price group 1	No cost	Specify fabric color number.
	• Fabric price group 2	+\$ 37	Specify fabric color number.
	• Fabric price group 3	+\$ 72	Specify fabric color number.
	• Fabric price group 4	+\$100	Specify fabric color number.
	• Fabric price group 5	+\$125	Specify fabric color number.
	• Fabric price group 6	+\$154	Specify fabric color number.
	• Fabric price group 7	+\$179	Specify fabric color number.
	• Fabric price group 8	+\$223	Specify fabric color number.
	• Fabric price group 9	+\$276	Specify fabric color number.
	• Fabric price group 10	+\$312	Specify fabric color number.
	• Steelcase leather upholstery	+\$413	Specify leather color number.
	• Select Surfaces leather price group 1	+\$413	► See <i>Surface Materials Reference Manual</i> . Specify Elmosoft leather color number.
	• Elmosoft leather upholstery	+\$492	► See <i>Surface Materials Reference Manual</i> . Specify vinyl color number.
• Select Surfaces leather price group 2	+\$492	► See <i>Surface Materials Reference Manual</i> . Specify leather color number.	
• Steelcase vinyl	+\$ 37		
• Customer's Own Material (COM)	No cost		
• Customer's Own Leather (COL)	+\$112		
	Soil-retardant treatment	+\$ 36	Specify with soil-retardant treatment.
Power	• Omit power	-\$397	Specify with no power.
	• Thread low profile plug	+\$ 40	Specify with Thread low profile plug.
	• One USB 2.0 outlet and one NEMA three-prong outlet	+\$134	Specify with USB and standard NEMA three-prong outlet.
dash mini LED light	• Paint price group 1	+\$607	Specify with light and indicate paint color number.
	• Paint price group 3	+\$651	Specify with light and indicate paint color number.
Related Products	• Footrest		► Page 466

Tip: The light option is only available if power has been specified.

Specification Information

Style Number	U.S. Base Price
488WO	\$4287

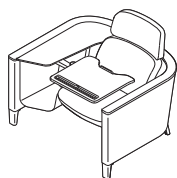

 **For Canadian Pricing**
 Multiply U.S. Price by the Canadian price factor.
 ► See page 1 for details.

Brody Privacy WorkLounge

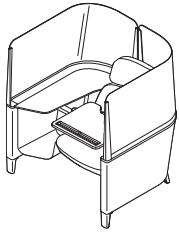

Tip: Illustration above shows right-hand privacy WorkLounge.

Tip: For more information regarding color schemes, see page 442.

Tip: Handedness is determined by the side surface location. If specified as right-hand the side surface and storage will be on the user's right (as seated).

Tip: The trim is the top edge of the lower surround. If fabric trim is selected, the upholstery will match the upholstery specified on the lower surround.

► Detailed dimensions, page 446



For Canadian Pricing
Multiply U.S. Price by the Canadian price factor.
► See page 1 for details.

Standard Includes		Required to Specify
► Need help? Product details, page 440	<ul style="list-style-type: none"> Lower surround: fabric price group 1 Screens: 6559 Satin Ice acrylic Seat: fabric price group 1 Side surface: laminate Personal worksurface: plastic defaulted by color scheme NEMA three prong power outlet: plastic defaulted by color scheme Caddy: paint defaulted by color scheme 	<ol style="list-style-type: none"> Style number Color scheme (see below under Required Selections) Left- or right-hand configuration (see below under Required Selections) Fabric color number for upholstery on lower surround Fabric color number for upholstery on seat Laminate for side surface Options, if selected (see below) <p>► See <i>Surface Materials</i>, page 634.</p>

Required Selections	U.S. Price	Required to Specify
Color Scheme	<ul style="list-style-type: none"> Light No cost Medium No cost Dark No cost Burnished bronze +\$423 Matte brass +\$423 Obsidian +\$423 	<p>Specify with <i>light color scheme</i>.</p> <p>Specify with <i>medium color scheme</i>.</p> <p>Specify with <i>dark color scheme</i>.</p> <p>Specify with <i>burnished bronze color scheme</i>.</p> <p>Specify with <i>matte brass color scheme</i>.</p> <p>Specify with <i>obsidian color scheme</i>.</p>
Handedness	<ul style="list-style-type: none"> Left No cost Right No cost 	<p>Specify with <i>left-hand side surface and storage location</i>.</p> <p>Specify with <i>right-hand side surface and storage location</i>.</p>

Options	U.S. Price	Required to Specify
Surface Materials	<p>Upholstery on lower surround</p> <ul style="list-style-type: none"> Fabric price group 1 No cost Fabric price group 2 +\$ 69 Fabric price group 3 +\$130 Fabric price group 4 +\$182 Fabric price group 5 +\$228 Fabric price group 6 +\$282 Fabric price group 7 +\$324 Fabric price group 8 +\$408 Fabric price group 9 +\$502 Fabric price group 10 +\$571 Vinyl +\$ 69 Customer's Own Material (COM) No cost 	<p>Specify fabric color number.</p> <p>Specify fabric color number.</p> <p>Specify fabric color number.</p> <p>Specify fabric color number.</p> <p>Specify fabric color number.</p> <p>Specify fabric color number.</p> <p>Specify fabric color number.</p> <p>Specify fabric color number.</p> <p>Specify fabric color number.</p> <p>Specify fabric color number.</p> <p>Specify vinyl color number.</p> <p>► See <i>Surface Materials Reference Manual</i>.</p>
	<p>Trim</p> <ul style="list-style-type: none"> Plastic No cost Fabric to match lower surround +\$362 	<p>Specify with <i>plastic trim</i>.</p> <p>Specify with <i>fabric trim</i>.</p>
	<p>Upholstery on trim</p> <ul style="list-style-type: none"> Fabric price group 1 No cost Fabric price group 2 +\$ 25 Fabric price group 3 +\$ 47 Fabric price group 4 +\$ 65 Fabric price group 5 +\$ 82 Fabric price group 6 +\$104 Fabric price group 7 +\$118 Fabric price group 8 +\$146 Fabric price group 9 +\$183 Fabric price group 10 +\$207 Vinyl +\$ 25 Customer's Own Material (COM) No cost 	<p>Specify fabric color number.</p> <p>Specify fabric color number.</p> <p>Specify fabric color number.</p> <p>Specify fabric color number.</p> <p>Specify fabric color number.</p> <p>Specify fabric color number.</p> <p>Specify fabric color number.</p> <p>Specify fabric color number.</p> <p>Specify fabric color number.</p> <p>Specify fabric color number.</p> <p>Specify vinyl color number.</p> <p>► See <i>Surface Materials Reference Manual</i>.</p>

► Options, continued on next page

► Options, continued from previous page

Options	U.S. Price	Required to Specify
Surface Materials, continued		
Upholstery on seat		
• Fabric price group 1	No cost	Specify fabric color number.
• Fabric price group 2	+\$ 37	Specify fabric color number.
• Fabric price group 3	+\$ 72	Specify fabric color number.
• Fabric price group 4	+\$100	Specify fabric color number.
• Fabric price group 5	+\$125	Specify fabric color number.
• Fabric price group 6	+\$154	Specify fabric color number.
• Fabric price group 7	+\$179	Specify fabric color number.
• Fabric price group 8	+\$223	Specify fabric color number.
• Fabric price group 9	+\$276	Specify fabric color number.
• Fabric price group 10	+\$312	Specify fabric color number.
• Steelcase leather upholstery	+\$413	Specify leather color number.
• Select Surfaces leather price group 1	+\$413	► See <i>Surface Materials Reference Manual</i> . Specify Elmosoft leather color number.
• Elmosoft leather upholstery	+\$492	► See <i>Surface Materials Reference Manual</i> . Specify vinyl color number.
• Select Surfaces leather price group 2	+\$492	► See <i>Surface Materials Reference Manual</i> . Specify leather color number.
• Steelcase vinyl	+\$ 37	
• Customer's Own Material (COM)	No cost	
• Customer's Own Leather (COL)	+\$112	
Soil-retardant treatment	+\$ 36	Specify with soil-retardant treatment.
Screen type		
• Acrylic	No cost	Specify with 6559 Satin Ice acrylic.
• Fabric – 1 screen	+\$287	Specify with fabric screen.
• Fabric – 2 screens	+\$573	Specify with fabric screens.
Upholstery on screen		
• Fabric price group 1	No cost	Specify fabric color number.
• Fabric price group 2	+\$ 45	Specify fabric color number.
• Fabric price group 3	+\$ 82	Specify fabric color number.
• Fabric price group 4	+\$114	Specify fabric color number.
• Fabric price group 5	+\$144	Specify fabric color number.
• Fabric price group 6	+\$181	Specify fabric color number.
• Fabric price group 7	+\$206	Specify fabric color number.
• Fabric price group 8	+\$259	Specify fabric color number.
• Fabric price group 9	+\$320	Specify fabric color number.
• Fabric price group 10	+\$362	Specify fabric color number.
• Customer's Own Material (COM)	No cost	► See <i>Surface Materials Reference Manual</i> .
Omit Screen		
• Omit right screen	–\$541	Specify with left screen location only.
• Omit left screen	–\$541	Specify with right screen location only.
Power		
• Omit power	–\$397	Specify with no power.
• Thread low profile plug	+\$ 40	Specify with Thread low profile plug.
• One USB 2.0 outlet and one NEMA three-prong outlet	+\$134	Specify with USB and standard NEMA three-prong outlet.
dash mini LED light		
• Paint price group 1	+\$607	Specify with light and indicate paint color number.
• Paint price group 3	+\$651	Specify with light and indicate paint color number.
Related Products	• Footrest	► Page 466

Tip: When omitting one fabric screen on a privacy lounge, the upholstery upcharge will be reduced by one half.

Tip: Buzz2 is the only Steelcase vertical upholstery group available on fabric screens.

Tip: COM selections are strictly limited, please reference the COM page at www.steelcase.com to make your selections.

Tip: When omitting a screen, only the screen opposite the side surface can be omitted.

Tip: The light option is only available if power has been specified.

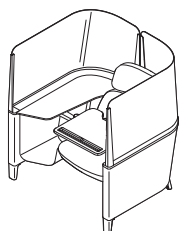

Specification Information

Style Number	U.S. Base Price
488WP	\$5510

Brody Privacy WorkLounge with Extension

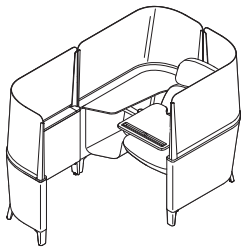

Tip: Illustration above shows right-hand privacy WorkLounge with extension.

Tip: For more information regarding color schemes, see page 442.

Tip: Handedness is determined by the side surface location. If specified as right-hand the side surface and storage will be on the user's right (as seated).

Tip: The trim is the top edge of the lower surround. If fabric trim is selected, the upholstery will match the upholstery specified on the lower surround.

► Detailed dimensions, page 446

 **For Canadian Pricing**
Multiply U.S. Price by the Canadian price factor.
► See page 1 for details.

Standard Includes		Required to Specify
► Need help? Product details, page 440	<ul style="list-style-type: none"> Lower surround: fabric price group 1 Screens: 6559 Satin Ice acrylic Seat: fabric price group 1 Side surface: laminate Personal worksurface: plastic defaulted by color scheme NEMA three prong power outlet: plastic defaulted by color scheme Caddy: paint defaulted by color scheme 	<ol style="list-style-type: none"> Style number Color scheme (see below under Required Selections) Left- or right-hand configuration (see below under Required Selections) Fabric color number for upholstery on lower surround Fabric color number for upholstery on seat Laminate for side surface Options, if selected (see below) <p>► See <i>Surface Materials</i>, page 634.</p>

Required Selections	U.S. Price	Required to Specify
Color Scheme	<ul style="list-style-type: none"> Light No cost Medium No cost Dark No cost Burnished bronze +\$423 Matte brass +\$423 Obsidian +\$423 	<p>Specify with <i>light color scheme</i>.</p> <p>Specify with <i>medium color scheme</i>.</p> <p>Specify with <i>dark color scheme</i>.</p> <p>Specify with <i>burnished bronze color scheme</i>.</p> <p>Specify with <i>matte brass color scheme</i>.</p> <p>Specify with <i>obsidian color scheme</i>.</p>
Handedness	<ul style="list-style-type: none"> Left No cost Right No cost 	<p>Specify with <i>left-hand side surface and storage location</i>.</p> <p>Specify with <i>right-hand side surface and storage location</i>.</p>

Options	U.S. Price	Required to Specify
Surface Materials	<p>Upholstery on lower surround</p> <ul style="list-style-type: none"> Fabric price group 1 No cost Fabric price group 2 +\$112 Fabric price group 3 +\$211 Fabric price group 4 +\$299 Fabric price group 5 +\$374 Fabric price group 6 +\$463 Fabric price group 7 +\$530 Fabric price group 8 +\$669 Fabric price group 9 +\$824 Fabric price group 10 +\$935 Vinyl +\$112 Customer's Own Material (COM) No cost 	<p>Specify fabric color number.</p> <p>Specify fabric color number.</p> <p>Specify fabric color number.</p> <p>Specify fabric color number.</p> <p>Specify fabric color number.</p> <p>Specify fabric color number.</p> <p>Specify fabric color number.</p> <p>Specify fabric color number.</p> <p>Specify fabric color number.</p> <p>Specify fabric color number.</p> <p>Specify vinyl color number.</p> <p>► See <i>Surface Materials Reference Manual</i>.</p>
	<p>Trim</p> <ul style="list-style-type: none"> Plastic No cost Fabric to match lower surround +\$543 	<p>Specify with <i>plastic trim</i>.</p> <p>Specify with <i>fabric trim</i>.</p>
	<p>Upholstery on trim</p> <ul style="list-style-type: none"> Fabric price group 1 No cost Fabric price group 2 +\$ 39 Fabric price group 3 +\$ 72 Fabric price group 4 +\$100 Fabric price group 5 +\$125 Fabric price group 6 +\$155 Fabric price group 7 +\$180 Fabric price group 8 +\$223 Fabric price group 9 +\$276 Fabric price group 10 +\$313 Vinyl +\$ 39 Customer's Own Material (COM) No cost 	<p>Specify fabric color number.</p> <p>Specify fabric color number.</p> <p>Specify fabric color number.</p> <p>Specify fabric color number.</p> <p>Specify fabric color number.</p> <p>Specify fabric color number.</p> <p>Specify fabric color number.</p> <p>Specify fabric color number.</p> <p>Specify fabric color number.</p> <p>Specify fabric color number.</p> <p>Specify vinyl color number.</p> <p>► See <i>Surface Materials Reference Manual</i>.</p>

► **Options, continued on next page**

► Options, continued from previous page

Options	U.S. Price	Required to Specify
Surface Materials, continued		
Upholstery on seat		
• Fabric price group 1	No cost	Specify fabric color number.
• Fabric price group 2	+\$ 37	Specify fabric color number.
• Fabric price group 3	+\$ 72	Specify fabric color number.
• Fabric price group 4	+\$100	Specify fabric color number.
• Fabric price group 5	+\$125	Specify fabric color number.
• Fabric price group 6	+\$154	Specify fabric color number.
• Fabric price group 7	+\$179	Specify fabric color number.
• Fabric price group 8	+\$223	Specify fabric color number.
• Fabric price group 9	+\$276	Specify fabric color number.
• Fabric price group 10	+\$312	Specify fabric color number.
• Steelcase leather upholstery	+\$413	Specify leather color number.
• Select Surfaces leather price group 1	+\$413	► See <i>Surface Materials Reference Manual</i> .
• Elmosoft leather upholstery	+\$492	Specify Elmosoft leather color number.
• Select Surfaces leather price group 2	+\$492	► See <i>Surface Materials Reference Manual</i> .
• Steelcase vinyl	+\$ 37	Specify vinyl color number.
• Customer's Own Material (COM)	No cost	► See <i>Surface Materials Reference Manual</i> .
• Customer's Own Leather (COL)	+\$112	Specify leather color number.
Soil-retardant treatment	+\$ 36	Specify with soil-retardant treatment.
Screen type		
• Acrylic	No cost	Specify with 6559 Satin Ice acrylic.
• Fabric – 2 screens	+\$ 573	Specify with fabric screens.
• Fabric – 3 screens	+\$ 860	Specify with fabric screens.
Upholstery on screen		
• Fabric price group 1	No cost	Specify fabric color number.
• Fabric price group 2	+\$ 45	Specify fabric color number.
• Fabric price group 3	+\$ 82	Specify fabric color number.
• Fabric price group 4	+\$114	Specify fabric color number.
• Fabric price group 5	+\$144	Specify fabric color number.
• Fabric price group 6	+\$181	Specify fabric color number.
• Fabric price group 7	+\$206	Specify fabric color number.
• Fabric price group 8	+\$259	Specify fabric color number.
• Fabric price group 9	+\$320	Specify fabric color number.
• Fabric price group 10	+\$362	Specify fabric color number.
• Customer's Own Material (COM)	No cost	► See <i>Surface Materials Reference Manual</i> .
Omit Screen		
• Omit right screen	–\$541	Specify with left screen location only.
• Omit left screen	–\$541	Specify with right screen location only.
Power		
• Omit power	–\$397	Specify with no power.
• Thread low profile plug	+\$ 40	Specify with Thread low profile plug.
• One USB 2.0 outlet and one NEMA three-prong outlet	+\$134	Specify with USB and standard NEMA three-prong outlet.
dash mini LED light		
• Paint price group 1	+\$607	Specify with light and indicate paint color number.
• Paint price group 3	+\$651	Specify with light and indicate paint color number.
Related Products	• Footrest	► Page 466

Tip: When omitting one fabric screen on a privacy WorkLounge with extension, the upholstery upcharge will be reduced by one third.

Tip: Buzz2 is the only Steelcase vertical upholstery group available on fabric screens.

Tip: COM selections are strictly limited, please reference the COM page at www.steelcase.com to make your selections.

Tip: When omitting a screen, only the screen opposite the side surface can be omitted.

Tip: The light option is only available if power has been specified.

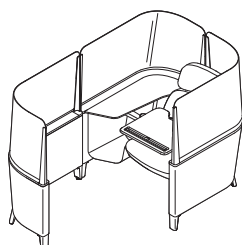

Specification Information	
Style Number	U.S. Base Price
488WE	\$7439

Brody Privacy Desk

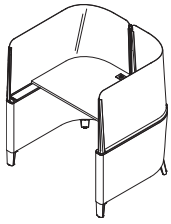

Standard Includes	Required to Specify
<ul style="list-style-type: none"> ▶ Need help? Product details, page 450 • Lower surround: fabric price group 1 • Screens: 6559 Satin Ice acrylic • Worksurface: High-Pressure Laminate price group 1 • Edge: plastic • NEMA three prong power outlet: paint • Wire management clips 	<ol style="list-style-type: none"> 1 Style number 2 Color scheme (see below under Required Selections) 3 Fabric color number for upholstery on lower surround 4 High-Pressure Laminate color number for worksurface 5 Plastic color number for worksurface edge 6 Paint color number for power outlet 7 Options, if selected (see below) <p>▶ See <i>Surface Materials</i>, page 634.</p>

Tip: For more information regarding color schemes, see page 452.

Color Scheme	Required Selections	U.S. Price	Required to Specify
	<ul style="list-style-type: none"> • Light • Medium • Dark • Burnished bronze 	<ul style="list-style-type: none"> No cost No cost No cost +\$423 	<ul style="list-style-type: none"> Specify with <i>light color scheme</i>. Specify with <i>medium color scheme</i>. Specify with <i>dark color scheme</i>. Specify with <i>burnished bronze color scheme</i>.
	<ul style="list-style-type: none"> • Matte brass • Obsidian 	<ul style="list-style-type: none"> +\$423 +\$423 	<ul style="list-style-type: none"> Specify with <i>matte brass color scheme</i>. Specify with <i>obsidian color scheme</i>.

For laminate price group 2 and 3 pricing, please refer to the electronic catalog or SmartTools.

Surface Materials	Options	U.S. Price	Required to Specify
	High-Pressure Laminate worksurface		
	<ul style="list-style-type: none"> • High-Pressure Laminate price group 2 • High-Pressure Laminate price group 3 • Open Line laminate 	<ul style="list-style-type: none"> See information at left See information at left +\$ 102 plus cost of laminate 	<ul style="list-style-type: none"> Specify laminate color number. Specify laminate color number. ▶ See <i>Surface Materials Reference Manual</i>.
	Wood veneer worksurface		
	<ul style="list-style-type: none"> • Wood group 1 • Wood group 2 • Wood group 3 • Customiz stain 	<ul style="list-style-type: none"> +\$1004 +\$1073 +\$1244 No cost 	<ul style="list-style-type: none"> Specify wood color number. Specify wood color number. Specify wood color number. Specify with <i>Customiz stain</i>. ▶ See <i>Surface Materials Reference Manual</i>.
	<ul style="list-style-type: none"> • Full-fill finish on wood group 1 	<ul style="list-style-type: none"> +\$1059 	<ul style="list-style-type: none"> Specify full-fill finish number.
	Upholstery on lower surround		
	<ul style="list-style-type: none"> • Fabric price group 1 • Fabric price group 2 • Fabric price group 3 • Fabric price group 4 • Fabric price group 5 • Fabric price group 6 • Fabric price group 7 • Fabric price group 8 • Fabric price group 9 • Fabric price group 10 • Vinyl • Customer's Own Material (COM) 	<ul style="list-style-type: none"> No cost +\$ 69 +\$ 130 +\$ 182 +\$ 228 +\$ 282 +\$ 324 +\$ 408 +\$ 502 +\$ 571 +\$ 69 No cost 	<ul style="list-style-type: none"> Specify fabric color number. Specify fabric color number. Specify fabric color number. Specify fabric color number. Specify fabric color number. Specify fabric color number. Specify fabric color number. Specify fabric color number. Specify fabric color number. Specify fabric color number. Specify vinyl color number. ▶ See <i>Surface Materials Reference Manual</i>.

▶ Options, continued on next page



For Canadian Pricing
 Multiply U.S. Price by the Canadian price factor.
 ▶ See page 1 for details.

► Options, continued from previous page

Options	U.S. Price	Required to Specify
Surface Materials, continued		
Trim		
• Plastic	No cost	Specify with plastic trim.
• Fabric to match lower surround	+\$362	Specify with fabric trim.
Upholstery on trim		
• Fabric price group 1	No cost	Specify fabric color number.
• Fabric price group 2	+\$ 25	Specify fabric color number.
• Fabric price group 3	+\$ 47	Specify fabric color number.
• Fabric price group 4	+\$ 65	Specify fabric color number.
• Fabric price group 5	+\$ 82	Specify fabric color number.
• Fabric price group 6	+\$104	Specify fabric color number.
• Fabric price group 7	+\$118	Specify fabric color number.
• Fabric price group 8	+\$146	Specify fabric color number.
• Fabric price group 9	+\$183	Specify fabric color number.
• Fabric price group 10	+\$207	Specify fabric color number.
• Vinyl	+\$ 25	Specify vinyl color number.
• Customer's Own Material (COM)	No cost	► See Surface Materials Reference Manual.
Screen type		
• Acrylic	No cost	Specify with 6559 Satin Ice acrylic.
• Fabric	+\$573	Specify with fabric screens.
Upholstery on screen		
• Fabric price group 1	No cost	Specify fabric color number.
• Fabric price group 2	+\$ 45	Specify fabric color number.
• Fabric price group 3	+\$ 82	Specify fabric color number.
• Fabric price group 4	+\$114	Specify fabric color number.
• Fabric price group 5	+\$144	Specify fabric color number.
• Fabric price group 6	+\$181	Specify fabric color number.
• Fabric price group 7	+\$206	Specify fabric color number.
• Fabric price group 8	+\$259	Specify fabric color number.
• Fabric price group 9	+\$320	Specify fabric color number.
• Fabric price group 10	+\$362	Specify fabric color number.
• Customer's Own Material (COM)	No cost	► See Surface Materials Reference Manual.
Power		
• Omit power	-\$397	Specify with no power.
• Thread low profile plug	+\$ 40	Specify with Thread low profile plug and indicate paint color number.
• One USB 2.0 outlet and one NEMA three-prong outlet	+\$134	Specify with USB and standard NEMA three-prong outlet and indicate paint color number.
dash mini LED light		
• Paint price group 1	+\$607	Specify with light and indicate paint color number.
• Paint price group 3	+\$651	Specify with light and indicate paint color number.
Related Products		
• Steelcase Series 1 chairs		► Page 188
• QiVi chairs		► Page 270
• Cobi chairs		► Page 280

Tip: The trim is the top edge of the lower surround. If fabric trim is selected, the upholstery will match the upholstery specified on the lower surround.

Tip: Buzz2 is the only Steelcase vertical upholstery group available on fabric screens.

Tip: COM selections are strictly limited, please reference the COM page at www.steelcase.com to make your selections.

Tip: The light option is only available if power has been specified.

Specification Information

Style Number	U.S. Base Price
488BD	\$4958

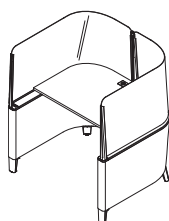

Brody Privacy Desk with Extension

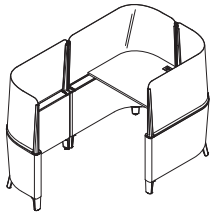

Tip: Illustration above shows privacy desk with extension, enter right.

Tip: For more information regarding color schemes, see page 452.

Tip: Extension opening is determined by where the user enters Brody desk unit.

For laminate price group 2 and 3 pricing, please refer to the electronic catalog or SmartTools.

Standard Includes		Required to Specify
<ul style="list-style-type: none"> ▶ Need help? Product details, page 450 	<ul style="list-style-type: none"> • Lower surround: fabric price group 1 • Screens: 6559 Satin Ice acrylic • Worksurface: High-Pressure Laminate price group 1 • Edge: plastic • NEMA three prong power outlet: paint • Wire management clips 	<ol style="list-style-type: none"> 1 Style number 2 Color scheme (see below under Required Selections) 3 Extension opening (see below under Required Selections) 4 Fabric color number for upholstery on lower surround 5 High-Pressure Laminate color number for worksurface 6 Plastic color number for worksurface edge 7 Paint color number for power outlet 8 Options, if selected (see below) <p>▶ See <i>Surface Materials</i>, page 634.</p>

Required Selections	U.S. Price	Required to Specify
Color Scheme <ul style="list-style-type: none"> • Light • Medium • Dark • Burnished bronze • Matte brass • Obsidian 	<ul style="list-style-type: none"> No cost No cost No cost +\$423 +\$423 +\$423 	<ul style="list-style-type: none"> Specify with <i>light color scheme</i>. Specify with <i>medium color scheme</i>. Specify with <i>dark color scheme</i>. Specify with <i>burnished bronze color scheme</i>. Specify with <i>matte brass color scheme</i>. Specify with <i>obsidian color scheme</i>.

Required Selections	U.S. Price	Required to Specify
Extension Opening <ul style="list-style-type: none"> • Enter left • Enter right 	<ul style="list-style-type: none"> No cost No cost 	<ul style="list-style-type: none"> Specify with <i>enter left</i>. Specify with <i>enter right</i>.

Options	U.S. Price	Required to Specify
Surface Materials <p>High-Pressure Laminate worksurface</p> <ul style="list-style-type: none"> • High-Pressure Laminate price group 2 • High-Pressure Laminate price group 3 • Open Line laminate <p>Wood veneer worksurface</p> <ul style="list-style-type: none"> • Wood group 1 • Wood group 2 • Wood group 3 • Customiz stain • Full-fill finish on wood group 1 <p>Upholstery on lower surround</p> <ul style="list-style-type: none"> • Fabric price group 1 • Fabric price group 2 • Fabric price group 3 • Fabric price group 4 • Fabric price group 5 • Fabric price group 6 • Fabric price group 7 • Fabric price group 8 • Fabric price group 9 • Fabric price group 10 • Vinyl • Customer's Own Material (COM) 	<ul style="list-style-type: none"> See information at left See information at left +\$ 102 plus cost of laminate +\$1004 +\$1073 +\$1244 No cost +\$1059 No cost +\$ 112 +\$ 211 +\$ 299 +\$ 374 +\$ 463 +\$ 530 +\$ 669 +\$ 824 +\$ 935 +\$ 112 No cost 	<ul style="list-style-type: none"> Specify laminate color number. Specify laminate color number. ▶ See <i>Surface Materials Reference Manual</i>. Specify wood color number. Specify wood color number. Specify wood color number. Specify with <i>Customiz stain</i>. ▶ See <i>Surface Materials Reference Manual</i>. Specify full-fill finish number. Specify fabric color number. Specify fabric color number. Specify fabric color number. Specify fabric color number. Specify fabric color number. Specify fabric color number. Specify fabric color number. Specify fabric color number. Specify fabric color number. Specify vinyl color number. ▶ See <i>Surface Materials Reference Manual</i>.

▶ Options, continued on next page



For Canadian Pricing
 Multiply U.S. Price by the Canadian price factor.
 ▶ See page 1 for details.

► Options, continued from previous page

Options	U.S. Price	Required to Specify
Surface Materials, continued		
Trim		
• Plastic	No cost	Specify with <i>plastic trim</i> .
• Fabric to match lower surround	+\$543	Specify with <i>fabric trim</i> .
Upholstery on trim		
• Fabric price group 1	No cost	Specify fabric color number.
• Fabric price group 2	+\$ 39	Specify fabric color number.
• Fabric price group 3	+\$ 72	Specify fabric color number.
• Fabric price group 4	+\$100	Specify fabric color number.
• Fabric price group 5	+\$125	Specify fabric color number.
• Fabric price group 6	+\$155	Specify fabric color number.
• Fabric price group 7	+\$180	Specify fabric color number.
• Fabric price group 8	+\$223	Specify fabric color number.
• Fabric price group 9	+\$276	Specify fabric color number.
• Fabric price group 10	+\$313	Specify fabric color number.
• Vinyl	+\$ 39	Specify vinyl color number.
• Customer's Own Material (COM)	No cost	► See <i>Surface Materials Reference Manual</i> .
Screen type		
• Acrylic	No cost	Specify with <i>6559 Satin Ice acrylic</i> .
• Fabric	+\$ 860	Specify with <i>fabric screens</i> .
Upholstery on screen		
• Fabric price group 1	No cost	Specify fabric color number.
• Fabric price group 2	+\$ 45	Specify fabric color number.
• Fabric price group 3	+\$ 82	Specify fabric color number.
• Fabric price group 4	+\$114	Specify fabric color number.
• Fabric price group 5	+\$144	Specify fabric color number.
• Fabric price group 6	+\$181	Specify fabric color number.
• Fabric price group 7	+\$206	Specify fabric color number.
• Fabric price group 8	+\$259	Specify fabric color number.
• Fabric price group 9	+\$320	Specify fabric color number.
• Fabric price group 10	+\$362	Specify fabric color number.
• Customer's Own Material (COM)	No cost	► See <i>Surface Materials Reference Manual</i> .
Power		
• Omit power	-\$397	Specify with <i>no power</i> .
• Thread low profile plug	+\$ 40	Specify with <i>Thread low profile plug</i> and indicate paint color number.
• One USB 2.0 outlet and one NEMA three-prong outlet	+\$134	Specify with <i>USB and standard NEMA three-prong outlet</i> and indicate paint color number.
dash mini LED light		
• Paint price group 1	+\$607	Specify with <i>light</i> and indicate paint color number.
• Paint price group 3	+\$651	Specify with <i>light</i> and indicate paint color number.
Related Products		
• Steelcase Series 1 chairs		► Page 188
• QiVi chairs		► Page 270
• Cobi chairs		► Page 280

Tip: The trim is the top edge of the lower surround. If fabric trim is selected, the upholstery will match the upholstery specified on the lower surround.

Tip: Buzz2 is the only Steelcase vertical upholstery group available on fabric screens.

Tip: COM selections are strictly limited, please reference the COM page at www.steelcase.com to make your selections.

Tip: The light option is only available if power has been specified.

Specification Information

Style Number	U.S. Base Price
488BDE	\$6887

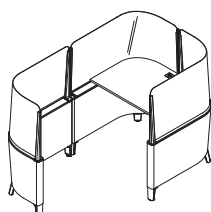

Brody Footrest



Standard Includes		Required to Specify
<ul style="list-style-type: none"> ▶ Need help? Product details, page 440 	<ul style="list-style-type: none"> • Lower footrest: plastic • Upper footrest: fabric price group 1 	<ol style="list-style-type: none"> 1 Style number 2 Fabric color number for upper footrest 3 Plastic color number for lower footrest: <ul style="list-style-type: none"> 6053 Seagull 6059 Sterling Dark 4 Options, if selected (see below) <ul style="list-style-type: none"> ▶ See <i>Surface Materials</i>, page 634.

Options	U.S. Price	Required to Specify
Surface Materials <ul style="list-style-type: none"> • Upholstery on upper footrest <ul style="list-style-type: none"> • Fabric price group 1 • Fabric price group 2 • Fabric price group 3 • Fabric price group 4 • Fabric price group 5 • Fabric price group 6 • Fabric price group 7 • Fabric price group 8 • Fabric price group 9 • Fabric price group 10 • Steelcase leather upholstery • Select Surfaces leather price group 1 • Elmosoft leather upholstery • Select Surfaces leather price group 2 • Steelcase vinyl • Customer's Own Material (COM) • Customer's Own Leather (COL) • Soil-retardant treatment 	<ul style="list-style-type: none"> No cost +\$ 25 +\$ 47 +\$ 65 +\$ 82 +\$104 +\$118 +\$146 +\$183 +\$207 +\$277 +\$277 +\$328 +\$328 +\$ 25 No cost +\$ 55 +\$ 36 	<ul style="list-style-type: none"> Specify fabric color number. Specify fabric color number. Specify fabric color number. Specify fabric color number. Specify fabric color number. Specify fabric color number. Specify fabric color number. Specify fabric color number. Specify fabric color number. Specify fabric color number. Specify leather color number. ▶ See <i>Surface Materials Reference Manual</i>. Specify Elmosoft leather color number. ▶ See <i>Surface Materials Reference Manual</i>. Specify vinyl color number. ▶ See <i>Surface Materials Reference Manual</i>. Specify leather color number. Specify with soil-retardant treatment.

Related Products <ul style="list-style-type: none"> • Brody 	▶ Pages 456–460
---	-----------------

Specification Information	
Style Number	U.S. Base Price
488FR	\$435



For Canadian Pricing
 Multiply U.S. Price by the Canadian price factor.
 ▶ See page 1 for details.

Understanding and Specifying Umami Lounge Seating

Product Details

Umami	468
Thought Starters	484
Dimensions	490

Specifying

Platforms	492
Lounges	500
Screens	514
Tables	526

Umami

Umami, with its flexible, modular design, can be used to create spaces that are unique to organizations and individuals. Multiple materials are used to promote variation and encourage creativity and self-expression. Integrated power, tables, and screens support the ability to perform in an open environment or in solitude.

► Specifying, pages 492-528

Lounge seating is upholstered and attaches to other seating or platforms. Different styles allow for a variety of configurations and applications.

Platforms may be used freestanding as tables or benches, or they can be attached to lounge seating or other platforms for additional seating. They can also be used to create purposeful separation between users. Platforms are available in various sizes and materials.

Umami screens are available in two heights, 48"H or 60"H. Screens offer privacy, reduce visual distraction, and provide purposeful space definition and shielding in the open plan.

Integrated tables are available in two shapes and can be optioned on lounges and platforms.

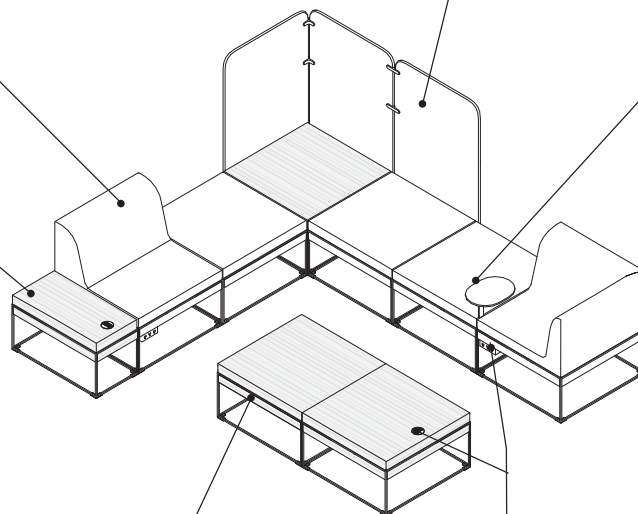

Fascia will match the top of the seat or platform unless the contrasting option is selected.

Power block can be attached below the frame anywhere along the lounge or platform. Power can also be integrated on single platforms with laminate or veneer tops (platform table power option).

Product Details

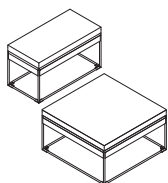

Single platforms come in 15"D x 30"W or 30"D x 30"W sizes. They are available in upholstery, laminate, or wood veneer.

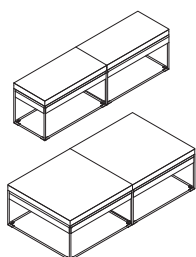

Double platforms come in 15"D x 60"W or 30"D x 60"W sizes. They are available in upholstery only.

Platforms can be ganged together or ganged to lounge seating.

When selecting contrasting option on platforms with depth of 15", the 15"D sides are the left and right sides. The front is either the 30"W side (if single platform), or 60"W side (if double platform).

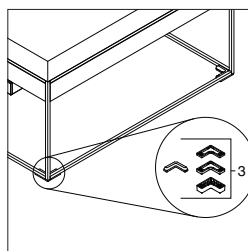

Glides come standard on the bottom of platform frame.

Three total sets of glides are included with each Umami platform. One set of each size; low, medium, and high.

Varying glide sizes may be used to level the product on uneven surfaces, or to raise the total height of the product.

Lounges are available in five different shapes:

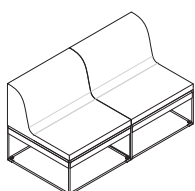
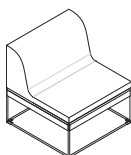

Straight lounge - double

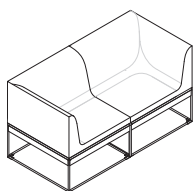
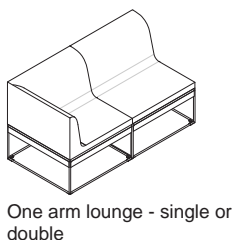
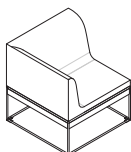

One arm lounge - single or double

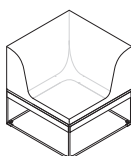

Two arm lounge - double

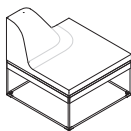

Corner lounge



End cap lounge

Applications of End Cap Positions

End cap arm position is determined in the user seated position based on the end of a lounge run in which the end cap will be ganged. For example, while in the user seated position, if attaching an end cap to the right end of a lounge, it would be a right arm position end cap.

Left Arm Position End Cap

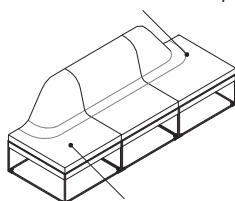

Right Arm Position End Cap

When seated in the straight lounge unit shown above, the end cap on the user's left is the left arm position end cap. The end cap on the user's right is the right arm position end cap.

Left Arm Position End Cap

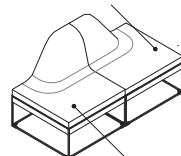

Right Arm Position End Cap

When seated in the right arm position end cap shown above, the left arm position end cap is on the user's left. When seated in the left arm position end cap shown above, the right arm position end cap is on the user's right.

Left Arm Position End Cap

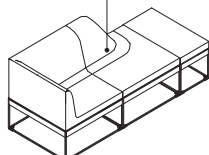

When seated in the left arm position end cap shown above, the right arm single lounge is on the user's right and the single platform is on the user's left.



Screens are available at installed heights of 48" or 60".



Standard screens come in widths of 15" or 30".

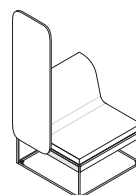

When a 15" screen is attached to a 30" frame, a 15" fascia must be ordered.

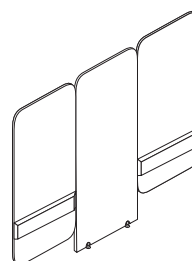

Spanner screens span across two lounge frames and an open space to create a cabin type application. They come in widths of 90" or 105". 90"W spanner screens come with (3) 30"W screens. 105"W spanner screens come with (2) 30"W screens and (1) 45"W center screen. Brackets shown on the screen are on the inside surface of the screens and attach to the frame.

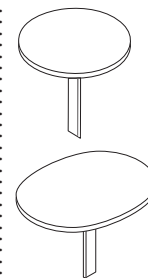

Round or pill tables can only be optioned on straight single, straight double, one arm double, and end cap lounge. Tables can be optioned on all upholstered top platforms except for 15"D x 30"W single platform and 15"D x 60"W double platform.

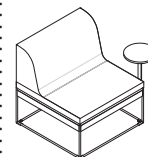

Tables are optioned as table left or table right (based on user sitting in lounge). Table left is shown above.

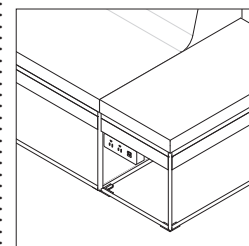

Lounge and platforms gang together with two bolts.

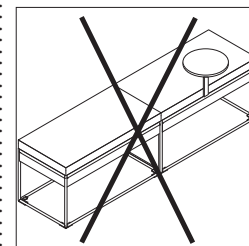

Tables may not be specified on 15"D x 30"W or 15"D x 60"W platforms.

Umami, continued

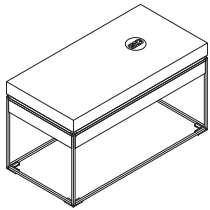

Platform table power can only be optioned on single platforms with laminate or veneer tops.

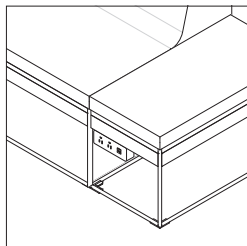

Power blocks can be installed anywhere along the bottom of the fascia on any platform or lounge.

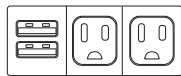

Power blocks and platform table power options come with three power or two power, one USB.

Surface Materials

The fascia will match the top surface unless the contrasting option is specified.

If top of platform is fabric, the fascia cannot be a hard surface. It can only be upholstery.

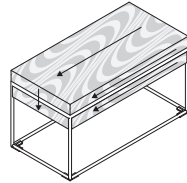

Fascia grain direction will always match the sides of the platforms when selecting hard surfaces. On 15"D platforms, the grain is a waterfall on 15" sides.

When a platform has a hard surface and either laminate or veneer is selected, only monolithic and contrasting fascia options are available. Contrasting sides is not an option.

When a platform has a hard surface and either laminate or veneer is selected with contrasting fascia, the contrasting fascia must either match the hard surface type or be upholstery. Example: A laminate top can have laminate or upholstered fascia. A veneer top can have veneer or upholstered fascia.

Only one contrasting surface option is available on each product. This includes fascia which is considered a contrasting surface. If more than one contrasting option is desired, please contact a specials representative.

When a lounge or platform is specified with contrasting and Elmosoft is selected for the top, the other contrast area must be specified in Elmosoft. Exception: When Elmosoft is selected for the top and contrasting fascia is specified, fascia may be specified in any upholstery.

Single platform

- Top and fascia
- Laminate
- Veneer
- Open Line laminate
- Customiz stain
- Fabric
- Elmosoft leather
- Vinyl
- COM

- Frame
- Paint
- Coatings
- Lux Coatings
- Accent paints
- PerfectMatch paint

Double platform

- Top and fascia
- Fabric
- Elmosoft leather
- Vinyl
- COM

- Frame
- Paint
- Coatings
- Lux Coatings
- Accent paints
- PerfectMatch paint

Lounge

- Top and fascia
- Fabric
- Elmosoft leather
- Vinyl
- COM

- Frame
- Paint
- Coatings
- Lux Coatings
- Accent paints
- PerfectMatch paint

Screen

- Fabric
- COM

Screen Clips

- 6053 Seagull
- 6527 Merle

Power block (option)

- Black

Platform table power (option)

- Silver

Round and pill table (option)

- Top
- Laminate

Support

- Paint

Solid, non-repeat fabrics are recommended for Umami lounge, platform, and screens. Steelcase will not pattern match fabrics which have a distinct repeating pattern (stripes, vertical repeats, etc). This includes pattern matching on the single unit but also pattern matching from one component to another. If pattern matching is of concern it is recommended to use one of the standard Steelcase fabrics, vinyls, or non-patterned COM.

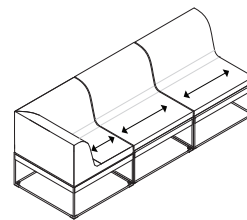

When specifying a corner unit as an end of run, if using the corner unit in a right hand orientation, the fabric on the seat will be in the same direction as the single unit seats.

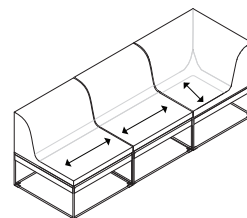

When specifying a corner unit as an end of run, if using the corner unit in a left hand orientation, the fabric on the seat will NOT be in the same direction as the single unit seats. Consider using a left arm unit or non directional fabrics.

Programs & Services

For more information on accent paints, Lux Coatings, PerfectMatch program, and Select Surfaces program, please refer to the *Surface Materials Reference Manual*.

The Customer's Own Material (COM) Program

offers the opportunity for customers to select fabrics that are not offered through the standard Steelcase surface materials program for use on Steelcase products. Through the COM program, Steelcase will test your materials for application on Steelcase products. Once approved, you can place your order. Steelcase will facilitate the entire ordering process and give you a production schedule. Steelcase will order the COM fabric directly from the textile manufacturer. For up-to-date information regarding fabric test results for all COM fabrics and details regarding yardage requirements for most Seating lines, visit the COM website. To locate the COM website:

- Visit www.steelcase.com

Contact your Steelcase Solutions Fulfillment Team Representative at 1.888.STEELCASE (1.888.783.3522) or send an email to lineone@steelcase.com.

Umami

Materiality

Contrasting fabric on Umami standard screens and spanner screens are available with contrasting fabric on the inside and outside of the screen. Contrasting fabrics must be from the same fabric family.

Screen clips attach screens together and are available in 6527 Merle or 6053 Seagull.

If the top of the platform is upholstered, the fascia must be upholstered.

Double platforms are available in upholstery only.

Round or pill table tops are available in 2HMG Merle and 2883 Seagull laminates.

Integrated round or pill tables can only be optioned onto lounges or upholstered platforms.

If top of platform is a hard surface, the fascia may be upholstered, laminate, or veneer.

When optioning contrasting fascia, the fascia will be contrasting around the entire frame (lower portion of all four sides).

Lounge seating fascia can only be ordered in upholstery. No hard surfaces on lounge or lounge fascia.

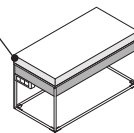
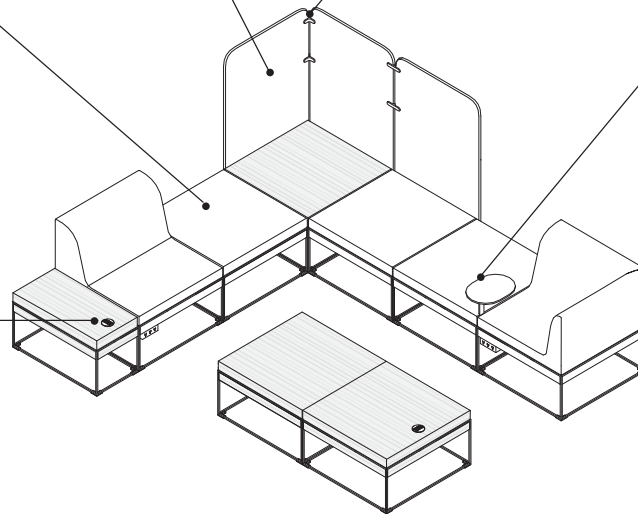

Contrasting Details

15"D Single Platform

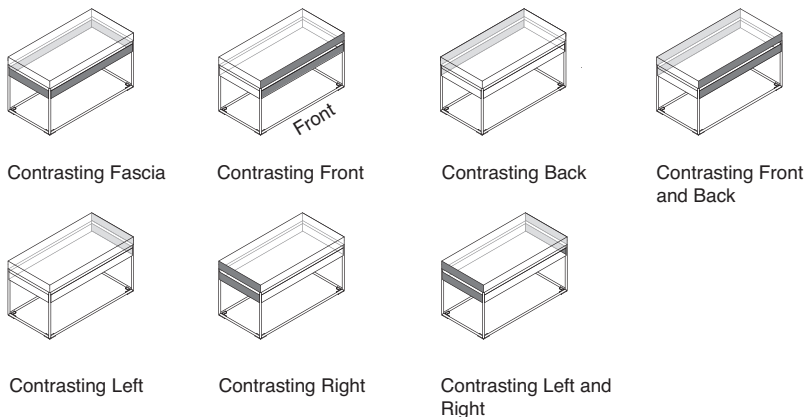

15"D Single Platform

- Contrasting Fascia
- Contrasting Front
- Contrasting Back
- Contrasting Front and Back
- Contrasting Left
- Contrasting Right
- Contrasting Left and Right

Only one contrasting selection can be made on each product. This includes contrasting fascia.

On the 15"D platform, the front is the 30"W side. The left and right sides are 15"D.

When a platform has a hard surface and either laminate or veneer is selected, only monolithic and contrasting fascia options are available. Contrasting sides is not an option.

30"D Single Platform

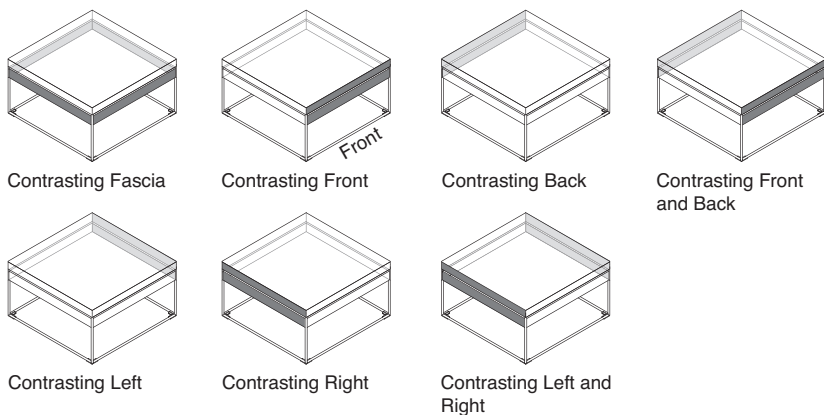

30"D Single Platform

- Contrasting Fascia
- Contrasting Front
- Contrasting Back
- Contrasting Front and Back
- Contrasting Left
- Contrasting Right
- Contrasting Left and Right

Only one contrasting selection can be made on each product. This includes contrasting fascia.

When a platform has a hard surface and either laminate or veneer is selected, only monolithic and contrasting fascia options are available. Contrasting sides is not an option.



Contrasting Details, continued

15"D and 30"D Double Platforms

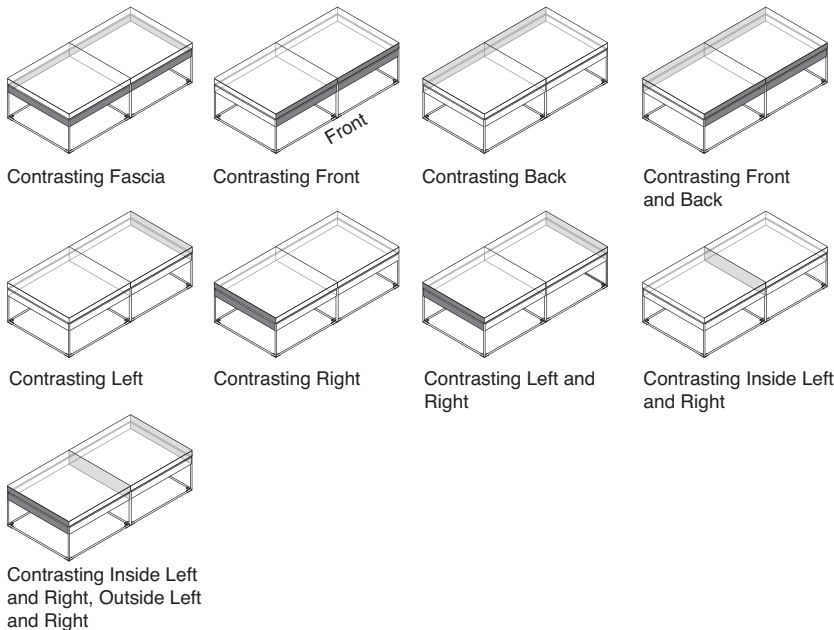

15"D and 30"D Double Platforms

- Contrasting Fascia
- Contrasting Front
- Contrasting Back
- Contrasting Front and Back
- Contrasting Left
- Contrasting Right
- Contrasting Left and Right
- Contrasting Inside Left and Right
- Contrasting Inside Left and Right, Outside Left and Right

Only one contrasting selection can be made on each product. This includes contrasting fascia.

On the 15"D platform, the front is the 60"W side. The left and right sides are 15"D.

When a platform has a hard surface and either laminate or veneer is selected, only monolithic and contrasting fascia options are available. Contrasting sides is not an option.

Straight Single Lounge

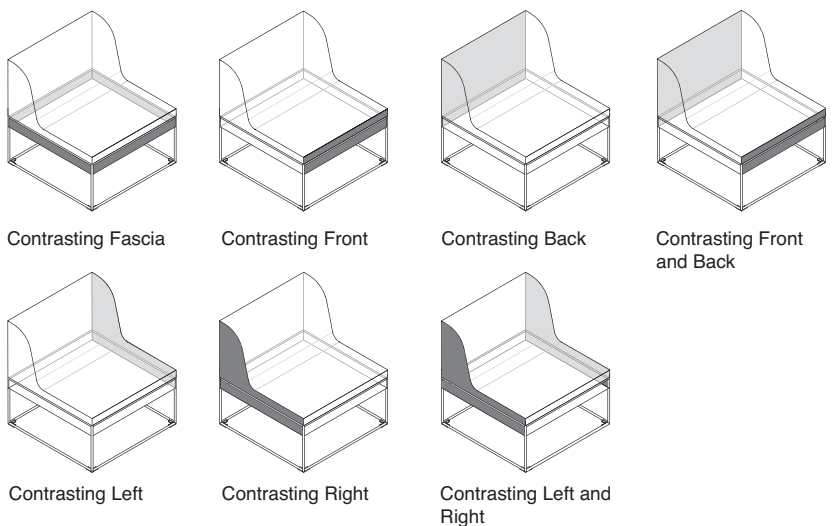

Straight Single Lounge

- Contrasting Fascia
- Contrasting Front
- Contrasting Back
- Contrasting Front and Back
- Contrasting Left
- Contrasting Right
- Contrasting Left and Right

Only one contrasting selection can be made on each product. This includes contrasting fascia.

Contrasting Details, continued

One Arm Single Lounge, Right Arm Position

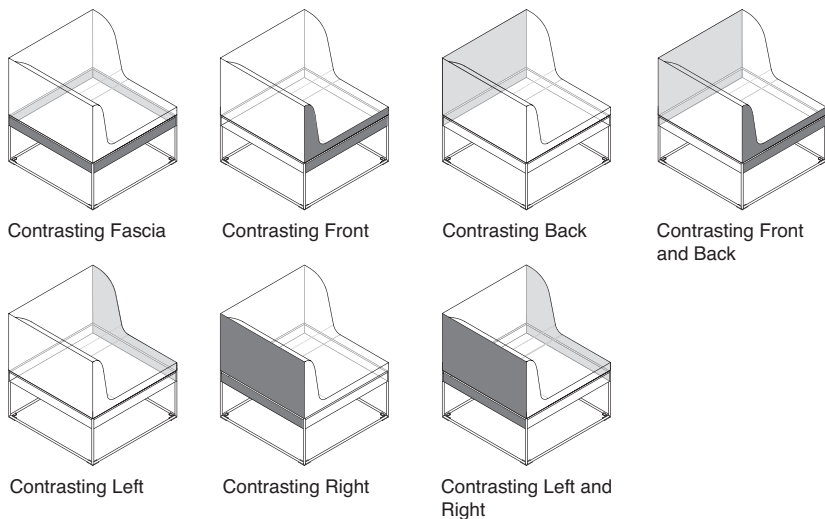

One Arm Single Lounge

- Contrasting Fascia
- Contrasting Front
- Contrasting Back
- Contrasting Front and Back
- Contrasting Left
- Contrasting Right
- Contrasting Left and Right

Only one contrasting selection can be made on each product. This includes contrasting fascia.

One Arm Single Lounge, Left Arm Position

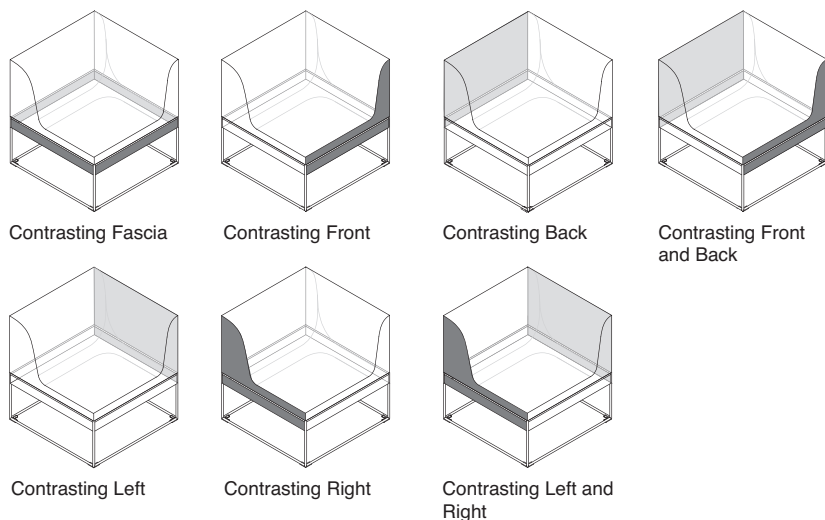

One Arm Single Lounge

- Contrasting Fascia
- Contrasting Front
- Contrasting Back
- Contrasting Front and Back
- Contrasting Left
- Contrasting Right
- Contrasting Left and Right

Only one contrasting selection can be made on each product. This includes contrasting fascia.



Contrasting Details, continued

Corner Single Lounge

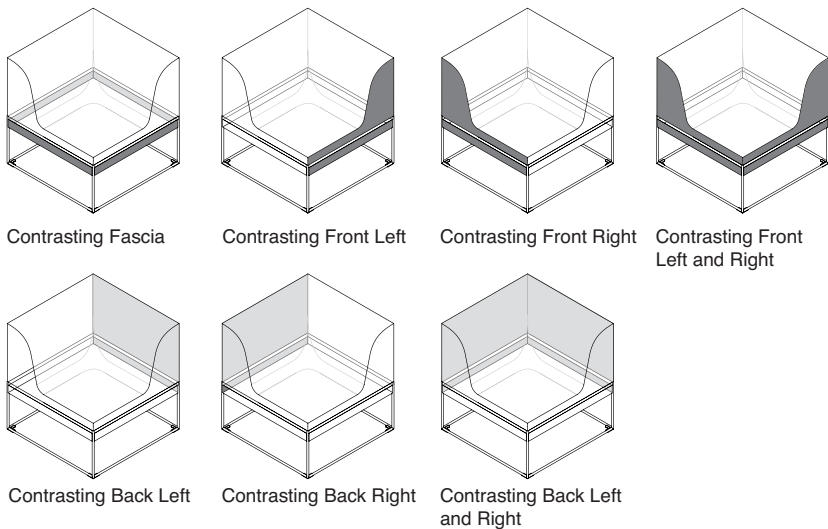

Corner Single Lounge

- Contrasting Fascia
- Contrasting Front Left
- Contrasting Front Right
- Contrasting Front Left and Right
- Contrasting Back Left
- Contrasting Back Right
- Contrasting Back Left and Right

Only one contrasting selection can be made on each product. This includes contrasting fascia.

End Cap, Left Arm Position

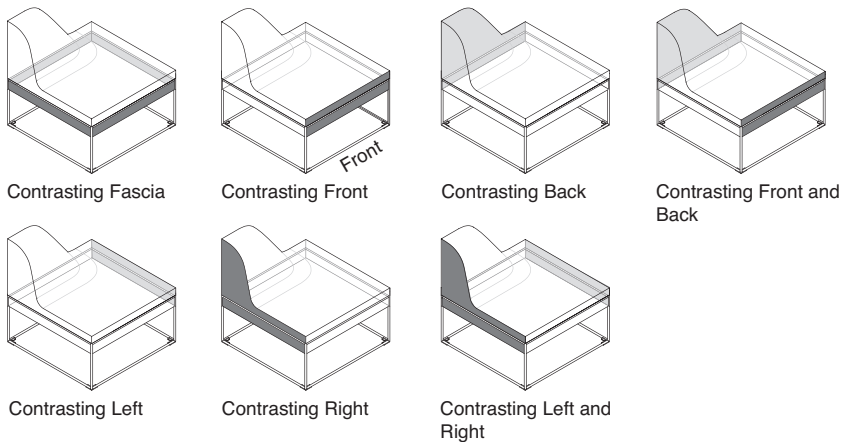

End Cap, Left Arm Position

- Contrasting Fascia
- Contrasting Front
- Contrasting Back
- Contrasting Front and Back
- Contrasting Left
- Contrasting Right
- Contrasting Left and Right

Only one contrasting selection can be made on each product. This includes contrasting fascia.

Contrasting Details, continued

End Cap, Right Arm Position

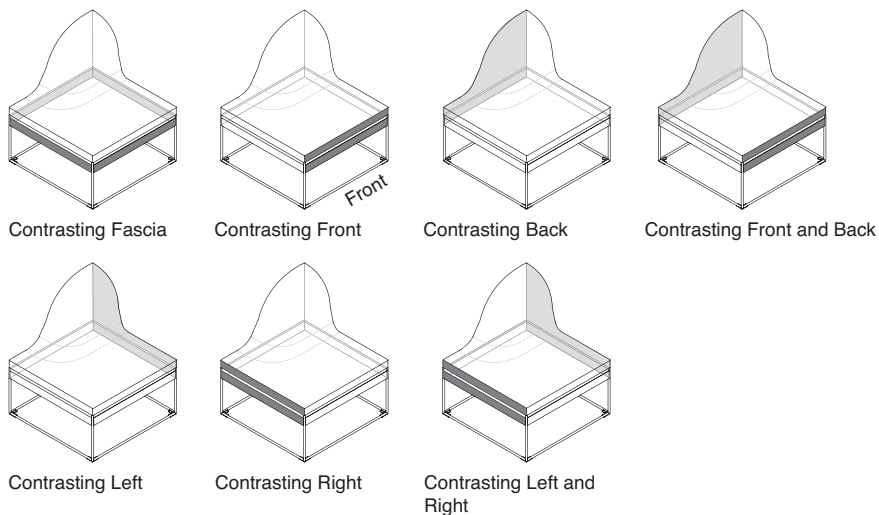

End Cap, Right Arm Position

- Contrasting Fascia
- Contrasting Front
- Contrasting Back
- Contrasting Front and Back
- Contrasting Left
- Contrasting Right
- Contrasting Left and Right

Only one contrasting selection can be made on each product. This includes contrasting fascia.

Straight Double Lounge

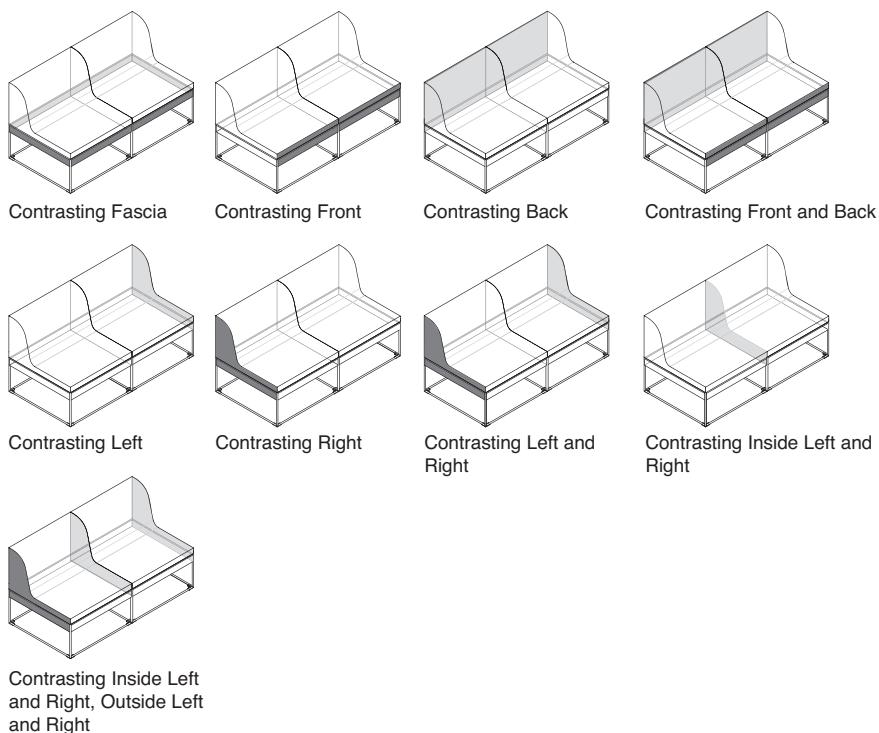

Straight Double Lounge

- Contrasting Fascia
- Contrasting Front
- Contrasting Back
- Contrasting Front and Back
- Contrasting Left
- Contrasting Right
- Contrasting Left and Right
- Contrasting Inside Left and Right
- Contrasting Inside Left and Right, Outside Left and Right

Only one contrasting selection can be made on each product. This includes contrasting fascia.



Contrasting Details, continued

One Arm Double Lounge, Right Arm Position

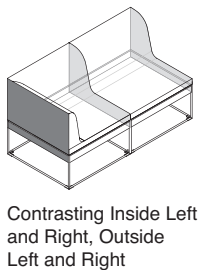
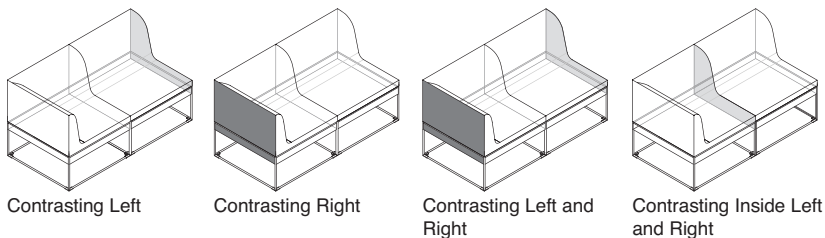
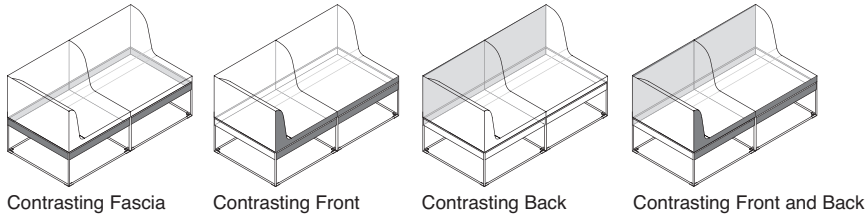

One Arm Double Lounge

- Contrasting Fascia
- Contrasting Front
- Contrasting Back
- Contrasting Front and Back
- Contrasting Left
- Contrasting Right
- Contrasting Left and Right
- Contrasting Inside Left and Right
- Contrasting Inside Left and Right, Outside Left and Right

Only one contrasting selection can be made on each product. This includes contrasting fascia.

One Arm Double Lounge, Left Arm Position

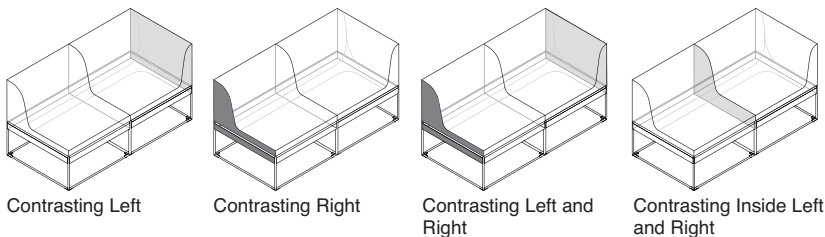
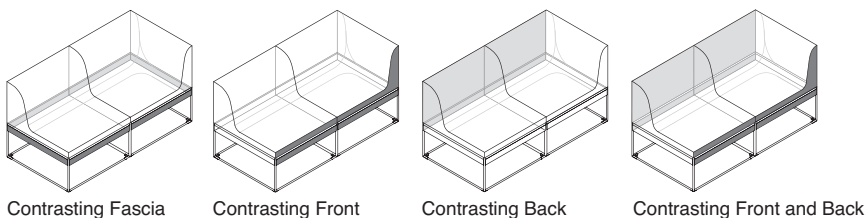

One Arm Double Lounge

- Contrasting Fascia
- Contrasting Front
- Contrasting Back
- Contrasting Front and Back
- Contrasting Left
- Contrasting Right
- Contrasting Left and Right
- Contrasting Inside Left and Right
- Contrasting Inside Left and Right, Outside Left and Right

Only one contrasting selection can be made on each product. This includes contrasting fascia.

Contrasting Details, continued

Two Arm Double Lounge

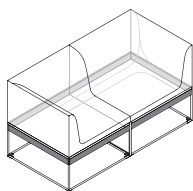

Contrasting Fascia

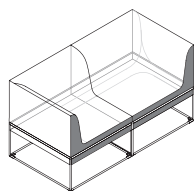

Contrasting Front

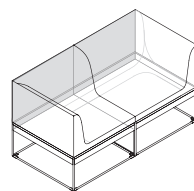

Contrasting Back

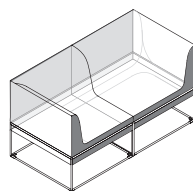

Contrasting Front and Back

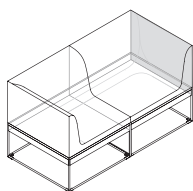

Contrasting Left

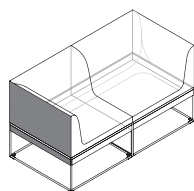

Contrasting Right

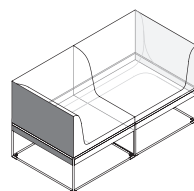

Contrasting Left and Right

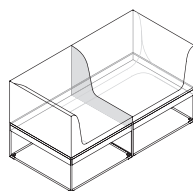

Contrasting Inside Left and Right

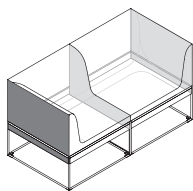

Contrasting Inside Left and Right, Outside Left and Right

Two Arm Double Lounge

- Contrasting Fascia
- Contrasting Front
- Contrasting Back
- Contrasting Front and Back
- Contrasting Left
- Contrasting Right
- Contrasting Left and Right
- Contrasting Inside Left and Right
- Contrasting Inside Left and Right, Outside Left and Right

Only one contrasting selection can be made on each product. This includes contrasting fascia.

Umami

Pill and Round Tables

Pill and round tables are options added as table left or table right (optioned based on user sitting in lounge).

Pill and round tables can be optioned on select platforms with upholstered top or on lounge products.

Round tables are 10" in diameter. Pill tables are 10" by 13 1/2".

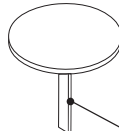

The post (support) of the table is available in paint.

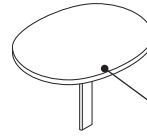
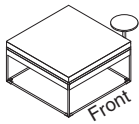

Table tops are available in 2883 Seagull and 2HMG Merle only.

Locations of round or pill tables are shown below.

Single Platforms



Left location

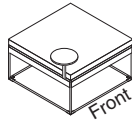

Right location

Round and pill tables cannot be attached to a 15"D x 30"W or 15"D x 60"W platform.

Double Platforms

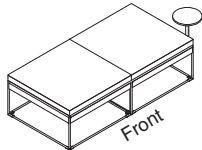

Left location

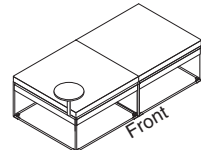

Right location

Round and pill tables cannot be attached to a 15"D x 60"W platform.

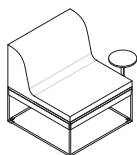
Straight Single Lounge

Left location

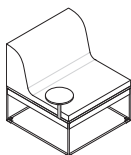

Right location

Round and pill tables cannot be attached to one arm single, two arm single, or corner lounge.

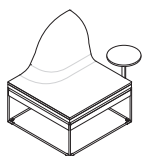
End Cap

Left location pill table, shown on the right arm position end cap

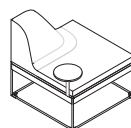

Right location pill table, shown on the left arm position end cap

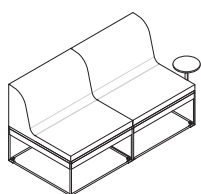
Straight Double Lounge

Left location

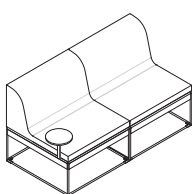

Right location

Round and pill tables cannot be attached to two arm double lounge.

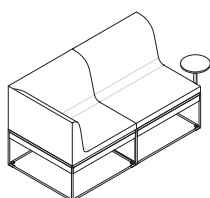
One Arm Double Lounge

Left location

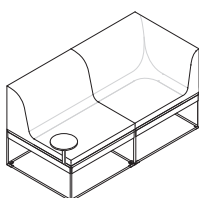

Right location

Umami

Screens

Standard screens are installed at 48" and 60" high.

Each screen will come with one or two clips that attach screens together in either 6527 Merle or 6053 Seagull.

Screen clips come in two types: straight or corner.

Standard screens come in 15" and 30" widths.

Contrasting fabric on Umami standard screens and spanner screens are available with contrasting fabric on the inside and outside of the screen. Contrasting fabrics must be from the same fabric family.

Screens cannot be placed in between platforms and lounge seating.

30"W screen can only be put on a 15"D x 30"W platform if the platform is attached to another platform or lounge.

30"W screens can be placed on a 30"D platform/lounge or two 15"D platforms.

Spanner screens come in 90" and 105" widths and the center screen goes completely to the floor. They are not allowed to be attached to a platform or end cap lounge.

90"W spanner screens can only be attached to the side of two lounge chairs. They cannot be attached to an end cap lounge or platform.

15"W screens can go on an end of a lounge for partial privacy. In this case, an upholstered fascia must be added.

Two 15"W screens will not fit on a 30"D platform or lounge.

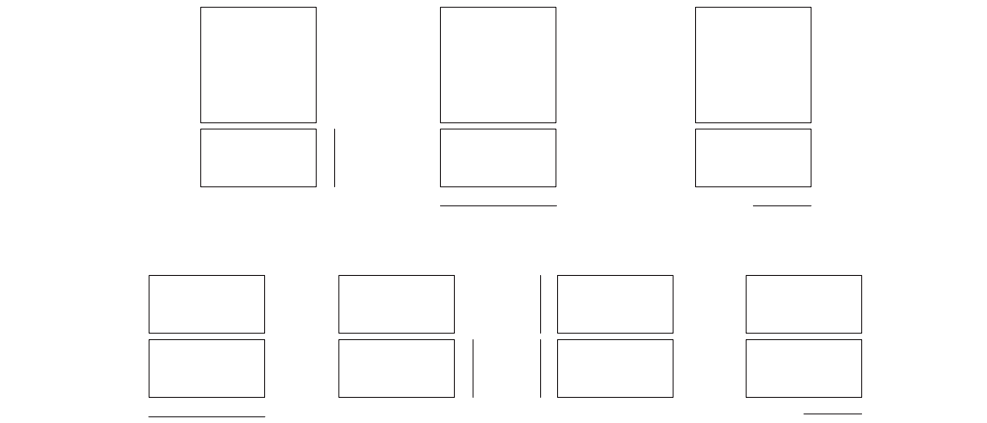
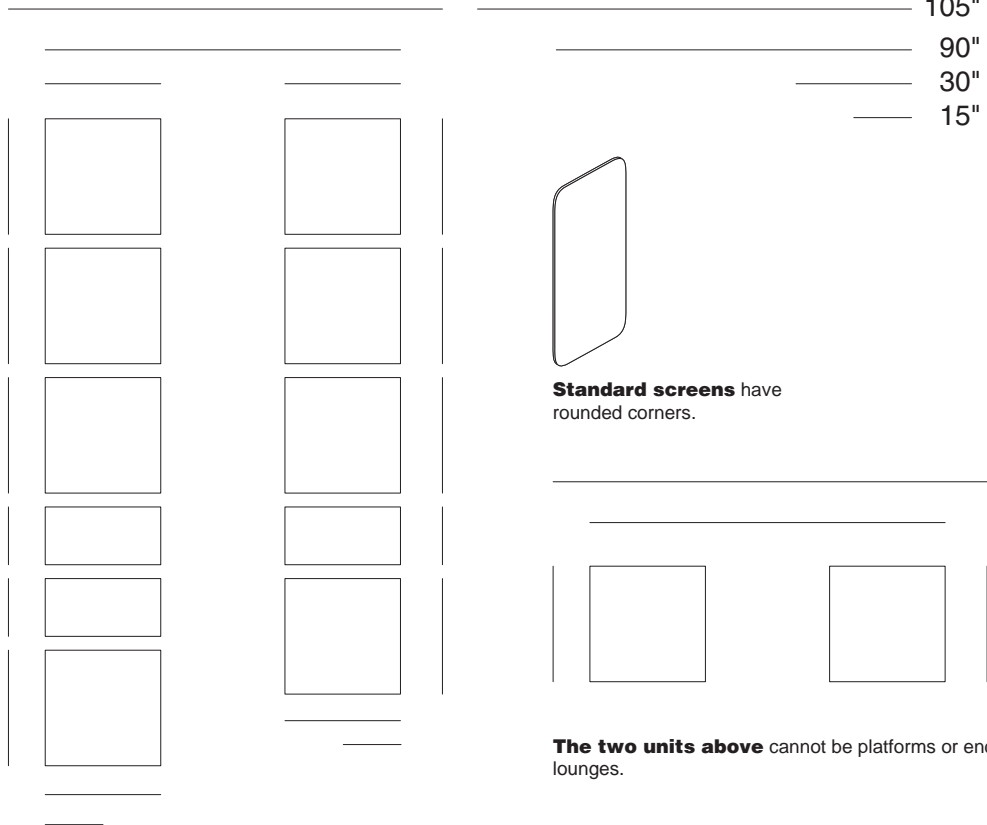

15"W and 30"W screens are only allowed on 15"D x 30"W frames in the shown above configurations.
Tip: When placing a 15"D screen on a 30"W frame, a fascia must be specified.

The following applications are not allowed:

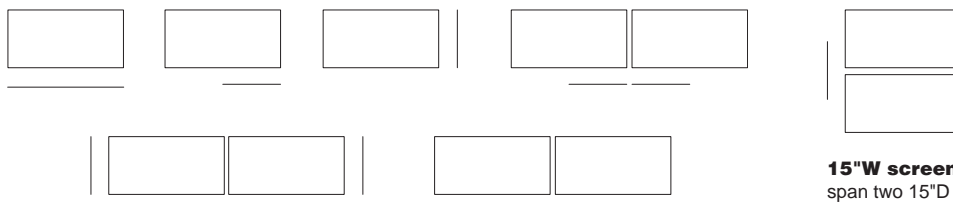

15\"/>

Specifications above are not allowed for stability reasons.



30\"/>

15\"/>

Two 15\"/>

15\"/>

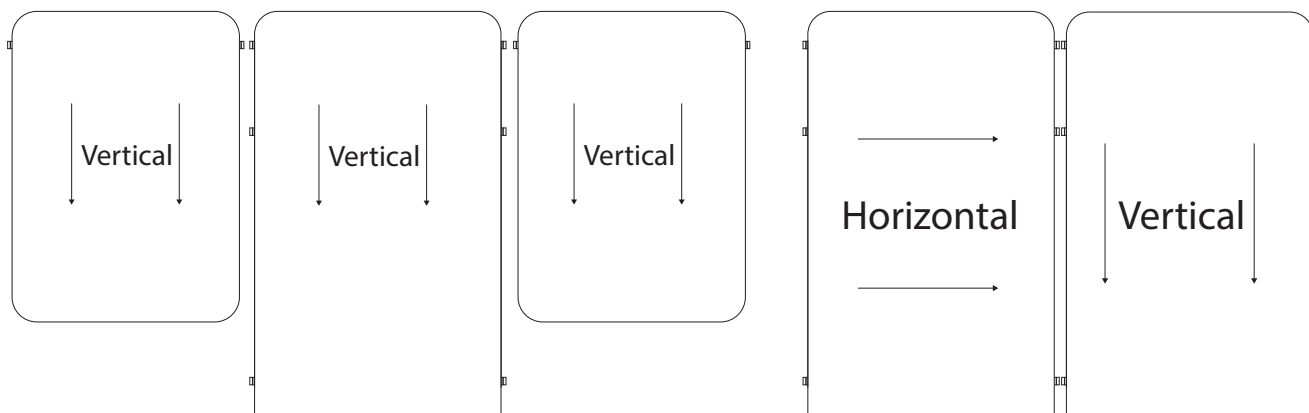

Fabric direction on Umami spanner screens can only be applied vertically. If you want standard screens to match spanner screens, make sure to specify vertical fabric applications on standard screens.

Fabric direction on Umami standard screens can be applied horizontally or vertically.

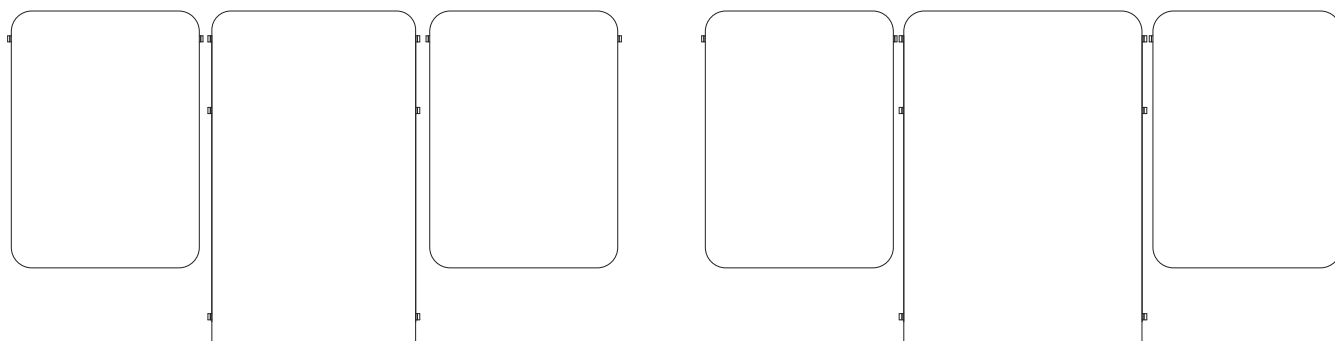

90\"/>

105\"/>

Thought Starters

Umami

Informal Meeting Space Together, But Distanced

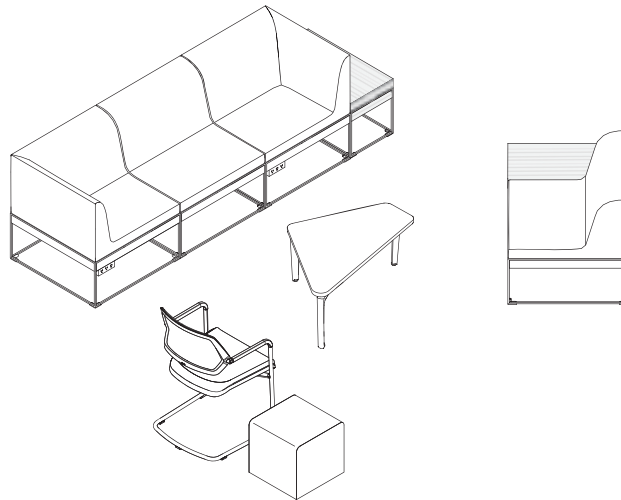

Quantity	Style Number	Description	Options	Page for Ordering
1	STLLNGAR1	One Arm, Single Lounge	Left Arm, with Power Block	▶ Page 504
1	STLLNGAR1	One Arm, Single Lounge	Right Arm, with Power Block	▶ Page 504
2	STLLNGST1	Straight, Single Lounge		▶ Page 500
2	STLPLTF1	Single Platform	15"D x 30"W, Laminate	▶ Page 492
1	TSBLNT3LEGS	Small Asymmetrical Table		▶ <i>Conference and Collaborative Tables Specification Guide</i>
1	428310	QiVi Chair with Sled Base		▶ Page 272
1	N3LCUBES	B-Free Small Cube		▶ Page 575

Socially Together, But Distanced

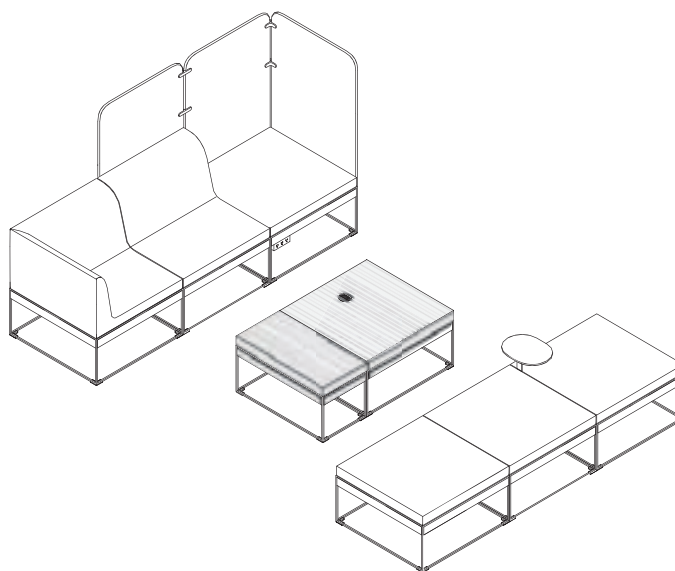

Quantity	Style Number	Description	Options	Page for Ordering
1	STLLNGAR1	One Arm, Single Lounge	Right Arm	▶ Page 504
1	STLLNGST1	Straight, Single Lounge		▶ Page 500
3	STLSCRPL	Standard Screen	30"W x 60"H	▶ Page 514
1	STLPLTF1	Single Platform	30"D x 30"W, Upholstered with Power Block	▶ Page 492
2	STLPLTF1	Single Platform	30"D x 30"W, Upholstered	▶ Page 492
1	STLPLTF1	Single Platform	30"D x 30"W, Upholstered with Pill Table	▶ Page 492
1	STLPLTF1	Single Platform	30"D x 30"W, Laminate with Platform Table Power	▶ Page 492
1	STLPLTF1	Single Platform	15"D x 30"W, Laminate	▶ Page 492

Café Booth-Inspired Collaborative Setting

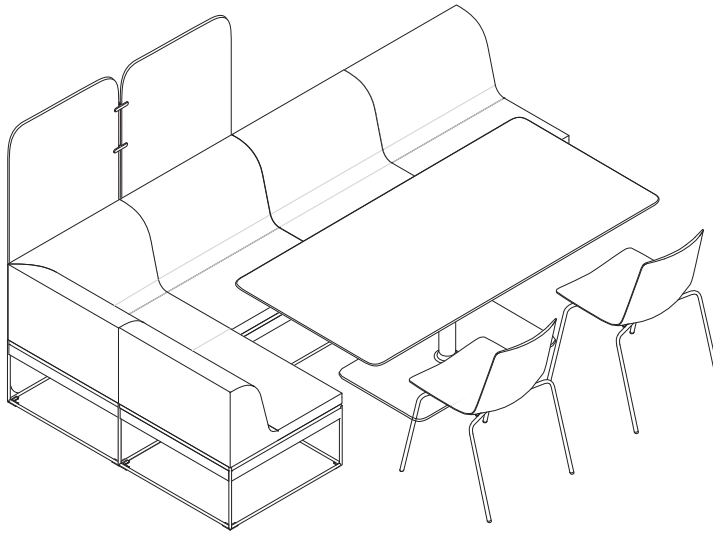

Quantity	Style Number	Description	Options	Page for Ordering
1	STLLNGST2	Straight, Double Lounge	Single	▶ Page 502
1	STLLNGCR1	Corner, Single Lounge		▶ Page 510
2	STLLNGST1	Straight, Single Lounge		▶ Page 500
1	COLAGTRECT	Lagunitas Work Table	36"D x 72"W	▶ Page 524
2	STLSRPL	Standard Screen	30"W x 48"H	▶ Page 514
2	WHG6606	Nooi 4-Leg Chair, Armless		▶ Page 422

Dyadic Collaboration with Shielding

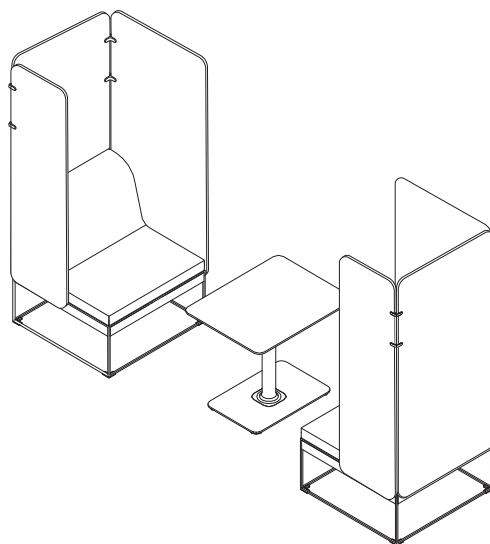

Quantity	Style Number	Description	Options	Page for Ordering
2	STLLNGST1	Straight, Single Lounge		▶ Page 500
1	COLAGTRECT	Lagunitas Work Table	24"D x 36"W	▶ Page 526
4	STLSCRPL	Standard Screen	30"W x 60"H	▶ Page 514
2	STLSCRPL	Standard Screen	15"W x 60"H, 15"H Fascia	▶ Page 514

Individual Focus with Shielded Boundary

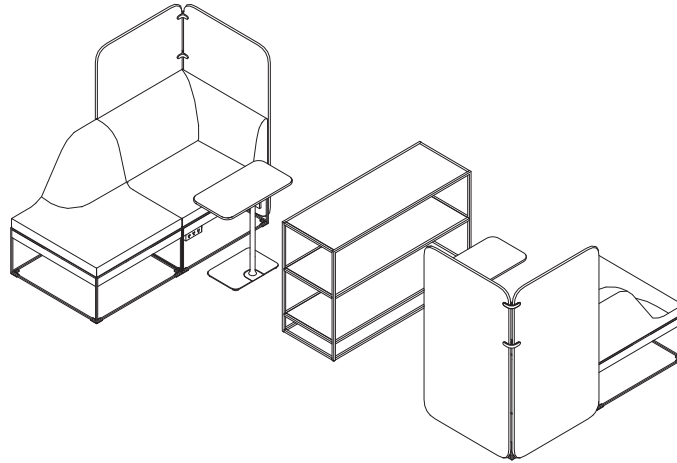

Quantity	Style Number	Description	Options	Page for Ordering
2	STLLNGAR1	One Arm, Single Lounge	Left Arm, Power Block	▶ Page 510
2	STLLNGEC	End Cap Lounge	Right Arm Position	▶ Page 512
4	STLSCRPL	Standard Screen	30"W x 60"H	▶ Page 514
2	COLAGTP	Lagunitas Personal Table		▶ Page 528
1	WESINDLOB	West Elm Greenpoint Low Bookcase		▶ See <i>West Elm Work Collection Specification Guide</i>

Informal Collaboration

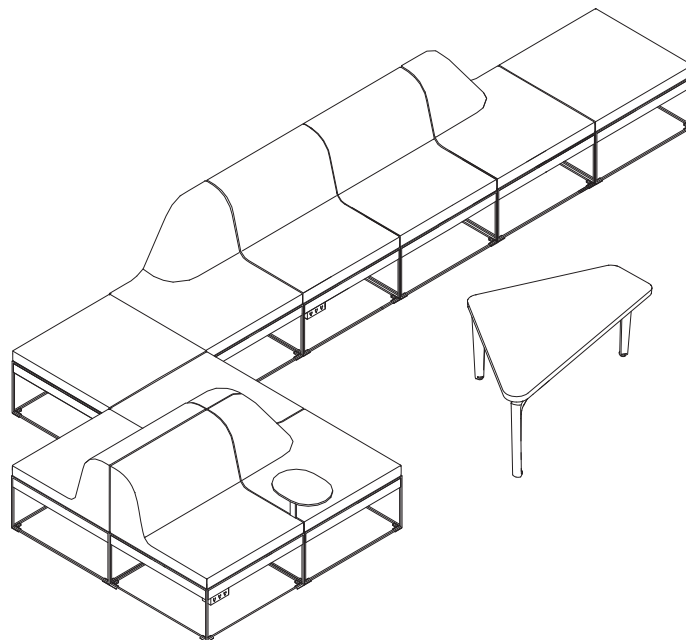

Quantity	Style Number	Description	Options	Page for Ordering
2	STLLNGST1	Straight, Single Lounge		▶ Page 500
1	STLLNGST1	Straight, Single Lounge	Power Block	▶ Page 500
1	STLLNGST1	Straight, Single Lounge	Power Block, with Pill Table	▶ Page 500
1	STLLNGEC	End Cap Lounge	Left Arm Position	▶ Page 512
1	STLLNGEC	End Cap Lounge	Left Arm Position, with Power Block	▶ Page 512
2	STLLNGEC	End Cap Lounge	Right Arm Position	▶ Page 512
2	STLPLTF1	Single Platform	30"D x 30"W, Upholstered	▶ Page 492
1	TSBLNT3LEGS	Small Asymmetrical Table		▶ <i>Conference and Collaborative Tables Specification Guide</i>

Dimensions

Umami

Features	Overall Depth	Width	Height	Seat Depth	Seat Height from Floor	Installed Screen Height
Umami						
Platform						
Small—Single	15"	30"	16½"	N.A.	N.A.	N.A.
Small—Double	15"	60"	16½"	N.A.	N.A.	N.A.
Large—Single	30"	30"	16½"	N.A.	N.A.	N.A.
Large—Double	30"	60"	16½"	N.A.	N.A.	N.A.
Lounge						
Lounge Seating, Single	30"	30"	31"	17¼"	16½"	N.A.
Lounge Seating, Double	30"	60"	31"	17¼"	16½"	N.A.
Screen						
Standard	⅝"	15"	36½"	N.A.	N.A.	48"
	⅝"	30"	36½"	N.A.	N.A.	48"
	⅝"	15"	48½"	N.A.	N.A.	60"
	⅝"	30"	48½"	N.A.	N.A.	60"
Standard Spanner	⅝"	90"	48"	N.A.	N.A.	48"
	⅝"	105"	48"	N.A.	N.A.	48"
	⅝"	90"	60"	N.A.	N.A.	60"
	⅝"	105"	60"	N.A.	N.A.	60"

Note: Lounge seat heights are measured with low glides installed. Seat height with medium glides is 17". Seat height with high glides is 17⅔".



Umami

Single Platform

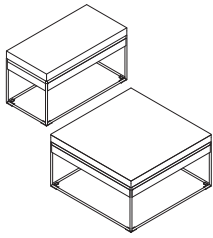

Tip: On 15"D platforms, the front is the 30"W side. When selecting contrasting left or right, the 15"D sides are the contrasting sides.

Tip: When contrasting fascia is selected, the fascia will be contrasting from the top.

Tip: Only a single material scheme can be selected. For example, both contrasting fascia and contrasting front cannot be selected together. If more than one material scheme is desired, contact a specials representative.

Tip: When a platform has a hard surface and either laminate or veneer is selected, only monolithic and contrasting fascia options are available. Contrasting sides is not an option.

Tip: Umami lounge and platforms may show minimal comfort wrinkling depending on the fabric or leather specified.

Standard Includes		Required to Specify
<ul style="list-style-type: none"> ▶ Need help? Product details, page 468 	<ul style="list-style-type: none"> • Top: fabric price group 1 or laminate • Fascia: monolithic, matches top • Frame: paint price group 1 • Glides • Ships fully assembled • Attachment package 	<ol style="list-style-type: none"> 1 Style number 2 Fabric or laminate color number for top 3 Paint color number for frame 4 Platform size (see below under Required Selections) 5 Material scheme (see below under Required Selections) 6 Options, if selected (see below) <p>▶ See <i>Surface Materials</i>, page 634.</p>

	Required Selections	U.S. Price	Required to Specify
Platform Size	<ul style="list-style-type: none"> • 15"D x 30"W • 30"D x 30"W 	Prices at right Prices at right	Specify <i>with 15"D</i> . Specify <i>with 30"D</i> .
Material Scheme	<ul style="list-style-type: none"> • Monolithic • Contrasting fascia • Contrasting front • Contrasting back • Contrasting left • Contrasting right • Contrasting front and back • Contrasting left and right 	No cost No cost No cost No cost No cost No cost No cost No cost	Specify <i>with monolithic</i> . Specify <i>with contrasting fascia</i> . Specify <i>with contrasting front</i> . Specify <i>with contrasting back</i> . Specify <i>with contrasting left</i> . Specify <i>with contrasting right</i> . Specify <i>with contrasting front and back</i> . Specify <i>with contrasting left and right</i> .

	Options	U.S. Price	Required to Specify
Surface Materials	Top finish for 15"D x 30"W <ul style="list-style-type: none"> • Fabric price group 1 • Fabric price group 2 • Fabric price group 3 • Fabric price group 4 • Fabric price group 5 • Fabric price group 6 • Fabric price group 7 • Fabric price group 8 • Fabric price group 9 • Fabric price group 10 • Elmosoft leather upholstery • Vinyl • Customer's Own Material (COM) • Laminate price group 1 • Laminate price group 2 • Laminate price group 3 • Open Line Laminate (OLL) • Wood group 1 • Wood group 2 • Wood group 3 • Customiz stain 	No cost +\$ 27 +\$ 41 +\$ 57 +\$ 73 +\$ 87 +\$101 +\$130 +\$158 +\$180 +\$377 +\$ 26 No cost No cost +\$ 5 +\$ 28 +\$102 +\$459 +\$521 +\$670 +\$459	Specify fabric color number. Specify fabric color number. Specify fabric color number. Specify fabric color number. Specify fabric color number. Specify fabric color number. Specify fabric color number. Specify fabric color number. Specify fabric color number. Specify fabric color number. Specify Elmosoft leather color number. Specify vinyl color number. ▶ See <i>Surface Materials Reference Manual</i> . Specify laminate color number. Specify laminate color number. Specify laminate color number. ▶ See <i>Surface Materials Reference Manual</i> . Specify wood color number. Specify wood color number. Specify wood color number. Specify <i>with Customiz stain</i> .

▶ Options, continued on next page



For Canadian Pricing
Multiply U.S. Price by the Canadian price factor.
▶ See page 1 for details.

► Options, continued from previous page

	Options	U.S. Price	Required to Specify
Surface Materials, continued	Top finish for 30"D x 30"W		
	• Fabric price group 1	No cost	Specify fabric color number.
	• Fabric price group 2	+\$ 36	Specify fabric color number.
	• Fabric price group 3	+\$ 69	Specify fabric color number.
	• Fabric price group 4	+\$ 97	Specify fabric color number.
	• Fabric price group 5	+\$ 120	Specify fabric color number.
	• Fabric price group 6	+\$ 147	Specify fabric color number.
	• Fabric price group 7	+\$ 172	Specify fabric color number.
	• Fabric price group 8	+\$ 217	Specify fabric color number.
	• Fabric price group 9	+\$ 266	Specify fabric color number.
	• Fabric price group 10	+\$ 304	Specify fabric color number.
	• Elmosoft leather upholstery	+\$ 640	Specify Elmosoft leather color number.
	• Vinyl	+\$ 36	Specify vinyl color number.
	• Customer's Own Material (COM)	No cost	► See <i>Surface Materials Reference Manual</i> .
	• Laminate price group 1	No cost	Specify laminate color number.
	• Laminate price group 2	+\$ 11	Specify laminate color number.
	• Laminate price group 3	+\$ 52	Specify laminate color number.
	• Open Line laminate (OLL)	+\$ 102	► See <i>Surface Materials Reference Manual</i> .
	• Wood group 1	+\$ 791	Specify wood color number.
	• Wood group 2	+\$ 893	Specify wood color number.
• Wood group 3	+\$1149	Specify wood color number.	
• Customiz stain	+\$ 791	Specify with <i>Customiz stain</i> .	
	Frame finish		
	• Paint price group 1	No cost	Specify paint color number.
	• Paint price group 2	+\$ 76	Specify paint color number.
	• Paint price group 3	+\$ 159	Specify paint color number.

Contrasting Material Scheme	Contrasting fascia finish, if contrasting fascia selected on platforms with upholstered tops		
	• Fabric price group 1	No cost	Specify fabric color number.
	• Fabric price group 2	+\$ 27	Specify fabric color number.
	• Fabric price group 3	+\$ 41	Specify fabric color number.
	• Fabric price group 4	+\$ 57	Specify fabric color number.
	• Fabric price group 5	+\$ 73	Specify fabric color number.
	• Fabric price group 6	+\$ 87	Specify fabric color number.
	• Fabric price group 7	+\$ 101	Specify fabric color number.
	• Fabric price group 8	+\$ 130	Specify fabric color number.
	• Fabric price group 9	+\$ 158	Specify fabric color number.
	• Fabric price group 10	+\$ 180	Specify fabric color number.
	• Elmosoft leather upholstery	+\$ 377	Specify Elmosoft leather color number.
	• Vinyl	+\$ 26	Specify vinyl color number.
• Customer's Own Material (COM)	No cost	► See <i>Surface Materials Reference Manual</i> .	

Contrasting fascia finish, if contrasting fascia selected on platforms with laminate or veneer tops

• Laminate price group 1 and 2	No cost	Specify laminate color number.
• Laminate price group 3	+\$ 28	Specify laminate color number.
• Open Line laminate (OLL)	+\$ 102	► See <i>Surface Materials Reference Manual</i> .
• Wood group 1	+\$ 459	Specify wood color number.
• Wood group 2	+\$ 521	Specify wood color number.
• Wood group 3	+\$ 670	Specify wood color number.
• Customiz stain	+\$ 459	Specify with <i>Customiz stain</i> .

Contrasting sides, if contrasting side selected

• Fabric price group 1	No cost	Specify fabric color number.
• Fabric price group 2	+\$ 12	Specify fabric color number.
• Fabric price group 3	+\$ 22	Specify fabric color number.
• Fabric price group 4	+\$ 28	Specify fabric color number.
• Fabric price group 5	+\$ 36	Specify fabric color number.
• Fabric price group 6	+\$ 44	Specify fabric color number.
• Fabric price group 7	+\$ 48	Specify fabric color number.
• Fabric price group 8	+\$ 56	Specify fabric color number.
• Fabric price group 9	+\$ 72	Specify fabric color number.
• Fabric price group 10	+\$ 81	Specify fabric color number.

Tip: Contrasting sides are only allowed on fabric platforms.

Tip: Contrasting sides include the following material schemes—contrasting front, contrasting back, contrasting left, contrasting right, contrasting front and back, and contrasting left and right.



For Canadian Pricing
Multiply U.S. Price by the Canadian price factor.
► See page 1 for details.

► Options, continued on next page

Umami, Single Platform, continued

► Options, continued from previous page

	Options	U.S. Price	Required to Specify
Contrasting Material Scheme, continued	Contrasting sides, if contrasting side selected, continued		
	• Elmosoft leather upholstery	+\$173	Specify Elmosoft leather color number.
	• Vinyl	+\$ 9	Specify vinyl color number.
	• Customer's Own Material (COM)	No cost	► See <i>Surface Materials Reference Manual</i> .
Tables (on platform with upholstered top)	Table type (on 30"D x 30"W platform only)		
	• No table	No cost	Specify <i>with no table</i> .
	• Round table	+\$518	Specify <i>with round table</i> and select color number.
	• Pill table	+\$518	Specify <i>with pill table</i> and select color number.
	Table location		
	• Table left	No cost	Specify <i>with table left</i> .
	• Table right	No cost	Specify <i>with table right</i> .
	Table support finish		
	• Paint group 1	No cost	Specify paint color number.
	• Paint group 2	+\$ 23	Specify paint color number.
	• Paint group 3	+\$ 39	Specify paint color number.
Power Configuration	Power type		
	• No power	No cost	Specify <i>with no power</i> .
	• Platform table power	+\$415	Specify <i>with platform table power</i> .
	• Power block	+\$488	Specify <i>with power block</i> .
	Power configuration for platform table power		
	• Two power	No cost	Specify <i>with 2 power</i> .
	• One power, one USB	+\$172	Specify <i>with 1 power, 1 USB</i> .
	Power configuration for power block		
	• Three power	No cost	Specify <i>with 3 power</i> .
	• Two power, one USB	+\$172	Specify <i>with 2 power, 1 USB</i> .
	Power plug type		
• Standard NEMA 5–15 3 prong	No cost	Specify <i>with NEMA</i> .	
• Low profile plug	+\$ 40	Specify <i>with low profile plug</i> .	
	Tamper resistant		
• No tamper resistant	No cost	Specify <i>with no tamper resistant</i> .	
• Tamper resistant	+\$ 29	Specify <i>with tamper resistant</i> .	

Tip: Platform table power is only available on platforms with laminate or veneer tops.

Tip: Power is provided by a 72" power cord.



For Canadian Pricing

Multiply U.S. Price by the Canadian price factor.

► See page 1 for details.

Specification Information

• Dimensions		• Style • Number	• U.S. Base Prices	
W	H		15"D	30"D
30"	16½"	STLPLTF1	\$1510	\$1961

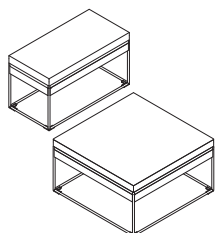

 **For Canadian Pricing**
 Multiply U.S. Price by the
 Canadian price factor.
 ▶ See page 1 for details.



Umami

Double Platform

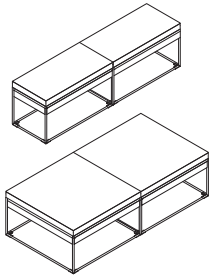

▶ Need help?
Product details,
page 468

Standard Includes

- Top: fabric price group 1
- Fascia: monolithic, matches top
- Frame: paint price group 1
- Glides
- Ships fully assembled
- Attachment package

Required to Specify

- 1 Style number
 - 2 Fabric color number for top
 - 3 Paint color number for frame
 - 4 Platform size (see below under Required Selections)
 - 5 Material scheme (see below under Required Selections)
 - 6 Options, if selected (see below)
- ▶ See *Surface Materials*, page 634.

Tip: On 15"D platforms, the front is the 60"W side. When selecting contrasting left or right, the 15"D sides are the contrasting sides

Tip: Only a single material scheme can be selected. For example, both contrasting fascia and contrasting front cannot be selected together. If more than one material scheme is desired, contact a specials representative.

Tip: Umami lounge and platforms may show minimal comfort wrinkling depending on the fabric or leather specified.

	Required Selections	U.S. Price	Required to Specify
Platform Size	<ul style="list-style-type: none"> • 15"D x 60"W • 30"D x 60"W 	Prices at right Prices at right	Specify with 15"D. Specify with 30"D.

Material Scheme	<ul style="list-style-type: none"> • Monolithic • Contrasting fascia • Contrasting front • Contrasting back • Contrasting left • Contrasting right • Contrasting front and back • Contrasting left and right • Contrasting inside left and right 	No cost No cost No cost No cost No cost No cost No cost No cost No cost	Specify with <i>monolithic</i> . Specify with <i>contrasting fascia</i> . Specify with <i>contrasting front</i> . Specify with <i>contrasting back</i> . Specify with <i>contrasting left</i> . Specify with <i>contrasting right</i> . Specify with <i>contrasting front and back</i> . Specify with <i>contrasting left and right</i> . Specify with <i>contrasting inside left and right</i> . Specify with <i>contrasting inside left and right, outside left and right</i> .
	<ul style="list-style-type: none"> • Contrasting inside left and right, outside left and right 	No cost	Specify with <i>contrasting inside left and right, outside left and right</i> .

	Options	U.S. Price	Required to Specify
--	---------	------------	---------------------

Surface Materials	Top finish for 15"D x 60"W		
	<ul style="list-style-type: none"> • Fabric price group 1 • Fabric price group 2 • Fabric price group 3 • Fabric price group 4 • Fabric price group 5 • Fabric price group 6 • Fabric price group 7 • Fabric price group 8 • Fabric price group 9 • Fabric price group 10 • Elmosoft leather upholstery • Vinyl • Customer's Own Material (COM) 	No cost +\$ 49 +\$ 75 +\$ 102 +\$ 130 +\$ 158 +\$ 182 +\$ 232 +\$ 282 +\$ 323 +\$ 679 +\$ 47 No cost	Specify fabric color number. Specify fabric color number. Specify fabric color number. Specify fabric color number. Specify fabric color number. Specify fabric color number. Specify fabric color number. Specify fabric color number. Specify fabric color number. Specify fabric color number. Specify Elmosoft leather color number. Specify vinyl color number. ▶ See <i>Surface Materials Reference Manual</i> .

	Top finish for 30"D x 60"W		
	<ul style="list-style-type: none"> • Fabric price group 1 • Fabric price group 2 • Fabric price group 3 • Fabric price group 4 • Fabric price group 5 • Fabric price group 6 • Fabric price group 7 • Fabric price group 8 • Fabric price group 9 • Fabric price group 10 • Elmosoft leather upholstery • Vinyl • Customer's Own Material (COM) 	No cost +\$ 72 +\$ 132 +\$ 183 +\$ 232 +\$ 282 +\$ 328 +\$ 413 +\$ 508 +\$ 577 +\$1214 +\$ 65 No cost	Specify fabric color number. Specify fabric color number. Specify fabric color number. Specify fabric color number. Specify fabric color number. Specify fabric color number. Specify fabric color number. Specify fabric color number. Specify fabric color number. Specify fabric color number. Specify Elmosoft leather color number. Specify vinyl color number. ▶ See <i>Surface Materials Reference Manual</i> .

▶ Options, continued on next page



For Canadian Pricing
Multiply U.S. Price by the
Canadian price factor.
▶ See page 1 for details.

► Options, continued from previous page

	Options	U.S. Price	Required to Specify	
Surface Materials, continued	Frame finish			
	• Paint price group 1	No cost	Specify paint color number.	
	• Paint price group 2	+\$126	Specify paint color number.	
	• Paint price group 3	+\$268	Specify paint color number.	
Contrasting Material Scheme	Contrasting fascia finish, if contrasting fascia selected			
	• Fabric price group 1	No cost	Specify fabric color number.	
	• Fabric price group 2	+\$ 45	Specify fabric color number.	
	• Fabric price group 3	+\$ 65	Specify fabric color number.	
	• Fabric price group 4	+\$ 92	Specify fabric color number.	
	• Fabric price group 5	+\$113	Specify fabric color number.	
	• Fabric price group 6	+\$140	Specify fabric color number.	
	• Fabric price group 7	+\$160	Specify fabric color number.	
	• Fabric price group 8	+\$206	Specify fabric color number.	
	• Fabric price group 9	+\$253	Specify fabric color number.	
	• Fabric price group 10	+\$284	Specify fabric color number.	
	• Elmosoft leather upholstery	+\$600	Specify Elmosoft leather color number.	
	• Vinyl	+\$ 44	Specify vinyl color number.	
	• Customer's Own Material (COM)	No cost	► See <i>Surface Materials Reference Manual</i> .	
		Contrasting sides finish, if contrasting side selected		
		• Fabric price group 1	No cost	Specify fabric color number.
		• Fabric price group 2	+\$ 27	Specify fabric color number.
	• Fabric price group 3	+\$ 41	Specify fabric color number.	
	• Fabric price group 4	+\$ 57	Specify fabric color number.	
	• Fabric price group 5	+\$ 73	Specify fabric color number.	
	• Fabric price group 6	+\$ 87	Specify fabric color number.	
	• Fabric price group 7	+\$101	Specify fabric color number.	
	• Fabric price group 8	+\$130	Specify fabric color number.	
	• Fabric price group 9	+\$158	Specify fabric color number.	
	• Fabric price group 10	+\$180	Specify fabric color number.	
	• Elmosoft leather upholstery	+\$377	Specify Elmosoft leather color number.	
	• Vinyl	+\$ 26	Specify color number.	
	• Customer's Own Material (COM)	No cost	► See <i>Surface Materials Reference Manual</i> .	
Tables	Table type (on 30"D x 60"W platform only)			
	• No table	No cost	Specify <i>with no table</i> .	
	• Round table	+\$518	Specify <i>with round table</i> and select color number.	
	• Pill table	+\$518	Specify <i>with pill table</i> and select color number.	
		Table location		
	• Table left	No cost	Specify <i>with table left</i> .	
	• Table right	No cost	Specify <i>with table right</i> .	
		Table support finish		
	• Paint group 1	No cost	Specify paint color number.	
	• Paint group 2	+\$ 23	Specify paint color number.	
• Paint group 3	+\$ 39	Specify paint color number.		

► Options, continued on next page

Tip: Contrasting sides are only allowed on fabric platforms.

Tip: Contrasting sides include the following material schemes—contrasting front, contrasting back, contrasting left, contrasting right, contrasting front and back, and contrasting left and right.

**For Canadian Pricing**

Multiply U.S. Price by the Canadian price factor.

► See page 1 for details.

Umami, Double Platform, continued

► Options, continued from previous page

Tip: Power is provided by a 72" power cord.

Options	U.S. Price	Required to Specify
Power Configuration		
Power type		
• No power	No cost	Specify with no power.
• Power block	+\$488	Specify with power block.
• Two power blocks	+\$976	Specify with two power blocks.
Outlet configuration		
• Three power	No cost	Specify with 3 power.
• Two power, one USB	+\$172	Specify with 2 power, 1 USB.
Power plug type		
• Standard NEMA 5-15 3 prong	No cost	Specify with NEMA.
• Low profile plug	+\$ 40	Specify with low profile plug.
Tamper resistant		
• No tamper resistant	No cost	Specify with no tamper resistant.
• Tamper resistant	+\$ 29	Specify with tamper resistant.

Specification Information

Dimensions W H	Style Number	U.S. Base Prices	
		15"D	30"D
60" 16 1/2"	STLPLTF2	\$2215	\$2880

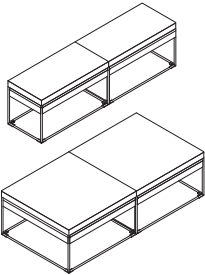

For Canadian Pricing

Multiply U.S. Price by the Canadian price factor.

► See page 1 for details.

Umami Straight Lounge

Single

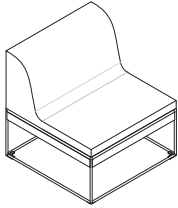

Tip: Only a single material scheme can be selected. For example, both contrasting fascia and contrasting front cannot be selected together. If more than one material scheme is desired, contact a specials representative.

Tip: Umami lounge and platforms may show minimal comfort wrinkling depending on the fabric or leather specified.

Tip: Light colored or thin fabrics are not compatible on Umami lounge.

Standard Includes		Required to Specify
<ul style="list-style-type: none"> ▶ Need help? Product details, page 468 	<ul style="list-style-type: none"> • Seat upholstery: fabric price group 1 • Fascia: monolithic, matches top • Frame: paint price group 1 • Ships fully assembled • Attachment package 	<ol style="list-style-type: none"> 1 Style number 2 Fabric color number for seat 3 Paint color number for frame 4 Material scheme (see below under Required Selections) 5 Options, if selected (see below) <ul style="list-style-type: none"> ▶ See <i>Surface Materials</i>, page 634.

Material Scheme	Required Selections	U.S. Price	Required to Specify
Material Scheme	• Monolithic	No cost	Specify <i>with monolithic</i> .
	• Contrasting fascia	No cost	Specify <i>with contrasting fascia</i> .
	• Contrasting front	No cost	Specify <i>with contrasting front</i> .
	• Contrasting back	No cost	Specify <i>with contrasting back</i> .
	• Contrasting left	No cost	Specify <i>with contrasting left</i> .
	• Contrasting right	No cost	Specify <i>with contrasting right</i> .
	• Contrasting front and back	No cost	Specify <i>with contrasting front and back</i> .
	• Contrasting left and right	No cost	Specify <i>with contrasting left and right</i> .

Surface Materials	Options	U.S. Price	Required to Specify	
Surface Materials	Seat finish			
	• Fabric price group 1	No cost	Specify fabric color number.	
	• Fabric price group 2	+\$ 72	Specify fabric color number.	
	• Fabric price group 3	+\$ 132	Specify fabric color number.	
	• Fabric price group 4	+\$ 183	Specify fabric color number.	
	• Fabric price group 5	+\$ 232	Specify fabric color number.	
	• Fabric price group 6	+\$ 282	Specify fabric color number.	
	• Fabric price group 7	+\$ 328	Specify fabric color number.	
	• Fabric price group 8	+\$ 413	Specify fabric color number.	
	• Fabric price group 9	+\$ 508	Specify fabric color number.	
	• Fabric price group 10	+\$ 577	Specify fabric color number.	
	• Elmosoft leather upholstery	+\$1214	Specify Elmosoft leather color number.	
	• Vinyl	+\$ 72	Specify vinyl color number.	
	• Customer's Own Material (COM)	No cost	▶ See <i>Surface Materials Reference Manual</i> .	
	• Soil-retardant treatment applied to upholstery fabric	+\$ 36	Specify <i>with soil-retardant treatment</i> .	
	Frame finish			
	• Paint price group 1	No cost	Specify paint color number.	
• Paint price group 2	+\$ 76	Specify paint color number.		
• Paint price group 3	+\$ 159	Specify paint color number.		

Contrasting Material Scheme	Contrasting fascia finish, if contrasting fascia selected	U.S. Price	Required to Specify
Contrasting Material Scheme	• Fabric price group 1	No cost	Specify fabric color number.
	• Fabric price group 2	+\$ 27	Specify fabric color number.
	• Fabric price group 3	+\$ 41	Specify fabric color number.
	• Fabric price group 4	+\$ 57	Specify fabric color number.
	• Fabric price group 5	+\$ 73	Specify fabric color number.
	• Fabric price group 6	+\$ 87	Specify fabric color number.
	• Fabric price group 7	+\$ 101	Specify fabric color number.
	• Fabric price group 8	+\$ 130	Specify fabric color number.
	• Fabric price group 9	+\$ 158	Specify fabric color number.
	• Fabric price group 10	+\$ 180	Specify fabric color number.
	• Elmosoft leather upholstery	+\$ 377	Specify Elmosoft leather color number.
	• Vinyl	+\$ 26	Specify vinyl color number.
	• Customer's Own Material (COM)	No cost	▶ See <i>Surface Materials Reference Manual</i> .

▶ Options, continued on next page



For Canadian Pricing

Multiply U.S. Price by the Canadian price factor.

▶ See page 1 for details.

► Options, continued from previous page

Options	U.S. Price	Required to Specify
Contrasting Material Scheme, continued		
Contrasting sides finish, if contrasting side selected		
• Fabric price group 1	No cost	Specify fabric color number.
• Fabric price group 2	+\$ 27	Specify fabric color number.
• Fabric price group 3	+\$ 41	Specify fabric color number.
• Fabric price group 4	+\$ 57	Specify fabric color number.
• Fabric price group 5	+\$ 73	Specify fabric color number.
• Fabric price group 6	+\$ 87	Specify fabric color number.
• Fabric price group 7	+\$101	Specify fabric color number.
• Fabric price group 8	+\$130	Specify fabric color number.
• Fabric price group 9	+\$158	Specify fabric color number.
• Fabric price group 10	+\$180	Specify fabric color number.
• Elmosoft leather upholstery	+\$377	Specify Elmosoft leather color number.
• Vinyl	+\$ 26	Specify vinyl color number.
• Customer's Own Material (COM)	No cost	► See <i>Surface Materials Reference Manual</i> .
Tables		
Table type		
• No table	No cost	Specify <i>with no table</i> .
• Round table	+\$518	Specify <i>with round table</i> and select color number.
• Pill table	+\$518	Specify <i>with pill table</i> and select color number.
Table location		
• Table left	No cost	Specify <i>with table left</i> .
• Table right	No cost	Specify <i>with table right</i> .
Table support finish		
• Paint price group 1	No cost	Specify paint color number.
• Paint price group 2	+\$ 23	Specify paint color number.
• Paint price group 3	+\$ 39	Specify paint color number.
Power Configuration		
Power type		
• No power	No cost	Specify <i>with no power</i> .
• Power block	+\$488	Specify <i>with power block</i> .
Outlet configuration		
• Three power	No cost	Specify with 3 power.
• Two power, one USB	+\$172	Specify with 2 power, 1 USB.
Power plug type		
• Standard NEMA 5–15 3 prong	No cost	Specify <i>with NEMA</i> .
• Low profile plug	+\$ 40	Specify <i>with low profile plug</i> .
Tamper resistant		
• No tamper resistant	No cost	Specify <i>with no tamper resistant</i> .
• Tamper resistant	+\$ 29	Specify <i>with tamper resistant</i> .

Tip: Power is provided by a 72" power cord.

Specification Information				
Dimensions			Style Number	U.S. Base Price
D	W	H		
30"	30"	31"	STLLNGST1	\$2832

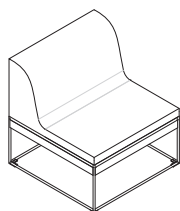

 **For Canadian Pricing**
 Multiply U.S. Price by the Canadian price factor.
 ► See page 1 for details.

Umami Straight Lounge

Double

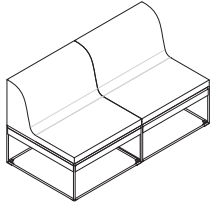

Tip: Only a single material scheme can be selected. For example, both contrasting fascia and contrasting front cannot be selected together. If more than one material scheme is desired, contact a specials representative.

Tip: Umami lounge and platforms may show minimal comfort wrinkling depending on the fabric or leather specified.

Tip: Light colored or thin fabrics are not compatible on Umami lounge.

Standard Includes		Required to Specify
<ul style="list-style-type: none"> ▶ Need help? Product details, page 468 	<ul style="list-style-type: none"> • Seat upholstery: fabric price group 1 • Fascia: monolithic, matches top • Frame: paint price group 1 • Ships ready to assemble • Attachment package 	<ol style="list-style-type: none"> 1 Style number 2 Fabric color number for seat 3 Paint color number for frame 4 Material scheme (see below under Required Selections) 5 Options, if selected (see below) <ul style="list-style-type: none"> ▶ See <i>Surface Materials</i>, page 634.

Required Selections	U.S. Price	Required to Specify
Material Scheme <ul style="list-style-type: none"> • Monolithic • Contrasting fascia • Contrasting front • Contrasting back • Contrasting left • Contrasting right • Contrasting front and back • Contrasting left and right • Contrasting inside left and right 	<ul style="list-style-type: none"> No cost No cost No cost No cost No cost No cost No cost No cost No cost No cost 	<ul style="list-style-type: none"> Specify <i>with monolithic</i>. Specify <i>with contrasting fascia</i>. Specify <i>with contrasting front</i>. Specify <i>with contrasting back</i>. Specify <i>with contrasting left</i>. Specify <i>with contrasting right</i>. Specify <i>with contrasting front and back</i>. Specify <i>with contrasting left and right</i>. Specify <i>with contrasting inside left and right</i>. Specify <i>with contrasting inside left and right, outside left and right</i>.

Options	U.S. Price	Required to Specify
Surface Materials		
Seat finish <ul style="list-style-type: none"> • Fabric price group 1 • Fabric price group 2 • Fabric price group 3 • Fabric price group 4 • Fabric price group 5 • Fabric price group 6 • Fabric price group 7 • Fabric price group 8 • Fabric price group 9 • Fabric price group 10 • Elmosoft leather upholstery • Vinyl • Customer's Own Material (COM) 	<ul style="list-style-type: none"> No cost +\$ 126 +\$ 234 +\$ 329 +\$ 416 +\$ 509 +\$ 589 +\$ 741 +\$ 916 +\$1040 +\$2185 +\$ 126 No cost 	<ul style="list-style-type: none"> Specify fabric color number. Specify fabric color number. Specify fabric color number. Specify fabric color number. Specify fabric color number. Specify fabric color number. Specify fabric color number. Specify fabric color number. Specify fabric color number. Specify fabric color number. Specify Elmosoft leather color number. Specify vinyl color number. <ul style="list-style-type: none"> ▶ See <i>Surface Materials Reference Manual</i>.
Frame finish <ul style="list-style-type: none"> • Paint price group 1 • Paint price group 2 • Paint price group 3 	<ul style="list-style-type: none"> No cost +\$ 126 +\$ 268 	<ul style="list-style-type: none"> Specify paint color number. Specify paint color number. Specify paint color number.

Contrasting Material Scheme	Contrasting fascia finish, if contrasting fascia selected	U.S. Price	Required to Specify
	<ul style="list-style-type: none"> • Fabric price group 1 • Fabric price group 2 • Fabric price group 3 • Fabric price group 4 • Fabric price group 5 • Fabric price group 6 • Fabric price group 7 • Fabric price group 8 • Fabric price group 9 • Fabric price group 10 • Elmosoft leather upholstery • Vinyl • Customer's Own Material (COM) 	<ul style="list-style-type: none"> No cost +\$ 45 +\$ 65 +\$ 92 +\$ 113 +\$ 140 +\$ 160 +\$ 206 +\$ 253 +\$ 284 +\$ 600 +\$ 44 No cost 	<ul style="list-style-type: none"> Specify fabric color number. Specify fabric color number. Specify fabric color number. Specify fabric color number. Specify fabric color number. Specify fabric color number. Specify fabric color number. Specify fabric color number. Specify fabric color number. Specify fabric color number. Specify Elmosoft leather color number. Specify vinyl color number. <ul style="list-style-type: none"> ▶ See <i>Surface Materials Reference Manual</i>.

▶ Options, continued on next page



For Canadian Pricing

Multiply U.S. Price by the Canadian price factor.

▶ See page 1 for details.

► Options, continued from previous page

Options	U.S. Price	Required to Specify
Contrasting Material Scheme, continued	Contrasting sides finish, if contrasting side selected	
• Fabric price group 1	No cost	Specify fabric color number.
• Fabric price group 2	+\$ 36	Specify fabric color number.
• Fabric price group 3	+\$ 69	Specify fabric color number.
• Fabric price group 4	+\$ 97	Specify fabric color number.
• Fabric price group 5	+\$120	Specify fabric color number.
• Fabric price group 6	+\$147	Specify fabric color number.
• Fabric price group 7	+\$172	Specify fabric color number.
• Fabric price group 8	+\$217	Specify fabric color number.
• Fabric price group 9	+\$266	Specify fabric color number.
• Fabric price group 10	+\$304	Specify fabric color number.
• Elmosoft leather upholstery	+\$640	Specify Elmosoft leather color number.
• Vinyl	+\$ 36	Specify vinyl color number.
• Customer's Own Material (COM)	No cost	► See <i>Surface Materials Reference Manual</i> .
Tables	Table type	
• No table	No cost	Specify <i>with no table</i> .
• Round table	+\$518	Specify <i>with round table</i> and select color number.
• Pill table	+\$518	Specify <i>with pill table</i> and select color number.
	Table location	
• Table left	No cost	Specify <i>with table left</i> .
• Table right	No cost	Specify <i>with table right</i> .
	Table support finish	
• Paint price group 1	No cost	Specify paint color number.
• Paint price group 2	+\$ 23	Specify paint color number.
• Paint price group 3	+\$ 39	Specify paint color number.
Power Configuration	Power type	
• No power	No cost	Specify <i>with no power</i> .
• Power block	+\$488	Specify <i>with power block</i> .
• Two power blocks	+\$976	Specify <i>with two power blocks</i> .
	Outlet configuration	
• Three power	No cost	Specify <i>with 3 power</i> .
• Two power, one USB	+\$172	Specify <i>with 2 power, 1 USB</i> .
	Power plug type	
• Standard NEMA 5–15 3 prong	No cost	Specify <i>with NEMA</i> .
• Low profile plug	+\$ 40	Specify <i>with low profile plug</i> .
	Tamper resistant	
• No tamper resistant	No cost	Specify <i>with no tamper resistant</i> .
• Tamper resistant	+\$ 29	Specify <i>with tamper resistant</i> .

Tip: Power is provided by a 72" power cord.

Specification Information

• Dimensions			• Style	• U.S.
D	W	H	Number	Base Price
30"	60"	31"	STLLNGST2	\$4096

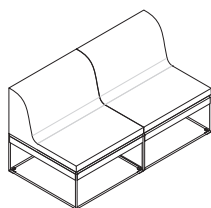

Umami Lounge

One Arm, Single

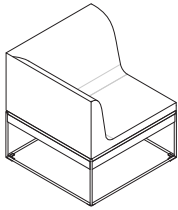

Right arm position shown above.

Tip: Only a single material scheme can be selected. For example, both contrasting fascia and contrasting front cannot be selected together. If more than one material scheme is desired, contact a specials representative.

Tip: Umami lounge and platforms may show minimal comfort wrinkling depending on the fabric or leather specified.

Tip: Light colored or thin fabrics are not compatible on Umami lounge.

Standard Includes		Required to Specify
<ul style="list-style-type: none"> ▶ Need help? Product details, page 468 	<ul style="list-style-type: none"> • Seat upholstery: fabric price group 1 • Fascia: monolithic, matches top • Frame: paint price group 1 • Ships fully assembled • Attachment package 	<ol style="list-style-type: none"> 1 Style number 2 Fabric color number for seat 3 Paint color number for frame 4 Material scheme (see below under Required Selections) 5 Arm Position (see below under Required Selections) 6 Options, if selected (see below) <p>▶ See <i>Surface Materials</i>, page 634.</p>

	Required Selections	U.S. Price	Required to Specify
Material Scheme	<ul style="list-style-type: none"> • Monolithic • Contrasting fascia • Contrasting front • Contrasting back • Contrasting left • Contrasting right • Contrasting front and back • Contrasting left and right 	<p>No cost</p> <p>No cost</p> <p>No cost</p> <p>No cost</p> <p>No cost</p> <p>No cost</p> <p>No cost</p> <p>No cost</p>	<p>Specify <i>with monolithic</i>.</p> <p>Specify <i>with contrasting fascia</i>.</p> <p>Specify <i>with contrasting front</i>.</p> <p>Specify <i>with contrasting back</i>.</p> <p>Specify <i>with contrasting left</i>.</p> <p>Specify <i>with contrasting right</i>.</p> <p>Specify <i>with contrasting front and back</i>.</p> <p>Specify <i>with contrasting left and right</i>.</p>
Arm Position	<ul style="list-style-type: none"> • Left arm • Right arm 	<p>No cost</p> <p>No cost</p>	<p>Specify <i>with left arm</i>.</p> <p>Specify <i>with right arm</i>.</p>

	Options	U.S. Price	Required to Specify
Surface Materials	<p>Seat finish</p> <ul style="list-style-type: none"> • Fabric price group 1 • Fabric price group 2 • Fabric price group 3 • Fabric price group 4 • Fabric price group 5 • Fabric price group 6 • Fabric price group 7 • Fabric price group 8 • Fabric price group 9 • Fabric price group 10 • Elmosoft leather upholstery • Vinyl • Customer's Own Material (COM) 	<p>No cost</p> <p>+\$ 78</p> <p>+\$ 143</p> <p>+\$ 203</p> <p>+\$ 254</p> <p>+\$ 312</p> <p>+\$ 359</p> <p>+\$ 455</p> <p>+\$ 560</p> <p>+\$ 635</p> <p>+\$1214</p> <p>+\$ 78</p> <p>No cost</p>	<p>Specify fabric color number.</p> <p>Specify fabric color number.</p> <p>Specify fabric color number.</p> <p>Specify fabric color number.</p> <p>Specify fabric color number.</p> <p>Specify fabric color number.</p> <p>Specify fabric color number.</p> <p>Specify fabric color number.</p> <p>Specify fabric color number.</p> <p>Specify fabric color number.</p> <p>Specify Elmosoft leather color number.</p> <p>Specify vinyl color number.</p> <p>▶ See <i>Surface Materials Reference Manual</i>.</p>
	<p>Frame finish</p> <ul style="list-style-type: none"> • Paint price group 1 • Paint price group 2 • Paint price group 3 	<p>No cost</p> <p>+\$ 76</p> <p>+\$ 159</p>	<p>Specify paint color number.</p> <p>Specify paint color number.</p> <p>Specify paint color number.</p>

▶ Options, continued on next page



For Canadian Pricing

Multiply U.S. Price by the Canadian price factor.

▶ See page 1 for details.

► Options, continued from previous page

	Options	U.S. Price	Required to Specify
Contrasting Material Scheme	Contrasting fascia finish, if contrasting fascia selected		
	• Fabric price group 1	No cost	Specify fabric color number.
	• Fabric price group 2	+\$ 27	Specify fabric color number.
	• Fabric price group 3	+\$ 41	Specify fabric color number.
	• Fabric price group 4	+\$ 57	Specify fabric color number.
	• Fabric price group 5	+\$ 73	Specify fabric color number.
	• Fabric price group 6	+\$ 87	Specify fabric color number.
	• Fabric price group 7	+\$101	Specify fabric color number.
	• Fabric price group 8	+\$130	Specify fabric color number.
	• Fabric price group 9	+\$158	Specify fabric color number.
	• Fabric price group 10	+\$180	Specify fabric color number.
	• Elmosoft leather upholstery	+\$377	Specify Elmosoft leather color number.
	• Vinyl	+\$ 26	Specify vinyl color number.
	• Customer's Own Material (COM)	No cost	► See <i>Surface Materials Reference Manual</i> .
	Contrasting sides finish, if contrasting side selected		
	• Fabric price group 1	No cost	Specify fabric color number.
	• Fabric price group 2	+\$ 27	Specify fabric color number.
	• Fabric price group 3	+\$ 41	Specify fabric color number.
	• Fabric price group 4	+\$ 57	Specify fabric color number.
	• Fabric price group 5	+\$ 73	Specify fabric color number.
	• Fabric price group 6	+\$ 87	Specify fabric color number.
• Fabric price group 7	+\$101	Specify fabric color number.	
• Fabric price group 8	+\$130	Specify fabric color number.	
• Fabric price group 9	+\$158	Specify fabric color number.	
• Fabric price group 10	+\$180	Specify fabric color number.	
• Elmosoft leather upholstery	+\$377	Specify Elmosoft leather color number.	
• Vinyl	+\$ 26	Specify vinyl color number.	
• Customer's Own Material (COM)	No cost	► See <i>Surface Materials Reference Manual</i> .	
Power Configuration	Power type		
	• No power	No cost	Specify <i>with no power</i> .
	• Power block	+\$488	Specify <i>with power block</i> .
	Outlet configuration		
	• Three power	No cost	Specify <i>with 3 power</i> .
	• Two power, one USB	+\$172	Specify <i>with 2 power, 1 USB</i> .
	Power plug type		
	• Standard NEMA 5–15 3 prong	No cost	Specify <i>with NEMA</i> .
	• Low profile plug	+\$ 40	Specify <i>with low profile plug</i> .
	Tamper resistant		
• No tamper resistant	No cost	Specify <i>with no tamper resistant</i> .	
• Tamper resistant	+\$ 29	Specify <i>with tamper resistant</i> .	

Tip: Power is provided by a 72" power cord.

Specification Information

Dimensions			Style	U.S.
D	W	H	Number	Base Price
30"	30"	31"	STLLNGAR1	\$3686

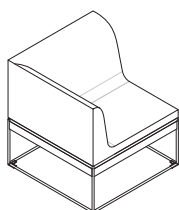

For Canadian Pricing
 Multiply U.S. Price by the Canadian price factor.
 ► See page 1 for details.

Umami Lounge

One Arm, Double

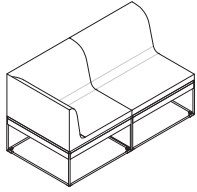

Right arm position shown above.

Tip: Only a single material scheme can be selected. For example, both contrasting fascia and contrasting front cannot be selected together. If more than one material scheme is desired, contact a specials representative.

Tip: Arm positions are determined based on user sitting in seat. For example, specify right arm if you want an arm on your right side while sitting.

Tip: Umami lounge and platforms may show minimal comfort wrinkling depending on the fabric or leather specified.

Tip: Light colored or thin fabrics are not compatible on Umami lounge.

Standard Includes		Required to Specify
<ul style="list-style-type: none"> ▶ Need help? Product details, page 468 	<ul style="list-style-type: none"> • Seat upholstery: fabric price group 1 • Fascia: monolithic, matches top • Frame: paint price group 1 • Ships ready to assemble • Attachment package 	<ol style="list-style-type: none"> 1 Style number 2 Fabric color number for seat 3 Paint color number for frame 4 Material scheme (see below under Required Selections) 5 Arm position (see below under Required Selections) 6 Options, if selected (see below) <p>▶ See <i>Surface Materials</i>, page 634.</p>

	Required Selections	U.S. Price	Required to Specify
Material Scheme	<ul style="list-style-type: none"> • Monolithic • Contrasting fascia • Contrasting front • Contrasting back • Contrasting left • Contrasting right • Contrasting front and back • Contrasting left and right • Contrasting inside left and right 	<ul style="list-style-type: none"> No cost No cost No cost No cost No cost No cost No cost No cost No cost 	<p>Specify <i>with monolithic</i>. Specify <i>with contrasting fascia</i>. Specify <i>with contrasting front</i>. Specify <i>with contrasting back</i>. Specify <i>with contrasting left</i>. Specify <i>with contrasting right</i>. Specify <i>with contrasting front and back</i>. Specify <i>with contrasting left and right</i>. Specify <i>with contrasting inside left and right</i>. Specify <i>with contrasting inside left and right, outside left and right</i>.</p>
Arm Position	<ul style="list-style-type: none"> • Left arm • Right arm 	<ul style="list-style-type: none"> No cost No cost 	<p>Specify <i>with left arm</i>. Specify <i>with right arm</i>.</p>

	Options	U.S. Price	Required to Specify
Surface Materials	<p>Seat finish</p> <ul style="list-style-type: none"> • Fabric price group 1 • Fabric price group 2 • Fabric price group 3 • Fabric price group 4 • Fabric price group 5 • Fabric price group 6 • Fabric price group 7 • Fabric price group 8 • Fabric price group 9 • Fabric price group 10 • Elmosoft leather upholstery • Vinyl • Customer's Own Material (COM) <p>Frame finish</p> <ul style="list-style-type: none"> • Paint price group 1 • Paint price group 2 • Paint price group 3 	<ul style="list-style-type: none"> No cost +\$ 138 +\$ 257 +\$ 361 +\$ 457 +\$ 562 +\$ 647 +\$ 820 +\$1007 +\$1141 +\$2185 +\$ 138 No cost No cost +\$ 126 +\$ 268 	<p>Specify fabric color number. Specify fabric color number. Specify fabric color number. Specify fabric color number. Specify fabric color number. Specify fabric color number. Specify fabric color number. Specify fabric color number. Specify fabric color number. Specify fabric color number. Specify fabric color number. Specify Elmosoft leather color number. Specify vinyl color number.</p> <p>▶ See <i>Surface Materials Reference Manual</i>.</p> <p>Specify paint color number. Specify paint color number. Specify paint color number.</p>

	Options	U.S. Price	Required to Specify
Contrasting Material Scheme	<p>Contrasting fascia finish, if contrasting fascia selected</p> <ul style="list-style-type: none"> • Fabric price group 1 • Fabric price group 2 • Fabric price group 3 • Fabric price group 4 • Fabric price group 5 • Fabric price group 6 • Fabric price group 7 • Fabric price group 8 • Fabric price group 9 • Fabric price group 10 • Elmosoft leather upholstery • Vinyl • Customer's Own Material (COM) 	<ul style="list-style-type: none"> No cost +\$ 45 +\$ 65 +\$ 92 +\$ 113 +\$ 140 +\$ 160 +\$ 206 +\$ 253 +\$ 284 +\$ 600 +\$ 44 No cost 	<p>Specify fabric color number. Specify fabric color number. Specify fabric color number. Specify fabric color number. Specify fabric color number. Specify fabric color number. Specify fabric color number. Specify fabric color number. Specify fabric color number. Specify fabric color number. Specify Elmosoft leather color number. Specify vinyl color number.</p> <p>▶ See <i>Surface Materials Reference Manual</i>.</p>

▶ Options, continued on next page



For Canadian Pricing
Multiply U.S. Price by the Canadian price factor.
▶ See page 1 for details.

► Options, continued from previous page

Options	U.S. Price	Required to Specify
Contrasting Material Scheme, continued	Contrasting sides finish, if contrasting side selected	
• Fabric price group 1	No cost	Specify fabric color number.
• Fabric price group 2	+\$ 36	Specify fabric color number.
• Fabric price group 3	+\$ 69	Specify fabric color number.
• Fabric price group 4	+\$ 97	Specify fabric color number.
• Fabric price group 5	+\$120	Specify fabric color number.
• Fabric price group 6	+\$147	Specify fabric color number.
• Fabric price group 7	+\$172	Specify fabric color number.
• Fabric price group 8	+\$217	Specify fabric color number.
• Fabric price group 9	+\$266	Specify fabric color number.
• Fabric price group 10	+\$304	Specify fabric color number.
• Elmosoft leather upholstery	+\$640	Specify Elmosoft leather color number.
• Vinyl	+\$ 36	Specify vinyl color number.
• Customer's Own Material (COM)	No cost	► See <i>Surface Materials Reference Manual</i> .
Tables	Table type	
	• No table	Specify <i>with no table</i> .
	• Round table	Specify <i>with round table</i> and select color number.
	• Pill table	Specify <i>with pill table</i> and select color number.
	Table location	
	• Table left	Specify <i>with table left</i> .
	• Table right	Specify <i>with table right</i> .
	Table support finish	
	• Paint group 1	Specify paint color number.
	• Paint group 2	Specify paint color number.
	• Paint group 3	Specify paint color number.
Power Configuration	Power type	
	• No power	Specify <i>with no power</i> .
	• Power block	Specify <i>with power block</i> .
	• Two power blocks	Specify <i>with power blocks</i> .
	Outlet configuration	
	• Three power	Specify <i>with 3 power</i> .
	• Two power, one USB	Specify <i>with 2 power, 1 USB</i> .
	Power plug type	
	• Standard NEMA 5–15 3 prong	Specify <i>with NEMA</i> .
	• Low profile plug	Specify <i>with low profile plug</i> .
	Tamper resistant	
	• No tamper resistant	Specify <i>with no tamper resistant</i> .
	• Tamper resistant	Specify <i>with tamper resistant</i> .

Tip: Power is provided by a 72" power cord.

Specification Information

Dimensions			Style	U.S.
D	W	H	Number	Base Price
30"	60"	31"	STLLNGAR2	\$4950

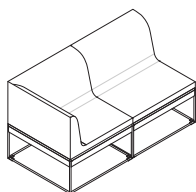

For Canadian Pricing
Multiply U.S. Price by the Canadian price factor.
► See page 1 for details.

Umami Lounge

Two Arms, Double

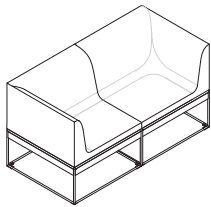

Tip: Only a single material scheme can be selected. For example, both contrasting fascia and contrasting front cannot be selected together. If more than one material scheme is desired, contact a specials representative.

Tip: Umami lounge and platforms may show minimal comfort wrinkling depending on the fabric or leather specified.

Tip: Light colored or thin fabrics are not compatible on Umami lounge.

Standard Includes	Required to Specify
<ul style="list-style-type: none"> ▶ Need help? Product details, page 468 • Seat upholstery: fabric price group 1 • Fascia: monolithic, matches top • Frame: paint price group • Ships ready to assemble • Attachment package 	<ol style="list-style-type: none"> 1 Style number 2 Fabric color number for seat 3 Paint color number for frame 4 Material scheme (see below under Required Selections) 5 Options, if selected (see below) <p>▶ See <i>Surface Materials</i>, page 634.</p>

Material Scheme	Required Selections	U.S. Price	Required to Specify
	• Monolithic	No cost	Specify <i>with monolithic</i> .
	• Contrasting fascia finish	No cost	Specify <i>with contrasting fascia</i> .
	• Contrasting front	No cost	Specify <i>with contrasting front</i> .
	• Contrasting back	No cost	Specify <i>with contrasting back</i> .
	• Contrasting left	No cost	Specify <i>with contrasting left</i> .
	• Contrasting right	No cost	Specify <i>with contrasting right</i> .
	• Contrasting front and back	No cost	Specify <i>with contrasting front and back</i> .
	• Contrasting left and right	No cost	Specify <i>with contrasting left and right</i> .
	• Contrasting inside left and right	No cost	Specify <i>with contrasting inside left and right</i> .
	• Contrasting inside left and right, outside left and right	No cost	Specify <i>with contrasting inside left and right, outside left and right</i> .

Surface Materials	Options	U.S. Price	Required to Specify	
	Seat finish			
	• Fabric price group 1	No cost	Specify fabric color number.	
	• Fabric price group 2	+\$ 152	Specify fabric color number.	
	• Fabric price group 3	+\$ 280	Specify fabric color number.	
	• Fabric price group 4	+\$ 395	Specify fabric color number.	
	• Fabric price group 5	+\$ 497	Specify fabric color number.	
	• Fabric price group 6	+\$ 615	Specify fabric color number.	
	• Fabric price group 7	+\$ 706	Specify fabric color number.	
	• Fabric price group 8	+\$ 895	Specify fabric color number.	
	• Fabric price group 9	+\$1101	Specify fabric color number.	
	• Fabric price group 10	+\$1248	Specify fabric color number.	
	• Elmosoft leather upholstery	+\$2185	Specify Elmosoft leather color number.	
	• Vinyl	+\$ 152	Specify vinyl color number.	
	• Customer's Own Material (COM)	No cost	▶ See <i>Surface Materials Reference Manual</i> .	
		Frame finish		
		• Paint price group 1	No cost	Specify paint color number.
		• Paint price group 2	+\$ 126	Specify paint color number.
		• Paint price group 3	+\$ 268	Specify paint color number.

▶ Options, continued on next page



For Canadian Pricing

Multiply U.S. Price by the Canadian price factor.

▶ See page 1 for details.

► Options, continued from previous page

Options	U.S. Price	Required to Specify
Contrasting Material Scheme		
Contrasting fascia finish, if contrasting fascia selected		
• Fabric price group 1	No cost	Specify fabric color number.
• Fabric price group 2	+\$ 45	Specify fabric color number.
• Fabric price group 3	+\$ 65	Specify fabric color number.
• Fabric price group 4	+\$ 92	Specify fabric color number.
• Fabric price group 5	+\$113	Specify fabric color number.
• Fabric price group 6	+\$140	Specify fabric color number.
• Fabric price group 7	+\$160	Specify fabric color number.
• Fabric price group 8	+\$206	Specify fabric color number.
• Fabric price group 9	+\$253	Specify fabric color number.
• Fabric price group 10	+\$284	Specify fabric color number.
• Elmosoft leather upholstery	+\$600	Specify Elmosoft leather color number.
• Vinyl	+\$ 44	Specify vinyl color number.
• Customer's Own Material (COM)	No cost	► See <i>Surface Materials Reference Manual</i> .
Contrasting sides finish, if contrasting side selected		
• Fabric price group 1	No cost	Specify fabric color number.
• Fabric price group 2	+\$ 36	Specify fabric color number.
• Fabric price group 3	+\$ 69	Specify fabric color number.
• Fabric price group 4	+\$ 97	Specify fabric color number.
• Fabric price group 5	+\$120	Specify fabric color number.
• Fabric price group 6	+\$147	Specify fabric color number.
• Fabric price group 7	+\$172	Specify fabric color number.
• Fabric price group 8	+\$217	Specify fabric color number.
• Fabric price group 9	+\$266	Specify fabric color number.
• Fabric price group 10	+\$304	Specify fabric color number.
• Elmosoft leather upholstery	+\$640	Specify Elmosoft leather color number.
• Vinyl	+\$ 36	Specify vinyl color number.
• Customer's Own Material (COM)	No cost	► See <i>Surface Materials Reference Manual</i> .
Power Configuration		
Power type		
• No power	No cost	Specify <i>with no power</i> .
• Power block	+\$488	Specify <i>with power block</i> .
• Two power blocks	+\$976	Specify <i>with two power blocks</i> .
Outlet configuration		
• Three power	No cost	Specify <i>with 3 power</i> .
• Two power, one USB	+\$172	Specify <i>with 2 power, 1 USB</i> .
Power plug type		
• Standard NEMA 5–15 3 prong	No cost	Specify <i>with NEMA</i> .
• Low profile plug	+\$ 40	Specify <i>with low profile plug</i> .
Tamper resistant		
• No tamper resistant	No cost	Specify <i>with no tamper resistant</i> .
• Tamper resistant	+\$ 29	Specify <i>with tamper resistant</i> .

Tip: Power is provided by a 72" power cord.

Specification Information				
Dimensions			Style	U.S.
D	W	H	Number	Base Price
30"	60"	31"	STLLNG2AR2	\$5806

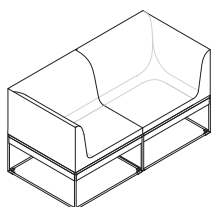

For Canadian Pricing
 Multiply U.S. Price by the Canadian price factor.
 ► See page 1 for details.



Umami Lounge

Corner, Single

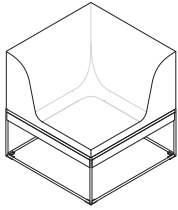

Tip: Only a single material scheme can be selected. For example, both contrasting fascia and contrasting front cannot be selected together. If more than one material scheme is desired, contact a specials representative.

Tip: Umami lounge and platforms may show minimal comfort wrinkling depending on the fabric or leather specified.

Tip: Light colored or thin fabrics are not compatible on Umami lounge.

Tip: When specifying a corner unit as an end of run with a left hand orientation, consider using a left arm or non directional fabric.

► Page 470 for details.

Standard Includes		Required to Specify
► Need help? Product details, page 468	<ul style="list-style-type: none"> • Seat upholstery: fabric price group 1 • Fascia: monolithic, matches top • Frame: paint price group 1 • Ships fully assembled • Attachment package 	<ol style="list-style-type: none"> 1 Style number 2 Fabric color number for seat 3 Paint color number for frame 4 Material scheme (see below under Required Selections) 5 Options, if selected (see below) <p>► See <i>Surface Materials</i>, page 634.</p>

Required Selections	U.S. Price	Required to Specify
Material Scheme		
• Monolithic	No cost	Specify with <i>monolithic</i> .
• Contrasting fascia	No cost	Specify with <i>contrasting fascia</i> .
• Contrasting front left	No cost	Specify with <i>contrasting front left</i> .
• Contrasting front right	No cost	Specify with <i>contrasting front right</i> .
• Contrasting back left	No cost	Specify with <i>contrasting back left</i> .
• Contrasting back right	No cost	Specify with <i>contrasting back right</i> .
• Contrasting front left and right	No cost	Specify with <i>contrasting front left and right</i> .
• Contrasting back left and right	No cost	Specify with <i>contrasting back left and right</i> .

Options	U.S. Price	Required to Specify
Surface Materials		
Seat finish		
• Fabric price group 1	No cost	Specify fabric color number.
• Fabric price group 2	+\$ 78	Specify fabric color number.
• Fabric price group 3	+\$ 143	Specify fabric color number.
• Fabric price group 4	+\$ 203	Specify fabric color number.
• Fabric price group 5	+\$ 254	Specify fabric color number.
• Fabric price group 6	+\$ 312	Specify fabric color number.
• Fabric price group 7	+\$ 359	Specify fabric color number.
• Fabric price group 8	+\$ 455	Specify fabric color number.
• Fabric price group 9	+\$ 560	Specify fabric color number.
• Fabric price group 10	+\$ 635	Specify fabric color number.
• Elmosoft leather upholstery	+\$1214	Specify Elmosoft leather color number.
• Vinyl	+\$ 78	Specify vinyl color number.
• Customer's Own Material (COM)	No cost	► See <i>Surface Materials Reference Manual</i> .
Frame finish		
• Paint price group 1	No cost	Specify paint color number.
• Paint price group 2	+\$ 76	Specify paint color number.
• Paint price group 3	+\$ 159	Specify paint color number.

► Options, continued on next page



For Canadian Pricing

Multiply U.S. Price by the Canadian price factor.

► See page 1 for details.

► Options, continued from previous page

	Options	U.S. Price	Required to Specify
Contrasting Material Scheme	Contrasting fascia finish, if contrasting fascia selected		
	• Fabric price group 1	No cost	Specify fabric color number.
	• Fabric price group 2	+\$ 27	Specify fabric color number.
	• Fabric price group 3	+\$ 41	Specify fabric color number.
	• Fabric price group 4	+\$ 57	Specify fabric color number.
	• Fabric price group 5	+\$ 73	Specify fabric color number.
	• Fabric price group 6	+\$ 87	Specify fabric color number.
	• Fabric price group 7	+\$101	Specify fabric color number.
	• Fabric price group 8	+\$130	Specify fabric color number.
	• Fabric price group 9	+\$158	Specify fabric color number.
	• Fabric price group 10	+\$180	Specify fabric color number.
	• Elmosoft leather upholstery	+\$377	Specify Elmosoft leather color number.
	• Vinyl	+\$ 26	Specify vinyl color number.
	• Customer's Own Material (COM)	No cost	► See <i>Surface Materials Reference Manual</i> .
	Contrasting sides finish, if contrasting side selected		
	• Fabric price group 1	No cost	Specify fabric color number.
	• Fabric price group 2	+\$ 27	Specify fabric color number.
	• Fabric price group 3	+\$ 41	Specify fabric color number.
	• Fabric price group 4	+\$ 57	Specify fabric color number.
	• Fabric price group 5	+\$ 73	Specify fabric color number.
	• Fabric price group 6	+\$ 87	Specify fabric color number.
• Fabric price group 7	+\$101	Specify fabric color number.	
• Fabric price group 8	+\$130	Specify fabric color number.	
• Fabric price group 9	+\$158	Specify fabric color number.	
• Fabric price group 10	+\$180	Specify fabric color number.	
• Elmosoft leather upholstery	+\$377	Specify Elmosoft leather color number.	
• Vinyl	+\$ 26	Specify vinyl color number.	
• Customer's Own Material (COM)	No cost	► See <i>Surface Materials Reference Manual</i> .	
Power Configuration	Power type		
	• No power	No cost	Specify <i>with no power</i> .
	• Power block	+\$488	Specify <i>with power block</i> .
	Outlet configuration		
	• Three power	No cost	Specify <i>with 3 power</i> .
	• Two power, one USB	+\$172	Specify <i>with 2 power, 1 USB</i> .
	Power plug type		
	• Standard NEMA 5–15 3 prong	No cost	Specify <i>with NEMA</i> .
	• Low profile plug	+\$ 40	Specify <i>with low profile plug</i> .
	Tamper resistant		
• No tamper resistant	No cost	Specify <i>with no tamper resistant</i> .	
• Tamper resistant	+\$ 29	Specify <i>with tamper resistant</i> .	

Tip: Power is provided by a 72" power cord.

Specification Information

Dimensions			Style	U.S.
D	W	H	Number	Base Price
30"	30"	31"	STLLNGCR1	\$3686

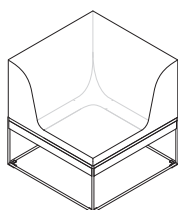

For Canadian Pricing
 Multiply U.S. Price by the Canadian price factor.
 ► See page 1 for details.

Umami Lounge

End Cap

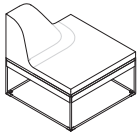

Left arm position

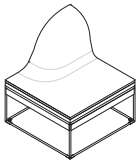

Right arm position

Tip: The end cap position is determined in the user seated position, based on the end of a lounge run in which the end cap will be ganged. For example, while in the user seated position, if attaching an end cap to the seated user's right end of a lounge run, it would be a right arm position end cap.

Tip: Only a single material scheme can be selected. For example, both contrasting fascia and contrasting front cannot be selected together. If more than one material scheme is desired, contact a specials representative.

Tip: Umami lounge and platforms may show minimal comfort wrinkling depending on the fabric or leather specified.

Tip: Light colored or thin fabrics are not compatible on Umami lounge.

Standard Includes		Required to Specify
<ul style="list-style-type: none"> ▶ Need help? Product details, page 468 	<ul style="list-style-type: none"> • Seat upholstery: fabric price group 1 • Fascia: monolithic, matches top • Frame: paint price group 1 • Ships fully assembled • Attachment package 	<ol style="list-style-type: none"> 1 Style number 2 Fabric color number for seat 3 Paint color number for frame 4 Material scheme (see below under Required Selections) 5 Arm position (see below under Required Selections) 6 Options, if selected (see below) <p>▶ See <i>Surface Materials</i>, page 634.</p>

	Required Selections	U.S. Price	Required to Specify
Material Scheme	<ul style="list-style-type: none"> • Monolithic • Contrasting fascia • Contrasting front • Contrasting back • Contrasting left • Contrasting right • Contrasting front and back • Contrasting left and right 	<ul style="list-style-type: none"> No cost No cost No cost No cost No cost No cost No cost No cost 	<ul style="list-style-type: none"> Specify <i>with monolithic</i>. Specify <i>with contrasting fascia</i>. Specify <i>with contrasting front</i>. Specify <i>with contrasting back</i>. Specify <i>with contrasting left</i>. Specify <i>with contrasting right</i>. Specify <i>with contrasting front and back</i>. Specify <i>with contrasting left and right</i>.
Arm Position	<ul style="list-style-type: none"> • Left arm • Right arm 	<ul style="list-style-type: none"> No cost No cost 	<ul style="list-style-type: none"> Specify <i>with left arm</i>. Specify <i>with right arm</i>.

	Options	U.S. Price	Required to Specify
Surface Materials	Seat finish <ul style="list-style-type: none"> • Fabric price group 1 • Fabric price group 2 • Fabric price group 3 • Fabric price group 4 • Fabric price group 5 • Fabric price group 6 • Fabric price group 7 • Fabric price group 8 • Fabric price group 9 • Fabric price group 10 • Elmosoft leather upholstery • Vinyl • Customer's Own Material (COM) 	<ul style="list-style-type: none"> No cost +\$ 78 +\$ 143 +\$ 203 +\$ 254 +\$ 312 +\$ 359 +\$ 455 +\$ 560 +\$ 635 +\$1214 +\$ 78 No cost 	<ul style="list-style-type: none"> Specify fabric color number. Specify fabric color number. Specify fabric color number. Specify fabric color number. Specify fabric color number. Specify fabric color number. Specify fabric color number. Specify fabric color number. Specify fabric color number. Specify fabric color number. Specify Elmosoft leather color number. Specify vinyl color number. <p>▶ See <i>Surface Materials Reference Manual</i>.</p>
	Frame finish <ul style="list-style-type: none"> • Paint price group 1 • Paint price group 2 • Paint price group 3 	<ul style="list-style-type: none"> No cost +\$ 76 +\$ 159 	<ul style="list-style-type: none"> Specify paint color number. Specify paint color number. Specify paint color number.

Contrasting Material Scheme	Contrasting fascia finish, if contrasting fascia selected		
	<ul style="list-style-type: none"> • Fabric price group 1 • Fabric price group 2 • Fabric price group 3 • Fabric price group 4 • Fabric price group 5 • Fabric price group 6 • Fabric price group 7 • Fabric price group 8 • Fabric price group 9 • Fabric price group 10 • Elmosoft leather upholstery • Vinyl • Customer's Own Material (COM) 	<ul style="list-style-type: none"> No cost +\$ 27 +\$ 41 +\$ 57 +\$ 73 +\$ 87 +\$ 101 +\$ 130 +\$ 158 +\$ 180 +\$ 377 +\$ 26 No cost 	<ul style="list-style-type: none"> Specify fabric color number. Specify fabric color number. Specify fabric color number. Specify fabric color number. Specify fabric color number. Specify fabric color number. Specify fabric color number. Specify fabric color number. Specify fabric color number. Specify fabric color number. Specify Elmosoft leather color number. Specify vinyl color number. <p>▶ See <i>Surface Materials Reference Manual</i>.</p>

▶ Options, continued on next page



For Canadian Pricing

Multiply U.S. Price by the Canadian price factor.

▶ See page 1 for details.

► Options, continued from previous page

Options	U.S. Price	Required to Specify
Contrasting Material Scheme, continued	Contrasting sides finish, if contrasting side selected	
• Fabric price group 1	No cost	Specify fabric color number.
• Fabric price group 2	+\$ 27	Specify fabric color number.
• Fabric price group 3	+\$ 41	Specify fabric color number.
• Fabric price group 4	+\$ 57	Specify fabric color number.
• Fabric price group 5	+\$ 73	Specify fabric color number.
• Fabric price group 6	+\$ 87	Specify fabric color number.
• Fabric price group 7	+\$101	Specify fabric color number.
• Fabric price group 8	+\$130	Specify fabric color number.
• Fabric price group 9	+\$158	Specify fabric color number.
• Fabric price group 10	+\$180	Specify fabric color number.
• Elmosoft leather upholstery	+\$377	Specify Elmosoft leather color number.
• Vinyl	+\$ 26	Specify vinyl color number.
• Customer's Own Material (COM)	No cost	► See <i>Surface Materials Reference Manual</i> .
Tables	Table type	
	• No table	No cost Specify <i>with no table</i> .
	• Round table	+\$518 Specify <i>with round table</i> and select color number.
	• Pill table	+\$518 Specify <i>with pill table</i> and select color number.
	Table location	
	• Table left	No cost Specify <i>with table left</i> .
	• Table right	No cost Specify <i>with table right</i> .
	Table support finish	
	• Paint price group 1	No cost Specify paint color number.
	• Paint price group 2	+\$ 23 Specify paint color number.
	• Paint price group 3	+\$ 39 Specify paint color number.
Power Configuration	Power type	
	• No power	No cost Specify <i>with no power</i> .
	• Power block	+\$488 Specify <i>with power block</i> .
	Outlet configuration	
	• Three power	No cost Specify <i>with 3 power</i> .
	• Two power, one USB	+\$172 Specify <i>with 2 power, 1 USB</i> .
	Power plug type	
	• Standard NEMA 5–15 3 prong	No cost Specify <i>with NEMA</i> .
	• Low profile plug	+\$ 40 Specify <i>with low profile plug</i> .
	Tamper resistant	
	• No tamper resistant	No cost Specify <i>with no tamper resistant</i> .
	• Tamper resistant	+\$ 29 Specify <i>with tamper resistant</i> .

Tip: Power is provided by a 72" power cord.

Specification Information				
Dimensions			Style	U.S.
D	W	H	Number	Base Price
30"	30"	31"	STLLNGEC	\$3686

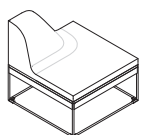

Left arm position

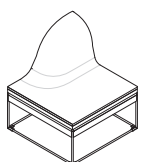

Right arm position



Umami Screens

Standard Screens



Tip: Specify straight clip if end of run and no additional clips required.

Tip: Fascia must be specified when 15"W screen is being placed on a 30" platform/lounge frame.

Tip: If user is seated on the lounge, the side that the 15"W screen will be applied on is the handedness of the fascia. If fascia needs to be applied to the left side of the lounge, then specify fascia left.

▶ See screen application rules for additional details, page 482.

Standard Includes	Required to Specify
<ul style="list-style-type: none"> ▶ Need help? Product details, page 482 • Screen: fabric price group 1 • Plastic clips for attachment to other screen (one clip for 48"H screens and two clips for 60"H screens) • Ships full assembled 	<ol style="list-style-type: none"> 1 Style number 2 Size of screen (see below under Required Selections) 3 Screen clips (see below under Required Selections) 4 Fascia (see below under Required Selections) 5 Fabric direction (see below under Required Selections) 6 Fabric color number for screen 7 Options, if selected (see below) <p>▶ See <i>Surface Materials</i>, page 634.</p>

Required Selections	U.S. Price	Required to Specify
Size of Screen <ul style="list-style-type: none"> • 15"W x 48"H • 30"W x 48"H • 15"W x 60"H • 30"W x 60"H 	Prices at right Prices at right Prices at right Prices at right	Specify with 15"W x 48"H. Specify with 30"W x 48"H. Specify with 15"W x 60"H. Specify with 30"W x 60"H.
Screen Clips <ul style="list-style-type: none"> • Straight • Corner 	No cost No cost	Specify with straight clip. Specify with corner clip.
Fascia (if 15"W screen selected) <ul style="list-style-type: none"> • No fascia • Fascia left • Fascia right 	No cost +\$ 88 +\$ 88	Specify with no fascia. Specify with fascia left and select fabric color number for fascia. Specify with fascia right and select fabric color number for fascia.
Fabric Direction <ul style="list-style-type: none"> • Horizontal • Vertical 	No cost No cost	Specify with horizontal direction. Specify with vertical direction.

Options	U.S. Price	Required to Specify
Surface Materials 15"W x 48"H <ul style="list-style-type: none"> • Non-contrasting • Fabric price group 1 • Fabric price group 2 • Fabric price group 3 • Fabric price group 4 • Fabric price group 5 • Fabric price group 6 • Fabric price group 7 • Fabric price group 8 • Fabric price group 9 • Fabric price group 10 • Customer's Own Material (COM) 	No cost +\$ 35 +\$ 62 +\$ 94 +\$111 +\$131 +\$157 +\$201 +\$240 +\$273 No cost	Specify fabric color number. Specify fabric color number. Specify fabric color number. Specify fabric color number. Specify fabric color number. Specify fabric color number. Specify fabric color number. Specify fabric color number. Specify fabric color number. Specify fabric color number. Specify fabric color number. Specify fabric color number. Specify fabric color number.

▶ See *Surface Materials Reference Manual*.

▶ Options, continued on next page



For Canadian Pricing

Multiply U.S. Price by the Canadian price factor.

▶ See page 1 for details.

► Options, continued from previous page

Tip: Fabrics must be in the same fabric family when specifying contrasting fabrics.

Options	U.S. Price	Required to Specify
Surface Materials 15"W x 48"H, continued		
Contrasting fabrics Inside of screen		
• Fabric price group 1	No cost	Specify <i>with contrasting</i> and select fabric color number for inside of screen.
• Fabric price group 2	+\$ 17	Specify <i>with contrasting</i> and select fabric color number for inside of screen.
• Fabric price group 3	+\$ 32	Specify <i>with contrasting</i> and select fabric color number for inside of screen.
• Fabric price group 4	+\$ 47	Specify <i>with contrasting</i> and select fabric color number for inside of screen.
• Fabric price group 5	+\$ 56	Specify <i>with contrasting</i> and select fabric color number for inside of screen.
• Fabric price group 6	+\$ 65	Specify <i>with contrasting</i> and select fabric color number for inside of screen.
• Fabric price group 7	+\$ 78	Specify <i>with contrasting</i> and select fabric color number for inside of screen.
• Fabric price group 8	+\$100	Specify <i>with contrasting</i> and select fabric color number for inside of screen.
• Fabric price group 9	+\$120	Specify <i>with contrasting</i> and select fabric color number for inside of screen.
• Fabric price group 10	+\$136	Specify <i>with contrasting</i> and select fabric color number for inside of screen.
• Customer's Own Material (COM)	No cost	► See <i>Surface Materials Reference Manual</i> .
Outside of screen		
• Fabric price group 1	No cost	Specify <i>with contrasting</i> and select fabric color number for outside of screen.
• Fabric price group 2	+\$ 17	Specify <i>with contrasting</i> and select fabric color number for inside of screen.
• Fabric price group 3	+\$ 32	Specify <i>with contrasting</i> and select fabric color number for inside of screen.
• Fabric price group 4	+\$ 47	Specify <i>with contrasting</i> and select fabric color number for inside of screen.
• Fabric price group 5	+\$ 56	Specify <i>with contrasting</i> and select fabric color number for inside of screen.
• Fabric price group 6	+\$ 65	Specify <i>with contrasting</i> and select fabric color number for inside of screen.
• Fabric price group 7	+\$ 78	Specify <i>with contrasting</i> and select fabric color number for inside of screen.
• Fabric price group 8	+\$100	Specify <i>with contrasting</i> and select fabric color number for inside of screen.
• Fabric price group 9	+\$120	Specify <i>with contrasting</i> and select fabric color number for inside of screen.
• Fabric price group 10	+\$136	Specify <i>with contrasting</i> and select fabric color number for inside of screen.
• Customer's Own Material (COM)	No cost	► See <i>Surface Materials Reference Manual</i> .

► Options, continued on next page



For Canadian Pricing
Multiply U.S. Price by the Canadian price factor.
► See page 1 for details.

Umami Screens, Standard Screens, continued

► Options, continued from previous page

Options	U.S. Price	Required to Specify
Surface Materials, 30"W x 48"H		
Non-contrasting		
• Fabric price group 1	No cost	Specify fabric color number.
• Fabric price group 2	+\$ 65	Specify fabric color number.
• Fabric price group 3	+\$122	Specify fabric color number.
• Fabric price group 4	+\$177	Specify fabric color number.
• Fabric price group 5	+\$207	Specify fabric color number.
• Fabric price group 6	+\$253	Specify fabric color number.
• Fabric price group 7	+\$290	Specify fabric color number.
• Fabric price group 8	+\$375	Specify fabric color number.
• Fabric price group 9	+\$462	Specify fabric color number.
• Fabric price group 10	+\$514	Specify fabric color number.
• Customer's Own Material (COM)	No cost	► See <i>Surface Materials Reference Manual</i> .

Tip: Fabrics must be in the same fabric family when specifying contrasting fabrics.

Contrasting fabrics Inside of screen		
• Fabric price group 1	No cost	Specify <i>with contrasting</i> and select fabric color number for inside of screen.
• Fabric price group 2	+\$ 33	Specify <i>with contrasting</i> and select fabric color number for inside of screen.
• Fabric price group 3	+\$ 61	Specify <i>with contrasting</i> and select fabric color number for inside of screen.
• Fabric price group 4	+\$ 88	Specify <i>with contrasting</i> and select fabric color number for inside of screen.
• Fabric price group 5	+\$104	Specify <i>with contrasting</i> and select fabric color number for inside of screen.
• Fabric price group 6	+\$126	Specify <i>with contrasting</i> and select fabric color number for inside of screen.
• Fabric price group 7	+\$145	Specify <i>with contrasting</i> and select fabric color number for inside of screen.
• Fabric price group 8	+\$187	Specify <i>with contrasting</i> and select fabric color number for inside of screen.
• Fabric price group 9	+\$231	Specify <i>with contrasting</i> and select fabric color number for inside of screen.
• Fabric price group 10	+\$257	Specify <i>with contrasting</i> and select fabric color number for inside of screen.
• Customer's Own Material (COM)	No cost	► See <i>Surface Materials Reference Manual</i> .

Outside of screen		
• Fabric price group 1	No cost	Specify <i>with contrasting</i> and select fabric color number for inside of screen.
• Fabric price group 2	+\$ 33	Specify <i>with contrasting</i> and select fabric color number for inside of screen.
• Fabric price group 3	+\$ 61	Specify <i>with contrasting</i> and select fabric color number for inside of screen.
• Fabric price group 4	+\$ 88	Specify <i>with contrasting</i> and select fabric color number for inside of screen.
• Fabric price group 5	+\$104	Specify <i>with contrasting</i> and select fabric color number for inside of screen.
• Fabric price group 6	+\$126	Specify <i>with contrasting</i> and select fabric color number for inside of screen.
• Fabric price group 7	+\$145	Specify <i>with contrasting</i> and select fabric color number for inside of screen.
• Fabric price group 8	+\$187	Specify <i>with contrasting</i> and select fabric color number for inside of screen.
• Fabric price group 9	+\$231	Specify <i>with contrasting</i> and select fabric color number for inside of screen.
• Fabric price group 10	+\$257	Specify <i>with contrasting</i> and select fabric color number for inside of screen.
• Customer's Own Material (COM)	No cost	► See <i>Surface Materials Reference Manual</i> .

► Options, continued on next page



For Canadian Pricing
 Multiply U.S. Price by the Canadian price factor.
 ► See page 1 for details.

► Options, continued from previous page

Options	U.S. Price	Required to Specify
Surface Materials, 15"W x 60"H		
Non-contrasting		
• Fabric price group 1	No cost	Specify fabric color number.
• Fabric price group 2	+\$ 41	Specify fabric color number.
• Fabric price group 3	+\$ 72	Specify fabric color number.
• Fabric price group 4	+\$109	Specify fabric color number.
• Fabric price group 5	+\$124	Specify fabric color number.
• Fabric price group 6	+\$155	Specify fabric color number.
• Fabric price group 7	+\$174	Specify fabric color number.
• Fabric price group 8	+\$227	Specify fabric color number.
• Fabric price group 9	+\$277	Specify fabric color number.
• Fabric price group 10	+\$307	Specify fabric color number.
• Customer's Own Material (COM)	No cost	► See <i>Surface Materials Reference Manual</i> .
Contrasting fabrics		
Inside of screen		
• Fabric price group 1	No cost	Specify <i>with contrasting</i> and select fabric color number for inside of screen.
• Fabric price group 2	+\$ 21	Specify <i>with contrasting</i> and select fabric color number for inside of screen.
• Fabric price group 3	+\$ 36	Specify <i>with contrasting</i> and select fabric color number for inside of screen.
• Fabric price group 4	+\$ 55	Specify <i>with contrasting</i> and select fabric color number for inside of screen.
• Fabric price group 5	+\$ 62	Specify <i>with contrasting</i> and select fabric color number for inside of screen.
• Fabric price group 6	+\$ 77	Specify <i>with contrasting</i> and select fabric color number for inside of screen.
• Fabric price group 7	+\$ 87	Specify <i>with contrasting</i> and select fabric color number for inside of screen.
• Fabric price group 8	+\$113	Specify <i>with contrasting</i> and select fabric color number for inside of screen.
• Fabric price group 9	+\$138	Specify <i>with contrasting</i> and select fabric color number for inside of screen.
• Fabric price group 10	+\$154	Specify <i>with contrasting</i> and select fabric color number for inside of screen.
• Customer's Own Material (COM)	No cost	► See <i>Surface Materials Reference Manual</i> .
Outside of screen		
• Fabric price group 1	No cost	Specify <i>with contrasting</i> and select fabric color number for outside of screen.
• Fabric price group 2	+\$ 21	Specify <i>with contrasting</i> and select fabric color number for inside of screen.
• Fabric price group 3	+\$ 36	Specify <i>with contrasting</i> and select fabric color number for inside of screen.
• Fabric price group 4	+\$ 55	Specify <i>with contrasting</i> and select fabric color number for inside of screen.
• Fabric price group 5	+\$ 62	Specify <i>with contrasting</i> and select fabric color number for inside of screen.
• Fabric price group 6	+\$ 77	Specify <i>with contrasting</i> and select fabric color number for inside of screen.
• Fabric price group 7	+\$ 87	Specify <i>with contrasting</i> and select fabric color number for inside of screen.
• Fabric price group 8	+\$113	Specify <i>with contrasting</i> and select fabric color number for inside of screen.
• Fabric price group 9	+\$138	Specify <i>with contrasting</i> and select fabric color number for inside of screen.
• Fabric price group 10	+\$154	Specify <i>with contrasting</i> and select fabric color number for inside of screen.
• Customer's Own Material (COM)	No cost	► See <i>Surface Materials Reference Manual</i> .

Tip: Fabrics must be in the same fabric family when specifying contrasting fabrics.

► Options, continued on next page

**For Canadian Pricing**

Multiply U.S. Price by the Canadian price factor.

► See page 1 for details.

Umami Screens, Standard Screens, continued

► Options, continued from previous page

	Options	U.S. Price	Required to Specify
Surface Materials, 30"W x 60"H	Non-contrasting		
	• Fabric price group 1	No cost	Specify fabric color number.
	• Fabric price group 2	+\$ 74	Specify fabric color number.
	• Fabric price group 3	+\$144	Specify fabric color number.
	• Fabric price group 4	+\$205	Specify fabric color number.
	• Fabric price group 5	+\$238	Specify fabric color number.
	• Fabric price group 6	+\$286	Specify fabric color number.
	• Fabric price group 7	+\$331	Specify fabric color number.
	• Fabric price group 8	+\$429	Specify fabric color number.
	• Fabric price group 9	+\$525	Specify fabric color number.
	• Fabric price group 10	+\$586	Specify fabric color number.
	• Customer's Own Material (COM)	No cost	► See <i>Surface Materials Reference Manual</i> .
	Contrasting fabrics Inside of screen		
	• Fabric price group 1	No cost	Specify <i>with contrasting</i> and select fabric color number for inside of screen.
	• Fabric price group 2	+\$ 37	Specify <i>with contrasting</i> and select fabric color number for inside of screen.
	• Fabric price group 3	+\$ 72	Specify <i>with contrasting</i> and select fabric color number for inside of screen.
	• Fabric price group 4	+\$102	Specify <i>with contrasting</i> and select fabric color number for inside of screen.
	• Fabric price group 5	+\$119	Specify <i>with contrasting</i> and select fabric color number for inside of screen.
	• Fabric price group 6	+\$143	Specify <i>with contrasting</i> and select fabric color number for inside of screen.
	• Fabric price group 7	+\$166	Specify <i>with contrasting</i> and select fabric color number for inside of screen.
	• Fabric price group 8	+\$215	Specify <i>with contrasting</i> and select fabric color number for inside of screen.
	• Fabric price group 9	+\$263	Specify <i>with contrasting</i> and select fabric color number for inside of screen.
	• Fabric price group 10	+\$293	Specify <i>with contrasting</i> and select fabric color number for inside of screen.
	• Customer's Own Material (COM)	No cost	► See <i>Surface Materials Reference Manual</i> .
	Outside of screen		
	• Fabric price group 1	No cost	Specify <i>with contrasting</i> and select fabric color number for outside of screen.
	• Fabric price group 2	+\$ 37	Specify <i>with contrasting</i> and select fabric color number for inside of screen.
	• Fabric price group 3	+\$ 72	Specify <i>with contrasting</i> and select fabric color number for inside of screen.
	• Fabric price group 4	+\$102	Specify <i>with contrasting</i> and select fabric color number for inside of screen.
	• Fabric price group 5	+\$119	Specify <i>with contrasting</i> and select fabric color number for inside of screen.
	• Fabric price group 6	+\$143	Specify <i>with contrasting</i> and select fabric color number for inside of screen.
	• Fabric price group 7	+\$166	Specify <i>with contrasting</i> and select fabric color number for inside of screen.
	• Fabric price group 8	+\$215	Specify <i>with contrasting</i> and select fabric color number for inside of screen.
	• Fabric price group 9	+\$263	Specify <i>with contrasting</i> and select fabric color number for inside of screen.
	• Fabric price group 10	+\$293	Specify <i>with contrasting</i> and select fabric color number for inside of screen.
	• Customer's Own Material (COM)	No cost	► See <i>Surface Materials Reference Manual</i> .

Tip: Fabrics must be in the same fabric family when specifying contrasting fabrics.

**For Canadian Pricing**

Multiply U.S. Price by the Canadian price factor.

► See page 1 for details.

Specification Information

• Depth	• Style Number	• U.S. Base Prices			
		15"W x 48"H	30"W x 48"H	15"W x 60"H	30"W x 60"H
5/8"	STLSCRPL	\$552	\$646	\$771	\$907

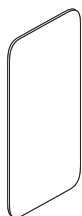

 **For Canadian Pricing**
 Multiply U.S. Price by the Canadian price factor.
 ▶ See page 1 for details.



Umami Screens

Spanner Screens

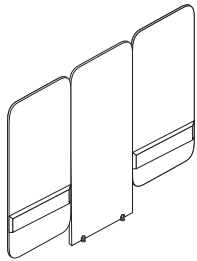

Tip: Spanner screens are not allowed to be attached to a platform or end cap lounge.

Tip: Specify straight clip if end of run and no additional clips required.

Tip: Fabrics will only be applied vertically on spanner screens.

Tip: If you want other screens to match spanner screens, make sure to specify vertical application on standard screens.

► See screen application rules for additional details, page 482.

Tip: Fabrics must be in the same fabric family when specifying contrasting fabrics.

Standard Includes		Required to Specify
► Need help? Product details, page 482	<ul style="list-style-type: none"> • Three 30"W screens, if 90"W selected: fabric price group 1 • Two 30"W screens and one 45"W center screen, if 105"W selected: fabric price group 1 • Plastic clips for attachment to other screen (one clip for 48"H screens and two clips for 60"H screens) • Ships full assembled 	<ol style="list-style-type: none"> 1 Style number 2 Size of screen (see below under Required Selections) 3 Screen clips (see below under Required Selections) 4 Fabric direction (see below under Required Selections) 5 Fabric color number for screen 6 Options, if selected (see below) <p>► See <i>Surface Materials</i>, page 634.</p>

	Required Selections	U.S. Price	Required to Specify
Size of Screen	<ul style="list-style-type: none"> • 90"W x 48"H • 105"W x 48"H • 90"W x 60"H • 105"W x 60"H 	<p>Prices at right</p> <p>Prices at right</p> <p>Prices at right</p> <p>Prices at right</p>	<p>Specify with 90"W x 48"H.</p> <p>Specify with 105"W x 48"H.</p> <p>Specify with 90"W x 60"H.</p> <p>Specify with 105"W x 60"H.</p>

	Required Selections	U.S. Price	Required to Specify
Screen Clips	<ul style="list-style-type: none"> • Straight • Corner 	<p>No cost</p> <p>No cost</p>	<p>Specify with straight clip.</p> <p>Specify with corner clip.</p>

	Options	U.S. Price	Required to Specify
Surface Materials 90"W x 48"H	<p>Non-contrasting</p> <ul style="list-style-type: none"> • Fabric price group 1 • Fabric price group 2 • Fabric price group 3 • Fabric price group 4 • Fabric price group 5 • Fabric price group 6 • Fabric price group 7 • Fabric price group 8 • Fabric price group 9 • Fabric price group 10 • Customer's Own Material (COM) 	<p>No cost</p> <p>+\$107</p> <p>+\$194</p> <p>+\$279</p> <p>+\$329</p> <p>+\$397</p> <p>+\$467</p> <p>+\$600</p> <p>+\$724</p> <p>+\$813</p> <p>No cost</p>	<p>Specify fabric color number.</p> <p>Specify fabric color number.</p> <p>Specify fabric color number.</p> <p>Specify fabric color number.</p> <p>Specify fabric color number.</p> <p>Specify fabric color number.</p> <p>Specify fabric color number.</p> <p>Specify fabric color number.</p> <p>Specify fabric color number.</p> <p>Specify fabric color number.</p> <p>Specify fabric color number.</p> <p>► See <i>Surface Materials Reference Manual</i>.</p>

	Options	U.S. Price	Required to Specify
	<p>Contrasting fabrics Inside of screen</p> <ul style="list-style-type: none"> • Fabric price group 1 • Fabric price group 2 • Fabric price group 3 • Fabric price group 4 • Fabric price group 5 • Fabric price group 6 • Fabric price group 7 • Fabric price group 8 • Fabric price group 9 • Fabric price group 10 • Customer's Own Material (COM) 	<p>No cost</p> <p>+\$ 53</p> <p>+\$ 97</p> <p>+\$140</p> <p>+\$165</p> <p>+\$198</p> <p>+\$233</p> <p>+\$300</p> <p>+\$362</p> <p>+\$407</p> <p>No cost</p>	<p>Specify with contrasting and select fabric color number for inside of screen.</p> <p>Specify with contrasting and select fabric color number for inside of screen.</p> <p>Specify with contrasting and select fabric color number for inside of screen.</p> <p>Specify with contrasting and select fabric color number for inside of screen.</p> <p>Specify with contrasting and select fabric color number for inside of screen.</p> <p>Specify with contrasting and select fabric color number for inside of screen.</p> <p>Specify with contrasting and select fabric color number for inside of screen.</p> <p>Specify with contrasting and select fabric color number for inside of screen.</p> <p>Specify with contrasting and select fabric color number for inside of screen.</p> <p>Specify with contrasting and select fabric color number for inside of screen.</p> <p>Specify with contrasting and select fabric color number for inside of screen.</p> <p>Specify with contrasting and select fabric color number for inside of screen.</p> <p>► See <i>Surface Materials Reference Manual</i>.</p>

► Options, continued on next

 **For Canadian Pricing**
 Multiply U.S. Price by the Canadian price factor.
 ► See page 1 for details.

► Options, continued from previous page

	Options	U.S. Price	Required to Specify
Surface Materials 90"W x 48"H, continued	Outside of screen		
	• Fabric price group 1	No cost	Specify <i>with contrasting</i> and select fabric color number for outside of screen.
	• Fabric price group 2	+\$ 53	Specify <i>with contrasting</i> and select fabric color number for outside of screen.
	• Fabric price group 3	+\$ 97	Specify <i>with contrasting</i> and select fabric color number for outside of screen.
	• Fabric price group 4	+\$ 140	Specify <i>with contrasting</i> and select fabric color number for outside of screen.
	• Fabric price group 5	+\$ 165	Specify <i>with contrasting</i> and select fabric color number for outside of screen.
	• Fabric price group 6	+\$ 198	Specify <i>with contrasting</i> and select fabric color number for outside of screen.
	• Fabric price group 7	+\$ 233	Specify <i>with contrasting</i> and select fabric color number for outside of screen.
	• Fabric price group 8	+\$ 300	Specify <i>with contrasting</i> and select fabric color number for outside of screen.
	• Fabric price group 9	+\$ 362	Specify <i>with contrasting</i> and select fabric color number for outside of screen.
	• Fabric price group 10	+\$ 407	Specify <i>with contrasting</i> and select fabric color number for outside of screen.
	• Customer's Own Material (COM)	No cost	► See <i>Surface Materials Reference Manual</i> .
105"W x 48"H	Non-contrasting		
	• Fabric price group 1	No cost	Specify fabric color number.
	• Fabric price group 2	+\$ 203	Specify fabric color number.
	• Fabric price group 3	+\$ 371	Specify fabric color number.
	• Fabric price group 4	+\$ 532	Specify fabric color number.
	• Fabric price group 5	+\$ 623	Specify fabric color number.
	• Fabric price group 6	+\$ 754	Specify fabric color number.
	• Fabric price group 7	+\$ 876	Specify fabric color number.
	• Fabric price group 8	+\$1125	Specify fabric color number.
	• Fabric price group 9	+\$1378	Specify fabric color number.
	• Fabric price group 10	+\$1546	Specify fabric color number.
	• Customer's Own Material (COM)	No cost	► See <i>Surface Materials Reference Manual</i> .
	Contrasting fabrics		
	Inside of screen		
	• Fabric price group 1	No cost	Specify <i>with contrasting</i> and select fabric color number for inside of screen.
	• Fabric price group 2	+\$ 101	Specify <i>with contrasting</i> and select fabric color number for inside of screen.
	• Fabric price group 3	+\$ 185	Specify <i>with contrasting</i> and select fabric color number for inside of screen.
	• Fabric price group 4	+\$ 266	Specify <i>with contrasting</i> and select fabric color number for inside of screen.
	• Fabric price group 5	+\$ 312	Specify <i>with contrasting</i> and select fabric color number for inside of screen.
	• Fabric price group 6	+\$ 377	Specify <i>with contrasting</i> and select fabric color number for inside of screen.
	• Fabric price group 7	+\$ 438	Specify <i>with contrasting</i> and select fabric color number for inside of screen.
	• Fabric price group 8	+\$ 562	Specify <i>with contrasting</i> and select fabric color number for inside of screen.
	• Fabric price group 9	+\$ 689	Specify <i>with contrasting</i> and select fabric color number for inside of screen.
	• Fabric price group 10	+\$ 773	Specify <i>with contrasting</i> and select fabric color number for inside of screen.
	• Customer's Own Material (COM)	No cost	► See <i>Surface Materials Reference Manual</i> .

Tip: Fabrics must be in the same fabric family when specifying contrasting fabrics.

► Options, continued on next page

**For Canadian Pricing**

Multiply U.S. Price by the Canadian price factor.

► See page 1 for details.

Umami Screens, Spanner Screens, continued

► Options, continued from previous page

	Options	U.S. Price	Required to Specify
Surface Materials, 105"W x 48"H continued	Outside of screen		
	• Fabric price group 1	No cost	Specify <i>with contrasting</i> and select fabric color number for outside of screen.
	• Fabric price group 2	+\$101	Specify <i>with contrasting</i> and select fabric color number for outside of screen.
	• Fabric price group 3	+\$185	Specify <i>with contrasting</i> and select fabric color number for outside of screen.
	• Fabric price group 4	+\$266	Specify <i>with contrasting</i> and select fabric color number for outside of screen.
	• Fabric price group 5	+\$312	Specify <i>with contrasting</i> and select fabric color number for outside of screen.
	• Fabric price group 6	+\$377	Specify <i>with contrasting</i> and select fabric color number for outside of screen.
	• Fabric price group 7	+\$438	Specify <i>with contrasting</i> and select fabric color number for outside of screen.
	• Fabric price group 8	+\$562	Specify <i>with contrasting</i> and select fabric color number for outside of screen.
	• Fabric price group 9	+\$689	Specify <i>with contrasting</i> and select fabric color number for outside of screen.
	• Fabric price group 10	+\$773	Specify <i>with contrasting</i> and select fabric color number for outside of screen.
	• Customer's Own Material (COM)	No cost	► See <i>Surface Materials Reference Manual</i> .
90"W x 60"H	Non-contrasting		
	• Fabric price group 1	No cost	Specify fabric color number.
	• Fabric price group 2	+\$122	Specify fabric color number.
	• Fabric price group 3	+\$218	Specify fabric color number.
	• Fabric price group 4	+\$323	Specify fabric color number.
	• Fabric price group 5	+\$377	Specify fabric color number.
	• Fabric price group 6	+\$456	Specify fabric color number.
	• Fabric price group 7	+\$525	Specify fabric color number.
	• Fabric price group 8	+\$685	Specify fabric color number.
	• Fabric price group 9	+\$835	Specify fabric color number.
	• Fabric price group 10	+\$929	Specify fabric color number.
	• Customer's Own Material (COM)	No cost	► See <i>Surface Materials Reference Manual</i> .
	Contrasting fabrics Inside of screen		
	• Fabric price group 1	No cost	Specify <i>with contrasting</i> and select fabric color number for inside of screen.
	• Fabric price group 2	+\$ 61	Specify <i>with contrasting</i> and select fabric color number for inside of screen.
	• Fabric price group 3	+\$109	Specify <i>with contrasting</i> and select fabric color number for inside of screen.
	• Fabric price group 4	+\$161	Specify <i>with contrasting</i> and select fabric color number for inside of screen.
	• Fabric price group 5	+\$189	Specify <i>with contrasting</i> and select fabric color number for inside of screen.
	• Fabric price group 6	+\$228	Specify <i>with contrasting</i> and select fabric color number for inside of screen.
	• Fabric price group 7	+\$263	Specify <i>with contrasting</i> and select fabric color number for inside of screen.
	• Fabric price group 8	+\$342	Specify <i>with contrasting</i> and select fabric color number for inside of screen.
	• Fabric price group 9	+\$417	Specify <i>with contrasting</i> and select fabric color number for inside of screen.
	• Fabric price group 10	+\$464	Specify <i>with contrasting</i> and select fabric color number for inside of screen.
	• Customer's Own Material (COM)	No cost	► See <i>Surface Materials Reference Manual</i> .

Tip: Fabrics must be in the same fabric family when specifying contrasting fabrics.

► Options, continued on next page



For Canadian Pricing

Multiply U.S. Price by the Canadian price factor.

► See page 1 for details.

► Options, continued from previous page

	Options	U.S. Price	Required to Specify
Surface Materials, 90"W x 60"H continued	Outside of screen		
	• Fabric price group 1	No cost	Specify <i>with contrasting</i> and select fabric color number for outside of screen.
	• Fabric price group 2	+\$ 61	Specify <i>with contrasting</i> and select fabric color number for outside of screen.
	• Fabric price group 3	+\$ 109	Specify <i>with contrasting</i> and select fabric color number for outside of screen.
	• Fabric price group 4	+\$ 161	Specify <i>with contrasting</i> and select fabric color number for outside of screen.
	• Fabric price group 5	+\$ 189	Specify <i>with contrasting</i> and select fabric color number for outside of screen.
	• Fabric price group 6	+\$ 228	Specify <i>with contrasting</i> and select fabric color number for outside of screen.
	• Fabric price group 7	+\$ 263	Specify <i>with contrasting</i> and select fabric color number for outside of screen.
	• Fabric price group 8	+\$ 342	Specify <i>with contrasting</i> and select fabric color number for outside of screen.
	• Fabric price group 9	+\$ 417	Specify <i>with contrasting</i> and select fabric color number for outside of screen.
	• Fabric price group 10	+\$ 464	Specify <i>with contrasting</i> and select fabric color number for outside of screen.
	• Customer's Own Material (COM)	No cost	► See <i>Surface Materials Reference Manual</i> .
105"W x 60"H	Non-contrasting		
	• Fabric price group 1	No cost	Specify fabric color number.
	• Fabric price group 2	+\$ 227	Specify fabric color number.
	• Fabric price group 3	+\$ 421	Specify fabric color number.
	• Fabric price group 4	+\$ 613	Specify fabric color number.
	• Fabric price group 5	+\$ 717	Specify fabric color number.
	• Fabric price group 6	+\$ 859	Specify fabric color number.
	• Fabric price group 7	+\$1007	Specify fabric color number.
	• Fabric price group 8	+\$1288	Specify fabric color number.
	• Fabric price group 9	+\$1578	Specify fabric color number.
	• Fabric price group 10	+\$1766	Specify fabric color number.
	• Customer's Own Material (COM)	No cost	► See <i>Surface Materials Reference Manual</i> .
	Contrasting fabrics		
	Inside of screen		
	• Fabric price group 1	No cost	Specify <i>with contrasting</i> and select fabric color number for inside of screen.
	• Fabric price group 2	+\$ 113	Specify <i>with contrasting</i> and select fabric color number for inside of screen.
	• Fabric price group 3	+\$ 210	Specify <i>with contrasting</i> and select fabric color number for inside of screen.
	• Fabric price group 4	+\$ 306	Specify <i>with contrasting</i> and select fabric color number for inside of screen.
	• Fabric price group 5	+\$ 359	Specify <i>with contrasting</i> and select fabric color number for inside of screen.
	• Fabric price group 6	+\$ 429	Specify <i>with contrasting</i> and select fabric color number for inside of screen.
	• Fabric price group 7	+\$ 504	Specify <i>with contrasting</i> and select fabric color number for inside of screen.
	• Fabric price group 8	+\$ 644	Specify <i>with contrasting</i> and select fabric color number for inside of screen.
	• Fabric price group 9	+\$ 789	Specify <i>with contrasting</i> and select fabric color number for inside of screen.
	• Fabric price group 10	+\$ 883	Specify <i>with contrasting</i> and select fabric color number for inside of screen.
	• Customer's Own Material (COM)	No cost	► See <i>Surface Materials Reference Manual</i> .

Tip: Fabrics must be in the same fabric family when specifying contrasting fabrics.

► Options, continued on next page

**For Canadian Pricing**

Multiply U.S. Price by the Canadian price factor.

► See page 1 for details.

Umami Screens, Spanner Screens, continued

► Options, continued from previous page

Options	U.S. Price	Required to Specify
Surface Materials 105"W x 60"H, continued	Outside of screen	
• Fabric price group 1	No cost	Specify <i>with contrasting</i> and select fabric color number for outside of screen.
• Fabric price group 2	+\$113	Specify <i>with contrasting</i> and select fabric color number for outside of screen.
• Fabric price group 3	+\$210	Specify <i>with contrasting</i> and select fabric color number for outside of screen.
• Fabric price group 4	+\$306	Specify <i>with contrasting</i> and select fabric color number for outside of screen.
• Fabric price group 5	+\$359	Specify <i>with contrasting</i> and select fabric color number for outside of screen.
• Fabric price group 6	+\$429	Specify <i>with contrasting</i> and select fabric color number for outside of screen.
• Fabric price group 7	+\$504	Specify <i>with contrasting</i> and select fabric color number for outside of screen.
• Fabric price group 8	+\$644	Specify <i>with contrasting</i> and select fabric color number for outside of screen.
• Fabric price group 9	+\$789	Specify <i>with contrasting</i> and select fabric color number for outside of screen.
• Fabric price group 10	+\$883	Specify <i>with contrasting</i> and select fabric color number for outside of screen.
• Customer's Own Material (COM)	No cost	► See <i>Surface Materials Reference Manual</i> .

Specification Information

Depth	Style Number	U.S. Base Prices			
		90"W x 48"H	105"W x 48"H	90"W x 60"H	105"W x 60"H
5/8"	STLSCRPLS	\$1942	\$2228	\$2717	\$3235

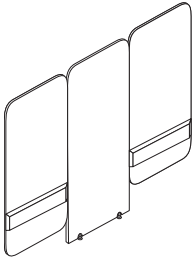

For Canadian Pricing

Multiply U.S. Price by the Canadian price factor.

► See page 1 for details.

Lagunitas Work Tables

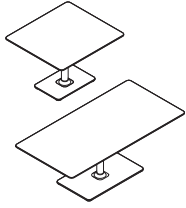

Standard Includes	Required to Specify
-------------------	---------------------

- Table top: laminate price group 1 with 3 mm flat plastic edge
- Base: paint price group 1 or group 2
- Ships ready to assemble

- 1 Style number
 - 2 Size of screen (see below under Required Selections)
 - 3 Laminate color number for table top
 - 4 Plastic edge color number for laminate table
 - 5 Paint color number for base
 - 6 Options, if selected (see below)
- ▶ See *Surface Materials*, page 634.

Size	Required Selections	U.S. Price	Required to Specify
------	---------------------	------------	---------------------

Size	• 30"W x 24"D	Prices at right	Specify <i>with 30"W x 24"D</i> .
	• 36"W x 24"D	Prices at right	Specify <i>with 36"W x 24"D</i> .
	• 40"W x 36"D	Prices at right	Specify <i>with 40"W x 36"D</i> .
	• 48"W x 36"D	Prices at right	Specify <i>with 48"W x 36"D</i> .
	• 57"W x 36"D	Prices at right	Specify <i>with 57"W x 36"D</i> .
	• 72"W x 36"D	Prices at right	Specify <i>with 72"W x 36"D</i> .

Surface Materials	Options	U.S. Price	Required to Specify
-------------------	---------	------------	---------------------

Surface Materials	Top		
	• Laminate price group 1	Prices at right	Specify laminate color number.
	• Laminate price group 2	Prices at right	Specify laminate color number.
	• Laminate price group 3	Prices at right	Specify laminate color number.
	• Wood group 1	Prices at right	Specify wood color number.
	• Wood group 2	Prices at right	Specify wood color number.
	• Customiz stain	No cost	Specify <i>with Customiz stain</i> .
			▶ See <i>Coalesse Surface Materials Reference Guide</i> .

Tip: Wood veneer tables have matching wood veneer edges.

	Base		
	• Paint price group 1	No cost	Specify paint color number.
	• Paint price group 2	No cost	Specify paint color number.
	• Paint price group 3	+\$145	Specify paint color number.
			▶ See <i>Coalesse Surface Materials Reference Guide</i> .

Power	Options	U.S. Price	Required to Specify
-------	---------	------------	---------------------

Power	• Power module	+\$380	Specify <i>with power module</i> .
	– Two TR simplex receptacles	No cost	Specify <i>with two power</i> .
	– One TR simplex receptacle and 2 USB A charging ports	+\$149	Specify <i>with one power, two USB A</i> .
	– One TR simplex receptacle, one USB A charging port, and one USB C charging port	+\$149	Specify <i>with one power, one USB A, one USB C</i> .
	3" metal grommet		
	• One metal grommet in anodized silver finish (center only)	+\$116	Specify <i>with 3" metal grommet</i> .
	PowerPod grommet		
• One PowerPod grommet in 6025 Milk or 6000 Black plastic finish (center only)	+\$ 76	Specify <i>with PowerPod grommet</i> and select color number.	

Tip: Column routes cables and wires when optional power or grommet are selected and exits through the base.

Tip: Devices and grommets are center location only to allow for routing of cords through the column and exits through the base.

Tip: Round power module is available in 4013 Silver/Black, 4180 Graphite Matte, 4242 Milk Smooth, or 4710 Low Gloss Black.

Tip: Power module configuration upcharges are in addition to the power module upcharge.



For Canadian Pricing

Multiply U.S. Price by the Canadian price factor.

▶ See page 1 for details.

Specification Information

• Style Number	• Dimensions			• U.S. Base Prices			
	D	W	H	Flat Plastic Edge on Laminate Top		Flat Wood Edge on Wood Top	
				Group 1	Group 2 and 3	Group 1	Group 2
COLAGTRECT	24"	30"	26"	\$2277	\$2383	\$4258	\$4526
	24"	36"	26"	\$2429	\$2541	\$4442	\$4732
	36"	40"	26"	\$2582	\$2708	\$5213	\$5557
	36"	48"	26"	\$3189	\$3343	\$5663	\$6073
	36"	57"	26"	\$3344	\$3506	\$5898	\$6326
	36"	72"	26"	\$3877	\$4066	\$6582	\$7049

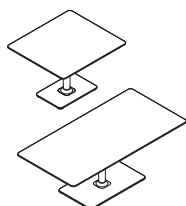

 **For Canadian Pricing**
 Multiply U.S. Price by the Canadian price factor.
 ▶ See page 1 for details.



Lagunitas Personal Table

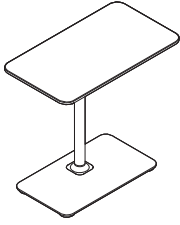

Standard Includes	Required to Specify
-------------------	---------------------

- Table top: laminate price group 1 with 3 mm flat plastic edge
- Base: paint price group 1
- Four non adjustable glides
- Ships ready to assemble

- 1 Style number
 - 2 Laminate color number for table top
 - 3 Plastic edge color number for laminate table
 - 4 Paint color number for base
 - 5 Options, if selected (see below)
- ▶ See *Surface Materials*, page 634.

Options	U.S. Price	Required to Specify
---------	------------	---------------------

Surface Materials

Top

- Laminate price group 1
No cost
- Laminate price group 2
+\$ 47
- Laminate price group 3
+\$ 47
- Fusion fabric wrapped
+\$382

Specify laminate color number.
Specify laminate color number.
Specify *with Fusion fabric* and select color number.

Base

- Paint price group 1
No cost
- Paint price group 2
No cost
- Paint price group 3
+\$145

Specify paint color number.
Specify paint color number.
Specify paint color number.

Specification Information				
Dimensions			Style Number	U.S. Base Price
D	W	H		

Dimensions			Style Number	U.S. Base Price
D	W	H		
13"	24"	25"	COLAGTP	\$910



For Canadian Pricing

Multiply U.S. Price by the Canadian price factor.

▶ See page 1 for details.

Turnstone Campfire

Seating

Lounge Seating

Tip: To see the rest of the Campfire Collection including Big Table, Slim Table, Big Lamp, and Power Accessories, please refer to the Conference and Collaborative Tables Specification Guide.

Product Details

Thought Starters	530
Big Lounge, Half Lounge, Corner Lounge, Ottoman, Pouf, and Wedge	534
Screen and Footrest	537

Lounge

Lounges	538
Ganging Brackets	551
Ottoman	552
Pouf	553
Wedge	554

Accessories

Footrest	555
Screens	555

Surface Materials

634

Thought Starters

Islands

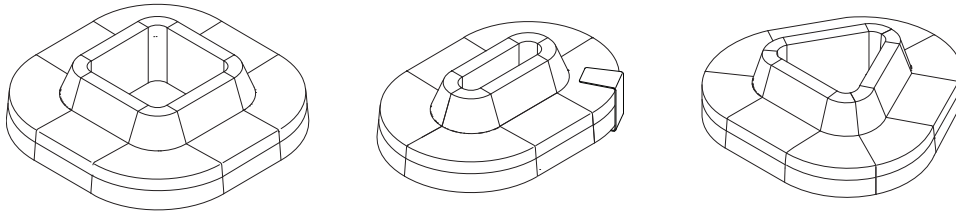

Quantity	Style Number	Description	Page for Ordering
Square Island			
4	TS3HLW	Campfire Half Lounge—Waterfall	543
4	TS3CROUT90W	Campfire 90° Corner Lounges—Waterfall	546
Oval Island			
2	TS3HLW	Campfire Half Lounge—Waterfall	543
4	TS3CROUT90W	Campfire 90° Corner Lounges—Waterfall	546
1	TS4TWP	Personal Table	▶ See <i>Conference and Collaborative Tables Specification Guide</i> .
Triangle Island			
3	TS3HLW	Campfire Half Lounge—Waterfall	543
6	TS3CROUT60W	Campfire 60° Corner Lounges—Waterfall	546

Tip: Island configurations create an open space in the middle due to the rounded backs of the corner lounges.

Collaborative Sharing

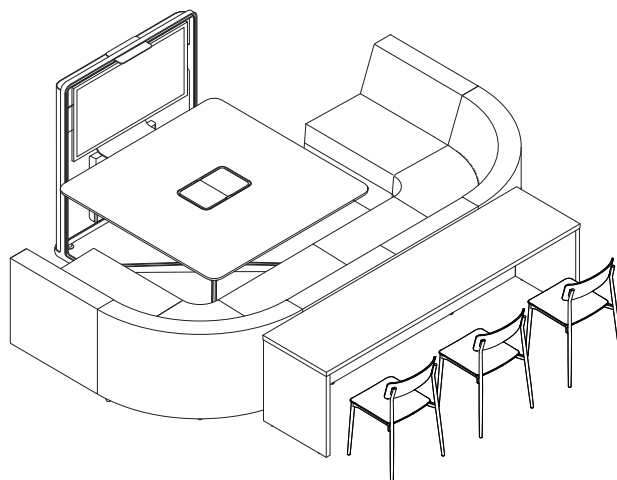

Quantity	Style Number	Description	Page for Ordering
1	TS3BCS	Campfire Big Lounge – Seam	539
2	TS3HLS	Campfire Half Lounge – Seam	542
2	TS3CRIN90S	Campfire 90° Corner Lounges – Seam	544
1	TS4TLH28	Campfire Big Table – Half Depth	▶ See <i>Conference and Collaborative Tables Specification Guide</i> .
3	TSAVNCH	Simple Chair	380
1	MT03DS6060T	media:scape Square Desk-Height Table	▶ See <i>Conference and Collaborative Tables Specification Guide</i> .

Serpentine

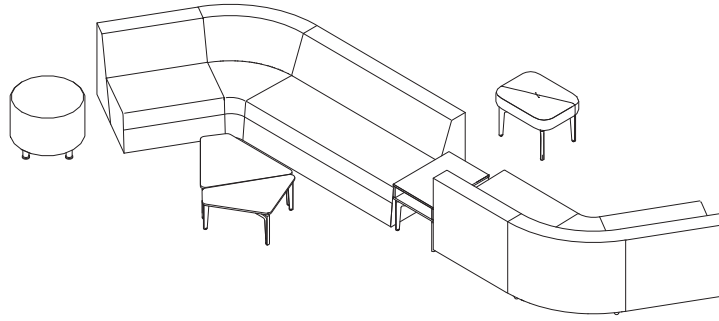

Quantity	Style Number	Description	Page for Ordering
1	TS3BCW	Campfire Big Lounge – Waterfall	540
3	TS3HLW	Campfire Half Lounge – Waterfall	543
2	TS3CRINGOW	Campfire 60° Corner Lounges – Waterfall	550
1	TSBLNT3LEGS	Bassline Small Asymmetrical Table	▶ See <i>Conference and Collaborative Tables Specification Guide</i> .
1	TSBLNT3LEGM	Bassline Medium Asymmetrical Table	▶ See <i>Conference and Collaborative Tables Specification Guide</i> .
1	TSBLNTBX	Bassline 30"D x 18"H Box Top Table	▶ See <i>Conference and Collaborative Tables Specification Guide</i> .
1	TSBLNS1	Bassline One Seat Bench	▶ See <i>Conference and Collaborative Tables Specification Guide</i> .
1	TS34401	Alight round	631

Big Lounge, Half Lounge, Corner Lounge, Ottoman, Pouf, and Wedge

Big Lounge, Half Lounge, and Corner Lounges come standard armless with black plastic feet. Available options include single, multiple, or waterfall upholstery. ▶ Specifying, pages 538–554

Campfire Lounge products are fully upholstered and have a relaxed appearance. They may show soft comfort wrinkles upon use.

Half Lounge is a generous seat for one at 33"W. When paired with other lounges use ganging brackets (ordered separately) to create a wide range of applications.

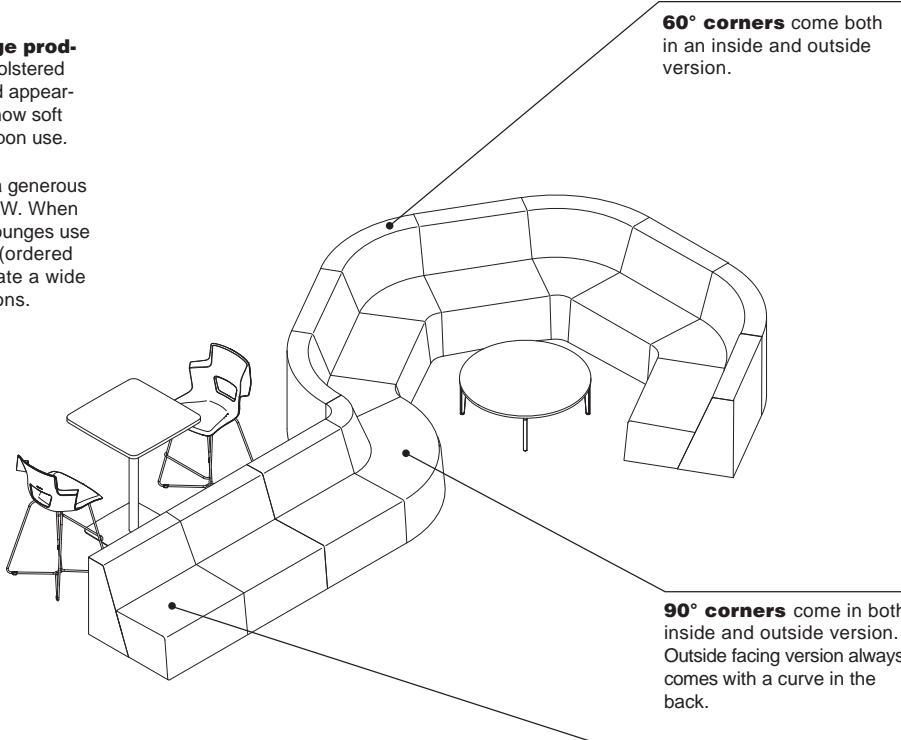

60° corners come both in an inside and outside version.

90° corners come in both inside and outside version. Outside facing version always comes with a curve in the back.

Big Lounge is 66"W and provides a comfortable seat for two. Pair with other lounges using ganging brackets (ordered separately) to create a wide range of applications.

Product Details

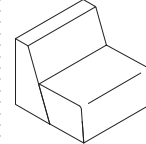
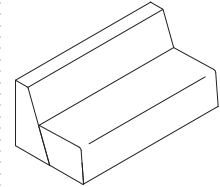

Straight seating available in Big Lounge or Half Lounge.

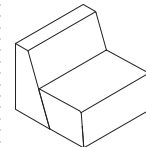

Big and Half Lounges with seams are available as standard styles. (TS3BCS and TS3HLS) Seams come standard on 90° and 60° Corner Lounges. Order Half and Big Lounges with seams when specifying with the corner lounges for a cohesive design aesthetic.

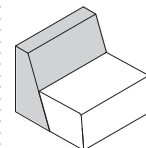

Styles with the "S" suffix, noting they have a seam, can also be ordered in multiple fabric combinations.

Actual Dimensions

	Big Lounge	Half Lounge	90° Inside Corner Lounge	90° Outside Corner Lounge	60° Inside Corner Lounge	60° Outside Corner Lounge	Ottoman	Pouf	Wedge
Depth	32"	32"	32"	32"	32"	32"		15"	17 ⁷ / ₈ "
Width	66"	33"	54 ¹ / ₂ "	55 ¹ / ₄ "	38 ¹ / ₂ "	39 ¹ / ₄ "	24"	15"	33"
Height	29"	29"	29"	29"	29"	29"	16"	18"	29"
Seat Depth	22"	22"	22"	22"	22"	22"			
Floor to Seat Height	16"	16"	16"	16"	16"	16"			

*Tip: Specify Ottoman with low profile glides to achieve 16"H.

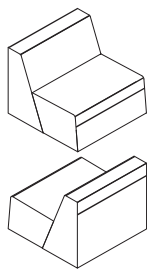

Waterfall option on lounges features upholstery that wraps around the top of the back and cascades over the front edge of the seat.

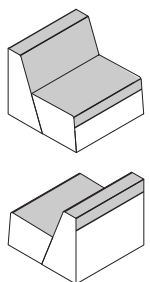

Styles with the "W" suffix, noting they have waterfall upholstery, can also be ordered in a multiple fabric combinations.

When ordering multi-fabric, note "upholstery" refers to the fabric selection for the lower section and "waterfall" refers to the fabric selection across the top.

On waterfall lounges with multiple fabrics, only one thread color is used. The thread color that coordinates with the waterfall upholstery will be used on the entire unit.

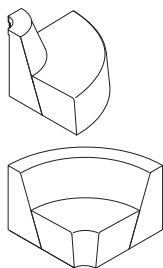

90° Lounges are available outside or inside facing.

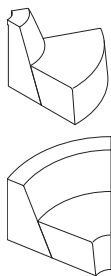

60° Lounges are available outside or inside facing.

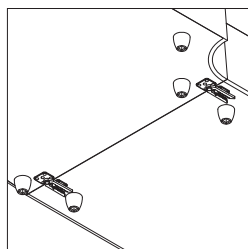

Corner Lounges connected to other lounges require the ganging brackets (TS3GANGING) ordered separately.

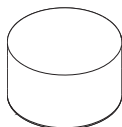

Ottoman ships fully assembled.

Ottoman is the same as Aight Round Ottoman. The Aight Round Ottoman with the low-profile glide option decreases the seat height from 19" down to 16". It is often shown with Campfire and referred to as Campfire Ottoman. It is being included in the Campfire lounge specifying section for easy reference.

► Specifying, page 552

Ottoman supports up to 225 pounds.

Pouf is designed for quick sits; and its lightweight construction of under eight pounds allows it to be easily moved. Pouf includes a nylon handle for easy carrying and a foam core with a top layer of softer foam for comfortable seating.

► Specifying, page 553

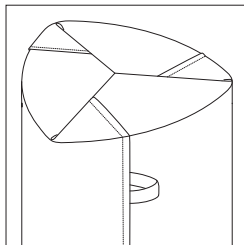

Pouf has a unique design feature that extends down all three sides.

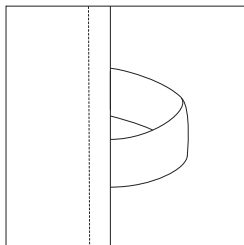

Handle is sewn on the side of the Pouf and is available in multiple colors.

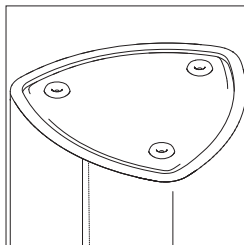

Glides on the bottom of the Pouf are part of a plastic molded base.

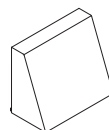

Wedge comes standard with black plastic feet and stability brackets. Independent Wedges and Half Lounges may be positioned into any configuration without moving or removing the stability brackets.

► Specifying, page 554

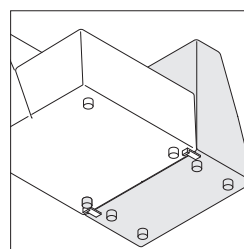

Wedges connected to the side of a Half Lounge would use the stability brackets facing towards the back as they come standard.

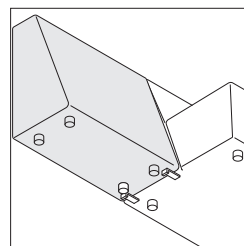

Wedges connected to the back of a Half Lounge or in-line with another Wedge would require moving the stability brackets to the side.

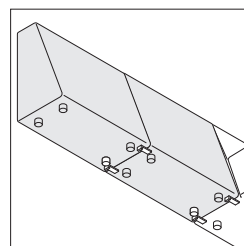

No more than two Wedges can be attached to a single lounge. Wedges can be freestanding, either alone or next to the Big Lounges or Half Lounges.

Surface Materials

Big Lounge, Half Lounge, and Wedge

- Fabric price groups 1-10
- COM

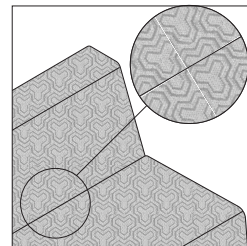

Solid, non-repeat fabrics are recommended for Campfire Lounge settings. Steelcase will not pattern match fabrics which have a distinct repeating pattern. It is recommended to use one of the standard fabrics or patterned COM.

Comfort wrinkles are intended to occur over the time to increase the comfort of Campfire Lounge. Very little maintenance is required to reduce the definition: smooth the cushion fabric with a spreading/wiping motion.

Pouf
Body
• Fabric

Base
• Black plastic

Handle
• Nylon Contrasting Thread
• UB01 Charcoal
• UB02 Ash
• UB03 Powder Blue
• UB04 Evergreen
• UB05 Bright Red

Tip: Contrasting stitching is optional for Pouf and must be specified.

Surface Materials, continued

Big Lounges and Half Lounges

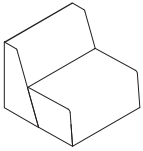

No Seam

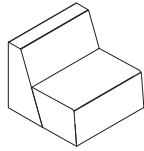

Seam

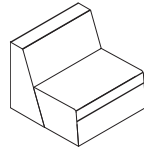

Waterfall (front)

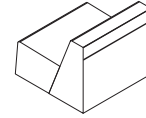

Waterfall (back)

Corner Lounges

NOT AVAILABLE

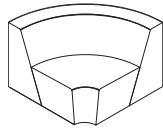

Seam

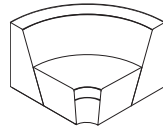

Waterfall (front)



Waterfall (back)

Screen and Footrest

Big Lamp can be found in *Conference and Collaborative Tables Specification Guide*.

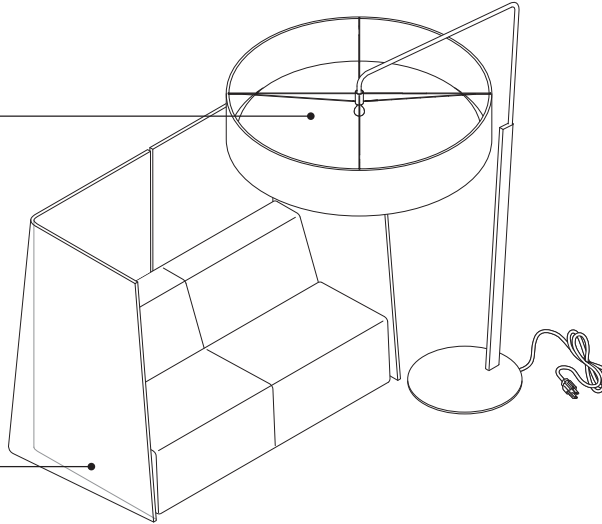

Screens are constructed with a steel frame and a mesh sock. Screens are handed. Right-hand and left-hand versions are available.
 ▶ Specifying, page 555

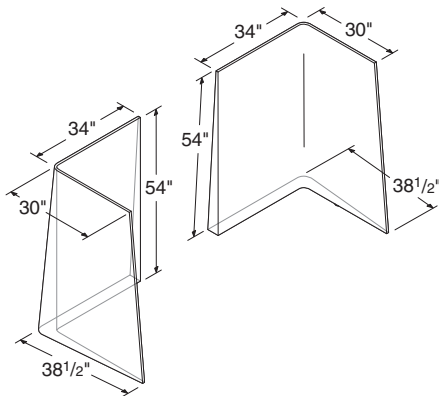

Product Details

16¹/₄"D 16⁵/₈"H
 11"W



Footrest supports feet and legs and is designed to be used in multiple orientations to encourage active movement when in a lounge posture.
 ▶ Specifying, page 555

Footrest is grey expanded polypropylene with a plastic band available in five finishes.

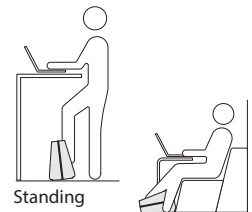

Footrest can be used when in a lounge posture, seated, or standing height. It can also be used as a guest chair.

Surface Materials

Footrest band

- 6009 Arctic White
- 6333 Picasso
- 6335 Wasabi
- 6338 Chili
- 6527 Merle

Screen

- Mesh:
 - T615 Sultry Smoke
 - T620 Arctic Ermine
 - T625 Marina Blue

Lounges

Big Lounge

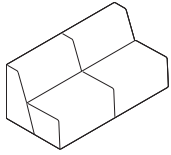

Tip: Campfire Lounges can be ordered as a single or multi-fabric upholstery.

Tip: When specifying multiple COM fabrics, indicate all surfaces where COM applies. Example: TS3BCM with Designtex 1234 on seat and Designtex 5678 on back.

Standard Includes	Required to Specify
-------------------	---------------------

- | | |
|--|---|
| ▶ Need help? Product details, page 534 | <ul style="list-style-type: none"> Fully upholstered armless lounge: fabric price group 1 Foot: black plastic Shipped fully assembled Meets Cal. 117 requirements |
| | <ul style="list-style-type: none"> 1 Style number 2 Fabric color number for upholstery 3 Options, if selected (see below) <p>▶ See <i>Surface Materials</i>, page 634.</p> |

Surface Materials	Options	U.S. Price	Required to Specify
-------------------	---------	------------	---------------------

Surface Materials	Single upholstery fabric		
	• Fabric price group 1	No cost	Specify fabric color number.
	• Fabric price group 2	+\$ 57	Specify fabric color number.
	• Fabric price group 3	+\$ 222	Specify fabric color number.
	• Fabric price group 4	+\$ 393	Specify fabric color number.
	• Fabric price group 5	+\$ 705	Specify fabric color number.
	• Fabric price group 6	+\$ 739	Specify fabric color number.
	• Fabric price group 7	+\$ 850	Specify fabric color number.
	• Fabric price group 8	+\$1210	Specify fabric color number.
	• Fabric price group 9	+\$1480	Specify fabric color number.
	• Fabric price group 10	+\$1548	Specify fabric color number.
	• Customer's Own Material (COM)	+\$ 56	Specify fabric color number.
			▶ See <i>Understanding Customer's Own Material (COM)</i> , page 642.

Multiple upholstery fabric	U.S. Price	Required to Specify
----------------------------	------------	---------------------

• Different fabric on seat and back	+\$ 93	Add suffix M to Big Lounge chair style number and select fabric color number for: 1 Seat, 2 Back
① Fabric on seat		
• Fabric price group 1	No cost	Specify fabric color number.
• Fabric price group 2	+\$ 23	Specify fabric color number.
• Fabric price group 3	+\$ 97	Specify fabric color number.
• Fabric price group 4	+\$ 169	Specify fabric color number.
• Fabric price group 5	+\$ 305	Specify fabric color number.
• Fabric price group 6	+\$ 316	Specify fabric color number.
• Fabric price group 7	+\$ 363	Specify fabric color number.
• Fabric price group 8	+\$ 517	Specify fabric color number.
• Fabric price group 9	+\$ 633	Specify fabric color number.
• Fabric price group 10	+\$ 665	Specify fabric color number.
• Customer's Own Material (COM)	+\$ 27	Specify fabric color number.
		▶ See <i>Understanding Customer's Own Material (COM)</i> , page 642.
② Fabric on back		
• Fabric price group 1	No cost	Specify fabric color number.
• Fabric price group 2	+\$ 37	Specify fabric color number.
• Fabric price group 3	+\$ 152	Specify fabric color number.
• Fabric price group 4	+\$ 277	Specify fabric color number.
• Fabric price group 5	+\$ 500	Specify fabric color number.
• Fabric price group 6	+\$ 523	Specify fabric color number.
• Fabric price group 7	+\$ 603	Specify fabric color number.
• Fabric price group 8	+\$ 862	Specify fabric color number.
• Fabric price group 9	+\$1054	Specify fabric color number.
• Fabric price group 10	+\$1102	Specify fabric color number.
• Customer's Own Material (COM)	+\$ 27	Specify fabric color number.
		▶ See <i>Understanding Customer's Own Material (COM)</i> , page 642.

Related Products	Options	Required to Specify
------------------	---------	---------------------

- | | | |
|-----------|--|------------|
| • Ottoman | | ▶ Page 552 |
|-----------|--|------------|

Specification Information				
Dimensions			Style Number	U.S. Base Price
D	W	H		

32"	66"	29"	TS3BC	\$3977
-----	-----	-----	-------	--------

For Canadian Pricing
Multiply U.S. Price by the Canadian price factor.
▶ See page 1 for details.

Big Lounge—Seam

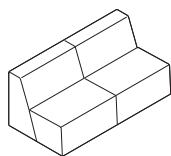

Tip: Seams are located at the top of the back and the front edge of the seat to match seams on Corner Lounges. Corner Lounges come standard with seams. Specify Big and Half Lounges with seams when creating an application with Corner Lounges to create a cohesive design aesthetic.

Tip: Campfire Lounges with seams can be ordered as a single or multi-fabric upholstery.

Tip: When specifying multiple COM fabrics, indicate all surfaces where COM applies. Example: TS3BCM with Designtex 1234 on seat and Designtex 5678 on back.

Tip: Order ganging brackets TS3GANGING to gang units together for more stable applications.

Standard Includes	Required to Specify
-------------------	---------------------

- | | | |
|--|---|---|
| <ul style="list-style-type: none"> ▶ Need help? Product details, page 534 | <ul style="list-style-type: none"> Fully upholstered armless lounge: fabric price group 1 Foot: black plastic Shipped fully assembled Meets Cal. 117 requirements | <ul style="list-style-type: none"> 1 Style number 2 Fabric color number for upholstery 3 Options, if selected (see below) ▶ See <i>Surface Materials</i>, page 634. |
|--|---|---|

Surface Materials	Options	U.S. Price	Required to Specify
-------------------	---------	------------	---------------------

- | | | | |
|---------------------------------|---------------------------------|---------|--|
| Surface Materials | Single upholstery fabric | | Specify fabric color number.
Specify fabric color number.
Specify fabric color number.
Specify fabric color number.
Specify fabric color number.
Specify fabric color number.
Specify fabric color number.
Specify fabric color number.
Specify fabric color number.
Specify fabric color number.
▶ See <i>Understanding Customer's Own Material (COM)</i> , page 642. |
| | • Fabric price group 1 | No cost | |
| | • Fabric price group 2 | +\$ 57 | |
| | • Fabric price group 3 | +\$ 222 | |
| | • Fabric price group 4 | +\$ 393 | |
| | • Fabric price group 5 | +\$ 705 | |
| | • Fabric price group 6 | +\$ 739 | |
| | • Fabric price group 7 | +\$ 850 | |
| | • Fabric price group 8 | +\$1210 | |
| | • Fabric price group 9 | +\$1480 | |
| • Fabric price group 10 | +\$1548 | | |
| • Customer's Own Material (COM) | +\$ 56 | | |

- | | | | |
|--|-------------------------------------|--------|---|
| | Multiple upholstery fabric | | Add suffix M to Big Lounge chair style number and select fabric color number for: 1 Seat, 2 Back |
| | • Different fabric on seat and back | +\$ 93 | |

- | | | | |
|--|---------------------------------|---------|--|
| | ① Fabric on seat | | Specify fabric color number.
Specify fabric color number.
Specify fabric color number.
Specify fabric color number.
Specify fabric color number.
Specify fabric color number.
Specify fabric color number.
Specify fabric color number.
Specify fabric color number.
Specify fabric color number.
▶ See <i>Understanding Customer's Own Material (COM)</i> , page 642. |
| | • Fabric price group 1 | No cost | |
| | • Fabric price group 2 | +\$ 23 | |
| | • Fabric price group 3 | +\$ 97 | |
| | • Fabric price group 4 | +\$ 169 | |
| | • Fabric price group 5 | +\$ 305 | |
| | • Fabric price group 6 | +\$ 316 | |
| | • Fabric price group 7 | +\$ 363 | |
| | • Fabric price group 8 | +\$ 517 | |
| | • Fabric price group 9 | +\$ 633 | |
| | • Fabric price group 10 | +\$ 665 | |
| | • Customer's Own Material (COM) | +\$ 27 | |

- | | | | |
|--|---------------------------------|---------|--|
| | ② Fabric on back | | Specify fabric color number.
Specify fabric color number.
Specify fabric color number.
Specify fabric color number.
Specify fabric color number.
Specify fabric color number.
Specify fabric color number.
Specify fabric color number.
Specify fabric color number.
Specify fabric color number.
▶ See <i>Understanding Customer's Own Material (COM)</i> , page 642. |
| | • Fabric price group 1 | No cost | |
| | • Fabric price group 2 | +\$ 37 | |
| | • Fabric price group 3 | +\$ 152 | |
| | • Fabric price group 4 | +\$ 277 | |
| | • Fabric price group 5 | +\$ 500 | |
| | • Fabric price group 6 | +\$ 523 | |
| | • Fabric price group 7 | +\$ 603 | |
| | • Fabric price group 8 | +\$ 862 | |
| | • Fabric price group 9 | +\$1054 | |
| | • Fabric price group 10 | +\$1102 | |
| | • Customer's Own Material (COM) | +\$ 27 | |

- | | | |
|-------------------------|---|------------|
| Related Products | <ul style="list-style-type: none"> • Ottoman | ▶ Page 552 |
|-------------------------|---|------------|

Specification Information

• Dimensions			• Style	• U.S.
D	W	H	Number	Base Price
32"	66"	29"	TS3BCS	\$4004

For Canadian Pricing
 Multiply U.S. Price by the Canadian price factor.
 ▶ See page 1 for details.

Lounges, continued

Big Lounge—Waterfall

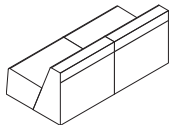
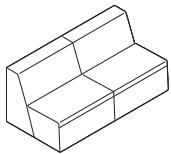

Tip: Waterfall seams are located at the top of the back, the front edge of the seat, 3½" below the front edge seam and 3½" below the top edge seam on the back of the lounge.

Tip: Campfire Lounges with waterfall upholstery can be ordered as a single or multi-fabric upholstery.

Tip: When specifying multiple COM fabrics, indicate all surfaces where COM applies. Example: TS3BCM with Designtex 1234 on seat and Designtex 5678 on back.

Tip: One thread color is used on waterfall lounges with multiple fabrics. The thread color used on the waterfall upholstery will be used on the entire unit.

Tip: Order ganging brackets TS3GANING to gang units together for more stable applications.

Standard Includes	Required to Specify
<ul style="list-style-type: none"> ▶ Need help? Product details, page 534 Fully upholstered armless lounge: fabric price group 1 Foot: black plastic Shipped fully assembled Meets Cal. 117 requirements 	<ul style="list-style-type: none"> 1 Style number 2 Fabric color number for upholstery 3 Options, if selected (see below) ▶ See <i>Surface Materials</i>, page 634.

Surface Materials	Options	U.S. Price	Required to Specify
	Single upholstery fabric		
	• Fabric price group 1	No cost	Specify fabric color number.
	• Fabric price group 2	+\$ 57	Specify fabric color number.
	• Fabric price group 3	+\$ 222	Specify fabric color number.
	• Fabric price group 4	+\$ 393	Specify fabric color number.
	• Fabric price group 5	+\$ 705	Specify fabric color number.
	• Fabric price group 6	+\$ 739	Specify fabric color number.
	• Fabric price group 7	+\$ 850	Specify fabric color number.
	• Fabric price group 8	+\$1210	Specify fabric color number.
	• Fabric price group 9	+\$1480	Specify fabric color number.
	• Fabric price group 10	+\$1548	Specify fabric color number.
	• Customer's Own Material (COM)	+\$ 56	▶ See <i>Understanding Customer's Own Material (COM)</i> , page 642.
	Multiple upholstery fabric		
	• Different fabric on seat and back	+\$ 93	Add suffix M to Big Lounge chair style number and select fabric color number for: 1 Seat, 2 Back
	① Fabric on seat		
	• Fabric price group 1	No cost	Specify fabric color number.
	• Fabric price group 2	+\$ 28	Specify fabric color number.
	• Fabric price group 3	+\$ 119	Specify fabric color number.
	• Fabric price group 4	+\$ 215	Specify fabric color number.
	• Fabric price group 5	+\$ 386	Specify fabric color number.
	• Fabric price group 6	+\$ 404	Specify fabric color number.
	• Fabric price group 7	+\$ 465	Specify fabric color number.
	• Fabric price group 8	+\$ 665	Specify fabric color number.
	• Fabric price group 9	+\$ 813	Specify fabric color number.
	• Fabric price group 10	+\$ 848	Specify fabric color number.
	• Customer's Own Material (COM)	+\$ 27	▶ See <i>Understanding Customer's Own Material (COM)</i> , page 642.
	② Fabric on back		
	• Fabric price group 1	No cost	Specify fabric color number.
	• Fabric price group 2	+\$ 35	Specify fabric color number.
	• Fabric price group 3	+\$ 145	Specify fabric color number.
	• Fabric price group 4	+\$ 263	Specify fabric color number.
	• Fabric price group 5	+\$ 475	Specify fabric color number.
	• Fabric price group 6	+\$ 494	Specify fabric color number.
	• Fabric price group 7	+\$ 569	Specify fabric color number.
	• Fabric price group 8	+\$ 813	Specify fabric color number.
	• Fabric price group 9	+\$ 994	Specify fabric color number.
	• Fabric price group 10	+\$1040	Specify fabric color number.
	• Customer's Own Material (COM)	+\$ 27	▶ See <i>Understanding Customer's Own Material (COM)</i> , page 642.

Related Products	<ul style="list-style-type: none"> • Ottoman 	▶ Page 552
-------------------------	---	------------

Specification Information				
• Dimensions			• Style	• U.S.
D	W	H	Number	Base Price
32"	66"	29"	TS3BCW	\$4046

For Canadian Pricing
Multiply U.S. Price by the Canadian price factor.
▶ See page 1 for details.

Half Lounge

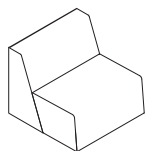

Standard Includes	Required to Specify
<ul style="list-style-type: none"> ▶ Need help? Product details, page 534 Fully upholstered armless lounge: fabric price group 1 Foot: black plastic Shipped fully assembled Meets Cal. 117 requirements 	<ul style="list-style-type: none"> 1 Style number 2 Fabric color number for upholstery 3 Options, if selected (see below) ▶ See <i>Surface Materials</i>, page 634.

Options	U.S. Price	Required to Specify
Surface Materials		
Single upholstery fabric		
• Fabric price group 1	No cost	Specify fabric color number.
• Fabric price group 2	+\$ 28	Specify fabric color number.
• Fabric price group 3	+\$101	Specify fabric color number.
• Fabric price group 4	+\$211	Specify fabric color number.
• Fabric price group 5	+\$376	Specify fabric color number.
• Fabric price group 6	+\$404	Specify fabric color number.
• Fabric price group 7	+\$427	Specify fabric color number.
• Fabric price group 8	+\$613	Specify fabric color number.
• Fabric price group 9	+\$714	Specify fabric color number.
• Fabric price group 10	+\$754	Specify fabric color number.
• Customer's Own Material (COM)	+\$ 56	Specify fabric color number.
Multiple upholstery fabric		
• Different fabric on seat and back	+\$ 93	Add suffix M to Half Lounge chair style number and select fabric color number for: 1 Seat, 2 Back

Tip: Campfire Lounges can be ordered as a single or multi-fabric upholstery.

Tip: When specifying multiple COM fabrics, indicate all surfaces where COM applies. Example: TS3HLM with Designtex 1234 on seat and Designtex 5678 on back.

- ① Fabric on seat**
 - Fabric price group 1 No cost
 - Fabric price group 2 +\$ 17
 - Fabric price group 3 +\$ 37
 - Fabric price group 4 +\$ 85
 - Fabric price group 5 +\$129
 - Fabric price group 6 +\$235
 - Fabric price group 7 +\$255
 - Fabric price group 8 +\$268
 - Fabric price group 9 +\$376
 - Fabric price group 10 +\$416
 - Customer's Own Material (COM) +\$ 27
- ② Fabric on back**
 - Fabric price group 1 No cost
 - Fabric price group 2 +\$ 24
 - Fabric price group 3 +\$ 78
 - Fabric price group 4 +\$144
 - Fabric price group 5 +\$255
 - Fabric price group 6 +\$263
 - Fabric price group 7 +\$279
 - Fabric price group 8 +\$427
 - Fabric price group 9 +\$460
 - Fabric price group 10 +\$465
 - Customer's Own Material (COM) +\$ 27

- Specify fabric color number.
- Specify fabric color number.
- Specify fabric color number.
- Specify fabric color number.
- Specify fabric color number.
- Specify fabric color number.
- Specify fabric color number.
- Specify fabric color number.
- Specify fabric color number.
- Specify fabric color number.
- ▶ See *Understanding Customer's Own Material (COM)*, page 642.
- Specify fabric color number.
- Specify fabric color number.
- Specify fabric color number.
- Specify fabric color number.
- Specify fabric color number.
- Specify fabric color number.
- Specify fabric color number.
- Specify fabric color number.
- Specify fabric color number.
- ▶ See *Understanding Customer's Own Material (COM)*, page 642.

Specification Information				
• Dimensions			• Style	• U.S.
D	W	H	Number	Base Price
32"	33"	29"	TS3HL	\$2325

For Canadian Pricing
Multiply U.S. Price by the Canadian price factor.
▶ See page 1 for details.

Lounges, continued

Half Lounge—Seam

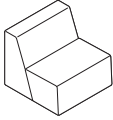

Tip: Seams are located at the top of the back and the front edge of the seat to match seams on Corner Lounges. Corner Lounges come standard with seams. Specify Big and Half Lounges with seams when creating an application with Corner Lounges to create a cohesive design aesthetic.

Tip: Campfire Lounges with seams can be ordered as a single or multi-fabric upholstery.

Tip: When specifying multiple COM fabrics, indicate all surfaces where COM applies. Example: TS3HLM with Designtex 1234 on seat and Designtex 5678 on back.

Tip: Order ganging brackets TS3GANGING to gang units together for more stable applications.

Standard Includes	Required to Specify
<ul style="list-style-type: none"> ▶ Need help? Product details, page 534 Fully upholstered armless lounge: fabric price group 1 Foot: black plastic Shipped fully assembled Meets Cal. 117 requirements 	<ul style="list-style-type: none"> 1 Style number 2 Fabric color number for upholstery 3 Options, if selected (see below) ▶ See <i>Surface Materials</i>, page 634.

Surface Materials	Options	U.S. Price	Required to Specify
	<p>Single upholstery fabric</p> <ul style="list-style-type: none"> Fabric price group 1 Fabric price group 2 Fabric price group 3 Fabric price group 4 Fabric price group 5 Fabric price group 6 Fabric price group 7 Fabric price group 8 Fabric price group 9 Fabric price group 10 Customer's Own Material (COM) 	<ul style="list-style-type: none"> No cost +\$ 28 +\$101 +\$211 +\$376 +\$404 +\$427 +\$613 +\$714 +\$754 +\$ 56 	<ul style="list-style-type: none"> Specify fabric color number. Specify fabric color number. Specify fabric color number. Specify fabric color number. Specify fabric color number. Specify fabric color number. Specify fabric color number. Specify fabric color number. Specify fabric color number. Specify fabric color number. ▶ See <i>Understanding Customer's Own Material (COM)</i>, page 642.
	<p>Multiple upholstery fabric</p> <ul style="list-style-type: none"> Different fabric on seat and back <p>1 Fabric on seat</p> <ul style="list-style-type: none"> Fabric price group 1 Fabric price group 2 Fabric price group 3 Fabric price group 4 Fabric price group 5 Fabric price group 6 Fabric price group 7 Fabric price group 8 Fabric price group 9 Fabric price group 10 Customer's Own Material (COM) <p>2 Fabric on back</p> <ul style="list-style-type: none"> Fabric price group 1 Fabric price group 2 Fabric price group 3 Fabric price group 4 Fabric price group 5 Fabric price group 6 Fabric price group 7 Fabric price group 8 Fabric price group 9 Fabric price group 10 Customer's Own Material (COM) 	<ul style="list-style-type: none"> +\$ 93 No cost +\$ 17 +\$ 37 +\$ 85 +\$129 +\$235 +\$255 +\$268 +\$376 +\$416 +\$ 27 No cost +\$ 24 +\$ 78 +\$144 +\$255 +\$263 +\$279 +\$427 +\$460 +\$465 +\$ 27 	<ul style="list-style-type: none"> Add suffix M to Half Lounge chair style number and select fabric color number for: 1 Seat, 2 Back Specify fabric color number. Specify fabric color number. Specify fabric color number. Specify fabric color number. Specify fabric color number. Specify fabric color number. Specify fabric color number. Specify fabric color number. Specify fabric color number. Specify fabric color number. ▶ See <i>Understanding Customer's Own Material (COM)</i>, page 642. Specify fabric color number. Specify fabric color number. Specify fabric color number. Specify fabric color number. Specify fabric color number. Specify fabric color number. Specify fabric color number. Specify fabric color number. Specify fabric color number. ▶ See <i>Understanding Customer's Own Material (COM)</i>, page 642.

Specification Information				
Dimensions			Style	U.S. Base Price
D	W	H	Number	
32"	33"	29"	TS3HLS	\$2352

For Canadian Pricing
Multiply U.S. Price by the Canadian price factor.
▶ See page 1 for details.

Half Lounge—Waterfall

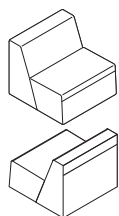

Tip: Waterfall seams are located at the top of the back, the front edge of the seat, 3½" below the front edge seam and 3½" below the top edge seam on the back of the lounge.

Tip: Campfire Lounges with waterfall upholstery can be ordered as a single or multi-fabric upholstery.

Tip: When specifying multiple COM fabrics, indicate all surfaces where COM applies. Example: TS3HLM with Designtex 1234 on seat and Designtex 5678 on back.

Tip: One thread color is used on waterfall lounges with multiple fabrics. The thread color used on the waterfall upholstery will be used on the entire unit.

Tip: Order ganging brackets TS3GANGING to gang units together for more stable applications.

Standard Includes	Required to Specify
<ul style="list-style-type: none"> ▶ Need help? Product details, page 534 Fully upholstered armless lounge: fabric price group 1 Foot: black plastic Shipped fully assembled Meets Cal. 117 requirements 	<ul style="list-style-type: none"> 1 Style number 2 Fabric color number for upholstery 3 Options, if selected (see below) ▶ See <i>Surface Materials</i>, page 634.

Surface Materials	Options	U.S. Price	Required to Specify
	Single upholstery fabric <ul style="list-style-type: none"> Fabric price group 1 Fabric price group 2 Fabric price group 3 Fabric price group 4 Fabric price group 5 Fabric price group 6 Fabric price group 7 Fabric price group 8 Fabric price group 9 Fabric price group 10 Customer's Own Material (COM) 	<ul style="list-style-type: none"> No cost +\$ 28 +\$101 +\$211 +\$376 +\$404 +\$427 +\$613 +\$714 +\$754 +\$ 56 	<ul style="list-style-type: none"> Specify fabric color number. Specify fabric color number. Specify fabric color number. Specify fabric color number. Specify fabric color number. Specify fabric color number. Specify fabric color number. Specify fabric color number. Specify fabric color number. Specify fabric color number. ▶ See <i>Understanding Customer's Own Material (COM)</i>, page 642.
	Multiple upholstery fabric <ul style="list-style-type: none"> Different fabric on seat and back 	<ul style="list-style-type: none"> +\$ 93 	<ul style="list-style-type: none"> Add suffix M to Half Lounge chair style number and select fabric color number for: 1 Seat, 2 Back
	① Fabric on seat <ul style="list-style-type: none"> Fabric price group 1 Fabric price group 2 Fabric price group 3 Fabric price group 4 Fabric price group 5 Fabric price group 6 Fabric price group 7 Fabric price group 8 Fabric price group 9 Fabric price group 10 Customer's Own Material (COM) 	<ul style="list-style-type: none"> No cost +\$ 21 +\$ 57 +\$111 +\$183 +\$239 +\$258 +\$336 +\$402 +\$426 +\$ 27 	<ul style="list-style-type: none"> Specify fabric color number. Specify fabric color number. Specify fabric color number. Specify fabric color number. Specify fabric color number. Specify fabric color number. Specify fabric color number. Specify fabric color number. Specify fabric color number. Specify fabric color number. ▶ See <i>Understanding Customer's Own Material (COM)</i>, page 642.
	② Fabric on back <ul style="list-style-type: none"> Fabric price group 1 Fabric price group 2 Fabric price group 3 Fabric price group 4 Fabric price group 5 Fabric price group 6 Fabric price group 7 Fabric price group 8 Fabric price group 9 Fabric price group 10 Customer's Own Material (COM) 	<ul style="list-style-type: none"> No cost +\$ 24 +\$ 69 +\$136 +\$225 +\$292 +\$315 +\$408 +\$492 +\$518 +\$ 27 	<ul style="list-style-type: none"> Specify fabric color number. Specify fabric color number. Specify fabric color number. Specify fabric color number. Specify fabric color number. Specify fabric color number. Specify fabric color number. Specify fabric color number. Specify fabric color number. Specify fabric color number. ▶ See <i>Understanding Customer's Own Material (COM)</i>, page 642.

Specification Information

• Dimensions			• Style	• U.S.
D	W	H	Number	Base Price
32"	33"	29"	TS3HLW	\$2394



For Canadian Pricing
Multiply U.S. Price by the Canadian price factor.
▶ See page 1 for details.

Lounges, continued

90° Corner Lounges

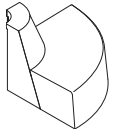
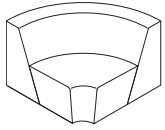

Tip: 90° Corner Lounges available inside or outside facing.

Tip: When creating an application using Big or Half Lounges, specify the Big and Half Lounges with a seam for a cohesive design aesthetic.

Tip: Campfire Corner Lounges can be ordered as a single or multi-fabric upholstery.

Tip: When specifying multiple COM fabrics, indicate all surfaces where COM applies. Example: TS3HLM with Designtex 1234 on seat and Designtex 5678 on back.

Tip: Order ganging brackets TS3GANGING to gang units together for more stable applications.

Standard Includes	Required to Specify
<ul style="list-style-type: none"> ▶ Need help? Product details, page 534 Fully upholstered armless corner lounge: fabric price group 1 Foot: black plastic Shipped fully assembled Meets Cal. 117 requirements 	<ul style="list-style-type: none"> 1 Style number 2 Fabric color number for upholstery 3 Options, if selected (see below) ▶ See <i>Surface Materials</i>, page 634.

Surface Materials	Options	U.S. Price	Required to Specify
	Single upholstery fabric		
	<ul style="list-style-type: none"> Fabric price group 1 Fabric price group 2 Fabric price group 3 Fabric price group 4 Fabric price group 5 Fabric price group 6 Fabric price group 7 Fabric price group 8 Fabric price group 9 Fabric price group 10 Customer's Own Material (COM) 	<ul style="list-style-type: none"> No cost +\$ 41 +\$ 159 +\$ 305 +\$ 544 +\$ 577 +\$ 637 +\$ 909 +\$1086 +\$1142 +\$ 56 	<ul style="list-style-type: none"> Specify fabric color number. Specify fabric color number. Specify fabric color number. Specify fabric color number. Specify fabric color number. Specify fabric color number. Specify fabric color number. Specify fabric color number. Specify fabric color number. Specify fabric color number. ▶ See <i>Understanding Customer's Own Material (COM)</i>, page 642.
	Multiple upholstery fabric		
	<ul style="list-style-type: none"> Different fabric on seat and back 	<ul style="list-style-type: none"> +\$ 93 	<ul style="list-style-type: none"> Add suffix M to Half Lounge chair style number and select fabric color number for: 1 Seat, 2 Back
	① Fabric on seat		
	<ul style="list-style-type: none"> Fabric price group 1 Fabric price group 2 Fabric price group 3 Fabric price group 4 Fabric price group 5 Fabric price group 6 Fabric price group 7 Fabric price group 8 Fabric price group 9 Fabric price group 10 Customer's Own Material (COM) 	<ul style="list-style-type: none"> No cost +\$ 22 +\$ 76 +\$ 141 +\$ 227 +\$ 343 +\$ 389 +\$ 452 +\$ 600 +\$ 647 +\$ 27 	<ul style="list-style-type: none"> Specify fabric color number. Specify fabric color number. Specify fabric color number. Specify fabric color number. Specify fabric color number. Specify fabric color number. Specify fabric color number. Specify fabric color number. Specify fabric color number. Specify fabric color number. ▶ See <i>Understanding Customer's Own Material (COM)</i>, page 642.
	② Fabric on back		
	<ul style="list-style-type: none"> Fabric price group 1 Fabric price group 2 Fabric price group 3 Fabric price group 4 Fabric price group 5 Fabric price group 6 Fabric price group 7 Fabric price group 8 Fabric price group 9 Fabric price group 10 Customer's Own Material (COM) 	<ul style="list-style-type: none"> No cost +\$ 31 +\$ 107 +\$ 198 +\$ 340 +\$ 360 +\$ 398 +\$ 586 +\$ 657 +\$ 674 +\$ 27 	<ul style="list-style-type: none"> Specify fabric color number. Specify fabric color number. Specify fabric color number. Specify fabric color number. Specify fabric color number. Specify fabric color number. Specify fabric color number. Specify fabric color number. Specify fabric color number. Specify fabric color number. ▶ See <i>Understanding Customer's Own Material (COM)</i>, page 642.



For Canadian Pricing
Multiply U.S. Price by the Canadian price factor.
▶ See page 1 for details.

Specification Information

Dimensions			Style	U.S.
D	W	H	Number	Base Price

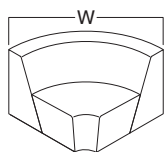

Inside Corner Lounge

32"	54½"	29"	TS3CRIN90S	\$2981
-----	------	-----	-------------------	--------

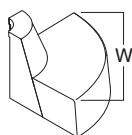

Outside Corner Lounge

32"	55¼"	29"	TS3CROUT90S	\$2981
-----	------	-----	--------------------	--------

 **For Canadian Pricing**
 Multiply U.S. Price by the Canadian price factor.
 ▶ See page 1 for details.

Lounges, continued

90° Corner Lounges—Waterfall

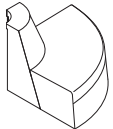
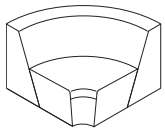

Tip: 90° Corner Lounges available inside or outside facing.

Tip: Waterfall seams are located at the top of the back, the front edge of the seat, 3½" below the front edge seam and 3½" below the top edge seam on the back of the lounge.

Tip: When creating an application using Big or Half Lounges, specify the Big and Half Lounges with a seam for a cohesive design aesthetic.

Tip: Campfire Corner Lounges with waterfall upholstery can be ordered as a single or multi-fabric upholstery.

Tip: When specifying multiple COM fabrics, indicate all surfaces where COM applies. Example: TS3HLM with Designtex 1234 on seat and Designtex 5678 on back.

Tip: One thread color is used on waterfall lounges with multiple fabrics. The thread color used on the waterfall upholstery will be used on the entire unit.

Tip: Order ganging brackets TS3GANGING to gang units together for more stable applications.

Standard Includes	Required to Specify
<ul style="list-style-type: none"> ▶ Need help? Product details, page 534 Fully upholstered armless corner lounge: fabric price group 1 Foot: black plastic Shipped fully assembled Meets Cal. 117 requirements 	<ul style="list-style-type: none"> 1 Style number 2 Fabric color number for upholstery 3 Options, if selected (see below) ▶ See <i>Surface Materials</i>, page 634.

Surface Materials	Options	U.S. Price	Required to Specify
	Single upholstery fabric		
	<ul style="list-style-type: none"> Fabric price group 1 Fabric price group 2 Fabric price group 3 Fabric price group 4 Fabric price group 5 Fabric price group 6 Fabric price group 7 Fabric price group 8 Fabric price group 9 Fabric price group 10 Customer's Own Material (COM) 	<ul style="list-style-type: none"> No cost +\$ 41 +\$ 159 +\$ 305 +\$ 544 +\$ 577 +\$ 637 +\$ 909 +\$1086 +\$1142 +\$ 56 	<ul style="list-style-type: none"> Specify fabric color number. Specify fabric color number. Specify fabric color number. Specify fabric color number. Specify fabric color number. Specify fabric color number. Specify fabric color number. Specify fabric color number. Specify fabric color number. Specify fabric color number. ▶ See <i>Understanding Customer's Own Material (COM)</i>, page 642.
	Multiple upholstery fabric		
	<ul style="list-style-type: none"> Different fabric on seat and back 	<ul style="list-style-type: none"> +\$ 93 	<ul style="list-style-type: none"> Add suffix M to Half Lounge chair style number and select fabric color number for: 1 Seat, 2 Back
	① Fabric on seat		
	<ul style="list-style-type: none"> Fabric price group 1 Fabric price group 2 Fabric price group 3 Fabric price group 4 Fabric price group 5 Fabric price group 6 Fabric price group 7 Fabric price group 8 Fabric price group 9 Fabric price group 10 Customer's Own Material (COM) 	<ul style="list-style-type: none"> No cost +\$ 25 +\$ 87 +\$ 164 +\$ 281 +\$ 329 +\$ 367 +\$ 498 +\$ 603 +\$ 637 +\$ 27 	<ul style="list-style-type: none"> Specify fabric color number. Specify fabric color number. Specify fabric color number. Specify fabric color number. Specify fabric color number. Specify fabric color number. Specify fabric color number. Specify fabric color number. Specify fabric color number. Specify fabric color number. ▶ See <i>Understanding Customer's Own Material (COM)</i>, page 642.
	② Fabric on back		
	<ul style="list-style-type: none"> Fabric price group 1 Fabric price group 2 Fabric price group 3 Fabric price group 4 Fabric price group 5 Fabric price group 6 Fabric price group 7 Fabric price group 8 Fabric price group 9 Fabric price group 10 Customer's Own Material (COM) 	<ul style="list-style-type: none"> No cost +\$ 31 +\$ 107 +\$ 201 +\$ 344 +\$ 402 +\$ 448 +\$ 610 +\$ 739 +\$ 777 +\$ 27 	<ul style="list-style-type: none"> Specify fabric color number. Specify fabric color number. Specify fabric color number. Specify fabric color number. Specify fabric color number. Specify fabric color number. Specify fabric color number. Specify fabric color number. Specify fabric color number. Specify fabric color number. ▶ See <i>Understanding Customer's Own Material (COM)</i>, page 642.



For Canadian Pricing
Multiply U.S. Price by the Canadian price factor.
▶ See page 1 for details.

Specification Information

Dimensions			Style	U.S.
D	W	H	Number	Base Price

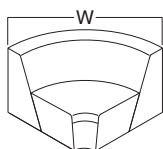

Inside Corner Lounge

32"	54½"	29"	TS3CRIN90W	\$3023
-----	------	-----	-------------------	--------



Outside Corner Lounge

32"	55¼"	29"	TS3CROUT90W	\$3023
-----	------	-----	--------------------	--------



For Canadian Pricing
 Multiply U.S. Price by the
 Canadian price factor.
 ▶ See page 1 for details.

Lounges, continued

60° Corner Lounges

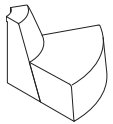
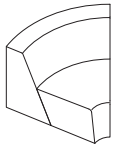

Tip: 60° Corner Lounges available inside or outside facing.

Tip: When creating an application using Big or Half Lounges, specify the Big and Half Lounges with a seam for a cohesive design aesthetic.

Tip: Campfire Corner Lounges can be ordered as a single or multi-fabric upholstery.

Tip: When specifying multiple COM fabrics, indicate all surfaces where COM applies. Example: TS3HLM with Designtex 1234 on seat and Designtex 5678 on back.

Tip: Order ganging brackets TS3GANGING to gang units together for more stable applications.

Standard Includes	Required to Specify
<ul style="list-style-type: none"> ▶ Need help? Product details, page 534 Fully upholstered armless corner lounge: fabric price group 1 Foot: black plastic Shipped fully assembled Meets Cal. 117 requirements 	<ul style="list-style-type: none"> 1 Style number 2 Fabric color number for upholstery 3 Options, if selected (see below) ▶ See <i>Surface Materials</i>, page 634.

Surface Materials	Options	U.S. Price	Required to Specify
	Single upholstery fabric		
	• Fabric price group 1	No cost	Specify fabric color number.
	• Fabric price group 2	+\$ 36	Specify fabric color number.
	• Fabric price group 3	+\$ 141	Specify fabric color number.
	• Fabric price group 4	+\$ 273	Specify fabric color number.
	• Fabric price group 5	+\$ 483	Specify fabric color number.
	• Fabric price group 6	+\$ 513	Specify fabric color number.
	• Fabric price group 7	+\$ 566	Specify fabric color number.
	• Fabric price group 8	+\$ 807	Specify fabric color number.
	• Fabric price group 9	+\$ 967	Specify fabric color number.
	• Fabric price group 10	+\$1018	Specify fabric color number.
	• Customer's Own Material (COM)	+\$ 56	▶ See <i>Understanding Customer's Own Material (COM)</i> , page 642.

	Multiple upholstery fabric		
	• Different fabric on seat and back	+\$ 93	Add suffix M to Half Lounge chair style number and select fabric color number for: 1 Seat, 2 Back
	① Fabric on seat		
	• Fabric price group 1	No cost	Specify fabric color number.
	• Fabric price group 2	+\$ 21	Specify fabric color number.
	• Fabric price group 3	+\$ 66	Specify fabric color number.
	• Fabric price group 4	+\$ 126	Specify fabric color number.
	• Fabric price group 5	+\$ 202	Specify fabric color number.
	• Fabric price group 6	+\$ 306	Specify fabric color number.
	• Fabric price group 7	+\$ 348	Specify fabric color number.
	• Fabric price group 8	+\$ 401	Specify fabric color number.
	• Fabric price group 9	+\$ 535	Specify fabric color number.
	• Fabric price group 10	+\$ 576	Specify fabric color number.
	• Customer's Own Material (COM)	+\$ 27	▶ See <i>Understanding Customer's Own Material (COM)</i> , page 642.
	② Fabric on back		
	• Fabric price group 1	No cost	Specify fabric color number.
	• Fabric price group 2	+\$ 27	Specify fabric color number.
	• Fabric price group 3	+\$ 96	Specify fabric color number.
	• Fabric price group 4	+\$ 174	Specify fabric color number.
	• Fabric price group 5	+\$ 303	Specify fabric color number.
	• Fabric price group 6	+\$ 320	Specify fabric color number.
	• Fabric price group 7	+\$ 356	Specify fabric color number.
	• Fabric price group 8	+\$ 519	Specify fabric color number.
	• Fabric price group 9	+\$ 585	Specify fabric color number.
	• Fabric price group 10	+\$ 598	Specify fabric color number.
	• Customer's Own Material (COM)	+\$ 27	▶ See <i>Understanding Customer's Own Material (COM)</i> , page 642.



For Canadian Pricing

Multiply U.S. Price by the Canadian price factor.

▶ See page 1 for details.

Specification Information

Dimensions			Style	U.S.
D	W	H	Number	Base Price

Inside Corner Lounge

32"	38½"	29"	TS3CRIN60S	\$2650
-----	------	-----	-------------------	--------

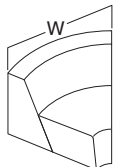

Outside Corner Lounge

32"	39¼"	29"	TS3CROUT60S	\$2650
-----	------	-----	--------------------	--------



For Canadian Pricing
 Multiply U.S. Price by the
 Canadian price factor.
 ▶ See page 1 for details.

60° Corner Lounges—Waterfall

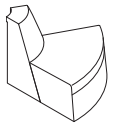
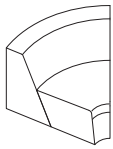

Tip: 60° Corner Lounges available inside or outside facing.

Tip: Waterfall seams are located at the top of the back, the front edge of the seat, 3½" below the front edge seam and 3½" below the top edge seam on the back of the lounge.

Tip: When creating an application using Big or Half Lounges, specify the Big and Half Lounges with a seam for a cohesive design aesthetic.

Tip: Campfire Corner Lounges with waterfall upholstery can be ordered as a single or multi-fabric upholstery.

Tip: When specifying multiple COM fabrics, indicate all surfaces where COM applies. Example: TS3HLM with Designtex 1234 on seat and Designtex 5678 on back.

Tip: One thread color is used on waterfall lounges with multiple fabrics. The thread color used on the waterfall upholstery will be used on the entire unit.

Tip: Order ganging brackets TS3GANGING to gang units together for more stable applications.

Standard Includes	Required to Specify
<ul style="list-style-type: none"> ▶ Need help? Product details, page 534 Fully upholstered armless corner lounge: fabric price group 1 Foot: black plastic Shipped fully assembled Meets Cal. 117 requirements 	<ul style="list-style-type: none"> 1 Style number 2 Fabric color number for upholstery 3 Options, if selected (see below) ▶ See <i>Surface Materials</i>, page 634.

Surface Materials	Options	U.S. Price	Required to Specify
	Single upholstery fabric		
	<ul style="list-style-type: none"> Fabric price group 1 Fabric price group 2 Fabric price group 3 Fabric price group 4 Fabric price group 5 Fabric price group 6 Fabric price group 7 Fabric price group 8 Fabric price group 9 Fabric price group 10 Customer's Own Material (COM) 	<ul style="list-style-type: none"> No cost +\$ 36 +\$ 141 +\$ 273 +\$ 483 +\$ 513 +\$ 566 +\$ 807 +\$ 967 +\$1018 +\$ 56 	<ul style="list-style-type: none"> Specify fabric color number. Specify fabric color number. Specify fabric color number. Specify fabric color number. Specify fabric color number. Specify fabric color number. Specify fabric color number. Specify fabric color number. Specify fabric color number. Specify fabric color number. Specify fabric color number. ▶ See <i>Understanding Customer's Own Material (COM)</i>, page 642.
	Multiple upholstery fabric		
	<ul style="list-style-type: none"> Different fabric on seat and back 	<ul style="list-style-type: none"> +\$ 93 	<ul style="list-style-type: none"> Add suffix M to Half Lounge chair style number and select fabric color number for: 1 Seat, 2 Back
	① Fabric on seat		
	<ul style="list-style-type: none"> Fabric price group 1 Fabric price group 2 Fabric price group 3 Fabric price group 4 Fabric price group 5 Fabric price group 6 Fabric price group 7 Fabric price group 8 Fabric price group 9 Fabric price group 10 Customer's Own Material (COM) 	<ul style="list-style-type: none"> No cost +\$ 23 +\$ 78 +\$ 144 +\$ 250 +\$ 292 +\$ 327 +\$ 444 +\$ 538 +\$ 566 +\$ 27 	<ul style="list-style-type: none"> Specify fabric color number. Specify fabric color number. Specify fabric color number. Specify fabric color number. Specify fabric color number. Specify fabric color number. Specify fabric color number. Specify fabric color number. Specify fabric color number. Specify fabric color number. Specify fabric color number. ▶ See <i>Understanding Customer's Own Material (COM)</i>, page 642.
	② Fabric on back		
	<ul style="list-style-type: none"> Fabric price group 1 Fabric price group 2 Fabric price group 3 Fabric price group 4 Fabric price group 5 Fabric price group 6 Fabric price group 7 Fabric price group 8 Fabric price group 9 Fabric price group 10 Customer's Own Material (COM) 	<ul style="list-style-type: none"> No cost +\$ 27 +\$ 96 +\$ 177 +\$ 307 +\$ 358 +\$ 398 +\$ 543 +\$ 659 +\$ 693 +\$ 27 	<ul style="list-style-type: none"> Specify fabric color number. Specify fabric color number. Specify fabric color number. Specify fabric color number. Specify fabric color number. Specify fabric color number. Specify fabric color number. Specify fabric color number. Specify fabric color number. Specify fabric color number. Specify fabric color number. ▶ See <i>Understanding Customer's Own Material (COM)</i>, page 642.



For Canadian Pricing
Multiply U.S. Price by the Canadian price factor.
▶ See page 1 for details.

Specification Information

Dimensions			Style	U.S.
D	W	H	Number	Base Price



Inside Corner Lounge

32"	38½"	29"	TS3CRIN60W	\$2692
-----	------	-----	-------------------	--------



Outside Corner Lounge

32"	39¼"	29"	TS3CROUT60W	\$2692
-----	------	-----	--------------------	--------

Ganging Brackets



Standard Includes **Required to Specify**

- | | |
|--|--|
| <ul style="list-style-type: none"> • Set of two ganging brackets: black plastic • Hardware kit | <ul style="list-style-type: none"> • Style number |
|--|--|

Related Products

- Corner Lounges ▶ Pages 544–550

Specification Information

Style Number	U.S. Price
--------------	------------

TS3GANGING	\$76
-------------------	------

For Canadian Pricing
 Multiply U.S. Price by the Canadian price factor.
 ▶ See page 1 for details.

Ottoman



Standard Includes	Required to Specify
<ul style="list-style-type: none"> ▶ Need help? Product details, page 534 Fully upholstered Ottoman: fabric price group 1 Four adjustable-height legs: brushed aluminum Meets Cal. 117 requirements 	<ul style="list-style-type: none"> 1 Style number 2 Fabric color number for upholstery 3 Options, if selected (see below) ▶ See <i>Surface Materials</i>, page 634.

Options	U.S. Price	Required to Specify
<p>Surface Materials</p> <p>Upholstery</p> <ul style="list-style-type: none"> Fabric price group 1 Fabric price group 2 Fabric price group 3 Fabric price group 4 Fabric price group 5 Fabric price group 6 Fabric price group 7 Fabric price group 8 Fabric price group 9 Fabric price group 10 Customer's Own Material (COM) <p>Legs</p> <ul style="list-style-type: none"> Solid round wood legs 	<ul style="list-style-type: none"> No cost +\$ 23 +\$ 61 +\$ 92 +\$114 +\$141 +\$168 +\$216 +\$265 +\$303 +\$ 55 <ul style="list-style-type: none"> +\$233 	<ul style="list-style-type: none"> Specify fabric color number. Specify fabric color number. Specify fabric color number. Specify fabric color number. Specify fabric color number. Specify fabric color number. Specify fabric color number. Specify fabric color number. Specify fabric color number. Specify fabric color number. ▶ See <i>Understanding Customer's Own Material (COM)</i>, page 642. <ul style="list-style-type: none"> Specify <i>with solid round wood legs</i> and select V1AC Natural Cherry, V1AM Clear Maple, or V1EW Dark Walnut.
<p>Glides</p> <ul style="list-style-type: none"> Low profile glide 	<ul style="list-style-type: none"> No cost 	<ul style="list-style-type: none"> Specify <i>with low profile glides</i>.

Tip: Wood legs are natural wood and may show variations in grain and color.

Tip: The Ottoman must be specified with low profile glides.

Specification Information	
Style Number	U.S. Base Price
TS34401	\$775



For Canadian Pricing
 Multiply U.S. Price by the Canadian price factor.
 ▶ See page 1 for details.

Pouf



Standard Includes		Required to Specify
<ul style="list-style-type: none"> ▶ Need help? Product details, page 534 	<ul style="list-style-type: none"> Upholstered body: fabric price group 1 Base: black plastic Handle: nylon Glides: plastic Ships fully assembled 	<ol style="list-style-type: none"> Style number Fabric color number for body Nylon color number for handle: <ul style="list-style-type: none"> 5JG0 Black 5JG1 Burgundy 5JG2 Taupe 5JG3 Silver 5JG4 Teal 5JG5 Red 5JG6 Pacific Blue Options, if selected (see below) <ul style="list-style-type: none"> ▶ See <i>Surface Materials</i>, page 634.

Options	U.S. Price	Required to Specify
Surface Materials <ul style="list-style-type: none"> Upholstery <ul style="list-style-type: none"> Fabric price group 1 Fabric price group 5 Customer's Own Material (COM) Contrasting stitching <ul style="list-style-type: none"> No contrast stitching Contrast stitching 	<ul style="list-style-type: none"> No cost +\$112 +\$ 56 No cost +\$ 41 	<ul style="list-style-type: none"> Specify fabric color number. Specify fabric color number. ▶ See <i>Understanding Customer's Own Material (COM)</i>, page 642. Specify with <i>no contrast stitching</i>. Specify with <i>contrasting stitching</i> and specify color number. ▶ See <i>Surface Materials</i>, page 634.

Tip: Contrast stitching will be 138 weight thread. Thread is normal weight when no contrast stitching is selected.

Tip: Pouf is designed to support weights up to 225 pounds.

Specification Information				
Dimensions			Style Number	U.S. Base Price
D	W	H		
15"	15"	18"	TS4PF	\$642



For Canadian Pricing
 Multiply U.S. Price by the Canadian price factor.
 ▶ See page 1 for details.

Wedge

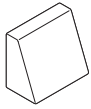

Tip: Wedge connects only to Big or Half Lounge, not corner lounges.

Standard Includes	Required to Specify
<ul style="list-style-type: none"> ▶ Need help? Product details, page 534 • Fully upholstered Wedge: fabric price group 1 • Foot: black plastic • Deck stitch detail • Connecting hardware 	<ul style="list-style-type: none"> 1 Style number 2 Fabric color number for upholstery 3 Options, if selected (see below) ▶ See <i>Surface Materials</i>, page 634.

Surface Materials	Upholstery	U.S. Price	Required to Specify
	<ul style="list-style-type: none"> • Fabric price group 1 • Fabric price group 2 • Fabric price group 3 • Fabric price group 4 • Fabric price group 5 • Fabric price group 6 • Fabric price group 7 • Fabric price group 8 • Fabric price group 9 • Fabric price group 10 • Customer's Own Material (COM) 	<ul style="list-style-type: none"> No cost +\$ 23 +\$ 61 +\$104 +\$162 +\$268 +\$340 +\$376 +\$441 +\$500 +\$ 56 	<ul style="list-style-type: none"> Specify fabric color number. Specify fabric color number. Specify fabric color number. Specify fabric color number. Specify fabric color number. Specify fabric color number. Specify fabric color number. Specify fabric color number. Specify fabric color number. Specify fabric color number. ▶ See <i>Understanding Customer's Own Material (COM)</i>, page 642.

Specification Information	
Style Number	U.S. Base Price
TS3WG	\$1408
.	.
.	.



For Canadian Pricing
 Multiply U.S. Price by the Canadian price factor.
 ▶ See page 1 for details.

Footrest



Standard Includes		Required to Specify
▶ Need help? Product details, page 537	<ul style="list-style-type: none"> Footrest: grey expanded polypropylene foam Band: 3 mm plastic 	1 Style number 2 Plastic color number for band ▶ See <i>Surface Materials</i> , page 634.

Related Products	
<ul style="list-style-type: none"> Big Lounge Half Lounge 	▶ Page 538 ▶ Page 541

Specification Information				
Dimensions			Style Number	U.S. Price
D	W	H		
16 ⁵ / ₈ "	16 ¹ / ₄ "	11"	TS3FR	\$308

Screens ✕10/24

Standard Includes		Required to Specify
▶ Need help? Product details, page 537	<ul style="list-style-type: none"> Screen: mesh Frame: 0835 Black paint Ships ready to assemble 	1 Style number 2 Fabric color number for mesh screen ▶ See <i>Surface Materials</i> , page 634.

Related Products	
<ul style="list-style-type: none"> Big Lamp Big Lounge 	▶ See <i>Conference and Collaborative Tables Specification Guide</i> . ▶ Page 538

Specification Information		
Height	Style Number	U.S. Price
54"	TS4TSCRNR ✕10/24	\$1454

Screens

Right-Hand

54"	TS4TSCRNR ✕10/24	\$1454
-----	--	--------

Left-Hand

54"	TS4TSCRNL ✕10/24	\$1454
-----	--	--------

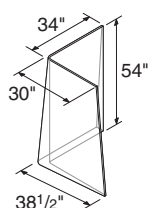
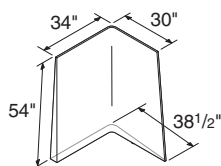

✕10/24 = Last order entry
October 20, 2024



Understanding and Specifying B-Free Lounge Seating

Product Details

B-Free Collection	558
B-Free Beams	560
B-Free Standing-Height Tables	564
B-Free Standing-Height Table Power Matrix	566
Thought Starters	568

Specifying

Large Cubes	574
Small Cube	575
Ganging Brackets	576
Screens	577
Screen Magnets	578
Occasional Tables	579
Large Beam, Aluminum Legs	580
Large Beam, Wood Legs	581
Small Beam, Aluminum Legs	582
Small Beam, Wood Legs	583
Standing-Height Tables	584

B-Free Collection

The B-Free collection

is a full range of furniture including modular lounges, knit screens, occasional tables, and standing-height tables aimed to design flexible, easily reconfigurable casual and convenient settings where teams can collaborate. Its modular design creates settings that support the individual and group work. B-Free beam and standing-height work table promote creativity and collaboration.

B-Free screens in knit

offer subtle privacy and promote concentration. Screens are available in small and large sizes with left or right applications in a variety of colors. Magnets allow screens to connect to another screen or connect to the large cube.

Occasional tables are available in coffee and corner configurations. They can be placed in between cubes, in front of cubes, on the side of cubes as an end table, or act as a corner piece with a screen configuration.

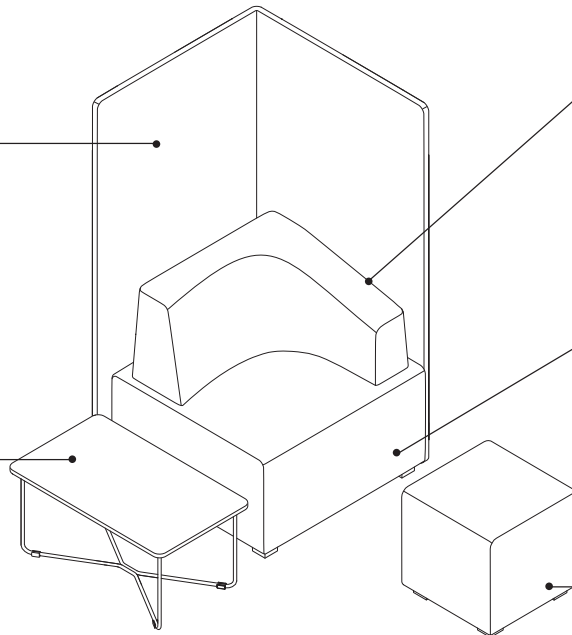

Lounge top block is contoured and sculpted to provide comfort for multiple postures. Top block is available on the large cube with either a straight application or a corner left or right application. Shown is a corner left application.

Large cubes can be standalone units or ganged together with other large cube units.

Small cube is both a seat and an ottoman. It can be specified with glides or casters.

B-Free Beams

B-Free beam encourages postural changes ranging from sit, perch, and stand, promoting wellbeing through movement while boosting creative thinking and engagement. Pair the beam with the B-Free standing height table which share the same leg design to elevate any team setting, creating a relaxed and informal atmosphere for dynamic collaboration to flourish.

Footrests are painted aluminum with option to contrast the footrest from the leg finish.

Legs are available in finished solid wood or painted aluminum.

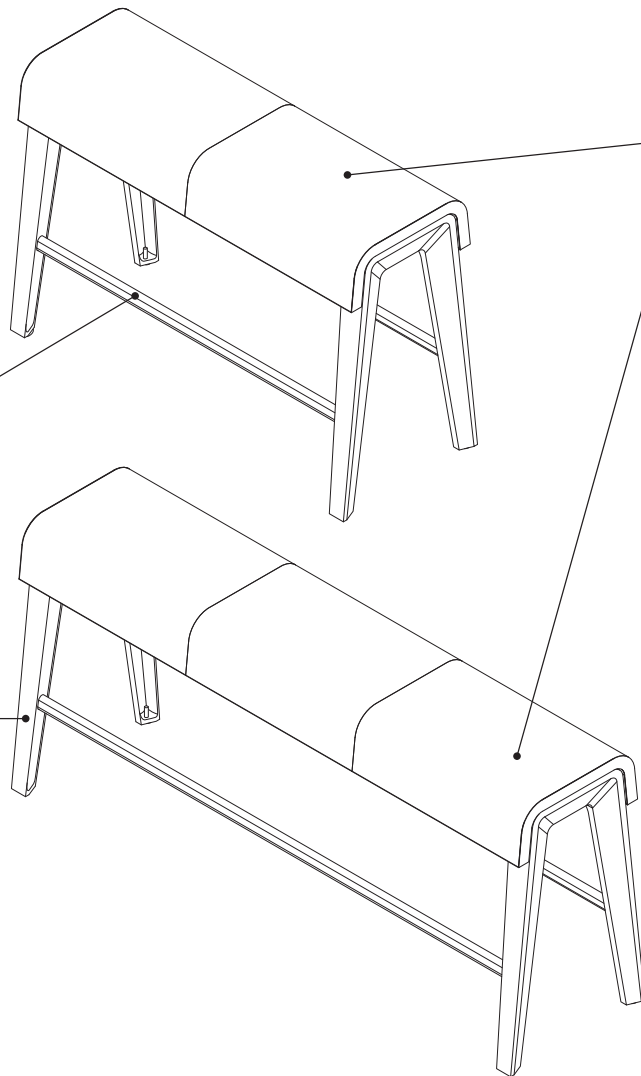

B-Free beams are available as a large three seater or a small two seater.

Actual Dimensions

	Depth	Width	Height	Seat Depth
Large cube	29½"	31"	17⅛"	N.A.
Large cube with top block	29½"	31"	31½"	19"
Small cube	16¾"	16¾"	17⅛"	N.A.
Screen (small)	30½"	32"	59"	N.A.
Screen (large)	30½"	40⅞"	59"	N.A.
Coffee table	29½"	17¾"	15⅛"	N.A.
Corner table	29½"	29½"	15⅛"	N.A.
Large beam	16¾"	63"	28⅜"	14¼"
Small beam	16¾"	47¼"	28⅜"	14¼"

Product Details

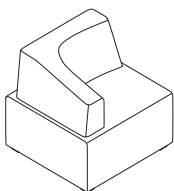

Corner left and right options on large cube integrate as armrests. The backrest is shaped to “wrap” around the user, providing greater lumbar support.



Ganging brackets are discreet and allow cubes to be well aligned when attached together.

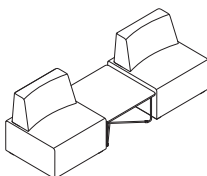

The corner occasional table can be used as a corner piece and/or to bridge together two large cubes. It also fits perfectly next to the cube and inside of the privacy screen, or works well out front.

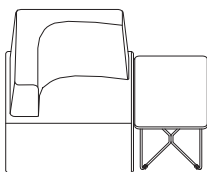

The coffee occasional table fits perfectly next to the cube and works well out in front of the cube.

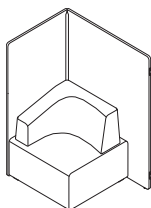

Left and right screens are decided based on the user seated position in the cube lounge in front of a large screen. The small side of the screen is on the arm side of the cube. The large side of the screen goes behind the cube. Shown above is a large, right screen application.

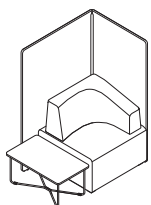

The large screen surrounds the cube and part of a coffee table.

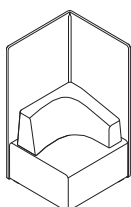

The small screen fits perfectly around the cube.

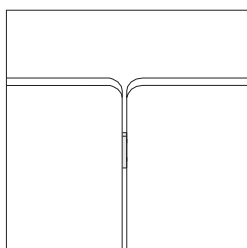

Screen to screen magnets come in a pair and attach two screens together.

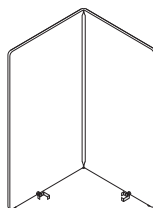

Screen to large cube magnets come in a pair and attach to the bottom of the screen and to the bottom of the large cube.

B-Free screens were designed for stationary use. The screens may be moved when lifted and carried. They are not designed to be dragged.

Surface Materials

Cube and top block

- Fabric
- Leather
- Elmosoft leather
- Select Surfaces leather
- Vinyl
- COL
- COM

Occasional tables

- Top
 - Laminate
 - Veneer

Frame

- Paint
- Lux Coatings
- Accent paints
- PerfectMatch

Beam

- Seat
 - Fabric
 - Leather
 - Elmosoft Leather
 - Select Surfaces Leather
 - Vinyl
 - COL
 - COM

Aluminum legs

- Paint
- Coatings
- Lux Coatings
- Accent paints
- PerfectMatch

Wood legs

- 3860 Espresso
- 3861 Natural Beech

Footrest

- Paint
- Coatings
- Lux Coatings
- Accent paints
- PerfectMatch

Screen

- B-Free Knit
 - 5Y30 White
 - 5Y31 Sky
 - 5Y32 Ice
 - 5Y33 Teal Blue
 - 5Y34 Tangerine
 - 5Y35 Paprika
 - 5Y36 Leaf
 - 5Y37 Chartreuse
 - 5Y38 Lime
 - 5Y39 Silver
 - 5Y40 Currant
 - 5Y41 Red Mittens
 - 5Y42 Hot Pink
 - 5Y58 Light Grey
 - 5Y99 Dark Grey

For more information on Select Surfaces, please refer to the *Surface Materials Reference Manual*.

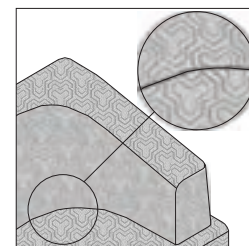

Solid, non-repeat fabrics are recommended for B-Free cube lounge settings because of the unique geometric shapes. Steelcase will not pattern match fabrics which have a distinct repeating pattern. It is recommended to use one of the standard fabrics, vinyls, leathers, or non-patterned COM/COL.

B-Free Beam, continued

Upholstery

Fabric Application

Warp horizontal application is the standard application direction for B-Free beam. Horizontal application for this product means that the warp yarns will run along the long end of the beam. If you would like the warp yarns to run parallel to the short end of the beam, specify the direction as warp vertical.

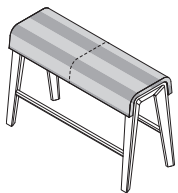

Warp Horizontal
(Railroaded)

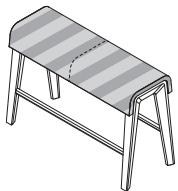

Warp Vertical (Woven way)

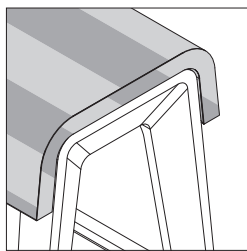

Pattern matching is not guaranteed on B-Free beam between top and end pieces.

Large Beam

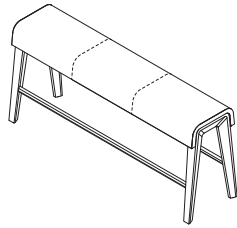

Large beam stitched seams are included on the end of the beam and across the beam, separating the seats.

Small Beam

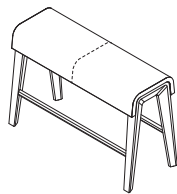

Small beam stitched seams are included on the ends of the beams and through the center of the beam, separating the seats.

Programs & Services

► See the *Surface Materials Reference Manual* for further detail about programs and services offered for seating.

The Customer's Own Material (COM) Program

offers the opportunity for customers to select fabrics that are not offered through the standard Steelcase surface materials program for use on Steelcase products. Through the COM program, Steelcase will test your materials for application on Steelcase products. Once approved, you can place your order. Steelcase will facilitate the entire ordering process and give you a production schedule. Steelcase will order the COM fabric directly from the textile manufacturer. For up-to-date information regarding fabric test results for all COM fabrics and details regarding yardage requirements for most Seating lines, visit the COM website. To locate the COM website:

- Visit www.steelcase.com

Soil retardants are treatments that provide long-term soil and stain resistance to a fabric without affecting the shade or the integrity of the fabric. The following Steelcase Textiles are available pre-treated with soil retardant. (You do not need to select the soil-retardant option for these fabrics and incur the upcharge.)

- Jacks
- Link

For information on soil retardant fabrics on Select Surfaces, please refer to the *Surface Materials Reference Manual*.

Soil-retardant treatment is available on all other seating fabrics at an additional upcharge per seating unit. To order this option, please select "Soil-Retardant Treatment" under "Optional Accessories."

For soil-retardant treatment on COMs, please select "Soil-Retardant Treatment" under "Optional Accessories." Minimums or additional yardage may be required. Please contact the vendor directly for specific information. Extended lead times may be necessary for this service.

Contact your Steelcase Solutions Fulfillment Team Representative at 1.888.STEELCASE (1.888.783.3522) or send an email to lineone@steelcase.com.

B-Free Standing-Height Tables

B-Free rectangle and pint tables make it easy to leverage in-between space across the entire floor plan and create effective workspaces for people to come together and collaborate. Tables support standing and high-sit postures encouraging postural changes while promoting wellbeing through movement and boosting creative thinking and engagement. Pair the B-Free standing-height table with the beam which share the same leg design to elevate any team setting, creating a relaxed and informal atmosphere for dynamic collaboration to flourish.

Tables are 39 1/2" H.

Top is 1" thick with High-Pressure Laminate or veneer and black backer. Laminate tops have 3 mm edge band on all sides. Edge band color is selectable for laminate tops. Veneer tops have 3 mm wood edge that matches the veneer top finish selection.

Rectangle tops have square corners.

Pint tops have square corners on the wide end of the table and 2" (50 mm) radius edges on the short end of the table. The pint table has standard dimensions of 32"D (short end: leg width 23 1/4"), 44"D (wide end: leg width 31") x 80"W.

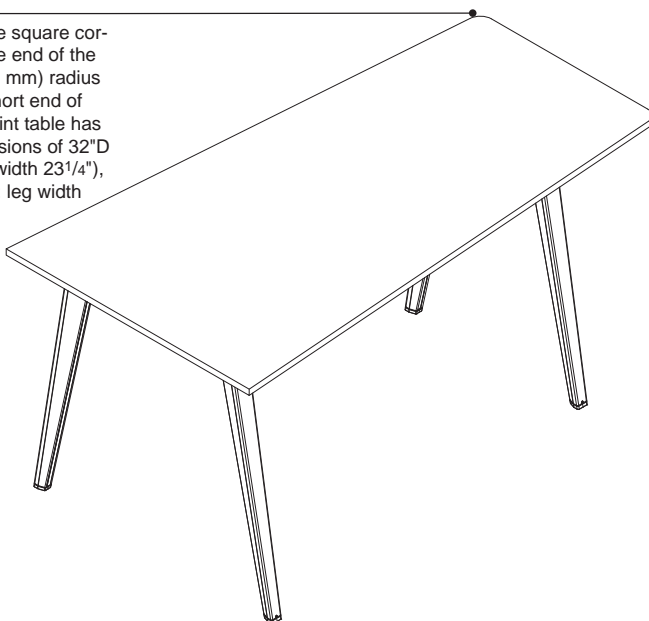
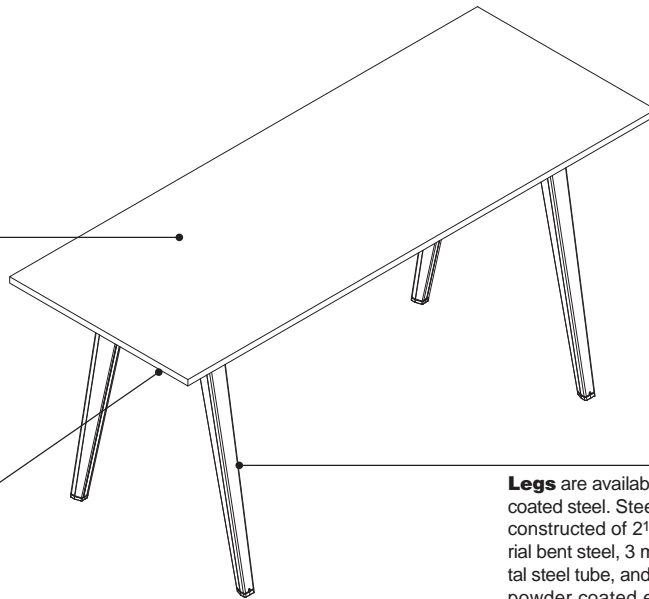

Product Details

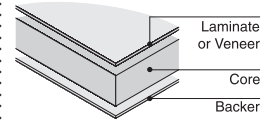

Solid core tops with 1" nominal edge thickness have a particle board core (45 lb cu ft density) with High-Pressure Laminate or wood veneer on the top and a backer applied to the opposite side for a balanced construction. High-Pressure Laminate, wood veneer, and backer are bonded to the core with a PVA adhesive.

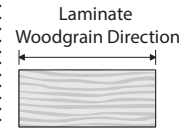

Woodgrain laminates are always oriented with the grain direction running parallel with the length of the table top. You cannot specify woodgrain laminates with end- or side-matched grain directions.



Woodgrain runs parallel to the length on rectangle and pint tops.

Legs are available in powder coated steel. Steel legs are constructed of 2 1/2 mm material bent steel, 3 mm horizontal steel tube, and 3 mm thick powder coated epoxy resin paint.

Legs ship standard with four glides.

- Steel leg table: 5/8" glide adjustment range

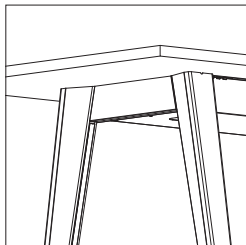
Wiring and Cabling**Steel leg profile**

Steel leg tables include integrated wire manager and merle cover in the leg.

Horizontal steel beam, located in the middle of the legs, is constructed of 1¹/₄ mm bent steel and powder coated epoxy resin paint.

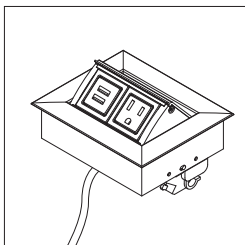
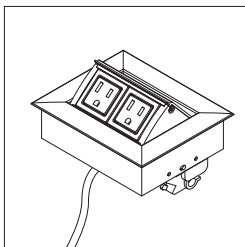

MhoB is a 4" x 5" flip-top power module that mounts at the top surface of the table and can be configured in different power/USB configurations:

- Two receptacles for power
- One power/one dual USB

Single/dual power and USB solutions come standard with a 15-amp, one-circuit power solution with a 10' cord.

► See *Power Matrix* on page 566 for available options and power module locations.

MhoB, one power module, is located 10" from the short end of the table; on the centerline of the width/depth specified.

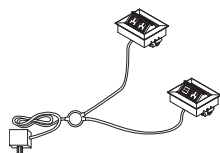

MhoB, two power modules (center or both ends), are connected by a corded system with just one infeed.

Surface Materials**Top**

- High-Pressure Laminate (standard)
- Open Line laminate (option)
- Wood veneer (option)
- Customiz stain (option)

Edge

- Plastic on laminate top
- Wood veneer to match veneer top

Steel legs

- Accent paint
- Paint
- Lux Coatings
- PerfectMatch

Wood legs

- 3860 Espresso
- 3861 Natural Beech

Power modules

- Paint

B-Free Standing-Height Table Power Matrix

Power Configuration	48"W	60"W	66"W	72"W	84"W
No Power	24"D 25"D 26"D				
One Power Module	24"D 25"D 26"D				
Two Power Modules	24"D 25"D 26"D				
No Power	32"D 33"D 34"D				
One Power Module	32"D 33"D 34"D				
Two Power Modules	32"D 33"D 34"D	<i>Tip: Center power position is only available on tables that are at least 32"D x 66"W.</i> 			
Two Power Modules	32"D 33"D 34"D	<i>Tip: Power on both ends is only available on tables that are at least 70"W.</i> 			

Tip: Center and two end power position options will default to two power modules, one with two receptacles for power and one with one receptacle for power/one dual USB port.

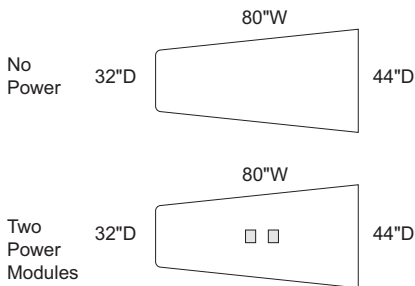

Key

- One Power Module
1 Power/1 USB-A or 2 Power
- Two Power Modules
Kit includes 2 modules: 1 Power/1 USB-A,
1 Power/1 USB-A and 2 Power

Standard MhoB Power Module Locations

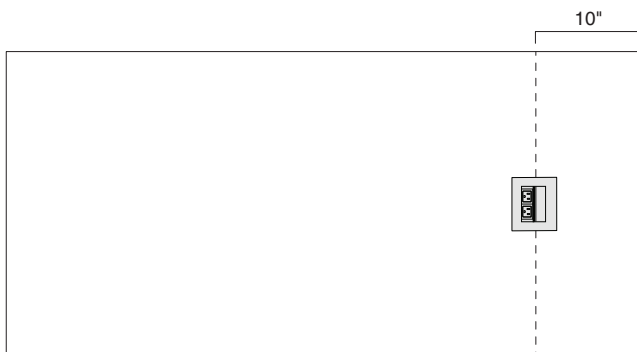

For the power option with one end only, the centerline of the power module is located 10" from the short edge of the table. Power module flips toward the center of the top.



For the power option with both ends, the centerline of each power module is located 10" from the short edge of the table. Power module flips toward the center of the top.

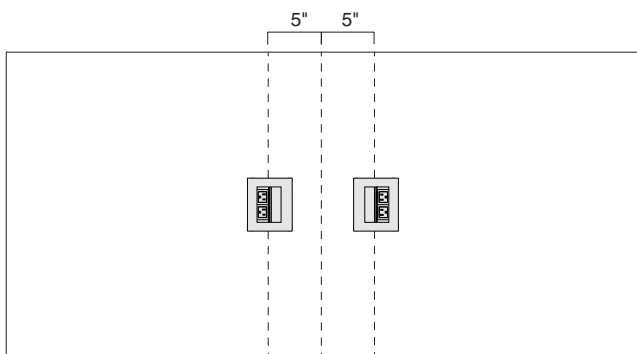

For the center power option, the centerline of each power module is located 5" from the centerline of the table. Power module flips toward the short edge of the top.

Thought Starters

B-Free

Individual Focus with Shielded Boundary

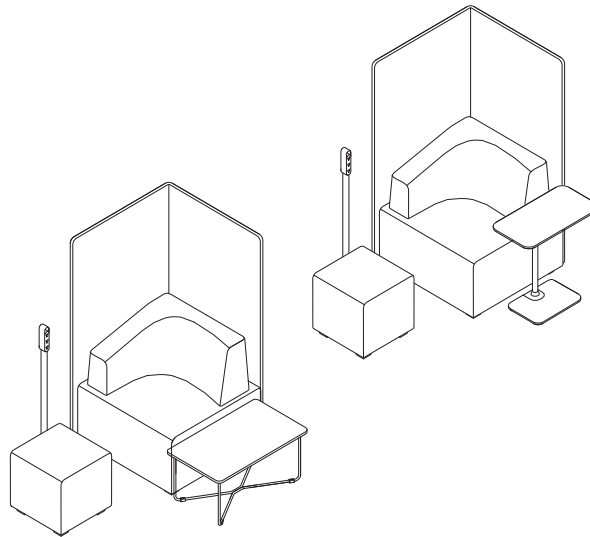

Quantity	Style Number	Description	Options	Page for Ordering
2	N3LCUBEL	Large cube	Corner right	▶ Page 574
2	N3LCUBES	Small cube		▶ Page 575
2	N3LSCREEN	Small screen	Connecting magnets, cube	▶ Page 577
1	N3LTABLECF	Coffee table		▶ Page 579
1	COLAGTP	Lagunitas personal table		▶ See <i>Coalesce Tables, Storage, and Accessories Specification Guide</i> .
2	PFLHUB	Thread power hub		▶ See <i>Architectural Solutions Specification Guide</i> .

Relaxed Collaboration Together, but Distanced

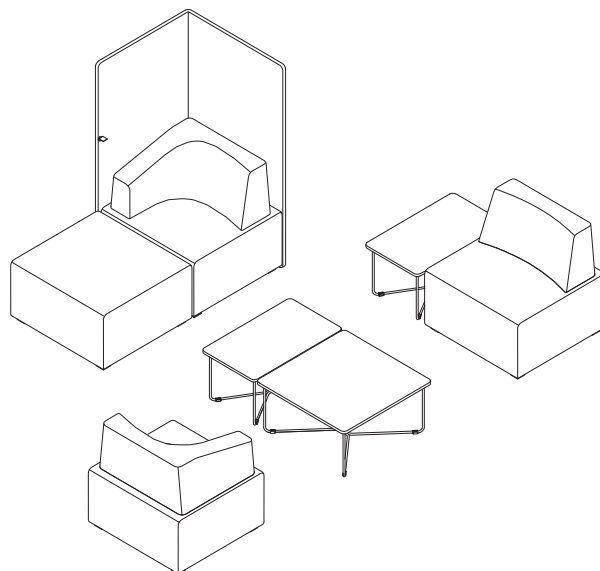

Quantity	Style Number	Description	Options	Page for Ordering
1	N3LCUBEL	Large cube	Straight back	▶ Page 574
1	N3LCUBEL	Large cube		▶ Page 574
2	N3LCUBEL	Large cube	Corner top block	▶ Page 574
2	N3LTABLECF	Coffee table		▶ Page 579
1	N3LTABLECR	Corner table		▶ Page 579
1	N3LSCREEN	Small screen		▶ Page 577

Social Lounge

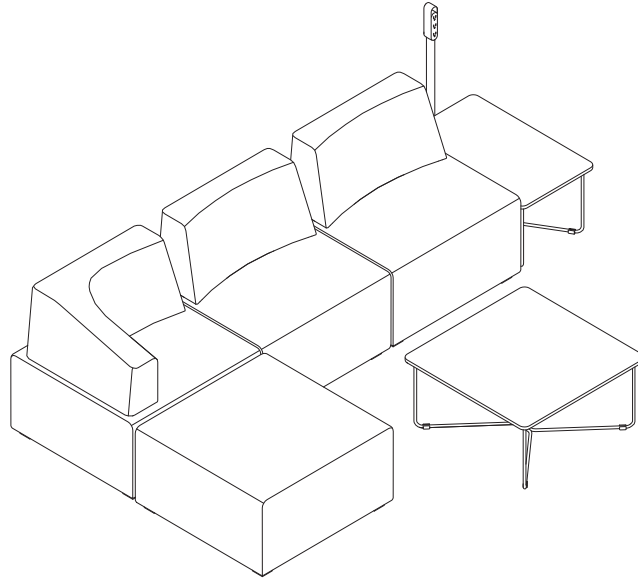

Quantity	Style Number	Description	Options	Page for Ordering
1	N3LCUBEL	Large cube	Corner right	▶ Page 574
1	N3LCUBEL	Large cube		▶ Page 574
2	N3LCUBEL	Large cube	Straight	▶ Page 574
1	N3LGA	Brackets		▶ Page 576
1	N3LTABLECF	Coffee table		▶ Page 579
1	N3LTABLECR	Corner table		▶ Page 579
1	PFLHUB	Thread power hub		▶ See <i>Architectural Solutions Specification Guide</i> .

Agile Informal Team Space

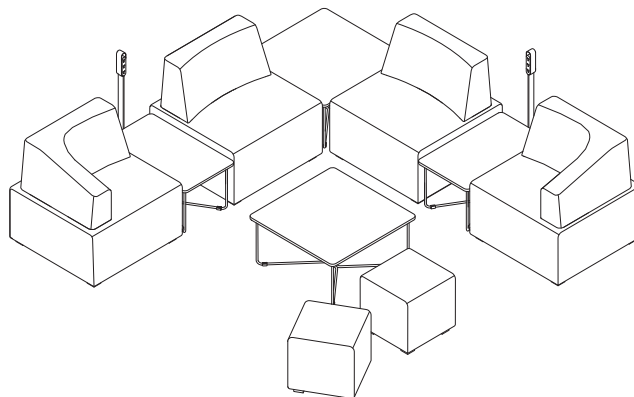

Quantity	Style Number	Description	Options	Page for Ordering
1	N3LCUBEL	Large cube	Corner left	▶ Page 574
1	N3LCUBEL	Large cube	Corner right	▶ Page 574
2	N3LCUBEL	Large cube	Straight	▶ Page 574
2	N3LCUBES	Small cube		▶ Page 575
2	N3LTABLECF	Coffee table		▶ Page 579
2	N3LTABLECR	Corner table		▶ Page 579
2	PFLHUB	Thread power hub		▶ See <i>Architectural Solutions Specification Guide</i> .

Collaboration

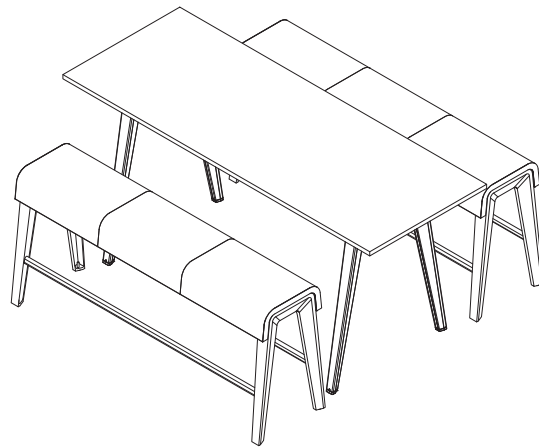

Quantity	Style Number	Description	Page for Ordering
2	N3LBA1600	Large beam, aluminum legs	▶ Page 580
1	N3LRECT	Rectangle table	▶ Page 584

Collaboration, continued

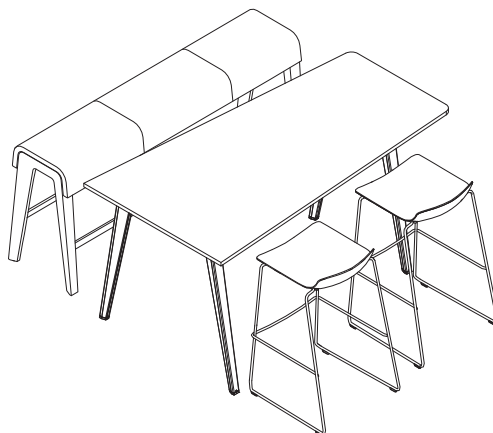

Quantity	Style Number	Description	Page for Ordering
2	WHG6625	Nooi bar-height stool	▶ Page 424
1	N3LPINT	Pint table, wood legs	▶ Page 586
1	N3LBW1600	Large beam, wood legs	▶ Page 581

B-Free Large Cube

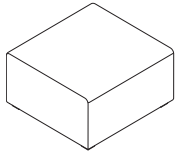

Tip: Large cube with top block has a height of 31½".

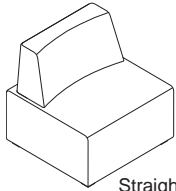

Straight

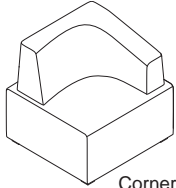

Corner left

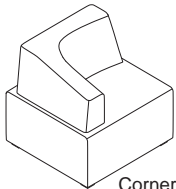

Corner right

Tip: Cubes do not ship with ganging brackets. Ganging brackets, N3LGA, need to be ordered separately.
▶ See page 576

Standard Includes		Required to Specify
▶ Need help? Product details, page 558	<ul style="list-style-type: none"> • Large cube: fabric • Plastic, hard glides • Shipped fully assembled 	<ol style="list-style-type: none"> 1 Style number 2 Fabric color number for cube 3 Top block, see below under Required Selections 4 Options, if selected (see below) <p>▶ See <i>Surface Materials</i>, page 634.</p>

Required Selections	U.S. Price	Required to Specify
Top Block		
• No top block	No cost	Specify <i>with no top block</i> .
• Straight	+\$ 725	Specify <i>with straight top block</i> .
• Corner left	+\$ 800	Specify <i>with corner left top block</i> .
• Corner right	+\$ 800	Specify <i>with corner right top block</i> .

Options	U.S. Price	Required to Specify
Surface Materials		
Cube		
• Fabric price group 1	No cost	Specify fabric color number.
• Fabric price group 2	+\$ 68	Specify fabric color number.
• Fabric price group 3	+\$ 126	Specify fabric color number.
• Fabric price group 4	+\$ 179	Specify fabric color number.
• Fabric price group 5	+\$ 222	Specify fabric color number.
• Fabric price group 6	+\$ 277	Specify fabric color number.
• Fabric price group 7	+\$ 315	Specify fabric color number.
• Fabric price group 8	+\$ 398	Specify fabric color number.
• Fabric price group 9	+\$ 489	Specify fabric color number.
• Fabric price group 10	+\$ 558	Specify fabric color number.
• Steelcase vinyl	+\$ 59	Specify vinyl color number.
• Steelcase leather upholstery	+\$ 907	Specify leather color number.
• Select Surfaces leather price group 1	+\$ 907	▶ See <i>Surface Materials Reference Manual</i> . Specify Elmosoft leather color number.
• Elmosoft leather upholstery	+\$1179	▶ See <i>Surface Materials Reference Manual</i> .
• Select Surfaces leather price group 2	+\$1179	▶ See <i>Surface Materials Reference Manual</i> .
• Customer's Own Material (COM)	No cost	▶ See <i>Surface Materials Reference Manual</i> .
• Customer's Own Leather (COL)	+\$ 109	▶ See <i>Surface Materials Reference Manual</i> .

Top block		
• Fabric price group 1	No cost	Specify fabric color number.
• Fabric price group 2	+\$ 36	Specify fabric color number.
• Fabric price group 3	+\$ 69	Specify fabric color number.
• Fabric price group 4	+\$ 97	Specify fabric color number.
• Fabric price group 5	+\$ 120	Specify fabric color number.
• Fabric price group 6	+\$ 147	Specify fabric color number.
• Fabric price group 7	+\$ 172	Specify fabric color number.
• Fabric price group 8	+\$ 217	Specify fabric color number.
• Fabric price group 9	+\$ 266	Specify fabric color number.
• Fabric price group 10	+\$ 304	Specify fabric color number.
• Steelcase vinyl	+\$ 36	Specify vinyl color number.
• Steelcase leather upholstery	+\$ 512	Specify leather color number.
• Select Surfaces leather price group 1	+\$ 512	▶ See <i>Surface Materials Reference Manual</i> . Specify Elmosoft leather color number.
• Elmosoft leather upholstery	+\$ 665	▶ See <i>Surface Materials Reference Manual</i> .
• Select Surfaces leather price group 2	+\$ 665	▶ See <i>Surface Materials Reference Manual</i> .
• Customers Own Material (COM)	No cost	▶ See <i>Surface Materials Reference Manual</i> .
• Customers Own Leather (COL)	+\$ 109	▶ See <i>Surface Materials Reference Manual</i> .
Soil-retardant treatment	+\$ 36	Specify <i>with soil-retardant treatment</i> .
Glide		
• Soft glide	+\$ 7	Specify <i>with soft glides</i> .

Specification Information				
Dimensions			Style	U.S. Base
D	W	H	Number	Price

29½" 31" 17⅛" **N3LCUBEL** \$1409



For Canadian Pricing
Multiply U.S. Price by the Canadian price factor.
▶ See page 1 for details.

B-Free Small Cube

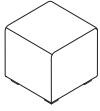

Standard Includes	Required to Specify
<ul style="list-style-type: none"> ▶ Need help? Product details, page 558 • Small cube: fabric • Plastic, hard glides 	<ul style="list-style-type: none"> 1 Style number 2 Fabric color number for cube 3 Options, if selected (see below) ▶ See <i>Surface Materials</i>, page 634.

Options	U.S. Price	Required to Specify
Surface Materials		
Cube		
• Fabric price group 1	No cost	Specify fabric color number.
• Fabric price group 2	+\$ 36	Specify fabric color number.
• Fabric price group 3	+\$ 69	Specify fabric color number.
• Fabric price group 4	+\$ 97	Specify fabric color number.
• Fabric price group 5	+\$120	Specify fabric color number.
• Fabric price group 6	+\$147	Specify fabric color number.
• Fabric price group 7	+\$172	Specify fabric color number.
• Fabric price group 8	+\$217	Specify fabric color number.
• Fabric price group 9	+\$266	Specify fabric color number.
• Fabric price group 10	+\$304	Specify fabric color number.
• Steelcase vinyl	+\$ 36	Specify vinyl color number.
• Steelcase leather upholstery	+\$512	Specify leather color number.
• Select Surfaces leather price group 1	+\$512	▶ See <i>Surface Materials Reference Manual</i> .
• Elmosoft leather upholstery	+\$665	Specify Elmosoft leather color number.
• Select Surfaces leather price group 2	+\$665	▶ See <i>Surface Materials Reference Manual</i> .
• Customer's Own Material (COM)	No cost	▶ See <i>Surface Materials Reference Manual</i> .
• Customer's Own Leather (COL)	+\$109	▶ See <i>Surface Materials Reference Manual</i> .
Soil-retardant treatment		
	+\$ 36	Specify with soil-retardant treatment.
Casters/Glides		
• Soft glides	+\$ 7	Specify with soft glides.
• Soft casters	+\$ 36	Specify with soft casters.
• Hard casters	+\$ 74	Specify with hard casters.

Specification Information				
• Dimensions			• Style	• U.S.
D	W	H	Number	Base Price
16¾"	16¾"	17½"	N3LCUBES	\$717

B-Free

For Canadian Pricing
 Multiply U.S. Price by the Canadian price factor.
 ▶ See page 1 for details.

B-Free Ganging Brackets



Standard Includes		Required to Specify
▶ Need help? Product details, page 560	• 10 ganging brackets	Style number

Related Products	
• B-Free large cube	▶ Page 574
• B-Free small cube	▶ Page 575

Specification Information	
Style Number	U.S. Price
N3LGA	\$28
.	.
.	.



For Canadian Pricing
 Multiply U.S. Price by the
 Canadian price factor.
 ▶ See page 1 for details.

B-Free Screens

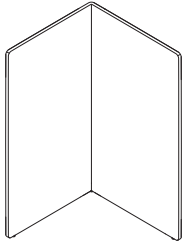

Tip: Small, right application screen is pictured above.

Tip: When moving a screen, it is recommended that two people lift and carry it, one on either side to avoid dragging.

Standard Includes		Required to Specify
<ul style="list-style-type: none"> ▶ Need help? Product details, page 558 	<ul style="list-style-type: none"> • Screen: steel tubular frame with a polyester cover: knit • Plastic, adjustable glides 	<ul style="list-style-type: none"> 1 Style number 2 Knit color number for screen 3 Options, if selected (see below)

Options	U.S. Price	Required to Specify
Screen Width <ul style="list-style-type: none"> • Small (32"W) • Large (40⁷/₈"W) 	Prices below Prices below	Specify with <i>small screen</i> . Specify with <i>large screen</i> .
Application <ul style="list-style-type: none"> • Left application • Right application 	No cost No cost	Specify with <i>left application</i> . Specify with <i>right application</i> .
Connecting Magnets <ul style="list-style-type: none"> • No connecting magnets • Connecting magnets, screen • Connecting magnets, cube • Connecting magnets, screen and cube 	No cost +\$ 36 +\$ 72 +\$106	Specify with <i>no magnets</i> . Specify with <i>screen magnets</i> . Specify with <i>cube magnets</i> . Specify with <i>screen and cube magnets</i> .

Specification Information

Dimensions		Style Number	U.S. Base Prices	
D	H		Small 32"W	Large 40 ⁷ / ₈ "W
30 ¹ / ₂ "	59"	N3LSCREEN	\$1294	\$1366

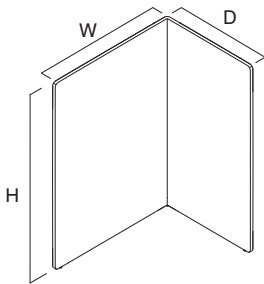

Tip: Large, left application screen is pictured above.

B-Free



For Canadian Pricing
 Multiply U.S. Price by the Canadian price factor.
 ▶ See page 1 for details.

B-Free Screen Magnets

Standard Includes	Required to Specify
<ul style="list-style-type: none"> ▶ Need help? Product details, page 558 • Pair of magnets 	<ul style="list-style-type: none"> Style number

Specification Information	
• Style Number	• U.S. Price
:	:
:	:

Screen to Screen

N3LMAGSS \$34

:

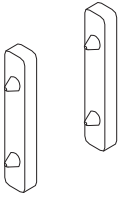

Screen to Large Cube

N3LMAGSC \$69

:

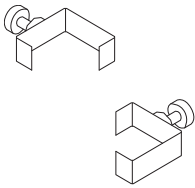

 **For Canadian Pricing**
 Multiply U.S. Price by the Canadian price factor.
 ▶ See page 1 for details.

B-Free Occasional Tables

B-Free

Standard Includes	Required to Specify
<ul style="list-style-type: none"> ▶ Need help? Product details, page 558 Table: High-Pressure Laminate price group 1 surface with plastic edge profile 12 mm steel wire and 1½ mm thick steel tube base: paint Fitted with four merle plastic glides clipped onto the framework Shipped ready to assemble 	<ol style="list-style-type: none"> Style number Laminate color number for table Paint color number for base Options, if selected (see below) <p>▶ See <i>Surface Materials</i>, page 634.</p>

For laminate price group 2 and 3 pricing, please refer to the electronic catalog or SmartTools.

Options	U.S. Price	Required to Specify
Surface Materials High-Pressure Laminate surface <ul style="list-style-type: none"> Laminate price group 2 Laminate price group 3 Open Line laminate 	See information at left See information at left +\$ 102	Specify laminate color number. Specify laminate color number. ▶ See <i>Surface Materials Reference Manual</i> .
Wood veneer surface <ul style="list-style-type: none"> Wood group 1 Wood group 2 Wood group 3 Customiz stain Full-fill finish on wood group 1 	+\$ 775 +\$ 877 +\$1133 +\$ 775 +\$ 877	Specify wood color number. Specify wood color number. Specify wood color number. Specify <i>with Customiz stain</i> . Specify full-fill finish number.
Base <ul style="list-style-type: none"> Paint price group 1 Paint price group 2 Paint price group 3 	No cost +\$ 77 +\$ 147	Specify paint color number. Specify paint color number. Specify paint color number.

Specification Information				
Dimensions			Style	U.S.
D	W	H	Number	Base Price

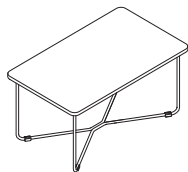

Coffee Table				
29½"	17¾"	15½"	N3LTABLECF	\$705

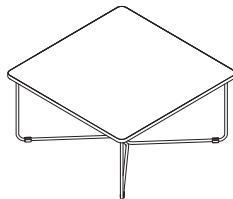

Corner Table				
29½"	29½"	15½"	N3LTABLECR	\$847

 **For Canadian Pricing**
 Multiply U.S. Price by the Canadian price factor.
 ▶ See page 1 for details.

B-Free Large Beam, Aluminum Legs

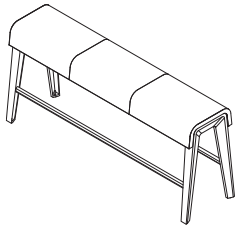

Standard Includes		Required to Specify
<ul style="list-style-type: none"> ▶ Need help? Product details, page 560 	<ul style="list-style-type: none"> • Seat: fabric price group 1 • Legs: paint price group 1 • Footrest: paint price group 1 • Soft felt glides 	<ol style="list-style-type: none"> 1 Style number 2 Fabric color number for seat 3 Paint color number for legs 4 Paint color number for footrest 5 Options, if selected (see below) <ul style="list-style-type: none"> ▶ See <i>Surface Materials</i>, page 633.

Options	U.S. Price	Required to Specify
Surface Materials Seat upholstery <ul style="list-style-type: none"> • Fabric price group 1 • Fabric price group 2 • Fabric price group 3 • Fabric price group 4 • Fabric price group 5 • Fabric price group 6 • Fabric price group 7 • Fabric price group 8 • Fabric price group 9 • Fabric price group 10 • Steelcase vinyl • Steelcase leather • Select Surfaces leather price group 1 • Elmosoft leather • Select Surfaces leather price group 2 • Customer's Own Material (COM) • Customer's Own Leather (COL) 	<ul style="list-style-type: none"> No cost +\$ 68 +\$ 129 +\$ 180 +\$ 223 +\$ 279 +\$ 317 +\$ 402 +\$ 494 +\$ 561 +\$ 59 +\$ 915 +\$ 915 +\$1186 +\$1186 No cost +\$ 107 	<ul style="list-style-type: none"> Specify fabric color number. Specify fabric color number. Specify fabric color number. Specify fabric color number. Specify fabric color number. Specify fabric color number. Specify fabric color number. Specify fabric color number. Specify fabric color number. Specify fabric color number. Specify vinyl color number. Specify leather color number. ▶ See <i>Surface Materials Reference Manual</i>. Specify Elmosoft leather color number. ▶ See <i>Surface Materials Reference Manual</i>. ▶ See <i>Surface Materials Reference Manual</i>. ▶ See <i>Surface Materials Reference Manual</i>.
Legs <ul style="list-style-type: none"> • Paint price group 1 • Paint price group 2 • Paint price group 3 	<ul style="list-style-type: none"> No cost +\$ 74 +\$ 146 	<ul style="list-style-type: none"> Specify paint color number. Specify paint color number. Specify paint color number.
Footrest <ul style="list-style-type: none"> • Paint price group 1 • Paint price group 2 • Paint price group 3 	<ul style="list-style-type: none"> No cost +\$ 74 +\$ 146 	<ul style="list-style-type: none"> Specify paint color number. Specify paint color number. Specify paint color number.

Specification Information				
• Dimensions			• Style	• U.S. Base
D	W	H	Number	Price
16¾"	63"	28⅜"	N3LBA1600	\$2346



For Canadian Pricing
 Multiply U.S. Price by the Canadian price factor.
 ▶ See page 1 for details.

B-Free Large Beam, Wood Legs

B-Free Large Beam,
Wood Legs

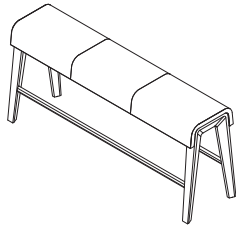

Standard Includes	Required to Specify
<ul style="list-style-type: none"> ▶ Need help? Product details, page 560 • Seat: fabric price group 1 • Legs: wood group 1 • Footrest: paint price group 1 • Soft felt glides 	<ol style="list-style-type: none"> 1 Style number 2 Fabric color number for seat 3 Wood color number for legs: <ul style="list-style-type: none"> 3860 Espresso 3861 Natural 4 Paint color number for footrest 5 Options, if selected (see below) <p>▶ See <i>Surface Materials</i>, page 633.</p>

Options	U.S. Price	Required to Specify
<p>Surface Materials</p> <p>Seat upholstery</p> <ul style="list-style-type: none"> • Fabric price group 1 • Fabric price group 2 • Fabric price group 3 • Fabric price group 4 • Fabric price group 5 • Fabric price group 6 • Fabric price group 7 • Fabric price group 8 • Fabric price group 9 • Fabric price group 10 • Steelcase vinyl • Steelcase leather • Select Surfaces leather price group 1 • Elmosoft leather • Select Surfaces leather price group 2 • Customer's Own Material (COM) • Customer's Own Leather (COL) <p>Footrest</p> <ul style="list-style-type: none"> • Paint price group 1 • Paint price group 2 • Paint price group 3 	<p>No cost</p> <p>+\$ 68</p> <p>+\$ 129</p> <p>+\$ 180</p> <p>+\$ 223</p> <p>+\$ 279</p> <p>+\$ 317</p> <p>+\$ 402</p> <p>+\$ 494</p> <p>+\$ 561</p> <p>+\$ 59</p> <p>+\$ 915</p> <p>+\$ 915</p> <p>+\$1186</p> <p>+\$1186</p> <p>No cost</p> <p>+\$ 107</p> <p>No cost</p> <p>+\$ 74</p> <p>+\$ 146</p>	<p>Specify fabric color number.</p> <p>Specify fabric color number.</p> <p>Specify fabric color number.</p> <p>Specify fabric color number.</p> <p>Specify fabric color number.</p> <p>Specify fabric color number.</p> <p>Specify fabric color number.</p> <p>Specify fabric color number.</p> <p>Specify fabric color number.</p> <p>Specify vinyl color number.</p> <p>Specify leather color number.</p> <p>▶ See <i>Surface Materials Reference Manual</i>. Specify Elmosoft leather color number.</p> <p>▶ See <i>Surface Materials Reference Manual</i>.</p> <p>▶ See <i>Surface Materials Reference Manual</i>.</p> <p>▶ See <i>Surface Materials Reference Manual</i>.</p> <p>Specify paint color number.</p> <p>Specify paint color number.</p> <p>Specify paint color number.</p>

Specification Information				
Dimensions			Style	U.S. Base
D	W	H	Number	Price
16 ³ / ₄ "	63"	28 ³ / ₈ "	N3LBW1600	\$2346

B-Free

 **For Canadian Pricing**
Multiply U.S. Price by the Canadian price factor.
▶ See page 1 for details.

B-Free Small Beam, Aluminum Legs

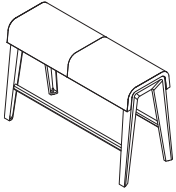

Standard Includes		Required to Specify
<ul style="list-style-type: none"> ▶ Need help? Product details, page 560 	<ul style="list-style-type: none"> • Seat: fabric price group 1 • Legs: paint price group 1 • Footrest: paint price group 1 • Soft felt glides 	<ol style="list-style-type: none"> 1 Style number 2 Fabric color number for seat 3 Paint color number for legs 4 Paint color number for footrest finish 5 Options, if selected (see below) <ul style="list-style-type: none"> ▶ See <i>Surface Materials</i>, page 633.

Options	U.S. Price	Required to Specify
Surface Materials Seat upholstery <ul style="list-style-type: none"> • Fabric price group 1 • Fabric price group 2 • Fabric price group 3 • Fabric price group 4 • Fabric price group 5 • Fabric price group 6 • Fabric price group 7 • Fabric price group 8 • Fabric price group 9 • Fabric price group 10 • Steelcase vinyl • Steelcase leather • Select Surfaces leather price group 1 • Elmosoft leather • Select Surfaces leather price group 2 • Customer's Own Material (COM) • Customer's Own Leather (COL) 	<ul style="list-style-type: none"> No cost +\$ 47 +\$ 85 +\$123 +\$153 +\$189 +\$220 +\$276 +\$340 +\$386 +\$ 47 +\$652 +\$652 +\$845 +\$845 No cost +\$107 	<ul style="list-style-type: none"> Specify fabric color number. Specify fabric color number. Specify fabric color number. Specify fabric color number. Specify fabric color number. Specify fabric color number. Specify fabric color number. Specify fabric color number. Specify fabric color number. Specify fabric color number. Specify vinyl color number. Specify leather color number. ▶ See <i>Surface Materials Reference Manual</i>. Specify Elmosoft leather color number. ▶ See <i>Surface Materials Reference Manual</i>. ▶ See <i>Surface Materials Reference Manual</i>. ▶ See <i>Surface Materials Reference Manual</i>.
Legs <ul style="list-style-type: none"> • Paint price group 1 • Paint price group 2 • Paint price group 3 	<ul style="list-style-type: none"> No cost +\$ 74 +\$146 	<ul style="list-style-type: none"> Specify paint color number. Specify paint color number. Specify paint color number.
Footrest <ul style="list-style-type: none"> • Paint price group 1 • Paint price group 2 • Paint price group 3 	<ul style="list-style-type: none"> No cost +\$ 74 +\$146 	<ul style="list-style-type: none"> Specify paint color number. Specify paint color number. Specify paint color number.

Specification Information				
Dimensions			Style	U.S. Base
D	W	H	Number	Price
16¾"	47¼"	28⅜"	N3LBA1200	\$2123



For Canadian Pricing
 Multiply U.S. Price by the Canadian price factor.
 ▶ See page 1 for details.

B-Free Small Beam, Wood Legs

B-Free Small Beam,
Wood Legs

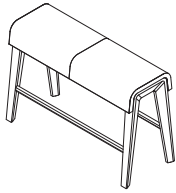

Standard Includes		Required to Specify
<ul style="list-style-type: none"> ▶ Need help? Product details, page 560 	<ul style="list-style-type: none"> • Seat: fabric price group 1 • Legs: wood price group 1 • Footrest: paint price group 1 • Soft felt glides 	<ol style="list-style-type: none"> 1 Style number 2 Fabric color number for seat 3 Wood color number for legs: <ul style="list-style-type: none"> 3860 Espresso 3861 Natural 4 Paint color number for footrest finish 5 Options, if selected (see below) <ul style="list-style-type: none"> ▶ See <i>Surface Materials</i>, page 633.

Options	U.S. Price	Required to Specify
Surface Materials Seat upholstery <ul style="list-style-type: none"> • Fabric price group 1 • Fabric price group 2 • Fabric price group 3 • Fabric price group 4 • Fabric price group 5 • Fabric price group 6 • Fabric price group 7 • Fabric price group 8 • Fabric price group 9 • Fabric price group 10 • Steelcase vinyl • Steelcase leather • Select Surfaces leather price group 1 • Elmosoft leather • Select Surfaces leather price group 2 • Customer's Own Material (COM) • Customer's Own Leather (COL) 	<ul style="list-style-type: none"> No cost +\$ 47 +\$ 85 +\$123 +\$153 +\$189 +\$220 +\$276 +\$340 +\$386 +\$ 47 +\$652 +\$652 +\$845 +\$845 No cost +\$107 	<ul style="list-style-type: none"> Specify fabric color number. Specify fabric color number. Specify fabric color number. Specify fabric color number. Specify fabric color number. Specify fabric color number. Specify fabric color number. Specify fabric color number. Specify fabric color number. Specify fabric color number. Specify vinyl color number. Specify leather color number. ▶ See <i>Surface Materials Reference Manual</i>. Specify Elmosoft leather color number. ▶ See <i>Surface Materials Reference Manual</i>. ▶ See <i>Surface Materials Reference Manual</i>. ▶ See <i>Surface Materials Reference Manual</i>.
Footrest <ul style="list-style-type: none"> • Paint price group 1 • Paint price group 2 • Paint price group 3 	<ul style="list-style-type: none"> No cost +\$ 74 +\$146 	<ul style="list-style-type: none"> Specify paint color number. Specify paint color number. Specify paint color number.

Specification Information				
Dimensions			Style	U.S. Base
D	W	H	Number	Price
16¾"	47¼"	28⅜"	N3LBW1 200	\$2123

 **For Canadian Pricing**
 Multiply U.S. Price by the Canadian price factor.
 ▶ See page 1 for details.

B-Free

B-Free Standing-Height Tables

Rectangle Table

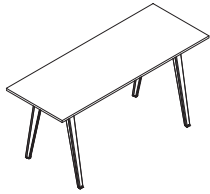

	Standard Includes	Required to Specify
▶ Need help? Product details, page 564	<ul style="list-style-type: none"> Table: 39½"H table with 1" thick particle board core, High-Pressure Laminate price group 1 top Edge: 3 mm radius profile: plastic Steel legs: powder coat paint price group 1 	<ol style="list-style-type: none"> Style number Size option (see below under Required Selections) Depth (see below under Required Selections) Width (see below under Required Selections) High-Pressure Laminate color number for top Plastic color number for edge Paint color number for legs Options, if selected (see below) <p>▶ See Surface Materials, page 634</p>

	Require Selections	U.S. Price	Required to Specify
Size Option	<ul style="list-style-type: none"> Modular Parametric 	No cost No cost	Specify <i>with modular</i> . Specify <i>with parametric</i> .
Depth	<ul style="list-style-type: none"> 24"D 25"D 26"D 32"D 33"D 34"D 	Prices at right Prices at right Prices at right Prices at right Prices at right Prices at right	Specify <i>with 24"D</i> . Specify <i>with 25"D</i> . Specify <i>with 26"D</i> . Specify <i>with 32"D</i> . Specify <i>with 33"D</i> . Specify <i>with 34"D</i> .
Width	<p>Modular</p> <ul style="list-style-type: none"> 48"W 60"W 66"W 72"W 84"W <p>Parametric</p> <ul style="list-style-type: none"> 48⅛"W-60"W 60⅛"W-66"W 66⅛"W-72"W 72⅛"W-84"W 	Prices at right Prices at right Prices at right Prices at right Prices at right Prices at right Prices at right Prices at right Prices at right Prices at right	Specify <i>with 48"W</i> . Specify <i>with 60"W</i> . Specify <i>with 66"W</i> . Specify <i>with 72"W</i> . Specify <i>with 84"W</i> . Specify <i>with 48⅛"W-60"W</i> . Specify <i>with 60⅛"W-66"W</i> . Specify <i>with 66⅛"W-72"W</i> . Specify <i>with 72⅛"W-84"W</i> .

	Options	U.S. Price	Required to Specify
Surface Materials	<p>High-Pressure Laminate top</p> <ul style="list-style-type: none"> Laminate price group 2 Laminate price group 3 Open Line laminate <p>Wood veneer top</p> <ul style="list-style-type: none"> Wood group 1 Wood group 2 Wood group 3 Customiz stain 	See information at left See information at left +\$102 plus cost of laminate Prices at right +\$102 +\$358 No cost	Specify laminate color number. Specify laminate color number. ▶ See <i>Surface Materials Reference Manual</i> . Specify wood color number. Specify wood color number. Specify wood color number. Specify <i>with Customiz stain</i> .
Legs	<p>Steel legs</p> <ul style="list-style-type: none"> Paint price group 1 Paint price group 2 Paint price group 3 	No cost +\$ 76 +\$159	Specify paint color number. Specify paint color number. Specify paint color number.

▶ Options, continued on next page

For laminate price group 2 and 3 pricing, please refer to the electronic catalog or SmartTools.

Tip: Wood group 2 and wood group 3 upcharges are in addition to wood group 1 upcharge.



For Canadian Pricing
Multiply U.S. Price by the Canadian price factor.
▶ See page 1 for details.



► Options, continued from previous page

Options	U.S. Price	Required to Specify
Power		
► Power Matrix, page 566	• No power • With power	No cost No cost
	Power position/configuration	
	• One end with two power	+\$375
	• One end with one power/ one dual USB	+\$477
	• Center (two receptacles for power and one receptacle for power/one dual USB)	+\$919
	• Both ends (two receptacles for power and one receptacle for power/one dual USB)	+\$919
		Specify with <i>no power</i> . Specify with <i>power</i> .
		Specify with <i>end and with two power</i> and select paint color number. Specify with <i>end and with one power/one USB</i> and select paint color number. Specify with <i>center</i> and select paint color number.
		Specify with <i>two ends</i> and select paint color number.

Tip: Center power position is only available on tables that are at least 32"D x 66"W.

Tip: Power on both ends is only available on tables that are at least 70"W.

Tip: Center and two end power position options will default to two power modules, one with two receptacles for power and one with one receptacle for power/one dual USB port.

Tip: Steel leg tables include integrated wire manager and cover in the leg.

Specification Information

Style Number	Dimensions D	Modular Width	U.S. Base Prices				
			48"W	60"W	66"W	72"W	84"W
		Parametric Width	N.A.	48 ¹ / ₈ "W-60"W	60 ¹ / ₈ "W-66"W	66 ¹ / ₈ "W-72"W	72 ¹ / ₈ "W-84"W

High-Pressure Laminate

N3LRECT	24"D, 25"D, or 26"D	\$2453	\$2589	\$2724	\$2860	N.A.
	32"D, 33"D, or 34"D	\$2520	\$2656	\$2793	\$2929	\$3065

Wood Group 1

N3LRECT	24"D, 25"D, or 26"D	\$3201	\$3365	\$3514	\$3656	N.A.
	32"D, 33"D, or 34"D	\$3324	\$3474	\$3617	\$3760	\$3911

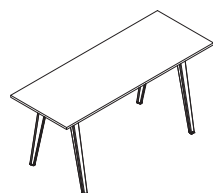

 **For Canadian Pricing**
Multiply U.S. Price by the
Canadian price factor.
► See page 1 for details.

B-Free Standing-Height Tables

Pint Table



For laminate price group 2 and 3 pricing, please refer to the electronic catalog or SmartTools.

Tip: Wood group 2 and wood group 3 upcharges are in addition to wood group 1 upcharge.

Tip: Center power position is the only power option available on the pint table.

Tip: Steel leg tables include integrated wire manager and cover in the leg.

Tip: N3LPINT has standard dimensions of 32"D (short end: leg width 23¼"), 44"D (wide end: leg width 31") x 80"W.

Standard Includes		Required to Specify
<ul style="list-style-type: none"> ▶ Need help? Product details, page 564 	<ul style="list-style-type: none"> Table: 39½"H table with 1" thick particle board core, High-Pressure Laminate price group 1 top Edge: 3 mm radius profile: plastic Steel legs: powder coat paint price group 1 	<ol style="list-style-type: none"> Style number High-Pressure Laminate color number for top Plastic color number for edge Paint color number for legs Options, if selected (see below) <ul style="list-style-type: none"> ▶ See Surface Materials, page 634

Options	U.S. Price	Required to Specify	
Surface Materials <ul style="list-style-type: none"> High-Pressure Laminate top <ul style="list-style-type: none"> Laminate price group 2 Laminate price group 3 Open Line laminate Wood veneer top <ul style="list-style-type: none"> Wood group 1 Wood group 2 Wood group 3 Customiz stain 	<ul style="list-style-type: none"> See information at left See information at left +\$102 plus cost of laminate Price below +\$102 +\$358 No cost 	<ul style="list-style-type: none"> Specify laminate color number. Specify laminate color number. ▶ See <i>Surface Materials Reference Manual</i>. Specify wood color number. Specify wood color number. Specify wood color number. Specify <i>with Customiz stain</i>. 	
Legs <ul style="list-style-type: none"> Steel legs <ul style="list-style-type: none"> Paint price group 1 Paint price group 2 Paint price group 3 	<ul style="list-style-type: none"> No cost +\$ 76 +\$159 	<ul style="list-style-type: none"> Specify paint color number. Specify paint color number. Specify paint color number. 	
Power <ul style="list-style-type: none"> ▶ Power Matrix, page 566 	<ul style="list-style-type: none"> No power With power: center position (two receptacles for power and one receptacle for power/one USB) 	<ul style="list-style-type: none"> No cost +\$919 	<ul style="list-style-type: none"> Specify <i>with no power</i>. Specify <i>with power</i> and select paint color number.

Specification Information

Style Number	U.S. Base Price
--------------	-----------------

High-Pressure Laminate

N3LPINT	\$3405
:	:

Wood Group 1

N3LPINT	\$4495
:	:



For Canadian Pricing
 Multiply U.S. Price by the Canadian price factor.
 ▶ See page 1 for details.

Understanding and Specifying Turnstone Jenny Lounge Lounge Seating

Product Details

Jenny Lounge	588
Application Guidelines	591
Dimensions	592

Specifying

Jenny Lounge	594
--------------	-----

Jenny Lounge

Jenny Lounge products

are fully upholstered and have a relaxed appearance. They may show soft comfort wrinkles upon use.

▶ Specifying, page 594

Standard Jenny chairs

are available in one arm, Armless, Wood Arms, Corner, Ottoman, Round, and Club.

Tip: There are height differences between Jenny Low and Jenny. Please use caution when mixing Jenny Low chairs with standard Jenny due to the lower height of Jenny Low.

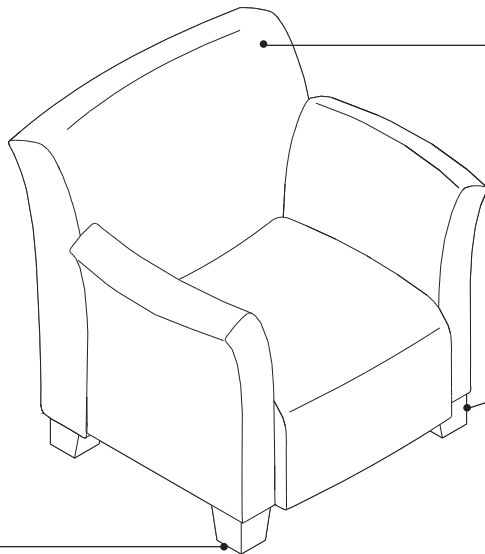

Jenny comes fully assembled.

Legs are standard in black plastic except for Jenny Round which has standard brushed aluminum legs.

Legs have options of wood (square or round), brushed aluminum, and/or with casters.

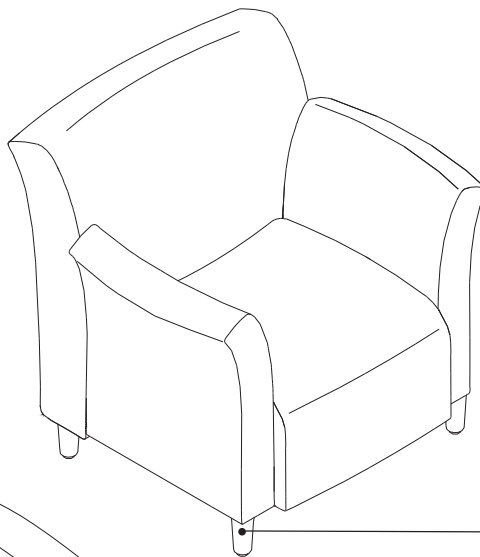

Round wood legs are solid maple and are available in three finishes. *Tip: Wood legs are natural wood and may have variations in color.*

Jenny Low chairs are available in Club and Round. They have an adjusted seat angle, and lowered height to align for work at lounge posture.

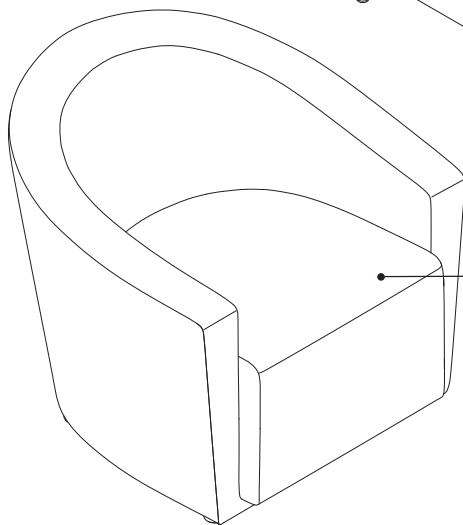

Seat is angled to allow a deeper sit.

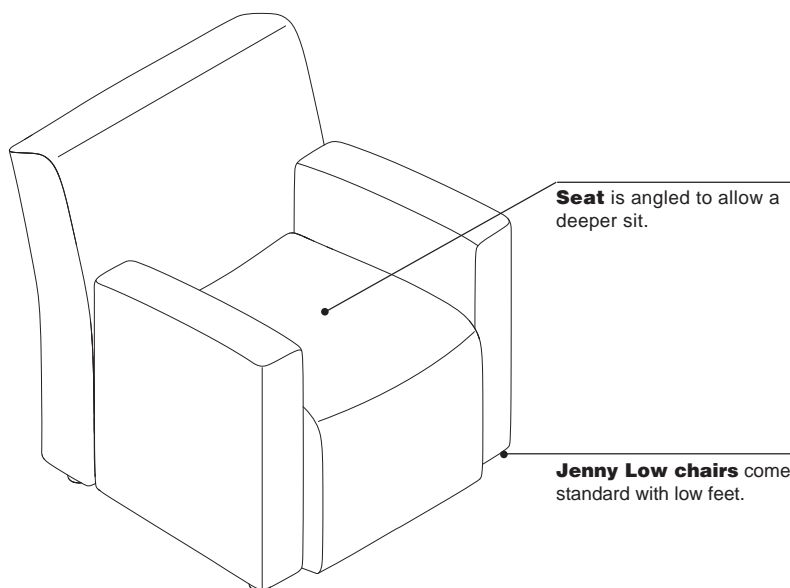

Product Details

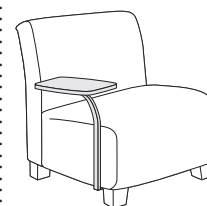

Tablet arm is only available on armless and one arm versions of Jenny.

Jenny tablet is 8¹/₂"W x 15¹/₂"L and 3/4" thick.

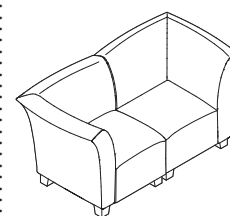

Two Jenny pieces shown as a love seat.

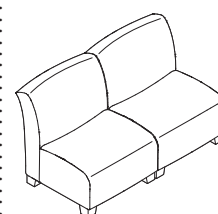

Two Armless Jenny pieces shown as a bench.

Jenny tables are available as a Coffee Table or End Table. Tops of tables are available in Low-Pressure Laminate and High-Pressure Laminate. Sides and bottom of table are only available in Low-Pressure Laminate. Jenny tables ship fully assembled without feet installed. Feet are ready to install.

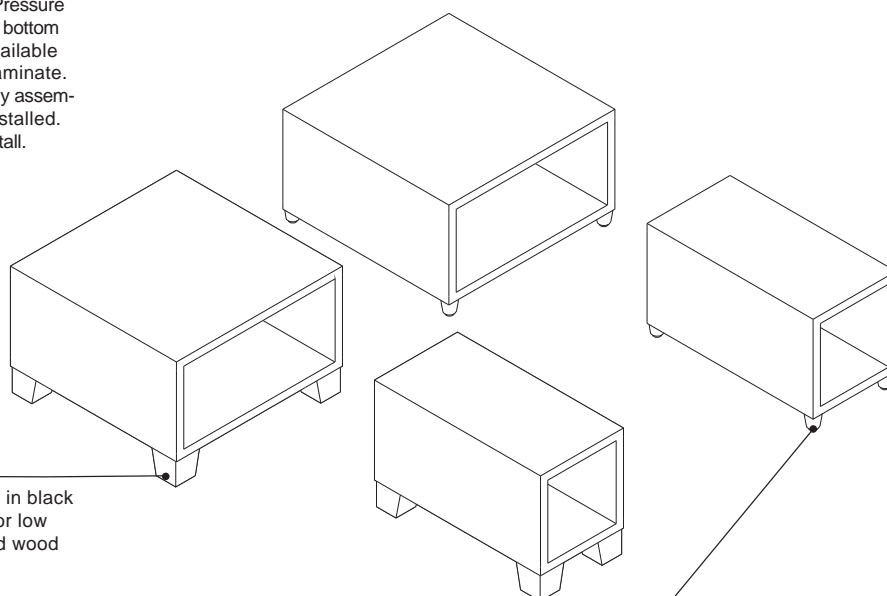

Legs are standard in black and have options for low feet, aluminum, and wood legs.

Round wood legs are solid maple and are available in three finishes.
Tip: Wood legs are natural wood and may have variations in color.

Jenny Lounge, continued

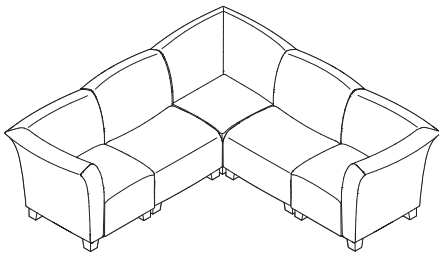

Jenny seating shown as a sectional.

Hard dual-wheel casters are for use on carpet. Use on hard surfaces, including floor mats, will affect chair stability and may result in personal injury.

Brushed aluminum legs are adjustable and have 3/4" of height adjustment.

Casters are not retrofittable on style numbers TS31403 or TS31404.

There are height differences between Jenny Low and Jenny. Please use caution when mixing Jenny Low chairs with standard Jenny due to the lower height of Jenny Low.

Club, Club Low, Round, and Round Low have deck stitch detail. The rest of Jenny has welting detail.

Surface Materials

Upholstery and hard components

There may be sheen or texture differences when using Low-Pressure Laminate and High-Pressure Laminate in adjacent applications. Please use caution when mixing and matching different work-surface types.

Leather price group option ships at extended lead times.

Jenny Corner

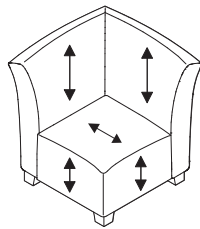

Tip: Standard seat fabric directionality is applied as the diagram above indicates (e.g. TS31406).

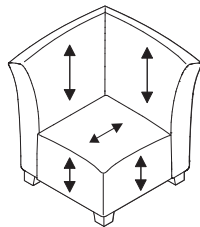

Tip: Reverse seat fabric directionality is applied as the diagram above indicates (e.g. TS31426).

With Wood Arms

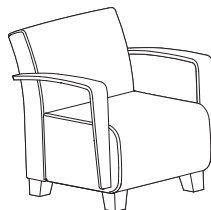

Note: On Jenny with Wood Arms, due to natural variations in wood, finished products may vary in color, texture, and grain.

Legs

- Black plastic
- Brushed aluminum

With Square Wood Legs

- 3412 Natural Cherry
- 3522 Clear Maple
- 3762 Dark Walnut

With Round Wood Legs

- V1AC Natural Cherry
- V1AM Clear Maple
- V1EW Dark Walnut

Tip: Finish 3522 Clear Maple and V1AM Clear Maple are a clear coat and therefore natural variations in wood will be visible.

Tip: Wood legs are natural wood and may have variations in color.

Dimensions

▶ Page 592

Application Guidelines

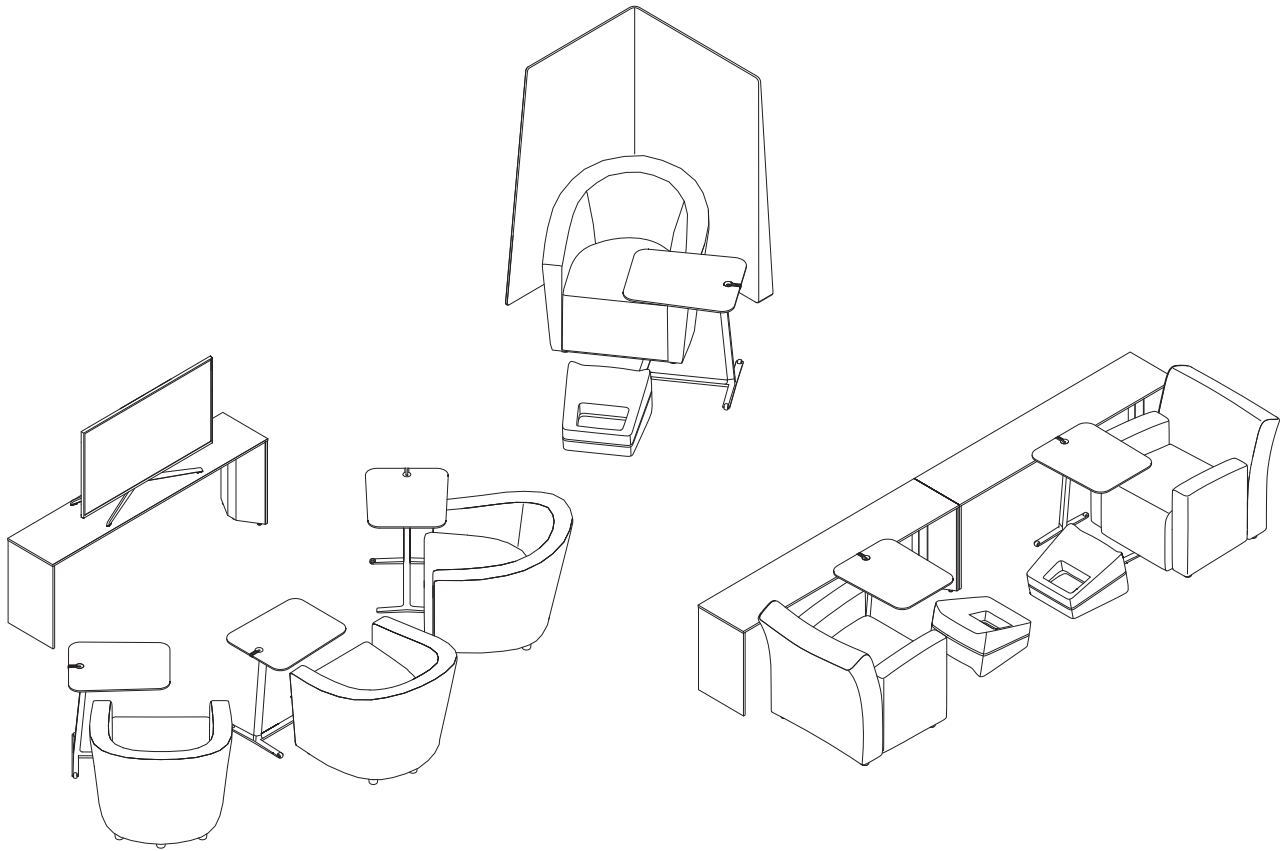

The Campfire Skate Table provides work space and slides easily around the Jenny Low feet and over the arms.
▶ See *Conference and Collaborative Tables Specification Guide*.

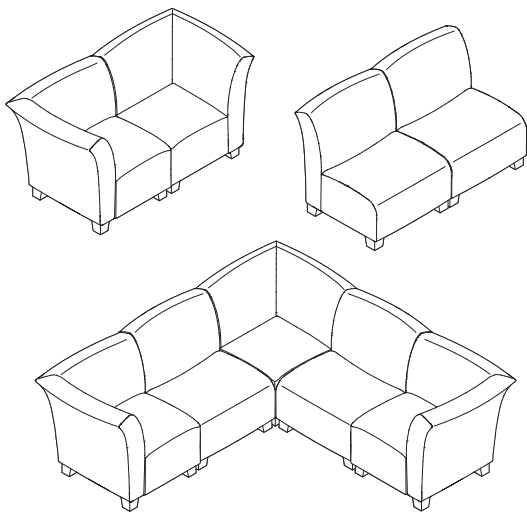

Jenny seating allows many different configurations using armless, left or right arms only, or corner version. Create a love seat, bench, or sectional using Jenny.

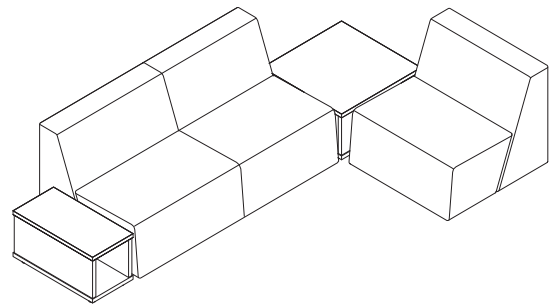

Jenny tables with the optional low foot align well with Campfire lounges.

Dimensions

Jenny Lounge

Features	Overall			Functional	Seat	Seat	Back	Back	Width
	Depth	Width	Height	Seat Depth	Width	Height from Floor	Width	Height from Seat	Between Arms
Jenny Lounge									
Lounge Seating									
Armless	32 ¹ / ₂ "	28 ¹ / ₂ "	32 ¹ / ₄ "	21"	28 ¹ / ₂ "	16", compressed	28 ¹ / ₂ "	18"	N.A.
Both Arms	32 ¹ / ₂ "	34 ¹ / ₂ "	32 ¹ / ₄ "	21"	19 ³ / ₄ "	16", compressed	28 ¹ / ₂ "	18"	26"
Right arm or Left arm only	32 ¹ / ₂ "	31 ¹ / ₂ "	32 ¹ / ₄ "	21"	23 ¹ / ₂ "	16", compressed	28 ¹ / ₂ "	18"	N.A.
Corner	32"	32"	32"	20"	20"	N.A.	N.A.	18"	N.A.
Club	32"	31 ³ / ₄ "	32 ¹ / ₄ "	21"	19"	16", compressed	28"	16"	19 ¹ / ₂ "
Round	32"	30"	31 ³ / ₄ "	21"	20"	16", compressed	28 ¹ / ₂ "	13"	19 ¹ / ₂ "
Wood Arms	32 ¹ / ₂ "	32 ¹ / ₂ "	32 ¹ / ₂ "	21"	24"	16", compressed	24"	16"	24 ¹ / ₄ "
Ottoman	27 ¹ / ₂ "	28 ¹ / ₂ "	18"	N.A.	N.A.	N.A.	N.A.	N.A.	N.A.
Club Low	32"	31 ³ / ₄ "	30"	21"	19"	14", compressed	28"	18 ¹ / ₂ "	19 ¹ / ₂ "
Round Low	32"	30"	28"	21"	20"	14", compressed	N.A.	14"	19 ¹ / ₂ "

• Arm Rest Width	• Arm Rest Length	• Arm Height to Floor	• Arm Height from Seat	• Tablet Width	• Tablet Length	• Tablet Height to Floor	• Tablet Height from Seat
N.A.	N.A.	N.A.	N.A.	9"	16"	24 ¹ / ₂ "	6 ³ / ₄ "
4"	19 ³ / ₄ "	26"	9 ¹ / ₂ "	N.A.	N.A.	N.A.	N.A.
4"	19 ³ / ₄ "	26"	9 ¹ / ₂ "	9"	16"	24 ¹ / ₂ "	6 ³ / ₄ "
N.A.	N.A.	N.A.	N.A.	N.A.	N.A.	N.A.	N.A.
4 ¹ / ₂ "	19 ³ / ₄ "	26"	7 ³ / ₄ "	N.A.	N.A.	N.A.	N.A.
4 ¹ / ₂ "	N.A.	25"	9 ¹ / ₂ "	N.A.	N.A.	N.A.	N.A.
3 ¹ / ₂ "	24"	26"	9"	N.A.	N.A.	N.A.	N.A.
N.A.	N.A.	N.A.	N.A.	N.A.	N.A.	N.A.	N.A.
4 ¹ / ₂ "	N.A.	22"	9 ¹ / ₂ "	N.A.	N.A.	N.A.	N.A.
4 ¹ / ₂ "	N.A.	22"	9 ¹ / ₂ "	N.A.	N.A.	N.A.	N.A.

Jenny Lounge

Armless

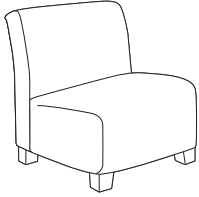

Tip: Tablet arm can be installed on either side.

Tip: Jenny Lounge chairs are available with multiple fabrics.

▶ See at right to specify.

Tip: When specifying multiple COM fabrics, indicate all surfaces where COM applies. Example: TS31401M with Designtex 1234 on seat, Designtex 5678 on inner back, and Designtex 9012 on outer back.

Tip: When specifying multiple fabrics and leather, specify suffix **M** before suffix **L**. Example: TS31401ML becomes TS31401CML

▶ Detailed dimensions, page 592



For Canadian Pricing

Multiply U.S. Price by the Canadian price factor.

▶ See page 1 for details.

Standard Includes	Required to Specify
<ul style="list-style-type: none"> ▶ Need help? Product details, page 588 Fully upholstered lounge chair: fabric price group 1 Tablet arm, if selected: Low-Pressure Laminate (LPL), or High-Pressure Laminate (HPL) price group 1 3 mm edge band for tablet arm, if selected: plastic Hard dual-wheel casters or legs with glides: black plastic Shipped fully assembled, some legs are field installed <i>Tablet arm is shipped ready to assemble.</i> Meets Cal. 117 requirements 	<ol style="list-style-type: none"> 1 Style number 2 Fabric color number for upholstery 3 Low-Pressure Laminate or High-Pressure Laminate color number for tablet arm, if selected 4 Plastic edge band color number for tablet arm, if selected 5 Options, if selected (see below) <p>▶ See <i>Surface Materials</i>, page 634.</p>

Surface Materials	Options	U.S. Price	Required to Specify
	Single upholstery fabric <ul style="list-style-type: none"> Fabric price group 1 Fabric price group 2 Fabric price group 3 Fabric price group 4 Fabric price group 5 Fabric price group 6 Fabric price group 7 Fabric price group 8 Fabric price group 9 Fabric price group 10 Leather price group 	<ul style="list-style-type: none"> No cost +\$ 47 +\$ 105 +\$ 144 +\$ 187 +\$ 234 +\$ 277 +\$ 349 +\$ 437 +\$ 494 +\$2996 	<ul style="list-style-type: none"> Specify fabric color number. Specify fabric color number. Specify fabric color number. Specify fabric color number. Specify fabric color number. Specify fabric color number. Specify fabric color number. Specify fabric color number. Specify fabric color number. Specify fabric color number. Specify fabric color number. Add suffix L to style number and specify leather color number. Specify vinyl color number. <p>▶ See <i>Understanding Customer's Own Material (COM)</i>, page 642.</p> <p>Add suffix L to style number and specify leather color number.</p>
	<ul style="list-style-type: none"> Vinyl Customer's Own Material (COM) Customer's Own Leather (COL) 	<ul style="list-style-type: none"> +\$ 47 +\$ 56 +\$ 53 	<ul style="list-style-type: none"> Specify vinyl color number. <p>▶ See <i>Understanding Customer's Own Material (COM)</i>, page 642.</p> <p>Add suffix L to style number and specify leather color number.</p>
	Multiple upholstery fabrics <ul style="list-style-type: none"> Two or more fabrics on different chair components <p>▶ See below and at right.</p>	<ul style="list-style-type: none"> +\$ 98 	<p>Add suffix M to lounge chair style number and select fabric color number for:</p> <ol style="list-style-type: none"> 1 Seat 2 Inner back 3 Outer back <p>Example: TS31401M with 5G61 on seat, 5F15 on inner back, and 5G51 on outer back.</p> <ul style="list-style-type: none"> Specify fabric color number. Specify fabric color number. Specify fabric color number. Specify fabric color number. Specify fabric color number. Specify fabric color number. Specify fabric color number. Specify fabric color number. Specify fabric color number. Specify fabric color number. Specify fabric color number. Add suffix L to style number and specify leather color number. Specify vinyl color number. <p>▶ See <i>Understanding Customer's Own Material (COM)</i>, page 642.</p> <p>Add suffix L to style number and specify leather color number.</p>
	<ol style="list-style-type: none"> 1 Fabric on seat <ul style="list-style-type: none"> Fabric price group 1 Fabric price group 2 Fabric price group 3 Fabric price group 4 Fabric price group 5 Fabric price group 6 Fabric price group 7 Fabric price group 8 Fabric price group 9 Fabric price group 10 Leather price group 	<ul style="list-style-type: none"> No cost +\$ 17 +\$ 49 +\$ 63 +\$ 85 +\$ 106 +\$ 126 +\$ 161 +\$ 197 +\$ 227 +\$1458 	<ul style="list-style-type: none"> Specify fabric color number. Specify fabric color number. Specify fabric color number. Specify fabric color number. Specify fabric color number. Specify fabric color number. Specify fabric color number. Specify fabric color number. Specify fabric color number. Specify fabric color number. Specify fabric color number. Add suffix L to style number and specify leather color number. Specify vinyl color number. <p>▶ See <i>Understanding Customer's Own Material (COM)</i>, page 642.</p> <p>Add suffix L to style number and specify leather color number.</p>
	<ul style="list-style-type: none"> Vinyl Customer's Own Material (COM) Customer's Own Leather (COL) 	<ul style="list-style-type: none"> +\$ 17 +\$ 27 +\$ 27 	<ul style="list-style-type: none"> Specify vinyl color number. <p>▶ See <i>Understanding Customer's Own Material (COM)</i>, page 642.</p> <p>Add suffix L to style number and specify leather color number.</p>

▶ Options, continued on next page

► Options, continued from previous page

	Options	U.S. Price	Required to Specify
Surface Materials, continued	2 Fabric on inner back		
	• Fabric price group 1	No cost	Specify fabric color number.
	• Fabric price group 2	+\$ 9	Specify fabric color number.
	• Fabric price group 3	+\$ 35	Specify fabric color number.
	• Fabric price group 4	+\$ 47	Specify fabric color number.
	• Fabric price group 5	+\$ 60	Specify fabric color number.
	• Fabric price group 6	+\$ 73	Specify fabric color number.
	• Fabric price group 7	+\$ 87	Specify fabric color number.
	• Fabric price group 8	+\$108	Specify fabric color number.
	• Fabric price group 9	+\$136	Specify fabric color number.
	• Fabric price group 10	+\$159	Specify fabric color number.
	• Leather price group	+\$670	Add suffix L to style number and specify leather color number.
	• Vinyl	+\$ 9	Specify vinyl color number.
	• Customer's Own Material (COM)	+\$ 27	► See <i>Understanding Customer's Own Material (COM)</i> , page 642.
	• Customer's Own Leather (COL)	+\$ 27	Add suffix L to style number and specify leather color number.
	3 Fabric on outer back		
	• Fabric price group 1	No cost	Specify fabric color number.
	• Fabric price group 2	+\$ 7	Specify fabric color number.
	• Fabric price group 3	+\$ 22	Specify fabric color number.
	• Fabric price group 4	+\$ 36	Specify fabric color number.
• Fabric price group 5	+\$ 46	Specify fabric color number.	
• Fabric price group 6	+\$ 56	Specify fabric color number.	
• Fabric price group 7	+\$ 63	Specify fabric color number.	
• Fabric price group 8	+\$ 81	Specify fabric color number.	
• Fabric price group 9	+\$104	Specify fabric color number.	
• Fabric price group 10	+\$114	Specify fabric color number.	
• Leather price group	+\$929	Add suffix L to style number and specify leather color number.	
• Vinyl	+\$ 7	Specify vinyl color number.	
• Customer's Own Material (COM)	+\$ 27	► See <i>Understanding Customer's Own Material (COM)</i> , page 642.	
• Customer's Own Leather (COL)	+\$ 27	Add suffix L to style number and specify leather color number.	
	Tablet arm		
	• Low-Pressure Laminate	No cost	Specify Low-Pressure Laminate color number.
	• High-Pressure Laminate price group 1	No cost	Specify High-Pressure Laminate color number.
	• High-Pressure Laminate price group 2	See information at left	Specify High-Pressure Laminate color number.
	• Open Line laminate	+\$102 plus cost of laminate	► See <i>Surface Materials Reference Manual</i> .
	Legs		
	• Brushed aluminum legs	+\$167	Specify with <i>brushed aluminum legs</i> .
	• Solid square wood legs	+\$222	Specify with <i>solid square wood legs</i> and select 3412 Natural Cherry, 3522 Clear Maple, or 3762 Dark Walnut.
	• Solid round wood legs	+\$233	Specify with <i>solid round wood legs</i> and select V1AC Natural Cherry, V1AM Clear Maple, or V1EW Dark Walnut.
	Related Products	• Ganging kit	► Page 615

For laminate group 2 and 3 pricing, please refer to the electronic catalog or SmartTools.

Tip: Brushed aluminum legs are adjustable and have 3/4" of height adjustment.

Tip: Wood legs are natural wood and may show variations in grain and color.

► Specification Information, on next page

**For Canadian Pricing**

Multiply U.S. Price by the Canadian price factor.

► See page 1 for details.

Jenny Lounge, continued

► Options, on previous page

Specification Information

Style Number LPL	U.S. Base Price	Style Number HPL	U.S. Base Price
------------------	-----------------	------------------	-----------------

Style Number LPL	U.S. Base Price	Style Number HPL	U.S. Base Price
------------------	-----------------	------------------	-----------------



Glides



Casters



Glides



Casters

With Glides

TS31401	\$1711	N.A.	N.A.
----------------	--------	------	------

With Two Casters and Two Glides

TS31401C	\$1780	N.A.	N.A.
-----------------	--------	------	------

With Tablet Arm with 180° Swivel

TS31401T	\$2102	TS31401H	\$2157
-----------------	--------	-----------------	--------

With Tablet Arm with 180° Swivel

TS31401CT	\$2171	TS31401CH	\$2226
------------------	--------	------------------	--------

► Detailed dimensions, page 592



For Canadian Pricing

Multiply U.S. Price by the Canadian price factor.

► See page 1 for details.

Jenny Lounge, continued

With Arms

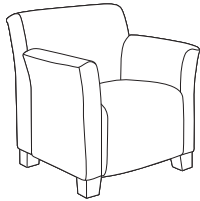

Tip: Jenny Lounge chairs are available with multiple fabrics.

▶ See at right to specify.

Tip: When specifying multiple COM fabrics, indicate all surfaces where COM applies. Example: TS31402M with Designtex 1234 on seat, Designtex 5678 on inner back, Designtex 9012 on outer back, and Designtex 9012 on arms.

Tip: When specifying multiple fabrics and leather, specify suffix **M** before suffix **L**. Example: TS31402ML becomes TS31402CML

▶ Detailed dimensions, page 592

Standard Includes	Required to Specify
<p>▶ Need help? Product details, page 588</p> <ul style="list-style-type: none"> Fully upholstered lounge chair with arms: fabric price group 1 Hard dual-wheel casters or legs with glides: black plastic Shipped fully assembled, some legs are field installed Meets Cal. 117 requirements 	<ul style="list-style-type: none"> 1 Style number 2 Fabric color number for upholstery 3 Options, if selected (see below) <p>▶ See <i>Surface Materials</i>, page 634.</p>

Surface Materials	Options	U.S. Price	Required to Specify
	<p>Single upholstery fabric</p> <ul style="list-style-type: none"> Fabric price group 1 Fabric price group 2 Fabric price group 3 Fabric price group 4 Fabric price group 5 Fabric price group 6 Fabric price group 7 Fabric price group 8 Fabric price group 9 Fabric price group 10 Leather price group 	<p>No cost</p> <p>+\$ 69</p> <p>+\$ 164</p> <p>+\$ 231</p> <p>+\$ 301</p> <p>+\$ 362</p> <p>+\$ 434</p> <p>+\$ 546</p> <p>+\$ 682</p> <p>+\$ 775</p> <p>+\$4630</p>	<p>Specify fabric color number.</p> <p>Specify fabric color number.</p> <p>Specify fabric color number.</p> <p>Specify fabric color number.</p> <p>Specify fabric color number.</p> <p>Specify fabric color number.</p> <p>Specify fabric color number.</p> <p>Specify fabric color number.</p> <p>Specify fabric color number.</p> <p>Specify fabric color number.</p> <p>Specify fabric color number.</p> <p>Add suffix L to style number and specify leather color number.</p> <p>Specify vinyl color number.</p> <p>▶ See <i>Understanding Customer's Own Material (COM)</i>, page 642.</p> <p>Add suffix L to style number and specify leather color number.</p>
	<ul style="list-style-type: none"> Vinyl Customer's Own Material (COM) Customer's Own Leather (COL) 	<p>+\$ 69</p> <p>+\$ 56</p> <p>+\$ 53</p>	<p>Add suffix L to style number and specify leather color number.</p>
	<p>Multiple upholstery fabrics</p> <ul style="list-style-type: none"> Two or more fabrics on different chair components <p>▶ See below and at right.</p>	<p>+\$ 98</p>	<p>Add suffix M to lounge chair style number and select fabric color number for:</p> <ul style="list-style-type: none"> 1 Seat 2 Inner back 3 Outer back 4 Arms <p>Example: TS31402M with 5G61 on seat, 5F15 on inner back, 5G51 on outer back, and 5F03 on arms.</p>
	<p>1 Fabric on seat</p> <ul style="list-style-type: none"> Fabric price group 1 Fabric price group 2 Fabric price group 3 Fabric price group 4 Fabric price group 5 Fabric price group 6 Fabric price group 7 Fabric price group 8 Fabric price group 9 Fabric price group 10 Leather price group 	<p>No cost</p> <p>+\$ 17</p> <p>+\$ 49</p> <p>+\$ 63</p> <p>+\$ 85</p> <p>+\$ 106</p> <p>+\$ 126</p> <p>+\$ 161</p> <p>+\$ 197</p> <p>+\$ 227</p> <p>+\$1321</p>	<p>Specify fabric color number.</p> <p>Specify fabric color number.</p> <p>Specify fabric color number.</p> <p>Specify fabric color number.</p> <p>Specify fabric color number.</p> <p>Specify fabric color number.</p> <p>Specify fabric color number.</p> <p>Specify fabric color number.</p> <p>Specify fabric color number.</p> <p>Specify fabric color number.</p> <p>Specify fabric color number.</p> <p>Add suffix L to style number and specify leather color number.</p> <p>Specify vinyl color number.</p> <p>▶ See <i>Understanding Customer's Own Material (COM)</i>, page 642.</p> <p>Add suffix L to style number and specify leather color number.</p>
	<ul style="list-style-type: none"> Vinyl Customer's Own Material (COM) Customer's Own Leather (COL) 	<p>+\$ 17</p> <p>+\$ 27</p> <p>+\$ 27</p>	<p>Specify vinyl color number.</p> <p>Add suffix L to style number and specify leather color number.</p>

▶ Options, continued on next page



For Canadian Pricing

Multiply U.S. Price by the Canadian price factor.

▶ See page 1 for details.

► Options, continued from previous page

	Options	U.S. Price	Required to Specify
Surface Materials, continued	② Fabric on inner back		
	• Fabric price group 1	No cost	Specify fabric color number.
	• Fabric price group 2	+\$ 9	Specify fabric color number.
	• Fabric price group 3	+\$ 35	Specify fabric color number.
	• Fabric price group 4	+\$ 47	Specify fabric color number.
	• Fabric price group 5	+\$ 60	Specify fabric color number.
	• Fabric price group 6	+\$ 73	Specify fabric color number.
	• Fabric price group 7	+\$ 87	Specify fabric color number.
	• Fabric price group 8	+\$ 108	Specify fabric color number.
	• Fabric price group 9	+\$ 136	Specify fabric color number.
	• Fabric price group 10	+\$ 159	Specify fabric color number.
	• Leather price group	+\$ 670	Specify fabric color number. Add suffix L to style number and specify leather color number.
	• Vinyl	+\$ 9	Specify vinyl color number.
	• Customer's Own Material (COM)	+\$ 27	► See <i>Understanding Customer's Own Material (COM)</i> , page 642.
	• Customer's Own Leather (COL)	+\$ 27	Add suffix L to style number and specify leather color number.
	③ Fabric on outer back		
	• Fabric price group 1	No cost	Specify fabric color number.
	• Fabric price group 2	+\$ 7	Specify fabric color number.
	• Fabric price group 3	+\$ 22	Specify fabric color number.
	• Fabric price group 4	+\$ 36	Specify fabric color number.
	• Fabric price group 5	+\$ 46	Specify fabric color number.
	• Fabric price group 6	+\$ 56	Specify fabric color number.
	• Fabric price group 7	+\$ 63	Specify fabric color number.
	• Fabric price group 8	+\$ 81	Specify fabric color number.
	• Fabric price group 9	+\$ 104	Specify fabric color number.
	• Fabric price group 10	+\$ 114	Specify fabric color number.
	• Leather price group	+\$ 929	Specify fabric color number. Add suffix L to style number and specify leather color number.
• Vinyl	+\$ 7	Specify vinyl color number.	
• Customer's Own Material (COM)	+\$ 27	► See <i>Understanding Customer's Own Material (COM)</i> , page 642.	
• Customer's Own Leather (COL)	+\$ 27	Add suffix L to style number and specify leather color number.	
④ Fabric on arms			
• Fabric price group 1	No cost	Specify fabric color number.	
• Fabric price group 2	+\$ 23	Specify fabric color number.	
• Fabric price group 3	+\$ 59	Specify fabric color number.	
• Fabric price group 4	+\$ 81	Specify fabric color number.	
• Fabric price group 5	+\$ 107	Specify fabric color number.	
• Fabric price group 6	+\$ 132	Specify fabric color number.	
• Fabric price group 7	+\$ 160	Specify fabric color number.	
• Fabric price group 8	+\$ 196	Specify fabric color number.	
• Fabric price group 9	+\$ 246	Specify fabric color number.	
• Fabric price group 10	+\$ 278	Specify fabric color number.	
• Leather price group	+\$1770	Specify fabric color number. Add suffix L to style number and specify leather color number.	
• Vinyl	+\$ 23	Specify vinyl color number.	
• Customer's Own Material (COM)	+\$ 27	► See <i>Understanding Customer's Own Material (COM)</i> , page 642.	
• Customer's Own Leather (COL)	+\$ 27	Add suffix L to style number and specify leather color number.	
Tablet arm			
• Low-Pressure Laminate	No cost	Specify Low-Pressure Laminate color number.	
• High-Pressure Laminate price group 1	No cost	Specify High-Pressure Laminate color number.	
• High-Pressure Laminate price group 2	See information at left	Specify High-Pressure Laminate color number.	
• Open Line laminate	+\$ 102 plus cost of laminate	► See <i>Surface Materials Reference Manual</i> .	

For laminate group 2 and 3 pricing, please refer to the electronic catalog or SmartTools.

► Options, continued on next page

Jenny Lounge, continued

► Options, continued from previous page

Tip: Brushed aluminum legs are adjustable and have 3/4" of height adjustment.

Tip: Wood legs are natural wood and may show variations in grain and color.

Options	U.S. Price	Required to Specify
Surface Materials, continued		
Legs <ul style="list-style-type: none"> • Brushed aluminum legs 	+\$167	Specify with brushed aluminum legs. Specify with solid square wood legs and select 3412 Natural Cherry, 3522 Clear Maple, or 3762 Dark Walnut. Specify with solid round wood legs and select V1AC Natural Cherry, V1AM Clear Maple, or V1EW Dark Walnut.
<ul style="list-style-type: none"> • Solid square wood legs 	+\$222	
<ul style="list-style-type: none"> • Solid round wood legs 	+\$233	

Specification Information			
Style Number	U.S. Base Price	Style Number	U.S. Base Price



Glides



Casters

With Glides	
Style Number	U.S. Base Price
TS31402	\$1917

With Two Casters and Two Glides	
Style Number	U.S. Base Price
TS31402C	\$1986



For Canadian Pricing

Multiply U.S. Price by the Canadian price factor.

► See page 1 for details.

Jenny Lounge, continued

With Arm Left or Right

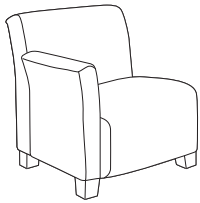

Tip: Jenny Lounge chairs are available with multiple fabrics.
 ▶ See at right to specify.

Tip: When specifying multiple COM fabrics, indicate all surfaces where COM applies.
 Example: TS31403M with Designtex 1234 on seat, Designtex 5678 on inner back, Designtex 9012 on outer back, and Designtex 9012 on arm.

Tip: When specifying multiple fabrics and leather, specify suffix **M** before suffix **L**.
 Example: TS31403L becomes TS31403ML

▶ Detailed dimensions, page 592

 **For Canadian Pricing**
 Multiply U.S. Price by the Canadian price factor.
 ▶ See page 1 for details.

Standard Includes	Required to Specify
<ul style="list-style-type: none"> ▶ Need help? Product details, page 588 Fully upholstered lounge chair with arm left or right: fabric price group 1 Tablet arm, if selected: Low-Pressure Laminate (LPL), or High-Pressure Laminate (HPL) price group 1 3 mm edge band for tablet arm, if selected: plastic Hard dual-wheel casters or legs with glides: black plastic Shipped fully assembled, some legs are field installed <i>Tablet arm is shipped ready to assemble.</i> Meets Cal. 117 requirements 	<ul style="list-style-type: none"> 1 Style number 2 Fabric color number for upholstery 3 Low-Pressure Laminate or High-Pressure Laminate color number for tablet arm, if selected 4 Plastic edge band color number for tablet arm, if selected 5 Options, if selected (see below) ▶ See <i>Surface Materials</i>, page 634.

Options	U.S. Price	Required to Specify
Surface Materials Single upholstery fabric <ul style="list-style-type: none"> Fabric price group 1 No cost Fabric price group 2 +\$ 57 Fabric price group 3 +\$ 133 Fabric price group 4 +\$ 186 Fabric price group 5 +\$ 245 Fabric price group 6 +\$ 302 Fabric price group 7 +\$ 356 Fabric price group 8 +\$ 446 Fabric price group 9 +\$ 561 Fabric price group 10 +\$ 633 Leather price group +\$3856 <ul style="list-style-type: none"> Vinyl +\$ 57 Customer's Own Material (COM) +\$ 56 Customer's Own Leather (COL) +\$ 53 		Specify fabric color number. Specify fabric color number. Specify fabric color number. Specify fabric color number. Specify fabric color number. Specify fabric color number. Specify fabric color number. Specify fabric color number. Specify fabric color number. Specify fabric color number. Add suffix L to style number and specify leather color number. Specify vinyl color number. ▶ See <i>Understanding Customer's Own Material (COM)</i> , page 642. Add suffix L to style number and specify leather color number.
Multiple upholstery fabrics <ul style="list-style-type: none"> Two or more fabrics on different chair components +\$ 98 ▶ See below and at right. 		Add suffix M to lounge chair style number and select fabric color number for: <ol style="list-style-type: none"> 1 Seat 2 Inner back 3 Outer back 4 Arm Example: TS31403M with 5G61 on seat, 5F15 on inner back, 5G51 on outer back, and 5F03 on arm. Specify fabric color number. Specify fabric color number. Specify fabric color number. Specify fabric color number. Specify fabric color number. Specify fabric color number. Specify fabric color number. Specify fabric color number. Specify fabric color number. Specify fabric color number. Add suffix L to style number and specify leather color number. Specify vinyl color number. ▶ See <i>Understanding Customer's Own Material (COM)</i> , page 642. Add suffix L to style number and specify leather color number.
1 Fabric on seat <ul style="list-style-type: none"> Fabric price group 1 No cost Fabric price group 2 +\$ 17 Fabric price group 3 +\$ 49 Fabric price group 4 +\$ 63 Fabric price group 5 +\$ 85 Fabric price group 6 +\$ 106 Fabric price group 7 +\$ 126 Fabric price group 8 +\$ 161 Fabric price group 9 +\$ 197 Fabric price group 10 +\$ 227 Leather price group +\$1430 <ul style="list-style-type: none"> Vinyl +\$ 17 Customer's Own Material (COM) +\$ 27 Customer's Own Leather (COL) +\$ 27 		

▶ Options, continued on next page

► Options, continued from previous page

	Options	U.S. Price	Required to Specify
Surface Materials, continued	2 Fabric on inner back		
	• Fabric price group 1	No cost	Specify fabric color number.
	• Fabric price group 2	+\$ 9	Specify fabric color number.
	• Fabric price group 3	+\$ 35	Specify fabric color number.
	• Fabric price group 4	+\$ 47	Specify fabric color number.
	• Fabric price group 5	+\$ 60	Specify fabric color number.
	• Fabric price group 6	+\$ 73	Specify fabric color number.
	• Fabric price group 7	+\$ 87	Specify fabric color number.
	• Fabric price group 8	+\$108	Specify fabric color number.
	• Fabric price group 9	+\$136	Specify fabric color number.
	• Fabric price group 10	+\$159	Specify fabric color number.
	• Leather price group	+\$670	Specify fabric color number. Add suffix L to style number and specify leather color number.
	• Vinyl	+\$ 9	Specify vinyl color number.
	• Customer's Own Material (COM)	+\$ 27	► See <i>Understanding Customer's Own Material (COM)</i> , page 642.
	• Customer's Own Leather (COL)	+\$ 27	Add suffix L to style number and specify leather color number.
	3 Fabric on outer back		
	• Fabric price group 1	No cost	Specify fabric color number.
	• Fabric price group 2	+\$ 7	Specify fabric color number.
	• Fabric price group 3	+\$ 22	Specify fabric color number.
	• Fabric price group 4	+\$ 36	Specify fabric color number.
	• Fabric price group 5	+\$ 46	Specify fabric color number.
	• Fabric price group 6	+\$ 56	Specify fabric color number.
	• Fabric price group 7	+\$ 63	Specify fabric color number.
• Fabric price group 8	+\$ 81	Specify fabric color number.	
• Fabric price group 9	+\$104	Specify fabric color number.	
• Fabric price group 10	+\$114	Specify fabric color number.	
• Leather price group	+\$929	Add suffix L to style number and specify leather color number.	
• Vinyl	+\$ 7	Specify vinyl color number.	
• Customer's Own Material (COM)	+\$ 27	► See <i>Understanding Customer's Own Material (COM)</i> , page 642.	
• Customer's Own Leather (COL)	+\$ 27	Add suffix L to style number and specify leather color number.	
4 Fabric on arm			
• Fabric price group 1	No cost	Specify fabric color number.	
• Fabric price group 2	+\$ 8	Specify fabric color number.	
• Fabric price group 3	+\$ 34	Specify fabric color number.	
• Fabric price group 4	+\$ 46	Specify fabric color number.	
• Fabric price group 5	+\$ 57	Specify fabric color number.	
• Fabric price group 6	+\$ 69	Specify fabric color number.	
• Fabric price group 7	+\$ 81	Specify fabric color number.	
• Fabric price group 8	+\$105	Specify fabric color number.	
• Fabric price group 9	+\$130	Specify fabric color number.	
• Fabric price group 10	+\$144	Specify fabric color number.	
• Leather price group	+\$884	Add suffix L to style number and specify leather color number.	
• Vinyl	+\$ 8	Specify vinyl color number.	
• Customer's Own Material (COM)	+\$ 27	► See <i>Understanding Customer's Own Material (COM)</i> , page 642.	
• Customer's Own Leather (COL)	+\$ 27	Add suffix L to style number and specify leather color number.	
Tablet arm			
• Low-Pressure Laminate	No cost	Specify Low-Pressure Laminate color number.	
• High-Pressure Laminate price group 1	No cost	Specify High-Pressure Laminate color number.	
• High-Pressure Laminate price group 2	See information at left	Specify High-Pressure Laminate color number.	
• Open Line laminate	+\$102 plus cost of laminate	► See <i>Surface Materials Reference Manual</i> .	

For laminate group 2 and 3 pricing, please refer to the electronic catalog or SmartTools.

► Options, continued on next page

Jenny Lounge, continued

► Options, continued from previous page

Options	U.S. Price	Required to Specify
Surface Materials, continued		
Legs		
• Brushed aluminum legs	+\$167	Specify with <i>brushed aluminum legs</i> . Specify with <i>solid square wood legs</i> and select 3412 Natural Cherry, 3522 Clear Maple, or 3762 Dark Walnut. Specify with <i>solid round wood legs</i> and select V1AC Natural Cherry, V1AM Clear Maple, or V1EW Dark Walnut.
• Solid square wood legs	+\$222	
• Solid round wood legs	+\$233	

Tip: Brushed aluminum legs are adjustable and have 3/4" of height adjustment.

Tip: Wood legs are natural wood and may show variations in grain and color.

Related Products • Ganging kit ► Page 615

Specification Information

Style Number LPL	U.S. Base Price	Style Number HPL	U.S. Base Price	Style Number LPL	U.S. Base Price	Style Number HPL	U.S. Base Price
------------------	-----------------	------------------	-----------------	------------------	-----------------	------------------	-----------------

With Glides

Arm Right			
TS31403	\$1812	N.A.	N.A.

With Two Casters and Two Glides

Arm Right			
TS31403C	\$1881	N.A.	N.A.

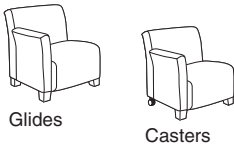

Tip: Casters are not retrofittable on style number TS31403.

Arm Right with Tablet Arm with 180° Swivel			
TS31403T	\$2203	TS31403H	\$2258

Arm Right with Tablet Arm with 180° Swivel			
TS31403CT	\$2272	TS31403CH	\$2327

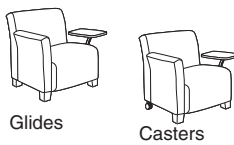

Arm Left			
TS31404	\$1812	N.A.	N.A.

Arm Left			
TS31404C	\$1881	N.A.	N.A.

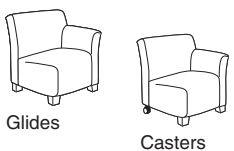

Tip: Casters are not retrofittable on style number TS31404.

Arm Left with Tablet Arm with 180° Swivel			
TS31404T	\$2203	TS31404H	\$2258

Arm Left with Tablet Arm with 180° Swivel			
TS31404CT	\$2272	TS31404CH	\$2327

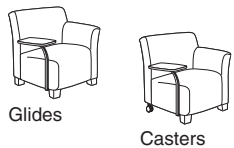

Tip: Tablet is 8 1/2"W x 15 1/2"L and 3/4" thick.



For Canadian Pricing
 Multiply U.S. Price by the Canadian price factor.
 ► See page 1 for details.

Jenny Lounge, continued

Corner

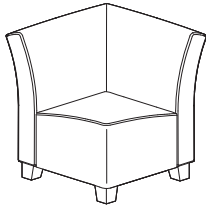

Tip: Jenny Lounge chairs are available with multiple fabrics.

▶ See at right to specify.

Tip: When specifying multiple COM fabrics, indicate all surfaces where COM applies. Example: TS31406M with Designtex 1234 on seat, Designtex 5678 on inner back, and Designtex 9012 on outer back.

Tip: When specifying multiple fabrics and leather, specify suffix **M** before suffix **L**. Example: TS31406L becomes TS31406ML

▶ Detailed dimensions, page 592

Standard Includes	Required to Specify
<ul style="list-style-type: none"> ▶ Need help? Product details, page 588 Fully upholstered lounge chair: fabric price group 1 Hard dual-wheel casters or legs with glides: black plastic Shipped fully assembled, some legs are field installed Meets Cal. 117 requirements 	<ul style="list-style-type: none"> 1 Style number 2 Fabric color number for upholstery 3 Options, if selected (see below) ▶ See <i>Surface Materials</i>, page 634.

Surface Materials	Options	U.S. Price	Required to Specify
	Single upholstery fabric		
	• Fabric price group 1	No cost	Specify fabric color number.
	• Fabric price group 2	+\$ 47	Specify fabric color number.
	• Fabric price group 3	+\$ 105	Specify fabric color number.
	• Fabric price group 4	+\$ 144	Specify fabric color number.
	• Fabric price group 5	+\$ 187	Specify fabric color number.
	• Fabric price group 6	+\$ 234	Specify fabric color number.
	• Fabric price group 7	+\$ 277	Specify fabric color number.
	• Fabric price group 8	+\$ 349	Specify fabric color number.
	• Fabric price group 9	+\$ 437	Specify fabric color number.
	• Fabric price group 10	+\$ 494	Specify fabric color number.
	• Leather price group	+\$2996	Specify fabric color number. Add suffix L to style number and specify leather color number.
	• Vinyl	+\$ 47	Specify vinyl color number.
	• Customer's Own Material (COM)	+\$ 56	▶ See <i>Understanding Customer's Own Material (COM)</i> , page 642.
	• Customer's Own Leather (COL)	+\$ 53	Add suffix L to style number and specify leather color number.
	Multiple upholstery fabrics		
	• Two or more fabrics on different chair components	+\$ 98	Add suffix M to lounge chair style number and select fabric color number for:
	▶ See below and at right.		<ol style="list-style-type: none"> 1 Seat 2 Inner back 3 Outer back

1 Fabric on seat		
• Fabric price group 1	No cost	Specify fabric color number.
• Fabric price group 2	+\$ 17	Specify fabric color number.
• Fabric price group 3	+\$ 49	Specify fabric color number.
• Fabric price group 4	+\$ 63	Specify fabric color number.
• Fabric price group 5	+\$ 85	Specify fabric color number.
• Fabric price group 6	+\$ 106	Specify fabric color number.
• Fabric price group 7	+\$ 126	Specify fabric color number.
• Fabric price group 8	+\$ 161	Specify fabric color number.
• Fabric price group 9	+\$ 197	Specify fabric color number.
• Fabric price group 10	+\$ 227	Specify fabric color number.
• Leather price group	+\$1458	Specify fabric color number. Add suffix L to style number and specify leather color number.
• Vinyl	+\$ 17	Specify vinyl color number.
• Customer's Own Material (COM)	+\$ 27	▶ See <i>Understanding Customer's Own Material (COM)</i> , page 642.
• Customer's Own Leather (COL)	+\$ 27	Add suffix L to style number and specify leather color number.

▶ Options, continued on next page

For Canadian Pricing
Multiply U.S. Price by the Canadian price factor.
▶ See page 1 for details.

► Options, continued from previous page

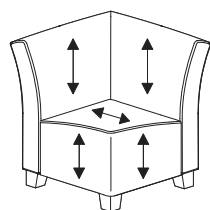

Tip: Standard seat fabric directionality is applied as the diagram above indicates (ex. TS31406).

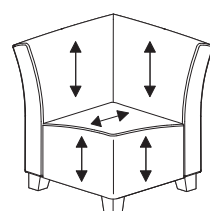

Tip: Reverse seat fabric directionality is applied as the diagram above indicates (ex. TS31426).

Tip: Brushed aluminum legs are adjustable and have 3/4" of height adjustment.

Tip: Wood legs are natural wood and may show variations in grain and color.

Options	U.S. Price	Required to Specify
Surface Materials, continued		
② Fabric on inner back		
• Fabric price group 1	No cost	Specify fabric color number.
• Fabric price group 2	+\$ 9	Specify fabric color number.
• Fabric price group 3	+\$ 35	Specify fabric color number.
• Fabric price group 4	+\$ 47	Specify fabric color number.
• Fabric price group 5	+\$ 60	Specify fabric color number.
• Fabric price group 6	+\$ 73	Specify fabric color number.
• Fabric price group 7	+\$ 87	Specify fabric color number.
• Fabric price group 8	+\$108	Specify fabric color number.
• Fabric price group 9	+\$136	Specify fabric color number.
• Fabric price group 10	+\$159	Specify fabric color number.
• Leather price group	+\$670	Specify fabric color number. Add suffix L to style number and specify leather color number.
• Vinyl	+\$ 9	Specify vinyl color number.
• Customer's Own Material (COM)	+\$ 27	► See <i>Understanding Customer's Own Material (COM)</i> , page 642.
• Customer's Own Leather (COL)	+\$ 27	Add suffix L to style number and specify leather color number.
③ Fabric on outer back		
• Fabric price group 1	No cost	Specify fabric color number.
• Fabric price group 2	+\$ 7	Specify fabric color number.
• Fabric price group 3	+\$ 22	Specify fabric color number.
• Fabric price group 4	+\$ 36	Specify fabric color number.
• Fabric price group 5	+\$ 46	Specify fabric color number.
• Fabric price group 6	+\$ 56	Specify fabric color number.
• Fabric price group 7	+\$ 63	Specify fabric color number.
• Fabric price group 8	+\$ 81	Specify fabric color number.
• Fabric price group 9	+\$104	Specify fabric color number.
• Fabric price group 10	+\$114	Specify fabric color number.
• Leather price group	+\$929	Add suffix L to style number and specify leather color number.
• Vinyl	+\$ 7	Specify vinyl color number.
• Customer's Own Material (COM)	+\$ 27	► See <i>Understanding Customer's Own Material (COM)</i> , page 642.
• Customer's Own Leather (COL)	+\$ 27	Add suffix L to style number and specify leather color number.
Legs		
• Brushed aluminum legs	+\$167	Specify <i>with brushed aluminum legs</i> .
• Solid square wood legs	+\$222	Specify <i>with solid square wood legs</i> and select 3412 Natural Cherry, 3522 Clear Maple, or 3762 Dark Walnut.
• Solid round wood legs	+\$233	Specify <i>with solid round wood legs</i> and select V1AC Natural Cherry, V1AM Clear Maple, or V1EW Dark Walnut.

Related Products

- Ganging kit

► Page 615

Specification Information

Style Number	U.S. Base Price	Style Number	U.S. Base Price
--------------	-----------------	--------------	-----------------

Standard Seat Fabric Directionality

With Glides

TS31406 \$1814

With Casters

TS31406C \$1883

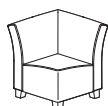

Glides



Casters

Reverse Seat Fabric Directionality

With Glides

TS31426 \$1814

With Casters

TS31426C \$1883



For Canadian Pricing

Multiply U.S. Price by the Canadian price factor.

► See page 1 for details.

Jenny Lounge, continued

Club

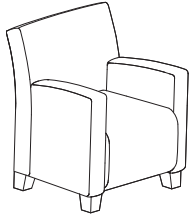

Tip: Jenny Lounge chairs are available with multiple fabrics.
▶ See at right to specify.

Tip: When specifying multiple COM fabrics, indicate all surfaces where COM applies.
Example: TS31407M with Designtex 1234 on seat, Designtex 5678 on inner back, Designtex 9012 on outer back, and Designtex 9012 on arms.

Tip: When specifying multiple fabrics and leather, specify suffix **M** before suffix **L**.
Example: TS31407L becomes TS31407ML

▶ Detailed dimensions, page 592



For Canadian Pricing
Multiply U.S. Price by the Canadian price factor.
▶ See page 1 for details.

Standard Includes	Required to Specify
<ul style="list-style-type: none"> ▶ Need help? Product details, page 588 Fully upholstered lounge chair with arms: • fabric price group 1 • Deck stitch detail • Hard dual wheel casters or legs with glides: black plastic • Shipped fully assembled, some legs are field installed • Meets Cal. 117 requirements 	<ul style="list-style-type: none"> 1 Style number 2 Fabric color number for upholstery 3 Options, if selected (see below) ▶ See <i>Surface Materials</i>, page 634.

Surface Materials	Options	U.S. Price	Required to Specify
	Single upholstery fabric		
	• Fabric price group 1	No cost	Specify fabric color number.
	• Fabric price group 2	+\$ 69	Specify fabric color number.
	• Fabric price group 3	+\$ 164	Specify fabric color number.
	• Fabric price group 4	+\$ 231	Specify fabric color number.
	• Fabric price group 5	+\$ 301	Specify fabric color number.
	• Fabric price group 6	+\$ 362	Specify fabric color number.
	• Fabric price group 7	+\$ 434	Specify fabric color number.
	• Fabric price group 8	+\$ 546	Specify fabric color number.
	• Fabric price group 9	+\$ 682	Specify fabric color number.
	• Fabric price group 10	+\$ 775	Specify fabric color number.
	• Leather price group	+\$4630	Specify fabric color number. Add suffix L to style number and specify leather color number.
	• Vinyl	+\$ 69	Specify vinyl color number.
	• Customer's Own Material (COM)	+\$ 56	▶ See <i>Understanding Customer's Own Material (COM)</i> , page 642.
	• Customer's Own Leather (COL)	+\$ 53	Add suffix L to style number and specify leather color number.

	Multiple upholstery fabrics		
	• Two or more fabrics on different chair components	+\$ 98	Add suffix M to lounge chair style number and select fabric color number for:
	▶ See below and at right.		<ol style="list-style-type: none"> 1 Seat 2 Inner back 3 Outer back 4 Arms Example: TS31407M with 5G61 on seat, 5F15 on inner back, 5G51 on outer back, and 5F03 on arms.
	1 Fabric on seat		
	• Fabric price group 1	No cost	Specify fabric color number.
	• Fabric price group 2	+\$ 17	Specify fabric color number.
	• Fabric price group 3	+\$ 49	Specify fabric color number.
	• Fabric price group 4	+\$ 63	Specify fabric color number.
	• Fabric price group 5	+\$ 85	Specify fabric color number.
	• Fabric price group 6	+\$ 106	Specify fabric color number.
	• Fabric price group 7	+\$ 126	Specify fabric color number.
	• Fabric price group 8	+\$ 161	Specify fabric color number.
	• Fabric price group 9	+\$ 197	Specify fabric color number.
	• Fabric price group 10	+\$ 227	Specify fabric color number.
	• Leather price group	+\$1321	Specify fabric color number. Add suffix L to style number and specify leather color number.
	• Vinyl	+\$ 17	Specify vinyl color number.
	• Customer's Own Material (COM)	+\$ 27	▶ See <i>Understanding Customer's Own Material (COM)</i> , page 642.
	• Customer's Own Leather (COL)	+\$ 27	Add suffix L to style number and specify leather color number.

▶ Options, continued on next page

► Options, continued from previous page

Options	U.S. Price	Required to Specify
Surface Materials, continued		
2 Fabric on inner back		
• Fabric price group 1	No cost	Specify fabric color number.
• Fabric price group 2	+\$ 9	Specify fabric color number.
• Fabric price group 3	+\$ 35	Specify fabric color number.
• Fabric price group 4	+\$ 47	Specify fabric color number.
• Fabric price group 5	+\$ 60	Specify fabric color number.
• Fabric price group 6	+\$ 73	Specify fabric color number.
• Fabric price group 7	+\$ 87	Specify fabric color number.
• Fabric price group 8	+\$ 108	Specify fabric color number.
• Fabric price group 9	+\$ 136	Specify fabric color number.
• Fabric price group 10	+\$ 159	Specify fabric color number.
• Leather price group	+\$ 670	Add suffix L to style number and specify leather color number.
• Vinyl	+\$ 9	Specify vinyl color number.
• Customer's Own Material (COM)	+\$ 27	► See <i>Understanding Customer's Own Material (COM)</i> , page 642.
• Customer's Own Leather (COL)	+\$ 27	Add suffix L to style number and specify leather color number.
3 Fabric on outer back		
• Fabric price group 1	No cost	Specify fabric color number.
• Fabric price group 2	+\$ 7	Specify fabric color number.
• Fabric price group 3	+\$ 22	Specify fabric color number.
• Fabric price group 4	+\$ 36	Specify fabric color number.
• Fabric price group 5	+\$ 46	Specify fabric color number.
• Fabric price group 6	+\$ 56	Specify fabric color number.
• Fabric price group 7	+\$ 63	Specify fabric color number.
• Fabric price group 8	+\$ 81	Specify fabric color number.
• Fabric price group 9	+\$ 104	Specify fabric color number.
• Fabric price group 10	+\$ 114	Specify fabric color number.
• Leather price group	+\$ 929	Add suffix L to style number and specify leather color number.
• Vinyl	+\$ 7	Specify vinyl color number.
• Customer's Own Material (COM)	+\$ 27	► See <i>Understanding Customer's Own Material (COM)</i> , page 642.
• Customer's Own Leather (COL)	+\$ 27	Add suffix L to style number and specify leather color number.
4 Fabric on arms		
• Fabric price group 1	No cost	Specify fabric color number.
• Fabric price group 2	+\$ 23	Specify fabric color number.
• Fabric price group 3	+\$ 59	Specify fabric color number.
• Fabric price group 4	+\$ 81	Specify fabric color number.
• Fabric price group 5	+\$ 107	Specify fabric color number.
• Fabric price group 6	+\$ 132	Specify fabric color number.
• Fabric price group 7	+\$ 160	Specify fabric color number.
• Fabric price group 8	+\$ 196	Specify fabric color number.
• Fabric price group 9	+\$ 246	Specify fabric color number.
• Fabric price group 10	+\$ 278	Specify fabric color number.
• Leather price group	+\$1770	Add suffix L to style number and specify leather color number.
• Vinyl	+\$ 23	Specify vinyl color number.
• Customer's Own Material (COM)	+\$ 27	► See <i>Understanding Customer's Own Material (COM)</i> , page 642.
• Customer's Own Leather (COL)	+\$ 27	Add suffix L to style number and specify leather color number.
Legs		
• Brushed aluminum legs	+\$ 167	Specify <i>with brushed aluminum legs</i> .
• Solid square wood legs	+\$ 222	Specify <i>with solid square wood legs</i> and select 3412 Natural Cherry, 3522 Clear Maple, or 3762 Dark Walnut.
• Solid round wood legs	+\$ 233	Specify <i>with solid round wood legs</i> and select V1AC Natural Cherry, V1AM Clear Maple, or V1EW Dark Walnut.

Tip: Brushed aluminum legs are adjustable and have 3/4" of height adjustment.

Tip: Wood legs are natural wood and may show variations in grain and color.

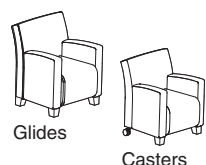

Specification Information			
Style Number	U.S. Base Price	Style Number	U.S. Base Price
With Glides		With Two Casters and Two Glides	
TS31407	\$1917	TS31407C	\$1986

Jenny Lounge, continued

Round

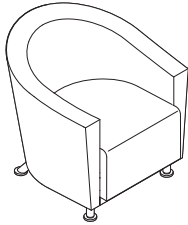

Tip: Jenny Round chairs are available with multiple fabrics.

▶ See at right to specify.

Tip: When specifying multiple COM fabrics, indicate all surfaces where COM applies. Example: TS31407M with Designtex 1234 on seat, Designtex 5678 on inner back, Designtex 9012 on outer back, and Designtex 9012 on arms.

Tip: When specifying multiple fabrics and leather, specify suffix **M** before suffix **L**. Example: TS31409L becomes TS31409ML

▶ Detailed dimensions, page 592

Standard Includes	Required to Specify
<ul style="list-style-type: none"> ▶ Need help? Product details, page 588 Fully upholstered Round chair with arms: fabric price group 1 Shipped fully assembled, legs are field installed Meets Cal. 117 requirements Brushed aluminum legs Deck stitch detail 	<ul style="list-style-type: none"> 1 Style number 2 Fabric color number for upholstery 3 Options, if selected (see below) ▶ See <i>Surface Materials</i>, page 634.

Surface Materials	Options	U.S. Price	Required to Specify
	Single upholstery fabric		
	<ul style="list-style-type: none"> Fabric price group 1 Fabric price group 2 Fabric price group 3 Fabric price group 4 Fabric price group 5 Fabric price group 6 Fabric price group 7 Fabric price group 8 Fabric price group 9 Fabric price group 10 Leather price group 	<ul style="list-style-type: none"> No cost +\$ 69 +\$ 164 +\$ 231 +\$ 301 +\$ 362 +\$ 434 +\$ 546 +\$ 682 +\$ 775 +\$4686 	<ul style="list-style-type: none"> Specify fabric color number. Specify fabric color number. Specify fabric color number. Specify fabric color number. Specify fabric color number. Specify fabric color number. Specify fabric color number. Specify fabric color number. Specify fabric color number. Specify fabric color number. Specify fabric color number. Add suffix L to style number and specify leather color number. Specify vinyl color number. ▶ See <i>Understanding Customer's Own Material (COM)</i>, page 642. Add suffix L to style number and specify leather color number.
	<ul style="list-style-type: none"> Vinyl Customer's Own Material (COM) Customer's Own Leather (COL) 	<ul style="list-style-type: none"> +\$ 69 +\$ 56 +\$ 53 	

	Multiple upholstery fabrics		
	<ul style="list-style-type: none"> Two or more fabrics on different chair components 	<ul style="list-style-type: none"> +\$ 98 	<ul style="list-style-type: none"> Add suffix M to Round chair style number and select fabric color number for:

	1 Fabric on seat		
	<ul style="list-style-type: none"> Fabric price group 1 Fabric price group 2 Fabric price group 3 Fabric price group 4 Fabric price group 5 Fabric price group 6 Fabric price group 7 Fabric price group 8 Fabric price group 9 Fabric price group 10 Leather price group 	<ul style="list-style-type: none"> No cost +\$ 23 +\$ 49 +\$ 92 +\$ 113 +\$ 130 +\$ 161 +\$ 197 +\$ 227 +\$ 254 +\$1542 	<ul style="list-style-type: none"> Specify fabric color number. Specify fabric color number. Specify fabric color number. Specify fabric color number. Specify fabric color number. Specify fabric color number. Specify fabric color number. Specify fabric color number. Specify fabric color number. Specify fabric color number. Specify fabric color number. Add suffix L to style number and specify leather color number. Specify vinyl color number. ▶ See <i>Understanding Customer's Own Material (COM)</i>, page 642. Add suffix L to style number and specify leather color number.
	<ul style="list-style-type: none"> Vinyl Customer's Own Material (COM) Customer's Own Leather (COL) 	<ul style="list-style-type: none"> +\$ 23 +\$ 27 +\$ 27 	

▶ Options, continued on next page



For Canadian Pricing

Multiply U.S. Price by the Canadian price factor.

▶ See page 1 for details.

► Options, continued from previous page

Options	U.S. Price	Required to Specify
Surface Materials, continued		
② Fabric on inner back		
• Fabric price group 1	No cost	Specify fabric color number.
• Fabric price group 2	+\$ 24	Specify fabric color number.
• Fabric price group 3	+\$ 57	Specify fabric color number.
• Fabric price group 4	+\$ 66	Specify fabric color number.
• Fabric price group 5	+\$ 78	Specify fabric color number.
• Fabric price group 6	+\$ 98	Specify fabric color number.
• Fabric price group 7	+\$ 104	Specify fabric color number.
• Fabric price group 8	+\$ 119	Specify fabric color number.
• Fabric price group 9	+\$ 136	Specify fabric color number.
• Fabric price group 10	+\$ 159	Specify fabric color number.
• Leather price group	+\$ 912	Add suffix L to style number and specify leather color number.
• Vinyl	+\$ 24	Specify vinyl color number.
• Customer's Own Material (COM)	+\$ 27	► See <i>Understanding Customer's Own Material (COM)</i> , page 642.
• Customer's Own Leather (COL)	+\$ 27	Add suffix L to style number and specify leather color number.
③ Fabric on outer back		
• Fabric price group 1	No cost	Specify fabric color number.
• Fabric price group 2	+\$ 31	Specify fabric color number.
• Fabric price group 3	+\$ 60	Specify fabric color number.
• Fabric price group 4	+\$ 83	Specify fabric color number.
• Fabric price group 5	+\$ 109	Specify fabric color number.
• Fabric price group 6	+\$ 141	Specify fabric color number.
• Fabric price group 7	+\$ 179	Specify fabric color number.
• Fabric price group 8	+\$ 201	Specify fabric color number.
• Fabric price group 9	+\$ 231	Specify fabric color number.
• Fabric price group 10	+\$ 255	Specify fabric color number.
• Leather price group	+\$1209	Add suffix L to style number and specify leather color number.
• Vinyl	+\$ 31	Specify vinyl color number.
• Customer's Own Material (COM)	+\$ 27	► See <i>Understanding Customer's Own Material (COM)</i> , page 642.
• Customer's Own Leather (COL)	+\$ 27	Add suffix L to style number and specify leather color number.
Legs		
• Solid round wood legs	+\$ 136	Specify with <i>solid round wood legs</i> and select V1AC Natural Cherry, V1AM Clear Maple, or V1EW Dark Walnut.

Jenny Lounge

Tip: Wood legs are natural wood and may show variations in grain and color.

Specification Information

Style Number	U.S. Base Price
--------------	-----------------

Round

TS31409	\$2233
---------	--------

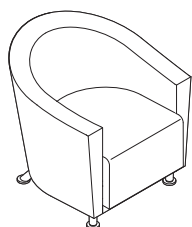

 **For Canadian Pricing**
 Multiply U.S. Price by the Canadian price factor.
 ► See page 1 for details.

Jenny Lounge, continued

With Wood Arms

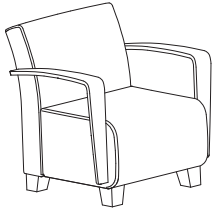

Tip: Jenny Lounge chairs are available with multiple fabrics.

▶ See at right to specify.

Tip: When specifying multiple COM fabrics, indicate all surfaces where COM applies. Example: TS31407M with Designtex 1234 on seat, Designtex 5678 on inner back, Designtex 9012 on outer back, and Designtex 9012 on arms.

Tip: When specifying multiple fabrics and leather, specify suffix **M** before suffix **L**. Example: TS31408L becomes TS31408ML

▶ Detailed dimensions, page 592

Standard Includes	Required to Specify
<ul style="list-style-type: none"> ▶ Need help? Product details, page 588 Fully upholstered lounge chair: fabric price group 1 Plywood arm: maple veneer Legs with glides: black plastic Shipped fully assembled, some legs are field installed Meets Cal. 117 requirements 	<ul style="list-style-type: none"> 1 Style number 2 Fabric color number for upholstery 3 Wood color number for arms 4 Options, if selected (see below) ▶ See <i>Surface Materials</i>, page 634.

Surface Materials	Options	U.S. Price	Required to Specify
	Single upholstery fabric		Specify fabric color number. Specify fabric color number. Specify fabric color number. Specify fabric color number. Specify fabric color number. Specify fabric color number. Specify fabric color number. Specify fabric color number. Specify fabric color number. Specify fabric color number. Specify fabric color number. Add suffix L to style number and specify leather color number. Specify vinyl color number. ▶ See <i>Understanding Customer's Own Material (COM)</i> , page 642. Add suffix L to style number and specify leather color number.
	<ul style="list-style-type: none"> Fabric price group 1 Fabric price group 2 Fabric price group 3 Fabric price group 4 Fabric price group 5 Fabric price group 6 Fabric price group 7 Fabric price group 8 Fabric price group 9 Fabric price group 10 Leather price group 	No cost +\$ 47 +\$ 105 +\$ 144 +\$ 187 +\$ 234 +\$ 277 +\$ 349 +\$ 437 +\$ 494 +\$2996	
	<ul style="list-style-type: none"> Vinyl Customer's Own Material (COM) Customer's Own Leather (COL) 	+\$ 47 +\$ 56 +\$ 53	Add suffix M to lounge chair style number and select fabric color number for: <ul style="list-style-type: none"> 1 Seat 2 Inner back 3 Outer back Example: TS31408M with 5G61 on seat, 5F15 on inner back, and 5G51 on outer back. Specify fabric color number. Specify fabric color number. Specify fabric color number. Specify fabric color number. Specify fabric color number. Specify fabric color number. Specify fabric color number. Specify fabric color number. Specify fabric color number. Specify fabric color number. Add suffix L to style number and specify leather color number. Specify vinyl color number. ▶ See <i>Understanding Customer's Own Material (COM)</i> , page 642. Add suffix L to style number and specify leather color number.
	Multiple upholstery fabrics		
	<ul style="list-style-type: none"> Two or more fabrics on different chair components ▶ See below and at right. 	+\$ 98	
	1 Fabric on seat		Specify fabric color number. Specify fabric color number. Specify fabric color number. Specify fabric color number. Specify fabric color number. Specify fabric color number. Specify fabric color number. Specify fabric color number. Specify fabric color number. Specify fabric color number. Add suffix L to style number and specify leather color number. Specify vinyl color number. ▶ See <i>Understanding Customer's Own Material (COM)</i> , page 642. Add suffix L to style number and specify leather color number.
	<ul style="list-style-type: none"> Fabric price group 1 Fabric price group 2 Fabric price group 3 Fabric price group 4 Fabric price group 5 Fabric price group 6 Fabric price group 7 Fabric price group 8 Fabric price group 9 Fabric price group 10 Leather price group 	No cost +\$ 17 +\$ 49 +\$ 63 +\$ 85 +\$ 106 +\$ 126 +\$ 161 +\$ 197 +\$ 227 +\$1430	
	<ul style="list-style-type: none"> Vinyl Customer's Own Material (COM) Customer's Own Leather (COL) 	+\$ 17 +\$ 27 +\$ 27	

▶ Options, continued on next page



For Canadian Pricing
 Multiply U.S. Price by the Canadian price factor.
 ▶ See page 1 for details.

► Options, continued from previous page

Options	U.S. Price	Required to Specify
Surface Materials, continued		
2 Fabric on inner back		
• Fabric price group 1	No cost	Specify fabric color number.
• Fabric price group 2	+\$ 9	Specify fabric color number.
• Fabric price group 3	+\$ 35	Specify fabric color number.
• Fabric price group 4	+\$ 47	Specify fabric color number.
• Fabric price group 5	+\$ 60	Specify fabric color number.
• Fabric price group 6	+\$ 73	Specify fabric color number.
• Fabric price group 7	+\$ 87	Specify fabric color number.
• Fabric price group 8	+\$108	Specify fabric color number.
• Fabric price group 9	+\$136	Specify fabric color number.
• Fabric price group 10	+\$159	Specify fabric color number.
• Leather price group	+\$670	Add suffix L to style number and specify leather color number.
• Vinyl	+\$ 9	Specify vinyl color number.
• Customer's Own Material (COM)	+\$ 27	► See <i>Understanding Customer's Own Material (COM)</i> , page 642.
• Customer's Own Leather (COL)	+\$ 27	Add suffix L to style number and specify leather color number.
3 Fabric on outer back		
• Fabric price group 1	No cost	Specify fabric color number.
• Fabric price group 2	+\$ 7	Specify fabric color number.
• Fabric price group 3	+\$ 22	Specify fabric color number.
• Fabric price group 4	+\$ 36	Specify fabric color number.
• Fabric price group 5	+\$ 46	Specify fabric color number.
• Fabric price group 6	+\$ 56	Specify fabric color number.
• Fabric price group 7	+\$ 63	Specify fabric color number.
• Fabric price group 8	+\$ 81	Specify fabric color number.
• Fabric price group 9	+\$104	Specify fabric color number.
• Fabric price group 10	+\$114	Specify fabric color number.
• Leather price group	+\$929	Add suffix L to style number and specify leather color number.
• Vinyl	+\$ 7	Specify vinyl color number.
• Customer's Own Material (COM)	+\$ 27	► See <i>Understanding Customer's Own Material (COM)</i> , page 642.
• Customer's Own Leather (COL)	+\$ 27	Add suffix L to style number and specify leather color number.
Legs		
• Brushed aluminum legs	+\$167	Specify <i>with brushed aluminum legs</i> .
• Solid square wood legs	+\$222	Specify <i>with solid wood legs</i> and select 3412 Natural Cherry, 3522 Clear Maple, or 3762 Dark Walnut.
• Solid round wood legs	+\$233	Specify <i>with solid round wood legs</i> and select V1AC Natural Cherry, V1AM Clear Maple, or V1EW Dark Walnut.

Tip: Brushed aluminum legs are adjustable and have ³/₄" of height adjustment.

Tip: Wood legs are natural wood and may show variations in grain and color.

Specification Information

Style Number	U.S. Base Price
With Wood Arms	
TS31408	\$2317
With Wood Arm Left	
TS31428	\$2037
With Wood Arm Right	
TS31438	\$2037



Jenny Lounge, continued

Ottoman

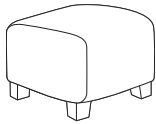

Tip: Hard dual-wheel casters are for use on carpet. Use on hard surfaces, including floor mats, will affect chair stability and may result in personal injury.

Tip: Jenny Ottoman is available with multiple fabrics. See at right to specify.

Tip: When specifying multiple COM fabrics, indicate all surfaces where COM applies. Example: TS31405M with Designtex 1234 on seat, front, and back and Designtex 9012 on sides.

Tip: When specifying multiple fabrics and leather, specify suffix **M** before suffix **L**. Example: TS31405L becomes TS31405ML

Detailed dimensions, page 592

Standard Includes	Required to Specify
<ul style="list-style-type: none"> Need help? Product details, page 588 Fully upholstered Ottoman: fabric price group 1 Hard dual-wheel casters or legs with glides: black plastic Shipped fully assembled, some legs are field installed Meets Cal. 117 requirements 	<ul style="list-style-type: none"> 1 Style number 2 Fabric color number for upholstery 3 Options, if selected (see below) See <i>Surface Materials</i>, page 634.

Surface Materials	Options	U.S. Price	Required to Specify
	Single upholstery fabric		Specify fabric color number. Specify fabric color number. Specify fabric color number. Specify fabric color number. Specify fabric color number. Specify fabric color number. Specify fabric color number. Specify fabric color number. Specify fabric color number. Specify fabric color number. Add suffix L to style number and specify leather color number. Specify vinyl color number. Specify vinyl color number. See <i>Understanding Customer's Own Material (COM)</i> , page 642. Add suffix L to style number and specify leather color number.
	• Fabric price group 1	No cost	
	• Fabric price group 2	+\$ 24	
	• Fabric price group 3	+\$ 62	
	• Fabric price group 4	+\$ 94	
	• Fabric price group 5	+\$ 117	
	• Fabric price group 6	+\$ 144	
	• Fabric price group 7	+\$ 172	
	• Fabric price group 8	+\$ 221	
	• Fabric price group 9	+\$ 273	
• Fabric price group 10	+\$ 308		
• Leather price group	+\$1555		
	• Vinyl	+\$ 24	Add suffix M to Ottoman style number and select fabric color number for: ① Seat, front, and back ② Sides Example: TS31405M with 5G61 on seat, front, and back and 5F15 on sides.
	• Customer's Own Material (COM)	+\$ 56	
	• Customer's Own Leather (COL)	+\$ 53	
	Multiple upholstery fabrics		Add suffix M to Ottoman style number and select fabric color number for: ① Seat, front, and back ② Sides Example: TS31405M with 5G61 on seat, front, and back and 5F15 on sides.
	• Two or more fabrics on different components	+\$ 98	
	See below and at right.		

① Fabric on seat, front, and back

- Fabric price group 1 No cost
- Fabric price group 2 +\$ 17
- Fabric price group 3 +\$ 49
- Fabric price group 4 +\$ 69
- Fabric price group 5 +\$ 88
- Fabric price group 6 +\$ 108
- Fabric price group 7 +\$ 130
- Fabric price group 8 +\$ 165
- Fabric price group 9 +\$ 206
- Fabric price group 10 +\$ 234
- Leather price group +\$1074

- Vinyl +\$ 17
- Customer's Own Material (COM) +\$ 27
- Customer's Own Leather (COL) +\$ 27

Specify fabric color number.
 Specify fabric color number.
 Specify fabric color number.
 Specify fabric color number.
 Specify fabric color number.
 Specify fabric color number.
 Specify fabric color number.
 Specify fabric color number.
 Specify fabric color number.
 Specify fabric color number.
 Specify fabric color number.
 Add suffix **L** to style number and specify leather color number.
 Specify vinyl color number.
 Specify vinyl color number.
 See *Understanding Customer's Own Material (COM)*, page 642.
 Add suffix **L** to style number and specify leather color number.

Options, continued on next page

For Canadian Pricing
 Multiply U.S. Price by the Canadian price factor.
 See page 1 for details.

► Options, continued from previous page

Options	U.S. Price	Required to Specify
Surface Materials, continued		
② Fabric on sides		
• Fabric price group 1	No cost	Specify fabric color number.
• Fabric price group 2	+\$ 4	Specify fabric color number.
• Fabric price group 3	+\$ 11	Specify fabric color number.
• Fabric price group 4	+\$ 22	Specify fabric color number.
• Fabric price group 5	+\$ 28	Specify fabric color number.
• Fabric price group 6	+\$ 37	Specify fabric color number.
• Fabric price group 7	+\$ 46	Specify fabric color number.
• Fabric price group 8	+\$ 56	Specify fabric color number.
• Fabric price group 9	+\$ 69	Specify fabric color number.
• Fabric price group 10	+\$ 77	Specify fabric color number.
• Leather price group	+\$546	Specify fabric color number. Add suffix L to style number and specify leather color number.
• Vinyl	+\$ 4	Specify vinyl color number.
• Customer's Own Material (COM)	+\$ 27	► See <i>Understanding Customer's Own Material (COM)</i> , page 642.
• Customer's Own Leather (COL)	+\$ 27	Add suffix L to style number and specify leather color number.
Legs		
• Brushed aluminum legs	+\$167	Specify with <i>brushed aluminum legs</i> .
• Solid square wood legs	+\$222	Specify with <i>solid square wood legs</i> and select 3412 Natural Cherry, 3522 Clear Maple, or 3762 Dark Walnut.
• Solid round wood legs	+\$233	Specify with <i>solid round wood legs</i> and select V1AC Natural Cherry, V1AM Clear Maple, or V1EW Dark Walnut.

Tip: Brushed aluminum legs are adjustable and have 3/4" of height adjustment.

Tip: Wood legs are natural wood and may show variations in grain and color.

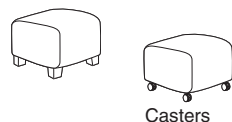

Specification Information			
Style Number	U.S. Base Price	Style Number	U.S. Base Price

With Glides	
TS31405	\$824

With Casters	
TS31405C	\$957

Ganging Kit

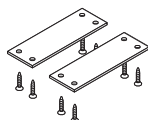

Standard Includes	Required to Specify
<ul style="list-style-type: none"> Ganging kit Two plates Attachment hardware 	Style number

Specification Information			
Dimensions	Style Number	U.S. Price	
D W			
2" 6"	TS31410	\$44	



For Canadian Pricing
Multiply U.S. Price by the Canadian price factor.
► See page 1 for details.

Club Low

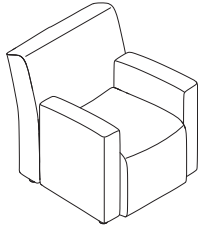

Tip: Jenny Low chairs come standard with low feet to allow for a lower chair height supporting working lounge posture.

Tip: Jenny Lounge chairs are available with multiple fabrics.

▶ See at right to specify.

Tip: When specifying multiple COM fabrics, indicate all surfaces where COM applies. Example: TS31407M with Designtex 1234 on seat, Designtex 5678 on inner back, Designtex 9012 on outer back, and Designtex 9012 on arms.

Tip: When specifying multiple fabrics and leather, specify suffix **M** before suffix **L**. Example: TS31412L becomes TS31412ML

▶ Detailed dimensions, page 592



For Canadian Pricing
Multiply U.S. Price by the Canadian price factor.
▶ See page 1 for details.

Standard Includes	Required to Specify
<ul style="list-style-type: none"> ▶ Need help? Product details, page 588 Fully upholstered lounge chair with arms: <ul style="list-style-type: none"> fabric price group 1 Deck stitch detail Shipped fully assembled Meets Cal. 117 requirements Low foot, black plastic 	<ul style="list-style-type: none"> 1 Style number 2 Fabric color number for upholstery 3 Options, if selected (see below) ▶ See <i>Surface Materials</i>, page 634.

Surface Materials	Options	U.S. Price	Required to Specify
	Single upholstery fabric		Specify fabric color number. Specify fabric color number. Specify fabric color number. Specify fabric color number. Specify fabric color number. Specify fabric color number. Specify fabric color number. Specify fabric color number. Specify fabric color number. Specify fabric color number. Add suffix L to style number and specify leather color number. Specify vinyl color number. ▶ See <i>Understanding Customer's Own Material (COM)</i> , page 642. Add suffix L to style number and specify leather color number.
	<ul style="list-style-type: none"> Fabric price group 1 Fabric price group 2 Fabric price group 3 Fabric price group 4 Fabric price group 5 Fabric price group 6 Fabric price group 7 Fabric price group 8 Fabric price group 9 Fabric price group 10 Leather price group 	<ul style="list-style-type: none"> No cost +\$ 69 +\$ 164 +\$ 231 +\$ 301 +\$ 362 +\$ 434 +\$ 546 +\$ 682 +\$ 775 +\$4630 	
	<ul style="list-style-type: none"> Vinyl Customer's Own Material (COM) Customer's Own Leather (COL) 	<ul style="list-style-type: none"> +\$ 69 +\$ 56 +\$ 56 	Add suffix M to lounge chair style number and select fabric color number for: <ol style="list-style-type: none"> Seat Inner back Outer back Arms Example: TS31412M with 5G61 on seat, 5F15 on inner back, 5G51 on outer back, and 5F03 on arms. Specify fabric color number. Specify fabric color number. Specify fabric color number. Specify fabric color number. Specify fabric color number. Specify fabric color number. Specify fabric color number. Specify fabric color number. Specify fabric color number. Specify fabric color number. Specify fabric color number. Add suffix L to style number and specify leather color number. Specify vinyl color number. ▶ See <i>Understanding Customer's Own Material (COM)</i> , page 642. Add suffix L to style number and specify leather color number.
	Multiple upholstery fabrics	<ul style="list-style-type: none"> Two or more fabrics on different chair components 	
	1 Fabric on seat		Specify fabric color number. Specify fabric color number. Specify fabric color number. Specify fabric color number. Specify fabric color number. Specify fabric color number. Specify fabric color number. Specify fabric color number. Specify fabric color number. Specify fabric color number. Specify fabric color number. Add suffix L to style number and specify leather color number. Specify vinyl color number. ▶ See <i>Understanding Customer's Own Material (COM)</i> , page 642. Add suffix L to style number and specify leather color number.
	<ul style="list-style-type: none"> Fabric price group 1 Fabric price group 2 Fabric price group 3 Fabric price group 4 Fabric price group 5 Fabric price group 6 Fabric price group 7 Fabric price group 8 Fabric price group 9 Fabric price group 10 Leather price group 	<ul style="list-style-type: none"> No cost +\$ 17 +\$ 49 +\$ 63 +\$ 85 +\$ 106 +\$ 126 +\$ 161 +\$ 197 +\$ 227 +\$1321 	
	<ul style="list-style-type: none"> Vinyl Customer's Own Material (COM) Customer's Own Leather (COL) 	<ul style="list-style-type: none"> +\$ 17 +\$ 27 +\$ 27 	

▶ Options, continued on next page

► Options, continued from previous page

Options	U.S. Price	Required to Specify
Surface Materials, continued		
2 Fabric on inner back		
• Fabric price group 1	No cost	Specify fabric color number.
• Fabric price group 2	+\$ 9	Specify fabric color number.
• Fabric price group 3	+\$ 35	Specify fabric color number.
• Fabric price group 4	+\$ 47	Specify fabric color number.
• Fabric price group 5	+\$ 60	Specify fabric color number.
• Fabric price group 6	+\$ 73	Specify fabric color number.
• Fabric price group 7	+\$ 87	Specify fabric color number.
• Fabric price group 8	+\$ 108	Specify fabric color number.
• Fabric price group 9	+\$ 136	Specify fabric color number.
• Fabric price group 10	+\$ 159	Specify fabric color number.
• Leather price group	+\$ 670	Add suffix L to style number and specify leather color number.
• Vinyl	+\$ 9	Specify vinyl color number.
• Customer's Own Material (COM)	+\$ 27	► See <i>Understanding Customer's Own Material (COM)</i> , page 642.
• Customer's Own Leather (COL)	+\$ 27	Add suffix L to style number and specify leather color number.
3 Fabric on outer back		
• Fabric price group 1	No cost	Specify fabric color number.
• Fabric price group 2	+\$ 7	Specify fabric color number.
• Fabric price group 3	+\$ 22	Specify fabric color number.
• Fabric price group 4	+\$ 36	Specify fabric color number.
• Fabric price group 5	+\$ 46	Specify fabric color number.
• Fabric price group 6	+\$ 56	Specify fabric color number.
• Fabric price group 7	+\$ 63	Specify fabric color number.
• Fabric price group 8	+\$ 81	Specify fabric color number.
• Fabric price group 9	+\$ 104	Specify fabric color number.
• Fabric price group 10	+\$ 114	Specify fabric color number.
• Leather price group	+\$ 929	Add suffix L to style number and specify leather color number.
• Vinyl	+\$ 7	Specify vinyl color number.
• Customer's Own Material (COM)	+\$ 27	► See <i>Understanding Customer's Own Material (COM)</i> , page 642.
• Customer's Own Leather (COL)	+\$ 27	Add suffix L to style number and specify leather color number.
4 Fabric on arms		
• Fabric price group 1	No cost	Specify fabric color number.
• Fabric price group 2	+\$ 23	Specify fabric color number.
• Fabric price group 3	+\$ 59	Specify fabric color number.
• Fabric price group 4	+\$ 81	Specify fabric color number.
• Fabric price group 5	+\$ 107	Specify fabric color number.
• Fabric price group 6	+\$ 132	Specify fabric color number.
• Fabric price group 7	+\$ 160	Specify fabric color number.
• Fabric price group 8	+\$ 196	Specify fabric color number.
• Fabric price group 9	+\$ 246	Specify fabric color number.
• Fabric price group 10	+\$ 278	Specify fabric color number.
• Leather price group	+\$1770	Add suffix L to style number and specify leather color number.
• Vinyl	+\$ 23	Specify vinyl color number.
• Customer's Own Material (COM)	+\$ 27	► See <i>Understanding Customer's Own Material (COM)</i> , page 642.
• Customer's Own Leather (COL)	+\$ 27	Add suffix L to style number and specify leather color number.

Jenny Lounge

Specification Information

Style Number	U.S. Base Price
Club Low	

TS31412	\$1917
----------------	--------

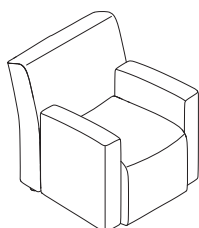

Round Low

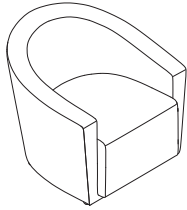

Tip: Jenny Low chairs come standard with low feet to allow for a lower chair height supporting working lounge posture.

Tip: Jenny Round chairs are available with multiple fabrics.

▶ See at right to specify.

Tip: When specifying multiple COM fabrics, indicate all surfaces where COM applies. Example: TS31407M with Designtex 1234 on seat, Designtex 5678 on inner back, Designtex 9012 on outer back, and Designtex 9012 on arms.

Tip: When specifying multiple fabrics and leather, specify suffix **M** before suffix **L**. Example: TS31413L becomes TS31413ML

▶ Detailed dimensions, page 592

 **For Canadian Pricing**
Multiply U.S. Price by the Canadian price factor.
▶ See page 1 for details.

Standard Includes	Required to Specify
<ul style="list-style-type: none"> ▶ Need help? Product details, page 588 Fully upholstered Round chair with arms: <ul style="list-style-type: none"> fabric price group 1 Deck stitch detail Shipped fully assembled Meets Cal. 117 requirements Low foot, black plastic 	<ul style="list-style-type: none"> 1 Style number 2 Fabric color number for upholstery 3 Options, if selected (see below) ▶ See <i>Surface Materials</i>, page 634.

Surface Materials	Options	U.S. Price	Required to Specify
	Single upholstery fabric		
	<ul style="list-style-type: none"> Fabric price group 1 Fabric price group 2 Fabric price group 3 Fabric price group 4 Fabric price group 5 Fabric price group 6 Fabric price group 7 Fabric price group 8 Fabric price group 9 Fabric price group 10 Leather price group 	<ul style="list-style-type: none"> No cost +\$ 69 +\$ 164 +\$ 231 +\$ 301 +\$ 362 +\$ 434 +\$ 546 +\$ 682 +\$ 775 +\$4686 	<ul style="list-style-type: none"> Specify fabric color number. Specify fabric color number. Specify fabric color number. Specify fabric color number. Specify fabric color number. Specify fabric color number. Specify fabric color number. Specify fabric color number. Specify fabric color number. Specify fabric color number. Specify fabric color number. Add suffix L to style number and specify leather color number. Specify vinyl color number. ▶ See <i>Understanding Customer's Own Material (COM)</i>, page 642. Add suffix L to style number and specify leather color number.
	<ul style="list-style-type: none"> Vinyl Customer's Own Material (COM) Customer's Own Leather (COL) 	<ul style="list-style-type: none"> +\$ 69 +\$ 56 +\$ 56 	

	Multiple upholstery fabrics		
	<ul style="list-style-type: none"> Two or more fabrics on different chair components 	<ul style="list-style-type: none"> +\$ 98 	<ul style="list-style-type: none"> Add suffix M to Round chair style number and select fabric color number for:
	▶ See below and at right.		
	1 Fabric on seat		
	<ul style="list-style-type: none"> Fabric price group 1 Fabric price group 2 Fabric price group 3 Fabric price group 4 Fabric price group 5 Fabric price group 6 Fabric price group 7 Fabric price group 8 Fabric price group 9 Fabric price group 10 Leather price group 	<ul style="list-style-type: none"> No cost +\$ 17 +\$ 49 +\$ 92 +\$ 113 +\$ 130 +\$ 161 +\$ 197 +\$ 227 +\$ 254 +\$1542 	<ul style="list-style-type: none"> Specify fabric color number. Specify fabric color number. Specify fabric color number. Specify fabric color number. Specify fabric color number. Specify fabric color number. Specify fabric color number. Specify fabric color number. Specify fabric color number. Specify fabric color number. Specify fabric color number. Add suffix L to style number and specify leather color number. Specify vinyl color number. ▶ See <i>Understanding Customer's Own Material (COM)</i>, page 642. Add suffix L to style number and specify leather color number.
	<ul style="list-style-type: none"> Vinyl Customer's Own Material (COM) Customer's Own Leather (COL) 	<ul style="list-style-type: none"> +\$ 17 +\$ 27 +\$ 27 	

▶ Options, continued on next page

► Options, continued from previous page

Options	U.S. Price	Required to Specify
Surface Materials, continued		
② Fabric on inner back		
• Fabric price group 1	No cost	Specify fabric color number.
• Fabric price group 2	+\$ 24	Specify fabric color number.
• Fabric price group 3	+\$ 57	Specify fabric color number.
• Fabric price group 4	+\$ 66	Specify fabric color number.
• Fabric price group 5	+\$ 78	Specify fabric color number.
• Fabric price group 6	+\$ 98	Specify fabric color number.
• Fabric price group 7	+\$ 104	Specify fabric color number.
• Fabric price group 8	+\$ 119	Specify fabric color number.
• Fabric price group 9	+\$ 136	Specify fabric color number.
• Fabric price group 10	+\$ 159	Specify fabric color number.
• Leather price group	+\$ 912	Add suffix L to style number and specify leather color number.
• Vinyl	+\$ 24	Specify vinyl color number.
• Customer's Own Material (COM)	+\$ 27	► See <i>Understanding Customer's Own Material (COM)</i> , page 642.
• Customer's Own Leather (COL)	+\$ 27	Add suffix L to style number and specify leather color number.
③ Fabric on outer back		
• Fabric price group 1	No cost	Specify fabric color number.
• Fabric price group 2	+\$ 31	Specify fabric color number.
• Fabric price group 3	+\$ 60	Specify fabric color number.
• Fabric price group 4	+\$ 83	Specify fabric color number.
• Fabric price group 5	+\$ 109	Specify fabric color number.
• Fabric price group 6	+\$ 141	Specify fabric color number.
• Fabric price group 7	+\$ 179	Specify fabric color number.
• Fabric price group 8	+\$ 201	Specify fabric color number.
• Fabric price group 9	+\$ 231	Specify fabric color number.
• Fabric price group 10	+\$ 255	Specify fabric color number.
• Leather price group	+\$1209	Add suffix L to style number and specify leather color number.
• Vinyl	+\$ 31	Specify vinyl color number.
• Customer's Own Material (COM)	+\$ 27	► See <i>Understanding Customer's Own Material (COM)</i> , page 642.
• Customer's Own Leather (COL)	+\$ 27	Add suffix L to style number and specify leather color number.

Jenny Lounge

Specification Information

Style Number	U.S. Base Price
--------------	-----------------

Round Low

TS31413	\$2233
---------	--------

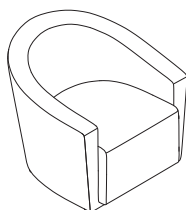

 **For Canadian Pricing**
 Multiply U.S. Price by the Canadian price factor.
 ► See page 1 for details.

Jenny Lounge, continued

Occasional Tables

Tip: There may be sheen or texture differences when using Low-Pressure Laminate and High-Pressure Laminate in adjacent applications. Please use caution when mixing and matching different worksurface types.

Tip: Edge band applies to entire table, not just the worksurface.

For laminate group 2 and 3 pricing, please refer to the electronic catalog or SmartTools.

Tip: Brushed aluminum legs are adjustable and have 3/4" of height adjustment.

Tip: Wood legs are natural wood and may show variations in grain and color.

Tip: Low foot option reduces overall table height to 15".

Standard Includes	Required to Specify
<ul style="list-style-type: none"> Need help? Product details, page 588 Table: Low-Pressure Laminate (LPL) or High-Pressure Laminate (HPL) price group 1 3 mm edge band: plastic Legs with glides: black plastic Shipped ready to assemble 	<ol style="list-style-type: none"> Style number Low-Pressure Laminate or High-Pressure Laminate color number for table top, as appropriate Plastic edge band color number for table Low-Pressure Laminate color number for sides and base of table Options, if selected <p>▶ See <i>Surface Materials</i>, page 634.</p>

Options	U.S. Price	Required to Specify
Surface Materials <ul style="list-style-type: none"> High-Pressure Laminate worksurfaces <ul style="list-style-type: none"> High-Pressure Laminate price group 2 High-Pressure Laminate price group 3 Open Line laminate 	<ul style="list-style-type: none"> See information at left See information at left +\$102 plus cost of laminate 	<ul style="list-style-type: none"> Specify High-Pressure Laminate color number. Specify High-Pressure Laminate color number. ▶ See <i>Surface Materials Reference Manual</i>.
Legs <ul style="list-style-type: none"> Brushed aluminum legs Solid square wood legs Solid round wood legs 	<ul style="list-style-type: none"> +\$167 +\$222 +\$233 	<ul style="list-style-type: none"> Specify <i>with brushed aluminum legs</i>. Specify <i>with solid square wood legs</i> and select 3412 Natural Cherry, 3522 Clear Maple, or 3762 Dark Walnut. Specify <i>with solid round wood legs</i> and select V1AC Natural Cherry, V1AM Clear Maple, or V1EW Dark Walnut.
Legs <ul style="list-style-type: none"> Low foot 	No cost	Specify <i>with low foot</i> .

Specification Information						
Dimensions			Style Number	U.S. Base Price	Style Number	U.S. Base Price
D	W	H	LPL		HPL	

End Table						
26½"	13½"	17"	TS31415L	\$488	TS31415H	\$538
:	:	:	:	:	:	:

Coffee Table						
26½"	26½"	17"	TS31416L	\$665	TS31416H	\$715
:	:	:	:	:	:	:

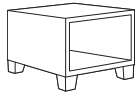
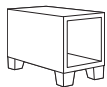

 **For Canadian Pricing**
 Multiply U.S. Price by the Canadian price factor.
 ▶ See page 1 for details.

Understanding and Specifying i2i 416 Series Collaborative Lounge Chairs

Product Details

i2i 416 Series	622
Dimensions	624

Specifying

Collaborative Lounge Chairs	626
-----------------------------	-----

Adjustability Features

▶ See page 26 for a comparison to other chairs

	i2i 416 Series
--	---------------------------

Mechanisms

Dual-swivel	●
-------------	---

Back Adjustments

Self adjusting	●
----------------	---

i2i 416 Series

i2i is collaborative lounge seating that helps people move freely, change postures, and stay energized and comfortable.

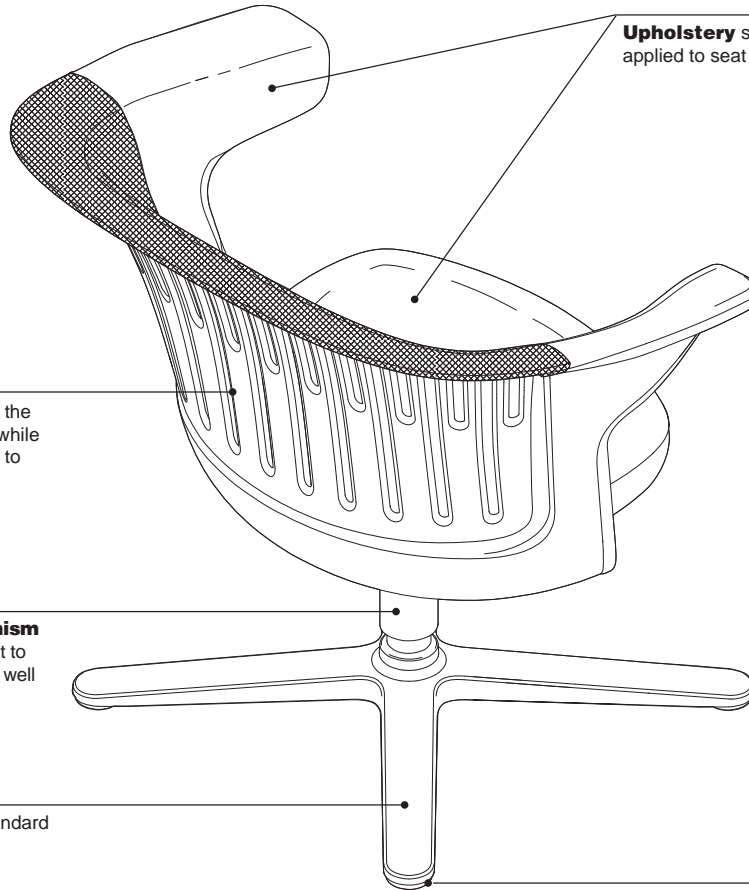

Upholstery specified is applied to seat and arms.

Flexing fingers form the back and offer support while moving and conforming to your body.

Dual-swivel mechanism allows the back and seat to swivel independently as well as together.

Four-arm base is standard in polished aluminum.

Glides are standard with the static base.

Product Details

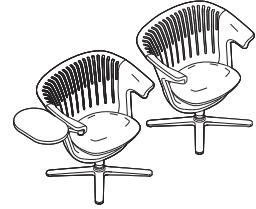

Chairs are available with or without tablet arm.

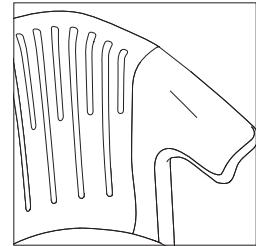

Flexing fingers in the back promote movement and provide support in a variety of postures.

Dual-swivel mechanism allows the back and seat to swivel independently as well as together.

Tablet arm attaches on the right side of the chair with a dual pivot function providing a range of motion that allows the tablet area to accommodate both left and right handed users. It provides a work-surface 12 $\frac{1}{4}$ "D x 18"W. The tablet ships separately and requires field assembly and installation.

Adjustment Features

Swivel-return cylinder option has a built in memory and will return to the fixed position when the user leaves the chair.

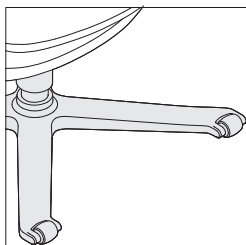

Mobile base includes two rollers on the front arms of the base that allow the chair to be moved easily.

Surface Materials

▶ See surface materials on page 634 for specific availability or refer to the *Surface Materials Reference Manual* for further information.

Back Upholstery

- 3D Knit (back only)

Seat and Arm Upholstery

- Cogent: Connect (seat and arm only)
- Fabric
- Fabric with soil-retardant treatment (option)
- Leather
- Elmosoft leather
- Select Surfaces leather
- Vinyl
- COM
- COL

Cogent: Connect maximizes quality and comfort on i2i. The selected upholstery will be applied to the seat and arms. It is standard with a sewn application.

Frame

- 6009 Arctic White
- 6249 Platinum
- 6295 Near Black

Tablet Arm

- Laminate
- Veneer

The laminate surface is available with a black edge only. The veneer surface has a self edge. The tablet ships separately and requires field assembly and installation.

Glides

- Black plastic

Rollers

- Optional rollers on mobile base are available in dark fusion only.

All Steelcase seating with standard upholstery fabrics complies with requirements of the State of California Technical Bulletin 117-2013. All standard seating is labeled to be in compliance with California 117-2013.

Programs & Services

▶ See the *Surface Materials Reference Manual* for further detail about programs and services offered for seating.

The Customer's Own Material (COM) Program

offers the opportunity for customers to select fabrics that are not offered through the standard Steelcase surface materials program for use on Steelcase products. Through the COM program, Steelcase will test your materials for application on Steelcase products. Once approved, you can place your order. Steelcase will facilitate the entire ordering process and give you a production schedule. Steelcase will order the COM fabric directly from the textile manufacturer. For up-to-date information regarding fabric test results for all COM fabrics and details regarding yardage requirements for most Seating lines, visit the COM website. To locate the COM website:

- Visit www.steelcase.com

Soil retardants are treatments that provide long-term soil and stain resistance to a fabric without affecting the shade or the integrity of the fabric. The following Steelcase Textiles are available pre-treated with soil retardant. (You do not need to select the soil-retardant option for these fabrics and incur the upcharge.)

- Jacks
- Link

For information on soil retardant fabrics on Select Surfaces, please refer to the *Surface Materials Reference Manual*.

Soil-retardant treatment is available on all other seating fabrics at an additional upcharge per seating unit. To order this option, please select "Soil-Retardant Treatment" under "Optional Accessories."

For soil-retardant treatment on COMs, please select "Soil-Retardant Treatment" under "Optional Accessories." Minimums or additional yardage may be required. Please contact the vendor directly for specific information.

Extended lead times may be necessary for this service.

Contact your Steelcase Solutions Fulfillment Team Representative at 1.888.STEELCASE (1.888.783.3522) or send an email to lineone@steelcase.com.

Dimensions

▶ Page 624

Resources

Printed Materials

▶ i2i Brochure (08-0001013)

Online Resources

▶ Come Together (PDF) available on www.steelcase.com

▶ Collaborative Seating video available on www.steelcase.com

▶ Product Environmental Profiles, which provide key environmental attributes and product certifications can be found by searching for Steelcase at *Origin.build*.

Dimensions

i2i 416 Series

Features	Overall Depth	Width	Height	Seat Depth	Functional Seat Depth	Seat Width	Seat Height from Floor	Back Height from Seat	Back Lumbar Height
i2i 416 Series									
Collaborative Lounge Chairs									
	25"	32½"	31⅛"	17½"	17¼"	19"	17½"	17¼"	9¼"

Dimensions were measured with BIFMA CMD (chair-measuring device).

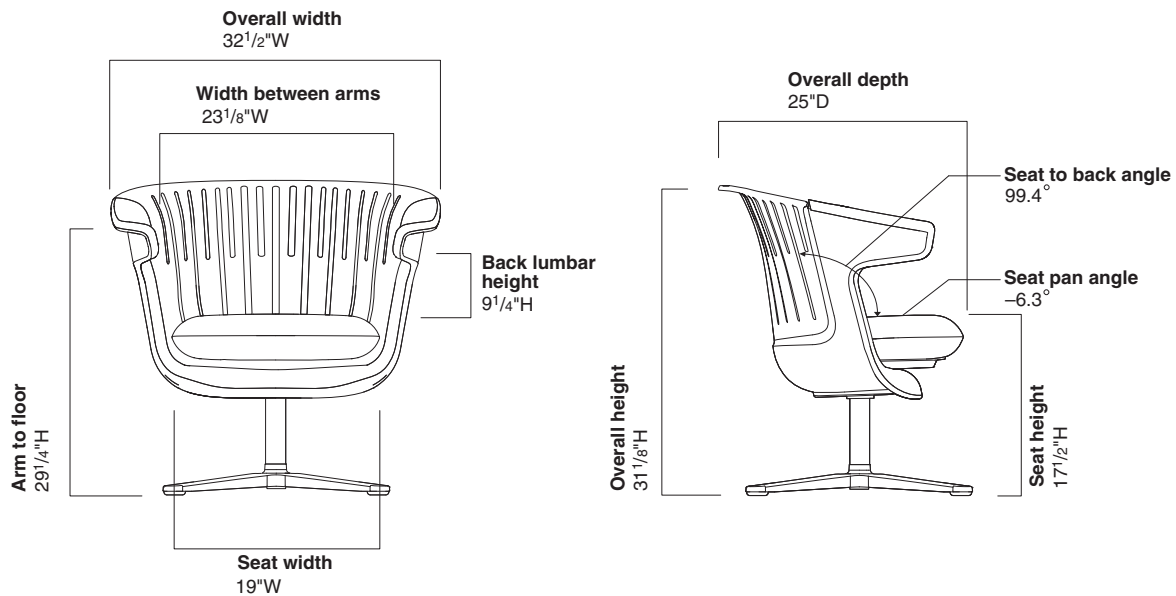

• Width • Between • Arms	• Arm • to • Floor	• Seat • Pan • Angle	• Angle • Between • Seat and • Back
--------------------------------	--------------------------	----------------------------	--

23 1/8"	29 1/4"	-6.3°	99.4°
---------	---------	-------	-------

:	:	:	:
---	---	---	---

Collaborative Lounge Chairs

i2i 416 Series

Standard Includes		Required to Specify
<ul style="list-style-type: none"> ▶ Need help? Product details, page 622 	<ul style="list-style-type: none"> • Back: near black • Static base with dual-swivel mechanism: polished aluminum • Back upholstery: 3D Knit • Seat and arms: sewn upholstery • Tablet arm, if selected: laminate • Glides: black plastic 	<ol style="list-style-type: none"> 1 Style number 2 Plastic color number for frame 3 3D Knit color number for back 4 Fabric color number for upholstery on seat and arms 5 Laminate color number for tablet arm, if selected 6 Options, if selected (see below) <p>▶ See <i>Surface Materials</i>, page 634.</p>

Tip: Cogent: Connect maximizes quality and comfort on the seat and arms on i2i.

Options	U.S. Price	Required to Specify
Surface Materials <ul style="list-style-type: none"> • Fabric price group 1 • Fabric price group 2 • Fabric price group 3 • Fabric price group 4 • Fabric price group 5 • Fabric price group 6 • Fabric price group 7 • Fabric price group 8 • Fabric price group 9 • Fabric price group 10 • Steelcase leather upholstery • Select Surfaces leather price group 1 • Elmosoft leather • Select Surfaces leather price group 2 • Steelcase vinyl • Customer's Own Material/Vinyl (COM) • Customer's Own Leather (COL) 	<ul style="list-style-type: none"> No cost No cost +\$ 73 +\$101 +\$129 +\$158 +\$182 +\$228 +\$280 +\$316 +\$523 +\$523 +\$606 +\$606 No cost +\$ 61 +\$ 61 	<ul style="list-style-type: none"> Specify fabric color number. Specify fabric color number. Specify fabric color number. Specify fabric color number. Specify fabric color number. Specify fabric color number. Specify fabric color number. Specify fabric color number. Specify fabric color number. Specify fabric color number. Specify leather color number. <p>▶ See <i>Surface Materials Reference Manual</i>. Specify Elmosoft leather color number.</p> <p>▶ See <i>Surface Materials Reference Manual</i>. Specify vinyl color number. See <i>Surface Materials Reference Manual</i> to specify.</p> <p>See <i>Surface Materials Reference Manual</i> to specify.</p>
Soil-retardant treatment	+\$ 36	Specify with soil-retardant treatment.
Back shell <ul style="list-style-type: none"> • Arctic White • Platinum 	<ul style="list-style-type: none"> +\$130 +\$130 	<ul style="list-style-type: none"> Specify with 6009 Arctic White. Specify with 6249 Platinum.
Base <ul style="list-style-type: none"> • Mobile base 	+\$ 86	Specify with mobile base.
Cylinder <ul style="list-style-type: none"> • Swivel with return 	+\$ 86	Specify with swivel return.
Tablet Arm <ul style="list-style-type: none"> • Wood group 1 	+\$343	Specify wood color number.

Tip: For list of wood veneer options available on tablet arm, see page 635.

Specification Information

		With tablet arm	
Style Number	U.S. Base Price	Style Number	U.S. Base Price
416911	\$3220	416911T	\$3575

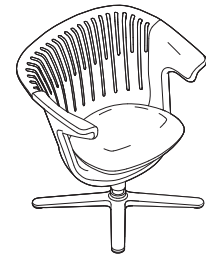

▶ Detailed dimensions, page 624

 **For Canadian Pricing**
 Multiply U.S. Price by the Canadian price factor.
 ▶ See page 1 for details.

Understanding and Specifying Turnstone Aight Lounge

Lounge Seating

Product Details

Aight Lounge	628
Dimensions	630

Specifying

Aight Lounge	631
--------------	-----

Alight Lounge

Alight comes fully upholstered as a Bench, Round, or Corner Ottoman. Alight supports up to 300 pounds.

► Specifying, page 631

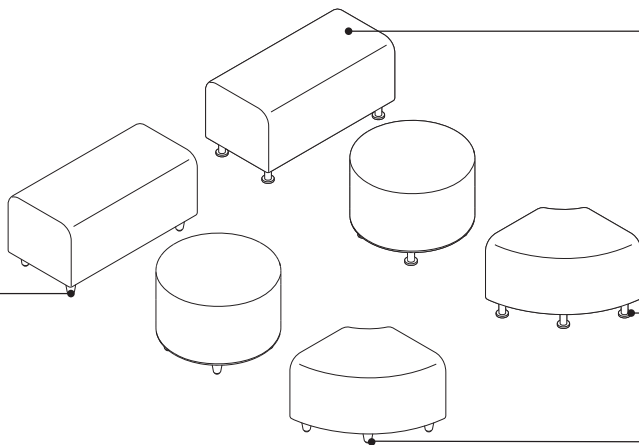

Alight Seating comes fully assembled.

Legs come standard brushed aluminum with an option of round wood legs and low profile glides.

Brushed aluminum legs are height adjustable.

Round wood legs are solid maple and are available in three finishes.
Tip: Wood legs are natural wood and may have variations in color.

Alight tables are available as an End Table or Coffee Table.

► Specifying, page 632

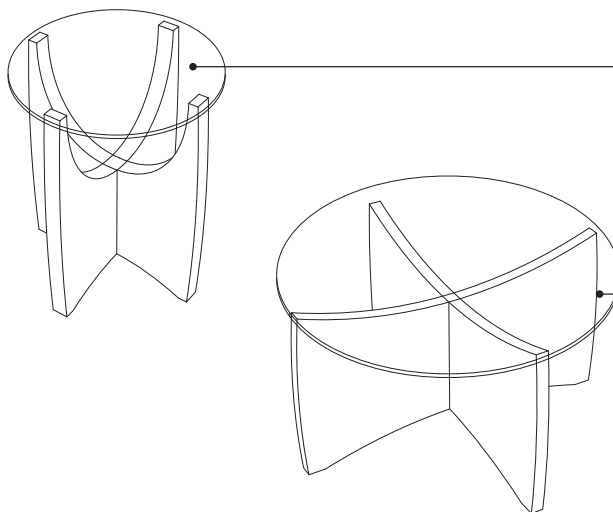

Alight tables have a glass top.

Alight tables require minor assembly.

Product Details

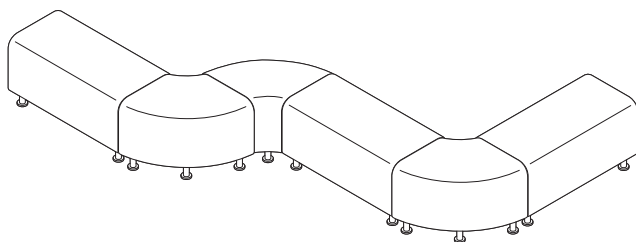
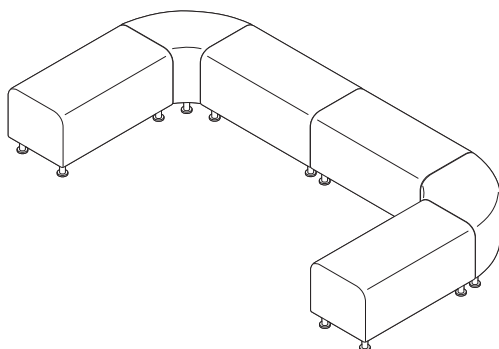
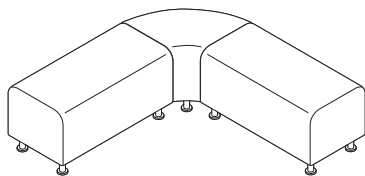

Alight Bench and Corner Ottoman can be combined to create a variety of configurations.

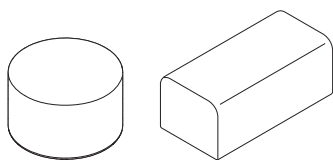

The low profile glide option reduces the overall height of the Ottoman from 19" to 16".

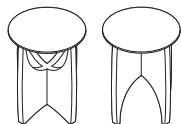

Alight End Table base can be reversed creating two unique looks.

Surface Materials

Legs

- Brushed aluminum

With Round Wood Legs

- V1AC Natural Cherry
- V1AM Clear Maple
- V1EW Dark Walnut

Tip: Wood legs are natural wood and may have variations in color.

Dimensions

▶ Page 630

Dimensions

Alight Lounge

• Features
• Overall
• Depth • Width • Height

Alight Lounge

Lounge Seating

Round	24"	24"	19"
Corner Ottoman	18"	31"	19"
Bench Ottoman	18"	36"	19"

Alight Lounge

Standard Includes		Required to Specify
▶ Need help? Product details, page 628	<ul style="list-style-type: none"> Fully upholstered Ottoman: fabric price group 1 Four adjustable-height legs: brushed aluminum Meets Cal. 117 requirements 	1 Style number 2 Fabric color number for upholstery 3 Options, if selected (see below) ▶ See <i>Surface Materials</i> , page 634.

Options	U.S. Price	Required to Specify
Surface Materials <ul style="list-style-type: none"> Fabric price group 1 Fabric price group 2 Fabric price group 3 Fabric price group 4 Fabric price group 5 Fabric price group 6 Fabric price group 7 Fabric price group 8 Fabric price group 9 Fabric price group 10 Vinyl Customer's Own Material (COM) 	No cost +\$ 23 +\$ 61 +\$ 92 +\$114 +\$141 +\$168 +\$216 +\$265 +\$303 +\$ 23 +\$ 55	Specify fabric color number. Specify fabric color number. Specify fabric color number. Specify fabric color number. Specify fabric color number. Specify fabric color number. Specify fabric color number. Specify fabric color number. Specify fabric color number. Specify vinyl color number. ▶ See <i>Understanding Customer's Own Material (COM)</i> , page 642.
Legs <ul style="list-style-type: none"> Solid round wood legs 	+\$233	Specify with <i>solid round wood legs</i> and select V1AC Natural Cherry, V1AM Clear Maple, or V1EW Dark Walnut.
Glides <ul style="list-style-type: none"> Low profile glide 	No cost	Specify with <i>low profile glides</i> .

Tip: Wood legs are natural wood and may show variations in grain and color.

Tip: Low profile glide reduces seat height from 19" to 16".

Specification Information	
Style Number	U.S. Base Price

Round Ottoman

TS34401	\$775
---------	-------

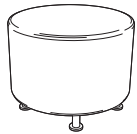

Corner Ottoman

TS34402	\$882
---------	-------

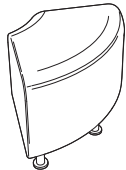

Bench Ottoman

TS34403	\$969
---------	-------

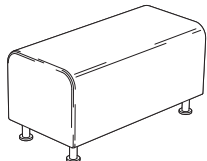

▶ Detailed dimensions, page 630

 **For Canadian Pricing**
 Multiply U.S. Price by the Canadian price factor.
 ▶ See page 1 for details.

Alight Lounge, continued

Ganging Kit

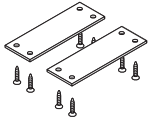

Standard Includes		Required to Specify
<ul style="list-style-type: none"> Ganging kit Two plates Attachment hardware 		Style number
Specification Information		
Dimensions	Style	U.S.
D W	Number	Price
2" 6"	TS31410	\$44

Occasional Tables

Standard Includes	Required to Specify
<ul style="list-style-type: none"> Need help? Product details, page 628 Table: maple veneer base Veneer edge band to match base 3/8" clear glass top Glides 	<ul style="list-style-type: none"> 1 Style number 2 Wood color number for base ▶ See <i>Surface Materials</i>, page 634.

Specification Information				
Dimensions	Style	U.S.		
D W H	Number	Price		

End Table

18"	18"	23"	TS34410T	\$ 904
-----	-----	-----	----------	--------

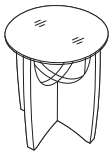

Coffee Table

30"	30"	17"	TS34411T	\$1165
-----	-----	-----	----------	--------



For Canadian Pricing
 Multiply U.S. Price by the Canadian price factor.
 ▶ See page 1 for details.

Surface Materials

Surface Materials	634
Understanding Customer's Own Material (COM)	642
Fabric Application Direction Guidelines	644
Maintenance and Cleaning	647
Seating Upholstery Matrix	648
Color Availability Matrix	658
Special Features	682

Surface Materials

This listing includes all the surface material choices that are available for the products in this specification guide.

Resources

For more information about surface materials, refer to the following resources:

Additional surface materials specification tools are available to assist you in the specification process—the Surface Materials Binders.

The global surface materials palette is a core collection of finishes that is available across multiple geographies (Americas/EMEA – Europe, Middle East, and Africa/APAC – Asia Pacific) and on global product lines, where applicable. For a list of finishes included in the offering, see the *Surface Materials Reference Manual*. Additional details, like product approvals by geography and finish number conversions, can also be found in the *Surface Materials Reference Manual* or see www.steelcase.com/surface-materials.

Surface Materials

Binders

- Surface Materials Reference Manual
- A complete set of swatch cards for hard surfaces, vertical surface fabrics, and seating upholstery

Plastic

Steelcase Surfaces

Not every plastic color is available on every plastic component.

- ▶ Refer to the *Color Availability Matrix* on page 658 before specifying.

Steelcase Surfaces

Applies to:

- Jenny tablet arm
- Jenny End Table
- Jenny Coffee Table
- 6000 Black
- 6009 Arctic White
- 6034 Natural Cherry
- 6036 Medium Cherry
- 6037 Winter on Maple
- 6038 Blonde on Maple **E**
- 6041 Natural Walnut **E**
- 6052 Milk
- 6053 Seagull
- 6169 Stone
- 6170 Mocha
- 61AA Persian Salt
- 61AB Rose
- 61AC Indigo
- 61AD Green Citrine
- 61AE Dark Olivine
- 61AF Cloudy
- 6213 Acacia
- 6219 Clear Oak
- 6237 Clear Maple
- 6242 Virginia Walnut
- 6243 Blackwood **E**
- 6245 Clear Walnut
- 6249 Platinum Solid
- 6271 Plywood
- 6527 Merle
- 6619 Ice **E**
- 6631 Cream **E**
- 6635 Dawn **E**
- 6636 Mist
- 6654 Sand
- 6655 Warm White
- 6695 Midnight
- 6697 Fog
- 6698 Fieldstone
- 66WA Grey Kingswood
- 66WB Planked Walnut
- 66WD Resolute Walnut
- 66WE Natural Recon
- 66WF Smoked Walnut
- 66WU Clay
- 66WV Chalk
- 6703 Ash Wenge
- 6704 Storm Wenge
- 6705 Bisque Wenge
- 6706 Clay Wenge
- 6707 Ash Noce
- 6708 Bisque Noce
- 6709 Clay Noce
- 6710 Storm Noce
- 6T02 Fawn Cypress
- 6T04 Saddle Oak
- 6T05 Veranda Teak
- 6T07 Walnut Heights
- 6T08 Aggregate
- 6T09 Gravel
- 6T10 Cement
- 6T12 Sheetrock

Applies to:

- Scoop

Price Group 1

- 6336 Jazz
- 6618 White
- 6682 Cobblestone **E**
- 6BE1 Ore

Price Group 2

- 6BD1 Aubergine
- 6BD2 Peacock
- 6BD5 Honey
- 6BD6 Lagoon
- 6BD7 Saffron

Applies to:

- Buoy

Price Group 1

- 6009 Arctic White
- 6205 Black
- 6333 Picasso
- 6335 Wasabi
- 6337 Element
- 6338 Chili
- 6BE1 Ore

Price Group 2

- 6BD1 Aubergine
- 6BD2 Peacock
- 6BD5 Honey
- 6BD6 Lagoon
- 6BD7 Saffron

Applies to:

- Buoy base
- 6527 Merle

Applies to:

- Perch stool
- 6302 Baltic
- 6527 Merle
- 6697 Fog
- 6BD7 Saffron
- 6BE2 Light Peacock

Applies to:

- Shortcut chair and stool five-star base
- 6205 Black

Applies to:

- Shortcut tripod base
- 6249 Platinum Solid
- 6295 Near Black
- 6337 Element

Applies to:

- Shortcut personal worksurface
- 6053 Seagull
- 6249 Platinum Solid
- 6295 Near Black
- 6337 Element

Applies to:

- Shortcut shell

Price Group 1

- 6009 Arctic White
- 6059 Sterling Dark Solid
- 6205 Black
- 6249 Platinum Solid
- 6259 Midnight
- 6332 Citron
- 6333 Picasso
- 6335 Wasabi
- 6336 Jazz
- 6337 Element
- 6338 Chili
- 6527 Merle

Price Group 2

- 6BD1 Aubergine
- 6BD2 Peacock
- 6BD5 Honey
- 6BD6 Lagoon
- 6BD7 Saffron
- 6BE5 Olivine
- 6BE6 Sea Salt

Applies to:

- Tenor back and seat shell

Price Group 1

- 6009 Arctic White
- 6059 Sterling Dark Solid
- 6205 Black
- 6249 Platinum Solid
- 6335 Wasabi
- 6336 Jazz
- 6338 Chili
- 6527 Merle

Price Group 2

- 6BD2 Peacock
- 6BD5 Honey
- 6BD6 Lagoon
- 6BD7 Saffron
- 6BE5 Olivine
- 6BE6 Sea Salt

Plastic Edge Bands

- 6000 Black
- 6009 Arctic White
- 6034 Natural Cherry
- 6036 Medium Cherry
- 6037 Winter on Maple
- 6038 Blonde on Maple **E**
- 6041 Natural Walnut **E**
- 6049 Honey Maple* Milk
- 6052 Milk
- 6053 Seagull
- 6169 Stone
- 6170 Mocha
- 61AA Persian Salt
- 61AB Rose
- 61AC Indigo
- 61AD Green Citrine
- 61AE Dark Olivine
- 61AF Cloudy
- 6213 Acacia
- 6219 Clear Oak
- 6231 Graphite Walnut
- 6237 Clear Maple
- 6242 Virginia Walnut
- 6243 Blackwood **E**
- 6245 Clear Walnut
- 6249 Platinum Solid
- 6271 Plywood
- 6527 Merle
- 6619 Ice **E**
- 6631 Cream **E**
- 6635 Dawn **E**
- 6636 Mist
- 6654 Sand
- 6695 Midnight
- 6697 Fog
- 6698 Fieldstone
- 6703 Ash Wenge
- 6704 Storm Wenge
- 6705 Bisque Wenge
- 6706 Clay Wenge
- 6707 Ash Noce
- 6708 Bisque Noce
- 6709 Clay Noce
- 6710 Storm Noce
- 6T02 Fawn Cypress
- 6T04 Saddle Oak
- 6T05 Veranda Teak
- 6T07 Walnut Heights
- 6T08 Aggregate
- 6T09 Gravel
- 6T10 Cement
- 6T12 Sheetrock

*Not available on B-Free

Tip: Light color plastic edges are susceptible to degradation due to normal wear and tear. Staining (e.g., ball point pen or clothing dyes such as blue jeans) and dirt effects are more pronounced in light colors and are not considered defects.

E = Established

Price Group 1

5U22	Royal Blue
5U23	Blue Jay
5U24	Scarlet
5U26	Wasabi Too
5U27	Concord
5U28	Canary
6009	Arctic White
6052	Milk
6053	Seagull
6059	Sterling Dark Solid
6205	Black
6248	Midnight Brown
6249	Platinum Solid
6259	Midnight
6295	Near Black
6332	Citron
6333	Picasso
6334	Flash
6335	Wasabi
6336	Jazz
6337	Element
6338	Chili
6527	Merle
6559	Satin Ice
6654	Sand
6655	Warm White
6BD8	Snow
6BD9	Carbon Flat
6BE1	Ore
WH69	White/Light Green
WH71	White/Mocca
	Anthracite
WH72	Black/Black
WH73	White/White
WH74	Mocca Anthracite/ Mocca Anthracite
WH75	White/Light Blue
WH76	White/Yellow
WH77	White/Terra
WH78	White/Warm Grey
WH79	White/Black

Price Group 2

6BC2	Purple
6BC5	Blue
6BC8	Gold*
6BD1	Aubergine
6BD2	Peacock
6BD3	Jungle
6BD4	Merlot
6BD5	Honey
6BD6	Lagoon
6BD7	Saffron

E = Established

Seating Coating**Steelcase Surfaces**

Applies to:

- Max-Stacker III 477 Series
7000 Black

Paint**Steelcase Surfaces**

Not every paint is available on every painted part.

- ▶ Refer to the *Color Availability Matrix* on page 658 before specifying.

Price Group 1**Smooth Paint**

4238	Mocha
4239	Clay
4240	Chalk
4242	Milk
7000	Black

Textured Paint

7207	Black
7225	Sand
7237	Slate E
7238	Fieldstone
7239	Midnight
7241	Arctic White
7243	Seagull
7250	Sterling Dark Solid
7360	Merle

Price Group 2**Smooth Paint**

0835	Black
4700	Warm White

Smooth Metallic Paint

4743	Mineral Metallic
4750	Champagne Metallic
4798	Sterling Metallic
4799	Platinum Metallic
4803	Near Black Metallic

Textured Metallic Paint

7245	Carbon Metallic
7246	Midnight Metallic

Price Group 3**Accent Paints**

1ATG	Rose Quartz
4AV3	Blue Jay
4AV4	Baltic
4AX1	Citron
4AY2	Chili
4AZ5	Marlin
4CL1	Dark Olivine
4CL2	Ice Blue
4CL3	Aura
4CL4	Sea Glass
4CL5	Light Matcha
4CL6	Terra
4CL7	Sandstone
4CL8	Smokey Plum
4CZ5	Honey
4CZ6	Lagoon
4CZ8	Light Peacock

Coatings

1ATT	Cast Shadow
------	-------------

Lux Coatings

4B20	Obsidian
4B22	Matte Brass
4B23	Burnished Bronze
4B24	Night Bronze
4B25	Matte Copper
4B26	Smoked Mica
4B29	Cast Iron

Worktools Paint**Steelcase Surfaces**

Not every paint is available on every painted part.

- ▶ Refer to the *Color Availability Matrix* on page 658 before specifying.

Architectural Paint**Steelcase Surfaces**

Not every paint is available on every painted part.

- ▶ Refer to the *Color Availability Matrix* on page 658 before specifying.
- | | |
|------|---------|
| 4843 | Linen |
| 4844 | Glacier |
| 4849 | Vapor |

Accessory Paint**Steelcase Surfaces**

Not every paint color is available on every product.

- ▶ Refer to the *Color Availability Matrix* on page 658 before specifying.
- | | |
|------|--------------------|
| 4140 | Arctic White Gloss |
| 4144 | Black Gloss |
| 4710 | Low Gloss Black |

Metal**Steelcase Surfaces**

Metal finishes are not available on every chair.

- ▶ Refer to the *Color Availability Matrix* on page 658 before specifying.
- | | |
|------|-------------------|
| 8046 | Polished Aluminum |
| 9201 | Polished Chrome |
| WH04 | Chrome |

Laminate**Steelcase Surfaces**

Not every laminate color is available on every product.

- ▶ Refer to the *Color Availability Matrix* on page 658 before specifying.

Steelcase Surfaces**Low-Pressure Laminate****Price Group 1**

Applies to:

- Jenny tablet arm
- Jenny End Table
- Jenny Coffee Table

Fiber Laminate

2L50	Vanadium Fiber LPL
------	--------------------

Solid Laminate

247L	Black V2 LPL
2L30	Arctic White LPL
2L83	Seagull LPL
2L85	Dune LPL

Woodgrain Laminate

25L1	Winter on Maple LPL
25L5	Virginia Walnut LPL
25L6	Blackwood LPL E
25L8	Clear Walnut LPL
264L	Chocolate Walnut LPL E
267L	Marbled Cherry V2 LPL E
26L1	Natural Cherry V2 LPL
2L09	Clear Maple LPL
2LAK	Clear Oak LPL
2LAN	Ash Noce LPL
2LAT	Acacia LPL
2LAW	Ash Wenge LPL
2LBN	Bisque Noce LPL
2LBW	Bisque Wenge LPL
2LCN	Clay Noce LPL
2LCW	Clay Wenge LPL
2LSN	Storm Noce LPL
2LSW	Storm Wenge LPL
2LWA	Grey Kingswood LPL
2LWB	Planked Walnut LPL
2LWD	Resolute Walnut LPL
2LWF	Smoked Walnut LPL
2LWG	Natural Recon LPL
2TL2	Fawn Cypress LPL

Surface Materials, continued

High-Pressure Laminate**Price Group 1**

Not every laminate color is available on every product.
▶ Refer to the *Color Availability Matrix* on page 658 before specifying.

Applies to:

- Jenny tablet arm
- Jenny End table
- Jenny Coffee Table

Woodgrain Laminate

- 2406 Clear Cherry **E**
- 2409 Clear Maple
- 2410 Graphite Walnut
- 2412 Natural Cherry
- 2422 Medium Cherry
- 2511 Winter on Maple
- 2535 Virginia Walnut
- 2536 Blackwood **E**
- 2538 Clear Walnut
- 2592 Blonde on Maple **E**
- 2714 Natural Walnut **E**
- 2HAK Clear Oak
- 2HAN Ash Noce
- 2HAT Acacia
- 2HAW Ash Wenge
- 2HBN Bisque Noce
- 2HBW Bisque Wenge
- 2HCN Clay Noce
- 2HCW Clay Wenge
- 2HSN Storm Noce
- 2HSW Storm Wenge
- 2HWA Grey Kingswood
- 2HWB Planked Walnut
- 2HWD Resolute Walnut
- 2HWE Natural Recon
- 2HWF Smoked Walnut

Fiber Laminate

- 2850 Vanadium Fiber
- 2854 Vellum Fiber **E**
- 2860 Granite Fiber
- 2862 Stucco Fiber **E**

Micro Laminate

- 2920 Marl Micro
- 2921 Gypsum Micro
- 2922 Clay Micro

Patina Laminate

- 2870 Blonde Bronze Patina
- 2873 Instant Iron Patina

Solid Laminate

- 2722 Cream **E**
- 2730 Arctic White
- 2746 Black
- 2759 Warm White
- 2811 Mist **E**
- 2883 Seagull
- 2884 Milk
- 2885 Dune
- 2HAA Persian Salt
- 2HAB Rose
- 2HAC Indigo
- 2HAD Green Citrine
- 2HAE Dark Olivine
- 2HAF Cloudy
- 2HMG Merle
- 2HWU Clay
- 2HWW Chalk

Speckle Laminate

- 2820 Coffee Speckle **E**
- 2823 Driftwood Speckle
- 2824 Smoke Speckle
- 2825 Vanadium Speckle

Price Group 2**Textured Laminate**

- 2TH2 Fawn Cypress
 - 2TH4 Saddle Oak
 - 2TH5 Veranda Teak
 - 2TH7 Walnut Heights
 - 2UH1 Reclaimed Aggregate
 - 2UH2 Reclaimed Gravel
 - 2UH4 Cement*
 - 2UH6 Sheetrock
- *2UH4 Cement has limited availability, determined by product sizing and/or options.

Applies to:

- Lagunitas tables

Price Group 3**Solid Laminate**

- 24H1 Satin White
- 24H2 Satin Black
- 24H3 Satin Stone
- 24H4 Satin Mocha

Custom Surfaces**Open Line Laminate (OLL)**

Applies to:

- Brody 488 Series desks
- Umami platform

This service allows you to order non-standard laminate at an additional processing fee of \$102 U.S. per unit, plus the cost of the laminate.

High-Pressure Laminate pricing does not include premium or digitally printed patterns from any suppliers. Laminate cost may also vary for basic or standard laminates from other suppliers. Please contact the OLL consultant at 616.475.2426 for pricing. The cost of the laminate will be added to your invoice as a separate line on the acknowledgement.

When processing orders for Open Line Laminate, specify 2900 in the laminate finish field and enter the OLL manufacturer information. Enter the required edge finish as you would a standard laminate.

Laminate Approval and Material Requirements

To confirm whether a particular laminate has already been tested for use on a specific Steelcase product or to determine material square foot requirements:

- Visit www.steelcase.com

For additional information, refer to the *Steelcase Surface Materials Reference Manual*.

Wood Stain

Applies to:

- B-Free beam and standing-height tables with wood legs
- 3860 Espresso
- 3861 Natural Beech

Wood**Steelcase Surfaces**

Veneers are matched for proper balance and consistency. Veneers are available quarter cut, except for Oak, which is rift cut. Refer to the *Surface Materials Reference Manual* for descriptions of each cut.

Open-pore finish is a medium gloss finish that leaves the wood grain texture visible to the eye and distinguishable to the touch.

Applies to:

- Jenny Lounge square wood legs
 - Jenny Lounge wood arms
 - Aight End Table
 - Aight Coffee Table
 - 3412 Natural Cherry **E**
 - 3522 Clear Maple
 - 3762 Dark Walnut
- Tip: Due to natural variations in wood, finished products may vary in color, texture and grain.*

Applies to:

- Jenny Lounge round wood legs
- Aight Ottoman round legs

Flat-Cut Low Sheen Grade 1

- V1AC Natural Cherry
- V1AM Clear Maple
- V1EW Dark Walnut

Open-Pore, Planked Veneer

- 3P41 OP Planked Cherry
- 3P51 OP Planked Maple
- 3P61 OP Planked Oak
- 3P71 OP Planked Walnut

Applies to:

- Brody 488 Series desks
- i2i
- B-Free occasional and standing-height tables
- Umami platform

Wood Group 1**Flat-Cut Open-Pore**

- 3062 FC/OP Graphite Walnut
- 3402 FC/OP Clear Cherry (Aged)
- 3412 FC/OP Natural Cherry **E**
- 3422 FC/OP Medium Cherry
- 3522 FC/OP Clear Maple
- 3592 FC/OP Blonde on Maple **E**
- 3702 FC/OP Clear Walnut
- 3712 FC/OP Natural Walnut
- 3752 FC/OP Medium Walnut **E**
- 3762 FC/OP Dark Walnut
- 3772 FC/OP Medium Mahogany on Walnut

Quarter-Cut Open-Pore

- 3042 QC/OP Ash **E**
- 3222 QC/OP Clear Maple
- 3292 QC/OP Blonde on Maple **E**
- 3302 QC/OP Clear Walnut
- 3312 QC/OP Natural Walnut
- 3352 QC/OP Medium Walnut **E**
- 3362 QC/OP Dark Walnut
- 3372 QC/OP Medium Mahogany on Walnut
- 3382 QC/OP Graphite Walnut

Rift-Cut Open-Pore

- 3602 RC/OP Desert Oak

E = Established

Full-Fill

Full-fill finish is a medium-gloss finish that completely fills the grain texture, yet allows the grain pattern to be seen. The wood has a lustrous, satiny look, and it is smooth to the touch. This finish is available on worksurfaces only.

Applies to:

- Brody 488 Series desks
- i2i
- B-Free occasional and standing-height tables

Wood Group 2**Flat-Cut Full-Fill**

- 3064 FC/FF Graphite Walnut
- 3404 FC/FF Clear Cherry (Aged)
- 3414 FC/FF Natural Cherry **E**
- 3424 FC/FF Medium Cherry
- 3524 FC/FF Clear Maple
- 3544 FC/FF Blonde on Maple **E**
- 3704 FC/FF Clear Walnut
- 3714 FC/FF Natural Walnut
- 3754 FC/FF Medium Walnut **E**
- 3764 FC/FF Dark Walnut
- 3774 FC/FF Medium Mahogany on Walnut

Quarter-Cut Full-Fill

- 3224 QC/FF Clear Maple
- 3294 QC/FF Blonde on Maple **E**
- 3304 QC/FF Clear Walnut
- 3314 QC/FF Natural Walnut
- 3354 QC/FF Medium Walnut **E**
- 3364 QC/FF Dark Walnut
- 3374 QC/FF Medium Mahogany on Walnut
- 3384 QC/FF Graphite Walnut

Rift-Cut Full-Fill

- 3604 RC/FF Desert Oak

Applies to:

- i2i
- Umami platform

Wood Group 1**Flat-Cut Open-Pore, Natural Veneers**

- 3342 FC/OP Black Walnut
- 35A2 FC/OP Blanch Maple
- 37A2 FC/OP Thunder Walnut

Quarter-Cut Open-Pore, Natural Veneers

- 32A2 QC/OP Blanch Maple
- 33A2 QC/OP Thunder Walnut
- 3392 QC/OP Black Walnut

Rift-Cut Open-Pore, Natural Veneers

- 36A2 RC/OP Volcanic Oak

Open-Pore Planked Veneers

- 3P41 OP Planked Cherry
- 3P51 OP Planked Maple
- 3P61 OP Planked Oak
- 3P71 OP Planked Walnut
- 3VFX OP Unmarked Oak

Wood Group 3**Flat-Cut Open-Pore, Natural Veneers**

- 3082 FC/OP Washed Walnut

Applies to:

- i2i

Wood Group 2**Flat-Cut Full-Fill, Natural Veneers**

- 3734 FC/FF Black Walnut

Quarter-Cut Full-Fill, Natural Veneers

- 3394 QC/FF Black Walnut

Wood Group 3**Flat-Cut Full-Fill, Natural Veneers**

- 3084 FC/FF Washed Walnut

Applies to:

- 480 Node Series wood base
- Shortcut wood base

Wood Group 1**Flat-Cut Low-Sheen**

- V1AC Natural Cherry
- V1AM Clear Maple
- V1CC Medium Amber Cherry
- V1EW Dark Walnut

▶ See *Coalesce Surface Materials Reference Guide* for more information on these finishes.

Premium Veneers

A selection of Premium veneers in this collection are available on most Steelcase brand products. The collection will be available as close to standard leadtimes as possible. However, because adequate supplies of veneer and solids must be secured, all orders will be scheduled individually. Leadtimes will vary based on Premium veneer and Premium solids availability at the time the order is placed. Please see the Steelcase surface materials section on village.steelcase.com for sample information and product line availability. All premium veneers are in clear-coat.

Applies to:

- Brody 488 Series desks
- i2i
- B-Free
- Umami platform
- 3832 QC/OP Figured Anegre

Tip: Full-fill finish is not available on premium veneers as a standard.

Composite Veneers

Composite veneers are an engineered wood intended to create specific grain patterns and characteristics. They are pre-stained and finished with Steelcase's Clarity water-borne UV topcoat, which protects the environment while providing durability and clarity. Only open-pore finishes are available on composite wood. Composite veneer and matching edge bands are available on most Steelcase brand products. Composites, for use as a solid nosing substitute, are not available. Steelcase does not recommend mixing composite veneers with natural solid nosings because composite and natural wood grain and color matching are rarely compatible. Composite veneers are part of our Select Surfaces program as Wood Group 1 pricing.

Tip: Known for their color consistency, composite veneers feature a clear coat finish. Because the veneers are sourced in large lots, overall color within a specific purchase order should have minimal color inconsistency. However, composite customers should know that colors may vary slightly from dye lot to dye lot. This inconsistency may be noticed when replacement pieces are ordered that may be from different dye lots, or when a new project phase is installed. Also note that composite veneers tend to fade and lighten over time, especially with sun exposure.

Wood Group 1**Flat-Cut Open-Pore**

- 3JDX FC/OP Oak Composite
- 3JJX FC/OP Walnut Composite

E = Established

Surface Materials, continued

Applies to:

- Umami platform

Quarter-Cut Open-Pore

- 3F8X QC/OP European Walnut Composite
- 3GGX QC/OP Zebbrano Composite
- 3HGX QC/OP Oak Composite
- 3HVX QC/OP Walnut Composite
- 3ZNX QC/OP Night Cerused Oak Composite

Tip: Be conscious if mixing the flat cut and the quarter cut in composites, as there may be large variation in color.

Custom Surfaces

Customiz stain is a service that allows you to create your own stain colors and finishes on standard veneer. Customiz stain color is available on all product lines that offer wood veneer.

A \$500 stain-matching fee applies on CUSTOMIZ requests (Exception: The \$500 fee does not apply on matches to Coalesse standard finishes, for a low-gloss finish request on a standard color, or for composite stain matching to Steelcase wood seating). The \$500 fee covers the cost of formulating the Customiz color finish and applies regardless of whether or not an order for product is placed.

Tip: Due to natural variation of woodgrain color and texture, the match between composite veneers and composite stain color finishes will be a commercially acceptable match, rather than an exact match.

In addition, an approval form must be signed to indicate customer acceptance of Customiz match. A \$1,500 initiation fee will be charged prior to first order entry. This initiation fee activates the finish for unlimited use on any Steelcase product for an 18 month time period. After the 18 month time period has lapsed, the Customiz finish may be reactivated for another 18 months for a \$1,000 fee at any point within five years after the \$1,500 initiation fee was paid. If the finish is not reactivated within five years after the \$1,500 initiation fee was paid, the finish will be culled and the customer will need to pay the \$1,500 initiation fee again. All style number related Customiz charges products are no cost as of April 2014, with the exception of Umami platform and B-Free table. The matching and initiation fees are not discountable.

Customiz stain takes 10 days to formulate. Consult the *Surface Materials Reference Manual* for more information. Custom veneers are also available and must be quoted by Steelcase specials group. Customiz stain on custom veneers takes 2 to 4 weeks to formulate.

Requirements and information on ordering a Customiz stain color are found in the *Surface Materials Reference Manual*.

Screen

Applies to:

- B-Free screens

Steelcase Surfaces**Price Group 1****B-Free Knit**

- 5Y30 White
- 5Y31 Sky
- 5Y32 Ice
- 5Y33 Teal Blue
- 5Y34 Tangerine
- 5Y35 Paprika
- 5Y36 Leaf
- 5Y37 Chartreuse
- 5Y38 Lime
- 5Y39 Silver
- 5Y40 Currant
- 5Y41 Red Mittens
- 5Y42 Hot Pink
- 5Y58 Light Grey
- 5Y99 Dark Grey

Steelcase Surfaces

Applies to:

- Umami screen

Price Group 1

- Buzz2
- Jacks **E**
- Link
- New Black: Bruce
- New Black: Henry

Price Group 2

- Chainmail
- Code
- Cogent: Connect
- Intersection
- New Black: Harley
- New Black: Jack
- New Black: James
- Stencil

Price Group 3

- Billiard Multi-Use by Designtex
- Redeem
- Retrieve

Mesh

Applies to:

- Campfire Screen
- T615 Sultry Smoke
- T620 Arctic Ermine
- T625 Marina Blue

Steelcase Surfaces

Applies to

- Reply Series

Reply Air Mesh

- AR01 Grey
- AR02 Black
- AR04 Red
- AR05 Royal Blue
- AR06 Apple Green
- AR09 Sable
- AR13 Aubergine
- AR14 Peacock
- AR15 Jungle
- AR16 Merlot
- AR17 Honey
- AR18 Lagoon
- AR19 Saffron

Nylon

Applies to:

- Campfire Pouf
- 5JG0 Black
- 5JG1 Burgundy
- 5JG2 Taupe
- 5JG3 Silver
- 5JG4 Teal
- 5JG5 Red
- 5JG6 Pacific Blue

Thread**Steelcase Surfaces**

Applies to:

- Campfire Pouf
- UB01 Charcoal
- UB02 Ash
- UB03 Powder Blue
- UB04 Evergreen
- UB05 Bright Red

3D Knit**Steelcase Surfaces**

Applies to:

- i2i 416 Series
- Leap 462 Series
- Think 465 Series
- Amia 482 Series
- 5054 Canary
- 5059 Sailor
- 5064 Licorice
- 5065 Coconut
- 5066 Malt
- 5067 Root Beer
- 5089 Royal Blue
- 5090 Wasabi
- 5092 Graphite
- 5093 Nickel
- 5094 Tangerine
- 5095 Scarlet
- 5096 Turmeric/Honey
- 5097 Concord
- 5098 Blue Jay
- 5560 Aubergine
- 5561 Peacock
- 5562 Jungle
- 5563 Merlot
- 5564 Lagoon
- 5565 Saffron

3D Microknit**Steelcase Surfaces**

Applies to:

- Amia 482 Series
- Steelcase Series 1
- Steelcase Series 2
- 5T20 Nickel
- 5T21 Licorice
- 5T22 Royal Blue
- 5T23 Blue Jay
- 5T24 Scarlet
- 5T25 Malt
- 5T26 Wasabi
- 5T27 Tangerine
- 5T28 Concord
- 5T29 Graphite
- 5T30 Canary
- 5T31 Seagull
- 5T32 Aubergine
- 5T33 Peacock
- 5T34 Jungle
- 5T35 Merlot
- 5T36 Honey
- 5T37 Lagoon
- 5T38 Saffron

E = Established

Connect 3D**Steelcase Surfaces**

Applies to:

- cob1 434 Series
- 5014 Royal Blue
- 5015 Coconut
- 5016 Turmeric/Honey
- 5017 Tangerine
- 5018 Scarlet
- 5019 Concord
- 5021 Blue Jay
- 5023 Wasabi
- 5024 Nickel
- 5025 Graphite
- 5026 Licorice
- 5027 Malt
- 5028 Root Beer
- 5030 Sailor
- 5036 Canary
- 5532 Aubergine
- 5533 Peacock
- 5534 Jungle
- 5535 Merlot
- 5536 Lagoon
- 5537 Saffron

Intermix

Applies to:

- Steelcase Karman

Price Group 1**Intermix**

- KR08 Black
- KR09 Baltic
- KR10 Bright Peacock
- KR11 Merlot

Price Group 2**Intermix Shift**

- KR12 Red/Blue
- KR13 Blue/Gold

Price Group 3**Intermix Opaque**

- KR14 Seagull
- KR15 Platinum
- KR16 Bronze
- KR17 Black
- KR18 Baltic
- KR19 Peacock
- KR20 Merlot

Seating Upholstery

Not every upholstery is available on every chair.

► Refer to the *Steelcase Upholstery Matrix* on page 648 before specifying.

Steelcase Surfaces**Price Group 1****Buzz2**

- 5F03 Tomato
- 5F04 Red **E**
- 5F05 Burgundy
- 5F06 Sky **E**
- 5F07 Blue
- 5F08 Navy
- 5F15 Stone
- 5F16 Grey
- 5F17 Black
- 5G50 Dunegrass
- 5G51 Sable
- 5G55 Pumpkin
- 5G57 Rouge
- 5G59 Meadow
- 5G61 Cyan
- 5G62 Atlantic
- 5G63 Crocus
- 5G64 Alpine
- 5G65 Tornado

Era

- 5ER0 Cobalt
- 5ER1 Harbor
- 5ER2 Blue Nickel
- 5ER3 Pistachio
- 5ER4 Canary
- 5ER5 Comet
- 5ER6 Truffle
- 5ER7 Saffron
- 5ER8 Pink Lemonade
- 5ER9 Onyx
- 5ES0 Scarlet
- 5ES1 Lentil
- 5ES2 Oatmeal
- 5ES3 Persimmon
- 5ES4 Sprout
- 5ES5 Blue Mint
- 5ES6 Royal Blue
- 5ES7 Night Owl
- 5ET1 Rose Quartz
- 5ET3 Olivine
- 5EU2 Electric Indigo
- 5EU3 Green Citrine
- 5EU4 Storm Cloud

Jacks

- 5B61 Taupe **E**
- 5B63 Camel **E**
- 5B64 Pewter **E**
- 5B70 Midnight **E**

Link

- 5A24 Blue
- 5A25 Navy
- 5A27 Black

New Black

- 5J10 New Black: Bruce
 - 5J11 New Black: Henry
- Tip: New Black upholstery has color numbers in both price group 1 and price group 2.*

Price Group 2**Chainmail**

- 5551 Space
- 5552 Silver Dollar
- 5553 Volcano
- 5555 Tricycle
- 5559 Lagoon

Cogent: Connect

- 5S15 Coconut
- 5S16 Turmeric/Honey
- 5S17 Tangerine
- 5S18 Scarlet
- 5S19 Concord
- 5S21 Blue Jay
- 5S23 Wasabi
- 5S24 Nickel
- 5S25 Graphite
- 5S26 Licorice
- 5S27 Malt
- 5S28 Root Beer
- 5S93 Indigo/Blueprint
- 5S94 Lizard/Jungle
- 5S95 Sailor
- 5S96 Quicksilver
- 5S99 Lipstick/Merlot
- 5SD0 Royal Blue
- 5SD1 Aubergine
- 5SD2 Peacock
- 5SD3 Lagoon
- 5SD4 Saffron
- 5SD5 Citrine
- 5SD6 Rose Quartz
- 5SD7 Sea Salt
- 5SF3 Storm Cloud
- 5SF4 Olivine

Dovetail by Designtex

- 5H39 Light Mocha
- 5H40 Pebble
- 5H41 Warm White
- 5H42 Sandstone
- 5H43 Honeycomb
- 5H44 Terra
- 5H45 Honeydew
- 5H46 Denim
- 5H47 Storm
- 5H48 Ice Blue
- 5H49 Aura
- 5H50 Darkest Grey

Foundation

- 5875 Black
- 5876 Navy
- 5877 Foggy Night
- 5878 Sailor
- 5879 Ivory
- 5880 Seal
- 5881 Peat
- 5882 New Sand
- 5883 Cranberry
- 5884 Spring
- 5885 Honey
- 5886 Folkstone
- 5887 Pebble
- 5888 Oregono

New Black

- 5J08 New Black: Jack
 - 5J09 New Black: James
 - 5J12 New Black: Harley
- Tip: New Black upholstery has color numbers in both price group 1 and price group 2.*

Nitelights

- 5F66 Stone
- 5F67 Moon

SoftNext

- 5H27 Obsidian
- 5H28 Foggy Night
- 5H29 Greystone
- 5H30 Mocha
- 5H31 Clay
- 5H32 Sandstone
- 5H33 Chalk
- 5H34 Midnight
- 5H35 Blue Mica
- 5H36 Jade
- 5H37 Burnt Umber
- 5H38 Cinnabar

Stand In

- 5621 Sleet
- 5622 Lunar
- 5623 Cyclone
- 5624 Eclipse
- 5625 Powder
- 5626 Chardonnay
- 5627 Graham
- 5628 Sediment
- 5629 Allspice
- 5630 Apple
- 5631 Lava
- 5632 Cayenne
- 5633 Plantain
- 5634 Parsley
- 5635 Scallion
- 5636 Atlantis
- 5691 Orca
- 5740 Burlap
- 5741 Porter
- 5742 Tusk
- 5743 Putty
- 5744 Blueberry
- 5745 Chartreuse
- 5746 Mango
- 5747 Sedona
- 5748 Juniper
- 5749 Peanut

Price Group 3**Billiard Multi-Use by Designtex**

- 5H11 Poppy
- 5H12 Tangelo
- 5H13 Citrine/Citron
- 5H14 Avocado
- 5H16 Indigo
- 5H17 Mallard
- 5H18 Teak
- 5H19 Cumulus
- 5H20 Pewter
- 5H21 Gunmetal
- 5H22 Ink
- 5H23 Rose Quartz
- 5H24 Sea Salt
- 5H25 Storm Cloud
- 5H26 Olivine

Gaja

- 5W40 Black
- 5W41 Pepper
- 5W42 Pearl Grey
- 5W43 Crimson
- 5W44 Ink
- 5W45 Night Blue
- 5W48 Sepia
- 5W51 Camellia Red
- 5W52 Emerald
- 5W53 Snow Pea
- 5W54 Olive
- 5W56 Maroon
- 5W57 Black Raspberry
- 5W58 Spruce
- 5W60 Deep Blue
- 5W61 Chili Pepper

Redeem

- TM50 Brick
- TM52 Cinnamon
- TM55 Water
- TM58 Mallard
- TM60 Greyhound
- TM62 Iceberg
- TM63 Chestnut
- TM64 Granite
- TM66 Barnwood

Retrieve

- TM31 Lake
- TM32 Gala
- TM37 Submarine
- TM40 Quarry
- TM42 Shadow
- TM43 Seal

E = Established

Surface Materials, continued

Price Group 5**Bo Peep**

5G67 Bone
 5G72 Honey Mustard
 5G73 Marmalade
 5G74 Picnic
 5G75 Pinot
 5G76 Bloom
 5G77 Grapevine
 5G79 Artichoke
 5G80 Serpent
 5G81 Carolina
 5G82 Blue Bonnet
 5G83 Nautical
 5G84 Gravel
 5G85 Sharkskin
 5G86 Kohl

Remix

RE01 Rust
 RE03 Pebble
 RE04 Dark Chocolate
 RE06 Linen Beige
 RE08 Concrete Grey
 RE09 Sky Blue
 RE10 Blue Jean
 RE11 Ivy Green
 RE13 Night Blue

Silk

5L31 Dijon
 5L32 Seaweed
 5L33 Boysenberry
 5L35 Marina
 5L36 Heather Blue
 5L37 Blue Raspberry
 5L38 Cauldron
 5L39 Flaxen

Price Group 6**Brisa**

BR01 Black Onyx
 BR04 Truffle
 BR06 Ash
 BR07 Sage
 BR08 Celery
 BR09 Sterling Blue
 BR10 Night Navy
 BR11 Cambridge Blue
 BR12 Abyss
 BR14 Pompeian Red
 BR16 Cinnabar
 BR18 New Sand
 BR20 White
 BR21 Moccasin
 BR22 Buckskin
 BR24 Mineral
 BR25 Skyway
 BR26 Iron
 BR27 Stormy
 BR28 Esmeralda
 BR29 Seaweed
 BR30 Bone
 BR31 Caramel
 BR32 Bridle
 BR33 Moon

Price Group 7**Steelcut Trio**

TR01 Mist Grey
 TR02 Stone Grey
 TR03 Cassonade Beige
 TR04 Nutmeg Beige
 TR06 Licorice Black
 TR11 Ice Blue
 TR15 Brown Frost
 TR18 Coastal Oasis
 TR19 Deep Sea

Leather Price Group**Café Leather**

L208 Black Tea
 L209 Earl Grey
 L210 Espresso Bean
 L211 Chocolate Mousse
 L212 Candied Pecan
 L213 Chai
 L214 Blueberry Tart

Steelcase Leather

L107 Black **E**
 L207 Mahogany **E**
 L220 Soapstone **E**
 L221 Rocky **E**

Elmosoft Leather Price Group**Elmosoft Leather**

L110 Maritime Blue
 L111 Midnight Blue
 L112 Ebony
 L113 Gunmetal
 L114 Mica
 L115 Dove Grey
 L116 Plum Pleasure
 L122 Truffle
 L128 Red Birch
 L133 Espresso
 L134 Ruby
 L135 Scarlet
 L138 Bourbon
 L139 Cinder
 L140 Garnet
 L143 Pecan
 L144 Chamois
 L146 Russet
 L147 Saddle
 L151 White
 L709 Sugar
 L711 Parchment
 L717 Cameo
 L723 Storm
 L730 Hunter
 L743 Forest Green
 L747 Cigar
 L749 Beaver
 L750 Bluffstone
 L752 Oxblood
 L755 Peanut Butter
 L758 Mustard
 L762 Canvas
 L763 Macadamia
 L768 Tropical
 L769 Mauve
 L770 Cadet
 L772 Timberwolf
 L773 Chalice
 L774 Oil
 L775 Coyote

Select Surfaces

For information on products within Select Surfaces, including accent paints, Signature plastics, and fabrics from Designtex, Gabriel, Kvadrat, and Pollack, please refer to the *Surface Materials Reference Manual* or visit www.steelcase.com/surface-materials under the Select Surfaces section.

Custom Surfaces**Price Group COM (Customer's Own Material)****Fabric Approval and Yardage**

To confirm whether a particular COM material has already been tested for use on a specific Steelcase product or to determine actual yardage requirements:

- Visit www.steelcase.com

For additional information regarding Customer's Own Material, call (1.888.783.3522) or send an email to line-one@steelcase.com.

Vertical Surface Fabric

Vertical upholstery is not available on all upholstered surfaces.

► See the Vertical Surface Fabric Matrix in *Surface Materials Reference Manual*.

E = Established

Understanding Customer's Own Material (COM)

The Customer's Own Material (COM) program allows customers to select textiles that are not offered through the standard Surface Materials program.

The COM process consists of seven steps: COM website, Testing/Approval, Steelcase to Purchase Service, Pricing, Cutting Direction, Yardage Requirements, and the Purchase Orders.

COM Application Testing or "approved for application" means the COM fabric has been reviewed for manufacturability using the standard manufacturing techniques to achieve acceptable appearance per Steelcase quality standards.

COM fabric performance, including durability, pilling, color fastness, stretch, splitting, fraying, etc. is not tested by Steelcase. Therefore, COMs are not covered by the Steelcase Warranty. Each COM vendor is responsible for all warranty claims related to fabric performance.

Steelcase reserves the right to reject or reverse any COM approval that does not meet the manufacturing requirements in actual production. COM approval may be rejected or reversed because not all application testing is based on actual production conditions and because some materials vary in fabrication.

- If the COM is approved, you may continue the order process.
- If the COM has failed, you must reselect a fabric.
- If the COM is not listed, that means Steelcase has not tested that fabric on our products.
Helpful hint: Foundation vinyl does not require testing. Customer's own vinyl is available on all seating products that accept Steelcase standard vinyl.

If your material has not been tested, then send yardage (4.5 yards for seating, 2 yards for vertical surfaces) and submit a completed COM Application Testing Request form to:

Steelcase, Inc.
Attn: COM Test Lab
Test Request #*
Door 630
901 44th St SE
Grand Rapids, MI 49508

**To avoid delays in receiving, please include the test request number on the shipping label.*

- To ensure rapid processing, please use the electronic COM Application Testing Request form found on the COM website under the "How To Test" tab **or** fax a copy of the COM Testing Request form from the *Surface Materials Reference Manual* to 616.698.4700. **All information on the form is required in order to complete testing. COM tests cannot be performed if information is incomplete. Contact your requested fabric vendor for any missing information.**
- Test results will be returned (by fax or e-mail) in four working days from receipt of fabric and completed form.

COM materials that are approved for application to panel systems might require UL approval after application test approval. UL approval does involve fees and extended lead times.

All vertical surface COMs tested and approved with a content of 100% polyester meet a minimum of class C/UL1286. If class A or B fire rating is indicated, a burn test must be performed. All vertical surface COMs with a blended fabric construction require a UL burn test. For further UL information, contact a COM Consultant at 616.475.2426.

Steelcase to Purchase Service

The COM program also includes a service to purchase approved COM for our customers for use on products. Steelcase will facilitate the ordering, scheduling and shipment of COM directly from the suppliers. There are no additional charges for this service.

Steelcase is the only party that may purchase COM for all products.

In some instances, not all colors in a fabric family are approved. You will be informed of these instances before Steelcase purchases the fabric.

If for some reason the fabric must be ordered directly from the supplier, contact your Steelcase Solutions Fulfillment Team Representative for approval and instructions prior to purchase. The only time the customer can purchase fabric is for testing.

COM Pricing

- Confirm COM is tested and approved.
- Use the COM or COL (Customer's Own Leather) price group found under Surface Materials Options within each product specification guide.
- Calculate yardage required by using the COM Calculator found on the COM website at www.steelcase.com.
- Or call 1.888.STEELCASE (1.888.783.3522) or send an e-mail to lineone@steelcase.com.
Helpful tip: Fabric width, repeat and product quantity and style number are required in order to calculate yardage accurately.
- Add the cost of the fabric to the COM or COL price group.
- The cost of the COM will be shown as a separate line on the acknowledgement.

COM vendors require fabric purchases in half or full yard increments. Therefore, Steelcase will round all final yardage calculations to the half yard.

COL (Customer's Own Leather) is calculated by the square foot, but purchased in hide. The customer is responsible for purchasing the minimum hide requirement.

Base price of chair includes standard fabrics. Steelcase will not allow credit or deduct the cost of the standard fabric when a COM fabric is selected in its place.

Steelcase cannot be held responsible for costs incurred when a COM supplier ships a COM fabric that does not meet Steelcase application standards or for costs incurred for late deliveries when a COM supplier commits to shipping a COM fabric for manufacturing by a specific date and misses that date.

COM Warranty

Steelcase standard warranty does not apply to Designtex or any other COM vendor's fabric.

- Designtex and other COM suppliers are responsible for color consistency within commercial tolerances, abrasion resistance, UV stability, and resistance to soiling and perspiration. These fabrics or vinyls are subject to policies regarding appearance, behavior, and durability that have been established by the fabric supplier. The customer's remedy for a fabric defect is limited to the replacement of the fabric by the supplier. Durability, performance, and fabric defects of COM fabrics are not guaranteed by Steelcase.

Steelcase cannot guarantee pattern repeat match from product to product. Steelcase also cannot guarantee pattern repeat match within each product listed. (i.e., seat and back, arms to back, etc.)

COM Yardage Requirements

- For the most accurate yardage requirements, visit the Calculator found on the COM website or call 1.888.STEELCASE (1.888.783.3522) or send an e-mail to lineone@steelcase.com.
- The Calculator on the COM website provides the same yardage requirements used by Steelcase purchasing.

Yardage requirements will change depending on:

- width of fabric
 - fabric repeat
 - cutting direction
 - product style number
 - quantity of products being manufactured
- COM vinyl requires upholstering in the railroad cutting direction. Please visit our website or call 1.888.STEELCASE (1.888.783.3522) or send an e-mail to lineone@steelcase.com for yardage requirements.

- Certain fabric treatments and backings require additional yardage or yardage minimums. Please contact the supplier for specific information.

- COM fabric vendors require fabric purchases in half- or full-yard increments, and the Steelcase COM calculator will automatically round all final yardage calculations to the half yard.

- Steelcase is the only party who may purchase COMs.

Fabric Application Direction Guidelines

What is the issue?

Some textiles are simple and look the same regardless of how you apply them to a product. Many other fabrics are patterned, textured, or have luster that will have a distinctly different appearance if applied in different directions on chairs. Because of these differences, and the fact that there are limits to how some fabrics can be applied to Steelcase products, it is important to understand fabric application direction standards at Steelcase in order to avoid being disappointed.

Talking about direction

Fabrics come on rolls. The long yarns that run down the length of the roll are called the "warp" yarns. These yarns are used to define the direction you are viewing the fabric as it is applied to a chair. Fabric directionality is determined by how the fabric comes off the roll. It is NOT determined by the way the pattern looks on the product (i.e., horizontal stripes do not mean the fabric was applied warp horizontal—it could have been applied warp vertical).

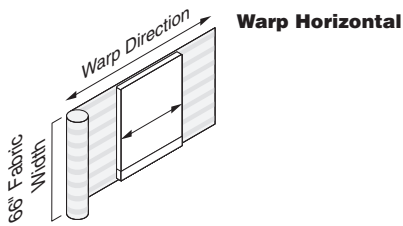

In the example below, the fabric is applied warp horizontal although the stripes appear vertical.



Warp horizontal application is the standard application direction for most Steelcase fabrics on Steelcase seating products. Horizontal application means that as you view the chair in its upright position, the warp yarns of the fabric are running in the horizontal direction.

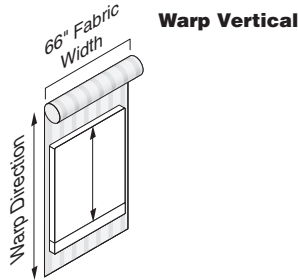

Warp vertical application is the standard application direction for SILQ 418 Series. Vertical application means that as you view the chair in its upright position, the warp yarns are running in the vertical direction.

► See page 646, *Fabric Application Direction Guidelines* matrix, for details on these exceptions.

Steelcase is not responsible for charges associated with replacement or reupholstery of products due to incorrect specifications.



The combination of most seating products (warp horizontal) with SILQ 418 (warp vertical) will result in the fabric patterns running in opposite directions.

To remedy this situation, the following options are available:

- Use non-directional fabric. Only a small selection of fabrics are non-directional.
- Use fabrics that have standard warp vertical application direction.
- Specify warp vertical application on fabrics that are standard warp horizontal.

Tip: If you require warp vertical and it is not the standard, you must specify the warp vertical option on every line in the order.

Warp Horizontal (Railroaded)

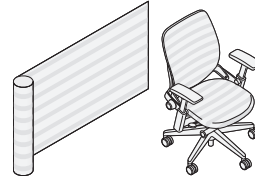

Railroaded means the same thing as *warp horizontal* and is often used when talking about chairs. *Across roll* is another term for running the fabric in this direction.

Warp Vertical (Woven Way)

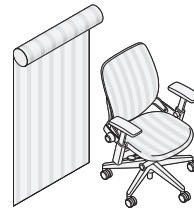

Woven way means the same thing as *warp vertical* and is often used when talking about chairs. *Down roll* is another term for running the fabric in this direction.

What determines fabric direction?

Standard default directions exist for all products. You may specify a fabric to be cut in a specific direction if the product allows it to be applied. The purchase order must clearly state the application direction if it is other than standard. Refer to the following tables for the standard directions.

Tip: If you are changing the application direction of fabric, yardage requirements may increase resulting in an additional upcharge. This upcharge will be applied to the purchase order.

Why do dealers have to specify fabric application direction?

Sometimes COM fabrics have patterns that look awkward or inappropriate if they are applied in the standard direction. Therefore, it is critical to know how the pattern is run on the roll to ensure that Steelcase builds and ships each order to the customer's expectation. Some examples are shown here.



Incorrect?



Correct?



Incorrect?



Correct?



Incorrect?



Correct?



Incorrect?



Correct?

- Steelcase does not know which way your customer wants to see these patterns on their furniture.
- Dealers must specify application direction on all COM orders.

Swatch directions

All Steelcase fabric swatches and samples are shown in the warp horizontal direction. If you hold any fabric sample in the orientation shown below, the fabric will be in the warp-horizontal direction.



Swatch card

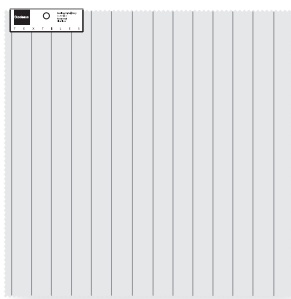

Memo sample

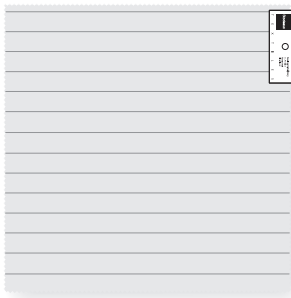

To see how a fabric will look if it is applied warp vertical, turn it 90°.

Tip: Fabric direction on samples from COM vendors may vary by product. Most textile companies will swatch their fabrics in a warp vertical (woven way, down roll) direction. Some exceptions might be made to address patterns especially with stripes. Typically, when a fabric is swatched in a warp horizontal (railroad or across roll) direction, the direction is noted on the swatch card or fabric sample. If in doubt of a fabric direction, we encourage you to contact the textile vendor for clarification.

Fabric Application Direction Guidelines, continued

Fabric Application Direction for Seating

Fabric	Standard Application Direction	Tips
Steelcase Textiles Upholstery	Railroaded (warp horizontal)	Fabrics on SILQ 418 Series will only be applied in the warp vertical/down roll direction, this includes all standard Steelcase fabrics, Select Surfaces, and COMs.
Select Surfaces-Designtex	Varies by fabric Dealers must specify desired fabric application direction on all select surfaces orders.	Confirm test results and application direction on COM website and <i>Designtex.com</i> prior to ordering.
Select Surfaces-Gabriel	Varies by fabric Dealers must specify desired fabric application direction on all select surfaces orders.	Confirm test results and application direction on COM website and <i>Gabriel.dk</i> prior to ordering.
Select Surfaces-Kvadrat	Varies by fabric Dealers must specify desired fabric application direction on all select surfaces orders.	Confirm test results and application direction on COM website and <i>Kvadrat.dk</i> prior to ordering.
Select Surfaces-Pollack	Warp vertical Dealers must specify desired fabric application direction on all select surfaces orders.	Confirm test results and application direction on COM website and <i>Pollackassociates.com</i> prior to ordering.
COM Fabrics	Varies by fabric Dealers must specify desired fabric application direction on all COM orders.	The most common COM application direction for seating is warp vertical. Confirm test results and application direction on COM website and your textile vendor's site prior to entering COM orders.
COM Vinyls	Varies by fabric Dealers must specify desired fabric application direction on all COM orders.	Most solid vinyls are commonly applied in the warp horizontal application direction.

Maintenance and Cleaning

Inspecting and cleaning. Have your chair's upholstery, finishes, controls, base, and other moving parts inspected and cleaned at least once a year.

Cleaning painted and plastic surfaces. Finishes should be cleaned with water and/or a non-abrasive cleaner (such as Formula 409® and Fantastik®).

Maintaining upholstery. Use a vacuum cleaner for regular cleaning. Periodic professional dry cleaning is recommended. Do not steam clean.

Removing excess stains or heavy soil. Soak up excess stain with a cloth. Do not dry the stain completely or it may set. For most water-soluble stains (coffee, fruit juice, washable ink), use an upholstery cleaning solution (such as Bissell® upholstery shampoo or Guardsman Fabri-Kleen® products) and follow directions on package. For oil-borne stains, use a dry cleaning solution at room temperature (never hot) and let solution work into the stain. Use quick, light strokes to brush the stain with a soft bristle brush. Work from outside toward the center to prevent rings. Soak up remaining dry cleaning solution, then sponge the fabric with cool water. Let fabric dry completely; then vacuum thoroughly. If stain is still visible, repeat procedure. Several light applications of cleaning solution are more effective and less damaging than one heavy application.

Formula 409 is a registered trademark of Clorox company. Fantastik is a registered trademark of Dow Consumer Products, Inc. Fabri-Kleen is a registered trademark of Guardsman Chemical. All other marks are marks of their respective owners.

Seating Upholstery Matrix

Legend

- = Not available
- = Available
- = Available with exceptions
- E = Established
- EL = Elmosoft leather
- L = Leather
- ▶ See specification pages for details.

Amia 482 Series sewn version models with leather or vinyl require an "S" suffix which features an additional stitch detail across the lumbar region on the back cushion. Vinyl is not available on models with upholstered outer back.

Brody 488 Series vertical fabrics can be found in the *Vertical Surface Fabric Matrix* in the *Surface Materials Reference Manual*.

3D Knit upholstery available only on models with 3D Knit back.

	Price Group	align Lounge Series - Standard	Amia 482 Series - 3D Knit - Standard	Amia 482 Series - Standard	Amia 482 Series - 3D Knit - Sewn	Amia 482 Series - Sewn	Amia Air 482 - Sewn	Amia Air 482 Standard	B-Free Lounge	Basic Cushion, Basic Cushion Enhanced	Brody 488 Series Worklounge - Seat	Brody 488 Series Worklounge - Lower Surround & Trim	Brody 488 Series Privacy Lounge - Seat	Brody 488 Series Privacy Lounge and Desk - Lower Surround & Trim	Brody 488 Series Privacy Lounge and Desk - Screen	Brody 488 Series Privacy Lounge with Extension - Seat	Brody 488 Series Privacy Lounge and Desk with Extension - Lower Surround & Trim	Brody 488 Series Privacy Lounge and Desk with Extension - Screen	Brody 488 Series Footrest
3D Knit	NA	•	■	•	■	•	•	•	•	•	•	•	•	•	•	•	•	•	•
3D Microknit	NA	•	•	•	•	•	□	□	•	•	•	•	•	•	•	•	•	•	•
Billiard Multi-Use by Designtex	3	■	■	■	■	■	■	■	■	■	■	■	■	■	■	■	■	■	■
Bo Peep	5	■	■	■	•	•	•	■	■	■	■	■	■	■	•	■	■	•	■
Brisa	6	■	■	■	■	■	■	■	■	•	■	■	■	■	•	■	■	•	■
Buzz2	1	■	■	■	■	■	■	■	■	■	■	■	■	■	■	■	■	■	■
Chainmail	2	■	■	■	•	•	•	■	■	■	■	■	■	■	•	■	■	•	■
Cogent: Connect	2	■	■	■	•	•	•	■	■	■	■	•	■	•	•	■	•	•	■
Connect 3D	NA	■	•	•	•	•	•	•	•	•	•	•	•	•	•	•	•	•	•
Elmosoft Leather	EL	•	•	•	■	■	■	•	■	•	■	•	■	•	•	■	•	•	■
Era	1	■	■	■	■	■	■	■	■	■	■	■	■	■	•	■	■	•	■
Foundation	2	■	•	•	■	□	□	•	■	•	■	■	■	■	•	■	■	•	■
Gaja	3	■	■	■	■	■	■	■	■	■	■	■	■	•	■	■	•	■	■
Intermix	1	•	•	•	•	•	•	•	•	•	•	•	•	•	•	•	•	•	•
Intermix (Shift)	2	•	•	•	•	•	•	•	•	•	•	•	•	•	•	•	•	•	•
Intermix (Opaque)	3	•	•	•	•	•	•	•	•	•	•	•	•	•	•	•	•	•	•
Jacks ^E	1	■	■	■	■	■	■	■	■	■	■	■	■	■	•	■	■	•	■
Link	1	■	■	■	■	■	■	■	■	■	■	■	■	■	•	■	■	•	■

Legend

- = Not available
- = Available
- = Available with exceptions
- ⓔ = Established
- EL = Elmosoft leather
- L = Leather
- ▶ See specification pages for details.

	Price Group	Buoy	Cachet 487 Series - Standard	Campfire Big Lamp	Campfire Lounges	Campfire Pouf	cobi 434 Series - Connect 3D - Standard	cobi 434 Series - Connect 3D - Sewn	Divisio Side Screen	FrameOne	Gesture 442 Series - Non-Sewn	Gesture 442 Series - Sewn	Gesture 442 Series - 3D Knit - Non-Sewn	i2i 416 Series - 3D Knit - Sewn	Jenny Lounge
3D Knit	NA	•	•	•	•	•	•	•	•	•	•	■	■	■	•
3D Microknit	NA	•	•	•	•	•	•	•	•	•	•	•	•	•	•
Billiard Multi-Use by Designtex	3	■	■	•	■	•	•	■	■	■	□	■	■	■	■
Bo Peep	5	■	■	•	■	■	•	■	•	•	•	■	■	■	■
Brisa	6	■	•	•	■	•	•	■	•	•	•	■	■	■	■
Buzz2	1	■	■	•	■	•	•	■	■	■	•	■	■	■	■
Chainmail	2	■	■	•	■	•	•	■	■	■	•	■	■	■	■
Cogent: Connect	2	■	■	■	■	•	■	•	■	■	■	■	■	■	■
Connect 3D	NA	■	•	•	■	•	■	•	•	•	•	•	•	•	■
Elmosoft Leather	EL	•	■	•	•	•	•	■	•	•	•	■	■	■	•
Era	1	■	■	•	■	■	•	■	•	■	•	■	■	■	■
Foundation	2	■	■	•	■	•	•	■	•	•	•	■	■	■	■
Gaja	3	■	■	•	■	•	•	■	•	•	•	■	■	■	■
Intermix	1	•	•	•	•	•	•	•	•	•	•	•	•	•	•
Intermix (Shift)	2	•	•	•	•	•	•	•	•	•	•	•	•	•	•
Intermix (Opaque)	3	•	•	•	•	•	•	•	•	•	•	•	•	•	•
Jacks ⓔ	1	■	■	•	■	•	•	■	•	•	•	■	■	■	■
Link	1	■	■	•	■	•	•	■	•	•	•	■	■	■	■

Brody 488 Series vertical fabrics can be found in the *Vertical Surface Fabric Matrix* in the *Surface Materials Reference Manual*.

3D Knit upholstery available only on models with 3D Knit back.

Seating Upholstery Matrix, continued

Legend

- = Not available
- = Available
- = Available with exceptions
- ⓔ = Established
- EL = Elmosoft leather
- L = Leather
- ▶ See specification pages for details.

	Price Group	Kart	Leap 462 Series - 3D Knit - Standard	Leap 462 Series - Standard	Leap Plus 462 Series - 3D Knit - Standard	Leap Plus 462 Series - Standard	Leap 462 Series - 3D Knit - Sewn	Leap 462 Series - Sewn	Leap Plus 462 Series - 3D Knit - Sewn	Leap Plus 462 Series - Sewn	Mobile Pad Cushion Tops - Avenir	Move 490 Series - Standard	Node 480 Series	Nooi	Player 475 Series - Standard
3D Knit	NA	•	■	•	■	•	■	•	■	•	•	•	•	•	•
3D Microknit	NA	•	•	•	•	•	•	•	•	•	•	•	•	•	•
Billiard Multi-Use by Designtex	3	■	■	■	■	■	•	•	•	•	■	■	■	■	■
Bo Peep	5	■	■	■	■	■	•	•	•	•	■	■	■	■	■
Brisa	6	■	■	■	•	•	■	■	■	■	■	■	■	■	■
Buzz2	1	■	■	■	■	■	•	•	•	•	■	■	■	■	■
Chainmail	2	■	■	■	■	■	•	•	•	•	■	■	■	■	■
Cogent: Connect	2	■	■	■	■	■	•	•	•	•	■	■	■	■	■
Connect 3D	NA	•	•	•	•	•	•	•	•	•	•	•	•	•	•
Elmosoft Leather	EL	■	■	•	•	•	■	■	■	■	■	■	■	■	•
Era	1	■	■	■	■	■	•	•	•	•	■	■	■	■	■
Foundation	2	■	■	•	•	•	■	■	■	■	■	■	■	■	■
Gaja	3	■	■	■	■	■	•	•	•	•	■	■	■	•	■
Intermix	1	•	•	•	•	•	•	•	•	•	•	•	•	•	•
Intermix (Shift)	2	•	•	•	•	•	•	•	•	•	•	•	•	•	•
Intermix (Opaque)	3	•	•	•	•	•	•	•	•	•	•	•	•	•	•
Jacks ⓔ	1	■	■	■	■	■	•	•	•	•	■	■	■	■	■
Link	1	■	■	■	■	■	•	•	•	•	■	■	■	■	■

3D Knit upholstery available only on models with 3D Knit back.

Legend

- = Not available
- = Available
- = Available with exceptions
- ⓔ = Established
- EL = Elmosoft leather
- L = Leather
- ▶ See specification pages for details.

Tip: SILQ 418 Series will only take warped vertical fabrics. This includes all standard Steelcase fabrics, Select Surfaces, and COMs.

	Price Group	QIVI 428 Series - QIVI Net - Standard	QIVI 428 Series - QIVI Net - Sewn	Reply 466 Series Work Chair; Uph Seat-Mesh Back	Reply 466 Series Multi-Use Side Chair; Uph Seat-Mesh Back	Reply 466 Series Work chair; Uph Seat-Uph Back	Reply 466 Series Multi-Use Side Chair; Uph Seat-Uph Back	Reply 466 Series Work Chair - Sewn Seat-Mesh Back	Reply 466 Series Multi-Use Side Chair; Sewn Seat-Mesh Back	Reply 466 Series Work Chair; Sewn Seat-Sewn Back	Reply 466 Series Multi-Use Side Chair; Sewn Seat-Sewn Back	Scoop - Standard, Upholstered Seat	Shortcut	Siento 499 Series - Standard	Siento 499 Series - Sewn	SILQ 418 Series - Standard	SILQ 418 Series - Sewn	Simple Seating
3D Knit	NA	•	•	•	•	•	•	•	•	•	•	•	•	•	•	•	•	•
3D Microknit	NA	•	•	•	•	•	•	•	•	•	•	•	•	•	•	•	•	•
Billiard Multi-Use by Designtex	3	■	■	■	■	■	■	■	■	■	■	■	■	■	■	■	■	■
Bo Peep	5	■	■	■	■	■	■	■	■	■	■	■	■	■	■	■	■	■
Brisa	6	■	■	■	•	•	•	■	■	■	■	■	■	■	•	•	■	■
Buzz2	1	■	■	■	■	■	■	■	•	•	•	■	■	■	•	■	•	■
Chainmail	2	■	•	■	■	■	■	■	•	•	•	■	■	■	•	■	•	■
Cogent: Connect	2	■	■	■	■	■	■	■	•	•	•	■	■	■	•	■	•	■
Connect 3D	NA	•	•	•	•	•	•	•	•	•	•	■	■	•	•	•	•	■
Elmosoft Leather	EL	■	■	■	•	•	•	■	■	■	■	•	■	•	■	•	□	•
Era	1	■	■	■	■	■	■	■	•	•	•	■	■	■	•	•	•	■
Foundation	2	■	■	■	•	•	•	■	■	■	■	■	■	•	•	•	■	■
Gaja	3	■	■	■	■	■	■	■	•	•	•	■	■	■	•	■	•	■
Intermix	1	•	•	•	•	•	•	•	•	•	•	•	•	•	•	•	•	•
Intermix (Shift)	2	•	•	•	•	•	•	•	•	•	•	•	•	•	•	•	•	•
Intermix (Opaque)	3	•	•	•	•	•	•	•	•	•	•	•	•	•	•	•	•	•
Jacks ⓔ	1	■	•	■	■	■	■	■	•	•	•	■	■	■	•	■	•	■
Link	1	■	•	■	■	■	■	■	•	•	•	■	■	■	•	■	•	■

Seating Upholstery Matrix, continued

Legend

- = Not available
 - = Available
 - = Available with exceptions
 - ⓔ = Established
 - EL = Elmosoft leather
 - L = Leather
- Tip: Cogent: Connect 5S15 Coconut is not available on Umami Lounge.*
- ▶ See specification pages for details.

	Price Group	Steelcase Karman	Steelcase Series 1	Steelcase Series 2 - Airback-Uph Seat	Steelcase Series 2 - 3D Microknit Back-Uph Seat	Steelcase Series 2 - Uph Seat-Uph Back	Think 465 Series - 3D Knit Back, Uph Seat	Think 465 Series - Uph Back, Uph Seat	Umami	Universal Pad Cushion Tops - Standard, RPM and RPX	Universal Lateral Cushion Tops - RPDC, 2 Seam	Universal Lateral Cushion Tops - RPDC, 4 Seam	Universal Privacy Modesty Screen
3D Knit	NA	•	•	•	•	•	■	•	•	•	•	•	•
3D Microknit	NA	•	■	•	■	•	•	•	•	•	•	•	•
Billiard Multi-Use by Designtex	3	•	■	■	■	■	■	■	•	•	•	■	•
Bo Peep	5	•	■	■	■	■	■	■	■	■	■	•	•
Brisa	6	•	■	■	■	■	■	■	•	•	•	■	•
Buzz2	1	•	■	■	■	■	■	■	■	■	•	■	•
Chainmail	2	•	■	■	■	■	•	•	•	■	■	•	•
Cogent: Connect	2	•	■	■	■	■	■	■	□	■	•	■	■
Connect 3D	NA	•	•	•	•	•	•	•	•	•	•	•	•
Elmosoft Leather	EL	•	■	■	■	■	■	■	•	•	•	■	•
Era	1	•	■	■	■	■	■	■	•	■	•	■	•
Foundation	2	•	■	■	■	■	■	■	■	•	•	■	•
Gaja	3	•	•	•	•	•	■	■	■	•	•	■	•
Intermix	1	■	•	•	•	•	•	•	•	•	•	•	•
Intermix (Shift)	2	■	•	•	•	•	•	•	•	•	•	•	•
Intermix (Opaque)	3	■	•	•	•	•	•	•	•	•	•	•	•
Jacks ⓔ	1	•	■	■	■	■	■	■	■	■	■	•	•
Link	1	•	■	■	■	■	■	■	•	■	■	•	•

Legend

- = Not available
- = Available
- = Available with exceptions
- ⓔ = Established
- EL = Elmosoft leather
- L = Leather
- ▒ = COM approved
- ▶ See specification pages for details.

	Price Group	alight Lounge Series - Standard	Amia 482 Series - 3D Knit - Standard	Amia 482 Series - Standard	Amia 482 Series - 3D Knit - Sewn	Amia 482 Series - Sewn	Amia Air 482 - Sewn	Amia Air 482 Standard	B-Free Lounge	Basic Cushion, Basic Cushion Enhanced	Brody 488 Series Worklounge - Seat	Brody 488 Series Worklounge - Lower Surround & Trim	Brody 488 Series Privacy Lounge - Seat	Brody 488 Series Privacy Lounge and Desk - Lower Surround & Trim	Brody 488 Series Privacy Lounge and Desk - Screen	Brody 488 Series Privacy Lounge with Extension - Seat	Brody 488 Series Privacy Lounge and Desk with Extension - Lower Surround & Trim	Brody 488 Series Privacy Lounge and Desk with Extension - Screen	Brody 488 Series Footrest
New Black: Bruce	1	■	■	■	■	■	■	■	■	■	■	■	■	■	•	■	■	•	■
New Black: Harley	2	■	■	■	■	■	■	■	■	■	■	■	■	■	•	■	■	•	■
New Black: Henry	1	■	■	■	■	■	■	■	■	■	■	■	■	■	•	■	■	•	■
New Black: Jack	2	■	■	■	■	■	■	■	■	■	■	■	■	■	•	■	■	•	■
New Black: James	2	■	■	■	■	■	■	■	■	■	■	■	■	■	•	■	■	•	■
Nitelights	2	■	■	■	•	•	•	■	■	■	■	■	■	■	•	■	■	•	■
Redeem	3	■	■	■	■	■	■	■	■	■	■	■	■	■	•	■	■	•	■
Remix	5	■	■	■	■	■	■	■	■	■	■	■	■	■	•	■	■	•	■
Reply Air Mesh	NA	■	•	•	•	•	•	•	•	•	•	•	•	•	•	•	•	•	•
Retrieve	3	■	■	■	■	■	■	■	■	■	■	■	■	■	•	■	■	•	■
Silk	5	■	■	■	■	■	■	■	■	■	■	■	■	■	•	■	■	•	■
Stand In	2	■	•	•	■	■	■	•	■	•	■	•	■	•	■	■	•	•	■
Steelcase Leather	L	•	•	•	■	■	■	•	■	•	■	•	■	•	■	■	•	•	■
Steelcut Trio	7	■	■	■	■	■	■	■	■	•	■	■	■	■	•	■	■	•	■
Turnstone Leather	NA	•	•	•	•	•	•	•	•	•	•	•	•	•	•	•	•	•	•

Surface Materials

Amia 482 Series sewn version models with leather or vinyl require an "S" suffix which features an additional stitch detail across the lumbar region on the back cushion. Vinyl is not available on models with upholstered outer back.

Brody 488 Series vertical fabrics can be found in the *Vertical Surface Fabric Matrix* in the *Surface Materials Reference Manual*.

Seating Upholstery Matrix, continued

Legend

- = Not available
- = Available
- = Available with exceptions
- E = Established
- EL = Elmosoft leather
- L = Leather
- ▶ See specification pages for details.

	Price Group	Buoy	Cachet 487 Series - Standard	Campfire Big Lamp	Campfire Lounges	Campfire Pouf	cobi 434 Series - Connect 3D - Standard	cobi 434 Series - Connect 3D - Sewn	Divisio Side Screen	FrameOne	Gesture 442 Series - Non-Sewn	Gesture 442 Series - Sewn	Gesture 442 Series - 3D Knit - Non-Sewn	i2i 416 Series - 3D Knit - Sewn	Jenny Lounge
New Black: Bruce	1	•	•	•	■	•	•	■	•	•	■	■	■	■	■
New Black: Harley	2	■	•	•	■	•	•	■	•	•	■	■	■	■	■
New Black: Henry	1	■	•	•	■	•	•	■	•	•	■	■	■	■	■
New Black: Jack	2	■	•	•	■	•	•	■	•	•	■	■	■	■	■
New Black: James	2	■	•	•	■	•	•	■	•	•	■	■	■	■	■
Nitelights	2	■	■	•	■	•	•	■	•	•	■	■	■	■	■
Redeem	3	■	•	•	■	•	•	■	•	•	■	■	■	■	■
Remix	5	■	■	•	■	•	•	■	•	•	■	■	■	■	■
Reply Air Mesh	NA	•	■	•	•	•	•	•	•	•	•	•	•	•	•
Retrieve	3	■	•	•	■	•	•	■	•	•	■	■	■	■	■
Silk	5	■	•	•	■	•	•	■	•	•	■	■	■	■	■
Stand In	2	■	■	•	■	•	•	■	•	•	■	■	■	■	■
Steelcase Leather	L	•	■	•	•	•	•	■	•	•	■	■	■	■	■
Steelcut Trio	7	■	■	•	•	•	•	■	•	•	■	■	■	■	■
Turnstone Leather	NA	•	•	•	•	•	•	•	•	•	•	•	•	•	•

Brody 488 Series vertical fabrics can be found in the *Vertical Surface Fabric Matrix* in the *Surface Materials Reference Manual*.

Legend

- = Not available
- = Available
- = Available with exceptions
- E = Established
- EL = Elmosoft leather
- L = Leather
- ▶ See specification pages for details.

	Price Group	Kart	Leap 462 Series - 3D Knit - Standard	Leap 462 Series - Standard	Leap Plus 462 Series - 3D Knit - Standard	Leap Plus 462 Series - Standard	Leap 462 Series - 3D Knit - Sewn	Leap 462 Series - Sewn	Leap Plus 462 Series - 3D Knit - Sewn	Leap Plus 462 Series - Sewn	Mobile Ped Cushion Tops - Avenir	Move 490 Series - Standard	Node 480 Series	Nooi	Player 475 Series - Standard
New Black: Bruce	1	■	■	■	■	■	•	•	•	•	■	■	■	■	■
New Black: Harley	2	■	■	■	■	■	•	•	•	•	■	■	■	■	■
New Black: Henry	1	■	■	■	■	■	•	•	•	•	■	■	■	■	■
New Black: Jack	2	■	■	■	■	■	•	•	•	•	■	■	■	■	■
New Black: James	2	■	■	■	■	■	•	•	•	•	■	■	■	■	■
Nitelights	2	■	■	■	■	■	•	•	•	•	■	■	■	■	■
Redeem	3	■	■	■	■	■	•	•	•	•	■	■	■	■	■
Remix	5	■	■	■	■	■	•	•	•	•	■	■	■	■	■
Reply Air Mesh	NA	•	•	•	•	•	•	•	•	•	■	•	•	•	•
Retrieve	3	■	■	■	■	■	•	•	•	•	■	■	■	■	■
Silk	5	■	■	■	■	■	•	•	•	•	■	■	■	■	■
Stand In	2	■	■	•	•	•	■	■	■	■	■	■	•	■	■
Steelcase Leather	L	■	■	•	•	•	■	■	■	■	■	■	■	■	•
Steelcut Trio	7	■	■	■	■	■	•	•	•	•	■	■	■	■	■
Turnstone Leather	NA	•	•	•	•	•	•	•	•	•	•	•	•	•	•

Seating Upholstery Matrix, continued

Legend

- = Not available
 - = Available
 - = Available with exceptions
 - Ⓢ = Established
 - EL = Elmosoft leather
 - L = Leather
 - ▶ See specification pages for details.
- Tip: SILQ 418 Series will only take warped vertical fabrics. This includes all standard Steelcase fabrics, Select Surfaces, and COMs.*

	Price Group	Qivi 428 Series - Qivi Net - Standard	Qivi 428 Series - Qivi Net - Sewn	Reply 466 Series Work Chair; Uph Seat-Mesh Back	Reply 466 Series Multi-Use Side Chair; Uph Seat-Mesh Back	Reply 466 Series Work chair; Uph Seat-Uph Back	Reply 466 Series Multi-Use Side Chair; Uph Seat-Uph Back	Reply 466 Series Work Chair - Sewn Seat-Mesh Back	Reply 466 Series Multi-Use Side Chair; Sewn Seat-Mesh Back	Reply 466 Series Work Chair; Sewn Seat-Sewn Back	Reply 466 Series Multi-Use Side Chair; Sewn Seat-Sewn Back	Scoop - Standard, Upholstered Seat	Shortcut	Siento 499 Series - Standard	Siento 499 Series - Sewn	SILQ 418 Series - Standard	SILQ 418 Series - Sewn	Simple Seating
New Black: Bruce	1	■	•	■	■	■	■	■	•	•	•	■	■	■	•	•	■	■
New Black: Harley	2	■	•	■	■	■	■	■	•	•	•	■	■	■	•	■	•	■
New Black: Henry	1	■	•	■	■	■	■	■	•	•	•	■	■	■	•	■	•	■
New Black: Jack	2	■	•	■	■	■	■	■	•	•	•	■	■	■	•	■	•	■
New Black: James	2	■	•	■	■	■	■	■	•	•	•	■	■	■	•	■	•	■
Nitelights	2	■	•	■	■	■	■	■	•	•	•	■	■	■	•	■	•	■
Redeem	3	■	•	■	■	■	■	■	•	•	•	■	■	■	•	■	•	■
Remix	5	■	■	■	■	■	■	■	•	•	•	■	■	■	•	■	•	■
Reply Air Mesh	NA	•	•	■	■	•	■	■	■	•	•	•	•	•	•	•	•	•
Retrieve	3	■	•	■	■	■	■	■	•	•	•	■	■	■	•	■	•	■
Silk	5	■	•	■	■	■	■	■	•	•	•	■	■	■	•	■	•	■
Stand In	2	■	■	■	•	•	•	■	■	■	■	■	■	•	•	•	■	•
Steelcase Leather	L	■	■	■	•	•	•	■	■	■	■	•	■	•	■	•	■	•
Steelcut Trio	7	■	■	■	■	■	■	■	•	•	•	■	■	•	•	•	■	■
Turnstone Leather	NA	•	•	•	•	•	•	•	•	•	•	•	•	•	•	•	•	•

Legend

- = Not available
- = Available
- = Available with exceptions
- Ⓢ = Established
- EL = Elmosoft leather
- L = Leather
- ▶ See specification pages for details.

	Price Group	Steelcase Karman	Steelcase Series 1	Steelcase Series 2 - Airback-Uph Seat	Steelcase Series 2 - 3D Microknit Back-Uph Seat	Steelcase Series 2 - Uph Seat-Uph Back	Think 465 Series - 3D Knit Back, Uph Seat	Think 465 Series - Uph Back, Uph Seat	Umami	Universal Ped Cushion Tops - Standard, RPM and RPX	Universal Lateral Cushion Tops - RPDC, 2 Seam	Universal Lateral Cushion Tops - RPDC, 4 Seam	Universal Privacy Modesty Screen
New Black: Bruce	1	•	■	■	■	■	■	■	•	■	•	■	•
New Black: Harley	2	•	■	■	■	■	■	■	•	■	•	■	•
New Black: Henry	1	•	■	■	■	■	■	■	■	■	•	■	•
New Black: Jack	2	•	■	■	■	■	■	■	■	■	•	■	•
New Black: James	2	•	■	■	■	■	■	■	■	■	•	■	•
Nitelights	2	•	■	■	■	■	■	■	■	■	•	■	•
Redeem	3	•	■	■	■	■	■	■	■	■	•	■	•
Remix	5	•	■	■	■	■	■	■	■	■	•	■	•
Reply Air Mesh	NA	•	•	•	•	•	•	•	•	■	■	•	•
Retrieve	3	•	■	■	■	■	■	■	■	■	•	■	•
Silk	5	•	■	■	■	■	■	■	•	■	•	■	•
Stand In	2	•	■	■	■	■	■	■	•	•	•	■	•
Steelcase Leather	L	•	■	■	■	■	■	■	•	•	•	■	•
Steelcut Trio	7	•	■	■	■	■	■	■	■	■	•	■	•
Turnstone Leather	NA	•	•	•	•	•	•	•	•	•	•	•	•

Color Availability Matrix, continued

Legend

- = Not available
- = Available
- = Available with exceptions
- Ⓜ = Established
- ▶ See specification pages for details.

		Smooth Paint							Textured Paint								
		0835	4238	4239	4240	4242	4700	7000	7207	7225	7237	7238	7239	7241	7243	7250	7360
		Black	Mocha	Clay	Chalk	Milk	Warm White	Black	Black	Sand	Slate	Fieldstone	Midnight	Arctic White	Seagull	Sterling Dark	Merle
Amia 482 Series	Outer back shell	•	•	•	•	•	•	•	•	•	•	•	•	•	•	•	•
	Outer back frame and arm holsters	•	•	•	•	•	•	•	•	•	•	•	•	•	■	■	•
	Arm holsters	•	•	•	•	•	•	•	•	•	•	•	•	•	■	■	•
	Outer seat shell	•	•	•	•	•	•	•	•	•	•	•	•	•	•	•	•
	Base	•	•	•	•	•	•	•	•	•	•	•	•	•	■	■	•
	Air back	•	•	•	•	•	•	•	•	•	•	•	•	•	•	•	•
B-Free	Beam leg	•	•	•	•	•	•	•	■	■	■	■	■	■	■	■	■
	Beam footrest	•	•	•	•	•	•	•	■	■	■	■	■	■	■	■	■
	Standing height table top	•	•	•	•	•	•	•	•	•	•	•	•	•	•	•	•
	Standing height table metal leg	•	•	•	•	•	•	•	■	■	■	■	■	■	■	■	■
	Table top	•	•	•	•	•	•	•	•	•	•	•	•	•	•	•	•
	Table base	•	•	•	•	•	•	•	•	•	•	•	•	■	•	•	■
Brody 488 WorkLounge	Caddy and lower footrest	•	•	•	•	•	•	•	•	•	•	•	•	•	•	•	•
	Foot, personal worksurface arm, and screen brackets	•	•	•	•	•	•	•	•	•	•	•	•	•	□	□	•
	Frame	•	•	•	•	•	•	•	•	•	•	•	•	•	•	•	■
	Light	•	•	•	•	•	•	•	•	•	•	•	•	•	•	•	•
	Personal worksurface and lower surround trim	•	•	•	•	•	•	•	•	•	•	•	•	•	•	•	•
	Power	•	•	•	•	•	•	•	•	•	•	•	•	•	•	•	•
	Screen	•	•	•	•	•	•	•	•	•	•	•	•	•	•	•	•
	Seat shell	•	•	•	•	•	•	•	•	•	•	•	•	•	•	•	•
	Side surface	•	•	•	•	•	•	•	•	•	•	•	•	•	•	•	•
	Brody 488 Desk	Foot and screen brackets	•	•	•	•	•	•	•	•	•	•	•	•	□	□	•
Frame		•	•	•	•	•	•	•	•	•	•	•	•	•	•	•	■
Lower surround trim		•	•	•	•	•	•	•	•	•	•	•	•	•	•	•	•
Light		•	•	•	•	•	•	•	•	•	•	•	•	•	•	•	•
Screen		•	•	•	•	•	•	•	•	•	•	•	•	•	•	•	•
Power		•	•	•	•	•	•	•	•	•	•	•	•	•	■	■	•
Cachet 487 Series	Swivel and 4-leg frame	•	•	•	•	•	•	•	•	•	•	•	•	•	•	•	•
	Stool frame	•	•	•	•	•	•	•	•	•	•	•	•	•	•	•	•
Cobi 434 Series	Base and back frame	•	•	•	•	•	•	•	•	•	•	•	•	•	•	•	•
	Arm caps, top edge, and casters	•	•	•	•	•	•	•	•	•	•	•	•	•	•	•	•
	Outer back	•	•	•	•	•	•	•	•	•	•	•	•	•	•	•	•
	Foot ring	•	•	•	•	•	•	•	•	•	•	•	•	•	•	•	•
Gesture 442 Series	Base	•	•	•	•	•	•	•	•	•	•	•	•	•	■	•	•
	Arms	•	•	•	•	•	•	•	•	•	•	•	•	•	•	•	•
	Seat perimeter, back shell, and headrest	•	•	•	•	•	•	•	•	•	•	•	•	•	•	•	•
	Back frame	•	•	•	•	•	•	•	•	•	•	•	•	•	•	•	•
i2i 416 Series	Outer back	•	•	•	•	•	•	•	■	•	•	•	•	•	•	•	•
	Base and cylinder	•	•	•	•	•	•	•	•	•	•	•	•	•	•	•	•
	Tablet arm	•	•	•	•	•	•	•	•	•	•	•	•	•	•	•	•

Smooth Metallic Paint	
4728 Nickel Metallic	•
4743 Mineral Metallic	•
4744 Pearl Metallic	•
4750 Champagne Metallic	•
4798 Sterling Metallic	•
4799 Platinum Metallic	■
4803 Near Black Metallic	•
Textured Metallic Paint	
7245 Carbon Metallic	•
7246 Midnight Metallic	•
Architectural Paint	
4843 Linen	•
4844 Glacier	•
4849 Vapor	•
Worktools Paint	
4231 Arctic White	•
Accessory Paint	
4140 Arctic White Gloss	•
4144 Black Gloss	•
4710 Low Gloss Black	•

Surface Materials

Color Availability Matrix, continued

Legend

- = Not available
- = Available
- = Available with exceptions
- Ⓜ = Established
- ▶ See specification pages for details.

		Accent Paints																				Coatings							
		1ATB	1ATG	1ATH	1ATJ	1ATK	4AQ9	4AV3	4AV4	4AX1	4AY2	4AZ5	4BQ7	4CL1	4CL2	4CL3	4CL4	4CL5	4CL6	4CL7	4CL8	4CZ2	4CZ5	4CZ6	4CZ8	4EE9	1ATT		
Amia 482 Series	Outer back shell	•	•	•	•	•	•	•	•	•	•	•	•	•	•	•	•	•	•	•	•	•	•	•	•	•	•	•	
	Outer back frame and arm holsters	•	•	•	•	•	•	•	•	•	•	•	•	•	•	•	•	•	•	•	•	•	•	•	•	•	•	•	•
	Arm holsters	•	•	•	•	•	•	•	•	•	•	•	•	•	•	•	•	•	•	•	•	•	•	•	•	•	•	•	•
	Outer seat shell	•	•	•	•	•	•	•	•	•	•	•	•	•	•	•	•	•	•	•	•	•	•	•	•	•	•	•	•
	Base	•	•	•	•	•	•	•	•	•	•	•	•	•	•	•	•	•	•	•	•	•	•	•	•	•	•	•	•
	Air back	•	•	•	•	•	•	•	•	•	•	•	•	•	•	•	•	•	•	•	•	•	•	•	•	•	•	•	•
B-Free	Beam leg	■	■	■	■	■	■	■	■	■	■	■	■	■	■	■	■	■	■	■	■	■	■	■	■	■	■	■	■
	Beam footrest	■	■	■	■	■	■	■	■	■	■	■	■	■	■	■	■	■	■	■	■	■	■	■	■	■	■	■	■
	Standing height table top	•	•	•	•	•	•	•	•	•	•	•	•	•	•	•	•	•	•	•	•	•	•	•	•	•	•	•	•
	Standing height table metal leg	■	■	■	■	■	■	■	■	■	■	■	■	■	■	■	■	■	■	■	■	■	■	■	■	■	■	■	■
	Table top	•	•	•	•	•	•	•	•	•	•	•	•	•	•	•	•	•	•	•	•	•	•	•	•	•	•	•	•
	Table base	■	■	■	■	■	■	■	■	■	■	■	■	■	■	■	■	■	■	■	■	■	■	■	■	■	■	■	■
Brody 488 WorkLounge	Caddy and lower footrest	•	•	•	•	•	•	•	•	•	•	•	•	•	•	•	•	•	•	•	•	•	•	•	•	•	•	•	
	Foot, personal worksurface arm, and screen brackets	•	•	•	•	•	•	•	•	•	•	•	•	•	•	•	•	•	•	•	•	•	•	•	•	•	•	•	
	Frame	•	•	•	•	•	•	•	•	•	•	•	•	•	•	•	•	•	•	•	•	•	•	•	•	•	•	•	
	Light	■	■	■	■	■	■	■	■	■	■	■	■	■	■	■	■	■	■	■	■	■	■	■	■	■	■	■	■
	Personal worksurface and lower surround trim	•	•	•	•	•	•	•	•	•	•	•	•	•	•	•	•	•	•	•	•	•	•	•	•	•	•	•	
	Power	•	•	•	•	•	•	•	•	•	•	•	•	•	•	•	•	•	•	•	•	•	•	•	•	•	•	•	
	Screen	•	•	•	•	•	•	•	•	•	•	•	•	•	•	•	•	•	•	•	•	•	•	•	•	•	•	•	
	Seat shell	•	•	•	•	•	•	•	•	•	•	•	•	•	•	•	•	•	•	•	•	•	•	•	•	•	•	•	
	Side surface	•	•	•	•	•	•	•	•	•	•	•	•	•	•	•	•	•	•	•	•	•	•	•	•	•	•	•	
Brody 488 Desk	Foot and screen brackets	•	•	•	•	•	•	•	•	•	•	•	•	•	•	•	•	•	•	•	•	•	•	•	•	•	•	•	
	Frame	•	•	•	•	•	•	•	•	•	•	•	•	•	•	•	•	•	•	•	•	•	•	•	•	•	•	•	
	Lower surround trim	•	•	•	•	•	•	•	•	•	•	•	•	•	•	•	•	•	•	•	•	•	•	•	•	•	•	•	
	Light	■	■	■	■	■	■	■	■	■	■	■	■	■	■	■	■	■	■	■	■	■	■	■	■	■	■	■	■
	Screen	•	•	•	•	•	•	•	•	•	•	•	•	•	•	•	•	•	•	•	•	•	•	•	•	•	•	•	
Cachet 487 Series	Swivel and 4-leg frame	•	•	•	•	•	•	•	•	•	•	•	•	•	•	•	•	•	•	•	•	•	•	•	•	•	•	•	
	Stool frame	•	•	•	•	•	•	•	•	•	•	•	•	•	•	•	•	•	•	•	•	•	•	•	•	•	•	•	
Cobi 434 Series	Base and back frame	•	•	•	•	•	•	•	•	•	•	•	•	•	•	•	•	•	•	•	•	•	•	•	•	•	•	•	
	Arm caps, top edge, and casters	•	•	•	•	•	•	•	•	•	•	•	•	•	•	•	•	•	•	•	•	•	•	•	•	•	•	•	
	Outer back	•	•	•	•	•	•	•	•	•	•	•	•	•	•	•	•	•	•	•	•	•	•	•	•	•	•	•	
Gesture 442 Series	Foot ring	•	•	•	•	•	•	•	•	•	•	•	•	•	•	•	•	•	•	•	•	•	•	•	•	•	•	•	
	Base	•	•	•	•	•	•	•	•	•	•	•	•	•	•	•	•	•	•	•	•	•	•	•	•	•	•	•	
	Arms	•	•	•	•	•	•	•	•	•	•	•	•	•	•	•	•	•	•	•	•	•	•	•	•	•	•	•	
	Seat perimeter, back shell, and headrest	•	•	•	•	•	•	•	•	•	•	•	•	•	•	•	•	•	•	•	•	•	•	•	•	•	•	•	
i2i 416 Series	Back frame	•	•	•	•	•	•	•	•	•	•	•	•	•	•	•	•	•	•	•	•	•	•	•	•	•	•	•	
	Outer back	•	•	•	•	•	•	•	•	•	•	•	•	•	•	•	•	•	•	•	•	•	•	•	•	•	•	•	
	Base and cylinder	•	•	•	•	•	•	•	•	•	•	•	•	•	•	•	•	•	•	•	•	•	•	•	•	•	•	•	
Tablet arm	Tablet arm	•	•	•	•	•	•	•	•	•	•	•	•	•	•	•	•	•	•	•	•	•	•	•	•	•	•	•	

Lux Coatings	
4B20 Obsidian	•
4B22 Matte Brass	•
4B23 Burnished Bronze	•
4B24 Night Bronze	•
4B25 Matte Copper	•
4B26 Smoked Mica	•
4B27 Blue Steel	•
4B28 Silver Lilac	•
4B29 Cast Iron	•
4B30 Bright Gold	•
Woodgrain Laminate	
2406 Clear Cherry E	•
2409 Clear Maple	•
2410 Graphite Walnut	•
2412 Natural Cherry	•
2422 Medium Cherry	•
2511 Winter on Maple	•
2535 Virginia Walnut	•
2536 Blackwood E	•
2538 Clear Walnut	•
2592 Blonde on Maple	•
2714 Natural Walnut E	•
2772 Med Mahogany on Walnut	•
2HAK Clear Oak	•
2HAN Ash Noce	•
2HAT Acacia	•
2HAW Ash Wenge	•
2HBN Bisque Noce	•
2HBW Bisque Wenge	•
2HCN Clay Noce	•
2HCW Clay Wenge	•
2HSN Storm Noce	•
2HSW Storm Wenge	•

Color Availability Matrix, continued

Legend

- = Not available
- = Available
- = Available with exceptions
- E = Established
- ▶ See specification pages for details.

		Woodgrain Laminate					Fiber Laminates				Micro Laminates				Patina Laminates		Solid Laminates							
		2HWA	2HWB	2HWD	2HWE	2HWF	2850	2854	2860	2862	2920	2921	2922	2870	2872	24H1	24H2	24H3	24H4	2722	2730			
		Grey Kingswood	Planked Walnut	Resolute Walnut	Natural Recon	Smoked Walnut	Vanadium Fiber	Vellum Fiber E	Granite Fiber	Stucco Fiber E	Marl Micro	Gypsum Micro	Clay Micro	Blonde Bronze Patina	Instant Iron Patina	Satin White	Satin Black	Satin Stone	Satin Mocha	Cream	Arctic White			
Amia 482 Series	Outer back shell	•	•	•	•	•	•	•	•	•	•	•	•	•	•	•	•	•	•	•	•	•		
	Outer back frame and arm holsters	•	•	•	•	•	•	•	•	•	•	•	•	•	•	•	•	•	•	•	•	•		
	Arm holsters	•	•	•	•	•	•	•	•	•	•	•	•	•	•	•	•	•	•	•	•	•		
	Outer seat shell	•	•	•	•	•	•	•	•	•	•	•	•	•	•	•	•	•	•	•	•	•		
	Base	•	•	•	•	•	•	•	•	•	•	•	•	•	•	•	•	•	•	•	•	•		
	Air back	•	•	•	•	•	•	•	•	•	•	•	•	•	•	•	•	•	•	•	•	•	•	
B-Free	Beam leg	•	•	•	•	•	•	•	•	•	•	•	•	•	•	•	•	•	•	•	•	•		
	Beam footrest	•	•	•	•	•	•	•	•	•	•	•	•	•	•	•	•	•	•	•	•	•		
	Standing height table top	■	■	■	■	■	■	■	■	■	■	■	■	■	■	•	•	•	•	■	■	•		
	Standing height table metal leg	•	•	•	•	•	•	•	•	•	•	•	•	•	•	•	•	•	•	•	•	•		
	Table top	■	■	■	■	■	■	■	■	■	■	■	■	■	■	•	•	•	•	■	■	•		
	Table base	•	•	•	•	•	•	•	•	•	•	•	•	•	•	•	•	•	•	•	•	•	•	
Brody 488 WorkLounge	Caddy and lower footrest	•	•	•	•	•	•	•	•	•	•	•	•	•	•	•	•	•	•	•	•	•		
	Foot, personal worksurface arm, and screen brackets	•	•	•	•	•	•	•	•	•	•	•	•	•	•	•	•	•	•	•	•	•		
	Frame	•	•	•	•	•	•	•	•	•	•	•	•	•	•	•	•	•	•	•	•	•		
	Light	•	•	•	•	•	•	•	•	•	•	•	•	•	•	•	•	•	•	•	•	•		
	Personal worksurface and lower surround trim	•	•	•	•	•	•	•	•	•	•	•	•	•	•	•	•	•	•	•	•	•		
	Power	•	•	•	•	•	•	•	•	•	•	•	•	•	•	•	•	•	•	•	•	•		
	Screen	•	•	•	•	•	•	•	•	•	•	•	•	•	•	•	•	•	•	•	•	•		
	Seat shell	•	•	•	•	•	•	•	•	•	•	•	•	•	•	•	•	•	•	•	•	•		
	Side surface	•	•	•	•	•	•	•	•	•	•	•	•	•	•	•	•	•	•	•	•	•		
Brody 488 Desk	Foot and screen brackets	•	•	•	•	•	•	•	•	•	•	•	•	•	•	•	•	•	•	•	•	•		
	Frame	•	•	•	•	•	•	•	•	•	•	•	•	•	•	•	•	•	•	•	•	•		
	Lower surround trim	•	•	•	•	•	•	•	•	•	•	•	•	•	•	•	•	•	•	•	•	•		
	Light	•	•	•	•	•	•	•	•	•	•	•	•	•	•	•	•	•	•	•	•	•		
	Screen	•	•	•	•	•	•	•	•	•	•	•	•	•	•	•	•	•	•	•	•	•		
	Power	•	•	•	•	•	•	•	•	•	•	•	•	•	•	•	•	•	•	•	•	•		
Cachet 487 Series	Swivel and 4-leg frame	•	•	•	•	•	•	•	•	•	•	•	•	•	•	•	•	•	•	•	•	•		
	Stool frame	•	•	•	•	•	•	•	•	•	•	•	•	•	•	•	•	•	•	•	•	•		
Cobi 434 Series	Base and back frame	•	•	•	•	•	•	•	•	•	•	•	•	•	•	•	•	•	•	•	•	•		
	Arm caps, top edge, and casters	•	•	•	•	•	•	•	•	•	•	•	•	•	•	•	•	•	•	•	•	•		
	Outer back	•	•	•	•	•	•	•	•	•	•	•	•	•	•	•	•	•	•	•	•	•		
Gesture 442 Series	Foot ring	•	•	•	•	•	•	•	•	•	•	•	•	•	•	•	•	•	•	•	•	•		
	Base	•	•	•	•	•	•	•	•	•	•	•	•	•	•	•	•	•	•	•	•	•		
	Arms	•	•	•	•	•	•	•	•	•	•	•	•	•	•	•	•	•	•	•	•	•		
	Seat perimeter, back shell, and headrest	•	•	•	•	•	•	•	•	•	•	•	•	•	•	•	•	•	•	•	•	•		
i2i 416 Series	Back frame	•	•	•	•	•	•	•	•	•	•	•	•	•	•	•	•	•	•	•	•	•		
	Outer back	•	•	•	•	•	•	•	•	•	•	•	•	•	•	•	•	•	•	•	•	•		
	Base and cylinder	•	•	•	•	•	•	•	•	•	•	•	•	•	•	•	•	•	•	•	•	•		
	Tablet arm	•	•	•	•	•	•	•	•	•	•	•	•	•	•	•	•	•	•	■	•	•		

Color Availability Matrix, continued

Legend

- = Not available
- = Available
- = Available with exceptions
- Ⓢ = Established
- ▶ See specification pages for details.

		Smooth Paint							Textured Paint							Smooth Metallic Paint									
		0835	4238	4239	4240	4242	4700	7000	7207	7225	7237	7238	7239	7241	7243	7250	7360	4728	4743	4744	4750	4798	4799	4803	
		Black	Mocha	Clay	Chalk	Milk	Warm White	Black	Black	Sand	Slate	Fieldstone	Midnight	Arctic White	Seagull	Sterling Dark	Merle	Nickel Metallic	Mineral Metallic	Pearl Metallic	Champagne Metallic	Sterling Metallic	Platinum Metallic	Near Black Metallic	
Kart	Base, back supports, and arm support bar	•	•	•	•	•	•	•	■	•	•	•	•	•	•	•	•	•	•	•	•	•	•	■	•
	Back frame and seat shell	•	•	•	•	•	•	•	•	•	•	•	•	•	•	•	•	•	•	•	•	•	•	•	•
	Arm caps and casters	•	•	•	•	•	•	•	•	•	•	•	•	•	•	•	•	•	•	•	•	•	•	•	•
	Stool foot ring	•	•	•	•	•	•	•	•	•	•	•	•	•	•	•	•	•	•	•	•	•	•	•	•
Leap 462 Series	Base, ribbon frame, outer back, arm retainer, and outer seat	•	•	•	•	•	•	•	•	•	•	•	•	•	•	•	•	•	•	•	•	•	•	•	•
	Arms	•	•	•	•	•	•	•	•	•	•	•	•	•	•	•	•	•	•	•	•	•	•	•	•
	Stool base and ribbon frame	•	•	•	•	•	•	•	•	•	•	•	•	•	•	•	•	•	•	•	•	•	•	•	•
	Stool foot ring	•	•	•	•	•	•	•	•	•	•	•	•	•	•	•	•	•	•	•	•	•	•	•	•
Max-Stacker 477 Series	Frame	•	•	•	•	•	•	■	•	•	•	•	■	•	•	•	•	•	•	•	•	•	■	•	
	Seat and back	•	•	•	•	•	•	•	•	•	•	•	•	•	•	•	•	•	•	•	•	•	•	•	•
Move 490 Series	Frame	■	•	•	•	•	•	•	•	•	•	•	■	•	•	•	•	•	•	•	•	•	■	•	
	Back shell and arms	•	•	•	•	•	•	•	•	•	•	•	•	•	•	•	•	•	•	•	•	•	•	•	•
Node 480 Series	Shell	•	•	•	•	•	•	•	•	•	•	•	•	•	•	•	•	•	•	•	•	•	•	•	•
	Personal worksurface	•	•	•	•	•	•	•	•	•	•	•	•	•	•	•	•	•	•	•	•	•	•	•	•
	Personal worksurface arm	■	•	•	•	•	•	•	•	•	•	•	•	•	•	•	•	•	•	•	■	•	■	•	
	Tripod base	•	•	•	•	•	•	•	•	•	•	•	•	•	•	•	•	•	•	•	•	•	•	•	•
	X-base	■	■	■	■	■	■	•	■	■	■	■	■	■	■	■	■	■	■	■	■	■	■	■	■
Five-star base	■	•	•	•	•	•	•	•	•	•	•	•	•	•	•	•	•	•	•	■	•	■	•		
Nooi by Wiesner Hager	Seat shell	•	•	•	•	•	•	•	•	•	•	•	•	•	•	•	•	•	•	•	•	•	•	•	•
	Frame	■	■	■	■	■	■	•	•	•	•	•	•	•	•	•	•	•	•	•	•	•	■	•	
Player 475 Series	Frame on chairs with smooth arms	•	•	•	•	•	•	•	•	•	•	•	•	•	•	•	•	•	•	•	•	•	•	•	•
	Smooth arms	•	•	•	•	•	•	•	•	•	•	•	•	•	•	•	•	•	•	•	•	•	•	•	•
	Frame on chairs with textured arms	•	•	•	•	•	•	•	•	•	•	•	•	•	•	•	•	•	•	•	•	•	•	•	•
	Textured arms	•	•	•	•	•	•	•	•	•	•	•	•	•	•	•	•	•	•	•	•	•	•	•	•
	Tablet arm	•	•	•	•	•	•	•	•	•	•	•	•	•	•	•	•	•	•	•	•	•	•	•	•
QiVi 428 Series	Back frame, seat shell, and arm caps	•	•	•	•	•	•	•	•	•	•	•	•	•	•	•	•	•	•	•	•	•	•	•	•
	Sled base	•	•	•	•	•	•	•	•	•	•	•	•	■	•	•	•	•	•	•	•	•	■	•	
	Stool foot ring	•	•	•	•	•	•	•	•	•	•	•	•	■	•	•	•	•	•	•	•	•	•	•	•
	Five-star base	•	•	•	•	•	•	•	•	•	•	•	•	■	•	•	•	•	•	•	•	•	•	•	•

Textured Metallic Paint	
7245 Carbon Metallic	•
7246 Midnight Metallic	•
Architectural Paint	
4843 Linen	•
4844 Glacier	•
4849 Vapor	•
Worktools Paint	
4231 Arctic White	•
Accessory Paint	
4140 Arctic White Gloss	•
4144 Black Gloss	■
4710 Low Gloss Black	•

Color Availability Matrix, continued

Legend

- = Not available
- = Available
- = Available with exceptions
- Ⓢ = Established
- ▶ See specification pages for details.

		Accent Paints																				Coatings					
		1ATB	1ATG	1ATH	1ATJ	1ATK	4AQ9	4AV3	4AV4	4AX1	4AY2	4AZ5	4BQ7	4CL1	4CL2	4CL3	4CL4	4CL5	4CL6	4CL7	4CL8	4CZ2	4CZ5	4CZ6	4CZ8	4EE9	1ATT
Kart	Base, back supports, and arm support bar	■	■	■	■	■	■	■	■	■	■	■	■	■	■	■	■	■	■	■	■	■	■	■	■	■	•
	Back frame and seat shell	•	•	•	•	•	•	•	•	•	•	•	•	•	•	•	•	•	•	•	•	•	•	•	•	•	•
	Arm caps and casters	•	•	•	•	•	•	•	•	•	•	•	•	•	•	•	•	•	•	•	•	•	•	•	•	•	•
	Stool foot ring	•	•	•	•	•	•	•	•	•	•	•	•	•	•	•	•	•	•	•	•	•	•	•	•	•	•
Leap 462 Series	Base, ribbon frame, outer back, arm retainer, and outer seat	•	•	•	•	•	•	•	•	•	•	•	•	•	•	•	•	•	•	•	•	•	•	•	•	•	•
	Arms	•	•	•	•	•	•	•	•	•	•	•	•	•	•	•	•	•	•	•	•	•	•	•	•	•	•
	Stool base and ribbon frame	•	•	•	•	•	•	•	•	•	•	•	•	•	•	•	•	•	•	•	•	•	•	•	•	•	•
	Stool foot ring	•	•	•	•	•	•	•	•	•	•	•	•	•	•	•	•	•	•	•	•	•	•	•	•	•	•
Max-Stacker 477 Series	Frame	•	•	•	•	•	•	•	•	•	•	•	•	•	•	•	•	•	•	•	•	•	•	•	•	•	■
	Seat and back	•	•	•	•	•	•	•	•	•	•	•	•	•	•	•	•	•	•	•	•	•	•	•	•	•	•
Move 490 Series	Frame	•	•	•	•	•	•	•	•	•	•	•	•	•	•	•	•	•	•	•	•	•	•	•	•	•	■
	Back shell and arms	•	•	•	•	•	•	•	•	•	•	•	•	•	•	•	•	•	•	•	•	•	•	•	•	•	•
Node 480 Series	Shell	•	•	•	•	•	•	•	•	•	•	•	•	•	•	•	•	•	•	•	•	•	•	•	•	•	•
	Personal worksurface	•	•	•	•	•	•	•	•	•	•	•	•	•	•	•	•	•	•	•	•	•	•	•	•	•	•
	Personal worksurface arm	•	•	•	•	•	•	•	•	•	•	•	•	•	•	•	•	•	•	•	•	•	•	•	•	•	•
	Tripod base	•	•	•	•	•	•	•	•	•	•	•	•	•	•	•	•	•	•	•	•	•	•	•	•	•	•
	X-base	■	■	■	■	■	■	■	■	■	■	■	■	■	■	■	■	■	■	■	■	■	■	■	■	■	■
Five-star base	•	•	•	•	•	•	•	•	•	•	•	•	•	•	•	•	•	•	•	•	•	•	•	•	•	•	
Nooi by Wiesner Hager	Seat shell	•	•	•	•	•	•	•	•	•	•	•	•	•	•	•	•	•	•	•	•	•	•	•	•	•	•
	Frame	•	•	•	•	•	•	•	•	•	•	•	•	•	•	•	•	•	•	•	•	•	•	•	•	•	•
Player 475 Series	Frame on chairs with smooth arms	•	•	•	•	•	•	•	•	•	•	•	•	•	•	•	•	•	•	•	•	•	•	•	•	•	•
	Smooth arms	•	•	•	•	•	•	•	•	•	•	•	•	•	•	•	•	•	•	•	•	•	•	•	•	•	•
	Frame on chairs with textured arms	•	•	•	•	•	•	•	•	•	•	•	•	•	•	•	•	•	•	•	•	•	•	•	•	•	•
	Textured arms	•	•	•	•	•	•	•	•	•	•	•	•	•	•	•	•	•	•	•	•	•	•	•	•	•	•
	Tablet arm	•	•	•	•	•	•	•	•	•	•	•	•	•	•	•	•	•	•	•	•	•	•	•	•	•	•
QiVi 428 Series	Back frame, seat shell, and arm caps	•	•	•	•	•	•	•	•	•	•	•	•	•	•	•	•	•	•	•	•	•	•	•	•	•	•
	Sled base	•	•	•	•	•	•	•	•	•	•	•	•	•	•	•	•	•	•	•	•	•	•	•	•	•	■
	Stool foot ring	•	•	•	•	•	•	•	•	•	•	•	•	•	•	•	•	•	•	•	•	•	•	•	•	•	•
	Five-star base	•	•	•	•	•	•	•	•	•	•	•	•	•	•	•	•	•	•	•	•	•	•	•	•	•	•

Lux Coatings	
4B20 Obsidian	•
4B22 Matte Brass	•
4B23 Burnished Bronze	•
4B24 Night Bronze	•
4B25 Matte Copper	•
4B26 Smoked Mica	•
4B27 Blue Steel	•
4B28 Silver Lilac	•
4B29 Cast Iron	•
4B30 Bright Gold	•
Woodgrain Laminate	
2406 Clear Cherry E	•
2409 Clear Maple	•
2410 Graphite Walnut	•
2412 Natural Cherry	•
2422 Medium Cherry	•
2511 Winter on Maple	•
2535 Virginia Walnut	•
2536 Blackwood E	•
2538 Clear Walnut	•
2592 Blonde on Maple	•
2714 Natural Walnut E	•
2772 Med Mahogany on Walnut	•
2HAK Clear Oak	•
2HAN Ash Noce	•
2HAT Acacia	•
2HAW Ash Wenge	•
2HBN Bisque Noce	•
2HBW Bisque Wenge	•
2HCN Clay Noce	•
2HCW Clay Wenge	•
2HSN Storm Noce	•
2HSW Storm Wenge	•

Color Availability Matrix, continued

Legend

- = Not available
- = Available
- = Available with exceptions
- Ⓜ = Established
- ▶ See specification pages for details.

		Woodgrain Laminate					Fiber Laminates				Micro Laminates			Patina Laminates		Solid Laminates						
		2HWA	2HWB	2HWD	2HWE	2HWF	2850	2854	2860	2862	2920	2921	2922	2870	2872	24H1	24H2	24H3	24H4	2722	2730	
		Grey Kingswood	Planked Walnut	Resolute Walnut	Natural Recon	Smoked Walnut	Vanadium Fiber	Vellum Fiber Ⓜ	Granite Fiber	Stucco Fiber Ⓜ	Marl Micro	Gypsum Micro	Clay Micro	Blonde Bronze Patina	Instant Iron Patina	Satin White	Satin Black	Satin Stone	Satin Mocha	Cream	Arctic White	
Kart	Base, back supports, and arm support bar	•	•	•	•	•	•	•	•	•	•	•	•	•	•	•	•	•	•	•	•	•
	Back frame and seat shell	•	•	•	•	•	•	•	•	•	•	•	•	•	•	•	•	•	•	•	•	•
	Arm caps and casters	•	•	•	•	•	•	•	•	•	•	•	•	•	•	•	•	•	•	•	•	•
	Stool foot ring	•	•	•	•	•	•	•	•	•	•	•	•	•	•	•	•	•	•	•	•	•
Leap 462 Series	Base, ribbon frame, outer back, arm retainer, and outer seat	•	•	•	•	•	•	•	•	•	•	•	•	•	•	•	•	•	•	•	•	•
	Arms	•	•	•	•	•	•	•	•	•	•	•	•	•	•	•	•	•	•	•	•	•
	Stool base and ribbon frame	•	•	•	•	•	•	•	•	•	•	•	•	•	•	•	•	•	•	•	•	•
	Stool foot ring	•	•	•	•	•	•	•	•	•	•	•	•	•	•	•	•	•	•	•	•	•
Max-Stacker 477 Series	Frame	•	•	•	•	•	•	•	•	•	•	•	•	•	•	•	•	•	•	•	•	•
	Seat and back	•	•	•	•	•	•	•	•	•	•	•	•	•	•	•	•	•	•	•	•	•
Move 490 Series	Frame	•	•	•	•	•	•	•	•	•	•	•	•	•	•	•	•	•	•	•	•	•
	Back shell and arms	•	•	•	•	•	•	•	•	•	•	•	•	•	•	•	•	•	•	•	•	•
Node 480 Series	Shell	•	•	•	•	•	•	•	•	•	•	•	•	•	•	•	•	•	•	•	•	•
	Personal worksurface	•	•	•	•	•	•	•	•	•	•	•	•	•	•	•	•	•	•	•	•	•
	Personal worksurface arm	•	•	•	•	•	•	•	•	•	•	•	•	•	•	•	•	•	•	•	•	•
	Tripod base	•	•	•	•	•	•	•	•	•	•	•	•	•	•	•	•	•	•	•	•	•
	X-base	•	•	•	•	•	•	•	•	•	•	•	•	•	•	•	•	•	•	•	•	•
Nooi by Wiesner Hager	Five-star base	•	•	•	•	•	•	•	•	•	•	•	•	•	•	•	•	•	•	•	•	•
	Seat shell	•	•	•	•	•	•	•	•	•	•	•	•	•	•	•	•	•	•	•	•	•
Player 475 Series	Frame	•	•	•	•	•	•	•	•	•	•	•	•	•	•	•	•	•	•	•	•	•
	Frame on chairs with smooth arms	•	•	•	•	•	•	•	•	•	•	•	•	•	•	•	•	•	•	•	•	•
	Smooth arms	•	•	•	•	•	•	•	•	•	•	•	•	•	•	•	•	•	•	•	•	•
	Frame on chairs with textured arms	•	•	•	•	•	•	•	•	•	•	•	•	•	•	•	•	•	•	•	•	•
	Textured arms	•	•	•	•	•	•	•	•	•	•	•	•	•	•	•	•	•	•	•	•	•
QiVi 428 Series	Tablet arm	•	•	•	•	•	•	•	•	•	•	•	•	•	•	•	•	•	•	■	■	■
	Back frame, seat shell, and arm caps	•	•	•	•	•	•	•	•	•	•	•	•	•	•	•	•	•	•	•	•	•
	Sled base	•	•	•	•	•	•	•	•	•	•	•	•	•	•	•	•	•	•	•	•	•
	Stool foot ring	•	•	•	•	•	•	•	•	•	•	•	•	•	•	•	•	•	•	•	•	•
	Five-star base	•	•	•	•	•	•	•	•	•	•	•	•	•	•	•	•	•	•	•	•	•

Color Availability Matrix, continued

Legend

- = Not available
- = Available
- = Available with exceptions
- Ⓢ = Established
- ▶ See specification pages for details.

		Plastic	5U22 Royal Blue	5U23 Blue Jay	5U24 Scarlet	5U25 Malt	5U26 Wasabi Too	5U27 Concord	5U28 Canary	6009 Arctic White	6052 Milk	6053 Seagull	6059 Sterling Dark Solid	6205 Black	6248 Midnight Brown	6249 Platinum Solid	6259 Midnight	6295 Near Black	6302 Baltic	6332 Citronwwh	6333 Picasso	6334 Flash	6335 Wasabi	6336 Jazz	6337 Element	6338 Chili
Reply 466 Series	Outer back, arm cap, mechanism, casters, and glides	•	•	•	•	•	•	•	•	•	•	•	•	■	•	•	•	•	•	•	•	•	•	•	•	•
	Frame (upholstered swivel-base chair)	•	•	•	•	•	•	•	•	•	•	•	•	■	•	•	•	•	•	•	•	•	•	•	•	•
	Frame (mesh back swivel-base chair)	•	•	•	•	•	•	•	•	•	•	■	■	•	•	•	•	•	•	•	•	•	•	•	•	•
	Frame (multi-use chair)	•	•	•	•	•	•	•	•	•	•	•	•	•	•	•	•	•	•	•	•	•	•	•	•	•
	Arm support (swivel-base chair)	•	•	•	•	•	•	•	•	•	•	•	•	■	■	■	•	•	•	•	•	•	•	•	•	•
	Swivel base	•	•	•	•	•	•	•	•	•	•	•	•	■	■	■	•	•	•	•	•	•	•	•	•	•
Siento 499 Series	Base and arm supports	•	•	•	•	•	•	•	•	•	•	•	•	•	•	•	•	•	•	•	•	•	•	•	•	
SILQ	Upper back shell	•	•	•	•	•	•	•	•	•	•	■	•	•	•	■	•	•	•	•	•	•	•	•	•	•
	Lower back shell	•	•	•	•	•	•	•	•	•	•	•	•	•	•	•	•	•	•	•	•	•	•	•	•	•
	Arms	•	•	•	•	•	•	•	•	•	•	•	•	•	•	•	•	•	•	•	•	•	•	•	•	•
	Base	•	•	•	•	•	•	•	•	•	•	•	•	■	•	•	•	•	•	•	•	•	•	•	•	•
	Stool foot ring	•	•	•	•	•	•	•	•	•	•	•	•	■	■	•	•	•	•	•	•	•	•	•	•	•
	Arm caps and casters	•	•	•	•	•	•	•	•	•	•	•	■	■	•	•	•	•	•	•	•	•	•	•	•	•
Steelcase Flex Perch Stool	Frame and seat	•	•	•	•	•	•	•	•	•	•	•	•	•	•	•	•	•	■	•	•	•	•	•	•	
Steelcase Series 1	Arms	•	•	•	•	•	•	•	•	•	•	■	■	•	•	•	•	•	•	•	•	•	•	•	•	
	Base	•	•	•	•	•	•	•	•	•	•	•	■	■	•	•	•	•	•	•	•	•	•	•	•	
	Frame	•	•	•	•	•	•	•	•	•	•	■	■	■	•	•	•	•	•	•	•	•	•	•	•	
	Lumbar and flexor	■	■	■	■	■	■	■	■	•	•	•	•	■	■	■	•	■	■	■	■	•	•	•	•	•
Steelcase Series 2	Inner back frame and lumbar	•	•	•	•	•	•	•	•	•	■	■	■	■	•	•	•	•	•	•	•	•	•	•	•	
	Outer back frame and arm holsters	•	•	•	•	•	•	•	•	•	•	•	■	■	■	■	•	•	•	•	•	•	•	•	•	
	Outer seat shell	•	•	•	•	•	•	•	•	•	•	•	■	■	■	■	•	•	•	•	•	•	•	•	•	
	Air back	■	■	■	■	■	■	■	■	•	•	•	■	■	■	■	■	■	■	■	■	■	■	■	■	■
	Base	•	•	•	•	•	•	•	•	•	•	■	■	■	■	■	■	■	■	■	■	■	■	■	■	■
	Stool foot ring	•	•	•	•	•	•	•	•	•	•	•	•	•	•	•	•	•	•	•	•	•	•	•	•	•
	Arm caps and casters	•	•	•	•	•	•	•	•	•	•	•	•	■	■	■	■	■	■	■	■	■	■	■	■	■
Think 465 Series	Back frame, arm retainer, and base	•	•	•	•	•	•	•	•	•	•	•	•	■	■	■	■	■	■	■	■	■	■	■	■	
	Cylinder and stool foot ring	•	•	•	•	•	•	•	•	•	•	•	•	•	•	•	•	•	•	•	•	•	•	•	•	
	Inner seat shell, adjustment handles, arm pads, arm stalk, casters and glides	•	•	•	•	•	•	•	•	•	•	•	•	•	■	■	■	■	■	■	■	■	■	■	■	■
	Outer seat shell	•	•	•	•	•	•	•	•	•	•	•	•	■	■	■	■	■	■	■	■	■	■	■	■	■
	Flexors and lumbar	•	•	•	•	•	•	•	•	•	•	•	•	■	■	■	■	■	■	■	■	■	■	■	■	■
Umami	Single platform top and fascia	•	•	•	•	•	•	•	•	•	•	•	•	•	•	•	•	•	•	•	•	•	•	•	•	
	Frame	•	•	•	•	•	•	•	•	•	•	•	•	•	•	•	•	•	•	•	•	•	•	•	•	
	Screen clips	•	•	•	•	•	•	•	•	•	•	■	■	■	■	■	■	■	■	■	■	■	■	■	■	■
	Pill and round table top	•	•	•	•	•	•	•	•	•	•	•	•	•	•	•	•	•	•	•	•	•	•	•	•	•

Color Availability Matrix, continued

Legend

- = Not available
- = Available
- = Available with exceptions
- E = Established
- ▶ See specification pages for details.

		Smooth Paint							Textured Paint							Smooth Metallic Paint								
		0835	4238	4239	4240	4242	4700	7000	7207	7225	7237	7238	7239	7241	7243	7250	7360	4728	4743	4744	4750	4798	4799	4803
		Black	Mocha	Clay	Chalk	Milk	Warm White	Black	Black	Sand	Slate	Fieldstone	Midnight	Arctic White	Seagull	Sterling Dark	Merle	Nickel Metallic	Mineral Metallic	Pearl Metallic	Champagne Metallic	Sterling Metallic	Platinum Metallic	Near Black Metallic
Reply 466 Series	Outer back, arm cap, mechanism, casters, and glides	•	•	•	•	•	•	•	•	•	•	•	•	•	•	•	•	•	•	•	•	•	•	•
	Frame (upholstered swivel-base chair)	•	•	•	•	•	•	•	•	•	•	•	•	•	•	•	•	•	•	•	•	•	•	•
	Frame (mesh back swivel-base chair)	•	•	•	•	•	•	•	•	•	•	•	•	•	•	•	•	•	•	•	•	•	•	•
	Frame (multi-use chair)	•	•	•	•	•	•	•	■	•	•	•	•	•	•	•	•	•	•	•	•	•	■	•
	Arm support (swivel-base chair)	•	•	•	•	•	•	•	•	•	•	•	•	•	•	•	•	•	•	•	•	•	•	•
	Swivel base	•	•	•	•	•	•	•	•	•	•	•	•	•	•	•	•	•	•	•	•	•	•	•
Siento 499 Series	Base and arm supports	■	•	•	•	•	•	•	•	•	•	•	•	•	•	•	•	•	•	•	•	•	■	•
	SILQ																							
	Upper back shell	•	•	•	•	•	•	•	•	•	•	•	•	•	•	•	•	•	•	•	•	•	•	•
	Lower back shell	•	•	•	•	•	•	•	•	•	•	•	•	•	•	•	■	•	•	•	•	•	•	•
	Arms	•	•	•	•	•	•	•	•	•	•	•	•	•	■	■	•	•	•	•	•	•	•	•
	Base	•	•	•	•	•	•	•	•	•	•	•	•	•	■	•	■	•	•	•	•	•	•	•
	Stool foot ring	•	•	•	•	•	•	•	•	•	•	•	•	•	•	■	•	•	•	•	•	•	•	•
	Arm caps and casters	•	•	•	•	•	•	•	•	•	•	•	•	•	•	•	•	•	•	•	•	•	•	•
Steelcase Flex Perch Stool	Frame and seat	•	•	•	•	•	•	•	•	•	•	•	•	•	•	•	•	•	•	•	•	•	•	•
Steelcase Series 1	Arms	•	•	•	•	•	•	•	•	•	•	•	•	•	•	•	•	•	•	•	•	•	•	•
	Base	•	•	•	•	•	•	•	•	•	•	•	•	•	■	•	•	•	•	•	•	•	•	•
	Frame	•	•	•	•	•	•	•	•	•	•	•	•	•	•	•	•	•	•	•	•	•	•	•
	Lumbar and flexor	•	•	•	•	•	•	•	•	•	•	•	•	•	•	•	•	•	•	•	•	•	•	•
Steelcase Series 2	Inner back frame and lumbar	•	•	•	•	•	•	•	•	•	•	•	•	•	•	•	•	•	•	•	•	•	•	•
	Outer back frame and arm holsters	•	•	•	•	•	•	•	•	•	•	•	•	•	■	■	•	•	•	•	•	•	•	•
	Outer seat shell	•	•	•	•	•	•	•	•	•	•	•	•	•	•	•	•	•	•	•	•	•	•	•
	Air back	•	•	•	•	•	•	•	•	•	•	•	•	•	•	•	•	•	•	•	•	•	•	•
	Base	•	•	•	•	•	•	•	•	•	•	•	•	•	•	•	•	•	•	•	•	•	•	•
	Stool foot ring	■	•	•	•	•	•	•	•	•	•	•	•	•	•	•	•	•	•	•	•	•	•	•
Arm caps and casters	•	•	•	•	•	•	•	•	•	•	•	•	•	•	•	•	•	•	•	•	•	•	•	
Think 465 Series	Back frame, arm retainer, and base	•	•	•	•	•	•	•	•	•	•	•	•	•	■	•	•	•	•	•	•	•	■	•
	Cylinder and stool foot ring	•	•	•	•	•	•	•	•	•	•	•	•	•	•	•	•	•	•	•	•	•	■	•
	Inner seat shell, adjustment handles, arm pads, arm stalk, casters and glides	•	•	•	•	•	•	•	•	•	•	•	•	•	•	•	•	•	•	•	•	•	•	•
	Outer seat shell	•	•	•	•	•	•	•	•	•	•	•	•	•	•	•	•	•	•	•	•	•	•	•
	Flexors and lumbar	•	•	•	•	•	•	•	•	•	•	•	•	•	•	•	•	•	•	•	•	•	•	•
Umami	Single platform top and fascia	•	•	•	•	•	•	•	•	•	•	•	•	•	•	•	•	•	•	•	•	•	•	•
	Frame	•	■	■	■	■	■	•	■	•	•	•	•	•	•	•	■	■	•	■	■	■	■	■
	Screen clips	•	•	•	•	•	•	•	•	•	•	•	•	•	•	•	•	•	•	•	•	•	•	•
	Pill and round table top	•	•	•	•	•	•	•	•	•	•	•	•	•	•	•	•	•	•	•	•	•	•	•

Textured Metallic Paint	
7245 Carbon Metallic	•
7246 Midnight Metallic	•
Architectural Paint	
4843 Linen	•
4844 Glacier	•
4849 Vapor	•
Worktools Paint	
4231 Arctic White	•
Accessory Paint	
4140 Arctic White Gloss	•
4144 Black Gloss	•
4710 Low Gloss Black	•

Surface Materials

Color Availability Matrix, continued

Legend

- = Not available
- = Available
- = Available with exceptions
- Ⓜ = Established
- ▶ See specification pages for details.

		Accent Paints																			Coatings								
		1ATB	1ATG	1ATH	1ATJ	1ATK	4AQ9	4AV3	4AV4	4AX1	4AY2	4AZ5	4BQ7	4CL1	4CL2	4CL3	4CL4	4CL5	4CL6	4CL7	4CL8	4CZ2	4CZ5	4CZ6	4CZ8	4EE9	1ATT		
		Cloud	Rose Quartz	Olivine	Sea Salt	Citrine	Scarlett	Blue Jay	Baltic	Citron	Chili	Marlin	Fuchsia	Dark Olivine	Ice Blue	Aura	Sea Glass	Light Matcha	Terra	Sandstone	Smokey Plum	Peacock	Honey	Lagoon	Light Peacock	Electric Indigo	Cast Shadow		
Reply 466 Series	Outer back, arm cap, mechanism, casters, and glides	•	•	•	•	•	•	•	•	•	•	•	•	•	•	•	•	•	•	•	•	•	•	•	•	•	•	•	
	Frame (upholstered swivel-base chair)	•	•	•	•	•	•	•	•	•	•	•	•	•	•	•	•	•	•	•	•	•	•	•	•	•	•	•	•
	Frame (mesh back swivel-base chair)	•	•	•	•	•	•	•	•	•	•	•	•	•	•	•	•	•	•	•	•	•	•	•	•	•	•	•	•
	Frame (multi-use chair)	•	•	•	•	•	•	•	•	•	•	•	•	•	•	•	•	•	•	•	•	•	•	•	•	•	•	•	•
	Arm support (swivel-base chair)	•	•	•	•	•	•	•	•	•	•	•	•	•	•	•	•	•	•	•	•	•	•	•	•	•	•	•	•
	Swivel base	•	•	•	•	•	•	•	•	•	•	•	•	•	•	•	•	•	•	•	•	•	•	•	•	•	•	•	•
Siento 499 Series	Base and arm supports	•	•	•	•	•	•	•	•	•	•	•	•	•	•	•	•	•	•	•	•	•	•	•	•	•	•	•	•
SILQ	Upper back shell	•	•	•	•	•	•	•	•	•	•	•	•	•	•	•	•	•	•	•	•	•	•	•	•	•	•	•	•
	Lower back shell	•	•	•	•	•	•	•	•	•	•	•	•	•	•	•	•	•	•	•	•	•	•	•	•	•	•	•	•
	Arms	•	•	•	•	•	•	•	•	•	•	•	•	•	•	•	•	•	•	•	•	•	•	•	•	•	•	•	■
	Base	•	•	•	•	•	•	•	•	•	•	•	•	•	•	•	•	•	•	•	•	•	•	•	•	•	•	•	■
	Stool foot ring	•	•	•	•	•	•	•	•	•	•	•	•	•	•	•	•	•	•	•	•	•	•	•	•	•	•	•	•
	Arm caps and casters	•	•	•	•	•	•	•	•	•	•	•	•	•	•	•	•	•	•	•	•	•	•	•	•	•	•	•	•
Steelcase Flex Perch Stool	Frame and seat	•	•	•	•	•	•	•	•	•	•	•	•	•	•	•	•	•	•	•	•	•	•	•	•	•	•	•	•
Steelcase Series 1	Arms	•	•	•	•	•	•	•	•	•	•	•	•	•	•	•	•	•	•	•	•	•	•	•	•	•	•	•	•
	Base	•	•	•	•	•	•	•	•	•	•	•	•	•	•	•	•	•	•	•	•	•	•	•	•	•	•	•	•
	Frame	•	•	•	•	•	•	•	•	•	•	•	•	•	•	•	•	•	•	•	•	•	•	•	•	•	•	•	•
	Lumbar and flexor	•	•	•	•	•	•	•	•	•	•	•	•	•	•	•	•	•	•	•	•	•	•	•	•	•	•	•	•
Steelcase Series 2	Inner back frame and lumbar	•	•	•	•	•	•	•	•	•	•	•	•	•	•	•	•	•	•	•	•	•	•	•	•	•	•	•	•
	Outer back frame and arm holsters	•	•	•	•	•	•	•	•	•	•	•	•	•	•	•	•	•	•	•	•	•	•	•	•	•	•	•	•
	Outer seat shell	•	•	•	•	•	•	•	•	•	•	•	•	•	•	•	•	•	•	•	•	•	•	•	•	•	•	•	•
	Air back	•	•	•	•	•	•	•	•	•	•	•	•	•	•	•	•	•	•	•	•	•	•	•	•	•	•	•	•
	Base	•	•	•	•	•	•	•	•	•	•	•	•	•	•	•	•	•	•	•	•	•	•	•	•	•	•	•	•
	Stool foot ring	•	•	•	•	•	•	•	•	•	•	•	•	•	•	•	•	•	•	•	•	•	•	•	•	•	•	•	•
	Arm caps and casters	•	•	•	•	•	•	•	•	•	•	•	•	•	•	•	•	•	•	•	•	•	•	•	•	•	•	•	•
	Think 465 Series	Back frame, arm retainer, and base	•	•	•	•	•	•	•	•	•	•	•	•	•	•	•	•	•	•	•	•	•	•	•	•	•	•	•
Cylinder and stool foot ring		•	•	•	•	•	•	•	•	•	•	•	•	•	•	•	•	•	•	•	•	•	•	•	•	•	•	•	•
Inner seat shell, adjustment handles, arm pads, arm stalk, casters and glides		•	•	•	•	•	•	•	•	•	•	•	•	•	•	•	•	•	•	•	•	•	•	•	•	•	•	•	•
Outer seat shell		•	•	•	•	•	•	•	•	•	•	•	•	•	•	•	•	•	•	•	•	•	•	•	•	•	•	•	•
Flexors and lumbar		•	•	•	•	•	•	•	•	•	•	•	•	•	•	•	•	•	•	•	•	•	•	•	•	•	•	•	•
Umami	Single platform top and fascia	•	•	•	•	•	•	•	•	•	•	•	•	•	•	•	•	•	•	•	•	•	•	•	•	•	•	•	•
	Frame	■	■	■	■	■	■	■	■	■	■	■	■	■	■	■	■	■	■	■	■	■	■	■	■	■	■	■	■
	Screen clips	•	•	•	•	•	•	•	•	•	•	•	•	•	•	•	•	•	•	•	•	•	•	•	•	•	•	•	•
	Pill and round table top	•	•	•	•	•	•	•	•	•	•	•	•	•	•	•	•	•	•	•	•	•	•	•	•	•	•	•	•

Lux Coatings	
4B20 Obsidian	•
4B22 Matte Brass	•
4B23 Burnished Bronze	•
4B24 Night Bronze	•
4B25 Matte Copper	•
4B26 Smoked Mica	•
4B27 Blue Steel	•
4B28 Silver Lilac	•
4B29 Cast Iron	•
4B30 Bright Gold	•
Woodgrain Laminate	
2406 Clear Cherry E	•
2409 Clear Maple	•
2410 Graphite Walnut	•
2412 Natural Cherry	•
2422 Medium Cherry	•
2511 Winter on Maple	•
2535 Virginia Walnut	•
2536 Blackwood E	•
2538 Clear Walnut	•
2592 Blonde on Maple	•
2714 Natural Walnut	•
2772 Med Mahogany on Walnut	•
2HAK Clear Oak	•
2HAN Ash Noce	•
2HAT Acacia	•
2HAW Ash Wenge	•
2HBN Bisque Noce	•
2HBW Bisque Wenge	•
2HCN Clay Noce	•
2HCW Clay Wenge	•
2HSN Storm Noce	•
2HSW Storm Wenge	•

Color Availability Matrix, continued

Legend

- = Not available
- = Available
- = Available with exceptions
- E = Established
- ▶ See specification pages for details.

		Woodgrain Laminate					Fiber Laminates				Micro Laminates				Patina Laminates		Solid Laminates						
		2HWA	2HWB	2HWD	2HWE	2HWF	2850	2854	2860	2862	2920	2921	2922	2870	2872	24H1	24H2	24H3	24H4	2722	2730		
		Grey Kingswood	Planked Walnut	Resolute Walnut	Natural Recon	Smoked Walnut	Vanadium Fiber	Vellum Fiber E	Granite Fiber	Stucco Fiber E	Marl Micro	Gypsum Micro	Clay Micro	Blonde Bronze Patina	Instant Iron Patina	Satin White	Satin Black	Satin Stone	Satin Mocha	Cream	Arctic White		
Reply 466 Series	Outer back, arm cap, mechanism, casters, and glides	•	•	•	•	•	•	•	•	•	•	•	•	•	•	•	•	•	•	•	•	•	
	Frame (upholstered swivel-base chair)	•	•	•	•	•	•	•	•	•	•	•	•	•	•	•	•	•	•	•	•	•	
	Frame (mesh back swivel-base chair)	•	•	•	•	•	•	•	•	•	•	•	•	•	•	•	•	•	•	•	•	•	
	Frame (multi-use chair)	•	•	•	•	•	•	•	•	•	•	•	•	•	•	•	•	•	•	•	•	•	
	Arm support (swivel-base chair)	•	•	•	•	•	•	•	•	•	•	•	•	•	•	•	•	•	•	•	•	•	
	Swivel base	•	•	•	•	•	•	•	•	•	•	•	•	•	•	•	•	•	•	•	•	•	
Siento 499 Series	Base and arm supports	•	•	•	•	•	•	•	•	•	•	•	•	•	•	•	•	•	•	•	•	•	
SILQ	Upper back shell	•	•	•	•	•	•	•	•	•	•	•	•	•	•	•	•	•	•	•	•	•	
	Lower back shell	•	•	•	•	•	•	•	•	•	•	•	•	•	•	•	•	•	•	•	•	•	
	Arms	•	•	•	•	•	•	•	•	•	•	•	•	•	•	•	•	•	•	•	•	•	
	Base	•	•	•	•	•	•	•	•	•	•	•	•	•	•	•	•	•	•	•	•	•	
	Stool foot ring	•	•	•	•	•	•	•	•	•	•	•	•	•	•	•	•	•	•	•	•	•	
	Arm caps and casters	•	•	•	•	•	•	•	•	•	•	•	•	•	•	•	•	•	•	•	•	•	
Steelcase Flex Perch Stool	Frame and seat	•	•	•	•	•	•	•	•	•	•	•	•	•	•	•	•	•	•	•	•	•	
Steelcase Series 1	Arms	•	•	•	•	•	•	•	•	•	•	•	•	•	•	•	•	•	•	•	•	•	
	Base	•	•	•	•	•	•	•	•	•	•	•	•	•	•	•	•	•	•	•	•	•	
	Frame	•	•	•	•	•	•	•	•	•	•	•	•	•	•	•	•	•	•	•	•	•	
	Lumbar and flexor	•	•	•	•	•	•	•	•	•	•	•	•	•	•	•	•	•	•	•	•	•	
Steelcase Series 2	Inner back frame and lumbar	•	•	•	•	•	•	•	•	•	•	•	•	•	•	•	•	•	•	•	•	•	
	Outer back frame and arm holsters	•	•	•	•	•	•	•	•	•	•	•	•	•	•	•	•	•	•	•	•	•	
	Outer seat shell	•	•	•	•	•	•	•	•	•	•	•	•	•	•	•	•	•	•	•	•	•	
	Air back	•	•	•	•	•	•	•	•	•	•	•	•	•	•	•	•	•	•	•	•	•	
	Base	•	•	•	•	•	•	•	•	•	•	•	•	•	•	•	•	•	•	•	•	•	
	Stool foot ring	•	•	•	•	•	•	•	•	•	•	•	•	•	•	•	•	•	•	•	•	•	
Think 465 Series	Arm caps and casters	•	•	•	•	•	•	•	•	•	•	•	•	•	•	•	•	•	•	•	•	•	
	Back frame, arm retainer, and base	•	•	•	•	•	•	•	•	•	•	•	•	•	•	•	•	•	•	•	•	•	
	Cylinder and stool foot ring	•	•	•	•	•	•	•	•	•	•	•	•	•	•	•	•	•	•	•	•	•	
	Inner seat shell, adjustment handles, arm pads, arm stalk, casters and glides	•	•	•	•	•	•	•	•	•	•	•	•	•	•	•	•	•	•	•	•	•	
	Outer seat shell	•	•	•	•	•	•	•	•	•	•	•	•	•	•	•	•	•	•	•	•	•	
	Flexors and lumbar	•	•	•	•	•	•	•	•	•	•	•	•	•	•	•	•	•	•	•	•	•	
Umami	Single platform top and fascia	•	•	•	•	•	•	•	•	•	•	•	•	•	■	•	•	•	•	•	■	■	
	Frame	•	•	•	•	•	•	•	•	•	•	•	•	•	•	•	•	•	•	•	•	•	
	Screen clips	•	•	•	•	•	•	•	•	•	•	•	•	•	•	•	•	•	•	•	•	•	
	Pill and round table top	•	•	•	•	•	•	•	•	•	•	•	•	•	•	•	•	•	•	•	•	•	

Special Features

This chart provides general guidelines about some of the types of special features that are available.

Legend

- = Not available
- = Available
- S = Standard Offering
- DO = Available in Design Options
- ▶ See specification pages for details.

	Different fabric on seat and back	Headrest	Sewn seam using vinyl or leather	Thicker seat cushion	Special seat height *	Special seat height base assemblies for field installation	Stool base	Jury base	Glides	Soft roll-control casters (specified with chair/stool)	Field-installed roll-control casters	Braking or reverse braking casters (specified with chair/stool)	Field-installed reverse-braking casters	High-performance arm	Oversized tablet arm	Corporate logo	Narrow arm width
Amia 482 Series	■	•	S	■	■	•	S	■	S	DO	DO	■	DO	S	•	•	•
Cachet 487 Series	■	•	•	■	■	■	S	■	•	S	S	DO	DO	•	•	•	•
cobi 434 Series	■	•	S	•	•	•	S	■	S	•	•	■	•	•	•	•	•
Gesture 442 Series	■	S	•	•	•	•	•	•	•	•	•	•	•	•	•	•	•
i2i 416 Series	■	•	•	•	•	•	•	•	S	•	•	•	•	•	•	•	•
Kart	•	•	•	■	■	•	S	•	■	■	•	•	•	•	•	•	•
Leap 462 Series	■	S	S	■	DO	■	S	■	S	DO	DO	■	DO	S	•	■	DO
Max-Stacker III 477 Series	•	•	•	•	•	•	•	•	S	•	•	•	•	•	•	•	•
Move 490 Series	■	•	•	•	•	•	S	•	S	•	•	•	•	•	•	•	•
Nooi	■	•	•	•	•	•	•	•	S	•	•	•	•	•	•	•	•
Player 475 Series	■	•	S	•	•	•	•	•	S	•	•	•	•	•	•	•	•
Reply 466 Series	■	•	•	•	•	■	•	•	S	■	DO	•	•	•	•	•	•
Siento 499 Series	■	■	S	•	■	•	•	•	■	•	•	•	•	■	•	•	•
Think 465 Series	■	S	S	•	■	•	S	■	S	S	S	■	DO	S	•	■	•

Design Options is a collection of commonly ordered Specials. Products in Design Options have a special quote number already assigned so it's not necessary to go through the normal E-quote process.

For individual quote information, or special requests not listed above, please submit an RFQ request form. The form may be accessed at the following: village.steelcase.com, search Specials RFQ.

*Maximum seat height is 33". Minimum seat height is 14 1/2" with 3" travel.

Wood Seating



Statement of Line **684**



Product Details

Guidelines for Selecting Appropriate Ergonomic Seating	685
Basics of Adjustability	686
Additional Resources	687



Understanding and Specifying

Collaboration	688
---------------	------------



Surface Materials **693**

Statement of Line

Guest Seating

Collaboration

- Understanding
- ▶ Page 688
- Specifying
- ▶ Page 690



Open

Tip: All Collaboration guest chairs are available with plain wood arms.

Guidelines for Selecting Appropriate Ergonomic Seating

<p>General-Use</p>	<p>High</p> <p>General-Use Seating</p> <p>Group Communicating Group Collaborating</p> <p>High-Performance Seating</p> <p>Individual Processing (task intensive) Individual Analyzing/Creating (multi-task)</p> <p>Low</p> <p>Low Autonomy High</p>	<ul style="list-style-type: none"> • Short periods of sitting • Moderate computer use • In some cases, a general-use chair can be used for short-term, individual analyzing/creating.
<p>High-Performance</p>		<ul style="list-style-type: none"> • Long periods of sitting • Heavy computer use • The more repetitive the task (individual processing work), the more critical it is to have a high-performance chair with full adjustability.
<p>Executive</p>	<p>Executive Seating</p> <p>Today's executive is an active participant, not just a delegator. Image is very important in the executive suite, but time at the computer must also be a consideration. Whether image or ergonomics drive the choice, this range of seating is diverse to provide the perfect chair for any executive work setting.</p>	<ul style="list-style-type: none"> • Design that acknowledges image • Aesthetics and detailing that suit the setting • Ergonomic features matched to the kinds of work
<p>Guest</p>	<p>Guest Seating</p> <p>Guest seating must be adaptable to many roles: as side chairs, pulled up to the conference table, in the learning center, in the private office, or in high-traffic areas where long use-life is essential. Guest seating is not intended for long periods of seated work, but must provide short-term comfort and have a welcoming, comfortable look.</p>	<ul style="list-style-type: none"> • A style in harmony with the other furniture • A scale that suits the environment • A durability that fits the intended use
<p>Stackable</p>	<p>Stackable Seating</p> <p>Stackable seating is used when occasional, transportable, easy-to-store seating is needed. Whether used as side chairs, meeting chairs, in classrooms, or cafeterias, the challenge is to maintain an excellent aesthetic combined with great strength even though the chairs are light in scale for portability.</p>	<ul style="list-style-type: none"> • Durability for high-volume, high-traffic use • Light weight for easy stacking and moving • Extra features if needed, such as tablet arms, bookracks, glides, transport and storage dollies, and ganging or alignment devices.
<p>Lounge</p>	<p>Lounge Seating</p> <p>Lounge seating is often multiple and is found throughout the organization from reception areas to executive offices. Lounge seating is the "first impression seating," critical to an organization's image.</p>	<ul style="list-style-type: none"> • Durability related to level of use • A design that looks right in multiples • Size, scale, and appearance that suits the environment

Basics of Adjustability

Steelcase chairs offer varying levels of adjustability to meet the needs of many types of users. Adjustable chairs may offer one or more of these features:

Mechanisms



Swivel feature allows the user to rotate the seat 360 degrees in either direction.
(All)

Seat Adjustments



Pneumatic-height adjustment allows the user to remain seated while adjusting the seat height by way of a control button or lever.
(All)

Back Adjustments



Back-tension adjustment allows the user to control the amount of resistance felt when leaning back in the chair.
(All)

Additional Resources

Wood seating products are supported with an array of informational materials, tools, and software to help you plan an installation efficiently.

Product brochures and planning tools can be ordered through your Steelcase area office by calling 1.800.784.0358 or through the Marketing Resources website at village.steelcase.com.

Product Brochures

The following publications focus on wood seating in greater detail:

Seating Overview
Form number 06-0000890

Collaboration
Form number S11078

Steelcase Inc. Corporate Capabilities Brochure

This publication offers a concise overview of Steelcase including insights into the attitudes and commitments that make the corporation unique. In addition, the brochure provides an illustrated listing of all the products and services offered and international activities are described.

Printed Materials

Surface Materials Reference Manual

This publication provides:

- An explanation of the surface materials and their categories
- “Available on” matrices
- Vertical surface fabric and seating upholstery selection listing
- Technical data for surface materials
- Surface material care and cleaning instructions

Planning Tools

Quick Ship Guide

This handbook describes all Steelcase and Coalesse products that are available for Rapid2 (ships in 2 days), Rapid5 (ships in 5-7 days), or Coalesse Rapid10 (ships in 10 days).

Computer Tools

Electronic Catalog

Accurate sales quotations and purchase orders for Steelcase products are created with specification software that uses Steelcase Electronic Catalog data. Use the data to specify and price style numbers and options for every Steelcase product. The data is updated bimonthly by Steelcase and provided to software programs including: the Hedberg Business System, SmartTools—Steelcase’s design and specification software (for more information on SmartTools, please email SmartTools@steelcase.com), the ProjectMatrix ProjectSystmols libraries, as well as 20-20 CAP Studio.

Furniture Symbol Graphic Data

Steelcase creates 2D and 3D furniture symbols (with attributes) for planning and initially specifying Steelcase products. This data is incorporated into several add-on software packages that work in either a Microstation or an AutoCAD drafting environment.

For more information about these and other software tools to help you plan effective work environments, please email fsl@steelcase.com.

Support

Steelcase Capabilities

Steelcase products are distributed, installed, and serviced through a network of more than 600 dealers worldwide. Steelcase is also represented with offices and corporate showrooms in 26 U.S. cities, 4 Canadian cities, and in France, Germany, Great Britain, and Japan. Every Steelcase product meets our exceptionally high standards of quality and durability and comes with the Steelcase assurance of excellence in service.

For ordering and product assistance,

please call your local dealer, the Steelcase Solutions Resource Team, or the Steelcase Solutions Fulfillment Team at 1.888.STEELCASE (1.888.783.3522) or send an e-mail to lineone@steelcase.com.

Call the Steelcase Solutions Resource Team prior to placing an order, when working on a bid, or when you need information about product applications and specifications.

Call the Steelcase Solutions Fulfillment Team if you have submitted an order to Steelcase and you need to speak to your Solutions Fulfillment Team Representative about the order. Also call if you have any post-shipment quality concerns or service parts questions.

For warranty information, please go to <http://www.steelcase.com/warranty/>.

Outside the U.S.A., Canada, Mexico, Puerto Rico, and the U.S. Virgin Islands, call 1.616.247.2500.

For information about Steelcase, the name of your nearest Steelcase dealer, or for product literature, call 1.800.333.9939 or visit our website: www.steelcase.com.

Collaboration

Collaboration guest chairs, designed by Dennie Pimental and John Duffy, have a classic design that is ideal for conference room, reception area, and dining room seating, or as guest seating in a workstation.

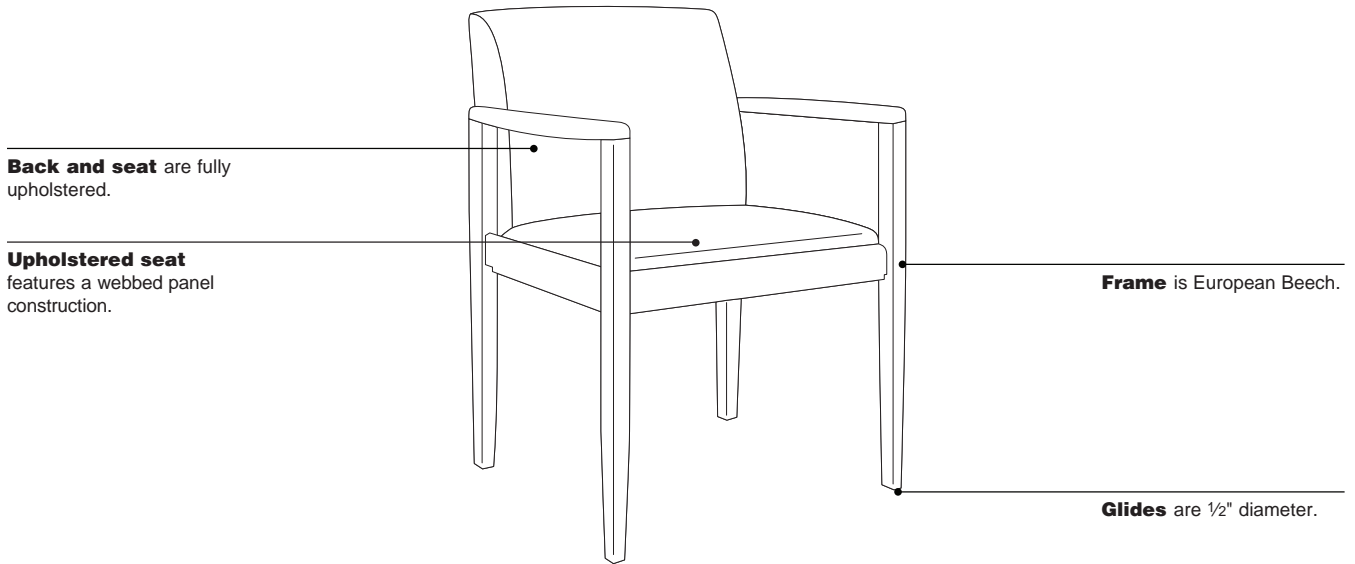

Actual Dimensions

Overall depth	24 1/4"
Overall width	22 1/2"
Overall height	31 1/2"
Seat depth	17"
Seat width	18 3/4"
Back width	18 3/4"
Back height	13 3/4"
Width between arms	18 3/4"
Seat to floor height	18"
Arm height from floor	25 1/2"

Product Details

All chairs are available with plain hardwood arms.

Surface Materials

Upholstery

- Fabric
- Fabric with soil-retardant treatment (option)
- Leather
- COM
- COL

Frame

- European Beech
- *Tip: Wood finishes applied to European Beech will match the color of stains applied to oak, walnut, or cherry but will not show the same natural grain.*
- Customiz stain (option)

Glides

- Stainless steel only

Wood touch-up kits

- Available in specific finishes for field repairs
- ▶ Page 696

All Steelcase seating with standard upholstery fabrics

complies with requirements of the State of California Technical Bulletin 117. All standard seating is labeled to be in compliance with California 117.

Programs & Services

▶ See the *Surface Materials Reference Manual* for further detail about programs and services offered for seating.

The Customer's Own Material (COM & COL)

Program offers the opportunity for customers to select fabrics and leather that are not offered through the standard Steelcase surface materials program for use on Steelcase products. Avoid pattern fabrics and heavily grained leathers. Through the COM & COL program, Steelcase will test your materials for application on Steelcase products. Once approved, you can place your order. Steelcase will facilitate the entire ordering process and give you a production schedule. Steelcase will order the COM & COL fabric and leather directly from the textile manufacturer. For up-to-date information regarding fabric test results for all COM & COL fabrics and details regarding yardage requirements for most Seating lines, visit the COM website. To locate the COM website:

- Visit www.steelcase.com

Soil retardants are treatments that provide long-term soil and stain resistance to a fabric without affecting the shade or the integrity of the fabric. The following Steelcase Textiles are available pre-treated with soil retardant. (You do not need to select the soil-retardant option for these fabrics and incur the upcharge.)

- Jacks
- Link

For information on soil retardant fabrics on Select Surfaces, please refer to the *Surface Materials Reference Manual*.

Soil-retardant treatment is available on all other seating fabrics at an additional upcharge per seating unit. To order this option, please select "Soil-Retardant Treatment" under "Optional Accessories."

For soil-retardant treatment on COMs, please select "Soil-Retardant Treatment" under "Optional Accessories." Minimums or additional yardage may be required. Please contact the vendor directly for specific information.

Extended lead times may be necessary for this service.

Contact your Steelcase Solutions Fulfillment Team Representative at 1.888.STEELCASE (1.888.783.3522) or send an e-mail to lineone@steelcase.com.

Resources

Collaboration Brochure
Form number S11078

Chairs for People at Work
Form number S11347

Quick Ship Guide

Collaboration



Standard Includes		Required to Specify
▶ Need help? Product details, page 688	<ul style="list-style-type: none"> • Frame: European Beech • Upholstery on seat and back: fabric price group 1 • Glides: stainless steel only 	<ol style="list-style-type: none"> 1 Style number 2 Fabric color number for upholstery 3 Wood color number for frame 4 Options, if selected (see below) <p>▶ See <i>Surface Materials</i>, page 694.</p>

Options	U.S. Price	Required to Specify
Surface Materials		
Upholstery on seat and back		
• Fabric price group 1	No cost	Specify fabric color number.
• Fabric price group 2	+\$ 37	Specify fabric color number.
• Fabric price group 3	+\$ 80	Specify fabric color number.
• Fabric price group 4	+\$125	Specify fabric color number.
• Fabric price group 5	+\$179	Specify fabric color number.
• Fabric price group 6	+\$255	Specify fabric color number.
• Fabric price group 7	+\$303	Specify fabric color number.
• Fabric price group 8	+\$444	Specify fabric color number.
• Fabric price group 9	+\$569	Specify fabric color number.
• Fabric price group 10	+\$697	Specify fabric color number.
• Leather price group	+\$667	Specify leather color number.
• Steelcase Vinyl	+\$ 37	Specify vinyl color number.
• Customer's Own Material (COM)	+\$ 48	▶ See <i>Surface Materials Reference Manual</i> .
• Customer's Own Leather (COL)	+\$ 48	▶ See <i>Surface Materials Reference Manual</i> .

Contrasting upholstery on seat and back

• Contrasting fabrics	+\$ 46	Add suffix K to the style number and specify fabric color numbers.
-----------------------	--------	---

Contrasting upholstery on seat

• Fabric price group 1	No cost	Specify fabric color number.
• Fabric price group 2	+\$ 21	Specify fabric color number.
• Fabric price group 3	+\$ 37	Specify fabric color number.
• Fabric price group 4	+\$ 62	Specify fabric color number.
• Fabric price group 5	+\$ 88	Specify fabric color number.
• Fabric price group 6	+\$129	Specify fabric color number.
• Fabric price group 7	+\$150	Specify fabric color number.
• Fabric price group 8	+\$221	Specify fabric color number.
• Fabric price group 9	+\$284	Specify fabric color number.
• Fabric price group 10	+\$348	Specify fabric color number.
• Leather price group	+\$334	Specify leather color number.
• Steelcase Vinyl	+\$ 21	Specify vinyl color number.
• Customer's Own Material (COM)	+\$ 24	▶ See <i>Surface Materials Reference Manual</i> .
• Customer's Own Leather (COL)	+\$ 24	▶ See <i>Surface Materials Reference Manual</i> .

Contrasting upholstery on back

• Fabric price group 1	No cost	Specify fabric color number.
• Fabric price group 2	+\$ 21	Specify fabric color number.
• Fabric price group 3	+\$ 39	Specify fabric color number.
• Fabric price group 4	+\$ 62	Specify fabric color number.
• Fabric price group 5	+\$ 88	Specify fabric color number.
• Fabric price group 6	+\$129	Specify fabric color number.
• Fabric price group 7	+\$152	Specify fabric color number.
• Fabric price group 8	+\$222	Specify fabric color number.
• Fabric price group 9	+\$284	Specify fabric color number.
• Fabric price group 10	+\$348	Specify fabric color number.
• Leather price group	+\$335	Specify leather color number.
• Steelcase Vinyl	+\$ 21	Specify vinyl color number.
• Customer's Own Material (COM)	+\$ 24	▶ See <i>Surface Materials Reference Manual</i> .
• Customer's Own Leather (COL)	+\$ 24	▶ See <i>Surface Materials Reference Manual</i> .

• Soil-retardant treatment applied to upholstery fabric	+\$ 36	Specify with soil-retardant treatment.
---	--------	--

Frame

• Customiz stain on wood	No cost	Specify with Customiz stain. ▶ See <i>Surface Materials Reference Manual</i> .
--------------------------	---------	---

Tip: Wood finishes applied to beech will match the color of stains applied to oak, walnut, or cherry but will not have the same natural grain.

Specification Information



Open

• Description	• Style Number	• U.S. Base Price
Wood arms	120	\$1419

 **For Canadian Pricing**
 Multiply U.S. Price by the Canadian price factor.
 ▶ See page 1 for details.



Surface Materials

Surface Materials	694
Wood Seating Upholstery Matrix	698
Solid Wood and Solid Surfaces Availability Matrix	700
Guidelines for Directional Fabrics	702

Surface Materials

This listing includes all the surface material choices that are available for the products in this specification guide.

Resources

For more information about surface materials, refer to the following resources:

Additional surface materials specification tools are available to assist you in the specification process—the Surface Materials Binders.

The global surface materials palette is a core collection of finishes that is available across multiple geographies (Americas/EMEA – Europe, Middle East, and Africa/ APAC – Asia Pacific) and on global product lines, where applicable. For a list of finishes included in the offering, see the *Surface Materials Reference Manual*. Additional details, like product approvals by geography and finish number conversions, can also be found in the *Surface Materials Reference Manual* or see www.steelcase.com/surface-materials

Surface Materials

Binders include:

- Surface Materials Reference Manual
- A complete set of swatch cards for hard surfaces, vertical surface fabrics, and seating upholstery

Metal

Select Surfaces

4798 Sterling Metallic
7207 Black
8046 Polished Aluminum
9201 Polished Chrome

Paint

Steelcase Surfaces

0835 Black
4799 Platinum Metallic
7207 Black

Wood

► See *Wood Color Availability Matrix* on page 700 for color availability by product line and wood species.

Tip: The wood used in the construction of chairs is either maple or European beech. Wood finishes applied to maple or beech will match the color of stains applied to oak, walnut, or cherry, but will not have the same natural grain. Composite color finishes will match the color of composites on veneered surfaces, but will not have the same grain pattern.

Veneer

Wood Group 1

3062 Graphite Walnut
3402 Clear Cherry (Aged)
3412 Natural Cherry **E**
3422 Medium Cherry
3522 Clear Maple*
3592 Blonde on Maple **E**
3602 Desert Oak
3702 Clear Walnut
3712 Natural Walnut
3752 Medium Walnut **E**
3762 Dark Walnut
3772 Medium Mahogany on Walnut

**To ensure an understanding of the color ranges and characteristic variations of natural veneer, a sign-off sheet is required prior to orders being accepted for this clear-coat finish. The sign-off sheet is available through Steelcase advertising stock. Form number 05-0001370*

Wood Group 1

Flat-Cut Open-Pore, Natural Veneers

3342 FC/OP Black Walnut
35A2 FC/OP Blanch Maple
37A2 FC/OP Thunder Walnut

Quarter-Cut Open-Pore, Natural Veneers

32A2 QC/OP Blanch Maple
33A2 QC/OP Thunder Walnut
3392 QC/OP Black Walnut

Rift-Cut Open-Pore, Natural Veneers

36A2 RC/OP Volcanic Oak

Wood Group 2

Flat-Cut Full-Fill, Natural Veneers

3734 FC/FF Black Walnut

Quarter-Cut Full-Fill, Natural Veneers

3394 QC/FF Black Walnut

Wood Group 3

Flat-Cut Open-Pore, Natural Veneers

3082 FC/OP Washed Walnut

Flat-Cut Full-Fill, Natural Veneers

3084 FC/FF Washed Walnut

Custom Surfaces

Customiz stain is a service that allows you to create your own stain colors and finishes on standard veneer. Customiz stain color is available on all product lines that offer wood veneer.

A \$500 stain-matching fee applies on CUSTOMIZ requests (Exception: The \$500 fee does not apply on matches to Coalesse standard finishes, for a low-gloss finish request on a standard color, or for composite stain matching to Steelcase wood seating). The \$500 fee covers the cost of formulating the Customiz color finish and applies regardless of whether or not an order for product is placed.

Tip: Due to natural variation of woodgrain color and texture, the match between composite veneers and composite stain color finishes will be a commercially acceptable match, rather than an exact match.

In addition, an approval form must be signed to indicate customer acceptance of Customiz match. A \$1,500 initiation fee will be charged prior to first order entry. This initiation fee activates the finish for unlimited use on any Steelcase product for an 18 month time period. After the 18 month time period has lapsed, the Customiz finish may be reactivated for another 18 months for a \$1,000 fee at any point within five years after the \$1,500 initiation fee was paid. If the finish is not reactivated within five years after the \$1,500 initiation fee was paid, the finish will be culled and the customer will need to pay the \$1,500 initiation fee again. All style number related Customiz charges products are no cost as of April 2014. The matching and initiation fees are not discountable.

Customiz stain takes 10 days to formulate. Consult the *Surface Materials Reference Manual* for more information. Custom veneers are also available and must be quoted by Steelcase specials group. Customiz stain on custom veneers takes 2 to 4 weeks to formulate.

Requirements and information on ordering a Customiz stain color are found in the *Surface Materials Reference Manual*.

E = Established

Upholstery**Steelcase Surfaces****Price Group 1****Buzz2**

5F03 Tomato
 5F04 Red **E**
 5F05 Burgundy
 5F06 Sky **E**
 5F07 Blue
 5F08 Navy
 5F15 Stone
 5F16 Grey
 5F17 Black
 5G50 Dunegrass
 5G51 Sable
 5G55 Pumpkin
 5G57 Rogue
 5G59 Meadow
 5G61 Cyan
 5G62 Atlantic
 5G63 Crocus
 5G64 Alpine
 5G65 Tornado

Era

5ER0 Cobalt
 5ER1 Harbor
 5ER2 Blue Nickel
 5ER3 Pistachio
 5ER4 Canary
 5ER5 Comet
 5ER6 Truffle
 5ER7 Saffron
 5ER8 Pink Lemonade
 5ER9 Onyx
 5ES0 Scarlet
 5ES1 Lentil
 5ES2 Oatmeal
 5ES3 Persimmon
 5ES4 Sprout
 5ES5 Blue Mint
 5ES6 Royal Blue
 5ES7 Night Owl
 5ET1 Rose Quartz
 5ET3 Olivine
 5EU2 Electric Indigo
 5EU3 Green Citrine
 5EU4 Storm Cloud

Jacks

5B61 Taupe **E**
 5B63 Camel **E**
 5B64 Pewter **E**
 5B70 Midnight **E**

Link

5A24 Blue
 5A25 Navy
 5A27 Black

New Black

5J10 New Black: Bruce
 5J11 New Black: Henry
Tip: New Black upholstery has color numbers in both price group 1 and price group 2.

Price Group 2**Chainmail**

5551 Space
 5552 Silver Dollar
 5553 Volcano
 5555 Tricycle
 5559 Lagoon

Cogent: Connect

5S15 Coconut
 5S16 Turmeric/Honey
 5S17 Tangerine
 5S18 Scarlet
 5S19 Concord
 5S21 Blue Jay
 5S23 Wasabi
 5S24 Nickel
 5S25 Graphite
 5S26 Licorice
 5S27 Malt
 5S28 Root Beer
 5S93 Indigo/Blueprint
 5S94 Lizard/Jungle
 5S95 Sailor
 5S96 Quicksilver
 5S99 Lipstick/Merlot
 5SD0 Royal Blue
 5SD1 Aubergine
 5SD2 Peacock
 5SD3 Lagoon
 5SD4 Saffron
 5SD5 Citrine
 5SD6 Rose Quartz
 5SD7 Sea Salt
 5SF3 Storm Cloud
 5SF4 Olivine

Foundation

5875 Black
 5876 Navy
 5877 Foggy Night
 5878 Sailor
 5879 Ivory
 5880 Seal
 5881 Peat
 5882 New Sand
 5883 Cranberry
 5884 Spring
 5885 Honey
 5886 Folkstone
 5887 Pebble
 5888 Oregano

New Black

5J08 New Black: Jack
 5J09 New Black: James
 5J12 New Black: Harley
Tip: New Black upholstery has color numbers in both price group 1 and price group 2.

Nitelights

5F66 Stone
 5F67 Moon

Stand In

5621 Sleet
 5622 Lunar
 5623 Cyclone
 5624 Eclipse
 5625 Powder
 5626 Chardonnay
 5627 Graham
 5628 Sediment
 5629 Allspice
 5630 Apple
 5631 Lava
 5632 Cayenne
 5633 Plantain
 5634 Parsley
 5635 Scallion
 5636 Atlantis
 5691 Orca
 5740 Burlap
 5741 Porter
 5742 Tusk
 5743 Putty
 5744 Blueberry
 5745 Chartreuse
 5746 Mango
 5747 Sedona
 5748 Juniper
 5749 Peanut

Price Group 3**Billiard Multi-Use by Designtex**

5H11 Poppy
 5H12 Tangelo
 5H13 Citrine/Citron
 5H14 Avocado
 5H16 Indigo
 5H17 Mallard
 5H18 Teak
 5H19 Cumulus
 5H20 Pewter
 5H21 Gunmetal
 5H22 Ink
 5H23 Rose Quartz
 5H24 Sea Salt
 5H25 Storm Cloud
 5H26 Olivine

Gaja

5W40 Black
 5W41 Pepper
 5W42 Pearl Grey
 5W43 Crimson
 5W44 Ink
 5W45 Night Blue
 5W48 Sepia
 5W51 Camellia Red
 5W52 Emerald
 5W53 Snow Pea
 5W54 Olive
 5W56 Maroon
 5W57 Black Raspberry
 5W58 Spruce
 5W60 Deep Blue
 5W61 Chili Pepper

Redeem

TM50 Brick
 TM52 Cinnamon
 TM55 Water
 TM58 Mallard
 TM60 Greyhound
 TM62 Iceberg
 TM63 Chestnut
 TM64 Granite
 TM66 Barnwood

Retrieve

TM31 Lake
 TM32 Gala
 TM37 Submarine
 TM40 Quarry
 TM42 Shadow
 TM43 Seal

Price Group 5**Bo Peep**

5G67 Bone
 5G72 Honey Mustard
 5G73 Marmalade
 5G74 Picnic
 5G75 Pinot
 5G76 Bloom
 5G77 Grapevine
 5G79 Artichoke
 5G80 Serpent
 5G81 Carolina
 5G82 Blue Bonnet
 5G83 Nautical
 5G84 Gravel
 5G85 Sharkskin
 5G86 Kohl

Remix

RE01 Rust
 RE03 Pebble
 RE04 Dark Chocolate
 RE06 Linen Beige
 RE08 Concrete Grey
 RE09 Sky Blue
 RE10 Blue Jean
 RE11 Ivy Green
 RE13 Night Blue

Silk

5L31 Dijon
 5L32 Seaweed
 5L33 Boysenberry
 5L35 Marina
 5L36 Heather Blue
 5L37 Blue Raspberry
 5L38 Cauldron
 5L39 Flaxen

E = Established

Surface Materials, continued

Price Group 6

Brisa

- BR01 Black Onyx
- BR04 Truffle
- BR06 Ash
- BR07 Sage
- BR08 Celery
- BR09 Sterling Blue
- BR10 Night Navy
- BR11 Cambridge Blue
- BR12 Abyss
- BR14 Pompeian Red
- BR16 Cinnabar
- BR18 New Sand
- BR20 White
- BR21 Moccasin
- BR22 Buckskin
- BR24 Mineral
- BR25 Skyway
- BR26 Iron
- BR27 Stormy
- BR28 Esmeralda
- BR29 Seaweed
- BR30 Bone
- BR31 Caramel
- BR32 Bridle
- BR33 Moon

Price Group 7

Steelcut Trio

- TR01 Mist Grey
- TR02 Stone Grey
- TR03 Cassonade Beige
- TR04 Nutmeg Beige
- TR06 Licorice Black
- TR11 Ice Blue
- TR15 Brown Frost
- TR18 Coastal Oasis
- TR19 Deep Sea

Leather Price Group

Steelcase Leather

- L107 Black **E**
- L207 Mahogany **E**
- L220 Soapstone **E**
- L221 Rocky **E**

Elmosoft Leather Price Group

Elmosoft Leather

- L110 Maritime Blue
- L111 Midnight Blue
- L112 Ebony
- L113 Gunmetal
- L114 Mica
- L115 Dove Grey
- L116 Plum Pleasure
- L122 Truffle
- L128 Red Birch
- L133 Espresso
- L134 Ruby
- L135 Scarlet
- L138 Bourbon
- L139 Cinder
- L140 Garnet
- L143 Pecan
- L144 Chamois
- L146 Russet
- L147 Saddle
- L151 White
- L709 Sugar
- L711 Parchment
- L717 Cameo
- L723 Storm
- L730 Hunter
- L743 Forest Green
- L747 Cigar
- L749 Beaver
- L750 Bluffstone
- L752 Oxblood
- L755 Peanut Butter
- L758 Mustard
- L762 Canvas
- L763 Macadamia
- L768 Tropical
- L769 Mauve
- L770 Cadet
- L772 Timberwolf
- L773 Chalice
- L774 Oil
- L775 Coyote

Select Surfaces

For information on products within **Select Surfaces**, including accent paints and fabrics from Designtex, Gabriel, Kvadrat, and Pollack, please refer to the *Surface Materials Reference Manual* or visit www.steelcase.com/surface-materials under the Select Surface section.

Custom Surfaces

Price Group COM (Customer's Own Material)

Fabric Approval and Yardage
To confirm whether a particular COM material has already been tested for use on a specific Steelcase product or to determine actual yardage requirements:
• Visit www.steelcase.com

For additional information regarding **Customer's Own Material**, call 1.888.STEELCASE.

How to Order Wood Touch-Up Kits

Order wood finish touch-up kits from J.Kaltz Co. Specific Steelcase finish codes (such as 3422) can be found under Finishes > Dealer Kits. Each kit contains one brush tip marker and one fill stick.

- Place orders as follows:
- Phone: 616.942.6070
 - Web: www.jkaltzco.com

E = Established

Wood Seating Upholstery Matrix

Not every fabric is available on every chair. This matrix gives an overview of the upholstery fabrics that can be specified on each seating product line.

	Price Group	Collaboration
Billiard Multi-Use by Designtex	3	■
Bo Peep	5	■
Brisa	6	■
Buzz2	1	■
Chainmail	2	■
Cogent: Connect	2	■
Elmosoft Leather	EL	•
Era	1	■
Foundation	2	■
Gaja	3	■
Jacks [ⓔ]	1	■
Steelcase Leather [ⓔ]	L	■
Link	1	■

Legend

- = Not available
- = Available
- = Available with exceptions
- ⓔ = Established
- ▶ See specification guide for details.

Tip: Certain fabrics and leathers appear loose with comfort wrinkles when upholstered.

Not every fabric is available on every chair. This matrix gives an overview of the upholstery fabrics that can be specified on each seating product line.

	Price Group	Collaboration
New Black: Bruce	1	■
New Black: Harley	2	■
New Black: Henry	1	■
New Black: Jack	2	■
New Black: James	2	■
Nitelights	2	■
Redeem	3	■
Remix	5	■
Reply Air Mesh	NA	■
Retrieve	3	■
Silk	5	■
Stand In	2	■
Steelcut Trio	7	■

Legend

- = Not available
- = Available
- = Available with exceptions
- ▶ See specification guide for details.

Tip: Certain fabrics and leathers appear loose with comfort wrinkles when upholstered.

Solid Wood and Solid Surfaces Availability Matrix

Not every wood color is available on every seating component. This matrix gives an overview of which wood colors can be specified for each seating component.

	Steelcase Seating	Collaboration
3062 Graphite Walnut	■	■
3402 Clear Cherry (Aged)	■	■
3412 Natural Cherry E	■	■
3422 Medium Cherry	■	■
3522 Clear Maple**	■	■
3592 Blonde on Maple E	■	■
3602 Desert Oak	■	■
3702 Clear Walnut	■	■
3712 Natural Walnut	■	■
3752 Medium Walnut E	■	■
3762 Dark Walnut	■	■
3772 Medium Mahogany on Walnut	■	■
3860 Espresso	•	•
3861 Natural	•	•
Flat Cut, Low Sheen*		
V1AC Natural Cherrywood	•	•
V1AM Clear Maplewood	•	•
V1CC Medium Amber Cherrywood	•	•
V1EW Dark Walnut	•	•
Natural Veneers		
Wood Group 1		
3342 Black Walnut	■	■
3392 Black Walnut	■	■
35A2 Blanch Maple	■	■
37A2 Thunder Walnut	■	■
32A2 Blanch Maple	•	•
33A2 Thunder Walnut	•	•
36A2 Volcanic Oak	•	•

Legend

- = Not available
- = Available
- = Available with exceptions
- E** = Established
- ▶ See specification guide for details.

▶ Wood Color Availability Matrix, continued

Tip: The wood used in the construction of chairs is either maple or European beech. Wood finishes applied to maple or beech will match the color of stains applied to oak, walnut, or cherry, but will not have the same natural grain. Composite color finishes will match the color of composites on veneered surfaces, but will not have the same grain pattern.

*See *Coalesse Surface Materials Reference Guide* for more information on this finish.

**To ensure an understanding of the color ranges and characteristic variations of natural veneer, a sign-off sheet is required prior to orders being accepted for this clear-coat finish. The sign-off sheet is available through Steelcase advertising stock. Form number 05-0001370

Tip: 3522 Clear Maple is a clear coat. Therefore, the natural variations in wood (maple or European beech) will be visible.

Tip: Due to natural variations in wood, finish products may vary in color, texture and grain.

Not every wood color is available on every seating component. This matrix gives an overview of which wood colors can be specified for each seating component.

Legend

- = Not available
- = Available
- = Available with exceptions
- Ⓢ = Established
- ▶ See specification guide for details.

	Steelcase Seating	Collaboration
Planked Veneers		
3P41 Planked Cherry		•
3P51 Planked Maple		•
3P61 Planked Maple		•
3P71 Planked Walnut		•
3VFX Unmarked Oak		•
Composite Veneers		
Wood Group 1		
3F8X European Walnut Composite		•
3GGX Zebrano Composite		•
3HGX Oak Composite		•
3HVX Walnut Composite		•
3JDX Oak Composite		•
3JJX Walnut Composite		•
3ZNX Night Cerused Oak Composite		•
Premium Veneers		
3832 Figured Anegre		•
Solid Surfaces		
2801 Glacier White		•
2873 Linen		•
2875 Bisque		•
2972 Antarctica		•
2974 Canvas		•
2978 Cameo White		•
2979 Silver Grey		•

Tip: Composite color finishes will match the color of composites on veneered surfaces, but will not have the same grain pattern. Select composite color finishes will be available through the Customiz Stain process for no additional fee.

Tip: The wood used in the construction of chairs is either maple or European beech. Wood finishes applied to maple or beech will match the color of stains applied to oak, walnut, or cherry, but will not have the same natural grain.

Tip: Due to natural variations in wood, finish products may vary in color, texture and grain.

Guidelines for Directional Fabrics

What is the issue?

Some textiles are plain and look the same regardless of which direction the fabric is applied to the product. But many customers prefer fabrics that have patterns that give a clear direction to the textile. Because there are limits to how directional fabrics can be applied to panels and chairs, it is important to understand directional fabrics to avoid being disappointed.

Talking about direction

Fabrics come on rolls. The long threads that run parallel to the length of the roll are called the warp. The perpendicular threads that run parallel to the width of the roll are called the filling.

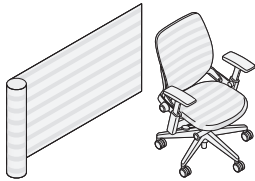

Railroaded means the height dimension of the product is perpendicular to the warp of the fabric; *warp horizontal* and *across roll* are other terms for running the fabric in this direction. All Steelcase standard fabrics are railroaded. The yardage requirements for railroaded cutting are calculated using the width of the fabric, quantity ordered, style of chair(s), and pattern repeat.



Woven way means the height dimension of the product is parallel to the warp of the fabric; *warp vertical* and *down roll* are other terms for running the fabric in this direction. The yardage requirements for woven way cutting are calculated using the width of the fabric, quantity ordered, and style of chair(s).

What determines fabric direction?

The width of the roll of fabric and the techniques that are used to apply it to the product can both determine the direction. Standard default direction for seating products with Steelcase standard fabrics is railroaded. No exceptions are possible. COM fabrics are standard woven way. You may specify a COM fabric to be cut in a specific direction if the product allows it to be applied. The purchase order must clearly state the cutting direction if it is other than standard.

Tip: If you are changing the cutting direction of fabric, yardage requirements may increase, resulting in an additional upcharge. This upcharge will be applied to the purchase order.

▶ See *Yardage Requirements* in the *Surface Materials Reference Manual* for specific information.

If you have any questions regarding cutting direction guidelines, please call the Steelcase Solutions Resource Team at 1.888.STEELCASE or 1.888.783.3522. You can also find this information on our website:

- Visit www.steelcase.com

COM pattern exceptions

Sometimes COM fabrics have patterns that look awkward or inappropriate if they are applied in the standard direction (woven way). Those cases are addressed with these two pattern exception rules.

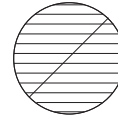

Incorrect

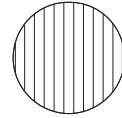

Correct

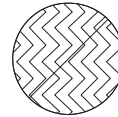

Incorrect

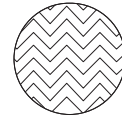

Correct

1

Fabrics with stripes or flame stitch will be applied so that the patterns are vertical.



Incorrect



Correct



Incorrect



Correct

2

Fabrics with patterns of people, vines, or flower arrangements will be applied so that the pattern is vertical.

Resources

Style Number Index

704

Resources

Style Number Index

Style Number	Page	Description
120	691	Collaboration Guest Chair
126900	236	Kart Accessory
126A100	235	Kart Nesting Chair
126A101	235	Kart Nesting Chair
126A200	236	Kart Nesting Chair
126A200S	236	Kart Nesting Chair
126A201	236	Kart Nesting Chair
126A201S	235	Kart Nesting Chair
126B100ST	239	Kart Stool
126B101ST	239	Kart Stool
126B200SST	240	Kart Stool
126B200ST	240	Kart Stool
126B201SST	239	Kart Stool
126B201ST	240	Kart Stool
416911	626	i2i 416 Work Chair
416911T	626	i2i 416 Work Chair/Tab
418A000	259	SILQ 418 Series Chair
418B000	261	SILQ 418 Series Stool
419A000	82	Karman Work Chair w/Intermix Perf Txt
419A500	84	Karman High-Back Work Chair
419B000	83	Karman Work Stool with Intermix Perf Txt
419COATHANGER	85	Karman Coat Hanger
419LUMBAR	85	Steelcase Karman Lumbar
428310	273	Qivi 428 Sled-Base Multi-Use Chair
428510	270	Qivi 428 Collab Chair
428710	271	Qivi 428 Collab Stool
428910	273	Qivi 428 Sled-Base Multi-Use Chair
434110	281	cobi 434 Work Chair
434111	281	cobi 434 Work Chair/Arm
434710	283	cobi 434 Work Stool
434711	283	cobi 434 Work Stool/Arm
435A00	189	Steelcase Series 1 Work Chair
435A00AIR	191	Steelcase Series 1 Work Chair
435B00	193	Steelcase Series 1 Stool
435B00AIR	195	Steelcase Series 1 Stool
435COATHANGER	196	Steelcase Series 1 Hanger
435HEADREST	196	Steelcae Series 1 Headrest
436AIR	167	Steelcase Series 2 Work Chair
436AIR3D	165	Steelcase Series 2 Work Chair
436AIR3DSTOOL	173	Steelcase Series 2 Stool
436AIRSTOOL	175	Steelcase Series 2 Stool
436COATHANGER	176	Steelcase Series 2 Coat Hanger
436HEADREST	177	Steelcase Series 2 Headrest
436UPH	162	Steelcase Series 2 Work Chair
436UPHSTOOL	170	Steelcase Series 2 Stool
442A30	41	Gesture 442 Shell Bck Chair
442A40	41	Gesture 442 Wrapped Bck Chair
442A50	43	Gesture 442 Series Wrk Chr w/Headrest
442B30	45	Gesture 442 Shell Bck Stool
442B40	45	Gesture 442 Wrapped Bck Stool
442COATHANGER	46	Gesture 442 Coat Hanger
46216179	56	Leap 462 Work Chair
46216189	59	Leap 462 Work Chair
46267179	62	Leap 462 Stool
46267189	65	Leap 462 Stool

Style Number	Page	Description
46296179	68	Leap Plus 462 Work Chair
46296189	71	Leap Plus 462 Work Chair
462COATHANGER	72	Leap 462 Coat Hanger
465A000	104	Think 465 Series Work Chair
465A000Q	108	Think 465 Series Work Chair
465A300	101	Think 465 Series Work Chair
465B000	114	Think 465 Series Stool
465B000Q	117	Think 465 Series Stool
465B300	111	Think 465 Series Stool
466160MP	219	Reply 466 Series Work Chair
466160MT	217	Reply 466 Series Work Chair
466450MH	223	Reply 466 Series Leg-Base Multi-Use Chair
466450MT	221	Reply 466 Series Leg-Base Multi-Use Chair
466452MH	223	Reply 466 Series Leg-Base Multi-Use Chair
466452MT	221	Reply 466 Series Leg-Base Multi-Use Chair
466480MH	227	Reply 466 Series Sled-Base Multi-Use Chair
466480MT	225	Reply 466 Series Sled-Base Multi-Use Chair
466482MH	227	Reply 466 Series Sled-Base Multi-Use Chair
466482MT	225	Reply 466 Series Sled-Base Multi-Use Chair
472G	433	Max-Stkr 472 Alignment Device
473D	433	Max-Stkr Trans/Strg Dolly
475410M	367	Player 475 Leg-Base Multi-Purp Chair
475410MTL	369	Player 475 Leg-Base Multi-Purp Chair
475410MTR	369	Player 475 Leg-Base Multi-Purp Chair
475412M	367	Player 475 Leg-Base Multi-Purp Chair
475412MC	367	Player 475 Leg-Base Multi-Purp Chair
475415M	367	Player 475 Leg-Base Multi-Purp Chair
475415MC	367	Player 475 Leg-Base
475480M	371	Player 475 Sled-Base
475480MTL	373	Player 475 Sled-Base
475480MTR	373	Player 475 Sled-Base
475482M	371	Player 475 Sled-Base
475485M	371	Player 475 Sled-Base
475710M	375	Player 475 Leg-Base Stool
475712M	375	Player 475 Leg-Base Stool
475715M	375	Player 475 Leg-Base Stool
475A	376	Player 475 Alignment Device
475D	376	Player 475 Transport/Strg Dolly
475G	376	Player 475 Ganging Device
477100	432	Max-Stacker III 477 Series Stackable Chair
480110	299	Node 480 Series Work Chair
480120	299	Node 480 Series Work Chair
480130	301	Node 480 Series Collaborative Chair
480140	306	Node 480 Series Collaborative Stool
480150	301	Node 480 Series Collaborative Chair
480210	303	Node 480 Series MidBk Collab Chair
480220	303	Node 480 Series MidBk Collab Chair
480230	305	Node 480 Series MidBk Collab Chair
480240	307	Node 480 Series MidBk Collab Stool
480250	305	Node 480 Series MidBk Collab Chair
480310	308	Node 480 Series Collaborative Chair
480320	309	Node 480 Series Collaborative Stool
480330	308	Node 480 Series Collaborative Chair
480340	309	Node 480 Series Collaborative Stool
480410	310	Node 480 Series Collaborative Chair

Style Number	Page	Description	Style Number	Page	Description
480420	310	Node 480 Series Collaborative Chair	490710U	398	Move 490
4821410	132	Amia 482 Series Work Chair	490710UC	398	Move 490
4821410LS	129	Amia 482 Series Work Chair	490712	398	Move 490
4821412	139	Amia 482 Series Air Back Work Chair	490712C	398	Move 490
4821414	137	Amia 482 Series Air Back Work Chair	490712CP	399	Move 490
4821418	135	Amia 482 Series Chair	490712P	399	Move 490
4827410	142	Amia 482 Series Stool	490712U	399	Move 490
4827412	149	Amia 482 Series Air Back Stool	490712UC	399	Move 490
4827414	147	Amia 482 Series Air Back Stool	490D	403	Move Transport/Storage Dolly
4827418	145	Amia 482 Series Stool	490GA4	403	Move Ganging/Alignment Device
4871110	351	Cachet 487 Swivel-Base	490GA7	403	Move Ganging/Alignment Device
4871210	351	Cachet 487 Swivel-Base	490WS	403	Wall Saver
4871211	351	Cachet 487 Swivel-Base	499111	248	Siento Mid-Back Desk Chair
4877110	355	Cachet 487 Stool	499112	248	Siento Mid-Back Desk Chair
4877210	355	Cachet 487 Stool	499113	248	Siento Mid-Back Desk Chair
4877211	355	Cachet 487 Stool	499121	248	Siento Mid-Back Desk Chair
4878100	353	Cachet 487 Leg-Base	499122	248	Siento Mid-Back Desk Chair
4878110	353	Cachet 487 Leg-Base	499123	248	Siento Mid-Back Desk Chair
4878200	353	Cachet 487 Leg-Base	499211	248	Siento High-Back Desk Chair
4878201	353	Cachet 487 Leg-Base	499212	248	Siento High-Back Desk Chair
4878210	353	Cachet 487 Leg-Base	499213	248	Siento High-Back Desk Chair
4878211	353	Cachet 487 Leg-Base	499221	248	Siento High-Back Desk Chair
487BK	358	Cachet 487 Cushion Upholstery Pkg	499222	248	Siento High-Back Desk Chair
487D	360	Cachet 487 Transport/Strg Dolly	499223	248	Siento High-Back Desk Chair
487G	360	Cachet 487 Ganging/Alignment Device	499SIENTO	244	Siento Design Pkg High-Back Chair
487ST	359	Cachet 487 Cushion Upholstery Pkg	COLAGTP	528	Lagunitas Personal Table
487STBK	357	Cachet 487 Cushion Upholstery Pkg	COLAGTRECT	527	Lagunitas Work Table
488BD	463	Brody Privacy Desk	FLXPR1	321	Perch Stool
488BDE	465	Brody Privacy Desk with Extension	FLXPR4	321	Perch Stool
488FR	466	Brody Footrest	N3LBA1200	582	B-Free Small Beam, Aluminum Leg
488WE	461	Brody Privacy WorkLounge with Extension	N3LBA1600	580	B-Free Large Beam, Aluminum Leg
488WO	457	Brody WorkLounge	N3LBW1200	583	B-Free Small Beam, Wood Leg
488WP	459	Brody Privacy WorkLounge	N3LBW1600	581	B-Free Large Beam, Wood Leg
490410	393	Move 490	N3LCUBEL	574	B-Free Large Cube
490410C	393	Move 490	N3LCUBES	575	B-Free Small Cube
490410CP	394	Move 490	N3LGA	576	B-Free Ganging Brackets
490410P	394	Move 490	N3LMAGSC	578	B-Free Screen to Cube Magnets
490410U	394	Move 490	N3LMAGSS	578	B-Free Screen to Screen Magnets
490410UC	394	Move 490	N3LPINT	586	Pint Tables
490412	394	Move 490	N3LRECT	585	Rectangle Tables
490412C	394	Move 490	N3LSCREEN	577	B-Free Screen
490412CP	395	Move 490	N3LTABLECF	579	B-Free Occasional Coffee Table
490412P	395	Move 490	N3LTABLECR	579	B-Free Occasional Corner Table
490412U	395	Move 490	SLCO	201	Tenor Chair
490412UC	395	Move 490	SLCF	202	Tenor Chair
490510	401	Move 490 Perching Stool	SLCFH	204	Tenor Chair
490510P	402	Move 490 Perching Stool	SLCH	203	Tenor Chair
490510U	401	Move 490 Perching Stool	SLSB	205	Tenor Stool
490512	402	Move 490 Perching Stool	SLSBH	206	Tenor Stool, Bag Hook
490512P	402	Move 490 Perching Stool	SLSC	207	Tenor Perching Stool
490512U	402	Move 490 Perching Stool	SLSCH	208	Tenor Perching Stool, Bag Hook
490710	397	Move 490	STLLNG2AR2	509	Umami Lounge, Two Arms, Double
490710C	397	Move 490	STLLNGAR1	505	Umami Lounge, One Arm, Single
490710CP	398	Move 490	STLLNGAR2	507	Umami Lounge, One Arm, Double
490710P	398	Move 490	STLLNGCR1	511	Umami Lounge, Corner, Single

Style Number Index, continued

Style Number	Page	Description
STLLNGEC	513	Umami Lounge, End Cap
STLLNGST1	501	Umami Straight Lounge, Single
STLLNGST2	503	Umami Straight Lounge, Double
STLPLTF1	495	Umami Single Platform
STLPLTF2	498	Umami Double Platform
STLSCRPL	519	Umami Screens, Standard
STLSCRPLS	524	Umami Screens, Spanner Screens
TS30701	408	Scoop Stool
TS30702	408	Scoop Stool
TS31201A	336	Shortcut Chair
TS31202B	337	Shortcut Stool
TS31203	344	Shortcut Cushion
TS31204A	339	Shortcut X Base Chair
TS31205B	340	Shortcut X Base Stool
TS31206A	341	Shortcut Wood Chair
TS31207A	343	Shortcut Tripod Base Chair
TS31208A	343	Shortcut Tripod Base Chair
TS31209A	338	Shortcut Chair with Personal Worksurface
TS31401	596	Jenny Chair
TS31401C	596	Jenny Chair
TS31401CH	596	Jenny Chair
TS31401CT	596	Jenny Chair
TS31401H	596	Jenny Chair
TS31401T	596	Jenny Chair
TS31402	600	Jenny Chair
TS31402C	600	Jenny Chair
TS31403	604	Jenny Chair
TS31403C	604	Jenny Chair
TS31403CH	604	Jenny Chair
TS31403CT	604	Jenny Chair
TS31403H	604	Jenny Chair
TS31403T	604	Jenny Chair
TS31404	604	Jenny Chair
TS31404C	604	Jenny Chair
TS31404CH	604	Jenny Chair
TS31404CT	604	Jenny Chair
TS31404H	604	Jenny Chair
TS31404T	604	Jenny Chair
TS31405	615	Jenny Ottoman
TS31405C	615	Jenny Ottoman
TS31406	607	Jenny Chair
TS31406C	607	Jenny Chair
TS31407	609	Jenny Chair
TS31407C	609	Jenny Chair
TS31408	613	Jenny Chair
TS31409	611	Jenny Chair
TS31410	615, 632	Alight Ganging Kit
TS31412	617	Club Low
TS31413	619	Round Low
TS31415H	620	Jenny Occasional Table
TS31415L	620	Jenny Occasional Table
TS31416H	620	Jenny Occasional Table
TS31416L	620	Jenny Occasional Table
TS31426	607	Jenny Chair
TS31426C	607	Jenny Chair

Style Number	Page	Description
TS31428	613	Jenny Chair
TS31438	613	Jenny Chair
TS34401	552, 631	Alight Lounge Ottoman
TS34402	631	Alight Corner Ottoman
TS34403	631	Alight Bench Ottoman
TS34410T	632	Alight End Table
TS34411T	632	Alight Coffee Table
TS3BC	538	Campfire Big Lounge
TS3BCS	539	Campfire Big Lounge
TS3BCW	540	Campfire Big Lounge
TS3CRIN60S	549	Campfire Corner Lounge
TS3CRIN60W	551	Campfire Corner Lounge
TS3CRIN90S	545	Campfire Corner Lounge
TS3CRIN90W	547	Campfire Corner Lounge
TS3CROUT60S	549	Campfire Corner Lounge
TS3CROUT60W	551	Campfire Corner Lounge
TS3CROUT90S	545	Campfire Corner Lounge
TS3CROUT90W	547	Campfire Corner Lounge
TS3FR	555	Footrest
TS3GANGING	551	Campfire Ganging Bracket
TS3HL	541	Campfire Half Lounge
TS3HLS	542	Campfire Half Lounge
TS3HLW	543	Campfire Half Lounge
TS3WG	554	Campfire Wedge
TS4PF	553	Campfire Pouf
TS4TSCRNL	555	Campfire Screen
TS4TSCRNR	555	Campfire Screen
TSAVNBC	384	Simple Back Cushion
TSAVNCH	380	Simple Chair
TSAVNLC	382	Simple Lounge
TSAVNS1	385	Simple Relaxed Slipcover
TSAVNS2	386	Simple Tailored Slipcover
TSAVNSC	383	Simple Seat Cushion
TSAVNST	381	Simple Stool
TSBUOY	438	Buoy
WHG6600	419	Nooi Linking Chair, Armless
WHG6602	419	Nooi Linking Chair, Arms
WHG6604	421	Nooi Sled-Based Chair
WHG6606	423	Nooi 4-Leg Base Chair, Armless
WHG6608	423	Nooi 4-Leg Base Chair, Arms
WHG6625	425	Nooi Bar-Height Stool
WHG6626	425	Nooi Cafe-Height Stool
WHGDOLLY	426	Nooi Transport Dolly

Trademark List

® The following are registered trademarks for products of Steelcase Inc. or one of its related corporate entities: 4 o'clock, 900 Series, à la carte, Airtouch, Ally, Amia, Answer, Archipelago, Avenir, Ballet, Bix, Brayton International, Cachet, Canopy, Canto, Chancellor, Coalesse, Confidante, Context, Convene, CopyCam, Criterion, Crushed Can, Currency, dash, Designtex, Details, Detour, Drive, Elective Elements, Ellipse, Ember Chrome, Emerge, E-Table 2, FYI, Garland, Gentry, Ginkgo Biloba, Groupwork, Ideo, Jacket, Jenny, Jersey, Kart, Kick, LaCosta, Leap, LessThanFive, Let's B, LiveBack, Max-Stacker, media:scape, Metro, Migrations, Mitra, Montage, Nurture, Oriana, Parade, Pathways, PCT, Permiso, Player, Portal, Power Pincher, Progeny, Protégé, R2, Rally, Relevant, Reply, Rizzi Arc, Sensor, Series 9000, Siento, Sieste, Sine, Softcare, Springboard, Steelcase, Steelcase Design Partnership, Stella, Stow Davis, Swathmore, Sylvi, TeamWork, Technique, Texpress, Think, Thunder, Topo, Train, turnstone, Underline, Unison, Vecta, Viridian, Walden, Wernld, and X-Stack.

® The following registered trademarks are under license from AWI Licensing Company, Dover, DE: SoundScapes, DuraBrite, BioBlock, and Armstrong.

® The following registered trademarks are under license from Byrne Electrical, Rockford, MI: Interport, Mini-Port, Axil Z, and Ellora.

® The following is a registered trademark of DuPont, Wilmington, DE: Corian.

® The following is a registered trademark of Genlyte Thomas Company, Louisville, KY: Lightlior.

® The following is a registered trademark of Hilti Corporation, FL-9494 Schaan, Principality of Liechtenstein: Hilti.

® The following is a registered trademark of Leviton Manufacturing Company, Little Neck, NY: Decora.

® The following is a registered trademark of Mechanical Plastics Corp, Elmsford, NY: Toggler.

® The following is a registered trademark of Microsoft Corporation, Redmond, WA: Microsoft.

® The following are registered trademarks of Orangebox Ltd., Cardiff, UK: Orangebox.

® The following is a registered trademark of Panduit Corporation, Lockport, IL: Panduit.

® The following is a registered trademark of Trav (Press), Cuneo, Italy: Assisa.

® The following is a registered trademark of Virtual Ink, Boston, MA: mimioActive.

® The following registered trademarks are under license from Wilkhahn Furniture Products: Avera, Senzo, Versal, and Wilkhahn FS.

® The following are registered trademarks of Polyvision Corp: Flow, Motif, Polyvision, Sans, and Serif.

® The following is a registered trademark of Wilsonart International, Temple, TX: Chemsurf.

® The following is a registered trademark of Wiremold, West Hartford, CT: Wiremold.

® The following is a registered trademark of EMU Group S.P.A., Perugia, Italy: EMU.

® The following is a registered trademark of Security People, Inc.: Digilock.

® The following are registered trademarks of Natural Capital Partners Europe Limited: CarbonNeutral and the CarbonNeutral Certified logo.

™ The following are trademarks for products of Steelcase Inc. or one of its related corporate entities: Access, Active/Passive Shelf, Agree, Ainsley, Akira, Alcove, Alerion, Alight, Amaris, American Elect, American Tradition, ap40, Arbor, Arriva, Asana, Ascot, Aspekt, Astor, Await, Bassline, B-Free, Bira, Bivi, Bixby, Bottomline, Brody, Brook, Buoy, Burton, c:scape, Calla, Calm, Camber, Campfire, Capa, Cappuccino, Cesar, Chester, Chord, Circa, Clarendon, Classic Rectangular, Clipper, cobl, Collaboration, Community, Company, Convey, Cortex, Coupe, Crea, Crew, Cura, Cypress, Davenport, Dearborn, Deck, Déjà, Denizen, Denska, Derby, DeskWizard, Divisio, Donovan, Dune, Duo, Echo, Edge, Elbrook, Elsa, Empath, Empress, Enea, ēno, EnSync, Enviro, Escapade, Everwall, Exchange, Exponents, Field, Flat Top, FlexFrame, Flip Top, Flute, Folio, FrameOne, FreeFlow, Frontier, Galilei, Gesture, Ginger, Ginkgo, Go Wall, Grip, Groove, Hatchback, Hawthorne, Hitch, Host Collection, Hosu, Huddleboard, i2i, Impact, Indy, InfoLink, IOS, I-Solve, Jack, Jarrah, Jetty, Juice, Kami, Kast, Kathryn, Lagunitas, Lark, L'Attitude, LearnLab, Leela, Lincoln, Linden, LiveSeat, Loria, Lyric, Malibu, Malibu Too, Mansfield, Marathon, Marien152, Martini, Mason, Masque, Migration, Millbrae, Mineral, Mingle, Mystic, Mystic Metal, Mystic Wood, Montara650, Montreal, MoreThanFive, Move, Nadia, Neighbor, nesso, Nickel, Nikko, Nod, Node, Norfolk, Ocular, Ology, Ontrak, Oom, Opus, Orchid, Outlook Collection, Ovation, Paloma, Paperflo, Parliament, Pasio, Passerelle, Patriarch, Payback, Peek, Pile File, Pisa, Pool, Potrero415, PUCK, QiVi, Quba, Radia, Rave, Reed, Regard, Relay, Reunion, Ripple, Riser, Roam, Rocco, Rocky, RoomWizard, Runner, Satellite, Sawyer, ScapeSeries, Senti, Sentinel, Senza, Sequoia, Session, ShareLink, Shield, Shortcut, Sidewalk, SILQ, Skylar, Slumber, Smoke, Snug, Soft Leaf, Sonata, Sorrel, SOTO, Southside, Stationkits, Steelcase Karman, Steelcase Series, Stiletto, Surprise!, Surround, Switch, Symphony, Sync, TagWizard, Tava, TeamStudio, TeamTheater, Tenaro, Tenor, Terrazzo, Theorem, Thread, Topaz, Touchdown, Tour, Tower Too, Trees, Trillium, Trolly, tX2, U-Free, Umami, Underscore, Uno, V.I.A., Verb, Verge, Verlay, Victor2, Visalia, Waldorf, Woodruff, Workspring, WorkValet, and X-tenz.

™ The following is a trademark of Microsoft Corporation, Redmond, WA: Windows.

™ The following is a trademark of Rodman Industries, Inc., Oconomowoc, WI: ResinCore1.

™ The following is a trademark of Ultrafabrics, LLC, Elmsford, NY: Ultraleather.

™ The following trademarks are under license from Wilkhahn Furniture products: Cana, Linus, Logon, Picto, Range, Stitz, Thema, Timetable, and Tubis.

™ The following is a trademark of Cradle to Cradle Products Innovation Institute, Oakland, CA: Cradle to Cradle Certified.

™ The following trademarks are under license from Walter Knoll: Andoo, Bob, Lazlo, Lox, Ribbon, and Together.

™ The following trademarks are under license from PP Møbler: Bar and Flag Halyard.

™ The following trademarks are under license from Carl Hansen: Elbow, Paddle, Shell, Wing, and Wishbone.

™ The following trademarks are under license from Cambridge Sound Management, LLC, Cambridge, MA: QtPro Soundmasking, Qt Quiet Technology, and Sonet Qt.

™ The following is a trademark of Electri-Cable Assemblies, Shelton, CT: Interact.

™ The following is a trademark of Clestra Hauserman: IRYS.

™ The following is a trademark of Wiesner-Hager Möbel GmbH: Nooi.

™ The following are trademarks of Polyvision: Accord, a³, e³, Boundri, and Nota.

™ The following is a trademark of Bostock Company, Inc: SnapCab.

™ The following is a trademark of Williams-Sonoma, Inc: West Elm.

™ The following is a trademark of Elena Marquina Testor: nanimarquina.

™ The following is a trademark of Forbo International SA: Forbo.

™ The following are trademarks of Orangebox Ltd., Cardiff, UK: Air³, Aspect, Avi, Away from the Desk, Border, Campers & Dens, Coppice, Cubb, Kirm, On the QT, Ramsey, Skoner, Sully, Track-B, and Vale.

™® The following are trademarks or registered trademarks of AMQ Solutions, LLC: AMQ, AMQ logo, KINEX, ILINE, ACTIV, AMOBI, CONCUR, 3F, REVI, S-SERIES, JAKU, SIYA, ZILO, BODI, FL-X, TIZU, EMBANK, TEKTIS, and BIXBY.

™® The following are trademarks or registered trademarks of Viccarbe Habitat, S.L.: Holy Day, Last Minute, Wrapp, Foro, Kelly, Noha, Viable, Solar, Sistema, Savina, Designed In The Sun, Cambio, Aleta, Viccarbe (logo), Viccarbe.

Trademarks used here in are the property of Steelcase Inc. or of their respective owners.