



Orangebox Specification Guide

Availability

Electronic price list updated with release 200.K (U.S.) and 156.K (Canada), dated February 26, 2024.

All specifications subject to change without notice. Reference the electronic catalog/Hedberg for current pricing.

Transitional products in this specification guide are **maintained for existing customers only** and are likely to be phased out over time. These products are indicated with a . Products that are scheduled to be culled are indicated with an , followed by the last order entry date.

Surface Materials

The surface materials team has announced the launch of the Finish Library, found at www.steelcase.com/finishlibrary/.

► For a list of all trademarks, refer to the last page of this specification guide. © 2024 Steelcase Inc.

Working with This Specification Guide

Ten Tips: How to Get The Most Out of This Book	2
Additional Resources	4

Statement of Line

6

Product Details

Air ³	16
On the QT	22
Aspect	26
Avi	28
Sully, Ramsey, and Skomer	29
Border	30
Away from the Desk	32
Cubb Seating and Tables	36

Specifying

41

Style Number Index

188



For Canadian Pricing

Canadian factor can be found at www.steelcase.com/CADpricing/. Calculate in the following order to avoid rounding errors:

- Multiply the base price and each option by the Canadian factor.
- Round each to the nearest dollar.
- Add base and options for total list price.

Tip 5

Refer to the specifying pages for all the information needed to order a product. Each product specifying page contains a variety of elements to help you complete a specification:

- Product Drawing
- Standard Includes
- Options
- Specification Information
- Dimensions
- Style Number
- Price

Product Drawing shows you what the product looks like.

Standard Includes (under the red or dark grey band) provides a list of what comes standard with the product.

Specification Information (under the teal or light grey band) provides product dimensions, style numbers, and prices for the standard product and any surface material choices that are available.

Options (under the black band) lists all the options that apply to the product, their price, and what is required to specify.

Tip 6

Required to Specify
Specify with <i>Customiz Stain</i>

Italic typeface on specifying pages usually identifies wording that you should use in your order.

i

Tip 7

To determine how many skins are needed to complete a panel, consult the table at the right.
Tip: Remember to order skins for both sides of the panel buildup.

Watch for tips throughout the text that give you explanations and helpful instructions.

Tip 8

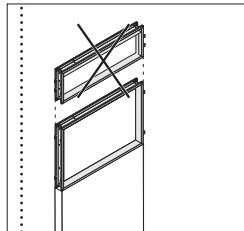

Learn what you cannot do by looking for drawings crossed out with an "X".

Tip 9

Style Number	Page
TS7042BL	131
TS7042S	130
TS7048BL	131
TS7048S	130
TS7060BL	131
TS7060S	130
TS7072BL	131

Refer to the style number index when you know a style number and you need to find the page that has more details about the product.

Additional Resources

Orangebox products are supported with informational materials, tools, and software to help you plan, specify, and order an installation efficiently.

Printed Materials

Other Specification Guides

Steelcase offers a comprehensive portfolio of furniture and solutions. For the full offering of products, refer to the individual product specification guides. These can be accessed at the www.steelcase.com web site or at village.steelcase.com

Computer Tools

Electronic Catalog

Accurate sales quotations and purchase orders for Steelcase products are created with specification software that uses Steelcase Electronic Catalog data. Use the data to specify and price style numbers and options for every Steelcase product. The data is updated bimonthly by Steelcase and provided to software programs including: the Hedberg Business System, SmartTools—Steelcase's design and specification software (for more information on SmartTools, please email SmartTools@steelcase.com), the ProjectMatrix Project Symbols libraries, as well as 20-20 CAP Studio.

Furniture Symbol Graphic Data

Steelcase creates 2D and 3D furniture symbols (with attributes) for planning and initially specifying Steelcase products. This data is incorporated into several add-on software packages that work in either a Microstation or an AutoCAD drafting environment.

Digital Publications

You can access these digital publications at www.steelcase.com or village.steelcase.com.

Support

Steelcase Capabilities

Steelcase products are distributed, installed, and serviced through a network of more than 600 dealers worldwide. Steelcase is also represented with offices and corporate showrooms in 26 U.S. cities, 4 Canadian cities, and in France, Germany, Great Britain, and Japan. Every Steelcase product meets our exceptionally high standards of quality and durability and comes with the Steelcase assurance of excellence in service.

For ordering or product assistance,

please call your local dealer, the Steelcase Solutions Resource Team, or the Steelcase Solutions Fulfillment Team at 1.888.STEELCASE (1.888.783.3522) or send an e-mail to lineone@steelcase.com.

Call the Steelcase Solutions Resource Team prior to placing an order, when working on a bid, or when you need information about product applications and specifications.

Call the Steelcase Solutions Fulfillment Team if you have submitted an order to Steelcase and you need to speak to your Solutions Fulfillment Team Representative about the order. Also call if you have any post-shipment quality concerns or service parts questions.

For warranty information, please go to: <http://www.steelcase.com/warranty/>.

Outside the U.S.A., Canada, Mexico, Puerto Rico, and the U.S. Virgin Islands, call 1.616.247.2500.

For information about Steelcase, the name of your nearest Steelcase dealer, or for product literature, call 1.800.333.9939 or visit our Web site: www.steelcase.com.

Statement of Line

Air³

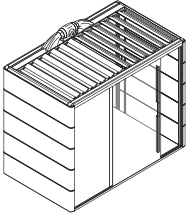

Half Square with Opening Roof

Understanding
▶ Page 16
Specifying
▶ Page 42

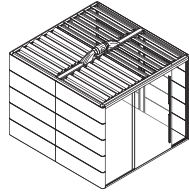

Square with Opening Roof

Understanding
▶ Page 16
Specifying
▶ Page 44

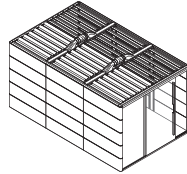

Rectangle with Opening Roof

Understanding
▶ Page 16
Specifying
▶ Page 46

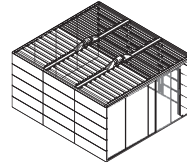

Square 3X3 with Opening Roof

Understanding
▶ Page 16
Specifying
▶ Page 48

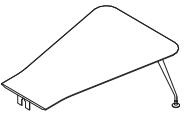

Small Pod Table

Understanding
▶ Page 16
Specifying
▶ Page 50

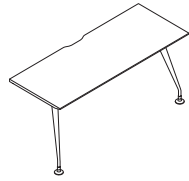

Short, Straight Pod Table

Understanding
▶ Page 16
Specifying
▶ Page 50

On the QT

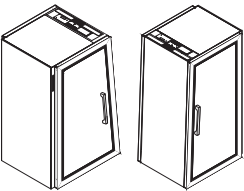

Short Angled Phone Booth, LH or RH Hinge

Understanding
▶ Page 22
Specifying
▶ Page 53

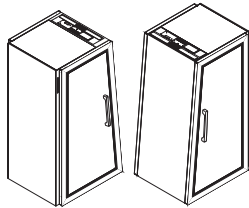

Tall Angled Phone Booth, LH or RH Hinge

Understanding
▶ Page 22
Specifying
▶ Page 56

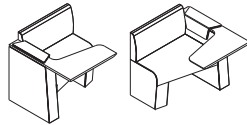

Furniture Seat, LH or RH Application

Understanding
▶ Page 22
Specifying
▶ Page 59

Aspect

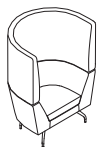

One Seat Work Unit with Curved Arm

Understanding
 ▶ Page 26
 Specifying
 ▶ Page 61

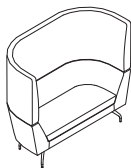

Two Seat Work Unit with Curved Arm

Understanding
 ▶ Page 26
 Specifying
 ▶ Page 63

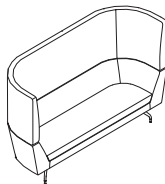

Three Seat Work Unit with Curved Arm

Understanding
 ▶ Page 26
 Specifying
 ▶ Page 65

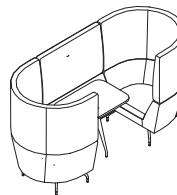

Two Seat Work Screened Unit with Fixed Table

Understanding
 ▶ Page 26
 Specifying
 ▶ Page 67

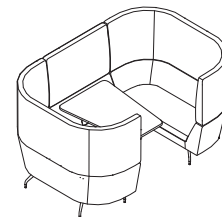

Four Seat Work Screened Unit with Fixed Table

Understanding
 ▶ Page 26
 Specifying
 ▶ Page 71

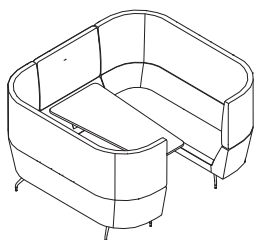

Six Seat Work Screened Unit with Fixed Table

Understanding
 ▶ Page 26
 Specifying
 ▶ Page 75

Avi



Upholstered Chair with Swivel Base

Understanding
 ▶ Page 28
 Specifying
 ▶ Page 79



Hooded Upholstered Chair with Swivel Base

Understanding
 ▶ Page 28
 Specifying
 ▶ Page 79



Upholstered Chair with Wire Frame Base

Understanding
 ▶ Page 28
 Specifying
 ▶ Page 80



Hooded Upholstered Chair with Wire Frame Base

Understanding
 ▶ Page 28
 Specifying
 ▶ Page 80

Sully, Skomer, and Ramsey

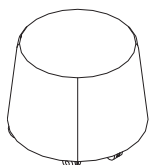

Upholstered Stool

Understanding

▶ Page 29

Specifying

▶ Page 82

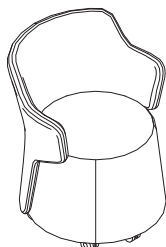

Upholstered Arm Chair

Understanding

▶ Page 29

Specifying

▶ Page 83

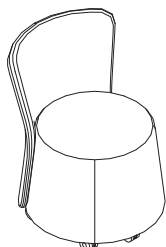

Upholstered Work Chair

Understanding

▶ Page 29

Specifying

▶ Page 85

Border

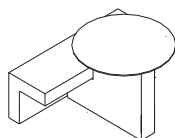

One Seat, Low, with 32" Dia. Table

Understanding

▶ Page 30

Specifying

▶ Page 87

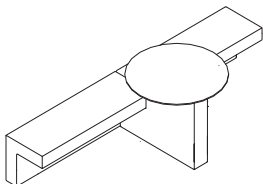

Two Seat Low, with 32" Dia. Table

Understanding

▶ Page 30

Specifying

▶ Page 88

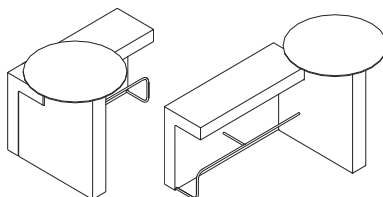

One Seat High, with Left or Right Hand 32" Dia. Table

Understanding

▶ Page 30

Specifying

▶ Page 89

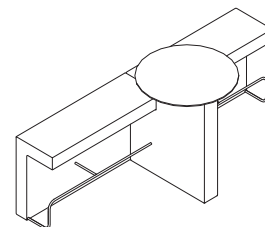

Two Seat, High, with 32" Dia. Table

Understanding

▶ Page 30

Specifying

▶ Page 89

Away from the Desk Seating

Understanding
▶ Page 32
Specifying
▶ Pages 93–134

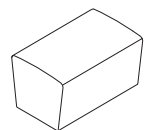

31 1/2"W Modular Straight Seat

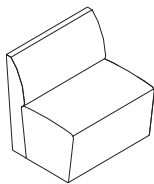

31 1/2"W Modular Straight Seat with Back

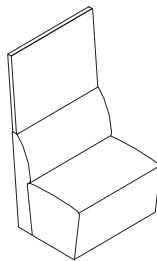

31 1/2"W Modular Straight Seat with Back and Screen

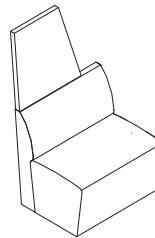

31 1/2"W Modular Straight Seat with Back and Left or Right Hand Tapered Screen

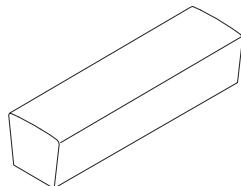
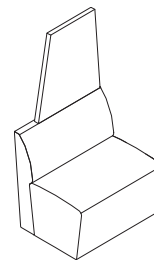

70 7/8"W Modular Straight Seat

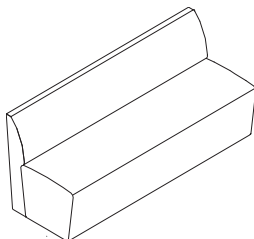

70 7/8"W Modular Straight Seat with Back

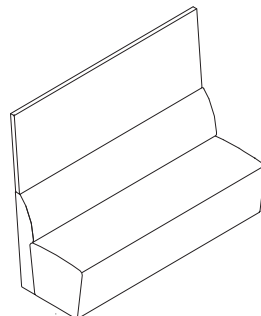

70 7/8"W Modular Straight Seat with Back and Screen

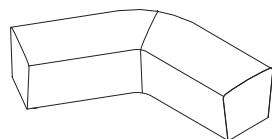

120° Modular Seat

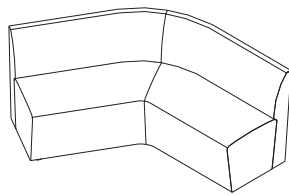

120° Modular Seat with External Back

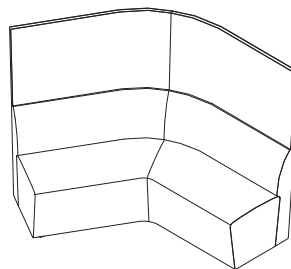

120° Modular Seat with External Back and Screen

Away from the Desk, continued

Seating

Understanding
▶ Page 32
Specifying
▶ Pages 93–134

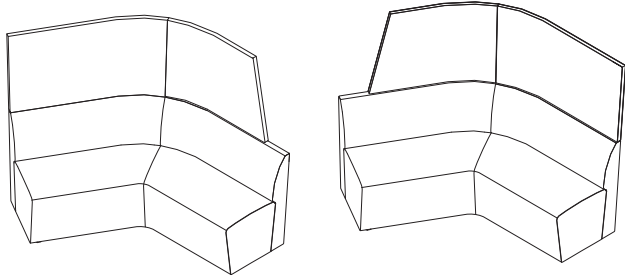

120° Modular Seat with External Back and Left or Right Hand Tapered Screen

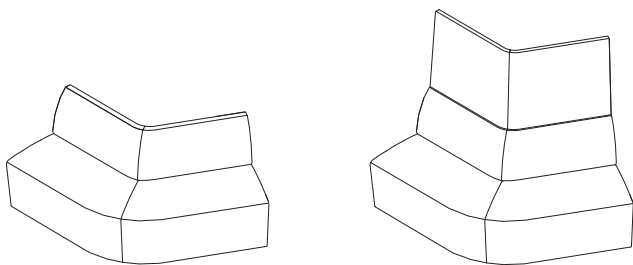

120° Modular Seat with Internal Back

120° Modular Seat with Internal Back and Screen

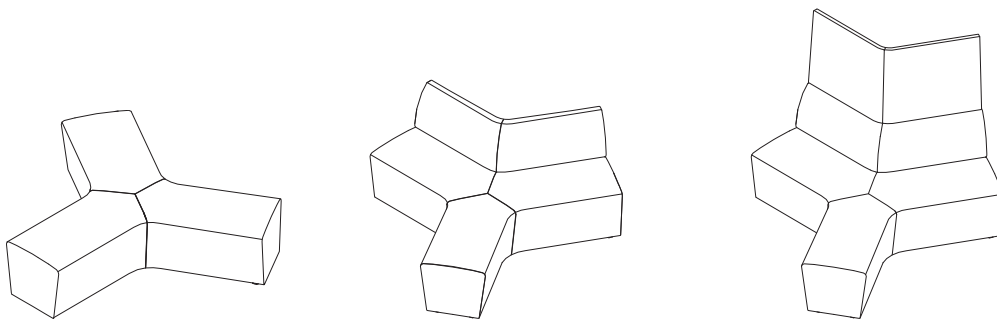

120° Modular Tri-Seat

120° Modular Tri-Seat with Internal Back

120° Modular Tri-Seat with Internal Back and Screen

Away from the Desk, continued

Seating

Understanding
▶ Page 32
Specifying
▶ Pages 93–134

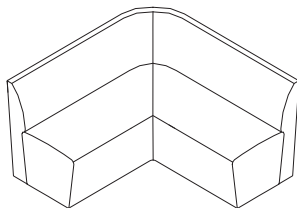

90° Modular Seat with Back

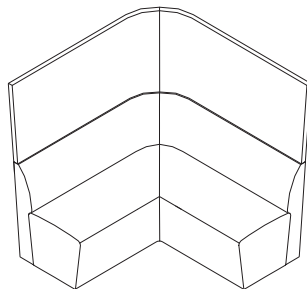

90° Modular Seat with Back and Screen

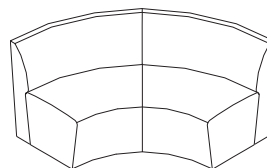

90° Modular Curved Seat with Back

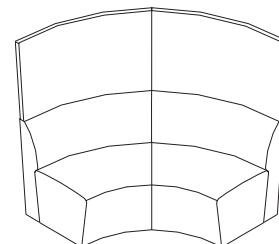

90° Modular Curved Seat with Back and Screen

Away from the Desk

Tables

Understanding
▶ Page 32
Specifying
▶ Pages 137–141

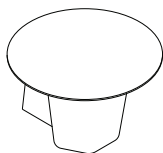

Modular Small Round Top with Large Upholstered Tapered Base

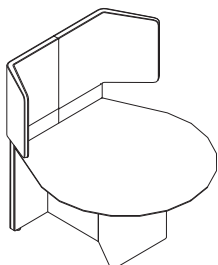

Media Unit with Low, D Shaped Top

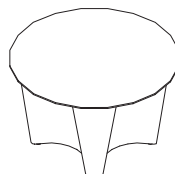

47¹/₄ Dia. Huddle Buddle Group Working Table

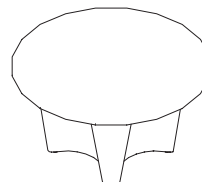

55¹/₈ Dia. Huddle Buddle Group Working Table



23⁵/₈ Dia. Low Table

Away from the Desk

Detached Seating

Understanding
▶ Page 32
Specifying
▶ Pages 142–149

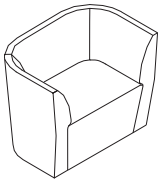

Single Seat Detached Unit

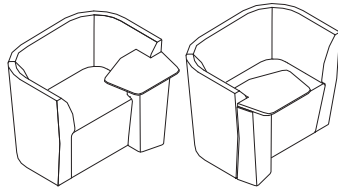

Single Seat Detached Unit with Left or Right Hand Integrated Tablet

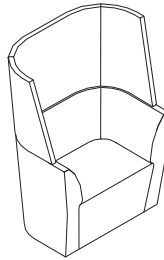

Single Seat Detached Unit with Screen

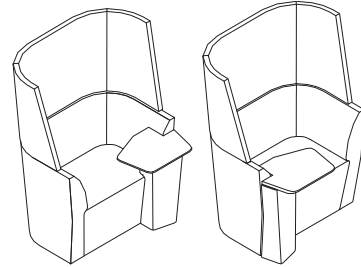

Single Seat Detached Unit with Screen and Left or Right Hand Integrated Tablet

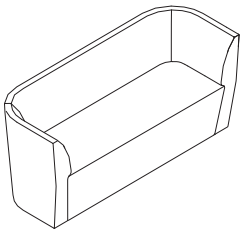

Three Seat Detached Unit

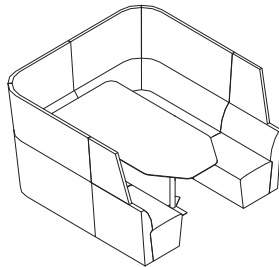

Enclosed Media Den

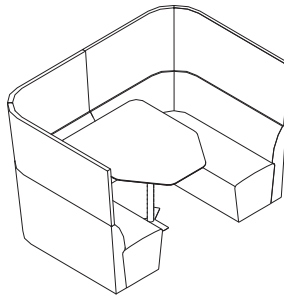

Enclosed Media Den for Four to Six People

Cubb Seating

Understanding
▶ Page 36
Specifying
▶ Pages 151–164



Armless Chair with Wood Legs

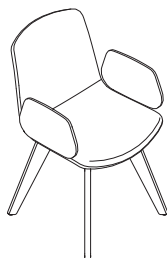

Upholstered Arm Chair with Wood Legs

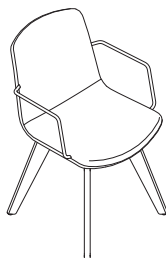

Wire Arm Chair with Wood Legs



Armless Chair on 4-Star Trestle Base

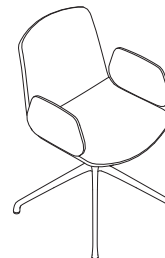

Upholstered Arm Chair on 4-Star Trestle Base



Wire Arm Chair on 4-Star Trestle Base

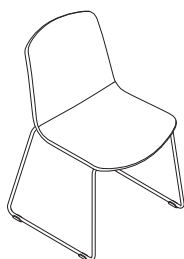

Armless Chair with Wire Frame Base

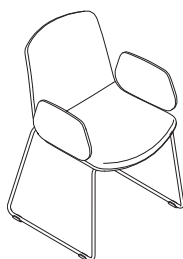

Upholstered Arm Chair with Wire Frame Base

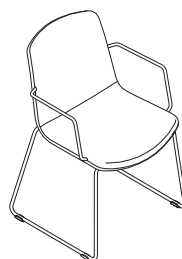

Wire Arm Chair with Wire Frame Base



Armless Chair on 5-Star Base



Upholstered Arm Chair on 5-Star Base

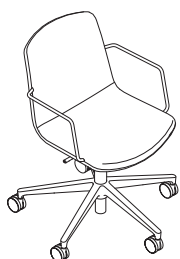

Wire Arm Chair on 5-Star Base

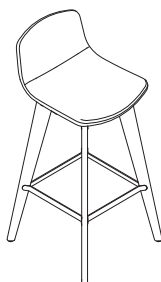

Barstool with Oak Base

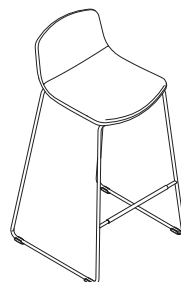

Barstool with Wire Frame Base



Occasional Stool with Oak Base

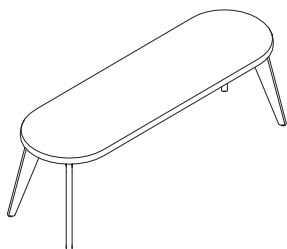

Two Seat Bench

Cubb Tables

Understanding
▶ Page 38
Specifying
▶ Pages 167–187



Four Person Round Meeting Table



Six Person Round Meeting Table

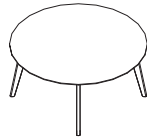

Seven Person Round Meeting Table

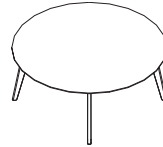

Eight Person Round Meeting Table

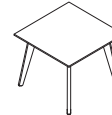

Four Person Square Meeting Table



Four Person Square Meeting Table with Softened Corners



Four Person Rectangle Meeting Table

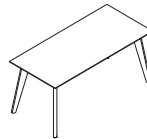

Four to Six Person Rectangle Meeting Table

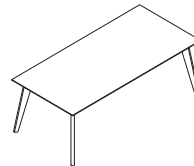

Six to Eight Person Rectangle Meeting Table

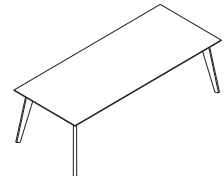

Eight Person Rectangle Meeting Table

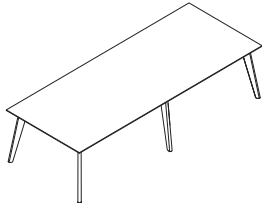

47"D Eight to Ten Person Rectangle Meeting Table

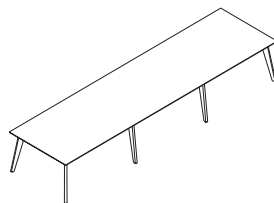

47"D 12-14 Person Rectangle Meeting Table

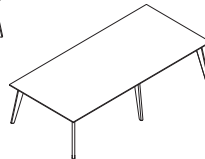

55"D Eight to Ten Person Rectangle Meeting Table

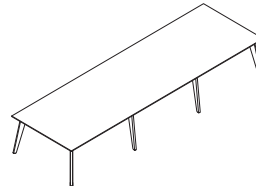

55"D 12-14 Person Rectangle Meeting Table

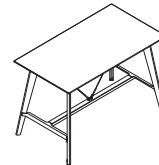

Four to Six Person Standing Height Project Table



Six to Eight Person Standing Height Project Table

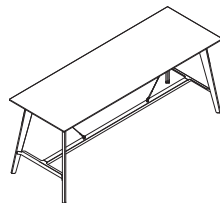

Eight to Ten Person Standing Height Project Table



23 5/8"W Round Occasional Table



31"W Round Occasional Table

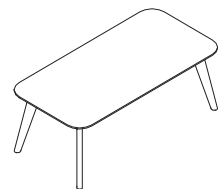

Rectangle Occasional Table



Square Occasional Table

Air³

Air³ is a modular freestanding meeting room. Its internationally patented opening roof system features an advanced fire safety system developed specifically for sprinklered office environments.

► Specifying, pages 42–48

Louved roof controlled by motion sensor as well as user control buttons.

Air circulation fan.

Exterior and interior side panels are upholstered acoustic panels.

Front and back panel glass are tempered glass.

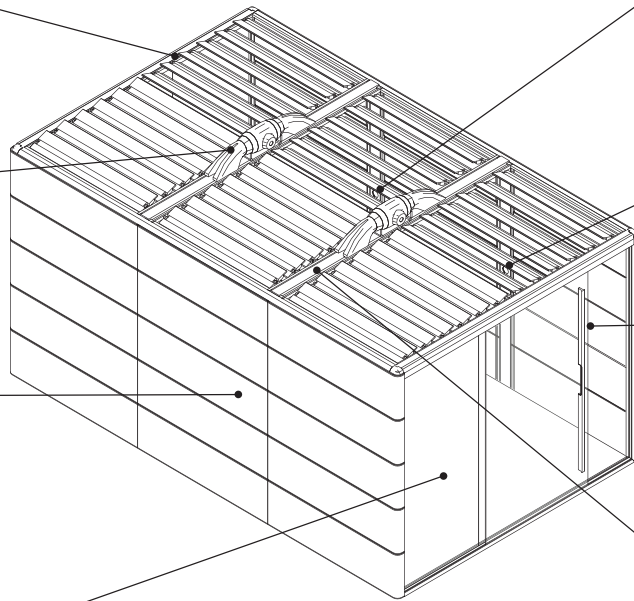

Service hoop control panel side includes touch button controls for lighting, air circulation, and roof.

Service hoop power side includes three NEMA 5-15 3-prong power outlets and two data connection cutouts.

Sliding glass door can be fitted to open right to left, or left to right, at time of installation.

Service hoop horizontal bar includes three LED lights, two heat detectors, monitor sensor, and fan.

Pod Dimensions

	External Dimensions			Internal Dimensions			
	Depth	Width	Height	Depth	Width	Height*	Weight
OB1AIR23	5' 6"	9' 2"	8' 4"	5' 1"	8' 7"	7'	1017 lb
OB1AIR25	9' 9"	9' 2"	8' 4"	9' 5"	8' 7"	7'	1313 lb
OB1AIR27	14' 5"	9' 2"	8' 4"	14' 1"	8' 7"	7'	1738 lb
OB1AIR29	14' 4"	13' 4"	8' 4"	14' 1"	13'	7'	2085 lb

Tip: Minimum height recommended for a sprinkler covered space is 9'3" to allow for 18" clearance between the top of the open roof blade and a sprinkler head above it. These are recommendations as it is still up to the local authority having jurisdiction to identify their building requirements.

**Internal height when roof blades open is 6'9".*

Table Dimensions

	Depth	Width	Height	Weight
OB1AIR30	69"	45"	29"	56 lb
OB1AIR35	24"	61"	29"	47 lb

Product Details

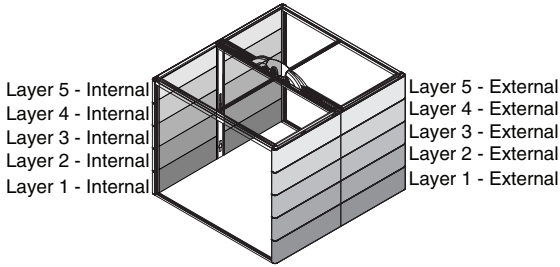

Fabric panel layer numbering begins from the bottom position.

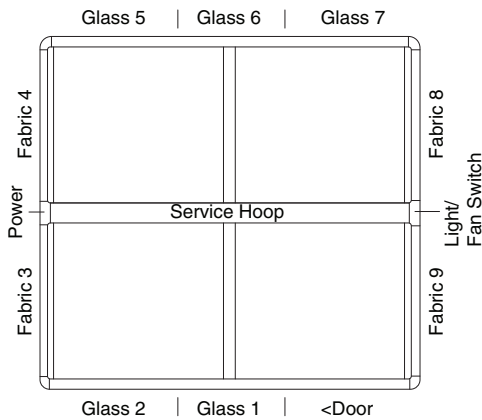

Panel positions account for both glass and fabric panels and are determined when standing outside of the pod with a right to left opening door.

Optional whiteboards can be installed in place of internal fabric panels on layers 3 and 4. Dimensions are 50³/₄" x 34³/₄".

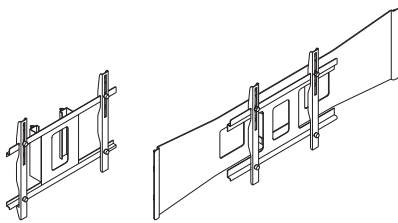

Monitor brackets are available in two different styles and both support a monitor up to a maximum weight of 55 pounds:

- Over upholstery monitor brackets—mounted directly to the fabric panels on layers 3 and 4.
- Hoop mounted monitor brackets—attached to the power side of the service hoop.

Space Layout Constraints

Do not obstruct exit corridor. Ensure visibility to on site alarm strobes is not blocked. If sprinklers are not required interior to the unit, be advised that local codes typically prohibit obstructions within 18" (457.2 mm) of the existing building sprinklers. Ensure final placement of the unit does not block airflow inlets or outlets of the building or unit ventilation systems.

Electrical Connections

Hardwired units: Electric power is delivered through a hardwired connection which must be routed to a junction box in the floor, wall, or ceiling via a conduit whip. Orangebox does not provide the conduit whip to make the power connection to the building. It is the responsibility of the qualified site electrician to supply and install a suitable power connection to the building in accordance with local codes.

The assembly directions and user guide describe the enclosures which contain the electrical services such as power, lighting, and airflow. Lighting, fan, outlets, and sensors share one circuit within the unit. The enclosure may accommodate a single 15 Amp connection. The maximum loading of the components within the enclosure is 1.8 Kilowatts at 120 VAC.

Power usage when occupied is 100W (not including any plugged-in external equipment) per hoop.

Electrical Components

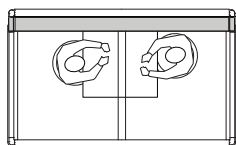
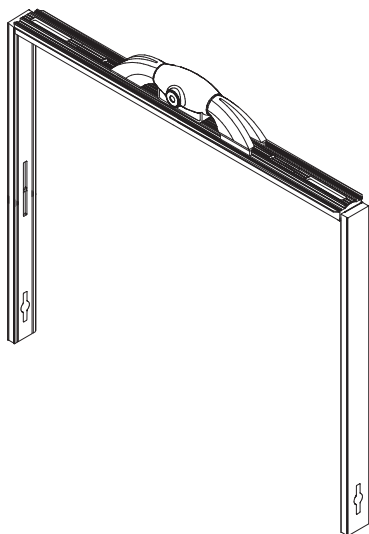

The **service hoop** contains all the electrical services, including power, lighting, and airflow.

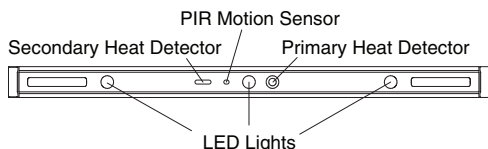

Service hoop horizontal bar includes three LED lights, two heat detectors, motion sensor, and fan.

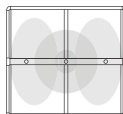

Work
 Lux level at table height: 450-850
 Center light: 100%
 Outer light: 100%

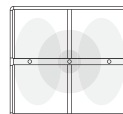

Think
 Lux level at table height: 120-400
 Center light: 50%
 Outer light: 20%

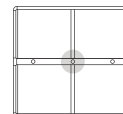

Present
 Lux level at table height: 50-60
 Center light: 20%
 Outer light: OFF

Three LED lights are used for illumination. The lights are 4000K with a max brightness of 1300 lumens.

Passive inferred (PIR) motion sensor turns on the power to the pod when activated. Power is shut off within the pod after five minutes of inactivity.

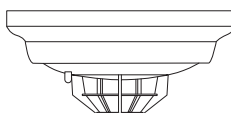

Primary heat detector will cut all power in the pod and open the roof fully if heat at 135°F (57°C) is detected.

Secondary heat detector acts as a failsafe fusible link and will cut all power in the pod and open the roof fully if heat at 150.8°F (66°C) is detected.

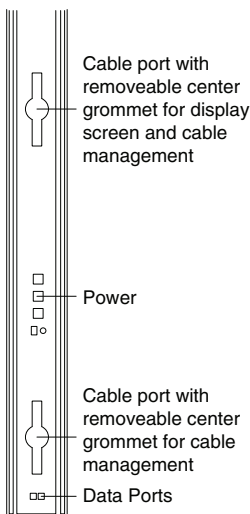

Service hoop power side comes standard with three NEMA 5-15 3-prong power outlets, two data connection cutouts, and two cable ports with removable center grommet for cable management.

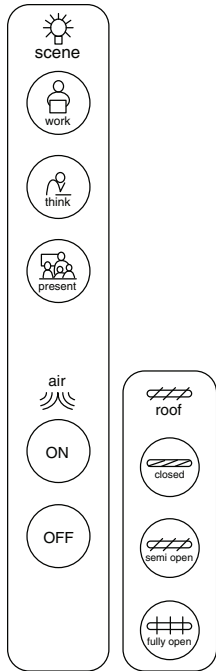

Service hoop control panel side includes touch button controls for lighting, air circulation, and roof.

The patented louvred roof has three settings: fully open, semi open, and closed. When the pod is unoccupied, the roof is always open. When entering the pod, the passive inferred sensor (PIR) senses movement and closes the roof to create acoustic privacy. When the pod is occupied, it is possible to select either 10° (semi) or 90° (fully) open position manually for enhanced airflow. The PIR turns the power off after five minutes and the roof automatically opens.

Occupancy sensor activates the lights and fan. The sensor operates at low voltage and utilizes both ultrasonic and infrared sensing to avoid false triggering.

Airflow and Handling

Ventilation fans are rated at 330 cubic feet of air per minute (CFM) and 23 dBA.

Tip: Fan CFM ratings alone cannot be used to determine the actual system ventilation rate.

Building and Fire Code Compliance

Seismic considerations: For seismic considerations, the building’s Structural Engineer of Record (SEOR) must be consulted. Seismic structural analysis report prepared by a licensed professional engineer may be required for specific locations.

Fire suppression: Sprinkler requirements are an important consideration for product assembly. Local codes may impact the number and location of mandated sprinklers. It is important to check with the local authorities to ensure product installation meets local requirements. If required, sprinkler location options within the unit are identified in product-specific assembly directions.

Fire alarms: National Fire Protection Agency (NFPA) 72 requires a fire alarm to be at least 15 dB above ambient to ensure occupants can hear the alarm. This is an on-site requirement. This may require a visible and/or audible notifier within the unit. If the unit is equipped with a fire detection system, some jurisdictions may require it be connected to the building’s fire detection system.

Energy efficiency: ASHRAE 90.1 and California Energy Commission (CEC) Title 24 identify lighting controls and power density requirements. This is an on-site requirement. Ensure this unit in its final environment adheres to these standards by confirming with local authorities.

Surface Materials

External and Internal Air³ Panels

- Camira Synergy
- Designtex Billiard Panel
- Designtex Billiard Select Surfaces
- Designtex Brushed Flannel
- Designtex Gamut
- Designtex Woolish
- Designtex Everywhere Texture
- Dovetail by Designtex
- Gabriel Europost 2
- Gabriel Tonal
- Gabriel Medley
- Guilford of Maine Anchorage*
- Kvadrat Divina MD*
- Kvadrat Divina Mélange 3*
- Kvadrat Divina 3*
- Maharam Mode*
- Steelcase Buzz2
- SoftNext

**Tip: Only fabrics permitted for use in Canada.*

Tip: Fabrics are Graded-In. Please reference the COM database to identify appropriate price grade.

Table Top Finish

- Fiber HPL
- Micro HPL
- Patina HPL
- Solid HPL
- Speckle HPL
- Woodgrain HPL
- Textured Industrial HPL
- Textured Woodgrain HPL

Table Edge Finish

- Plastic

Table Leg Finish

- Black
- Polished
- Silver

Tip: For comparable finish, please reference Steelcase standard finishes 7207 Textured Black, 4799 Platinum Metallic, 9201/9207 Polished Trivalent Chrome.

Frame

- RAL9003 Signal White

Roof Blades

- RAL7035 Light Grey

On the QT

On the QT phone booths were designed to provide compact enclosed space in open plan workspaces to allow work to be carried out more effectively with reduced distractions.

► Specifying, pages 53–59

Frame constructed of aluminum.

Cover caps frame the glass door and glass wall. Available in a range of paint finishes.

Front and back panel glass are clear laminated glass.

Seat designed with ergonomic focus to promote comfortable longer term use.

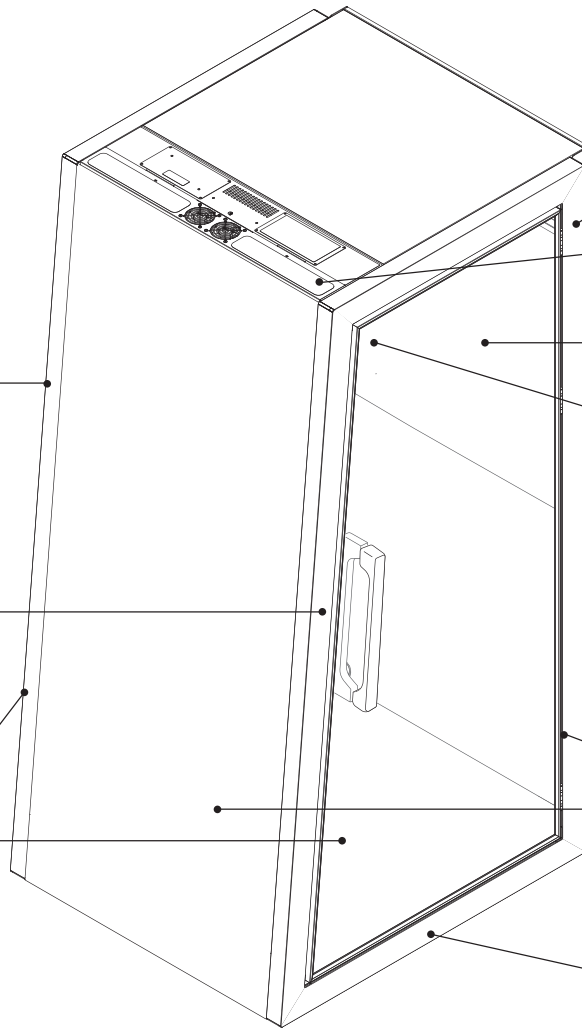

Occupancy light illuminates red when booth is in use.

Fan built discretely into the roof panel.

Interior cladding is polyester felt.

Lighting positioned near the front of the booth for optimal work lighting.

Front and rear cladding is laminate as standard, with option of fabric, painted steel, plywood, or whiteboard.

Threshold height is 5" min to 7" max.

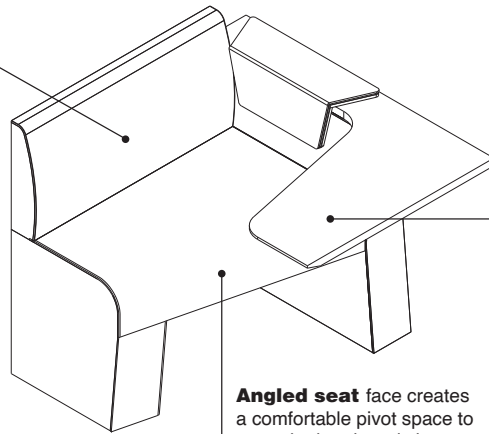

Tablet included as standard.

Angled seat face creates a comfortable pivot space to enter the booth and sit.

Phone Booths								
	External Dimensions					Internal Dimensions		
	Depth	Width	Height	Weight*	Shelf Height	Depth	Width	Height
OB1QT01/OB1QT02	39 ³ / ₈ "	47 ¹ / ₄ "	74 ⁴ / ₅ "	535 lb	28 ³ / ₄ "	36"	39"	69 ⁷ / ₈ "
OB1QT03/OB1QT04	39 ³ / ₈ "	47 ¹ / ₄ "	86 ³ / ₅ "	661 lb	41 ³ / ₄ "	36"	39"	78 ³ / ₄ "

Furniture Units						
	Depth	Width	Height	Weight	Seat Height	Tablet Height
OB1QTF01/OB1QTF02	25"	35"	32"	101 lb	18 ⁸ / ₉ "	28 ³ / ₄ "

*includes plywood cladding

On the QT, continued

Product Details

Left hand (LH) and right hand (RH) are determined by the location of the door hinge when entering the booth.

Front and rear are determined based on the user seated position. "Front" will indicate the wall the user faces, while "rear" will indicate the wall behind the user.

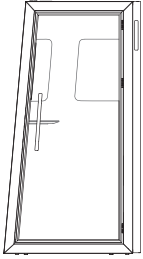

Baffles can be optioned to add an additional layer of visual and acoustic privacy. These fully upholstered baffles are available as a privacy screen or lean pad.

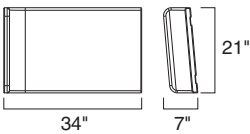
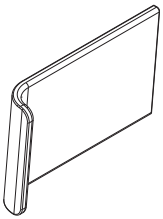

Privacy screens install to the front of the phone booth and sit above worksurface height.

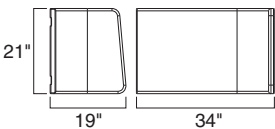
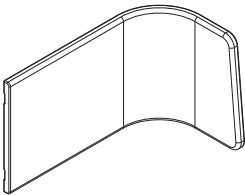

Lean pads install to the rear of the phone booth and sit at shoulder/head height.

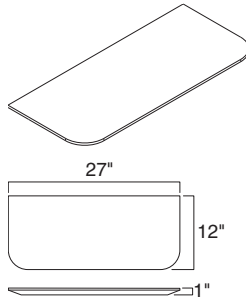

Shelf can be specified in both the short and tall phone booths. When specified, the shelf height is 28 3/4" in the short booth and 41 3/4" in the tall booth. Tip: Shelf should not be optioned if an On the QT furniture unit (OB1QTF01 or OB1QTF02) is specified.

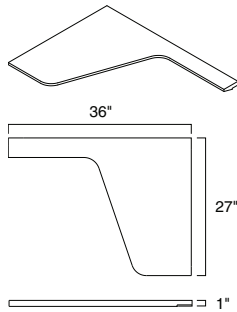

L-shelf can be specified in the tall phone booths only. When specified, the shelf height is 41 3/4".

All worksurfaces come standard in High-Pressure Laminate.

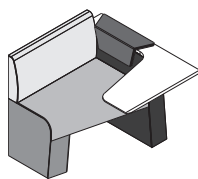

Contrasting upholstery option available on lounge furniture units with four specifiable upholstery surfaces.

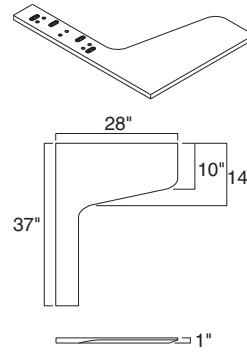

Each furniture unit comes standard with an integrated worksurface in laminate.

Occupancy light is available as an option. When the phone booth is in use, the occupancy light will illuminate red. When not specified, illumination will not occur.

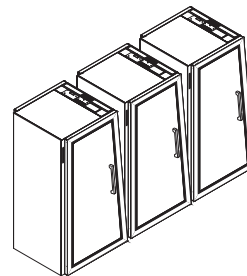

Do not obstruct exit corridor. Ensure visibility to on site alarm strobes is not blocked. If sprinklers are not required interior to the unit, be advised that local codes typically prohibit obstructions within 18" of the existing building sprinklers. Ensure final placement of the unit does not block airflow inlets or outlets of the building or unit ventilation systems.

Electrical Connections

Hardwired units: Electric power is delivered through a hardwired connection which must be routed to a junction box in the floor, wall, or ceiling via a conduit whip. Orangebox does not provide the conduit whip to make the power connection to the building. It is the responsibility of the qualified site electrician to supply and install a suitable power connection to the building in accordance with local codes.

The assembly directions and user guide describe the enclosures which contain the electrical services such as power, lighting, and airflow. Lighting, fan, outlets, and sensors share one circuit within the unit. The enclosure may accommodate a single 15 Amp connection. The maximum loading of the components within the enclosure is 1.8 Kilowatts at 120 VAC.

Cord and plug units: The unit is provided with a flexible power cord which is to be plugged directly into a building's hardwired electrical receptacle. A minimum spacing of 4" between the receptacle and the assembled unit is needed to protect the plug from damage.

Total cord length is 12' from the point of connection at the power distribution unit (PDU). Exposed length will be dependent on exit location.

Short phone booth:

- 116" when exiting from front
- 77" when exiting from rear

Tall phone booth:

- 103" when exiting from the front
- 64" when exiting from the rear

Power usage: when occupied is 30W (not including any plugged-in external equipment).

Electrical Components

Occupancy sensor activates the lights and fan. The sensor operates at low voltage and utilizes both ultrasonic and infrared sensing to avoid false triggering. Three minutes after the booth is vacated, all features will power down.

One LED light panel is used for illumination. The light is 3000K and 450 lux at worksurface height.

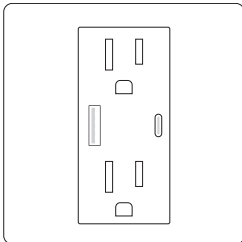

When selected, unit includes two power outlets, one USB A, and one USB C port. Each outlet will supply 3 Amps max with a total of 4.5 Amp max draw collectively.

An isolator switch is located directly below the power outlets and can be used to turn off all power to the booth.

Airflow and Handling

The air handling ventilation system is designed to provide a minimum of 10 air changes per hour when the unit is occupied, per Business & Institutional Furniture Manufacturer's Association (BIFMA) Guidance for Pods (2020) and American Society of Heating Refrigerating and Air Conditioning Engineers (ASHRAE) 111 Testing, Adjusting, and Balancing of Building HVAC Systems.

On the QT has been designed to perform 35 (short booth) and 30 (tall booth) air changes per hour (ACH).

Ventilation fans are rated at 21.9 CFM and 21.5 dBA.

Tip: Fan CFM ratings alone cannot be used to determine the actual system ventilation rate.

Building and Fire Code Compliance

Seismic considerations: For seismic considerations, the building's Structural Engineer of Record (SEOR) must be consulted. Seismic structural analysis report prepared by a licensed professional engineer may be required for specific locations.

Fire suppression: Sprinkler requirements are an important consideration for product assembly. Local codes may impact the number and location of mandated sprinklers. It is important to check with the local authorities to ensure product installation meets local requirements. If required, sprinkler location options within the unit are identified in product-specific assembly directions.

Fire alarms: National Fire Protection Agency (NFPA) 72 requires a fire alarm to be at least 15 dB above ambient to ensure occupants can hear the alarm. This is an on-site requirement. This may require a visible and/or audible notifier within the unit. If the unit is equipped with a fire detection system, some jurisdictions may require it be connected to the building's fire detection system.

Energy efficiency: ASHRAE 90.1 and California Energy Commission (CEC) Title 24 identify lighting controls and power density requirements. This is an on-site requirement. Ensure this unit in its final environment adheres to these standards by confirming with local authorities.

Frame

- 7207 Textured Black

Door handle

- V3AK Natural Oak
- VP03 Black Oak

Cover caps

- Accent paint
- Accessory paint
- Smooth metallic
- Smooth paint
- Textured paint
- Textured metallic

Front and rear cladding

Laminate

- Fiber HPL
- Micro HPL
- Patina HPL
- Solid HPL
- Speckle HPL
- Textured Woodgrain HPL
- Woodgrain HPL
- Textured Industrial HPL
- Open Line laminate

Whiteboard

- 2977 White Markerboard

Painted Metal

- Accent paint
- Accessory paint
- Smooth metallic
- Smooth paint
- Textured paint
- Textured metallic

Fabric

- Graded-In Price Group 1-10
- Customer's Own Material (COM)

Plywood

- 3862 Baltic Birch

Internal cladding

- PT19 Charcoal
- PT36 Silver

Privacy screen

- Fabric
- Customer's Own Material (COM)

Lean pad

- Fabric
- Customer's Own Material (COM)

Furniture upholstery

- Fabric
- Customer's Own Material (COM)

Tip: This product does not use glue due to the environmental impact. Because of this, occasional dressing of the upholstery may be required.

Shelf and tablet

- Fiber HPL
- Micro HPL
- Patina HPL
- Solid HPL
- Speckle HPL
- Textured Woodgrain HPL
- Woodgrain HPL
- Textured Industrial HPL
- Open Line laminate

Custom Surfaces

Applies to:

- Cover caps
- Front and rear cladding

PerfectMatch

PerfectMatch is a service that allows you to create your own paint color. Refer to the *Surface Materials Reference Guide* for more information about this program.

Aspect

Aspect is a high back, semi-enclosed sofa line. Aspect sofas can be connected via a screen to create semi-private working booths with power and media capabilities.

► Specifying, pages 61–75

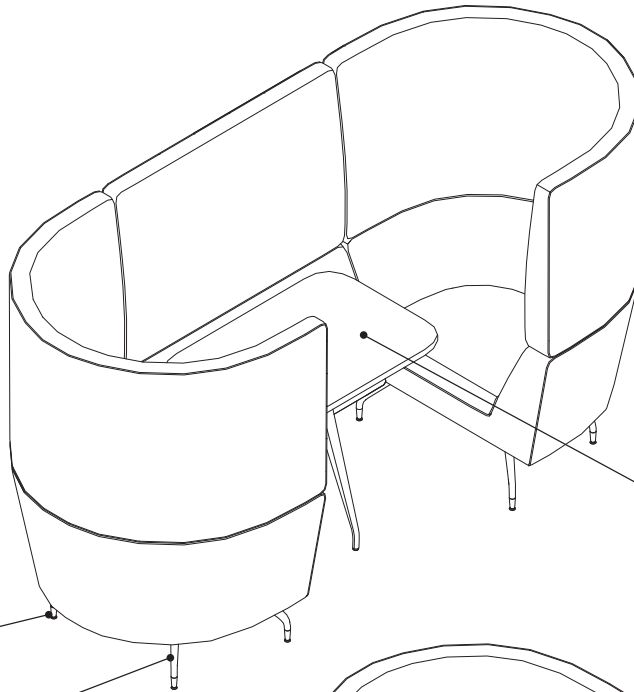

Feet adjustable up to 1/2".

Legs 8" high.

Table top available in laminate with tapered edge detail.

Reveal seam intrinsically designed for contrast, matching seat as standard.

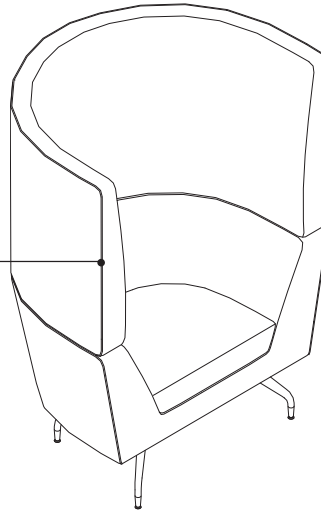

Actual Dimensions

	Depth	Width	Height	Weight	Seat Depth	Seat Height	Worksurface Depth	Worksurface Width	Worksurface Height
OBASPECT07HB	29"	41"	54"	100 lb	19"	17"	N.A.	N.A.	N.A.
OBASPECT08HB	29"	64"	54"	131 lb	19"	17"	N.A.	N.A.	N.A.
OBASPECT09HB	29"	87"	54"	166 lb	19"	17"	N.A.	N.A.	N.A.
OBASPECT57HB	30"	87"	54"	277 lb	19"	17"	22"	22"	29"
OBASPECT58HB	64"	97"	54"	371 lb	19"	17"	44"	32"	29"
OBASPECT59HB	87"	97"	54"	457 lb	19"	17"	63"	32"	29"

Product Details

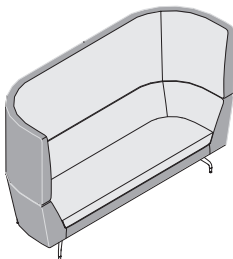

Two-tone contrasting upholstery option is available through specifying inner and outer contrasting colorways.

Tip: Inner/outer selection must stay in the same fabric family.

Patterned fabric works best when specified on the seat only. Patterns should be avoided on the upper and lower body due to predominant double stitch seams making pattern matching unachievable.

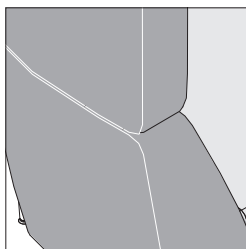

Reveal seam matches seat as standard but can match body finish or "other." Other allows specification to be independent of the seat and body finish selection.

Tip: Reveal seam not allowed to match seat when patterned.

Tip: Reveal seam may only be vinyl if body is also vinyl.

Power and Media

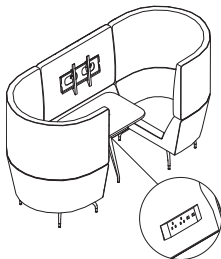

Power integrated in lower screen when optioned on media den units.

- 4 power outlets
- 2 power, 1 CAT6 data, 1 dual USB-A outlets
- 2 power, 1 CAT6 data, 1 HDMI outlets
- 2 power, 2 CAT6 data outlets

72" cord length exits through bottom of lower screen and comes fitted with a standard NEMA 5-15 plug.

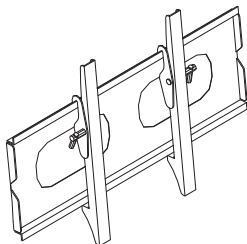

Tilting monitor brackets available as an option on media den units. Monitor bracket supports a single screen up to 32" and 44 pounds.

Wire channel and grommet are located in the upper screen for cable management.

Surface Materials

Upholstery

- Fabric
- Customer's Own Material (COM)

Tip: This product does not use glue due to the environmental impact. Because of this, occasional dressing of the upholstery may be required.

Table tops

- Fiber HPL
- Micro HPL
- Patina HPL
- Solid HPL
- Speckle HPL
- Textured Woodgrain HPL
- Woodgrain HPL
- Textured Industrail HPL
- Open Line laminate

Legs/feet

- Black
- Silver
- Chrome

Tip: For comparable finish, please reference Steelcase standard finishes 7207 Textured Black, 4799 Platinum Metallic, 9201/9207 Polished Trivalent Chrome.

Power

- 4118 Warm Platinum
- 7015 Silk Textured
- 7207 Black

Avi

Avi is a classic low- or high-back upholstered lounge chair.
 ▶ Specifying, pages 79–80

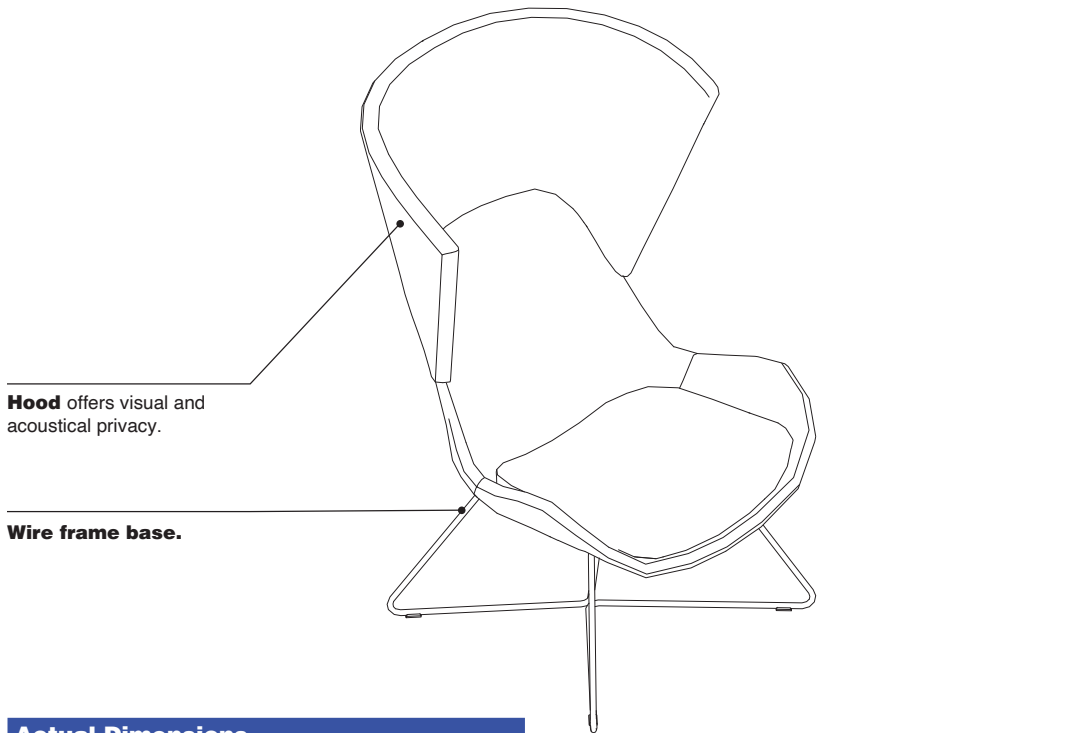
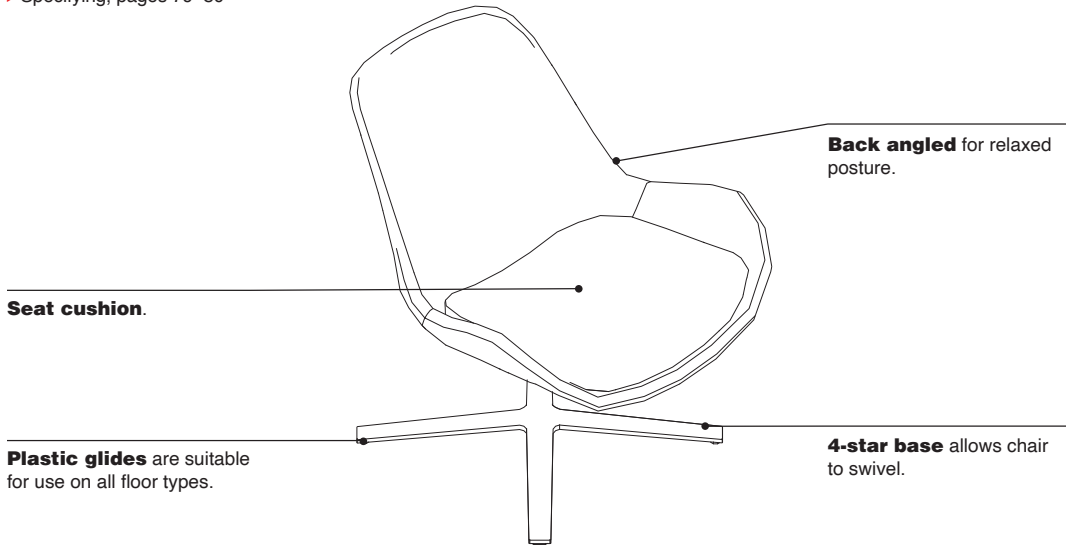

Product Details

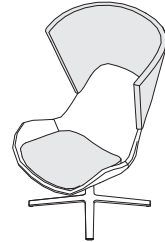

Contrasting upholstery is available by specifying each surface independently.

Avi low- and high-back chairs are both available on 4-star swivel or wire frame bases.

Surface Materials

Upholstery

- Fabric
- Customer's Own Material (COM)
- Customer's Own Leather (COL)

Tip: This product does not use glue due to the environmental impact. Because of this, occasional dressing of the upholstery may be required.

Base

- Black
- Silver
- Chrome

Tip: For comparable finish, please reference Steelcase standard finishes 7207 Textured Black, 4799 Platinum Metallic, 9201/9207 Polished Trivalent Chrome.

Actual Dimensions

Depth	31"
Width	27"
Height	32" and 46"
Weight	34 lb and 42 lb
Seat Depth	19"
Seat Height	17"

Sully, Ramsey, and Skomer

Sully, Ramsey, and Skomer

Sully, Ramsey, and Skomer are fully upholstered chairs designed to work together in small clusters or as part of larger configurations.
 ▶ Specifying, pages 82–85

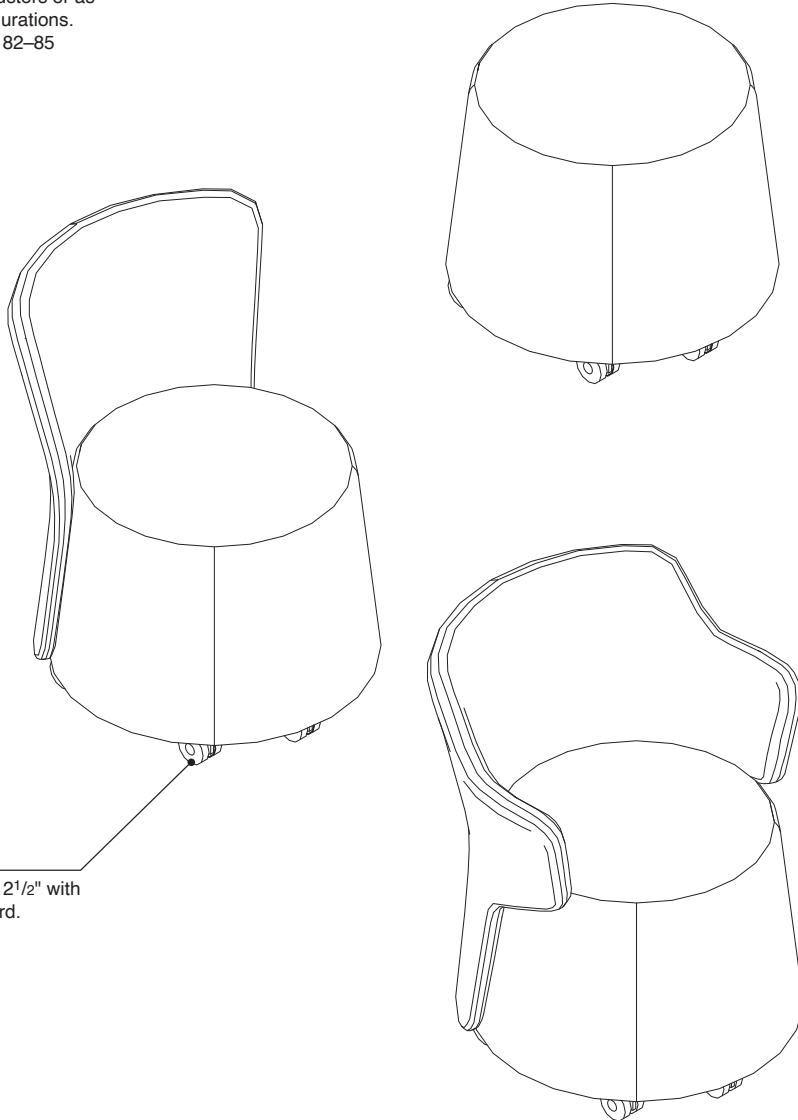

Soft casters are 2 1/2" with no brake as standard.

Product Details

Two-tone contrasting upholstery is available as an option.

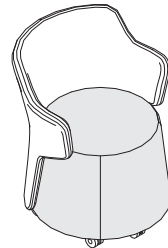

Option 1—seat and back.
Tip: If two-tone upholstered option one is selected, contrasting price groups are available. Total seat finish and back finish price is driven by highest price group selection.

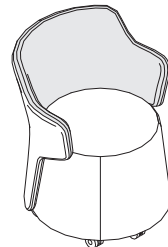

Option 2—seat and outer back with contrasting inner back.
Tip: If two-tone upholstered option two is selected, contrasting price groups are not available. Total seat and outer back finish and inner back finish must come from the same finish family.

Surface Materials

Upholstery

- Fabric
- Customer's Own Material (COM)
- Customer's Own Leather (COL)

Tip: This product does not use glue due to the environmental impact. Because of this, occasional dressing of the upholstery may be required.

Casters

- Black
- Grey

Sully, Ramsey, and Skomer

Actual Dimensions

	Depth	Width	Height	Weight	Seat Depth	Seat Height
OBSSULLY01	21"	21"	19"	18 lb	16"	19"
OBSRAMSEY01	26"	23"	32"	29 lb	19"	19"
OBSSKOMER01	26"	26"	32"	34 lb	19"	19"

Border

Border provides a simple and precise way of dividing up space.
 ▶ Specifying, pages 87–91

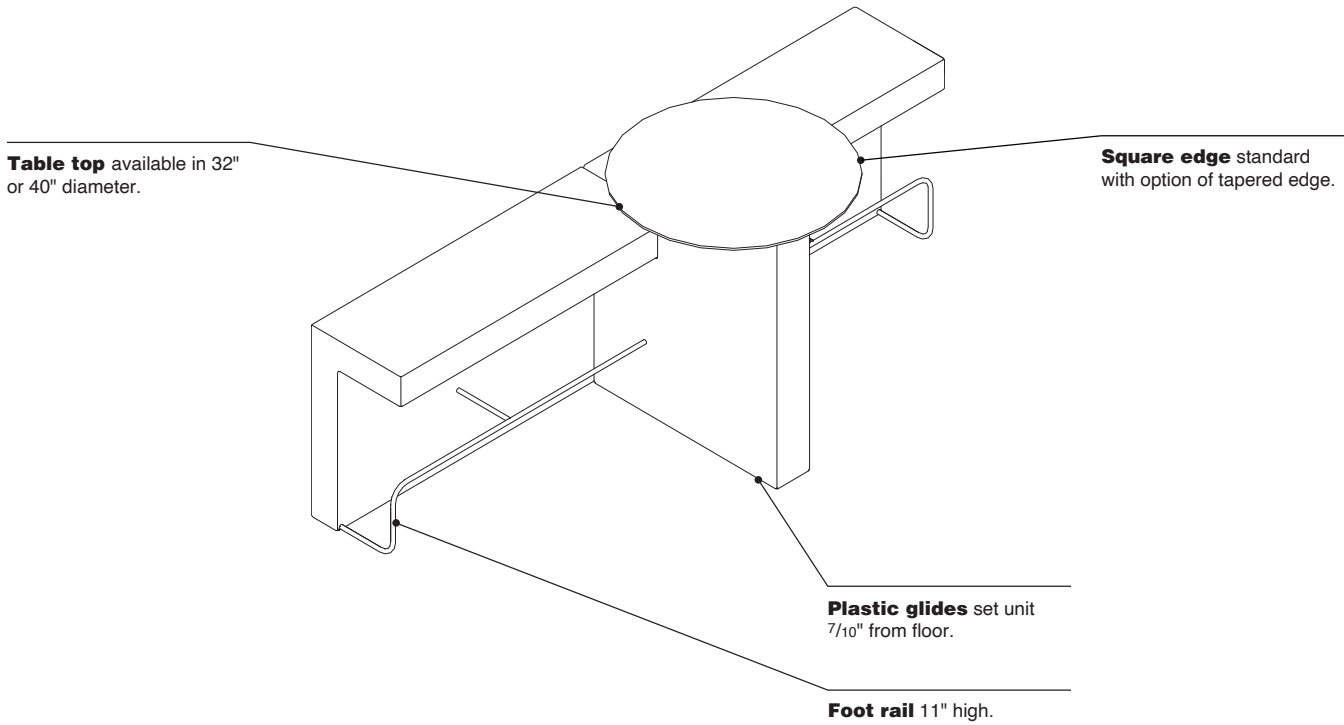

Actual Dimensions							
	Depth	Width	Height	Weight	Seat Depth	Seat Height	Table Height
OBBORDER01	42"	47"	30"	80 lb	16"	18"	30"
OBBORDER02	42"	94"	30"	111 lb	16"	18"	30"
OBBORDER03/ OBBORDER04	42"	47"	42"	106 lb	16"	30"	42"
OBBORDER05	42"	94"	42"	146 lb	16"	30"	42"

Product Details

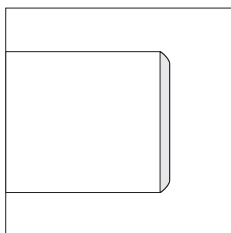
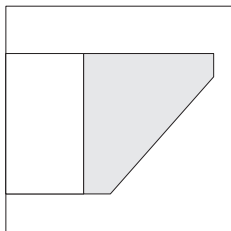

Edge profile available tapered or squared.

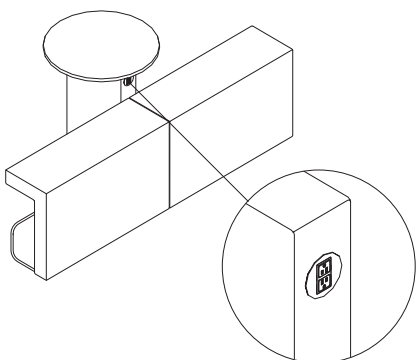

Round power module is available as an option and located in table base.

- 2 power outlets
- 1 power, 1 dual USB-A outlets
- 1 power, 1 HDMI outlets
- 1 power, 1 CAT6 data outlets

Tip: Power is not available in the table top due to the presence of a mounting plate.

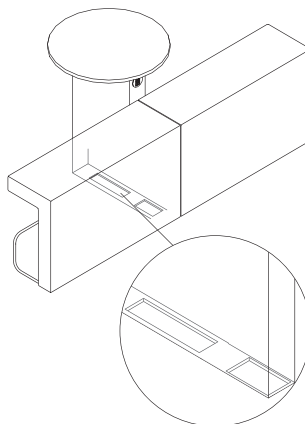

120" cord length exits through bottom of table base and comes fitted with a standard NEMA 5-15 plug.

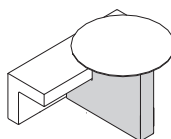

Two-tone contrasting upholstery is available as an option.

Tip: If two-tone upholstered option is selected, contrasting price groups are available. Total seat finish and table base finish price is driven by highest price group selection.

Surface Materials

Table tops

- Fiber HPL
- Micro HPL
- Patina HPL
- Solid HPL
- Speckle HPL
- Textured Woodgrain HPL
- Woodgrain HPL
- Textured Industrial HPL
- Open Line laminate

Upholstery

- Fabric
- Customer's Own Material (COM)
- Customer's Own Leather (COL)

Tip: This product does not use glue due to the environmental impact. Because of this, occasional dressing of the upholstery may be required.

Foot rail

- Chrome

Power

- 4118 Warm Platinum
- 7015 Silk Textured
- 7207 Black

Away from the Desk

Away from the Desk is a dynamic and extensive upholstery modular sofa system.
▶ Specifying, pages 93–149

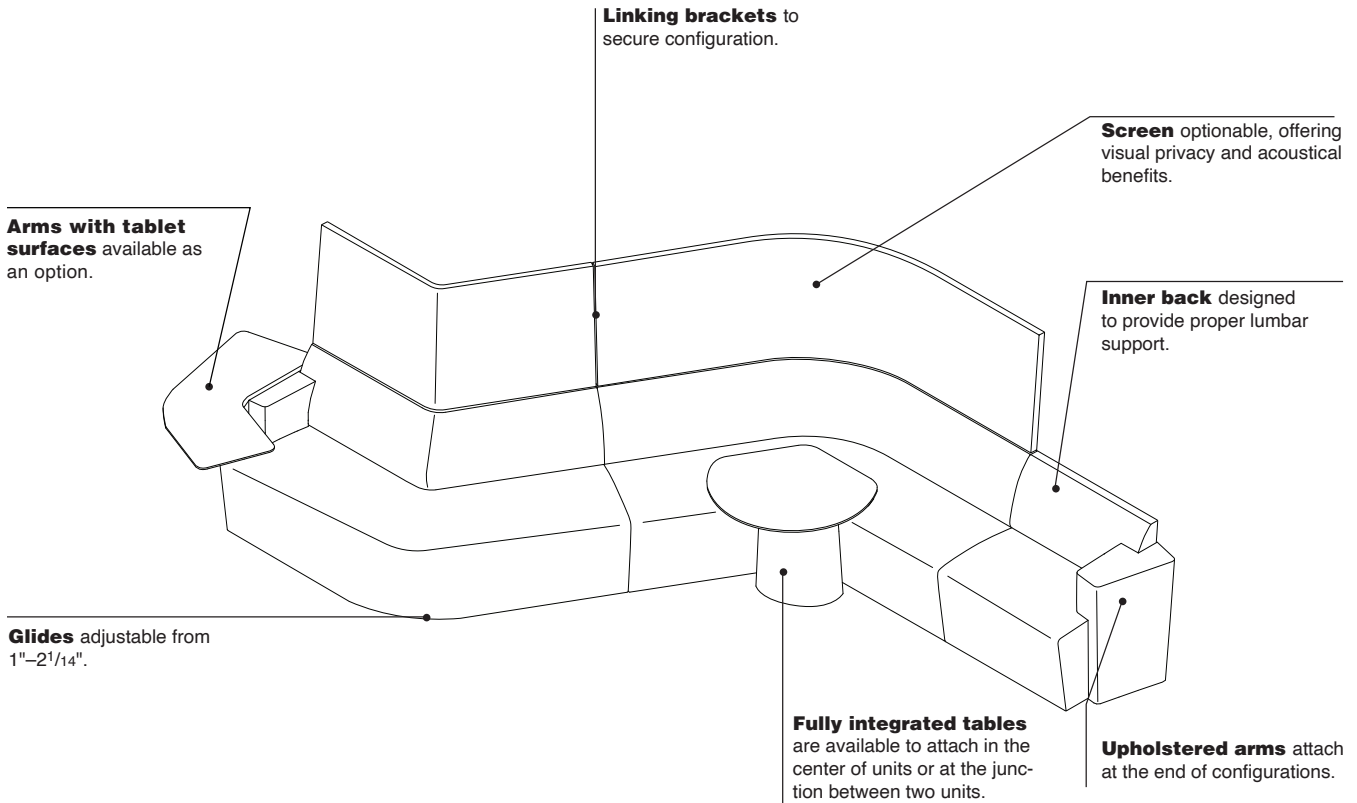

Actual Dimensions						
	Depth	Width	Height	Weight	Seat Depth	Seat Height
OBAD01	20"	31"	19"	32 lb	20"	19"
OBAD02	26"	31"	32"	39 lb	20"	19"
OBAD03	28"	31"	58"	62 lb	20"	19"
OBAD03LC	28"	31"	58"	59 lb	20"	19"
OBAD03RC	28"	31"	58"	59 lb	20"	19"
OBAD11	28"	71"	19"	55 lb	20"	19"
OBAD12	24"	71"	32"	98 lb	20"	19"
OBAD13	28"	71"	58"	115 lb	20"	19"
OBAD21	36"	78"	19"	71 lb	20"	19"
OBAD22	42"	84"	32"	135 lb	20"	19"
OBAD23	44"	86"	58"	160 lb	20"	19"
OBAD23LC	44"	85"	58"	154 lb	20"	19"
OBAD23RC	44"	85"	58"	154 lb	20"	19"
OBAD24	41"	78"	32"	135 lb	20"	19"
OBAD25	43"	78"	58"	160 lb	20"	19"
OBAD31	68"	78"	19"	111 lb	20"	19"
OBAD32	73"	78"	32"	159 lb	20"	19"
OBAD33	74"	78"	58"	181 lb	20"	19"
OBAD42	57"	57"	32"	135 lb	20"	19"
OBAD43	59"	59"	58"	161 lb	20"	19"
OBAD52	33"	72"	32"	120 lb	20"	19"
OBAD53	35"	75"	58"	142 lb	20"	19"
OBAD64SRO	43"	43"	29"	78 lb	N.A.	N.A.
OBAD81DS	53"	51"	57"	100 lb	N.A.	N.A.
OBAD91SRO	47"	47"	29"	100 lb	N.A.	N.A.
OBAD91LRO	55"	55"	29"	111 lb	N.A.	N.A.
OBAD92	24"	24"	20"	20 lb	N.A.	N.A.
OBAD101	26"	41"	32"	58 lb	20"	19"
OBAD102	28"	45"	58"	86 lb	20"	19"
OBAD101LT	36"	41"	32"	71 lb	20"	19"
OBAD101RT	36"	41"	32"	71 lb	20"	19"
OBAD102LT	38"	45"	58"	100 lb	20"	19"
OBAD102RT	38"	45"	58"	100 lb	20"	19"

► **Actual Dimensions, continued on next page**

Away from the Desk, continued

► Actual Dimensions, continued from previous page

Actual Dimensions, continued						
	Depth	Width	Height	Weight	Seat Depth	Seat Height
OBAD103	26"	72"	32"	128 lb	20"	19"
OBAD85	90"	93"	58"	474 lb	20"	19"
OBAD85A	59"	93"	58"	358 lb	20"	19"
AD-61LA*	18"	11"	28"	16 lb	N.A.	N.A.
AD-61RA*	18"	11"	28"	16 lb	N.A.	N.A.
AD-62LC*	41"	31"	29"	25 lb	N.A.	N.A.
AD-62RC*	41"	31"	29"	25 lb	N.A.	N.A.
AD-71*	31"	24"	29"	23 lb	N.A.	N.A.
AD-72*	28"	31"	29"	23 lb	N.A.	N.A.

* AD-61LA, AD-61RA, AD-62LC, AD-62RC, AD-71, and AD-72 tables are not available as standalone styles. Please refer to Away from the Desk specifying pages for styles that have AD-71 and AD-72 tables available as an option.

Product Details

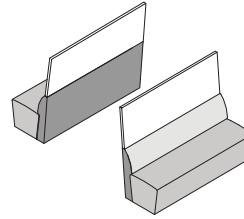

Contrasting upholstery option possible through specifying each surface independently.

The four main upholstery surfaces are:

- Seat
- Backrest inner
- Backrest outer
- Screen

Patterned fabric works best when specified on the seat or inner back only. Patterns should be avoided on the outer back and screen due to predominant double stitch seams making pattern matching unachievable.

Away from the Desk is upholstered utilizing the width of fabric rolls. This means when a pattern is specified it will always lie railroad.

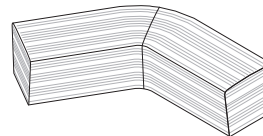
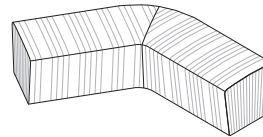

The use of patterned fabrics on curved units may result in the "chevron effect". This effect is apparent at the seam of two fabric panels that run in different directions.

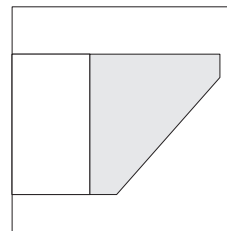

Edge profile is tapered as standard on tables and tablets.

Power and Media

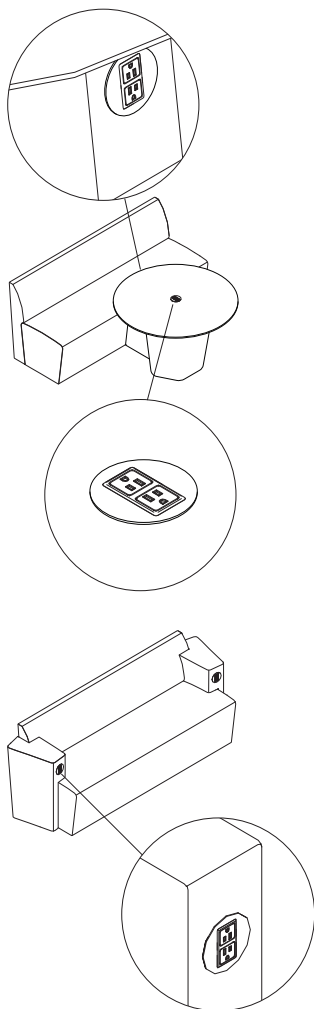

Round power modules are available as an option on table tops, table bases, and arm:

- 2 power outlets
- 1 power, 1 dual USB-A outlets
- 1 power, 1 HDMI outlets
- 1 power, 1 CAT6 data outlets

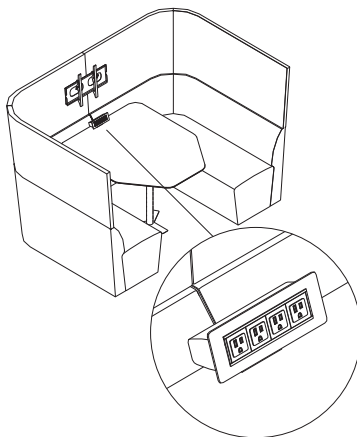

Table mounted power is available as an option for booth style numbers:

- 4 power outlets
- 2 power, 1 CAT6 data, 1 dual USB-A outlets
- 2 power, 1 CAT6 data, 1 HDMI outlets
- 2 power, 2 CAT6 data outlets

72" cord length exits through base of the tables and arms and comes fitted with a standard NEMA 5-15 plug.

Tilting monitor brackets available as an option on media den units. Monitor bracket supports a single screen up to 32" and 44 pounds.

Application Topics

Handedness of units and connection points are determined based on the user sitting position.

Arms can only connect to the outer most ends of a configuration.

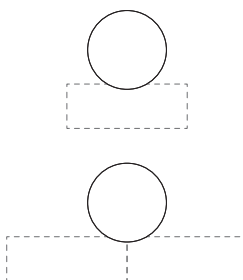

Tables can connect to the center of a single unit or at the junction between units.

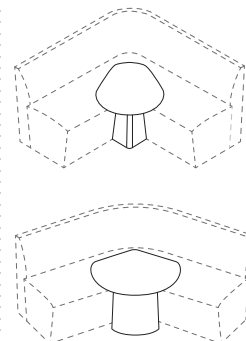

Dedicated tables AD-71 and AD-72 can only be specified for use with 90° and 120° units respectively.

Surface Materials

Table tops

- Fiber HPL
- Micro HPL
- Patina HPL
- Solid HPL
- Speckle HPL
- Textured Woodgrain HPL
- Woodgrain HPL
- Textured Industrial HPL
- Open Line laminate

Upholstery

- Fabric
- Customer's Own Material (COM)

Tip: This product does not use glue due to the environmental impact. Because of this, occasional dressing of the upholstery may be required.

Power

- 4118 Warm Platinum
- 7015 Silk Textured
- 7207 Black

Cubb Seating

Cubb seating is a succinct range of chairs and stools with a clear personality, delivering robust functionality for any environment.
 ▶ Specifying, pages 151–164

Upholstered arms.

Wood legs made of solid white oak with glides.

Metal chassis secure legs to each other as well as seat shell.

Wire arms designed to complement wire frame base.

Wire frame base.

Plastic glides suitable for all surfaces.

Seat shell is gently curved, offering integrated lumbar support.

Trestle base allows 360° of swivel and is available in polished chrome or black.

Hard glides are standard. Soft glides available as an option.

Gas lift allows for travel up to 5" of seat height adjustment.

Five-star base available in polished chrome or black.

Casters are 2½" in diameter. Hard casters for use on carpet as standard.

Actual Dimensions

	Depth	Width	Height	Weight	Seat Depth	Seat Height
OBCUBB01	18"	19"	33"	20 lb	16"	19"
OBCUBB02	18"	21"	33"	26 lb	16"	19"
OBCUBB03	18"	21"	33"	22 lb	16"	19"
OBCUBB04	19"	22"	33"	19 lb	16"	19"
OBCUBB05	19"	22"	33"	27 lb	16"	19"
OBCUBB06	19"	22"	33"	20 lb	16"	19"
OBCUBB07	19"	22"	33"	19 lb	16"	19"
OBCUBB08	19"	22"	33"	25 lb	16"	19"
OBCUBB09	19"	22"	33"	20 lb	16"	19"
OBCUBB10	26"	26"	33"	25 lb	16"	19"
OBCUBB11	26"	26"	33"	31 lb	16"	19"
OBCUBB12	26"	26"	33"	26 lb	16"	19"
OBCUBB13	19"	18"	39"	21 lb	15"	30"
OBCUBB14	20"	20"	39"	21 lb	15"	30"
OBCUBB15	17"	18"	19"	10 lb	N.A.	N.A.
OBCUBB19	16"	51"	19"	27 lb	N.A.	N.A.

Product Details

Cubb seating utilizes the same core seat with a combination of two arm options and four base styles.

Both the trestle and five-star base options swivel 360°.

A foot rail cover is available as an option on wire base stool.

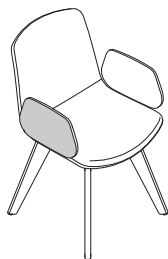

Two-tone contrasting upholstery option is available.

Tip: If two-tone upholstered option is selected, contrasting price groups are available. Total seat finish and outer seat finish price is driven by highest price group selection.

Cubb seating does not stack.

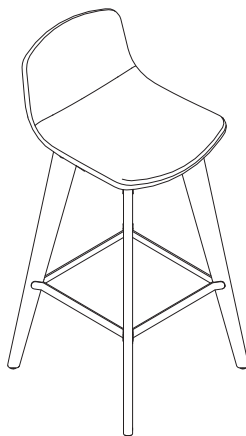

Armless seat on wood base available as bar height stool.

Tip: Foot rail finish will match that of chassis.

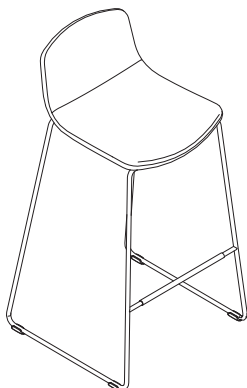

Armless seat on wire frame base available as bar height stool.

Surface Materials**Upholstery**

- Fabric
- Customer's Own Material (COM)
- Customer's Own Leather (COL)

Wood leg base

- 31WK Medium Walnut on Oak
- 3652 Dark Distressed Oak Stain
- V3AK Natural Oak
- VP03 Black Oak

Metal chassis

- Accent paint
- Accessory paint
- Smooth metallic
- Smooth paint
- Textured paint
- Textured metallic

Wire frame base

- Accent paint
- Accessory paint
- Polished chrome
- Smooth metallic
- Smooth paint
- Textured paint
- Textured metallic
- Lux coatings

Trestle base

- Black
- Polished chrome

5-Star base

- Black
- Polished chrome

Wire arms

- Accent paint
- Accessory paint
- Smooth metallic
- Smooth paint
- Textured paint
- Textured metallic

Tip: Wire arms will always match finish of base when base is trestle or five-star.

Custom Surfaces**Perfect Match**

PerfectMatch is a service that allows you to create your own paint color Refer to the *Surface Materials Reference Guide* for more information about this program.

Applies to:

- Metal chassis
- Wire frame base
- Wire arms

Cubb Tables

Cubb tables are a distinctive range of meeting and project tables with a laid-back, informal feel— great for any environment.

► Specifying, pages 167–187

Meeting tables sit 29"H and are available in widths ranging from 35" to 177".

Worksurface available with tapered edge detail as standard.

Metal chassis secure legs to each other as well as worksurface.

Project tables stand 41³/₈"H and are available at 63", 82¹/₁₆", or 102³/₈"W.

Footrail designed to match the finish of the metal chassis.

Leg channel allows for cables to be managed seamlessly through any leg.

Cables provide additional stability and support.

Actual Dimensions

	Depth	Width	Height	Weight
OBCUBBRCM01	30"	56"	30"	70 lb
OBCUBBRCM02	30"	63"	30"	78 lb
OBCUBBRCM03	40"	83"	30"	121 lb
OBCUBBRCM04	40"	95"	30"	138 lb
OBCUBBRCM05	48"	119"	30"	198 lb
OBCUBBRCM07	48"	178"	30"	289 lb
OBCUBBRCM09	56"	119"	30"	222 lb
OBCUBBRCM11	56"	178"	30"	325 lb
OBCUBBRCP01	48"	24"	18"	43 lb
OBCUBBRCP01	36"	63"	42"	113 lb
OBCUBBRCP02	36"	83"	42"	139 lb
OBCUBBRCP03	36"	103"	42"	166 lb
OBCUBBRDM01	48"	48"	30"	70 lb
OBCUBBRDM02	56"	56"	30"	88 lb
OBCUBBRDM03	63"	63"	30"	109 lb
OBCUBBRDM04	71"	71"	30"	137 lb
OBCUBBRDO01	27"	27"	18"	19 lb
OBCUBBRDO02	32"	32"	18"	37 lb
OBCUBBSQM01	36"	36"	30"	57 lb
OBCUBBSQO01	24"	24"	18"	24 lb
OBCUBBSSM01	36"	36"	30"	57 lb

Product Details

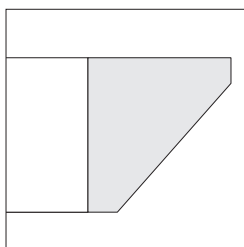

Edge profile is tapered as standard.

Integrated power available in all meeting and project table worksurfaces. All power cords are 10' long and available with either a standard three prong NEMA plug or hardwire.

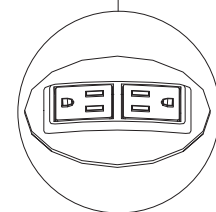
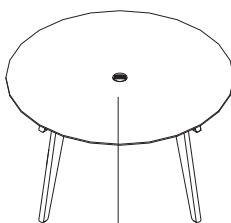

Round meeting tables can accept a single centrally located round face power unit in the following configurations:

- 2 power outlets
- 1 power, 1 dual USB-A outlets

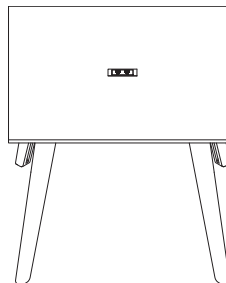

Square meeting tables can accept a centrally located rectangular face power unit in the following configurations:

- 2 power outlets
- 1 power, 1 dual USB-A outlets

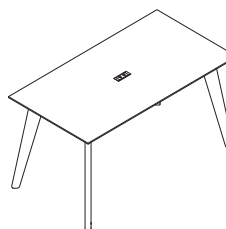

Small, rectangular meeting tables can accept a centrally located rectangular face power unit in the following configurations:

- 2 power outlets
- 1 power, 1 dual USB-A outlets
- 3 power, 1 dual USB-A outlets
- 2 power, 2 dual USB-A outlets
- 3 power, 1 USB-C outlets

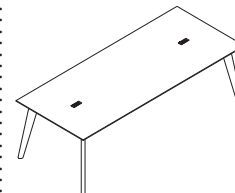

Medium and large rectangular meeting tables can accept multiple rectangular face power units in the following configurations:

- 2 power outlets
- 1 power, 1 dual USB-A outlets
- 3 power, 1 dual USB-A outlets
- 2 power, 2 dual USB-A outlets
- 3 power, 1 USB-C outlets

Cubb Tables, continued



Center only



Left and center



Left and right

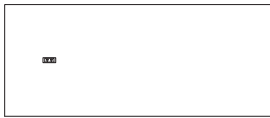

Left only

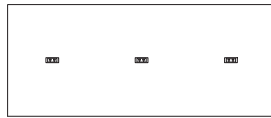

Left, right and center



Center and right



Right only

When multiple power units are specified, power location can be left, right, or center of the table.

Tip: Location and quantity allowed is dependent on the style number.

Wiring and Cabling

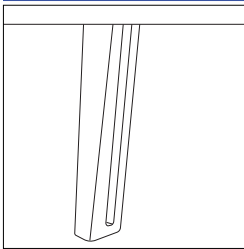

Wood legs designed with a channel for seamless cable management. Each leg come standard with a channel and rubber riser insert (black).

When multiple power units per table are specified, Interlink daisy chaining will come standard with a single plug located at the end of the configuration.

Multiple hardwire power units per table do not daisy chain and require independent connections.

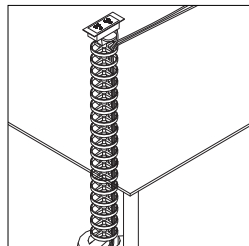
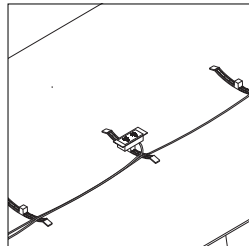

Additional cable management options are available through specification of a set of cable clips or an umbilical riser.

Surface Materials

Worksurface

- Fiber LPL
- Solid LPL
- Woodgrain LPL
- Fiber HPL
- Micro HPL
- Patina HPL
- Solid HPL
- Speckle HPL
- Textured Woodgrain HPL
- Woodgrain HPL
- Textured Industrial HPL
- Open Line laminate



Woodgrain laminate on single-piece tables will always be oriented at 0° with the grain direction running parallel with the length of the table top.

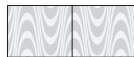

Woodgrain laminate on multi-piece tables will always be oriented at 90° with the grain direction running perpendicular with the length of the table top.

Woodgrain laminates cannot be grain matched.

Wood leg base

- 31WK Medium Walnut on Oak
- 3652 Dark Distressed Oak Stain
- V3AK Natural Oak
- VP03 Black Oak

Metal chassis

- Accent paint
- Accessory paint
- Smooth metallic
- Smooth paint
- Textured paint
- Textured metallic

Tip: Project table foot rail will always match finish of the chassis finish.

Power

- 0835 Black
- 4242 Milk
- 4799 Platinum
- 7360 Merle

Applies to:

- Metal chassis

Custom Surfaces

Perfect Match

PerfectMatch is a service that allows you to create your own paint color Refer to the Surface Materials Reference Guide for more information about this program.

Specifying

Acoustic Pods	
Air³	42
Air³ Tables	50
Accessories	51
On the QT	
Phone Booths	53
Seating	59
Seating	
Aspect	
Work Unit with Curved Arm	61
Work Screened Units with Fixed Table	67
Avi	79
Sully, Skomer, and Ramsey	82
Border	87
Away from the Desk	
Seating	93
Tables	137
Detached Seating	142
Media Dens	147
Cubb Seating and Tables	
Seating	151
Tables	167

Acoustic Pods

Pods

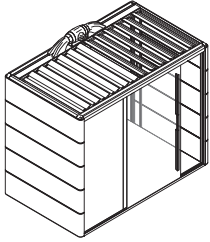

Tip: All Air3 models must be installed by Orangebox certified installers or warranty is void.

Standard Includes

- One service hoop:
 - three NEMA 5-15 3-prong power outlets
 - three LED lights
 - heat detector
 - occupancy sensor
 - user control panel
- 10 exterior fabric panels: one grommet
- 10 interior fabric panels
- Five glass panels (clear):
 - one 85 7/16" x 26 3/4"
 - four 85 7/16" x 34 3/8"
- One 86 3/16" x 45 11/16" glass sliding door: clear
- One air circulation fan
- Two louvered roof ceiling squares: aluminum roof blades (grey)

Options

Over Upholstery Fixed Monitor Bracket	No Over Upholstery Monitor Bracket	No cost
	Over Upholstery Fixed Monitor Bracket	+\$1268
	2 Over Upholstery Fixed Monitor Brackets	+\$2536
Whiteboard	No Whiteboard	No cost
	Straight Glass Magnetic Whiteboard	+\$3159
	2 Straight Glass Magnetic Whiteboards	+\$6318
Door Size	Standard Door Size	No cost
	Ontario AODA Compliant Door	+\$5328
Door Lock	No Lock	No cost
	Locking Door	+\$1965

► **Product Information continued on next page**

Acoustic Pods

Pods

► Product Information continued from previous page

Specification Information

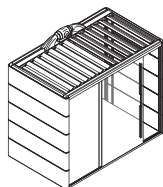

Style Number	Base Price	
Air³ Half-Square with Opening Roof		
OB1AIR23	\$47,216	
Single Grade Prices (for all five layers)	Internal Fabric	External Fabric
Grade 2	+\$865	+\$1150
Grade 3	+\$1080	+\$1435
Grade 4	+\$1370	+\$1810
Grade 5	+\$1825	+\$2430
Grade 6	+\$2400	+\$3185
Grade 7	+\$2935	+\$3905
Grade 8	+\$3410	+\$4540
Grade 9	+\$4435	+\$5900
Grade 10	+\$5585	+\$7435
Layered Grade Prices (per layer)		
Grade 2 Layer	+\$173	+\$230
Grade 3 Layer	+\$216	+\$287
Grade 4 Layer	+\$274	+\$362
Grade 5 Layer	+\$365	+\$486
Grade 6 Layer	+\$480	+\$637
Grade 7 Layer	+\$587	+\$781
Grade 8 Layer	+\$682	+\$908
Grade 9 Layer	+\$887	+\$1180
Grade 10 Layer	+\$1117	+\$1487

Acoustic Pods

Acoustic Pods

Pods

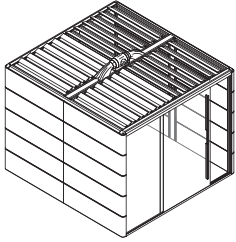

Tip: All Air3 models must be installed by Orangebox certified installers or warranty is void.

Standard Includes

- One service hoop:
 - three NEMA 5-15 3-prong power outlets
 - three LED lights
 - heat detector
 - occupancy sensor
 - user control panel
- 20 exterior fabric panels: one grommet
- 20 interior fabric panels
- Five glass panels (clear):
 - one 85 7/16" x 26 3/4"
 - four 85 7/16" x 34 3/8"
- One 86 3/16" x 45 11/16" glass sliding door: clear
- One air circulation fan
- Four louvered roof ceiling squares: aluminum roof blades (grey)

Options

Hoop Mounted Monitor Bracket	No Hoop Mounted Monitor Bracket	No cost
	Hoop Mounted Fixed Monitor Bracket	+\$820
Over Upholstery Fixed Monitor Bracket	No Over Upholstery Monitor Bracket	No cost
	Over Upholstery Fixed Monitor Bracket	+\$1268
	2 Over Upholstery Fixed Monitor Brackets	+\$2536
	3 Over Upholstery Fixed Monitor Brackets	+\$3804
	4 Over Upholstery Fixed Monitor Brackets	+\$5072
Whiteboard	No Whiteboard	No cost
	Straight Glass Magnetic Whiteboard	+\$3159
	2 Straight Glass Magnetic Whiteboards	+\$6318
	3 Straight Glass Magnetic Whiteboards	+\$9477
	4 Straight Glass Magnetic Whiteboards	+\$12,636
Door Size	Standard Door Size	No cost
	Ontario AODA Compliant Door	+\$5328
Door Lock	No Lock	No cost
	Locking Door	+\$1965

► **Product Information continued on next page**

Acoustic Pods

Pods

► **Product Information continued from previous page**

Specification Information

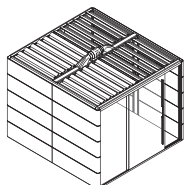

Style Number	Base Price	
Air³ Half-Square with Opening Roof		
OB1AIR25	\$57,974	
Single Grade Prices (for all five layers)	Internal Fabric	External Fabric
Grade 2	+\$1700	+\$2195
Grade 3	+\$2125	+\$2745
Grade 4	+\$2675	+\$3425
Grade 5	+\$3565	+\$4500
Grade 6	+\$4620	+\$5780
Grade 7	+\$5695	+\$7050
Grade 8	+\$6620	+\$8200
Grade 9	+\$8605	+\$10,660
Grade 10	+\$10,845	+\$13,430
Layered Grade Prices (per layer)		
Grade 2 Layer	+\$340	+\$439
Grade 3 Layer	+\$425	+\$549
Grade 4 Layer	+\$535	+\$685
Grade 5 Layer	+\$713	+\$900
Grade 6 Layer	+\$924	+\$1156
Grade 7 Layer	+\$1139	+\$1410
Grade 8 Layer	+\$1324	+\$1640
Grade 9 Layer	+\$1721	+\$2132
Grade 10 Layer	+\$2169	+\$2686

Acoustic Pods

Acoustic Pods

Pods

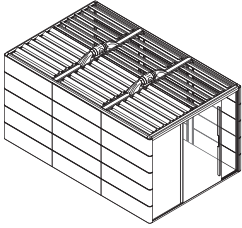

Tip: All Air3 models must be installed by Orangebox certified installers or warranty is void.

Standard Includes

- Two service hoops:
 - three NEMA 5-15 3-prong power outlets
 - three LED lights
 - heat detector
 - user control panel
 - occupancy sensor
- 30 exterior panels: two grommets
- 30 interior panels
- Five glass panels (clear):
 - one 85 7/16" x 26 3/4"
 - four 85 7/16" x 34 3/8"
- One 86 3/16" x 45 11/16" glass sliding door: clear
- Two air circulation fans
- Six louvered roof ceiling squares: aluminum roof blades (grey)

Options

Hoop Mounted Monitor Bracket	No Hoop Mounted Monitor Bracket	No cost
	Hoop Mounted Fixed Monitor Bracket	+\$820
	2 Hoop Mounted Fixed Monitor Brackets	+\$1640
Over Upholstery Fixed Monitor Bracket	No Over Upholstery Monitor Bracket	No cost
	Over Upholstery Fixed Monitor Bracket	+\$1268
	2 Over Upholstery Fixed Monitor Brackets	+\$2536
	3 Over Upholstery Fixed Monitor Brackets	+\$3804
	4 Over Upholstery Fixed Monitor Brackets	+\$5072
	5 Over Upholstery Fixed Monitor Brackets	+\$6340
Whiteboard	6 Over Upholstery Fixed Monitor Brackets	+\$7608
	No Whiteboard	No cost
	Straight Glass Magnetic Whiteboard	+\$3159
	2 Straight Glass Magnetic Whiteboards	+\$6318
	3 Straight Glass Magnetic Whiteboards	+\$9477
	4 Straight Glass Magnetic Whiteboards	+\$12,636
Door Size	5 Straight Glass Magnetic Whiteboards	+\$15,795
	6 Straight Glass Magnetic Whiteboards	+\$18,954
Door Lock	Standard Door Size	No cost
	Ontario AODA Compliant Door	+\$5328
Door Lock	No Lock	No cost
	Locking Door	+\$1965

► **Product Information continued on next page**

Acoustic Pods

Pods

► **Product Information continued from previous page**

Specification Information

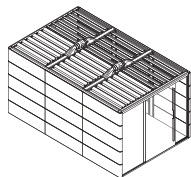

Style Number	Base Price	
Air³ Half-Square with Opening Roof		
OB1AIR27	\$91,019	
Single Grade Prices (for all five layers)	Internal Fabric	External Fabric
Grade 2	+\$2540	+\$3020
Grade 3	+\$3175	+\$3775
Grade 4	+\$3995	+\$4740
Grade 5	+\$5310	+\$6315
Grade 6	+\$6965	+\$8195
Grade 7	+\$8480	+\$10,065
Grade 8	+\$9860	+\$11,705
Grade 9	+\$12,820	+\$15,215
Grade 10	+\$16,150	+\$19,175
Layered Grade Prices (per layer)		
Grade 2 Layer	+\$508	+\$604
Grade 3 Layer	+\$635	+\$755
Grade 4 Layer	+\$799	+\$948
Grade 5 Layer	+\$1062	+\$1263
Grade 6 Layer	+\$1393	+\$1639
Grade 7 Layer	+\$1696	+\$2013
Grade 8 Layer	+\$1972	+\$2341
Grade 9 Layer	+\$2564	+\$3043
Grade 10 Layer	+\$3230	+\$3835

Acoustic Pods

Acoustic Pods

Pods

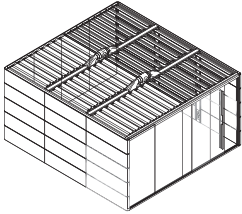

Tip: All Air3 models must be installed by Orangebox certified installers or warranty is void.

Standard Includes

- Two service hoops:
 - three NEMA 5-15 3-prong power outlets
 - three LED lights
 - heat detector
 - user control panel
 - occupancy sensor
- 30 exterior panels: two grommets
- 30 interior panels
- Seven glass panels (clear):
 - two 85 5/16" x 40 3/4"
 - five 85 7/16" x 26 3/4"
- One 86 3/16" x 45 11/16" glass sliding door: clear
- Two air circulation fans
- Six louvered roof ceiling squares: aluminum roof blades (grey)

Options

Hoop Mounted Monitor Bracket	No Hoop Mounted Monitor Bracket	No cost
	Hoop Mounted Fixed Monitor Bracket	+\$820
	2 Hoop Mounted Fixed Monitor Brackets	+\$1640
Over Upholstery Fixed Monitor Bracket	No Over Upholstery Monitor Bracket	No cost
	Over Upholstery Fixed Monitor Bracket	+\$1268
	2 Over Upholstery Fixed Monitor Brackets	+\$2536
	3 Over Upholstery Fixed Monitor Brackets	+\$3804
	4 Over Upholstery Fixed Monitor Brackets	+\$5072
	5 Over Upholstery Fixed Monitor Brackets	+\$6340
Whiteboard	6 Over Upholstery Fixed Monitor Brackets	+\$7608
	No Whiteboard	No cost
	Straight Glass Magnetic Whiteboard	+\$3159
	2 Straight Glass Magnetic Whiteboards	+\$6318
	3 Straight Glass Magnetic Whiteboards	+\$9477
	4 Straight Glass Magnetic Whiteboards	+\$12,636
Door Size	5 Straight Glass Magnetic Whiteboards	+\$15,795
	6 Straight Glass Magnetic Whiteboards	+\$18,954
Door Lock	Standard Door Size	No cost
	Ontario AODA Compliant Door	+\$5328
Door Lock	No Lock	No cost
	Locking Door	+\$1965

► **Product Information continued on next page**

Acoustic Pods

Pods

► **Product Information continued from previous page**

Specification Information

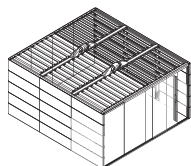

Style Number	Base Price	
Air³ Half-Square with Opening Roof		
OB1AIR29	\$58,266	
Single Grade Prices (for all five layers)	Internal Fabric	External Fabric
Grade 2	+\$2540	+\$3020
Grade 3	+\$3175	+\$3775
Grade 4	+\$3995	+\$4740
Grade 5	+\$5310	+\$6315
Grade 6	+\$6965	+\$8195
Grade 7	+\$8480	+\$10,065
Grade 8	+\$9860	+\$11,705
Grade 9	+\$12,820	+\$15,215
Grade 10	+\$16,150	+\$19,175
Layered Grade Prices (per layer)		
Grade 2 Layer	+\$508	+\$604
Grade 3 Layer	+\$635	+\$755
Grade 4 Layer	+\$799	+\$948
Grade 5 Layer	+\$1062	+\$1263
Grade 6 Layer	+\$1393	+\$1639
Grade 7 Layer	+\$1696	+\$2013
Grade 8 Layer	+\$1972	+\$2341
Grade 9 Layer	+\$2564	+\$3043
Grade 10 Layer	+\$3230	+\$3835

Acoustic Pods

Acoustic Pods

Pod Tables

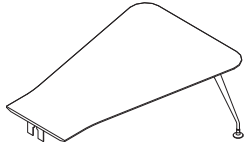

Tip: Recommended for use in OB1AIR25.

Standard Includes

- 1" thick table top: High-Pressure Laminate price group 01
- 3 mm edgeband: plastic price group 01
- Two legs with feet
- Attachment bracket with hardware

Options

Option	Price Group	Cost
Top Finish	Laminate HPL Price Group 01	No cost
	Laminate HPL Price Group 02	+\$187
	Laminate HPL Price Group 03	+\$388
	OLL Price Group 1	+\$102
Edge Finish	Plastic Group 1	No cost
Leg Finish	Orangebox Paint Price Group 01	No cost
	Orangebox Paint Price Group 02	+\$74

Specification Information

Style Number	Base Price
Air3 Small Pod Table	
OB1AIR30	\$2818

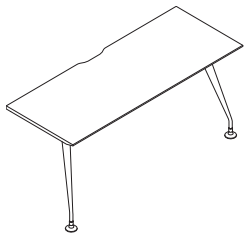

Tip: Recommended for use in OB1AIR23.

Standard Includes

- 1" thick table top: High-Pressure Laminate price group 01
- 3 mm edgeband: plastic price group 01
- Two legs with feet
- Attachment bracket with hardware

Options

Option	Price Group	Cost
Top Finish	Laminate HPL Price Group 01	No cost
	Laminate HPL Price Group 02	+\$87
	Laminate HPL Price Group 03	+\$183
	OLL Price Group 1	+\$102
Edge Finish	Plastic Group 1	No cost
Leg Finish	Orangebox Paint Price Group 01	No cost
	Orangebox Paint Price Group 02	+\$74

Specification Information

Style Number	Base Price
Air3 Short, Straight Pod Table	
OB1AIR35	\$2584

Acoustic Pods

Accessories

Standard Includes

- Style Number

Specification Information

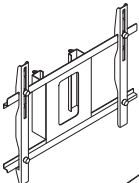
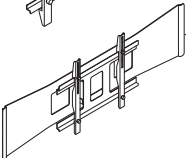
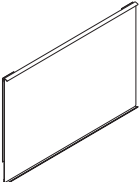
	Style Number	Price
	Hoop Mounted Monitor Bracket	
	OB1AIRGA153US	\$820
	Over Upholstery Monitor Bracket	
	OB1AIRGA174US	\$1268
	Straight Glass Magnetic Whiteboard	
	OB1AIRGA151	\$3159



Acoustic Pods

Tip: Use of the installation template is highly recommended. The installation template can be ordered from the CS3 catalog under style number 1379688001SR.

Standard Includes

- Installation training

Specification Information

	Style Number	Price
	Air3 Installation Training, One to Five Units	
	OB1AIRINSTALL1	\$1309
	Air3 Installation Training, Six to 10 Units	
	OB1AIRINSTALL2	\$2619
	Air3 Installation Training, 11+ Units	
	OB1AIRINSTALL3	\$6549

Acoustic Pods

Accessories

Tip: Seismic kits do not include hardware to anchor brackets to the building.

Standard Includes

- Seismic bracket

Specification Information

Style Number	Price
Air23 Pod Seismic Kit	
OB1AIRGA180	\$692
Air25 Pod Seismic Kit	
OB1AIRGA176	\$692
Air27 Pod Seismic Kit	
OB1AIRGA181	\$1069
Air29 Pod Seismic Kit	
OB1AIRGA204	\$1448

On the QT

Phone Booths

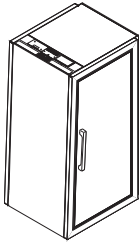

Standard Includes

- Frame assembly:
 - aluminum framework
 - acoustic wall cassettes
 - roof and floor panels (black)
- Carpet
- One set of framed laminated glass, door, and wall
- One solid oak door handle
- Two laminate cladding exterior walls: High-Pressure Laminate price group 01
- Two pressed felt interior cladding walls
- Integrated lighting and air ventilation, with motion sensor

Options

Front Exterior Cladding Type	Laminate	No cost
	Painted Metal	+\$193
	Whiteboard	+\$651
	Fabric	+\$1026
	Plywood	+\$1332
Front Exterior Cladding Finish	Fabric Customer's Own Material	No cost
	Fabric Price Group 01	No cost
	Laminate HPL Price Group 01	No cost
	Markerboard Price Group 01	No cost
	Paint Price Group 01	No cost
	Plywood Price Group 01	No cost
	Fabric Price Group 02	+\$39
	Fabric Price Group 03	+\$72
	Paint Price Group 02	+\$72
	Laminate HPL Price Group 02	+\$88
	Fabric Price Group 04	+\$112
	Paint Price Group 03	+\$117
	Fabric Price Group 05	+\$174
	Laminate HPL Price Group 03	+\$186
	Fabric Price Group 06	+\$240
Fabric Price Group 07	+\$304	
Fabric Price Group 08	+\$368	
Fabric Price Group 09	+\$441	
Fabric Price Group 10	+\$509	
OLL Price Group 1	+\$102	
Rear Exterior Cladding Type	Laminate	No cost
	Painted Metal	+\$193
	Whiteboard	+\$651
	Fabric	+\$1026
	Plywood	+\$1332
Rear Exterior Cladding Finish	Fabric Customer's Own Material	No cost
	Fabric Price Group 01	No cost
	Laminate HPL Price Group 01	No cost
	Markerboard Price Group 01	No cost
	Paint Price Group 01	No cost
	Plywood Price Group 01	No cost
	Fabric Price Group 02	+\$39
Fabric Price Group 03	+\$72	

► **Product Information continued on next page**

On the QT

On the QT**Phone Booths****► Product Information continued from previous page**

Options		
Rear Exterior Cladding Finish	Paint Price Group 02	+\$72
	Laminate HPL Price Group 02	+\$88
	Fabric Price Group 04	+\$112
	Paint Price Group 03	+\$117
	Fabric Price Group 05	+\$174
	Laminate HPL Price Group 03	+\$186
	Fabric Price Group 06	+\$240
	Fabric Price Group 07	+\$304
	Fabric Price Group 08	+\$368
	Fabric Price Group 09	+\$441
	Fabric Price Group 10	+\$509
	OLL Price Group 1	+\$102
Cover Cap Finish	Paint Price Group 01	No cost
	Paint Price Group 02	+\$55
	Paint Price Group 03	+\$111
Lean Pad Option	No Lean Pad	No cost
	Lean Pad	+\$895
Lean Pad Finish	Fabric Customer's Own Material	No cost
	Fabric Price Group 01	No cost
	Fabric Price Group 02	+\$24
	Vinyl Price Group 02	+\$24
	Fabric Price Group 03	+\$47
	Fabric Price Group 04	+\$81
	Fabric Price Group 05	+\$134
	Fabric Price Group 06	+\$186
	Fabric Price Group 07	+\$254
	Fabric Price Group 08	+\$316
	Fabric Price Group 09	+\$368
	Fabric Price Group 10	+\$438
Screen Type	No Screen	No cost
	Privacy Screen	+\$686
Screen Finish	Fabric Customer's Own Material	No cost
	Fabric Price Group 01	No cost
	Fabric Price Group 02	+\$24
	Vinyl Price Group 02	+\$24
	Fabric Price Group 03	+\$47
	Fabric Price Group 04	+\$81
	Fabric Price Group 05	+\$134
	Fabric Price Group 06	+\$186
	Fabric Price Group 07	+\$254
	Fabric Price Group 08	+\$316
	Fabric Price Group 09	+\$368
	Fabric Price Group 10	+\$438
Power Plug Type	Hardwire	No cost
	Type B	No cost
Power Outlet Type	No Power Outlet	No cost
	Type B	No cost

► Product Information continued on next page

► **Product Information continued from previous page**

Tip: "Type B" is the standard North American NEMA 5-15 plug.

Options		
Power Configuration	QT 2 Power 1 USB A+C	+\$258
Light	No Light	No cost
	Occupancy Light	+\$375
Seismic Kit Option	No Kit	No cost
	Seismic Kit	+\$729
Shelf Option	No Shelf	No cost
	With Shelf	+\$364
Shelf Finish	Laminate HPL Price Group 01	No cost
	Laminate HPL Price Group 02	+\$76
	Laminate HPL Price Group 03	+\$154
	OLL Price Group 1	+\$102

Specification Information

Style Number Base Price

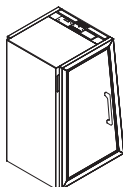

Short Angled Phone Booth, LH Hinge

OB1QT01 \$20,903



Short Angled Phone Booth, RH Hinge

OB1QT02 \$20,903



On the QT

Phone Booths

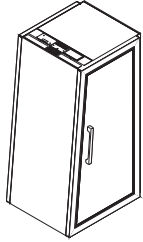

Standard Includes

- Frame assembly:
 - aluminum framework
 - acoustic wall cassettes
 - roof and floor panels (black)
- Carpet
- One set of framed laminated glass, door, and wall
- One solid oak door handle
- Two laminate cladding exterior walls: High-Pressure Laminate price group 01
- Two pressed felt interior cladding walls
- Integrated lighting and air ventilation, with motion sensor

Options

Front Exterior Cladding Type	Laminate	No cost
	Painted Metal	+\$251
	Whiteboard	+\$741
	Fabric	+\$1114
	Plywood	+\$1446
Front Exterior Cladding Finish	Fabric Customer's Own Material	No cost
	Fabric Price Group 01	No cost
	Laminate HPL Price Group 01	No cost
	Markerboard Price Group 01	No cost
	Paint Price Group 01	No cost
	Plywood Price Group 01	No cost
	Fabric Price Group 02	+\$44
	Fabric Price Group 03	+\$72
	Paint Price Group 02	+\$85
	Laminate HPL Price Group 02	+\$107
	Fabric Price Group 04	+\$119
	Paint Price Group 03	+\$144
	Fabric Price Group 05	+\$186
	Laminate HPL Price Group 03	+\$223
	Fabric Price Group 06	+\$254
Fabric Price Group 07	+\$320	
Fabric Price Group 08	+\$389	
Fabric Price Group 09	+\$465	
Fabric Price Group 10	+\$541	
OLL Price Group 1	+\$102	
Rear Exterior Cladding Type	Laminate	No cost
	Painted Metal	+\$251
	Whiteboard	+\$741
	Fabric	+\$1114
	Plywood	+\$1446
Rear Exterior Cladding Finish	Fabric Customer's Own Material	No cost
	Fabric Price Group 01	No cost
	Laminate HPL Price Group 01	No cost
	Markerboard Price Group 01	No cost
	Paint Price Group 01	No cost
	Plywood Price Group 01	No cost
	Fabric Price Group 02	+\$44
	Fabric Price Group 03	+\$75

► **Product Information continued on next page**

► **Product Information continued from previous page**

Options		
Rear Exterior Cladding Finish	Paint Price Group 02	+\$85
	Laminate HPL Price Group 02	+\$107
	Fabric Price Group 04	+\$119
	Paint Price Group 03	+\$144
	Fabric Price Group 05	+\$186
	Laminate HPL Price Group 03	+\$223
	Fabric Price Group 06	+\$254
	Fabric Price Group 07	+\$320
	Fabric Price Group 08	+\$389
	Fabric Price Group 09	+\$465
	Fabric Price Group 10	+\$541
	OLL Price Group 1	+\$102
Cover Cap Finish	Paint Price Group 01	No cost
	Paint Price Group 02	+\$74
	Paint Price Group 03	+\$140
Lean Pad Option	No Lean Pad	No cost
	Lean Pad	+\$895
Lean Pad Finish	Fabric Customer's Own Material	No cost
	Fabric Price Group 01	No cost
	Fabric Price Group 02	+\$24
	Vinyl Price Group 02	+\$24
	Fabric Price Group 03	+\$47
	Fabric Price Group 04	+\$81
	Fabric Price Group 05	+\$134
	Fabric Price Group 06	+\$186
	Fabric Price Group 07	+\$254
	Fabric Price Group 08	+\$316
Screen Type	No Screen	No cost
	Privacy Screen	+\$686
Screen Finish	Fabric Customer's Own Material	No cost
	Fabric Price Group 01	No cost
	Fabric Price Group 02	+\$24
	Vinyl Price Group 02	+\$24
	Fabric Price Group 03	+\$47
	Fabric Price Group 04	+\$81
	Fabric Price Group 05	+\$134
	Fabric Price Group 06	+\$186
	Fabric Price Group 07	+\$254
	Fabric Price Group 08	+\$316
Power Plug Type	Hardwire	No cost
	Type B	No cost
Power Outlet Type	No Power Outlet	No cost
	Type B	No cost

► **Product Information continued on next page**

On the QT

Phone Booths

► **Product Information continued from previous page**

Tip: "Type B" is the standard North American NEMA 5-15 plug.

Options		
Power Configuration	QT 2 Power 1 USB A+C	+\$258
Light	No Light	No cost
	Occupancy Light	+\$375
Seismic Kit Option	No Kit	No cost
	Seismic Kit	+\$729
Shelf Option	No Shelf	No cost
	With Shelf	+\$364
	With L-Shelf	+\$414
Shelf Finish	Laminate HPL Price Group 01	No cost
	Laminate HPL Price Group 02	+\$76
	Laminate HPL Price Group 03	+\$154
	OLL Price Group 1	+\$102

Specification Information

Style Number Base Price

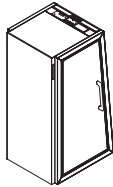

Tall Angled Phone Booth, LH Hinge

OB1QT03 \$21,020



Tall Angled Phone Booth, RH Hinge

OB1QT04 \$21,020

On the QT Seating

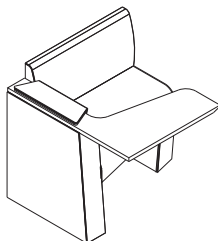

Tip: (OB1QTF01) and (OB1QTF02) are not standalone units and are only for use in On the Q.T. phone booths.

Standard Includes

- Fully upholstered seating unit: fabric price group 01
- 1" thick integrated tablet: High-Pressure Laminate price group 01 with 3 mm plastic edge

Options

Color Scheme	Non Contrasting	No cost
	Contrasting	+\$102
Upholstery Finish	Fabric Customer's Own Material	No cost
	Fabric Price Group 01	No cost
	Fabric Price Group 02	+\$84
	Vinyl Price Group 02	+\$84
	Fabric Price Group 03	+\$222
	Fabric Price Group 04	+\$301
	Fabric Price Group 05	+\$352
	Fabric Price Group 06	+\$428
	Fabric Price Group 07	+\$529
	Fabric Price Group 08	+\$642
Seat Finish	Fabric Customer's Own Material	No cost
	Fabric Price Group 01	No cost
	Fabric Price Group 02	+\$24
	Vinyl Price Group 02	+\$24
	Fabric Price Group 03	+\$61
	Fabric Price Group 04	+\$82
	Fabric Price Group 05	+\$97
	Fabric Price Group 06	+\$117
	Fabric Price Group 07	+\$144
	Fabric Price Group 08	+\$174
Back Finish	Fabric Customer's Own Material	No cost
	Fabric Price Group 01	No cost
	Fabric Price Group 02	+\$16
	Vinyl Price Group 02	+\$16
	Fabric Price Group 03	+\$39
	Fabric Price Group 04	+\$55
	Fabric Price Group 05	+\$63
	Fabric Price Group 06	+\$78
	Fabric Price Group 07	+\$97
	Fabric Price Group 08	+\$117
Arm Finish	Fabric Customer's Own Material	No cost
	Fabric Price Group 01	No cost
	Fabric Price Group 02	+\$31
	Vinyl Price Group 02	+\$31
	Fabric Price Group 03	+\$81
	Fabric Price Group 04	+\$108
	Fabric Price Group 05	+\$129
	Fabric Price Group 06	+\$155

► Product Information continued on next page

On the QT

On the QT

Seating

► **Product Information continued from previous page**

Options			
Arm Finish	Fabric Price Group 07	+\$193	
	Fabric Price Group 08	+\$234	
	Fabric Price Group 09	+\$288	
	Fabric Price Group 10	+\$335	
Arm Pad Finish	Fabric Customer's Own Material	No cost	
	Fabric Price Group 01	No cost	
	Fabric Price Group 02	+\$16	
	Vinyl Price Group 02	+\$16	
	Fabric Price Group 03	+\$39	
	Fabric Price Group 04	+\$55	
	Fabric Price Group 05	+\$63	
	Fabric Price Group 06	+\$78	
	Fabric Price Group 07	+\$97	
	Fabric Price Group 08	+\$117	
	Fabric Price Group 09	+\$144	
Tablet Finish	Fabric Price Group 01	No cost	
	Fabric Price Group 02	No cost	
	Fabric Price Group 03	No cost	
	Fabric Price Group 05	No cost	
	Fabric Price Group 06	No cost	
	Fabric Price Group 07	No cost	
	Laminate HPL Price Group 01	No cost	
	Vinyl Price Group 02	No cost	
	Laminate HPL Price Group 02	+\$76	
	Laminate HPL Price Group 03	+\$154	
	OLL Price Group 1	+\$102	
	Edge Finish	Plastic - PG1	No cost

Specification Information

Style Number Base Price

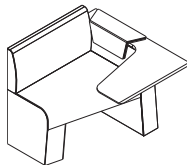

Furniture Seat Left Hand Application

OB1QTF01 \$3099

OB1QTF01 *only compatible in phone booths OB1QT01 and OB1QT03.*

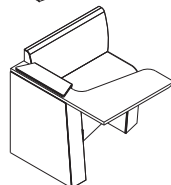

Furniture Seat Right Hand Application

OB1QTF02 \$3099

OB1QTF02 *only compatible in phone booths OB1QT02 and OB1QT04.*

Aspect

Work Unit with Curved Arm

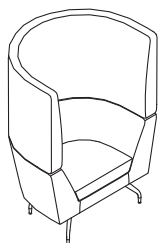

Tip: Body lower and body upper finishes are only selectable if upholstered body configuration is selected.

Standard Includes

- Fully upholstered seating unit: fabric price group 01
- Contrasting reveal seam matching seat or body finish
- Adjustable feet

Options

Body Configuration	Upholstered Body Inner/Outer Configuration	No cost +\$261
Body Lower Finish	Fabric Customer's Own Material	No cost
	Fabric Price Group 01	No cost
	Fabric Price Group 02	+\$69
	Fabric Price Group 03	+\$138
	Fabric Price Group 04	+\$234
	Fabric Price Group 05	+\$387
	Fabric Price Group 06	+\$542
	Fabric Price Group 07	+\$739
	Fabric Price Group 08	+\$917
	Fabric Price Group 09	+\$1070
Body Upper Finish	Fabric Customer's Own Material	No cost
	Fabric Price Group 01	No cost
	Fabric Price Group 02	+\$114
	Fabric Price Group 03	+\$233
	Fabric Price Group 04	+\$393
	Fabric Price Group 05	+\$652
	Fabric Price Group 06	+\$909
	Fabric Price Group 07	+\$1243
	Fabric Price Group 08	+\$1539
	Fabric Price Group 09	+\$1799
Body Inner Finish	Fabric Customer's Own Material	No cost
	Fabric Price Group 01	No cost
	Fabric Price Group 02	+\$183
	Fabric Price Group 03	+\$372
	Fabric Price Group 04	+\$626
	Fabric Price Group 05	+\$1040
	Fabric Price Group 06	+\$1451
	Fabric Price Group 07	+\$1982
	Fabric Price Group 08	+\$2456
	Fabric Price Group 09	+\$2867
Body Outer Finish	Fabric Customer's Own Material	No cost
	Fabric Price Group 01	No cost
	Fabric Price Group 02	No cost
	Fabric Price Group 03	No cost
	Fabric Price Group 04	No cost
	Fabric Price Group 05	No cost
	Fabric Price Group 06	No cost
	Fabric Price Group 07	No cost
	Fabric Price Group 08	No cost
	Fabric Price Group 09	No cost

Tip: Body inner and body outer finishes are only selectable if body inner/outer configuration is selected. Inner/outer selection must stay in the same fabric family.

► **Product Information continued on next page**

Aspect

Work Unit with Curved Arm

► **Product Information continued from previous page**

Options		
Body Outer Finish	Fabric Price Group 10	No cost
Seat Finish	Customer's Own Leather	No cost
	Fabric Customer's Own Material	No cost
	Fabric Price Group 01	No cost
	Fabric Price Group 02	+\$28
	Fabric Price Group 03	+\$59
	Fabric Price Group 04	+\$100
	Fabric Price Group 05	+\$165
	Fabric Price Group 06	+\$232
	Fabric Price Group 07	+\$316
	Fabric Price Group 08	+\$389
	Fabric Price Group 09	+\$457
	Fabric Price Group 10	+\$543
Reveal Seam	Does Not Match Seat or Body	No cost
	Matches Body	No cost
	Matches Body - Inner	No cost
	Matches Body - Outer	No cost
	Matches Seat	No cost
Reveal Seam Finish	Fabric Price Group 03	+\$164
	Fabric Price Group 04	+\$164
	Fabric Price Group 08	+\$195
Leg Finish	Orangebox Paint Price Group 01	No cost
	Orangebox Paint Price Group 02	+\$125
Foot Finish	Orangebox Paint Price Group 01	No cost
	Orangebox Paint Price Group 02	+\$49

Tip: Reveal seam finish is only selectable if "Does Not Match Seat or Body" option is chosen.

Specification Information



Style Number Base Price

Aspect One Seat Work Unit with Curved Arm

OBASPECT07HB \$8209

Aspect

Work Unit with Curved Arm

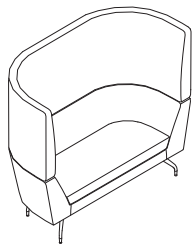

Tip: Body lower and body upper finishes are only selectable if upholstered body configuration is selected.

Tip: Body inner and body outer finishes are only selectable if body inner/outer configuration is selected. Inner/outer selection must stay in the same fabric family.

Standard Includes

- Fully upholstered seating unit: fabric price group 01
- Contrasting reveal seam matching seat or body finish
- Adjustable feet

Options

Body Configuration	Upholstered	No cost
	Body Inner/Outer Configuration	+\$396
Body Lower Finish	Fabric Customer's Own Material	No cost
	Fabric Price Group 01	No cost
	Fabric Price Group 02	+\$93
	Fabric Price Group 03	+\$189
	Fabric Price Group 04	+\$317
	Fabric Price Group 05	+\$529
	Fabric Price Group 06	+\$737
	Fabric Price Group 07	+\$1005
	Fabric Price Group 08	+\$1245
	Fabric Price Group 09	+\$1456
	Fabric Price Group 10	+\$1731
Body Upper Finish	Fabric Customer's Own Material	No cost
	Fabric Price Group 01	No cost
	Fabric Price Group 02	+\$145
	Fabric Price Group 03	+\$293
	Fabric Price Group 04	+\$495
	Fabric Price Group 05	+\$822
	Fabric Price Group 06	+\$1150
	Fabric Price Group 07	+\$1567
	Fabric Price Group 08	+\$1943
	Fabric Price Group 09	+\$2268
	Fabric Price Group 10	+\$2700
Body Inner Finish	Fabric Customer's Own Material	No cost
	Fabric Price Group 01	No cost
	Fabric Price Group 02	+\$238
	Fabric Price Group 03	+\$483
	Fabric Price Group 04	+\$814
	Fabric Price Group 05	+\$1349
	Fabric Price Group 06	+\$1886
	Fabric Price Group 07	+\$2575
	Fabric Price Group 08	+\$3187
	Fabric Price Group 09	+\$3725
	Fabric Price Group 10	+\$4431
Body Outer Finish	Fabric Customer's Own Material	No cost
	Fabric Price Group 01	No cost
	Fabric Price Group 02	No cost
	Fabric Price Group 03	No cost
	Fabric Price Group 04	No cost
	Fabric Price Group 05	No cost
	Fabric Price Group 06	No cost
	Fabric Price Group 07	No cost
	Fabric Price Group 08	No cost
	Fabric Price Group 09	No cost

► **Product Information continued on next page**



Aspect

Work Unit with Curved Arm

► **Product Information continued from previous page**

Options		
Body Outer Finish	Fabric Price Group 10	No cost
Seat Finish	Customer's Own Leather	No cost
	Fabric Customer's Own Material	No cost
	Fabric Price Group 01	No cost
	Fabric Price Group 02	+\$52
	Fabric Price Group 03	+\$104
	Fabric Price Group 04	+\$174
	Fabric Price Group 05	+\$289
	Fabric Price Group 06	+\$404
	Fabric Price Group 07	+\$552
	Fabric Price Group 08	+\$683
	Fabric Price Group 09	+\$799
	Fabric Price Group 10	+\$950
Reveal Seam	Does Not Match Seat or Body	No cost
	Matches Body	No cost
	Matches Body - Inner	No cost
	Matches Body - Outer	No cost
	Matches Seat	No cost
Reveal Seam Finish	Fabric Price Group 03	+\$164
	Fabric Price Group 04	+\$164
	Fabric Price Group 08	+\$195
Leg Finish	Orangebox Paint Price Group 01	No cost
	Orangebox Paint Price Group 02	+\$125
Foot Finish	Orangebox Paint Price Group 01	No cost
	Orangebox Paint Price Group 02	+\$49

Tip: Reveal seam finish is only selectable if "Does Not Match Seat or Body" option is chosen.

Specification Information

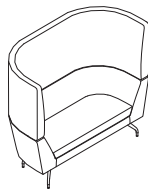

Style Number	Base Price
--------------	------------

Aspect Two Seat Work Unit with Curved Arm

OBASPECT08HB	\$10,323
---------------------	----------

Aspect

Work Unit with Curved Arm

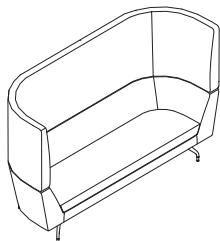

Tip: Body lower and body upper finishes are only selectable if upholstered body configuration is selected.

Standard Includes

- Fully upholstered seating unit: fabric price group 01
- Contrasting reveal seam matching seat or body finish
- Adjustable feet

Options

Body Configuration	Upholstered	No cost
	Body Inner/Outer Configuration	+\$525
Body Lower Finish	Fabric Customer's Own Material	No cost
	Fabric Price Group 01	No cost
	Fabric Price Group 02	+\$107
	Fabric Price Group 03	+\$217
	Fabric Price Group 04	+\$365
	Fabric Price Group 05	+\$603
	Fabric Price Group 06	+\$845
	Fabric Price Group 07	+\$1155
	Fabric Price Group 08	+\$1429
	Fabric Price Group 09	+\$1670
	Fabric Price Group 10	+\$1987
Body Upper Finish	Fabric Customer's Own Material	No cost
	Fabric Price Group 01	No cost
	Fabric Price Group 02	+\$179
	Fabric Price Group 03	+\$361
	Fabric Price Group 04	+\$606
	Fabric Price Group 05	+\$1007
	Fabric Price Group 06	+\$1408
	Fabric Price Group 07	+\$1924
	Fabric Price Group 08	+\$2382
	Fabric Price Group 09	+\$2782
	Fabric Price Group 10	+\$3313
Body Inner Finish	Fabric Customer's Own Material	No cost
	Fabric Price Group 01	No cost
	Fabric Price Group 02	+\$286
	Fabric Price Group 03	+\$577
	Fabric Price Group 04	+\$972
	Fabric Price Group 05	+\$1613
	Fabric Price Group 06	+\$2255
	Fabric Price Group 07	+\$3079
	Fabric Price Group 08	+\$3810
	Fabric Price Group 09	+\$4452
	Fabric Price Group 10	+\$5300
Body Outer Finish	Fabric Customer's Own Material	No cost
	Fabric Price Group 01	No cost
	Fabric Price Group 02	No cost
	Fabric Price Group 03	No cost
	Fabric Price Group 04	No cost
	Fabric Price Group 05	No cost
	Fabric Price Group 06	No cost
	Fabric Price Group 07	No cost
	Fabric Price Group 08	No cost
	Fabric Price Group 09	No cost

Tip: Body inner and body outer finishes are only selectable if body inner/outer configuration is selected. Inner/outer selection must stay in the same fabric family.

► Product Information continued on next page



Aspect

Work Unit with Curved Arm

► **Product Information continued from previous page**

Options		
Body Outer Finish	Fabric Price Group 10	No cost
Seat Finish	Customer's Own Leather	No cost
	Fabric Customer's Own Material	No cost
	Fabric Price Group 01	No cost
	Fabric Price Group 02	+\$52
	Fabric Price Group 03	+\$106
	Fabric Price Group 04	+\$178
	Fabric Price Group 05	+\$294
	Fabric Price Group 06	+\$412
	Fabric Price Group 07	+\$562
	Fabric Price Group 08	+\$697
Fabric Price Group 09	+\$814	
Fabric Price Group 10	+\$968	
Reveal Seam	Does Not Match Seat or Body	No cost
	Matches Body	No cost
	Matches Body - Inner	No cost
	Matches Body - Outer	No cost
	Matches Seat	No cost
Reveal Seam Finish	Fabric Price Group 03	+\$164
	Fabric Price Group 04	+\$164
	Fabric Price Group 08	+\$195
Leg Finish	Orangebox Paint Price Group 01	No cost
	Orangebox Paint Price Group 02	+\$125
Foot Finish	Orangebox Paint Price Group 01	No cost
	Orangebox Paint Price Group 02	+\$49

Tip: Reveal seam finish is only selectable if "Does Not Match Seat or Body" option is chosen.

Specification Information

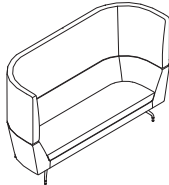
	Style Number	Base Price
	Aspect Three Seat Work Unit with Curved Arm	
	OBASPECT09HB	\$11,489

Aspect

Work Screened Units with Fixed Table

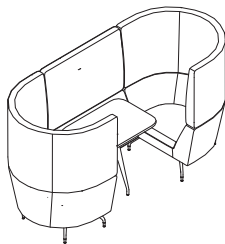

Standard Includes

- Fully upholstered booth: fabric price group 01
- Contrasting reveal seam matching seat or body finish
- 1" thick tabletop with tapered edge:
 - High-Pressure Laminate price group 01
 - Fixed
- 3 mm edgeband: plastic price group 01
- Single table leg with foot
- Adjustable feet

Options

Body Configuration	Upholstered	No cost
	Body Inner/Outer Configuration	+\$398
Body Lower Finish	Fabric Customer's Own Material	No cost
	Fabric Price Group 01	No cost
	Fabric Price Group 02	+\$137
	Fabric Price Group 03	+\$278
	Fabric Price Group 04	+\$467
	Fabric Price Group 05	+\$776
	Fabric Price Group 06	+\$1083
	Fabric Price Group 07	+\$1480
	Fabric Price Group 08	+\$1831
	Fabric Price Group 09	+\$2141
	Fabric Price Group 10	+\$2547
Body Upper Finish	Fabric Customer's Own Material	No cost
	Fabric Price Group 01	No cost
	Fabric Price Group 02	+\$227
	Fabric Price Group 03	+\$460
	Fabric Price Group 04	+\$776
	Fabric Price Group 05	+\$1287
	Fabric Price Group 06	+\$1799
	Fabric Price Group 07	+\$2458
	Fabric Price Group 08	+\$3041
	Fabric Price Group 09	+\$3552
	Fabric Price Group 10	+\$4229
Body Inner Finish	Fabric Customer's Own Material	No cost
	Fabric Price Group 01	No cost
	Fabric Price Group 02	+\$365
	Fabric Price Group 03	+\$738
	Fabric Price Group 04	+\$1244
	Fabric Price Group 05	+\$2063
	Fabric Price Group 06	+\$2883
	Fabric Price Group 07	+\$3937
	Fabric Price Group 08	+\$4872
	Fabric Price Group 09	+\$5693
	Fabric Price Group 10	+\$6777
Body Outer Finish	Fabric Customer's Own Material	No cost
	Fabric Price Group 01	No cost
	Fabric Price Group 02	No cost
	Fabric Price Group 03	No cost
	Fabric Price Group 04	No cost

Tip: Body lower and body upper finishes are only selectable if upholstered body configuration is selected.

Tip: Body inner and body outer finishes are only selectable if body inner/outer configuration is selected. Inner/outer selection must stay in the same fabric family.

▶ **Product Information continued on next page**



Aspect

Work Screened Units with Fixed Table

► **Product Information continued from previous page**

Options		
Body Outer Finish	Fabric Price Group 05	No cost
	Fabric Price Group 06	No cost
	Fabric Price Group 07	No cost
	Fabric Price Group 08	No cost
	Fabric Price Group 09	No cost
	Fabric Price Group 10	No cost
Seat Finish	Customer's Own Leather	No cost
	Fabric Customer's Own Material	No cost
	Fabric Price Group 01	No cost
	Fabric Price Group 02	+\$41
	Fabric Price Group 03	+\$83
	Fabric Price Group 04	+\$140
	Fabric Price Group 05	+\$233
	Fabric Price Group 06	+\$325
	Fabric Price Group 07	+\$444
	Fabric Price Group 08	+\$548
	Fabric Price Group 09	+\$643
Reveal Seam	Does Not Match Seat or Body	No cost
	Matches Body	No cost
	Matches Body - Inner	No cost
	Matches Body - Outer	No cost
	Matches Seat	No cost
Reveal Seam Finish	Fabric Price Group 03	+\$483
	Fabric Price Group 04	+\$483
	Fabric Price Group 08	+\$584
Screen Configuration	Upholstered	No cost
	Screen Inner/Outer Configuration	+\$143
Screen Upper Finish	Customer's Own Leather	No cost
	Fabric Customer's Own Material	No cost
	Fabric Price Group 01	No cost
	Fabric Price Group 02	+\$73
	Fabric Price Group 03	+\$144
	Fabric Price Group 04	+\$243
	Fabric Price Group 05	+\$403
	Fabric Price Group 06	+\$564
	Fabric Price Group 07	+\$770
	Fabric Price Group 08	+\$953
Screen Lower Finish	Fabric Price Group 09	+\$1113
	Fabric Price Group 10	+\$1324
	Customer's Own Leather	No cost
	Fabric Customer's Own Material	No cost
	Fabric Price Group 01	No cost
	Fabric Price Group 02	+\$60
	Fabric Price Group 03	+\$122
	Fabric Price Group 04	+\$206
Fabric Price Group 05	+\$341	
Fabric Price Group 06	+\$479	
Fabric Price Group 07	+\$650	

Tip: Reveal seam finish is only selectable if "Does Not Match Seat or Body" option is chosen.

Tip: Screen upper and screen lower finishes are only selectable if upholstered screen configuration is selected.

► **Product Information continued on next page**

► Product Information continued from previous page

Options		
Screen Lower Finish	Fabric Price Group 08	+\$806
	Fabric Price Group 09	+\$942
	Fabric Price Group 10	+\$1123
Screen Inner Finish	Customer's Own Leather	No cost
	Fabric Customer's Own Material	No cost
	Fabric Price Group 01	No cost
	Fabric Price Group 02	+\$133
	Fabric Price Group 03	+\$265
	Fabric Price Group 04	+\$449
	Fabric Price Group 05	+\$744
	Fabric Price Group 06	+\$1041
	Fabric Price Group 07	+\$1420
	Fabric Price Group 08	+\$1758
	Fabric Price Group 09	+\$2056
Screen Outer Finish	Customer's Own Leather	No cost
	Fabric Customer's Own Material	No cost
	Fabric Price Group 01	No cost
	Fabric Price Group 02	No cost
	Fabric Price Group 03	No cost
	Fabric Price Group 04	No cost
	Fabric Price Group 05	No cost
	Fabric Price Group 06	No cost
	Fabric Price Group 07	No cost
	Fabric Price Group 08	No cost
	Fabric Price Group 09	No cost
Leg Finish	Orangebox Paint Price Group 01	No cost
	Orangebox Paint Price Group 02	+\$280
Foot Finish	Orangebox Paint Price Group 01	No cost
	Orangebox Paint Price Group 02	+\$101
Top Finish	Laminate HPL Price Group 01	No cost
	Laminate HPL Price Group 02	+\$94
	Laminate HPL Price Group 03	+\$195
	OLL Price Group 1	+\$102
Edge Finish	Plastic Group 1	No cost
Monitor Bracket	No Monitor Bracket Required	No cost
	Tilting Monitor Bracket	+\$311
Lower Screen Power/Data Axil	No Power/Data Required	No cost
	4 Duplex Outlets	+\$507
	2 Outlets with CAT6 & HDMI Ports	+\$579
	2 Outlets with Two CAT6 Data Ports	+\$585
	2 Outlets with CAT6 and USB Data Ports	+\$602
Power Finish	Paint Price Group 01	No cost
	Paint Price Group 02	No cost

► Product Information continued on next page

Tip: Screen inner and screen outer finishes are only selectable if screen inner/outer configuration is selected. Inner/outer selection must stay in the same fabric family.

Aspect

Work Screened Units with Fixed Table

▶ **Product Information continued from previous page**

Specification Information

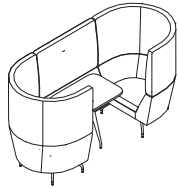

Style Number Base Price

Aspect Two Seat Work Screened Unit with Fixed Table

OBASPECT57HB \$20,976

Aspect

Work Screened Units with Fixed Table

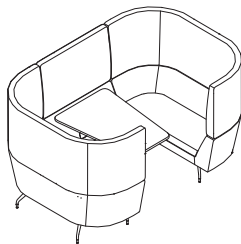

Standard Includes

- Fully upholstered booth: fabric price group 01
- Contrasting reveal seam matching seat or body finish
- 1" thick tabletop with tapered edge:
 - High-Pressure Laminate price group 01
 - Fixed
- 3 mm edgeband: plastic price group 01
- Single table leg with foot
- Adjustable feet

Options

Body Configuration	Upholstered	No cost
	Body Inner/Outer Configuration	+\$593
Body Lower Finish	Fabric Customer's Own Material	No cost
	Fabric Price Group 01	No cost
	Fabric Price Group 02	+\$186
	Fabric Price Group 03	+\$377
	Fabric Price Group 04	+\$637
	Fabric Price Group 05	+\$1055
	Fabric Price Group 06	+\$1474
	Fabric Price Group 07	+\$2013
	Fabric Price Group 08	+\$2491
	Fabric Price Group 09	+\$2910
	Fabric Price Group 10	+\$3465
Body Upper Finish	Fabric Customer's Own Material	No cost
	Fabric Price Group 01	No cost
	Fabric Price Group 02	+\$291
	Fabric Price Group 03	+\$589
	Fabric Price Group 04	+\$992
	Fabric Price Group 05	+\$1644
	Fabric Price Group 06	+\$2297
	Fabric Price Group 07	+\$3137
	Fabric Price Group 08	+\$3884
	Fabric Price Group 09	+\$4538
	Fabric Price Group 10	+\$5402
Body Inner Finish	Fabric Customer's Own Material	No cost
	Fabric Price Group 01	No cost
	Fabric Price Group 02	+\$479
	Fabric Price Group 03	+\$966
	Fabric Price Group 04	+\$1625
	Fabric Price Group 05	+\$2699
	Fabric Price Group 06	+\$3770
	Fabric Price Group 07	+\$5149
	Fabric Price Group 08	+\$6374
	Fabric Price Group 09	+\$7449
	Fabric Price Group 10	+\$8868
Body Outer Finish	Fabric Customer's Own Material	No cost
	Fabric Price Group 01	No cost
	Fabric Price Group 02	No cost
	Fabric Price Group 03	No cost
	Fabric Price Group 04	No cost

Tip: Body lower and body upper finishes are only selectable if upholstered body configuration is selected.

Tip: Body inner and body outer finishes are only selectable if body inner/outer configuration is selected. Inner/outer selection must stay in the same fabric family.

► **Product Information continued on next page**



Aspect

Work Screened Units with Fixed Table

► **Product Information continued from previous page**

Options		
Body Outer Finish	Fabric Price Group 05	No cost
	Fabric Price Group 06	No cost
	Fabric Price Group 07	No cost
	Fabric Price Group 08	No cost
	Fabric Price Group 09	No cost
	Fabric Price Group 10	No cost
Seat Finish	Customer's Own Leather	No cost
	Fabric Customer's Own Material	No cost
	Fabric Price Group 01	No cost
	Fabric Price Group 02	+\$75
	Fabric Price Group 03	+\$150
	Fabric Price Group 04	+\$253
	Fabric Price Group 05	+\$420
	Fabric Price Group 06	+\$585
	Fabric Price Group 07	+\$799
	Fabric Price Group 08	+\$989
Reveal Seam	Does Not Match Seat or Body	No cost
	Matches Body	No cost
	Matches Body - Inner	No cost
	Matches Body - Outer	No cost
	Matches Seat	No cost
Reveal Seam Finish	Fabric Price Group 03	+\$483
	Fabric Price Group 04	+\$483
	Fabric Price Group 08	+\$584
Screen Configuration	Upholstered	No cost
	Screen Inner/Outer Configuration	+\$143
Screen Upper Finish	Customer's Own Leather	No cost
	Fabric Customer's Own Material	No cost
	Fabric Price Group 01	No cost
	Fabric Price Group 02	+\$73
	Fabric Price Group 03	+\$144
	Fabric Price Group 04	+\$243
	Fabric Price Group 05	+\$403
	Fabric Price Group 06	+\$564
	Fabric Price Group 07	+\$770
	Fabric Price Group 08	+\$953
Screen Lower Finish	Fabric Price Group 09	+\$1113
	Fabric Price Group 10	+\$1324
	Customer's Own Leather	No cost
	Fabric Customer's Own Material	No cost
	Fabric Price Group 01	No cost
	Fabric Price Group 02	+\$60
	Fabric Price Group 03	+\$122
Fabric Price Group 04	+\$206	
Fabric Price Group 05	+\$341	
Fabric Price Group 06	+\$479	
Fabric Price Group 07	+\$650	

Tip: Reveal seam finish is only selectable if "Does Not Match Seat or Body" option is chosen.

Tip: Screen upper and screen lower finishes are only selectable if upholstered screen configuration is selected.

► **Product Information continued on next page**

► Product Information continued from previous page

Options		
Screen Lower Finish	Fabric Price Group 08	+\$806
	Fabric Price Group 09	+\$942
	Fabric Price Group 10	+\$1123
Screen Inner Finish	Customer's Own Leather	No cost
	Fabric Customer's Own Material	No cost
	Fabric Price Group 01	No cost
	Fabric Price Group 02	+\$133
	Fabric Price Group 03	+\$265
	Fabric Price Group 04	+\$449
	Fabric Price Group 05	+\$744
	Fabric Price Group 06	+\$1041
	Fabric Price Group 07	+\$1420
	Fabric Price Group 08	+\$1758
	Fabric Price Group 09	+\$2056
Screen Outer Finish	Customer's Own Leather	No cost
	Fabric Customer's Own Material	No cost
	Fabric Price Group 01	No cost
	Fabric Price Group 02	No cost
	Fabric Price Group 03	No cost
	Fabric Price Group 04	No cost
	Fabric Price Group 05	No cost
	Fabric Price Group 06	No cost
	Fabric Price Group 07	No cost
	Fabric Price Group 08	No cost
	Fabric Price Group 09	No cost
Leg Finish	Orangebox Paint Price Group 01	No cost
	Orangebox Paint Price Group 02	+\$280
Foot Finish	Orangebox Paint Price Group 01	No cost
	Orangebox Paint Price Group 02	+\$101
Top Finish	Laminate HPL Price Group 01	No cost
	Laminate HPL Price Group 02	+\$169
	Laminate HPL Price Group 03	+\$355
	OLL Price Group 1	+\$102
Edge Finish	Plastic Group 1	No cost
Monitor Bracket	No Monitor Bracket Required	No cost
	Tilting Monitor Bracket	+\$311
Lower Screen Power/Data Axil	No Power/Data Required	No cost
	4 Duplex Outlets	+\$507
	2 Outlets with CAT6 & HDMI Ports	+\$579
	2 Outlets with Two CAT6 Data Ports	+\$585
	2 Outlets with CAT6 and USB Data Ports	+\$602
Power Finish	Paint Price Group 01	No cost
	Paint Price Group 02	No cost

► Product Information continued on next page

Tip: Screen inner and screen outer finishes are only selectable if screen inner/outer configuration is selected. Inner/outer selection must stay in the same fabric family.

Aspect

Work Screened Units with Fixed Table

▶ Product Information continued from previous page

Specification Information

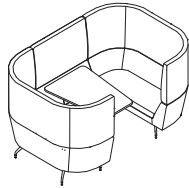

Style Number	Base Price
--------------	------------

Aspect Four Seat Work Screened Unit with Fixed Table

OBASPECT58HB	\$25,721
---------------------	----------

Aspect

Work Screened Units with Fixed Table

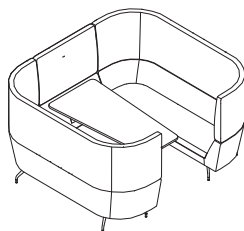

Standard Includes

- Fully upholstered booth: fabric price group 01
- Contrasting reveal seam matching seat or body finish
- 1" thick tabletop with tapered edge:
 - High-Pressure Laminate price group 01
 - Fixed
- 3 mm edgeband: plastic price group 01
- Single table leg with foot
- Adjustable feet

Options

Body Configuration	Upholstered	No cost
	Body Inner/Outer Configuration	+\$786
Body Lower Finish	Fabric Customer's Own Material	No cost
	Fabric Price Group 01	No cost
	Fabric Price Group 02	+\$211
	Fabric Price Group 03	+\$427
	Fabric Price Group 04	+\$719
	Fabric Price Group 05	+\$1194
	Fabric Price Group 06	+\$1669
	Fabric Price Group 07	+\$2278
	Fabric Price Group 08	+\$2822
	Fabric Price Group 09	+\$3296
	Fabric Price Group 10	+\$3922
Body Upper Finish	Fabric Customer's Own Material	No cost
	Fabric Price Group 01	No cost
	Fabric Price Group 02	+\$353
	Fabric Price Group 03	+\$716
	Fabric Price Group 04	+\$1207
	Fabric Price Group 05	+\$2001
	Fabric Price Group 06	+\$2797
	Fabric Price Group 07	+\$3817
	Fabric Price Group 08	+\$4726
	Fabric Price Group 09	+\$5523
	Fabric Price Group 10	+\$6574
Body Inner Finish	Fabric Customer's Own Material	No cost
	Fabric Price Group 01	No cost
	Fabric Price Group 02	+\$565
	Fabric Price Group 03	+\$1141
	Fabric Price Group 04	+\$1925
	Fabric Price Group 05	+\$3194
	Fabric Price Group 06	+\$4465
	Fabric Price Group 07	+\$6095
	Fabric Price Group 08	+\$7546
	Fabric Price Group 09	+\$8818
	Fabric Price Group 10	+\$10496
Body Outer Finish	Fabric Customer's Own Material	No cost
	Fabric Price Group 01	No cost
	Fabric Price Group 02	No cost
	Fabric Price Group 03	No cost
	Fabric Price Group 04	No cost

Tip: Body lower and body upper finishes are only selectable if upholstered body configuration is selected.

Tip: Body inner and body outer finishes are only selectable if body inner/outer configuration is selected. Inner/outer selection must stay in the same fabric family.

▶ Product Information continued on next page



Aspect

Work Screened Units with Fixed Table

► **Product Information continued from previous page**

Options		
Body Outer Finish	Fabric Price Group 05	No cost
	Fabric Price Group 06	No cost
	Fabric Price Group 07	No cost
	Fabric Price Group 08	No cost
	Fabric Price Group 09	No cost
	Fabric Price Group 10	No cost
Seat Finish	Customer's Own Leather	No cost
	Fabric Customer's Own Material	No cost
	Fabric Price Group 01	No cost
	Fabric Price Group 02	+\$105
	Fabric Price Group 03	+\$211
	Fabric Price Group 04	+\$356
	Fabric Price Group 05	+\$590
	Fabric Price Group 06	+\$824
	Fabric Price Group 07	+\$1126
	Fabric Price Group 08	+\$1393
Reveal Seam	Does Not Match Seat or Body	No cost
	Matches Body	No cost
	Matches Body - Inner	No cost
	Matches Body - Outer	No cost
	Matches Seat	No cost
Reveal Seam Finish	Fabric Price Group 03	+\$483
	Fabric Price Group 04	+\$483
	Fabric Price Group 08	+\$584
Screen Configuration	Upholstered	No cost
	Screen Inner/Outer Configuration	+\$143
Screen Upper Finish	Customer's Own Leather	No cost
	Fabric Customer's Own Material	No cost
	Fabric Price Group 01	No cost
	Fabric Price Group 02	+\$73
	Fabric Price Group 03	+\$144
	Fabric Price Group 04	+\$243
	Fabric Price Group 05	+\$403
	Fabric Price Group 06	+\$564
	Fabric Price Group 07	+\$770
	Fabric Price Group 08	+\$953
Screen Lower Finish	Fabric Price Group 09	+\$1113
	Fabric Price Group 10	+\$1324
	Customer's Own Leather	No cost
	Fabric Customer's Own Material	No cost
	Fabric Price Group 01	No cost
	Fabric Price Group 02	+\$60
	Fabric Price Group 03	+\$122
Fabric Price Group 04	+\$206	
Fabric Price Group 05	+\$341	
Fabric Price Group 06	+\$479	
Fabric Price Group 07	+\$650	

Tip: Reveal seam finish is only selectable if "Does Not Match Seat or Body" option is chosen.

Tip: Screen upper and screen lower finishes are only selectable if upholstered screen configuration is selected.

► **Product Information continued on next page**

Aspect

Work Screened Units with Fixed Table

► **Product Information continued from previous page**

Options		
Screen Lower Finish	Fabric Price Group 08	+\$806
	Fabric Price Group 09	+\$942
	Fabric Price Group 10	+\$1123
Screen Inner Finish	Customer's Own Leather	No cost
	Fabric Customer's Own Material	No cost
	Fabric Price Group 01	No cost
	Fabric Price Group 02	+\$133
	Fabric Price Group 03	+\$265
	Fabric Price Group 04	+\$449
	Fabric Price Group 05	+\$744
	Fabric Price Group 06	+\$1041
	Fabric Price Group 07	+\$1420
	Fabric Price Group 08	+\$1758
	Fabric Price Group 09	+\$2056
Screen Outer Finish	Customer's Own Leather	No cost
	Fabric Customer's Own Material	No cost
	Fabric Price Group 01	No cost
	Fabric Price Group 02	No cost
	Fabric Price Group 03	No cost
	Fabric Price Group 04	No cost
	Fabric Price Group 05	No cost
	Fabric Price Group 06	No cost
	Fabric Price Group 07	No cost
	Fabric Price Group 08	No cost
	Fabric Price Group 09	No cost
Leg Finish	Orangebox Paint Price Group 01	No cost
	Orangebox Paint Price Group 02	+\$280
Foot Finish	Orangebox Paint Price Group 01	No cost
	Orangebox Paint Price Group 02	+\$101
Top Finish	Laminate HPL Price Group 01	No cost
	Laminate HPL Price Group 02	+\$243
	Laminate HPL Price Group 03	+\$508
	OLL Price Group 1	+\$102
Edge Finish	Plastic Group 1	No cost
Monitor Bracket	No Monitor Bracket Required	No cost
	Tilting Monitor Bracket	+\$311
Lower Screen Power/Data Axil	No Power/Data Required	No cost
	4 Duplex Outlets	+\$507
	2 Outlets with CAT6 & HDMI Ports	+\$579
	2 Outlets with Two CAT6 Data Ports	+\$585
	2 Outlets with CAT6 and USB Data Ports	+\$602
Power Finish	Paint Price Group 01	No cost
	Paint Price Group 02	No cost

Tip: Screen inner and screen outer finishes are only selectable if screen inner/outer configuration is selected. Inner/outer selection must stay in the same fabric family.

► **Product Information continued on next page**



Aspect

Work Screened Units with Fixed Table

▶ **Product Information continued from previous page**

Specification Information

Style Number Base Price

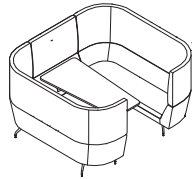

Aspect Six Seat Work Screened Unit with Fixed Table

OBASPECT59HB \$28,484



Standard Includes

- Fully upholstered lounge chair: fabric price group 01
- 4-star swivel base
- Glides
- Shipped fully assembled

Options

Body Finish	Customer's Own Leather	No cost
	Fabric Customer's Own Material	No cost
	Fabric Price Group 01	No cost
	Fabric Price Group 02	+\$47
	Fabric Price Group 03	+\$94
	Fabric Price Group 04	+\$159
	Fabric Price Group 05	+\$263
	Fabric Price Group 06	+\$368
	Fabric Price Group 07	+\$504
	Fabric Price Group 08	+\$622
Seat Finish	Fabric Price Group 09	+\$727
	Fabric Price Group 10	+\$867
	Customer's Own Leather	No cost
	Fabric Customer's Own Material	No cost
	Fabric Price Group 01	No cost
	Fabric Price Group 02	+\$25
	Fabric Price Group 03	+\$52
	Fabric Price Group 04	+\$86
	Fabric Price Group 05	+\$145
	Fabric Price Group 06	+\$203
4-Star Base Finish	Fabric Price Group 07	+\$277
	Fabric Price Group 08	+\$342
	Fabric Price Group 09	+\$400
	Fabric Price Group 10	+\$477
4-Star Base Finish	Black	No cost
	Silver	No cost
	Polished Base & Black Column	+\$78
	Polished Chrome	+\$95
Hood Finish	Customer's Own Leather	No cost
	Fabric Customer's Own Material	No cost
	Fabric Price Group 01	No cost
	Fabric Price Group 02	+\$48
	Fabric Price Group 03	+\$97
	Fabric Price Group 04	+\$162
	Fabric Price Group 05	+\$267
	Fabric Price Group 06	+\$376
	Fabric Price Group 07	+\$513
	Fabric Price Group 08	+\$635
Fabric Price Group 09	+\$741	
	Fabric Price Group 10	+\$883

► **Product Information continued on next page**

Seating

Avi

► **Product Information continued from previous page**

Specification Information

Style Number Base Price



Avi Upholstered Chair with Swivel Base

OBAVI01 \$2458



Avi Hooded Upholstered Chair with Swivel Base

OBAVI02 \$3156



Standard Includes

- Fully upholstered lounge chair: fabric price group 01
- Wire frame base
- Glides
- Shipped fully assembled

Options

Body Finish	Customer's Own Leather	No cost
	Fabric Customer's Own Material	No cost
	Fabric Price Group 01	No cost
	Fabric Price Group 02	+\$47
	Fabric Price Group 03	+\$94
	Fabric Price Group 04	+\$159
	Fabric Price Group 05	+\$263
	Fabric Price Group 06	+\$368
	Fabric Price Group 07	+\$504
	Fabric Price Group 08	+\$622
Seat Finish	Fabric Price Group 09	+\$727
	Fabric Price Group 10	+\$867
	Customer's Own Leather	No cost
	Fabric Customer's Own Material	No cost
	Fabric Price Group 01	No cost
	Fabric Price Group 02	+\$25
	Fabric Price Group 03	+\$52
	Fabric Price Group 04	+\$86
	Fabric Price Group 05	+\$145
	Fabric Price Group 06	+\$203
Fabric Price Group 07	+\$277	
Fabric Price Group 08	+\$342	

► **Product Information continued on next page**

► **Product Information continued from previous page**

Options		
Seat Finish	Fabric Price Group 09	+\$400
	Fabric Price Group 10	+\$477
Wire Frame Base Finish	Orangebox Paint Price Group 01	No cost
	Orangebox Paint Price Group 02	+\$96
Hood Finish	Customer's Own Leather	No cost
	Fabric Customer's Own Material	No cost
	Fabric Price Group 01	No cost
	Fabric Price Group 02	+\$48
	Fabric Price Group 03	+\$97
	Fabric Price Group 04	+\$162
	Fabric Price Group 05	+\$267
	Fabric Price Group 06	+\$376
	Fabric Price Group 07	+\$513
	Fabric Price Group 08	+\$635
Fabric Price Group 09	+\$741	
Fabric Price Group 10	+\$883	

Specification Information

Style Number Base Price



Avi Upholstered Chair with Wire Frame Base

OBAVI03 \$2458



Avi Hooded Upholstered Chair with Wire Frame Base

OBAVI04 \$3156



Seating

Sully, Skomer, and Ramsey

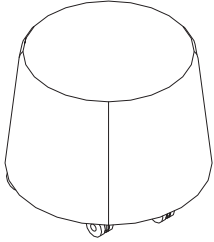

Standard Includes

- Fully upholstered stool: fabric price group 01
- Soft casters: black
- Shipped fully assembled

Options

Seat Finish	Customer's Own Leather	No cost
	Fabric Customer's Own Material	No cost
	Fabric Price Group 01	No cost
	Fabric Price Group 02	+\$45
	Fabric Price Group 03	+\$87
	Fabric Price Group 04	+\$150
	Fabric Price Group 05	+\$249
	Fabric Price Group 06	+\$346
	Fabric Price Group 07	+\$474
	Fabric Price Group 08	+\$586
	Fabric Price Group 09	+\$685
	Fabric Price Group 10	+\$816
Caster Type	Black Soft Casters	No cost
	Grey Soft Casters	No cost
	Black Soft Casters W/ Brakes	+\$81
	Grey Soft Casters W/ Brakes	+\$81

Specification Information

Style Number Base Price

Sully Upholstered Stool

OBSSULLY01 \$1136

Seating

Sully, Skomer, and Ramsey

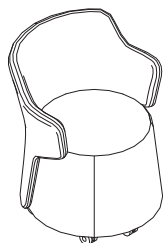

Tip: If two tone upholstered option one is selected, contrasting price groups are available. Total seat finish and back finish price is driven by highest price group selection.

Standard Includes

- Fully upholstered armchair: fabric price group 01
- Soft casters: black
- Shipped fully assembled

Options

Configuration	Upholstered	No cost
	Two Tone Upholstered-Option 1	+\$101
	Two Tone Upholstered-Option 2	+\$101
Seat Finish	Customer's Own Leather	No cost
	Fabric Customer's Own Material	No cost
	Fabric Price Group 01	No cost
	Fabric Price Group 02	+\$65
	Fabric Price Group 03	+\$134
	Fabric Price Group 04	+\$225
	Fabric Price Group 05	+\$372
	Fabric Price Group 06	+\$519
	Fabric Price Group 07	+\$710
	Fabric Price Group 08	+\$880
Back Finish	Customer's Own Leather	No cost
	Fabric Customer's Own Material	No cost
	Fabric Price Group 01	No cost
	Fabric Price Group 02	No cost
	Fabric Price Group 03	No cost
	Fabric Price Group 04	No cost
	Fabric Price Group 05	No cost
	Fabric Price Group 06	No cost
	Fabric Price Group 07	No cost
	Fabric Price Group 08	No cost
Seat & Outer Back Finish	Customer's Own Leather	No cost
	Fabric Customer's Own Material	No cost
	Fabric Price Group 01	No cost
	Fabric Price Group 02	+\$65
	Fabric Price Group 03	+\$134
	Fabric Price Group 04	+\$225
	Fabric Price Group 05	+\$372
	Fabric Price Group 06	+\$519
	Fabric Price Group 07	+\$710
	Fabric Price Group 08	+\$880
Inner Back Finish	Customer's Own Leather	No cost
	Fabric Customer's Own Material	No cost
	Fabric Price Group 01	No cost
	Fabric Price Group 02	No cost
	Fabric Price Group 03	No cost

► **Product Information continued on next page**

Seating

Sully, Skomer, and Ramsey

► **Product Information continued from previous page**

Options		
Inner Back Finish	Fabric Price Group 05	No cost
	Fabric Price Group 06	No cost
	Fabric Price Group 07	No cost
	Fabric Price Group 08	No cost
	Fabric Price Group 09	No cost
	Fabric Price Group 10	No cost
Caster Type	Black Soft Casters	No cost
	Grey Soft Casters	No cost
	Black Soft Casters W/ Brakes	+\$81
	Grey Soft Casters W/ Brakes	+\$81

Specification Information



Style Number	Base Price
--------------	------------

Skomer Upholstered Arm Chair

OBSSKOMER01	\$2377
--------------------	--------

Seating

Sully, Skomer, and Ramsey

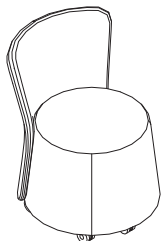

Tip: If two tone upholstered option one is selected, contrasting price groups are available. Total seat finish and back finish price is driven by highest price group selection.

Standard Includes

- Fully upholstered armless chair: fabric price group 01
- Soft casters: black
- Shipped fully assembled

Options

Configuration	Upholstered	No cost
	Two Tone Upholstered-Option 1	+\$101
	Two Tone Upholstered-Option 2	+\$101
Seat Finish	Customer's Own Leather	No cost
	Fabric Customer's Own Material	No cost
	Fabric Price Group 01	No cost
	Fabric Price Group 02	+\$60
	Fabric Price Group 03	+\$122
	Fabric Price Group 04	+\$206
	Fabric Price Group 05	+\$341
	Fabric Price Group 06	+\$479
	Fabric Price Group 07	+\$650
	Fabric Price Group 08	+\$806
Back Finish	Fabric Price Group 09	+\$942
	Fabric Price Group 10	+\$1123
	Customer's Own Leather	No cost
	Fabric Customer's Own Material	No cost
	Fabric Price Group 01	No cost
	Fabric Price Group 02	No cost
	Fabric Price Group 03	No cost
	Fabric Price Group 04	No cost
	Fabric Price Group 05	No cost
	Fabric Price Group 06	No cost
Seat & Outer Back Finish	Fabric Price Group 07	No cost
	Fabric Price Group 08	No cost
	Fabric Price Group 09	No cost
	Fabric Price Group 10	No cost
	Customer's Own Leather	No cost
	Fabric Customer's Own Material	No cost
	Fabric Price Group 01	No cost
	Fabric Price Group 02	+\$60
	Fabric Price Group 03	+\$122
	Fabric Price Group 04	+\$206
Inner Back Finish	Fabric Price Group 05	+\$341
	Fabric Price Group 06	+\$479
	Fabric Price Group 07	+\$650
	Fabric Price Group 08	+\$806
	Fabric Price Group 09	+\$942
	Fabric Price Group 10	+\$1123
	Customer's Own Leather	No cost
	Fabric Customer's Own Material	No cost
	Fabric Price Group 01	No cost
	Fabric Price Group 02	No cost
	Fabric Price Group 03	No cost
	Fabric Price Group 04	No cost

Tip: If two tone upholstered option one is selected, contrasting price groups are available. Total seat finish and back finish price is driven by highest price group selection.

► **Product Information continued on next page**



Seating

Sully, Skomer, and Ramsey

► **Product Information continued from previous page**

Options

Inner Back Finish	Fabric Price Group 05	No cost
	Fabric Price Group 06	No cost
	Fabric Price Group 07	No cost
	Fabric Price Group 08	No cost
	Fabric Price Group 09	No cost
	Fabric Price Group 10	No cost
Caster Type	Black Soft Casters	No cost
	Grey Soft Casters	No cost
	Black Soft Casters W/ Brakes	+\$81
	Grey Soft Casters W/ Brakes	+\$81

Specification Information

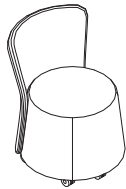

Style Number	Base Price
Ramsey Upholstered Work Chair	
OBSRAMSEY01	\$2121

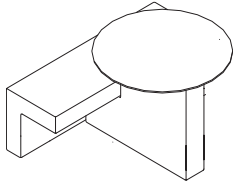

Tip: If two tone upholstered option is selected, contrasting price groups are available. Total seat finish and table base finish price is driven by highest price group selection.

Standard Includes

- Fully upholstered bench with attached table: fabric price group 01
- 31" dia., 1" thick tabletop with square edge: High-Pressure Laminate price group 01
- 3 mm edgeband: plastic price group 01
- Two foot rails: polished chrome
- Plastic feet: black

Options

Configuration	Upholstered	No cost
	Two Tone Upholstered	+\$198
Seat Finish	Customer's Own Leather	No cost
	Fabric Customer's Own Material	No cost
	Fabric Price Group 01	No cost
	Fabric Price Group 02	+\$109
	Fabric Price Group 03	+\$222
	Fabric Price Group 04	+\$375
	Fabric Price Group 05	+\$620
	Fabric Price Group 06	+\$868
	Fabric Price Group 07	+\$1184
	Fabric Price Group 08	+\$1465
Table Base Finish	Customer's Own Leather	No cost
	Fabric Customer's Own Material	No cost
	Fabric Price Group 01	No cost
	Fabric Price Group 02	No cost
	Fabric Price Group 03	No cost
	Fabric Price Group 04	No cost
	Fabric Price Group 05	No cost
	Fabric Price Group 06	No cost
	Fabric Price Group 07	No cost
	Fabric Price Group 08	No cost
Top Finish	Laminate HPL Price Group 01	No cost
	Laminate HPL Price Group 02	+\$80
	Laminate HPL Price Group 03	+\$164
	OLL Price Group 1	+\$102
Edge Finish	Plastic Group 1	No cost
Top Size and Edge	31 1/2" Top with Square Edge	No cost
	39 3/8" Top with Square Edge	+\$82
	31 1/2" Top with Tapered Edge	+\$258
	39 3/8" Top with Tapered Edge	+\$337
Base Power/Data Node	No Power/Data Required	No cost
	2 Duplex Outlets	+\$287
	Duplex Outlet with HDMI Video Port	+\$376
	Duplex Outlet with CAT6 Data Port	+\$382
	Duplex Outlet with USB Data Port	+\$395
Power Finish	Paint Price Group 01	No cost
	Paint Price Group 02	No cost

► **Product Information continued on next page**

Seating

Border

► **Product Information continued from previous page**

Specification Information

Style Number Base Price

Border One Seat- Low, with 32" Dia Table

OBBORDER01 \$5006

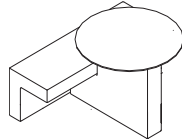

Standard Includes

- Fully upholstered bench with attached table: fabric price group 01
- 31" dia., 1" thick tabletop with square edge: High-Pressure Laminate price group 01
- 3 mm edgeband: plastic price group 01
- Two foot rails: polished chrome
- Plastic feet: black

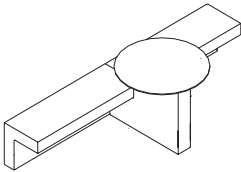

Tip: If two tone upholstered option is selected, contrasting price groups are available. Total seat finish and table base finish price is driven by highest price group selection.

Options

Configuration	Upholstered	No cost
	Two Tone Upholstered	+\$198
Seat Finish	Customer's Own Leather	No cost
	Fabric Customer's Own Material	No cost
	Fabric Price Group 01	No cost
	Fabric Price Group 02	+\$164
	Fabric Price Group 03	+\$334
	Fabric Price Group 04	+\$561
	Fabric Price Group 05	+\$932
	Fabric Price Group 06	+\$1300
	Fabric Price Group 07	+\$1777
	Fabric Price Group 08	+\$2197
	Fabric Price Group 09	+\$2568
Table Base Finish	Fabric Price Group 10	+\$3057
	Customer's Own Leather	No cost
	Fabric Customer's Own Material	No cost
	Fabric Price Group 01	No cost
	Fabric Price Group 02	No cost
	Fabric Price Group 03	No cost
	Fabric Price Group 04	No cost
	Fabric Price Group 05	No cost
	Fabric Price Group 06	No cost
	Fabric Price Group 07	No cost
	Fabric Price Group 08	No cost
Top Finish	Fabric Price Group 09	No cost
	Fabric Price Group 10	No cost
	Laminated HPL Price Group 01	No cost
	Laminated HPL Price Group 02	+\$80
	Laminated HPL Price Group 03	+\$164

► **Product Information continued on next page**

► **Product Information continued from previous page**

Options		
Top Finish	OLL Price Group 1	+\$102
Edge Finish	Plastic Group 1	No cost
Top Size and Edge	31 1/2" Top with Square Edge	No cost
	39 3/8" Top with Square Edge	+\$82
	31 1/2" Top with Tapered Edge	+\$258
	39 3/8" Top with Tapered Edge	+\$337
Base Power/Data Node	No Power/Data Required	No cost
	2 Duplex Outlets	+\$287
	Duplex Outlet with HDMI Video Port	+\$376
	Duplex Outlet with CAT6 Data Port	+\$382
	Duplex Outlet with USB Data Port	+\$395
Power Finish	Paint Price Group 01	No cost
	Paint Price Group 02	No cost

Specification Information

Style Number Base Price

Border Two Seat- Low, with 32" Dia Table

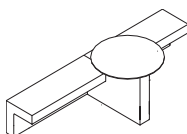

OBBORDER02 \$6750

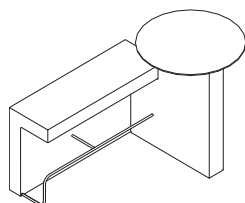

Tip: If two tone upholstered option is selected, contrasting price groups are available. Total seat finish and table base finish price is driven by highest price group selection.

Standard Includes

- Fully upholstered bench with attached table: fabric price group 01
- 31" dia., 1" thick tabletop with square edge: High-Pressure Laminate price group 01
- 3 mm edgeband on user's side: plastic price group 01
- Foot rail: polished chrome
- Plastic feet: black

Options

Configuration	Upholstered	No cost
	Two Tone Upholstered	+\$198
Seat Finish	Customer's Own Leather	No cost
	Fabric Customer's Own Material	No cost
	Fabric Price Group 01	No cost
	Fabric Price Group 02	+\$152
	Fabric Price Group 03	+\$305
	Fabric Price Group 04	+\$514
	Fabric Price Group 05	+\$853
	Fabric Price Group 06	+\$1190
	Fabric Price Group 07	+\$1626
Fabric Price Group 08	+\$2015	
Fabric Price Group 09	+\$2352	

► **Product Information continued on next page**

Seating

Border

► **Product Information continued from previous page**

Options		
Seat Finish	Fabric Price Group 10	+\$2802
Table Base Finish	Customer's Own Leather	No cost
	Fabric Customer's Own Material	No cost
	Fabric Price Group 01	No cost
	Fabric Price Group 02	No cost
	Fabric Price Group 03	No cost
	Fabric Price Group 04	No cost
	Fabric Price Group 05	No cost
	Fabric Price Group 06	No cost
	Fabric Price Group 07	No cost
	Fabric Price Group 08	No cost
Fabric Price Group 09	No cost	
Fabric Price Group 10	No cost	
Top Finish	Laminate HPL Price Group 01	No cost
	Laminate HPL Price Group 02	+\$80
	Laminate HPL Price Group 03	+\$164
	OLL Price Group 1	+\$102
Edge Finish	Plastic Group 1	No cost
Top Size and Edge	31 1/2" Top with Square Edge	No cost
	39 3/8" Top with Square Edge	+\$82
	31 1/2" Top with Tapered Edge	+\$258
	39 3/8" Top with Tapered Edge	+\$337
Base Power/Data Node	No Power/Data Required	No cost
	2 Duplex Outlets	+\$287
	Duplex Outlet with HDMI Video Port	+\$376
	Duplex Outlet with CAT6 Data Port	+\$382
	Duplex Outlet with USB Data Port	+\$395
Power Finish	Paint Price Group 01	No cost
	Paint Price Group 02	No cost

Specification Information

Style Number Base Price

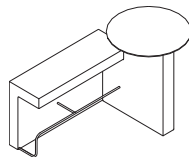

Border One Seat- High, with Left Hand 32" Dia Table

OBBORDER03 \$5878

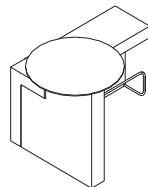

Border One Seat- High, with Right Hand 32" Dia Table

OBBORDER04 \$5878

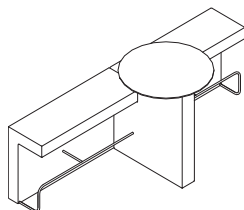

Tip: If two tone upholstered option is selected, contrasting price groups are available. Total seat finish and table base finish price is driven by highest price group selection.

Standard Includes

- Fully upholstered bench with attached table: fabric price group 01
- 31" dia., 1" thick tabletop with square edge: High-Pressure Laminate price group 01
- 3 mm edgeband: plastic price group 01
- Two foot rails: polished chrome
- Plastic feet: black

Options

Configuration	Upholstered	No cost
	Two Tone Upholstered	+\$198
Seat Finish	Customer's Own Leather	No cost
	Fabric Customer's Own Material	No cost
	Fabric Price Group 01	No cost
	Fabric Price Group 02	+\$222
	Fabric Price Group 03	+\$449
	Fabric Price Group 04	+\$758
	Fabric Price Group 05	+\$1257
	Fabric Price Group 06	+\$1755
	Fabric Price Group 07	+\$2398
	Fabric Price Group 08	+\$2967
Table Base Finish	Fabric Price Group 09	+\$3466
	Fabric Price Group 10	+\$4128
	Customer's Own Leather	No cost
	Fabric Customer's Own Material	No cost
	Fabric Price Group 01	No cost
	Fabric Price Group 02	No cost
	Fabric Price Group 03	No cost
	Fabric Price Group 04	No cost
	Fabric Price Group 05	No cost
	Fabric Price Group 06	No cost
Top Finish	Fabric Price Group 07	No cost
	Fabric Price Group 08	No cost
	Fabric Price Group 09	No cost
	Fabric Price Group 10	No cost
Top Finish	Laminate HPL Price Group 01	No cost
	Laminate HPL Price Group 02	+\$80
	Laminate HPL Price Group 03	+\$164
	OLL Price Group 1	+\$102
Edge Finish	Plastic Group 1	No cost
Top Size and Edge	31 1/2" Top with Square Edge	No cost
	39 3/8" Top with Square Edge	+\$82
	31 1/2" Top with Tapered Edge	+\$258
	39 3/8" Top with Tapered Edge	+\$337
Base Power/Data Node	No Power/Data Required	No cost
	2 Duplex Outlets	+\$287
	Duplex Outlet with HDMI Video Port	+\$376
	Duplex Outlet with CAT6 Data Port	+\$382
	Duplex Outlet with USB Data Port	+\$395
Power Finish	Paint Price Group 01	No cost
	Paint Price Group 02	No cost

► **Product Information continued on next page**

Seating

Border

▶ **Product Information continued from previous page**

Specification Information

Style Number Base Price

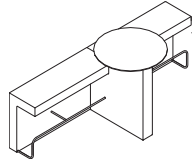

Border Two Seat- High, with 32" Dia Table

OBBORDER05 \$8752

Away from the Desk

Seating

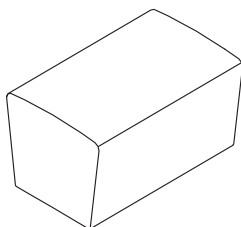

Tip: Customer's Own Material (COM) is available at a price group 1.

Standard Includes

- Fully upholstered seat: fabric price group 01
- Adjustable glides: black
- Linking brackets

Options

Seat Finish	Fabric Price Group 01	No cost
	Fabric Price Group 02	+\$41
	Fabric Price Group 03	+\$83
	Fabric Price Group 04	+\$140
	Fabric Price Group 05	+\$233
	Fabric Price Group 06	+\$325
	Fabric Price Group 07	+\$444
	Fabric Price Group 08	+\$548
	Fabric Price Group 09	+\$643
	Fabric Price Group 10	+\$764
Left End Configuration	Connecting Unit	No cost
	Open	No cost
Right End Configuration	Connecting Unit	No cost
	Open	No cost

Specification Information

Style Number Base Price

31 1/2" W Modular Straight Seat

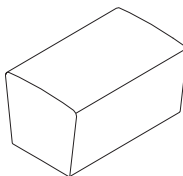

OBAD01 \$1994

Away from the Desk

Seating

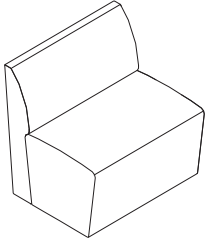

Tip: Customer's Own Material (COM) is available at a price group 1.

Standard Includes

- Fully upholstered seat with back: fabric price group 01
- Adjustable glides: black
- Linking brackets

Options

Seat Finish	Fabric Price Group 01	No cost
	Fabric Price Group 02	+\$41
	Fabric Price Group 03	+\$83
	Fabric Price Group 04	+\$140
	Fabric Price Group 05	+\$233
	Fabric Price Group 06	+\$325
	Fabric Price Group 07	+\$444
	Fabric Price Group 08	+\$548
	Fabric Price Group 09	+\$643
	Fabric Price Group 10	+\$764
Backrest Outer Finish	Fabric Price Group 01	No cost
	Fabric Price Group 02	+\$48
	Fabric Price Group 03	+\$97
	Fabric Price Group 04	+\$162
	Fabric Price Group 05	+\$267
	Fabric Price Group 06	+\$376
	Fabric Price Group 07	+\$513
	Fabric Price Group 08	+\$635
	Fabric Price Group 09	+\$741
	Fabric Price Group 10	+\$883
Backrest Inner Finish	Fabric Price Group 01	No cost
	Fabric Price Group 02	+\$36
	Fabric Price Group 03	+\$75
	Fabric Price Group 04	+\$124
	Fabric Price Group 05	+\$206
	Fabric Price Group 06	+\$288
	Fabric Price Group 07	+\$395
	Fabric Price Group 08	+\$487
	Fabric Price Group 09	+\$571
	Fabric Price Group 10	+\$679
Left End Configuration	Connecting Unit	No cost
	Open	No cost
	AD-61 LA Uph LH Arm	+\$1226
	AD-62 LC Uph LH Arm with Tablet	+\$2623
Left Arm Finish	Fabric Price Group 01	No cost
	Fabric Price Group 02	+\$48
	Fabric Price Group 03	+\$97
	Fabric Price Group 04	+\$162
	Fabric Price Group 05	+\$267
	Fabric Price Group 06	+\$376
	Fabric Price Group 07	+\$513
	Fabric Price Group 08	+\$635
	Fabric Price Group 09	+\$741
	Fabric Price Group 10	+\$883

Tip: Tablet is selectable on one end only.

Tip: The AD-62LC option can only be specified on an OBAD02 when it is connected to another unit and part of a larger configuration.

▶ **Product Information continued on next page**

Away from the Desk

Seating

► Product Information continued from previous page

Options		
Left Tablet Top Finish	Laminate HPL Price Group 01	No cost
	Laminate HPL Price Group 02	+\$76
	Laminate HPL Price Group 03	+\$154
	OLL Price Group 1	+\$102
Left Tablet Edge Finish	Plastic Group 1	No cost
Left Arm Power/Data Node	No Power/Data Required	No cost
	2 Duplex Outlets	+\$287
	Duplex Outlet with HDMI Video Port	+\$376
	Duplex Outlet with CAT6 Data	+\$382
	Duplex Outlet with USB Data Ports	+\$395
Left Arm Power Finish	Paint Price Group 01	No cost
	Paint Price Group 02	No cost
Right End Configuration	Connecting Unit	No cost
	Open	No cost
	AD-61 RA Uph RH Arm	+\$1226
	AD-62 RC Uph RH Arm with Tablet	+\$2623
Right Arm Finish	Fabric Price Group 01	No cost
	Fabric Price Group 02	+\$48
	Fabric Price Group 03	+\$97
	Fabric Price Group 04	+\$162
	Fabric Price Group 05	+\$267
	Fabric Price Group 06	+\$376
	Fabric Price Group 07	+\$513
	Fabric Price Group 08	+\$635
	Fabric Price Group 09	+\$741
	Fabric Price Group 10	+\$883
Right Tablet Top Finish	Laminate HPL Price Group 01	No cost
	Laminate HPL Price Group 02	+\$76
	Laminate HPL Price Group 03	+\$154
	OLL Price Group 1	+\$102
Right Tablet Edge Finish	Plastic Group 1	No cost
Right Arm Power/Data Node	No Power/Data Required	No cost
	2 Duplex Outlets	+\$287
	Duplex Outlet with HDMI Video Port	+\$376
	Duplex Outlet with CAT6 Data	+\$382
	Duplex Outlet with USB Data Ports	+\$395
Right Arm Power Finish	Paint Price Group 01	No cost
	Paint Price Group 02	No cost

Tip: The AD-62RC option can only be specified on an OBAD02 when it is connected to another unit and part of a larger configuration.

Specification Information

Style Number Base Price

31 1/2" W Modular Straight Seat with Back

OBAD02 \$3552

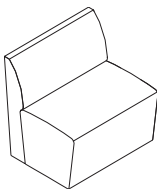

Away from the Desk

Seating

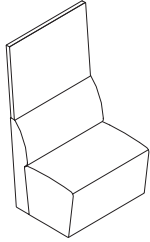

Tip: Customer's Own Material (COM) is available at a price group 1.

Tip: OBAD03, OBAD03LC, and OBAD03RC are not standalone units and must connect to another unit as part of a larger configuration.

Tip: Tablet is selectable on one end only.

Standard Includes

- Fully upholstered seat, back, and screen: fabric price group 01
- Adjustable glides: black
- Linking brackets

Options

Seat Finish	Fabric Price Group 01	No cost
	Fabric Price Group 02	+\$41
	Fabric Price Group 03	+\$83
	Fabric Price Group 04	+\$140
	Fabric Price Group 05	+\$233
	Fabric Price Group 06	+\$325
	Fabric Price Group 07	+\$444
	Fabric Price Group 08	+\$548
	Fabric Price Group 09	+\$643
	Fabric Price Group 10	+\$764
Backrest Outer Finish	Fabric Price Group 01	No cost
	Fabric Price Group 02	+\$48
	Fabric Price Group 03	+\$97
	Fabric Price Group 04	+\$162
	Fabric Price Group 05	+\$267
	Fabric Price Group 06	+\$376
	Fabric Price Group 07	+\$513
	Fabric Price Group 08	+\$635
	Fabric Price Group 09	+\$741
	Fabric Price Group 10	+\$883
Backrest Inner Finish	Fabric Price Group 01	No cost
	Fabric Price Group 02	+\$36
	Fabric Price Group 03	+\$75
	Fabric Price Group 04	+\$124
	Fabric Price Group 05	+\$206
	Fabric Price Group 06	+\$288
	Fabric Price Group 07	+\$395
	Fabric Price Group 08	+\$487
	Fabric Price Group 09	+\$571
	Fabric Price Group 10	+\$679
Screen Connection	No Screen Connections	No cost
	Screen Connection-Left	No cost
	Screen Connection-Left & Right	No cost
	Screen Connection-Right	No cost
Left End Configuration	Connecting Unit	No cost
	Open	No cost
	AD-61 LA Uph LH Arm	+\$1226
	AD-62 LC Uph LH Arm with Tablet	+\$2623
Left Arm Finish	Fabric Price Group 01	No cost
	Fabric Price Group 02	+\$48
	Fabric Price Group 03	+\$97
	Fabric Price Group 04	+\$162
	Fabric Price Group 05	+\$267
	Fabric Price Group 06	+\$376
	Fabric Price Group 07	+\$513

► **Product Information continued on next page**

Away from the Desk

Seating

► Product Information continued from previous page

Options		
Left Arm Finish	Fabric Price Group 08	+\$635
	Fabric Price Group 09	+\$741
	Fabric Price Group 10	+\$883
Left Tablet Top Finish	Laminate HPL Price Group 01	No cost
	Laminate HPL Price Group 02	+\$76
	Laminate HPL Price Group 03	+\$154
	OLL Price Group 1	+\$102
Left Tablet Edge Finish	Plastic Group 1	No cost
Left Arm Power/Data Node	No Power/Data Required	No cost
	2 Duplex Outlets	+\$287
	Duplex Outlet with HDMI Video Port	+\$376
	Duplex Outlet with CAT6 Data	+\$382
	Duplex Outlet with USB Data Ports	+\$395
Left Arm Power Finish	Paint Price Group 01	No cost
	Paint Price Group 02	No cost
Right End Configuration	Connecting Unit	No cost
	Open	No cost
	AD-61 RA Uph RH Arm	+\$1226
	AD-62 RC Uph RH Arm with Tablet	+\$2623
Right Arm Finish	Fabric Price Group 01	No cost
	Fabric Price Group 02	+\$48
	Fabric Price Group 03	+\$97
	Fabric Price Group 04	+\$162
	Fabric Price Group 05	+\$267
	Fabric Price Group 06	+\$376
	Fabric Price Group 07	+\$513
	Fabric Price Group 08	+\$635
	Fabric Price Group 09	+\$741
	Fabric Price Group 10	+\$883
Right Tablet Top Finish	Laminate HPL Price Group 01	No cost
	Laminate HPL Price Group 02	+\$76
	Laminate HPL Price Group 03	+\$154
	OLL Price Group 1	+\$102
Right Tablet Edge Finish	Plastic Group 1	No cost
Right Arm Power/Data Node	No Power/Data Required	No cost
	2 Duplex Outlets	+\$287
	Duplex Outlet with HDMI Video Port	+\$376
	Duplex Outlet with CAT6 Data	+\$382
	Duplex Outlet with USB Data Ports	+\$395
Right Arm Power Finish	Paint Price Group 01	No cost
	Paint Price Group 02	No cost

► Product Information continued on next page

Away from the Desk

Seating

► Product Information continued from previous page

Specification Information

Style Number	Base Price									
	Screen Grades:									
	1	2	3	4	5	6	7	8	9	10

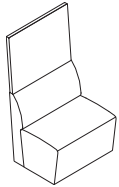

31 1/2" W Modular Straight Seat with Back and Screen

OBAD03	\$4780	\$4829	\$4880	\$4948	\$5059	\$5169	\$5314	\$5439	\$5552	\$5698
---------------	--------	--------	--------	--------	--------	--------	--------	--------	--------	--------

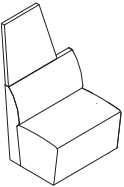

31 1/2" W Modular Straight Seat with Back and Left Hand Tapered Screen

OBAD03LC	\$4726	\$4762	\$4801	\$4850	\$4932	\$5014	\$5121	\$5213	\$5297	\$5405
-----------------	--------	--------	--------	--------	--------	--------	--------	--------	--------	--------

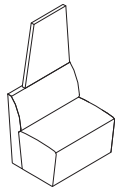

31 1/2" W Modular Straight Seat with Back and Right Hand Tapered Screen

OBAD03RC	\$4726	\$4762	\$4801	\$4850	\$4932	\$5014	\$5121	\$5213	\$5297	\$5405
-----------------	--------	--------	--------	--------	--------	--------	--------	--------	--------	--------

Away from the Desk

Seating

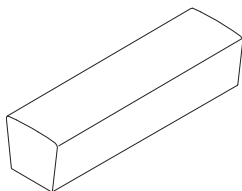

Tip: Customer's Own Material (COM) is available at a price group 1.

Standard Includes

- Fully upholstered seat: fabric price group 01
- Adjustable glides: black
- Linking brackets

Options

Seat Finish	Fabric Price Group 01	No cost
	Fabric Price Group 02	+\$69
	Fabric Price Group 03	+\$138
	Fabric Price Group 04	+\$234
	Fabric Price Group 05	+\$387
	Fabric Price Group 06	+\$542
	Fabric Price Group 07	+\$739
	Fabric Price Group 08	+\$917
	Fabric Price Group 09	+\$1070
	Fabric Price Group 10	+\$1273
Left End Configuration	Connecting Unit	No cost
	Open	No cost
Right End Configuration	Connecting Unit	No cost
	Open	No cost

Specification Information

Style Number Base Price

70 7/8" W Modular Straight Seat

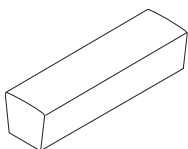

OBAD11 \$2860

Away from the Desk

Seating

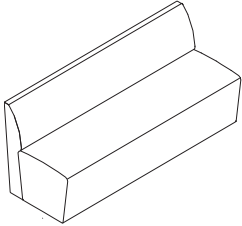

Tip: Customer's Own Material (COM) is available at a price group 1.

Standard Includes

- Fully upholstered seat with back: fabric price group 01
- Adjustable glides: black
- Linking brackets

Options

Seat Finish	Fabric Price Group 01	No cost
	Fabric Price Group 02	+\$69
	Fabric Price Group 03	+\$138
	Fabric Price Group 04	+\$234
	Fabric Price Group 05	+\$387
	Fabric Price Group 06	+\$542
	Fabric Price Group 07	+\$739
	Fabric Price Group 08	+\$917
	Fabric Price Group 09	+\$1070
	Fabric Price Group 10	+\$1273
Backrest Outer Finish	Fabric Price Group 01	No cost
	Fabric Price Group 02	+\$65
	Fabric Price Group 03	+\$134
	Fabric Price Group 04	+\$225
	Fabric Price Group 05	+\$372
	Fabric Price Group 06	+\$519
	Fabric Price Group 07	+\$710
	Fabric Price Group 08	+\$880
	Fabric Price Group 09	+\$1027
	Fabric Price Group 10	+\$1223
Backrest Inner Finish	Fabric Price Group 01	No cost
	Fabric Price Group 02	+\$39
	Fabric Price Group 03	+\$82
	Fabric Price Group 04	+\$137
	Fabric Price Group 05	+\$227
	Fabric Price Group 06	+\$317
	Fabric Price Group 07	+\$434
	Fabric Price Group 08	+\$537
	Fabric Price Group 09	+\$627
	Fabric Price Group 10	+\$747
Left End Configuration	Connecting Unit	No cost
	Open	No cost
	AD-61 LA Uph LH Arm	+\$1226
	AD-62 LC Uph LH Arm with Tablet	+\$2623
Left Arm Finish	Fabric Price Group 01	No cost
	Fabric Price Group 02	+\$48
	Fabric Price Group 03	+\$97
	Fabric Price Group 04	+\$162
	Fabric Price Group 05	+\$267
	Fabric Price Group 06	+\$376
	Fabric Price Group 07	+\$513
	Fabric Price Group 08	+\$635
	Fabric Price Group 09	+\$741
	Fabric Price Group 10	+\$883

Tip: The OBAD12 cannot be specified with both the AD-62 LC and AD-62 RC arm with tablet options.

► **Product Information continued on next page**

Away from the Desk

Seating

► Product Information continued from previous page

Options		
Left Tablet Top Finish	Laminate HPL Price Group 01	No cost
	Laminate HPL Price Group 02	+\$76
	Laminate HPL Price Group 03	+\$154
	OLL Price Group 1	+\$102
Left Tablet Edge Finish	Plastic Group 1	No cost
Left Arm Power/Data Node	No Power/Data Required	No cost
	2 Duplex Outlets	+\$287
	Duplex Outlet with HDMI Video Port	+\$376
	Duplex Outlet with CAT6 Data	+\$382
Left Arm Power Finish	Duplex Outlet with USB Data Ports	+\$395
	Paint Price Group 01	No cost
Right End Configuration	Paint Price Group 02	No cost
	Connecting Unit	No cost
Right Arm Finish	Open	No cost
	AD-61 RA Uph RH Arm	+\$1226
	AD-62 RC Uph RH Arm with Tablet	+\$2623
	Fabric Price Group 01	No cost
Right Tablet Top Finish	Fabric Price Group 02	+\$48
	Fabric Price Group 03	+\$97
	Fabric Price Group 04	+\$162
	Fabric Price Group 05	+\$267
	Fabric Price Group 06	+\$376
	Fabric Price Group 07	+\$513
	Fabric Price Group 08	+\$635
	Fabric Price Group 09	+\$741
	Fabric Price Group 10	+\$883
	Right Tablet Edge Finish	Laminate HPL Price Group 01
Laminate HPL Price Group 02		+\$76
Laminate HPL Price Group 03		+\$154
OLL Price Group 1		+\$102
Right Tablet Edge Finish	Plastic Group 1	No cost
Right Arm Power/Data Node	No Power/Data Required	No cost
	2 Duplex Outlets	+\$287
	Duplex Outlet with HDMI Video Port	+\$376
	Duplex Outlet with CAT6 Data	+\$382
Right Arm Power Finish	Duplex Outlet with USB Data Ports	+\$395
	Paint Price Group 01	No cost
Right Arm Power Finish	Paint Price Group 02	No cost

Specification Information

Style Number Base Price

70 7/8" W Modular Straight Seat with Back

OBAD12 \$5201

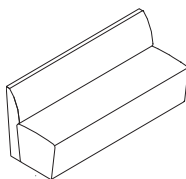

Away from the Desk

Seating

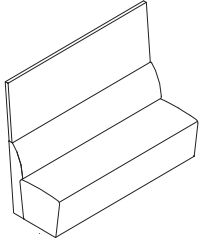

Tip: Customer's Own Material (COM) is available at a price group 1.

Standard Includes

- Fully upholstered seat, back, and screen: fabric price group 01
- Adjustable glides: black
- Linking brackets

Options

Seat Finish	Fabric Price Group 01	No cost
	Fabric Price Group 02	+\$69
	Fabric Price Group 03	+\$138
	Fabric Price Group 04	+\$234
	Fabric Price Group 05	+\$387
	Fabric Price Group 06	+\$542
	Fabric Price Group 07	+\$739
	Fabric Price Group 08	+\$917
	Fabric Price Group 09	+\$1070
	Fabric Price Group 10	+\$1273
Backrest Outer Finish	Fabric Price Group 01	No cost
	Fabric Price Group 02	+\$65
	Fabric Price Group 03	+\$134
	Fabric Price Group 04	+\$225
	Fabric Price Group 05	+\$372
	Fabric Price Group 06	+\$519
	Fabric Price Group 07	+\$710
	Fabric Price Group 08	+\$880
	Fabric Price Group 09	+\$1027
	Fabric Price Group 10	+\$1223
Backrest Inner Finish	Fabric Price Group 01	No cost
	Fabric Price Group 02	+\$39
	Fabric Price Group 03	+\$82
	Fabric Price Group 04	+\$137
	Fabric Price Group 05	+\$227
	Fabric Price Group 06	+\$317
	Fabric Price Group 07	+\$434
	Fabric Price Group 08	+\$537
	Fabric Price Group 09	+\$627
	Fabric Price Group 10	+\$747
Screen Connection	No Screen Connections	No cost
	Screen Connection-Left	No cost
	Screen Connection-Left & Right	No cost
	Screen Connection-Right	No cost
Left End Configuration	Connecting Unit	No cost
	Open	No cost
	AD-61 LA Uph LH Arm	+\$1226
	AD-62 LC Uph LH Arm with Tablet	+\$2623
Left Arm Finish	Fabric Price Group 01	No cost
	Fabric Price Group 02	+\$48
	Fabric Price Group 03	+\$97
	Fabric Price Group 04	+\$162
	Fabric Price Group 05	+\$267
	Fabric Price Group 06	+\$376
	Fabric Price Group 07	+\$513

Tip: The OBAD13 cannot be specified with both the AD-62 LC and AD-62 RC arm with tablet options.

► **Product Information continued on next page**

Away from the Desk

Seating

► Product Information continued from previous page

Options		
Left Arm Finish	Fabric Price Group 08	+\$635
	Fabric Price Group 09	+\$741
	Fabric Price Group 10	+\$883
Left Tablet Top Finish	Laminate HPL Price Group 01	No cost
	Laminate HPL Price Group 02	+\$76
	Laminate HPL Price Group 03	+\$154
	OLL Price Group 1	+\$102
Left Tablet Edge Finish	Plastic Group 1	No cost
Left Arm Power/Data Node	No Power/Data Required	No cost
	2 Duplex Outlets	+\$287
	Duplex Outlet with HDMI Video Port	+\$376
	Duplex Outlet with CAT6 Data	+\$382
	Duplex Outlet with USB Data Ports	+\$395
Left Arm Power Finish	Paint Price Group 01	No cost
	Paint Price Group 02	No cost
Right End Configuration	Connecting Unit	No cost
	Open	No cost
	AD-61 RA Uph RH Arm	+\$1226
	AD-62 RC Uph RH Arm with Tablet	+\$2623
Right Arm Finish	Fabric Price Group 01	No cost
	Fabric Price Group 02	+\$48
	Fabric Price Group 03	+\$97
	Fabric Price Group 04	+\$162
	Fabric Price Group 05	+\$267
	Fabric Price Group 06	+\$376
	Fabric Price Group 07	+\$513
	Fabric Price Group 08	+\$635
	Fabric Price Group 09	+\$741
	Fabric Price Group 10	+\$883
Right Tablet Top Finish	Laminate HPL Price Group 01	No cost
	Laminate HPL Price Group 02	+\$76
	Laminate HPL Price Group 03	+\$154
	OLL Price Group 1	+\$102
Right Tablet Edge Finish	Plastic Group 1	No cost
Right Arm Power/Data Node	No Power/Data Required	No cost
	2 Duplex Outlets	+\$287
	Duplex Outlet with HDMI Video Port	+\$376
	Duplex Outlet with CAT6 Data	+\$382
	Duplex Outlet with USB Data Ports	+\$395
Right Arm Power Finish	Paint Price Group 01	No cost
	Paint Price Group 02	No cost

► Product Information continued on next page

Away from the Desk

Seating

► Product Information continued from previous page

Specification Information

Style Number	Base Price									
	Screen Grades:									
	1	2	3	4	5	6	7	8	9	10
70 7/8" W Modular Straight Seat with Back and Screen										
OBAD13	\$7020	\$7100	\$7181	\$7293	\$7469	\$7647	\$7878	\$8081	\$8262	\$8498

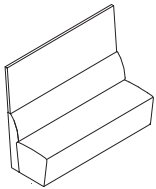

Away from the Desk

Seating

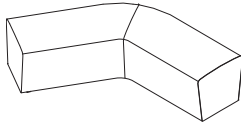

Tip: Customer's Own Material (COM) is available at a price group 1.

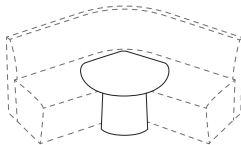

Standard Includes

- Fully upholstered seat: fabric price group 01
- Adjustable glides: black
- Linking brackets

Options

Seat Finish	Fabric Price Group 01	No cost
	Fabric Price Group 02	+\$77
	Fabric Price Group 03	+\$155
	Fabric Price Group 04	+\$262
	Fabric Price Group 05	+\$434
	Fabric Price Group 06	+\$606
	Fabric Price Group 07	+\$828
	Fabric Price Group 08	+\$1026
	Fabric Price Group 09	+\$1198
	Fabric Price Group 10	+\$1426
Left End Configuration	Connecting Unit	No cost
	Open	No cost
Right End Configuration	Connecting Unit	No cost
	Open	No cost
Table	No Table	No cost
	AD-72 120 Corner Table	+\$3142
Table Top Finish	Laminate HPL Price Group 01	No cost
	Laminate HPL Price Group 02	+\$76
	Laminate HPL Price Group 03	+\$154
	OLL Price Group 1	+\$102
Table Edge Finish	Plastic Group 1	No cost
Table Base Finish	Fabric Price Group 01	No cost
	Fabric Price Group 02	+\$36
	Fabric Price Group 03	+\$75
	Fabric Price Group 04	+\$124
	Fabric Price Group 05	+\$206
	Fabric Price Group 06	+\$288
	Fabric Price Group 07	+\$395
	Fabric Price Group 08	+\$487
	Fabric Price Group 09	+\$571
	Fabric Price Group 10	+\$679
Base Power/Data Node	No Power/Data Required	No cost
	2 Duplex Outlets	+\$287
	Duplex Outlet with HDMI Video Port	+\$376
	Duplex Outlet with CAT6 Data	+\$382
	Duplex Outlet with USB Data Ports	+\$395
Base Power Finish	Paint Price Group 01	No cost
	Paint Price Group 02	No cost

► **Product Information continued on next page**

Away from the Desk

Seating

▶ **Product Information continued from previous page**

Specification Information

Style Number Base Price

120° Modular Seat

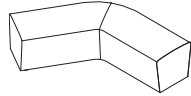

OBAD21 \$3600

Away from the Desk

Seating

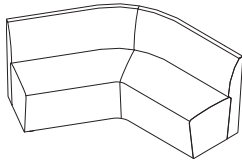

Tip: Customer's Own Material (COM) is available at a price group 1.

Standard Includes

- Fully upholstered seat with back: fabric price group 01
- Adjustable glides: black
- Linking brackets

Options

Seat Finish	Fabric Price Group 01	No cost
	Fabric Price Group 02	+\$77
	Fabric Price Group 03	+\$155
	Fabric Price Group 04	+\$262
	Fabric Price Group 05	+\$434
	Fabric Price Group 06	+\$606
	Fabric Price Group 07	+\$828
	Fabric Price Group 08	+\$1026
	Fabric Price Group 09	+\$1198
	Fabric Price Group 10	+\$1426
Backrest Outer Finish	Fabric Price Group 01	No cost
	Fabric Price Group 02	+\$80
	Fabric Price Group 03	+\$161
	Fabric Price Group 04	+\$273
	Fabric Price Group 05	+\$449
	Fabric Price Group 06	+\$627
	Fabric Price Group 07	+\$858
	Fabric Price Group 08	+\$1061
	Fabric Price Group 09	+\$1242
	Fabric Price Group 10	+\$1478
Backrest Inner Finish	Fabric Price Group 01	No cost
	Fabric Price Group 02	+\$52
	Fabric Price Group 03	+\$104
	Fabric Price Group 04	+\$174
	Fabric Price Group 05	+\$289
	Fabric Price Group 06	+\$404
	Fabric Price Group 07	+\$552
	Fabric Price Group 08	+\$683
	Fabric Price Group 09	+\$799
	Fabric Price Group 10	+\$950
Left End Configuration	Connecting Unit	No cost
	Open	No cost
	AD-61 LA Uph LH Arm	+\$1226
	AD-62 LC Uph LH Arm with Tablet	+\$2623
Left Arm Finish	Fabric Price Group 01	No cost
	Fabric Price Group 02	+\$48
	Fabric Price Group 03	+\$97
	Fabric Price Group 04	+\$162
	Fabric Price Group 05	+\$267
	Fabric Price Group 06	+\$376
	Fabric Price Group 07	+\$513
	Fabric Price Group 08	+\$635
	Fabric Price Group 09	+\$741
	Fabric Price Group 10	+\$883

► Product Information continued on next page

Away from the Desk

Seating

► **Product Information continued from previous page**

Options		
Left Tablet Top Finish	Laminate HPL Price Group 01	No cost
	Laminate HPL Price Group 02	+\$76
	Laminate HPL Price Group 03	+\$154
	OLL Price Group 1	+\$102
Left Tablet Edge Finish	Plastic Group 1	No cost
Left Arm Power/Data Node	No Power/Data Required	No cost
	2 Duplex Outlets	+\$287
	Duplex Outlet with HDMI Video Port	+\$376
	Duplex Outlet with CAT6 Data	+\$382
	Duplex Outlet with USB Data Ports	+\$395
Left Arm Power Finish	Paint Price Group 01	No cost
	Paint Price Group 02	No cost
Right End Configuration	Connecting Unit	No cost
	Open	No cost
	AD-61 RA Uph RH Arm	+\$1226
	AD-62 RC Uph RH Arm with Tablet	+\$2623
Right Arm Finish	Fabric Price Group 01	No cost
	Fabric Price Group 02	+\$48
	Fabric Price Group 03	+\$97
	Fabric Price Group 04	+\$162
	Fabric Price Group 05	+\$267
	Fabric Price Group 06	+\$376
	Fabric Price Group 07	+\$513
	Fabric Price Group 08	+\$635
	Fabric Price Group 09	+\$741
	Fabric Price Group 10	+\$883
Right Tablet Top Finish	Laminate HPL Price Group 01	No cost
	Laminate HPL Price Group 02	+\$76
	Laminate HPL Price Group 03	+\$154
	OLL Price Group 1	+\$102
Right Tablet Edge Finish	Plastic Group 1	No cost
Right Arm Power/Data Node	No Power/Data Required	No cost
	2 Duplex Outlets	+\$287
	Duplex Outlet with HDMI Video Port	+\$376
	Duplex Outlet with CAT6 Data	+\$382
	Duplex Outlet with USB Data Ports	+\$395
Right Arm Power Finish	Paint Price Group 01	No cost
	Paint Price Group 02	No cost
Table	No Table	No cost
	AD-72 120 Corner Table	+\$3142
Table Top Finish	Laminate HPL Price Group 01	No cost
	Laminate HPL Price Group 02	+\$76
	Laminate HPL Price Group 03	+\$154
	OLL Price Group 1	+\$102
Table Edge Finish	Plastic Group 1	No cost
Table Base Finish	Fabric Price Group 01	No cost
	Fabric Price Group 02	+\$36

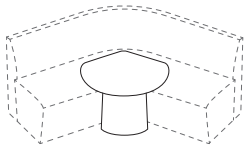

► **Product Information continued on next page**

Away from the Desk

Seating

► Product Information continued from previous page

Options		
Table Base Finish	Fabric Price Group 03	+\$75
	Fabric Price Group 04	+\$124
	Fabric Price Group 05	+\$206
	Fabric Price Group 06	+\$288
	Fabric Price Group 07	+\$395
	Fabric Price Group 08	+\$487
	Fabric Price Group 09	+\$571
	Fabric Price Group 10	+\$679
Base Power/Data Node	No Power/Data Required	No cost
	2 Duplex Outlets	+\$287
	Duplex Outlet with HDMI Video Port	+\$376
	Duplex Outlet with CAT6 Data	+\$382
	Duplex Outlet with USB Data Ports	+\$395
Base Power Finish	Paint Price Group 01	No cost
	Paint Price Group 02	No cost

Specification Information

Style Number Base Price

120° Modular Seat with External Back

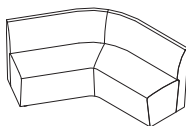

OBAD22 \$6991

Away from the Desk

Seating

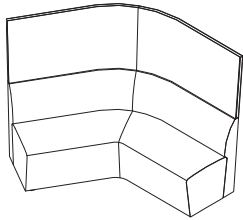

Tip: Customer's Own Material (COM) is available at a price group 1.

Standard Includes

- Fully upholstered seat, back, and screen: fabric price group 01
- Adjustable glides: black
- Linking brackets

Options

Seat Finish	Fabric Price Group 01	No cost
	Fabric Price Group 02	+\$77
	Fabric Price Group 03	+\$155
	Fabric Price Group 04	+\$262
	Fabric Price Group 05	+\$434
	Fabric Price Group 06	+\$606
	Fabric Price Group 07	+\$828
	Fabric Price Group 08	+\$1026
	Fabric Price Group 09	+\$1198
	Fabric Price Group 10	+\$1426
Backrest Outer Finish	Fabric Price Group 01	No cost
	Fabric Price Group 02	+\$80
	Fabric Price Group 03	+\$161
	Fabric Price Group 04	+\$273
	Fabric Price Group 05	+\$449
	Fabric Price Group 06	+\$627
	Fabric Price Group 07	+\$858
	Fabric Price Group 08	+\$1061
	Fabric Price Group 09	+\$1242
	Fabric Price Group 10	+\$1478
Backrest Inner Finish	Fabric Price Group 01	No cost
	Fabric Price Group 02	+\$52
	Fabric Price Group 03	+\$104
	Fabric Price Group 04	+\$174
	Fabric Price Group 05	+\$289
	Fabric Price Group 06	+\$404
	Fabric Price Group 07	+\$552
	Fabric Price Group 08	+\$683
	Fabric Price Group 09	+\$799
	Fabric Price Group 10	+\$950
Screen Connection	No Screen Connections	No cost
	Screen Connection-Left	No cost
	Screen Connection-Left & Right	No cost
	Screen Connection-Right	No cost
Left End Configuration	Connecting Unit	No cost
	Open	No cost
	AD-61 LA Uph LH Arm	+\$1226
	AD-62 LC Uph LH Arm with Tablet	+\$2623
Left Arm Finish	Fabric Price Group 01	No cost
	Fabric Price Group 02	+\$48
	Fabric Price Group 03	+\$97
	Fabric Price Group 04	+\$162
	Fabric Price Group 05	+\$267
	Fabric Price Group 06	+\$376
	Fabric Price Group 07	+\$513

► **Product Information continued on next page**

Away from the Desk

Seating

► Product Information continued from previous page

Options		
Left Arm Finish	Fabric Price Group 08	+\$635
	Fabric Price Group 09	+\$741
	Fabric Price Group 10	+\$883
Left Tablet Top Finish	Laminate HPL Price Group 01	No cost
	Laminate HPL Price Group 02	+\$76
	Laminate HPL Price Group 03	+\$154
	OLL Price Group 1	+\$102
Left Tablet Edge Finish	Plastic Group 1	No cost
Left Arm Power/Data Node	No Power/Data Required	No cost
	2 Duplex Outlets	+\$287
	Duplex Outlet with HDMI Video Port	+\$376
	Duplex Outlet with CAT6 Data	+\$382
	Duplex Outlet with USB Data Ports	+\$395
Left Arm Power Finish	Paint Price Group 01	No cost
	Paint Price Group 02	No cost
Right End Configuration	Connecting Unit	No cost
	Open	No cost
	AD-61 RA Uph RH Arm	+\$1226
	AD-62 RC Uph RH Arm with Tablet	+\$2623
Right Arm Finish	Fabric Price Group 01	No cost
	Fabric Price Group 02	+\$48
	Fabric Price Group 03	+\$97
	Fabric Price Group 04	+\$162
	Fabric Price Group 05	+\$267
	Fabric Price Group 06	+\$376
	Fabric Price Group 07	+\$513
	Fabric Price Group 08	+\$635
	Fabric Price Group 09	+\$741
	Fabric Price Group 10	+\$883
Right Tablet Top Finish	Laminate HPL Price Group 01	No cost
	Laminate HPL Price Group 02	+\$76
	Laminate HPL Price Group 03	+\$154
	OLL Price Group 1	+\$102
Right Tablet Edge Finish	Plastic Group 1	No cost
Right Arm Power/Data Node	No Power/Data Required	No cost
	2 Duplex Outlets	+\$287
	Duplex Outlet with HDMI Video Port	+\$376
	Duplex Outlet with CAT6 Data	+\$382
	Duplex Outlet with USB Data Ports	+\$395
Right Arm Power Finish	Paint Price Group 01	No cost
	Paint Price Group 02	No cost
Table	No Table	No cost
	AD-72 120 Corner Table	+\$3142
Table Top Finish	Laminate HPL Price Group 01	No cost
	Laminate HPL Price Group 02	+\$76
	Laminate HPL Price Group 03	+\$154
	OLL Price Group 1	+\$102

► Product Information continued on next page

Away from the Desk

Seating

► **Product Information continued from previous page**

Options

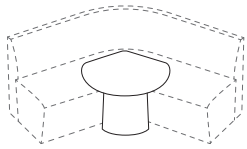
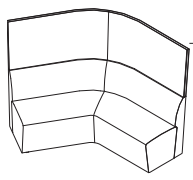

Table Edge Finish	Plastic Group 1	No cost
Table Base Finish	Fabric Price Group 01	No cost
	Fabric Price Group 02	+\$36
	Fabric Price Group 03	+\$75
	Fabric Price Group 04	+\$124
	Fabric Price Group 05	+\$206
	Fabric Price Group 06	+\$288
	Fabric Price Group 07	+\$395
	Fabric Price Group 08	+\$487
	Fabric Price Group 09	+\$571
	Fabric Price Group 10	+\$679
Base Power/Data Node	No Power/Data Required	No cost
	2 Duplex Outlets	+\$287
	Duplex Outlet with HDMI Video Port	+\$376
	Duplex Outlet with CAT6 Data	+\$382
Base Power Finish	Paint Price Group 01	No cost
	Paint Price Group 02	No cost

Specification Information

Style Number	Base Price									
	Screen Grades:									
	1	2	3	4	5	6	7	8	9	10



120° Modular Seat with External Back and Screen

OBAD23	\$8892	\$8994	\$9097	\$9238	\$9465	\$9693	\$9989	\$10,248	\$10,477	\$10,778
---------------	--------	--------	--------	--------	--------	--------	--------	----------	----------	----------

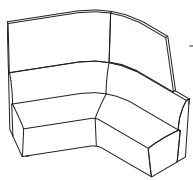

120° Modular Seat with External Back and Left Hand Tapered Screen

OBAD23LC	\$8844	\$8928	\$9016	\$9133	\$9326	\$9517	\$9762	\$9980	\$10,172	\$10,425
-----------------	--------	--------	--------	--------	--------	--------	--------	--------	----------	----------

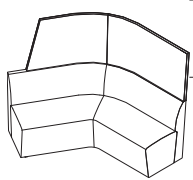

120° Modular Seat with External Back and Right Hand Tapered Screen

OBAD23RC	\$8844	\$8928	\$9016	\$9133	\$9326	\$9517	\$9762	\$9980	\$10,172	\$10,425
-----------------	--------	--------	--------	--------	--------	--------	--------	--------	----------	----------

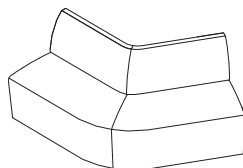
Away from the Desk**Seating**

Tip: Customer's Own Material (COM) is available at a price group 1.

Standard Includes

- Fully upholstered seat with back: fabric price group 01
- Adjustable glides: black
- Linking brackets

Options

Seat Finish	Fabric Price Group 01	No cost
	Fabric Price Group 02	+\$77
	Fabric Price Group 03	+\$155
	Fabric Price Group 04	+\$262
	Fabric Price Group 05	+\$434
	Fabric Price Group 06	+\$606
	Fabric Price Group 07	+\$828
	Fabric Price Group 08	+\$1026
	Fabric Price Group 09	+\$1198
	Fabric Price Group 10	+\$1426
Backrest Outer Finish	Fabric Price Group 01	No cost
	Fabric Price Group 02	+\$58
	Fabric Price Group 03	+\$117
	Fabric Price Group 04	+\$197
	Fabric Price Group 05	+\$325
	Fabric Price Group 06	+\$456
	Fabric Price Group 07	+\$621
	Fabric Price Group 08	+\$770
	Fabric Price Group 09	+\$899
	Fabric Price Group 10	+\$1070
Backrest Inner Finish	Fabric Price Group 01	No cost
	Fabric Price Group 02	+\$36
	Fabric Price Group 03	+\$75
	Fabric Price Group 04	+\$124
	Fabric Price Group 05	+\$206
	Fabric Price Group 06	+\$288
	Fabric Price Group 07	+\$395
	Fabric Price Group 08	+\$487
	Fabric Price Group 09	+\$571
	Fabric Price Group 10	+\$679
Left End Configuration	Connecting Unit	No cost
	Open	No cost
	AD-61 LA Uph LH Arm	+\$1226
	AD-62 LC Uph LH Arm with Tablet	+\$2623
Left Arm Finish	Fabric Price Group 01	No cost
	Fabric Price Group 02	+\$48
	Fabric Price Group 03	+\$97
	Fabric Price Group 04	+\$162
	Fabric Price Group 05	+\$267
	Fabric Price Group 06	+\$376
	Fabric Price Group 07	+\$513
	Fabric Price Group 08	+\$635
	Fabric Price Group 09	+\$741
	Fabric Price Group 10	+\$883

► **Product Information continued on next page**

Away from the Desk

Seating

► **Product Information continued from previous page**

Options		
Left Tablet Top Finish	Laminate HPL Price Group 01	No cost
	Laminate HPL Price Group 02	+\$76
	Laminate HPL Price Group 03	+\$154
	OLL Price Group 1	+\$102
Left Tablet Edge Finish	Plastic Group 1	No cost
Left Arm Power/Data Node	No Power/Data Required	No cost
	2 Duplex Outlets	+\$287
	Duplex Outlet with HDMI Video Port	+\$376
	Duplex Outlet with CAT6 Data	+\$382
	Duplex Outlet with USB Data Ports	+\$395
Left Arm Power Finish	Paint Price Group 01	No cost
	Paint Price Group 02	No cost
Right End Configuration	Connecting Unit	No cost
	Open	No cost
	AD-61 RA Uph RH Arm	+\$1226
	AD-62 RC Uph RH Arm with Tablet	+\$2623
Right Arm Finish	Fabric Price Group 01	No cost
	Fabric Price Group 02	+\$48
	Fabric Price Group 03	+\$97
	Fabric Price Group 04	+\$162
	Fabric Price Group 05	+\$267
	Fabric Price Group 06	+\$376
	Fabric Price Group 07	+\$513
	Fabric Price Group 08	+\$635
	Fabric Price Group 09	+\$741
	Fabric Price Group 10	+\$883
Right Tablet Top Finish	Laminate HPL Price Group 01	No cost
	Laminate HPL Price Group 02	+\$76
	Laminate HPL Price Group 03	+\$154
	OLL Price Group 1	+\$102
Right Tablet Edge Finish	Plastic Group 1	No cost
Right Arm Power/Data Node	No Power/Data Required	No cost
	2 Duplex Outlets	+\$287
	Duplex Outlet with HDMI Video Port	+\$376
	Duplex Outlet with CAT6 Data	+\$382
	Duplex Outlet with USB Data Ports	+\$395
Right Arm Power Finish	Paint Price Group 01	No cost
	Paint Price Group 02	No cost

Specification Information

Style Number Base Price

120° Modular Seat with Internal Back

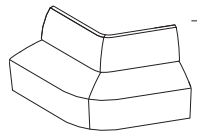

OBAD24 \$6515

Away from the Desk

Seating

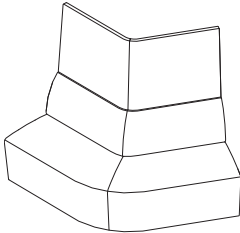

Tip: Customer's Own Material (COM) is available at a price group 1.

Standard Includes

- Fully upholstered seat, back, and screen: fabric price group 01
- Adjustable glides: black
- Linking brackets

Options

Seat Finish	Fabric Price Group 01	No cost
	Fabric Price Group 02	+\$77
	Fabric Price Group 03	+\$155
	Fabric Price Group 04	+\$262
	Fabric Price Group 05	+\$434
	Fabric Price Group 06	+\$606
	Fabric Price Group 07	+\$828
	Fabric Price Group 08	+\$1026
	Fabric Price Group 09	+\$1198
	Fabric Price Group 10	+\$1426
Backrest Outer Finish	Fabric Price Group 01	No cost
	Fabric Price Group 02	+\$58
	Fabric Price Group 03	+\$117
	Fabric Price Group 04	+\$197
	Fabric Price Group 05	+\$325
	Fabric Price Group 06	+\$456
	Fabric Price Group 07	+\$621
	Fabric Price Group 08	+\$770
	Fabric Price Group 09	+\$899
	Fabric Price Group 10	+\$1070
Backrest Inner Finish	Fabric Price Group 01	No cost
	Fabric Price Group 02	+\$36
	Fabric Price Group 03	+\$75
	Fabric Price Group 04	+\$124
	Fabric Price Group 05	+\$206
	Fabric Price Group 06	+\$288
	Fabric Price Group 07	+\$395
	Fabric Price Group 08	+\$487
	Fabric Price Group 09	+\$571
	Fabric Price Group 10	+\$679
Screen Connection	No Screen Connections	No cost
	Screen Connection-Left	No cost
	Screen Connection-Left & Right	No cost
	Screen Connection-Right	No cost
Left End Configuration	Connecting Unit	No cost
	Open	No cost
	AD-61 LA Uph LH Arm	+\$1226
	AD-62 LC Uph LH Arm with Tablet	+\$2623
Left Arm Finish	Fabric Price Group 01	No cost
	Fabric Price Group 02	+\$48
	Fabric Price Group 03	+\$97
	Fabric Price Group 04	+\$162
	Fabric Price Group 05	+\$267
	Fabric Price Group 06	+\$376
	Fabric Price Group 07	+\$513

► **Product Information continued on next page**

Away from the Desk

Seating

► **Product Information continued from previous page**

Options		
Left Arm Finish	Fabric Price Group 08	+\$635
	Fabric Price Group 09	+\$741
	Fabric Price Group 10	+\$883
Left Tablet Top Finish	Laminate HPL Price Group 01	No cost
	Laminate HPL Price Group 02	+\$76
	Laminate HPL Price Group 03	+\$154
	OLL Price Group 1	+\$102
Left Tablet Edge Finish	Plastic Group 1	No cost
Left Arm Power/Data Node	No Power/Data Required	No cost
	2 Duplex Outlets	+\$287
	Duplex Outlet with HDMI Video Port	+\$376
	Duplex Outlet with CAT6 Data	+\$382
	Duplex Outlet with USB Data Ports	+\$395
Left Arm Power Finish	Paint Price Group 01	No cost
	Paint Price Group 02	No cost
Right End Configuration	Connecting Unit	No cost
	Open	No cost
	AD-61 RA Uph RH Arm	+\$1226
	AD-62 RC Uph RH Arm with Tablet	+\$2623
Right Arm Finish	Fabric Price Group 01	No cost
	Fabric Price Group 02	+\$48
	Fabric Price Group 03	+\$97
	Fabric Price Group 04	+\$162
	Fabric Price Group 05	+\$267
	Fabric Price Group 06	+\$376
	Fabric Price Group 07	+\$513
	Fabric Price Group 08	+\$635
	Fabric Price Group 09	+\$741
	Fabric Price Group 10	+\$883
Right Tablet Top Finish	Laminate HPL Price Group 01	No cost
	Laminate HPL Price Group 02	+\$76
	Laminate HPL Price Group 03	+\$154
	OLL Price Group 1	+\$102
Right Tablet Edge Finish	Plastic Group 1	No cost
Right Arm Power/Data Node	No Power/Data Required	No cost
	2 Duplex Outlets	+\$287
	Duplex Outlet with HDMI Video Port	+\$376
	Duplex Outlet with CAT6 Data	+\$382
	Duplex Outlet with USB Data Ports	+\$395
Right Arm Power Finish	Paint Price Group 01	No cost
	Paint Price Group 02	No cost

► **Product Information continued on next page**

Away from the Desk

Seating

► Product Information continued from previous page

Specification Information

Style Number	Base Price									
	Screen Grades:									
	1	2	3	4	5	6	7	8	9	10
120° Modular Seat with Internal Back and Screen										
OBAD25	\$8047	\$8116	\$8185	\$8281	\$8434	\$8589	\$8786	\$8964	\$9117	\$9320

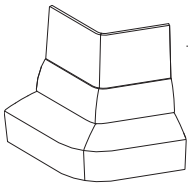

Away from the Desk

Seating

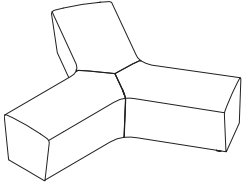

Tip: Customer's Own Material (COM) is available at a price group 1.

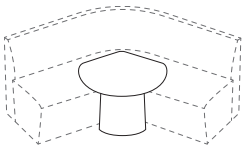

Standard Includes

- Fully upholstered seat: fabric price group 01
- Adjustable glides: black
- Linking brackets

Options

Seat Finish	Fabric Price Group 01	No cost
	Fabric Price Group 02	+\$109
	Fabric Price Group 03	+\$222
	Fabric Price Group 04	+\$375
	Fabric Price Group 05	+\$620
	Fabric Price Group 06	+\$868
	Fabric Price Group 07	+\$1184
	Fabric Price Group 08	+\$1465
	Fabric Price Group 09	+\$1712
	Fabric Price Group 10	+\$2039
Left End Configuration	Connecting Unit	No cost
	Open	No cost
Center End Configuration	Connecting Unit	No cost
	Open	No cost
Right End Configuration	Connecting Unit	No cost
	Open	No cost
Table	No Table	No cost
	AD-72 120 Corner Table	+\$3142
Table Top Finish	Laminate HPL Price Group 01	No cost
	Laminate HPL Price Group 02	+\$76
	Laminate HPL Price Group 03	+\$154
	OLL Price Group 1	+\$102
Table Edge Finish	Plastic Group 1	No cost
Table Base Finish	Fabric Price Group 01	No cost
	Fabric Price Group 02	+\$36
	Fabric Price Group 03	+\$75
	Fabric Price Group 04	+\$124
	Fabric Price Group 05	+\$206
	Fabric Price Group 06	+\$288
	Fabric Price Group 07	+\$395
	Fabric Price Group 08	+\$487
	Fabric Price Group 09	+\$571
	Fabric Price Group 10	+\$679
Base Power/Data Node	No Power/Data Required	No cost
	2 Duplex Outlets	+\$287
	Duplex Outlet with HDMI Video Port	+\$376
	Duplex Outlet with CAT6 Data	+\$382
Base Power Finish	Duplex Outlet with USB Data Ports	+\$395
	Paint Price Group 01	No cost
	Paint Price Group 02	No cost

► **Product Information continued on next page**

Away from the Desk

Seating

▶ **Product Information continued from previous page**

Specification Information

Style Number Base Price

120° Modular Tri Seat

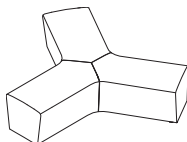

OBAD31 \$5142

Away from the Desk

Seating

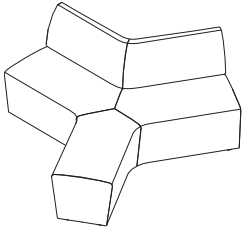

Tip: Customer's Own Material (COM) is available at a price group 1.

Standard Includes

- Fully upholstered seat with back: fabric price group 01
- Adjustable glides: black
- Linking brackets

Options

Seat Finish	Fabric Price Group 01	No cost
	Fabric Price Group 02	+\$109
	Fabric Price Group 03	+\$222
	Fabric Price Group 04	+\$375
	Fabric Price Group 05	+\$620
	Fabric Price Group 06	+\$868
	Fabric Price Group 07	+\$1184
	Fabric Price Group 08	+\$1465
	Fabric Price Group 09	+\$1712
	Fabric Price Group 10	+\$2039
Backrest Outer Finish	Fabric Price Group 01	No cost
	Fabric Price Group 02	+\$58
	Fabric Price Group 03	+\$117
	Fabric Price Group 04	+\$197
	Fabric Price Group 05	+\$325
	Fabric Price Group 06	+\$456
	Fabric Price Group 07	+\$621
	Fabric Price Group 08	+\$770
	Fabric Price Group 09	+\$899
	Fabric Price Group 10	+\$1070
Backrest Inner Finish	Fabric Price Group 01	No cost
	Fabric Price Group 02	+\$36
	Fabric Price Group 03	+\$75
	Fabric Price Group 04	+\$124
	Fabric Price Group 05	+\$206
	Fabric Price Group 06	+\$288
	Fabric Price Group 07	+\$395
	Fabric Price Group 08	+\$487
	Fabric Price Group 09	+\$571
	Fabric Price Group 10	+\$679
Left End Configuration	Connecting Unit	No cost
	Open	No cost
	AD-61 LA Uph LH Arm	+\$1226
	AD-62 LC Uph LH Arm with Tablet	+\$2623
Left Arm Finish	Fabric Price Group 01	No cost
	Fabric Price Group 02	+\$48
	Fabric Price Group 03	+\$97
	Fabric Price Group 04	+\$162
	Fabric Price Group 05	+\$267
	Fabric Price Group 06	+\$376
	Fabric Price Group 07	+\$513
	Fabric Price Group 08	+\$635
	Fabric Price Group 09	+\$741
	Fabric Price Group 10	+\$883

► **Product Information continued on next page**

Away from the Desk

Seating

► Product Information continued from previous page

Options		
Left Tablet Top Finish	Laminate HPL Price Group 01	No cost
	Laminate HPL Price Group 02	+\$76
	Laminate HPL Price Group 03	+\$154
	OLL Price Group 1	+\$102
Left Tablet Edge Finish	Plastic Group 1	No cost
Left Arm Power/Data Node	No Power/Data Required	No cost
	2 Duplex Outlets	+\$287
	Duplex Outlet with HDMI Video Port	+\$376
	Duplex Outlet with CAT6 Data	+\$382
	Duplex Outlet with USB Data Ports	+\$395
Left Arm Power Finish	Paint Price Group 01	No cost
	Paint Price Group 02	No cost
Center End Configuration	Connecting Unit	No cost
	Open	No cost
Right End Configuration	Connecting Unit	No cost
	Open	No cost
	AD-61 RA Uph RH Arm	+\$1226
	AD-62 RC Uph RH Arm with Tablet	+\$2623
Right Arm Finish	Fabric Price Group 01	No cost
	Fabric Price Group 02	+\$48
	Fabric Price Group 03	+\$97
	Fabric Price Group 04	+\$162
	Fabric Price Group 05	+\$267
	Fabric Price Group 06	+\$376
	Fabric Price Group 07	+\$513
	Fabric Price Group 08	+\$635
	Fabric Price Group 09	+\$741
	Fabric Price Group 10	+\$883
Right Tablet Top Finish	Laminate HPL Price Group 01	No cost
	Laminate HPL Price Group 02	+\$76
	Laminate HPL Price Group 03	+\$154
	OLL Price Group 1	+\$102
Right Tablet Edge Finish	Plastic Group 1	No cost
Right Arm Power/Data Node	No Power/Data Required	No cost
	2 Duplex Outlets	+\$287
	Duplex Outlet with HDMI Video Port	+\$376
	Duplex Outlet with CAT6 Data	+\$382
	Duplex Outlet with USB Data Ports	+\$395
Right Arm Power Finish	Paint Price Group 01	No cost
	Paint Price Group 02	No cost
Table	No Table AD-72 120 Corner Table	No cost +\$3142
Table Location	Table - Left	No cost
	Table - Right	No cost
Table Top Finish	Laminate HPL Price Group 01	No cost
	Laminate HPL Price Group 02	+\$76
	Laminate HPL Price Group 03	+\$154

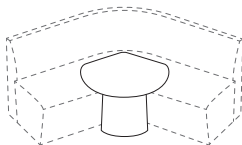

► Product Information continued on next page

Away from the Desk

Seating

► **Product Information continued from previous page**

Options		
Table Top Finish	OLL Price Group 1	+\$102
Table Edge Finish	Plastic Group 1	No cost
Table Base Finish	Fabric Price Group 01	No cost
	Fabric Price Group 02	+\$36
	Fabric Price Group 03	+\$75
	Fabric Price Group 04	+\$124
	Fabric Price Group 05	+\$206
	Fabric Price Group 06	+\$288
	Fabric Price Group 07	+\$395
	Fabric Price Group 08	+\$487
	Fabric Price Group 09	+\$571
	Fabric Price Group 10	+\$679
Base Power/Data Node	No Power/Data Required	No cost
	2 Duplex Outlets	+\$287
	Duplex Outlet with HDMI Video Port	+\$376
	Duplex Outlet with CAT6 Data	+\$382
Base Power Finish	Duplex Outlet with USB Data Ports	+\$395
	Paint Price Group 01	No cost
	Paint Price Group 02	No cost

Specification Information

Style Number Base Price

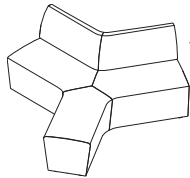

120° Modular Tri Seat with Internal Back

OBAD32 \$8053

Away from the Desk

Seating

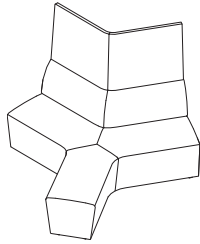

Tip: Customer's Own Material (COM) is available at a price group 1.

Standard Includes

- Fully upholstered seat, back, and screen: fabric price group 01
- Adjustable glides: black
- Linking brackets

Options

Seat Finish	Fabric Price Group 01	No cost
	Fabric Price Group 02	+\$109
	Fabric Price Group 03	+\$222
	Fabric Price Group 04	+\$375
	Fabric Price Group 05	+\$620
	Fabric Price Group 06	+\$868
	Fabric Price Group 07	+\$1184
	Fabric Price Group 08	+\$1465
	Fabric Price Group 09	+\$1712
	Fabric Price Group 10	+\$2039
Backrest Outer Finish	Fabric Price Group 01	No cost
	Fabric Price Group 02	+\$58
	Fabric Price Group 03	+\$117
	Fabric Price Group 04	+\$197
	Fabric Price Group 05	+\$325
	Fabric Price Group 06	+\$456
	Fabric Price Group 07	+\$621
	Fabric Price Group 08	+\$770
	Fabric Price Group 09	+\$899
	Fabric Price Group 10	+\$1070
Backrest Inner Finish	Fabric Price Group 01	No cost
	Fabric Price Group 02	+\$36
	Fabric Price Group 03	+\$75
	Fabric Price Group 04	+\$124
	Fabric Price Group 05	+\$206
	Fabric Price Group 06	+\$288
	Fabric Price Group 07	+\$395
	Fabric Price Group 08	+\$487
	Fabric Price Group 09	+\$571
	Fabric Price Group 10	+\$679
Screen Connection	No Screen Connections	No cost
	Screen Connection-Left	No cost
	Screen Connection-Left & Right	No cost
	Screen Connection-Right	No cost
Left End Configuration	Connecting Unit	No cost
	Open	No cost
	AD-61 LA Uph LH Arm	+\$1226
	AD-62 LC Uph LH Arm with Tablet	+\$2623
Left Arm Finish	Fabric Price Group 01	No cost
	Fabric Price Group 02	+\$48
	Fabric Price Group 03	+\$97
	Fabric Price Group 04	+\$162
	Fabric Price Group 05	+\$267
	Fabric Price Group 06	+\$376
	Fabric Price Group 07	+\$513

► **Product Information continued on next page**

Away from the Desk

Seating

► **Product Information continued from previous page**

Options		
Left Arm Finish	Fabric Price Group 08	+\$635
	Fabric Price Group 09	+\$741
	Fabric Price Group 10	+\$883
Left Tablet Top Finish	Laminate HPL Price Group 01	No cost
	Laminate HPL Price Group 02	+\$76
	Laminate HPL Price Group 03	+\$154
	OLL Price Group 1	+\$102
Left Tablet Edge Finish	Plastic Group 1	No cost
Left Arm Power/Data Node	No Power/Data Required	No cost
	2 Duplex Outlets	+\$287
	Duplex Outlet with HDMI Video Port	+\$376
	Duplex Outlet with CAT6 Data	+\$382
	Duplex Outlet with USB Data Ports	+\$395
Left Arm Power Finish	Paint Price Group 01	No cost
	Paint Price Group 02	No cost
Center End Configuration	Connecting Unit	No cost
	Open	No cost
Right End Configuration	Connecting Unit	No cost
	Open	No cost
	AD-61 RA Uph RH Arm	+\$1226
	AD-62 RC Uph RH Arm with Tablet	+\$2623
Right Arm Finish	Fabric Price Group 01	No cost
	Fabric Price Group 02	+\$48
	Fabric Price Group 03	+\$97
	Fabric Price Group 04	+\$162
	Fabric Price Group 05	+\$267
	Fabric Price Group 06	+\$376
	Fabric Price Group 07	+\$513
	Fabric Price Group 08	+\$635
	Fabric Price Group 09	+\$741
	Fabric Price Group 10	+\$883
Right Tablet Top Finish	Laminate HPL Price Group 01	No cost
	Laminate HPL Price Group 02	+\$76
	Laminate HPL Price Group 03	+\$154
	OLL Price Group 1	+\$102
Right Tablet Edge Finish	Plastic Group 1	No cost
Right Arm Power/Data Node	No Power/Data Required	No cost
	2 Duplex Outlets	+\$287
	Duplex Outlet with HDMI Video Port	+\$376
	Duplex Outlet with CAT6 Data	+\$382
	Duplex Outlet with USB Data Ports	+\$395
Right Arm Power Finish	Paint Price Group 01	No cost
	Paint Price Group 02	No cost
Table	No Table	No cost
	AD-72 120 Corner Table	+\$3142
Table Location	Table - Left	No cost
	Table - Right	No cost

► **Product Information continued on next page**

Away from the Desk Seating

► **Product Information continued from previous page**

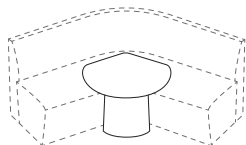

Options		
Table Top Finish	Laminate HPL Price Group 01	No cost
	Laminate HPL Price Group 02	+\$76
	Laminate HPL Price Group 03	+\$154
	OLL Price Group 1	+\$102
Table Edge Finish	Plastic Group 1	No cost
Table Base Finish	Fabric Price Group 01	No cost
	Fabric Price Group 02	+\$36
	Fabric Price Group 03	+\$75
	Fabric Price Group 04	+\$124
	Fabric Price Group 05	+\$206
	Fabric Price Group 06	+\$288
	Fabric Price Group 07	+\$395
	Fabric Price Group 08	+\$487
	Fabric Price Group 09	+\$571
	Fabric Price Group 10	+\$679
Base Power/Data Node	No Power/Data Required	No cost
	2 Duplex Outlets	+\$287
	Duplex Outlet with HDMI Video Port	+\$376
	Duplex Outlet with CAT6 Data	+\$382
Base Power Finish	Duplex Outlet with USB Data Ports	+\$395
	Paint Price Group 01	No cost
	Paint Price Group 02	No cost

Specification Information

Style Number	Base Price									
	Screen Grades:									
	1	2	3	4	5	6	7	8	9	10
120° Modular Tri Seat with Internal Back and Screen										
OBAD33	\$9589	\$9658	\$9727	\$9823	\$9976	\$10,131	\$10,328	\$10,506	\$10,659	\$10,862

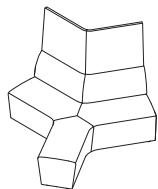

Away from the Desk

Seating

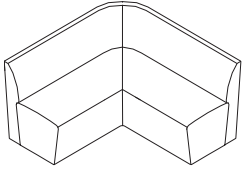

Tip: Customer's Own Material (COM) is available at a price group 1.

Tip: Tablet is selectable on one end only.

Standard Includes

- Fully upholstered seat with back: fabric price group 01
- Adjustable glides: black
- Linking brackets

Options

Seat Finish	Fabric Price Group 01	No cost
	Fabric Price Group 02	+\$80
	Fabric Price Group 03	+\$161
	Fabric Price Group 04	+\$273
	Fabric Price Group 05	+\$449
	Fabric Price Group 06	+\$627
	Fabric Price Group 07	+\$858
	Fabric Price Group 08	+\$1061
	Fabric Price Group 09	+\$1242
	Fabric Price Group 10	+\$1478
Backrest Outer Finish	Fabric Price Group 01	No cost
	Fabric Price Group 02	+\$88
	Fabric Price Group 03	+\$183
	Fabric Price Group 04	+\$307
	Fabric Price Group 05	+\$512
	Fabric Price Group 06	+\$716
	Fabric Price Group 07	+\$977
	Fabric Price Group 08	+\$1209
	Fabric Price Group 09	+\$1413
	Fabric Price Group 10	+\$1681
Backrest Inner Finish	Fabric Price Group 01	No cost
	Fabric Price Group 02	+\$45
	Fabric Price Group 03	+\$87
	Fabric Price Group 04	+\$150
	Fabric Price Group 05	+\$249
	Fabric Price Group 06	+\$346
	Fabric Price Group 07	+\$474
	Fabric Price Group 08	+\$586
	Fabric Price Group 09	+\$685
	Fabric Price Group 10	+\$816
Left End Configuration	Connecting Unit	No cost
	Open	No cost
	AD-61 LA Uph LH Arm	+\$1226
	AD-62 LC Uph LH Arm with Tablet	+\$2623
Left Arm Finish	Fabric Price Group 01	No cost
	Fabric Price Group 02	+\$48
	Fabric Price Group 03	+\$97
	Fabric Price Group 04	+\$162
	Fabric Price Group 05	+\$267
	Fabric Price Group 06	+\$376
	Fabric Price Group 07	+\$513
	Fabric Price Group 08	+\$635
	Fabric Price Group 09	+\$741
	Fabric Price Group 10	+\$883

► Product Information continued on next page

Away from the Desk

Seating

► **Product Information continued from previous page**

Options		
Left Tablet Top Finish	Laminate HPL Price Group 01	No cost
	Laminate HPL Price Group 02	+\$76
	Laminate HPL Price Group 03	+\$154
	OLL Price Group 1	+\$102
Left Tablet Edge Finish	Plastic Group 1	No cost
Left Arm Power/Data Node	No Power/Data Required	No cost
	2 Duplex Outlets	+\$287
	Duplex Outlet with HDMI Video Port	+\$376
	Duplex Outlet with CAT6 Data	+\$382
Left Arm Power Finish	Duplex Outlet with USB Data Ports	+\$395
	Paint Price Group 01	No cost
	Paint Price Group 02	No cost
Right End Configuration	Connecting Unit	No cost
	Open	No cost
	AD-61 RA Uph RH Arm	+\$1226
	AD-62 RC Uph RH Arm with Tablet	+\$2623
Right Arm Finish	Fabric Price Group 01	No cost
	Fabric Price Group 02	+\$48
	Fabric Price Group 03	+\$97
	Fabric Price Group 04	+\$162
	Fabric Price Group 05	+\$267
	Fabric Price Group 06	+\$376
	Fabric Price Group 07	+\$513
	Fabric Price Group 08	+\$635
	Fabric Price Group 09	+\$741
	Fabric Price Group 10	+\$883
Right Tablet Top Finish	Laminate HPL Price Group 01	No cost
	Laminate HPL Price Group 02	+\$76
	Laminate HPL Price Group 03	+\$154
	OLL Price Group 1	+\$102
Right Tablet Edge Finish	Plastic Group 1	No cost
Right Arm Power/Data Node	No Power/Data Required	No cost
	2 Duplex Outlets	+\$287
	Duplex Outlet with HDMI Video Port	+\$376
	Duplex Outlet with CAT6 Data	+\$382
Right Arm Power Finish	Duplex Outlet with USB Data Ports	+\$395
	Paint Price Group 01	No cost
	Paint Price Group 02	No cost
Table	No Table	No cost
	AD-71 90 Corner Table	+\$2703
Table Top Finish	Laminate HPL Price Group 01	No cost
	Laminate HPL Price Group 02	No cost
	Laminate HPL Price Group 02	+\$76
	Laminate HPL Price Group 03	+\$154
Table Edge Finish	OLL Price Group 1	+\$102
	Plastic Group 1	No cost

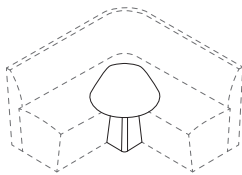

► **Product Information continued on next page**

Away from the Desk

Seating

► **Product Information continued from previous page**

Options		
Table Base Finish	Fabric Price Group 01	No cost
	Fabric Price Group 02	+\$36
	Fabric Price Group 03	+\$75
	Fabric Price Group 04	+\$124
	Fabric Price Group 05	+\$206
	Fabric Price Group 06	+\$288
	Fabric Price Group 07	+\$395
	Fabric Price Group 08	+\$487
	Fabric Price Group 09	+\$571
	Fabric Price Group 10	+\$679
Base Power/Data Node	No Power/Data Required	No cost
	2 Duplex Outlets	+\$287
	Duplex Outlet with HDMI Video Port	+\$376
	Duplex Outlet with CAT6 Data	+\$382
Base Power Finish	Paint Price Group 01	No cost
	Paint Price Group 02	No cost

Specification Information

Style Number Base Price

90° Modular Seat with Back

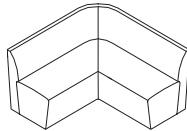

OBAD42 \$7763

Away from the Desk

Seating

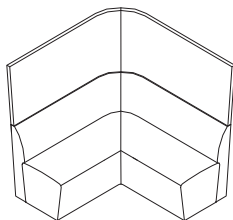

Tip: Customer's Own Material (COM) is available at a price group 1.

Standard Includes

- Fully upholstered seat, back, and screen: fabric price group 01
- Adjustable glides: black
- Linking brackets

Options

Seat Finish	Fabric Price Group 01	No cost
	Fabric Price Group 02	+\$80
	Fabric Price Group 03	+\$161
	Fabric Price Group 04	+\$273
	Fabric Price Group 05	+\$449
	Fabric Price Group 06	+\$627
	Fabric Price Group 07	+\$858
	Fabric Price Group 08	+\$1061
	Fabric Price Group 09	+\$1242
	Fabric Price Group 10	+\$1478
Backrest Outer Finish	Fabric Price Group 01	No cost
	Fabric Price Group 02	+\$88
	Fabric Price Group 03	+\$183
	Fabric Price Group 04	+\$307
	Fabric Price Group 05	+\$512
	Fabric Price Group 06	+\$716
	Fabric Price Group 07	+\$977
	Fabric Price Group 08	+\$1209
	Fabric Price Group 09	+\$1413
	Fabric Price Group 10	+\$1681
Backrest Inner Finish	Fabric Price Group 01	No cost
	Fabric Price Group 02	+\$45
	Fabric Price Group 03	+\$87
	Fabric Price Group 04	+\$150
	Fabric Price Group 05	+\$249
	Fabric Price Group 06	+\$346
	Fabric Price Group 07	+\$474
	Fabric Price Group 08	+\$586
	Fabric Price Group 09	+\$685
	Fabric Price Group 10	+\$816
Screen Connection	No Screen Connections	No cost
	Screen Connection-Left	No cost
	Screen Connection-Left & Right	No cost
	Screen Connection-Right	No cost
Left End Configuration	Connecting Unit	No cost
	Open	No cost
	AD-61 LA Uph LH Arm	+\$1226
	AD-62 LC Uph LH Arm with Tablet	+\$2623
Left Arm Finish	Fabric Price Group 01	No cost
	Fabric Price Group 02	+\$48
	Fabric Price Group 03	+\$97
	Fabric Price Group 04	+\$162
	Fabric Price Group 05	+\$267
	Fabric Price Group 06	+\$376
	Fabric Price Group 07	+\$513

Tip: Tablet is selectable on one end only.

► **Product Information continued on next page**



Away from the Desk

Seating

► Product Information continued from previous page

Options		
Left Arm Finish	Fabric Price Group 08	+\$635
	Fabric Price Group 09	+\$741
	Fabric Price Group 10	+\$883
Left Tablet Top Finish	Laminate HPL Price Group 01	No cost
	Laminate HPL Price Group 02	+\$76
	Laminate HPL Price Group 03	+\$154
	OLL Price Group 1	+\$102
Left Tablet Edge Finish	Plastic Group 1	No cost
Left Arm Power/Data Node	No Power/Data Required	No cost
	2 Duplex Outlets	+\$287
	Duplex Outlet with HDMI Video Port	+\$376
	Duplex Outlet with CAT6 Data	+\$382
	Duplex Outlet with USB Data Ports	+\$395
Left Arm Power Finish	Paint Price Group 01	No cost
	Paint Price Group 02	No cost
Right End Configuration	Connecting Unit	No cost
	Open	No cost
	AD-61 RA Uph RH Arm	+\$1226
	AD-62 RC Uph RH Arm with Tablet	+\$2623
Right Arm Finish	Fabric Price Group 01	No cost
	Fabric Price Group 02	+\$48
	Fabric Price Group 03	+\$97
	Fabric Price Group 04	+\$162
	Fabric Price Group 05	+\$267
	Fabric Price Group 06	+\$376
	Fabric Price Group 07	+\$513
	Fabric Price Group 08	+\$635
	Fabric Price Group 09	+\$741
	Fabric Price Group 10	+\$883
Right Tablet Top Finish	Laminate HPL Price Group 01	No cost
	Laminate HPL Price Group 02	+\$76
	Laminate HPL Price Group 03	+\$154
	OLL Price Group 1	+\$102
Right Tablet Edge Finish	Plastic Group 1	No cost
Right Arm Power/Data Node	No Power/Data Required	No cost
	2 Duplex Outlets	+\$287
	Duplex Outlet with HDMI Video Port	+\$376
	Duplex Outlet with CAT6 Data	+\$382
	Duplex Outlet with USB Data Ports	+\$395
Right Arm Power Finish	Paint Price Group 01	No cost
	Paint Price Group 02	No cost
Table	No Table	No cost
	AD-71 90 Corner Table	+\$2703
Table Top Finish	Laminate HPL Price Group 01	No cost
	Laminate HPL Price Group 02	+\$76
	Laminate HPL Price Group 03	+\$154
	OLL Price Group 1	+\$102

► Product Information continued on next page

Away from the Desk

Seating

► **Product Information continued from previous page**

Options		
Table Edge Finish	Plastic Group 1	No cost
Table Base Finish	Fabric Price Group 01	No cost
	Fabric Price Group 02	+\$36
	Fabric Price Group 03	+\$75
	Fabric Price Group 04	+\$124
	Fabric Price Group 05	+\$206
	Fabric Price Group 06	+\$288
	Fabric Price Group 07	+\$395
	Fabric Price Group 08	+\$487
	Fabric Price Group 09	+\$571
	Fabric Price Group 10	+\$679
Base Power/Data Node	No Power/Data Required	No cost
	2 Duplex Outlets	+\$287
	Duplex Outlet with HDMI Video Port	+\$376
	Duplex Outlet with CAT6 Data	+\$382
Base Power Finish	Paint Price Group 01	No cost
	Paint Price Group 02	No cost

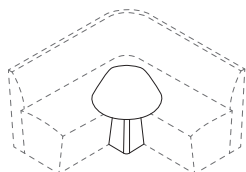

Specification Information

Style Number	Base Price									
	Screen Grades:									
	1	2	3	4	5	6	7	8	9	10
90° Modular Seat with Back and Screen										
OBAD43	\$9433	\$9553	\$9678	\$9845	\$10,115	\$10,387	\$10,736	\$11,046	\$11,317	\$11,675

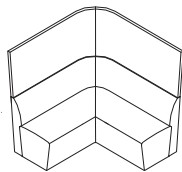

Away from the Desk

Seating

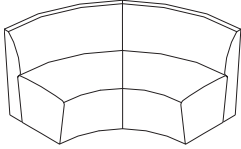

Tip: Customer's Own Material (COM) is available at a price group 1.

Standard Includes

- Fully upholstered seat with back: fabric price group 01
- Adjustable glides: black
- Linking brackets

Options

Seat Finish	Fabric Price Group 01	No cost
	Fabric Price Group 02	+\$69
	Fabric Price Group 03	+\$138
	Fabric Price Group 04	+\$234
	Fabric Price Group 05	+\$387
	Fabric Price Group 06	+\$542
	Fabric Price Group 07	+\$739
	Fabric Price Group 08	+\$917
	Fabric Price Group 09	+\$1070
	Fabric Price Group 10	+\$1273
Backrest Outer Finish	Fabric Price Group 01	No cost
	Fabric Price Group 02	+\$69
	Fabric Price Group 03	+\$138
	Fabric Price Group 04	+\$234
	Fabric Price Group 05	+\$387
	Fabric Price Group 06	+\$542
	Fabric Price Group 07	+\$739
	Fabric Price Group 08	+\$917
	Fabric Price Group 09	+\$1070
	Fabric Price Group 10	+\$1273
Backrest Inner Finish	Fabric Price Group 01	No cost
	Fabric Price Group 02	+\$52
	Fabric Price Group 03	+\$104
	Fabric Price Group 04	+\$174
	Fabric Price Group 05	+\$289
	Fabric Price Group 06	+\$404
	Fabric Price Group 07	+\$552
	Fabric Price Group 08	+\$683
	Fabric Price Group 09	+\$799
	Fabric Price Group 10	+\$950
Left End Configuration	Connecting Unit	No cost
	Open	No cost
	AD-61 LA Uph LH Arm	+\$1226
	AD-62 LC Uph LH Arm with Tablet	+\$2623
Left Arm Finish	Fabric Price Group 01	No cost
	Fabric Price Group 02	+\$48
	Fabric Price Group 03	+\$97
	Fabric Price Group 04	+\$162
	Fabric Price Group 05	+\$267
	Fabric Price Group 06	+\$376
	Fabric Price Group 07	+\$513
	Fabric Price Group 08	+\$635
	Fabric Price Group 09	+\$741
	Fabric Price Group 10	+\$883

Tip: Tablet is selectable on one end only.

► **Product Information continued on next page**

Away from the Desk

Seating

► Product Information continued from previous page

Options		
Left Tablet Top Finish	Laminate HPL Price Group 01	No cost
	Laminate HPL Price Group 02	+\$76
	Laminate HPL Price Group 03	+\$154
	OLL Price Group 1	+\$102
Left Tablet Edge Finish	Plastic Group 1	No cost
Left Arm Power/Data Node	No Power/Data Required	No cost
	2 Duplex Outlets	+\$287
	Duplex Outlet with HDMI Video Port	+\$376
	Duplex Outlet with CAT6 Data	+\$382
Left Arm Power Finish	Duplex Outlet with USB Data Ports	+\$395
	Paint Price Group 01	No cost
	Paint Price Group 02	No cost
Right End Configuration	Connecting Unit	No cost
	Open	No cost
	AD-61 RA Uph RH Arm	+\$1226
	AD-62 RC Uph RH Arm with Tablet	+\$2623
Right Arm Finish	Fabric Price Group 01	No cost
	Fabric Price Group 02	+\$48
	Fabric Price Group 03	+\$97
	Fabric Price Group 04	+\$162
	Fabric Price Group 05	+\$267
	Fabric Price Group 06	+\$376
	Fabric Price Group 07	+\$513
	Fabric Price Group 08	+\$635
	Fabric Price Group 09	+\$741
	Fabric Price Group 10	+\$883
Right Tablet Top Finish	Laminate HPL Price Group 01	No cost
	Laminate HPL Price Group 02	+\$76
	Laminate HPL Price Group 03	+\$154
	OLL Price Group 1	+\$102
Right Tablet Edge Finish	Plastic Group 1	No cost
Right Arm Power/Data Node	No Power/Data Required	No cost
	2 Duplex Outlets	+\$287
	Duplex Outlet with HDMI Video Port	+\$376
	Duplex Outlet with CAT6 Data	+\$382
Right Arm Power Finish	Duplex Outlet with USB Data Ports	+\$395
	Paint Price Group 01	No cost
	Paint Price Group 02	No cost

Specification Information

Style Number Base Price

90° Modular Curved Seat with Back

OBAD52 \$7044

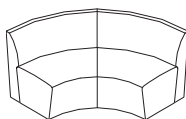

Away from the Desk

Seating

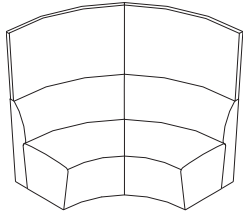

Tip: Customer's Own Material (COM) is available at a price group 1.

Standard Includes

- Fully upholstered seat, back, and screen: fabric price group 01
- Adjustable glides: black
- Linking brackets

Options

Seat Finish	Fabric Price Group 01	No cost
	Fabric Price Group 02	+\$69
	Fabric Price Group 03	+\$138
	Fabric Price Group 04	+\$234
	Fabric Price Group 05	+\$387
	Fabric Price Group 06	+\$542
	Fabric Price Group 07	+\$739
	Fabric Price Group 08	+\$917
	Fabric Price Group 09	+\$1070
	Fabric Price Group 10	+\$1273
Backrest Outer Finish	Fabric Price Group 01	No cost
	Fabric Price Group 02	+\$69
	Fabric Price Group 03	+\$138
	Fabric Price Group 04	+\$234
	Fabric Price Group 05	+\$387
	Fabric Price Group 06	+\$542
	Fabric Price Group 07	+\$739
	Fabric Price Group 08	+\$917
	Fabric Price Group 09	+\$1070
	Fabric Price Group 10	+\$1273
Backrest Inner Finish	Fabric Price Group 01	No cost
	Fabric Price Group 02	+\$52
	Fabric Price Group 03	+\$104
	Fabric Price Group 04	+\$174
	Fabric Price Group 05	+\$289
	Fabric Price Group 06	+\$404
	Fabric Price Group 07	+\$552
	Fabric Price Group 08	+\$683
	Fabric Price Group 09	+\$799
	Fabric Price Group 10	+\$950
Screen Connection	No Screen Connections	No cost
	Screen Connection-Left	No cost
	Screen Connection-Left & Right	No cost
	Screen Connection-Right	No cost
Left End Configuration	Connecting Unit	No cost
	Open	No cost
	AD-61 LA Uph LH Arm	+\$1226
	AD-62 LC Uph LH Arm with Tablet	+\$2623
Left Arm Finish	Fabric Price Group 01	No cost
	Fabric Price Group 02	+\$48
	Fabric Price Group 03	+\$97
	Fabric Price Group 04	+\$162
	Fabric Price Group 05	+\$267
	Fabric Price Group 06	+\$376
	Fabric Price Group 07	+\$513

Tip: Tablet is selectable on one end only.

► **Product Information continued on next page**

Away from the Desk

Seating

► Product Information continued from previous page

Options		
Left Arm Finish	Fabric Price Group 08	+\$635
	Fabric Price Group 09	+\$741
	Fabric Price Group 10	+\$883
Left Tablet Top Finish	Laminate HPL Price Group 01	No cost
	Laminate HPL Price Group 02	+\$76
	Laminate HPL Price Group 03	+\$154
	OLL Price Group 1	+\$102
Left Tablet Edge Finish	Plastic Group 1	No cost
Left Arm Power/Data Node	No Power/Data Required	No cost
	2 Duplex Outlets	+\$287
	Duplex Outlet with HDMI Video Port	+\$376
	Duplex Outlet with CAT6 Data	+\$382
	Duplex Outlet with USB Data Ports	+\$395
Left Arm Power Finish	Paint Price Group 01	No cost
	Paint Price Group 02	No cost
Right End Configuration	Connecting Unit	No cost
	Open	No cost
	AD-61 RA Uph RH Arm	+\$1226
	AD-62 RC Uph RH Arm with Tablet	+\$2623
Right Arm Finish	Fabric Price Group 01	No cost
	Fabric Price Group 02	+\$48
	Fabric Price Group 03	+\$97
	Fabric Price Group 04	+\$162
	Fabric Price Group 05	+\$267
	Fabric Price Group 06	+\$376
	Fabric Price Group 07	+\$513
	Fabric Price Group 08	+\$635
	Fabric Price Group 09	+\$741
	Fabric Price Group 10	+\$883
Right Tablet Top Finish	Laminate HPL Price Group 01	No cost
	Laminate HPL Price Group 02	+\$76
	Laminate HPL Price Group 03	+\$154
	OLL Price Group 1	+\$102
Right Tablet Edge Finish	Plastic Group 1	No cost
Right Arm Power/Data Node	No Power/Data Required	No cost
	2 Duplex Outlets	+\$287
	Duplex Outlet with HDMI Video Port	+\$376
	Duplex Outlet with CAT6 Data	+\$382
	Duplex Outlet with USB Data Ports	+\$395
Right Arm Power Finish	Paint Price Group 01	No cost
	Paint Price Group 02	No cost

► Product Information continued on next page

Away from the Desk

Seating

► Product Information continued from previous page

Specification Information

Style Number	Base Price									
	Screen Grades:									
	1	2	3	4	5	6	7	8	9	10

90° Modular Curved Seat with Back and Screen

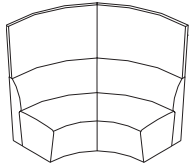

OBAD53	\$8974	\$9062	\$9157	\$9281	\$9486	\$9690	\$9951	\$10,183	\$10,387	\$10,655
---------------	--------	--------	--------	--------	--------	--------	--------	----------	----------	----------

Away from the Desk

Tables

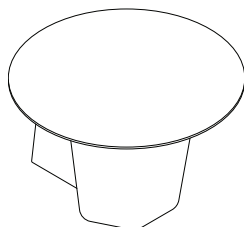

Tip: Customer's Own Material (COM) is available at a price group 1.

Standard Includes

- 1" thick tabletop with tapered edge: High-Pressure Laminate price group 01
- 3 mm edgeband: plastic price group 01
- Fully upholstered base: fabric price group 01
- Linking brackets

Options

Table Top Finish	Laminate HPL Price Group 01	No cost
	Laminate HPL Price Group 02	+\$80
	Laminate HPL Price Group 03	+\$164
	OLL Price Group 1	+\$102
Table Edge Finish	Plastic Group 1	No cost
Table Base Finish	Fabric Price Group 01	No cost
	Fabric Price Group 02	No cost
	Fabric Price Group 03	No cost
	Fabric Price Group 02	+\$75
	Fabric Price Group 03	+\$150
	Fabric Price Group 04	+\$253
	Fabric Price Group 05	+\$420
	Fabric Price Group 06	+\$585
	Fabric Price Group 07	+\$799
	Fabric Price Group 08	+\$989
Top Power / Data Node	No Power/Data Required	No cost
	2 Duplex Outlets	+\$287
	Duplex Outlet with HDMI Video Port	+\$376
	Duplex Outlet with CAT6 Data	+\$382
	Duplex Outlet with USB Data Ports	+\$395
Top Power Finish	Paint Price Group 01	No cost
	Paint Price Group 02	No cost
Base Power/Data Node	No Power/Data Required	No cost
	2 Duplex Outlets	+\$287
	Duplex Outlet with HDMI Video Port	+\$376
	Duplex Outlet with CAT6 Data	+\$382
Base Power Finish	Paint Price Group 01	No cost
	Paint Price Group 02	No cost

Specification Information

Style Number Base Price

Modular Small Round Top with Large Upholstered Tapered Base

OBAD64SRO \$4796



Away from the Desk

Tables

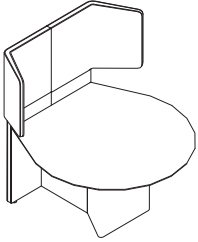

Tip: Customer's Own Material (COM) is available at a price group 1.

Standard Includes

- Upholstered media unit: fabric price group 01
- 1" thick table top: High-Pressure Laminate price group 01
- 3 mm edgeband: plastic price group 01
- Fixed monitor bracket
- Adjustable glides: black

Options

Table Top Finish	Laminate HPL Price Group 01	No cost
	Laminate HPL Price Group 02	+\$86
	Laminate HPL Price Group 03	+\$181
	OLL Price Group 1	+\$102
Table Edge Finish	Plastic Group 1	No cost
Table Base Finish	Fabric Price Group 01	No cost
	Fabric Price Group 02	+\$69
	Fabric Price Group 03	+\$138
	Fabric Price Group 04	+\$234
	Fabric Price Group 05	+\$387
	Fabric Price Group 06	+\$542
	Fabric Price Group 07	+\$739
	Fabric Price Group 08	+\$917
	Fabric Price Group 09	+\$1070
	Fabric Price Group 10	+\$1273
Screen Finish	Fabric Price Group 01	No cost
	Fabric Price Group 02	+\$109
	Fabric Price Group 03	+\$222
	Fabric Price Group 04	+\$375
	Fabric Price Group 05	+\$620
	Fabric Price Group 06	+\$868
	Fabric Price Group 07	+\$1184
	Fabric Price Group 08	+\$1465
	Fabric Price Group 09	+\$1712
	Fabric Price Group 10	+\$2039
Top Power / Data Node	No Power/Data Required	No cost
	2 Duplex Outlets	+\$287
	Duplex Outlet with HDMI Video Port	+\$376
	Duplex Outlet with CAT6 Data	+\$382
Top Power Finish	Duplex Outlet with USB Data Ports	+\$395
	Paint Price Group 01	No cost
	Paint Price Group 02	No cost

Specification Information

Style Number Base Price

Media Unit with Low, D Shaped Top

OBAD81DS \$5681

Away from the Desk Tables

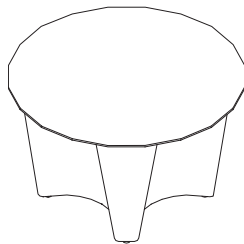

Tip: Customer's Own Material (COM) is available at a price group 1.

Standard Includes

- 1" thick tabletop with tapered edge: High-Pressure Laminate price group 01
- 3 mm edgeband: plastic price group 01
- Fully upholstered base: fabric price group 01
- Adjustable glides: black

Options

Table Top Finish	Laminate HPL Price Group 01	No cost
	Laminate HPL Price Group 02	+\$86
	Laminate HPL Price Group 03	+\$181
	OLL Price Group 1	+\$102
Table Edge Finish	Plastic Group 1	No cost
Table Base Finish	Fabric Price Group 01	No cost
	Fabric Price Group 02	+\$112
	Fabric Price Group 03	+\$227
	Fabric Price Group 04	+\$384
	Fabric Price Group 05	+\$637
	Fabric Price Group 06	+\$888
	Fabric Price Group 07	+\$1214
	Fabric Price Group 08	+\$1502
	Fabric Price Group 09	+\$1755
	Fabric Price Group 10	+\$2088
Top Power / Data Node	No Power/Data Required	No cost
	2 Duplex Outlets	+\$287
	Duplex Outlet with HDMI Video Port	+\$376
	Duplex Outlet with CAT6 Data	+\$382
Top Power Finish	Duplex Outlet with USB Data Ports	+\$395
	Paint Price Group 01	No cost
	Paint Price Group 02	No cost

Specification Information

Style Number Base Price

47 1/4" Dia Huddle Buddle Group Working Table

OBAD91SRO \$4411

Away from the Desk

Tables

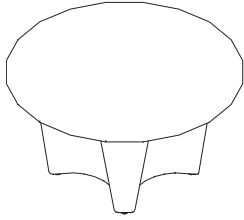

Tip: Customer's Own Material (COM) is available at a price group 1.

Standard Includes

- 1" thick tabletop with tapered edge: High-Pressure Laminate price group 01
- 3 mm edgeband: plastic price group 01
- Fully upholstered base: fabric price group 01
- Adjustable glides: black

Options

Table Top Finish	Laminate HPL Price Group 01	No cost
	Laminate HPL Price Group 02	+\$96
	Laminate HPL Price Group 03	+\$198
	OLL Price Group 1	+\$102
Table Edge Finish	Plastic Group 1	No cost
Table Base Finish	Fabric Price Group 01	No cost
	Fabric Price Group 02	+\$112
	Fabric Price Group 03	+\$227
	Fabric Price Group 04	+\$384
	Fabric Price Group 05	+\$637
	Fabric Price Group 06	+\$888
	Fabric Price Group 07	+\$1214
	Fabric Price Group 08	+\$1502
	Fabric Price Group 09	+\$1755
	Fabric Price Group 10	+\$2088
Top Power / Data Node	No Power/Data Required	No cost
	2 Duplex Outlets	+\$287
	Duplex Outlet with HDMI Video Port	+\$376
	Duplex Outlet with CAT6 Data	+\$382
Top Power Finish	Duplex Outlet with USB Data Ports	+\$395
	Paint Price Group 01	No cost
	Paint Price Group 02	No cost

Specification Information

Style Number Base Price

55 1/8" Dia Huddle Buddle Group Working Table

OBAD91LRO \$4594

Away from the Desk

Tables

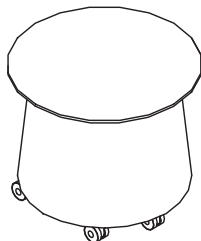

Tip: Customer's Own Material (COM) is available at a price group 1.

Standard Includes

- 1" thick tabletop with tapered edge: High-Pressure Laminate price group 01
- 3 mm edgeband: plastic price group 01
- Fully upholstered base: fabric price group 01
- Locking, hard casters: black

Options

Table Top Finish	Laminate HPL Price Group 01	No cost
	Laminate HPL Price Group 02	+\$73
	Laminate HPL Price Group 03	+\$145
	OLL Price Group 1	+\$102
Table Edge Finish	Plastic Group 1	No cost
Table Base Finish	Fabric Price Group 01	No cost
	Fabric Price Group 02	+\$36
	Fabric Price Group 03	+\$75
	Fabric Price Group 04	+\$124
	Fabric Price Group 05	+\$206
	Fabric Price Group 06	+\$288
	Fabric Price Group 07	+\$395
	Fabric Price Group 08	+\$487
	Fabric Price Group 09	+\$571
	Fabric Price Group 10	+\$679

Specification Information

Style Number Base Price

23 5/8" Dia Low Table

OBAD92 \$2333

Away from the Desk

Detached Seating

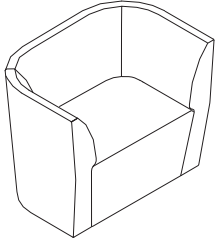

Tip: Customer's Own Material (COM) is available at a price group 1.

Standard Includes

- Fully upholstered seating unit: fabric price group 01
- 1" thick integrated tablet with tapered edge, if selected:
 - High-Pressure Laminate price group 01
 - 3 mm edgeband: plastic price group 1
- Adjustable glides: black

Options

Seat Finish	Fabric Price Group 01	No cost
	Fabric Price Group 02	+\$45
	Fabric Price Group 03	+\$87
	Fabric Price Group 04	+\$150
	Fabric Price Group 05	+\$249
	Fabric Price Group 06	+\$346
	Fabric Price Group 07	+\$474
	Fabric Price Group 08	+\$586
	Fabric Price Group 09	+\$685
	Fabric Price Group 10	+\$816
Backrest Outer Finish	Fabric Price Group 01	No cost
	Fabric Price Group 02	+\$73
	Fabric Price Group 03	+\$144
	Fabric Price Group 04	+\$243
	Fabric Price Group 05	+\$403
	Fabric Price Group 06	+\$564
	Fabric Price Group 07	+\$770
	Fabric Price Group 08	+\$953
	Fabric Price Group 09	+\$1113
	Fabric Price Group 10	+\$1324
Backrest Inner Finish	Fabric Price Group 01	No cost
	Fabric Price Group 02	+\$52
	Fabric Price Group 03	+\$104
	Fabric Price Group 04	+\$174
	Fabric Price Group 05	+\$289
	Fabric Price Group 06	+\$404
	Fabric Price Group 07	+\$552
	Fabric Price Group 08	+\$683
	Fabric Price Group 09	+\$799
	Fabric Price Group 10	+\$950
Arm Finish	Fabric Price Group 01	No cost
	Fabric Price Group 02	+\$36
	Fabric Price Group 03	+\$75
	Fabric Price Group 04	+\$124
	Fabric Price Group 05	+\$206
	Fabric Price Group 06	+\$288
	Fabric Price Group 07	+\$395
	Fabric Price Group 08	+\$487
	Fabric Price Group 09	+\$571
	Fabric Price Group 10	+\$679
Tablet Top Finish	Laminate HPL Price Group 01	No cost
	Laminate HPL Price Group 02	+\$65
	Laminate HPL Price Group 03	+\$137

► **Product Information continued on next page**

Away from the Desk

Detached Seating

► **Product Information continued from previous page**

Options		
Tablet Top Finish	OLL Price Group 1	+\$102
Tablet Edge Finish	Plastic Group 1	No cost
Arm Power / Data Node	No Power/Data Required	No cost
	2 Duplex Outlets	+\$287
	Duplex Outlet with HDMI Video Port	+\$376
	Duplex Outlet with CAT6 Data	+\$382
Power Finish	Duplex Outlet with USB Data Ports	+\$395
	Paint Price Group 01	No cost
	Paint Price Group 02	No cost

Specification Information

Style Number Base Price

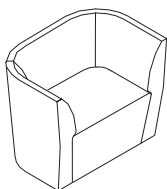

Single Seat Detached Unit

OBAD101 \$4119

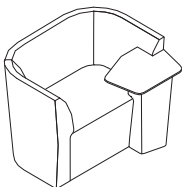

Single Seat Detached Unit with Left Hand Integrated Tablet

OBAD101LT \$6381

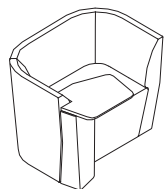

Single Seat Detached Unit with Right Hand Integrated Tablet

OBAD101RT \$6381

Away from the Desk

Detached Seating

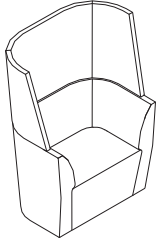

Tip: Customer's Own Material (COM) is available at a price group 1.

Standard Includes

- Fully upholstered seating unit with screen: fabric price group 01
- 1" thick integrated tablet with tapered edge, if selected:
 - High-Pressure Laminate price group 01
 - 3 mm edgeband: plastic price group 1
- Adjustable glides: black

Options

Seat Finish	Fabric Price Group 01	No cost
	Fabric Price Group 02	+\$45
	Fabric Price Group 03	+\$87
	Fabric Price Group 04	+\$150
	Fabric Price Group 05	+\$249
	Fabric Price Group 06	+\$346
	Fabric Price Group 07	+\$474
	Fabric Price Group 08	+\$586
	Fabric Price Group 09	+\$685
	Fabric Price Group 10	+\$816
Backrest Outer Finish	Fabric Price Group 01	No cost
	Fabric Price Group 02	+\$73
	Fabric Price Group 03	+\$144
	Fabric Price Group 04	+\$243
	Fabric Price Group 05	+\$403
	Fabric Price Group 06	+\$564
	Fabric Price Group 07	+\$770
	Fabric Price Group 08	+\$953
	Fabric Price Group 09	+\$1113
	Fabric Price Group 10	+\$1324
Backrest Inner Finish	Fabric Price Group 01	No cost
	Fabric Price Group 02	+\$52
	Fabric Price Group 03	+\$104
	Fabric Price Group 04	+\$174
	Fabric Price Group 05	+\$289
	Fabric Price Group 06	+\$404
	Fabric Price Group 07	+\$552
	Fabric Price Group 08	+\$683
	Fabric Price Group 09	+\$799
	Fabric Price Group 10	+\$950
Arm Finish	Fabric Price Group 01	No cost
	Fabric Price Group 02	+\$36
	Fabric Price Group 03	+\$75
	Fabric Price Group 04	+\$124
	Fabric Price Group 05	+\$206
	Fabric Price Group 06	+\$288
	Fabric Price Group 07	+\$395
	Fabric Price Group 08	+\$487
	Fabric Price Group 09	+\$571
	Fabric Price Group 10	+\$679
Tablet Top Finish	Laminate HPL Price Group 01	No cost
	Laminate HPL Price Group 02	+\$65
	Laminate HPL Price Group 03	+\$137

► **Product Information continued on next page**

Away from the Desk

Detached Seating

► **Product Information continued from previous page**

Options		
Tablet Top Finish	OLL Price Group 1	+\$102
Tablet Edge Finish	Plastic Group 1	No cost
Arm Power / Data Node	No Power/Data Required	No cost
	2 Duplex Outlets	+\$287
	Duplex Outlet with HDMI Video Port	+\$376
	Duplex Outlet with CAT6 Data	+\$382
Power Finish	Duplex Outlet with USB Data Ports	+\$395
	Paint Price Group 01	No cost
	Paint Price Group 02	No cost

Specification Information

Style Number	Base Price									
	Screen Grades:									
	1	2	3	4	5	6	7	8	9	10

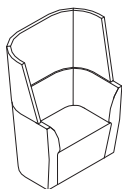

Single Seat Detached Unit with Screen

OBAD102	\$5564	\$5666	\$5769	\$5910	\$6137	\$6365	\$6661	\$6920	\$7149	\$7450
----------------	--------	--------	--------	--------	--------	--------	--------	--------	--------	--------

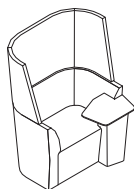

Single Seat Detached Unit with Left Hand Integrated Tablet and Screen

OBAD102LT	\$7828	\$7930	\$8033	\$8174	\$8401	\$8629	\$8925	\$9184	\$9413	\$9714
------------------	--------	--------	--------	--------	--------	--------	--------	--------	--------	--------

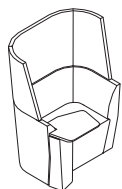

Single Seat Detached Unit with Right Hand Integrated Tablet and Screen

OBAD102RT	\$7828	\$7930	\$8033	\$8174	\$8401	\$8629	\$8925	\$9184	\$9413	\$9714
------------------	--------	--------	--------	--------	--------	--------	--------	--------	--------	--------



Away from the Desk

Detached Seating

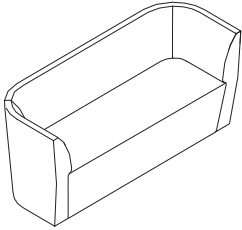

Tip: Customer's Own Material (COM) is available at a price group 1.

Standard Includes

- Fully upholstered seating unit: fabric price group 01
- 1" thick integrated tablet with tapered edge, if selected:
 - High-Pressure Laminate price group 01
 - 3 mm edgeband: plastic price group 1
- Adjustable glides: black

Options

Seat Finish	Fabric Price Group 01	No cost
	Fabric Price Group 02	+\$55
	Fabric Price Group 03	+\$111
	Fabric Price Group 04	+\$186
	Fabric Price Group 05	+\$312
	Fabric Price Group 06	+\$434
	Fabric Price Group 07	+\$593
	Fabric Price Group 08	+\$732
	Fabric Price Group 09	+\$856
	Fabric Price Group 10	+\$1020
Backrest Outer Finish	Fabric Price Group 01	No cost
	Fabric Price Group 02	+\$93
	Fabric Price Group 03	+\$189
	Fabric Price Group 04	+\$317
	Fabric Price Group 05	+\$529
	Fabric Price Group 06	+\$737
	Fabric Price Group 07	+\$1005
	Fabric Price Group 08	+\$1245
	Fabric Price Group 09	+\$1456
	Fabric Price Group 10	+\$1731
Backrest Inner Finish	Fabric Price Group 01	No cost
	Fabric Price Group 02	+\$47
	Fabric Price Group 03	+\$94
	Fabric Price Group 04	+\$159
	Fabric Price Group 05	+\$263
	Fabric Price Group 06	+\$368
	Fabric Price Group 07	+\$504
	Fabric Price Group 08	+\$622
	Fabric Price Group 09	+\$727
	Fabric Price Group 10	+\$867

Specification Information

Style Number	Base Price
Three Seat Detached Unit	
OBAD103	\$6218

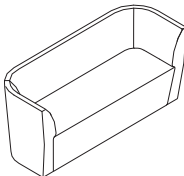

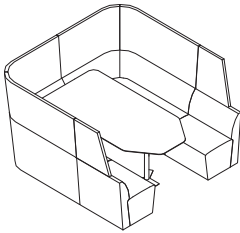
Away from the Desk**Media Dens**

Tip: Customer's Own Material (COM) is available at a price group 1.

Standard Includes

- Fully upholstered booth: fabric price group 01
- 1" thick tabletop with tapered edge:
 - High-Pressure Laminate price group 01
 - Fixed
- 3 mm edgeband: plastic price group 01
- Single table leg with foot
- Adjustable glides: black
- Linking brackets

Options

Seat Finish	Fabric Price Group 01	No cost
	Fabric Price Group 02	+\$179
	Fabric Price Group 03	+\$361
	Fabric Price Group 04	+\$606
	Fabric Price Group 05	+\$1007
	Fabric Price Group 06	+\$1408
	Fabric Price Group 07	+\$1924
	Fabric Price Group 08	+\$2382
	Fabric Price Group 09	+\$2782
	Fabric Price Group 10	+\$3313
Backrest Outer Finish	Fabric Price Group 01	No cost
	Fabric Price Group 02	+\$222
	Fabric Price Group 03	+\$449
	Fabric Price Group 04	+\$758
	Fabric Price Group 05	+\$1257
	Fabric Price Group 06	+\$1755
	Fabric Price Group 07	+\$2398
	Fabric Price Group 08	+\$2967
	Fabric Price Group 09	+\$3466
	Fabric Price Group 10	+\$4128
Backrest Inner Finish	Fabric Price Group 01	No cost
	Fabric Price Group 02	+\$120
	Fabric Price Group 03	+\$245
	Fabric Price Group 04	+\$412
	Fabric Price Group 05	+\$682
	Fabric Price Group 06	+\$954
	Fabric Price Group 07	+\$1303
	Fabric Price Group 08	+\$1613
	Fabric Price Group 09	+\$1884
	Fabric Price Group 10	+\$2242
Table Top Finish	Laminate HPL Price Group 01	No cost
	Laminate HPL Price Group 02	+\$412
	Laminate HPL Price Group 03	+\$857
	OLL Price Group 1	+\$102
Table Edge Finish	Plastic Group 1	No cost
Top Power / Data Axil	No Power/Data Required	No cost
	4 Duplex Outlets	+\$547
	2 Outlets with CAT6 & HDMI Ports	+\$626
	2 Outlets with Two CAT6 Data Ports	+\$631
	2 Outlets with CAT6 and USB Data Port	+\$650

► **Product Information continued on next page**

Away from the Desk

Media Dens

► **Product Information continued from previous page**

Options		
Power Finish	Paint Price Group 01	No cost
	Paint Price Group 02	No cost
Monitor Bracket	No Monitor Bracket Required	No cost
	Tilting Monitor Bracket	+\$311
Leg/Foot Scheme	Black Foot & Column	No cost
	Silver Foot & Column	No cost
	Black Foot Chrome Column	+\$173

Specification Information

Style Number	Base Prices									
	Screen Grades:									
	1	2	3	4	5	6	7	8	9	10

Enclosed Media Den

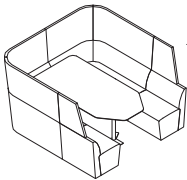

OBAD85	\$31,064	\$31,263	\$31,468	\$31,746	\$32,197	\$32,646	\$33,224	\$33,739	\$34,188	\$34,784
---------------	----------	----------	----------	----------	----------	----------	----------	----------	----------	----------

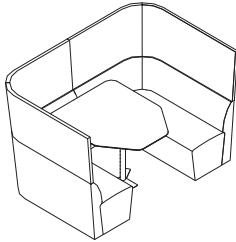
Away from the Desk**Media Dens**

Tip: Customer's Own Material (COM) is available at a price group 1.

Standard Includes

- Fully upholstered booth: fabric price group 01
- 1" thick tabletop with tapered edge:
 - High-Pressure Laminate price group 01
 - Fixed
- 3 mm edgeband: plastic price group 01
- Single table leg with foot
- Adjustable glides: black
- Linking brackets

Options

Seat Finish	Fabric Price Group 01	No cost
	Fabric Price Group 02	+\$105
	Fabric Price Group 03	+\$211
	Fabric Price Group 04	+\$356
	Fabric Price Group 05	+\$590
	Fabric Price Group 06	+\$824
	Fabric Price Group 07	+\$1126
	Fabric Price Group 08	+\$1393
	Fabric Price Group 09	+\$1625
	Fabric Price Group 10	+\$1936
Backrest Outer Finish	Fabric Price Group 01	No cost
	Fabric Price Group 02	+\$159
	Fabric Price Group 03	+\$323
	Fabric Price Group 04	+\$542
	Fabric Price Group 05	+\$899
	Fabric Price Group 06	+\$1257
	Fabric Price Group 07	+\$1718
	Fabric Price Group 08	+\$2126
	Fabric Price Group 09	+\$2484
	Fabric Price Group 10	+\$2956
Backrest Inner Finish	Fabric Price Group 01	No cost
	Fabric Price Group 02	+\$97
	Fabric Price Group 03	+\$195
	Fabric Price Group 04	+\$328
	Fabric Price Group 05	+\$543
	Fabric Price Group 06	+\$759
	Fabric Price Group 07	+\$1036
	Fabric Price Group 08	+\$1283
	Fabric Price Group 09	+\$1499
	Fabric Price Group 10	+\$1783
Table Top Finish	Laminate HPL Price Group 01	No cost
	Laminate HPL Price Group 02	+\$245
	Laminate HPL Price Group 03	+\$508
	OLL Price Group 1	+\$102
Table Edge Finish	Plastic Group 1	No cost
Top Power / Data Axil	No Power/Data Required	No cost
	4 Duplex Outlets	+\$547
	2 Outlets with CAT6 & HDMI Ports	+\$626
	2 Outlets with Two CAT6 Data Ports	+\$631
	2 Outlets with CAT6 and USB Data Port	+\$650

► **Product Information continued on next page**

Away from the Desk

Media Dens

► **Product Information continued from previous page**

Options		
Power Finish	Paint Price Group 01	No cost
	Paint Price Group 02	No cost
Monitor Bracket	No Monitor Bracket Required	No cost
	Tilting Monitor Bracket	+\$311
Leg/Foot Scheme	Black Foot & Column	No cost
	Silver Foot & Column	No cost
	Black Foot Chrome Column	+\$173

Specification Information

Style Number	Base Price									
	Screen Grades:									
	1	2	3	4	5	6	7	8	9	10

Enclosed Media Den, Four to Six People

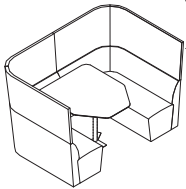

OBAD85A	\$18,829	\$18,998	\$19,172	\$19,407	\$19,790	\$20,172	\$20,665	\$21,099	\$21,482	\$21,988
----------------	----------	----------	----------	----------	----------	----------	----------	----------	----------	----------

Cubb Seating and Tables

Seating

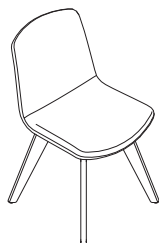

Standard Includes

- Fully upholstered armless chair: fabric price group 01
- Metal chassis: paint price group 01
- Solid oak legs: wood group 01
- Glides
- Shipped fully assembled

Options

Configuration	Upholstered	No cost
	Two Toned Upholstered	+\$41
Seat Finish	Customer's Own Leather	No cost
	Fabric Customer's Own Material	No cost
	Fabric Price Group 01	No cost
	Fabric Price Group 02	+\$28
	Vinyl Price Group 02	+\$28
	Fabric Price Group 03	+\$59
	Fabric Price Group 04	+\$100
	Fabric Price Group 05	+\$162
	Fabric Price Group 06	+\$228
	Fabric Price Group 07	+\$313
	Fabric Price Group 08	+\$385
Outer Seat Finish	Fabric Price Group 09	+\$452
	Fabric Price Group 10	+\$536
	Customer's Own Leather	No cost
	Fabric Customer's Own Material	No cost
	Fabric Price Group 01	No cost
	Fabric Price Group 02	+\$28
	Vinyl Price Group 02	+\$28
	Fabric Price Group 03	+\$59
	Fabric Price Group 04	+\$100
	Fabric Price Group 05	+\$162
	Fabric Price Group 06	+\$228
Fabric Price Group 07	+\$313	
Fabric Price Group 08	+\$385	
Fabric Price Group 09	+\$452	
Fabric Price Group 10	+\$536	
Frame Finish	Paint Price Group 01	No cost
	Paint Price Group 02	+\$27
	Paint Price Group 03	+\$44
Leg Finish	Wood	No cost

Tip: When two toned upholstered (contrasting) is selected, both seat finish and outer seat finish will need to be specified. Only a single price grade upcharge will be applied. The highest price group upcharge will be applied if multiple price groups are selected.

Specification Information

Style Number Base Price

Cubb Armless Chair with Wood Legs

OBCUBB01 \$941

Cubb Seating and Tables

Seating



Standard Includes

- Fully upholstered armchair: fabric price group 01
- Metal chassis: paint price group 01
- Solid oak legs: wood group 01
- Glides
- Shipped fully assembled

Options

Configuration	Upholstered	No cost
	Two Toned Upholstered	+\$41
Seat Finish	Customer's Own Leather	No cost
	Fabric Customer's Own Material	No cost
	Fabric Price Group 01	No cost
	Fabric Price Group 02	+\$28
	Vinyl Price Group 02	+\$28
	Fabric Price Group 03	+\$60
	Fabric Price Group 04	+\$101
	Fabric Price Group 05	+\$166
	Fabric Price Group 06	+\$234
	Fabric Price Group 07	+\$318
	Fabric Price Group 08	+\$393
Outer Seat Finish	Fabric Price Group 09	+\$460
	Fabric Price Group 10	+\$547
	Customer's Own Leather	No cost
	Fabric Customer's Own Material	No cost
	Fabric Price Group 01	No cost
	Fabric Price Group 02	+\$28
	Vinyl Price Group 02	+\$28
	Fabric Price Group 03	+\$60
	Fabric Price Group 04	+\$101
	Fabric Price Group 05	+\$166
	Fabric Price Group 06	+\$234
Fabric Price Group 07	+\$318	
Fabric Price Group 08	+\$393	
Fabric Price Group 09	+\$460	
Fabric Price Group 10	+\$547	
Frame Finish	Paint Price Group 01	No cost
	Paint Price Group 02	+\$27
	Paint Price Group 03	+\$44
Leg Finish	Wood	No cost

Tip: When two toned upholstered (contrasting) is selected, both seat finish and outer seat finish will need to be specified. Only a single price grade upcharge will be applied. The highest price group upcharge will be applied if multiple price groups are selected.

Specification Information

Style Number Base Price

Cubb Upholstered Arm Chair with Wood Legs

OBCUBB02 \$1202

Cubb Seating and Tables

Seating

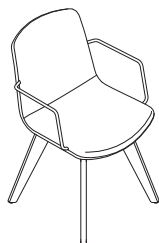

Standard Includes

- Upholstered armchair with wire arms: fabric price group 01
- Metal chassis: paint price group 01
- Solid oak legs: wood group 01
- Glides
- Shipped fully assembled

Options

Configuration	Upholstered	No cost
	Two Toned Upholstered	+\$41
Seat Finish	Customer's Own Leather	No cost
	Fabric Customer's Own Material	No cost
	Fabric Price Group 01	No cost
	Fabric Price Group 02	+\$28
	Vinyl Price Group 02	+\$28
	Fabric Price Group 03	+\$59
	Fabric Price Group 04	+\$100
	Fabric Price Group 05	+\$162
	Fabric Price Group 06	+\$228
	Fabric Price Group 07	+\$313
	Fabric Price Group 08	+\$385
Outer Seat Finish	Fabric Price Group 09	+\$452
	Fabric Price Group 10	+\$536
	Customer's Own Leather	No cost
	Fabric Customer's Own Material	No cost
	Fabric Price Group 01	No cost
	Fabric Price Group 02	+\$28
	Vinyl Price Group 02	+\$28
	Fabric Price Group 03	+\$59
	Fabric Price Group 04	+\$100
	Fabric Price Group 05	+\$162
	Fabric Price Group 06	+\$228
Fabric Price Group 07	+\$313	
Fabric Price Group 08	+\$385	
Fabric Price Group 09	+\$452	
Fabric Price Group 10	+\$536	
Frame Finish	Paint Price Group 01	No cost
	Paint Price Group 02	+\$27
	Paint Price Group 03	+\$44
Arms	Match Frame	No cost
	Polished Chrome	+\$50
Leg Finish	Wood	No cost

Tip: When two toned upholstered (contrasting) is selected, both seat finish and outer seat finish will need to be specified. Only a single price grade upcharge will be applied. The highest price group upcharge will be applied if multiple price groups are selected.

Specification Information

Style Number Base Price

Cubb Wire Arm Chair with Wood Legs

OBCUBB03 \$1053

Cubb Seating and Tables

Seating



Standard Includes

- Fully upholstered armless chair: fabric price group 01
- 4-star trestle base:
 - black
 - polished aluminum
- Glides
- Shipped fully assembled

Options

Configuration	Upholstered	No cost
	Two Toned Upholstered	+\$41
Seat Finish	Customer's Own Leather	No cost
	Fabric Customer's Own Material	No cost
	Fabric Price Group 01	No cost
	Fabric Price Group 02	+\$28
	Vinyl Price Group 02	+\$28
	Fabric Price Group 03	+\$59
	Fabric Price Group 04	+\$100
	Fabric Price Group 05	+\$162
	Fabric Price Group 06	+\$228
	Fabric Price Group 07	+\$313
Outer Seat Finish	Customer's Own Leather	No cost
	Fabric Customer's Own Material	No cost
	Fabric Price Group 01	No cost
	Fabric Price Group 02	+\$28
	Vinyl Price Group 02	+\$28
	Fabric Price Group 03	+\$59
	Fabric Price Group 04	+\$100
	Fabric Price Group 05	+\$162
	Fabric Price Group 06	+\$228
	Fabric Price Group 07	+\$313
Base Finish	Paint Price Group 01	No cost
	Polished Aluminum	No cost
Glides	Standard Glides	No cost
	Soft Glides	+\$5

Tip: When two toned upholstered (contrasting) is selected, both seat finish and outer seat finish will need to be specified. Only a single price grade upcharge will be applied. The highest price group upcharge will be applied if multiple price groups are selected.

Specification Information

Style Number Base Price

Cubb Armless Chair on 4-Star Trestle Base

OBCUBB04 \$1074

Cubb Seating and Tables

Seating



Standard Includes

- Fully upholstered armchair: fabric price group 01
- 4-star trestle base:
 - black
 - polished aluminum
- Glides
- Shipped fully assembled

Options

Configuration	Upholstered	No cost
	Two Toned Upholstered	+\$41
Seat Finish	Customer's Own Leather	No cost
	Fabric Customer's Own Material	No cost
	Fabric Price Group 01	No cost
	Fabric Price Group 02	+\$28
	Vinyl Price Group 02	+\$28
	Fabric Price Group 03	+\$60
	Fabric Price Group 04	+\$101
	Fabric Price Group 05	+\$166
	Fabric Price Group 06	+\$234
	Fabric Price Group 07	+\$318
Outer Seat Finish	Customer's Own Leather	No cost
	Fabric Customer's Own Material	No cost
	Fabric Price Group 01	No cost
	Fabric Price Group 02	+\$28
	Vinyl Price Group 02	+\$28
	Fabric Price Group 03	+\$60
	Fabric Price Group 04	+\$101
	Fabric Price Group 05	+\$166
	Fabric Price Group 06	+\$234
	Fabric Price Group 07	+\$318
Base Finish	Paint Price Group 01	No cost
	Polished Aluminum	No cost
Glides	Standard Glides	No cost
	Soft Glides	+\$5

Tip: When two toned upholstered (contrasting) is selected, both seat finish and outer seat finish will need to be specified. Only a single price grade upcharge will be applied. The highest price group upcharge will be applied if multiple price groups are selected.

Specification Information

Style Number Base Price

Cubb Upholstered Arm Chair on 4-Star Trestle Base

OBCUBB05 \$1252

Cubb Seating and Tables

Seating



Standard Includes

- Upholstered armchair with wire arms: fabric price group 01
- 4-star trestle base:
 - black
 - polished aluminum
- Glides
- Shipped fully assembled

Options

Configuration	Upholstered	No cost
	Two Toned Upholstered	+\$41
Seat Finish	Customer's Own Leather	No cost
	Fabric Customer's Own Material	No cost
	Fabric Price Group 01	No cost
	Fabric Price Group 02	+\$28
	Vinyl Price Group 02	+\$28
	Fabric Price Group 03	+\$59
	Fabric Price Group 04	+\$100
	Fabric Price Group 05	+\$162
	Fabric Price Group 06	+\$228
	Fabric Price Group 07	+\$313
Outer Seat Finish	Customer's Own Leather	No cost
	Fabric Customer's Own Material	No cost
	Fabric Price Group 01	No cost
	Fabric Price Group 02	+\$28
	Vinyl Price Group 02	+\$28
	Fabric Price Group 03	+\$59
	Fabric Price Group 04	+\$100
	Fabric Price Group 05	+\$162
	Fabric Price Group 06	+\$228
	Fabric Price Group 07	+\$313
Base Finish	Paint Price Group 01	No cost
	Polished Aluminum	No cost
Glides	Standard Glides	No cost
	Soft Glides	+\$5

Tip: When two toned upholstered (contrasting) is selected, both seat finish and outer seat finish will need to be specified. Only a single price grade upcharge will be applied. The highest price group upcharge will be applied if multiple price groups are selected.

Specification Information

Style Number Base Price

Cubb Wire Arm Chair on 4-Star Trestle Base

OBCUBB06 \$1105

Cubb Seating and Tables

Seating

Cubb Seating and Tables

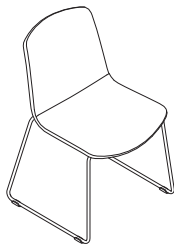

Standard Includes

- Fully upholstered armless chair: fabric price group 01
- Wire frame base: paint price group 01
- Glides
- Shipped fully assembled

Options

Configuration	Upholstered	No cost
	Two Toned Upholstered	+\$41
Seat Finish	Customer's Own Leather	No cost
	Fabric Customer's Own Material	No cost
	Fabric Price Group 01	No cost
	Fabric Price Group 02	+\$28
	Vinyl Price Group 02	+\$28
	Fabric Price Group 03	+\$59
	Fabric Price Group 04	+\$100
	Fabric Price Group 05	+\$162
	Fabric Price Group 06	+\$228
	Fabric Price Group 07	+\$313
	Fabric Price Group 08	+\$385
Outer Seat Finish	Fabric Price Group 09	+\$452
	Fabric Price Group 10	+\$536
	Customer's Own Leather	No cost
	Fabric Customer's Own Material	No cost
	Fabric Price Group 01	No cost
	Fabric Price Group 02	+\$28
	Vinyl Price Group 02	+\$28
	Fabric Price Group 03	+\$59
	Fabric Price Group 04	+\$100
	Fabric Price Group 05	+\$162
	Fabric Price Group 06	+\$228
Frame Finish	Fabric Price Group 07	+\$313
	Fabric Price Group 08	+\$385
	Fabric Price Group 09	+\$452
	Fabric Price Group 10	+\$536
Frame Finish	Paint Price Group 01	No cost
	Paint Price Group 02	+\$53
	Paint Price Group 03	+\$83
	Polished Chrome	+\$109

Tip: When two toned upholstered (contrasting) is selected, both seat finish and outer seat finish will need to be specified. Only a single price grade upcharge will be applied. The highest price group upcharge will be applied if multiple price groups are selected.

Specification Information

Style Number Base Price

Cubb Armless Chair with Wire Frame Base

OBCUBB07 \$825

Cubb Seating and Tables

Seating

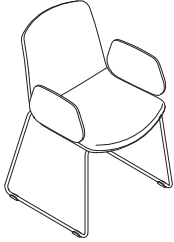

Standard Includes

- Fully upholstered armchair: fabric price group 01
- Wire frame base: paint price group 01
- Glides
- Shipped fully assembled

Options

Configuration	Upholstered	No cost
	Two Toned Upholstered	+\$41
Seat Finish	Customer's Own Leather	No cost
	Fabric Customer's Own Material	No cost
	Fabric Price Group 01	No cost
	Fabric Price Group 02	+\$28
	Vinyl Price Group 02	+\$28
	Fabric Price Group 03	+\$60
	Fabric Price Group 04	+\$101
	Fabric Price Group 05	+\$166
	Fabric Price Group 06	+\$234
	Fabric Price Group 07	+\$318
	Fabric Price Group 08	+\$393
Outer Seat Finish	Fabric Price Group 09	+\$460
	Fabric Price Group 10	+\$547
	Customer's Own Leather	No cost
	Fabric Customer's Own Material	No cost
	Fabric Price Group 01	No cost
	Fabric Price Group 02	+\$28
	Vinyl Price Group 02	+\$28
	Fabric Price Group 03	+\$60
	Fabric Price Group 04	+\$101
	Fabric Price Group 05	+\$166
	Fabric Price Group 06	+\$234
Fabric Price Group 07	+\$318	
Fabric Price Group 08	+\$393	
Fabric Price Group 09	+\$460	
Fabric Price Group 10	+\$547	
Frame Finish	Paint Price Group 01	No cost
	Paint Price Group 02	+\$53
	Paint Price Group 03	+\$83
	Polished Chrome	+\$109

Tip: When two toned upholstered (contrasting) is selected, both seat finish and outer seat finish will need to be specified. Only a single price grade upcharge will be applied. The highest price group upcharge will be applied if multiple price groups are selected.

Specification Information

Style Number Base Price

Cubb Upholstered Arm Chair with Wire Frame Base

OBCUBB08 \$1089

Cubb Seating and Tables

Seating

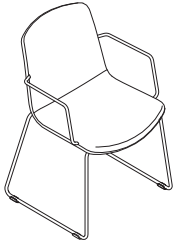

Standard Includes

- Upholstered armchair with wire arms: fabric price group 01
- Wire frame base: paint price group 01
- Glides
- Shipped fully assembled

Options

Configuration	Upholstered	No cost
	Two Toned Upholstered	+\$41
Seat Finish	Customer's Own Leather	No cost
	Fabric Customer's Own Material	No cost
	Fabric Price Group 01	No cost
	Fabric Price Group 02	+\$28
	Vinyl Price Group 02	+\$28
	Fabric Price Group 03	+\$59
	Fabric Price Group 04	+\$100
	Fabric Price Group 05	+\$162
	Fabric Price Group 06	+\$228
	Fabric Price Group 07	+\$313
	Fabric Price Group 08	+\$385
Outer Seat Finish	Fabric Price Group 09	+\$452
	Fabric Price Group 10	+\$536
	Customer's Own Leather	No cost
	Fabric Customer's Own Material	No cost
	Fabric Price Group 01	No cost
	Fabric Price Group 02	+\$28
	Vinyl Price Group 02	+\$28
	Fabric Price Group 03	+\$59
	Fabric Price Group 04	+\$100
	Fabric Price Group 05	+\$162
	Fabric Price Group 06	+\$228
Frame Finish	Fabric Price Group 07	+\$313
	Fabric Price Group 08	+\$385
	Fabric Price Group 09	+\$452
	Fabric Price Group 10	+\$536
	Paint Price Group 01	No cost
Paint Price Group 02	+\$53	
Paint Price Group 03	+\$83	
Polished Chrome	+\$109	

Tip: When two toned upholstered (contrasting) is selected, both seat finish and outer seat finish will need to be specified. Only a single price grade upcharge will be applied. The highest price group upcharge will be applied if multiple price groups are selected.

Specification Information

Style Number Base Price

Cubb Wire Arm Chair with Wire Frame Base

OBCUBB09 \$941

Cubb Seating and Tables

Seating



Standard Includes

- Fully upholstered armless chair: fabric price group 01
- 5-star base:
 - black
 - polished aluminum
- Hard casters: black
- Pneumatic seat height
- Shipped fully assembled

Options

Configuration	Upholstered	No cost
	Two Toned Upholstered	+\$41
Seat Finish	Customer's Own Leather	No cost
	Fabric Customer's Own Material	No cost
	Fabric Price Group 01	No cost
	Fabric Price Group 02	+\$28
	Vinyl Price Group 02	+\$28
	Fabric Price Group 03	+\$59
	Fabric Price Group 04	+\$100
	Fabric Price Group 05	+\$162
	Fabric Price Group 06	+\$228
	Fabric Price Group 07	+\$313
Outer Seat Finish	Customer's Own Leather	No cost
	Fabric Customer's Own Material	No cost
	Fabric Price Group 01	No cost
	Fabric Price Group 02	+\$28
	Vinyl Price Group 02	+\$28
	Fabric Price Group 03	+\$59
	Fabric Price Group 04	+\$100
	Fabric Price Group 05	+\$162
	Fabric Price Group 06	+\$228
	Fabric Price Group 07	+\$313
Base Finish	Paint Price Group 01	No cost
	Polished Aluminum	No cost
Caster Type	Hard Black Casters	No cost
	Soft Black Casters	+\$40

Tip: When two toned upholstered (contrasting) is selected, both seat finish and outer seat finish will need to be specified. Only a single price grade upcharge will be applied. The highest price group upcharge will be applied if multiple price groups are selected.

Specification Information

Style Number Base Price

Cubb Armless Chair on 5-Star Base

OBCUBB10 \$1017

Cubb Seating and Tables

Seating



Standard Includes

- Fully upholstered armchair: fabric price group 01
- 5-star base:
 - black
 - polished aluminum
- Hard casters: black
- Pneumatic seat height
- Shipped fully assembled

Options

Configuration	Upholstered	No cost
	Two Toned Upholstered	+\$41
Seat Finish	Customer's Own Leather	No cost
	Fabric Customer's Own Material	No cost
	Fabric Price Group 01	No cost
	Fabric Price Group 02	+\$28
	Vinyl Price Group 02	+\$28
	Fabric Price Group 03	+\$60
	Fabric Price Group 04	+\$101
	Fabric Price Group 05	+\$166
	Fabric Price Group 06	+\$234
	Fabric Price Group 07	+\$318
Outer Seat Finish	Customer's Own Leather	No cost
	Fabric Customer's Own Material	No cost
	Fabric Price Group 01	No cost
	Fabric Price Group 02	+\$28
	Vinyl Price Group 02	+\$28
	Fabric Price Group 03	+\$60
	Fabric Price Group 04	+\$101
	Fabric Price Group 05	+\$166
	Fabric Price Group 06	+\$234
	Fabric Price Group 07	+\$318
Base Finish	Paint Price Group 01	No cost
	Polished Aluminum	No cost
Caster Type	Hard Black Casters	No cost
	Soft Black Casters	+\$40

Tip: When two toned upholstered (contrasting) is selected, both seat finish and outer seat finish will need to be specified. Only a single price grade upcharge will be applied. The highest price group upcharge will be applied if multiple price groups are selected.

Specification Information

Style Number Base Price

Cubb Upholstered Arm Chair on 5-Star Base

OBCUBB11 \$1276

Cubb Seating and Tables

Seating



Standard Includes

- Upholstered armchair with wire arms: fabric price group 01
- 5-star base:
 - black
 - polished aluminum
- Hard casters: black
- Pneumatic seat height
- Shipped fully assembled

Options

Configuration	Upholstered	No cost
	Two Toned Upholstered	+\$41
Seat Finish	Customer's Own Leather	No cost
	Fabric Customer's Own Material	No cost
	Fabric Price Group 01	No cost
	Fabric Price Group 02	+\$28
	Vinyl Price Group 02	+\$28
	Fabric Price Group 03	+\$59
	Fabric Price Group 04	+\$100
	Fabric Price Group 05	+\$162
	Fabric Price Group 06	+\$228
	Fabric Price Group 07	+\$313
Outer Seat Finish	Customer's Own Leather	No cost
	Fabric Customer's Own Material	No cost
	Fabric Price Group 01	No cost
	Fabric Price Group 02	+\$28
	Vinyl Price Group 02	+\$28
	Fabric Price Group 03	+\$59
	Fabric Price Group 04	+\$100
	Fabric Price Group 05	+\$162
	Fabric Price Group 06	+\$228
	Fabric Price Group 07	+\$313
Base Finish	Paint Price Group 01	No cost
	Polished Aluminum	No cost
Caster Type	Hard Black Casters	No cost
	Soft Black Casters	+\$40

Tip: When two toned upholstered (contrasting) is selected, both seat finish and outer seat finish will need to be specified. Only a single price grade upcharge will be applied. The highest price group upcharge will be applied if multiple price groups are selected.

Specification Information

Style Number Base Price

Cubb Wire Arm Chair on 5-Star Base

OBCUBB12 \$1131

Cubb Seating and Tables

Seating

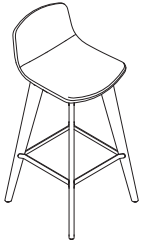

Standard Includes

- Fully upholstered barstool: fabric price group 01
- Solid oak legs: wood group 01
- Metal chassis: paint price group 01
- Glides
- Shipped fully assembled

Options

Configuration	Upholstered	No cost
	Two Toned Upholstered	+\$41
Seat Finish	Customer's Own Leather	No cost
	Fabric Customer's Own Material	No cost
	Fabric Price Group 01	No cost
	Fabric Price Group 02	+\$24
	Vinyl Price Group 02	+\$24
	Fabric Price Group 03	+\$47
	Fabric Price Group 04	+\$81
	Fabric Price Group 05	+\$134
	Fabric Price Group 06	+\$186
	Fabric Price Group 07	+\$254
	Fabric Price Group 08	+\$316
Outer Seat Finish	Fabric Price Group 09	+\$368
	Fabric Price Group 10	+\$438
	Customer's Own Leather	No cost
	Fabric Customer's Own Material	No cost
	Fabric Price Group 01	No cost
	Fabric Price Group 02	+\$24
	Vinyl Price Group 02	+\$24
	Fabric Price Group 03	+\$47
	Fabric Price Group 04	+\$81
	Fabric Price Group 05	+\$134
	Fabric Price Group 06	+\$186
Frame Finish	Fabric Price Group 07	+\$254
	Fabric Price Group 08	+\$316
	Fabric Price Group 09	+\$368
	Fabric Price Group 10	+\$438
Paint Price Group 01	Paint Price Group 01	No cost
	Paint Price Group 02	+\$27
	Paint Price Group 03	+\$44
Leg Finish	Wood	No cost

Tip: When two toned upholstered (contrasting) is selected, both seat finish and outer seat finish will need to be specified. Only a single price grade upcharge will be applied. The highest price group upcharge will be applied if multiple price groups are selected.

Specification Information

Style Number Base Price

Cubb Barstool with Oak Base

OBCUBB13 \$1100

Cubb Seating and Tables

Seating

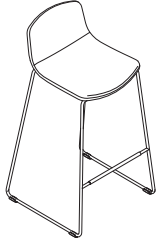

Standard Includes

- Wire frame base: paint price group 01
- Glides
- Shipped fully assembled

Options

Configuration	Upholstered	No cost
	Two Toned Upholstered	+\$41
Seat Finish	Customer's Own Leather	No cost
	Fabric Customer's Own Material	No cost
	Fabric Price Group 01	No cost
	Fabric Price Group 02	+\$24
	Vinyl Price Group 02	+\$24
	Fabric Price Group 03	+\$47
	Fabric Price Group 04	+\$81
	Fabric Price Group 05	+\$134
	Fabric Price Group 06	+\$186
	Fabric Price Group 07	+\$254
	Fabric Price Group 08	+\$316
Outer Seat Finish	Customer's Own Leather	No cost
	Fabric Customer's Own Material	No cost
	Fabric Price Group 01	No cost
	Fabric Price Group 02	+\$24
	Vinyl Price Group 02	+\$24
	Fabric Price Group 03	+\$47
	Fabric Price Group 04	+\$81
	Fabric Price Group 05	+\$134
	Fabric Price Group 06	+\$186
	Fabric Price Group 07	+\$254
	Fabric Price Group 08	+\$316
Frame Finish	Paint Price Group 01	No cost
	Paint Price Group 02	+\$53
	Paint Price Group 03	+\$83
	Polished Chrome	+\$109
Footrail Cover	No Footrail Cover	No cost
	With Footrail Cover	+\$5

Tip: When two toned upholstered (contrasting) is selected, both seat finish and outer seat finish will need to be specified. Only a single price grade upcharge will be applied. The highest price group upcharge will be applied if multiple price groups are selected.

Specification Information

Style Number Base Price

Cubb Barstool with Wire Frame Base

OBCUBB14 \$858

Cubb Seating and Tables

Seating

Cubb Seating and Tables

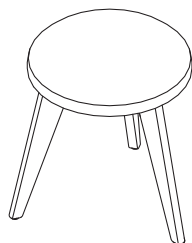

Standard Includes

- Fully upholstered occasional stool: fabric price group 01
- Solid oak legs: wood group 01
- Metal chassis: paint price group 01
- Glides
- Shipped fully assembled

Options

Seat Finish	Customer's Own Leather	No cost
	Fabric Customer's Own Material	No cost
	Fabric Price Group 01	No cost
	Fabric Price Group 02	+\$11
	Vinyl Price Group 02	+\$11
	Fabric Price Group 03	+\$26
	Fabric Price Group 04	+\$45
	Fabric Price Group 05	+\$75
	Fabric Price Group 06	+\$105
	Fabric Price Group 07	+\$141
Frame Finish	Paint Price Group 01	No cost
	Paint Price Group 02	+\$27
	Paint Price Group 03	+\$44
Leg Finish	Wood	No cost

Specification Information

Style Number Base Price

Cubb Occasional Stool with Oak Base

OBCUBB15 \$582

Cubb Seating and Tables

Seating

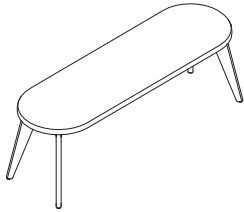

Standard Includes

- Fully upholstered bench: fabric price group 01
- Solid oak legs: wood group 01
- Metal chassis: paint price group 01
- Glides
- Shipped fully assembled

Options

Seat Finish	Customer's Own Leather	No cost
	Fabric Customer's Own Material	No cost
	Fabric Price Group 01	No cost
	Fabric Price Group 02	+\$22
	Vinyl Price Group 02	+\$22
	Fabric Price Group 03	+\$44
	Fabric Price Group 04	+\$73
	Fabric Price Group 05	+\$118
	Fabric Price Group 06	+\$165
	Fabric Price Group 07	+\$227
Frame Finish	Paint Price Group 01	No cost
	Paint Price Group 02	+\$27
	Paint Price Group 03	+\$44
Leg Finish	Wood	No cost

Specification Information

Style Number Base Price

Cubb Two Seat Bench

OBCUBB19 \$1337

Cubb Seating and Tables

Tables

Cubb Seating and Tables

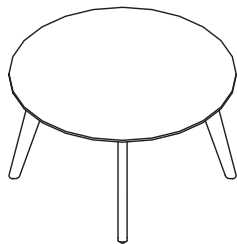

Standard Includes

- 1" thick table top: Low-Pressure Laminate price group 01
- 3 mm edgeband: plastic price group 01
- Solid oak legs: wood group 01
- Cable management channel with rubber riser inset per leg: black
- Metal chassis: paint price group 01
- Glides

Options

Top Finish	Laminate LPL Price Group 01	No cost
	Laminate HPL Price Group 01	+\$481
	Laminate HPL Price Group 02	+\$794
	Laminate HPL Price Group 03	+\$1397
	OLL Price Group 1	+\$102
Edge Finish	Plastic Group 1	No cost
Leg Finish	Wood	No cost
Frame Finish	Paint Price Group 01	No cost
	Paint Price Group 02	+\$55
	Paint Price Group 03	+\$111
Power Option	No Power	No cost
	Node 201 - 2 Power	+\$274
	Node 204 - 1 Power, 1 USB	+\$375
Power Location	Center Only	No cost
Plug or Hardwire	Hardwire	No cost
	Plug	No cost
Power Finish	Paint Price Group 01	No cost
	Paint Price Group 02	No cost
Cable Clips	No Cable Clips	No cost
	Cable Clips	+\$49
Umbilical Cable Riser	No Cable Riser	No cost
	Umbilical Cable Riser	+\$209

Specification Information

Style Number Base Price

Cubb Four Person Round Meeting Table

OBCUBBRDM01 \$2420

Cubb Seating and Tables

Tables

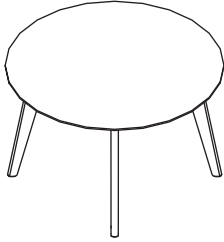

Standard Includes

- 1" thick table top: Low-Pressure Laminate price group 01
- 3 mm edgeband: plastic price group 01
- Solid oak legs: wood group 01
- Cable management channel with rubber riser inset per leg: black
- Metal chassis: paint price group 01
- Glides

Options

Top Finish	Laminate LPL Price Group 01	No cost
	Laminate HPL Price Group 01	+\$505
	Laminate HPL Price Group 02	+\$832
	Laminate HPL Price Group 03	+\$1464
	OLL Price Group 1	+\$102
Edge Finish	Plastic Group 1	No cost
Leg Finish	Wood	No cost
Frame Finish	Paint Price Group 01	No cost
	Paint Price Group 02	+\$55
	Paint Price Group 03	+\$111
Power Option	No Power	No cost
	Node 201 - 2 Power	+\$274
	Node 204 - 1 Power, 1 USB	+\$375
Power Location	Center Only	No cost
Plug or Hardwire	Hardwire	No cost
	Plug	No cost
Power Finish	Paint Price Group 01	No cost
	Paint Price Group 02	No cost
Cable Clips	No Cable Clips	No cost
	Cable Clips	+\$49
Umbilical Cable Riser	No Cable Riser	No cost
	Umbilical Cable Riser	+\$209

Specification Information

Style Number Base Price

Cubb Six Person Round Meeting Table

OBCUBBRDM02 \$2539

Cubb Seating and Tables

Tables

Cubb Seating and Tables

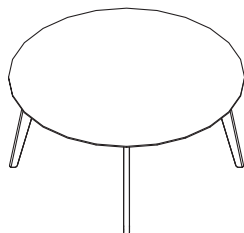

Standard Includes

- 1" thick table top: Low-Pressure Laminate price group 01
- 3 mm edgeband: plastic price group 01
- Solid oak legs: wood group 01
- Cable management channel with rubber riser inset per leg: black
- Metal chassis: paint price group 01
- Glides

Options

Top Finish	Laminate LPL Price Group 01	No cost
	Laminate HPL Price Group 01	+\$585
	Laminate HPL Price Group 02	+\$964
	Laminate HPL Price Group 03	+\$1697
	OLL Price Group 1	+\$102
Edge Finish	Plastic Group 1	No cost
Leg Finish	Wood	No cost
Frame Finish	Paint Price Group 01	No cost
	Paint Price Group 02	+\$55
	Paint Price Group 03	+\$111
Power Option	No Power	No cost
	Node 201 - 2 Power	+\$274
	Node 204 - 1 Power, 1 USB	+\$375
Power Location	Center Only	No cost
Plug or Hardwire	Hardwire	No cost
	Plug	No cost
Power Finish	Paint Price Group 01	No cost
	Paint Price Group 02	No cost
Cable Clips	No Cable Clips	No cost
	Cable Clips	+\$49
Umbilical Cable Riser	No Cable Riser	No cost
	Umbilical Cable Riser	+\$209

Specification Information

Style Number	Base Price
--------------	------------

Cubb Seven Person Round Meeting Table

OBCUBBRDM03 \$2938

Cubb Seating and Tables

Tables

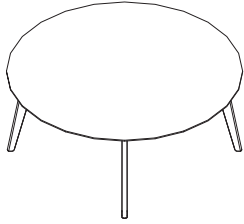

Standard Includes

- 1" thick table top: Low-Pressure Laminate price group 01
- 3 mm edgeband: plastic price group 01
- Solid oak legs: wood group 01
- Cable management channel with rubber riser inset per leg: black
- Metal chassis: paint price group 01
- Glides

Options

Top Finish	Laminate LPL Price Group 01	No cost
	Laminate HPL Price Group 01	+\$589
	Laminate HPL Price Group 02	+\$970
	Laminate HPL Price Group 03	+\$1707
	OLL Price Group 1	+\$102
Edge Finish	Plastic Group 1	No cost
Leg Finish	Wood	No cost
Frame Finish	Paint Price Group 01	No cost
	Paint Price Group 02	+\$55
	Paint Price Group 03	+\$111
Power Option	No Power	No cost
	Node 201 - 2 Power	+\$274
	Node 204 - 1 Power, 1 USB	+\$375
Power Location	Center Only	No cost
Plug or Hardwire	Hardwire	No cost
	Plug	No cost
Power Finish	Paint Price Group 01	No cost
	Paint Price Group 02	No cost
Cable Clips	No Cable Clips	No cost
	Cable Clips	+\$49
Umbilical Cable Riser	No Cable Riser	No cost
	Umbilical Cable Riser	+\$209

Specification Information

Style Number Base Price

Cubb Eight Person Round Meeting Table

OBCUBBRDM04 \$2963

Cubb Seating and Tables

Tables

Cubb Seating and Tables

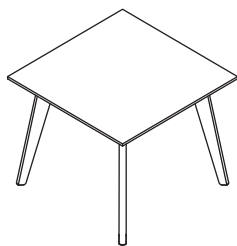

Standard Includes

- 1" thick table top: Low-Pressure Laminate price group 01
- 3 mm edgeband: plastic price group 01
- Solid oak legs: wood group 01
- Cable management channel with rubber riser inset per leg: black
- Metal chassis: paint price group 01
- Glides

Options

Top Finish	Laminate LPL Price Group 01	No cost
	Laminate HPL Price Group 01	+\$461
	Laminate HPL Price Group 02	+\$762
	Laminate HPL Price Group 03	+\$1341
	OLL Price Group 1	+\$102
Edge Finish	Plastic Group 1	No cost
Leg Finish	Wood	No cost
Frame Finish	Paint Price Group 01	No cost
	Paint Price Group 02	+\$55
	Paint Price Group 03	+\$111
Power Option	No Power	No cost
	Dean Z 201 - 2 Power	+\$281
	Dean Z 202 - 1 Power, 1 USB	+\$391
Power Location	Center Only	No cost
Plug or Hardwire	Hardwire	No cost
	Plug	No cost
Power Finish	Paint Price Group 01	No cost
	Paint Price Group 02	No cost
Cable Clips	No Cable Clips	No cost
	Cable Clips	+\$49
Umbilical Cable Riser	No Cable Riser	No cost
	Umbilical Cable Riser	+\$209

Specification Information

Style Number Base Price

Cubb Four Person Square Meeting Table

OBCUBBSQM01 \$2323

Cubb Seating and Tables

Tables

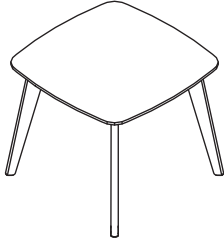

Standard Includes

- 1" thick table top: Low-Pressure Laminate price group 01
- 3 mm edgeband: plastic price group 01
- Solid oak legs: wood group 01
- Cable management channel with rubber riser inset per leg: black
- Metal chassis: paint price group 01
- Glides

Options

Top Finish	Laminate LPL Price Group 01	No cost
	Laminate HPL Price Group 01	+\$467
	Laminate HPL Price Group 02	+\$774
	Laminate HPL Price Group 03	+\$1360
	OLL Price Group 1	+\$102
Edge Finish	Plastic Group 1	No cost
Leg Finish	Wood	No cost
Frame Finish	Paint Price Group 01	No cost
	Paint Price Group 02	+\$55
	Paint Price Group 03	+\$111
Power Option	No Power	No cost
	Dean Z 201 - 2 Power	+\$281
	Dean Z 202 - 1 Power, 1 USB	+\$391
Power Location	Center Only	No cost
Plug or Hardwire	Hardwire	No cost
	Plug	No cost
Power Finish	Paint Price Group 01	No cost
	Paint Price Group 02	No cost
Cable Clips	No Cable Clips	No cost
	Cable Clips	+\$49
Umbilical Cable Riser	No Cable Riser	No cost
	Umbilical Cable Riser	+\$209

Specification Information

Style Number Base Price

Cubb Four Person Square Meeting Table with Softened Corners

OBCUBBSSM01 \$2360

Cubb Seating and Tables

Tables

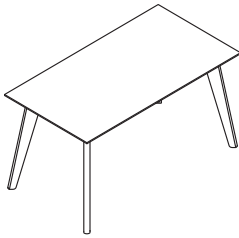

Standard Includes

- 1" thick table top: Low-Pressure Laminate price group 01
- 3 mm edgeband: plastic price group 01
- Solid oak legs: wood group 01
- Cable management channel with rubber riser inset per leg: black
- Metal chassis: paint price group 01
- Glides

Options

Top Finish	Laminate LPL Price Group 01	No cost
	Laminate HPL Price Group 01	+\$459
	Laminate HPL Price Group 02	+\$755
	Laminate HPL Price Group 03	+\$1329
	OLL Price Group 1	+\$102
Edge Finish	Plastic Group 1	No cost
Leg Finish	Wood	No cost
Frame Finish	Paint Price Group 01	No cost
	Paint Price Group 02	+\$55
	Paint Price Group 03	+\$111
Power Option	No Power	No cost
	Dean Z 201 - 2 Power	+\$281
	Dean Z 202 - 1 Power, 1 USB	+\$391
	Dean Z 401 - 3 Power, 1 USB	+\$437
	Dean Z 402 - 2 Power, 2 USB	+\$544
	Dean Z 501 - 3 Power, 1 USB-C	+\$670
Power Location	Center Only	No cost
Plug or Hardwire	Hardwire	No cost
	Plug	No cost
Power Finish	Paint Price Group 01	No cost
	Paint Price Group 02	No cost
Cable Clips	No Cable Clips	No cost
	Cable Clips	+\$49
Umbilical Cable Riser	No Cable Riser	No cost
	Umbilical Cable Riser	+\$209

Specification Information

Style Number	Base Price
--------------	------------

Cubb Four Person Rectangle Meeting Table

OBCUBBRM01	\$2305
-------------------	--------

Cubb Seating and Tables

Tables

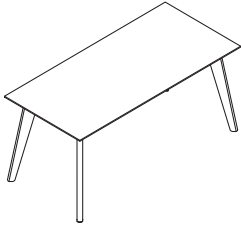

Standard Includes

- 1" thick table top: Low-Pressure Laminate price group 01
- 3 mm edgeband: plastic price group 01
- Solid oak legs: wood group 01
- Cable management channel with rubber riser inset per leg: black
- Metal chassis: paint price group 01
- Glides

Options

Top Finish	Laminate LPL Price Group 01	No cost
	Laminate HPL Price Group 01	+\$475
	Laminate HPL Price Group 02	+\$784
	Laminate HPL Price Group 03	+\$1380
	OLL Price Group 1	+\$102
Edge Finish	Plastic Group 1	No cost
Leg Finish	Wood	No cost
Frame Finish	Paint Price Group 01	No cost
	Paint Price Group 02	+\$55
	Paint Price Group 03	+\$111
Power Option	No Power	No cost
	Dean Z 201 - 2 Power	+\$281
	Dean Z 202 - 1 Power, 1 USB	+\$391
	Dean Z 401 - 3 Power, 1 USB	+\$437
	Dean Z 402 - 2 Power, 2 USB	+\$544
	Dean Z 501 - 3 Power, 1 USB-C	+\$670
Power Location	Center Only	No cost
Plug or Hardwire	Hardwire	No cost
	Plug	No cost
Power Finish	Paint Price Group 01	No cost
	Paint Price Group 02	No cost
Cable Clips	No Cable Clips	No cost
	Cable Clips	+\$49
Umbilical Cable Riser	No Cable Riser	No cost
	Umbilical Cable Riser	+\$209

Specification Information

Style Number Base Price

Cubb Four to Six Person Rectangle Meeting Table

OBCUBBRM02 \$2387

Cubb Seating and Tables

Tables

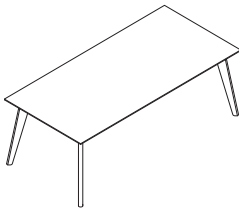

Standard Includes

- 1" thick table top: Low-Pressure Laminate price group 01
- 3 mm edgeband: plastic price group 01
- Solid oak legs: wood group 01
- Cable management channel with rubber riser inset per leg: black
- Metal chassis: paint price group 01
- Glides

Options

Top Finish	Laminate LPL Price Group 01	No cost
	Laminate HPL Price Group 01	+\$514
	Laminate HPL Price Group 02	+\$850
	Laminate HPL Price Group 03	+\$1497
	OLL Price Group 1	+\$102
Edge Finish	Plastic Group 1	No cost
Leg Finish	Wood	No cost
Frame Finish	Paint Price Group 01	No cost
	Paint Price Group 02	+\$55
	Paint Price Group 03	+\$111
Power Option	No Power	No cost
	Dean Z 201 - 2 Power	+\$281
	Dean Z 202 - 1 Power, 1 USB	+\$391
	Dean Z 401 - 3 Power, 1 USB	+\$437
	Dean Z 402 - 2 Power, 2 USB	+\$544
	Dean Z 501 - 3 Power, 1 USB-C	+\$670
Power Location	Center Only	No cost
	Left & Right	No cost
	Left Only	No cost
	Left and center	No cost
	Left, Right and center	No cost
	Right Only	No cost
	Right and center	No cost
Plug or Hardwire	Hardwire	No cost
	Plug	No cost
Power Finish	Paint Price Group 01	No cost
	Paint Price Group 02	No cost
Cable Clips	No Cable Clips	No cost
	Cable Clips	+\$49
Umbilical Cable Riser	No Cable Riser	No cost
	Umbilical Cable Riser	+\$209

Specification Information

Style Number Base Price

Cubb Six to Eight Person Rectangle Meeting Table

OBCUBBRCM03 \$2592

Cubb Seating and Tables

Tables

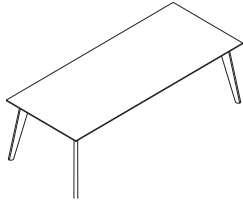

Standard Includes

- 1" thick table top: Low-Pressure Laminate price group 01
- 3 mm edgeband: plastic price group 01
- Solid oak legs: wood group 01
- Cable management channel with rubber riser inset per leg: black
- Metal chassis: paint price group 01
- Glides

Options

Top Finish	Laminate LPL Price Group 01	No cost
	Laminate HPL Price Group 01	+\$534
	Laminate HPL Price Group 02	+\$876
	Laminate HPL Price Group 03	+\$1542
	OLL Price Group 1	+\$102
Edge Finish	Plastic Group 1	No cost
Leg Finish	Wood	No cost
Frame Finish	Paint Price Group 01	No cost
	Paint Price Group 02	+\$55
	Paint Price Group 03	+\$111
Power Option	No Power	No cost
	Dean Z 201 - 2 Power	+\$281
	Dean Z 202 - 1 Power, 1 USB	+\$391
	Dean Z 401 - 3 Power, 1 USB	+\$437
	Dean Z 402 - 2 Power, 2 USB	+\$544
	Dean Z 501 - 3 Power, 1 USB-C	+\$670
Power Location	Center Only	No cost
	Left & Right	No cost
	Left Only	No cost
	Left and center	No cost
	Left, Right and center	No cost
	Right Only	No cost
	Right and center	No cost
Plug or Hardwire	Hardwire	No cost
	Plug	No cost
Power Finish	Paint Price Group 01	No cost
	Paint Price Group 02	No cost
Cable Clips	No Cable Clips	No cost
	Cable Clips	+\$49
Umbilical Cable Riser	No Cable Riser	No cost
	Umbilical Cable Riser	+\$209

Specification Information

Style Number	Base Price
OBCUBBRCM04	\$2672

Cubb Eight Person Rectangle Meeting Table

Cubb Seating and Tables

Tables

Cubb Seating and Tables

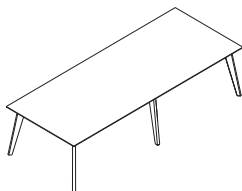

Standard Includes

- 1" thick table top: Low-Pressure Laminate price group 01
- 3 mm edgeband: plastic price group 01
- Solid oak legs: wood group 01
- Cable management channel with rubber riser inset per leg: black
- Metal chassis: paint price group 01
- Glides

Options

Top Finish	Laminate LPL Price Group 01	No cost
	Laminate HPL Price Group 01	+\$948
	Laminate HPL Price Group 02	+\$1565
	Laminate HPL Price Group 03	+\$2754
	OLL Price Group 1	+\$102
Edge Finish	Plastic Group 1	No cost
Leg Finish	Wood	No cost
Frame Finish	Paint Price Group 01	No cost
	Paint Price Group 02	+\$55
	Paint Price Group 03	+\$111
Power Option	No Power	No cost
	Dean Z 201 - 2 Power	+\$281
	Dean Z 202 - 1 Power, 1 USB	+\$391
	Dean Z 401 - 3 Power, 1 USB	+\$437
	Dean Z 402 - 2 Power, 2 USB	+\$544
	Dean Z 501 - 3 Power, 1 USB-C	+\$670
Power Location	Left & Right	No cost
	Left Only	No cost
	Right Only	No cost
Plug or Hardwire	Hardwire	No cost
	Plug	No cost
Power Finish	Paint Price Group 01	No cost
	Paint Price Group 02	No cost
Cable Clips	No Cable Clips	No cost
	Cable Clips	+\$49
Umbilical Cable Riser	No Cable Riser	No cost
	Umbilical Cable Riser	+\$209

Specification Information

Style Number	Base Price
--------------	------------

Cubb 47" D Eight to Ten Person Rectangle Meeting Table

OBCUBBRCM05	\$4774
--------------------	--------

Cubb Seating and Tables

Tables

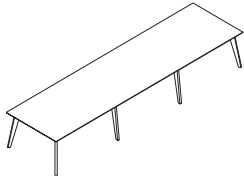

Standard Includes

- 1" thick table top: Low-Pressure Laminate price group 01
- 3 mm edgeband: plastic price group 01
- Solid oak legs: wood group 01
- Cable management channel with rubber riser inset per leg: black
- Metal chassis: paint price group 01
- Glides

Options

Top Finish	Laminate LPL Price Group 01	No cost
	Laminate HPL Price Group 01	+\$1366
	Laminate HPL Price Group 02	+\$2251
	Laminate HPL Price Group 03	+\$3965
	OLL Price Group 1	+\$102
Edge Finish	Plastic Group 1	No cost
Leg Finish	Wood	No cost
Frame Finish	Paint Price Group 01	No cost
	Paint Price Group 02	+\$55
	Paint Price Group 03	+\$111
Power Option	No Power	No cost
	Dean Z 201 - 2 Power	+\$281
	Dean Z 202 - 1 Power, 1 USB	+\$391
	Dean Z 401 - 3 Power, 1 USB	+\$437
	Dean Z 402 - 2 Power, 2 USB	+\$544
	Dean Z 501 - 3 Power, 1 USB-C	+\$670
Power Location	Center Only	No cost
	Left & Right	No cost
	Left Only	No cost
	Left and center	No cost
	Left, Right and center	No cost
	Right Only	No cost
	Right and center	No cost
Plug or Hardwire	Hardwire	No cost
	Plug	No cost
Power Finish	Paint Price Group 01	No cost
	Paint Price Group 02	No cost
Cable Clips	No Cable Clips	No cost
	Cable Clips	+\$49
Umbilical Cable Riser	No Cable Riser	No cost
	Umbilical Cable Riser	+\$209

Specification Information

Style Number Base Price

Cubb 47" D 12 to 14 Person Rectangle Meeting Table

OBCUBBRCM07 \$6870

Cubb Seating and Tables

Tables

Cubb Seating and Tables

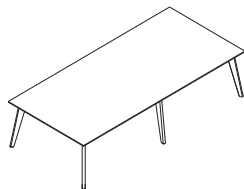

Standard Includes

- 1" thick table top: Low-Pressure Laminate price group 01
- 3 mm edgeband: plastic price group 01
- Solid oak legs: wood group 01
- Cable management channel with rubber riser inset per leg: black
- Metal chassis: paint price group 01
- Glides

Options

Top Finish	Laminate LPL Price Group 01	No cost
	Laminate HPL Price Group 01	+\$1030
	Laminate HPL Price Group 02	+\$1701
	Laminate HPL Price Group 03	+\$2993
	OLL Price Group 1	+\$102
Edge Finish	Plastic Group 1	No cost
Leg Finish	Wood	No cost
Frame Finish	Paint Price Group 01	No cost
	Paint Price Group 02	+\$55
	Paint Price Group 03	+\$111
Power Option	No Power	No cost
	Dean Z 201 - 2 Power	+\$281
	Dean Z 202 - 1 Power, 1 USB	+\$391
	Dean Z 401 - 3 Power, 1 USB	+\$437
	Dean Z 402 - 2 Power, 2 USB	+\$544
	Dean Z 501 - 3 Power, 1 USB-C	+\$670
Power Location	Left & Right	No cost
	Left Only	No cost
	Right Only	No cost
Plug or Hardwire	Hardwire	No cost
	Plug	No cost
Power Finish	Paint Price Group 01	No cost
	Paint Price Group 02	No cost
Cable Clips	No Cable Clips	No cost
	Cable Clips	+\$49
Umbilical Cable Riser	No Cable Riser	No cost
	Umbilical Cable Riser	+\$209

Specification Information

Style Number	Base Price
--------------	------------

Cubb 55" D Eight to Ten Person Rectangle Meeting Table

OBCUBBRM09	\$5189
-------------------	--------

Cubb Seating and Tables

Tables

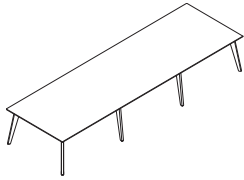

Standard Includes

- 1" thick table top: Low-Pressure Laminate price group 01
- 3 mm edgeband: plastic price group 01
- Solid oak legs: wood group 01
- Cable management channel with rubber riser inset per leg: black
- Metal chassis: paint price group 01
- Glides

Options

Top Finish	Laminate LPL Price Group 01	No cost
	Laminate HPL Price Group 01	+\$1450
	Laminate HPL Price Group 02	+\$2391
	Laminate HPL Price Group 03	+\$4207
	OLL Price Group 1	+\$102
Edge Finish	Plastic Group 1	No cost
Leg Finish	Wood	No cost
Frame Finish	Paint Price Group 01	No cost
	Paint Price Group 02	+\$55
	Paint Price Group 03	+\$111
Power Option	No Power	No cost
	Dean Z 201 - 2 Power	+\$281
	Dean Z 202 - 1 Power, 1 USB	+\$391
	Dean Z 401 - 3 Power, 1 USB	+\$437
	Dean Z 402 - 2 Power, 2 USB	+\$544
	Dean Z 501 - 3 Power, 1 USB-C	+\$670
Power Location	Center Only	No cost
	Left & Right	No cost
	Left Only	No cost
	Left and center	No cost
	Left, Right and center	No cost
	Right Only	No cost
	Right and center	No cost
Plug or Hardwire	Hardwire	No cost
	Plug	No cost
Power Finish	Paint Price Group 01	No cost
	Paint Price Group 02	No cost
Cable Clips	No Cable Clips	No cost
	Cable Clips	+\$49
Umbilical Cable Riser	No Cable Riser	No cost
	Umbilical Cable Riser	+\$209

Specification Information

Style Number Base Price

Cubb 55" D 12 to 14 Person Rectangle Meeting Table

OBCUBBRCM11 \$7301

Cubb Seating and Tables

Tables

Cubb Seating and Tables

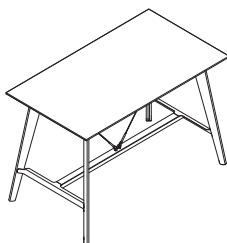

Standard Includes

- 1" thick table top: Low-Pressure Laminate price group 01
- 3 mm edgeband: plastic price group 01
- Solid oak legs: wood group 01
- Cable management channel with rubber riser inset per leg: black
- Metal chassis and beam: paint price group 01
- Two structural cable attachments with hardware
- Glides

Options

Top Finish	Laminate LPL Price Group 01	No cost
	Laminate HPL Price Group 01	+\$822
	Laminate HPL Price Group 02	+\$1357
	Laminate HPL Price Group 03	+\$2394
	OLL Price Group 1	+\$102
Edge Finish	Plastic Group 1	No cost
Leg Finish	Wood	No cost
Frame Finish	Paint Price Group 01	No cost
	Paint Price Group 02	+\$111
	Paint Price Group 03	+\$222
Power Option	No Power	No cost
	Dean Z 201 - 2 Power	+\$281
	Dean Z 202 - 1 Power, 1 USB	+\$391
	Dean Z 401 - 3 Power, 1 USB	+\$437
	Dean Z 402 - 2 Power, 2 USB	+\$544
	Dean Z 501 - 3 Power, 1 USB-C	+\$670
Power Location	Center Only	No cost
Plug or Hardwire	Hardwire	No cost
	Plug	No cost
Power Finish	Paint Price Group 01	No cost
	Paint Price Group 02	No cost
Cable Clips	No Cable Clips	No cost
	Cable Clips	+\$49

Specification Information

Style Number	Base Price
Cubb Four to Six Person Standing Height Project Table	
OBCUBBRCP01	\$4140

Cubb Seating and Tables

Tables



Standard Includes

- 1" thick table top: Low-Pressure Laminate price group 01
- 3 mm edgeband: plastic price group 01
- Solid oak legs: wood group 01
- Cable management channel with rubber riser inset per leg: black
- Metal chassis and beam: paint price group 01
- Two structural cable attachments with hardware
- Glides

Options

Top Finish	Laminate LPL Price Group 01	No cost
	Laminate HPL Price Group 01	+\$857
	Laminate HPL Price Group 02	+\$1414
	Laminate HPL Price Group 03	+\$2488
	OLL Price Group 1	+\$102
Edge Finish	Plastic Group 1	No cost
Leg Finish	Wood	No cost
Frame Finish	Paint Price Group 01	No cost
	Paint Price Group 02	+\$111
	Paint Price Group 03	+\$222
Power Option	No Power	No cost
	Dean Z 201 - 2 Power	+\$281
	Dean Z 202 - 1 Power, 1 USB	+\$391
	Dean Z 401 - 3 Power, 1 USB	+\$437
	Dean Z 402 - 2 Power, 2 USB	+\$544
	Dean Z 501 - 3 Power, 1 USB-C	+\$670
Power Location	Center Only	No cost
	Left & Right	No cost
	Left Only	No cost
	Left and center	No cost
	Left, Right and center	No cost
	Right Only	No cost
	Right and center	No cost
Plug or Hardwire	Hardwire	No cost
	Plug	No cost
Power Finish	Paint Price Group 01	No cost
	Paint Price Group 02	No cost
Cable Clips	No Cable Clips	No cost
	Cable Clips	+\$49

Specification Information

Style Number Base Price

Cubb Six to Eight Person Standing Height Project Table

OBCUBBRCP02 \$4310

Cubb Seating and Tables

Tables

Cubb Seating and Tables

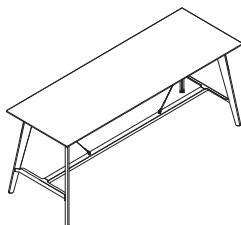

Tip: OBCUBBRCP03 is unavailable in LPL due to manufacturing restrictions related to the single-piece worksurface size.

Standard Includes

- 1" thick table top: Low-Pressure Laminate price group 01
- 3 mm edgeband: plastic price group 01
- Solid oak legs: wood group 01
- Cable management channel with rubber riser inset per leg: black
- Metal chassis and beam: paint price group 01
- Two structural cable attachments with hardware
- Glides

Options

Top Finish	Laminate HPL Price Group 01	+\$882
	Laminate HPL Price Group 02	+\$1457
	Laminate HPL Price Group 03	+\$2566
	OLL Price Group 1	+\$102
Edge Finish	Plastic Group 1	No cost
Leg Finish	Wood	No cost
Frame Finish	Paint Price Group 01	No cost
	Paint Price Group 02	+\$111
	Paint Price Group 03	+\$222
Power Option	No Power	No cost
	Dean Z 201 - 2 Power	+\$281
	Dean Z 202 - 1 Power, 1 USB	+\$391
	Dean Z 401 - 3 Power, 1 USB	+\$437
	Dean Z 402 - 2 Power, 2 USB	+\$544
	Dean Z 501 - 3 Power, 1 USB-C	+\$670
Power Location	Center Only	No cost
	Left & Right	No cost
	Left Only	No cost
	Left and center	No cost
	Left, Right and center	No cost
	Right Only	No cost
	Right and center	No cost
Plug or Hardwire	Hardwire	No cost
	Plug	No cost
Power Finish	Paint Price Group 01	No cost
	Paint Price Group 02	No cost
Cable Clips	No Cable Clips	No cost
	Cable Clips	+\$49

Specification Information

Style Number	Base Price
--------------	------------

Cubb Eight to Ten Person Standing Height Project Table

OBCUBBRCP03 \$4442

Cubb Seating and Tables

Tables



Standard Includes

- 1" thick table top: Low-Pressure Laminate price group 01
- 3 mm edgeband: plastic price group 01
- Solid oak legs: wood group 01
- Metal chassis: paint price group 01
- Glides

Options

Top Finish	Laminate LPL Price Group 01	No cost
	Laminate HPL Price Group 01	+\$313
	Laminate HPL Price Group 02	+\$513
	Laminate HPL Price Group 03	+\$901
	OLL Price Group 1	+\$102
Edge Finish	Plastic Group 1	No cost
Leg Finish	Wood	No cost
Frame Finish	Paint Price Group 01	No cost
	Paint Price Group 02	+\$55
	Paint Price Group 03	+\$111

Specification Information

Style Number Base Price

Cubb 23 5/8" W Round Occasional Table

OBCUBBRD001 \$1569

Cubb Seating and Tables

Tables

Cubb Seating and Tables

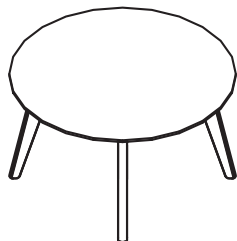

Standard Includes

- 1" thick table top: Low-Pressure Laminate price group 01
- 3 mm edgeband: plastic price group 01
- Solid oak legs: wood group 01
- Metal chassis: paint price group 01
- Glides

Options

Top Finish	Laminate LPL Price Group 01	No cost
	Laminate HPL Price Group 01	+\$359
	Laminate HPL Price Group 02	+\$592
	Laminate HPL Price Group 03	+\$1041
	OLL Price Group 1	+\$102
Edge Finish	Plastic Group 1	No cost
Leg Finish	Wood	No cost
Frame Finish	Paint Price Group 01	No cost
	Paint Price Group 02	+\$55
	Paint Price Group 03	+\$111

Specification Information

Style Number	Base Price
Cubb 31" W Round Occasional Table	
OBCUBBRD002	\$1804

Cubb Seating and Tables

Tables

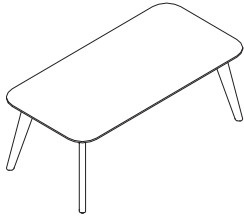

Standard Includes

- 1" thick table top: Low-Pressure Laminate price group 01
- 3 mm edgeband: plastic price group 01
- Solid oak legs: wood group 01
- Metal chassis: paint price group 01
- Glides

Options

Top Finish	Laminate LPL Price Group 01	No cost
	Laminate HPL Price Group 01	+\$380
	Laminate HPL Price Group 02	+\$628
	Laminate HPL Price Group 03	+\$1107
	OLL Price Group 1	+\$102
Edge Finish	Plastic Group 1	No cost
Leg Finish	Wood	No cost
Frame Finish	Paint Price Group 01	No cost
	Paint Price Group 02	+\$55
	Paint Price Group 03	+\$111

Specification Information

Style Number Base Price

Cubb Rectangle Occasional Table

OBCUBBRC001 \$1923

Cubb Seating and Tables

Tables

Cubb Seating and Tables

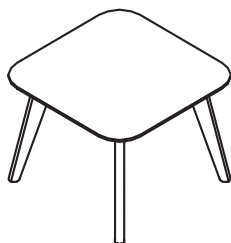

Standard Includes

- 1" thick table top: Low-Pressure Laminate price group 01
- 3 mm edgeband: plastic price group 01
- Solid oak legs: wood group 01
- Metal chassis: paint price group 01
- Glides

Options

Top Finish	Laminate LPL Price Group 01	No cost
	Laminate HPL Price Group 01	+\$320
	Laminate HPL Price Group 02	+\$530
	Laminate HPL Price Group 03	+\$930
	OLL Price Group 1	+\$102
Edge Finish	Plastic Group 1	No cost
Leg Finish	Wood	No cost
Frame Finish	Paint Price Group 01	No cost
	Paint Price Group 02	+\$55
	Paint Price Group 03	+\$111

Specification Information

Style Number	Base Price
OBCUBBSQ001	\$1615

Cubb Square Occasional Table

Style Number Index

Style Number	Page	Description
OB1AIR23	43	Air ³ ; Half-Sq, Opening roof
OB1AIR25	45	Air ³ ; Sq, Opening roof
OB1AIR27	47	Air ³ ; Rect, Opening roof
OB1AIR29	49	Air ³ ; Sq-3x3, Opening roof
OB1AIR30	50	Air ³ ; Pod table-Small
OB1AIR35	50	Air ³ ; Pod table-Short, Str
OB1AIRGA151	51	Magnetic-Whiteboard, Glass, Str
OB1AIRGA153US	51	Monitor bracket-Hoop mounted
OB1AIRGA174US	51	Monitor bracket-Over upholster
OB1AIRGA176	52	Air25 Pod Seismic Kit
OB1AIRGA180	52	Air23 Pod Seismic Kit
OB1AIRGA181	52	Air27 Pod Seismic Kit
OB1AIRGA204	52	Air29 Pod Seismic Kit
OB1AIRINSTALL1	51	Air ³ Installation Training-1 to 5 units
OB1AIRINSTALL2	51	Air ³ Installation Training-6 to 10 units
OB1AIRINSTALL3	51	Air ³ Installation Training-11+ units
OB1QT01	55	Short Angled Phone Booth, LH
OB1QT02	55	Short Angled Phone Booth, RH
OB1QT03	58	Tall Angled Phone Booth, LH
OB1QT04	58	Tall Angled Phone Booth, RH
OB1QTF01	60	Furniture Seat, LH
OB1QTF02	60	Furniture Seat, RH
OBAD01	93	Str Seat-Mod, 31 ¹ / ₂ "W
OBAD02	95	Str Seat-Mod, Back, 31 ¹ / ₂ "W
OBAD03	98	Str Seat-Mod, Back, Scr, 31 ¹ / ₂ "W
OBAD03LC	98	Str seat-Back, LH, Tprd Scr, 31 ¹ / ₂ "W
OBAD03RC	98	Str seat-Back, RH, Tprd Scr, 31 ¹ / ₂ "W
OBAD101	143	Sgl seat-Det, Unit
OBAD101LT	143	Sgl seat-Det, Unit, Int tablet, LH
OBAD101RT	143	Sgl seat-Det, Unit, Int tablet, RH
OBAD102	145	Sgl seat-Det, Unit, Scr
OBAD102LT	145	Sgl seat-Det, Unit, Scr, Int tablet, LH
OBAD102RT	145	Sgl seat-Det, Unit, Scr, Int tablet, RH
OBAD103	146	Three seat-Det, Unit
OBAD11	99	Str Seat-Mod, 70 ⁷ / ₈ "W
OBAD12	101	Str Seat-Mod, Back, 70 ⁷ / ₈ "W
OBAD13	104	Str Seat-Mod, Back, Scr, 70 ⁷ / ₈ "W
OBAD21	106	Seat-Mod, 120°
OBAD22	109	Seat-Ext back, 120°, Mod
OBAD23	112	Seat-Ext back, 120°, Scr, Mod
OBAD23LC	112	Seat-Ext back, 120°, LH, Tprd Scr, Mod
OBAD23RC	112	Seat-Ext back, 120°, RH, Tprd Scr, Mod
OBAD24	114	Seat-Intl back, 120°, Mod
OBAD25	117	Seat-Intl back, 120°, Scr, Mod
OBAD31	119	Tri Seat-Mod, 120°
OBAD32	122	Tri seat-Intl back, 120°, Mod
OBAD33	125	Tri seat-Intl back, 120°, Scr, Mod
OBAD42	128	Seat-Back, 90°, Mod
OBAD43	131	Seat-Back, 90°, Scr, Mod
OBAD52	133	Curved seat-Back, 90°, Mod
OBAD53	136	Curved seat-Back, 90°, Scr, Mod
OBAD64SRO	137	Lrg Uph Trprd base-Round top, Small, Mod
OBAD81DS	138	Media unit-Low, Top, D shaped
OBAD85	148	Media den-Enclosed

Style Number	Page	Description
OBAD85A	150	Media den-Enclosed, 4 to 6 ppl
OBAD91LRO	140	Huddle buddle-Group working table, 55 ¹ / ₈ " dia
OBAD91SRO	139	Huddle buddle-Group working table, 47 ¹ / ₄ " dia
OBAD92	141	Table-Low, 23 ⁵ / ₈ " dia
OBASPECT07HB	62	Aspect; Work unit with curved arm-1 seat
OBASPECT08HB	64	Aspect; Work unit with curved arm-2 seat
OBASPECT09HB	66	Aspect; Work unit with curved arm-3 seat
OBASPECT57HB	70	Aspect; Work Scred unit with fixed table-2 seat
OBASPECT58HB	74	Aspect; Work Scred unit with fixed table-4 seat
OBASPECT59HB	78	Aspect; Work Scred unit with fixed table-6 seat
OBAVI01	80	Avi; Chair-Uph, Swvl base
OBAVI02	80	Avi; Chair-Uph, Swvl base, Hood
OBAVI03	81	Avi; Chair-Uph, Wire frm base
OBAVI04	81	Avi; Chair-Uph, Wire frm base, Hood
OBORDER01	88	Border; 1 seat-Low, Tbl, 32" dia
OBORDER02	89	Border; 2 seat-Low, Tbl, 32" dia
OBORDER03	90	Border; 1 seat-Hi, LH, Tbl, 32" dia
OBORDER04	90	Border; 1 seat-Hi, RH, Tbl, 32" dia
OBORDER05	92	Border; 2 seat-Hi, Tbl, 32" dia
OBCUBB01	151	Cubb; Chair-Armless, Wood legs
OBCUBB02	152	Cubb; Chair-Uph arm, Wood legs
OBCUBB03	153	Cubb; Chair-Wire arm, Wood legs
OBCUBB04	154	Cubb; Chair-Armless, Trestle base, 4 star
OBCUBB05	155	Cubb; Chair-Uph arm, Trestle base, 4 star
OBCUBB06	156	Cubb; Chair-Wire arm, Trestle base, 4 star
OBCUBB07	157	Cubb; Chair-Armless, Wire frame base
OBCUBB08	158	Cubb; Chair-Uph arm, Wire frame base
OBCUBB09	159	Cubb; Chair-Wire arm, Wire frame base
OBCUBB10	160	Cubb; Chair-Armless, Base, 5 star
OBCUBB11	161	Cubb; Chair-Uph arm, Base, 5 star
OBCUBB12	162	Cubb; Chair-Wire arm, Base, 5 star
OBCUBB13	163	Cubb; Barstool-Base, Oak
OBCUBB14	164	Cubb; Barstool-Wire frame base
OBCUBB15	165	Cubb; Stool-Occasional, Base, Oak
OBCUBB19	166	Cubb; Bench-2 seat
OBCUBBRM01	173	Cubb; Table-Mtg, 4 pers, Rect
OBCUBBRM02	174	Cubb; Table-Mtg, 4-6 ppl, Rect
OBCUBBRM03	175	Cubb; Table-Mtg, 6-8 ppl, Rect
OBCUBBRM04	176	Cubb; Table-Mtg, 8 pers, Rect
OBCUBBRM05	177	Cubb; Table-Mtg, Rect, 8-10 ppl, 47"D
OBCUBBRM07	178	Cubb; Table-Mtg, Rect, 12-14 ppl, 47"D
OBCUBBRM09	179	Cubb; Table-Mtg, Rect, 8-10 ppl, 55"D
OBCUBBRM11	180	Cubb; Table-Mtg, Rect, 12-14 ppl, 55"D
OBCUBBRM01	186	Cubb; Table-Rect, Occasional
OBCUBBRCP01	181	Cubb; Table-Project, 4-6 ppl, Standing height
OBCUBBRCP02	182	Cubb; Table-Project, 6-8 ppl, Standing height
OBCUBBRCP03	183	Cubb; Table-Project, 8-10 ppl, Standing height
OBCUBBRDM01	167	Cubb; Table-Mtg, 4 pers, Round
OBCUBBRDM02	168	Cubb; Table-Mtg, 6 pers, Round
OBCUBBRDM03	169	Cubb; Table-Mtg, 7 pers, Round
OBCUBBRDM04	170	Cubb; Table-Mtg, 8 pers, Round
OBCUBBRDO01	184	Cubb; Table-Round, Occasional, 23 ⁵ / ₈ "W
OBCUBBRDO02	185	Cubb; Table-Round, Occasional, 31"W
OBCUBBSQM01	171	Cubb; Table-Mtg, 4 pers, Sq

Style Number	Page	Description
OBCUBBSQ001	187	Cubb; Table-Sq, Occasional
OBCUBBSSM01	172	Cubb; Table-Mtg, 4 pers, Sq, Softened corners
OBSRAMSEY01	86	Ramsey; Chair-Work, Uph
OBSSKOMERO1	84	Skomer; Arm chair-Uph
OBSSULLY01	82	Sully; Stool-Uph

Trademark List

® The following are registered trademarks for products of Steelcase Inc. or one of its related corporate entities: 4 o'clock, 900 Series, à la carte, Airtouch, Ally, Amia, Answer, Archipelago, Avenir, Ballet, Bix, Brayton International, Cachet, Canopy, Canto, Chancellor, Coalesse, Confidante, Context, Convene, CopyCam, Criterion, Crushed Can, Currency, dash, Designtex, Details, Detour, Drive, Elective Elements, Ellipse, Ember Chrome, Emerge, E-Table 2, FYI, Garland, Gentry, Ginkgo Biloba, Groupwork, Ideo, Jacket, Jenny, Jersey, Kart, Kick, LaCosta, Leap, LessThanFive, Let's B, LiveBack, Max-Stacker, media:scape, Metro, Migrations, Mitra, Montage, Nurture, Oriana, Parade, Pathways, PCT, Permiso, Player, Portal, Power Pincher, Progeny, Protégé, R2, Rally, Relevant, Reply, Rizzi Arc, Sensor, Series 9000, Siento, Sieste, Sine, Softcare, Springboard, Steelcase, Steelcase Design Partnership, Stella, Stow Davis, Swathmore, Sylvi, TeamWork, Technique, Texpress, Think, Thunder, Topo, Train, turnstone, Underline, Unison, Vecta, Viridian, Walden, Wernld, and X-Stack.

® The following registered trademarks are under license from AWI Licensing Company, Dover, DE: SoundScapes, DuraBrite, BioBlock, and Armstrong.

® The following registered trademarks are under license from Byrne Electrical, Rockford, MI: Interport, Mini-Port, Axil Z, and Ellora.

® The following is a registered trademark of DuPont, Wilmington, DE: Corian.

® The following is a registered trademark of Genlyte Thomas Company, Louisville, KY: Lightolier.

® The following is a registered trademark of Hilti Corporation, FL-9494 Schaan, Principality of Liechtenstein: Hilti.

® The following is a registered trademark of Leviton Manufacturing Company, Little Neck, NY: Decora.

® The following is a registered trademark of Mechanical Plastics Corp, Elmsford, NY: Toggler.

® The following is a registered trademark of Microsoft Corporation, Redmond, WA: Microsoft.

® The following are registered trademarks of Orangebox Ltd., Cardiff, UK: Orangebox.

® The following is a registered trademark of Panduit Corporation, Lockport, IL: Panduit.

® The following is a registered trademark of Trav (Press), Cuneo, Italy: Assisa.

® The following is a registered trademark of Virtual Ink, Boston, MA: mimioActive.

® The following registered trademarks are under license from Wilkhahn Furniture Products: Avera, Senzo, Versal, and Wilkhahn FS.

® The following are registered trademarks of Polyvision Corp: Flow, Motif, Polyvision, Sans, and Serif.

® The following is a registered trademark of Wilsonart International, Temple, TX: Chemsurf.

® The following is a registered trademark of Wiremold, West Hartford, CT: Wiremold.

® The following is a registered trademark of EMU Group S.P.A., Perugia, Italy: EMU.

® The following is a registered trademark of Security People, Inc.: Digilock.

® The following are registered trademarks of Natural Capital Partners Europe Limited: CarbonNeutral and the CarbonNeutral Certified logo.

™ The following are trademarks for products of Steelcase Inc. or one of its related corporate entities: Access, Active/Passive Shelf, Agree, Ainsley, Akira, Alcove, Alerion, Alight, Amaris, American Elect, American Tradition, ap40, Arbor, Arriva, Asana, Ascot, Aspekt, Astor, Await, Bassline, B-Free, Bira, Bivi, Bixby, Bottomline, Brody, Brook, Buoy, Burton, c:scape, Calla, Calm, Camber, Campfire, Capa, Cappuccino, Cesar, Chester, Chord, Circa, Clarendon, Classic Rectangular, Clipper, cobl, Collaboration, Community, Company, Convey, Cortex, Coupe, Crea, Crew, Cura, Cypress, Davenport, Dearborn, Deck, Déjà, Denizen, Denska, Derby, DeskWizard, Divisio, Donovan, Dune, Duo, Echo, Edge, Elbrook, Elsa, Empath, Empress, Enea, ēno, EnSync, Enviro, Escapade, Everwall, Exchange, Exponents, Field, Flat Top, FlexFrame, Flip Top, Flute, Folio, FrameOne, FreeFlow, Frontier, Galilei, Gesture, Ginger, Ginkgo, Go Wall, Grip, Groove, Hatchback, Hawthorne, Hitch, Host Collection, Hosu, Huddleboard, i2i, Impact, Indy, InfoLink, IOS, I-Solve, Jack, Jarrah, Jetty, Juice, Kami, Kast, Kathryn, Lagunitas, Lark, L'Attitude, LearnLab, Leela, Lincoln, Linden, LiveSeat, Loria, Lyric, Malibu, Malibu Too, Mansfield, Marathon, Marien152, Martini, Mason, Masque, Migration, Millbrae, Mineral, Mingle, Mystic, Mystic Metal, Mystic Wood, Montara650, Montreal, MoreThanFive, Move, Nadia, Neighbor, nesso, Nickel, Nikko, Nod, Node, Norfolk, Ocular, Ology, Ontrak, Oom, Opus, Orchid, Outlook Collection, Ovation, Paloma, Paperflo, Parliament, Pasio, Passerelle, Patriarch, Payback, Peek, Pile File, Pisa, Pool, Potrero415, PUCK, QiVi, Quba, Radia, Rave, Reed, Regard, Relay, Reunion, Ripple, Riser, Roam, Rocco, Rocky, RoomWizard, Runner, Satellite, Sawyer, ScapeSeries, Senti, Sentinel, Senza, Sequoia, Session, ShareLink, Shield, Shortcut, Sidewalk, SILQ, Skylar, Slumber, Smoke, Snug, Soft Leaf, Sonata, Sorrel, SOTO, Southside, Stationkits, Steelcase Karman, Steelcase Series, Stiletto, Surprise!, Surround, Switch, Symphony, Sync, TagWizard, Tava, TeamStudio, TeamTheater, Tenaro, Tenor, Terrazzo, Theorem, Thread, Topaz, Touchdown, Tour, Tower Too, Trees, Trillium, Trolly, tX2, U-Free, Umami, Underscore, Uno, V.I.A., Verb, Verge, Verlay, Victor2, Visalia, Waldorf, Woodruff, Workspring, WorkValet, and X-tenz.

™ The following is a trademark of Microsoft Corporation, Redmond, WA: Windows.

™ The following is a trademark of Rodman Industries, Inc., Oconomowoc, WI: ResinCore1.

™ The following is a trademark of Ultrafabrics, LLC, Elmsford, NY: Ultraleather.

™ The following trademarks are under license from Wilkhahn Furniture products: Cana, Linus, Logon, Picto, Range, Stitz, Thema, Timetable, and Tubis.

™ The following is a trademark of Cradle to Cradle Products Innovation Institute, Oakland, CA: Cradle to Cradle Certified.

™ The following trademarks are under license from Walter Knoll: Andoo, Bob, Lazlo, Lox, Ribbon, and Together.

™ The following trademarks are under license from PP Møbler: Bar and Flag Halyard.

™ The following trademarks are under license from Carl Hansen: Elbow, Paddle, Shell, Wing, and Wishbone.

™ The following trademarks are under license from Cambridge Sound Management, LLC, Cambridge, MA: QtPro Soundmasking, Qt Quiet Technology, and Sonet Qt.

™ The following is a trademark of Electri-Cable Assemblies, Shelton, CT: Interact.

™ The following is a trademark of Clestra Hauserman: IRYS.

™ The following is a trademark of Wiesner-Hager Möbel GmbH: Nooi.

™ The following are trademarks of Polyvision: Accord, a³, e³, Boundri, and Nota.

™ The following is a trademark of Bostock Company, Inc: SnapCab.

™ The following is a trademark of Williams-Sonoma, Inc: West Elm.

™ The following is a trademark of Elena Marquina Testor: nanimarquina.

™ The following is a trademark of Forbo International SA: Forbo.

™ The following are trademarks of Orangebox Ltd., Cardiff, UK: Air³, Aspect, Avi, Away from the Desk, Border, Campers & Dens, Coppice, Cubb, Kim, On the QT, Ramsey, Skoner, Sully, Track-B, and Vale.

™/® The following are trademarks or registered trademarks of AMQ Solutions, LLC: AMQ, AMQ logo, KINEX, ILINE, ACTIV, AMOBI, CONCUR, 3F, REVI, S-SERIES, JAKU, SIYA, ZILO, BODI, FL-X, TIZU, EMBANK, TEKTIS, and BIXBY.

™/® The following are trademarks or registered trademarks of Viccarbe Habitat, S.L.: Holy Day, Last Minute, Wrapp, Foro, Kelly, Noha, Viable, Solar, Sistema, Savina, Designed In The Sun, Cambio, Aleta, Viccarbe (logo), Viccarbe.

Trademarks used here in are the property of Steelcase Inc. or of their respective owners.