

Coalesse Tables, Storage, and Accessories

Availability

Electronic price list updated with release 200.J (U.S.) and 156.J (Canada), dated December 18, 2023.

All specifications subject to change without notice. Reference the electronic catalog/Hedberg for current pricing.

Transitional products in this specification guide are **maintained for existing customers only** and are likely to be phased out over time. These products are indicated with a . Products that are scheduled to be culled are indicated with an , followed by the last order entry date.

► For a list of all trademarks, refer to the last page of this specification guide. © 2023 Steelcase Inc.

General Information

Ordering and Warranty	2
Sustainability	4
Collections	5

Tables	7
Storage	709
Accessories	737

Resources	753
Lock and Keying	754
Style Number Index	756



For Canadian Pricing

Canadian factor can be found at steelcase.com/CADpricing.

Calculate in the following order to avoid rounding errors:

- Multiply the base price and each option by the Canadian factor.
- Round each to the nearest dollar.
- Add base and options for total list price.

Ordering and Warranty

How to Order

Coalesse furniture is available through authorized dealers and retailers. Select products are available for order from our web site. The authorized dealer can help you with everything from surface material selection and order placement, to specialized services, such as space planning and design, delivery and installation. Best of all, they are part of your local community, providing expert advice with a thorough understanding of local needs. For more information and a listing of dealers and retailers, visit www.coalesse.com or call 1.800.627.6770.

Coalesse reserves the right to limit distribution of any or all models.

MAIN TELEPHONE
866.645.6952

CUSTOMER SERVICE
1.800.627.6770

Credit, Prices, and Terms

Credit may be established upon acceptance of satisfactory references. For payment terms, contact Coalesse's Credit Department. Coalesse may cancel or change credit terms at its discretion and may request advance payment at any time.

The order confirmation will be deemed by the customer and by Coalesse, as the final expression of agreement and will be deemed the exclusive statement of terms. The order confirmation supersedes all prior writings and may not be modified or rescinded, except by a revised Coalesse order confirmation signed by the customer. No changes are binding on Coalesse until delivery of the order confirmation. Any storage charges and applicable sales taxes are in addition to the prices shown for merchandise. Inside delivery, uncartoning and installation are customer's responsibility unless separately quoted. All list pricing shown includes freight prepaid to one destination for delivery in the 48 contiguous United States. Hawaii and Alaska are not included. We reserve the right to increase prices without notice due to increases in labor and material costs. If timely payment is not made, customer is liable for reasonable collection costs, including attorney's fees.

Shipping and Storage

Coalesse reserves the right to select carrier and packaging method. Partial shipments may be delivered. Coalesse is not liable for delays or delivery failure due to strikes, lockouts, labor, or transportation difficulties, failure or delay of supply sources, accidents, fire, acts of God, or any other cause of like or unlike nature beyond Coalesse's control. Coalesse may transfer merchandise to storage if not accepted when shipment scheduled. Transfer and storage charges will be the customer's expense. Coalesse's invoice is payable upon transfer. If transfer is made prior to confirmed shipping date, storage expenses will be borne by customer.

Shipping charges MAY be calculated per order. Lead times vary by product. Coalesse reserves the right to select carrier. Partial shipments may be delivered. Coalesse will make every effort to provide current and accurate lead time information, however, Coalesse is not liable for delays or delivery failure due to strikes, lockouts, labor, or transportation difficulties, failure or delay of supply sources, accidents, fire, acts of God, or any other cause of like or unlike nature beyond Coalesse's control.

Freight is included on domestically manufactured products within the 48 contiguous states of the United States and standard freight service of Carl Hansen & Son and EMU.

Claims

Merchandise shipped from Coalesse is thoroughly inspected and properly packed before leaving the factory. Responsibility of its safe delivery is assumed by the carrier at the time of shipment. Customer must match the freight delivered with the bill of lading. Customer must examine packaging material upon delivery and note any damage on the carrier bill of lading. If there is damage to the packaging material, inspect the furniture immediately. If concealed damage is found, contact the carrier within 10 days of delivery date. Save all packaging materials until after inspection.

Freight damage and claims must be reported by the purchaser to the carrier. Coalesse is not responsible for freight claims. Claims for loss or damage must not be deducted from our invoice, nor payment withheld awaiting adjustment of such claims. Do not return any merchandise to Coalesse without a Return Authorization number. By following these procedures carefully, Coalesse guarantees our full support of your claims to protect you against loss or damages. All claims against Coalesse for defects, errors or shortages must be made by customer in writing within fifteen (15) days after delivery. Failure to make claims within fifteen (15) days constitutes acceptance of merchandise and waives claims. Cutting of textiles deems acceptance of yardage and waives all defects, errors, and shortages. Coalesse is not liable for subsequent damages.

Special/Custom Products

Coalesse prides itself on being responsive to our customer's needs. Contact our Customer Service team at 1.800.627.6770 to discuss a special opportunity. Due to product modifications and engineering time, special orders may not be cancelled. Charges will apply.

FOR MORE INFORMATION (on ordering our products) Please contact Coalesse Customer Service at: 1.800.627.6770.

Ordering and Warranty

Order Cancellations/Changes

All order change/cancellation requests must be submitted using the Coalesse order change/cancellation request form. Late changes could jeopardize the committed delivery of an order.

Coalesse Rapid10 programs no change or cancellations allowed.

Coalesse Products:

- No charges will be assessed for change or cancellation 14 or more calendar days prior to the manufacturing completion date (excludes holidays and/or large quantity project size orders). For import products, charges may apply.

- No manufacturing changes are allowed 0-13 calendar days prior to the manufacturing completion date. Simple changes including shipping address changes are subject to approval but will be accommodated when possible.

- No cancellations or product changes will be accepted for quick ship or special/custom product orders including special laminates. A cancellation fee will be applicable for any custom product and/or change may jeopardize lead time.

- If COM/COL has been received at time of change or cancellation, it is the dealer's responsibility to advise disposition or return of materials. Coalesse will not store materials after 30 days.

Additional Charges

- Changes or cancellations that involve any of the following may be subject to a charge earlier and/or greater than shown above: Special engineering product, CSM, pre-ordered components, materials with extended lead times (e.g., veneers, special paint, etc.) or large quantities of standard materials.

- Use our Order Change/Cancellation Request Form for all order changes. It is Coalesse responsibility to accurately process change order requests. It is the dealer's responsibility to verify that we have accurately interpreted your change requests by checking the acknowledgement after the change has been made. If you do not use the web-based change order form process and an error occurs during our translation which cannot be corrected prior to ship, all costs will be shared on a 50/50 basis. Changing ship dates or adding product to your order is subject to the availability of manufacturing capacity.

- Cartoning changes and shipping address changes are subject to approval and to a change charge. Please consult your Customer Service for specific information pertaining to your order.

Reserved Fabric Policy

Prior to order receipt, reserving textiles (COM/COL, Maharam, Designtex, and select Luna Select Surfaces) is the responsibility of the dealer. Coalesse cannot reserve textiles based on projected orders. Coalesse cannot guarantee Maharam or Designtex fabric availability. If dealer reserves Maharam or Designtex textiles, Coalesse will require the reserve number and zip code for locating purposes when ordering.

Schedule Enhancements

Coalesse will entertain schedule enhancements on a case-by-case basis; however, please understand that we must receive complete information such as installation date, opening date in order to make informed scheduling decisions.

No order move-ups or move-outs are allowed on any order that falls within the 15-working day period of its manufacturing completion date. If it is within the 15-working day period, Coalesse will invoice at shipment but may offer storage options at a charge for manufactured product.

Rapid 10

The Coalesse Rapid10 program provides a broad selection of our most popular seating, outdoor furniture, and tables with expedited manufacturing. To view and specify products that are included in the Coalesse Rapid10 program, please refer to the *Quick Ship Guide*. The comprehensive Coalesse offering in this program can easily provide a range of solutions for any setting. Coalesse Rapid10 is designed for clients whose needs require fast delivery of products. All products are made-to-order and ship in 10 business days.

Warranty

For warranty information, please go to <http://www.coalesse.com/warranty/>.

Sustainability

Sustainability

At Steelcase, we believe business can be a force for good. We create long-lasting products that are better for people and better for the planet. Our products and operations use life cycle thinking to meet our commitment to reducing climate change. This commitment is reinforced by practices such as designing to minimize global warming and other life cycle impacts, ensuring material health, and enabling end-of-use strategies.

To learn more at a corporate level, visit: www.steelcase.com/discover/steelcase/esg-overview/environmental/ Product Environmental Profiles, which provide key environmental attributes such as recycled content, embodied carbon and recyclability, as well as product certifications can be found by searching for Steelcase at Origin.build.

Collections

Await Collection

- Occasional Tables ▶ See *Coalesse Tables, Storage, and Accessories Specification Guide*
- Lounge Seating ▶ See *Coalesse Seating Specification Guide*

Bix Collection

- Collaborative and Conference Tables ▶ See *Coalesse Tables, Storage, and Accessories Specification Guide*
- Occasional Tables ▶ See *Coalesse Tables, Storage, and Accessories Specification Guide*
- Lounge Seating ▶ See *Coalesse Seating Specification Guide*

Bob Collection

- Collaborative and Conference Tables ▶ See *Coalesse Tables, Storage, and Accessories Specification Guide*
- Occasional Tables ▶ See *Coalesse Tables, Storage, and Accessories Specification Guide*
- Lounge Seating ▶ See *Coalesse Seating Specification Guide*
- Guest Seating ▶ See *Coalesse Seating Specification Guide*

Circa Collection

- Occasional Tables ▶ See *Coalesse Seating Specification Guide*
- Lounge Seating ▶ See *Coalesse Seating Specification Guide, and Coalesse Tables, Storage, and Accessories Specification Guide*

Enea Collection

- Café Tables ▶ See *Coalesse Tables, Storage, and Accessories Specification Guide*
- Occasional Tables ▶ See *Coalesse Tables, Storage, and Accessories Specification Guide*
- Guest Seating ▶ See *Coalesse Seating Specification Guide*
- Stools ▶ See *Coalesse Seating Specification Guide*

Enea Lottus Collection

- Café Tables ▶ See *Coalesse Tables, Storage, and Accessories Specification Guide*
- Occasional Tables ▶ See *Coalesse Tables, Storage, and Accessories Specification Guide*
- Guest Seating ▶ See *Coalesse Seating Specification Guide*
- Stools ▶ See *Coalesse Seating Specification Guide*

Exponents Collection

- Accessories** ▶ See *Coalesse Tables, Storage, and Accessories Specification Guide*
 - Lectern
 - Mobile Display Boards

Host Collection

- Collaborative and Conference Tables ▶ See *Coalesse Tables, Storage, and Accessories Specification Guide*

Lagunitas Collection

- Collaborative and Conference Tables ▶ See *Coalesse Tables, Storage, and Accessories Specification Guide*
- Occasional Tables ▶ See *Coalesse Tables, Storage, and Accessories Specification Guide*
- Lounge Seating ▶ See *Coalesse Seating Specification Guide*

Massaud Collection

- Lounge Seating ▶ See *Coalesse Seating Specification Guide*
- Collaboration Seating ▶ See *Coalesse Seating Specification Guide*

Millbrae Collection

- Occasional Tables ▶ See *Coalesse Tables, Storage, and Accessories Specification Guide*
- Lounge Seating ▶ See *Coalesse Seating Specification Guide*

Montara650 Collection

- Café Tables ▶ See *Coalesse Tables, Storage, and Accessories Specification Guide*
- Occasional Tables ▶ See *Coalesse Tables, Storage, and Accessories Specification Guide*
- Guest Seating ▶ See *Coalesse Seating Specification Guide*
- Lounge Seating ▶ See *Coalesse Seating Specification Guide*
- Stools ▶ See *Coalesse Seating Specification Guide*

Passerelle Collection

- Occasional Tables ▶ See *Coalesse Tables, Storage, and Accessories Specification Guide*
- Lounge Seating ▶ See *Coalesse Seating Specification Guide*

Sidewalk Collection

- Lounge Seating ▶ See *Coalesse Seating Specification Guide*

Switch Collection

- Occasional Tables ▶ See *Coalesse Tables, Storage, and Accessories Specification Guide*
- Lounge Seating ▶ See *Coalesse Seating Specification Guide*
- Guest Seating ▶ See *Coalesse Seating Specification Guide*
- Stools ▶ See *Coalesse Seating Specification Guide*

SW_1 Collection

- Collaborative and Conference Tables ▶ See *Coalesse Tables, Storage, and Accessories Specification Guide*
- Occasional Tables ▶ See *Coalesse Tables, Storage, and Accessories Specification Guide*
- Lounge Seating ▶ See *Coalesse Seating Specification Guide*
- Collaboration Seating ▶ See *Coalesse Seating Specification Guide*

Tables

Statement of Line 8

Collaborative and Conference Tables 31
Café Tables 647
Occasional Tables 667

Statement of Line

Collaborative and Conference Tables



Folding



Non-Folding

Understanding
▶ Page 34
Specifying
▶ Page 39



Round



Racetrack

Understanding
▶ Page 34
Specifying
▶ Page 40

Ballet Arc Tables

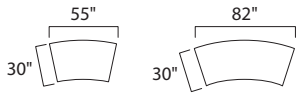

Ballet Non-Folding Side Tables

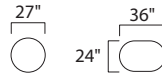

Understanding
▶ Page 34
Specifying
▶ Page 41



Understanding
▶ Page 34
Specifying
▶ Page 42

Ballet Round Pedestal Base Tables

(Fixed and Flip Top)

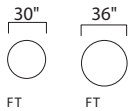

FT = Flip Top

Ballet Square Pedestal Base Tables

(Fixed and Flip Top)

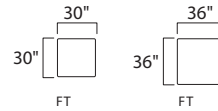

FT = Flip Top

Statement of Line

Collaborative and Conference Tables, continued



X- Folding



X- Non-Folding

Understanding
 ▶ Page 34
 Specifying
 ▶ Pages 44–47

Ballet Rectangular X-Base Tables

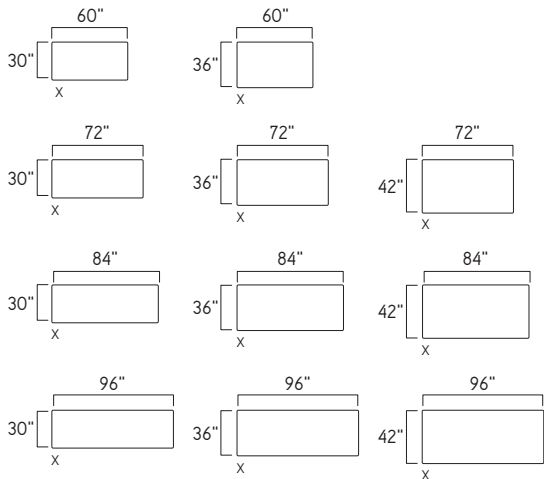

X = X-base



Understanding
 ▶ Page 37
 Specifying
 ▶ Page 48

Ballet Connecting Tops

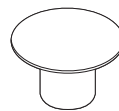
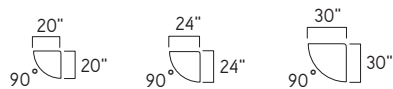

Understanding
 ▶ Page 54
 Specifying
 ▶ Pages 86–88

E-Table 2 Parametric Round Tables



*Parametric width and depth are in 1" increments.

D = Drum base

Collaborative and Conference Tables, continued

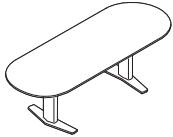

Understanding
 ▶ Page 54
 Specifying
 ▶ Pages 90–128

E-Table 2 Parametric Racetrack Tables

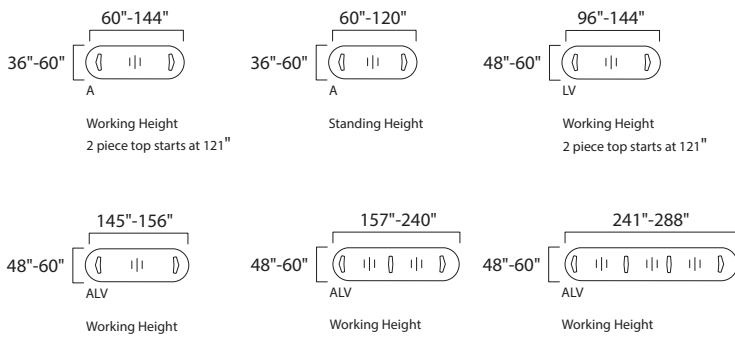

*Parametric width and depth are in 1" increments.

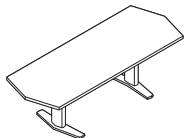

Understanding
 ▶ Page 54
 Specifying
 ▶ Pages 140–176

E-Table 2 Parametric Faceted Tables

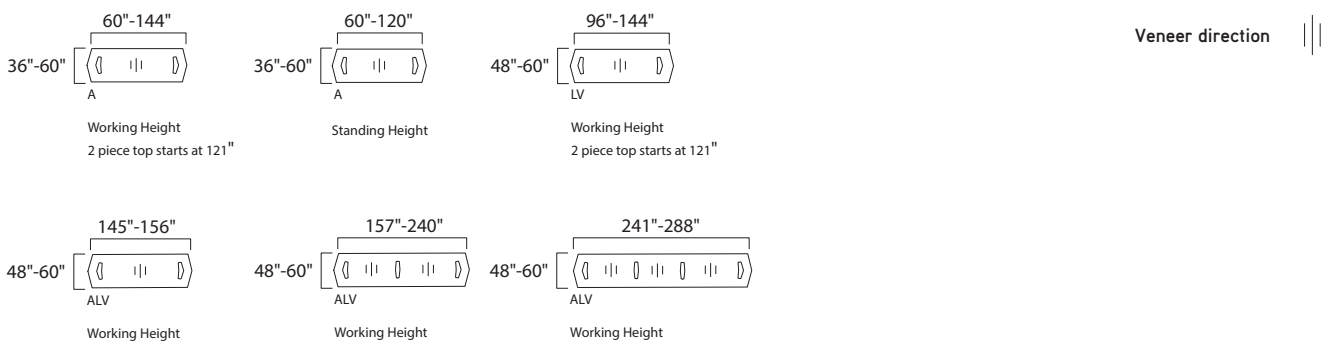

*Parametric width and depth are in 1" increments.

A = Aluminum base
 L = Laminate base
 V = Veneer base

Statement of Line

Collaborative and Conference Tables, continued

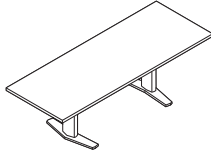

Understanding
 ▶ Page 54
 Specifying
 ▶ Pages 188–226

E-Table 2 Parametric Rectangular Tables

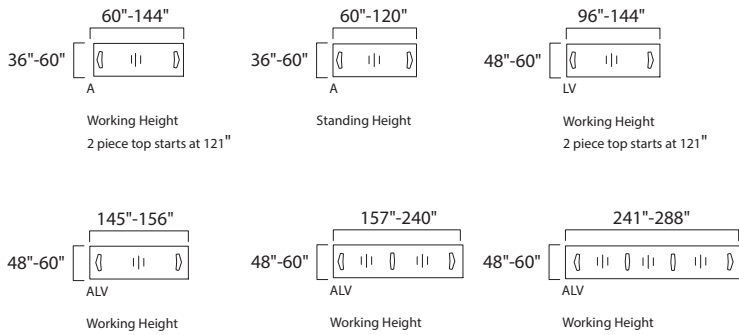

*Parametric width and depth are in 1" increments.

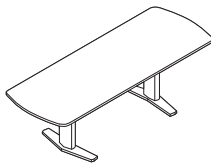

Understanding
 ▶ Page 54
 Specifying
 ▶ Pages 238–274

E-Table 2 Parametric Soft Radiused End Tables

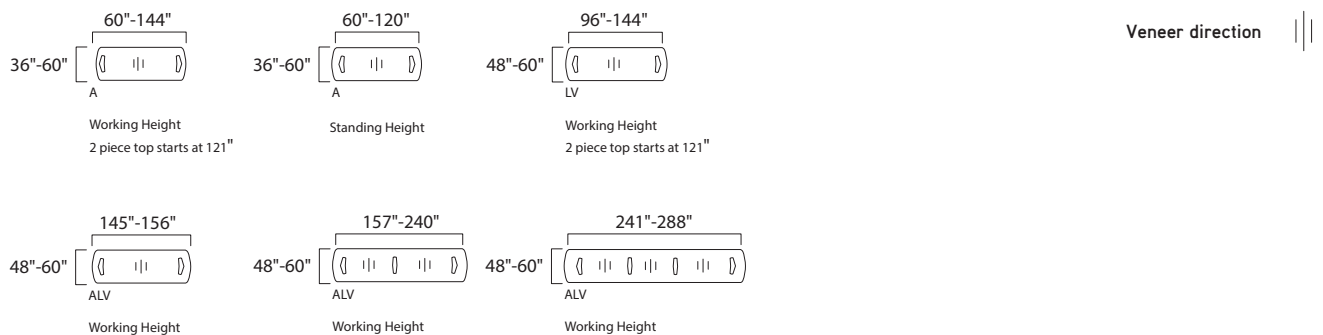

*Parametric width and depth are in 1" increments.

A = Aluminum base
 L = Laminate base
 V = Veneer base

Collaborative and Conference Tables, continued

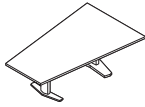

Understanding
 ▶ Page 54
 Specifying
 ▶ Pages 286–302

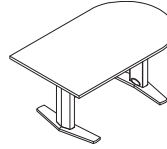

Understanding
 ▶ Page 54
 Specifying
 ▶ Pages 308–328

E-Table 2 Parametric Trapezoid Tables

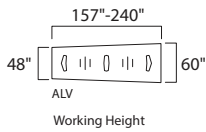
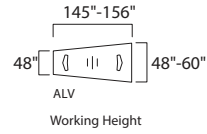
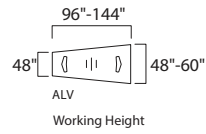
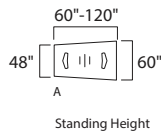
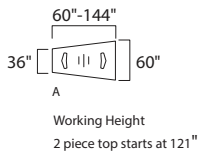

E-Table 2 Parametric D-Shape Tables

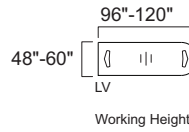
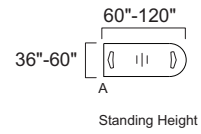
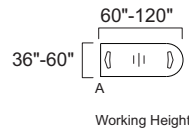

*Parametric width and depth are in 1" increments.

A = Aluminum base
 L = Laminate base
 V = Veneer base

*Parametric width and depth are in 1" increments.

Veneer direction |||

Statement of Line

Collaborative and Conference Tables, continued



Understanding
 ▶ Page 334
 Specifying
 ▶ Page 356

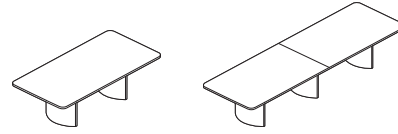

Understanding
 ▶ Page 334
 Specifying
 ▶ Pages 360–368

Host Round Tables



Veneer direction

Host Rectangular Tables

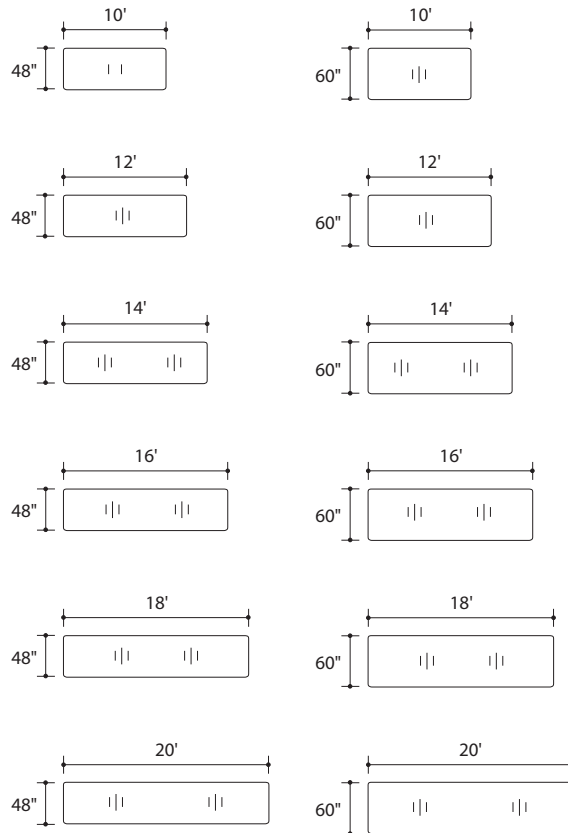

Collaborative and Conference Tables, continued

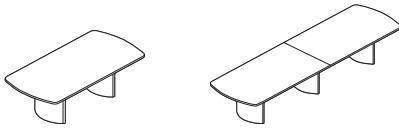

Understanding
 ▶ Page 334
 Specifying
 ▶ Pages 388–396

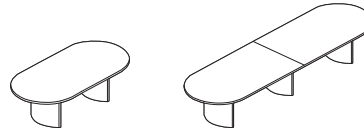

Understanding
 ▶ Page 334
 Specifying
 ▶ Pages 416–426

Host Soft Radiused Tables

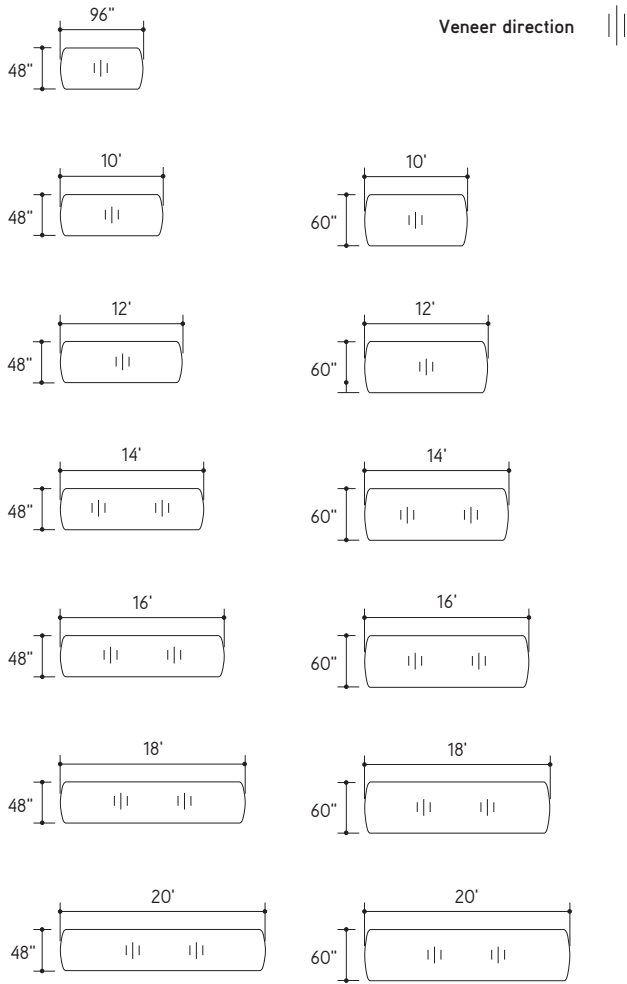

Host Racetrack Tables

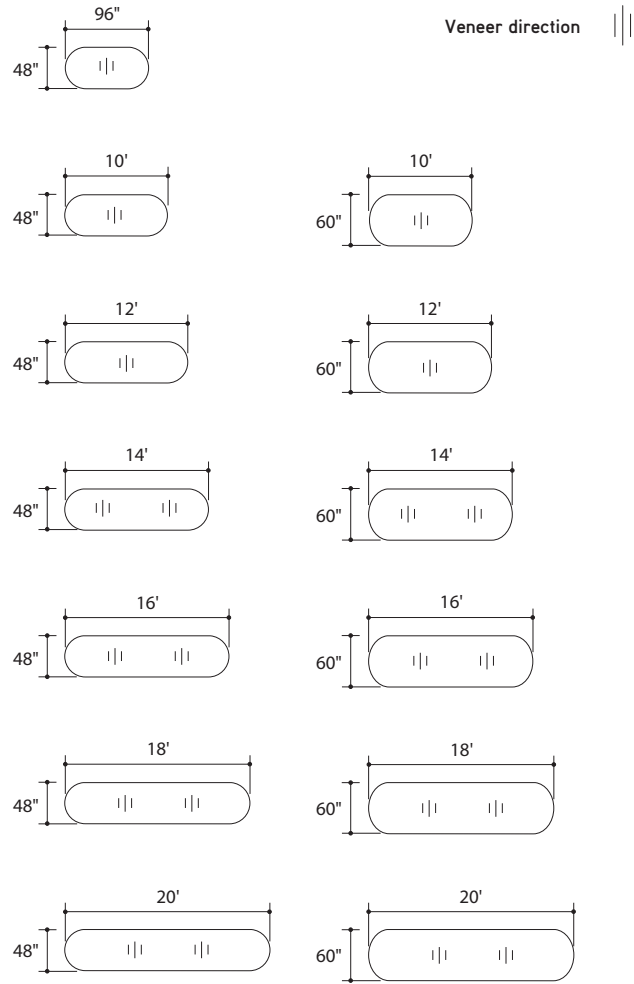

Statement of Line

Collaborative and Conference Tables, continued

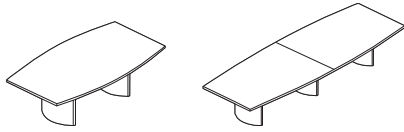

Understanding
▶ Page 334
Specifying
▶ Pages 446-450

Host Boat Shaped Tables

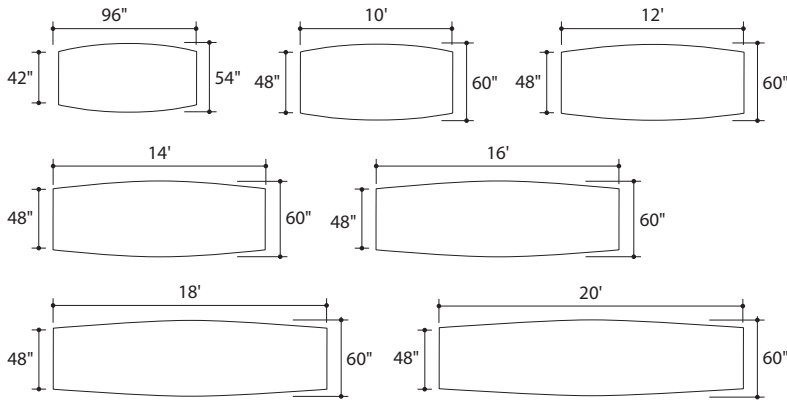

Veneer direction |||

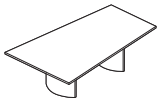

Understanding
▶ Page 334
Specifying
▶ Page 462

Host Trapezoid Tables with Two Bases

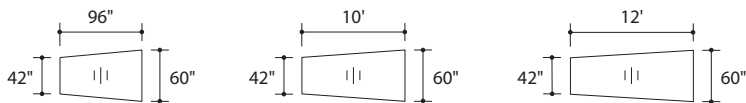

Veneer direction |||

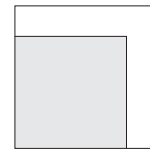

Flat, bullnose, and beveled wood edges with square corners

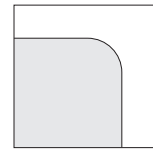

Tapered and horizontal wood edges with 4" radius corners

Statement of Line *continued*

Collaborative and Conference Tables, continued

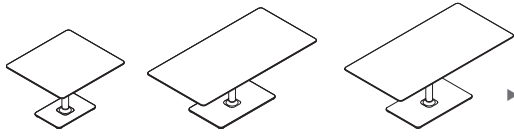

Work Tables

Understanding
 ▶ See *Coalesse Seating Specification Guide*
 Specifying
 ▶ Page 474

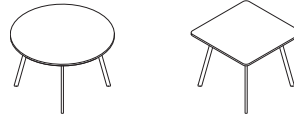

Understanding
 ▶ Page 478
 Specifying
 ▶ Page 482

Lagunitas Work Tables

MoreThanFive Round and Square Tables



Understanding
 ▶ Page 478
 Specifying
 ▶ Page 483

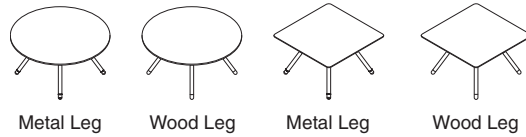

Understanding
 ▶ Page 486
 Specifying
 ▶ Page 500

MoreThanFive Rectangle Tables

Potrero415 Round and Square Tables, Metal and Wood Legs

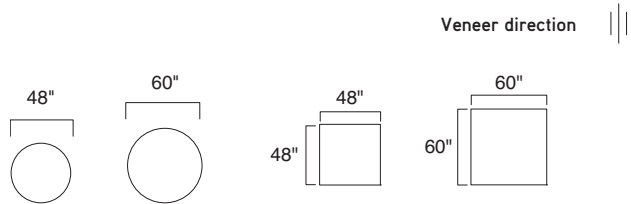
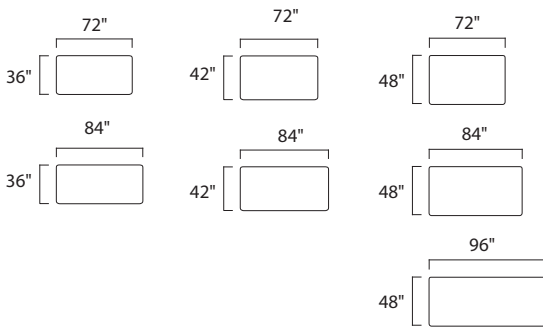

Statement of Line

Collaborative and Conference Tables, continued

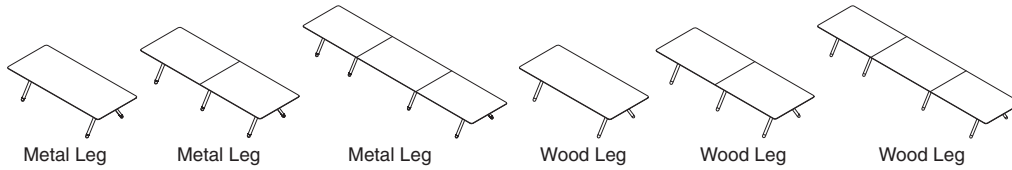

Understanding
 ▶ Page 486
 Specifying
 ▶ Pages 502–510

Potrero415 Rectangular Tables, Metal and Wood Legs

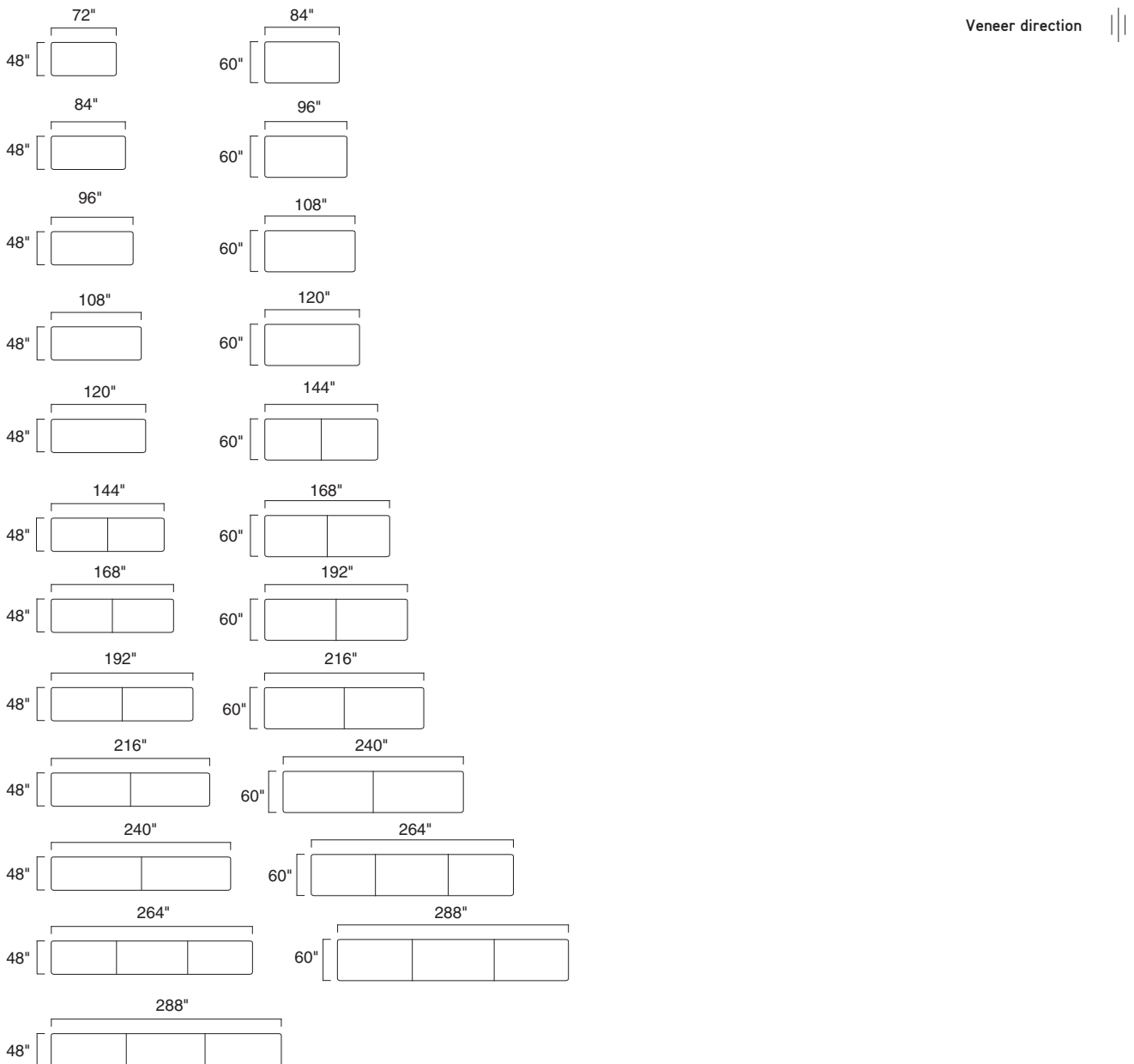

Statement of Line *continued*

Collaborative and Conference Tables, continued

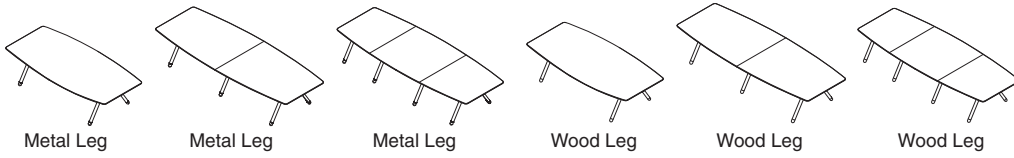

Understanding
 ▶ Page 486
 Specifying
 ▶ Pages 512-542

Potrero415 Boat Shaped Tables, Metal and Wood Legs

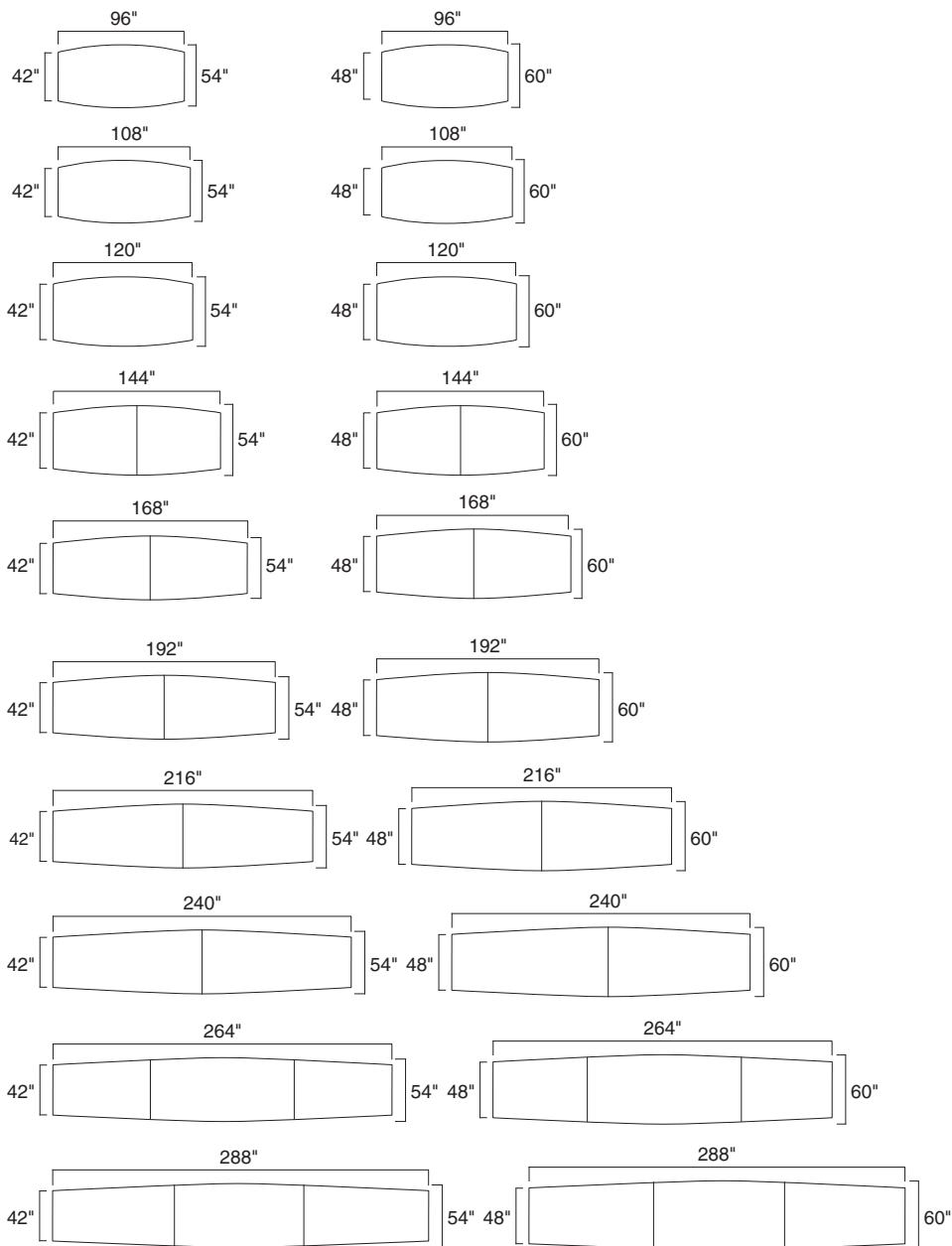

Statement of Line

Collaborative and Conference Tables, continued



Understanding
 ▶ Page 548
 Specifying
 ▶ Pages 558 and 566

Potrero415 Light Round and Square Tables, Metal and Wood Legs

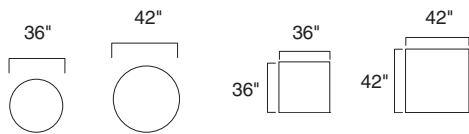

Veneer and woodgrain laminate direction

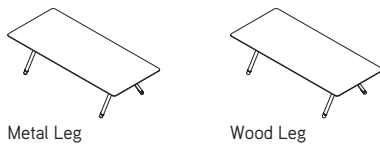

Understanding
 ▶ Page 548
 Specifying
 ▶ Pages 560 and 568

Potrero415 Light Rectangular Tables, Metal and Wood Legs

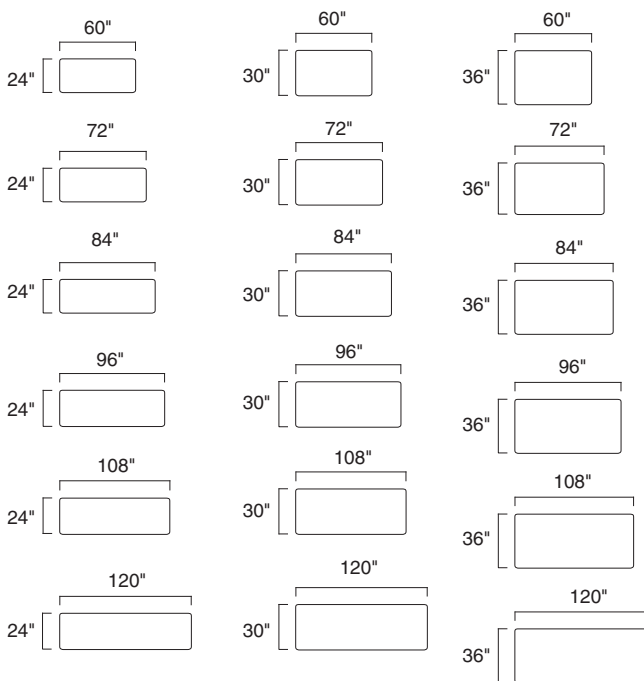

Veneer and woodgrain laminate direction

Statement of Line *continued*

Collaborative and Conference Tables, continued



Large Round
One-Piece Top

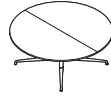

Large Round
Two-Piece Top



Square



Large Square
One-Piece Top

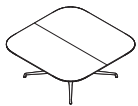

Large Square
Two-Piece Top



Rectangular



Super Elliptical
One-Piece Top

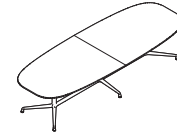

Super Elliptical
Two-Piece Top

Understanding
▶ Page 576
Specifying
▶ Page 592

SW_1 Low Collaborative Conference Tables

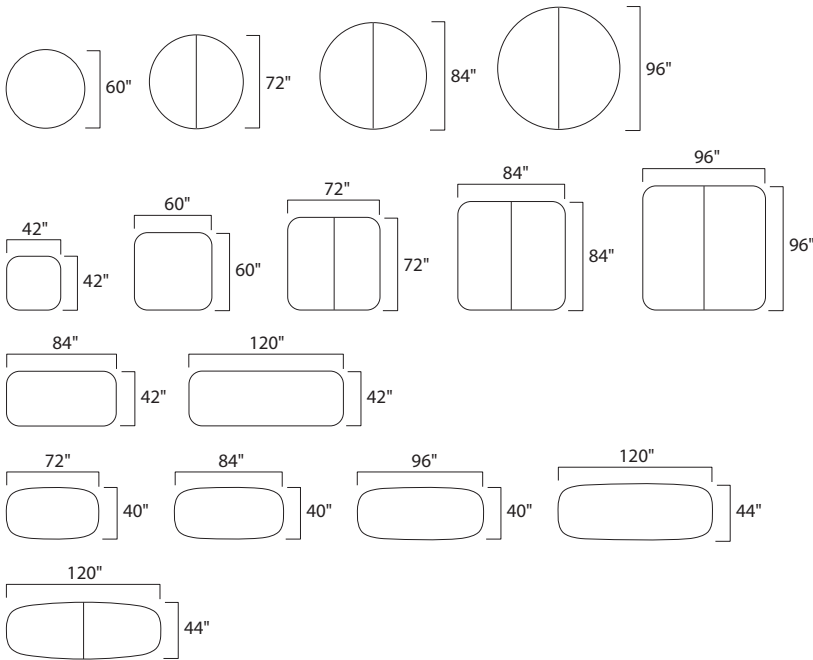

Statement of Line

Collaborative and Conference Tables, continued



Large Round
One-Piece Top

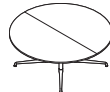

Large Round
Two-Piece Top



Large Square
One-Piece Top

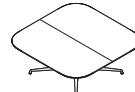

Large Square
Two-Piece Top



Rectangular
One-Piece Top



Rectangular
Two-Piece Top



Super Elliptical
One-Piece Top

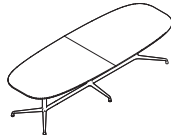

Super Elliptical
Two-Piece Top

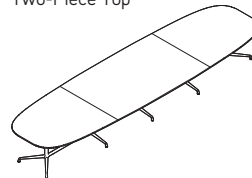

Super Elliptical
Three-Piece Top

Understanding
▶ Page 576
Specifying
▶ Page 596

SW_1 Conference Tables

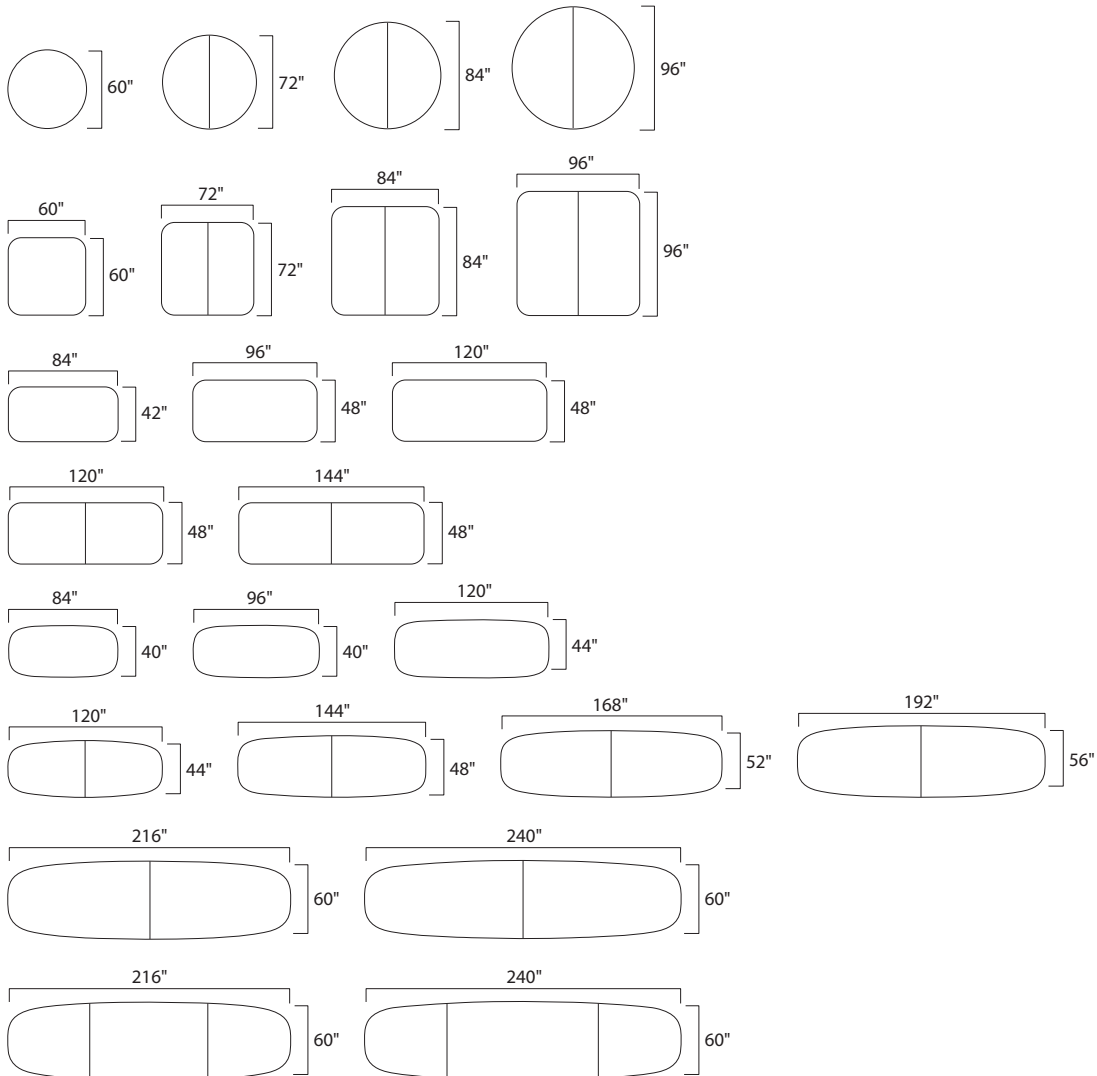

Statement of Line *continued*

Collaborative and Conference Tables, continued



Round



Square



Super Square

Understanding
 ▶ Page 576
 Specifying
 ▶ Page 600



Rectangular



Super Elliptical

Understanding
 ▶ Page 576
 Specifying
 ▶ Page 602

SW_1 Round, Square, and Super-Square Tables

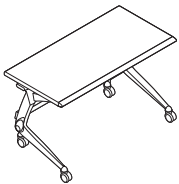
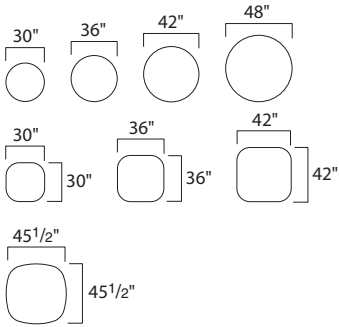

Understanding
 ▶ Page 608
 Specifying
 ▶ Page 630

SW_1 Work Tables

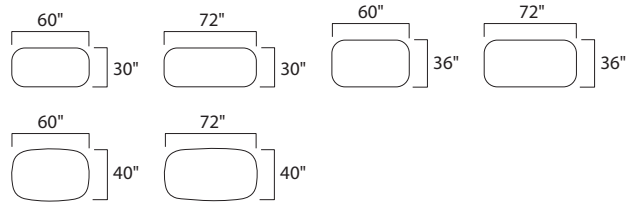

Understanding
 ▶ Page 609
 Specifying
 ▶ Page 636

Train Rectangular Tables

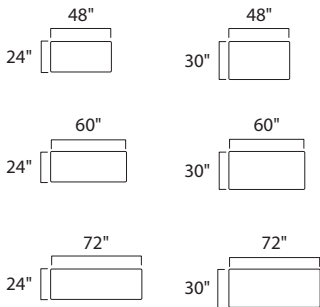

Train Corner Tops



Statement of Line

Café Tables

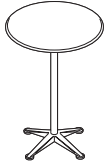

Understanding
▶ Page 34
Specifying
▶ Page 648

Ballet Café Tables

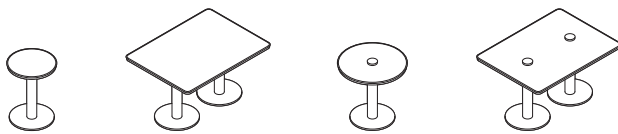
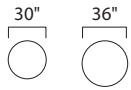

Understanding
▶ See *Coalesse Seating Specification Guide*
Specifying
▶ Page 649

Bix 27\"/>

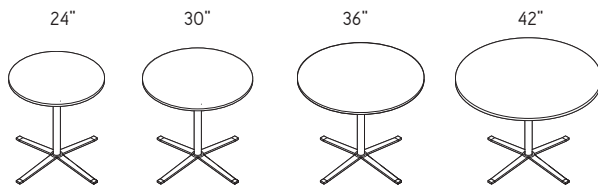

Understanding
▶ See *Coalesse Seating Specification Guide*
Specifying
▶ Page 650

Bob Round Conference Dining Tables

Statement of Line *continued*

Café Tables, continued

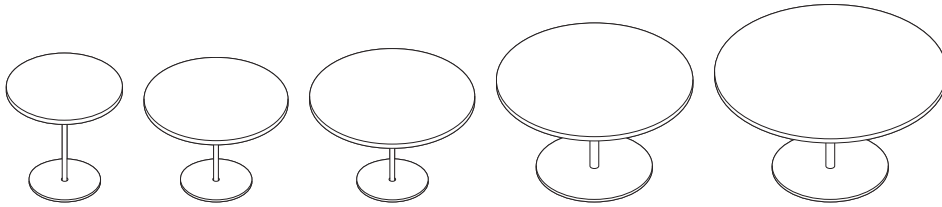

Café/Conference Height

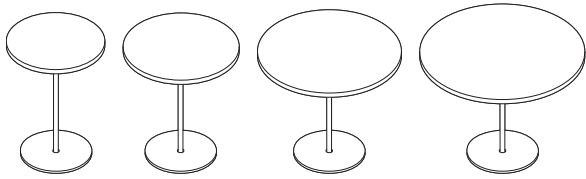

Café/Counter Height

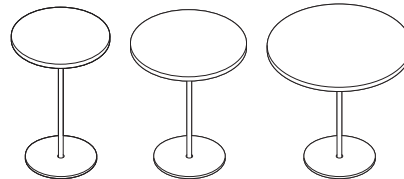

Café/Bar Height

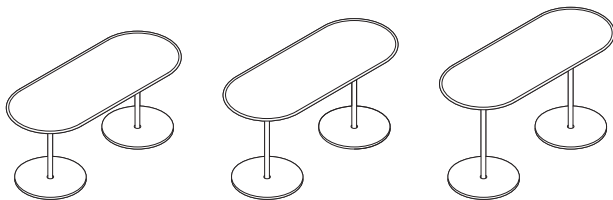

Conference Racetrack

Counter Racetrack

Café Racetrack

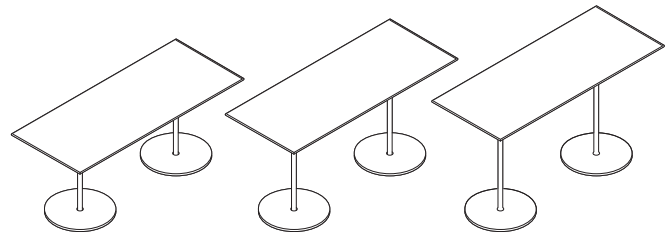

Rectangular



Oval

Specifying
▶ Pages 652-654

Enea Café Tables

Statement of Line

Café Tables, continued

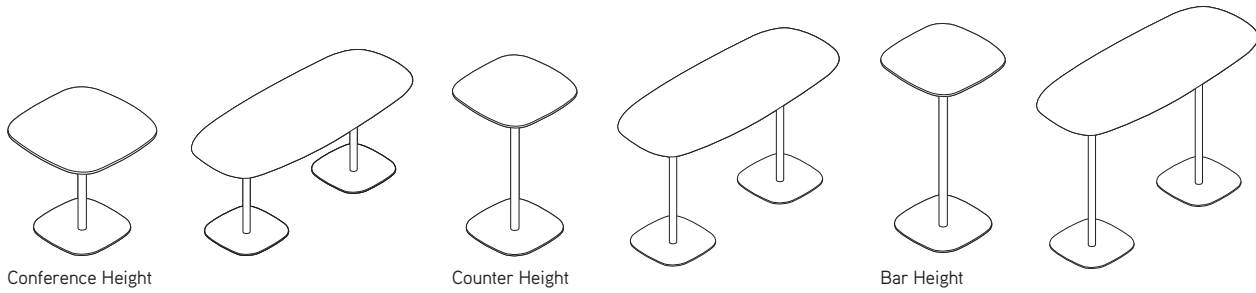

Specifying
▶ Pages 657-659

Enea Lottus Café Tables

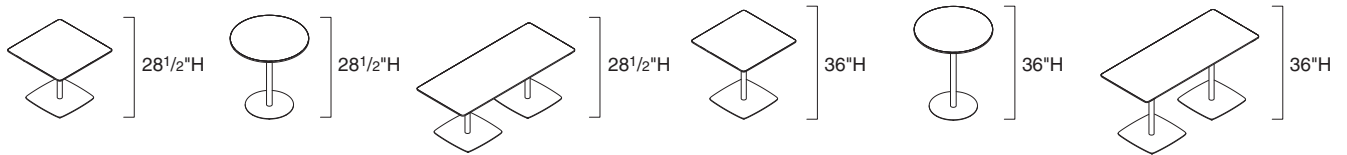

Understanding
▶ Page 660
Specifying
▶ Page 662

Understanding
▶ Page 660
Specifying
▶ Page 664

Montara650 Work-Height Café Tables

Montara650 Café-Height Café Tables

Statement of Line *continued*

Occasional Tables

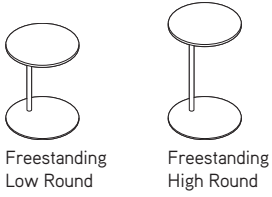

Understanding
▶ Page 668
Specifying
▶ Page 669

Await Occasional Tables

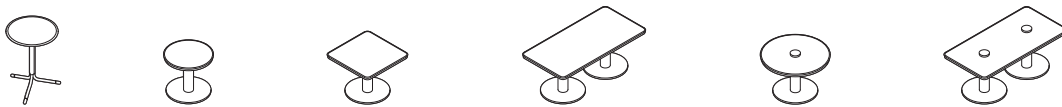

Understanding
▶ Page 670
Specifying
▶ Pages 672–673

Bix Side Table and 18"H Occasional Tables

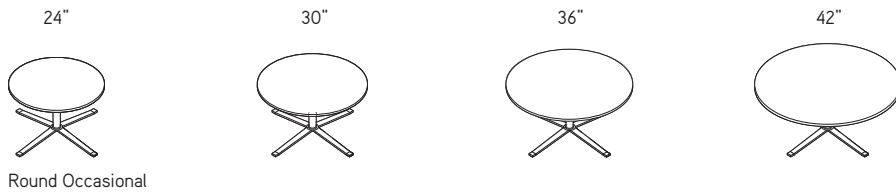

Round Occasional

Understanding
▶ Page 674
Specifying
▶ Page 676

Bob Occasional Tables

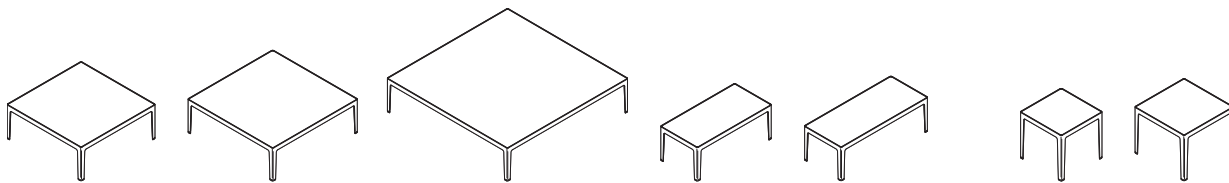

Low Square Tables

Low Rectangular Tables

High Square Tables

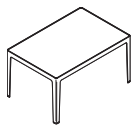

High Rectangular Table

Understanding
▶ Page 678
Specifying
▶ Pages 680–682

CG_1 Occasional Tables

Statement of Line

Occasional Tables, continued

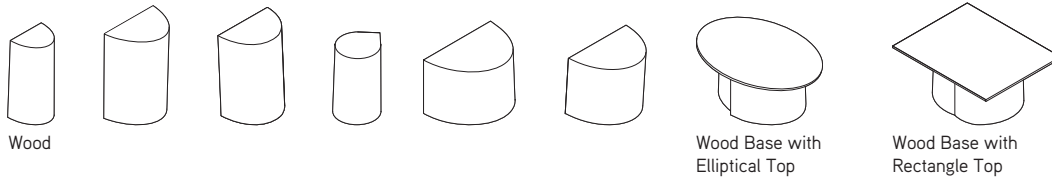

Wood

Wood Base with Elliptical Top

Wood Base with Rectangle Top

- Understanding
- ▶ Page 685
- Specifying
- ▶ Page 686

Diekman Occasional Tables

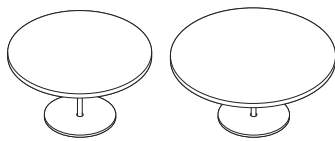

Occasional

- Understanding
- ▶ Page 687
- Specifying
- ▶ Page 688

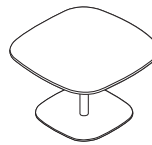

Occasional

- Understanding
- ▶ Page 689
- Specifying
- ▶ Page 690

Enea Occasional Tables

Enea Lottus Occasional Tables

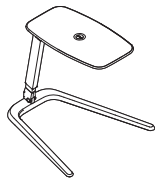

Free Stand Occasional Table

- Understanding
- ▶ Page 691
- Specifying
- ▶ Page 692

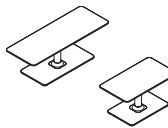

Lagunitas Occasional Tables

- Understanding
- ▶ See *Coalesse Seating Specification Guide*
- Specifying
- ▶ Page 693

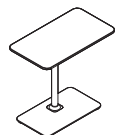

Lagunitas Personal Table

- Understanding
- ▶ See *Coalesse Seating Specification Guide*
- Specifying
- ▶ Page 694

Statement of Line *continued*

Occasional Tables, continued

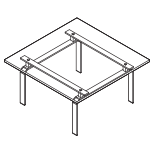

Square Tables

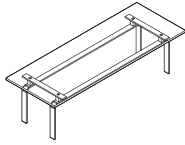

Rectangular Tables

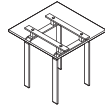

Side Table

Understanding
▶ See *Coalesse Seating Specification Guide*
Specifying
▶ Page 695

Millbrae Occasional Tables

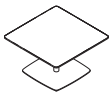

18"H



18"H

Understanding
▶ Page 660
Specifying
▶ Page 696

Montara650 Occasional Tables

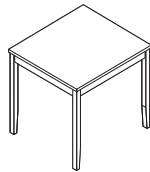
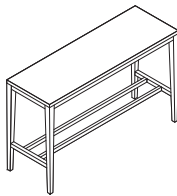
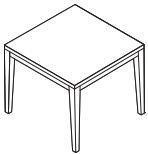

Understanding
▶ See *Coalesse Seating Specification Guide*
Specifying
▶ Page 697

Passerelle Occasional Tables

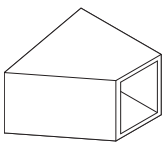

16" High Tables

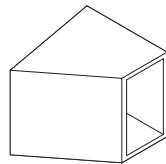
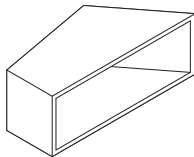

22" High Tables

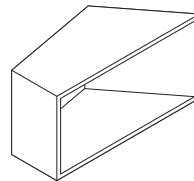

Understanding
▶ Page 698
Specifying
▶ Page 699

Sebastopol Occasional Tables

Statement of Line

Occasional Tables, continued

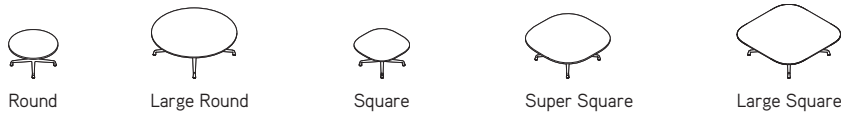

Understanding
 ▶ Page 576
 Specifying
 ▶ Page 702

SW_1 Occasional Tables

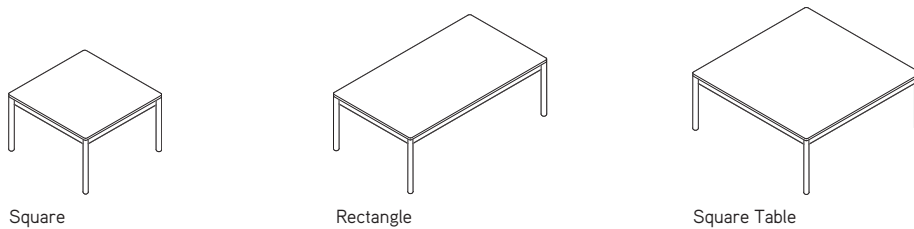

Specifying
 ▶ Page 706

Switch Occasional Tables

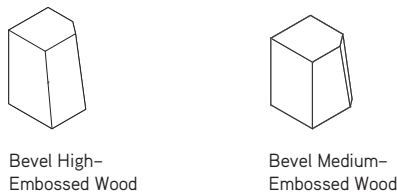

Specifying
 ▶ Page 707

Trees Occasional Tables

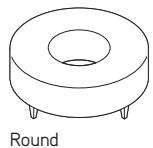

Understanding
 ▶ See *Coalesse Seating Specification Guide*
 Specifying
 ▶ Page 684

Circa Lounge System Freestanding Round Table

Collaborative and Conference Tables

* These product lines are collections and will be found in multiple locations in this specification guide and/or *Coalesse Seating Specification Guide*.
▶ See Collections, page 5

Ballet Collaborative and Conference Tables	33
E-Table 2 Collaborative and Conference Tables*	53
Host Collaborative and Conference Tables*	333
Lagunitas Lounge System	470
Lagunitas Collaborative and Conference Tables*	474
MoreThanFive Collaborative and Conference Tables	477
Potrero415 Collaborative and Conference Tables*	485
Potrero415 Light Collaborative and Conference Tables*	547
SW_1 Collaborative and Conference Tables*	575
Train Collaborative and Conference Tables	607

Ballet Collaborative and Conference Tables

Understanding	34
Specifying	
Arc Tables	39
Non-Folding Side Tables	40
Round Pedestal Base Tables	41
Square Pedestal Base Tables	42
Rectangular Folding X-Base Tables	44
Rectangular Non-Folding X-Base Tables	46
Connecting Tops	48
Accessories	49

Ballet Collaborative and Conference Tables

Ballet tables form a versatile series that provides solutions in a variety of applications—conference, training, workplace, dining, and utility. Base configurations are available in folding and fixed versions.

Modesty panel has a horizontal wire management trough for a clean look.

Cast aluminum legs are available in folding or non-folding, X-bases.

Adjustable leveling glides are included for uneven floors.

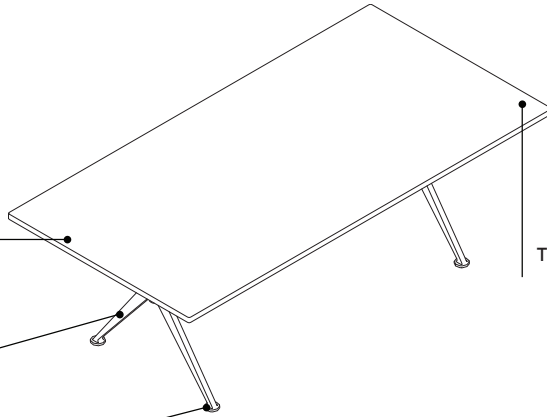

Top is 1" thick laminate.

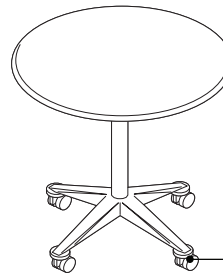

Dual wheel casters are 2" diameter and lock.

Seating Capacity Guidelines
▶ See page 618

Ballet Collaborative and Conference Tables

Product Details

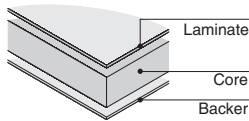

Solid core tops with 3/4" and 1" nominal edge thickness have a particle board core (45 lb cu ft density) with High-Pressure Laminate on the top and a backer applied to the opposite side for a balanced construction. High-Pressure Laminate and backer are bonded to the core with a PVA adhesive.

Flip-top option is available on pedestal base tables only.

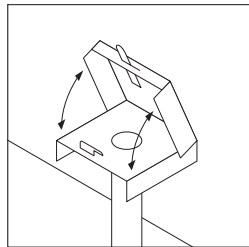

Flip-top mechanism is available on pedestal base tables 36"D or less. The flip-top mechanism allows tops to tilt for more compact storage of tables that are not in use. Safety latch secures the top in flat position and must be released to flip top up.

Tip: Flip-top tables are not meant to be used in configurations. Tops may not align.

Special table heights may be practical. To confirm practicality and obtain a quotation, contact Customer Service at 1.800.627.6770.

Folding is possible for select X-base tables to allow compact storage of tables that are not in use. X-base is 4" thick when folded. Folded height is 3 5/8".

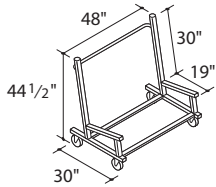

Mobile storage cart stores and transports up to 5 folded Ballet tables from lengths of 48"-72" and widths up to 42". Folded height is 3 5/8".

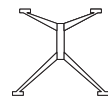

X-base

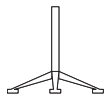

Pedestal-base

Bases are available in two configurations—X-base and pedestal base. Base assemblies are constructed of die-cast and extruded aluminum. X-base assemblies are joined by 1" x 3" extruded aluminum stretcher bar for stability. Base finish can be any powder coat color.

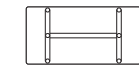

10"-13"

Base inset on Ballet X-base tables is 10" on tables 60"L and 13" on tables longer than 60"L.

Table height is standard at 28 1/2"H.

Adjustable leveling glides are non-marring, black plastic.



Casters can replace glides on many Ballet tables factory installed. Casters are 2"-diameter, locking dual-wheel casters in black plastic and do not alter the table height.

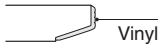

Edges are black ribbed vinyl T-mold with matching plastic corner inserts.

Custom shapes and sizes are possible. To confirm practicality and obtain a quotation, contact Customer Service at 1.800.627.6770.

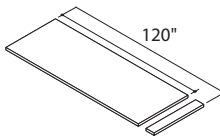

Cut-down tops, which are standard table tops with smaller dimensions, are available. Use the product number of the next larger size and specify the exact dimensions you want. Some restrictions apply, including minimum quantities. This option is not available for folding tables. Additional lead times may be required. Contact Coalesse Customer Service at 972.641.2860.

Tip: Upcharge for a cut-down top is applied one time only per size/style number.



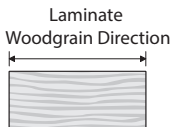



Tip: Fee is at list and contract discounts apply.



Woodgrain laminates are always oriented with the grain direction running parallel with the length of the table top. You cannot specify woodgrain laminates with end- or side-matched grain directions.

Ballet Collaborative and Conference Tables *continued*

Edge Alternatives

Edge Alternatives	Table Top Shape					
	Round	Square	Rectangular	Racetrack	Arc	Connecting Tops
1" Tops						
 <ul style="list-style-type: none"> • 1" Ballet black ribbed vinyl T-mold • 1/8" D profile 	<ul style="list-style-type: none"> • Available 	<ul style="list-style-type: none"> • Available with square corners only, injection-molded plastic 	<ul style="list-style-type: none"> • Available with square corners only, injection-molded plastic 	<ul style="list-style-type: none"> • Available 	<ul style="list-style-type: none"> • Available with square corners only, injection-molded plastic 	<ul style="list-style-type: none"> • Available

Ballet Collaborative and Conference Tables

Connections

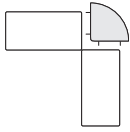

Connecting tops can link perpendicular tables at 90° and expand the useable area in many different configurations. ▶ See page 48

Modesty panel is available on many Ballet tables. Panel is ribbed extruded aluminum with powder coat color and includes a non-exposed horizontal wire management trough. ▶ See individual product specification pages for availability.

Gangers are available in one type—bar. Use bar gangers in applications where tables need to be rigidly linked for long periods of time. Threaded inserts for bar gangers are always factory installed. Bar gangers are field installed.

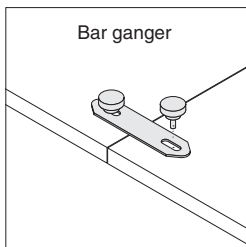

Bar gangers use steel bars to join adjacent tables. One end of the bar is captured by the host table and allows the bar to pivot beneath adjacent table where it is captured by a threaded post with knob. Factory-installed threaded insert in underside of table top accepts the threaded knob. No tools are required to link tables with bar gangers.

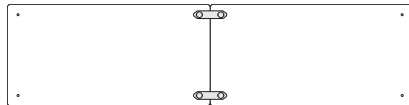

End-to-end

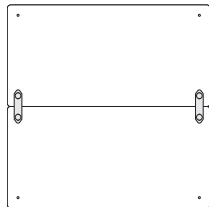

Side-to-side (Not available on tables with modesty panels.)

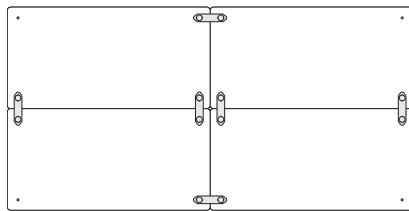

End-and-side (Not available on tables with modesty panels.)

Factory-installed bar ganger inserts are standard on all rectangular Ballet tables to allow tables to be joined end-to-end and/or side-to-side. Threaded inserts are available as an option on Ballet tables with vinyl or self edges. Specify universal ganging when you order your tables. You must also order the appropriate number of ganger packages separately. Order one package for each pair of table edges that are going to be joined.

Tip: Please send a drawing of your arrangement along with your order to ensure that gangers are properly installed.

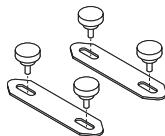

Bar ganger package is available.

Bar Ganger Package	Style Number
Bar ganger for 1/4"-thick tops	793335



If your tables are going to be used in a configuration that requires ganging, please send us a drawing or sketch so that we can give you exactly what you want.

Wiring & Cabling

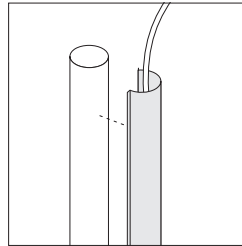

Vertical wire manager is available to clip on to Ballet table leg to conceal power cords and voice/data cables routed vertically from the floor to the worksurface. Vertical wire manager is black plastic. ▶ See page 49

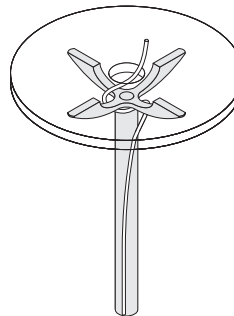

Technology spider is a cable-management version of the traditional spider that is used to attach a table top to a column. The spider provides clearance for power cords and voice/data cables to pass through the table top so that Interport modules, grommets, and spheres can be positioned directly above a table base.



Grommets are available factory installed. Locations are listed in the table below (left, right, center).

Field installation available. To specify, order the grommet and the table as separate items.

Grommet has 2"-diameter opening. Dimensions given are from the center of opening and are accurate within 1/4". Left, right, and center are from the user's perspective.

Ballet X-base grommets are available for field installation. To specify, order the grommet and the table as separate items. Custom locations are possible.

Spheres are available factory installed (left, right, center) as a special. Locations are listed in the table to the right.

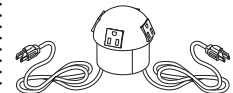

Four simplex power outlets



Two simplex power outlets and two data jack locations



Four data jack locations

Field-installed sphere is practical on many table tops. Order unit separately and cut the required hole in the table top on site. Installation instructions will be shipped with the sphere.

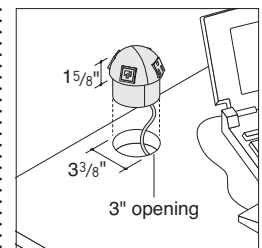

Sphere has 3"-diameter opening. Dimensions given are from center of opening and are accurate within 1/4". Left, right, and center are from the user's perspective. Additional locations are possible. Contact Customer Service at 1.800.627.6770.

Ballet Collaborative and Conference Tables *continued*

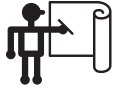

Please send a drawing of your arrangement along with your order to ensure that grommets and spheres are properly installed.

Interport and Mini-Port are available factory cut in custom locations. This process requires engineering review and additional lead time may be required. *Tip: Send us a drawing indicating desired location(s). An additional charge may apply if the standard table design requires modification.*

Interport and Mini-Port are also available for field installation. To specify, order the Interport or Mini-Port and the table as separate items.

Interact is available factory cut in custom locations. This process requires engineering review and additional lead time may be required. *Tip: Send us a drawing indicating desired location(s). An additional charge may apply if the standard table design requires modification.*

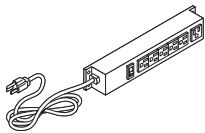

Power strips are available as an accessory, ordered separately.

Surface Materials

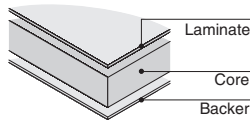

Laminates are available in two standard grades. Additional laminates from any manufacturer may also be practical—see below.

Grade 1 laminates include:

- Coalesse standard High-Pressure Laminates
- ▶ See *Coalesse Surface Materials Reference Guide*.

- Steelcase standard High-Pressure Laminates (code 290A)

▶ See *Steelcase Surface Materials Reference Manual*.

- Any standard-grade Wilsonart High-Pressure Laminates in solid color, woodgrain, or pattern finish (code 290A)

Grade 2 laminates (code 290B)

include any standard-grade, solid color, woodgrain, or patterned High-Pressure Laminates from Nevamar (includes Matrix), Formica, or Pionite. Grade 2 laminates may have extended lead times. For details, contact Customer Service at 1.800.627.6770.

Other laminates that are not included in the Grade 1 or Grade 2 offerings may also be available, such as Abet Laminati and Laminart. To determine availability and pricing, contact Customer Service at 1.800.627.6770, with the laminate manufacturer's name and the name and number of the laminate you want.

Laminate swatches are reproduced in the *Coalesse Surface Materials Reference Guide*.

Swatch cards and actual samples of Coalesse standard laminates are available from your Coalesse Customer Service representative. For samples of High-Pressure Laminates from other manufacturers, contact them directly:
Wilsonart
1.800.433.3222
Nevamar
1.800.638.4380
Formica
1.800.FORMICA
Pionite
1.800.285.5161
Tip: Laminate manufacturers change their offerings frequently. Always check availability before ordering.

Care & Maintenance

Laminate should be cleaned with soap and water. For stubborn stains, use a non-abrasive household cleaner.

Powder coat finishes on table bases should be cleaned with a liquid detergent and water. Remove stubborn stains with liquid cleanser, such as Formula 409.

Polished aluminum finishes on table bases should be cleaned with a commercial powder, liquid, or paste metal cleaner and polish. Follow the manufacturer's directions.

Tables should be inspected and maintained regularly by tightening screws and bolts, inspecting casters and glides for damage, and inspecting all moving parts for damage and wear.

Seating Capacity Guidelines

Depth	Width	Approximate Capacity
Round Tops		
30"		3
36"		4
Square Tops		
30"	30"	4
36"	36"	4
Rectangular Tops		
60"	30"	6 Ballet X-leg
72"	30"	6 Ballet X-leg
84"	30"	6
96"	30"	8
60"	36"	6
72"	36"	6
84"	36"	6
96"	36"	8
72"	42"	6
84"	42"	6
96"	42"	8

Ballet Collaborative and Conference Tables Arc Tables

Tip: Shipped knocked down.

Standard Includes	Required to Specify
<p>► Need help? Product details, page 34</p> <ul style="list-style-type: none"> • Top: 1" particle board core with High-Pressure Laminate • Edge: black ribbed vinyl T-mold with matching plastic corner inserts • X-base: cast aluminum legs and 1" x 3" extruded aluminum stretcher bar between legs with single powder coat color • Threaded inserts in underside of top for end-to-end ganging • Leveling glides: non-marring, black plastic 	<ul style="list-style-type: none"> 1 Style number 2 Powder coat color number for base 3 Laminate color number for top 4 Options, if selected (see below) <p>► See <i>Coalesse Surface Materials Reference Guide</i>.</p>

Options	U.S. Price	Required to Specify
<p>Surface Materials</p> <p>Top</p> <ul style="list-style-type: none"> • Grade 2 laminate • Grade 3 laminate 	<p>Prices below</p> <p>Prices below</p>	<p>Specify with <i>Grade 2 laminate</i> and select color number.</p> <p>Specify with <i>Grade 3 laminate</i> and select color number.</p>
<p>Related Products</p> <ul style="list-style-type: none"> • Bar ganger package • Power strip • Café tables 		<ul style="list-style-type: none"> ► Page 49 ► Page 739 ► Page 648

Tip: For installation of a grommet or sphere, submit a drawing indicating the desired location for a factory installed cutout. Field installation is also available. Both require the grommet or sphere to be ordered as a separate item.



Specification Information			
Dimensions	Style	Finish	U.S. Price
L W H	Number		
			
		Ballet Ribbed Vinyl T-Mold Edge:	

Folding Arc Tables					
55"	30"	28½"	915415	Grade 1 Laminate	\$3364
				Grade 2 and 3 Laminate	\$3442
82"	30"	28½"	916416	Grade 1 Laminate	\$3650
				Grade 2 and 3 Laminate	\$3769

Non-Folding Arc Tables					
55"	30"	28½"	915405	Grade 1 Laminate	\$2865
				Grade 2 and 3 Laminate	\$2943
82"	30"	28½"	916406	Grade 1 Laminate	\$3031
				Grade 2 and 3 Laminate	\$3150

 **For Canadian Pricing**
 Multiply U.S. Price by the Canadian price factor.
 ► See page 1 for details.

Ballet Collaborative and Conference Tables Non-Folding Side Tables

Tip: Shipped knocked down.

Standard Includes	Required to Specify
<p>► Need help? Product details, page 34</p> <ul style="list-style-type: none"> • Top: 3/4" particle board core with High-Pressure Laminate • Edge: black ribbed vinyl T-mold • Pedestal base: aluminum with powder coat • 19" cast aluminum technology spider • 2" diameter, locking, dual-wheel casters: black plastic 	<ul style="list-style-type: none"> 1 Style number 2 Powder coat color number for base 3 Laminate color number for top 4 Options, if selected (see below) <p>► See <i>Coalesse Surface Materials Reference Guide</i>.</p>

Tip: When specifying glides height of table does not change.

Options	U.S. Price	Required to Specify
<p>Surface Materials</p> <p>Top</p> <ul style="list-style-type: none"> • Grade 2 laminate • Grade 3 laminate 	<p>Prices below</p> <p>Prices below</p>	<p>Specify with <i>Grade 2 laminate</i> and select color number.</p> <p>Specify with <i>Grade 3 laminate</i> and select color number.</p>
<p>Glides</p> <ul style="list-style-type: none"> • Leveling glides in place of casters: non-marring, black plastic 	<p>-\$259</p>	<p>Delete suffix C from the style number.</p>
<p>Related Products</p> <ul style="list-style-type: none"> • Café tables 		<p>► Page 648</p>

Tip: For installation of a grommet or sphere, submit a drawing indicating the desired location for a factory installed cutout. Field installation is also available. Both require the grommet or sphere to be ordered as a separate item.

Specification Information					
Dimensions			Style	Finish	U.S. Base Price
Dia	L	W	H	Number	
					 <p>Ballet Ribbed Vinyl T-Mold Edge:</p>



Round Table

27"	N.A.	N.A.	25½"	919423C	Grade 1 Laminate	\$1323
					Grade 2 and 3 Laminate	\$1369



Racetrack Table

N.A.	36"	24"	25½"	920424C	Grade 1 Laminate	\$1485
					Grade 2 and 3 Laminate	\$1531



For Canadian Pricing
 Multiply U.S. Price by the Canadian price factor.
 ► See page 1 for details.

Ballet Collaborative and Conference Tables Round Pedestal Base Tables



Tip: Special table height available, call Customer Service for quote.

Tip: Shipped knocked down.

Tip: When specifying casters height of table does not change.

Tip: For installation of a grommet or sphere, submit a drawing indicating the desired location for a factory installed cutout. Field installation is also available. Both require the grommet or sphere to be ordered as a separate item.

Standard Includes	Required to Specify
<ul style="list-style-type: none"> ▶ Need help? Product details, page 34 • Top: ¾" particle board core with High-Pressure Laminate • Edge: black ribbed vinyl T-mold • Base: 2" diameter steel column and 4-prong cast aluminum feet with single powder coat • 19" cast aluminum technology spider • Adjustable leveling glides: non-marring, black plastic 	<ul style="list-style-type: none"> 1 Style number 2 Powder coat color number for base 3 Laminate or wood color number for top 4 Options, if selected (see below) ▶ See <i>Coalesse Surface Materials Reference Guide</i>.

Options	U.S. Price	Required to Specify
Surface Materials <ul style="list-style-type: none"> • Top • Grade 2 laminate • Grade 3 laminate 	<ul style="list-style-type: none"> Prices below Prices below 	<ul style="list-style-type: none"> Specify with <i>Grade 2 laminate</i> and select color number. Specify with <i>Grade 3 laminate</i> and select color number.
Flip top ▶ Page 35 <ul style="list-style-type: none"> • Flip top on tables 	+\$259	Add suffix F to the style number.
Casters ▶ Page 35 <ul style="list-style-type: none"> • 2" diameter, locking, dual-wheel casters in place of leveling glides: black plastic 	+\$259	Add suffix C to style number.
Related Products <ul style="list-style-type: none"> • Café tables 		▶ Page 648

Specification Information			
Dimensions	Style Number	Finish	U.S. Base Price
30" Dia 28½" H	933421	Grade 1 Laminate	\$1327
		Grade 2 and 3 Laminate	\$1373
36" Dia 28½" H	934421	Grade 1 Laminate	\$1477
		Grade 2 and 3 Laminate	\$1538



Ballet Ribbed Vinyl T-Mold Edge:



For Canadian Pricing
 Multiply U.S. Price by the Canadian price factor.
 ▶ See page 1 for details.

Ballet Collaborative and Conference Tables Square Pedestal Base Tables



Tip: Special table height available, call Customer Service for quote.

Tip: Shipped knocked down.

Tip: When specifying casters height of table does not change.

Tip: For installation of a grommet or sphere, submit a drawing indicating the desired location for a factory installed cutout. Field installation is also available. Both require the grommet or sphere to be ordered as a separate item.

Standard Includes	Required to Specify
<p>► Need help? Product details, page 34</p> <ul style="list-style-type: none"> • Top: 1" particle board core with High-Pressure Laminate • Edge: black ribbed vinyl T-mold with matching plastic corner inserts • Base: 2" diameter steel column and 4-prong cast aluminum feet with single powder coat • 19" cast aluminum technology spider • Adjustable leveling glides: non-marring, black plastic 	<ul style="list-style-type: none"> 1 Style number 2 Powder coat color number for base 3 Laminate color number for top 4 Options, if selected (see below) <p>► See <i>Coalesse Surface Materials Reference Guide</i>.</p>

Options	U.S. Price	Required to Specify
<p>Surface Materials</p> <p>Top</p> <ul style="list-style-type: none"> • Grade 2 laminate • Grade 3 laminate 	<p>Prices below</p> <p>Prices below</p>	<p>Specify with <i>Grade 2 laminate</i> and select color number.</p> <p>Specify with <i>Grade 3 laminate</i> and select color number.</p>
<p>Flip top</p> <p>► Page 35</p> <ul style="list-style-type: none"> • Flip top on tables 	<p>+\$259</p>	<p>Add suffix F to the style number.</p>
<p>Casters</p> <p>► Page 35</p> <ul style="list-style-type: none"> • 2" diameter, locking, dual-wheel casters in place of leveling glides: black plastic 	<p>+\$259</p>	<p>Add suffix C to the style number.</p>
<p>Related Products</p> <ul style="list-style-type: none"> • Café tables 		<p>► Page 648</p>

Specification Information					
Dimensions			Style Number	Finish	U.S. Price
L	W	H			
30"	30"	28½"	926421	Grade 1 Laminate	\$1425
				Grade 2 and 3 Laminate	\$1471
36"	36"	28½"	927422	Grade 1 Laminate	\$1560
				Grade 2 and 3 Laminate	\$1621



Ballet Ribbed Vinyl T-Mold Edge:

For Canadian Pricing
 Multiply U.S. Price by the Canadian price factor.
 ► See page 1 for details.

Ballet Collaborative and Conference Tables

Square Pedestal Base Tables

Ballet Collaborative and Conference Tables Rectangular Folding X-Base Tables

Tip: Shipped assembled.

Standard Includes	Required to Specify
<p>► Need help? Product details, page 34</p> <ul style="list-style-type: none"> • Top: 1" multi-ply wood core with High-Pressure Laminate • Edge: black ribbed vinyl T-mold with matching plastic corner inserts • X-base: cast aluminum legs and 1" x 3" extruded aluminum stretcher bar between legs with single powder coat color • Modesty panel with horizontal wire management trough, if selected: extruded aluminum with powder coat color • Threaded inserts in underside of top for end-to-end ganging • Adjustable leveling glides: non-marring, black plastic 	<ol style="list-style-type: none"> 1 Style number 2 Powder coat color number for base 3 Laminate color number for top 4 Powder coat color number for modesty panel, if selected 5 Options, if selected (see below) <p>► See <i>Coalesse Surface Materials Reference Guide</i>.</p>

Options	U.S. Price	Required to Specify
<p>Surface Materials</p> <p>Top</p> <ul style="list-style-type: none"> • Grade 2 laminate • Grade 3 laminate 	<p>Prices below and at right</p> <p>Prices below and at right</p>	<p>Specify with <i>Grade 2 laminate</i> and select laminate color number.</p> <p>Specify with <i>Grade 3 laminate</i> and select color number.</p>
<p>Related Products</p> <ul style="list-style-type: none"> • Bar ganger package • Power strip • Café tables 		<p>► Page 49</p> <p>► Page 739</p> <p>► Page 648</p>

Tip: For installation of a grommet or sphere, submit a drawing indicating the desired location for a factory installed cutout. Field installation is also available. Both require the grommet or sphere to be ordered as a separate item.

Specification Information			
Dimensions	Style Number	Finish	U.S. Price
L W H			
			
		Ballet Ribbed Vinyl T-Mold Edge:	

30"W Rectangular Folding X-Base Tables

Without Modesty Panel

60"	30"	28½"	853411	Grade 1 Laminate	\$2635
				Grade 2 and 3 Laminate	\$2718
72"	30"	28½"	854412	Grade 1 Laminate	\$2705
				Grade 2 and 3 Laminate	\$2806
84"	30"	28½"	855413	Grade 1 Laminate	\$3061
				Grade 2 and 3 Laminate	\$3181
96"	30"	28½"	856414	Grade 1 Laminate	\$3214
				Grade 2 and 3 Laminate	\$3348

With Modesty Panel

60"	30"	28½"	853461	Grade 1 Laminate	\$3296
				Grade 2 and 3 Laminate	\$3379
72"	30"	28½"	854462	Grade 1 Laminate	\$3389
				Grade 2 and 3 Laminate	\$3490
84"	30"	28½"	855463	Grade 1 Laminate	\$3751
				Grade 2 and 3 Laminate	\$3871
96"	30"	28½"	856464	Grade 1 Laminate	\$3912
				Grade 2 and 3 Laminate	\$4046

► Specification Information, continued on next page



For Canadian Pricing
 Multiply U.S. Price by the Canadian price factor.
 ► See page 1 for details.

Ballet Collaborative and Conference Tables

Rectangular Folding X-Base Tables

► Specification Information, continued from previous page

Specification Information

Dimensions			Style Number	Finish	U.S. Price
L	W	H			
					 <p>Ballet Ribbed Vinyl T-Mold Edge:</p>

36"W Rectangular Folding X-Base Tables



Without Modesty Panel

60"	36"	28½"	823411	Grade 1 Laminate	\$2768
				Grade 2 and 3 Laminate	\$2869
72"	36"	28½"	824412	Grade 1 Laminate	\$2818
				Grade 2 and 3 Laminate	\$2940
84"	36"	28½"	825413	Grade 1 Laminate	\$3129
				Grade 2 and 3 Laminate	\$3267
96"	36"	28½"	826414	Grade 1 Laminate	\$3389
				Grade 2 and 3 Laminate	\$3548



With Modesty Panel

60"	36"	28½"	823461	Grade 1 Laminate	\$3425
				Grade 2 and 3 Laminate	\$3526
72"	36"	28½"	824462	Grade 1 Laminate	\$3502
				Grade 2 and 3 Laminate	\$3624
84"	36"	28½"	825463	Grade 1 Laminate	\$3816
				Grade 2 and 3 Laminate	\$3954
96"	36"	28½"	826464	Grade 1 Laminate	\$4097
				Grade 2 and 3 Laminate	\$4256

42"W Rectangular Folding X-Base Tables



Without Modesty Panel

72"	42"	28½"	814412	Grade 1 Laminate	\$3649
				Grade 2 and 3 Laminate	\$3787
84"	42"	28½"	815413	Grade 1 Laminate	\$3708
				Grade 2 and 3 Laminate	\$3873
96"	42"	28½"	816414	Grade 1 Laminate	\$3829
				Grade 2 and 3 Laminate	\$4015



With Modesty Panel

72"	42"	28½"	814462	Grade 1 Laminate	\$4298
				Grade 2 and 3 Laminate	\$4436
84"	42"	28½"	815463	Grade 1 Laminate	\$4395
				Grade 2 and 3 Laminate	\$4560
96"	42"	28½"	816464	Grade 1 Laminate	\$4538
				Grade 2 and 3 Laminate	\$4724

For Canadian Pricing
 Multiply U.S. Price by the
 Canadian price factor.
 ► See page 1 for details.

Ballet Collaborative and Conference Tables Rectangular Non-Folding X-Base Tables

Tip: Shipped knocked down.

Standard Includes	Required to Specify
<p>► Need help? Product details, page 34</p> <ul style="list-style-type: none"> • Top: 1" MDF core with High-Pressure Laminate • Edge: black ribbed vinyl T-mold with matching plastic corner inserts • X-base: cast aluminum legs and 1" x 3" extruded aluminum stretcher bar between legs with single powder coat color • Modesty panel with horizontal wire management trough, if selected: extruded aluminum with powder coat • Threaded inserts in underside of top for end-to-end ganging • Adjustable leveling glides: non-marring, black plastic 	<ol style="list-style-type: none"> 1 Style number 2 Powder coat color number for base 3 Laminate color number for top 4 Powder coat color number for modesty panel, if selected 5 Options, if selected (see below) <p>► See <i>Coalesse Surface Materials Reference Guide</i>.</p>

Options	U.S. Price	Required to Specify
<p>Surface Materials</p> <p>Top</p> <ul style="list-style-type: none"> • Grade 2 laminate • Grade 3 laminate 	<p>Prices below and at right</p> <p>Prices below and at right</p>	<p>Specify with <i>Grade 2 laminate</i> and select color number.</p> <p>Specify with <i>Grade 3 laminate</i> and select color number.</p>
<p>Related Products</p> <ul style="list-style-type: none"> • Bar ganger package • Café tables 		<p>► Page 49</p> <p>► Page 648</p>

Tip: For installation of grommets, spheres, Mini-Port, Interport, Interact, Axil Z, or Ellora submit a drawing indicating the desired location for a factory installed cutout(s). Field installation is also available. All require the grommet(s), sphere(s), Mini-Port, Interport, Interact, Axil Z, or Ellora to be ordered as a separate item.

Specification Information					
Dimensions			Style	Finish	U.S. Price
L	W	H	Number		
				 <p>Ballet Ribbed Vinyl T-Mold Edge:</p>	

30"W Rectangular Non-Folding X-Base Tables

Without Modesty Panel

60"	30"	28½"	873401	Grade 1 Laminate	\$2471
				Grade 2 and 3 Laminate	\$2554
72"	30"	28½"	874402	Grade 1 Laminate	\$2552
				Grade 2 and 3 Laminate	\$2653
84"	30"	28½"	875403	Grade 1 Laminate	\$2897
				Grade 2 and 3 Laminate	\$3017
96"	30"	28½"	876404	Grade 1 Laminate	\$3055
				Grade 2 and 3 Laminate	\$3189

With Modesty Panel

60"	30"	28½"	873451	Grade 1 Laminate	\$3134
				Grade 2 and 3 Laminate	\$3217
72"	30"	28½"	874452	Grade 1 Laminate	\$3222
				Grade 2 and 3 Laminate	\$3323
84"	30"	28½"	875453	Grade 1 Laminate	\$3594
				Grade 2 and 3 Laminate	\$3714
96"	30"	28½"	876454	Grade 1 Laminate	\$3753
				Grade 2 and 3 Laminate	\$3887

► Specification Information, continued on next page



For Canadian Pricing
 Multiply U.S. Price by the Canadian price factor.
 ► See page 1 for details.

Ballet Collaborative and Conference Tables Rectangular Non-Folding X-Base Tables

Tip: For installation of grommets, spheres, Mini-Port, Interport, Interact, Axil Z, or Ellora submit a drawing indicating the desired location for a factory installed cutout(s). Field installation is also available. All require the grommet(s), sphere(s), Mini-Port, Interport, Interact, Axil Z, or Ellora to be ordered as a separate item.

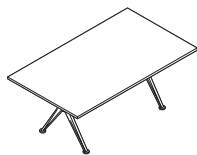

 **For Canadian Pricing**
 Multiply U.S. Price by the Canadian price factor.
 ▶ See page 1 for details.

► Specification Information, continued from previous page

Specification Information

Dimensions			Style Number	Finish	U.S. Price
L	W	H			
					 Ballet Ribbed Vinyl T-Mold Edge:

36"W Rectangular Non-Folding X-Base Tables

Without Modesty Panel

60"	36"	28½"	883401	Grade 1 Laminate	\$2600
				Grade 2 and 3 Laminate	\$2701
72"	36"	28½"	884402	Grade 1 Laminate	\$2655
				Grade 2 and 3 Laminate	\$2777
84"	36"	28½"	885403	Grade 1 Laminate	\$2965
				Grade 2 and 3 Laminate	\$3103
96"	36"	28½"	886404	Grade 1 Laminate	\$3222
				Grade 2 and 3 Laminate	\$3381

With Modesty Panel

60"	36"	28½"	883451	Grade 1 Laminate	\$3263
				Grade 2 and 3 Laminate	\$3364
72"	36"	28½"	884452	Grade 1 Laminate	\$3329
				Grade 2 and 3 Laminate	\$3451
84"	36"	28½"	885453	Grade 1 Laminate	\$3660
				Grade 2 and 3 Laminate	\$3798
96"	36"	28½"	886454	Grade 1 Laminate	\$3934
				Grade 2 and 3 Laminate	\$4093

42"W Rectangular Non-Folding X-Base Tables

Without Modesty Panel

72"	42"	28½"	834402	Grade 1 Laminate	\$3459
				Grade 2 and 3 Laminate	\$3597
84"	42"	28½"	835403	Grade 1 Laminate	\$3544
				Grade 2 and 3 Laminate	\$3709
96"	42"	28½"	836404	Grade 1 Laminate	\$3668
				Grade 2 and 3 Laminate	\$3854

With Modesty Panel

72"	42"	28½"	834452	Grade 1 Laminate	\$4133
				Grade 2 and 3 Laminate	\$4271
84"	42"	28½"	835453	Grade 1 Laminate	\$4241
				Grade 2 and 3 Laminate	\$4406
96"	42"	28½"	836454	Grade 1 Laminate	\$4380
				Grade 2 and 3 Laminate	\$4566

Ballet Collaborative and Conference Tables Connecting Tops



Standard Includes	Required to Specify
<ul style="list-style-type: none"> ▶ Need help? Product details, page 37 • Top: 1" MDF core with High-Pressure Laminate • Edge: black ribbed vinyl T-mold with matching plastic corner inserts • Connecting hardware to attach to adjacent tables 	<ul style="list-style-type: none"> 1 Style number 2 Laminate color number for top 3 Options, if selected (see below) ▶ See <i>Coalesse Surface Materials Reference Guide</i>.

Options	U.S. Price	Required to Specify
Surface Materials <ul style="list-style-type: none"> • Top • Grade 2 laminate • Grade 3 laminate 	<ul style="list-style-type: none"> Prices below Prices below 	<ul style="list-style-type: none"> Specify with <i>Grade 2 laminate</i> and select laminate color number. Specify with <i>Grade 3 laminate</i> and select color number.

Specification Information			
Dimension Width	Style Number	Finish	U.S. Price
			
		Ballet Ribbed Vinyl T-Mold Edge:	

90° Connecting Tops

Dimension Width	Style Number	Finish	U.S. Price
20"	849000	Grade 1 Laminate	\$ 838
		Grade 2 and 3 Laminate	\$ 894
24"	809000	Grade 1 Laminate	\$ 903
		Grade 2 and 3 Laminate	\$ 959
30"	909000	Grade 1 Laminate	\$1021
		Grade 2 and 3 Laminate	\$1077



For Canadian Pricing
 Multiply U.S. Price by the Canadian price factor.
 ▶ See page 1 for details.

Vertical Wire Manager



Standard Includes	Required to Specify
<ul style="list-style-type: none"> ▶ Need help? Product details, page 37 • Vertical wire manager to attach to Ballet K-legs: black plastic only 	Style number

Specification Information				
Dimensions			Style	U.S.
L	D	W	Number	Price
3/4"	1"	17"	793332	\$51

Bar Ganger Package

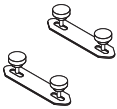

Standard Includes	Required to Specify
<ul style="list-style-type: none"> ▶ Need help? Product details, page 37 • Two field-installed steel bars and four threaded hand knobs: black steel only 	Style number

Specification Information	
Style Number	U.S. Price
793335	\$86

Ballet Collaborative and Conference Tables



For Canadian Pricing
 Multiply U.S. Price by the Canadian price factor.
 ▶ See page 1 for details.

Grommets for Standard Locations

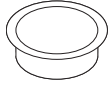

Tip: The grommet will be shipped with the table so it can be installed on site in the factory-cut opening.

Tip: Custom locations are possible. Custom locations require an engineering review to confirm practicality. Please send a drawing to your Customer Service representative to show the locations you want, confirm practicality, and obtain a quotation.

Tip: Please send a drawing of your arrangement along with your order to ensure that grommets are properly installed.

Tip: Additional tables may be able to accommodate grommets. Ask your Customer Service representative at 1.800.627.6770 to help you determine practicality.

	Standard Includes	Required to Specify
▶ Need help? Product details, page 37	<ul style="list-style-type: none"> • 2" diameter opening with snap out covers allow power cords and voice/data cables to pass through the worksurface: black plastic 	Style number

Specification Information

Style Number	U.S. Price
793215	\$105



For Canadian Pricing
 Multiply U.S. Price by the Canadian price factor.
 ▶ See page 1 for details.

Power and Communication Spheres for Standard Locations

Tip: The sphere will be shipped with the table so it can be installed on site in the factory-cut opening.

Tip: Field-installed sphere is practical on many table tops. Order unit separately and cut the required hole in the table top on site. Installation instructions will be shipped with the sphere.

Tip: Custom locations are possible. Custom locations require an engineering review to confirm practicality. Please send a drawing to your Customer Service representative to show the locations you want, confirm practicality, and obtain a quotation.

Tip: Please send a drawing of your arrangement along with your order to ensure that spheres are properly installed.

Tip: Additional tables may be able to accommodate spheres. Ask your Customer Service representative at 1.800.627.6770 to help you determine practicality.

Tip: If couplers are needed on PCS or CSP they must be ordered separately.



Standard Includes	Required to Specify
<p>► Need help? Product details, page 38</p> <ul style="list-style-type: none"> • 3$\frac{3}{8}$" diameter and 1$\frac{5}{8}$"H above table surface: black plastic • 6' power cord • Sphere selection: <ul style="list-style-type: none"> - Power sphere (PSP) with four simplex power outlets - Power and communication sphere (PCS) with two simplex power outlets and two spaces to connect RJ11 or RJ45 couplers on site - Communication sphere (CSP) with four spaces to connect RJ11 or RJ45 couplers on site 	<p>Style number</p>

Specification Information

Style Number	U.S. Price
--------------	------------

Four Data Jack Locations

CSP	\$265
-----	-------

Two Simplex Power Outlets and Two Data Jack Locations

PCS	\$403
-----	-------

Four Simplex Power Outlets

PSP	\$586
-----	-------

For Canadian Pricing
 Multiply U.S. Price by the Canadian price factor.
 ► See page 1 for details.

Ballet Collaborative and Conference Tables Accessories

Data Jack Couplers

Standard Includes	Required to Specify
<ul style="list-style-type: none"> Data coupler 	Style number

Specification Information

Style Number	U.S. Price
RJ11	\$19
RJ45	\$23

Mobile Storage Cart

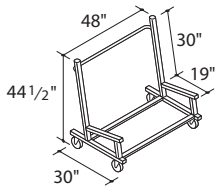

Tip: Shipped knocked down.

Tip: Mobile storage cart accommodates folding Ballet tables of lengths from 48"-72" and widths up to 42". Folded height is 35/8".

Standard Includes	Required to Specify
<ul style="list-style-type: none"> Need help? Product details, page 35 Cart to accommodate up to five folding Ballet tables: black only Bumpers: black 	Style number

Specification Information

Style Number	U.S. Price
--------------	------------

Accommodates 48"L, 60"L, or 72"L Tables up to 42"W

793333	\$3389
--------	--------



For Canadian Pricing
 Multiply U.S. Price by the Canadian price factor.
 ▶ See page 1 for details.

E-Table 2

Collaborative and Conference Tables

Understanding		54	Specifying, continued	
Specifying				
Parametric Round Working Height Tables with Laminate Base		86	Parametric Rectangular Working Height Tables with Laminate Bases	214
Parametric Round Working Height Tables with Veneer Base		88	Parametric Rectangular Working Height Tables with Veneer Bases	226
Parametric Racetrack Working Height Tables with Aluminum Bases		90	Parametric Soft Radiused Working Height Tables with Aluminum Bases	238
Parametric Racetrack Standing Height Tables with Aluminum Bases		108	Parametric Soft Radiused Standing Height Tables with Aluminum Bases	254
Parametric Racetrack Working Height Tables with Laminate Bases		116	Parametric Soft Radiused Working Height Tables with Laminate Bases	262
Parametric Racetrack Working Height Tables with Veneer Bases		128	Parametric Soft Radiused Working Height Tables with Veneer Bases	274
Parametric Faceted Working Height Tables with Aluminum Bases		140	Parametric Trapezoid Working Height Tables with Aluminum Bases	286
Parametric Faceted Standing Height Tables with Aluminum Bases		156	Parametric Trapezoid Standing Height Tables with Aluminum Bases	292
Parametric Faceted Working Height Tables with Laminate Bases		164	Parametric Trapezoid Working Height Tables with Laminate Bases	296
Parametric Faceted Working Height Tables with Veneer Bases		176	Parametric Trapezoid Working Height Tables with Veneer Bases	302
Parametric Rectangular Working Height Tables with Aluminum Bases		188	Parametric D-Shape Working Height Tables with Aluminum Bases	308
Parametric Rectangular Standing Height Tables with Aluminum Bases		206	Parametric D-Shape Standing Height Tables with Aluminum Bases	316
			Parametric D-Shape Working Height Tables with Laminate Bases	324
			Parametric D-Shape Working Height Tables with Veneer Bases	328
			Accessories	331

E-Table 2 Collaborative and Conference Tables

E-Table 2 tables seamlessly integrate unsurpassed technology access into an elegant conference table, by way of one-touch utility bays in the table top. The one-touch utility bay provides convenient, intuitive, and attractive connectivity to power and data outlets for portable computers, projectors, and speakerphones. E-Table 2 tables also have built-in vertical and horizontal wire management that meets the growing technological needs of the contemporary conference and meeting room.

Tops are 1/4" thick with particle board core, with either laminate or wood veneer surface. Parametric sizes are also available in 1" increments.

Drum base is molded MDF with either a laminate or wood veneer surface.

Utility bays available on all tables for easy access to power and data.

Bases are available in either laminate, veneer, or aluminum. All bases have cable routing capability.

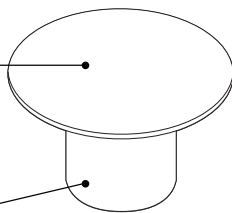

Product Details

Working height table is standard at 29"H. Standing height table is standard at 40"H for aluminum bases only.

Adjustable leveling glides have a range of 1/2" to accommodate uneven floors.



Round

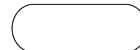

Racetrack



Faceted



Rectangular



Soft radiused end



Trapezoid



D-shape

Table shapes include round, racetrack, faceted, rectangular, soft radiused end, trapezoid, and D-Shape. A wide range of sizes up to 24'L is available to fit any room size.

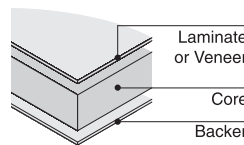

Solid core tops with 1/4" nominal edge thickness have a particle board core (45 lb cu ft density) with High-Pressure Laminate or wood veneer on the top and a backer applied to the opposite side for a balanced construction. High-Pressure Laminate, wood veneer, and backer are bonded to the core with a PVA adhesive.



Flat



Convex

Vinyl edge profiles are available in the following shapes and colors on table tops that are 1/4" thick.

- Flat 1/4" edge
- ▶ See available edgeband finishes in *Coalesse Surface Materials Reference Guide*.
- Convex 1/4" edge available in 6000 Black, 6655 Warm White, 6607 Woodrose, 6609 Smoke. Parametric sizes allow for 6000 Black and 6609 Smoke only.

Tip: 3 mm vinyl edge profiles require a 4" radius on all corners.

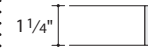

3mm



Beveled



Bullnose

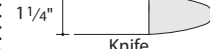

Knife



Waterfall



Faceted

Wood edges are available in six alternatives—beveled, bullnose, knife, waterfall, faceted, and 3 mm. Not every edge is available on every top shape. Parametric top shapes are available in four alternatives beveled, bullnose, knife, and 3 mm.

▶ Refer to the *Edge Availability* matrix.

Seating Capacity Guidelines
▶ See page 62.

E-Table 2 Collaborative and Conference Tables

Parametric Sizing

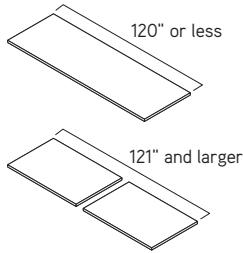

Non-Parametric Sizing

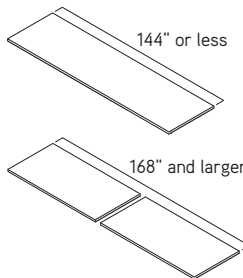

Large tops are shipped in sections with hardware for field assembly. Parametric tops 121"W through 240"W are manufactured and shipped in two equal pieces. Nonparametric tops 168" through 240" are manufactured and shipped in two equal pieces. Parametric tops 241"W through 288"W are manufactured and shipped in three pieces. Nonparametric tops 268" through 288" are manufactured and shipped in three pieces. On all 4 base tables, the two end pieces are equal to each other and will flex, whereas, the center piece will be one fixed dimension.

Sectioned Tops

Large tops can be difficult to move through some buildings.
Tip: Inspect the building where the table will be installed to confirm that elevators, loading docks, hallways, doorways, windows, etc., can accommodate large table tops. You can request any one-piece top to be fabricated and shipped in two pieces to accommodate these small spaces.

To specify sectioned tops, designate sectioned top option. For parametric tables the sectioned top option range is 96"W-120"W. For nonparametric tables, the sectioned top option range is 96"W-144"W.

Custom shapes and sizes

Special table sizes and shapes are possible. To confirm practicality and obtain a quotation, contact Customer Service at 1.800.627.6770.

Parametric Sizing

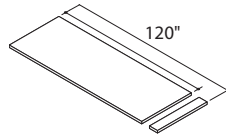

Non-Parametric Sizing

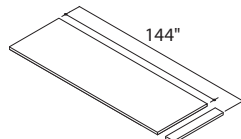

Cut-down tops, which are standard table tops with smaller dimensions, are available. Use the style number of the next larger size and specify the exact dimensions you want. Some restrictions apply, including minimum quantities. Additional lead times may be required. Contact Customer Service at 1.800.627.6770.
Tip: Upcharge for a cut-down top is applied one time only per size/style number.

Tip: Fee is at list and contract discounts apply.

Bases

Removable access door on each base allows for easy installation of utility infeeds. A knockout grommet in each access door allows infeeds through the door from a floor monument outside the base.

Bases are available in four styles—drum, laminate, veneer, and aluminum.

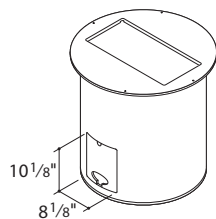

Drum base is molded MDF with either a laminate or a wood veneer surface. The removable access door, 8 1/8"W x 10 1/8"H, is secured with a reclosable fastener. The 24"-diameter drum base has a 12 1/2"-diameter opening in the bottom surrounded by a 60 lb concrete weight for stability.

24" End Support

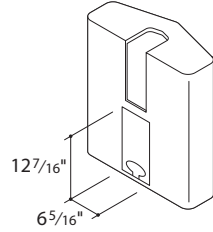

24" Mid Support

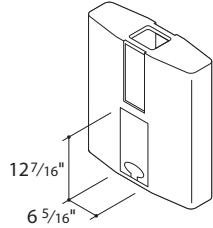

30" End Support

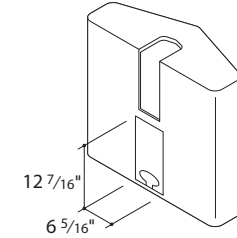

30" Mid Support

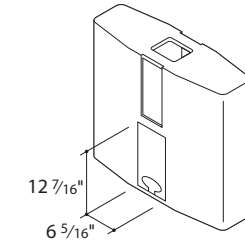

Laminate base has a laminate surface on molded fiberboard. The removable access door, 6 5/16"W x 12 7/16"H, is secured with a reclosable fastener. Laminate bases are available in two sizes, 24"W and 30"W. Bases have glides adjustable up to 1/2" (providing a total floor clearance of 3/4").

24" End Support

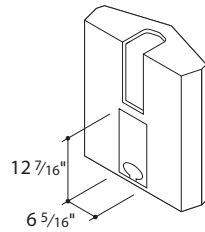

24" Mid Support

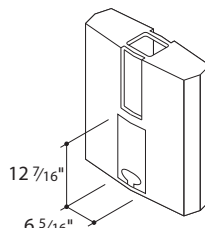

30" End Support

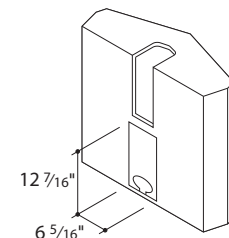

30" Mid Support

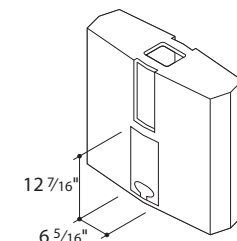

Veneer base is hardwood veneer on MDF. Wood veneer surfaces are available in all Coalesse standard species and finishes. The removable access door, 6 5/16"W x 12 7/16"H, is secured with a reclosable fastener. Veneer bases are available in two sizes, 24"W and 30"W. Bases have glides adjustable up to 1/2" (providing a total floor clearance of 3/4").

30" End Support

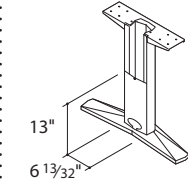

36" Mid Support

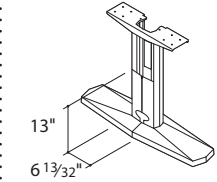

36" End Support

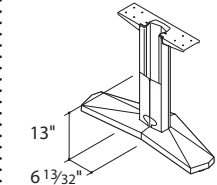

Aluminum base is cast and extruded aluminum, painted with Coalesse powder coat in any color. The black removable access door, 6 13/32"W x 13"H, is secured with screws. Aluminum bases are available in two sizes, 30"W and 36"W. Bases have glides adjustable up to 1/2" (providing a total floor clearance of 3/4").

Cable routing is accommodated by hollow base interiors.

Style, size, and number of bases required are determined by table top shape and length. Round table tops have a single drum base. Table tops 6'L through 12'L have two bases. Table tops 14'L through 20'L have three bases. Table tops 22'L and 24'L have four bases.

All bases conceal flush floor monuments up to 6 3/4" in diameter.

Exception: The 30"W aluminum base fits over but does not completely conceal a flush floor monument.

► For dimensions to aid in locating floor monuments, see page 66.

E-Table 2 Collaborative and Conference Tables *continued*

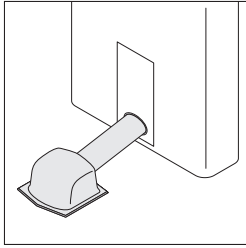

Floor monument kit should be specified when above-the-floor monument is used or when a flush floor monument is not positioned under a base. Above-the-floor monuments may not fit inside a base. Oval conduit is 4 1/5" x 2"H. The floor monument is 6 1/5"L x 7 1/2"W x 3 3/8"H.
 ▶ See page 331.

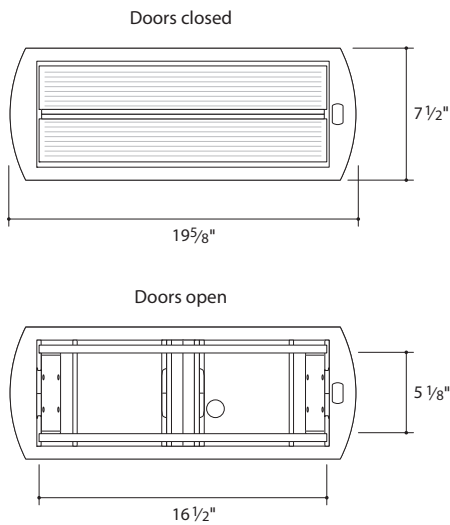

Utility bay is made of formed steel, painted gray, and houses power and data outlets. Overall, utility bay is 19 5/8"L x 7 1/2"W. Door opening is 16 1/2"L x 5 1/8"W.

From one to seven utility bays can be specified depending on the table size. Utility bays are available as an option on all E-Table 2 tables.

Button-actuated doors made of polycarbonate and ABS enclose each utility bay. The doors are available in four colors: nickel mica, silver mica, charcoal mica, and matte black. Soft, compressible cushions of black sanoprene line the doors down the center, allowing cables up to 3/8" diameter to pass between the closed doors.

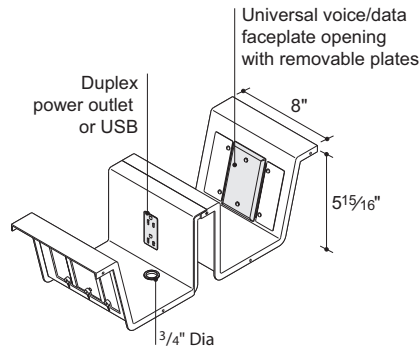

Utility bay interior is 8"W x 5 15/16"D, providing ample room for cords.

Each utility bay has two duplex power outlets that are factory provided and installed at no additional charge. For an additional charge, two USB A ports are available in place of one duplex power outlet.
 ▶ See chart for duplex circuits, page 83.
 ▶ See chart for USB circuits, page 84.

Each utility bay has openings for two customer-supplied standard architectural faceplates. Voice/data faceplate opening has universal adapter with removable plates allowing single-gang size, 2"W x 4"H; double-gang size, 4"W x 4"H; or triple-gang size, 6"W x 4"H. Faceplates that provide network, telephone, and audio-visual outlets are available from various technology suppliers.

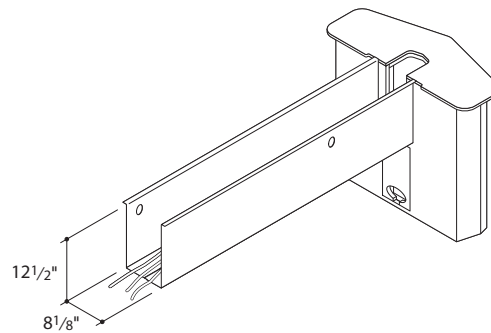

Beam assembly hangs from brackets attached to the bases and encloses all power and voice/data cables. Beam assembly consists of painted steel stretchers, side panels with a 1 1/2"-diameter access grommet on each panel, and a 4 1/2" wide raceway access door on the bottom of the raceway. Beams are 8 1/8"W x 12 1/2"H, with a capacity of 48 UTP cables.

Tip: Access grommet locations are determined by raceway length at the factory.

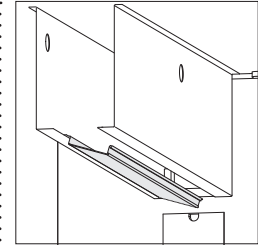

Wireway access door is placed in bottom of wireway. Flanges on top of door rest on side panel flanges.

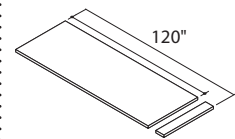

Cut-down tops, which are standard table tops with smaller dimensions, are available. Use the style number of the next larger size and specify the exact dimensions you want. Some restrictions apply, including minimum quantities. This option is not available for folding tables. Additional lead times may be required. Contact Customer Service at 1.800.627.6770.

Tip: Upcharge for a cut-down top is applied one time only per size/style number.

Tip: Fee is at list and contract discounts apply.

E-Table 2 Collaborative and Conference Tables

Laminate
Woodgrain Direction

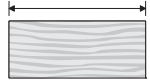

Woodgrain laminates are always oriented with the grain direction running parallel with the length of the table top.

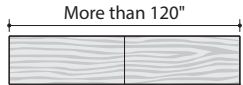

Woodgrain laminate sectioned tops cannot be guaranteed to have a perfect match of the grain pattern along the seam that joins the sections. Large tops that are more than 12' in length require two or more separate sheets of laminate. Coalesse will create the best match that is possible between two sheets of laminate, but depending on the woodgrain laminate pattern that you choose, a perfect match between sections cannot be guaranteed.

For sectioned 3- or 4-piece tops, it is not recommended to use woodgrain laminates, as the grain pattern of each section will not match.

Wood edges are not recommended on tables with wood-grain laminates because matching of woodgrain laminate and natural, solid wood is not guaranteed. For tables with wood edge profiles, always specify either laminates in solid colors or patterns or wood veneer surfaces.

Tip: Because of natural variations, you should know that finished solid wood edges may vary slightly in tone or character from each other or from the samples Coalesse produces. No guarantee can be made of an absolutely exact match.

Standard veneer grain directions—grain direction on E-Table 2 tops runs parallel to the width of the top regardless of the size of the table.

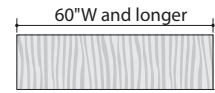

Grain runs parallel to the width on all tops.

Same flitch veneer is available as a special for tables that require similar graining and color, but will not be ganged. For example, specify same flitch veneer for two tables used in the same room, but spaced apart.

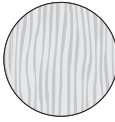
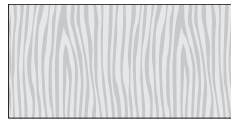

Same flitch matching is specified in cases where you want the veneer grain and pattern on two or more tops to come from the same flitch of veneer. This ensures a consistent grain pattern and coloration and should be specified when tops will be used near each other but not ganged.

U.L. listed, five-wire, 20-amp electrical system is available.

The standard wiring schematic is 3+0, providing three general use circuits. A two-circuit/separate neutrals electrical schematic may also be specified.

► For more details, see *Wiring Schematics*, to the right.



BPIPLUG

NEMA

5-20R outlet

Single circuit plug, 20-amp, base power-in, 3+0 wiring schematic is available on tables with one, two, three, or four utility bays. This offers the quickest, easiest installation of tables. An electrician must provide a NEMA 5-20R outlet for each row within 18" of the infed location. The single circuit plug is U.L. recognized.

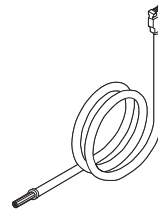

Connection to the building power supply is typically hardwired. A licensed electrician must install the hardwire base power-in. The installation must be done according to all local and national codes.

New York City-approved hardwire base power-in is available (NYC Calendar #37297).

Chicago version of E-Table 2 replaces the modular electrical system with 4"-square single-sided, two-gang, steel junction boxes. To order, specify the option "with utility bay with Chicago wireway". An electrician supplies all other electrical components including wire, conduit, and duplex outlets.

E-Table 2 Collaborative and Conference Tables *continued*

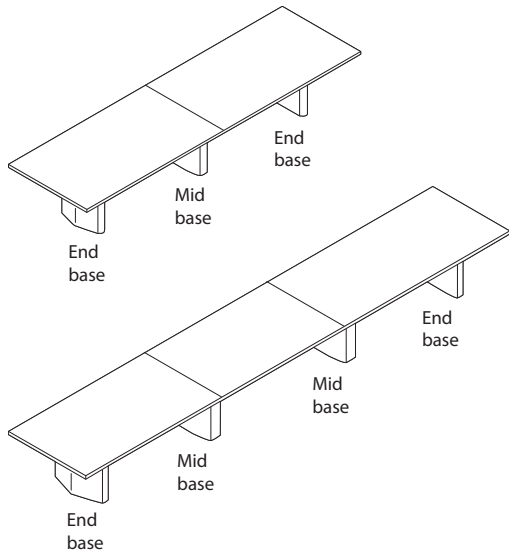

For tables 157”L and longer, you must specify the entry location for the base power of either “end base” or “mid base” entry location.

Three-Circuit, 3+0.

Circuit Panel 1

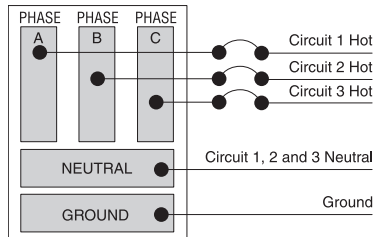

In the three-circuit, 3+0 schematic, circuits 1, 2, and 3 are distributed from the first circuit panel and are supported with one shared neutral and one shared ground.

Single 3-Phase

Circuit Panel

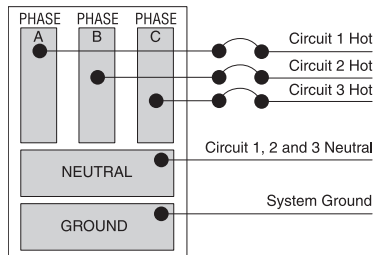

On a single 3-phase circuit panel, all three circuits are distributed as shown.

Two-Circuit Separate Neutrals





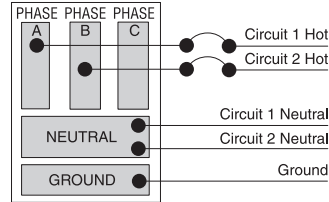









Two circuits are each provided with their own neutral wire.

Circuit Panel 1



In the two-circuit, separate neutral schematic, circuits 1 and 2 are distributed from two different phases from the first circuit panel. Each circuit is supported with its own neutral and a common ground.

E-Table 2 Collaborative and Conference Tables

Edge Alternatives		Table Top Shape							
		Round	Soft Radiused End	Rectangular	Racetrack	D-Shape	Trapezoid	Faceted	
2" Tops									
	<ul style="list-style-type: none"> • 2" faceted wood 	• No	• No	• Available	• No	• No	• Available	• Available	
<i>Tip: Faceted edge profile not available on parametric top offering.</i>									
1 1/4" Tops			<ul style="list-style-type: none"> • 1/4" self-edge wood • 1/8"D profile 	• Available	• Available	• Available	• Available	• Available	• Available
<i>Tip: 3 mm vinyl edge profiles on tables require a 4" radius on all corners.</i>									
	<ul style="list-style-type: none"> • 1/4" bullnose wood • 5/8"D profile 	• Available	• Available	• Available	• Available	• Available	• Available	• Available	
	<ul style="list-style-type: none"> • 1/4" beveled wood • 1/4"D profile 	• Available	• No	• Available	• Available	• Available	• Available	• Available	
	<ul style="list-style-type: none"> • 1/4" knife wood • 2"D profile 	• Available	• No	• Available	• Available	• Available	• Available	• Available	
	<ul style="list-style-type: none"> • 1/4" waterfall wood • 3/2"D profile 	• No	• No	• Available	• No	• No	• Available	• No	
<i>Tip: Waterfall edge profile not available on parametric top offering.</i>									
	<ul style="list-style-type: none"> • 1/4" convex vinyl • 1/4"D profile • Black, Warm White, Woodrose, Smoke 	• Available	• Available	• Available	• Available	• Available	• Available	• Available	
<i>Tip: Parametric top offering is available with black and smoke finishes only.</i>									
	<ul style="list-style-type: none"> • 1/4" flat vinyl • 1/8"D profile ▶ See available edgeband finishes in <i>Coalesse Surface Materials Reference Guide</i>. 	• Available	• Available	• Available	• Available	• Available	• Available	• Available	

E-Table 2 Collaborative and Conference Tables

E-Table 2 Collaborative and Conference Tables *continued*

Surface Materials

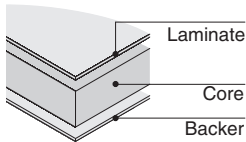

Laminates are available in two standard grades. Additional laminates from any manufacturer may also be practical—see Other laminates below.

Laminate Grades 1 and 2 are price groupings. Grade 2 costs slightly more.

See product specification pages for prices.

Grade 1 laminates include:

- Coalesse standard laminates
- ▶ See *Coalesse Surface Materials Reference Guide*.
- Steelcase standard laminates (code 290A)

See Steelcase Surface Materials Reference Manual.

- Any standard-grade Wilsonart laminate in solid color, woodgrain, or pattern finish (code 290A)

Grade 2 laminates (code 290B) include any standard-grade, solid color, woodgrain, or patterned laminate from Nevamar (includes Matrix), Formica, or Pionite. Grade 2 laminates may have extended lead times. For details, contact Customer Service at 1.800.627.6770.

Other laminates that are not included in the Grade 1 or Grade 2 offerings may also be available, such as Abet Laminati and Laminart. To determine availability and pricing, contact Customer Service at 1.800.627.6770 with the laminate manufacturer's name and the name and number of the laminate you want.

Laminate swatches are reproduced in the Surface Materials Color Palettes.
▶ See *Coalesse Surface Materials Reference Guide* for a list.

Swatch cards and actual samples of Coalesse standard laminates are available from your Coalesse Customer Service representative. For samples of laminates from other manufacturers, contact them directly:

- Wilsonart
1.800.433.3222
- Nevamar
1.800.638.4380
- Formica
1.800.FORMICA
- Pionite
1.800.285.5161

Tip: Laminate manufacturers change their offerings frequently. Always check availability before ordering.

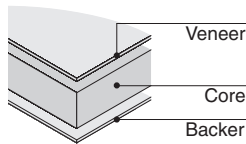

Wood veneer table tops are fabricated with Architectural Grade AA hand-selected hardwood veneer, plain sliced, book matched, and bonded to the core with a backing sheet for balance. Veneer tops and solid wood edge profiles are stained, and then finished with Coalesse's primary wood finish clarity, a water-borne UV topcoat, which protects the environment while providing exceptional durability and resistance to water and chemical stains.

Wood is a natural material; slight variations occur in veneer texture, color, grain configuration, and stain acceptance. Coalesse stains are all applied with an exacting regard for consistency and are well within traditional tolerances for wood products.

Tip: You should know that finished tops may vary slightly in tone or character from each other or from the samples Coalesse produces. No guarantee can be made of an absolutely exact match.

Stains applied to Coalesse wood veneer table tops are standard with the same stain color applied to both the top and the solid hardwood edge profile. Coalesse strives to produce a consistently high quality product and some natural variation in color is to be expected. This is especially apparent on natural woods which have no stain applied, for example 3525 Natural Maple. This color variation is normal and reflects the unique and natural properties of wood. This should not be considered a defect.

Stain swatches are reproduced in the Surface Materials Color Palettes.

▶ See *Coalesse Surface Materials Reference Guide* for a list.

Swatch cards and actual samples of Coalesse standard wood veneers are available from your Coalesse Customer Service representative.

Stain-to-Match is available on this product and allows the matching of any wood finish with a one-time charge per finish.

▶ See *Coalesse Surface Materials Reference Guide* for details.

Table bases are available with polished aluminum or powder coat colors. Refer to the individual product specifying pages for availability. Powder coat colors are shown in the Coalesse Surface Materials Reference Guide.

Care & Maintenance

Laminate should be cleaned with soap and water. For stubborn stains, use a non-abrasive household cleaner.

Veneers should be cleaned regularly with mild soap and water and dried with a soft cloth. To polish, use silicone-free household polishers. Use sparingly.

Tip: Never use ammonia-based cleaners or wax on wood surfaces.

Powder coat finishes on table bases should be cleaned with a liquid detergent and water. Remove stubborn stains with liquid cleanser, such as Formula 409.

Polished aluminum finishes on table bases should be cleaned with a commercial powder, liquid, or paste metal cleaner and polish. Follow the manufacturer's directions.

Tables should be inspected and maintained regularly by tightening screws and bolts, inspecting casters and glides for damage, and inspecting all moving parts for damage and wear.

E-Table 2 Collaborative and Conference Tables

E-Table 2 Collaborative and Conference Tables *continued*

Seating Capacity Guidelines

Depth	Width	Approximate Capacity	Depth	Width	Approximate Capacity	Depth	Center Width	End Width	Approximate Capacity
Rectangular Faceted or Soft Radiused Tops			Racetrack Tops			Trapezoid Tops			
72"	36"	6	72"	36"	6	96"	36"	60"	9
84"	36"	6	84"	36"	6	10'	36"	60"	11
96"	36"	8	96"	36"	6	12'	36"	60"	11
72"	42"	6	72"	42"	6	14'	36"	60"	13
84"	42"	6	84"	42"	6	96"	48"	60"	9
96"	42"	8	96"	42"	6	10'	48"	60"	11
72"	48"	6	72"	48"	6	12'	48"	60"	11
84"	48"	8	84"	48"	6	14'	48"	60"	13
96"	48"	8	96"	48"	6				
10'	48"	12	10'	48"	8				
12'	48"	10	12'	48"	10				
14'	48"	12	14'	48"	12				
16'	48"	14	16'	48"	12				
18'	48"	16	17'	48"	14				
20'	48"	16	20'	48"	16				
22'	48"	16	22'	48"	16				
24'	48"	18	24'	48"	18				
86"	54"	8	96"	54"	6				
10'	54"	10	10'	54"	8				
12'	54"	10	12'	54"	10				
14'	54"	12	14'	54"	12				
16'	54"	14	16'	54"	12				
18'	54"	16	18'	54"	14				
20'	54"	16	20'	54"	16				
22'	54"	16	22'	54"	18				
24'	54"	18	24'	54"	18				
96"	60"	10	96"	60"	8				
10'	60"	12	10'	60"	10				
12'	60"	12	12'	60"	10				
14'	60"	14	15'	60"	12				
16'	60"	16	18'	60"	14				
18'	60"	18	20'	60"	16				
20'	60"	18							
22'	60"	18							
24'	60"	20							
Round Tops									
48"		5							
54"		5							
60"		6							

E-Table 2 Collaborative and Conference Tables

Seating Capacity Guidelines

Style Number*	Width	Depth	Approximate Capacity	Style Number*	Width	Depth	Approximate Capacity	Style Number*	Width	Depth	Approximate Capacity
Round Table Tops				Rectangular Table Tops				Faceted Table Tops			
COET2RND_	48"	48"	5	COET2RECA	72"	36"	6	COET2FCTA	72"	36"	6
COET2RND_	54"	54"	5	COET2RECA	60"	36"	6	COET2FCTA	60"	36"	6
COET2RND_	42"	42"	4	COET2RECA	84"	36"	6	COET2FCTA	84"	36"	6
COET2RND_	60"	60"	6	COET2RECA	96"	36"	8	COET2FCTA	96"	36"	8
				COET2RECA	72"	42"	6	COET2FCTA	72"	42"	6
				COET2RECA	84"	42"	6	COET2FCTA	84"	42"	6
				COET2RECA	96"	42"	8	COET2FCTA	96"	42"	8
				COET2RECA	72"	48"	6	COET2FCTA	72"	48"	6
				COET2RECA	84"	48"	8	COET2FCTA	84"	48"	8
				COET2RECA	96"	48"	8	COET2FCTA	96"	48"	8
				COET2RECA	120"	48"	10	COET2FCTA	120"	48"	10
				COET2RECA	120"	36"	10	COET2FCTA	120"	36"	10
				COET2RECA	144"	48"	10	COET2FCTA	144"	48"	10
				COET2RECA	144"	36"	10	COET2FCTA	144"	36"	10
				COET2RECA	120"	42"	10	COET2FCTA	120"	42"	10
				COET2RECA	144"	42"	10	COET2FCTA	144"	42"	10
				COET2RECA	60"	42"	6	COET2FCTA	60"	42"	6
				COET2RECA	60"	48"	6	COET2FCTA	60"	48"	6
				COET2REC_	168"	48"	12	COET2FCT_	168"	48"	12
				COET2REC_	192"	48"	14	COET2FCT_	192"	48"	14
				COET2REC_	216"	48"	16	COET2FCT_	216"	48"	16
				COET2REC_	240"	48"	16	COET2FCT_	240"	48"	16
				COET2REC_	264"	48"	16	COET2FCT_	264"	48"	16
				COET2REC_	288"	48"	18	COET2FCT_	288"	48"	18
				COET2REC_	96"	54"	8	COET2FCT_	96"	54"	8
				COET2REC_	120"	54"	10	COET2FCT_	120"	54"	10
				COET2REC_	144"	54"	10	COET2FCT_	144"	54"	10
				COET2REC_	168"	54"	12	COET2FCT_	168"	54"	12
				COET2REC_	192"	54"	14	COET2FCT_	192"	54"	14
				COET2REC_	216"	54"	16	COET2FCT_	216"	54"	16
				COET2REC_	240"	54"	16	COET2FCT_	240"	54"	16
				COET2REC_	264"	54"	16	COET2FCT_	264"	54"	16
				COET2REC_	288"	54"	18	COET2FCT_	288"	54"	18
				COET2REC_	96"	60"	10	COET2FCT_	96"	60"	10
				COET2REC_	120"	60"	12	COET2FCT_	120"	60"	12
				COET2REC_	144"	60"	12	COET2FCT_	144"	60"	12
				COET2REC_	168"	60"	14	COET2FCT_	168"	60"	14
				COET2REC_	192"	60"	16	COET2FCT_	192"	60"	16
				COET2REC_	216"	60"	18	COET2FCT_	216"	60"	18
				COET2REC_	240"	60"	18	COET2FCT_	240"	60"	18
				COET2REC_	264"	60"	18	COET2FCT_	264"	60"	18
				COET2REC_	288"	60"	20	COET2FCT_	288"	60"	20

*Style number is not complete until suffix of A, L, or V is in the blank space, where noted.

E-Table 2 Collaborative and Conference Tables *continued*

Seating Capacity Guidelines

Style Number*	Width	Depth	Approximate Capacity
Soft Radius Table Tops			
COET2SFTA	72"	36"	6
COET2SFTA	60"	36"	6
COET2SFTA	84"	36"	6
COET2SFTA	96"	36"	8
COET2SFTA	72"	42"	6
COET2SFTA	84"	42"	6
COET2SFTA	96"	42"	8
COET2SFTA	72"	48"	6
COET2SFTA	84"	48"	8
COET2SFTA	96"	48"	8
COET2SFTA	120"	48"	10
COET2SFTA	120"	36"	10
COET2SFTA	144"	48"	10
COET2SFTA	144"	36"	10
COET2SFTA	120"	42"	10
COET2SFTA	144"	42"	10
COET2SFTA	60"	42"	6
COET2SFTA	60"	48"	6
COET2SFT_	168"	48"	12
COET2SFT_	192"	48"	14
COET2SFT_	216"	48"	16
COET2SFT_	240"	48"	16
COET2SFT_	264"	48"	16
COET2SFT_	288"	48"	18
COET2SFT_	96"	54"	8
COET2SFT_	120"	54"	10
COET2SFT_	144"	54"	10
COET2SFT_	168"	54"	12
COET2SFT_	192"	54"	14
COET2SFT_	216"	54"	16
COET2SFT_	240"	54"	16
COET2SFT_	264"	54"	16
COET2SFT_	288"	54"	18
COET2SFT_	96"	60"	10
COET2SFT_	120"	60"	12
COET2SFT_	144"	60"	12
COET2SFT_	168"	60"	14
COET2SFT_	192"	60"	16
COET2SFT_	216"	60"	18
COET2SFT_	240"	60"	18
COET2SFT_	264"	60"	18
COET2SFT_	288"	60"	20

Style Number*	Width	Depth	Approximate Capacity
Racetrack Table Tops			
COET2RACEA	72"	36"	6
COET2RACEA	60"	36"	6
COET2RACEA	84"	36"	6
COET2RACEA	96"	36"	6
COET2RACEA	72"	42"	6
COET2RACEA	84"	42"	6
COET2RACEA	96"	42"	6
COET2RACEA	72"	48"	6
COET2RACEA	84"	48"	6
COET2RACEA	96"	48"	8
COET2RACEA	120"	48"	10
COET2RACEA	120"	36"	8
COET2RACEA	144"	48"	10
COET2RACEA	144"	36"	8
COET2RACEA	120"	42"	6
COET2RACEA	144"	42"	6
COET2RACEA	60"	42"	12
COET2RACEA	60"	48"	12
COET2RACE_	168"	48"	14
COET2RACE_	192"	48"	16
COET2RACE_	216"	48"	16
COET2RACE_	240"	48"	18
COET2RACE_	264"	48"	8
COET2RACE_	288"	48"	8
COET2RACE_	96"	54"	10
COET2RACE_	120"	54"	10
COET2RACE_	144"	54"	12
COET2RACE_	168"	54"	14
COET2RACE_	192"	54"	14
COET2RACE_	216"	54"	14
COET2RACE_	240"	54"	16
COET2RACE_	264"	54"	8
COET2RACE_	288"	54"	10
COET2RACE_	96"	60"	10
COET2RACE_	120"	60"	12
COET2RACE_	144"	60"	14
COET2RACE_	168"	60"	16
COET2RACE_	192"	60"	16
COET2RACE_	216"	60"	18
COET2RACE_	240"	60"	18
COET2RACE_	264"	60"	8
COET2RACE_	288"	60"	8

Style Number*	Width	Depth	Approximate Capacity
D-Shape Table Tops			
COET2DA	72"	36"	5
COET2DA	60"	36"	5
COET2DA	84"	36"	5
COET2DA	96"	36"	5
COET2DA	120"	36"	6
COET2DA	72"	42"	5
COET2DA	84"	42"	5
COET2DA	96"	42"	5
COET2DA	120"	42"	6
COET2DA	60"	42"	5
COET2D_	72"	48"	5
COET2D_	84"	48"	5
COET2D_	96"	48"	5
COET2D_	120"	48"	6
COET2D_	60"	48"	5
COET2D_	96"	54"	6
COET2D_	120"	54"	7
COET2D_	96"	60"	6
COET2D_	120"	60"	7

*Style number is not complete until suffix of A, L, or V is in the blank space, where noted.

E-Table 2 Collaborative and Conference Tables

Seating Capacity Guidelines

Style Number*	Width	Large End Depth	Small End Depth	Approximate Capacity
D-Shape Table Tops				
Trapezoid Table Tops				
COET2RAPA	72"	60"	36"	7
COET2TRAPA	60"	60"	36"	7
COET2TRAPA	84"	60"	36"	7
COET2TRAPA	96"	60"	48"	9
COET2RAP_	120"	60"	48"	11
COET2TRAP_	144"	60"	48"	11
COET2TRAP_	168"	60"	48"	13
COET2TRAP_	192"	60"	48"	15
COET2TRAP_	216"	60"	48"	17
COET2TRAP_	240"	60"	48"	17

*Style number is not complete until suffix of A, L, or V is in the blank space, where noted.

E-Table 2 Collaborative and Conference Tables Base Locations

24" Drum Bases

► Page 55

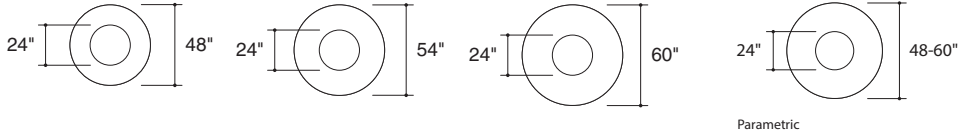

Base veneer and woodgrain laminate direction



24" Drum Base Footprint

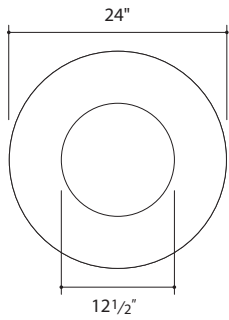

E-Table 2 Collaborative and Conference Tables Base Locations

24" Laminate Bases

► Page 55

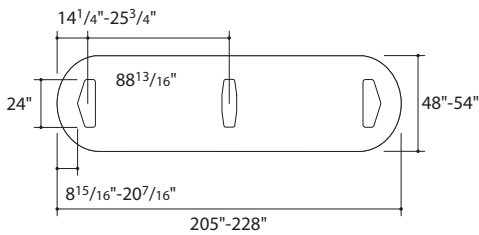
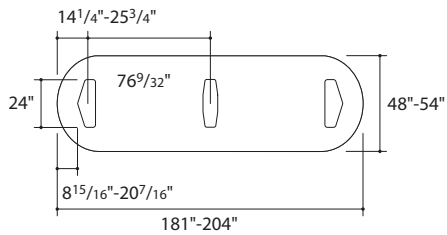
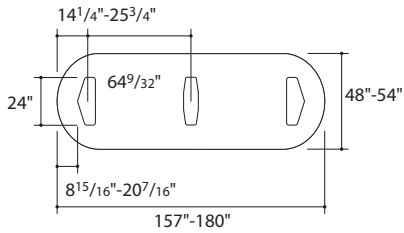
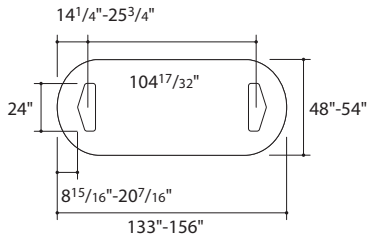
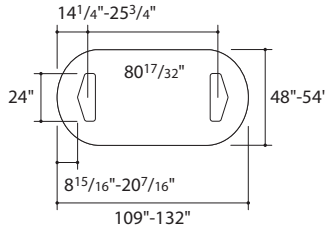
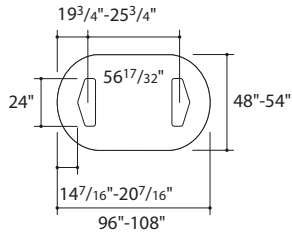

*Dimensions reference center line of base.

Base veneer and woodgrain laminate direction

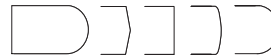
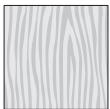

Bases are located in the same position for any given table top size, regardless of table shape. Exception: Trapezoid table tops. ► Page 78

24" Laminate Base Footprints

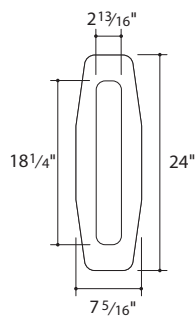
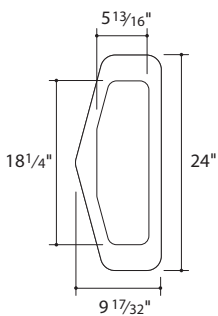

24" Laminate Bases

►Page 55

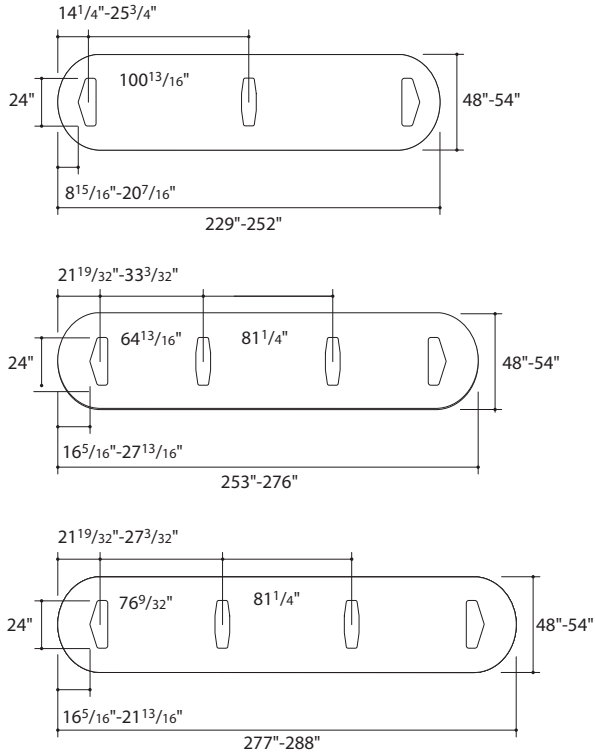

*Dimensions reference center line of base.

Base veneer and woodgrain laminate direction

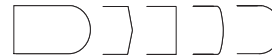
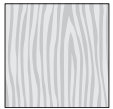

Bases are located in the same position for any given table top size, regardless of table shape. Exception: Trapezoid table tops. ►Page 78

24" Laminate Base Footprints

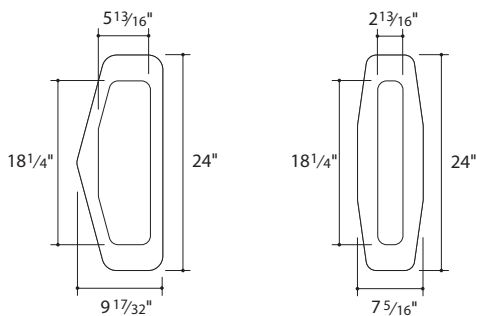

E-Table 2 Collaborative and Conference Tables Base Locations

30" Laminate Bases

►Page 55

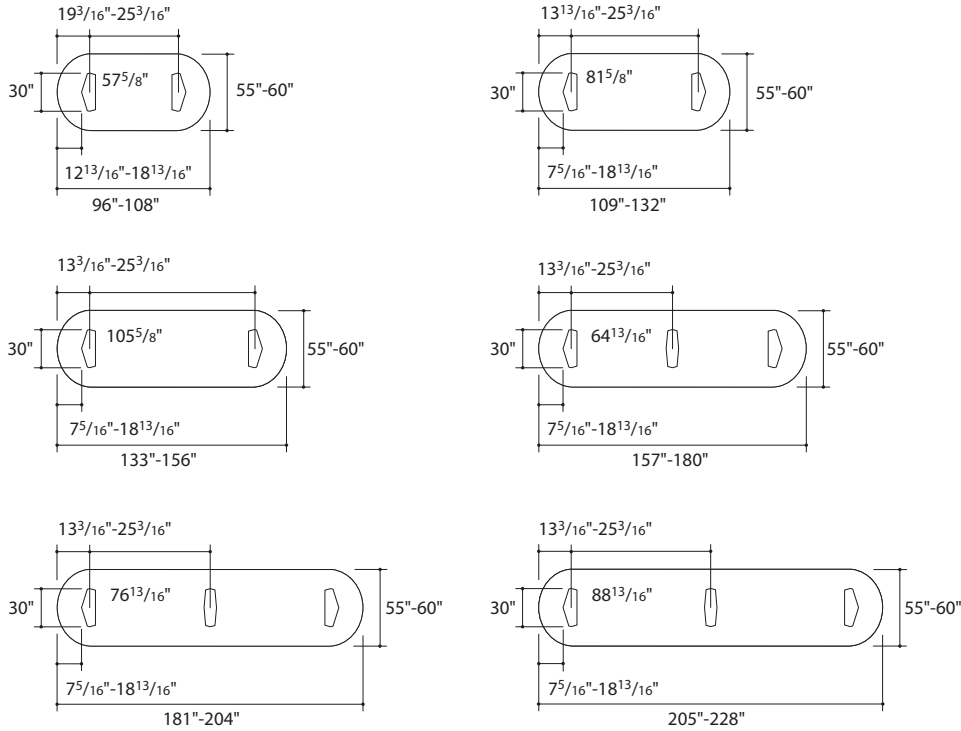

*Dimensions reference center line of base.

Base veneer and woodgrain laminate direction

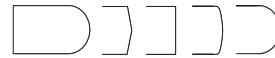
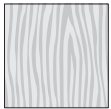

Bases are located in the same position for any given table top size, regardless of table shape. Exception: Trapezoid table tops. ►Page 78

30" Laminate Base Footprints

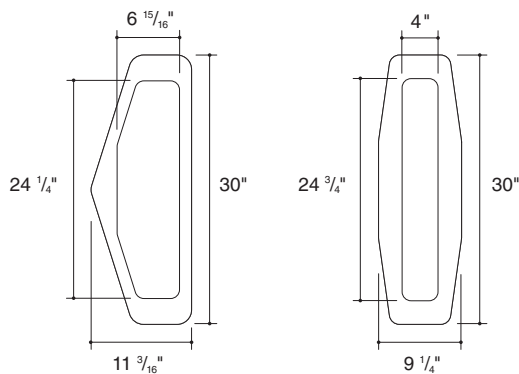

30" Laminate Bases

►Page 55

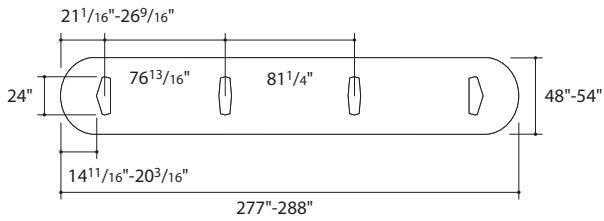
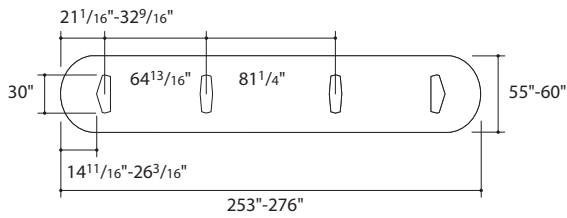
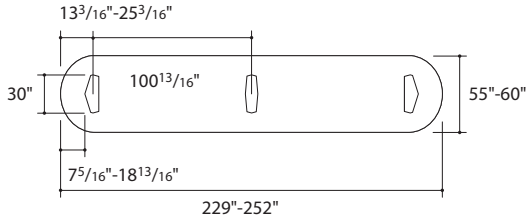

*Dimensions reference center line of base.

Base veneer and woodgrain laminate direction

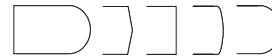
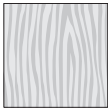

Bases are located in the same position for any given table top size, regardless of table shape. Exception: Trapezoid table tops. ►Page 78

30" Laminate Base Footprints

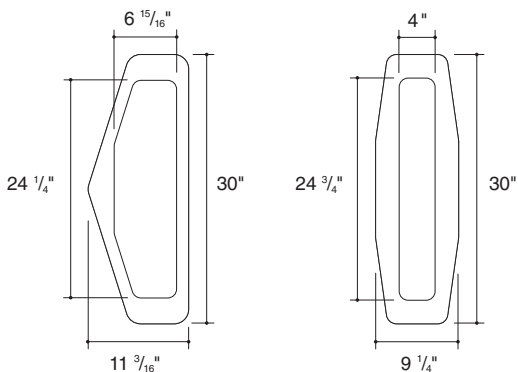

E-Table 2 Collaborative and Conference Tables Base Locations

24" Veneer Bases

►Page 55

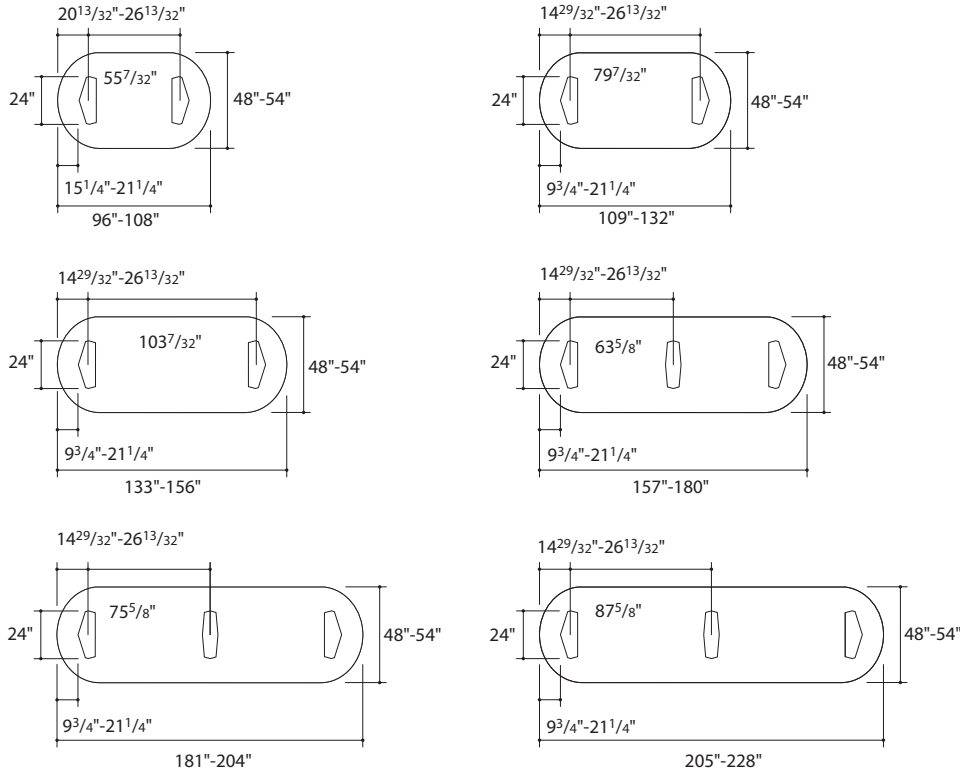

*Dimensions reference center line of base.

Base veneer and woodgrain laminate direction

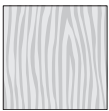

Bases are located in the same position for any given table top size, regardless of table shape. Exception: Trapezoid table tops. ►Page 78

E-Table 2 Collaborative and Conference Tables

24" Veneer Base Footprints

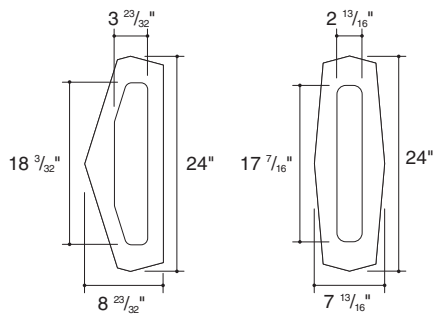

E-Table 2 Collaborative and Conference Tables Base Locations *continued*

24" Veneer Bases

►Page 55

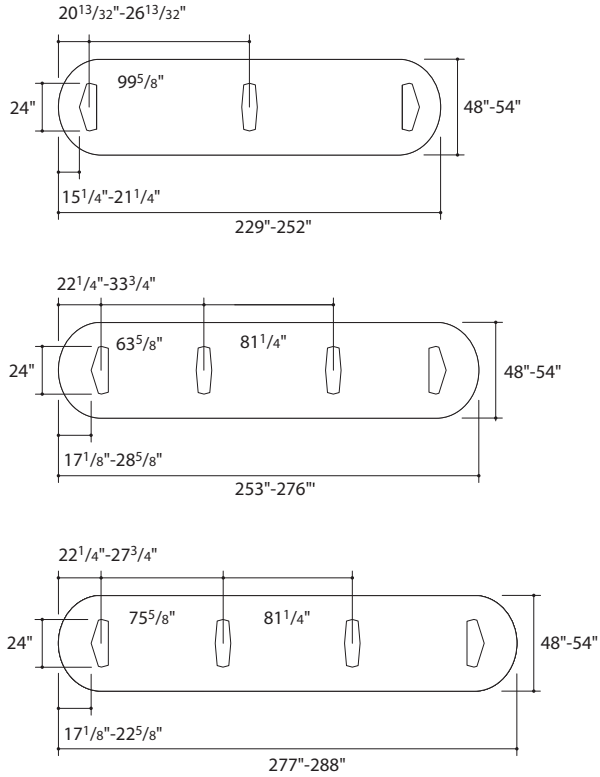

*Dimensions reference center line of base.

Base veneer and woodgrain laminate direction

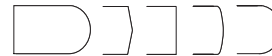
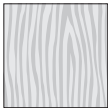

Bases are located in the same position for any given table top size, regardless of table shape. Exception: Trapezoid table tops. ►Page 78

24" Veneer Base Footprints

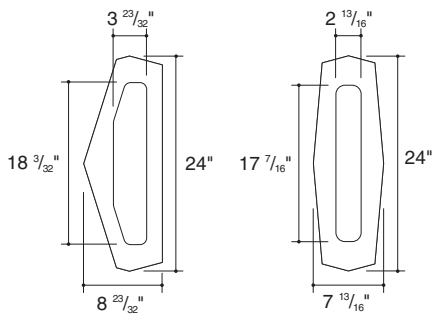

E-Table 2 Collaborative and Conference Tables Base Locations

30" Veneer Bases

►Page 55

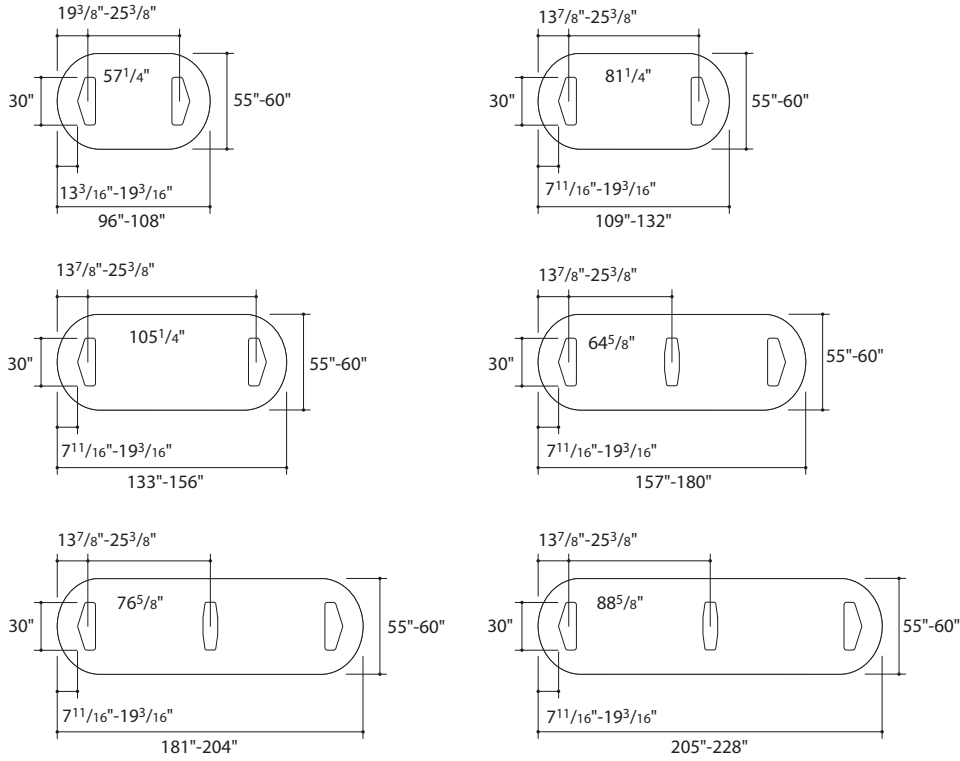

*Dimensions reference center line of base.

Base veneer and woodgrain laminate direction

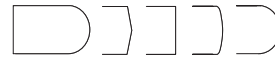

Bases are located in the same position for any given table top size, regardless of table shape. Exception: Trapezoid table tops. ►Page 78

30" Veneer Base Footprints

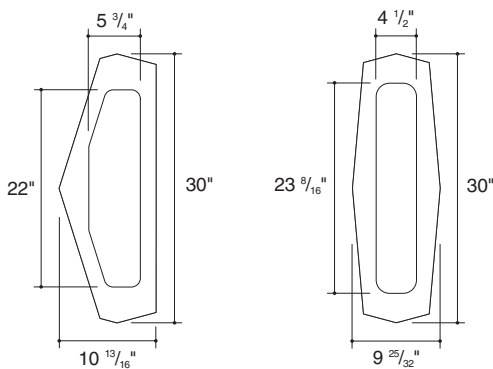

30" Veneer Bases

►Page 55

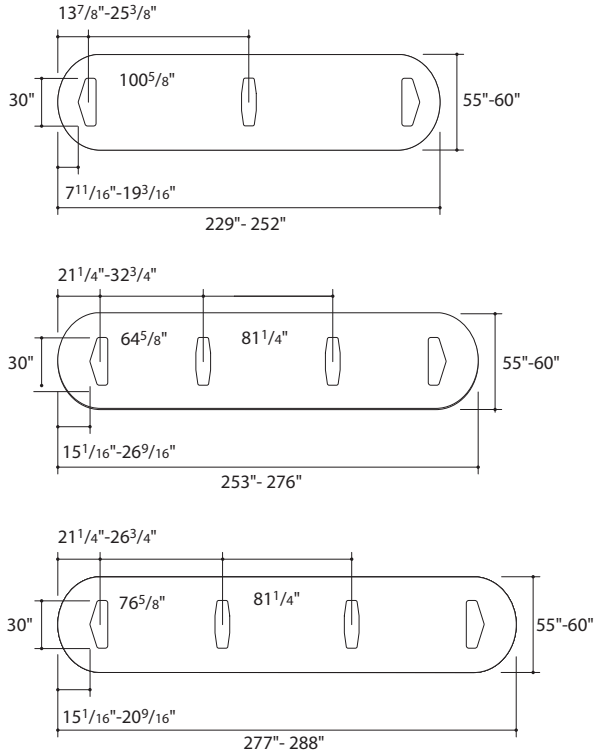

*Dimensions reference center line of base.

Base veneer and woodgrain laminate direction

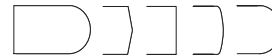
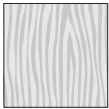

Bases are located in the same position for any given table top size, regardless of table shape. Exception: Trapezoid table tops. ►Page 78

30" Veneer Base Footprints

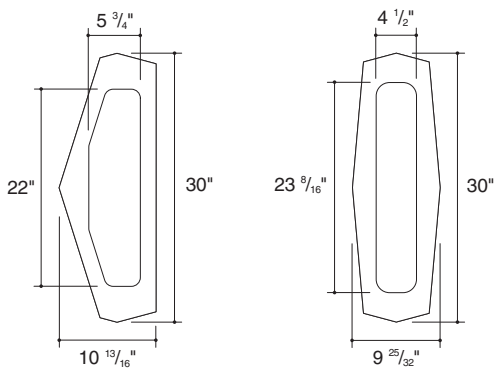

E-Table 2 Collaborative and Conference Tables Base Locations

30" Aluminum Bases

►Page 55

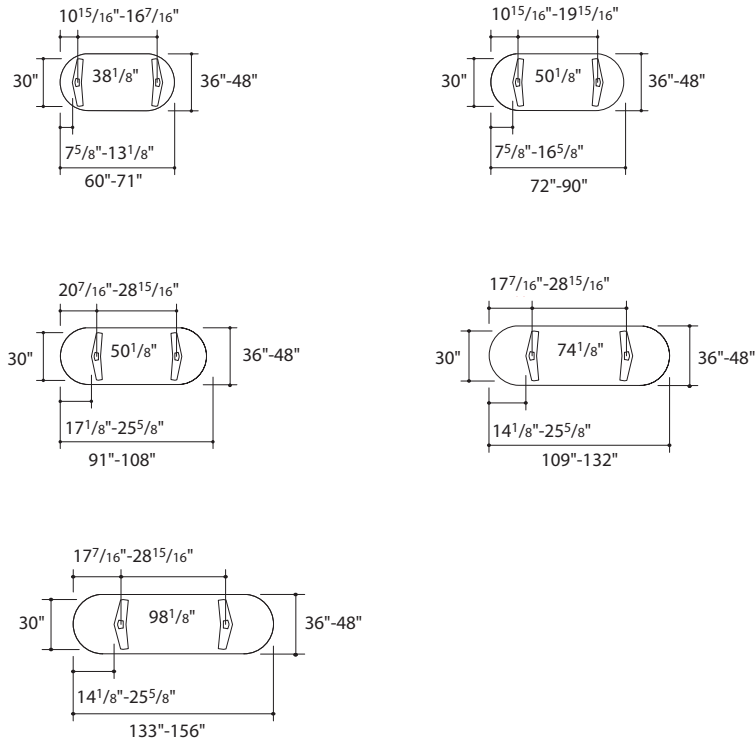

*Dimensions reference center line of base.

Base veneer and woodgrain laminate direction



Bases are located in the same position for any given table top size, regardless of table shape.
Exception: Trapezoid table tops.
►Page 78

30" Aluminum Base Footprints

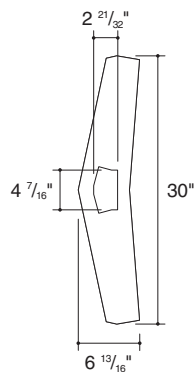

E-Table 2 Collaborative and Conference Tables Base Locations *continued*

36" Aluminum Bases

► Page 55

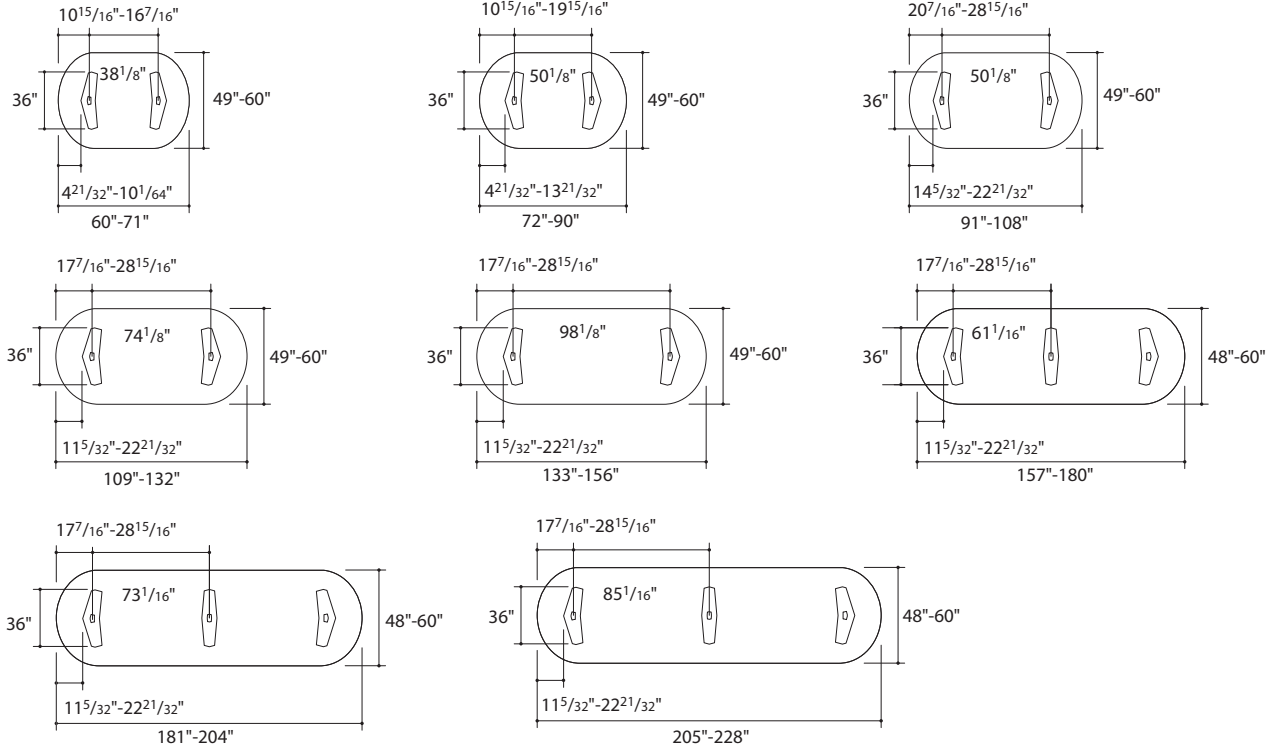

*Dimensions reference center line of base.

Base veneer and woodgrain laminate direction

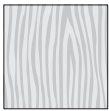

Bases are located in the same position for any given table top size, regardless of table shape.
Exception: Trapezoid table tops.
► Page 78

36" Aluminum Base Footprints

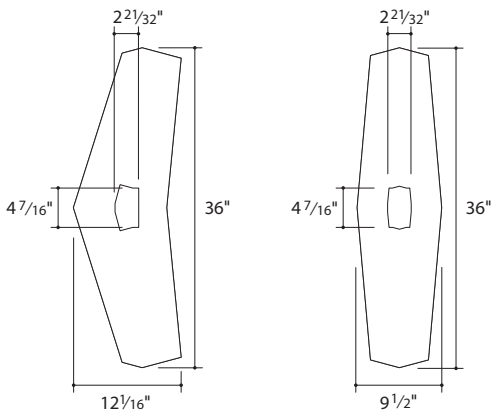

E-Table 2 Collaborative and Conference Tables Base Locations

36" Aluminum Bases

►Page 55

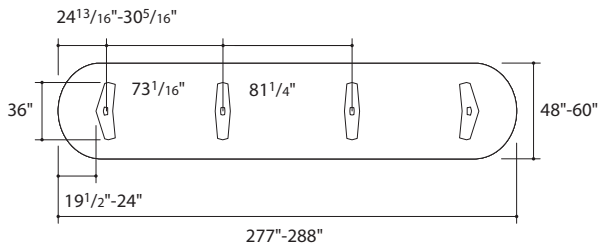
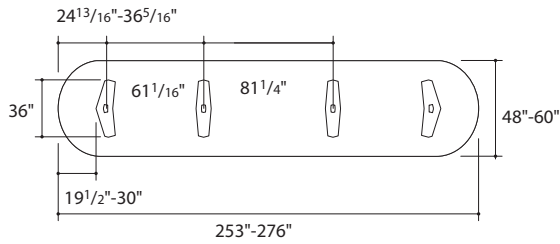
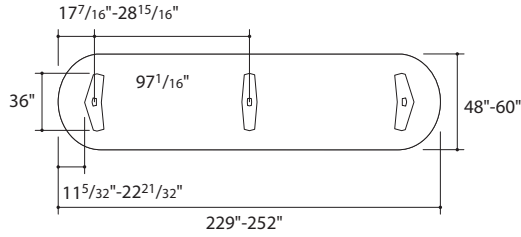

*Dimensions reference center line of base.

Base veneer and woodgrain laminate direction

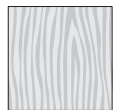

Bases are located in the same position for any given table top size, regardless of table shape. Exception: Trapezoid table tops. ►Page 78

36" Aluminum Base Footprints

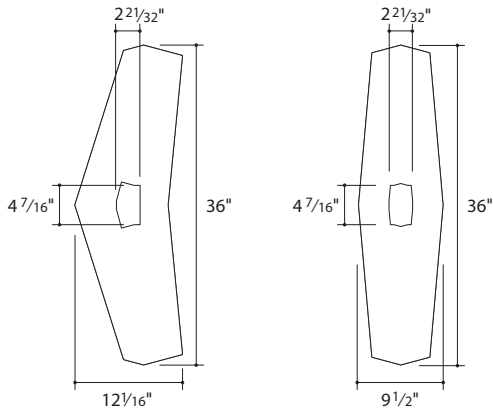

E-Table 2 Collaborative and Conference Tables Base Locations *continued*

24" and 30" Laminate Bases

► Page 55

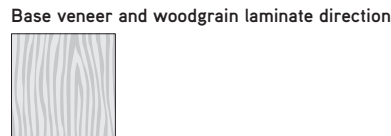
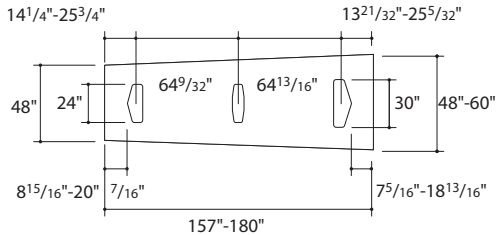
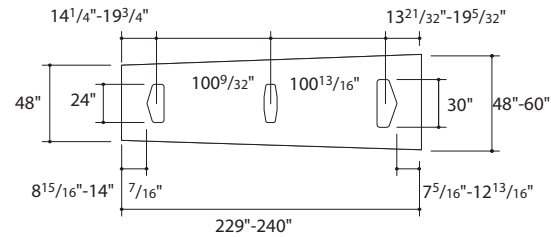
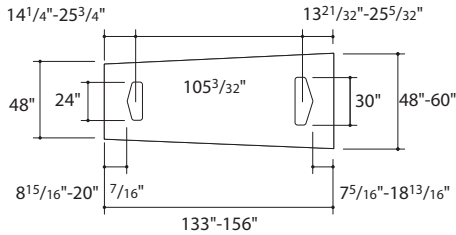
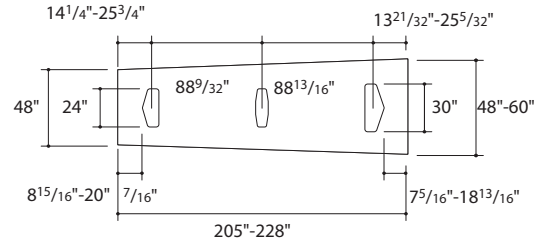
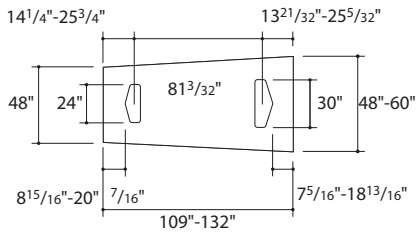
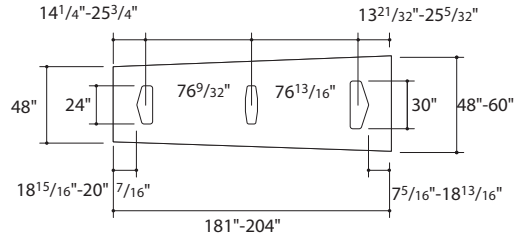
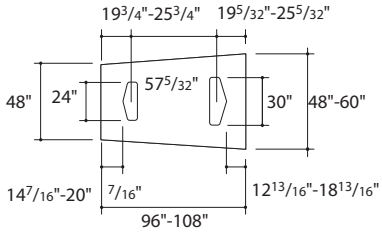

*Dimensions reference center line of base.

24" and 30" Laminate Base Footprints

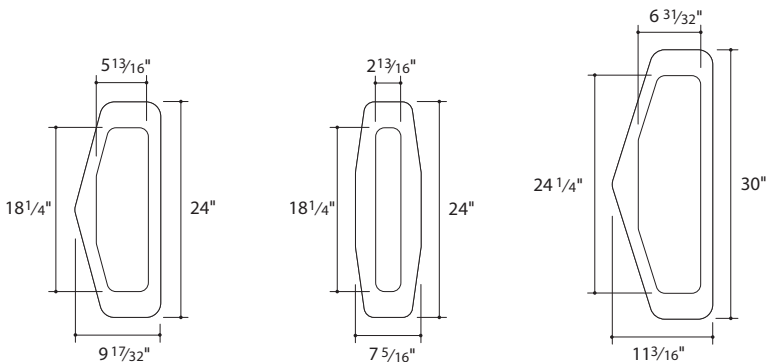

E-Table 2 Collaborative and Conference Tables Base Locations

24" and 30" Veneer Base

►Page 55

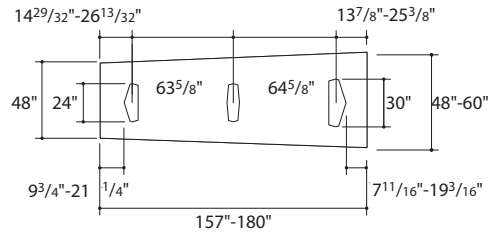
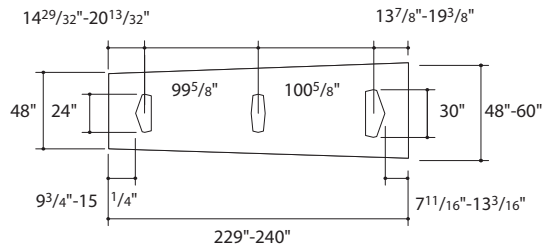
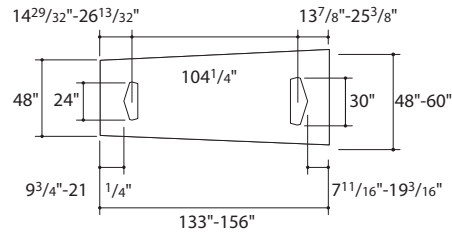
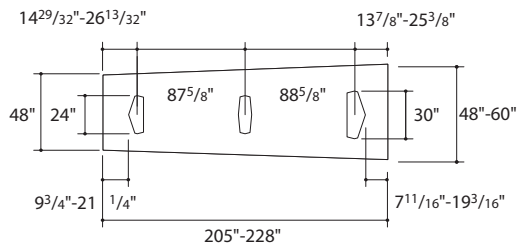
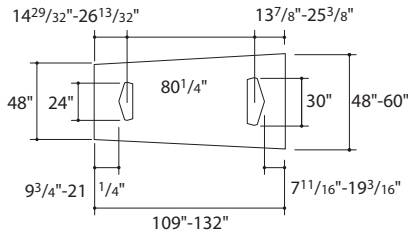
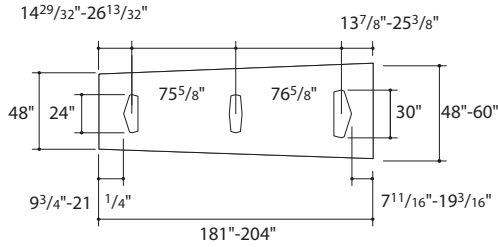
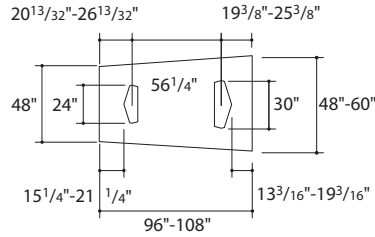

Base veneer and woodgrain laminate direction



*Dimensions reference center line of base.

24" and 30" Veneer Base Footprints

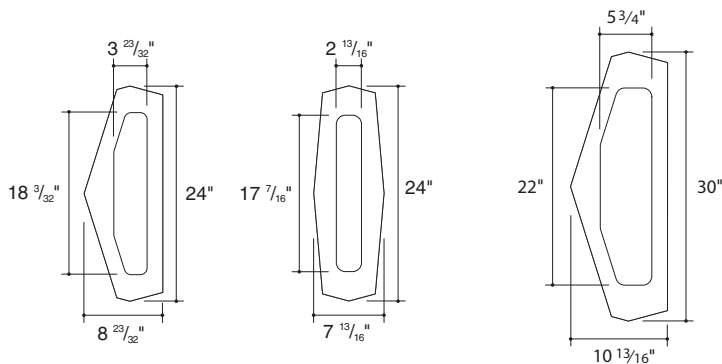

E-Table 2 Collaborative and Conference Tables Base Locations *continued*

30" and 36" Aluminum Bases

►Page 55

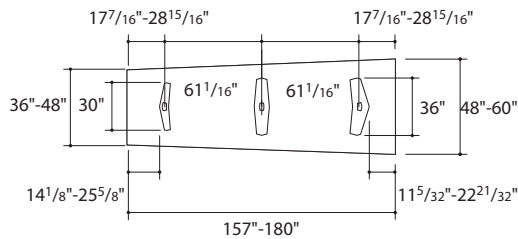
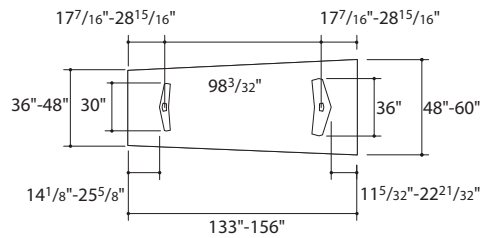
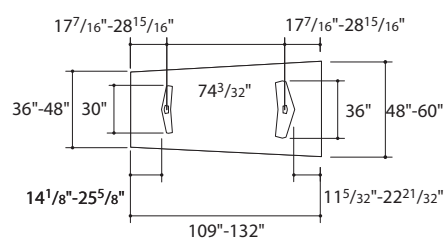
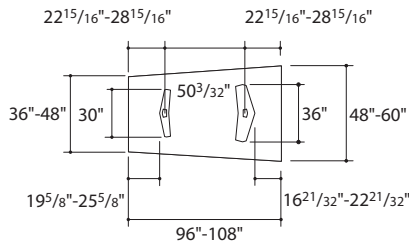
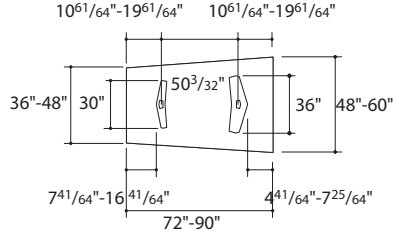
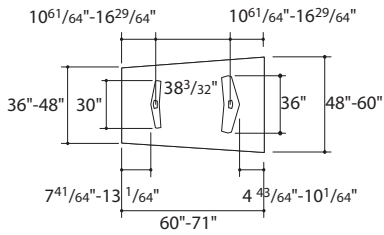

Base veneer and woodgrain laminate direction

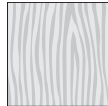

*Dimensions reference center line of base.

30" and 36" Aluminum Base Footprints

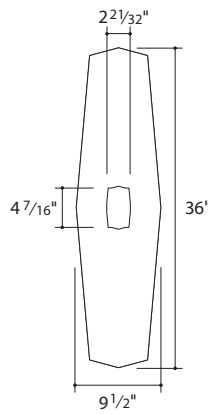
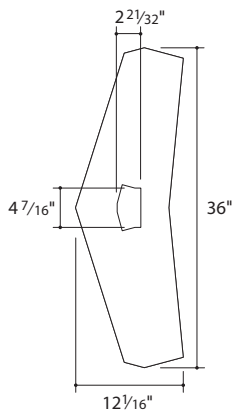
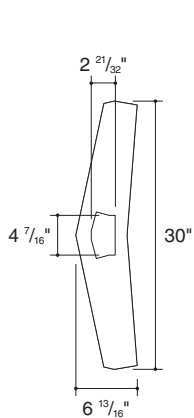

E-Table 2 Collaborative and Conference Tables Base Locations

30" and 36" Aluminum Bases

► Page 55

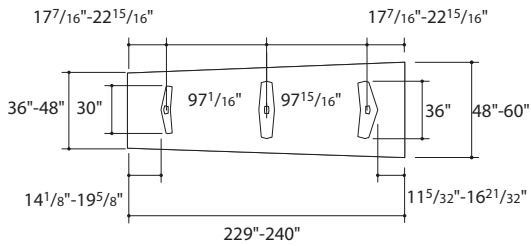
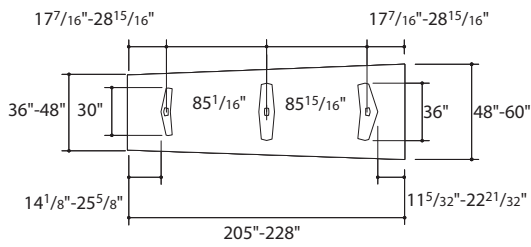
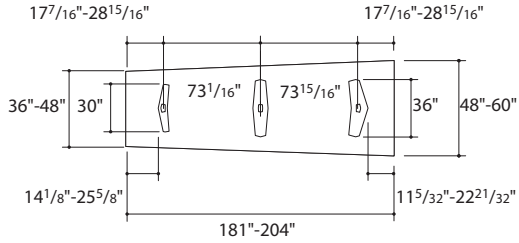

Base veneer and woodgrain laminate direction

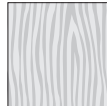

*Dimensions reference center line of base.

30" and 36" Aluminum Base Footprints

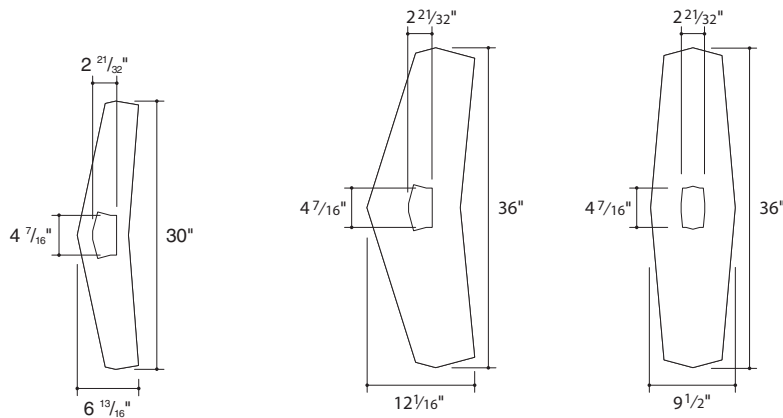

E-Table 2 Collaborative and Conference Tables Utility Bay Quantities by Dimensions

Number of Utility Bays

Table Widths



0 Utility Bays

Available in widths 60"-288" and diameters 42"-60"



1 Utility Bay

Available in widths 60"-90" and diameters 42"-60"

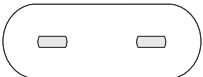

2 Utility Bays

Available in widths 72"-288"



3 Utility Bays

Available in widths 109"-156"

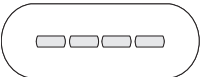

4 Utility Bays

Available in widths 133"-288"



6 Utility Bays

Available in widths 205"-252"

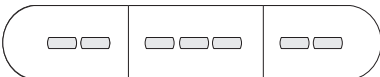

7 Utility Bays

Available in widths 253"-288"

E-Table 2 Collaborative and Conference Tables Power Duplex Wiring Schematics

Each Standard Utility Bay has two factory installed power duplex outlets at no additional charge.

3+0 Wiring Schematic

For the Standard 3+0 Schematic, outlets will be standardized as follows:

For tables with one, two, three, or four utility bays, each bay will have two Circuit 1 duplex outlets.

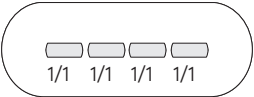
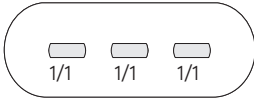
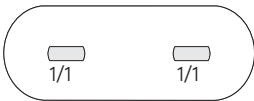
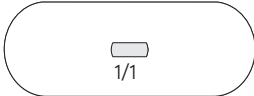

For tables with six utility bays, the first three bays will each have two Circuit 1 duplexes and the last three bays will each have two Circuit 2 duplexes.

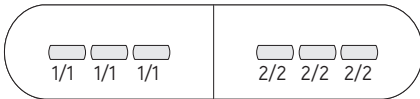

For tables with seven utility bays, the first two bays will each have two Circuit 1 duplexes, the three middle bays will each have two Circuit 2 duplexes, and the last two bays will each have two Circuit 3 duplexes.

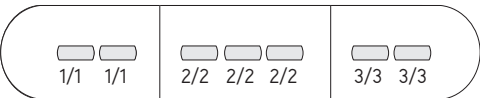

1+1 Separate Neutrals Wiring Schematic

For the 1+1 Separate Neutrals Wiring Schematic, outlets will be standardized as follows:

For tables with one, two, three, four, or six utility bays, each bay will have one Circuit 1 duplex and one Circuit 2 duplex.

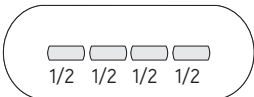
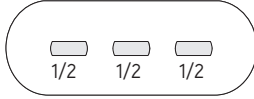
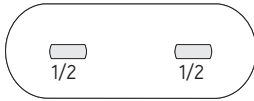
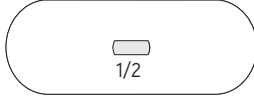

For tables with six utility bays, the first three bays will have two Circuit 1 duplex outlets. The last three will have two Circuit 2 duplex outlets.

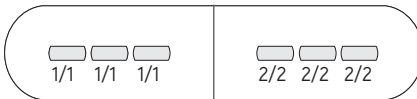

For tables with seven utility bays, the 1+1 separate neutrals wiring schematic is not available.

E-Table 2 Collaborative and Conference Tables USB Wiring Schematics

Each Standard Utility Bay has two factory installed power duplex outlets at no additional charge. For an additional charge, one duplex power outlet can be replaced with two USB A ports on each bay.

3+0 USB Wiring Schematic

For the standard 3+0 schematic with USB, outlets will be standardized as follows:

For tables with one, two, three, or four utility bays, each bay will have one Circuit 1 duplex and two Circuit 1 USB ports.

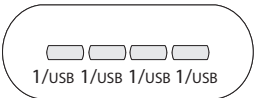
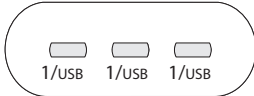
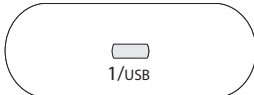

For tables with six utility bays, the first three bays will each have one Circuit 1 duplex and two Circuit 1 USB ports. The last three bays will each have one Circuit 2 duplex and two Circuit 2 USB ports.

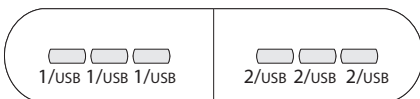

For tables with seven utility bays, the first and second utility bay will each have one Circuit 1 duplex and two Circuit 1 USB ports. The three middle utility bays will each have one Circuit 2 duplex and two Circuit 2 USB ports. The last two utility bays will each have one Circuit 3 duplex and two Circuit 3 USB ports.

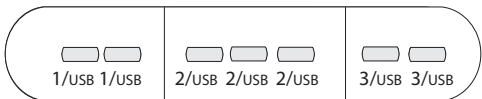

1+1 USB Separate Neutrals Wiring Schematic

For the 1+1 separate neutrals wiring schematic with USB, outlets will be standardized as follows:

For tables with one, two, three, four, or six utility bays, each bay will have one Circuit 1 duplex and two Circuit 2 USB ports.

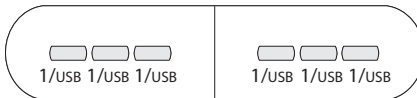
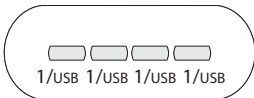
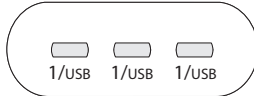
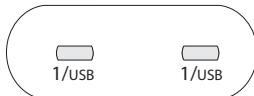
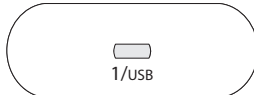

For tables with seven utility bays, the 1+1 separate neutrals wiring schematic is not available.

E-Table 2 Collaborative and Conference Tables USB Wiring Schematics

E-Table 2 Collaborative and Conference Tables

Round Laminate Base Tables

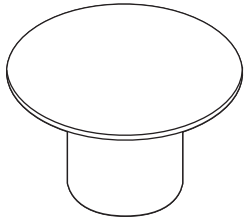

Tip: Shipped knocked down.

Tip: A flat, plastic edge can be specified on veneer tops by selecting the "flat" edge option. Flat edge is only available in 6000 Black on veneer tops.

Tip: When a wood edge is specified on a wood veneer top, the edge finish will match the top finish.

Tip: Each utility bay comes with two universal faceplate openings that accept customer-supplied faceplates in any of the following sizes: single-gang, double-gang, or triple-gang.

Standard Includes

- Top:
 - 1 1/4" particle board core with grade 1 laminate
 - parametric diameter in 1" increments ranging from 42"-60"
- Edge: 3 mm plastic edge, 3 mm wood edge, or convex vinyl edge
- Base: black laminate on MDF core
- Concealed leveling glides: non-marring, black plastic
- Overall height: 29"

Options

Top Finish	Laminate Price Group 02	Price below
	Laminate Price Group 03	Price below
	Veneer Price Group 01	Price below
	Veneer Price Group 02	Price below
Edge Type	3mm Plastic Edge	Price below
	3mm Wood Edge	Price below
	Beveled Wood Edge	Price below
	Bullnose Wood Edge	Price below
	Convex Vinyl Edge	Price below
	Knife Wood Edge	Price below
Base Type	Black HPL	No cost
	Curated HPL	+\$784
Bay Option	No Bays	No cost
	One Bay	+\$789
Wiring Schematic	1+1 Hardwire, 2 Circuits	No cost
	3 + 0 Wireway	No cost
	Chicago Wireway	No cost
	1+1 Hardwire,2 Circuits,USB	+\$157
Infeed	3 + 0 Wireway,USB	+\$157
	Hardwire	No cost
	NYC Hardwire Infeed	No cost
	Plug	No cost

► **Product Information continued on next page**

E-Table 2 Collaborative and Conference Tables

Round Laminate Base Tables

► Product Information continued from previous page

Specification Information

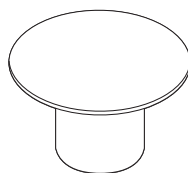

Tip: Tables are available parametrically in 1" increments.

Style Number	Finish	Base Prices			
		3 mm Plastic/ 3 mm Wood Edge, Flat Edge, or Convex Vinyl Edge:	Bullnose Wood Edge:	Beveled Wood Edge:	Knife Wood Edge:
42" Dia. Round Table with Laminate Base - Working Height					
COET2RNDL	Grade 1 Laminate	\$2526	\$3675	\$4080	\$4302
	Grade 2 and 3 Laminate	\$2603	\$3752	\$4157	\$4379
	Grade 1 Wood Veneer	\$3422	\$4571	\$4976	\$5198
	Grade 2 Wood Veneer	\$3687	\$4836	\$5241	\$5463
43"-48" Dia. Round Table with Laminate Base - Working Height					
COET2RNDL	Grade 1 Laminate	\$2530	\$3778	\$4203	\$4554
	Grade 2 and 3 Laminate	\$2641	\$3889	\$4314	\$4665
	Grade 1 Wood Veneer	\$3632	\$4880	\$5305	\$5656
	Grade 2 Wood Veneer	\$4004	\$5252	\$5677	\$6028
49"-54" Dia. Round Table with Laminate Base - Working Height					
COET2RNDL	Grade 1 Laminate	\$2867	\$4265	\$4906	\$5390
	Grade 2 and 3 Laminate	\$3010	\$4408	\$5049	\$5533
	Grade 1 Wood Veneer	\$4585	\$5983	\$6624	\$7108
	Grade 2 Wood Veneer	\$5056	\$6454	\$7095	\$7579
55"-60" Dia. Round Table with Laminate Base - Working Height					
COET2RNDL	Grade 1 Laminate	\$2872	\$4370	\$5030	\$5648
	Grade 2 and 3 Laminate	\$3051	\$4549	\$5209	\$5827
	Grade 1 Wood Veneer	\$4782	\$6280	\$6940	\$7558
	Grade 2 Wood Veneer	\$5359	\$6857	\$7517	\$8135

E-Table 2 Collaborative and Conference Tables

Round Veneer Base Tables

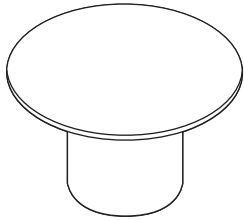

Tip: Shipped knocked down.

Tip: A flat, plastic edge can be specified on veneer tops by selecting the "flat" edge option. Flat edge is only available in 6000 Black on veneer tops.

Tip: When a wood edge is specified on a wood veneer top, the edge finish will match the top finish.

Tip: Each utility bay comes with two universal faceplate openings that accept customer-supplied faceplates in any of the following sizes: single-gang, double-gang, or triple-gang.

Standard Includes

- Top:
 - 1 1/4" particle board core with grade 1 laminate
 - parametric diameter in 1" increments ranging from 42"-60"
- Edge: 3 mm plastic edge, 3 mm wood edge, or convex vinyl edge
- Concealed leveling glides: non-marring, black plastic
- Overall height: 29"

Options

Top Finish	Laminate Price Group 02	Price below
	Laminate Price Group 03	Price below
	Veneer Price Group 01	Price below
	Veneer Price Group 02	Price below
Edge Type	3mm Plastic Edge	Price below
	3mm Wood Edge	Price below
	Beveled Wood Edge	Price below
	Bullnose Wood Edge	Price below
	Convex Vinyl Edge	Price below
Bay Option	Knife Wood Edge	Price below
	No Bays	No cost
Wiring Schematic	One Bay	+\$789
	1+1 Hardwire, 2 Circuits	No cost
	3 + 0 Wireway	No cost
	Chicago Wireway	No cost
	1+1 Hardwire,2 Circuits,USB	+\$157
Infeed	3 + 0 Wireway,USB	+\$157
	Hardwire	No cost
	NYC Hardwire Infeed	No cost
	Plug	No cost

► **Product Information continued on next page**

E-Table 2 Collaborative and Conference Tables

Round Veneer Base Tables

► Product Information continued from previous page

Specification Information

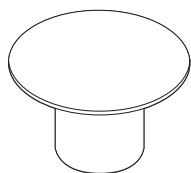

Tip: Tables are available parametrically in 1" increments.

Style Number	Finish	Base Prices			
		3 mm Plastic/ 3 mm Wood Edge, Flat Edge, or Convex Vinyl Edge:	Bullnose Wood Edge:	Beveled Wood Edge:	Knife Wood Edge:
42" Dia. Round Table with Veneer Base - Working Height					
COET2RNDV	Grade 1 Laminate	\$3551	\$4700	\$5105	\$5327
	Grade 2 and 3 Laminate	\$3630	\$4779	\$5184	\$5406
	Grade 1 Wood Veneer	\$4446	\$5595	\$6000	\$6222
	Grade 2 Wood Veneer	\$4713	\$5862	\$6267	\$6489
43"-48" Dia. Round Table with Veneer Base - Working Height					
COET2RNDV	Grade 1 Laminate	\$3547	\$4795	\$5220	\$5571
	Grade 2 and 3 Laminate	\$3658	\$4906	\$5331	\$5682
	Grade 1 Wood Veneer	\$4649	\$5897	\$6322	\$6673
	Grade 2 Wood Veneer	\$5021	\$6269	\$6694	\$7045
49"-54" Dia. Round Table with Veneer Base - Working Height					
COET2RNDV	Grade 1 Laminate	\$3884	\$5282	\$5923	\$6407
	Grade 2 and 3 Laminate	\$4027	\$5425	\$6066	\$6550
	Grade 1 Wood Veneer	\$5602	\$7000	\$7641	\$8125
	Grade 2 Wood Veneer	\$6073	\$7471	\$8112	\$8596
55"-60" Dia. Round Table with Veneer Base - Working Height					
COET2RNDV	Grade 1 Laminate	\$3889	\$5387	\$6047	\$6665
	Grade 2 and 3 Laminate	\$4068	\$5566	\$6226	\$6844
	Grade 1 Wood Veneer	\$5799	\$7297	\$7957	\$8575
	Grade 2 Wood Veneer	\$6376	\$7874	\$8534	\$9152

E-Table 2 Collaborative and Conference Tables

Racetrack Aluminum Base Tables-Working Height



Tip: Shipped knocked down.

Tip: Utility bay quantity offering by table width is available in the understanding section.

Tip: If you specify a wood edge on a top with woodgrain laminate, the edge and the top may not match.

Tip: Sectioned top option is a two piece top and is only available on tops 96"W-120"W.

Tip: When a wood edge is specified on a wood veneer top, the edge finish will match the top finish.

Tip: Each utility bay comes with two universal faceplate openings that accept customer-supplied faceplates in any of the following sizes: single-gang, double-gang, or triple-gang.

Standard Includes

- Top:
 - 1 1/4" particle board core with grade 1 laminate
 - parametric width in 1" increments ranging from 60"-288"
 - For tables with widths up to 144", parametric depth is in 1" increments ranging from 36"-60".
 - For tables with widths from 145"-288", parametric depth is in 1" increments ranging from 43"-60".
- Edge: 3 mm plastic edge, 3 mm wood edge, or convex vinyl edge
- Bases: cast and extruded aluminum with powder coat
- Wireway: painted steel side panels with powder coat and black plastic access door
- Concealed leveling glides: non-marring, black plastic
- Overall height: 29"

Options

Sectioned Top	No Sectioned Top	No cost
	With Sectioned Top	+\$569
Top Finish	Laminate Price Group 02	Price below
	Laminate Price Group 03	Price below
	Veneer Price Group 01	Price below
	Veneer Price Group 02	Price below
Edge Type	3mm Plastic Edge	Price below
	3mm Wood Edge	Price below
	Beveled Wood Edge	Price below
	Bullnose Wood Edge	Price below
	Convex Vinyl Edge	Price below
	Knife Wood Edge	Price below
Bay Option	No Bays	No cost
	One Bay	+\$789
	Two Bays	+\$1578
	Three Bays	+\$2367
	Four Bays	+\$3156
	Six Bays	+\$4734
	Seven Bays	+\$5523
Wiring Schematic	1+1 Hardwire, 2 Circuits	No cost
	3 + 0 Wireway	No cost
	Chicago Wireway	No cost
	1+1 Hardwire,2 Circuits,USB	+\$157
Infeed	3 + 0 Wireway,USB	+\$157
	Hardwire	No cost
	NYC Hardwire Infeed	No cost
Infeed Location	Plug	No cost
	End Base Power Infeed	No cost
	Mid Base Power Infeed	No cost

► **Product Information continued on next page**

E-Table 2 Collaborative and Conference Tables

Racetrack Aluminum Base Tables-Working Height

► Product Information continued from previous page

Specification Information



Dimensions		Style H	Style Number	Finish	Base Prices			
W	D				3 mm Plastic/ 3 mm Wood, Flat, or Convex Vinyl Edge:	Bullnose Wood Edge:	Beveled Wood Edge:	Knife Wood Edge:

Racetrack Tables with Two Aluminum Bases - Working Height

Tip: Top ships in one piece.

60" -71"	36"	29"	COET2RACEA	Grade 1 Laminate	\$4423	\$4914	\$4978	\$5065
				Grade 2 and 3 Laminate	\$4542	\$5033	\$5097	\$5184
				Grade 1 Wood Veneer	\$5287	\$5778	\$5842	\$5929
				Grade 2 Wood Veneer	\$5670	\$6161	\$6225	\$6312

Tip: Tables are available parametrically in 1" increments.

60" -71"	37" -42"	29"	COET2RACEA	Grade 1 Laminate	\$4981	\$6033	\$6002	\$6220
				Grade 2 and 3 Laminate	\$5098	\$6150	\$6119	\$6337
				Grade 1 Wood Veneer	\$6702	\$7754	\$7723	\$7941
				Grade 2 Wood Veneer	\$7075	\$8127	\$8096	\$8314

Tip: For 60"W- 95"W tables, if you require your table top to be made into two pieces, this can be done as a special. Please contact Customer Service at 1.800.627.6770 to obtain a quote.

60" -71"	43" -48"	29"	COET2RACEA	Grade 1 Laminate	\$5066	\$6105	\$6070	\$6304
				Grade 2 and 3 Laminate	\$5248	\$6287	\$6252	\$6486
				Grade 1 Wood Veneer	\$6731	\$7770	\$7735	\$7969
				Grade 2 Wood Veneer	\$7163	\$8202	\$8167	\$8401

60" -71"	49" -54"	29"	COET2RACEA	Grade 1 Laminate	\$5562	\$6631	\$6554	\$6792
				Grade 2 and 3 Laminate	\$5744	\$6813	\$6736	\$6974
				Grade 1 Wood Veneer	\$7250	\$8319	\$8242	\$8480
				Grade 2 Wood Veneer	\$7771	\$8840	\$8763	\$9001

60" -71"	55" -60"	29"	COET2RACEA	Grade 1 Laminate	\$6031	\$7131	\$7010	\$7253
				Grade 2 and 3 Laminate	\$6239	\$7339	\$7218	\$7461
				Grade 1 Wood Veneer	\$7768	\$8868	\$8747	\$8990
				Grade 2 Wood Veneer	\$8378	\$9478	\$9357	\$9600

► Product Information continued on next page

E-Table 2 Collaborative and Conference Tables

Racetrack Aluminum Base Tables-Working Height

► Product Information continued from previous page

Specification Information



Dimensions		Style H Number	Finish	Base Prices			
W	D			3 mm Plastic/ 3 mm Wood, Flat, or Convex Vinyl Edge:	Bullnose Wood Edge:	Beveled Wood Edge:	Knife Wood Edge:

Racetrack Tables with Two Aluminum Bases - Working Height

72"	36"	29"	COET2RACEA	Grade 1 Laminate	\$4625	\$5549	\$5651	\$5817
				Grade 2 and 3 Laminate	\$4758	\$5682	\$5784	\$5950
				Grade 1 Wood Veneer	\$6183	\$7107	\$7209	\$7375
				Grade 2 Wood Veneer	\$6675	\$7599	\$7701	\$7867
72"	37" -42"	29"	COET2RACEA	Grade 1 Laminate	\$4995	\$6175	\$6214	\$6438
				Grade 2 and 3 Laminate	\$5141	\$6321	\$6360	\$6584
				Grade 1 Wood Veneer	\$6933	\$8113	\$8152	\$8376
				Grade 2 Wood Veneer	\$7466	\$8646	\$8685	\$8909
72"	43" -48"	29"	COET2RACEA	Grade 1 Laminate	\$5110	\$6276	\$6317	\$6558
				Grade 2 and 3 Laminate	\$5287	\$6453	\$6494	\$6735
				Grade 1 Wood Veneer	\$6954	\$8120	\$8161	\$8402
				Grade 2 Wood Veneer	\$7522	\$8688	\$8729	\$8970
72"	49" -54"	29"	COET2RACEA	Grade 1 Laminate	\$5627	\$6824	\$6821	\$7068
				Grade 2 and 3 Laminate	\$5830	\$7027	\$7024	\$7271
				Grade 1 Wood Veneer	\$7523	\$8720	\$8717	\$8964
				Grade 2 Wood Veneer	\$8179	\$9376	\$9373	\$9620
72"	55" -60"	29"	COET2RACEA	Grade 1 Laminate	\$6094	\$7322	\$7274	\$7526
				Grade 2 and 3 Laminate	\$6325	\$7553	\$7505	\$7757
				Grade 1 Wood Veneer	\$8041	\$9269	\$9221	\$9473
				Grade 2 Wood Veneer	\$8785	\$10,013	\$9965	\$10,217

Tip: Tables are available parametrically in 1" increments.

► Product Information continued on next page

E-Table 2 Collaborative and Conference Tables

Racetrack Aluminum Base Tables-Working Height

► Product Information continued from previous page

Specification Information



Dimensions		Style H	Style Number	Finish	Base Prices			
W	D				3 mm Plastic/ 3 mm Wood, Flat, or Convex Vinyl Edge:	Bullnose Wood Edge:	Beveled Wood Edge:	Knife Wood Edge:

Racetrack Tables with Two Aluminum Bases - Working Height

73" -84"	36"	29"	COET2RACEA	Grade 1 Laminate	\$4870	\$6226	\$6370	\$6611
				Grade 2 and 3 Laminate	\$5016	\$6372	\$6516	\$6757
				Grade 1 Wood Veneer	\$7115	\$8471	\$8615	\$8856
				Grade 2 Wood Veneer	\$7723	\$9079	\$9223	\$9464
73" -84"	37" -42"	29"	COET2RACEA	Grade 1 Laminate	\$5055	\$6362	\$6470	\$6701
				Grade 2 and 3 Laminate	\$5232	\$6539	\$6647	\$6878
				Grade 1 Wood Veneer	\$7212	\$8519	\$8627	\$8858
				Grade 2 Wood Veneer	\$7870	\$9177	\$9285	\$9516
73" -84"	43" -48"	29"	COET2RACEA	Grade 1 Laminate	\$5170	\$6464	\$6578	\$6827
				Grade 2 and 3 Laminate	\$5369	\$6663	\$6777	\$7026
				Grade 1 Wood Veneer	\$7227	\$8521	\$8635	\$8884
				Grade 2 Wood Veneer	\$7929	\$9223	\$9337	\$9586
73" -84"	49" -54"	29"	COET2RACEA	Grade 1 Laminate	\$5689	\$7016	\$7084	\$7338
				Grade 2 and 3 Laminate	\$5917	\$7244	\$7312	\$7566
				Grade 1 Wood Veneer	\$7796	\$9123	\$9191	\$9445
				Grade 2 Wood Veneer	\$8588	\$9915	\$9983	\$10,237
73" -84"	55" -60"	29"	COET2RACEA	Grade 1 Laminate	\$6156	\$7513	\$7538	\$7799
				Grade 2 and 3 Laminate	\$6410	\$7767	\$7792	\$8053
				Grade 1 Wood Veneer	\$8315	\$9672	\$9697	\$9958
				Grade 2 Wood Veneer	\$9195	\$10,552	\$10,577	\$10,838

Tip: Tables are available parametrically in 1" increments.

► Product Information continued on next page

E-Table 2 Collaborative and Conference Tables

Racetrack Aluminum Base Tables-Working Height

► Product Information continued from previous page

Specification Information



Dimensions		Style Number	Finish	Base Prices			
W	D			H			

3 mm Plastic/
3 mm Wood,
Flat, or Convex
Vinyl Edge:

Bullnose Wood
Edge:

Beveled Wood
Edge:

Knife Wood
Edge:

Racetrack Tables with Two Aluminum Bases - Working Height

Tip: Tables are available parametrically in 1" increments.

W	D	H	Style Number	Finish	Price 1	Price 2	Price 3	Price 4
85" -96"	36"	29"	COET2RACEA	Grade 1 Laminate	\$5155	\$6432	\$6585	\$6831
				Grade 2 and 3 Laminate	\$5326	\$6603	\$6756	\$7002
				Grade 1 Wood Veneer	\$7253	\$8530	\$8683	\$8929
				Grade 2 Wood Veneer	\$7954	\$9231	\$9384	\$9630
85" -96"	37" -42"	29"	COET2RACEA	Grade 1 Laminate	\$5617	\$6925	\$7035	\$7285
				Grade 2 and 3 Laminate	\$5815	\$7123	\$7233	\$7483
				Grade 1 Wood Veneer	\$7766	\$9074	\$9184	\$9434
				Grade 2 Wood Veneer	\$8556	\$9864	\$9974	\$10,224
85" -96"	43" -48"	29"	COET2RACEA	Grade 1 Laminate	\$6082	\$7412	\$7533	\$7789
				Grade 2 and 3 Laminate	\$6314	\$7644	\$7765	\$8021
				Grade 1 Wood Veneer	\$8285	\$9615	\$9736	\$9992
				Grade 2 Wood Veneer	\$9180	\$10,510	\$10,631	\$10,887
85" -96"	49" -54"	29"	COET2RACEA	Grade 1 Laminate	\$6258	\$7759	\$7891	\$8179
				Grade 2 and 3 Laminate	\$6516	\$8017	\$8149	\$8437
				Grade 1 Wood Veneer	\$8732	\$10,233	\$10,365	\$10,653
				Grade 2 Wood Veneer	\$9657	\$11,158	\$11,290	\$11,578
85" -96"	55" -60"	29"	COET2RACEA	Grade 1 Laminate	\$6435	\$8099	\$8248	\$8568
				Grade 2 and 3 Laminate	\$6719	\$8383	\$8532	\$8852
				Grade 1 Wood Veneer	\$9186	\$10,850	\$10,999	\$11,319
				Grade 2 Wood Veneer	\$10,151	\$11,815	\$11,964	\$12,284

► Product Information continued on next page

E-Table 2 Collaborative and Conference Tables

Racetrack Aluminum Base Tables-Working Height

► Product Information continued from previous page

Specification Information



Dimensions		Style H	Style Number	Finish	Base Prices			
W	D				3 mm Plastic/ 3 mm Wood, Flat, or Convex Vinyl Edge:	Bullnose Wood Edge:	Beveled Wood Edge:	Knife Wood Edge:

Racetrack Tables with Two Aluminum Bases - Working Height

97" -108"	36"	29"	COET2RACEA	Grade 1 Laminate	\$5671	\$6970	\$7137	\$7384
				Grade 2 and 3 Laminate	\$5876	\$7175	\$7342	\$7589
				Grade 1 Wood Veneer	\$7822	\$9121	\$9288	\$9535
				Grade 2 Wood Veneer	\$8620	\$9919	\$10,086	\$10,333
97" -108"	37" -42"	29"	COET2RACEA	Grade 1 Laminate	\$5850	\$7329	\$7448	\$7734
				Grade 2 and 3 Laminate	\$6075	\$7554	\$7673	\$7959
				Grade 1 Wood Veneer	\$8271	\$9750	\$9869	\$10,155
				Grade 2 Wood Veneer	\$9097	\$10,576	\$10,695	\$10,981
97" -108"	43" -48"	29"	COET2RACEA	Grade 1 Laminate	\$6331	\$8218	\$8400	\$8750
				Grade 2 and 3 Laminate	\$6588	\$8475	\$8657	\$9007
				Grade 1 Wood Veneer	\$8566	\$10,453	\$10,635	\$10,985
				Grade 2 Wood Veneer	\$9568	\$11,455	\$11,637	\$11,987
97" -108"	49" -54"	29"	COET2RACEA	Grade 1 Laminate	\$6567	\$8693	\$8895	\$9287
				Grade 2 and 3 Laminate	\$6855	\$8981	\$9183	\$9575
				Grade 1 Wood Veneer	\$9184	\$11,310	\$11,512	\$11,904
				Grade 2 Wood Veneer	\$10,274	\$12,400	\$12,602	\$12,994
97" -108"	55" -60"	29"	COET2RACEA	Grade 1 Laminate	\$6801	\$9163	\$9389	\$9819
				Grade 2 and 3 Laminate	\$7117	\$9479	\$9705	\$10,135
				Grade 1 Wood Veneer	\$9796	\$12,158	\$12,384	\$12,814
				Grade 2 Wood Veneer	\$10,981	\$13,343	\$13,569	\$13,999

Tip: Tables are available parametrically in 1" increments.

E-Table 2 Collaborative and Conference Tables

► Product Information continued on next page

E-Table 2 Collaborative and Conference Tables

Racetrack Aluminum Base Tables-Working Height

► Product Information continued from previous page

Specification Information



Dimensions		Style Number	Finish	Base Prices				
W	D			H	3 mm Plastic/ 3 mm Wood, Flat, or Convex Vinyl Edge:		Bullnose Wood Edge:	Beveled Wood Edge:

Racetrack Tables with Two Aluminum Bases - Working Height

Tip: Tables are available parametrically in 1" increments.

109" -120"	36"	29"	COET2RACEA	Grade 1 Laminate	\$5808	\$7605	\$7766	\$8104
				Grade 2 and 3 Laminate	\$6024	\$7821	\$7982	\$8320
				Grade 1 Wood Veneer	\$7884	\$9681	\$9842	\$10,180
				Grade 2 Wood Veneer	\$8731	\$10,528	\$10,689	\$11,027
109" -120"	37" -42"	29"	COET2RACEA	Grade 1 Laminate	\$6287	\$8493	\$8717	\$9116
				Grade 2 and 3 Laminate	\$6538	\$8744	\$8968	\$9367
				Grade 1 Wood Veneer	\$8180	\$10,386	\$10,610	\$11,009
				Grade 2 Wood Veneer	\$9203	\$11,409	\$11,633	\$12,032
109" -120"	43" -48"	29"	COET2RACEA	Grade 1 Laminate	\$6461	\$8904	\$9149	\$9591
				Grade 2 and 3 Laminate	\$6742	\$9185	\$9430	\$9872
				Grade 1 Wood Veneer	\$8731	\$11,174	\$11,419	\$11,861
				Grade 2 Wood Veneer	\$9859	\$12,302	\$12,547	\$12,989
109" -120"	49" -54"	29"	COET2RACEA	Grade 1 Laminate	\$6750	\$9500	\$9775	\$10,267
				Grade 2 and 3 Laminate	\$7069	\$9819	\$10,094	\$10,586
				Grade 1 Wood Veneer	\$9507	\$12,257	\$12,532	\$13,024
				Grade 2 Wood Veneer	\$10,778	\$13,528	\$13,803	\$14,295
109" -120"	55" -60"	29"	COET2RACEA	Grade 1 Laminate	\$7033	\$10,095	\$10,395	\$10,935
				Grade 2 and 3 Laminate	\$7388	\$10,450	\$10,750	\$11,290
				Grade 1 Wood Veneer	\$10,275	\$13,337	\$13,637	\$14,177
				Grade 2 Wood Veneer	\$11,689	\$14,751	\$15,051	\$15,591

► Product Information continued on next page

E-Table 2 Collaborative and Conference Tables

Racetrack Aluminum Base Tables-Working Height

► Product Information continued from previous page

Specification Information

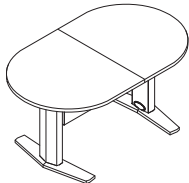

Dimensions		Style H Number	Finish	Base Prices				
W	D			3 mm Plastic/ 3 mm Wood, Flat, or Convex Vinyl Edge:	Bullnose Wood Edge:	Beveled Wood Edge:	Knife Wood Edge:	

Racetrack Tables with Two Aluminum Bases - Working Height

121" -132"	36"	29"	COET2RACEA	Grade 1 Laminate	\$5893	\$8316	\$8569	\$8992
				Grade 2 and 3 Laminate	\$6150	\$8573	\$8826	\$9249
				Grade 1 Wood Veneer	\$8599	\$11,022	\$11,275	\$11,698
				Grade 2 Wood Veneer	\$9624	\$12,047	\$12,300	\$12,723
121" -132"	37" -42"	29"	COET2RACEA	Grade 1 Laminate	\$6071	\$8675	\$8881	\$9337
				Grade 2 and 3 Laminate	\$6348	\$8952	\$9158	\$9614
				Grade 1 Wood Veneer	\$9047	\$11,651	\$11,857	\$12,313
				Grade 2 Wood Veneer	\$10,100	\$12,704	\$12,910	\$13,366
121" -132"	43" -48"	29"	COET2RACEA	Grade 1 Laminate	\$6491	\$9502	\$9774	\$10,293
				Grade 2 and 3 Laminate	\$6801	\$9812	\$10,084	\$10,603
				Grade 1 Wood Veneer	\$9284	\$12,295	\$12,567	\$13,086
				Grade 2 Wood Veneer	\$10,522	\$13,533	\$13,805	\$14,324
121" -132"	49" -54"	29"	COET2RACEA	Grade 1 Laminate	\$6797	\$10,185	\$10,484	\$11,074
				Grade 2 and 3 Laminate	\$7150	\$10,538	\$10,837	\$11,427
				Grade 1 Wood Veneer	\$10,187	\$13,575	\$13,874	\$14,464
				Grade 2 Wood Veneer	\$11,586	\$14,974	\$15,273	\$15,863
121" -132"	55" -60"	29"	COET2RACEA	Grade 1 Laminate	\$7099	\$10,866	\$11,197	\$11,854
				Grade 2 and 3 Laminate	\$7492	\$11,259	\$11,590	\$12,247
				Grade 1 Wood Veneer	\$11,083	\$14,850	\$15,181	\$15,838
				Grade 2 Wood Veneer	\$12,641	\$16,408	\$16,739	\$17,396
133" -144"	36"	29"	COET2RACEA	Grade 1 Laminate	\$5922	\$8913	\$9192	\$9692
				Grade 2 and 3 Laminate	\$6208	\$9199	\$9478	\$9978
				Grade 1 Wood Veneer	\$9149	\$12,140	\$12,419	\$12,919
				Grade 2 Wood Veneer	\$10,286	\$13,277	\$13,556	\$14,056

Tip: Top ships in two pieces. Hardware is included for field assembly.

Tip: Tables are available parametrically in 1" increments.

Tip: If you require your table top to be made into three pieces, this can be done as a special. Please contact Customer Service at 1.800.627.6770 to obtain a quote.

E-Table 2 Collaborative and Conference Tables

► Product Information continued on next page

E-Table 2 Collaborative and Conference Tables

Racetrack Aluminum Base Tables-Working Height

► Product Information continued from previous page

Specification Information



Dimensions		Style Number	Finish	Base Prices			
W	D			H	Edge:		
				3 mm Plastic/ 3 mm Wood, Flat, or Convex Vinyl Edge:	Bullnose Wood Edge:	Beveled Wood Edge:	Knife Wood Edge:

Racetrack Tables with Two Aluminum Bases - Working Height

Tip: Tables are available parametrically in 1" increments.

133" -144"	37" -42"	29"	COET2RACEA	Grade 1 Laminate	\$6101	\$9273	\$9506	\$10,040
				Grade 2 and 3 Laminate	\$6407	\$9579	\$9812	\$10,346
				Grade 1 Wood Veneer	\$9600	\$12,772	\$13,005	\$13,539
				Grade 2 Wood Veneer	\$10,765	\$13,937	\$14,170	\$14,704

133" -144"	43" -48"	29"	COET2RACEA	Grade 1 Laminate	\$6519	\$10,096	\$10,396	\$10,993
				Grade 2 and 3 Laminate	\$6858	\$10,435	\$10,735	\$11,332
				Grade 1 Wood Veneer	\$9835	\$13,412	\$13,712	\$14,309
				Grade 2 Wood Veneer	\$11,183	\$14,760	\$15,060	\$15,657

133" -144"	49" -54"	29"	COET2RACEA	Grade 1 Laminate	\$6844	\$10,869	\$11,195	\$11,880
				Grade 2 and 3 Laminate	\$7230	\$11,255	\$11,581	\$12,266
				Grade 1 Wood Veneer	\$10,867	\$14,892	\$15,218	\$15,903
				Grade 2 Wood Veneer	\$12,393	\$16,418	\$16,744	\$17,429

Tip: Table widths starting at 145" will only have a parametric depth range of 43"-60".

133" -144"	55" -60"	29"	COET2RACEA	Grade 1 Laminate	\$7164	\$11,635	\$11,999	\$12,768
				Grade 2 and 3 Laminate	\$7592	\$12,063	\$12,427	\$13,196
				Grade 1 Wood Veneer	\$11,890	\$16,361	\$16,725	\$17,494
				Grade 2 Wood Veneer	\$13,590	\$18,061	\$18,425	\$19,194

145" -156"	43" -48"	29"	COET2RACEA	Grade 1 Laminate	\$7954	\$12,464	\$12,752	\$13,529
				Grade 2 and 3 Laminate	\$8311	\$12,821	\$13,109	\$13,886
				Grade 1 Wood Veneer	\$13,076	\$17,586	\$17,874	\$18,651
				Grade 2 Wood Veneer	\$14,526	\$19,036	\$19,324	\$20,101

► Product Information continued on next page

E-Table 2 Collaborative and Conference Tables

Racetrack Aluminum Base Tables-Working Height

► Product Information continued from previous page

Specification Information

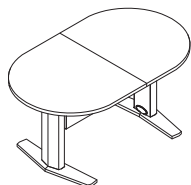

Dimensions		Style H	Style Number	Finish	Base Prices				
W	D				3 mm Plastic/ 3 mm Wood, Flat, or Convex Vinyl Edge:	Bullnose Wood Edge:	Beveled Wood Edge:	Knife Wood Edge:	

Racetrack Tables with Two Aluminum Bases - Working Height

145" -156"	49" -54"	29"	COET2RACEA	Grade 1 Laminate	\$8376	\$13,449	\$13,772	\$14,648
				Grade 2 and 3 Laminate	\$8781	\$13,854	\$14,177	\$15,053
				Grade 1 Wood Veneer	\$14,423	\$19,496	\$19,819	\$20,695
				Grade 2 Wood Veneer	\$16,068	\$21,141	\$21,464	\$22,340
145" -156"	55" -60"	29"	COET2RACEA	Grade 1 Laminate	\$8796	\$14,435	\$14,789	\$15,768
				Grade 2 and 3 Laminate	\$9244	\$14,883	\$15,237	\$16,216
				Grade 1 Wood Veneer	\$15,766	\$21,405	\$21,759	\$22,738
				Grade 2 Wood Veneer	\$17,605	\$23,244	\$23,598	\$24,577

Tip: Tables are available parametrically in 1" increments.

► Product Information continued on next page

E-Table 2 Collaborative and Conference Tables

E-Table 2 Collaborative and Conference Tables

Racetrack Aluminum Base Tables-Working Height

► Product Information continued from previous page

Specification Information

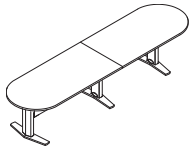

Dimensions		Style	Finish	Base Prices			
W	D	H	Number				
				3 mm Plastic/ 3 mm Wood, Flat, or Convex Vinyl Edge:	Bullnose Wood Edge:	Beveled Wood Edge:	Knife Wood Edge:

Racetrack Tables with Three Aluminum Bases - Working Height

Tip: Top ships in two pieces.
Hardware is included for
field assembly.

Dimensions	Style	Finish	Base Prices
157" -168" 43" -48" 29"	COET2RACEA	Grade 1 Laminate	\$9594 \$15,037 \$15,313 \$16,267
		Grade 2 and 3 Laminate	\$9971 \$15,414 \$15,690 \$16,644
		Grade 1 Wood Veneer	\$16,518 \$21,961 \$22,237 \$23,191
		Grade 2 Wood Veneer	\$18,100 \$23,543 \$23,819 \$24,773

Tip: For tables with three
or more bases, you must
specify the entry point of the
base power infeed, either
an end base or a mid base
location, in order to receive
the correct length of base
power infeed.

157" -168" 49" -54" 29"	COET2RACEA	Grade 1 Laminate	\$10,106 \$16,225 \$16,546 \$17,614
		Grade 2 and 3 Laminate	\$10,532 \$16,651 \$16,972 \$18,040
		Grade 1 Wood Veneer	\$18,173 \$24,292 \$24,613 \$25,681
		Grade 2 Wood Veneer	\$19,966 \$26,085 \$26,406 \$27,474

157" -168" 55" -60" 29"	COET2RACEA	Grade 1 Laminate	\$10,615 \$17,420 \$17,766 \$18,952
		Grade 2 and 3 Laminate	\$11,084 \$17,889 \$18,235 \$19,421
		Grade 1 Wood Veneer	\$19,827 \$26,632 \$26,978 \$28,164
		Grade 2 Wood Veneer	\$21,830 \$28,635 \$28,981 \$30,167

Tip: If you require your
table top to be made into
three pieces, this can be
done as a special. Please
contact Customer Service
at 1.800.627.6770 to obtain
a quote.

169" -180" 43" -48" 29"	COET2RACEA	Grade 1 Laminate	\$9647 \$15,205 \$15,485 \$16,456
		Grade 2 and 3 Laminate	\$10,051 \$15,609 \$15,889 \$16,860
		Grade 1 Wood Veneer	\$16,633 \$22,191 \$22,471 \$23,442
		Grade 2 Wood Veneer	\$18,325 \$23,883 \$24,163 \$25,134

169" -180" 49" -54" 29"	COET2RACEA	Grade 1 Laminate	\$10,181 \$16,432 \$16,750 \$17,838
		Grade 2 and 3 Laminate	\$10,635 \$16,886 \$17,204 \$18,292
		Grade 1 Wood Veneer	\$18,322 \$24,573 \$24,891 \$25,979
		Grade 2 Wood Veneer	\$20,120 \$26,371 \$26,689 \$27,777

169" -180" 55" -60" 29"	COET2RACEA	Grade 1 Laminate	\$10,708 \$17,658 \$18,008 \$19,215
		Grade 2 and 3 Laminate	\$11,211 \$18,161 \$18,511 \$19,718
		Grade 1 Wood Veneer	\$20,006 \$26,956 \$27,306 \$28,513
		Grade 2 Wood Veneer	\$22,148 \$29,098 \$29,448 \$30,655

► Product Information continued on next page

E-Table 2 Collaborative and Conference Tables

Racetrack Aluminum Base Tables-Working Height

► Product Information continued from previous page

Specification Information

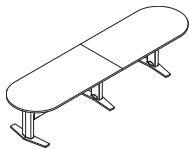

Dimensions		Style H	Style Number	Finish	Base Prices			
W	D				3 mm Plastic/ 3 mm Wood, Flat, or Convex Vinyl Edge:	Bullnose Wood Edge:	Beveled Wood Edge:	Knife Wood Edge:

Racetrack Tables with Three Aluminum Bases - Working Height

181" -192"	43" -48"	29"	COET2RACEA	Grade 1 Laminate	\$9699	\$15,372	\$15,657	\$16,644
				Grade 2 and 3 Laminate	\$10,131	\$15,804	\$16,089	\$17,076
				Grade 1 Wood Veneer	\$16,749	\$22,422	\$22,707	\$23,694
				Grade 2 Wood Veneer	\$18,549	\$24,222	\$24,507	\$25,494
181" -192"	49" -54"	29"	COET2RACEA	Grade 1 Laminate	\$10,255	\$16,635	\$16,952	\$18,062
				Grade 2 and 3 Laminate	\$10,738	\$17,118	\$17,435	\$18,545
				Grade 1 Wood Veneer	\$18,470	\$24,850	\$25,167	\$26,277
				Grade 2 Wood Veneer	\$20,275	\$26,655	\$26,972	\$28,082
181" -192"	55" -60"	29"	COET2RACEA	Grade 1 Laminate	\$10,801	\$17,894	\$18,248	\$19,480
				Grade 2 and 3 Laminate	\$11,338	\$18,431	\$18,785	\$20,017
				Grade 1 Wood Veneer	\$20,185	\$27,278	\$27,632	\$28,864
				Grade 2 Wood Veneer	\$22,466	\$29,559	\$29,913	\$31,145
193" -204"	43" -48"	29"	COET2RACEA	Grade 1 Laminate	\$9869	\$15,717	\$16,028	\$17,097
				Grade 2 and 3 Laminate	\$10,326	\$16,174	\$16,485	\$17,554
				Grade 1 Wood Veneer	\$18,127	\$23,975	\$24,286	\$25,355
				Grade 2 Wood Veneer	\$20,044	\$25,892	\$26,203	\$27,272
193" -204"	49" -54"	29"	COET2RACEA	Grade 1 Laminate	\$10,455	\$17,035	\$17,378	\$18,582
				Grade 2 and 3 Laminate	\$10,969	\$17,549	\$17,892	\$19,096
				Grade 1 Wood Veneer	\$20,028	\$26,608	\$26,951	\$28,155
				Grade 2 Wood Veneer	\$22,086	\$28,666	\$29,009	\$30,213

Tip: Tables are available parametrically in 1" increments.

► Product Information continued on next page

E-Table 2 Collaborative and Conference Tables

Racetrack Aluminum Base Tables-Working Height

► Product Information continued from previous page

Specification Information

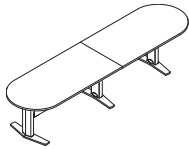

Dimensions		Style H Number	Finish	Base Prices			
W	D			3 mm Plastic/ 3 mm Wood, Flat, or Convex Vinyl Edge:	Bullnose Wood Edge:	Beveled Wood Edge:	Knife Wood Edge:

Racetrack Tables with Three Aluminum Bases - Working Height

193" -204"	55" -60"	29"	COET2RACEA	Grade 1 Laminate	\$11,040	\$18,362	\$18,736	\$20,073
				Grade 2 and 3 Laminate	\$11,610	\$18,932	\$19,306	\$20,643
				Grade 1 Wood Veneer	\$21,927	\$29,249	\$29,623	\$30,960
				Grade 2 Wood Veneer	\$24,359	\$31,681	\$32,055	\$33,392
205" -216"	43" -48"	29"	COET2RACEA	Grade 1 Laminate	\$10,038	\$16,057	\$16,397	\$17,549
				Grade 2 and 3 Laminate	\$10,521	\$16,540	\$16,880	\$18,032
				Grade 1 Wood Veneer	\$19,504	\$25,523	\$25,863	\$27,015
				Grade 2 Wood Veneer	\$21,540	\$27,559	\$27,899	\$29,051
205" -216"	49" -54"	29"	COET2RACEA	Grade 1 Laminate	\$10,656	\$17,439	\$17,802	\$19,102
				Grade 2 and 3 Laminate	\$11,199	\$17,982	\$18,345	\$19,645
				Grade 1 Wood Veneer	\$21,584	\$28,367	\$28,730	\$30,030
				Grade 2 Wood Veneer	\$23,895	\$30,678	\$31,041	\$32,341
205" -216"	55" -60"	29"	COET2RACEA	Grade 1 Laminate	\$11,278	\$18,825	\$19,223	\$20,665
				Grade 2 and 3 Laminate	\$11,881	\$19,428	\$19,826	\$21,268
				Grade 1 Wood Veneer	\$23,669	\$31,216	\$31,614	\$33,056
				Grade 2 Wood Veneer	\$26,252	\$33,799	\$34,197	\$35,639
217" -228"	43" -48"	29"	COET2RACEA	Grade 1 Laminate	\$10,065	\$16,389	\$16,751	\$17,935
				Grade 2 and 3 Laminate	\$10,574	\$16,898	\$17,260	\$18,444
				Grade 1 Wood Veneer	\$20,204	\$26,528	\$26,890	\$28,074
				Grade 2 Wood Veneer	\$22,348	\$28,672	\$29,034	\$30,218

Tip: Tables are available parametrically in 1" increments.

► Product Information continued on next page

E-Table 2 Collaborative and Conference Tables

Racetrack Aluminum Base Tables-Working Height

► Product Information continued from previous page

Specification Information

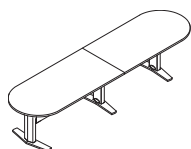

Dimensions		Style H	Style Number	Finish	Base Prices			
W	D				3 mm Plastic/ 3 mm Wood, Flat, or Convex Vinyl Edge:	Bullnose Wood Edge:	Beveled Wood Edge:	Knife Wood Edge:

Racetrack Tables with Three Aluminum Bases - Working Height

217" -228"	49" -54"	29"	COET2RACEA	Grade 1 Laminate	\$10,704	\$17,828	\$18,224	\$19,556
				Grade 2 and 3 Laminate	\$11,276	\$18,400	\$18,796	\$20,128
				Grade 1 Wood Veneer	\$22,390	\$29,514	\$29,910	\$31,242
				Grade 2 Wood Veneer	\$24,824	\$31,948	\$32,344	\$33,676
217" -228"	55" -60"	29"	COET2RACEA	Grade 1 Laminate	\$11,342	\$19,270	\$19,700	\$21,178
				Grade 2 and 3 Laminate	\$11,980	\$19,908	\$20,338	\$21,816
				Grade 1 Wood Veneer	\$24,578	\$32,506	\$32,936	\$34,414
				Grade 2 Wood Veneer	\$27,297	\$35,225	\$35,655	\$37,133
229" -240"	43" -48"	29"	COET2RACEA	Grade 1 Laminate	\$10,091	\$16,718	\$17,104	\$18,318
				Grade 2 and 3 Laminate	\$10,627	\$17,254	\$17,640	\$18,854
				Grade 1 Wood Veneer	\$20,904	\$27,531	\$27,917	\$29,131
				Grade 2 Wood Veneer	\$23,156	\$29,783	\$30,169	\$31,383
229" -240"	49" -54"	29"	COET2RACEA	Grade 1 Laminate	\$10,752	\$18,216	\$18,647	\$20,009
				Grade 2 and 3 Laminate	\$11,353	\$18,817	\$19,248	\$20,610
				Grade 1 Wood Veneer	\$23,194	\$30,658	\$31,089	\$32,451
				Grade 2 Wood Veneer	\$25,751	\$33,215	\$33,646	\$35,008
229" 240"	55" -60"	29"	COET2RACEA	Grade 1 Laminate	\$11,406	\$19,712	\$20,174	\$21,691
				Grade 2 and 3 Laminate	\$12,079	\$20,385	\$20,847	\$22,364
				Grade 1 Wood Veneer	\$25,487	\$33,793	\$34,255	\$35,772
				Grade 2 Wood Veneer	\$28,341	\$36,647	\$37,109	\$38,626

Tip: Tables are available parametrically in 1" increments.

E-Table 2
Collaborative and
Conference Tables

► Product Information continued on next page

E-Table 2 Collaborative and Conference Tables

Racetrack Aluminum Base Tables-Working Height

► Product Information continued from previous page

Specification Information

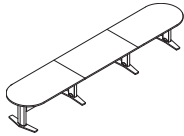

Dimensions		Style Number	Finish	Base Prices			
W	D			H			

Racetrack Tables with Four Aluminum Bases - Working Height

Tip: Top ships in three pieces. Hardware is included for field assembly.

Dimensions	Style	Finish	3 mm Plastic/ 3 mm Wood, Flat, or Convex Vinyl Edge:	Bullnose Wood Edge:	Beveled Wood Edge:	Knife Wood Edge:
241" -252" 43" -48" 29"	COET2RACEA	Grade 1 Laminate	\$12,094	\$19,768	\$20,167	\$21,552
		Grade 2 and 3 Laminate	\$12,653	\$20,327	\$20,726	\$22,111
		Grade 1 Wood Veneer	\$24,828	\$32,502	\$32,901	\$34,286
		Grade 2 Wood Veneer	\$27,177	\$34,851	\$35,250	\$36,635

Tip: Tables are available parametrically in 1" increments.

241" -252" 49" -54" 29"	COET2RACEA	Grade 1 Laminate	\$12,867	\$21,489	\$21,939	\$23,513
		Grade 2 and 3 Laminate	\$13,494	\$22,116	\$22,566	\$24,140
		Grade 1 Wood Veneer	\$27,467	\$36,089	\$36,539	\$38,113
		Grade 2 Wood Veneer	\$30,131	\$38,753	\$39,203	\$40,777

Tip: For tables with three or more bases, you must specify the entry point of the base power infeed, either an end base or a mid base location, in order to receive the correct length of base power infeed.

241" -252" 55" -60" 29"	COET2RACEA	Grade 1 Laminate	\$13,630	\$23,244	\$23,709	\$25,468
		Grade 2 and 3 Laminate	\$14,329	\$23,943	\$24,408	\$26,167
		Grade 1 Wood Veneer	\$30,105	\$39,719	\$40,184	\$41,943
		Grade 2 Wood Veneer	\$33,089	\$42,703	\$43,168	\$44,927

253" -264" 43" -48" 29"	COET2RACEA	Grade 1 Laminate	\$13,521	\$22,240	\$22,652	\$24,208
		Grade 2 and 3 Laminate	\$14,105	\$22,824	\$23,236	\$24,792
		Grade 1 Wood Veneer	\$28,178	\$36,897	\$37,309	\$38,865
		Grade 2 Wood Veneer	\$30,659	\$39,378	\$39,790	\$41,346

Tip: If you require your table top to be made into four pieces, this can be done as a special. Please contact Customer Service at 1.800.627.6770 to obtain a quote.

253" -264" 49" -54" 29"	COET2RACEA	Grade 1 Laminate	\$14,392	\$24,173	\$24,645	\$26,425
		Grade 2 and 3 Laminate	\$15,046	\$24,827	\$25,299	\$27,079
		Grade 1 Wood Veneer	\$31,147	\$40,928	\$41,400	\$43,180
		Grade 2 Wood Veneer	\$33,958	\$43,739	\$44,211	\$45,991

► Product Information continued on next page

E-Table 2 Collaborative and Conference Tables

Racetrack Aluminum Base Tables-Working Height

► Product Information continued from previous page

Specification Information

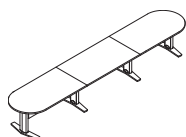

Dimensions		Style Number	Finish	Base Prices			
W	D			H			
				3 mm Plastic/ 3 mm Wood, Flat, or Convex Vinyl Edge:	Bullnose Wood Edge:	Beveled Wood Edge:	Knife Wood Edge:

Racetrack Tables with Four Aluminum Bases - Working Height

253" -264"	55" -60"	29"	COET2RACEA	Grade 1 Laminate	\$15,249	\$26,172	\$26,636	\$28,637
				Grade 2 and 3 Laminate	\$15,976	\$26,899	\$27,363	\$29,364
				Grade 1 Wood Veneer	\$34,119	\$45,042	\$45,506	\$47,507
				Grade 2 Wood Veneer	\$37,266	\$48,189	\$48,653	\$50,654
265" -276"	43" -48"	29"	COET2RACEA	Grade 1 Laminate	\$13,580	\$22,480	\$22,913	\$24,406
				Grade 2 and 3 Laminate	\$14,188	\$23,088	\$23,521	\$25,014
				Grade 1 Wood Veneer	\$28,335	\$37,235	\$37,668	\$39,161
				Grade 2 Wood Veneer	\$30,937	\$39,837	\$40,270	\$41,763
265" -276"	49" -54"	29"	COET2RACEA	Grade 1 Laminate	\$14,482	\$24,437	\$24,886	\$26,671
				Grade 2 and 3 Laminate	\$15,165	\$25,120	\$25,569	\$27,354
				Grade 1 Wood Veneer	\$31,315	\$41,270	\$41,719	\$43,504
				Grade 2 Wood Veneer	\$34,264	\$44,219	\$44,668	\$46,453
265" -276"	55" -60"	29"	COET2RACEA	Grade 1 Laminate	\$15,325	\$26,459	\$26,865	\$28,945
				Grade 2 and 3 Laminate	\$16,085	\$27,219	\$27,625	\$29,705
				Grade 1 Wood Veneer	\$34,303	\$45,437	\$45,843	\$47,923
				Grade 2 Wood Veneer	\$37,605	\$48,739	\$49,145	\$51,225
277" -288"	43" -48"	29"	COET2RACEA	Grade 1 Laminate	\$13,638	\$22,717	\$23,176	\$24,599
				Grade 2 and 3 Laminate	\$14,270	\$23,349	\$23,808	\$25,231
				Grade 1 Wood Veneer	\$28,489	\$37,568	\$38,027	\$39,450
				Grade 2 Wood Veneer	\$31,215	\$40,294	\$40,753	\$42,176

► Product Information continued on next page

E-Table 2 Collaborative and Conference Tables

Racetrack Aluminum Base Tables-Working Height

► Product Information continued from previous page

Specification Information

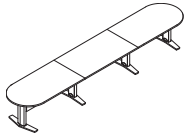

Dimensions		Style Number	Finish	Base Prices			
W	D			H			
				3 mm Plastic/ 3 mm Wood, Flat, or Convex Vinyl Edge:	Bullnose Wood Edge:	Beveled Wood Edge:	Knife Wood Edge:

Racetrack Tables with Four Aluminum Bases - Working Height

277" -288"	49" -54"	29"	COET2RACEA	Grade 1 Laminate	\$14,570	\$24,700	\$25,126	\$26,919
				Grade 2 and 3 Laminate	\$15,283	\$25,413	\$25,839	\$27,632
				Grade 1 Wood Veneer	\$31,480	\$41,610	\$42,036	\$43,829
				Grade 2 Wood Veneer	\$34,570	\$44,700	\$45,126	\$46,919
277" -288"	55" -60"	29"	COET2RACEA	Grade 1 Laminate	\$15,401	\$26,745	\$27,092	\$29,249
				Grade 2 and 3 Laminate	\$16,193	\$27,537	\$27,884	\$30,041
				Grade 1 Wood Veneer	\$34,486	\$45,830	\$46,177	\$48,334
				Grade 2 Wood Veneer	\$37,943	\$49,287	\$49,634	\$51,791

E-Table 2 Collaborative and Conference Tables

Racetrack Aluminum Base Tables-Standing Height

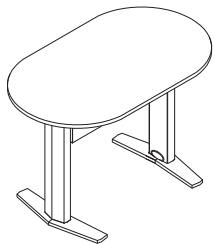

Tip: Shipped knocked down.

Tip: Utility bay quantity offering by table width is available in the understanding section.

Tip: If you specify a wood edge on a top with woodgrain laminate, the edge and the top may not match.

Tip: Sectioned top option is a two piece top and is only available on tops 96"W-120"W.

Tip: When a wood edge is specified on a wood veneer top, the edge finish will match the top finish.

Tip: Each utility bay comes with two universal faceplate openings that accept customer-supplied faceplates in any of the following sizes: single-gang, double-gang, or triple-gang.

Standard Includes

- Top:
 - 1 1/4" particle board core with grade 1 laminate
 - parametric width in 1" increments ranging from 60"-120"
 - parametric depth in 1" increments ranging from 36"-60"
- Edge: 3 mm plastic edge, 3 mm wood edge, or convex vinyl edge
- Bases: cast and extruded aluminum with powder coat
- Wireway: painted steel side panels with powder coat and black plastic access door
- Concealed leveling glides: non-marring, black plastic
- Overall height: 40"

Options

Sectioned Top	No Sectioned Top	No cost
	With Sectioned Top	+\$569
Top Finish	Laminate Price Group 02	Price below
	Laminate Price Group 03	Price below
	Veneer Price Group 01	Price below
	Veneer Price Group 02	Price below
Edge Type	3mm Plastic Edge	Price below
	3mm Wood Edge	Price below
	Beveled Wood Edge	Price below
	Bullnose Wood Edge	Price below
	Convex Vinyl Edge	Price below
	Knife Wood Edge	Price below
Bay Option	No Bays	No cost
	One Bay	+\$789
	Two Bays	+\$1578
	Three Bays	+\$2367
Wiring Schematic	1+1 Hardwire, 2 Circuits	No cost
	3 + 0 Wireway	No cost
	Chicago Wireway	No cost
	1+1 Hardwire,2 Circuits,USB	+\$157
	3 + 0 Wireway,USB	+\$157
Infeed	Hardwire	No cost
	NYC Hardwire Infeed	No cost
	Plug	No cost

► Product Information continued on next page

E-Table 2 Collaborative and Conference Tables

Racetrack Aluminum Base Tables-Standing Height

► Product Information continued from previous page

Specification Information



Dimensions		Style H Number	Finish	Base Prices				
W	D			3 mm Plastic/ 3 mm Wood, Flat, or Convex Vinyl Edge:	Bullnose Wood Edge:	Beveled Wood Edge:	Knife Wood Edge:	

Racetrack Tables with Two Aluminum Bases - Standing Height

Tip: Top ships in one piece.

60" -71"	36"	40"	COET2RACESTA	Grade 1 Laminate	\$4909	\$5400	\$5464	\$5551
				Grade 2 and 3 Laminate	\$5028	\$5519	\$5583	\$5670
				Grade 1 Wood Veneer	\$5774	\$6265	\$6329	\$6416
				Grade 2 Wood Veneer	\$6160	\$6651	\$6715	\$6802

Tip: For 60"W-95"W tables, if you require your table top to be made into two pieces, this can be done as a special. Please contact Customer Service at 1.800.627.6770 to obtain a quote.

60" -71"	37" -42"	40"	COET2RACESTA	Grade 1 Laminate	\$5469	\$6521	\$6490	\$6708
				Grade 2 and 3 Laminate	\$5584	\$6636	\$6605	\$6823
				Grade 1 Wood Veneer	\$7187	\$8239	\$8208	\$8426
				Grade 2 Wood Veneer	\$7562	\$8614	\$8583	\$8801

60" -71"	43" -48"	40"	COET2RACESTA	Grade 1 Laminate	\$5583	\$6622	\$6587	\$6821
				Grade 2 and 3 Laminate	\$5737	\$6776	\$6741	\$6975
				Grade 1 Wood Veneer	\$7215	\$8254	\$8219	\$8453
				Grade 2 Wood Veneer	\$7649	\$8688	\$8653	\$8887

Tip: Tables are available parametrically in 1" increments.

60" -71"	49" -54"	40"	COET2RACESTA	Grade 1 Laminate	\$6050	\$7119	\$7042	\$7280
				Grade 2 and 3 Laminate	\$6230	\$7299	\$7222	\$7460
				Grade 1 Wood Veneer	\$7734	\$8803	\$8726	\$8964
				Grade 2 Wood Veneer	\$8257	\$9326	\$9249	\$9487

60" -71"	55" -60"	40"	COET2RACESTA	Grade 1 Laminate	\$6517	\$7617	\$7496	\$7739
				Grade 2 and 3 Laminate	\$6725	\$7825	\$7704	\$7947
				Grade 1 Wood Veneer	\$8253	\$9353	\$9232	\$9475
				Grade 2 Wood Veneer	\$8866	\$9966	\$9845	\$10,088

72"	36"	40"	COET2RACESTA	Grade 1 Laminate	\$5156	\$6080	\$6182	\$6348
				Grade 2 and 3 Laminate	\$5289	\$5289	\$6315	\$6481
				Grade 1 Wood Veneer	\$6712	\$7636	\$7738	\$7904
				Grade 2 Wood Veneer	\$7206	\$8130	\$8232	\$8398

► Product Information continued on next page

E-Table 2 Collaborative and Conference Tables

E-Table 2 Collaborative and Conference Tables

Racetrack Aluminum Base Tables-Standing Height

► Product Information continued from previous page

Specification Information

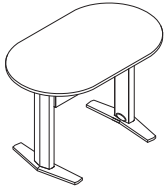

Dimensions		Style H Number	Finish	Base Prices				
W	D			3 mm Plastic/ 3 mm Wood, Flat, or Convex Vinyl Edge:	Bullnose Wood Edge:	Beveled Wood Edge:	Knife Wood Edge:	

Racetrack Tables with Two Aluminum Bases - Standing Height

72"	37" -42"	40"	COET2RACESTA	Grade 1 Laminate	\$5530	\$6710	\$6749	\$6973
				Grade 2 and 3 Laminate	\$5677	\$6857	\$6896	\$7120
				Grade 1 Wood Veneer	\$7469	\$8649	\$8688	\$8912
				Grade 2 Wood Veneer	\$7985	\$9165	\$9204	\$9428
72"	43" -48"	40"	COET2RACESTA	Grade 1 Laminate	\$5644	\$6810	\$6851	\$7092
				Grade 2 and 3 Laminate	\$5822	\$6988	\$7029	\$7270
				Grade 1 Wood Veneer	\$7489	\$8655	\$8696	\$8937
				Grade 2 Wood Veneer	\$8057	\$9223	\$9264	\$9505
72"	49" -54"	40"	COET2RACESTA	Grade 1 Laminate	\$6112	\$7309	\$7306	\$7553
				Grade 2 and 3 Laminate	\$6315	\$7512	\$7509	\$7756
				Grade 1 Wood Veneer	\$8009	\$9206	\$9203	\$9450
				Grade 2 Wood Veneer	\$8664	\$9861	\$9858	\$10,105
72"	55" -60"	40"	COET2RACESTA	Grade 1 Laminate	\$6579	\$7807	\$7759	\$8011
				Grade 2 and 3 Laminate	\$6810	\$8038	\$7990	\$8242
				Grade 1 Wood Veneer	\$8529	\$9757	\$9709	\$9961
				Grade 2 Wood Veneer	\$9274	\$10,502	\$10,454	\$10,706
73" -84"	36"	40"	COET2RACESTA	Grade 1 Laminate	\$5402	\$6758	\$6902	\$7143
				Grade 2 and 3 Laminate	\$5550	\$6906	\$7050	\$7291
				Grade 1 Wood Veneer	\$7650	\$9006	\$9150	\$9391
				Grade 2 Wood Veneer	\$8256	\$9612	\$9756	\$9997

Tip: Tables are available parametrically in 1" increments.

► Product Information continued on next page

E-Table 2 Collaborative and Conference Tables

Racetrack Aluminum Base Tables-Standing Height

► Product Information continued from previous page

Specification Information



Dimensions		Style Number	Finish	Base Prices				
W	D			H				

Racetrack Tables with Two Aluminum Bases - Standing Height

73" -84"	37" -42"	40"	COET2RACESTA	Grade 1 Laminate	\$5592	\$6899	\$7007	\$7238
				Grade 2 and 3 Laminate	\$5768	\$7075	\$7183	\$7414
				Grade 1 Wood Veneer	\$7749	\$9056	\$9164	\$9395
				Grade 2 Wood Veneer	\$8409	\$9716	\$9824	\$10,055
73" -84"	43" -48"	40"	COET2RACESTA	Grade 1 Laminate	\$5708	\$7002	\$7116	\$7365
				Grade 2 and 3 Laminate	\$5906	\$7200	\$7314	\$7563
				Grade 1 Wood Veneer	\$7764	\$9058	\$9172	\$9421
				Grade 2 Wood Veneer	\$8467	\$9761	\$9875	\$10,124
73" -84"	49" -54"	40"	COET2RACESTA	Grade 1 Laminate	\$6176	\$7503	\$7571	\$7825
				Grade 2 and 3 Laminate	\$6403	\$7730	\$7798	\$8052
				Grade 1 Wood Veneer	\$8282	\$9609	\$9677	\$9931
				Grade 2 Wood Veneer	\$9073	\$10,400	\$10,468	\$10,722
73" -84"	55" -60"	40"	COET2RACESTA	Grade 1 Laminate	\$6642	\$7999	\$8024	\$8285
				Grade 2 and 3 Laminate	\$6896	\$8253	\$8278	\$8539
				Grade 1 Wood Veneer	\$8803	\$10,160	\$10,185	\$10,446
				Grade 2 Wood Veneer	\$9682	\$11,039	\$11,064	\$11,325
85" -96"	36"	40"	COET2RACESTA	Grade 1 Laminate	\$5690	\$6967	\$7120	\$7366
				Grade 2 and 3 Laminate	\$5861	\$7138	\$7291	\$7537
				Grade 1 Wood Veneer	\$7788	\$9065	\$9218	\$9464
				Grade 2 Wood Veneer	\$8488	\$9765	\$9918	\$10,164

Tip: Tables are available parametrically in 1" increments.

► Product Information continued on next page

E-Table 2 Collaborative and Conference Tables

Racetrack Aluminum Base Tables-Standing Height

► Product Information continued from previous page

Specification Information

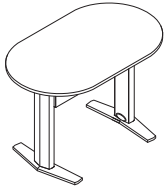

Dimensions		Style		Finish	Base Prices					
W	D	H	Number		Edge:					
					3 mm Plastic/ 3 mm Wood, Flat, or Convex Vinyl Edge:	Bullnose Wood Edge:	Beveled Wood Edge:	Knife Wood Edge:		

Racetrack Tables with Two Aluminum Bases - Standing Height

Dimensions	Style	Finish	Base Price	Edge Price 1	Edge Price 2	Edge Price 3
85"-96" 37" -42" 40"	COET2RACESTA	Grade 1 Laminate	\$6156	\$7464	\$7574	\$7824
		Grade 2 and 3 Laminate	\$6355	\$7663	\$7773	\$8023
		Grade 1 Wood Veneer	\$8305	\$9613	\$9723	\$9973
		Grade 2 Wood Veneer	\$9095	\$10,403	\$10,513	\$10,763
85"-96" 43" -48" 40"	COET2RACESTA	Grade 1 Laminate	\$6626	\$7956	\$8077	\$8333
		Grade 2 and 3 Laminate	\$6857	\$8187	\$8308	\$8564
		Grade 1 Wood Veneer	\$8829	\$10,159	\$10,280	\$10,536
		Grade 2 Wood Veneer	\$9716	\$11,046	\$11,167	\$11,423
85"-96" 49" -54" 40"	COET2RACESTA	Grade 1 Laminate	\$6808	\$8309	\$8441	\$8729
		Grade 2 and 3 Laminate	\$7064	\$8565	\$8697	\$8985
		Grade 1 Wood Veneer	\$9281	\$10,782	\$10,914	\$11,202
		Grade 2 Wood Veneer	\$10,208	\$11,709	\$11,841	\$12,129
85"-96" 55" -60" 40"	COET2RACESTA	Grade 1 Laminate	\$6985	\$8649	\$8798	\$9118
		Grade 2 and 3 Laminate	\$7269	\$8933	\$9082	\$9402
		Grade 1 Wood Veneer	\$9737	\$11,401	\$11,550	\$11,870
		Grade 2 Wood Veneer	\$10,699	\$12,363	\$12,512	\$12,832
97" -108" 36" 40"	COET2RACESTA	Grade 1 Laminate	\$6159	\$7458	\$7625	\$7872
		Grade 2 and 3 Laminate	\$6362	\$7661	\$7828	\$8075
		Grade 1 Wood Veneer	\$8309	\$9608	\$9775	\$10,022
		Grade 2 Wood Veneer	\$9106	\$10,405	\$10,572	\$10,819

Tip: Tables are available parametrically in 1" increments.

► Product Information continued on next page

E-Table 2 Collaborative and Conference Tables

Racetrack Aluminum Base Tables-Standing Height

► Product Information continued from previous page

Specification Information



Dimensions		Style Number	Finish	Base Prices				
W	D			H				

Racetrack Tables with Two Aluminum Bases - Standing Height

Dimensions	Style Number	Finish	3 mm Plastic/ 3 mm Wood, Flat, or Convex Vinyl Edge:	Bullnose Wood Edge:	Beveled Wood Edge:	Knife Wood Edge:
97" -108" 37" -42" 40"	COET2RACESTA	Grade 1 Laminate	\$6336	\$7815	\$7934	\$8220
		Grade 2 and 3 Laminate	\$6562	\$8041	\$8160	\$8446
		Grade 1 Wood Veneer	\$8759	\$10,238	\$10,357	\$10,643
		Grade 2 Wood Veneer	\$9587	\$11,066	\$11,185	\$11,471
97" -108" 43" -48" 40"	COET2RACESTA	Grade 1 Laminate	\$6819	\$8706	\$8888	\$9238
		Grade 2 and 3 Laminate	\$7076	\$8963	\$9145	\$9495
		Grade 1 Wood Veneer	\$9055	\$10,942	\$11,124	\$11,474
		Grade 2 Wood Veneer	\$10,055	\$11,942	\$12,124	\$12,474
97" -108" 49" -54" 40"	COET2RACESTA	Grade 1 Laminate	\$7056	\$9182	\$9384	\$9776
		Grade 2 and 3 Laminate	\$7344	\$9470	\$9672	\$10,064
		Grade 1 Wood Veneer	\$9672	\$11,798	\$12,000	\$12,392
		Grade 2 Wood Veneer	\$10,760	\$12,886	\$13,088	\$13,480
97" -108" 55" -60" 40"	COET2RACESTA	Grade 1 Laminate	\$7286	\$9648	\$9874	\$10,304
		Grade 2 and 3 Laminate	\$7606	\$9968	\$10,194	\$10,624
		Grade 1 Wood Veneer	\$10,283	\$12,645	\$12,871	\$13,301
		Grade 2 Wood Veneer	\$11,468	\$13,830	\$14,056	\$14,486
109" -120" 36" 40"	COET2RACESTA	Grade 1 Laminate	\$6293	\$8090	\$8251	\$8589
		Grade 2 and 3 Laminate	\$6511	\$8308	\$8469	\$8807
		Grade 1 Wood Veneer	\$8371	\$10,168	\$10,329	\$10,667
		Grade 2 Wood Veneer	\$9219	\$11,016	\$11,177	\$11,515

Tip: Tables are available parametrically in 1" increments.

► Product Information continued on next page

E-Table 2 Collaborative and Conference Tables

Racetrack Aluminum Base Tables-Standing Height

► Product Information continued from previous page

Specification Information

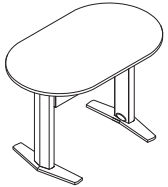

Dimensions		Style		Finish	Base Prices				
W	D	H	Number						

Racetrack Tables with Two Aluminum Bases - Standing Height

Dimensions	Style	Finish	Base Prices	Base Prices	Base Prices	Base Prices
109" -120" 37" -42" 40"	COET2RACESTA	Grade 1 Laminate	\$6773	\$8979	\$9203	\$9602
		Grade 2 and 3 Laminate	\$7024	\$9230	\$9454	\$9853
		Grade 1 Wood Veneer	\$8668	\$10,874	\$11,098	\$11,497
		Grade 2 Wood Veneer	\$9689	\$11,895	\$12,119	\$12,518
109" -120" 43" -48" 40"	COET2RACESTA	Grade 1 Laminate	\$7008	\$9451	\$9696	\$10,138
		Grade 2 and 3 Laminate	\$7290	\$9733	\$9978	\$10,420
		Grade 1 Wood Veneer	\$9281	\$11,724	\$11,969	\$12,411
		Grade 2 Wood Veneer	\$10,394	\$12,837	\$13,082	\$13,524
109" -120" 49" -54" 40"	COET2RACESTA	Grade 1 Laminate	\$7301	\$10,051	\$10,326	\$10,818
		Grade 2 and 3 Laminate	\$7621	\$10,371	\$10,646	\$11,138
		Grade 1 Wood Veneer	\$10,057	\$12,807	\$13,082	\$13,574
		Grade 2 Wood Veneer	\$11,316	\$14,066	\$14,341	\$14,833
109" -120" 55" -60" 40"	COET2RACESTA	Grade 1 Laminate	\$7586	\$10,648	\$10,945	\$11,488
		Grade 2 and 3 Laminate	\$7943	\$11,005	\$11,302	\$11,845
		Grade 1 Wood Veneer	\$10,828	\$13,890	\$14,187	\$14,730
		Grade 2 Wood Veneer	\$12,233	\$15,295	\$15,592	\$16,135

E-Table 2 Collaborative and Conference Tables

Racetrack Aluminum Base Tables-Standing Height

E-Table 2
Collaborative and
Conference Tables

E-Table 2 Collaborative and Conference Tables

Racetrack Laminate Base Tables

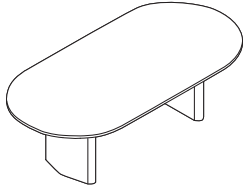

Tip: Shipped knocked down.

Tip: Utility bay quantity offering by table width is available in the understanding section.

Tip: If you specify a wood edge on a top with woodgrain laminate, the edge and the top may not match.

Tip: Sectioned top option is a two piece top and is only available on tops 96"W-120"W.

Tip: When a wood edge is specified on a wood veneer top, the edge finish will match the top finish.

Tip: Each utility bay comes with two universal faceplate openings that accept customer-supplied faceplates in any of the following sizes: single-gang, double-gang, or triple-gang.

Standard Includes

- Top:
 - 1 1/4" particle board core with grade 1 laminate
 - parametric width in 1" increments ranging from 96"-288"
 - parametric depth in 1" increments ranging from 48"-60"
- Base: black laminate on MDF core
- Edge: 3 mm plastic edge, 3 mm wood edge, or convex vinyl edge
- Wireway: painted steel side panels with powder coat and black plastic access door
- Concealed leveling glides: non-marring, black plastic
- Overall height: 29"

Options

Sectioned Top	No Sectioned Top With Sectioned Top	No cost +\$569
Top Finish	Laminate Price Group 02 Laminate Price Group 03 Veneer Price Group 01 Veneer Price Group 02	Price below Price below Price below Price below
Edge Type	3mm Plastic Edge 3mm Wood Edge Beveled Wood Edge Bullnose Wood Edge Convex Vinyl Edge Knife Wood Edge	Price below Price below Price below Price below Price below Price below
Base Type	Black HPL Curated HPL	No cost +\$873
Bay Option	No Bays Two Bays Three Bays Four Bays Six Bays Seven Bays	No cost +\$1578 +\$2367 +\$3156 +\$4734 +\$5523
Wiring Schematic	1+1 Hardwire, 2 Circuits 3 + 0 Wireway Chicago Wireway 1+1 Hardwire, 2 Circuits, USB 3 + 0 Wireway, USB	No cost No cost No cost +\$157 +\$157
Infeed	Hardwire NYC Hardwire Infeed Plug	No cost No cost No cost
Infeed Location	End Base Power Infeed Mid Base Power Infeed	No cost No cost

► **Product Information continued on next page**

E-Table 2 Collaborative and Conference Tables

Racetrack Laminate Base Tables

► Product Information continued from previous page

Specification Information

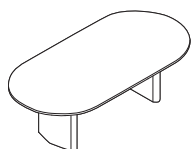

Dimensions		Style Number	Finish	Base Prices			
W	D			H			
				3 mm Plastic/ 3 mm Wood, Flat, or Convex Vinyl Edge:	Bullnose Wood Edge:	Beveled Wood Edge:	Knife Wood Edge:

Racetrack Tables with Two Laminate Bases - Working Height

96"	48"	29"	COET2RACEL	Grade 1 Laminate	\$5871	\$7201	\$7322	\$7578
				Grade 2 and 3 Laminate	\$6103	\$7433	\$7554	\$7810
				Grade 1 Wood Veneer	\$8074	\$9404	\$9525	\$9781
				Grade 2 Wood Veneer	\$8969	\$10,299	\$10,420	\$10,676
96"	49" -54"	29"	COET2RACEL	Grade 1 Laminate	\$6047	\$7548	\$7680	\$7968
				Grade 2 and 3 Laminate	\$6305	\$7806	\$7938	\$8226
				Grade 1 Wood Veneer	\$8521	\$10,022	\$10,154	\$10,442
				Grade 2 Wood Veneer	\$9446	\$10,947	\$11,079	\$11,367
96"	55" -60"	29"	COET2RACEL	Grade 1 Laminate	\$6224	\$7888	\$8037	\$8357
				Grade 2 and 3 Laminate	\$6508	\$8172	\$8321	\$8641
				Grade 1 Wood Veneer	\$8975	\$10,639	\$10,788	\$11,108
				Grade 2 Wood Veneer	\$9940	\$11,604	\$11,753	\$12,073
97" -108"	48"	29"	COET2RACEL	Grade 1 Laminate	\$6119	\$8006	\$8188	\$8538
				Grade 2 and 3 Laminate	\$6374	\$8261	\$8443	\$8793
				Grade 1 Wood Veneer	\$8353	\$10,240	\$10,422	\$10,772
				Grade 2 Wood Veneer	\$9353	\$11,240	\$11,422	\$11,772
97" -108"	49" -54"	29"	COET2RACEL	Grade 1 Laminate	\$6353	\$8479	\$8681	\$9073
				Grade 2 and 3 Laminate	\$6641	\$8767	\$8969	\$9361
				Grade 1 Wood Veneer	\$8969	\$11,095	\$11,297	\$11,689
				Grade 2 Wood Veneer	\$10,060	\$12,186	\$12,388	\$12,780

Tip: Top ships in one piece.

Tip: Tables are available parametrically in 1" increments.

E-Table 2
Collaborative and
Conference Tables

► Product Information continued on next page

E-Table 2 Collaborative and Conference Tables

Racetrack Laminate Base Tables

► Product Information continued from previous page

Specification Information

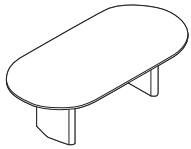

Dimensions		Style Number	Finish	Base Prices			
W	D			H			
				3 mm Plastic/ 3 mm Wood, Flat, or Convex Vinyl Edge:	Bullnose Wood Edge:	Beveled Wood Edge:	Knife Wood Edge:

Racetrack Tables with Two Laminate Bases - Working Height

97" -108"	55" -60"	29"	COET2RACEL	Grade 1 Laminate	\$6585	\$8947	\$9173	\$9603
				Grade 2 and 3 Laminate	\$6904	\$9266	\$9492	\$9922
				Grade 1 Wood Veneer	\$9584	\$11,946	\$12,172	\$12,602
				Grade 2 Wood Veneer	\$10,768	\$13,130	\$13,356	\$13,786
109" -120"	48"	29"	COET2RACEL	Grade 1 Laminate	\$6250	\$8693	\$8938	\$9380
				Grade 2 and 3 Laminate	\$6531	\$8974	\$9219	\$9661
				Grade 1 Wood Veneer	\$8520	\$10,963	\$11,208	\$11,650
				Grade 2 Wood Veneer	\$9648	\$12,091	\$12,336	\$12,778
109" -120"	47" -54"	29"	COET2RACEL	Grade 1 Laminate	\$6539	\$9289	\$9564	\$10,056
				Grade 2 and 3 Laminate	\$6858	\$9608	\$9883	\$10,375
				Grade 1 Wood Veneer	\$9296	\$12,046	\$12,321	\$12,813
				Grade 2 Wood Veneer	\$10,567	\$13,317	\$13,592	\$14,084
109" -120"	55" -60"	29"	COET2RACEL	Grade 1 Laminate	\$6822	\$9884	\$10,184	\$10,724
				Grade 2 and 3 Laminate	\$7177	\$10,239	\$10,539	\$11,079
				Grade 1 Wood Veneer	\$10,064	\$13,126	\$13,426	\$13,966
				Grade 2 Wood Veneer	\$11,478	\$14,540	\$14,840	\$15,380

Tip: Tables are available parametrically in 1" increments.

► Product Information continued on next page

E-Table 2 Collaborative and Conference Tables

Racetrack Laminate Base Tables

► Product Information continued from previous page

Specification Information

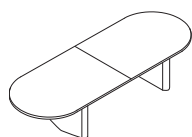

Dimensions		Style H	Style Number	Finish	Base Prices			
W	D				3 mm Plastic/ 3 mm Wood, Flat or Convex Vinyl Edge:	Bullnose Wood Edge:	Beveled Wood Edge:	Knife Wood Edge:

Racetrack Tables with Two Laminate Bases - Working Height

Tip: Top ships in two pieces. Hardware is included for field assembly.

121" -132"	48"	29"	COET2RACEL	Grade 1 Laminate	\$6279	\$9290	\$9562	\$10,081
				Grade 2 and 3 Laminate	\$6589	\$9600	\$9872	\$10,391
				Grade 1 Wood Veneer	\$9072	\$12,083	\$12,355	\$12,874
				Grade 2 Wood Veneer	\$10,310	\$13,321	\$13,593	\$14,112

Tip: If you require your table top to be made into three pieces, this can be done as a special. Please contact Customer Service at 1.800.627.6770 to obtain a quote.

121" -132"	49" -54"	29"	COET2RACEL	Grade 1 Laminate	\$6586	\$9974	\$10,273	\$10,863
				Grade 2 and 3 Laminate	\$6939	\$10,327	\$10,626	\$11,216
				Grade 1 Wood Veneer	\$9976	\$13,364	\$13,663	\$14,253
				Grade 2 Wood Veneer	\$11,374	\$14,762	\$15,061	\$15,651

121" -132"	55" -60"	29"	COET2RACEL	Grade 1 Laminate	\$6888	\$10,655	\$10,986	\$11,643
				Grade 2 and 3 Laminate	\$7280	\$11,047	\$11,378	\$12,035
				Grade 1 Wood Veneer	\$10,872	\$14,639	\$14,970	\$15,627
				Grade 2 Wood Veneer	\$12,429	\$16,196	\$16,527	\$17,184

Tip: Tables are available parametrically in 1" increments.

133" -144"	48"	29"	COET2RACEL	Grade 1 Laminate	\$6308	\$9885	\$10,185	\$10,782
				Grade 2 and 3 Laminate	\$6647	\$10,224	\$10,524	\$11,121
				Grade 1 Wood Veneer	\$9624	\$13,201	\$13,501	\$14,098
				Grade 2 Wood Veneer	\$10,972	\$14,549	\$14,849	\$15,446

133" -144"	49" -54"	29"	COET2RACEL	Grade 1 Laminate	\$6633	\$10,658	\$10,984	\$11,669
				Grade 2 and 3 Laminate	\$7019	\$11,044	\$11,370	\$12,055
				Grade 1 Wood Veneer	\$10,656	\$14,681	\$15,007	\$15,692
				Grade 2 Wood Veneer	\$12,182	\$16,207	\$16,533	\$17,218

133" -144"	55" -60"	29"	COET2RACEL	Grade 1 Laminate	\$6953	\$11,424	\$11,788	\$12,557
				Grade 2 and 3 Laminate	\$7381	\$11,852	\$12,216	\$12,985
				Grade 1 Wood Veneer	\$11,679	\$16,150	\$16,514	\$17,283
				Grade 2 Wood Veneer	\$13,379	\$17,850	\$18,214	\$18,983

► Product Information continued on next page

E-Table 2 Collaborative and Conference Tables

Racetrack Laminate Base Tables

► Product Information continued from previous page

Specification Information

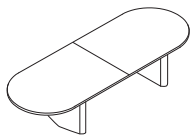

Dimensions		Style Number	Finish	Base Prices			
W	D			H			
				3 mm Plastic/ 3 mm Wood, Flat or Convex Vinyl Edge:	Bullnose Wood Edge:	Beveled Wood Edge:	Knife Wood Edge:

Racetrack Tables with Two Laminate Bases - Working Height

Dimensions	Style Number	Finish	Grade 1 Laminate	Grade 2 and 3 Laminate	Grade 1 Wood Veneer	Grade 2 Wood Veneer
145" -156" 43" -48" 29"	COET2RACEL	Grade 1 Laminate	\$7741	\$12,251	\$12,539	\$13,316
		Grade 2 and 3 Laminate	\$8098	\$12,608	\$12,896	\$13,673
		Grade 1 Wood Veneer	\$12,859	\$17,369	\$17,657	\$18,434
		Grade 2 Wood Veneer	\$14,310	\$18,820	\$19,108	\$19,885
145" -156" 49" -54" 29"	COET2RACEL	Grade 1 Laminate	\$8163	\$13,236	\$13,559	\$14,435
		Grade 2 and 3 Laminate	\$8570	\$13,643	\$13,966	\$14,842
		Grade 1 Wood Veneer	\$14,208	\$19,281	\$19,604	\$20,480
		Grade 2 Wood Veneer	\$15,854	\$20,927	\$21,250	\$22,126
145" -156" 55" -60" 29"	COET2RACEL	Grade 1 Laminate	\$8580	\$14,219	\$14,573	\$15,552
		Grade 2 and 3 Laminate	\$9032	\$14,671	\$15,025	\$16,004
		Grade 1 Wood Veneer	\$15,552	\$21,191	\$21,545	\$22,524
		Grade 2 Wood Veneer	\$17,391	\$23,030	\$23,384	\$24,363

► Product Information continued on next page

E-Table 2 Collaborative and Conference Tables

Racetrack Laminate Base Tables

► Product Information continued from previous page

Specification Information

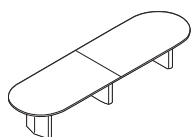

Dimensions		Style Number	Finish	Base Prices			
W	D			H			
				3 mm Plastic/ 3 mm Wood, Flat or Convex Vinyl Edge:	Bullnose Wood Edge:	Beveled Wood Edge:	Knife Wood Edge:

Racetrack Tables with Three Laminate Bases - Working Height

Tip: Top ships in two pieces. Hardware is included for field assembly.

Dimensions	Style Number	Finish	Grade 1 Laminate	Grade 2 and 3 Laminate	Grade 1 Wood Veneer	Grade 2 Wood Veneer
157" -168" 48"	29" COET2RACEL		\$9027	\$9404	\$15,951	\$17,533
			\$14,470	\$14,847	\$21,394	\$22,976
			\$14,746	\$15,123	\$21,670	\$23,252
			\$15,700	\$16,077	\$22,624	\$24,206

Tip: For tables with three or more bases, you must specify the entry point of the base power infeed, either an end base or a mid base location, in order to receive the correct length of base power infeed.

Dimensions	Style Number	Finish	Grade 1 Laminate	Grade 2 and 3 Laminate	Grade 1 Wood Veneer	Grade 2 Wood Veneer
157" -168" 49" -54"	29" COET2RACEL		\$9539	\$9965	\$17,606	\$19,399
			\$15,658	\$16,084	\$23,725	\$25,518
			\$15,979	\$16,405	\$24,046	\$25,839
			\$17,047	\$17,473	\$25,114	\$26,907

Tip: If you require your table top to be made into three pieces, this can be done as a special. Please contact Customer Service at 1.800.627.6770 to obtain a quote.

Dimensions	Style Number	Finish	Grade 1 Laminate	Grade 2 and 3 Laminate	Grade 1 Wood Veneer	Grade 2 Wood Veneer
157" -168" 55" -60"	29" COET2RACEL		\$10,048	\$10,517	\$19,260	\$21,263
			\$16,853	\$17,322	\$26,065	\$28,068
			\$17,199	\$17,668	\$26,411	\$28,414
			\$18,385	\$18,854	\$27,597	\$29,600

Dimensions	Style Number	Finish	Grade 1 Laminate	Grade 2 and 3 Laminate	Grade 1 Wood Veneer	Grade 2 Wood Veneer
169" -180" 48"	29" COET2RACEL		\$9080	\$9484	\$16,067	\$17,758
			\$14,638	\$15,042	\$21,625	\$23,316
			\$14,918	\$15,322	\$21,905	\$23,596
			\$15,889	\$16,293	\$22,876	\$24,567

Dimensions	Style Number	Finish	Grade 1 Laminate	Grade 2 and 3 Laminate	Grade 1 Wood Veneer	Grade 2 Wood Veneer
169" -180" 49" -54"	29" COET2RACEL		\$9614	\$10,068	\$17,755	\$19,554
			\$15,865	\$16,319	\$24,006	\$25,805
			\$16,183	\$16,637	\$24,324	\$26,123
			\$17,271	\$17,725	\$25,412	\$27,211

► Product Information continued on next page

E-Table 2 Collaborative and Conference Tables

Racetrack Laminate Base Tables

► Product Information continued from previous page

Specification Information

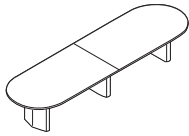

Dimensions		Style Number	Finish	Base Prices			
W	D			H			
				3 mm Plastic/ 3 mm Wood, Flat or Convex Vinyl Edge:	Bullnose Wood Edge:	Beveled Wood Edge:	Knife Wood Edge:

Racetrack Tables with Three Laminate Bases - Working Height

169" -180"	55" -60"	29"	COET2RACEL	Grade 1 Laminate	\$10,141	\$17,091	\$17,441	\$18,648
				Grade 2 and 3 Laminate	\$10,644	\$17,594	\$17,944	\$19,151
				Grade 1 Wood Veneer	\$19,439	\$26,389	\$26,739	\$27,946
				Grade 2 Wood Veneer	\$21,581	\$28,531	\$28,881	\$30,088
181" -192"	48"	29"	COET2RACEL	Grade 1 Laminate	\$9132	\$14,805	\$15,090	\$16,077
				Grade 2 and 3 Laminate	\$9564	\$15,237	\$15,522	\$16,509
				Grade 1 Wood Veneer	\$16,182	\$21,855	\$22,140	\$23,127
				Grade 2 Wood Veneer	\$17,982	\$23,655	\$23,940	\$24,927
181" -192"	49" -54"	29"	COET2RACEL	Grade 1 Laminate	\$9688	\$16,068	\$16,385	\$17,495
				Grade 2 and 3 Laminate	\$10,171	\$16,551	\$16,868	\$17,978
				Grade 1 Wood Veneer	\$17,903	\$24,283	\$24,600	\$25,710
				Grade 2 Wood Veneer	\$19,708	\$26,088	\$26,405	\$27,515
181" -192"	55" -60"	29"	COET2RACEL	Grade 1 Laminate	\$10,234	\$17,327	\$17,681	\$18,913
				Grade 2 and 3 Laminate	\$10,771	\$17,864	\$18,218	\$19,450
				Grade 1 Wood Veneer	\$19,618	\$26,711	\$27,065	\$28,297
				Grade 2 Wood Veneer	\$21,899	\$28,992	\$29,346	\$30,578
193" -204"	48"	29"	COET2RACEL	Grade 1 Laminate	\$9302	\$15,150	\$15,461	\$16,530
				Grade 2 and 3 Laminate	\$9759	\$15,607	\$15,918	\$16,987
				Grade 1 Wood Veneer	\$17,560	\$23,408	\$23,719	\$24,788
				Grade 2 Wood Veneer	\$19,477	\$25,325	\$25,636	\$26,705

► Product Information continued on next page

E-Table 2 Collaborative and Conference Tables

Racetrack Laminate Base Tables

► Product Information continued from previous page

Specification Information

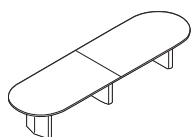

Dimensions		Style H Number	Finish	Base Prices			
W	D			3 mm Plastic/ 3 mm Wood, Flat or Convex Vinyl Edge:	Bullnose Wood Edge:	Beveled Wood Edge:	Knife Wood Edge:

Racetrack Tables with Three Laminate Bases - Working Height

193" -204"	49" -54"	29"	COET2RACEL	Grade 1 Laminate	\$9888	\$16,468	\$16,811	\$18,015
				Grade 2 and 3 Laminate	\$10,402	\$16,982	\$17,325	\$18,529
				Grade 1 Wood Veneer	\$19,461	\$26,041	\$26,384	\$27,588
				Grade 2 Wood Veneer	\$21,519	\$28,099	\$28,442	\$29,646
193" -204"	55" -60"	29"	COET2RACEL	Grade 1 Laminate	\$10,473	\$17,795	\$18,169	\$19,506
				Grade 2 and 3 Laminate	\$11,043	\$18,365	\$18,739	\$20,076
				Grade 1 Wood Veneer	\$21,361	\$28,683	\$29,057	\$30,394
				Grade 2 Wood Veneer	\$23,793	\$31,115	\$31,489	\$32,826
205" -216"	48"	29"	COET2RACEL	Grade 1 Laminate	\$9471	\$15,490	\$15,830	\$16,982
				Grade 2 and 3 Laminate	\$9954	\$15,973	\$16,313	\$17,465
				Grade 1 Wood Veneer	\$18,937	\$24,956	\$25,296	\$26,448
				Grade 2 Wood Veneer	\$20,973	\$26,992	\$27,332	\$28,484
205" -216"	49" -54"	29"	COET2RACEL	Grade 1 Laminate	\$10,089	\$16,872	\$17,235	\$18,535
				Grade 2 and 3 Laminate	\$10,632	\$17,415	\$17,778	\$19,078
				Grade 1 Wood Veneer	\$21,017	\$27,800	\$28,163	\$29,463
				Grade 2 Wood Veneer	\$23,328	\$30,111	\$30,474	\$31,774
205" -216"	55" -60"	29"	COET2RACEL	Grade 1 Laminate	\$10,711	\$18,258	\$18,656	\$20,098
				Grade 2 and 3 Laminate	\$11,314	\$18,861	\$19,259	\$20,701
				Grade 1 Wood Veneer	\$23,102	\$30,649	\$31,047	\$32,489
				Grade 2 Wood Veneer	\$25,685	\$33,232	\$33,630	\$35,072

► Product Information continued on next page

E-Table 2 Collaborative and Conference Tables

Racetrack Laminate Base Tables

► Product Information continued from previous page

Specification Information

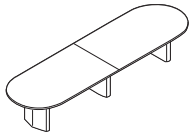

Dimensions		Style Number	Finish	Base Prices			
W	D			H			
				3 mm Plastic/ 3 mm Wood, Flat or Convex Vinyl Edge:	Bullnose Wood Edge:	Beveled Wood Edge:	Knife Wood Edge:

Racetrack Tables with Three Laminate Bases - Working Height

217" -228"	48"	29"	COET2RACEL	Grade 1 Laminate	\$9498	\$15,822	\$16,184	\$17,368
				Grade 2 and 3 Laminate	\$10,007	\$16,331	\$16,693	\$17,877
				Grade 1 Wood Veneer	\$19,637	\$25,961	\$26,323	\$27,507
				Grade 2 Wood Veneer	\$21,781	\$28,105	\$28,467	\$29,651
217" -228"	49" -54"	29"	COET2RACEL	Grade 1 Laminate	\$10,137	\$17,261	\$17,657	\$18,989
				Grade 2 and 3 Laminate	\$10,709	\$17,833	\$18,229	\$19,561
				Grade 1 Wood Veneer	\$21,823	\$28,947	\$29,343	\$30,675
				Grade 2 Wood Veneer	\$24,257	\$31,381	\$31,777	\$33,109
217" -228"	55" -60"	29"	COET2RACEL	Grade 1 Laminate	\$10,776	\$18,704	\$19,134	\$20,612
				Grade 2 and 3 Laminate	\$11,413	\$19,341	\$19,771	\$21,249
				Grade 1 Wood Veneer	\$24,012	\$31,940	\$32,370	\$33,848
				Grade 2 Wood Veneer	\$26,730	\$34,658	\$35,088	\$36,566
229" -240"	48"	29"	COET2RACEL	Grade 1 Laminate	\$9524	\$16,151	\$16,537	\$17,751
				Grade 2 and 3 Laminate	\$10,060	\$16,687	\$17,073	\$18,287
				Grade 1 Wood Veneer	\$20,337	\$26,964	\$27,350	\$28,564
				Grade 2 Wood Veneer	\$22,589	\$29,216	\$29,602	\$30,816
229" -240"	49" -54"	29"	COET2RACEL	Grade 1 Laminate	\$10,185	\$17,649	\$18,080	\$19,442
				Grade 2 and 3 Laminate	\$10,786	\$18,250	\$18,681	\$20,043
				Grade 1 Wood Veneer	\$22,627	\$30,091	\$30,522	\$31,884
				Grade 2 Wood Veneer	\$25,184	\$32,648	\$33,079	\$34,441
229" -240"	55" -60"	29"	COET2RACEL	Grade 1 Laminate	\$10,839	\$19,145	\$19,607	\$21,124
				Grade 2 and 3 Laminate	\$11,512	\$19,818	\$20,280	\$21,797
				Grade 1 Wood Veneer	\$24,920	\$33,226	\$33,688	\$35,205
				Grade 2 Wood Veneer	\$27,774	\$36,080	\$36,542	\$38,059

► Product Information continued on next page

E-Table 2 Collaborative and Conference Tables

Racetrack Laminate Base Tables

► Product Information continued from previous page

Specification Information

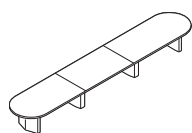

Dimensions		Style H Number	Finish	Base Prices			
W	D			3 mm Plastic/ 3 mm Wood, Flat or Convex Vinyl Edge:	Bullnose Wood Edge:	Beveled Wood Edge:	Knife Wood Edge:

Racetrack Tables with Four Laminate Bases - Working Height

Tip: Top ships in three pieces. Hardware is included for field assembly.

241" -252"	48"	29"	COET2RACEL	Grade 1 Laminate	\$11,173	\$18,847	\$19,246	\$20,631
				Grade 2 and 3 Laminate	\$11,732	\$19,406	\$19,805	\$21,190
				Grade 1 Wood Veneer	\$23,908	\$31,582	\$31,981	\$33,366
				Grade 2 Wood Veneer	\$26,257	\$33,931	\$34,330	\$35,715

Tip: For tables with three or more bases, you must specify the entry point of the base power infeed, either an end base or a mid base location, in order to receive the correct length of base power infeed.

241" -252"	49" -54"	29"	COET2RACEL	Grade 1 Laminate	\$11,945	\$20,567	\$21,017	\$22,591
				Grade 2 and 3 Laminate	\$12,575	\$21,197	\$21,647	\$23,221
				Grade 1 Wood Veneer	\$26,546	\$35,168	\$35,618	\$37,192
				Grade 2 Wood Veneer	\$29,212	\$37,834	\$38,284	\$39,858

241" -252"	55" -60"	29"	COET2RACEL	Grade 1 Laminate	\$12,709	\$22,323	\$22,788	\$24,547
				Grade 2 and 3 Laminate	\$13,409	\$23,023	\$23,488	\$25,247
				Grade 1 Wood Veneer	\$29,185	\$38,799	\$39,264	\$41,023
				Grade 2 Wood Veneer	\$32,168	\$41,782	\$42,247	\$44,006

Tip: If you require your table top to be made into four pieces, this can be done as a special. Please contact Customer Service at 1.800.627.6770 to obtain a quote.

253" -264"	48"	29"	COET2RACEL	Grade 1 Laminate	\$12,610	\$21,329	\$21,741	\$23,297
				Grade 2 and 3 Laminate	\$13,194	\$21,913	\$22,325	\$23,881
				Grade 1 Wood Veneer	\$27,267	\$35,986	\$36,398	\$37,954
				Grade 2 Wood Veneer	\$29,748	\$38,467	\$38,879	\$40,435

253" -264"	49" -54"	29"	COET2RACEL	Grade 1 Laminate	\$13,481	\$23,262	\$23,734	\$25,514
				Grade 2 and 3 Laminate	\$14,135	\$23,916	\$24,388	\$26,168
				Grade 1 Wood Veneer	\$30,236	\$40,017	\$40,489	\$42,269
				Grade 2 Wood Veneer	\$33,047	\$42,828	\$43,300	\$45,080

► Product Information continued on next page

E-Table 2 Collaborative and Conference Tables

Racetrack Laminate Base Tables

► Product Information continued from previous page

Specification Information

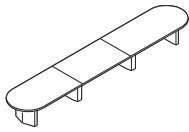

Dimensions		Style	Finish	Base Prices			
W	D	H	Number	Edge:			
				3 mm Plastic/ 3 mm Wood, Flat or Convex Vinyl Edge:	Bullnose Wood Edge:	Beveled Wood Edge:	Knife Wood Edge:

Racetrack Tables with Four Laminate Bases - Working Height

253" -264"	55" -60"	29"	COET2RACEL	Grade 1 Laminate	\$14,338	\$25,261	\$25,725	\$27,726
				Grade 2 and 3 Laminate	\$15,065	\$25,988	\$26,452	\$28,453
				Grade 1 Wood Veneer	\$33,208	\$44,131	\$44,595	\$46,596
				Grade 2 Wood Veneer	\$36,355	\$47,278	\$47,742	\$49,743
265" -276"	48"	29"	COET2RACEL	Grade 1 Laminate	\$12,669	\$21,569	\$22,002	\$23,495
				Grade 2 and 3 Laminate	\$13,277	\$22,177	\$22,610	\$24,103
				Grade 1 Wood Veneer	\$27,423	\$36,323	\$36,756	\$38,249
				Grade 2 Wood Veneer	\$30,026	\$38,926	\$39,359	\$40,852
265" -276"	49" -54"	29"	COET2RACEL	Grade 1 Laminate	\$13,570	\$23,525	\$23,974	\$25,759
				Grade 2 and 3 Laminate	\$14,254	\$24,209	\$24,658	\$26,443
				Grade 1 Wood Veneer	\$30,403	\$40,358	\$40,807	\$42,592
				Grade 2 Wood Veneer	\$33,353	\$43,308	\$43,757	\$45,542
265" -276"	55" -60"	29"	COET2RACEL	Grade 1 Laminate	\$14,414	\$25,548	\$25,954	\$28,034
				Grade 2 and 3 Laminate	\$15,174	\$26,308	\$26,714	\$28,794
				Grade 1 Wood Veneer	\$33,392	\$44,526	\$44,932	\$47,012
				Grade 2 Wood Veneer	\$36,694	\$47,828	\$48,234	\$50,314
277" -288"	48"	29"	COET2RACEL	Grade 1 Laminate	\$12,727	\$21,806	\$22,265	\$23,688
				Grade 2 and 3 Laminate	\$13,359	\$22,438	\$22,897	\$24,320
				Grade 1 Wood Veneer	\$27,578	\$36,657	\$37,116	\$38,539
				Grade 2 Wood Veneer	\$30,304	\$39,383	\$39,842	\$41,265

Tip: Tables are available parametrically in 1" increments.

► Product Information continued on next page

E-Table 2 Collaborative and Conference Tables

Racetrack Laminate Base Tables

► Product Information continued from previous page

Specification Information

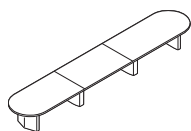

Dimensions		Style	Finish	Base Prices					
W	D	H	Number						
				3 mm Plastic/ 3 mm Wood, Flat or Convex Vinyl Edge:	Bullnose Wood Edge:	Beveled Wood Edge:	Knife Wood Edge:		

Racetrack Tables with Four Laminate Bases - Working Height

277" -288"	49" -54"	29"	COET2RACEL	Grade 1 Laminate	\$13,659	\$23,789	\$24,215	\$26,008
				Grade 2 and 3 Laminate	\$14,372	\$24,502	\$24,928	\$26,721
				Grade 1 Wood Veneer	\$30,569	\$40,699	\$41,125	\$42,918
				Grade 2 Wood Veneer	\$33,659	\$43,789	\$44,215	\$46,008
277" -288"	55" -60"	29"	COET2RACEL	Grade 1 Laminate	\$14,490	\$25,834	\$26,181	\$28,338
				Grade 2 and 3 Laminate	\$15,282	\$26,626	\$26,973	\$29,130
				Grade 1 Wood Veneer	\$33,575	\$44,919	\$45,266	\$47,423
				Grade 2 Wood Veneer	\$37,032	\$48,376	\$48,723	\$50,880

E-Table 2
Collaborative and
Conference Tables

E-Table 2 Collaborative and Conference Tables

Racetrack Veneer Base Tables

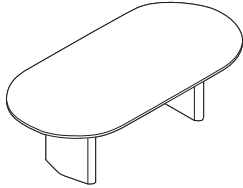

Tip: Shipped knocked down.

Tip: Utility bay quantity offering by table width is available in the understanding section.

Tip: If you specify a wood edge on a top with woodgrain laminate, the edge and the top may not match.

Tip: Sectioned top option is a two piece top and is only available on tops 96"W-120"W.

Tip: When a wood edge is specified on a wood veneer top, the edge finish will match the top finish.

Tip: Each utility bay comes with two universal faceplate openings that accept customer-supplied faceplates in any of the following sizes: single-gang, double-gang, or triple-gang.

Standard Includes

- Top:
 - 1 1/4" particle board core with grade 1 laminate
 - parametric width in 1" increments ranging from 96"-288"
 - parametric depth in 1" increments ranging from 48"-60"
- Edge: 3 mm plastic edge, 3 mm wood edge, or convex vinyl edge
- Bases: grade 01 or grade 02 veneer on MDF core
- Wireway: painted steel side panels with powder coat and black plastic access door
- Concealed leveling glides: non-marring, black plastic

Options

Sectioned Top	No Sectioned Top	No cost
	With Sectioned Top	+\$569
Top Finish	Laminate Price Group 02	Price below
	Laminate Price Group 03	Price below
	Veneer Price Group 01	Price below
	Veneer Price Group 02	Price below
Edge Type	3mm Plastic Edge	Price below
	3mm Wood Edge	Price below
	Beveled Wood Edge	Price below
	Bullnose Wood Edge	Price below
	Convex Vinyl Edge	Price below
	Knife Wood Edge	Price below
Bay Option	No Bays	No cost
	Two Bays	+\$1578
	Three Bays	+\$2367
	Four Bays	+\$3156
	Six Bays	+\$4734
	Seven Bays	+\$5523
	Wiring Schematic	1+1 Hardwire, 2 Circuits
3 + 0 Wireway		No cost
Chicago Wireway		No cost
1+1 Hardwire, 2 Circuits, USB		+\$157
3 + 0 Wireway, USB		+\$157
Infeed	Hardwire	No cost
	NYC Hardwire Infeed	No cost
	Plug	No cost
Infeed Location	End Base Power Infeed	No cost
	Mid Base Power Infeed	No cost

► **Product Information continued on next page**

E-Table 2 Collaborative and Conference Tables

Racetrack Veneer Base Tables

► Product Information continued from previous page

Specification Information

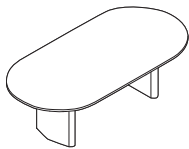

Dimensions		Style Number	Finish	Base Prices			
W	D			H			

Racetrack Tables with Two Veneer Bases - Working Height

Tip: Top ships in one piece.

96"	48"	29"	COET2RACEV	Grade 1 Laminate	\$9263	\$10,593	\$10,714	\$10,970
				Grade 2 and 3 Laminate	\$9495	\$10,825	\$10,946	\$11,202
				Grade 1 Wood Veneer	\$11,466	\$12,796	\$12,917	\$13,173
				Grade 2 Wood Veneer	\$12,361	\$13,691	\$13,812	\$14,068

Tip: Tables are available parametrically in 1" increments.

96"	49" -54"	29"	COET2RACEV	Grade 1 Laminate	\$9439	\$10,940	\$11,072	\$11,360
				Grade 2 and 3 Laminate	\$9697	\$11,198	\$11,330	\$11,618
				Grade 1 Wood Veneer	\$11,913	\$13,414	\$13,546	\$13,834
				Grade 2 Wood Veneer	\$12,838	\$14,339	\$14,471	\$14,759

96"	55" -60"	29"	COET2RACEV	Grade 1 Laminate	\$9616	\$11,280	\$11,429	\$11,749
				Grade 2 and 3 Laminate	\$9900	\$11,564	\$11,713	\$12,033
				Grade 1 Wood Veneer	\$12,367	\$14,031	\$14,180	\$14,500
				Grade 2 Wood Veneer	\$13,332	\$14,996	\$15,145	\$15,465

97" -108"	48"	29"	COET2RACEV	Grade 1 Laminate	\$9542	\$11,429	\$11,611	\$11,961
				Grade 2 and 3 Laminate	\$9800	\$11,687	\$11,869	\$12,219
				Grade 1 Wood Veneer	\$11,779	\$13,666	\$13,848	\$14,198
				Grade 2 Wood Veneer	\$12,780	\$14,667	\$14,849	\$15,199

97" -108"	49" -54"	29"	COET2RACEV	Grade 1 Laminate	\$9778	\$11,904	\$12,106	\$12,498
				Grade 2 and 3 Laminate	\$10,068	\$12,194	\$12,396	\$12,788
				Grade 1 Wood Veneer	\$12,392	\$14,518	\$14,720	\$15,112
				Grade 2 Wood Veneer	\$13,483	\$15,609	\$15,811	\$16,203

Tip: Tables are available parametrically in 1" increments.

97" -108"	55" -60"	29"	COET2RACEV	Grade 1 Laminate	\$10,009	\$12,371	\$12,597	\$13,027
				Grade 2 and 3 Laminate	\$10,330	\$12,692	\$12,918	\$13,348
				Grade 1 Wood Veneer	\$13,007	\$15,369	\$15,595	\$16,025
				Grade 2 Wood Veneer	\$14,192	\$16,554	\$16,780	\$17,210

► Product Information continued on next page

E-Table 2 Collaborative and Conference Tables

E-Table 2 Collaborative and Conference Tables

Racetrack Veneer Base Tables

► Product Information continued from previous page

Specification Information

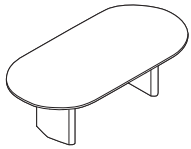

Dimensions		Style H	Style Number	Finish	Base Prices			
W	D				3 mm Plastic/ 3 mm Wood, Flat, or Convex Vinyl Edge:	Bullnose Wood Edge:	Beveled Wood Edge:	Knife Wood Edge:

Racetrack Tables with Two Veneer Bases - Working Height

109" -120"	48"	29"	COET2RACEV	Grade 1 Laminate	\$9642	\$12,085	\$12,330	\$12,772
				Grade 2 and 3 Laminate	\$9923	\$12,366	\$12,611	\$13,053
				Grade 1 Wood Veneer	\$11,912	\$14,355	\$14,600	\$15,042
				Grade 2 Wood Veneer	\$13,040	\$15,483	\$15,728	\$16,170
109" -120"	49" -54"	29"	COET2RACEV	Grade 1 Laminate	\$9931	\$12,681	\$12,956	\$13,448
				Grade 2 and 3 Laminate	\$10,250	\$13,000	\$13,275	\$13,767
				Grade 1 Wood Veneer	\$12,688	\$15,438	\$15,713	\$16,205
				Grade 2 Wood Veneer	\$13,959	\$16,709	\$16,984	\$17,476
109" -120"	55" -60"	29"	COET2RACEV	Grade 1 Laminate	\$10,214	\$13,276	\$13,576	\$14,116
				Grade 2 and 3 Laminate	\$10,569	\$13,631	\$13,931	\$14,471
				Grade 1 Wood Veneer	\$13,456	\$16,518	\$16,818	\$17,358
				Grade 2 Wood Veneer	\$14,870	\$17,932	\$18,232	\$18,772

► Product Information continued on next page

E-Table 2 Collaborative and Conference Tables

Racetrack Veneer Base Tables

► Product Information continued from previous page

Specification Information

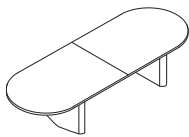

Dimensions		Style Number	Finish	Base Prices				
W	D			H				

Racetrack Tables with Two Veneer Bases - Working Height

Tip: Top ships in two pieces. Hardware is included for field assembly.

121" -132"	48"	29"	COET2RACEV	Grade 1 Laminate	\$9672	\$12,683	\$12,955	\$13,474
				Grade 2 and 3 Laminate	\$9981	\$12,992	\$13,264	\$13,783
				Grade 1 Wood Veneer	\$12,464	\$15,475	\$15,747	\$16,266
				Grade 2 Wood Veneer	\$13,702	\$16,713	\$16,985	\$17,504

Tip: If you require your table top to be made into three pieces, this can be done as a special. Please contact Customer Service at 1.800.627.6770 to obtain a quote.

121" -132"	49" -54"	29"	COET2RACEV	Grade 1 Laminate	\$9978	\$13,366	\$13,665	\$14,255
				Grade 2 and 3 Laminate	\$10,331	\$13,719	\$14,018	\$14,608
				Grade 1 Wood Veneer	\$13,368	\$16,756	\$17,055	\$17,645
				Grade 2 Wood Veneer	\$14,766	\$18,154	\$18,453	\$19,043

121" -132"	55" -60"	29"	COET2RACEV	Grade 1 Laminate	\$10,280	\$14,047	\$14,378	\$15,035
				Grade 2 and 3 Laminate	\$10,672	\$14,439	\$14,770	\$15,427
				Grade 1 Wood Veneer	\$14,264	\$18,031	\$18,362	\$19,019
				Grade 2 Wood Veneer	\$15,821	\$19,588	\$19,919	\$20,576

Tip: Tables are available parametrically in 1" increments.

133" -144"	48"	29"	COET2RACEV	Grade 1 Laminate	\$9700	\$13,277	\$13,577	\$14,174
				Grade 2 and 3 Laminate	\$10,039	\$13,616	\$13,916	\$14,513
				Grade 1 Wood Veneer	\$13,016	\$16,593	\$16,893	\$17,490
				Grade 2 Wood Veneer	\$14,364	\$17,941	\$18,241	\$18,838

133" -144"	49" -54"	29"	COET2RACEV	Grade 1 Laminate	\$10,025	\$14,050	\$14,376	\$15,061
				Grade 2 and 3 Laminate	\$10,411	\$14,436	\$14,762	\$15,447
				Grade 1 Wood Veneer	\$14,048	\$18,073	\$18,399	\$19,084
				Grade 2 Wood Veneer	\$15,574	\$19,599	\$19,925	\$20,610

133" -144"	55" -60"	29"	COET2RACEV	Grade 1 Laminate	\$10,345	\$14,816	\$15,180	\$15,949
				Grade 2 and 3 Laminate	\$10,773	\$15,244	\$15,608	\$16,377
				Grade 1 Wood Veneer	\$15,071	\$19,542	\$19,906	\$20,675
				Grade 2 Wood Veneer	\$16,771	\$21,242	\$21,606	\$22,375

► Product Information continued on next page

E-Table 2 Collaborative and Conference Tables

E-Table 2 Collaborative and Conference Tables

Racetrack Veneer Base Tables

► Product Information continued from previous page

Specification Information

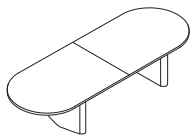

Dimensions		Style	Finish	Base Prices			
W	D	H	Number				
				3 mm Plastic/ 3 mm Wood, Flat or Convex Vinyl Edge:	Bullnose Wood Edge:	Beveled Wood Edge:	Knife Wood Edge:

Racetrack Tables with Two Veneer Bases - Working Height

145" -156"	43" -48"	29"	COET2RACEV	Grade 1 Laminate	\$11,165	\$15,675	\$15,963	\$16,740
				Grade 2 and 3 Laminate	\$11,522	\$16,032	\$16,320	\$17,097
				Grade 1 Wood Veneer	\$16,285	\$20,795	\$21,083	\$21,860
				Grade 2 Wood Veneer	\$17,735	\$22,245	\$22,533	\$23,310
145" -156"	49" -54"	29"	COET2RACEV	Grade 1 Laminate	\$11,586	\$16,659	\$16,982	\$17,858
				Grade 2 and 3 Laminate	\$11,991	\$17,064	\$17,387	\$18,263
				Grade 1 Wood Veneer	\$17,631	\$22,704	\$23,027	\$23,903
				Grade 2 Wood Veneer	\$19,277	\$24,350	\$24,673	\$25,549
145" -156"	55" -60"	29"	COET2RACEV	Grade 1 Laminate	\$12,006	\$17,645	\$17,999	\$18,978
				Grade 2 and 3 Laminate	\$12,454	\$18,093	\$18,447	\$19,426
				Grade 1 Wood Veneer	\$18,976	\$24,615	\$24,969	\$25,948
				Grade 2 Wood Veneer	\$20,815	\$26,454	\$26,808	\$27,787

► Product Information continued on next page

E-Table 2 Collaborative and Conference Tables

Racetrack Veneer Base Tables

► Product Information continued from previous page

Specification Information

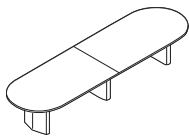

Dimensions		Style Number	Finish	Base Prices			
W	D			H	3 mm Plastic/ 3 mm Wood, Flat or Convex Vinyl Edge:	Bullnose Wood Edge:	Beveled Wood Edge:

Racetrack Tables with Three Veneer Bases - Working Height

Tip: Top ships in two pieces. Hardware is included for field assembly.

157" -168"	48"	29"	COET2RACEV	Grade 1 Laminate	\$14,239	\$19,682	\$19,958	\$20,912
				Grade 2 and 3 Laminate	\$14,616	\$20,059	\$20,335	\$21,289
				Grade 1 Wood Veneer	\$21,163	\$26,606	\$26,882	\$27,836
				Grade 2 Wood Veneer	\$22,745	\$28,188	\$28,464	\$29,418

Tip: For tables with three or more bases, you must specify the entry point of the base power infeed, either an end base or a mid base location, in order to receive the correct length of base power infeed.

157" -168"	49" -54"	29"	COET2RACEV	Grade 1 Laminate	\$14,751	\$20,870	\$21,191	\$22,259
				Grade 2 and 3 Laminate	\$15,177	\$21,296	\$21,617	\$22,685
				Grade 1 Wood Veneer	\$22,818	\$28,937	\$29,258	\$30,326
				Grade 2 Wood Veneer	\$24,611	\$30,730	\$31,051	\$32,119

157" -168"	55" -60"	29"	COET2RACEV	Grade 1 Laminate	\$15,260	\$22,065	\$22,411	\$23,597
				Grade 2 and 3 Laminate	\$15,729	\$22,534	\$22,880	\$24,066
				Grade 1 Wood Veneer	\$24,472	\$31,277	\$31,623	\$32,809
				Grade 2 Wood Veneer	\$26,475	\$33,280	\$33,626	\$34,812

Tip: If you require your table top to be made into three pieces, this can be done as a special. Please contact Customer Service at 1.800.627.6770 to obtain a quote.

169" -180"	48"	29"	COET2RACEV	Grade 1 Laminate	\$14,292	\$19,850	\$20,130	\$21,101
				Grade 2 and 3 Laminate	\$14,696	\$20,254	\$20,534	\$21,505
				Grade 1 Wood Veneer	\$21,279	\$26,837	\$27,117	\$28,088
				Grade 2 Wood Veneer	\$22,971	\$28,529	\$28,809	\$29,780

169" -180"	49" -54"	29"	COET2RACEV	Grade 1 Laminate	\$14,826	\$21,077	\$21,395	\$22,483
				Grade 2 and 3 Laminate	\$15,281	\$21,532	\$21,850	\$22,938
				Grade 1 Wood Veneer	\$22,967	\$29,218	\$29,536	\$30,624
				Grade 2 Wood Veneer	\$24,766	\$31,017	\$31,335	\$32,423

► Product Information continued on next page

E-Table 2 Collaborative and Conference Tables

E-Table 2 Collaborative and Conference Tables

Racetrack Veneer Base Tables

► Product Information continued from previous page

Specification Information

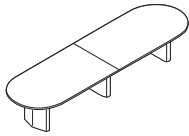

Dimensions		Style	Finish	Base Prices			
W	D	H	Number				
				3 mm Plastic/ 3 mm Wood, Flat or Convex Vinyl Edge:	Bullnose Wood Edge:	Beveled Wood Edge:	Knife Wood Edge:

Racetrack Tables with Three Veneer Bases - Working Height

Tip: Tables are available parametrically in 1" increments.

169" -180"	55" -60"	29"	COET2RACEV	Grade 1 Laminate	\$15,354	\$22,304	\$22,654	\$23,861
				Grade 2 and 3 Laminate	\$15,856	\$22,806	\$23,156	\$24,363
				Grade 1 Wood Veneer	\$24,651	\$31,601	\$31,951	\$33,158
				Grade 2 Wood Veneer	\$26,793	\$33,743	\$34,093	\$35,300
181" -192"	48"	29"	COET2RACEV	Grade 1 Laminate	\$14,344	\$20,017	\$20,302	\$21,289
				Grade 2 and 3 Laminate	\$14,776	\$20,449	\$20,734	\$21,721
				Grade 1 Wood Veneer	\$21,394	\$27,067	\$27,352	\$28,339
				Grade 2 Wood Veneer	\$23,194	\$28,867	\$29,152	\$30,139
181" -192"	49" -54"	29"	COET2RACEV	Grade 1 Laminate	\$14,900	\$21,280	\$21,597	\$22,707
				Grade 2 and 3 Laminate	\$15,383	\$21,763	\$22,080	\$23,190
				Grade 1 Wood Veneer	\$23,115	\$29,495	\$29,812	\$30,922
				Grade 2 Wood Veneer	\$24,920	\$31,300	\$31,617	\$32,727
181" -192"	55" -60"	29"	COET2RACEV	Grade 1 Laminate	\$15,446	\$22,539	\$22,893	\$24,125
				Grade 2 and 3 Laminate	\$15,983	\$23,076	\$23,430	\$24,662
				Grade 1 Wood Veneer	\$24,830	\$31,923	\$32,277	\$33,509
				Grade 2 Wood Veneer	\$27,111	\$34,204	\$34,558	\$35,790
193" -204"	48"	29"	COET2RACEV	Grade 1 Laminate	\$14,514	\$20,362	\$20,673	\$21,742
				Grade 2 and 3 Laminate	\$14,971	\$20,819	\$21,130	\$22,199
				Grade 1 Wood Veneer	\$22,772	\$28,620	\$28,931	\$30,000
				Grade 2 Wood Veneer	\$24,690	\$30,538	\$30,849	\$31,918

► Product Information continued on next page

E-Table 2 Collaborative and Conference Tables

Racetrack Veneer Base Tables

► Product Information continued from previous page

Specification Information

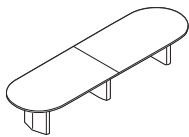

Dimensions		Style Number	Finish	Base Prices			
W	D			H	3 mm Plastic/ 3 mm Wood, Flat or Convex Vinyl Edge:	Bullnose Wood Edge:	Beveled Wood Edge:

Racetrack Tables with Three Veneer Bases - Working Height

193" -204"	49" -54"	29"	COET2RACEV	Grade 1 Laminate	\$15,101	\$21,681	\$22,024	\$23,228
				Grade 2 and 3 Laminate	\$15,614	\$22,194	\$22,537	\$23,741
				Grade 1 Wood Veneer	\$24,673	\$31,253	\$31,596	\$32,800
				Grade 2 Wood Veneer	\$26,731	\$33,311	\$33,654	\$34,858
193" -204"	55" -60"	29"	COET2RACEV	Grade 1 Laminate	\$15,685	\$23,007	\$23,381	\$24,718
				Grade 2 and 3 Laminate	\$16,255	\$23,577	\$23,951	\$25,288
				Grade 1 Wood Veneer	\$26,573	\$33,895	\$34,269	\$35,606
				Grade 2 Wood Veneer	\$29,005	\$36,327	\$36,701	\$38,038
205" -216"	48"	29"	COET2RACEV	Grade 1 Laminate	\$14,683	\$20,702	\$21,042	\$22,194
				Grade 2 and 3 Laminate	\$15,166	\$21,185	\$21,525	\$22,677
				Grade 1 Wood Veneer	\$24,149	\$30,168	\$30,508	\$31,660
				Grade 2 Wood Veneer	\$26,185	\$32,204	\$32,544	\$33,696
205" -216"	49" -54"	29"	COET2RACEV	Grade 1 Laminate	\$15,301	\$22,084	\$22,447	\$23,747
				Grade 2 and 3 Laminate	\$15,844	\$22,627	\$22,990	\$24,290
				Grade 1 Wood Veneer	\$26,229	\$33,012	\$33,375	\$34,675
				Grade 2 Wood Veneer	\$28,540	\$35,323	\$35,686	\$36,986
205" -216"	55" -60"	29"	COET2RACEV	Grade 1 Laminate	\$15,923	\$23,470	\$23,868	\$25,310
				Grade 2 and 3 Laminate	\$16,526	\$24,073	\$24,471	\$25,913
				Grade 1 Wood Veneer	\$28,314	\$35,861	\$36,259	\$37,701
				Grade 2 Wood Veneer	\$30,897	\$38,444	\$38,842	\$40,284

Tip: Tables are available parametrically in 1" increments.

E-Table 2 Collaborative and Conference Tables

► Product Information continued on next page

E-Table 2 Collaborative and Conference Tables

Racetrack Veneer Base Tables

► Product Information continued from previous page

Specification Information

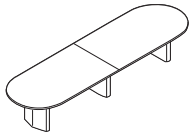

Dimensions		Style H Number	Finish	Base Prices			
W	D			3 mm Plastic/ 3 mm Wood, Flat or Convex Vinyl Edge:	Bullnose Wood Edge:	Beveled Wood Edge:	Knife Wood Edge:

Racetrack Tables with Three Veneer Bases - Working Height

217" -228"	48"	29"	COET2RACEV	Grade 1 Laminate	\$14,711	\$21,035	\$21,397	\$22,581
				Grade 2 and 3 Laminate	\$15,220	\$21,544	\$21,906	\$23,090
				Grade 1 Wood Veneer	\$24,850	\$31,174	\$31,536	\$32,720
				Grade 2 Wood Veneer	\$26,994	\$33,318	\$33,680	\$34,864
217" -228"	49" -54"	29"	COET2RACEV	Grade 1 Laminate	\$15,349	\$22,473	\$22,869	\$24,201
				Grade 2 and 3 Laminate	\$15,922	\$23,046	\$23,442	\$24,774
				Grade 1 Wood Veneer	\$27,035	\$34,159	\$34,555	\$35,887
				Grade 2 Wood Veneer	\$29,469	\$36,593	\$36,989	\$38,321
217" -228"	55" -60"	29"	COET2RACEV	Grade 1 Laminate	\$15,988	\$23,916	\$24,346	\$25,824
				Grade 2 and 3 Laminate	\$16,626	\$24,554	\$24,984	\$26,462
				Grade 1 Wood Veneer	\$29,224	\$37,152	\$37,582	\$39,060
				Grade 2 Wood Veneer	\$31,942	\$39,870	\$40,300	\$41,778
229" -240"	48"	29"	COET2RACEV	Grade 1 Laminate	\$14,736	\$21,363	\$21,749	\$22,963
				Grade 2 and 3 Laminate	\$15,272	\$21,899	\$22,285	\$23,499
				Grade 1 Wood Veneer	\$25,549	\$32,176	\$32,562	\$33,776
				Grade 2 Wood Veneer	\$27,801	\$34,428	\$34,814	\$36,028
229" -240"	49" -54"	29"	COET2RACEV	Grade 1 Laminate	\$15,397	\$22,861	\$23,292	\$24,654
				Grade 2 and 3 Laminate	\$15,998	\$23,462	\$23,893	\$25,255
				Grade 1 Wood Veneer	\$27,839	\$35,303	\$35,734	\$37,096
				Grade 2 Wood Veneer	\$30,396	\$37,860	\$38,291	\$39,653
229" -240"	55" -60"	29"	COET2RACEV	Grade 1 Laminate	\$16,051	\$24,357	\$24,819	\$26,336
				Grade 2 and 3 Laminate	\$16,724	\$25,030	\$25,492	\$27,009
				Grade 1 Wood Veneer	\$30,132	\$38,438	\$38,900	\$40,417
				Grade 2 Wood Veneer	\$32,986	\$41,292	\$41,754	\$43,271

► Product Information continued on next page

E-Table 2 Collaborative and Conference Tables

Racetrack Veneer Base Tables

► Product Information continued from previous page

Specification Information

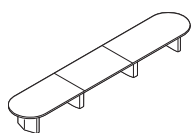

Dimensions		Style H Number	Finish	Base Prices			
W	D			3 mm Plastic/ 3 mm Wood, Flat or Convex Vinyl Edge:	Bullnose Wood Edge:	Beveled Wood Edge:	Knife Wood Edge:

Racetrack Tables with Four Veneer Bases - Working Height

Tip: Top ships in three pieces. Hardware is included for field assembly.

241" -252"	48"	29"	COET2RACEV	Grade 1 Laminate	\$18,268	\$25,942	\$26,341	\$27,726
				Grade 2 and 3 Laminate	\$18,828	\$26,502	\$26,901	\$28,286
				Grade 1 Wood Veneer	\$31,005	\$38,679	\$39,078	\$40,463
				Grade 2 Wood Veneer	\$33,354	\$41,028	\$41,427	\$42,812

Tip: For tables with three or more bases, you must specify the entry point of the base power infeed, either an end base or a mid base location, in order to receive the correct length of base power infeed.

241" -252"	49" -54"	29"	COET2RACEV	Grade 1 Laminate	\$19,041	\$27,663	\$28,113	\$29,687
				Grade 2 and 3 Laminate	\$19,669	\$28,291	\$28,741	\$30,315
				Grade 1 Wood Veneer	\$33,642	\$42,264	\$42,714	\$44,288
				Grade 2 Wood Veneer	\$36,306	\$44,928	\$45,378	\$46,952

241" -252"	55" -60"	29"	COET2RACEV	Grade 1 Laminate	\$19,805	\$29,419	\$29,884	\$31,643
				Grade 2 and 3 Laminate	\$20,504	\$30,118	\$30,583	\$32,342
				Grade 1 Wood Veneer	\$36,280	\$45,894	\$46,359	\$48,118
				Grade 2 Wood Veneer	\$39,263	\$48,877	\$49,342	\$51,101

Tip: If you require your table top to be made into four pieces, this can be done as a special. Please contact Customer Service at 1.800.627.6770 to obtain a quote.

253" -264"	48"	29"	COET2RACEV	Grade 1 Laminate	\$19,638	\$28,357	\$28,769	\$30,325
				Grade 2 and 3 Laminate	\$20,222	\$28,941	\$29,353	\$30,909
				Grade 1 Wood Veneer	\$34,295	\$43,014	\$43,426	\$44,982
				Grade 2 Wood Veneer	\$36,776	\$45,495	\$45,907	\$47,463

253" -264"	49" -54"	29"	COET2RACEV	Grade 1 Laminate	\$20,509	\$30,290	\$30,762	\$32,542
				Grade 2 and 3 Laminate	\$21,163	\$30,944	\$31,416	\$33,196
				Grade 1 Wood Veneer	\$37,264	\$47,045	\$47,517	\$49,297
				Grade 2 Wood Veneer	\$40,075	\$49,856	\$50,328	\$52,108

► Product Information continued on next page

E-Table 2 Collaborative and Conference Tables

E-Table 2 Collaborative and Conference Tables

Racetrack Veneer Base Tables

► Product Information continued from previous page

Specification Information

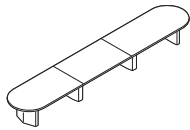

Dimensions		Style Number	Finish	Base Prices			
W	D			H	3 mm Plastic/ 3 mm Wood, Flat or Convex Vinyl Edge:	Bullnose Wood Edge:	Beveled Wood Edge:

Racetrack Tables with Four Veneer Bases - Working Height

253" -264"	55" -60"	29"	COET2RACEV	Grade 1 Laminate	\$21,366	\$32,289	\$32,753	\$34,754
				Grade 2 and 3 Laminate	\$22,093	\$33,016	\$33,480	\$35,481
				Grade 1 Wood Veneer	\$40,236	\$51,159	\$51,623	\$53,624
				Grade 2 Wood Veneer	\$43,383	\$54,306	\$54,770	\$56,771
265" -276"	48"	29"	COET2RACEV	Grade 1 Laminate	\$19,697	\$28,597	\$29,030	\$30,523
				Grade 2 and 3 Laminate	\$20,306	\$29,206	\$29,639	\$31,132
				Grade 1 Wood Veneer	\$34,452	\$43,352	\$43,785	\$45,278
				Grade 2 Wood Veneer	\$37,055	\$45,955	\$46,388	\$47,881
265" -276"	49" -54"	29"	COET2RACEV	Grade 1 Laminate	\$20,599	\$30,554	\$31,003	\$32,788
				Grade 2 and 3 Laminate	\$21,282	\$31,237	\$31,686	\$33,471
				Grade 1 Wood Veneer	\$37,432	\$47,387	\$47,836	\$49,621
				Grade 2 Wood Veneer	\$40,381	\$50,336	\$50,785	\$52,570
265" -276"	55" -60"	29"	COET2RACEV	Grade 1 Laminate	\$21,442	\$32,576	\$32,982	\$35,062
				Grade 2 and 3 Laminate	\$22,202	\$33,336	\$33,742	\$35,822
				Grade 1 Wood Veneer	\$40,420	\$51,554	\$51,960	\$54,040
				Grade 2 Wood Veneer	\$43,722	\$54,856	\$55,262	\$57,342
277" -288"	48"	29"	COET2RACEV	Grade 1 Laminate	\$19,755	\$28,834	\$29,293	\$30,716
				Grade 2 and 3 Laminate	\$20,387	\$29,466	\$29,925	\$31,348
				Grade 1 Wood Veneer	\$34,606	\$43,685	\$44,144	\$45,567
				Grade 2 Wood Veneer	\$37,332	\$46,411	\$46,870	\$48,293

Tip: Tables are available parametrically in 1" increments.

► Product Information continued on next page

E-Table 2 Collaborative and Conference Tables

Racetrack Veneer Base Tables

► Product Information continued from previous page

Specification Information

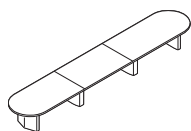

Dimensions		Style	Finish	Base Prices			
W	D	H	Number				
				3 mm Plastic/ 3 mm Wood, Flat or Convex Vinyl Edge:	Bullnose Wood Edge:	Beveled Wood Edge:	Knife Wood Edge:

Racetrack Tables with Four Veneer Bases - Working Height

277" -288"	49" -54"	29"	COET2RACEV	Grade 1 Laminate	\$20,687	\$30,817	\$31,243	\$33,036
				Grade 2 and 3 Laminate	\$21,400	\$31,530	\$31,956	\$33,749
				Grade 1 Wood Veneer	\$37,597	\$47,727	\$48,153	\$49,946
				Grade 2 Wood Veneer	\$40,687	\$50,817	\$51,243	\$53,036
277" -288"	55" -60"	29"	COET2RACEV	Grade 1 Laminate	\$21,518	\$32,862	\$33,209	\$35,366
				Grade 2 and 3 Laminate	\$22,310	\$33,654	\$34,001	\$36,158
				Grade 1 Wood Veneer	\$40,603	\$51,947	\$52,294	\$54,451
				Grade 2 Wood Veneer	\$44,060	\$55,404	\$55,751	\$57,908

E-Table 2
Collaborative and
Conference Tables

E-Table 2 Collaborative and Conference Tables

Faceted Aluminum Base Tables-Working Height

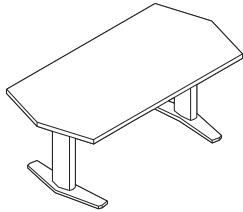

Tip: Shipped knocked down.

Tip: Utility bay quantity offering by table width is available in the understanding section.

Tip: 3 mm vinyl edge profiles on tables require a 4" radius on all corners.

Tip: A flat, plastic edge can be specified on veneer tops by selecting the "flat" edge option. Flat edge is only available in 6000 Black on veneer tops.

Tip: If you specify a wood edge on a top with woodgrain laminate, the edge and the top may not match.

Tip: Sectioned top option is a two piece top and is only available on tops 96"W-120"W.

Tip: When a wood edge is specified on a wood veneer top, the edge finish will match the top finish.

Tip: Each utility bay comes with two universal faceplate openings that accept customer-supplied faceplates in any of the following sizes: single-gang, double-gang, or triple-gang.

Standard Includes

- Top:
 - 1 1/4" particle board core with grade 1 laminate
 - parametric width in 1" increments ranging from 60"-288"
 - For tables with widths up to 144", parametric depth is in 1" increments ranging from 36"-60".
 - For tables with widths from 145"-288", parametric depth is in 1" increments ranging from 43"-60".
- Edge: 3 mm plastic edge, 3 mm wood edge, or convex vinyl edge
- Bases: cast and extruded aluminum with powder coat
- Wireway: painted steel side panels with powder coat and black plastic access door
- Concealed leveling glides: non-marring, black plastic
- Overall height: 29"

Options

Sectioned Top	No Sectioned Top	No cost
	With Sectioned Top	+\$569
Top Finish	Laminate Price Group 02	Price below
	Laminate Price Group 03	Price below
	Veneer Price Group 01	Price below
	Veneer Price Group 02	Price below
Edge Type	3mm Plastic Edge	Price below
	3mm Wood Edge	Price below
	Beveled Wood Edge	Price below
	Bullnose Wood Edge	Price below
	Convex Vinyl Edge	Price below
	Knife Wood Edge	Price below
Bay Option	No Bays	No cost
	One Bay	+\$789
	Two Bays	+\$1578
	Three Bays	+\$2367
	Four Bays	+\$3156
	Six Bays	+\$4734
	Seven Bays	+\$5523
Wiring Schematic	1+1 Hardwire, 2 Circuits	No cost
	3 + 0 Wireway	No cost
	Chicago Wireway	No cost
	1+1 Hardwire,2 Circuits,USB	+\$157
Infeed	3 + 0 Wireway,USB	+\$157
	Hardwire	No cost
	NYC Hardwire Infeed	No cost
Infeed Location	Plug	No cost
	End Base Power Infeed	No cost
	Mid Base Power Infeed	No cost

► **Product Information continued on next page**

E-Table 2 Collaborative and Conference Tables

Faceted Aluminum Base Tables-Working Height

► Product Information continued from previous page

Specification Information

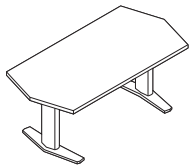

Dimensions		Style Number	Finish	Base Prices				
W	D			H	Edge:			
				3 mm Plastic/ 3 mm Wood, Flat, or Convex Vinyl Edge:		Bullnose Wood Edge:	Beveled Wood Edge:	Knife Wood Edge:

Faceted Tables with Two Aluminum Bases - Working Height

Tip: Top ships in one piece.

Dimensions	Style Number	Finish	3 mm Plastic/ 3 mm Wood, Flat, or Convex Vinyl Edge:	Bullnose Wood Edge:	Beveled Wood Edge:	Knife Wood Edge:
60" -71" 36" 29"	COET2FCTA	Grade 1 Laminate	\$4675	\$5166	\$5230	\$5317
		Grade 2 and 3 Laminate	\$4792	\$5283	\$5347	\$5434
		Grade 1 Wood Veneer	\$5786	\$6277	\$6341	\$6428
		Grade 2 Wood Veneer	\$6168	\$6659	\$6723	\$6810

Tip: For 60"W-95"W tables, if you require your table top to be made into two pieces, this can be done as a special. Please contact Customer Service at 1.800.627.6770 to obtain a quote.

60" -71" 37" -42" 29"	COET2FCTA	Grade 1 Laminate	\$5192	\$6244	\$6213	\$6431
		Grade 2 and 3 Laminate	\$5340	\$6392	\$6361	\$6579
		Grade 1 Wood Veneer	\$6941	\$7993	\$7962	\$8180
		Grade 2 Wood Veneer	\$7315	\$8367	\$8336	\$8554

60" -71" 43" -48" 29"	COET2FCTA	Grade 1 Laminate	\$5309	\$6348	\$6313	\$6547
		Grade 2 and 3 Laminate	\$5496	\$6535	\$6500	\$6734
		Grade 1 Wood Veneer	\$6976	\$8015	\$7980	\$8214
		Grade 2 Wood Veneer	\$7411	\$8450	\$8415	\$8649

Tip: Tables are available parametrically in 1" increments.

60" -71" 49" -54" 29"	COET2FCTA	Grade 1 Laminate	\$5257	\$6166	\$6105	\$6309
		Grade 2 and 3 Laminate	\$5438	\$6347	\$6286	\$6490
		Grade 1 Wood Veneer	\$7146	\$8055	\$7994	\$8198
		Grade 2 Wood Veneer	\$7604	\$8513	\$8452	\$8656

60" -71" 55" -60" 29"	COET2FCTA	Grade 1 Laminate	\$5169	\$5949	\$5859	\$6034
		Grade 2 and 3 Laminate	\$5380	\$6160	\$6070	\$6245
		Grade 1 Wood Veneer	\$7317	\$8097	\$8007	\$8182
		Grade 2 Wood Veneer	\$7801	\$8581	\$8491	\$8666

72" 36" 29"	COET2FCTA	Grade 1 Laminate	\$4870	\$5794	\$5896	\$6062
		Grade 2 and 3 Laminate	\$5003	\$5927	\$6029	\$6195
		Grade 1 Wood Veneer	\$6428	\$7352	\$7454	\$7620
		Grade 2 Wood Veneer	\$6920	\$7844	\$7946	\$8112

► Product Information continued on next page

E-Table 2 Collaborative and Conference Tables

E-Table 2 Collaborative and Conference Tables

Faceted Aluminum Base Tables-Working Height

► Product Information continued from previous page

Specification Information

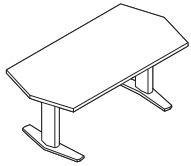

Dimensions		Style Number	Finish	Base Prices			
W	D			H	Edge:		
				3 mm Plastic/ 3 mm Wood, Flat, or Convex Vinyl Edge:	Bullnose Wood Edge:	Beveled Wood Edge:	Knife Wood Edge:

Faceted Tables with Two Aluminum Bases - Working Height

W	D	H	Style Number	Finish	Grade 1 Laminate	Grade 2 and 3 Laminate	Grade 1 Wood Veneer	Grade 2 Wood Veneer
72"	37" -42"	29"	COET2FCTA	Grade 1 Laminate	\$5235	\$6415	\$6454	\$6678
				Grade 2 and 3 Laminate	\$5381	\$6561	\$6600	\$6824
				Grade 1 Wood Veneer	\$7173	\$8353	\$8392	\$8616
				Grade 2 Wood Veneer	\$7691	\$8871	\$8910	\$9134
72"	43" -48"	29"	COET2FCTA	Grade 1 Laminate	\$5353	\$6519	\$6560	\$6801
				Grade 2 and 3 Laminate	\$5530	\$6696	\$6737	\$6978
				Grade 1 Wood Veneer	\$7197	\$8363	\$8404	\$8645
				Grade 2 Wood Veneer	\$7765	\$8931	\$8972	\$9213
72"	49" -54"	29"	COET2FCTA	Grade 1 Laminate	\$5594	\$6711	\$6715	\$6945
				Grade 2 and 3 Laminate	\$5801	\$6918	\$6922	\$7152
				Grade 1 Wood Veneer	\$7593	\$8710	\$8714	\$8944
				Grade 2 Wood Veneer	\$8219	\$9336	\$9340	\$9570
72"	55" -60"	29"	COET2FCTA	Grade 1 Laminate	\$5785	\$6854	\$6822	\$7039
				Grade 2 and 3 Laminate	\$6019	\$7088	\$7056	\$7273
				Grade 1 Wood Veneer	\$7938	\$9007	\$8975	\$9192
				Grade 2 Wood Veneer	\$8621	\$9690	\$9658	\$9875
73" -84"	36"	29"	COET2FCTA	Grade 1 Laminate	\$5110	\$6466	\$6610	\$6851
				Grade 2 and 3 Laminate	\$5256	\$6612	\$6756	\$6997
				Grade 1 Wood Veneer	\$7112	\$8468	\$8612	\$8853
				Grade 2 Wood Veneer	\$7715	\$9071	\$9215	\$9456

Tip: Tables are available parametrically in 1" increments.

► Product Information continued on next page

E-Table 2 Collaborative and Conference Tables

Faceted Aluminum Base Tables-Working Height

► Product Information continued from previous page

Specification Information

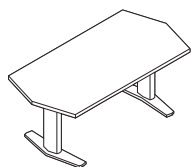

Dimensions		Style Number	Finish	Base Prices			
W	D			H			
				3 mm Plastic/ 3 mm Wood, Flat, or Convex Vinyl Edge:	Bullnose Wood Edge:	Beveled Wood Edge:	Knife Wood Edge:

Faceted Tables with Two Aluminum Bases - Working Height

Dimensions	Style Number	Finish	Grade 1	Grade 2 and 3	Grade 1	Grade 2	
73" -84"	37" -42"	29" COET2FCTA	Grade 1 Laminate	\$5298	\$6605	\$6713	\$6944
			Grade 2 and 3 Laminate	\$5475	\$6782	\$6890	\$7121
			Grade 1 Wood Veneer	\$7455	\$8762	\$8870	\$9101
			Grade 2 Wood Veneer	\$8113	\$9420	\$9528	\$9759
73" -84"	43" -48"	29" COET2FCTA	Grade 1 Laminate	\$5413	\$6707	\$6821	\$7070
			Grade 2 and 3 Laminate	\$5612	\$6906	\$7020	\$7269
			Grade 1 Wood Veneer	\$7470	\$8764	\$8878	\$9127
			Grade 2 Wood Veneer	\$8172	\$9466	\$9580	\$9829
73" -84"	49" -54"	29" COET2FCTA	Grade 1 Laminate	\$5932	\$7259	\$7327	\$7581
			Grade 2 and 3 Laminate	\$6160	\$7487	\$7555	\$7809
			Grade 1 Wood Veneer	\$8040	\$9367	\$9435	\$9689
			Grade 2 Wood Veneer	\$8832	\$10,159	\$10,227	\$10,481
73" -84"	55" -60"	29" COET2FCTA	Grade 1 Laminate	\$6402	\$7759	\$7784	\$8045
			Grade 2 and 3 Laminate	\$6654	\$8011	\$8036	\$8297
			Grade 1 Wood Veneer	\$8559	\$9916	\$9941	\$10,202
			Grade 2 Wood Veneer	\$9442	\$10,799	\$10,824	\$11,085
85" -96"	36"	29" COET2FCTA	Grade 1 Laminate	\$5400	\$6677	\$6830	\$7076
			Grade 2 and 3 Laminate	\$5571	\$6848	\$7001	\$7247
			Grade 1 Wood Veneer	\$7498	\$8775	\$8928	\$9174
			Grade 2 Wood Veneer	\$8199	\$9476	\$9629	\$9875

Tip: Tables are available parametrically in 1" increments.

► Product Information continued on next page

E-Table 2 Collaborative and Conference Tables

Faceted Aluminum Base Tables-Working Height

► Product Information continued from previous page

Specification Information

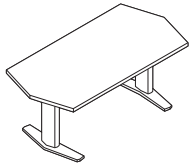

Dimensions		Style Number	Finish	Base Prices			
W	D			H	Edge:		
				3 mm Plastic/ 3 mm Wood, Flat, or Convex Vinyl Edge:	Bullnose Wood Edge:	Beveled Wood Edge:	Knife Wood Edge:

Faceted Tables with Two Aluminum Bases - Working Height

Dimensions (W x D x H)	Style Number	Finish	Grade 1 Price	Grade 2 & 3 Price	Grade 1 Wood Price	Grade 2 Wood Price
85" -96" x 37" -42" x 29"	COET2FCTA	Grade 1 Laminate	\$5862	\$7170	\$7280	\$7530
		Grade 2 and 3 Laminate	\$6060	\$7368	\$7478	\$7728
		Grade 1 Wood Veneer	\$8011	\$9319	\$9429	\$9679
		Grade 2 Wood Veneer	\$8801	\$10,109	\$10,219	\$10,469
85" -96" x 43" -48" x 29"	COET2FCTA	Grade 1 Laminate	\$6324	\$7654	\$7775	\$8031
		Grade 2 and 3 Laminate	\$6556	\$7886	\$8007	\$8263
		Grade 1 Wood Veneer	\$8527	\$9857	\$9978	\$10,234
		Grade 2 Wood Veneer	\$9412	\$10,742	\$10,863	\$11,119
85" -96" x 49" -54" x 29"	COET2FCTA	Grade 1 Laminate	\$6501	\$8002	\$8134	\$8422
		Grade 2 and 3 Laminate	\$6759	\$8260	\$8392	\$8680
		Grade 1 Wood Veneer	\$8975	\$10,476	\$10,608	\$10,896
		Grade 2 Wood Veneer	\$9900	\$11,401	\$11,533	\$11,821
85" -96" x 55" -60" x 29"	COET2FCTA	Grade 1 Laminate	\$6676	\$8340	\$8489	\$8807
		Grade 2 and 3 Laminate	\$6960	\$8624	\$8773	\$9091
		Grade 1 Wood Veneer	\$9427	\$11,091	\$11,240	\$11,558
		Grade 2 Wood Veneer	\$10,392	\$12,056	\$12,205	\$12,523
97" -108" x 36" x 29"	COET2FCTA	Grade 1 Laminate	\$5917	\$7216	\$7383	\$7630
		Grade 2 and 3 Laminate	\$6120	\$7419	\$7586	\$7833
		Grade 1 Wood Veneer	\$8065	\$9364	\$9531	\$9778
		Grade 2 Wood Veneer	\$8863	\$10,162	\$10,329	\$10,576

Tip: Tables are available parametrically in 1" increments.

► Product Information continued on next page

E-Table 2 Collaborative and Conference Tables

Faceted Aluminum Base Tables-Working Height

► Product Information continued from previous page

Specification Information

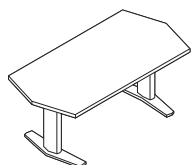

Dimensions		Style Number	Finish	Base Prices			
W	D			H			
				3 mm Plastic/ 3 mm Wood, Flat, or Convex Vinyl Edge:	Bullnose Wood Edge:	Beveled Wood Edge:	Knife Wood Edge:

Faceted Tables with Two Aluminum Bases - Working Height

97" -108"	37" -42"	29"	COET2FCTA	Grade 1 Laminate	\$6100	\$7579	\$7698	\$7984
				Grade 2 and 3 Laminate	\$6323	\$7802	\$7921	\$8207
				Grade 1 Wood Veneer	\$8519	\$9998	\$10,117	\$10,403
				Grade 2 Wood Veneer	\$9348	\$10,827	\$10,946	\$11,232
97" -108"	43" -48"	29"	COET2FCTA	Grade 1 Laminate	\$6576	\$8463	\$8645	\$8995
				Grade 2 and 3 Laminate	\$6833	\$8720	\$8902	\$9252
				Grade 1 Wood Veneer	\$8814	\$10,701	\$10,883	\$11,233
				Grade 2 Wood Veneer	\$9815	\$11,702	\$11,884	\$12,234
97" -108"	49" -54"	29"	COET2FCTA	Grade 1 Laminate	\$6813	\$8939	\$9141	\$9533
				Grade 2 and 3 Laminate	\$7101	\$9227	\$9429	\$9821
				Grade 1 Wood Veneer	\$9429	\$11,555	\$11,757	\$12,149
				Grade 2 Wood Veneer	\$10,520	\$12,646	\$12,848	\$13,240
97" -108"	55" -60"	29"	COET2FCTA	Grade 1 Laminate	\$7041	\$9403	\$9629	\$10,062
				Grade 2 and 3 Laminate	\$7362	\$9724	\$9950	\$10,383
				Grade 1 Wood Veneer	\$10,040	\$12,402	\$12,628	\$13,061
				Grade 2 Wood Veneer	\$11,224	\$13,586	\$13,812	\$14,245
109" -120"	36"	29"	COET2FCTA	Grade 1 Laminate	\$6059	\$7858	\$8019	\$8355
				Grade 2 and 3 Laminate	\$6276	\$8075	\$8236	\$8572
				Grade 1 Wood Veneer	\$8137	\$9936	\$10,097	\$10,433
				Grade 2 Wood Veneer	\$8986	\$10,785	\$10,946	\$11,282

Tip: Tables are available parametrically in 1" increments.

► Product Information continued on next page

E-Table 2 Collaborative and Conference Tables

Faceted Aluminum Base Tables-Working Height

► Product Information continued from previous page

Specification Information

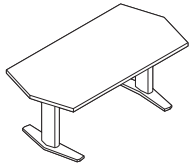

Dimensions		Style Number	Finish	Base Prices			
W	D			H	Edge:		
				3 mm Plastic/ 3 mm Wood, Flat, or Convex Vinyl Edge:	Bullnose Wood Edge:	Beveled Wood Edge:	Knife Wood Edge:

Faceted Tables with Two Aluminum Bases - Working Height

Dimensions	Style Number	Finish	Price 1	Price 2	Price 3	Price 4
109" -120" 37" -42" 29"	COET2FCTA	Grade 1 Laminate	\$6537	\$8743	\$8967	\$9366
		Grade 2 and 3 Laminate	\$6786	\$8992	\$9216	\$9615
		Grade 1 Wood Veneer	\$8429	\$10,635	\$10,859	\$11,258
		Grade 2 Wood Veneer	\$9452	\$11,658	\$11,882	\$12,281
109" -120" 43" -48" 29"	COET2FCTA	Grade 1 Laminate	\$6706	\$9149	\$9394	\$9836
		Grade 2 and 3 Laminate	\$6987	\$9430	\$9675	\$10,117
		Grade 1 Wood Veneer	\$8976	\$11,419	\$11,664	\$12,106
		Grade 2 Wood Veneer	\$10,090	\$12,533	\$12,778	\$13,220
109" -120" 49" -54" 29"	COET2FCTA	Grade 1 Laminate	\$6991	\$9741	\$10,016	\$10,508
		Grade 2 and 3 Laminate	\$7310	\$10,060	\$10,335	\$10,827
		Grade 1 Wood Veneer	\$9748	\$12,498	\$12,773	\$13,265
		Grade 2 Wood Veneer	\$11,008	\$13,758	\$14,033	\$14,525
109" -120" 55" -60" 29"	COET2FCTA	Grade 1 Laminate	\$7274	\$10,336	\$10,636	\$11,183
		Grade 2 and 3 Laminate	\$7629	\$10,691	\$10,991	\$11,538
		Grade 1 Wood Veneer	\$10,516	\$13,578	\$13,878	\$14,425
		Grade 2 Wood Veneer	\$11,922	\$14,984	\$15,284	\$15,831

► Product Information continued on next page

E-Table 2 Collaborative and Conference Tables

Faceted Aluminum Base Tables-Working Height

► Product Information continued from previous page

Specification Information

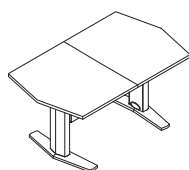

Dimensions		Style H Number	Finish	Base Prices				
W	D			3 mm Plastic/ 3 mm Wood, Flat, or Convex Vinyl Edge:	Bullnose Wood Edge:	Beveled Wood Edge:	Knife Wood Edge:	

Faceted Tables with Two Aluminum Bases - Working Height

Tip: Top ships in two pieces. Hardware is included for field assembly.

121" -132"	36"	29"	COET2FCTA	Grade 1 Laminate	\$6140	\$8563	\$8816	\$9239
				Grade 2 and 3 Laminate	\$6398	\$8821	\$9074	\$9497
				Grade 1 Wood Veneer	\$8846	\$11,269	\$11,522	\$11,945
				Grade 2 Wood Veneer	\$9871	\$12,294	\$12,547	\$12,970

Tip: If you require your table top to be made into three pieces, this can be done as a special. Please contact Customer Service at 1.800.627.6770 to obtain a quote.

121" -132"	37" -42"	29"	COET2FCTA	Grade 1 Laminate	\$6323	\$8927	\$9133	\$9589
				Grade 2 and 3 Laminate	\$6602	\$9206	\$9412	\$9868
				Grade 1 Wood Veneer	\$9302	\$11,906	\$12,112	\$12,568
				Grade 2 Wood Veneer	\$10,355	\$12,959	\$13,165	\$13,621

121" -132"	43" -48"	29"	COET2FCTA	Grade 1 Laminate	\$6737	\$9748	\$10,020	\$10,539
				Grade 2 and 3 Laminate	\$7047	\$10,058	\$10,330	\$10,849
				Grade 1 Wood Veneer	\$9530	\$12,541	\$12,813	\$13,332
				Grade 2 Wood Veneer	\$10,755	\$13,766	\$14,038	\$14,557

Tip: Tables are available parametrically in 1" increments.

121" -132"	49" -54"	29"	COET2FCTA	Grade 1 Laminate	\$7039	\$10,427	\$10,726	\$11,316
				Grade 2 and 3 Laminate	\$7391	\$10,779	\$11,078	\$11,668
				Grade 1 Wood Veneer	\$10,429	\$13,817	\$14,116	\$14,706
				Grade 2 Wood Veneer	\$11,813	\$15,201	\$15,500	\$16,090

121" -132"	55" -60"	29"	COET2FCTA	Grade 1 Laminate	\$7340	\$11,107	\$11,438	\$12,093
				Grade 2 and 3 Laminate	\$7731	\$11,498	\$11,829	\$12,484
				Grade 1 Wood Veneer	\$11,324	\$15,091	\$15,422	\$16,077
				Grade 2 Wood Veneer	\$12,870	\$16,637	\$16,968	\$17,623

133" -144"	36"	29"	COET2FCTA	Grade 1 Laminate	\$6173	\$9164	\$9443	\$9943
				Grade 2 and 3 Laminate	\$6458	\$9449	\$9728	\$10,228
				Grade 1 Wood Veneer	\$9399	\$12,390	\$12,669	\$13,169
				Grade 2 Wood Veneer	\$10,536	\$13,527	\$13,806	\$14,306

► Product Information continued on next page

E-Table 2 Collaborative and Conference Tables

E-Table 2 Collaborative and Conference Tables

Faceted Aluminum Base Tables-Working Height

► Product Information continued from previous page

Specification Information

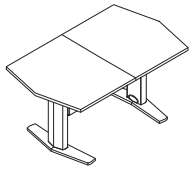

Dimensions		Style Number	Finish	Base Prices			
W	D			H	Edge:		
				3 mm Plastic/ 3 mm Wood, Flat, or Convex Vinyl Edge:	Bullnose Wood Edge:	Beveled Wood Edge	Knife Wood Edge:

Faceted Tables with Two Aluminum Bases - Working Height

Dimensions W	Dimensions D	Dimensions H	Style Number	Finish	Grade 1 Price	Grade 2 and 3 Price	Grade 1 Veneer Price	Grade 2 Veneer Price
133" -144"	37" -42"	29"	COET2FCTA	Grade 1 Laminate	\$6355	\$9527	\$9760	\$10,294
				Grade 2 and 3 Laminate	\$6663	\$9835	\$10,068	\$10,602
				Grade 1 Wood Veneer	\$9857	\$13,029	\$13,262	\$13,796
				Grade 2 Wood Veneer	\$11,022	\$14,194	\$14,427	\$14,961
133" -144"	43" -48"	29"	COET2FCTA	Grade 1 Laminate	\$6766	\$10,343	\$10,643	\$11,240
				Grade 2 and 3 Laminate	\$7105	\$10,682	\$10,982	\$11,579
				Grade 1 Wood Veneer	\$10,082	\$13,659	\$13,959	\$14,556
				Grade 2 Wood Veneer	\$11,418	\$14,995	\$15,295	\$15,892
133" -144"	49" -54"	29"	COET2FCTA	Grade 1 Laminate	\$7086	\$11,111	\$11,437	\$12,122
				Grade 2 and 3 Laminate	\$7472	\$11,497	\$11,823	\$12,508
				Grade 1 Wood Veneer	\$11,109	\$15,134	\$15,460	\$16,145
				Grade 2 Wood Veneer	\$12,618	\$16,643	\$16,969	\$17,654
133" -144"	55" -60"	29"	COET2FCTA	Grade 1 Laminate	\$7404	\$11,875	\$12,239	\$12,998
				Grade 2 and 3 Laminate	\$7832	\$12,303	\$12,667	\$13,426
				Grade 1 Wood Veneer	\$12,130	\$16,601	\$16,965	\$17,724
				Grade 2 Wood Veneer	\$13,816	\$18,287	\$18,651	\$19,410
145" -156"	43" -48"	29"	COET2FCTA	Grade 1 Laminate	\$8198	\$12,708	\$12,996	\$13,773
				Grade 2 and 3 Laminate	\$8553	\$13,063	\$13,351	\$14,128
				Grade 1 Wood Veneer	\$13,318	\$17,828	\$18,116	\$18,893
				Grade 2 Wood Veneer	\$14,767	\$19,277	\$19,565	\$20,342

Tip: Table widths starting at 145" will only have a parametric depth range of 43"-60".

► Product Information continued on next page

E-Table 2 Collaborative and Conference Tables

Faceted Aluminum Base Tables-Working Height

► Product Information continued from previous page

Specification Information

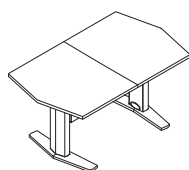

Dimensions		Style H	Style Number	Finish	Base Prices				
W	D				3 mm Plastic/ 3 mm Wood, Flat, or Convex Vinyl Edge:	Bullnose Wood Edge:	Beveled Wood Edge:	Knife Wood Edge:	

Faceted Tables with Two Aluminum Bases - Working Height								
145" -156"	49" -54"	29"	COET2FCTA	Grade 1 Laminate	\$8614	\$13,687	\$14,010	\$14,886
				Grade 2 and 3 Laminate	\$9020	\$14,093	\$14,416	\$15,292
				Grade 1 Wood Veneer	\$14,661	\$19,734	\$20,057	\$20,933
				Grade 2 Wood Veneer	\$16,306	\$21,379	\$21,702	\$22,578
145" -156"	55" -60"	29"	COET2FCTA	Grade 1 Laminate	\$9034	\$14,673	\$15,027	\$16,002
				Grade 2 and 3 Laminate	\$9483	\$15,122	\$15,476	\$16,451
				Grade 1 Wood Veneer	\$16,002	\$21,641	\$21,995	\$22,970
				Grade 2 Wood Veneer	\$17,841	\$23,480	\$23,834	\$24,809

Tip: Tables are available parametrically in 1" increments.

► Product Information continued on next page

E-Table 2
Collaborative and
Conference Tables

E-Table 2 Collaborative and Conference Tables

Faceted Aluminum Base Tables-Working Height

► Product Information continued from previous page

Specification Information

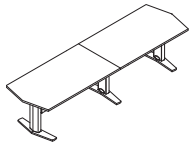

Dimensions		Style Number	Finish	Base Prices			
W	D			H	Vinyl Edge:		
				3 mm Plastic/ 3 mm Wood, Flat, or Convex	Bullnose Wood Edge:	Beveled Wood Edge:	Knife Wood Edge:

Faceted Tables with Three Aluminum Bases - Working Height

Tip: Top ships in two pieces. Hardware is included for field assembly.

Dimensions	Style	Finish	Grade 1 Laminate	Grade 2 and 3 Laminate	Grade 1 Wood Veneer	Grade 2 Wood Veneer
157" -168" x 43" -48" x 29"	COET2FCTA		\$9825	\$10,202	\$16,749	\$18,315
		Grade 1 Laminate	\$9825	\$15,268	\$22,192	\$23,758
		Grade 2 and 3 Laminate	\$10,202	\$15,645	\$22,468	\$24,034
		Grade 1 Wood Veneer	\$16,749	\$15,544	\$23,422	\$24,988
		Grade 2 Wood Veneer	\$18,315	\$15,921	\$23,422	\$24,988

Tip: For tables with three or more bases, you must specify the entry point of the base power infeed, either an end base or a mid base location, in order to receive the correct length of base power infeed.

Dimensions	Style	Finish	Grade 1 Laminate	Grade 2 and 3 Laminate	Grade 1 Wood Veneer	Grade 2 Wood Veneer
157" -168" x 49" -54" x 29"	COET2FCTA		\$10,334	\$10,760	\$18,401	\$20,184
		Grade 1 Laminate	\$10,334	\$16,453	\$24,520	\$26,303
		Grade 2 and 3 Laminate	\$10,760	\$16,879	\$24,841	\$26,624
		Grade 1 Wood Veneer	\$18,401	\$17,200	\$25,909	\$27,692
		Grade 2 Wood Veneer	\$20,184	\$17,200	\$25,909	\$27,692

Dimensions	Style	Finish	Grade 1 Laminate	Grade 2 and 3 Laminate	Grade 1 Wood Veneer	Grade 2 Wood Veneer
157" -168" x 55" -60" x 29"	COET2FCTA		\$10,847	\$11,316	\$20,059	\$22,052
		Grade 1 Laminate	\$10,847	\$17,652	\$26,864	\$28,857
		Grade 2 and 3 Laminate	\$11,316	\$18,121	\$27,210	\$29,203
		Grade 1 Wood Veneer	\$20,059	\$17,998	\$27,210	\$29,392
		Grade 2 Wood Veneer	\$22,052	\$18,467	\$27,210	\$30,392

Tip: If you require your table top to be made into three pieces, this can be done as a special. Please contact Customer Service at 1.800.627.6770 to obtain a quote.

Dimensions	Style	Finish	Grade 1 Laminate	Grade 2 and 3 Laminate	Grade 1 Wood Veneer	Grade 2 Wood Veneer
169" -180" x 43" -48" x 29"	COET2FCTA		\$9878	\$10,282	\$16,864	\$18,542
		Grade 1 Laminate	\$9878	\$15,436	\$22,422	\$24,100
		Grade 2 and 3 Laminate	\$10,282	\$15,840	\$22,702	\$24,380
		Grade 1 Wood Veneer	\$16,864	\$15,716	\$22,702	\$24,380
		Grade 2 Wood Veneer	\$18,542	\$16,120	\$22,702	\$25,351

Dimensions	Style	Finish	Grade 1 Laminate	Grade 2 and 3 Laminate	Grade 1 Wood Veneer	Grade 2 Wood Veneer
169" -180" x 49" -54" x 29"	COET2FCTA		\$10,407	\$10,862	\$18,549	\$20,457
		Grade 1 Laminate	\$10,407	\$16,658	\$24,800	\$26,708
		Grade 2 and 3 Laminate	\$10,862	\$17,113	\$25,118	\$27,026
		Grade 1 Wood Veneer	\$18,549	\$16,976	\$25,118	\$27,026
		Grade 2 Wood Veneer	\$20,457	\$17,431	\$25,118	\$28,114

► Product Information continued on next page

E-Table 2 Collaborative and Conference Tables

Faceted Aluminum Base Tables-Working Height

► Product Information continued from previous page

Specification Information

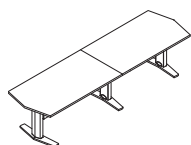

Dimensions		Style Number	Finish	Base Prices			
W	D			H			
				3 mm Plastic/ 3 mm Wood, Flat, or Convex Vinyl Edge:	Bullnose Wood Edge:	Beveled Wood Edge:	Knife Wood Edge:

Faceted Tables with Three Aluminum Bases - Working Height

169" -180"	55" -60"	29"	COET2FCTA	Grade 1 Laminate	\$10,938	\$17,888	\$18,238	\$19,444
				Grade 2 and 3 Laminate	\$11,442	\$18,392	\$18,742	\$19,948
				Grade 1 Wood Veneer	\$20,236	\$27,186	\$27,536	\$28,742
				Grade 2 Wood Veneer	\$22,366	\$29,316	\$29,666	\$30,872
181" -192"	43" -48"	29"	COET2FCTA	Grade 1 Laminate	\$9929	\$15,602	\$15,887	\$16,874
				Grade 2 and 3 Laminate	\$10,361	\$16,034	\$16,319	\$17,306
				Grade 1 Wood Veneer	\$16,979	\$22,652	\$22,937	\$23,924
				Grade 2 Wood Veneer	\$18,769	\$24,442	\$24,727	\$25,714
181" -192"	49" -54"	29"	COET2FCTA	Grade 1 Laminate	\$10,481	\$16,861	\$17,178	\$18,288
				Grade 2 and 3 Laminate	\$10,964	\$17,344	\$17,661	\$18,771
				Grade 1 Wood Veneer	\$18,696	\$25,076	\$25,393	\$26,503
				Grade 2 Wood Veneer	\$20,729	\$27,109	\$27,426	\$28,536
181" -192"	55" -60"	29"	COET2FCTA	Grade 1 Laminate	\$11,030	\$18,123	\$18,477	\$19,702
				Grade 2 and 3 Laminate	\$11,567	\$18,660	\$19,014	\$20,239
				Grade 1 Wood Veneer	\$20,414	\$27,507	\$27,861	\$29,086
				Grade 2 Wood Veneer	\$22,679	\$29,772	\$30,126	\$31,351
193" -204"	43" -48"	29"	COET2FCTA	Grade 1 Laminate	\$10,098	\$15,946	\$16,257	\$17,326
				Grade 2 and 3 Laminate	\$10,554	\$16,402	\$16,713	\$17,782
				Grade 1 Wood Veneer	\$18,356	\$24,204	\$24,515	\$25,584
				Grade 2 Wood Veneer	\$20,258	\$26,106	\$26,417	\$27,486

Tip: Tables are available parametrically in 1" increments.

E-Table 2
Collaborative and
Conference Tables

► Product Information continued on next page

E-Table 2 Collaborative and Conference Tables

Faceted Aluminum Base Tables-Working Height

► Product Information continued from previous page

Specification Information

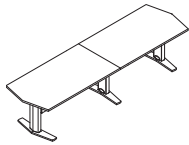

Dimensions		Style Number	Finish	Base Prices			
W	D			H	Edge:		
				3 mm Plastic/ 3 mm Wood, Flat, or Convex Vinyl Edge:	Bullnose Wood Edge:	Beveled Wood Edge:	Knife Wood Edge:

Faceted Tables with Three Aluminum Bases - Working Height

W	D	H	Style Number	Finish	3 mm Plastic/3 mm Wood, Flat, or Convex Vinyl Edge	Bullnose Wood Edge	Beveled Wood Edge	Knife Wood Edge
193" -204"	49" -54"	29"	COET2FCTA	Grade 1 Laminate	\$10,684	\$17,264	\$17,607	\$18,811
				Grade 2 and 3 Laminate	\$11,196	\$17,776	\$18,119	\$19,323
				Grade 1 Wood Veneer	\$20,255	\$26,835	\$27,178	\$28,382
				Grade 2 Wood Veneer	\$22,419	\$28,999	\$29,342	\$30,546
193" -204"	55" -60"	29"	COET2FCTA	Grade 1 Laminate	\$11,269	\$18,591	\$18,965	\$20,300
				Grade 2 and 3 Laminate	\$11,840	\$19,162	\$19,536	\$20,871
				Grade 1 Wood Veneer	\$22,156	\$29,478	\$29,852	\$31,187
				Grade 2 Wood Veneer	\$24,573	\$31,895	\$32,269	\$33,604
205" -216"	43" -48"	29"	COET2FCTA	Grade 1 Laminate	\$10,266	\$16,285	\$16,625	\$17,777
				Grade 2 and 3 Laminate	\$10,749	\$16,768	\$17,108	\$18,260
				Grade 1 Wood Veneer	\$19,732	\$25,751	\$26,091	\$27,243
				Grade 2 Wood Veneer	\$21,746	\$27,765	\$28,105	\$29,257
205" -216"	49" -54"	29"	COET2FCTA	Grade 1 Laminate	\$10,887	\$17,670	\$18,033	\$19,333
				Grade 2 and 3 Laminate	\$11,430	\$18,213	\$18,576	\$19,876
				Grade 1 Wood Veneer	\$21,815	\$28,598	\$28,961	\$30,261
				Grade 2 Wood Veneer	\$24,109	\$30,892	\$31,255	\$32,555
205" -216"	55" -60"	29"	COET2FCTA	Grade 1 Laminate	\$11,508	\$19,055	\$19,453	\$20,895
				Grade 2 and 3 Laminate	\$12,111	\$19,658	\$20,056	\$21,498
				Grade 1 Wood Veneer	\$23,899	\$31,446	\$31,844	\$33,286
				Grade 2 Wood Veneer	\$26,466	\$34,013	\$34,411	\$35,853

Tip: Tables are available parametrically in 1" increments.

► Product Information continued on next page

E-Table 2 Collaborative and Conference Tables

Faceted Aluminum Base Tables-Working Height

► Product Information continued from previous page

Specification Information

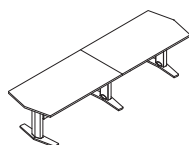

Dimensions		Style Number	Finish	Base Prices			
W	D			H	3 mm Plastic/ 3 mm Wood, Flat, or Convex Vinyl Edge:		Bullnose Wood Edge:

Faceted Tables with Three Aluminum Bases - Working Height

217" -228"	43" -48"	29"	COET2FCTA	Grade 1 Laminate	\$10,294	\$16,618	\$16,980	\$18,164
				Grade 2 and 3 Laminate	\$10,804	\$17,128	\$17,490	\$18,674
				Grade 1 Wood Veneer	\$20,433	\$26,757	\$27,119	\$28,303
				Grade 2 Wood Veneer	\$22,559	\$28,883	\$29,245	\$30,429
217" -228"	49" -54"	29"	COET2FCTA	Grade 1 Laminate	\$10,932	\$18,056	\$18,452	\$19,784
				Grade 2 and 3 Laminate	\$11,504	\$18,628	\$19,024	\$20,356
				Grade 1 Wood Veneer	\$22,617	\$29,741	\$30,137	\$31,469
				Grade 2 Wood Veneer	\$25,033	\$32,157	\$32,553	\$33,885
217" -228"	55" -60"	29"	COET2FCTA	Grade 1 Laminate	\$11,572	\$19,500	\$19,930	\$21,409
				Grade 2 and 3 Laminate	\$12,210	\$20,138	\$20,568	\$22,047
				Grade 1 Wood Veneer	\$24,808	\$32,736	\$33,166	\$34,645
				Grade 2 Wood Veneer	\$27,511	\$35,439	\$35,869	\$37,348
229" -240"	43" -48"	29"	COET2FCTA	Grade 1 Laminate	\$10,323	\$16,950	\$17,336	\$18,550
				Grade 2 and 3 Laminate	\$10,859	\$17,486	\$17,872	\$19,086
				Grade 1 Wood Veneer	\$21,136	\$27,763	\$28,149	\$29,363
				Grade 2 Wood Veneer	\$23,372	\$29,999	\$30,385	\$31,599
229" -240"	49" -54"	29"	COET2FCTA	Grade 1 Laminate	\$10,977	\$18,441	\$18,872	\$20,234
				Grade 2 and 3 Laminate	\$11,578	\$19,042	\$19,473	\$20,835
				Grade 1 Wood Veneer	\$23,419	\$30,883	\$31,314	\$32,676
				Grade 2 Wood Veneer	\$25,958	\$33,422	\$33,853	\$35,215
229" -240"	55" -60"	29"	COET2FCTA	Grade 1 Laminate	\$11,636	\$19,942	\$20,404	\$21,923
				Grade 2 and 3 Laminate	\$12,309	\$20,615	\$21,077	\$22,596
				Grade 1 Wood Veneer	\$25,717	\$34,023	\$34,485	\$36,004
				Grade 2 Wood Veneer	\$28,555	\$36,861	\$37,323	\$38,842

Tip: Tables are available parametrically in 1" increments.

► Product Information continued on next page

E-Table 2 Collaborative and Conference Tables

Faceted Aluminum Base Tables-Working Height

▶ **Product Information continued from previous page**

Specification Information

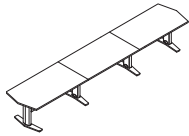

Dimensions		Style Number	Finish	Base Prices			
W	D			H			

Faceted Tables with Four Aluminum Bases - Working Height

Tip: Top ships in three pieces. Hardware is included for field assembly.

241" -252"	43" -48"	29"	COET2FCTA	Grade 1 Laminate	\$12,327	\$20,001	\$20,400	\$21,785
				Grade 2 and 3 Laminate	\$12,886	\$20,560	\$20,959	\$22,344
				Grade 1 Wood Veneer	\$25,062	\$32,736	\$33,135	\$34,520
				Grade 2 Wood Veneer	\$27,409	\$35,083	\$35,482	\$36,867

Tip: For table with three or more bases, you must specify the entry point of the base power infeed, either an end base or mid base location, in order to receive the correct length of base power infeed.

241" -252"	49" -54"	29"	COET2FCTA	Grade 1 Laminate	\$13,097	\$21,719	\$22,169	\$23,743
				Grade 2 and 3 Laminate	\$13,725	\$22,347	\$22,797	\$24,371
				Grade 1 Wood Veneer	\$27,697	\$36,319	\$36,769	\$38,343
				Grade 2 Wood Veneer	\$30,362	\$38,984	\$39,434	\$41,008

241" -252"	55" -60"	29"	COET2FCTA	Grade 1 Laminate	\$13,860	\$23,474	\$23,939	\$25,681
				Grade 2 and 3 Laminate	\$14,560	\$24,174	\$24,639	\$26,381
				Grade 1 Wood Veneer	\$30,336	\$39,950	\$40,415	\$42,157
				Grade 2 Wood Veneer	\$33,320	\$42,934	\$43,399	\$45,141

Tip: If you require your table top to be made into four pieces, this can be done as a special. Please contact Customer Service at 1.800.627.6770 to obtain a quote.

253" -264"	43" -48"	29"	COET2FCTA	Grade 1 Laminate	\$13,750	\$22,469	\$22,881	\$24,437
				Grade 2 and 3 Laminate	\$14,334	\$23,053	\$23,465	\$25,021
				Grade 1 Wood Veneer	\$28,407	\$37,126	\$37,538	\$39,094
				Grade 2 Wood Veneer	\$30,871	\$39,590	\$40,002	\$41,558

253" -264"	49" -54"	29"	COET2FCTA	Grade 1 Laminate	\$14,623	\$24,404	\$24,876	\$26,656
				Grade 2 and 3 Laminate	\$15,277	\$25,058	\$25,530	\$27,310
				Grade 1 Wood Veneer	\$31,378	\$41,159	\$41,631	\$43,411
				Grade 2 Wood Veneer	\$34,172	\$43,953	\$44,425	\$46,205

253" -264"	55" -60"	29"	COET2FCTA	Grade 1 Laminate	\$15,479	\$26,402	\$26,866	\$28,834
				Grade 2 and 3 Laminate	\$16,206	\$27,129	\$27,593	\$29,561
				Grade 1 Wood Veneer	\$34,349	\$45,272	\$45,736	\$47,704
				Grade 2 Wood Veneer	\$37,477	\$48,400	\$48,864	\$50,832

Tip: Tables are available parametrically in 1" increments.

▶ **Product Information continued on next page**

E-Table 2 Collaborative and Conference Tables

Faceted Aluminum Base Tables-Working Height

► Product Information continued from previous page

Specification Information

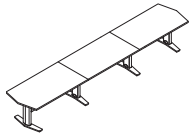

Dimensions		Style Number	Finish	Base Prices			
W	D			H	Edge:		
				3 mm Plastic/ 3 mm Wood, Flat, or Convex Vinyl Edge:	Bullnose Wood Edge:	Beveled Wood Edge:	Knife Wood Edge:

Faceted Tables with Four Aluminum Bases - Working Height

Dimensions	Style Number	Finish	Grade 1 Price	Grade 2 and 3 Price	Grade 1 Veneer Price	Grade 2 Veneer Price
265" -276" 43" -48" 29"	COET2FCTA	Grade 1 Laminate	\$13,809	\$22,709	\$23,142	\$24,635
		Grade 2 and 3 Laminate	\$14,417	\$23,317	\$23,750	\$25,243
		Grade 1 Wood Veneer	\$28,563	\$37,463	\$37,896	\$39,389
		Grade 2 Wood Veneer	\$31,143	\$40,043	\$40,476	\$41,969
265" -276" 49" -54" 29"	COET2FCTA	Grade 1 Laminate	\$14,710	\$24,665	\$25,114	\$26,899
		Grade 2 and 3 Laminate	\$15,393	\$25,348	\$25,797	\$27,582
		Grade 1 Wood Veneer	\$31,542	\$41,497	\$41,946	\$43,731
		Grade 2 Wood Veneer	\$34,473	\$44,428	\$44,877	\$46,662
265" -276" 55" -60" 29"	COET2FCTA	Grade 1 Laminate	\$15,553	\$26,687	\$27,093	\$29,079
		Grade 2 and 3 Laminate	\$16,313	\$27,447	\$27,853	\$29,839
		Grade 1 Wood Veneer	\$34,531	\$45,665	\$46,071	\$48,057
		Grade 2 Wood Veneer	\$37,815	\$48,949	\$49,355	\$51,341
277" -288" 43" -48" 29"	COET2FCTA	Grade 1 Laminate	\$13,867	\$22,946	\$23,405	\$24,828
		Grade 2 and 3 Laminate	\$14,499	\$23,578	\$24,037	\$25,460
		Grade 1 Wood Veneer	\$28,718	\$37,797	\$38,256	\$39,679
		Grade 2 Wood Veneer	\$31,415	\$40,494	\$40,953	\$42,376
277" -288" 49" -54" 29"	COET2FCTA	Grade 1 Laminate	\$14,795	\$24,925	\$25,351	\$27,144
		Grade 2 and 3 Laminate	\$15,508	\$25,638	\$26,064	\$27,857
		Grade 1 Wood Veneer	\$31,705	\$41,835	\$42,261	\$44,054
		Grade 2 Wood Veneer	\$34,773	\$44,903	\$45,329	\$47,122
277" -288" 55" -60" 29"	COET2FCTA	Grade 1 Laminate	\$15,627	\$26,971	\$27,318	\$29,322
		Grade 2 and 3 Laminate	\$16,419	\$27,763	\$28,110	\$30,114
		Grade 1 Wood Veneer	\$34,712	\$46,056	\$46,403	\$48,407
		Grade 2 Wood Veneer	\$38,153	\$49,497	\$49,844	\$51,848

E-Table 2 Collaborative and Conference Tables

E-Table 2 Collaborative and Conference Tables

Faceted Aluminum Base Tables-Standing Height

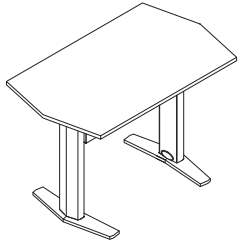

Tip: Shipped knocked down.

Tip: Utility bay quantity offering by table width is available in the understanding section.

Tip: 3 mm vinyl edge profiles on tables require a 4" radius on all corners.

Tip: A flat, plastic edge can be specified on veneer tops by selecting the "flat" edge option. Flat edge is only available in 6000 Black on veneer tops.

Tip: If you specify a wood edge on a top with woodgrain laminate, the edge and the top may not match.

Tip: Sectioned top option is a two piece top and is only available on tops 96"W-120"W.

Tip: When a wood edge is specified on a wood veneer top, the edge finish will match the top finish.

Tip: Each utility bay comes with two universal faceplate openings that accept customer-supplied faceplates in any of the following sizes: single-gang, double-gang, or triple-gang.

Standard Includes

- Top:
 - 1 1/4" particle board core with grade 1 laminate
 - parametric width in 1" increments ranging from 60"-120"
 - parametric depth in 1" increments ranging from 36"-60"
- Edge: 3 mm plastic edge, 3 mm wood edge, or convex vinyl edge
- Bases: cast and extruded aluminum with powder coat
- Wireway: painted steel side panels with powder coat and black plastic access door
- Concealed leveling glides: non-marring, black plastic
- Overall height: 40"

Options

Sectioned Top	No Sectioned Top With Sectioned Top	No cost +\$569
Top Finish	Laminate Price Group 02 Laminate Price Group 03 Veneer Price Group 01 Veneer Price Group 02	Price below Price below Price below Price below
Edge Type	3mm Plastic Edge 3mm Wood Edge Beveled Wood Edge Bullnose Wood Edge Convex Vinyl Edge Knife Wood Edge	Price below Price below Price below Price below Price below Price below
Bay Option	No Bays One Bay Two Bays Three Bays	No cost +\$789 +\$1578 +\$2367
Wiring Schematic	1+1 Hardwire, 2 Circuits 3 + 0 Wireway Chicago Wireway 1+1 Hardwire,2 Circuits,USB 3 + 0 Wireway,USB	No cost No cost No cost +\$157 +\$157
Infeed	Hardwire NYC Hardwire Infeed Plug	No cost No cost No cost

► Product Information continued on next page

E-Table 2 Collaborative and Conference Tables

Faceted Aluminum Base Tables-Standing Height

► Product Information continued from previous page

Specification Information

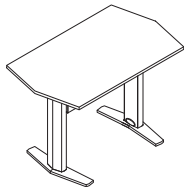

Dimensions		Style Number	Finish	Base Prices				
W	D			H	3 mm Plastic/ 3 mm Wood, Flat, or Convex Vinyl Edge:		Bullnose Wood Edge:	Beveled Wood Edge:

Faceted Tables with Two Aluminum Bases - Standing Height

Tip: Top ships in one piece.

Dimensions	Style Number	Finish	3 mm Plastic/ 3 mm Wood, Flat, or Convex Vinyl Edge:	Bullnose Wood Edge:	Beveled Wood Edge:	Knife Wood Edge:
60" -71" 36" 40"	COET2FCTSTA	Grade 1 Laminate	\$5160	\$5651	\$5715	\$5802
		Grade 2 and 3 Laminate	\$5278	\$5769	\$5833	\$5920
		Grade 1 Wood Veneer	\$6273	\$6764	\$6828	\$6915
		Grade 2 Wood Veneer	\$6658	\$7149	\$7213	\$7300

Tip: For 60"W- 95"W tables, if you require your table top to be made into two pieces, this can be done as a special. Please contact Customer Service at 1.800.627.6770 to obtain a quote.

60" -71" 37" -42" 40"	COET2FCTSTA	Grade 1 Laminate	\$5707	\$6759	\$6728	\$6946
		Grade 2 and 3 Laminate	\$5826	\$6878	\$6847	\$7065
		Grade 1 Wood Veneer	\$7428	\$8480	\$8449	\$8667
		Grade 2 Wood Veneer	\$7801	\$8853	\$8822	\$9040

60" -71" 43" -48" 40"	COET2FCTSTA	Grade 1 Laminate	\$5829	\$6868	\$6833	\$7067
		Grade 2 and 3 Laminate	\$5982	\$7021	\$6986	\$7220
		Grade 1 Wood Veneer	\$7461	\$8500	\$8465	\$8699
		Grade 2 Wood Veneer	\$7897	\$8936	\$8901	\$9135

Tip: Tables are available parametrically in 1" increments.

60" -71" 49" -54" 40"	COET2FCTSTA	Grade 1 Laminate	\$5743	\$6652	\$6591	\$6795
		Grade 2 and 3 Laminate	\$5925	\$6834	\$6773	\$6977
		Grade 1 Wood Veneer	\$7633	\$8542	\$8481	\$8685
		Grade 2 Wood Veneer	\$8092	\$9001	\$8940	\$9144

60" -71" 55" -60" 40"	COET2FCTSTA	Grade 1 Laminate	\$5656	\$6436	\$6346	\$6521
		Grade 2 and 3 Laminate	\$5869	\$6649	\$6559	\$6734
		Grade 1 Wood Veneer	\$7805	\$8585	\$8495	\$8670
		Grade 2 Wood Veneer	\$8288	\$9068	\$8978	\$9153

72" 36" 40"	COET2FCTSTA	Grade 1 Laminate	\$5402	\$6326	\$6428	\$6594
		Grade 2 and 3 Laminate	\$5535	\$6459	\$6561	\$6727
		Grade 1 Wood Veneer	\$6961	\$7885	\$7987	\$8153
		Grade 2 Wood Veneer	\$7453	\$8377	\$8479	\$8645

► Product Information continued on next page

E-Table 2 Collaborative and Conference Tables

E-Table 2 Collaborative and Conference Tables

Faceted Aluminum Base Tables-Standing Height

► Product Information continued from previous page

Specification Information

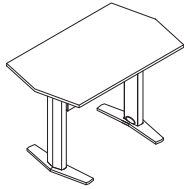

Dimensions		Style H	Number	Finish	Base Prices				
W	D				3 mm Plastic/ 3 mm Wood, Flat, or Convex Vinyl Edge:	Bullnose Wood Edge:	Beveled Wood Edge	Knife Wood Edge:	

Faceted Tables with Two Aluminum Bases - Standing Height

W	D	H	Style Number	Finish	3 mm Plastic/ 3 mm Wood, Flat, or Convex Vinyl Edge:	Bullnose Wood Edge:	Beveled Wood Edge	Knife Wood Edge:
72"	37" -42"	40"	COET2FCTSTA	Grade 1 Laminate	\$5772	\$6952	\$6991	\$7215
				Grade 2 and 3 Laminate	\$5919	\$7099	\$7138	\$7362
				Grade 1 Wood Veneer	\$7710	\$8890	\$8929	\$9153
				Grade 2 Wood Veneer	\$8227	\$9407	\$9446	\$9670
72"	43" -48"	40"	COET2FCTSTA	Grade 1 Laminate	\$5890	\$7056	\$7097	\$7338
				Grade 2 and 3 Laminate	\$6067	\$7233	\$7274	\$7515
				Grade 1 Wood Veneer	\$7735	\$8901	\$8942	\$9183
				Grade 2 Wood Veneer	\$8304	\$9470	\$9511	\$9752
72"	49" -54"	40"	COET2FCTSTA	Grade 1 Laminate	\$6081	\$7198	\$7202	\$7432
				Grade 2 and 3 Laminate	\$6286	\$7403	\$7407	\$7637
				Grade 1 Wood Veneer	\$8079	\$9196	\$9200	\$9430
				Grade 2 Wood Veneer	\$8706	\$9823	\$9827	\$10,057
72"	55" -60"	40"	COET2FCTSTA	Grade 1 Laminate	\$6271	\$7340	\$7308	\$7525
				Grade 2 and 3 Laminate	\$6505	\$7574	\$7542	\$7759
				Grade 1 Wood Veneer	\$8428	\$9497	\$9465	\$9682
				Grade 2 Wood Veneer	\$9108	\$10,177	\$10,145	\$10,362
73" -84"	36"	40"	COET2FCTSTA	Grade 1 Laminate	\$5644	\$7000	\$7144	\$7385
				Grade 2 and 3 Laminate	\$5792	\$7148	\$7292	\$7533
				Grade 1 Wood Veneer	\$7646	\$9002	\$9146	\$9387
				Grade 2 Wood Veneer	\$8250	\$9606	\$9750	\$9991

Tip: Tables are available parametrically in 1" increments.

► Product Information continued on next page

E-Table 2 Collaborative and Conference Tables

Faceted Aluminum Base Tables-Standing Height

► Product Information continued from previous page

Specification Information

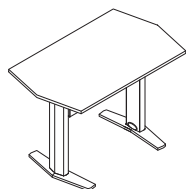

Dimensions		Style Number	Finish	Base Prices			
W	D			H			
				3 mm Plastic/ 3 mm Wood, Flat, or Convex Vinyl Edge:	Bullnose Wood Edge:	Beveled Wood Edge	Knife Wood Edge:

Faceted Tables with Two Aluminum Bases - Standing Height

73" -84"	37" -42"	40"	COET2FCTSTA	Grade 1 Laminate	\$5836	\$7143	\$7251	\$7482
				Grade 2 and 3 Laminate	\$6011	\$7318	\$7426	\$7657
				Grade 1 Wood Veneer	\$7991	\$9298	\$9406	\$9637
				Grade 2 Wood Veneer	\$8650	\$9957	\$10,065	\$10,296
73" -84"	43" -48"	40"	COET2FCTSTA	Grade 1 Laminate	\$5950	\$7244	\$7358	\$7607
				Grade 2 and 3 Laminate	\$6151	\$7445	\$7559	\$7808
				Grade 1 Wood Veneer	\$8008	\$9302	\$9416	\$9665
				Grade 2 Wood Veneer	\$8710	\$10,004	\$10,118	\$10,367
73" -84"	49" -54"	40"	COET2FCTSTA	Grade 1 Laminate	\$6419	\$7746	\$7814	\$8068
				Grade 2 and 3 Laminate	\$6646	\$7973	\$8041	\$8295
				Grade 1 Wood Veneer	\$8528	\$9855	\$9923	\$10,177
				Grade 2 Wood Veneer	\$9321	\$10,648	\$10,716	\$10,970
73" -84"	55" -60"	40"	COET2FCTSTA	Grade 1 Laminate	\$6887	\$8244	\$8269	\$8530
				Grade 2 and 3 Laminate	\$7141	\$8498	\$8523	\$8784
				Grade 1 Wood Veneer	\$9048	\$10,405	\$10,430	\$10,691
				Grade 2 Wood Veneer	\$9928	\$11,285	\$11,310	\$11,571
85" -96"	36"	40"	COET2FCTSTA	Grade 1 Laminate	\$5938	\$7215	\$7368	\$7614
				Grade 2 and 3 Laminate	\$6106	\$7383	\$7536	\$7782
				Grade 1 Wood Veneer	\$8033	\$9310	\$9463	\$9709
				Grade 2 Wood Veneer	\$8734	\$10,011	\$10,164	\$10,410

Tip: Tables are available parametrically in 1" increments.

► Product Information continued on next page

E-Table 2 Collaborative and Conference Tables

Faceted Aluminum Base Tables-Standing Height

► Product Information continued from previous page

Specification Information

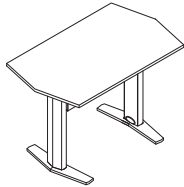

Dimensions			Style Number	Finish	Base Prices				
W	D	H			3 mm Plastic/ 3 mm Wood, Flat, or Convex Vinyl Edge:	Bullnose Wood Edge:	Beveled Wood Edge	Knife Wood Edge:	

Faceted Tables with Two Aluminum Bases - Standing Height

85"-96"	37" -42"	40"	COET2FCTSTA	Grade 1 Laminate	\$6405	\$7713	\$7823	\$8073
				Grade 2 and 3 Laminate	\$6602	\$7910	\$8020	\$8270
				Grade 1 Wood Veneer	\$8555	\$9863	\$9973	\$10,223
				Grade 2 Wood Veneer	\$9343	\$10,651	\$10,761	\$11,011
85"-96"	43" -48"	40"	COET2FCTSTA	Grade 1 Laminate	\$6871	\$8201	\$8322	\$8578
				Grade 2 and 3 Laminate	\$7102	\$8432	\$8553	\$8809
				Grade 1 Wood Veneer	\$9073	\$10,403	\$10,524	\$10,780
				Grade 2 Wood Veneer	\$9958	\$11,288	\$11,409	\$11,665
85"-96"	49" -54"	40"	COET2FCTSTA	Grade 1 Laminate	\$7052	\$8553	\$8685	\$8973
				Grade 2 and 3 Laminate	\$7310	\$8811	\$8943	\$9231
				Grade 1 Wood Veneer	\$9527	\$11,028	\$11,160	\$11,448
				Grade 2 Wood Veneer	\$10,450	\$11,951	\$12,083	\$12,371
85"-96"	55" -60"	40"	COET2FCTSTA	Grade 1 Laminate	\$7226	\$8890	\$9039	\$9357
				Grade 2 and 3 Laminate	\$7512	\$9176	\$9325	\$9643
				Grade 1 Wood Veneer	\$9978	\$11,642	\$11,791	\$12,109
				Grade 2 Wood Veneer	\$10,941	\$12,605	\$12,754	\$13,072
97" -108"	36"	40"	COET2FCTSTA	Grade 1 Laminate	\$6403	\$7702	\$7869	\$8116
				Grade 2 and 3 Laminate	\$6605	\$7904	\$8071	\$8318
				Grade 1 Wood Veneer	\$8551	\$9850	\$10,017	\$10,264
				Grade 2 Wood Veneer	\$9351	\$10,650	\$10,817	\$11,064

Tip: Tables are available parametrically in 1" increments.

► Product Information continued on next page

E-Table 2 Collaborative and Conference Tables

Faceted Aluminum Base Tables-Standing Height

► Product Information continued from previous page

Specification Information

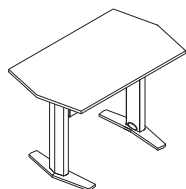

Dimensions			Style	Finish	Base Prices			
W	D	H	Number					
					3 mm Plastic/ 3 mm Wood, Flat, or Convex Vinyl Edge:	Bullnose Wood Edge:	Beveled Wood Edge	Knife Wood Edge:

Faceted Tables with Two Aluminum Bases - Standing Height

97" -108"	37" -42"	40"	COET2FCTSTA	Grade 1 Laminate	\$6588	\$8067	\$8186	\$8472
				Grade 2 and 3 Laminate	\$6809	\$8288	\$8407	\$8693
				Grade 1 Wood Veneer	\$9007	\$10,486	\$10,605	\$10,891
				Grade 2 Wood Veneer	\$9834	\$11,313	\$11,432	\$11,718
97" -108"	43" -48"	40"	COET2FCTSTA	Grade 1 Laminate	\$7065	\$8952	\$9134	\$9484
				Grade 2 and 3 Laminate	\$7323	\$9210	\$9392	\$9742
				Grade 1 Wood Veneer	\$9302	\$11,189	\$11,371	\$11,721
				Grade 2 Wood Veneer	\$10,303	\$12,190	\$12,372	\$12,722
97" -108"	49" -54"	40"	COET2FCTSTA	Grade 1 Laminate	\$7300	\$9426	\$9628	\$10,020
				Grade 2 and 3 Laminate	\$7587	\$9713	\$9915	\$10,307
				Grade 1 Wood Veneer	\$9914	\$12,040	\$12,242	\$12,634
				Grade 2 Wood Veneer	\$11,006	\$13,132	\$13,334	\$13,726
97" -108"	55" -60"	40"	COET2FCTSTA	Grade 1 Laminate	\$7529	\$9891	\$10,117	\$10,550
				Grade 2 and 3 Laminate	\$7848	\$10,210	\$10,436	\$10,869
				Grade 1 Wood Veneer	\$10,526	\$12,888	\$13,114	\$13,547
				Grade 2 Wood Veneer	\$11,710	\$14,072	\$14,298	\$14,731
109" -120"	36"	40"	COET2FCTSTA	Grade 1 Laminate	\$6545	\$8344	\$8505	\$8841
				Grade 2 and 3 Laminate	\$6761	\$8560	\$8721	\$9057
				Grade 1 Wood Veneer	\$8623	\$10,422	\$10,583	\$10,919
				Grade 2 Wood Veneer	\$9471	\$11,270	\$11,431	\$11,767

Tip: Tables are available parametrically in 1" increments.

► Product Information continued on next page

E-Table 2 Collaborative and Conference Tables

Faceted Aluminum Base Tables-Standing Height

► Product Information continued from previous page

Specification Information

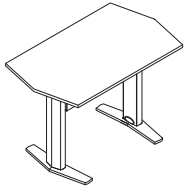

Dimensions
W D H

Style
Number

Finish

Base Prices

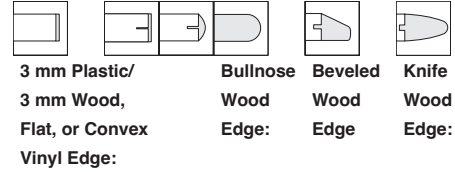

Faceted Tables with Two Aluminum Bases - Standing Height

Dimensions	Style	Finish	3 mm Plastic/ 3 mm Wood, Flat, or Convex Vinyl Edge:	Bullnose Wood Edge:	Beveled Wood Edge:	Knife Wood Edge:
109" -120" 37" -42" 40"	COET2FCTSTA	Grade 1 Laminate	\$7026	\$9232	\$9456	\$9855
		Grade 2 and 3 Laminate	\$7271	\$9477	\$9701	\$10,100
		Grade 1 Wood Veneer	\$8918	\$11,124	\$11,348	\$11,747
		Grade 2 Wood Veneer	\$9940	\$12,146	\$12,370	\$12,769
109" -120" 43" -48" 40"	COET2FCTSTA	Grade 1 Laminate	\$7258	\$9701	\$9946	\$10,388
		Grade 2 and 3 Laminate	\$7541	\$9984	\$10,229	\$10,671
		Grade 1 Wood Veneer	\$9530	\$11,973	\$12,218	\$12,660
		Grade 2 Wood Veneer	\$10,643	\$13,086	\$13,331	\$13,773
109" -120" 49" -54" 40"	COET2FCTSTA	Grade 1 Laminate	\$7545	\$10,295	\$10,570	\$11,062
		Grade 2 and 3 Laminate	\$7865	\$10,615	\$10,890	\$11,382
		Grade 1 Wood Veneer	\$10,302	\$13,052	\$13,327	\$13,819
		Grade 2 Wood Veneer	\$11,559	\$14,309	\$14,584	\$15,076
109" -120" 55" -60" 40"	COET2FCTSTA	Grade 1 Laminate	\$7832	\$10,894	\$11,194	\$11,741
		Grade 2 and 3 Laminate	\$8186	\$11,248	\$11,548	\$12,095
		Grade 1 Wood Veneer	\$11,072	\$14,134	\$14,434	\$14,981
		Grade 2 Wood Veneer	\$12,478	\$15,540	\$15,840	\$16,387

E-Table 2 Collaborative and Conference Tables

Faceted Aluminum Base Tables-Standing Height

**E-Table 2
Collaborative and
Conference Tables**

E-Table 2 Collaborative and Conference Tables

Faceted Laminate Base Tables

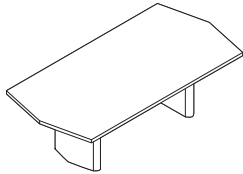

Tip: Shipped knocked down.

Tip: Utility bay quantity offering by table width is available in the understanding section.

Tip: 3 mm vinyl edge profiles on tables require a 4" radius on all corners.

Tip: A flat, plastic edge can be specified on veneer tops by selecting the "flat" edge option. Flat edge is only available in 6000 Black on veneer tops.

Tip: If you specify a wood edge on a top with woodgrain laminate, the edge and the top may not match.

Tip: Sectioned top option is a two piece top and is only available on tops 96"W-120"W.

Tip: When a wood edge is specified on a wood veneer top, the edge finish will match the top finish.

Tip: Each utility bay comes with two universal faceplate openings that accept customer-supplied faceplates in any of the following sizes: single-gang, double-gang, or triple-gang.

Standard Includes

- Top:
 - 1 1/4" particle board core with grade 1 laminate
 - parametric width in 1" increments ranging from 96"-288"
 - parametric depth in 1" increments ranging from 48"-60"
- Edge: 3 mm plastic edge, 3 mm wood edge, or convex vinyl edge
- Bases: black laminate on MDF core
- Wireway: painted steel side panels with powder coat and black plastic access door
- Concealed leveling glides: non-marring, black plastic
- Overall height: 29"

Options

Sectioned Top	No Sectioned Top With Sectioned Top	No cost +\$569
Top Finish	Laminate Price Group 02 Laminate Price Group 03 Veneer Price Group 01 Veneer Price Group 02	Price below Price below Price below Price below
Edge Type	3mm Plastic Edge 3mm Wood Edge Beveled Wood Edge Bullnose Wood Edge Convex Vinyl Edge Knife Wood Edge	Price below Price below Price below Price below Price below Price below
Base Type	Black HPL Curated HPL	No cost +\$873
Bay Option	No Bays Two Bays Three Bays Four Bays Six Bays Seven Bays	No cost +\$1578 +\$2367 +\$3156 +\$4734 +\$5523
Wiring Schematic	1+1 Hardwire, 2 Circuits 3 + 0 Wireway Chicago Wireway 1+1 Hardwire, 2 Circuits, USB 3 + 0 Wireway, USB	No cost No cost No cost +\$157 +\$157
Infeed	Hardwire NYC Hardwire Infeed Plug	No cost No cost No cost
Infeed Location	End Base Power Infeed Mid Base Power Infeed	No cost No cost

► **Product Information continued on next page**

E-Table 2 Collaborative and Conference Tables

Faceted Laminate Base Tables

► Product Information continued from previous page

Specification Information

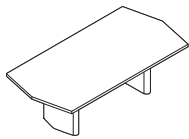

Dimensions		Style Number	Finish	Base Prices				
W	D			H	3 mm Plastic/ 3 mm Wood, Flat, or Convex Vinyl Edge:		Bullnose Wood Edge:	Beveled Wood Edge:

Faceted Tables with Two Laminate Bases - Working Height

Tip: Top ships in one piece.

Dimensions	Style Number	Finish	3 mm Plastic/ 3 mm Wood, Flat, or Convex Vinyl Edge:	Bullnose Wood Edge:	Beveled Wood Edge:	Knife Wood Edge:
96" x 48" x 29"	COET2FCTL	Grade 1 Laminate	\$6113	\$7443	\$7564	\$7820
		Grade 2 and 3 Laminate	\$6345	\$7675	\$7796	\$8052
		Grade 1 Wood Veneer	\$8316	\$9646	\$9767	\$10,023
		Grade 2 Wood Veneer	\$9201	\$10,531	\$10,652	\$10,908

Tip: Tables are available parametrically in 1" increments.

96" x 49"-54" x 29"	COET2FCTL	Grade 1 Laminate	\$6290	\$7791	\$7923	\$8211
		Grade 2 and 3 Laminate	\$6548	\$8049	\$8181	\$8469
		Grade 1 Wood Veneer	\$8764	\$10,265	\$10,397	\$10,685
		Grade 2 Wood Veneer	\$9689	\$11,190	\$11,322	\$11,610

96" x 55"-60" x 29"	COET2FCTL	Grade 1 Laminate	\$6465	\$8129	\$8278	\$8596
		Grade 2 and 3 Laminate	\$6749	\$8413	\$8562	\$8880
		Grade 1 Wood Veneer	\$9216	\$10,880	\$11,029	\$11,347
		Grade 2 Wood Veneer	\$10,181	\$11,845	\$11,994	\$12,312

97" -108" x 48" x 29"	COET2FCTL	Grade 1 Laminate	\$6363	\$8250	\$8432	\$8782
		Grade 2 and 3 Laminate	\$6620	\$8507	\$8689	\$9039
		Grade 1 Wood Veneer	\$8600	\$10,487	\$10,669	\$11,019
		Grade 2 Wood Veneer	\$9602	\$11,489	\$11,671	\$12,021

97" -108" x 49"-54" x 29"	COET2FCTL	Grade 1 Laminate	\$6597	\$8723	\$8925	\$9317
		Grade 2 and 3 Laminate	\$6886	\$9012	\$9214	\$9606
		Grade 1 Wood Veneer	\$9214	\$11,340	\$11,542	\$11,934
		Grade 2 Wood Veneer	\$10,305	\$12,431	\$12,633	\$13,025

97" -108" x 55"-60" x 29"	COET2FCTL	Grade 1 Laminate	\$6830	\$9192	\$9418	\$9851
		Grade 2 and 3 Laminate	\$7148	\$9510	\$9736	\$10,169
		Grade 1 Wood Veneer	\$9826	\$12,188	\$12,414	\$12,847
		Grade 2 Wood Veneer	\$11,011	\$13,373	\$13,599	\$14,032

► Product Information continued on next page

E-Table 2 Collaborative and Conference Tables

E-Table 2 Collaborative and Conference Tables

Faceted Laminate Base Tables

► Product Information continued from previous page

Specification Information

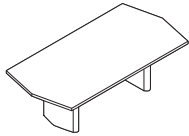

Dimensions		Style	Finish	Base Prices			
W	D	H	Number	Vinyl Edge:			
				3 mm Plastic/ 3 mm Wood, Flat, or Convex	Bullnose Wood Edge:	Beveled Wood Edge	Knife Wood Edge:

Faceted Tables with Two Laminate Bases - Working Height

109" -120"	48"	29"	COET2FCTL	Grade 1 Laminate	\$6495	\$8938	\$9183	\$9625
				Grade 2 and 3 Laminate	\$6776	\$9219	\$9464	\$9906
				Grade 1 Wood Veneer	\$8765	\$11,208	\$11,453	\$11,895
				Grade 2 Wood Veneer	\$9879	\$12,322	\$12,567	\$13,009
109" -120"	49" -54"	29"	COET2FCTL	Grade 1 Laminate	\$6780	\$9530	\$9805	\$10,297
				Grade 2 and 3 Laminate	\$7099	\$9849	\$10,124	\$10,616
				Grade 1 Wood Veneer	\$9537	\$12,287	\$12,562	\$13,054
				Grade 2 Wood Veneer	\$10,797	\$13,547	\$13,822	\$14,314
109" -120"	55" -60"	29"	COET2FCTL	Grade 1 Laminate	\$7063	\$10,125	\$10,425	\$10,972
				Grade 2 and 3 Laminate	\$7418	\$10,480	\$10,780	\$11,327
				Grade 1 Wood Veneer	\$10,305	\$13,367	\$13,667	\$14,214
				Grade 2 Wood Veneer	\$11,711	\$14,773	\$15,073	\$15,620

Tip: Tables are available parametrically in 1" increments.

► Product Information continued on next page

E-Table 2 Collaborative and Conference Tables

Faceted Laminate Base Tables

► Product Information continued from previous page

Specification Information

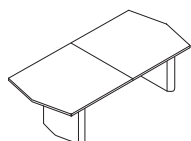

Dimensions		Style H Number	Finish	Base Prices				
W	D			3 mm Plastic/ 3 mm Wood, Flat, or Convex Vinyl Edge:	Bullnose Wood Edge:	Beveled Wood Edge:	Knife Wood Edge:	

Faceted Tables with Two Laminate Bases - Working Height

Tip: Top ships in two pieces. Hardware is included for field assembly.

121" -132"	48"	29"	COET2FCTL	Grade 1 Laminate	\$6526	\$9537	\$9809	\$10,328
				Grade 2 and 3 Laminate	\$6835	\$9846	\$10,118	\$10,637
				Grade 1 Wood Veneer	\$9318	\$12,329	\$12,601	\$13,120
				Grade 2 Wood Veneer	\$10,544	\$13,555	\$13,827	\$14,346

Tip: If you require your table top to be made into three pieces, this can be done as a special. Please contact Customer Service at 1.800.627.6770 to obtain a quote.

121" -132"	49" -54"	29"	COET2FCTL	Grade 1 Laminate	\$6828	\$10,216	\$10,515	\$11,105
				Grade 2 and 3 Laminate	\$7180	\$10,568	\$10,867	\$11,457
				Grade 1 Wood Veneer	\$10,218	\$13,606	\$13,905	\$14,495
				Grade 2 Wood Veneer	\$11,602	\$14,990	\$15,289	\$15,879

121" -132"	55" -60"	29"	COET2FCTL	Grade 1 Laminate	\$7129	\$10,896	\$11,227	\$11,882
				Grade 2 and 3 Laminate	\$7520	\$11,287	\$11,618	\$12,273
				Grade 1 Wood Veneer	\$11,113	\$14,880	\$15,211	\$15,866
				Grade 2 Wood Veneer	\$12,658	\$16,425	\$16,756	\$17,411

Tip: Tables are available parametrically in 1" increments.

133" -144"	48"	29"	COET2FCTL	Grade 1 Laminate	\$6555	\$10,132	\$10,432	\$11,029
				Grade 2 and 3 Laminate	\$6894	\$10,471	\$10,771	\$11,368
				Grade 1 Wood Veneer	\$9871	\$13,448	\$13,748	\$14,345
				Grade 2 Wood Veneer	\$11,207	\$14,784	\$15,084	\$15,681

133" -144"	49" -54"	29"	COET2FCTL	Grade 1 Laminate	\$6875	\$10,900	\$11,226	\$11,911
				Grade 2 and 3 Laminate	\$7261	\$11,286	\$11,612	\$12,297
				Grade 1 Wood Veneer	\$10,898	\$14,923	\$15,249	\$15,934
				Grade 2 Wood Veneer	\$12,407	\$16,432	\$16,758	\$17,443

133" -144"	55" -60"	29"	COET2FCTL	Grade 1 Laminate	\$7193	\$11,664	\$12,028	\$12,787
				Grade 2 and 3 Laminate	\$7621	\$12,092	\$12,456	\$13,215
				Grade 1 Wood Veneer	\$11,919	\$16,390	\$16,754	\$17,513
				Grade 2 Wood Veneer	\$13,605	\$18,076	\$18,440	\$19,199

► Product Information continued on next page

E-Table 2 Collaborative and Conference Tables

E-Table 2 Collaborative and Conference Tables

Faceted Laminate Base Tables

► Product Information continued from previous page

Specification Information

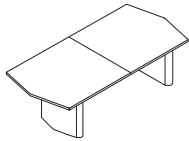

Dimensions		Style Number	Finish	Base Prices			
W	D			H	Edge:		
				3 mm Plastic/ 3 mm Wood, Flat, or Convex Vinyl Edge:	Bullnose Wood Edge:	Beveled Wood Edge	Knife Wood Edge:

Faceted Tables with Two Laminate Bases - Working Height

Dimensions	Style Number	Finish	Grade 1 Laminate	Grade 2 and 3 Laminate	Grade 1 Wood Veneer	Grade 2 Wood Veneer
145" -156" 43" -48" 29"	COET2FCTL	Grade 1 Laminate	\$7984	\$12,494	\$12,782	\$13,559
		Grade 2 and 3 Laminate	\$8341	\$12,851	\$13,139	\$13,916
		Grade 1 Wood Veneer	\$13,102	\$17,612	\$17,900	\$18,677
		Grade 2 Wood Veneer	\$14,553	\$19,063	\$19,351	\$20,128
145" -156" 49" -54" 29"	COET2FCTL	Grade 1 Laminate	\$8398	\$13,471	\$13,794	\$14,670
		Grade 2 and 3 Laminate	\$8806	\$13,879	\$14,202	\$15,078
		Grade 1 Wood Veneer	\$14,446	\$19,519	\$19,842	\$20,718
		Grade 2 Wood Veneer	\$16,093	\$21,166	\$21,489	\$22,365
145" -156" 55" -60" 29"	COET2FCTL	Grade 1 Laminate	\$8819	\$14,458	\$14,812	\$15,787
		Grade 2 and 3 Laminate	\$9268	\$14,907	\$15,261	\$16,236
		Grade 1 Wood Veneer	\$15,790	\$21,429	\$21,783	\$22,758
		Grade 2 Wood Veneer	\$17,630	\$23,269	\$23,623	\$24,598

► Product Information continued on next page

E-Table 2 Collaborative and Conference Tables

Faceted Laminate Base Tables

► Product Information continued from previous page

Specification Information

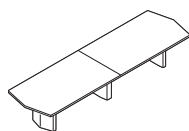

Dimensions		Style H Number	Finish	Base Prices			
W	D			3 mm Plastic/ 3 mm Wood, Flat, or Convex Vinyl Edge:	Bullnose Wood Edge:	Beveled Wood Edge	Knife Wood Edge:

Faceted Tables with Three Laminate Bases - Working Height

Tip: Top ships in two pieces. Hardware is included for field assembly.

157" -168"	48"	29"	COET2FCTL	Grade 1 Laminate	\$9258	\$14,701	\$14,977	\$15,931
				Grade 2 and 3 Laminate	\$9635	\$15,078	\$15,354	\$16,308
				Grade 1 Wood Veneer	\$16,182	\$21,625	\$21,901	\$22,855
				Grade 2 Wood Veneer	\$17,748	\$23,191	\$23,467	\$24,421

Tip: For tables with three or more bases, you must specify the entry point of the base power infeed, either an end base or a mid base location, in order to receive the correct length of base power infeed.

157" -168"	49" -54"	29"	COET2FCTL	Grade 1 Laminate	\$9767	\$15,886	\$16,207	\$17,275
				Grade 2 and 3 Laminate	\$10,193	\$16,312	\$16,633	\$17,701
				Grade 1 Wood Veneer	\$17,834	\$23,953	\$24,274	\$25,342
				Grade 2 Wood Veneer	\$19,617	\$25,736	\$26,057	\$27,125

157" -168"	55" -60"	29"	COET2FCTL	Grade 1 Laminate	\$10,280	\$17,085	\$17,431	\$18,620
				Grade 2 and 3 Laminate	\$10,749	\$17,554	\$17,900	\$19,089
				Grade 1 Wood Veneer	\$19,492	\$26,297	\$26,643	\$27,832
				Grade 2 Wood Veneer	\$21,485	\$28,290	\$28,636	\$29,825

Tip: If you require your table top to be made into three pieces, this can be done as a special. Please contact Customer Service at 1.800.627.6770 to obtain a quote.

169" -180"	48"	29"	COET2FCTL	Grade 1 Laminate	\$9311	\$14,869	\$15,149	\$16,120
				Grade 2 and 3 Laminate	\$9715	\$15,273	\$15,553	\$16,524
				Grade 1 Wood Veneer	\$16,298	\$21,856	\$22,136	\$23,107
				Grade 2 Wood Veneer	\$17,975	\$23,533	\$23,813	\$24,784

169" -180"	49" -54"	29"	COET2FCTL	Grade 1 Laminate	\$9841	\$16,092	\$16,410	\$17,498
				Grade 2 and 3 Laminate	\$10,295	\$16,546	\$16,864	\$17,952
				Grade 1 Wood Veneer	\$17,982	\$24,233	\$24,551	\$25,639
				Grade 2 Wood Veneer	\$19,890	\$26,141	\$26,459	\$27,547

► Product Information continued on next page

E-Table 2 Collaborative and Conference Tables

Faceted Laminate Base Tables

► Product Information continued from previous page

Specification Information

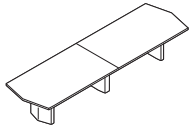

Dimensions		Style Number	Finish	Base Prices			
W	D			H			

3 mm Plastic/
3 mm Wood,
Flat, or Convex
Vinyl Edge:

Bullnose Wood
Edge:

Beveled Wood
Edge:

Knife Wood
Edge:

Faceted Tables with Three Laminate Bases - Working Height

W	D	H	Style Number	Finish	Grade 1 Laminate	Grade 2 and 3 Laminate	Grade 1 Wood Veneer	Grade 2 Wood Veneer
169" -180"	55" -60"	29"	COET2FCTL	Grade 1 Laminate	\$10,371	\$17,321	\$17,671	\$18,877
				Grade 2 and 3 Laminate	\$10,875	\$17,825	\$18,175	\$19,381
				Grade 1 Wood Veneer	\$19,669	\$26,619	\$26,969	\$28,175
				Grade 2 Wood Veneer	\$21,799	\$28,749	\$29,099	\$30,305
181" -192"	48"	29"	COET2FCTL	Grade 1 Laminate	\$9362	\$15,035	\$15,320	\$16,307
				Grade 2 and 3 Laminate	\$9794	\$15,467	\$15,752	\$16,739
				Grade 1 Wood Veneer	\$16,412	\$22,085	\$22,370	\$23,357
				Grade 2 Wood Veneer	\$18,202	\$23,875	\$24,160	\$25,147
181" -192"	49" -54"	29"	COET2FCTL	Grade 1 Laminate	\$9914	\$16,294	\$16,611	\$17,721
				Grade 2 and 3 Laminate	\$10,397	\$16,777	\$17,094	\$18,204
				Grade 1 Wood Veneer	\$18,129	\$24,509	\$24,826	\$25,936
				Grade 2 Wood Veneer	\$20,162	\$26,542	\$26,859	\$27,969
181" -192"	55" -60"	29"	COET2FCTL	Grade 1 Laminate	\$10,463	\$17,556	\$17,910	\$19,135
				Grade 2 and 3 Laminate	\$11,000	\$18,093	\$18,447	\$19,672
				Grade 1 Wood Veneer	\$19,847	\$26,940	\$27,294	\$28,519
				Grade 2 Wood Veneer	\$22,112	\$29,205	\$29,559	\$30,784
193" -204"	48"	29"	COET2FCTL	Grade 1 Laminate	\$9531	\$15,379	\$15,690	\$16,759
				Grade 2 and 3 Laminate	\$9988	\$15,836	\$16,147	\$17,216
				Grade 1 Wood Veneer	\$17,789	\$23,637	\$23,948	\$25,017
				Grade 2 Wood Veneer	\$19,691	\$25,539	\$25,850	\$26,919

Tip: Tables are available parametrically in 1" increments.

► Product Information continued on next page

E-Table 2 Collaborative and Conference Tables

Faceted Laminate Base Tables

► Product Information continued from previous page

Specification Information

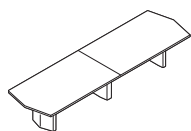

Dimensions		Style Number	Finish	Base Prices			
W	D			H			
				3 mm Plastic/ 3 mm Wood, Flat, or Convex Vinyl Edge:	Bullnose Wood Edge:	Beveled Wood Edge:	Knife Wood Edge:

Faceted Tables with Three Laminate Bases - Working Height

193" -204"	49" -54"	29"	COET2FCTL	Grade 1 Laminate	\$10,117	\$16,697	\$17,040	\$18,244
				Grade 2 and 3 Laminate	\$10,630	\$17,210	\$17,553	\$18,757
				Grade 1 Wood Veneer	\$19,689	\$26,269	\$26,612	\$27,816
				Grade 2 Wood Veneer	\$21,852	\$28,432	\$28,775	\$29,979
193" -204"	55" -60"	29"	COET2FCTL	Grade 1 Laminate	\$10,703	\$18,025	\$18,399	\$19,734
				Grade 2 and 3 Laminate	\$11,273	\$18,595	\$18,969	\$20,304
				Grade 1 Wood Veneer	\$21,590	\$28,912	\$29,286	\$30,621
				Grade 2 Wood Veneer	\$24,006	\$31,328	\$31,702	\$33,037
205" -216"	48"	29"	COET2FCTL	Grade 1 Laminate	\$9,699	\$15,718	\$16,058	\$17,210
				Grade 2 and 3 Laminate	\$10,182	\$16,201	\$16,541	\$17,693
				Grade 1 Wood Veneer	\$19,165	\$25,184	\$25,524	\$26,676
				Grade 2 Wood Veneer	\$21,179	\$27,198	\$27,538	\$28,690
205" -216"	49" -54"	29"	COET2FCTL	Grade 1 Laminate	\$10,320	\$17,103	\$17,466	\$18,766
				Grade 2 and 3 Laminate	\$10,863	\$17,646	\$18,009	\$19,309
				Grade 1 Wood Veneer	\$21,248	\$28,031	\$28,394	\$29,694
				Grade 2 Wood Veneer	\$23,542	\$30,325	\$30,688	\$31,988
205" -216"	55" - 60"	29"	COET2FCTL	Grade 1 Laminate	\$10,941	\$18,488	\$18,886	\$20,328
				Grade 2 and 3 Laminate	\$11,544	\$19,091	\$19,489	\$20,931
				Grade 1 Wood Veneer	\$23,332	\$30,879	\$31,277	\$32,719
				Grade 2 Wood Veneer	\$25,899	\$33,446	\$33,844	\$35,286

Tip: Tables are available parametrically in 1" increments.

► Product Information continued on next page

E-Table 2 Collaborative and Conference Tables

Faceted Laminate Base Tables

► Product Information continued from previous page

Specification Information

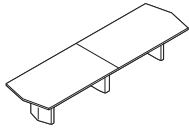

Dimensions		Style	Finish	Base Prices			
W	D	H	Number				
				3 mm Plastic/ 3 mm Wood, Flat, or Convex Vinyl Edge:	Bullnose Wood Edge:	Beveled Wood Edge	Knife Wood Edge:

Faceted Tables with Three Laminate Bases - Working Height

Dimensions	Style	Finish	Grade	Price	Bullnose	Beveled	Knife
217" -228" 48" 29"	COET2FCTL	Grade 1 Laminate	Grade 1 Laminate	\$9727	\$16,051	\$16,413	\$17,597
			Grade 2 and 3 Laminate	\$10,237	\$16,561	\$16,923	\$18,107
			Grade 1 Wood Veneer	\$19,866	\$26,190	\$26,552	\$27,736
			Grade 2 Wood Veneer	\$21,992	\$28,316	\$28,678	\$29,862
217" -228" 49" -54" 29"	COET2FCTL	Grade 1 Laminate	Grade 1 Laminate	\$10,365	\$17,489	\$17,885	\$19,217
			Grade 2 and 3 Laminate	\$10,937	\$18,061	\$18,457	\$19,789
			Grade 1 Wood Veneer	\$22,051	\$29,175	\$29,571	\$30,903
			Grade 2 Wood Veneer	\$24,466	\$31,590	\$31,986	\$33,318
217" -228" 55" -60" 29"	COET2FCTL	Grade 1 Laminate	Grade 1 Laminate	\$11,006	\$18,934	\$19,364	\$20,843
			Grade 2 and 3 Laminate	\$11,643	\$19,571	\$20,001	\$21,480
			Grade 1 Wood Veneer	\$24,242	\$32,170	\$32,600	\$34,079
			Grade 2 Wood Veneer	\$26,944	\$34,872	\$35,302	\$36,781
229" -240" 48" 29"	COET2FCTL	Grade 1 Laminate	Grade 1 Laminate	\$9756	\$16,383	\$16,769	\$17,983
			Grade 2 and 3 Laminate	\$10,292	\$16,919	\$17,305	\$18,519
			Grade 1 Wood Veneer	\$20,569	\$27,196	\$27,582	\$28,796
			Grade 2 Wood Veneer	\$22,805	\$29,432	\$29,818	\$31,032
229" -240" 49" -54" 29"	COET2FCTL	Grade 1 Laminate	Grade 1 Laminate	\$10,410	\$17,874	\$18,305	\$19,667
			Grade 2 and 3 Laminate	\$11,011	\$18,475	\$18,906	\$20,268
			Grade 1 Wood Veneer	\$22,852	\$30,316	\$30,747	\$32,109
			Grade 2 Wood Veneer	\$25,391	\$32,855	\$33,286	\$34,648
229" -240" 55" -60" 29"	COET2FCTL	Grade 1 Laminate	Grade 1 Laminate	\$11,069	\$19,375	\$19,837	\$21,356
			Grade 2 and 3 Laminate	\$11,742	\$20,048	\$20,510	\$22,029
			Grade 1 Wood Veneer	\$25,150	\$33,456	\$33,918	\$35,437
			Grade 2 Wood Veneer	\$27,988	\$36,294	\$36,756	\$38,275

Tip: Tables are available parametrically in 1" increments.

► Product Information continued on next page

E-Table 2 Collaborative and Conference Tables

Faceted Laminate Base Tables

► Product Information continued from previous page

Specification Information

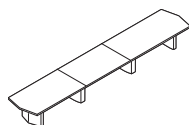

Dimensions		Style H Number	Finish	Base Prices				
W	D			3 mm Plastic/ 3 mm Wood, Flat, or Convex Vinyl Edge:	Bullnose Wood Edge:	Beveled Wood Edge:	Knife Wood Edge:	

Faceted Tables with Four Laminate Bases - Working Height

Tip: Top ships in three pieces. Hardware is included for field assembly.

241" -252"	48"	29"	COET2FCTL	Grade 1 Laminate	\$11,406	\$19,080	\$19,479	\$20,864
				Grade 2 and 3 Laminate	\$11,964	\$19,638	\$20,037	\$21,422
				Grade 1 Wood Veneer	\$24,140	\$31,814	\$32,213	\$33,598
				Grade 2 Wood Veneer	\$26,489	\$34,163	\$34,562	\$35,947

Tip: For tables with three or more bases, you must specify the entry point of the base power infeed, either an end base or a mid base location, in order to receive the correct length of base power infeed.

241" -252"	49" -54"	29"	COET2FCTL	Grade 1 Laminate	\$12,177	\$20,799	\$21,249	\$22,823
				Grade 2 and 3 Laminate	\$12,804	\$21,426	\$21,876	\$23,450
				Grade 1 Wood Veneer	\$26,777	\$35,399	\$35,849	\$37,423
				Grade 2 Wood Veneer	\$29,443	\$38,065	\$38,515	\$40,089

241" -252"	55" -60"	29"	COET2FCTL	Grade 1 Laminate	\$12,942	\$22,556	\$23,021	\$24,763
				Grade 2 and 3 Laminate	\$13,641	\$23,255	\$23,720	\$25,462
				Grade 1 Wood Veneer	\$29,416	\$39,030	\$39,495	\$41,237
				Grade 2 Wood Veneer	\$32,400	\$42,014	\$42,479	\$44,221

Tip: If you require your table top to be made into four pieces, this can be done as a special. Please contact Customer Service at 1.800.627.6770 to obtain a quote.

253" -264"	48"	29"	COET2FCTL	Grade 1 Laminate	\$12,839	\$21,558	\$21,970	\$23,526
				Grade 2 and 3 Laminate	\$13,423	\$22,142	\$22,554	\$24,110
				Grade 1 Wood Veneer	\$27,496	\$36,215	\$36,627	\$38,183
				Grade 2 Wood Veneer	\$29,960	\$38,679	\$39,091	\$40,647

253" -264"	49" -54"	29"	COET2FCTL	Grade 1 Laminate	\$13,712	\$23,493	\$23,965	\$25,745
				Grade 2 and 3 Laminate	\$14,366	\$24,147	\$24,619	\$26,399
				Grade 1 Wood Veneer	\$30,467	\$40,248	\$40,720	\$42,500
				Grade 2 Wood Veneer	\$33,261	\$43,042	\$43,514	\$45,294

► Product Information continued on next page

E-Table 2 Collaborative and Conference Tables

Faceted Laminate Base Tables

► Product Information continued from previous page

Specification Information

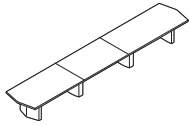

Dimensions		Style Number	Finish	Base Prices			
W	D			H	Edge:		
				3 mm Plastic/ 3 mm Wood, Flat, or Convex Vinyl Edge:	Bullnose Wood Edge:	Beveled Wood Edge:	Knife Wood Edge:

Faceted Tables with Four Laminate Bases - Working Height

253" -264"	55" -60"	29"	COET2FCTL	Grade 1 Laminate	\$14,568	\$25,491	\$25,955	\$27,923
				Grade 2 and 3 Laminate	\$15,295	\$26,218	\$26,682	\$28,650
				Grade 1 Wood Veneer	\$33,438	\$44,361	\$44,825	\$46,793
				Grade 2 Wood Veneer	\$36,566	\$47,489	\$47,953	\$49,921
265" -276"	48"	29"	COET2FCTL	Grade 1 Laminate	\$12,898	\$21,798	\$22,231	\$23,724
				Grade 2 and 3 Laminate	\$13,506	\$22,406	\$22,839	\$24,332
				Grade 1 Wood Veneer	\$27,652	\$36,552	\$36,985	\$38,478
				Grade 2 Wood Veneer	\$30,232	\$39,132	\$39,565	\$41,058
265" -276"	49" -54"	29"	COET2FCTL	Grade 1 Laminate	\$13,798	\$23,753	\$24,202	\$25,987
				Grade 2 and 3 Laminate	\$14,482	\$24,437	\$24,886	\$26,671
				Grade 1 Wood Veneer	\$30,631	\$40,586	\$41,035	\$42,820
				Grade 2 Wood Veneer	\$33,562	\$43,517	\$43,966	\$45,751
265" -276"	55" -60"	29"	COET2FCTL	Grade 1 Laminate	\$14,642	\$25,776	\$26,182	\$28,168
				Grade 2 and 3 Laminate	\$15,402	\$26,536	\$26,942	\$28,928
				Grade 1 Wood Veneer	\$33,620	\$44,754	\$45,160	\$47,146
				Grade 2 Wood Veneer	\$36,904	\$48,038	\$48,444	\$50,430
277" -288"	48"	29"	COET2FCTL	Grade 1 Laminate	\$12,956	\$22,035	\$22,494	\$23,917
				Grade 2 and 3 Laminate	\$13,588	\$22,667	\$23,126	\$24,549
				Grade 1 Wood Veneer	\$27,807	\$36,886	\$37,345	\$38,768
				Grade 2 Wood Veneer	\$30,504	\$39,583	\$40,042	\$41,465

Tip: Tables are available parametrically in 1" increments.

► Product Information continued on next page





E-Table 2 Collaborative and Conference Tables

Faceted Laminate Base Tables

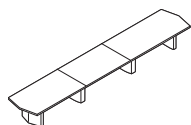
► Product Information continued from previous page

Specification Information



Dimensions		Style	Finish	Base Prices					
W	D	H	Number						
									
				3 mm Plastic/ 3 mm Wood, Flat, or Convex Vinyl Edge:	Bullnose Wood Edge:	Beveled Wood Edge:	Knife Wood Edge:		

Faceted Tables with Four Laminate Bases - Working Height

277" -288"	49" -54"	29"	COET2FCTL	Grade 1 Laminate	\$13,884	\$24,014	\$24,440	\$26,233
				Grade 2 and 3 Laminate	\$14,597	\$24,727	\$25,153	\$26,946
				Grade 1 Wood Veneer	\$30,794	\$40,924	\$41,350	\$43,143
				Grade 2 Wood Veneer	\$33,862	\$43,992	\$44,418	\$46,211
277" -288"	55" -60"	29"	COET2FCTL	Grade 1 Laminate	\$14,716	\$26,060	\$26,407	\$28,411
				Grade 2 and 3 Laminate	\$15,508	\$26,852	\$27,199	\$29,203
				Grade 1 Wood Veneer	\$33,801	\$45,145	\$45,492	\$47,496
				Grade 2 Wood Veneer	\$37,242	\$48,586	\$48,933	\$50,937

E-Table 2
Collaborative and
Conference Tables

E-Table 2 Collaborative and Conference Tables

Faceted Veneer Base Tables

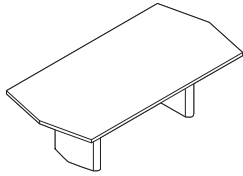

Tip: Shipped knocked down.

Tip: Utility bay quantity offering by table width is available in the understanding section.

Tip: 3 mm vinyl edge profiles on tables require a 4" radius on all corners.

Tip: A flat, plastic edge can be specified on veneer tops by selecting the "flat" edge option. Flat edge is only available in 6000 Black on veneer tops.

Tip: If you specify a wood edge on a top with woodgrain laminate, the edge and the top may not match.

Tip: Sectioned top option is a two piece top and is only available on tops 96"W-120"W.

Tip: When a wood edge is specified on a wood veneer top, the edge finish will match the top finish.

Tip: Each utility bay comes with two universal faceplate openings that accept customer-supplied faceplates in any of the following sizes: single-gang, double-gang, or triple-gang.

Standard Includes

- Top:
 - 1 1/4" particle board core with grade 1 laminate
 - parametric width in 1" increments ranging from 96"-288"
 - parametric depth in 1" increments ranging from 48"-60"
- Edge: 3 mm plastic edge, 3 mm wood edge, or convex vinyl edge
- Bases: grade 01 or grade 02 veneer on MDF core
- Wireway: painted steel side panels with powder coat and black plastic access door
- Concealed leveling glides: non-marring, black plastic
- Overall height: 29"

Options

Sectioned Top	No Sectioned Top With Sectioned Top	No cost +\$569
Top Finish	Laminate Price Group 02 Laminate Price Group 03 Veneer Price Group 01 Veneer Price Group 02	Price below Price below Price below Price below
Edge Type	3mm Plastic Edge 3mm Wood Edge Beveled Wood Edge Bullnose Wood Edge Convex Vinyl Edge Knife Wood Edge	Price below Price below Price below Price below Price below Price below
Bay Option	No Bays Two Bays Three Bays Four Bays Six Bays Seven Bays	No cost +\$1578 +\$2367 +\$3156 +\$4734 +\$5523
Wiring Schematic	1+1 Hardwire, 2 Circuits 3 + 0 Wireway Chicago Wireway 1+1 Hardwire,2 Circuits,USB 3 + 0 Wireway,USB	No cost No cost No cost +\$157 +\$157
Infeed	Hardwire NYC Hardwire Infeed Plug	No cost No cost No cost
Infeed Location	End Base Power Infeed Mid Base Power Infeed	No cost No cost

► **Product Information continued on next page**

E-Table 2 Collaborative and Conference Tables

Faceted Veneer Base Tables

► Product Information continued from previous page

Specification Information

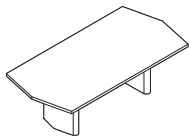

Dimensions		Style Number	Finish	Base Prices				
W	D			H	3 mm Plastic/ 3 mm Wood, Flat, or Convex Vinyl Edge:		Bullnose Wood Edge:	Beveled Wood Edge:

Faceted Tables with Two Veneer Bases - Working Height

Tip: Top ships in one piece.

W	D	H	Style Number	Finish	3 mm Plastic/ 3 mm Wood, Flat, or Convex Vinyl Edge	Bullnose Wood Edge	Beveled Wood Edge	Knife Wood Edge
96"	48"	29"	COET2FCTV	Grade 1 Laminate	\$9505	\$10,835	\$10,956	\$11,212
				Grade 2 and 3 Laminate	\$9737	\$11,067	\$11,188	\$11,444
				Grade 1 Wood Veneer	\$11,708	\$13,038	\$13,159	\$13,415
				Grade 2 Wood Veneer	\$12,593	\$13,923	\$14,044	\$14,300

Tip: Tables are available parametrically in 1" increments.

96"	49" -54"	29"	COET2FCTV	Grade 1 Laminate	\$9682	\$11,183	\$11,315	\$11,603
				Grade 2 and 3 Laminate	\$9940	\$11,441	\$11,573	\$11,861
				Grade 1 Wood Veneer	\$12,156	\$13,657	\$13,789	\$14,077
				Grade 2 Wood Veneer	\$13,081	\$14,582	\$14,714	\$15,002

96"	55" -60"	29"	COET2FCTV	Grade 1 Laminate	\$9857	\$11,521	\$11,670	\$11,988
				Grade 2 and 3 Laminate	\$10,141	\$11,805	\$11,954	\$12,272
				Grade 1 Wood Veneer	\$12,608	\$14,272	\$14,421	\$14,739
				Grade 2 Wood Veneer	\$13,573	\$15,237	\$15,386	\$15,704

97" -108"	48"	29"	COET2FCTV	Grade 1 Laminate	\$9788	\$11,675	\$11,857	\$12,207
				Grade 2 and 3 Laminate	\$10,045	\$11,932	\$12,114	\$12,464
				Grade 1 Wood Veneer	\$12,023	\$13,910	\$14,092	\$14,442
				Grade 2 Wood Veneer	\$13,026	\$14,913	\$15,095	\$15,445

97" -108"	49" -54"	29"	COET2FCTV	Grade 1 Laminate	\$10,024	\$12,150	\$12,352	\$12,744
				Grade 2 and 3 Laminate	\$10,310	\$12,436	\$12,638	\$13,030
				Grade 1 Wood Veneer	\$12,639	\$14,765	\$14,967	\$15,359
				Grade 2 Wood Veneer	\$13,727	\$15,853	\$16,055	\$16,447

97" -108"	55" -60"	29"	COET2FCTV	Grade 1 Laminate	\$10,253	\$12,615	\$12,841	\$13,274
				Grade 2 and 3 Laminate	\$10,573	\$12,935	\$13,161	\$13,594
				Grade 1 Wood Veneer	\$13,249	\$15,611	\$15,837	\$16,270
				Grade 2 Wood Veneer	\$14,433	\$16,795	\$17,021	\$17,454

► Product Information continued on next page

E-Table 2 Collaborative and Conference Tables

E-Table 2 Collaborative and Conference Tables

Faceted Veneer Base Tables

► Product Information continued from previous page

Specification Information

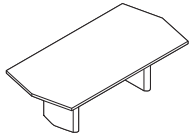

Dimensions		Style Number	Finish	Base Prices			
W	D			H	Edge:		
				3 mm Plastic/ 3 mm Wood, Flat, or Convex Vinyl Edge:	Bullnose Wood Edge:	Beveled Wood Edge:	Knife Wood Edge:

Faceted Tables with Two Veneer Bases - Working Height

109" -120"	48"	29"	COET2FCTV	Grade 1 Laminate	\$9887	\$12,330	\$12,575	\$13,017
				Grade 2 and 3 Laminate	\$10,168	\$12,611	\$12,856	\$13,298
				Grade 1 Wood Veneer	\$12,157	\$14,600	\$14,845	\$15,287
				Grade 2 Wood Veneer	\$13,271	\$15,714	\$15,959	\$16,401
109" -120"	49" -54"	29"	COET2FCTV	Grade 1 Laminate	\$10,172	\$12,922	\$13,197	\$13,689
				Grade 2 and 3 Laminate	\$10,491	\$13,241	\$13,516	\$14,008
				Grade 1 Wood Veneer	\$12,929	\$15,679	\$15,954	\$16,446
				Grade 2 Wood Veneer	\$14,189	\$16,939	\$17,214	\$17,706
109" -120"	55" -60"	29"	COET2FCTV	Grade 1 Laminate	\$10,455	\$13,517	\$13,817	\$14,364
				Grade 2 and 3 Laminate	\$10,810	\$13,872	\$14,172	\$14,719
				Grade 1 Wood Veneer	\$13,697	\$16,759	\$17,059	\$17,606
				Grade 2 Wood Veneer	\$15,103	\$18,165	\$18,465	\$19,012

Tip: Tables are available parametrically in 1" increments.

► Product Information continued on next page

E-Table 2 Collaborative and Conference Tables

Faceted Veneer Base Tables

► Product Information continued from previous page

Specification Information

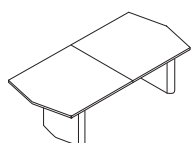

Dimensions		Style Number	Finish	Base Prices			
W	D			H			
				3 mm Plastic/ 3 mm Wood, Flat, or Convex Vinyl Edge:	Bullnose Wood Edge:	Beveled Wood Edge:	Knife Wood Edge:

Faceted Tables with Two Veneer Bases - Working Height

Tip: Top ships in two pieces. Hardware is included for field assembly.

121" -132"	48"	29"	COET2FCTV	Grade 1 Laminate	\$9918	\$12,929	\$13,201	\$13,720
				Grade 2 and 3 Laminate	\$10,227	\$13,238	\$13,510	\$14,029
				Grade 1 Wood Veneer	\$12,710	\$15,721	\$15,993	\$16,512
				Grade 2 Wood Veneer	\$13,936	\$16,947	\$17,219	\$17,738

Tip: If you require your table top to be made into three pieces, this can be done as a special. Please contact Customer Service at 1.800.627.6770 to obtain a quote.

121" -132"	49" -54"	29"	COET2FCTV	Grade 1 Laminate	\$10,220	\$13,608	\$13,907	\$14,497
				Grade 2 and 3 Laminate	\$10,572	\$13,960	\$14,259	\$14,849
				Grade 1 Wood Veneer	\$13,610	\$16,998	\$17,297	\$17,887
				Grade 2 Wood Veneer	\$14,994	\$18,382	\$18,681	\$19,271

121" -132"	55" -60"	29"	COET2FCTV	Grade 1 Laminate	\$10,521	\$14,288	\$14,619	\$15,274
				Grade 2 and 3 Laminate	\$10,912	\$14,679	\$15,010	\$15,665
				Grade 1 Wood Veneer	\$14,505	\$18,272	\$18,603	\$19,258
				Grade 2 Wood Veneer	\$16,050	\$19,817	\$20,148	\$20,803

Tip: Tables are available parametrically in 1" increments.

133" -144"	48"	29"	COET2FCTV	Grade 1 Laminate	\$9947	\$13,524	\$13,824	\$14,421
				Grade 2 and 3 Laminate	\$10,286	\$13,863	\$14,163	\$14,760
				Grade 1 Wood Veneer	\$13,263	\$16,840	\$17,140	\$17,737
				Grade 2 Wood Veneer	\$14,599	\$18,176	\$18,476	\$19,073

133" -144"	49" -54"	29"	COET2FCTV	Grade 1 Laminate	\$10,267	\$14,292	\$14,618	\$15,303
				Grade 2 and 3 Laminate	\$10,653	\$14,678	\$15,004	\$15,689
				Grade 1 Wood Veneer	\$14,290	\$18,315	\$18,641	\$19,326
				Grade 2 Wood Veneer	\$15,799	\$19,824	\$20,150	\$20,835

133" -144"	55" -60"	29"	COET2FCTV	Grade 1 Laminate	\$10,585	\$15,056	\$15,420	\$16,179
				Grade 2 and 3 Laminate	\$11,013	\$15,484	\$15,848	\$16,607
				Grade 1 Wood Veneer	\$15,311	\$19,782	\$20,146	\$20,905
				Grade 2 Wood Veneer	\$16,997	\$21,468	\$21,832	\$22,591

► Product Information continued on next page

E-Table 2 Collaborative and Conference Tables

Faceted Veneer Base Tables

► Product Information continued from previous page

Specification Information

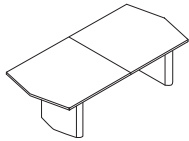

Dimensions		Style Number	Finish	Base Prices			
W	D			H			
				3 mm Plastic/ 3 mm Wood, Flat, or Convex Vinyl Edge:	Bullnose Wood Edge:	Beveled Wood Edge:	Knife Wood Edge:

Faceted Tables with Two Veneer Bases - Working Height

145" -156"	43" -48"	29"	COET2FCTV	Grade 1 Laminate	\$11,408	\$15,918	\$16,206	\$16,983
				Grade 2 and 3 Laminate	\$11,764	\$16,274	\$16,562	\$17,339
				Grade 1 Wood Veneer	\$16,525	\$21,035	\$21,323	\$22,100
				Grade 2 Wood Veneer	\$17,980	\$22,490	\$22,778	\$23,555
145" -156"	49" -54"	29"	COET2FCTV	Grade 1 Laminate	\$11,824	\$16,897	\$17,220	\$18,096
				Grade 2 and 3 Laminate	\$12,231	\$17,304	\$17,627	\$18,503
				Grade 1 Wood Veneer	\$17,871	\$22,944	\$23,267	\$24,143
				Grade 2 Wood Veneer	\$19,518	\$24,591	\$24,914	\$25,790
145" -156"	55" -60"	29"	COET2FCTV	Grade 1 Laminate	\$12,243	\$17,882	\$18,236	\$19,211
				Grade 2 and 3 Laminate	\$12,694	\$18,333	\$18,687	\$19,662
				Grade 1 Wood Veneer	\$19,216	\$24,855	\$25,209	\$26,184
				Grade 2 Wood Veneer	\$21,056	\$26,695	\$27,049	\$28,024

► Product Information continued on next page

E-Table 2 Collaborative and Conference Tables

Faceted Veneer Base Tables

► Product Information continued from previous page

Specification Information

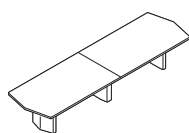

Dimensions		Style H	Style Number	Finish	Base Prices			
W	D				3 mm Plastic/ 3 mm Wood, Flat, or Convex Vinyl Edge:	Bullnose Wood Edge:	Beveled Wood Edge:	Knife Wood Edge:

Faceted Tables with Three Veneer Bases - Working Height

Tip: Top ships in two pieces. Hardware is included for field assembly.

157" -168"	48"	29"	COET2FCTV	Grade 1 Laminate	\$14,470	\$19,913	\$20,189	\$21,143
				Grade 2 and 3 Laminate	\$14,847	\$20,290	\$20,566	\$21,520
				Grade 1 Wood Veneer	\$21,394	\$26,837	\$27,113	\$28,067
				Grade 2 Wood Veneer	\$22,960	\$28,403	\$28,679	\$29,633

Tip: For tables with three or more bases, you must specify the entry point of the base power infeed, either an end base or a mid base location, in order to receive the correct length of base power infeed.

157" -168"	49" -54"	29"	COET2FCTV	Grade 1 Laminate	\$14,979	\$21,098	\$21,419	\$22,487
				Grade 2 and 3 Laminate	\$15,405	\$21,524	\$21,845	\$22,913
				Grade 1 Wood Veneer	\$23,046	\$29,165	\$29,486	\$30,554
				Grade 2 Wood Veneer	\$24,829	\$30,948	\$31,269	\$32,337

157" -168"	55" -60"	29"	COET2FCTV	Grade 1 Laminate	\$15,492	\$22,297	\$22,643	\$23,832
				Grade 2 and 3 Laminate	\$15,961	\$22,766	\$23,112	\$24,301
				Grade 1 Wood Veneer	\$24,704	\$31,509	\$31,855	\$33,044
				Grade 2 Wood Veneer	\$26,697	\$33,502	\$33,848	\$35,037

Tip: If you require your table top to be made into three pieces, this can be done as a special. Please contact Customer Service at 1.800.627.6770 to obtain a quote.

169" -180"	48"	29"	COET2FCTV	Grade 1 Laminate	\$14,523	\$20,081	\$20,361	\$21,332
				Grade 2 and 3 Laminate	\$14,928	\$20,486	\$20,766	\$21,737
				Grade 1 Wood Veneer	\$21,510	\$27,068	\$27,348	\$28,319
				Grade 2 Wood Veneer	\$23,188	\$28,746	\$29,026	\$29,997

169" -180"	49" -54"	29"	COET2FCTV	Grade 1 Laminate	\$15,053	\$21,304	\$21,622	\$22,710
				Grade 2 and 3 Laminate	\$15,507	\$21,758	\$22,076	\$23,164
				Grade 1 Wood Veneer	\$23,194	\$29,445	\$29,763	\$30,851
				Grade 2 Wood Veneer	\$25,103	\$31,354	\$31,672	\$32,760

► Product Information continued on next page

E-Table 2 Collaborative and Conference Tables

Faceted Veneer Base Tables

► Product Information continued from previous page

Specification Information

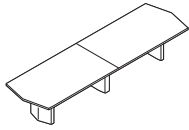

Dimensions		Style Number	Finish	Base Prices			
W	D			H	Edge:		
				3 mm Plastic/ 3 mm Wood, Flat, or Convex Vinyl Edge:	Bullnose Wood Edge:	Beveled Wood Edge:	Knife Wood Edge:

Faceted Tables with Three Veneer Bases - Working Height

169" -180"	55" -60"	29"	COET2FCTV	Grade 1 Laminate	\$15,584	\$22,534	\$22,884	\$24,090
				Grade 2 and 3 Laminate	\$16,087	\$23,037	\$23,387	\$24,593
				Grade 1 Wood Veneer	\$24,881	\$31,831	\$32,181	\$33,387
				Grade 2 Wood Veneer	\$27,011	\$33,961	\$34,311	\$35,517
181" -192"	48"	29"	COET2FCTV	Grade 1 Laminate	\$14,574	\$20,247	\$20,532	\$21,519
				Grade 2 and 3 Laminate	\$15,006	\$20,679	\$20,964	\$21,951
				Grade 1 Wood Veneer	\$21,624	\$27,297	\$27,582	\$28,569
				Grade 2 Wood Veneer	\$23,414	\$29,087	\$29,372	\$30,359
181" -192"	49" -54"	29"	COET2FCTV	Grade 1 Laminate	\$15,126	\$21,506	\$21,823	\$22,933
				Grade 2 and 3 Laminate	\$15,609	\$21,989	\$22,306	\$23,416
				Grade 1 Wood Veneer	\$23,341	\$29,721	\$30,038	\$31,148
				Grade 2 Wood Veneer	\$25,374	\$31,754	\$32,071	\$33,181
181" -192"	55" -60"	29"	COET2FCTV	Grade 1 Laminate	\$15,675	\$22,768	\$23,122	\$24,347
				Grade 2 and 3 Laminate	\$16,212	\$23,305	\$23,659	\$24,884
				Grade 1 Wood Veneer	\$25,059	\$32,152	\$32,506	\$33,731
				Grade 2 Wood Veneer	\$27,324	\$34,417	\$34,771	\$35,996
193" -204"	48"	29"	COET2FCTV	Grade 1 Laminate	\$14,743	\$20,591	\$20,902	\$21,971
				Grade 2 and 3 Laminate	\$15,200	\$21,048	\$21,359	\$22,428
				Grade 1 Wood Veneer	\$23,001	\$28,849	\$29,160	\$30,229
				Grade 2 Wood Veneer	\$24,903	\$30,751	\$31,062	\$32,131

Tip: Tables are available parametrically in 1" increments.

► Product Information continued on next page

E-Table 2 Collaborative and Conference Tables

Faceted Veneer Base Tables

► Product Information continued from previous page

Specification Information

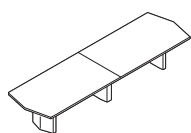

Dimensions		Style Number	Finish	Base Prices			
W	D			H			
				3 mm Plastic/ 3 mm Wood, Flat, or Convex Vinyl Edge:	Bullnose Wood Edge:	Beveled Wood Edge:	Knife Wood Edge:

Faceted Tables with Three Veneer Bases - Working Height

193" -204"	49" -54"	29"	COET2FCTV	Grade 1 Laminate	\$15,330	\$21,910	\$22,253	\$23,457
				Grade 2 and 3 Laminate	\$15,842	\$22,422	\$22,765	\$23,969
				Grade 1 Wood Veneer	\$24,901	\$31,481	\$31,824	\$33,028
				Grade 2 Wood Veneer	\$27,065	\$33,645	\$33,988	\$35,192
193" -204"	55" -60"	29"	COET2FCTV	Grade 1 Laminate	\$15,915	\$23,237	\$23,611	\$24,946
				Grade 2 and 3 Laminate	\$16,485	\$23,807	\$24,181	\$25,516
				Grade 1 Wood Veneer	\$26,802	\$34,124	\$34,498	\$35,833
				Grade 2 Wood Veneer	\$29,218	\$36,540	\$36,914	\$38,249
205" -216"	48"	29"	COET2FCTV	Grade 1 Laminate	\$14,911	\$20,930	\$21,270	\$22,422
				Grade 2 and 3 Laminate	\$15,394	\$21,413	\$21,753	\$22,905
				Grade 1 Wood Veneer	\$24,377	\$30,396	\$30,736	\$31,888
				Grade 2 Wood Veneer	\$26,391	\$32,410	\$32,750	\$33,902
205" -216"	49" -54"	29"	COET2FCTV	Grade 1 Laminate	\$15,532	\$22,315	\$22,678	\$23,978
				Grade 2 and 3 Laminate	\$16,075	\$22,858	\$23,221	\$24,521
				Grade 1 Wood Veneer	\$26,460	\$33,243	\$33,606	\$34,906
				Grade 2 Wood Veneer	\$28,754	\$35,537	\$35,900	\$37,200
205" -216"	55" - 60"	29"	COET2FCTV	Grade 1 Laminate	\$16,153	\$23,700	\$24,098	\$25,540
				Grade 2 and 3 Laminate	\$16,756	\$24,303	\$24,701	\$26,143
				Grade 1 Wood Veneer	\$28,544	\$36,091	\$36,489	\$37,931
				Grade 2 Wood Veneer	\$31,111	\$38,658	\$39,056	\$40,498

Tip: Tables are available parametrically in 1" increments.

► Product Information continued on next page

E-Table 2 Collaborative and Conference Tables

Faceted Veneer Base Tables

► Product Information continued from previous page

Specification Information

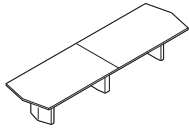

Dimensions		Style Number	Finish	Base Prices			
W	D			H	3 mm Plastic/ 3 mm Wood, Flat, or Convex Vinyl Edge:	Bullnose Wood Edge:	Beveled Wood Edge:

Faceted Tables with Three Veneer Bases - Working Height

217" -228"	48"	29"	COET2FCTV	Grade 1 Laminate	\$14,940	\$21,264	\$21,626	\$22,810
				Grade 2 and 3 Laminate	\$15,450	\$21,774	\$22,136	\$23,320
				Grade 1 Wood Veneer	\$25,079	\$31,403	\$31,765	\$32,949
				Grade 2 Wood Veneer	\$27,204	\$33,528	\$33,890	\$35,074
217" -228"	49" -54"	29"	COET2FCTV	Grade 1 Laminate	\$15,577	\$22,701	\$23,097	\$24,429
				Grade 2 and 3 Laminate	\$16,149	\$23,273	\$23,669	\$25,001
				Grade 1 Wood Veneer	\$27,263	\$34,387	\$34,783	\$36,115
				Grade 2 Wood Veneer	\$29,679	\$36,803	\$37,199	\$38,531
217" -228"	55" -60"	29"	COET2FCTV	Grade 1 Laminate	\$16,218	\$24,146	\$24,576	\$26,055
				Grade 2 and 3 Laminate	\$16,856	\$24,784	\$25,214	\$26,693
				Grade 1 Wood Veneer	\$29,454	\$37,382	\$37,812	\$39,291
				Grade 2 Wood Veneer	\$32,156	\$40,084	\$40,514	\$41,993
229" -240"	48"	29"	COET2FCTV	Grade 1 Laminate	\$14,968	\$21,595	\$21,981	\$23,195
				Grade 2 and 3 Laminate	\$15,504	\$22,131	\$22,517	\$23,731
				Grade 1 Wood Veneer	\$25,781	\$32,408	\$32,794	\$34,008
				Grade 2 Wood Veneer	\$28,017	\$34,644	\$35,030	\$36,244
229" -240"	49" -54"	29"	COET2FCTV	Grade 1 Laminate	\$15,622	\$23,086	\$23,517	\$24,879
				Grade 2 and 3 Laminate	\$16,223	\$23,687	\$24,118	\$25,480
				Grade 1 Wood Veneer	\$28,064	\$35,528	\$35,959	\$37,321
				Grade 2 Wood Veneer	\$30,603	\$38,067	\$38,498	\$39,860
229" -240"	55" -60"	29"	COET2FCTV	Grade 1 Laminate	\$16,281	\$24,587	\$25,049	\$26,568
				Grade 2 and 3 Laminate	\$16,954	\$25,260	\$25,722	\$27,241
				Grade 1 Wood Veneer	\$30,362	\$38,668	\$39,130	\$40,649
				Grade 2 Wood Veneer	\$33,200	\$41,506	\$41,968	\$43,487

Tip: Tables are available parametrically in 1" increments.

► Product Information continued on next page

E-Table 2 Collaborative and Conference Tables

Faceted Veneer Base Tables

► Product Information continued from previous page

Specification Information

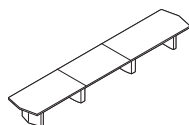

Dimensions		Style H	Style Number	Finish	Base Prices			
W	D				3 mm Plastic/ 3 mm Wood, Flat, or Convex Vinyl Edge:	Bullnose Wood Edge:	Beveled Wood Edge:	Knife Wood Edge:

Faceted Tables with Four Veneer Bases - Working Height

Tip: Top ships in three pieces. Hardware is included for field assembly.

241" -252"	48"	29"	COET2FCTV	Grade 1 Laminate	\$18,502	\$26,176	\$26,575	\$27,960
				Grade 2 and 3 Laminate	\$19,060	\$26,734	\$27,133	\$28,518
				Grade 1 Wood Veneer	\$31,237	\$38,911	\$39,310	\$40,695
				Grade 2 Wood Veneer	\$33,586	\$41,260	\$41,659	\$43,044

Tip: For tables with three or more bases, you must specify the entry point of the base power infeed, either an end base or a mid base location, in order to receive the correct length of base power infeed.

241" -252"	49" -54"	29"	COET2FCTV	Grade 1 Laminate	\$19,271	\$27,893	\$28,343	\$29,917
				Grade 2 and 3 Laminate	\$19,901	\$28,523	\$28,973	\$30,547
				Grade 1 Wood Veneer	\$33,872	\$42,494	\$42,944	\$44,518
				Grade 2 Wood Veneer	\$36,537	\$45,159	\$45,609	\$47,183

241" -252"	55" -60"	29"	COET2FCTV	Grade 1 Laminate	\$20,035	\$29,649	\$30,114	\$31,856
				Grade 2 and 3 Laminate	\$20,735	\$30,349	\$30,814	\$32,556
				Grade 1 Wood Veneer	\$36,511	\$46,125	\$46,590	\$48,332
				Grade 2 Wood Veneer	\$39,495	\$49,109	\$49,574	\$51,316

Tip: If you require your table top to be made into four pieces, this can be done as a special. Please contact Customer Service at 1.800.627.6770 to obtain a quote.

253" -264"	48"	29"	COET2FCTV	Grade 1 Laminate	\$19,867	\$28,586	\$28,998	\$30,554
				Grade 2 and 3 Laminate	\$20,451	\$29,170	\$29,582	\$31,138
				Grade 1 Wood Veneer	\$34,524	\$43,243	\$43,655	\$45,211
				Grade 2 Wood Veneer	\$36,988	\$45,707	\$46,119	\$47,675

253" -264"	49" -54"	29"	COET2FCTV	Grade 1 Laminate	\$20,740	\$30,521	\$30,993	\$32,773
				Grade 2 and 3 Laminate	\$21,394	\$31,175	\$31,647	\$33,427
				Grade 1 Wood Veneer	\$37,495	\$47,276	\$47,748	\$49,528
				Grade 2 Wood Veneer	\$40,289	\$50,070	\$50,542	\$52,322

► Product Information continued on next page





E-Table 2 Collaborative and Conference Tables

Faceted Veneer Base Tables

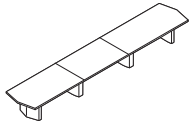
► Product Information continued from previous page

Specification Information



Dimensions		Style	Finish	Base Prices			
W	D	H	Number				

Faceted Tables with Four Veneer Bases - Working Height

253" -264"	55" -60"	29"	COET2FCTV	Grade 1 Laminate	\$21,596	\$32,519	\$32,983	\$34,951
				Grade 2 and 3 Laminate	\$22,323	\$33,246	\$33,710	\$35,678
				Grade 1 Wood Veneer	\$40,466	\$51,389	\$51,853	\$53,821
				Grade 2 Wood Veneer	\$43,594	\$54,517	\$54,981	\$56,949
265" -276"	48"	29"	COET2FCTV	Grade 1 Laminate	\$19,926	\$28,826	\$29,259	\$30,752
				Grade 2 and 3 Laminate	\$20,534	\$29,434	\$29,867	\$31,360
				Grade 1 Wood Veneer	\$34,680	\$43,580	\$44,013	\$45,506
				Grade 2 Wood Veneer	\$37,261	\$46,161	\$46,594	\$48,087
265" -276"	49" -54"	29"	COET2FCTV	Grade 1 Laminate	\$20,827	\$30,782	\$31,231	\$33,016
				Grade 2 and 3 Laminate	\$21,510	\$31,465	\$31,914	\$33,699
				Grade 1 Wood Veneer	\$37,660	\$47,615	\$48,064	\$49,849
				Grade 2 Wood Veneer	\$40,590	\$50,545	\$50,994	\$52,779
265" -276"	55" -60"	29"	COET2FCTV	Grade 1 Laminate	\$21,670	\$32,804	\$33,210	\$35,196
				Grade 2 and 3 Laminate	\$22,430	\$33,564	\$33,970	\$35,956
				Grade 1 Wood Veneer	\$40,648	\$51,782	\$52,188	\$54,174
				Grade 2 Wood Veneer	\$43,932	\$55,066	\$55,472	\$57,458
277" -288"	48"	29"	COET2FCTV	Grade 1 Laminate	\$19,984	\$29,063	\$29,522	\$30,945
				Grade 2 and 3 Laminate	\$20,616	\$29,695	\$30,154	\$31,577
				Grade 1 Wood Veneer	\$34,835	\$43,914	\$44,373	\$45,796
				Grade 2 Wood Veneer	\$37,532	\$46,611	\$47,070	\$48,493

Tip: Tables are available parametrically in 1" increments.

► Product Information continued on next page

E-Table 2 Collaborative and Conference Tables

Faceted Veneer Base Tables

► Product Information continued from previous page

Specification Information

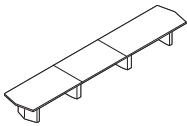

Dimensions		Style	Finish	Base Prices					
W	D	H	Number						
				3 mm Plastic/ 3 mm Wood, Flat, or Convex Vinyl Edge:	Bullnose Wood Edge:	Beveled Wood Edge:	Knife Wood Edge:		

Faceted Tables with Four Veneer Bases - Working Height

277" -288"	49" -54"	29"	COET2FCTV	Grade 1 Laminate	\$20,912	\$31,042	\$31,468	\$33,261
				Grade 2 and 3 Laminate	\$21,625	\$31,755	\$32,181	\$33,974
				Grade 1 Wood Veneer	\$37,822	\$47,952	\$48,378	\$50,171
				Grade 2 Wood Veneer	\$40,890	\$51,020	\$51,446	\$53,239
277" -288"	55" -60"	29"	COET2FCTV	Grade 1 Laminate	\$21,744	\$33,088	\$33,435	\$35,439
				Grade 2 and 3 Laminate	\$22,536	\$33,880	\$34,227	\$36,231
				Grade 1 Wood Veneer	\$40,829	\$52,173	\$52,520	\$54,524
				Grade 2 Wood Veneer	\$44,270	\$55,614	\$55,961	\$57,965

E-Table 2
Collaborative and
Conference Tables

E-Table 2 Collaborative and Conference Tables

Rectangular Aluminum Base Tables-Working Height

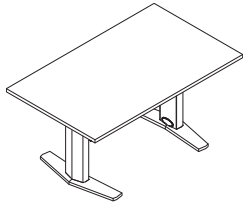

Tip: Shipped knocked down.

Tip: Utility bay quantity offering by table width is available in the understanding section.

Tip: 3 mm vinyl edge profiles on tables require a 4" radius on all corners.

Tip: A flat, plastic edge can be specified on veneer tops by selecting the "flat" edge option. Flat edge is only available in 6000 Black on veneer tops.

Tip: If you specify a wood edge on a top with woodgrain laminate, the edge and the top may not match.

Tip: Sectioned top option is a two piece top and is only available on tops 96"W-120"W.

Tip: When a wood edge is specified on a wood veneer top, the edge finish will match the top finish.

Tip: Each utility bay comes with two universal faceplate openings that accept customer-supplied faceplates in any of the following sizes: single-gang, double-gang, or triple-gang.

Standard Includes

- Top:
 - 1 1/4" particle board core with grade 1 laminate
 - parametric width in 1" increments ranging from 60"-288"
 - For tables with widths up to 144", parametric depth is in 1" increments ranging from 36"-60".
 - For tables with widths from 145"-288", parametric depth is in 1" increments ranging from 43"-60".
- Edge: 3 mm plastic edge, 3 mm wood edge, or convex vinyl edge
- Bases: cast and extruded aluminum with powder coat
- Wireway: painted steel side panels with powder coat and black plastic access door
- Concealed leveling glides: non-marring, black plastic
- Overall height: 29"

Options

Sectioned Top	No Sectioned Top	No cost
	With Sectioned Top	+\$569
Top Finish	Laminate Price Group 02	Price below
	Laminate Price Group 03	Price below
	Veneer Price Group 01	Price below
	Veneer Price Group 02	Price below
Edge Type	3mm Plastic Edge	Price below
	3mm Wood Edge	Price below
	Beveled Wood Edge	Price below
	Bullnose Wood Edge	Price below
	Convex Vinyl Edge	Price below
	Knife Wood Edge	Price below
Bay Option	No Bays	No cost
	One Bay	+\$789
	Two Bays	+\$1578
	Three Bays	+\$2367
	Four Bays	+\$3156
	Six Bays	+\$4734
	Seven Bays	+\$5523
Wiring Schematic	1+1 Hardwire, 2 Circuits	No cost
	3 + 0 Wireway	No cost
	Chicago Wireway	No cost
	1+1 Hardwire,2 Circuits,USB	+\$157
Infeed	3 + 0 Wireway,USB	+\$157
	Hardwire	No cost
	NYC Hardwire Infeed	No cost
Infeed Location	Plug	No cost
	End Base Power Infeed	No cost
	Mid Base Power Infeed	No cost

► **Product Information continued on next page**

E-Table 2 Collaborative and Conference Tables

Rectangular Aluminum Base Tables-Working Height

► Product Information continued from previous page

Specification Information

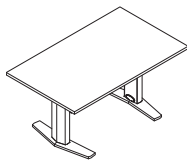

Dimensions		Style H Number	Finish	Base Prices				
W	D			3 mm Plastic/ 3 mm Wood, Flat, or Convex Vinyl Edge:	Bullnose Wood Edge:	Beveled Wood Edge:	Knife Wood Edge:	

Rectangular Tables with Two Aluminum Bases - Working Height

Tip: Top ships in one piece.

60" -71"	36"	29"	COET2RECA	Grade 1 Laminate	\$4303	\$5010	\$5094	\$5220
				Grade 2 and 3 Laminate	\$4432	\$5139	\$5223	\$5349
				Grade 1 Wood Veneer	\$5513	\$6220	\$6304	\$6430
				Grade 2 Wood Veneer	\$5952	\$6659	\$6743	\$6869

Tip: For 60"W-95"W tables, if you require your table top to be made into two pieces, this can be done as a special. Please contact Customer Service at 1.800.627.6770 to obtain a quote.

60" -71"	37" -42"	29"	COET2RECA	Grade 1 Laminate	\$4709	\$5826	\$5830	\$6050
				Grade 2 and 3 Laminate	\$4855	\$5972	\$5976	\$6196
				Grade 1 Wood Veneer	\$6596	\$7713	\$7717	\$7937
				Grade 2 Wood Veneer	\$7040	\$8157	\$8161	\$8381

60" -71"	43" -48"	29"	COET2RECA	Grade 1 Laminate	\$4827	\$5928	\$5931	\$6169
				Grade 2 and 3 Laminate	\$5003	\$6104	\$6107	\$6345
				Grade 1 Wood Veneer	\$6626	\$7727	\$7730	\$7968
				Grade 2 Wood Veneer	\$7128	\$8229	\$8232	\$8470

Tip: Tables are available parametrically in 1" increments.

60" -71"	49" -54"	29"	COET2RECA	Grade 1 Laminate	\$5322	\$6391	\$6314	\$6552
				Grade 2 and 3 Laminate	\$5502	\$6571	\$6494	\$6732
				Grade 1 Wood Veneer	\$7009	\$8078	\$8001	\$8239
				Grade 2 Wood Veneer	\$7531	\$8600	\$8523	\$8761

60" -71"	55" -60"	29"	COET2RECA	Grade 1 Laminate	\$5788	\$6888	\$6767	\$7010
				Grade 2 and 3 Laminate	\$5997	\$7097	\$6976	\$7219
				Grade 1 Wood Veneer	\$7525	\$8625	\$8504	\$8747
				Grade 2 Wood Veneer	\$8135	\$9235	\$9114	\$9357

72"	36"	29"	COET2RECA	Grade 1 Laminate	\$4384	\$5308	\$5410	\$5576
				Grade 2 and 3 Laminate	\$4517	\$5441	\$5543	\$5709
				Grade 1 Wood Veneer	\$5942	\$6866	\$6968	\$7134
				Grade 2 Wood Veneer	\$6434	\$7358	\$7460	\$7626

► Product Information continued on next page

E-Table 2 Collaborative and Conference Tables

E-Table 2 Collaborative and Conference Tables

Rectangular Aluminum Base Tables-Working Height

► Product Information continued from previous page

Specification Information

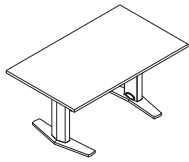

Dimensions		Style	Finish	Base Prices			
W	D	H	Number				
				3 mm Plastic/ 3 mm Wood, Flat, or Convex Vinyl Edge:	Bullnose Wood Edge:	Beveled Wood Edge:	Knife Wood Edge:

Rectangular Tables with Two Aluminum Bases - Working Height

W	D	H	Style Number	Finish	Grade 1 Price	Grade 2 and 3 Price	Grade 1 Veneer Price	Grade 2 Veneer Price
72"	37" -42"	29"	COET2RECA	Grade 1 Laminate	\$4752	\$5932	\$5971	\$6195
				Grade 2 and 3 Laminate	\$4898	\$6078	\$6117	\$6341
				Grade 1 Wood Veneer	\$6690	\$7870	\$7909	\$8133
				Grade 2 Wood Veneer	\$7208	\$8388	\$8427	\$8651
72"	43" -48"	29"	COET2RECA	Grade 1 Laminate	\$4870	\$6036	\$6077	\$6318
				Grade 2 and 3 Laminate	\$5047	\$6213	\$6254	\$6495
				Grade 1 Wood Veneer	\$6714	\$7880	\$7921	\$8162
				Grade 2 Wood Veneer	\$7282	\$8448	\$8489	\$8730
72"	49" -54"	29"	COET2RECA	Grade 1 Laminate	\$5381	\$6578	\$6575	\$6822
				Grade 2 and 3 Laminate	\$5584	\$6781	\$6778	\$7025
				Grade 1 Wood Veneer	\$7279	\$8476	\$8473	\$8720
				Grade 2 Wood Veneer	\$7934	\$9131	\$9128	\$9375
72"	55" -60"	29"	COET2RECA	Grade 1 Laminate	\$5847	\$7075	\$7027	\$7279
				Grade 2 and 3 Laminate	\$6079	\$7307	\$7259	\$7511
				Grade 1 Wood Veneer	\$7795	\$9023	\$8975	\$9227
				Grade 2 Wood Veneer	\$8539	\$9767	\$9719	\$9971
73" -84"	36"	29"	COET2RECA	Grade 1 Laminate	\$4625	\$5981	\$6125	\$6366
				Grade 2 and 3 Laminate	\$4771	\$6127	\$6271	\$6512
				Grade 1 Wood Veneer	\$6870	\$8226	\$8370	\$8611
				Grade 2 Wood Veneer	\$7478	\$8834	\$8978	\$9219

Tip: Tables are available parametrically in 1" increments.

► Product Information continued on next page

E-Table 2 Collaborative and Conference Tables

Rectangular Aluminum Base Tables-Working Height

► Product Information continued from previous page

Specification Information

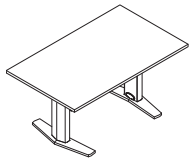

Dimensions		Style Number	Finish	Base Prices			
W	D			H			
				3 mm Plastic/ 3 mm Wood, Flat, or Convex Vinyl Edge:	Bullnose Wood Edge:	Beveled Wood Edge:	Knife Wood Edge:

Rectangular Tables with Two Aluminum Bases - Working Height

W	D	H	Style Number	Finish	Grade 1	Grade 2 and 3	Grade 1 Wood Veneer	Grade 2 Wood Veneer
73" -84"	37" -42"	29"	COET2RECA	Grade 1 Laminate	\$4816	\$6123	\$6231	\$6462
				Grade 2 and 3 Laminate	\$4993	\$6300	\$6408	\$6639
				Grade 1 Wood Veneer	\$6973	\$8280	\$8388	\$8619
				Grade 2 Wood Veneer	\$7631	\$8938	\$9046	\$9277
73" -84"	43" -48"	29"	COET2RECA	Grade 1 Laminate	\$4927	\$6221	\$6335	\$6584
				Grade 2 and 3 Laminate	\$5126	\$6420	\$6534	\$6783
				Grade 1 Wood Veneer	\$6984	\$8278	\$8392	\$8641
				Grade 2 Wood Veneer	\$7686	\$8980	\$9094	\$9343
73" -84"	49" -54"	29"	COET2RECA	Grade 1 Laminate	\$5439	\$6766	\$6834	\$7088
				Grade 2 and 3 Laminate	\$5667	\$6994	\$7062	\$7316
				Grade 1 Wood Veneer	\$7548	\$8875	\$8943	\$9197
				Grade 2 Wood Veneer	\$8341	\$9668	\$9736	\$9990
73" -84"	55" -60"	29"	COET2RECA	Grade 1 Laminate	\$5905	\$7262	\$7287	\$7548
				Grade 2 and 3 Laminate	\$6160	\$7517	\$7542	\$7803
				Grade 1 Wood Veneer	\$8065	\$9422	\$9447	\$9708
				Grade 2 Wood Veneer	\$8943	\$10,300	\$10,325	\$10,586
85" -96"	36"	29"	COET2RECA	Grade 1 Laminate	\$4918	\$6195	\$6348	\$6596
				Grade 2 and 3 Laminate	\$5089	\$6366	\$6519	\$6767
				Grade 1 Wood Veneer	\$7016	\$8293	\$8446	\$8694
				Grade 2 Wood Veneer	\$7717	\$8994	\$9147	\$9395

E-Table 2
Collaborative and
Conference Tables

Tip: Tables are available parametrically in 1" increments.

► Product Information continued on next page

E-Table 2 Collaborative and Conference Tables

Rectangular Aluminum Base Tables-Working Height

► Product Information continued from previous page

Specification Information

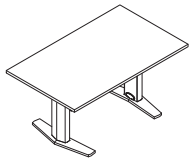

Dimensions		Style	Finish	Base Prices			
W	D	H	Number				
				3 mm Plastic/ 3 mm Wood, Flat, or Vinyl Edge:	Bullnose Wood Edge:	Beveled Wood Edge:	Knife Wood Edge:

Rectangular Tables with Two Aluminum Bases - Working Height

W	D	H	Style Number	Finish	Grade 1 Price	Grade 2 and 3 Price	Grade 1 Veneer Price	Grade 2 Veneer Price
85" -96"	37" -42"	29"	COET2RECA	Grade 1 Laminate	\$5378	\$6688	\$6795	\$7047
				Grade 2 and 3 Laminate	\$5576	\$6886	\$6993	\$7245
				Grade 1 Wood Veneer	\$7527	\$8837	\$8944	\$9196
				Grade 2 Wood Veneer	\$8317	\$9627	\$9734	\$9986
85" -96"	43" -48"	29"	COET2RECA	Grade 1 Laminate	\$5845	\$7175	\$7296	\$7552
				Grade 2 and 3 Laminate	\$6077	\$7407	\$7528	\$7784
				Grade 1 Wood Veneer	\$8048	\$9378	\$9499	\$9755
				Grade 2 Wood Veneer	\$8933	\$10,263	\$10,384	\$10,640
85" -96"	49" -54"	29"	COET2RECA	Grade 1 Laminate	\$6016	\$7517	\$7649	\$7937
				Grade 2 and 3 Laminate	\$6274	\$7775	\$7907	\$8195
				Grade 1 Wood Veneer	\$8490	\$9991	\$10,123	\$10,411
				Grade 2 Wood Veneer	\$9415	\$10,916	\$11,048	\$11,336
85" -96"	55" -60"	29"	COET2RECA	Grade 1 Laminate	\$6192	\$7856	\$8005	\$8323
				Grade 2 and 3 Laminate	\$6476	\$8140	\$8289	\$8607
				Grade 1 Wood Veneer	\$8943	\$10,607	\$10,756	\$11,074
				Grade 2 Wood Veneer	\$9908	\$11,572	\$11,721	\$12,039
97" -108"	36"	29"	COET2RECA	Grade 1 Laminate	\$5436	\$6735	\$6902	\$7149
				Grade 2 and 3 Laminate	\$5640	\$6939	\$7106	\$7353
				Grade 1 Wood Veneer	\$7586	\$8885	\$9052	\$9299
				Grade 2 Wood Veneer	\$8385	\$9684	\$9851	\$10,098

Tip: Tables are available parametrically in 1" increments.

► Product Information continued on next page

E-Table 2 Collaborative and Conference Tables

Rectangular Aluminum Base Tables-Working Height

► Product Information continued from previous page

Specification Information

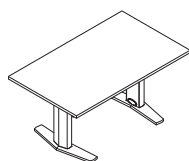

Dimensions		Style Number	Finish	Base Prices			
W	D			H			
				3 mm Plastic/ 3 mm Wood, Flat, or Convex Vinyl Edge:	Bullnose Wood Edge:	Beveled Wood Edge:	Knife Wood Edge:

Rectangular Tables with Two Aluminum Bases - Working Height

97" -108"	37" -42"	29"	COET2RECA	Grade 1 Laminate	\$5604	\$7084	\$7203	\$7485
				Grade 2 and 3 Laminate	\$5827	\$7307	\$7426	\$7708
				Grade 1 Wood Veneer	\$8023	\$9503	\$9622	\$9904
				Grade 2 Wood Veneer	\$8850	\$10,330	\$10,449	\$10,731
97" -108"	43" -48"	29"	COET2RECA	Grade 1 Laminate	\$6093	\$7980	\$8162	\$8512
				Grade 2 and 3 Laminate	\$6349	\$8236	\$8418	\$8768
				Grade 1 Wood Veneer	\$8327	\$10,214	\$10,396	\$10,746
				Grade 2 Wood Veneer	\$9327	\$11,214	\$11,396	\$11,746
97" -108"	49" -54"	29"	COET2RECA	Grade 1 Laminate	\$6322	\$8448	\$8650	\$9042
				Grade 2 and 3 Laminate	\$6611	\$8737	\$8939	\$9331
				Grade 1 Wood Veneer	\$8939	\$11,065	\$11,267	\$11,659
				Grade 2 Wood Veneer	\$10,029	\$12,155	\$12,357	\$12,749
97" -108"	55" -60"	29"	COET2RECA	Grade 1 Laminate	\$6403	\$8765	\$8991	\$9424
				Grade 2 and 3 Laminate	\$6871	\$9233	\$9459	\$9892
				Grade 1 Wood Veneer	\$9552	\$11,914	\$12,140	\$12,573
				Grade 2 Wood Veneer	\$10,735	\$13,097	\$13,323	\$13,756
109" -120"	36"	29"	COET2RECA	Grade 1 Laminate	\$5562	\$7359	\$7520	\$7856
				Grade 2 and 3 Laminate	\$5781	\$7578	\$7739	\$8075
				Grade 1 Wood Veneer	\$7642	\$9439	\$9600	\$9936
				Grade 2 Wood Veneer	\$8489	\$10,286	\$10,447	\$10,783

► Product Information continued on next page

E-Table 2 Collaborative and Conference Tables

Rectangular Aluminum Base Tables-Working Height

► Product Information continued from previous page

Specification Information

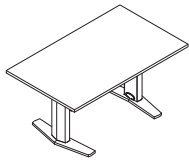

Dimensions		Style	Finish	Base Prices			
W	D	H	Number	Vinyl Edge:			
				3 mm Plastic/ 3 mm Wood, Flat, or Convex	Bullnose Wood Edge:	Beveled Wood Edge:	Knife Wood Edge:

Rectangular Tables with Two Aluminum Bases - Working Height

109" -120"	37" -42"	29"	COET2RECA	Grade 1 Laminate	\$6053	\$8257	\$8482	\$8884
				Grade 2 and 3 Laminate	\$6302	\$8506	\$8731	\$9133
				Grade 1 Wood Veneer	\$7945	\$10,149	\$10,374	\$10,776
				Grade 2 Wood Veneer	\$8966	\$11,170	\$11,395	\$11,797
109" -120"	43" -48"	29"	COET2RECA	Grade 1 Laminate	\$6223	\$8666	\$8911	\$9353
				Grade 2 and 3 Laminate	\$6504	\$8947	\$9192	\$9634
				Grade 1 Wood Veneer	\$8493	\$10,936	\$11,181	\$11,623
				Grade 2 Wood Veneer	\$9607	\$12,050	\$12,295	\$12,737
109" -120"	49" -54"	29"	COET2RECA	Grade 1 Laminate	\$6508	\$9258	\$9533	\$10,025
				Grade 2 and 3 Laminate	\$6827	\$9577	\$9852	\$10,344
				Grade 1 Wood Veneer	\$9265	\$12,015	\$12,290	\$12,782
				Grade 2 Wood Veneer	\$10,525	\$13,275	\$13,550	\$14,042
109" -120"	55" -60"	29"	COET2RECA	Grade 1 Laminate	\$6788	\$9850	\$10,150	\$10,697
				Grade 2 and 3 Laminate	\$7143	\$10,205	\$10,505	\$11,052
				Grade 1 Wood Veneer	\$10,030	\$13,092	\$13,392	\$13,939
				Grade 2 Wood Veneer	\$11,436	\$14,498	\$14,798	\$15,345

Tip: Tables are available parametrically in 1" increments.

► Product Information continued on next page

E-Table 2 Collaborative and Conference Tables

Rectangular Aluminum Base Tables-Working Height

► Product Information continued from previous page

Specification Information

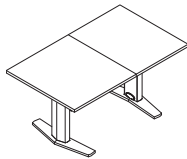

Dimensions		Style H Number	Finish	Base Prices				
W	D			3 mm Plastic/ 3 mm Wood, Flat, or Convex Vinyl Edge:	Bullnose Wood Edge:	Beveled Wood Edge:	Knife Wood Edge:	

Rectangular Tables with Two Aluminum Bases - Working Height

Tip: Top ships in two pieces. Hardware is included for field assembly.

121" -132"	36"	29"	COET2RECA	Grade 1 Laminate	\$5658	\$8081	\$8334	\$8757
				Grade 2 and 3 Laminate	\$5914	\$8337	\$8590	\$9013
				Grade 1 Wood Veneer	\$8362	\$10,785	\$11,038	\$11,461
				Grade 2 Wood Veneer	\$9388	\$11,811	\$12,064	\$12,487

Tip: If you require your table top to be made into three pieces, this can be done as a special. Please contact Customer Service at 1.800.627.6770 to obtain a quote.

121" -132"	37" -42"	29"	COET2RECA	Grade 1 Laminate	\$5824	\$8428	\$8636	\$9091
				Grade 2 and 3 Laminate	\$6101	\$8705	\$8913	\$9368
				Grade 1 Wood Veneer	\$8801	\$11,405	\$11,613	\$12,068
				Grade 2 Wood Veneer	\$9853	\$12,457	\$12,665	\$13,120

121" -132"	43" -48"	29"	COET2RECA	Grade 1 Laminate	\$6252	\$9263	\$9535	\$10,054
				Grade 2 and 3 Laminate	\$6563	\$9574	\$9846	\$10,365
				Grade 1 Wood Veneer	\$9046	\$12,057	\$12,329	\$12,848
				Grade 2 Wood Veneer	\$10,271	\$13,282	\$13,554	\$14,073

Tip: Tables are available parametrically in 1" increments.

121" -132"	49" -54"	29"	COET2RECA	Grade 1 Laminate	\$6555	\$9943	\$10,242	\$10,832
				Grade 2 and 3 Laminate	\$6907	\$10,295	\$10,594	\$11,184
				Grade 1 Wood Veneer	\$9945	\$13,333	\$13,632	\$14,222
				Grade 2 Wood Veneer	\$11,329	\$14,717	\$15,016	\$15,606

121" -132"	55" -60"	29"	COET2RECA	Grade 1 Laminate	\$6856	\$10,623	\$10,954	\$11,609
				Grade 2 and 3 Laminate	\$7247	\$11,014	\$11,345	\$12,000
				Grade 1 Wood Veneer	\$10,840	\$14,607	\$14,938	\$15,593
				Grade 2 Wood Veneer	\$12,386	\$16,153	\$16,484	\$17,139

133" -144"	36"	29"	COET2RECA	Grade 1 Laminate	\$5687	\$8678	\$8957	\$9457
				Grade 2 and 3 Laminate	\$5971	\$8962	\$9241	\$9741
				Grade 1 Wood Veneer	\$8913	\$11,904	\$12,183	\$12,683
				Grade 2 Wood Veneer	\$10,049	\$13,040	\$13,319	\$13,819

► Product Information continued on next page

E-Table 2 Collaborative and Conference Tables

Rectangular Aluminum Base Tables-Working Height

► Product Information continued from previous page

Specification Information

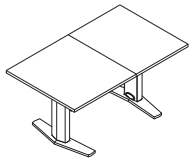

Dimensions		Style Number	Finish	Base Prices			
W	D			H			

Rectangular Tables with Two Aluminum Bases - Working Height

Dimensions (W x D x H)	Style Number	Finish	3 mm Plastic/ 3 mm Wood, Flat, or Convex Vinyl Edge:	Bullnose Wood Edge:	Beveled Wood Edge:	Knife Wood Edge:
133" -144" x 37" -42" x 29"	COET2RECA	Grade 1 Laminate	\$5851	\$9024	\$9257	\$9789
		Grade 2 and 3 Laminate	\$6159	\$9332	\$9565	\$10,097
		Grade 1 Wood Veneer	\$9350	\$12,523	\$12,756	\$13,288
		Grade 2 Wood Veneer	\$10,516	\$13,689	\$13,922	\$14,454
133" -144" x 43" -48" x 29"	COET2RECA	Grade 1 Laminate	\$6280	\$9857	\$10,157	\$10,754
		Grade 2 and 3 Laminate	\$6619	\$10,196	\$10,496	\$11,093
		Grade 1 Wood Veneer	\$9596	\$13,173	\$13,473	\$14,070
		Grade 2 Wood Veneer	\$10,932	\$14,509	\$14,809	\$15,406
133" -144" x 49" -54" x 29"	COET2RECA	Grade 1 Laminate	\$6601	\$10,626	\$10,952	\$11,637
		Grade 2 and 3 Laminate	\$6987	\$11,012	\$11,338	\$12,023
		Grade 1 Wood Veneer	\$10,624	\$14,649	\$14,975	\$15,660
		Grade 2 Wood Veneer	\$12,133	\$16,158	\$16,484	\$17,169
133" -144" x 55" -60" x 29"	COET2RECA	Grade 1 Laminate	\$6922	\$11,393	\$11,757	\$12,516
		Grade 2 and 3 Laminate	\$7350	\$11,821	\$12,185	\$12,944
		Grade 1 Wood Veneer	\$11,648	\$16,119	\$16,483	\$17,242
		Grade 2 Wood Veneer	\$13,334	\$17,805	\$18,169	\$18,928
145" -156" x 43" -48" x 29"	COET2RECA	Grade 1 Laminate	\$7720	\$12,230	\$12,518	\$13,295
		Grade 2 and 3 Laminate	\$8079	\$12,589	\$12,877	\$13,654
		Grade 1 Wood Veneer	\$12,839	\$17,349	\$17,637	\$18,414
		Grade 2 Wood Veneer	\$14,292	\$18,802	\$19,090	\$19,867

Tip: Tables are available parametrically in 1" increments.

Tip: Table widths starting at 145" will only have a parametric depth range of 43"-60".

► Product Information continued on next page

E-Table 2 Collaborative and Conference Tables

Rectangular Aluminum Base Tables-Working Height

► Product Information continued from previous page

Specification Information

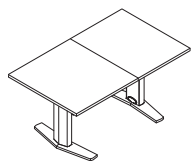

Dimensions		Style H	Style Number	Finish	Base Prices				
W	D				3 mm Plastic/ 3 mm Wood, Flat, or Convex Vinyl Edge:	Bullnose Wood Edge:	Beveled Wood Edge:	Knife Wood Edge:	

Rectangular Tables with Two Aluminum Bases - Working Height

145" -156"	49" -54"	29"	COET2RECA	Grade 1 Laminate	\$8139	\$13,212	\$13,535	\$14,411
				Grade 2 and 3 Laminate	\$8545	\$13,618	\$13,941	\$14,817
				Grade 1 Wood Veneer	\$14,185	\$19,258	\$19,581	\$20,457
				Grade 2 Wood Veneer	\$15,831	\$20,904	\$21,227	\$22,103
145" -156"	55" -60"	29"	COET2RECA	Grade 1 Laminate	\$8559	\$14,198	\$14,552	\$15,527
				Grade 2 and 3 Laminate	\$9007	\$14,646	\$15,000	\$15,975
				Grade 1 Wood Veneer	\$15,527	\$21,166	\$21,520	\$22,495
				Grade 2 Wood Veneer	\$17,368	\$23,007	\$23,361	\$24,336

► Product Information continued on next page

E-Table 2
Collaborative and
Conference Tables

E-Table 2 Collaborative and Conference Tables

Rectangular Aluminum Base Tables-Working Height

► Product Information continued from previous page

Specification Information

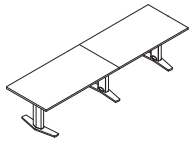

Dimensions		Style	Finish	Base Prices			
W	D	H	Number				
				3 mm Plastic/ 3 mm Wood, Flat, or Convex Vinyl Edge:	Bullnose Wood Edge:	Beveled Wood Edge:	Knife Wood Edge:

Rectangular Tables with Three Aluminum Bases - Working Height

Tip: Top ships in two pieces. Hardware is included for field assembly.

157" -168"	43" -48"	29"	COET2RECA	Grade 1 Laminate	\$9369	\$14,812	\$15,088	\$16,042
				Grade 2 and 3 Laminate	\$9746	\$15,189	\$15,465	\$16,419
				Grade 1 Wood Veneer	\$16,293	\$21,736	\$22,012	\$22,966
				Grade 2 Wood Veneer	\$17,859	\$23,302	\$23,578	\$24,532

Tip: For tables with three or more bases, you must specify the entry point of the base power infeed, either an end base or a mid base location, in order to receive the correct length of base power infeed

157" -168"	49" -54"	29"	COET2RECA	Grade 1 Laminate	\$9876	\$15,995	\$16,316	\$17,384
				Grade 2 and 3 Laminate	\$10,302	\$16,421	\$16,742	\$17,810
				Grade 1 Wood Veneer	\$17,943	\$24,062	\$24,383	\$25,451
				Grade 2 Wood Veneer	\$19,726	\$25,845	\$26,166	\$27,234

157" -168"	55" -60"	29"	COET2RECA	Grade 1 Laminate	\$10,385	\$17,190	\$17,536	\$18,725
				Grade 2 and 3 Laminate	\$10,854	\$17,659	\$18,005	\$19,194
				Grade 1 Wood Veneer	\$19,597	\$26,402	\$26,748	\$27,937
				Grade 2 Wood Veneer	\$21,590	\$28,395	\$28,741	\$29,930

Tip: If you require your table top to be made into three pieces, this can be done as a special. Please contact Customer Service at 1.800.627.6770 to obtain a quote.

169" -180"	43" -48"	29"	COET2RECA	Grade 1 Laminate	\$9420	\$14,978	\$15,258	\$16,229
				Grade 2 and 3 Laminate	\$9824	\$15,382	\$15,662	\$16,633
				Grade 1 Wood Veneer	\$16,407	\$21,965	\$22,245	\$23,216
				Grade 2 Wood Veneer	\$18,084	\$23,642	\$23,922	\$24,893

169" -180"	49" -54"	29"	COET2RECA	Grade 1 Laminate	\$9952	\$16,203	\$16,521	\$17,609
				Grade 2 and 3 Laminate	\$10,406	\$16,657	\$16,975	\$18,063
				Grade 1 Wood Veneer	\$18,093	\$24,344	\$24,662	\$25,750
				Grade 2 Wood Veneer	\$20,000	\$26,251	\$26,569	\$27,657

► Product Information continued on next page

E-Table 2 Collaborative and Conference Tables

Rectangular Aluminum Base Tables-Working Height

► Product Information continued from previous page

Specification Information

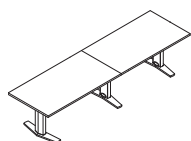

Dimensions		Style Number	Finish	Base Prices				
W	D			H	Edge:			
				3 mm Plastic/ 3 mm Wood, Flat, or Convex Vinyl Edge:	Bullnose Wood Edge:	Beveled Wood Edge:	Knife Wood Edge:	

Rectangular Tables with Three Aluminum Bases - Working Height

169" -180"	55" -60"	29"	COET2RECA	Grade 1 Laminate	\$10,479	\$17,429	\$17,779	\$18,985
				Grade 2 and 3 Laminate	\$10,982	\$17,932	\$18,282	\$19,488
				Grade 1 Wood Veneer	\$19,777	\$26,727	\$27,077	\$28,283
				Grade 2 Wood Veneer	\$21,906	\$28,856	\$29,206	\$30,412
181" -192"	43" -48"	29"	COET2RECA	Grade 1 Laminate	\$9470	\$15,143	\$15,428	\$16,415
				Grade 2 and 3 Laminate	\$9902	\$15,575	\$15,860	\$16,847
				Grade 1 Wood Veneer	\$16,520	\$22,193	\$22,478	\$23,465
				Grade 2 Wood Veneer	\$18,310	\$23,983	\$24,268	\$25,255
181" -192"	49" -54"	29"	COET2RECA	Grade 1 Laminate	\$10,027	\$16,407	\$16,724	\$17,834
				Grade 2 and 3 Laminate	\$10,510	\$16,890	\$17,207	\$18,317
				Grade 1 Wood Veneer	\$18,242	\$24,622	\$24,939	\$26,049
				Grade 2 Wood Veneer	\$20,275	\$26,655	\$26,972	\$28,082
181" -192"	55" -60"	29"	COET2RECA	Grade 1 Laminate	\$10,573	\$17,666	\$18,020	\$19,245
				Grade 2 and 3 Laminate	\$11,110	\$18,203	\$18,557	\$19,782
				Grade 1 Wood Veneer	\$19,957	\$27,050	\$27,404	\$28,629
				Grade 2 Wood Veneer	\$22,222	\$29,315	\$29,669	\$30,894
193" -204"	43" -48"	29"	COET2RECA	Grade 1 Laminate	\$9639	\$15,487	\$15,798	\$16,867
				Grade 2 and 3 Laminate	\$10,096	\$15,944	\$16,255	\$17,324
				Grade 1 Wood Veneer	\$17,897	\$23,745	\$24,056	\$25,125
				Grade 2 Wood Veneer	\$19,799	\$25,647	\$25,958	\$27,027

Tip: Tables are available parametrically in 1" increments.

E-Table 2
Collaborative and
Conference Tables

► Product Information continued on next page

E-Table 2 Collaborative and Conference Tables

Rectangular Aluminum Base Tables-Working Height

► Product Information continued from previous page

Specification Information

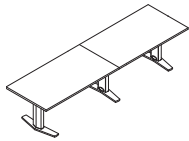

Dimensions		Style Number	Finish	Base Prices			
W	D			H			

Rectangular Tables with Three Aluminum Bases - Working Height

W	D	H	Style Number	Finish	3 mm Plastic/ 3 mm Wood, Flat, or Convex Vinyl Edge:	Bullnose Wood Edge:	Beveled Wood Edge:	Knife Wood Edge:
193" -204"	49" -54"	29"	COET2RECA	Grade 1 Laminate	\$10,229	\$16,809	\$17,152	\$18,356
				Grade 2 and 3 Laminate	\$10,741	\$17,321	\$17,664	\$18,868
				Grade 1 Wood Veneer	\$19,800	\$26,380	\$26,723	\$27,927
				Grade 2 Wood Veneer	\$21,963	\$28,543	\$28,886	\$30,090
193" -204"	55" -60"	29"	COET2RECA	Grade 1 Laminate	\$10,815	\$18,137	\$18,511	\$19,846
				Grade 2 and 3 Laminate	\$11,385	\$18,707	\$19,081	\$20,416
				Grade 1 Wood Veneer	\$21,702	\$29,024	\$29,398	\$30,733
				Grade 2 Wood Veneer	\$24,118	\$31,440	\$31,814	\$33,149
205" -216"	43" -48"	29"	COET2RECA	Grade 1 Laminate	\$9807	\$15,826	\$16,166	\$17,318
				Grade 2 and 3 Laminate	\$10,290	\$16,309	\$16,649	\$17,801
				Grade 1 Wood Veneer	\$19,273	\$25,292	\$25,632	\$26,784
				Grade 2 Wood Veneer	\$21,287	\$27,306	\$27,646	\$28,798
205" -216"	49" -54"	29"	COET2RECA	Grade 1 Laminate	\$10,429	\$17,212	\$17,575	\$18,875
				Grade 2 and 3 Laminate	\$10,972	\$17,755	\$18,118	\$19,418
				Grade 1 Wood Veneer	\$21,357	\$28,140	\$28,503	\$29,803
				Grade 2 Wood Veneer	\$23,651	\$30,434	\$30,797	\$32,097
205" -216"	55" -60"	29"	COET2RECA	Grade 1 Laminate	\$11,056	\$18,603	\$19,001	\$20,443
				Grade 2 and 3 Laminate	\$11,659	\$19,206	\$19,604	\$21,046
				Grade 1 Wood Veneer	\$23,447	\$30,994	\$31,392	\$32,834
				Grade 2 Wood Veneer	\$26,014	\$33,561	\$33,959	\$35,401

Tip: Tables are available parametrically in 1" increments.

► Product Information continued on next page

E-Table 2 Collaborative and Conference Tables

Rectangular Aluminum Base Tables-Working Height

► Product Information continued from previous page

Specification Information

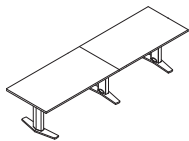

Dimensions		Style Number	Finish	Base Prices			
W	D			H	Edge Profiles		
				3 mm Plastic/ 3 mm Wood, Flat, or Convex Vinyl Edge:	Bullnose Wood Edge:	Beveled Wood Edge:	Knife Wood Edge:

Rectangular Tables with Three Aluminum Bases - Working Height

Dimensions	Style Number	Finish	Grade 1 Price	Grade 2 and 3 Price	Grade 1 Veneer Price	Grade 2 Veneer Price
217" -228" 43" -48" 29"	COET2RECA	Grade 1 Laminate	\$9835	\$16,159	\$16,521	\$17,705
		Grade 2 and 3 Laminate	\$10,345	\$16,669	\$17,031	\$18,215
		Grade 1 Wood Veneer	\$19,974	\$26,298	\$26,660	\$27,844
		Grade 2 Wood Veneer	\$22,100	\$28,424	\$28,786	\$29,970
217" -228" 49" -54" 29"	COET2RECA	Grade 1 Laminate	\$10,475	\$17,599	\$17,995	\$19,327
		Grade 2 and 3 Laminate	\$11,047	\$18,171	\$18,567	\$19,899
		Grade 1 Wood Veneer	\$22,161	\$29,285	\$29,681	\$31,013
		Grade 2 Wood Veneer	\$24,576	\$31,700	\$32,096	\$33,428
217" -228" 55" -60" 29"	COET2RECA	Grade 1 Laminate	\$11,120	\$19,048	\$19,478	\$20,957
		Grade 2 and 3 Laminate	\$11,758	\$19,686	\$20,116	\$21,595
		Grade 1 Wood Veneer	\$24,356	\$32,284	\$32,714	\$34,193
		Grade 2 Wood Veneer	\$27,058	\$34,986	\$35,416	\$36,895
229" -240" 43" -48" 29"	COET2RECA	Grade 1 Laminate	\$9864	\$16,491	\$16,877	\$18,091
		Grade 2 and 3 Laminate	\$10,400	\$17,027	\$17,413	\$18,627
		Grade 1 Wood Veneer	\$20,677	\$27,304	\$27,690	\$28,904
		Grade 2 Wood Veneer	\$22,913	\$29,540	\$29,926	\$31,140
229" -240" 49" -54" 29"	COET2RECA	Grade 1 Laminate	\$10,521	\$17,985	\$18,416	\$19,778
		Grade 2 and 3 Laminate	\$11,122	\$18,586	\$19,017	\$20,379
		Grade 1 Wood Veneer	\$22,963	\$30,427	\$30,858	\$32,220
		Grade 2 Wood Veneer	\$25,502	\$32,966	\$33,397	\$34,759
229" 240" 55" -60" 29"	COET2RECA	Grade 1 Laminate	\$11,184	\$19,490	\$19,952	\$21,471
		Grade 2 and 3 Laminate	\$11,857	\$20,163	\$20,625	\$22,144
		Grade 1 Wood Veneer	\$25,265	\$33,571	\$34,033	\$35,552
		Grade 2 Wood Veneer	\$28,103	\$36,409	\$36,871	\$38,390

Tip: Tables are available parametrically in 1" increments.

► Product Information continued on next page

E-Table 2 Collaborative and Conference Tables

E-Table 2 Collaborative and Conference Tables

Rectangular Aluminum Base Tables-Working Height

► Product Information continued from previous page

Specification Information

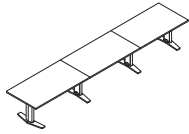

Dimensions		Style	Finish	Base Prices			
W	D	H	Number				
				3 mm Plastic/ 3 mm Wood, Flat, or Convex Vinyl Edge:	Bullnose Wood Edge:	Beveled Wood Edge:	Knife Wood Edge:

Rectangular Tables with Four Aluminum Bases - Working Height

Tip: Top ships in three pieces. Hardware is included for field assembly.

241" -252"	43" -48"	29"	COET2RECA	Grade 1 Laminate	\$11,861	\$19,535	\$19,934	\$21,319
				Grade 2 and 3 Laminate	\$12,422	\$20,096	\$20,495	\$21,880
				Grade 1 Wood Veneer	\$24,597	\$32,271	\$32,670	\$34,055
				Grade 2 Wood Veneer	\$26,946	\$34,620	\$35,019	\$36,404

Tip: For table with three or more bases, you must specify the entry point of the base power infeed, either an end base or mid base location, in order to receive the correct length of base power infeed.

241" -252"	49" -54"	29"	COET2RECA	Grade 1 Laminate	\$12,635	\$21,257	\$21,707	\$23,281
				Grade 2 and 3 Laminate	\$13,264	\$21,886	\$22,336	\$23,910
				Grade 1 Wood Veneer	\$27,235	\$35,857	\$36,307	\$37,881
				Grade 2 Wood Veneer	\$29,902	\$38,524	\$38,974	\$40,548

241" -252"	55" -60"	29"	COET2RECA	Grade 1 Laminate	\$13,400	\$23,014	\$23,479	\$25,221
				Grade 2 and 3 Laminate	\$14,100	\$23,714	\$24,179	\$25,921
				Grade 1 Wood Veneer	\$29,876	\$39,490	\$39,955	\$41,697
				Grade 2 Wood Veneer	\$32,859	\$42,473	\$42,938	\$44,680

Tip: If you require your table top to be made into four pieces, this can be done as a special. Please contact Customer Service at 1.800.627.6770 to obtain a quote.

253" -264"	43" -48"	29"	COET2RECA	Grade 1 Laminate	\$13,291	\$22,010	\$22,422	\$23,978
				Grade 2 and 3 Laminate	\$13,875	\$22,594	\$23,006	\$24,562
				Grade 1 Wood Veneer	\$27,948	\$36,667	\$37,079	\$38,635
				Grade 2 Wood Veneer	\$30,412	\$39,131	\$39,543	\$41,099

253" -264"	49" -54"	29"	COET2RECA	Grade 1 Laminate	\$14,166	\$23,947	\$24,419	\$26,199
				Grade 2 and 3 Laminate	\$14,820	\$24,601	\$25,073	\$26,853
				Grade 1 Wood Veneer	\$30,921	\$40,702	\$41,174	\$42,954
				Grade 2 Wood Veneer	\$33,715	\$43,496	\$43,968	\$45,748

► Product Information continued on next page

E-Table 2 Collaborative and Conference Tables

Rectangular Aluminum Base Tables-Working Height

► Product Information continued from previous page

Specification Information

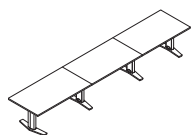

Dimensions		Style Number	Finish	Base Prices				
W	D			H	Edge:			
				3 mm Plastic/ 3 mm Wood, Flat, or Convex Vinyl Edge:	Bullnose Wood Edge:	Beveled Wood Edge:	Knife Wood Edge:	

Rectangular Tables with Four Aluminum Bases - Working Height

253" -264"	55" -60"	29"	COET2RECA	Grade 1 Laminate	\$15,022	\$25,945	\$26,409	\$28,377
				Grade 2 and 3 Laminate	\$15,749	\$26,672	\$27,136	\$29,104
				Grade 1 Wood Veneer	\$33,892	\$44,815	\$45,279	\$47,247
				Grade 2 Wood Veneer	\$37,020	\$47,943	\$48,407	\$50,375
265" -276"	43" -48"	29"	COET2RECA	Grade 1 Laminate	\$13,352	\$22,252	\$22,685	\$24,178
				Grade 2 and 3 Laminate	\$13,961	\$22,861	\$23,294	\$24,787
				Grade 1 Wood Veneer	\$28,107	\$37,007	\$37,440	\$38,933
				Grade 2 Wood Veneer	\$30,687	\$39,587	\$40,020	\$41,513
265" -276"	49" -54"	29"	COET2RECA	Grade 1 Laminate	\$14,254	\$24,209	\$24,658	\$26,443
				Grade 2 and 3 Laminate	\$14,937	\$24,892	\$25,341	\$27,126
				Grade 1 Wood Veneer	\$31,087	\$41,042	\$41,491	\$43,276
				Grade 2 Wood Veneer	\$34,017	\$43,972	\$44,421	\$46,206
265" -276"	55" -60"	29"	COET2RECA	Grade 1 Laminate	\$15,099	\$26,233	\$26,639	\$28,625
				Grade 2 and 3 Laminate	\$15,858	\$26,992	\$27,398	\$29,384
				Grade 1 Wood Veneer	\$34,077	\$45,211	\$45,617	\$47,603
				Grade 2 Wood Veneer	\$37,361	\$48,495	\$48,901	\$50,887
277" -288"	43" -48"	29"	COET2RECA	Grade 1 Laminate	\$13,412	\$22,491	\$22,950	\$24,373
				Grade 2 and 3 Laminate	\$14,044	\$23,123	\$23,582	\$25,005
				Grade 1 Wood Veneer	\$28,263	\$37,342	\$37,801	\$39,224
				Grade 2 Wood Veneer	\$30,960	\$40,039	\$40,498	\$41,921

Tip: Tables are available parametrically in 1" increments.

E-Table 2
Collaborative and
Conference Tables

► Product Information continued on next page

E-Table 2 Collaborative and Conference Tables

Rectangular Aluminum Base Tables-Working Height

► Product Information continued from previous page

Specification Information

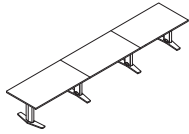

Dimensions		Style	Finish	Base Prices			
W	D	H	Number				
				3 mm Plastic/ 3 mm Wood, Flat, or Convex Vinyl Edge:	Bullnose Wood Edge:	Beveled Wood Edge:	Knife Wood Edge:

Rectangular Tables with Four Aluminum Bases - Working Height

277" -288"	49" -54"	29"	COET2RECA	Grade 1 Laminate	\$14,340	\$24,470	\$24,896	\$26,689
				Grade 2 and 3 Laminate	\$15,053	\$25,183	\$25,609	\$27,402
				Grade 1 Wood Veneer	\$31,250	\$41,380	\$41,806	\$43,599
				Grade 2 Wood Veneer	\$34,318	\$44,448	\$44,874	\$46,667
277" -288"	55" -60"	29"	COET2RECA	Grade 1 Laminate	\$15,175	\$26,519	\$26,866	\$28,870
				Grade 2 and 3 Laminate	\$15,967	\$27,311	\$27,658	\$29,662
				Grade 1 Wood Veneer	\$34,260	\$45,604	\$45,951	\$47,955
				Grade 2 Wood Veneer	\$37,701	\$49,045	\$49,392	\$51,396

E-Table 2 Collaborative and Conference Tables

Rectangular Aluminum Base Tables-Working Height

**E-Table 2
Collaborative and
Conference Tables**

E-Table 2 Collaborative and Conference Tables

Rectangular Aluminum Base Tables-Standing Height

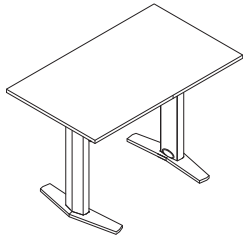

Tip: Shipped knocked down.

Tip: Utility bay quantity offering by table width is available in the understanding section.

Tip: 3 mm vinyl edge profiles on tables require a 4" radius on all corners.

Tip: A flat, plastic edge can be specified on veneer tops by selecting the "flat" edge option. Flat edge is only available in 6000 Black on veneer tops.

Tip: If you specify a wood edge on a top with woodgrain laminate, the edge and the top may not match.

Tip: Sectioned top option is a two piece top and is only available on tops 96"W-120"W.

Tip: When a wood edge is specified on a wood veneer top, the edge finish will match the top finish.

Tip: Each utility bay comes with two universal faceplate openings that accept customer-supplied faceplates in any of the following sizes: single-gang, double-gang, or triple-gang.

Standard Includes

- Top:
 - 1 1/4" particle board core with grade 1 laminate
 - parametric width in 1" increments ranging from 60"-120"
 - parametric depth in 1" increments ranging from 36"-60"
- Edge: 3 mm plastic edge, 3 mm wood edge, or convex vinyl edge
- Bases: cast and extruded aluminum with powder coat
- Wireway: painted steel side panels with powder coat and black plastic access door
- Concealed leveling glides: non-marring, black plastic
- Overall height: 40"

Options

Sectioned Top	No Sectioned Top With Sectioned Top	No cost +\$569
Top Finish	Laminate Price Group 02 Laminate Price Group 03 Veneer Price Group 01 Veneer Price Group 02	Price below Price below Price below Price below
Edge Type	3mm Plastic Edge 3mm Wood Edge Beveled Wood Edge Bullnose Wood Edge Convex Vinyl Edge Knife Wood Edge	Price below Price below Price below Price below Price below Price below
Bay Option	No Bays One Bay Two Bays Three Bays	No cost +\$789 +\$1578 +\$2367
Wiring Schematic	1+1 Hardwire, 2 Circuits 3 + 0 Wireway Chicago Wireway 1+1 Hardwire,2 Circuits,USB 3 + 0 Wireway,USB	No cost No cost No cost +\$157 +\$157
Infeed	Hardwire NYC Hardwire Infeed Plug	No cost No cost No cost

► Product Information continued on next page

E-Table 2 Collaborative and Conference Tables

Rectangular Aluminum Base Tables-Standing Height

► Product Information continued from previous page

Specification Information

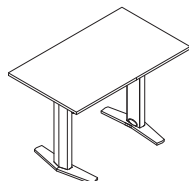

Dimensions		Style H Number	Finish	Base Prices			
W	D			3 mm Plastic/ 3 mm Wood, Flat, or Convex Vinyl Edge:	Bullnose Wood Edge:	Beveled Wood Edge:	Knife Wood Edge:

Rectangular Tables with Two Aluminum Bases - Standing Height

Tip: Top ships in one piece.

60" -71"	36"	40"	COET2RECSTA	Grade 1 Laminate	\$4791	\$5498	\$5582	\$5708
				Grade 2 and 3 Laminate	\$4916	\$5623	\$5707	\$5833
				Grade 1 Wood Veneer	\$6003	\$6710	\$6794	\$6920
				Grade 2 Wood Veneer	\$6441	\$7148	\$7232	\$7358

Tip: For 60"W - 95"W tables, if you require your table top to be made into two pieces, this can be done as a special. Please contact Customer Service at 1.800.627.6770 to obtain a quote.

60" -71"	37" -42"	40"	COET2RECSTA	Grade 1 Laminate	\$5253	\$6370	\$6374	\$6594
				Grade 2 and 3 Laminate	\$5384	\$6501	\$6505	\$6725
				Grade 1 Wood Veneer	\$7081	\$8198	\$8202	\$8422
				Grade 2 Wood Veneer	\$7528	\$8645	\$8649	\$8869

60" -71"	43" -48"	40"	COET2RECSTA	Grade 1 Laminate	\$5374	\$6475	\$6478	\$6716
				Grade 2 and 3 Laminate	\$5537	\$6638	\$6641	\$6879
				Grade 1 Wood Veneer	\$7112	\$8213	\$8216	\$8454
				Grade 2 Wood Veneer	\$7614	\$8715	\$8718	\$8956

Tip: Tables are available parametrically in 1" increments.

60" -71"	49" -54"	40"	COET2RECSTA	Grade 1 Laminate	\$5810	\$6879	\$6802	\$7040
				Grade 2 and 3 Laminate	\$5990	\$7059	\$6982	\$7220
				Grade 1 Wood Veneer	\$7494	\$8563	\$8486	\$8724
				Grade 2 Wood Veneer	\$8016	\$9085	\$9008	\$9246

60" -71"	55" -60"	40"	COET2RECSTA	Grade 1 Laminate	\$6274	\$7374	\$7253	\$7496
				Grade 2 and 3 Laminate	\$6483	\$7583	\$7462	\$7705
				Grade 1 Wood Veneer	\$8014	\$9114	\$8993	\$9236
				Grade 2 Wood Veneer	\$8622	\$9722	\$9601	\$9844

72"	36"	40"	COET2RECSTA	Grade 1 Laminate	\$4913	\$5837	\$5939	\$6105
				Grade 2 and 3 Laminate	\$5045	\$5969	\$6071	\$6237
				Grade 1 Wood Veneer	\$6470	\$7394	\$7496	\$7662
				Grade 2 Wood Veneer	\$6963	\$7887	\$7989	\$8155

► Product Information continued on next page

E-Table 2 Collaborative and Conference Tables

E-Table 2 Collaborative and Conference Tables

Rectangular Aluminum Base Tables-Standing Height

► Product Information continued from previous page

Specification Information

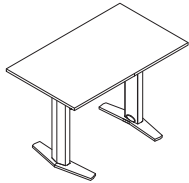

Dimensions		Style Number	Finish	Base Prices			
W	D			H	3 mm Plastic/ 3 mm Wood, Flat, or Convex Vinyl Edge:	Bullnose Wood Edge:	Beveled Wood Edge:

Rectangular Tables with Two Aluminum Bases - Standing Height

72"	37" -42"	40"	COET2RECSTA	Grade 1 Laminate	\$5283	\$6463	\$6502	\$6726
				Grade 2 and 3 Laminate	\$5430	\$6610	\$6649	\$6873
				Grade 1 Wood Veneer	\$7223	\$8403	\$8442	\$8666
				Grade 2 Wood Veneer	\$7740	\$8920	\$8959	\$9183
72"	43" -48"	40"	COET2RECSTA	Grade 1 Laminate	\$5402	\$6568	\$6609	\$6850
				Grade 2 and 3 Laminate	\$5579	\$6745	\$6786	\$7027
				Grade 1 Wood Veneer	\$7249	\$8415	\$8456	\$8697
				Grade 2 Wood Veneer	\$7816	\$8982	\$9023	\$9264
72"	49" -54"	40"	COET2RECSTA	Grade 1 Laminate	\$5867	\$7064	\$7061	\$7308
				Grade 2 and 3 Laminate	\$6071	\$7268	\$7265	\$7512
				Grade 1 Wood Veneer	\$7765	\$8962	\$8959	\$9206
				Grade 2 Wood Veneer	\$8420	\$9617	\$9614	\$9861
72"	55" -60"	40"	COET2RECSTA	Grade 1 Laminate	\$6333	\$7561	\$7513	\$7765
				Grade 2 and 3 Laminate	\$6565	\$7793	\$7745	\$7997
				Grade 1 Wood Veneer	\$8282	\$9510	\$9462	\$9714
				Grade 2 Wood Veneer	\$9025	\$10,253	\$10,205	\$10,457
73" -84"	36"	40"	COET2RECSTA	Grade 1 Laminate	\$5155	\$6511	\$6655	\$6896
				Grade 2 and 3 Laminate	\$5302	\$6658	\$6802	\$7043
				Grade 1 Wood Veneer	\$7403	\$8759	\$8903	\$9144
				Grade 2 Wood Veneer	\$8007	\$9363	\$9507	\$9748

Tip: Tables are available parametrically in 1" increments.

► Product Information continued on next page

E-Table 2 Collaborative and Conference Tables

Rectangular Aluminum Base Tables-Standing Height

► Product Information continued from previous page

Specification Information

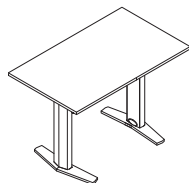

Dimensions
W D H

Style
Number

Finish

Base Prices

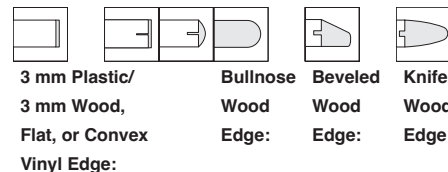

Rectangular Tables with Two Aluminum Bases - Standing Height

Dimensions	Style	Finish	Base Prices
73" -84" 37" -42" 40"	COET2RECSTA	Grade 1 Laminate	\$5348 \$6655 \$6763 \$6994
		Grade 2 and 3 Laminate	\$5524 \$6831 \$6939 \$7170
		Grade 1 Wood Veneer	\$7505 \$8812 \$8920 \$9151
		Grade 2 Wood Veneer	\$8165 \$9472 \$9580 \$9811
73" -84" 43" -48" 40"	COET2RECSTA	Grade 1 Laminate	\$5460 \$6754 \$6868 \$7117
		Grade 2 and 3 Laminate	\$5661 \$6955 \$7069 \$7318
		Grade 1 Wood Veneer	\$7517 \$8811 \$8925 \$9174
		Grade 2 Wood Veneer	\$8222 \$9516 \$9630 \$9879
73" -84" 49" -54" 40"	COET2RECSTA	Grade 1 Laminate	\$5926 \$7253 \$7321 \$7575
		Grade 2 and 3 Laminate	\$6154 \$7481 \$7549 \$7803
		Grade 1 Wood Veneer	\$8034 \$9361 \$9429 \$9683
		Grade 2 Wood Veneer	\$8826 \$10,153 \$10,221 \$10,475
73" -84" 55" -60" 40"	COET2RECSTA	Grade 1 Laminate	\$6391 \$7748 \$7773 \$8034
		Grade 2 and 3 Laminate	\$6646 \$8003 \$8028 \$8289
		Grade 1 Wood Veneer	\$8552 \$9909 \$9934 \$10,195
		Grade 2 Wood Veneer	\$9432 \$10,789 \$10,814 \$11,075
85"-96" 36" 40"	COET2RECSTA	Grade 1 Laminate	\$5451 \$6728 \$6881 \$7129
		Grade 2 and 3 Laminate	\$5620 \$6897 \$7050 \$7298
		Grade 1 Wood Veneer	\$7548 \$8825 \$8978 \$9226
		Grade 2 Wood Veneer	\$8249 \$9526 \$9679 \$9927

Tip: Tables are available parametrically in 1" increments.

► Product Information continued on next page

E-Table 2 Collaborative and Conference Tables

Rectangular Aluminum Base Tables-Standing Height

► Product Information continued from previous page

Specification Information

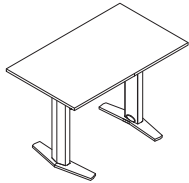

Dimensions		Style H	Style Number	Finish	Base Prices			
W	D				3 mm Plastic/ 3 mm Wood, Flat, or Convex Vinyl Edge:	Bullnose Wood Edge:	Beveled Wood Edge:	Knife Wood Edge:

Rectangular Tables with Two Aluminum Bases - Standing Height

Dimensions W	Dimensions D	Dimensions H	Style Number	Finish	3 mm Plastic/ 3 mm Wood, Flat, or Convex Vinyl Edge:	Bullnose Wood Edge:	Beveled Wood Edge:	Knife Wood Edge:
85"-96"	37" -42"	40"	COET2RECSTA	Grade 1 Laminate	\$5917	\$7227	\$7334	\$7586
				Grade 2 and 3 Laminate	\$6113	\$7423	\$7530	\$7782
				Grade 1 Wood Veneer	\$8064	\$9374	\$9481	\$9733
				Grade 2 Wood Veneer	\$8853	\$10,163	\$10,270	\$10,522
85"-96"	43" -48"	40"	COET2RECSTA	Grade 1 Laminate	\$6386	\$7716	\$7837	\$8093
				Grade 2 and 3 Laminate	\$6617	\$7947	\$8068	\$8324
				Grade 1 Wood Veneer	\$8589	\$9919	\$10,040	\$10,296
				Grade 2 Wood Veneer	\$9478	\$10,808	\$10,929	\$11,185
85"-96"	49" -54"	40"	COET2RECSTA	Grade 1 Laminate	\$6560	\$8061	\$8193	\$8481
				Grade 2 and 3 Laminate	\$6819	\$8320	\$8452	\$8740
				Grade 1 Wood Veneer	\$9035	\$10,536	\$10,668	\$10,956
				Grade 2 Wood Veneer	\$9958	\$11,459	\$11,591	\$11,879
85"-96"	55" -60"	40"	COET2RECSTA	Grade 1 Laminate	\$6737	\$8401	\$8550	\$8868
				Grade 2 and 3 Laminate	\$7023	\$8687	\$8836	\$9154
				Grade 1 Wood Veneer	\$9490	\$11,154	\$11,303	\$11,621
				Grade 2 Wood Veneer	\$10,454	\$12,118	\$12,267	\$12,585
97" -108"	36"	40"	COET2RECSTA	Grade 1 Laminate	\$5922	\$7221	\$7388	\$7635
				Grade 2 and 3 Laminate	\$6126	\$7425	\$7592	\$7839
				Grade 1 Wood Veneer	\$8071	\$9370	\$9537	\$9784
				Grade 2 Wood Veneer	\$8872	\$10,171	\$10,338	\$10,585

Tip: Tables are available parametrically in 1" increments.

► Product Information continued on next page

E-Table 2 Collaborative and Conference Tables

Rectangular Aluminum Base Tables-Standing Height

► Product Information continued from previous page

Specification Information

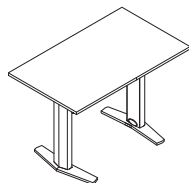

Dimensions		Style Number	Finish	Base Prices				
W	D			H	3 mm Plastic/ 3 mm Wood, Flat, or Convex Vinyl Edge:		Bullnose Wood Edge:	Beveled Wood Edge:

Rectangular Tables with Two Aluminum Bases - Standing Height

97" -108"	37" -42"	40"	COET2RECSTA	Grade 1 Laminate	\$6088	\$7568	\$7687	\$7969
				Grade 2 and 3 Laminate	\$6313	\$7793	\$7912	\$8194
				Grade 1 Wood Veneer	\$8509	\$9989	\$10,108	\$10,390
				Grade 2 Wood Veneer	\$9336	\$10,816	\$10,935	\$11,217
97" -108"	43" -48"	40"	COET2RECSTA	Grade 1 Laminate	\$6577	\$8464	\$8646	\$8996
				Grade 2 and 3 Laminate	\$6834	\$8721	\$8903	\$9253
				Grade 1 Wood Veneer	\$8815	\$10,702	\$10,884	\$11,234
				Grade 2 Wood Veneer	\$9817	\$11,704	\$11,886	\$12,236
97" -108"	49" -54"	40"	COET2RECSTA	Grade 1 Laminate	\$6810	\$8936	\$9138	\$9530
				Grade 2 and 3 Laminate	\$7099	\$9225	\$9427	\$9819
				Grade 1 Wood Veneer	\$9427	\$11,553	\$11,755	\$12,147
				Grade 2 Wood Veneer	\$10,517	\$12,643	\$12,845	\$13,237
97" -108"	55" -60"	40"	COET2RECSTA	Grade 1 Laminate	\$7039	\$9401	\$9627	\$10,060
				Grade 2 and 3 Laminate	\$7359	\$9721	\$9947	\$10,380
				Grade 1 Wood Veneer	\$10,038	\$12,400	\$12,626	\$13,059
				Grade 2 Wood Veneer	\$11,222	\$13,584	\$13,810	\$14,243
109" -120"	36"	40"	COET2RECSTA	Grade 1 Laminate	\$6050	\$7847	\$8008	\$8344
				Grade 2 and 3 Laminate	\$6266	\$8063	\$8224	\$8560
				Grade 1 Wood Veneer	\$8128	\$9925	\$10,086	\$10,422
				Grade 2 Wood Veneer	\$8975	\$10,772	\$10,933	\$11,269

E-Table 2
Collaborative and
Conference Tables

Tip: Tables are available parametrically in 1" increments.

► Product Information continued on next page

E-Table 2 Collaborative and Conference Tables

Rectangular Aluminum Base Tables-Standing Height

► Product Information continued from previous page

Specification Information

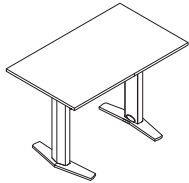

Dimensions		Style H	Style Number	Finish	Base Prices			
W	D				3 mm Plastic/ 3 mm Wood, Flat, or Convex Vinyl Edge:	Bullnose Wood Edge:	Beveled Wood Edge:	Knife Wood Edge:

Rectangular Tables with Two Aluminum Bases - Standing Height

109" -120"	37" -42"	40"	COET2RECSTA	Grade 1 Laminate	\$6539	\$8743	\$8968	\$9370
				Grade 2 and 3 Laminate	\$6789	\$8993	\$9218	\$9620
				Grade 1 Wood Veneer	\$8432	\$10,636	\$10,861	\$11,263
				Grade 2 Wood Veneer	\$9456	\$11,660	\$11,885	\$12,287
109" -120"	43" -48"	40"	COET2RECSTA	Grade 1 Laminate	\$6771	\$9214	\$9459	\$9901
				Grade 2 and 3 Laminate	\$7053	\$9496	\$9741	\$10,183
				Grade 1 Wood Veneer	\$9043	\$11,486	\$11,731	\$12,173
				Grade 2 Wood Veneer	\$10,156	\$12,599	\$12,844	\$13,286
109" -120"	49" -54"	40"	COET2RECSTA	Grade 1 Laminate	\$7059	\$9809	\$10,084	\$10,576
				Grade 2 and 3 Laminate	\$7378	\$10,128	\$10,403	\$10,895
				Grade 1 Wood Veneer	\$9815	\$12,565	\$12,840	\$13,332
				Grade 2 Wood Veneer	\$11,073	\$13,823	\$14,098	\$14,590
109" -120"	55" -60"	40"	COET2RECSTA	Grade 1 Laminate	\$7342	\$10,404	\$10,704	\$11,251
				Grade 2 and 3 Laminate	\$7696	\$10,758	\$11,058	\$11,605
				Grade 1 Wood Veneer	\$10,583	\$13,645	\$13,945	\$14,492
				Grade 2 Wood Veneer	\$11,988	\$15,050	\$15,350	\$15,897

E-Table 2 Collaborative and Conference Tables

Rectangular Aluminum Base Tables-Standing Height

E-Table 2
Collaborative and
Conference Tables

E-Table 2 Collaborative and Conference Tables

Rectangular Laminate Base Tables

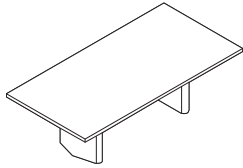

Tip: Shipped knocked down.

Tip: Utility bay quantity offering by table width is available in the understanding section.

Tip: 3 mm vinyl edge profiles on tables require a 4" radius on all corners.

Tip: A flat, plastic edge can be specified on veneer tops by selecting the "flat" edge option. Flat edge is only available in 6000 Black on veneer tops.

Tip: If you specify a wood edge on a top with woodgrain laminate, the edge and the top may not match.

Tip: Sectioned top option is a two piece top and is only available on tops 96"W-120"W.

Tip: When a wood edge is specified on a wood veneer top, the edge finish will match the top finish.

Tip: Each utility bay comes with two universal faceplate openings that accept customer-supplied faceplates in any of the following sizes: single-gang, double-gang, or triple-gang.

Standard Includes

- Top:
 - 1 1/4" particle board core with grade 1 laminate
 - parametric width in 1" increments ranging from 96"-288"
 - parametric depth in 1" increments ranging from 48"-60"
- Edge: 3 mm plastic edge, 3 mm wood edge, or convex vinyl edge
- Bases: black laminate on MDF core
- Wireway: painted steel side panels with powder coat and black plastic access door
- Concealed leveling glides: non-marring, black plastic
- Overall height: 29"

Options

Sectioned Top	No Sectioned Top With Sectioned Top	No cost +\$569
Top Finish	Laminate Price Group 02 Laminate Price Group 03 Veneer Price Group 01 Veneer Price Group 02	Price below Price below Price below Price below
Edge Type	3mm Plastic Edge 3mm Wood Edge Beveled Wood Edge Bullnose Wood Edge Convex Vinyl Edge Knife Wood Edge	Price below Price below Price below Price below Price below Price below
Base Type	Black HPL Curated HPL	No cost +\$873
Bay Option	No Bays Two Bays Three Bays Four Bays Six Bays Seven Bays	No cost +\$1578 +\$2367 +\$3156 +\$4734 +\$5523
Wiring Schematic	1+1 Hardwire, 2 Circuits 3 + 0 Wireway Chicago Wireway 1+1 Hardwire, 2 Circuits, USB 3 + 0 Wireway, USB	No cost No cost No cost +\$157 +\$157
Infeed	Hardwire NYC Hardwire Infeed Plug	No cost No cost No cost
Infeed Location	End Base Power Infeed Mid Base Power Infeed	No cost No cost

▶ **Product Information continued on next page**

E-Table 2 Collaborative and Conference Tables

Rectangular Laminate Base Tables

► Product Information continued from previous page

Specification Information

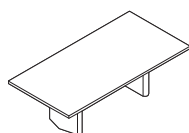

Dimensions		Style Number	Finish	Base Prices			
W	D			H			
				3 mm Plastic/ 3 mm Wood, Flat or Convex Vinyl Edge:	Bullnose Wood Edge:	Beveled Wood Edge:	Knife Wood Edge:

Rectangular Tables with Two Laminate Bases - Working Height

96"	48"	29"	COET2RECL	Grade 1 Laminate	\$5634	\$6964	\$7085	\$7341
				Grade 2 and 3 Laminate	\$5866	\$7196	\$7317	\$7573
				Grade 1 Wood Veneer	\$7837	\$9167	\$9288	\$9544
				Grade 2 Wood Veneer	\$8722	\$10,052	\$10,173	\$10,429
96"	49" -54"	29"	COET2RECL	Grade 1 Laminate	\$5805	\$7306	\$7438	\$7726
				Grade 2 and 3 Laminate	\$6063	\$7564	\$7696	\$7984
				Grade 1 Wood Veneer	\$8279	\$9780	\$9912	\$10,200
				Grade 2 Wood Veneer	\$9204	\$10,705	\$10,837	\$11,125
96"	55" -60"	29"	COET2RECL	Grade 1 Laminate	\$5981	\$7645	\$7794	\$8112
				Grade 2 and 3 Laminate	\$6265	\$7929	\$8078	\$8396
				Grade 1 Wood Veneer	\$8732	\$10,396	\$10,545	\$10,863
				Grade 2 Wood Veneer	\$9697	\$11,361	\$11,510	\$11,828
97" -108"	48"	29"	COET2RECL	Grade 1 Laminate	\$5878	\$7765	\$7947	\$8297
				Grade 2 and 3 Laminate	\$6133	\$8020	\$8202	\$8552
				Grade 1 Wood Veneer	\$8114	\$10,001	\$10,183	\$10,533
				Grade 2 Wood Veneer	\$9116	\$11,003	\$11,185	\$11,535
97" -108"	49" -54"	29"	COET2RECL	Grade 1 Laminate	\$6107	\$8233	\$8435	\$8827
				Grade 2 and 3 Laminate	\$6396	\$8522	\$8724	\$9116
				Grade 1 Wood Veneer	\$8723	\$10,849	\$11,051	\$11,443
				Grade 2 Wood Veneer	\$9814	\$11,940	\$12,142	\$12,534
97" -108"	55" -60"	29"	COET2RECL	Grade 1 Laminate	\$6339	\$8701	\$8927	\$9360
				Grade 2 and 3 Laminate	\$6660	\$9022	\$9248	\$9681
				Grade 1 Wood Veneer	\$9337	\$11,699	\$11,925	\$12,358
				Grade 2 Wood Veneer	\$10,521	\$12,883	\$13,109	\$13,542

Tip: Top ships in one piece.

Tip: Tables are available parametrically in 1" increments.

E-Table 2
Collaborative and
Conference Tables

► Product Information continued on next page

E-Table 2 Collaborative and Conference Tables

Rectangular Laminate Base Tables

► Product Information continued from previous page

Specification Information

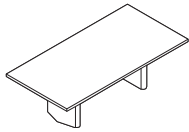

Dimensions		Style	Finish	Base Prices			
W	D	H	Number	Edge:			
				3 mm Plastic/ 3 mm Wood, Flat or Convex Vinyl Edge:	Bullnose Wood Edge:	Beveled Wood Edge:	Knife Wood Edge:

Rectangular Tables with Two Laminate Bases - Working Height

Dimensions	Style	Finish	Grade 1 Laminate	Grade 2 and 3 Laminate	Grade 1 Wood Veneer	Grade 2 Wood Veneer
109" -120" 48" 29"	COET2RECL	Grade 1 Laminate	\$6012	\$8455	\$8700	\$9142
		Grade 2 and 3 Laminate	\$6293	\$8736	\$8981	\$9423
		Grade 1 Wood Veneer	\$8282	\$10,725	\$10,970	\$11,412
		Grade 2 Wood Veneer	\$9396	\$11,839	\$12,084	\$12,526
109" -120" 49" -54" 29"	COET2RECL	Grade 1 Laminate	\$6297	\$9047	\$9322	\$9814
		Grade 2 and 3 Laminate	\$6616	\$9366	\$9641	\$10,133
		Grade 1 Wood Veneer	\$9054	\$11,804	\$12,079	\$12,571
		Grade 2 Wood Veneer	\$10,314	\$13,064	\$13,339	\$13,831
109" -120" 55" -60" 29"	COET2RECL	Grade 1 Laminate	\$6577	\$9639	\$9939	\$10,486
		Grade 2 and 3 Laminate	\$6932	\$9994	\$10,294	\$10,841
		Grade 1 Wood Veneer	\$9819	\$12,881	\$13,181	\$13,728
		Grade 2 Wood Veneer	\$11,225	\$14,287	\$14,587	\$15,134

Tip: Tables are available parametrically in 1" increments.

► Product Information continued on next page

E-Table 2 Collaborative and Conference Tables

Rectangular Laminate Base Tables

► Product Information continued from previous page

Specification Information

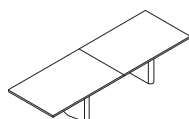

Dimensions		Style	Finish	Base Prices			
W	D	H	Number				
				3 mm Plastic/ 3 mm Wood, Flat or Convex Vinyl Edge:	Bullnose Wood Edge:	Beveled Wood Edge:	Knife Wood Edge:

Rectangular Tables with Two Laminate Bases - Working Height

Tip: Top ships in two pieces. Hardware is included for field assembly.

121" -132"	48"	29"	COET2RECL	Grade 1 Laminate	\$6041	\$9052	\$9324	\$9843
				Grade 2 and 3 Laminate	\$6351	\$9362	\$9634	\$10,153
				Grade 1 Wood Veneer	\$8834	\$11,845	\$12,117	\$12,636
				Grade 2 Wood Veneer	\$10,060	\$13,071	\$13,343	\$13,862

121" -132"	49" -54"	29"	COET2RECL	Grade 1 Laminate	\$6344	\$9732	\$10,031	\$10,621
				Grade 2 and 3 Laminate	\$6696	\$10,084	\$10,383	\$10,973
				Grade 1 Wood Veneer	\$9734	\$13,122	\$13,421	\$14,011
				Grade 2 Wood Veneer	\$11,118	\$14,506	\$14,805	\$15,395

Tip: If you require your table top to be made into three pieces, this can be done as a special. Please contact Customer Service at 1.800.627.6770 to obtain a quote.

121" -132"	55" -60"	29"	COET2RECL	Grade 1 Laminate	\$6645	\$10,412	\$10,743	\$11,398
				Grade 2 and 3 Laminate	\$7036	\$10,803	\$11,134	\$11,789
				Grade 1 Wood Veneer	\$10,629	\$14,396	\$14,727	\$15,382
				Grade 2 Wood Veneer	\$12,174	\$15,941	\$16,272	\$16,927

133" -144"	48"	29"	COET2RECL	Grade 1 Laminate	\$6069	\$9646	\$9946	\$10,543
				Grade 2 and 3 Laminate	\$6408	\$9985	\$10,285	\$10,882
				Grade 1 Wood Veneer	\$9385	\$12,962	\$13,262	\$13,859
				Grade 2 Wood Veneer	\$10,721	\$14,298	\$14,598	\$15,195

133" -144"	49" -54"	29"	COET2RECL	Grade 1 Laminate	\$6390	\$10,415	\$10,741	\$11,426
				Grade 2 and 3 Laminate	\$6776	\$10,801	\$11,127	\$11,812
				Grade 1 Wood Veneer	\$10,413	\$14,438	\$14,764	\$15,449
				Grade 2 Wood Veneer	\$11,922	\$15,947	\$16,273	\$16,958

Tip: Tables are available parametrically in 1" increments.

133" -144"	55" -60"	29"	COET2RECL	Grade 1 Laminate	\$6711	\$11,182	\$11,546	\$12,305
				Grade 2 and 3 Laminate	\$7139	\$11,610	\$11,974	\$12,733
				Grade 1 Wood Veneer	\$11,437	\$15,908	\$16,272	\$17,031
				Grade 2 Wood Veneer	\$13,123	\$17,594	\$17,958	\$18,717

► Product Information continued on next page

E-Table 2 Collaborative and Conference Tables

Rectangular Laminate Base Tables

► Product Information continued from previous page

Specification Information

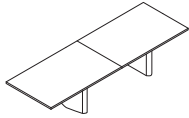

Dimensions		Style	Finish	Base Prices			
W	D	H	Number	Edge:			
				3 mm Plastic/ 3 mm Wood, Flat or Convex Vinyl Edge:	Bullnose Wood Edge:	Beveled Wood Edge:	Knife Wood Edge:

Rectangular Tables with Two Laminate Bases - Working Height

Dimensions	Style	Finish	Base Price	Bullnose Wood Edge	Beveled Wood Edge	Knife Wood Edge
145" -156" 43" -48" 29"	COET2RECL	Grade 1 Laminate	\$7507	\$12,017	\$12,305	\$13,082
		Grade 2 and 3 Laminate	\$7865	\$12,375	\$12,663	\$13,440
		Grade 1 Wood Veneer	\$12,627	\$17,137	\$17,425	\$18,202
		Grade 2 Wood Veneer	\$14,078	\$18,588	\$18,876	\$19,653
145" -156" 49" -54" 29"	COET2RECL	Grade 1 Laminate	\$7926	\$12,999	\$13,322	\$14,198
		Grade 2 and 3 Laminate	\$8331	\$13,404	\$13,727	\$14,603
		Grade 1 Wood Veneer	\$13,969	\$19,042	\$19,365	\$20,241
		Grade 2 Wood Veneer	\$15,615	\$20,688	\$21,011	\$21,887
145" -156" 55" -60" 29"	COET2RECL	Grade 1 Laminate	\$8345	\$13,984	\$14,338	\$15,313
		Grade 2 and 3 Laminate	\$8793	\$14,432	\$14,786	\$15,761
		Grade 1 Wood Veneer	\$15,313	\$20,952	\$21,306	\$22,281
		Grade 2 Wood Veneer	\$17,153	\$22,792	\$23,146	\$24,121

► Product Information continued on next page

E-Table 2 Collaborative and Conference Tables

Rectangular Laminate Base Tables

► Product Information continued from previous page

Specification Information

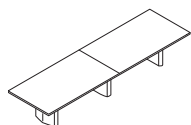

Dimensions		Style Number	Finish	Base Prices			
W	D			H			
				3 mm Plastic/ 3 mm Wood, Flat or Convex Vinyl Edge:	Bullnose Wood Edge:	Beveled Wood Edge:	Knife Wood Edge:

Rectangular Tables with Three Laminate Bases - Working Height

Tip: Top ships in two pieces. Hardware is included for field assembly.

157" -168"	48"	29"	COET2RECL	Grade 1 Laminate	\$8802	\$14,245	\$14,521	\$15,475
				Grade 2 and 3 Laminate	\$9179	\$14,622	\$14,898	\$15,852
				Grade 1 Wood Veneer	\$15,726	\$21,169	\$21,445	\$22,399
				Grade 2 Wood Veneer	\$17,292	\$22,735	\$23,011	\$23,965

Tip: For tables with three or more bases, you must specify the entry point of the base power infeed, either an end base or a mid base location, in order to receive the correct length of base power infeed.

157" -168"	49" -54"	29"	COET2RECL	Grade 1 Laminate	\$9309	\$15,428	\$15,749	\$16,817
				Grade 2 and 3 Laminate	\$9735	\$15,854	\$16,175	\$17,243
				Grade 1 Wood Veneer	\$17,376	\$23,495	\$23,816	\$24,884
				Grade 2 Wood Veneer	\$19,159	\$25,278	\$25,599	\$26,667

157" -168"	55" -60"	29"	COET2RECL	Grade 1 Laminate	\$9818	\$16,623	\$16,969	\$18,158
				Grade 2 and 3 Laminate	\$10,287	\$17,092	\$17,438	\$18,627
				Grade 1 Wood Veneer	\$19,030	\$25,835	\$26,181	\$27,370
				Grade 2 Wood Veneer	\$21,023	\$27,828	\$28,174	\$29,363

Tip: If you require your table top to be made into three pieces, this can be done as a special. Please contact Customer Service at 1.800.627.6770 to obtain a quote.

169" -180"	48"	29"	COET2RECL	Grade 1 Laminate	\$8853	\$14,411	\$14,691	\$15,662
				Grade 2 and 3 Laminate	\$9257	\$14,815	\$15,095	\$16,066
				Grade 1 Wood Veneer	\$15,840	\$21,398	\$21,678	\$22,649
				Grade 2 Wood Veneer	\$17,517	\$23,075	\$23,355	\$24,326

169" -180"	49" -54"	29"	COET2RECL	Grade 1 Laminate	\$9385	\$15,636	\$15,954	\$17,042
				Grade 2 and 3 Laminate	\$9839	\$16,090	\$16,408	\$17,496
				Grade 1 Wood Veneer	\$17,526	\$23,777	\$24,095	\$25,183
				Grade 2 Wood Veneer	\$19,434	\$25,685	\$26,003	\$27,091

► Product Information continued on next page

E-Table 2 Collaborative and Conference Tables

E-Table 2 Collaborative and Conference Tables

Rectangular Laminate Base Tables

► Product Information continued from previous page

Specification Information

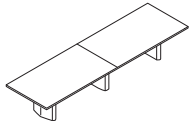

Dimensions		Style	Finish	Base Prices			
W	D	H	Number				
				3 mm Plastic/ 3 mm Wood, Flat or Convex Vinyl Edge:	Bullnose Wood Edge:	Beveled Wood Edge:	Knife Wood Edge:

Rectangular Tables with Three Laminate Bases - Working Height

169" -180"	55" -60"	29"	COET2RECL	Grade 1 Laminate	\$9912	\$16,862	\$17,212	\$18,418
				Grade 2 and 3 Laminate	\$10,415	\$17,365	\$17,715	\$18,921
				Grade 1 Wood Veneer	\$19,210	\$26,160	\$26,510	\$27,716
				Grade 2 Wood Veneer	\$21,339	\$28,289	\$28,639	\$29,845
181" -192"	48"	29"	COET2RECL	Grade 1 Laminate	\$8903	\$14,576	\$14,861	\$15,848
				Grade 2 and 3 Laminate	\$9335	\$15,008	\$15,293	\$16,280
				Grade 1 Wood Veneer	\$15,953	\$21,626	\$21,911	\$22,898
				Grade 2 Wood Veneer	\$17,743	\$23,416	\$23,701	\$24,688
181" -192"	49" -54"	29"	COET2RECL	Grade 1 Laminate	\$9460	\$15,840	\$16,157	\$17,267
				Grade 2 and 3 Laminate	\$9943	\$16,323	\$16,640	\$17,750
				Grade 1 Wood Veneer	\$17,675	\$24,055	\$24,372	\$25,482
				Grade 2 Wood Veneer	\$19,708	\$26,088	\$26,405	\$27,515
181" -192"	55" -60"	29"	COET2RECL	Grade 1 Laminate	\$10,006	\$17,099	\$17,453	\$18,678
				Grade 2 and 3 Laminate	\$10,543	\$17,636	\$17,990	\$19,215
				Grade 1 Wood Veneer	\$19,390	\$26,483	\$26,837	\$28,062
				Grade 2 Wood Veneer	\$21,655	\$28,748	\$29,102	\$30,327
193" -204"	48"	29"	COET2RECL	Grade 1 Laminate	\$9072	\$14,920	\$15,231	\$16,300
				Grade 2 and 3 Laminate	\$9529	\$15,377	\$15,688	\$16,757
				Grade 1 Wood Veneer	\$17,330	\$23,178	\$23,489	\$24,558
				Grade 2 Wood Veneer	\$19,232	\$25,080	\$25,391	\$26,460

Tip: Tables are available parametrically in 1" increments.

► Product Information continued on next page

E-Table 2 Collaborative and Conference Tables

Rectangular Laminate Base Tables

► Product Information continued from previous page

Specification Information

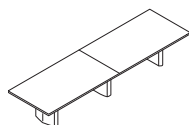

Dimensions		Style Number	Finish	Base Prices			
W	D			H			
				3 mm Plastic/ 3 mm Wood, Flat or Convex Vinyl Edge:	Bullnose Wood Edge:	Beveled Wood Edge:	Knife Wood Edge:

Rectangular Tables with Three Laminate Bases - Working Height

193" -204"	49" -54"	29"	COET2RECL	Grade 1 Laminate	\$9662	\$16,242	\$16,585	\$17,789
				Grade 2 and 3 Laminate	\$10,174	\$16,754	\$17,097	\$18,301
				Grade 1 Wood Veneer	\$19,233	\$25,813	\$26,156	\$27,360
				Grade 2 Wood Veneer	\$21,397	\$27,977	\$28,320	\$29,524
193" -204"	55" -60"	29"	COET2RECL	Grade 1 Laminate	\$10,248	\$17,570	\$17,944	\$19,279
				Grade 2 and 3 Laminate	\$10,818	\$18,140	\$18,514	\$19,849
				Grade 1 Wood Veneer	\$21,135	\$28,457	\$28,831	\$30,166
				Grade 2 Wood Veneer	\$23,552	\$30,874	\$31,248	\$32,583
205" -216"	48"	29"	COET2RECL	Grade 1 Laminate	\$9240	\$15,259	\$15,599	\$16,751
				Grade 2 and 3 Laminate	\$9723	\$15,742	\$16,082	\$17,234
				Grade 1 Wood Veneer	\$18,706	\$24,725	\$25,065	\$26,217
				Grade 2 Wood Veneer	\$20,720	\$26,739	\$27,079	\$28,231
205" -216"	49" -54"	29"	COET2RECL	Grade 1 Laminate	\$9862	\$16,645	\$17,008	\$18,308
				Grade 2 and 3 Laminate	\$10,405	\$17,188	\$17,551	\$18,851
				Grade 1 Wood Veneer	\$20,790	\$27,573	\$27,936	\$29,236
				Grade 2 Wood Veneer	\$23,084	\$29,867	\$30,230	\$31,530
205" -216"	55" -60"	29"	COET2RECL	Grade 1 Laminate	\$10,489	\$18,036	\$18,434	\$19,876
				Grade 2 and 3 Laminate	\$11,092	\$18,639	\$19,037	\$20,479
				Grade 1 Wood Veneer	\$22,880	\$30,427	\$30,825	\$32,267
				Grade 2 Wood Veneer	\$25,447	\$32,994	\$33,392	\$34,834

Tip: Tables are available parametrically in 1" increments.

► Product Information continued on next page





E-Table 2 Collaborative and Conference Tables

Rectangular Laminate Base Tables

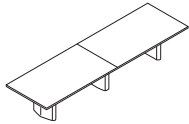
► Product Information continued from previous page

Specification Information



Dimensions		Style	Finish	Base Prices			
W	D	H Number					

Rectangular Tables with Three Laminate Bases - Working Height

217" -228"	48"	29"	COET2RECL	Grade 1 Laminate	\$9268	\$15,592	\$15,954	\$17,138
				Grade 2 and 3 Laminate	\$9778	\$16,102	\$16,464	\$17,648
				Grade 1 Wood Veneer	\$19,407	\$25,731	\$26,093	\$27,277
				Grade 2 Wood Veneer	\$21,533	\$27,857	\$28,219	\$29,403
217" -228"	49" -54"	29"	COET2RECL	Grade 1 Laminate	\$9908	\$17,032	\$17,428	\$18,760
				Grade 2 and 3 Laminate	\$10,480	\$17,604	\$18,000	\$19,332
				Grade 1 Wood Veneer	\$21,594	\$28,718	\$29,114	\$30,446
				Grade 2 Wood Veneer	\$24,009	\$31,133	\$31,529	\$32,861
217" -228"	55" -60"	29"	COET2RECL	Grade 1 Laminate	\$10,553	\$18,481	\$18,911	\$20,390
				Grade 2 and 3 Laminate	\$11,191	\$19,119	\$19,549	\$21,028
				Grade 1 Wood Veneer	\$23,789	\$31,717	\$32,147	\$33,626
				Grade 2 Wood Veneer	\$26,491	\$34,419	\$34,849	\$36,328
229" -240"	48"	29"	COET2RECL	Grade 1 Laminate	\$9297	\$15,924	\$16,310	\$17,524
				Grade 2 and 3 Laminate	\$9833	\$16,460	\$16,846	\$18,060
				Grade 1 Wood Veneer	\$20,110	\$26,737	\$27,123	\$28,337
				Grade 2 Wood Veneer	\$22,346	\$28,973	\$29,359	\$30,573
229" -240"	49" -54"	29"	COET2RECL	Grade 1 Laminate	\$9954	\$17,418	\$17,849	\$19,211
				Grade 2 and 3 Laminate	\$10,555	\$18,019	\$18,450	\$19,812
				Grade 1 Wood Veneer	\$22,396	\$29,860	\$30,291	\$31,653
				Grade 2 Wood Veneer	\$24,935	\$32,399	\$32,830	\$34,192
229" -240"	55" -60"	29"	COET2RECL	Grade 1 Laminate	\$10,617	\$18,923	\$19,385	\$20,904
				Grade 2 and 3 Laminate	\$11,290	\$19,596	\$20,058	\$21,577
				Grade 1 Wood Veneer	\$24,698	\$33,004	\$33,466	\$34,985
				Grade 2 Wood Veneer	\$27,536	\$35,842	\$36,304	\$37,823

Tip: Tables are available parametrically in 1" increments.

► Product Information continued on next page

E-Table 2 Collaborative and Conference Tables

Rectangular Laminate Base Tables

► Product Information continued from previous page

Specification Information

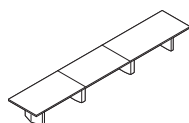

Dimensions		Style H	Style Number	Finish	Base Prices				
W	D				3 mm Plastic/ 3 mm Wood, Flat or Convex Vinyl Edge:	Bullnose Wood Edge:	Beveled Wood Edge:	Knife Wood Edge:	

Rectangular Tables with Four Laminate Bases - Working Height

Tip: Top ships in three pieces. Hardware is included for field assembly.

241" -252"	48"	29"	COET2RECL	Grade 1 Laminate	\$10,941	\$18,615	\$19,014	\$20,399
				Grade 2 and 3 Laminate	\$11,501	\$19,175	\$19,574	\$20,959
				Grade 1 Wood Veneer	\$23,676	\$31,350	\$31,749	\$33,134
				Grade 2 Wood Veneer	\$26,027	\$33,701	\$34,100	\$35,485

Tip: For tables with three or more bases, you must specify the entry point of the base power infeed, either an end base or a mid base location, in order to receive the correct length of base power infeed.

241" -252"	49" -54"	29"	COET2RECL	Grade 1 Laminate	\$11,714	\$20,336	\$20,786	\$22,360
				Grade 2 and 3 Laminate	\$12,343	\$20,965	\$21,415	\$22,989
				Grade 1 Wood Veneer	\$26,314	\$34,936	\$35,386	\$36,960
				Grade 2 Wood Veneer	\$28,982	\$37,604	\$38,054	\$39,628

241" -252"	55" -60"	29"	COET2RECL	Grade 1 Laminate	\$12,479	\$22,093	\$22,558	\$24,300
				Grade 2 and 3 Laminate	\$13,181	\$22,795	\$23,260	\$25,002
				Grade 1 Wood Veneer	\$28,956	\$38,570	\$39,035	\$40,777
				Grade 2 Wood Veneer	\$31,940	\$41,554	\$42,019	\$43,761

Tip: If you require your table top to be made into four pieces, this can be done as a special. Please contact Customer Service at 1.800.627.6770 to obtain a quote.

253" -264"	48"	29"	COET2RECL	Grade 1 Laminate	\$12,380	\$21,099	\$21,511	\$23,067
				Grade 2 and 3 Laminate	\$12,964	\$21,683	\$22,095	\$23,651
				Grade 1 Wood Veneer	\$27,037	\$35,756	\$36,168	\$37,724
				Grade 2 Wood Veneer	\$29,501	\$38,220	\$38,632	\$40,188

253" -264"	49" -54"	29"	COET2RECL	Grade 1 Laminate	\$13,255	\$23,036	\$23,508	\$25,288
				Grade 2 and 3 Laminate	\$13,909	\$23,690	\$24,162	\$25,942
				Grade 1 Wood Veneer	\$30,010	\$39,791	\$40,263	\$42,043
				Grade 2 Wood Veneer	\$32,804	\$42,585	\$43,057	\$44,837

► Product Information continued on next page

E-Table 2 Collaborative and Conference Tables

Rectangular Laminate Base Tables

► Product Information continued from previous page

Specification Information

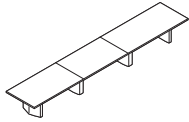

Dimensions		Style Number	Finish	Base Prices			
W	D			H	3 mm Plastic/ 3 mm Wood, Flat or Convex Vinyl Edge:	Bullnose Wood Edge:	Beveled Wood Edge:

Rectangular Tables with Four Laminate Bases - Working Height

253" -264"	55" -60"	29"	COET2RECL	Grade 1 Laminate	\$14,111	\$25,034	\$25,498	\$27,466
				Grade 2 and 3 Laminate	\$14,838	\$25,761	\$26,225	\$28,193
				Grade 1 Wood Veneer	\$32,981	\$43,904	\$44,368	\$46,336
				Grade 2 Wood Veneer	\$36,109	\$47,032	\$47,496	\$49,464
265" -276"	48"	29"	COET2RECL	Grade 1 Laminate	\$12,441	\$21,341	\$21,774	\$23,267
				Grade 2 and 3 Laminate	\$13,049	\$21,949	\$22,382	\$23,875
				Grade 1 Wood Veneer	\$27,195	\$36,095	\$36,528	\$38,021
				Grade 2 Wood Veneer	\$29,775	\$38,675	\$39,108	\$40,601
265" -276"	49" -54"	29"	COET2RECL	Grade 1 Laminate	\$13,343	\$23,298	\$23,747	\$25,532
				Grade 2 and 3 Laminate	\$14,026	\$23,981	\$24,430	\$26,215
				Grade 1 Wood Veneer	\$30,176	\$40,131	\$40,580	\$42,365
				Grade 2 Wood Veneer	\$33,105	\$43,060	\$43,509	\$45,294
265" -276"	55" -60"	29"	COET2RECL	Grade 1 Laminate	\$14,187	\$25,321	\$25,727	\$27,713
				Grade 2 and 3 Laminate	\$14,947	\$26,081	\$26,487	\$28,473
				Grade 1 Wood Veneer	\$33,165	\$44,299	\$44,705	\$46,691
				Grade 2 Wood Veneer	\$36,450	\$47,584	\$47,990	\$49,976
277" -288"	48"	29"	COET2RECL	Grade 1 Laminate	\$12,501	\$21,580	\$22,039	\$23,462
				Grade 2 and 3 Laminate	\$13,133	\$22,212	\$22,671	\$24,094
				Grade 1 Wood Veneer	\$27,352	\$36,431	\$36,890	\$38,313
				Grade 2 Wood Veneer	\$30,049	\$39,128	\$39,587	\$41,010

Tip: Tables are available parametrically in 1" increments.

► Product Information continued on next page





E-Table 2 Collaborative and Conference Tables

Rectangular Laminate Base Tables

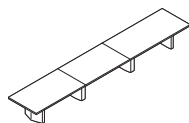
► Product Information continued from previous page

Specification Information



Dimensions		Style	Finish	Base Prices					
W	D	H	Number						
									
				3 mm Plastic/ 3 mm Wood, Flat or Convex Vinyl Edge:		Bullnose Wood Edge:	Beveled Wood Edge:	Knife Wood Edge:	

Rectangular Tables with Four Laminate Bases - Working Height

277" -288"	49" -54"	29"	COET2RECL	Grade 1 Laminate	\$13,429	\$23,559	\$23,985	\$25,778
				Grade 2 and 3 Laminate	\$14,142	\$24,272	\$24,698	\$26,491
				Grade 1 Wood Veneer	\$30,339	\$40,469	\$40,895	\$42,688
				Grade 2 Wood Veneer	\$33,407	\$43,537	\$43,963	\$45,756
277" -288"	55" -60"	29"	COET2RECL	Grade 1 Laminate	\$14,264	\$25,608	\$25,955	\$27,959
				Grade 2 and 3 Laminate	\$15,056	\$26,400	\$26,747	\$28,751
				Grade 1 Wood Veneer	\$33,349	\$44,693	\$45,040	\$47,044
				Grade 2 Wood Veneer	\$36,790	\$48,134	\$48,481	\$50,485

E-Table 2
Collaborative and
Conference Tables

E-Table 2 Collaborative and Conference Tables

Rectangular Veneer Base Tables

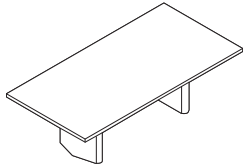

Tip: Shipped knocked down.

Tip: Utility bay quantity offering by table width is available in the understanding section.

Tip: 3 mm vinyl edge profiles on tables require a 4" radius on all corners.

Tip: A flat, plastic edge can be specified on veneer tops by selecting the "flat" edge option. Flat edge is only available in 6000 Black on veneer tops.

Tip: If you specify a wood edge on a top with woodgrain laminate, the edge and the top may not match.

Tip: Sectioned top option is a two piece top and is only available on tops 96"W-120"W.

Tip: When a wood edge is specified on a wood veneer top, the edge finish will match the top finish.

Tip: Each utility bay comes with two universal faceplate openings that accept customer-supplied faceplates in any of the following sizes: single-gang, double-gang, or triple-gang.

Standard Includes

- Top:
 - 1 1/4" particle board core with grade 1 laminate
 - parametric width in 1" increments ranging from 96"-288"
 - parametric depth in 1" increments ranging from 48"-60"
- Edge: 3 mm plastic edge, 3 mm wood edge, or convex vinyl edge
- Bases: grade 01 or grade 02 veneer on MDF core
- Wireway: painted steel side panels with powder coat and black plastic access door
- Concealed leveling glides: non-marring, black plastic
- Overall height: 29"

Options

Sectioned Top	No Sectioned Top With Sectioned Top	No cost +\$569
Top Finish	Laminate Price Group 02 Laminate Price Group 03 Veneer Price Group 01 Veneer Price Group 02	Price below Price below Price below Price below
Edge Type	3mm Plastic Edge 3mm Wood Edge Beveled Wood Edge Bullnose Wood Edge Convex Vinyl Edge Knife Wood Edge	Price below Price below Price below Price below Price below Price below
Bay Option	No Bays Two Bays Three Bays Four Bays Six Bays Seven Bays	No cost +\$1578 +\$2367 +\$3156 +\$4734 +\$5523
Wiring Schematic	1+1 Hardwire, 2 Circuits 3 + 0 Wireway Chicago Wireway 1+1 Hardwire,2 Circuits,USB 3 + 0 Wireway,USB	No cost No cost No cost +\$157 +\$157
Infeed	Hardwire NYC Hardwire Infeed Plug	No cost No cost No cost
Infeed Location	End Base Power Infeed Mid Base Power Infeed	No cost No cost

► **Product Information continued on next page**

E-Table 2 Collaborative and Conference Tables

Rectangular Veneer Base Tables

► Product Information continued from previous page

Specification Information

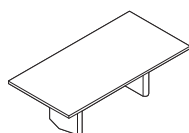

Dimensions		Style Number	Finish	Base Prices			
W	D			H	3 mm Plastic/ 3 mm Wood, Flat, or Convex Vinyl Edge:	Bullnose Wood Edge:	Beveled Wood Edge:

Rectangular Tables with Two Veneer Bases - Working Height

96"	48"	29"	COET2RECV	Grade 1 Laminate	\$9026	\$10,356	\$10,477	\$10,733
				Grade 2 and 3 Laminate	\$9258	\$10,588	\$10,709	\$10,965
				Grade 1 Wood Veneer	\$11,229	\$12,559	\$12,680	\$12,936
				Grade 2 Wood Veneer	\$12,114	\$13,444	\$13,565	\$13,821
96"	49" -54"	29"	COET2RECV	Grade 1 Laminate	\$9197	\$10,698	\$10,830	\$11,118
				Grade 2 and 3 Laminate	\$9455	\$10,956	\$11,088	\$11,376
				Grade 1 Wood Veneer	\$11,671	\$13,172	\$13,304	\$13,592
				Grade 2 Wood Veneer	\$12,596	\$14,097	\$14,229	\$14,517
96"	55" -60"	29"	COET2RECV	Grade 1 Laminate	\$9373	\$11,037	\$11,186	\$11,504
				Grade 2 and 3 Laminate	\$9657	\$11,321	\$11,470	\$11,788
				Grade 1 Wood Veneer	\$12,124	\$13,788	\$13,937	\$14,255
				Grade 2 Wood Veneer	\$13,089	\$14,753	\$14,902	\$15,220
97" -108"	48"	29"	COET2RECV	Grade 1 Laminate	\$9303	\$11,190	\$11,372	\$11,722
				Grade 2 and 3 Laminate	\$9560	\$11,447	\$11,629	\$11,979
				Grade 1 Wood Veneer	\$11,540	\$13,427	\$13,609	\$13,959
				Grade 2 Wood Veneer	\$12,540	\$14,427	\$14,609	\$14,959
97" -108"	49" -54"	29"	COET2RECV	Grade 1 Laminate	\$9534	\$11,660	\$11,862	\$12,254
				Grade 2 and 3 Laminate	\$9822	\$11,948	\$12,150	\$12,542
				Grade 1 Wood Veneer	\$12,150	\$14,276	\$14,478	\$14,870
				Grade 2 Wood Veneer	\$13,241	\$15,367	\$15,569	\$15,961
97" -108"	55" -60"	29"	COET2RECV	Grade 1 Laminate	\$9764	\$12,126	\$12,352	\$12,785
				Grade 2 and 3 Laminate	\$10,084	\$12,446	\$12,672	\$13,105
				Grade 1 Wood Veneer	\$12,761	\$15,123	\$15,349	\$15,782
				Grade 2 Wood Veneer	\$13,945	\$16,307	\$16,533	\$16,966

Tip: Top ships in one piece.

Tip: Tables are available parametrically in 1" increments.

E-Table 2 Collaborative and Conference Tables

► Product Information continued on next page

E-Table 2 Collaborative and Conference Tables

Rectangular Veneer Base Tables

► Product Information continued from previous page

Specification Information

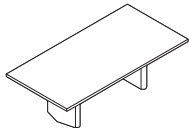

Dimensions		Style	Finish	Base Prices			
W	D	H	Number	Edge:			
				3 mm Plastic/ 3 mm Wood, Flat, or Convex Vinyl Edge:	Bullnose Wood Edge:	Beveled Wood Edge:	Knife Wood Edge:

Rectangular Tables with Two Veneer Bases - Working Height

W	D	H	Style Number	Finish	Grade 1	Grade 2 and 3	Grade 1 Veneer	Grade 2 Veneer
109" -120"	48"	29"	COET2RECV	Grade 1 Laminate	\$9404	\$11,847	\$12,092	\$12,534
				Grade 2 and 3 Laminate	\$9685	\$12,128	\$12,373	\$12,815
				Grade 1 Wood Veneer	\$11,674	\$14,117	\$14,362	\$14,804
				Grade 2 Wood Veneer	\$12,788	\$15,231	\$15,476	\$15,918
109" -120"	49" -54"	29"	COET2RECV	Grade 1 Laminate	\$9689	\$12,439	\$12,714	\$13,206
				Grade 2 and 3 Laminate	\$10,008	\$12,758	\$13,033	\$13,525
				Grade 1 Wood Veneer	\$12,446	\$15,196	\$15,471	\$15,963
				Grade 2 Wood Veneer	\$13,706	\$16,456	\$16,731	\$17,223
109" -120"	55" -60"	29"	COET2RECV	Grade 1 Laminate	\$9969	\$13,031	\$13,331	\$13,878
				Grade 2 and 3 Laminate	\$10,324	\$13,386	\$13,686	\$14,233
				Grade 1 Wood Veneer	\$13,211	\$16,273	\$16,573	\$17,120
				Grade 2 Wood Veneer	\$14,617	\$17,679	\$17,979	\$18,526

Tip: Tables are available parametrically in 1" increments.

► Product Information continued on next page

E-Table 2 Collaborative and Conference Tables

Rectangular Veneer Base Tables

► Product Information continued from previous page

Specification Information

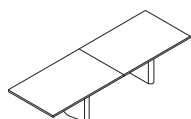

Dimensions		Style H Number	Finish	Base Prices				
W	D			3 mm Plastic/ 3 mm Wood, Flat, or Convex Vinyl Edge:	Bullnose Wood Edge:	Beveled Wood Edge:	Knife Wood Edge:	

Rectangular Tables with Two Veneer Bases - Working Height

Tip: Top ships in two pieces. Hardware is included for field assembly.

121" -132"	48"	29"	COET2RECV	Grade 1 Laminate	\$9433	\$12,444	\$12,716	\$13,235
				Grade 2 and 3 Laminate	\$9743	\$12,754	\$13,026	\$13,545
				Grade 1 Wood Veneer	\$12,226	\$15,237	\$15,509	\$16,028
				Grade 2 Wood Veneer	\$13,452	\$16,463	\$16,735	\$17,254

Tip: If you require your table top to be made into three pieces, this can be done as a special. Please contact Customer Service at 1.800.627.6770 to obtain a quote.

121" -132"	49" -54"	29"	COET2RECV	Grade 1 Laminate	\$9736	\$13,124	\$13,423	\$14,013
				Grade 2 and 3 Laminate	\$10,088	\$13,476	\$13,775	\$14,365
				Grade 1 Wood Veneer	\$13,126	\$16,514	\$16,813	\$17,403
				Grade 2 Wood Veneer	\$14,510	\$17,898	\$18,197	\$18,787

121" -132"	55" -60"	29"	COET2RECV	Grade 1 Laminate	\$10,037	\$13,804	\$14,135	\$14,790
				Grade 2 and 3 Laminate	\$10,428	\$14,195	\$14,526	\$15,181
				Grade 1 Wood Veneer	\$14,021	\$17,788	\$18,119	\$18,774
				Grade 2 Wood Veneer	\$15,566	\$19,333	\$19,664	\$20,319

Tip: Tables are available parametrically in 1" increments.

133" -144"	48"	29"	COET2RECV	Grade 1 Laminate	\$9461	\$13,038	\$13,338	\$13,935
				Grade 2 and 3 Laminate	\$9800	\$13,377	\$13,677	\$14,274
				Grade 1 Wood Veneer	\$12,777	\$16,354	\$16,654	\$17,251
				Grade 2 Wood Veneer	\$14,113	\$17,690	\$17,990	\$18,587

133" -144"	49" -54"	29"	COET2RECV	Grade 1 Laminate	\$9782	\$13,807	\$14,133	\$14,818
				Grade 2 and 3 Laminate	\$10,168	\$14,193	\$14,519	\$15,204
				Grade 1 Wood Veneer	\$13,805	\$17,830	\$18,156	\$18,841
				Grade 2 Wood Veneer	\$15,314	\$19,339	\$19,665	\$20,350

133" -144"	55" -60"	29"	COET2RECV	Grade 1 Laminate	\$10,103	\$14,574	\$14,938	\$15,697
				Grade 2 and 3 Laminate	\$10,531	\$15,002	\$15,366	\$16,125
				Grade 1 Wood Veneer	\$14,829	\$19,300	\$19,664	\$20,423
				Grade 2 Wood Veneer	\$16,515	\$20,986	\$21,350	\$22,109

► Product Information continued on next page

E-Table 2 Collaborative and Conference Tables

E-Table 2 Collaborative and Conference Tables

Rectangular Veneer Base Tables

► Product Information continued from previous page

Specification Information

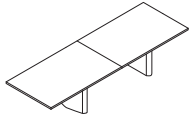

Dimensions		Style	Finish	Base Prices			
W	D	H	Number	Edge:			
				3 mm Plastic/ 3 mm Wood, Flat, or Convex Vinyl Edge:	Bullnose Wood Edge:	Beveled Wood Edge:	Knife Wood Edge:

Rectangular Tables with Two Veneer Bases - Working Height

Dimensions	Style	Finish	Grade 1 Laminate	Grade 2 and 3 Laminate	Grade 1 Wood Veneer	Grade 2 Wood Veneer
145" -156" 43" -48" 29"	COET2RECV	Grade 1 Laminate	\$10,931	\$15,441	\$15,729	\$16,506
		Grade 2 and 3 Laminate	\$11,288	\$15,798	\$16,086	\$16,863
		Grade 1 Wood Veneer	\$16,049	\$20,559	\$20,847	\$21,624
		Grade 2 Wood Veneer	\$17,503	\$22,013	\$22,301	\$23,078
145" -156" 49" -54" 29"	COET2RECV	Grade 1 Laminate	\$11,352	\$16,425	\$16,748	\$17,624
		Grade 2 and 3 Laminate	\$11,757	\$16,830	\$17,153	\$18,029
		Grade 1 Wood Veneer	\$17,394	\$22,467	\$22,790	\$23,666
		Grade 2 Wood Veneer	\$19,040	\$24,113	\$24,436	\$25,312
145" -156" 55" -60" 29"	COET2RECV	Grade 1 Laminate	\$11,770	\$17,409	\$17,763	\$18,738
		Grade 2 and 3 Laminate	\$12,219	\$17,858	\$18,212	\$19,187
		Grade 1 Wood Veneer	\$18,739	\$24,378	\$24,732	\$25,707
		Grade 2 Wood Veneer	\$20,578	\$26,217	\$26,571	\$27,546

► Product Information continued on next page

E-Table 2 Collaborative and Conference Tables

Rectangular Veneer Base Tables

► Product Information continued from previous page

Specification Information

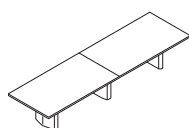

Dimensions		Style	Finish	Base Prices			
W	D	H	Number				
				3 mm Plastic/ 3 mm Wood, Flat, or Convex Vinyl Edge:	Bullnose Wood Edge:	Beveled Wood Edge:	Knife Wood Edge:

Rectangular Tables with Three Veneer Bases - Working Height

Tip: Top ships in two pieces. Hardware is included for field assembly.

157" -168"	48"	29"	COET2RECV	Grade 1 Laminate	\$14,014	\$19,457	\$19,733	\$20,687
				Grade 2 and 3 Laminate	\$14,391	\$19,834	\$20,110	\$21,064
				Grade 1 Wood Veneer	\$20,938	\$26,381	\$26,657	\$27,611
				Grade 2 Wood Veneer	\$22,504	\$27,947	\$28,223	\$29,177

Tip: For tables with three or more bases, you must specify the entry point of the base power infeed, either an end base or a mid base location, in order to receive the correct length of base power infeed.

157" -168"	49" -54"	29"	COET2RECV	Grade 1 Laminate	\$14,521	\$20,640	\$20,961	\$22,029
				Grade 2 and 3 Laminate	\$14,947	\$21,066	\$21,387	\$22,455
				Grade 1 Wood Veneer	\$22,588	\$28,707	\$29,028	\$30,096
				Grade 2 Wood Veneer	\$24,371	\$30,490	\$30,811	\$31,879

157" -168"	55" -60"	29"	COET2RECV	Grade 1 Laminate	\$15,030	\$21,835	\$22,181	\$23,370
				Grade 2 and 3 Laminate	\$15,499	\$22,304	\$22,650	\$23,839
				Grade 1 Wood Veneer	\$24,242	\$31,047	\$31,393	\$32,582
				Grade 2 Wood Veneer	\$26,235	\$33,040	\$33,386	\$34,575

Tip: If you require your table top to be made into three pieces, this can be done as a special. Please contact Customer Service at 1.800.627.6770 to obtain a quote.

169" -180"	48"	29"	COET2RECV	Grade 1 Laminate	\$14,065	\$19,626	\$19,903	\$20,873
				Grade 2 and 3 Laminate	\$14,470	\$20,031	\$20,308	\$21,278
				Grade 1 Wood Veneer	\$21,052	\$26,613	\$26,890	\$27,860
				Grade 2 Wood Veneer	\$22,730	\$28,291	\$28,568	\$29,538

169" -180"	49" -54"	29"	COET2RECV	Grade 1 Laminate	\$14,597	\$20,847	\$21,164	\$22,256
				Grade 2 and 3 Laminate	\$15,052	\$21,302	\$21,619	\$22,711
				Grade 1 Wood Veneer	\$22,738	\$28,988	\$29,305	\$30,397
				Grade 2 Wood Veneer	\$24,646	\$30,896	\$31,213	\$32,305

► Product Information continued on next page

E-Table 2 Collaborative and Conference Tables

Rectangular Veneer Base Tables

► Product Information continued from previous page

Specification Information

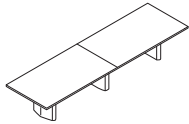

Dimensions		Style	Finish	Base Prices			
W	D	H	Number				

Rectangular Tables with Three Veneer Bases - Working Height

169" -180"	55" -60"	29"	COET2RECV	Grade 1 Laminate	\$15,125	\$22,077	\$22,427	\$23,631
				Grade 2 and 3 Laminate	\$15,627	\$22,579	\$22,929	\$24,133
				Grade 1 Wood Veneer	\$24,422	\$31,374	\$31,724	\$32,928
				Grade 2 Wood Veneer	\$26,551	\$33,503	\$33,853	\$35,057
181" -192"	48"	29"	COET2RECV	Grade 1 Laminate	\$14,115	\$19,788	\$20,073	\$21,060
				Grade 2 and 3 Laminate	\$14,547	\$20,220	\$20,505	\$21,492
				Grade 1 Wood Veneer	\$21,165	\$26,838	\$27,123	\$28,110
				Grade 2 Wood Veneer	\$22,955	\$28,628	\$28,913	\$29,900
181" -192"	49" -54"	29"	COET2RECV	Grade 1 Laminate	\$14,672	\$21,052	\$21,369	\$22,479
				Grade 2 and 3 Laminate	\$15,155	\$21,535	\$21,852	\$22,962
				Grade 1 Wood Veneer	\$22,887	\$29,267	\$29,584	\$30,694
				Grade 2 Wood Veneer	\$24,920	\$31,300	\$31,617	\$32,727
181" -192"	55" -60"	29"	COET2RECV	Grade 1 Laminate	\$15,218	\$22,311	\$22,665	\$23,890
				Grade 2 and 3 Laminate	\$15,755	\$22,848	\$23,202	\$24,427
				Grade 1 Wood Veneer	\$24,602	\$31,695	\$32,049	\$33,274
				Grade 2 Wood Veneer	\$26,867	\$33,960	\$34,314	\$35,539
193" -204"	48"	29"	COET2RECV	Grade 1 Laminate	\$14,284	\$20,132	\$20,443	\$21,513
				Grade 2 and 3 Laminate	\$14,741	\$20,589	\$20,900	\$21,970
				Grade 1 Wood Veneer	\$22,542	\$28,390	\$28,701	\$29,771
				Grade 2 Wood Veneer	\$24,444	\$30,292	\$30,603	\$31,673

Tip: Tables are available parametrically in 1" increments.

► Product Information continued on next page

E-Table 2 Collaborative and Conference Tables

Rectangular Veneer Base Tables

► Product Information continued from previous page

Specification Information

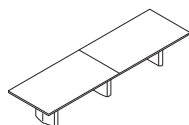

Dimensions		Style Number	Finish	Base Prices			
W	D			H			
				3 mm Plastic/ 3 mm Wood, Flat, or Convex Vinyl Edge:	Bullnose Wood Edge:	Beveled Wood Edge:	Knife Wood Edge:

Rectangular Tables with Three Veneer Bases - Working Height

193" -204"	49" -54"	29"	COET2RECV	Grade 1 Laminate	\$14,874	\$21,458	\$21,799	\$23,001
				Grade 2 and 3 Laminate	\$15,386	\$21,970	\$22,311	\$23,513
				Grade 1 Wood Veneer	\$24,445	\$31,029	\$31,370	\$32,572
				Grade 2 Wood Veneer	\$26,609	\$33,193	\$33,534	\$34,736
193" -204"	55" -60"	29"	COET2RECV	Grade 1 Laminate	\$15,461	\$22,786	\$23,155	\$24,491
				Grade 2 and 3 Laminate	\$16,031	\$23,356	\$23,725	\$25,061
				Grade 1 Wood Veneer	\$26,347	\$33,672	\$34,041	\$35,377
				Grade 2 Wood Veneer	\$28,764	\$36,089	\$36,458	\$37,794
205" -216"	48"	29"	COET2RECV	Grade 1 Laminate	\$14,452	\$20,471	\$20,811	\$21,963
				Grade 2 and 3 Laminate	\$14,935	\$20,954	\$21,294	\$22,446
				Grade 1 Wood Veneer	\$23,918	\$29,937	\$30,277	\$31,429
				Grade 2 Wood Veneer	\$25,932	\$31,951	\$32,291	\$33,443
205" -216"	49" -54"	29"	COET2RECV	Grade 1 Laminate	\$15,074	\$21,857	\$22,220	\$23,520
				Grade 2 and 3 Laminate	\$15,617	\$22,400	\$22,763	\$24,063
				Grade 1 Wood Veneer	\$26,002	\$32,785	\$33,148	\$34,448
				Grade 2 Wood Veneer	\$28,296	\$35,079	\$35,442	\$36,742
205" -216"	55" -60"	29"	COET2RECV	Grade 1 Laminate	\$15,701	\$23,248	\$23,646	\$25,088
				Grade 2 and 3 Laminate	\$16,304	\$23,851	\$24,249	\$25,691
				Grade 1 Wood Veneer	\$28,092	\$35,639	\$36,037	\$37,479
				Grade 2 Wood Veneer	\$30,659	\$38,206	\$38,604	\$40,046

Tip: Tables are available parametrically in 1" increments.

► Product Information continued on next page

E-Table 2 Collaborative and Conference Tables

Rectangular Veneer Base Tables

► Product Information continued from previous page

Specification Information

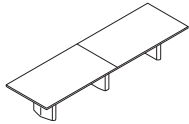

Dimensions		Style Number	Finish	Base Prices			
W	D			H	3 mm Plastic/ 3 mm Wood, Flat, or Convex Vinyl Edge:	Bullnose Wood Edge:	Beveled Wood Edge:

Rectangular Tables with Three Veneer Bases - Working Height

217" -228"	48"	29"	COET2RECV	Grade 1 Laminate	\$14,481	\$20,805	\$21,168	\$22,350
				Grade 2 and 3 Laminate	\$14,991	\$21,315	\$21,678	\$22,860
				Grade 1 Wood Veneer	\$24,620	\$30,944	\$31,307	\$32,489
				Grade 2 Wood Veneer	\$26,745	\$33,069	\$33,432	\$34,614
217" -228"	49" -54"	29"	COET2RECV	Grade 1 Laminate	\$15,120	\$22,243	\$22,640	\$23,973
				Grade 2 and 3 Laminate	\$15,693	\$22,816	\$23,213	\$24,546
				Grade 1 Wood Veneer	\$26,806	\$33,929	\$34,326	\$35,659
				Grade 2 Wood Veneer	\$29,222	\$36,345	\$36,742	\$38,075
217" -228"	55" -60"	29"	COET2RECV	Grade 1 Laminate	\$15,766	\$23,691	\$24,122	\$25,605
				Grade 2 and 3 Laminate	\$16,403	\$24,328	\$24,759	\$26,242
				Grade 1 Wood Veneer	\$29,002	\$36,927	\$37,358	\$38,841
				Grade 2 Wood Veneer	\$31,704	\$39,629	\$40,060	\$41,543
229" -240"	48"	29"	COET2RECV	Grade 1 Laminate	\$14,509	\$21,136	\$21,522	\$22,736
				Grade 2 and 3 Laminate	\$15,045	\$21,672	\$22,058	\$23,272
				Grade 1 Wood Veneer	\$25,322	\$31,949	\$32,335	\$33,549
				Grade 2 Wood Veneer	\$27,558	\$34,185	\$34,571	\$35,785
229" -240"	49" -54"	29"	COET2RECV	Grade 1 Laminate	\$15,166	\$22,630	\$23,061	\$24,423
				Grade 2 and 3 Laminate	\$15,767	\$23,231	\$23,662	\$25,024
				Grade 1 Wood Veneer	\$27,608	\$35,072	\$35,503	\$36,865
				Grade 2 Wood Veneer	\$30,147	\$37,611	\$38,042	\$39,404
229" -240"	55" -60"	29"	COET2RECV	Grade 1 Laminate	\$15,829	\$24,135	\$24,597	\$26,116
				Grade 2 and 3 Laminate	\$16,502	\$24,808	\$25,270	\$26,789
				Grade 1 Wood Veneer	\$29,910	\$38,216	\$38,678	\$40,197
				Grade 2 Wood Veneer	\$32,748	\$41,054	\$41,516	\$43,035

Tip: Tables are available parametrically in 1" increments.

► Product Information continued on next page

E-Table 2 Collaborative and Conference Tables

Rectangular Veneer Base Tables

► Product Information continued from previous page

Specification Information

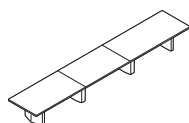

Dimensions		Style Number	Finish	Base Prices			
W	D			H			
				3 mm Plastic/ 3 mm Wood, Flat, or Convex Vinyl Edge:	Bullnose Wood Edge:	Beveled Wood Edge:	Knife Wood Edge:

Rectangular Tables with Four Veneer Bases - Working Height

Tip: Top ships in three pieces. Hardware is included for field assembly.

Dimensions	Style Number	Finish	Grade 1 Laminate	Grade 2 and 3 Laminate	Grade 1 Wood Veneer	Grade 2 Wood Veneer
241" -252" 48"	29" COET2RECV		\$18,038	\$18,596	\$30,771	\$33,121
		Grade 1 Laminate	\$18,038	\$25,711	\$26,111	\$27,494
		Grade 2 and 3 Laminate	\$18,596	\$26,269	\$26,669	\$28,052
		Grade 1 Wood Veneer	\$30,771	\$38,444	\$38,844	\$40,227
		Grade 2 Wood Veneer	\$33,121	\$40,794	\$41,194	\$42,577

Tip: For tables with three or more bases, you must specify the entry point of the base power infeed, either an end base or a mid base location, in order to receive the correct length of base power infeed.

Dimensions	Style Number	Finish	Grade 1 Laminate	Grade 2 and 3 Laminate	Grade 1 Wood Veneer	Grade 2 Wood Veneer
241" -252" 49" -54"	29" COET2RECV		\$18,811	\$19,438	\$33,410	\$36,077
		Grade 1 Laminate	\$18,811	\$27,433	\$27,883	\$29,456
		Grade 2 and 3 Laminate	\$19,438	\$28,060	\$28,510	\$30,083
		Grade 1 Wood Veneer	\$33,410	\$42,032	\$42,482	\$44,055
		Grade 2 Wood Veneer	\$36,077	\$44,699	\$45,149	\$46,722

Tip: If you require your table top to be made into four pieces, this can be done as a special. Please contact Customer Service at 1.800.627.6770 to obtain a quote.

Dimensions	Style Number	Finish	Grade 1 Laminate	Grade 2 and 3 Laminate	Grade 1 Wood Veneer	Grade 2 Wood Veneer
241" -252" 55" -60"	29" COET2RECV		\$19,576	\$20,274	\$36,051	\$39,035
		Grade 1 Laminate	\$19,576	\$29,190	\$29,655	\$31,398
		Grade 2 and 3 Laminate	\$20,274	\$29,888	\$30,353	\$32,096
		Grade 1 Wood Veneer	\$36,051	\$45,665	\$46,130	\$47,873
		Grade 2 Wood Veneer	\$39,035	\$48,649	\$49,114	\$50,857

Dimensions	Style Number	Finish	Grade 1 Laminate	Grade 2 and 3 Laminate	Grade 1 Wood Veneer	Grade 2 Wood Veneer
253" -264" 48"	29" COET2RECV		\$19,408	\$19,992	\$34,065	\$36,529
		Grade 1 Laminate	\$19,408	\$28,127	\$28,539	\$30,095
		Grade 2 and 3 Laminate	\$19,992	\$28,711	\$29,123	\$30,679
		Grade 1 Wood Veneer	\$34,065	\$42,784	\$43,196	\$44,752
		Grade 2 Wood Veneer	\$36,529	\$45,248	\$45,660	\$47,216

Dimensions	Style Number	Finish	Grade 1 Laminate	Grade 2 and 3 Laminate	Grade 1 Wood Veneer	Grade 2 Wood Veneer
253" -264" 49" -54"	29" COET2RECV		\$20,283	\$20,937	\$37,038	\$39,832
		Grade 1 Laminate	\$20,283	\$30,064	\$30,536	\$32,316
		Grade 2 and 3 Laminate	\$20,937	\$30,718	\$31,190	\$32,970
		Grade 1 Wood Veneer	\$37,038	\$46,819	\$47,291	\$49,071
		Grade 2 Wood Veneer	\$39,832	\$49,613	\$50,085	\$51,865

► Product Information continued on next page

E-Table 2 Collaborative and Conference Tables

Rectangular Veneer Base Tables

► Product Information continued from previous page

Specification Information

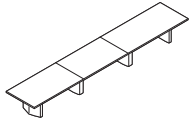

Dimensions		Style	Finish	Base Prices			
W	D	H	Number				
				3 mm Plastic/ 3 mm Wood, Flat, or Convex Vinyl Edge:	Bullnose Wood Edge:	Beveled Wood Edge:	Knife Wood Edge:

Rectangular Tables with Four Veneer Bases - Working Height

253" -264"	55" -60"	29"	COET2RECV	Grade 1 Laminate	\$21,139	\$32,062	\$32,526	\$34,494
				Grade 2 and 3 Laminate	\$21,866	\$32,789	\$33,253	\$35,221
				Grade 1 Wood Veneer	\$40,009	\$50,932	\$51,396	\$53,364
				Grade 2 Wood Veneer	\$43,137	\$54,060	\$54,524	\$56,492
265" -276"	48"	29"	COET2RECV	Grade 1 Laminate	\$19,470	\$28,370	\$28,801	\$30,295
				Grade 2 and 3 Laminate	\$20,078	\$28,978	\$29,409	\$30,903
				Grade 1 Wood Veneer	\$34,224	\$43,124	\$43,555	\$45,049
				Grade 2 Wood Veneer	\$36,804	\$45,704	\$46,135	\$47,629
265" -276"	49" -54"	29"	COET2RECV	Grade 1 Laminate	\$20,371	\$30,325	\$30,774	\$32,562
				Grade 2 and 3 Laminate	\$21,054	\$31,008	\$31,457	\$33,245
				Grade 1 Wood Veneer	\$37,204	\$47,158	\$47,607	\$49,395
				Grade 2 Wood Veneer	\$40,134	\$50,088	\$50,537	\$52,325
265" -276"	55" -60"	29"	COET2RECV	Grade 1 Laminate	\$21,216	\$32,349	\$32,754	\$34,740
				Grade 2 and 3 Laminate	\$21,975	\$33,108	\$33,513	\$35,499
				Grade 1 Wood Veneer	\$40,194	\$51,327	\$51,732	\$53,718
				Grade 2 Wood Veneer	\$43,478	\$54,611	\$55,016	\$57,002
277" -288"	48"	29"	COET2RECV	Grade 1 Laminate	\$19,529	\$28,608	\$29,067	\$30,490
				Grade 2 and 3 Laminate	\$20,161	\$29,240	\$29,699	\$31,122
				Grade 1 Wood Veneer	\$34,380	\$43,459	\$43,918	\$45,341
				Grade 2 Wood Veneer	\$37,077	\$46,156	\$46,615	\$48,038

Tip: Tables are available parametrically in 1" increments.

► Product Information continued on next page





E-Table 2 Collaborative and Conference Tables

Rectangular Veneer Base Tables

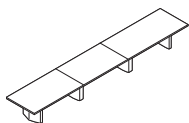
► Product Information continued from previous page

Specification Information



Dimensions		Style	Finish	Base Prices					
W	D	H	Number						
									
				3 mm Plastic/ 3 mm Wood, Flat, or Convex Vinyl Edge:		Bullnose Wood Edge:	Beveled Wood Edge:	Knife Wood Edge:	

Rectangular Tables with Four Veneer Bases - Working Height

277" -288"	49" -54"	29"	COET2RECV	Grade 1 Laminate	\$20,457	\$30,587	\$31,013	\$32,806
				Grade 2 and 3 Laminate	\$21,170	\$31,300	\$31,726	\$33,519
				Grade 1 Wood Veneer	\$37,367	\$47,497	\$47,923	\$49,716
				Grade 2 Wood Veneer	\$40,435	\$50,565	\$50,991	\$52,784
277" -288"	55" -60"	29"	COET2RECV	Grade 1 Laminate	\$21,292	\$32,636	\$32,983	\$34,987
				Grade 2 and 3 Laminate	\$22,084	\$33,428	\$33,775	\$35,779
				Grade 1 Wood Veneer	\$40,377	\$51,721	\$52,068	\$54,072
				Grade 2 Wood Veneer	\$43,818	\$55,162	\$55,509	\$57,513

E-Table 2
Collaborative and
Conference Tables

E-Table 2 Collaborative and Conference Tables

Soft Radiused Aluminum Base Tables-Working Height

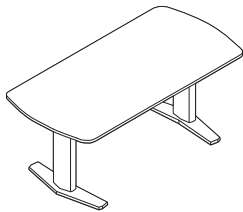

Tip: Shipped knocked down.

Tip: Soft radiused tables are not available with beveled or knife wood edge.

Tip: Utility bay quantity offering by table width is available in the understanding section.

Tip: 3 mm vinyl edge profiles on tables require a 4" radius on all corners.

Tip: A flat, plastic edge can be specified on veneer tops by selecting the "flat" edge option. Flat edge is only available in 6000 Black on veneer tops.

Tip: If you specify a wood edge on a top with woodgrain laminate, the edge and the top may not match.

Tip: Sectioned top option is a two piece top and is only available on tops 96"W-120"W.

Tip: When a wood edge is specified on a wood veneer top, the edge finish will match the top finish.

Tip: Each utility bay comes with two universal faceplate openings that accept customer-supplied faceplates in any of the following sizes: single-gang, double-gang, or triple-gang.

Standard Includes

- Top:
 - 1 1/4" particle board core with grade 1 laminate
 - parametric width in 1" increments ranging from 60"-288"
 - For tables with widths up to 144", parametric depth is in 1" increments ranging from 36"-60".
 - For tables with widths from 145"-288", parametric depth is in 1" increments ranging from 43"-60".
- Edge: 3 mm plastic edge, 3 mm wood edge, or convex vinyl edge
- Bases: cast and extruded aluminum with powder coat
- Wireway: painted steel side panels with powder coat and black plastic access door
- Concealed leveling glides: non-marring, black plastic
- Overall height: 29"

Options

Sectioned Top	No Sectioned Top	No cost
	With Sectioned Top	+\$569
Top Finish	Laminate Price Group 02	Price below
	Laminate Price Group 03	Price below
	Veneer Price Group 01	Price below
	Veneer Price Group 02	Price below
Edge Type	3mm Plastic Edge	Price below
	3mm Wood Edge	Price below
	Bullnose Wood Edge	Price below
	Convex Vinyl Edge	Price below
Bay Option	No Bays	No cost
	One Bay	+\$789
	Two Bays	+\$1578
	Three Bays	+\$2367
	Four Bays	+\$3156
	Six Bays	+\$4734
	Seven Bays	+\$5523
Wiring Schematic	1+1 Hardwire, 2 Circuits	No cost
	3 + 0 Wireway	No cost
	Chicago Wireway	No cost
	1+1 Hardwire, 2 Circuits, USB	+\$157
	3 + 0 Wireway, USB	+\$157
Infeed	Hardwire	No cost
	NYC Hardwire Infeed	No cost
	Plug	No cost
Infeed Location	End Base Power Infeed	No cost
	Mid Base Power Infeed	No cost

► Product Information continued on next page



E-Table 2 Collaborative and Conference Tables

Soft Radiused Aluminum Base Tables-Working Height

► Product Information continued from previous page

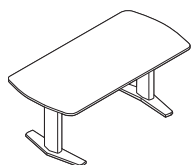
Specification Information



Dimensions		Style Number	Finish	Base Prices	
W	D			H	
			  		
			3 mm Plastic/ 3 mm Bullnose Wood Edge, Flat Edge, Wood or Convex Vinyl Edge: Edge:		

Soft Radiused Tables with Two Aluminum Bases - Working Height

60" -71"	36"	29"	COET2SFTA	Grade 1 Laminate	\$4423	\$4914
				Grade 2 and 3 Laminate	\$4542	\$5033
				Grade 1 Wood Veneer	\$5287	\$5778
				Grade 2 Wood Veneer	\$5670	\$6161
60" -71"	37" -42"	29"	COET2SFTA	Grade 1 Laminate	\$4952	\$6004
				Grade 2 and 3 Laminate	\$5098	\$6150
				Grade 1 Wood Veneer	\$6702	\$7754
				Grade 2 Wood Veneer	\$7075	\$8127
60" -71"	43" -48"	29"	COET2SFTA	Grade 1 Laminate	\$5066	\$6105
				Grade 2 and 3 Laminate	\$5248	\$6287
				Grade 1 Wood Veneer	\$6731	\$7770
				Grade 2 Wood Veneer	\$7163	\$8202
60" -71"	49" -54"	29"	COET2SFTA	Grade 1 Laminate	\$5562	\$6631
				Grade 2 and 3 Laminate	\$5744	\$6813
				Grade 1 Wood Veneer	\$7250	\$8319
				Grade 2 Wood Veneer	\$7771	\$8840
60" -71"	55" -60"	29"	COET2SFTA	Grade 1 Laminate	\$6031	\$7131
				Grade 2 and 3 Laminate	\$6239	\$7339
				Grade 1 Wood Veneer	\$7768	\$8868
				Grade 2 Wood Veneer	\$8378	\$9478
72"	36"	29"	COET2SFTA	Grade 1 Laminate	\$4625	\$5549
				Grade 2 and 3 Laminate	\$4758	\$5682
				Grade 1 Wood Veneer	\$6183	\$7107
				Grade 2 Wood Veneer	\$6675	\$7599

Tip: Top ships in one piece.

Tip: For 60"W - 95"W tables, if you require your table top to be made into two pieces, this can be done as a special. Please contact Customer Service at 1.800.627.6770 to obtain a quote.

Tip: Tables are available parametrically in 1" increments.

► Product Information continued on next page

E-Table 2 Collaborative and Conference Tables

Soft Radiused Aluminum Base Tables-Working Height

► Product Information continued from previous page

Specification Information

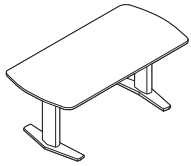

Dimensions		Style Number	Finish	Base Prices	
W	D			H	

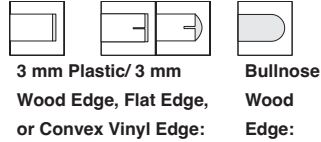

Soft Radiused Tables with Two Aluminum Bases - Working Height

72"	37" -42"	29"	COET2SFTA	Grade 1 Laminate	\$4995	\$6175
				Grade 2 and 3 Laminate	\$5141	\$6321
				Grade 1 Wood Veneer	\$6933	\$8113
				Grade 2 Wood Veneer	\$7451	\$8631
72"	43" -48"	29"	COET2SFTA	Grade 1 Laminate	\$5110	\$6276
				Grade 2 and 3 Laminate	\$5287	\$6453
				Grade 1 Wood Veneer	\$6954	\$8120
				Grade 2 Wood Veneer	\$7522	\$8688
72"	49" -54"	29"	COET2SFTA	Grade 1 Laminate	\$5627	\$6824
				Grade 2 and 3 Laminate	\$5830	\$7027
				Grade 1 Wood Veneer	\$7523	\$8720
				Grade 2 Wood Veneer	\$8179	\$9376
72"	55" -60"	29"	COET2SFTA	Grade 1 Laminate	\$6094	\$7322
				Grade 2 and 3 Laminate	\$6325	\$7553
				Grade 1 Wood Veneer	\$8041	\$9269
				Grade 2 Wood Veneer	\$8785	\$10,013
73" -84"	36"	29"	COET2SFTA	Grade 1 Laminate	\$4870	\$6226
				Grade 2 and 3 Laminate	\$5016	\$6372
				Grade 1 Wood Veneer	\$7115	\$8471
				Grade 2 Wood Veneer	\$7723	\$9079
73" -84"	37" -42"	29"	COET2SFTA	Grade 1 Laminate	\$5055	\$6362
				Grade 2 and 3 Laminate	\$5232	\$6539
				Grade 1 Wood Veneer	\$7212	\$8519
				Grade 2 Wood Veneer	\$7870	\$9177

Tip: Tables are available parametrically in 1" increments.

► Product Information continued on next page

E-Table 2 Collaborative and Conference Tables

Soft Radiused Aluminum Base Tables-Working Height

► Product Information continued from previous page

Specification Information

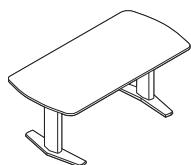

Dimensions		Style Number	Finish	Base Prices	
W	D			H	
				3 mm Plastic/ 3 mm	Bullnose
				Wood Edge, Flat Edge,	Wood
				or Convex Vinyl Edge:	Edge:

Soft Radiused Tables with Two Aluminum Bases - Working Height

73" -84"	43" -48"	29"	COET2SFTA	Grade 1 Laminate	\$5170	\$6464
				Grade 2 and 3 Laminate	\$5369	\$6663
				Grade 1 Wood Veneer	\$7227	\$8521
				Grade 2 Wood Veneer	\$7929	\$9223
73" -84"	49" -54"	29"	COET2SFTA	Grade 1 Laminate	\$5689	\$7016
				Grade 2 and 3 Laminate	\$5917	\$7244
				Grade 1 Wood Veneer	\$7796	\$9123
				Grade 2 Wood Veneer	\$8588	\$9915
73" -84"	55" -60"	29"	COET2SFTA	Grade 1 Laminate	\$6156	\$7513
				Grade 2 and 3 Laminate	\$6410	\$7767
				Grade 1 Wood Veneer	\$8315	\$9672
				Grade 2 Wood Veneer	\$9195	\$10,552
85" -96"	36"	29"	COET2SFTA	Grade 1 Laminate	\$5155	\$6432
				Grade 2 and 3 Laminate	\$5326	\$6603
				Grade 1 Wood Veneer	\$7253	\$8530
				Grade 2 Wood Veneer	\$7954	\$9231
85" -96"	37" -42"	29"	COET2SFTA	Grade 1 Laminate	\$5617	\$6925
				Grade 2 and 3 Laminate	\$5815	\$7123
				Grade 1 Wood Veneer	\$7766	\$9074
				Grade 2 Wood Veneer	\$8556	\$9864
85" -96"	43" -48"	29"	COET2SFTA	Grade 1 Laminate	\$6082	\$7412
				Grade 2 and 3 Laminate	\$6314	\$7644
				Grade 1 Wood Veneer	\$8285	\$9615
				Grade 2 Wood Veneer	\$9170	\$10,500

Tip: Tables are available parametrically in 1" increments.

► Product Information continued on next page

E-Table 2 Collaborative and Conference Tables

Soft Radiused Aluminum Base Tables-Working Height

► Product Information continued from previous page

Specification Information

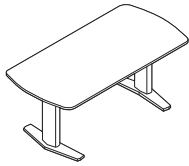

Dimensions		Style Number	Finish	Base Prices	
W	D			H	

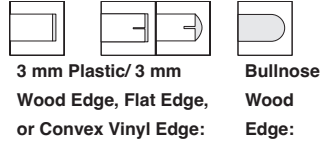

Soft Radiused Tables with Two Aluminum Bases - Working Height

85" -96"	49" -54"	29"	COET2SFTA	Grade 1 Laminate	\$6258	\$7759
				Grade 2 and 3 Laminate	\$6516	\$8017
				Grade 1 Wood Veneer	\$8732	\$10,233
				Grade 2 Wood Veneer	\$9657	\$11,158
85" -96"	55" -60"	29"	COET2SFTA	Grade 1 Laminate	\$6435	\$8099
				Grade 2 and 3 Laminate	\$6719	\$8383
				Grade 1 Wood Veneer	\$9186	\$10,850
				Grade 2 Wood Veneer	\$10,151	\$11,815
97" -108"	36"	29"	COET2SFTA	Grade 1 Laminate	\$5671	\$6970
				Grade 2 and 3 Laminate	\$5876	\$7175
				Grade 1 Wood Veneer	\$7822	\$9121
				Grade 2 Wood Veneer	\$8620	\$9919
97" -108"	37" -42"	29"	COET2SFTA	Grade 1 Laminate	\$5850	\$7329
				Grade 2 and 3 Laminate	\$6075	\$7554
				Grade 1 Wood Veneer	\$8271	\$9750
				Grade 2 Wood Veneer	\$9097	\$10,576
97" -108"	43" -48"	29"	COET2SFTA	Grade 1 Laminate	\$6331	\$8218
				Grade 2 and 3 Laminate	\$6588	\$8475
				Grade 1 Wood Veneer	\$8566	\$10,453
				Grade 2 Wood Veneer	\$9568	\$11,455
97" -108"	49" -54"	29"	COET2SFTA	Grade 1 Laminate	\$6567	\$8693
				Grade 2 and 3 Laminate	\$6855	\$8981
				Grade 1 Wood Veneer	\$9184	\$11,310
				Grade 2 Wood Veneer	\$10,274	\$12,400

Tip: Tables are available parametrically in 1" increments.

► Product Information continued on next page

E-Table 2 Collaborative and Conference Tables

Soft Radiused Aluminum Base Tables-Working Height

► Product Information continued from previous page

Specification Information

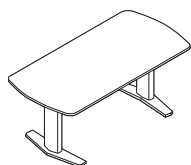

Dimensions		Style Number	Finish	Base Prices	
W	D			H	
				3 mm Plastic/ 3 mm Wood Edge, Flat Edge, or Convex Vinyl Edge:	Bullnose Wood Edge:

Soft Radiused Tables with Two Aluminum Bases - Working Height

97" -108"	55" -60"	29"	COET2SFTA	Grade 1 Laminate	\$6801	\$9163
				Grade 2 and 3 Laminate	\$7117	\$9479
				Grade 1 Wood Veneer	\$9796	\$12,158
				Grade 2 Wood Veneer	\$10,981	\$13,343
109" -120"	36"	29"	COET2SFTA	Grade 1 Laminate	\$5808	\$7605
				Grade 2 and 3 Laminate	\$6024	\$7821
				Grade 1 Wood Veneer	\$7884	\$9681
				Grade 2 Wood Veneer	\$8731	\$10,528
109" -120"	37" -42"	29"	COET2SFTA	Grade 1 Laminate	\$6287	\$8493
				Grade 2 and 3 Laminate	\$6538	\$8744
				Grade 1 Wood Veneer	\$8180	\$10,386
				Grade 2 Wood Veneer	\$9203	\$11,409
109" -120"	43" -48"	29"	COET2SFTA	Grade 1 Laminate	\$6461	\$8904
				Grade 2 and 3 Laminate	\$6742	\$9185
				Grade 1 Wood Veneer	\$8731	\$11,174
				Grade 2 Wood Veneer	\$9845	\$12,288
109" -120"	49" -54"	29"	COET2SFTA	Grade 1 Laminate	\$6750	\$9500
				Grade 2 and 3 Laminate	\$7069	\$9819
				Grade 1 Wood Veneer	\$9507	\$12,257
				Grade 2 Wood Veneer	\$10,767	\$13,517
109" -120"	55" -60"	29"	COET2SFTA	Grade 1 Laminate	\$7033	\$10,095
				Grade 2 and 3 Laminate	\$7388	\$10,450
				Grade 1 Wood Veneer	\$10,275	\$13,337
				Grade 2 Wood Veneer	\$11,681	\$14,743

► Product Information continued on next page

E-Table 2 Collaborative and Conference Tables

Soft Radiused Aluminum Base Tables-Working Height

► Product Information continued from previous page

Specification Information

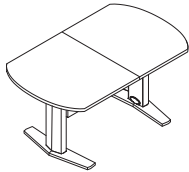

Dimensions		Style Number	Finish	Base Prices	
W	D			H	

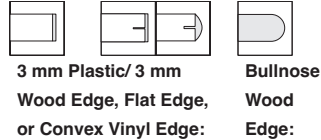

Soft Radiused Tables with Two Aluminum Bases - Working Height

Tip: Top ships in two pieces. Hardware is included for field assembly.

121" -132"	36"	29"	COET2SFTA	Grade 1 Laminate	\$5893	\$8316
				Grade 2 and 3 Laminate	\$6150	\$8573
				Grade 1 Wood Veneer	\$8599	\$11,022
				Grade 2 Wood Veneer	\$9624	\$12,047

Tip: If you require your table top to be made into three pieces, this can be done as a special. Please contact Customer Service at 1.800.627.6770 to obtain a quote.

121" -132"	37" -42"	29"	COET2SFTA	Grade 1 Laminate	\$6071	\$8675
				Grade 2 and 3 Laminate	\$6348	\$8952
				Grade 1 Wood Veneer	\$9047	\$11,651
				Grade 2 Wood Veneer	\$10,100	\$12,704

121" -132"	43" -48"	29"	COET2SFTA	Grade 1 Laminate	\$6491	\$9502
				Grade 2 and 3 Laminate	\$6801	\$9812
				Grade 1 Wood Veneer	\$9284	\$12,295
				Grade 2 Wood Veneer	\$10,509	\$13,520

121" -132"	49" -54"	29"	COET2SFTA	Grade 1 Laminate	\$6797	\$10,185
				Grade 2 and 3 Laminate	\$7150	\$10,538
				Grade 1 Wood Veneer	\$10,187	\$13,575
				Grade 2 Wood Veneer	\$11,571	\$14,959

121" -132"	55" -60"	29"	COET2SFTA	Grade 1 Laminate	\$7099	\$10,866
				Grade 2 and 3 Laminate	\$7492	\$11,259
				Grade 1 Wood Veneer	\$11,083	\$14,850
				Grade 2 Wood Veneer	\$12,630	\$16,397

133" -144"	36"	29"	COET2SFTA	Grade 1 Laminate	\$5922	\$8913
				Grade 2 and 3 Laminate	\$6208	\$9199
				Grade 1 Wood Veneer	\$9149	\$12,140
				Grade 2 Wood Veneer	\$10,286	\$13,277

Tip: Tables are available parametrically in 1" increments.

► Product Information continued on next page

E-Table 2 Collaborative and Conference Tables

Soft Radiused Aluminum Base Tables-Working Height

► Product Information continued from previous page

Specification Information

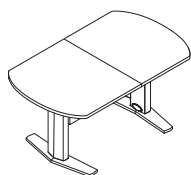

Dimensions		Style Number	Finish	Base Prices	
W	D			H	
				3 mm Plastic/ 3 mm	Bullnose
				Wood Edge, Flat Edge,	Wood
				or Convex Vinyl Edge:	Edge:

Soft Radiused Tables with Two Aluminum Bases - Working Height

133" -144"	37" -42"	29"	COET2SFTA	Grade 1 Laminate	\$6101	\$9273
				Grade 2 and 3 Laminate	\$6407	\$9579
				Grade 1 Wood Veneer	\$9600	\$12,772
				Grade 2 Wood Veneer	\$10,765	\$13,937
133" -144"	43" -48"	29"	COET2SFTA	Grade 1 Laminate	\$6519	\$10,096
				Grade 2 and 3 Laminate	\$6858	\$10,435
				Grade 1 Wood Veneer	\$9835	\$13,412
				Grade 2 Wood Veneer	\$11,171	\$14,748
133" -144"	49" -54"	29"	COET2SFTA	Grade 1 Laminate	\$6844	\$10,869
				Grade 2 and 3 Laminate	\$7230	\$11,255
				Grade 1 Wood Veneer	\$10,867	\$14,892
				Grade 2 Wood Veneer	\$12,376	\$16,401
133" -144"	55" -60"	29"	COET2SFTA	Grade 1 Laminate	\$7164	\$11,635
				Grade 2 and 3 Laminate	\$7592	\$12,063
				Grade 1 Wood Veneer	\$11,890	\$16,361
				Grade 2 Wood Veneer	\$13,576	\$18,047
145" -156"	43" -48"	29"	COET2SFTA	Grade 1 Laminate	\$7954	\$12,464
				Grade 2 and 3 Laminate	\$8311	\$12,821
				Grade 1 Wood Veneer	\$13,076	\$17,586
				Grade 2 Wood Veneer	\$14,526	\$19,036
145" -156"	49" -54"	29"	COET2SFTA	Grade 1 Laminate	\$8376	\$13,449
				Grade 2 and 3 Laminate	\$8781	\$13,854
				Grade 1 Wood Veneer	\$14,423	\$19,496
				Grade 2 Wood Veneer	\$16,068	\$21,141

Tip: Table widths starting at 145" will only have a parametric depth range of 43"-60".

► Product Information continued on next page

E-Table 2 Collaborative and Conference Tables

Soft Radiused Aluminum Base Tables-Working Height

► Product Information continued from previous page

Specification Information

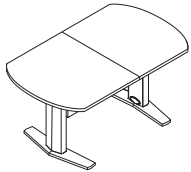

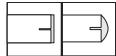
Dimensions		Style	Finish	Base Prices	
W	D	H	Number		
					
				3 mm Plastic/ 3 mm	Bullnose
				Wood Edge, Flat Edge,	Wood
				or Convex Vinyl Edge:	Edge:

Soft Radiused Tables with Two Aluminum Bases - Working Height

145" -156"	55" -60"	29"	COET2SFTA	Grade 1 Laminate	\$8796	\$14,435
				Grade 2 and 3 Laminate	\$9244	\$14,883
				Grade 1 Wood Veneer	\$15,766	\$21,405
				Grade 2 Wood Veneer	\$17,605	\$23,244

► Product Information continued on next page

E-Table 2 Collaborative and Conference Tables

Soft Radiused Aluminum Base Tables-Working Height

► Product Information continued from previous page

Specification Information

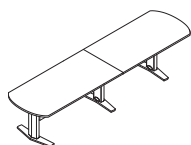

Dimensions		Style Number	Finish	Base Prices	
W	D			H	
				3 mm Plastic/ 3 mm Wood Edge, Flat Edge, or Convex Vinyl Edge:	Bullnose Wood Edge:

Soft Radiused Tables with Three Aluminum Bases - Working Height

Tip: Top ships in two pieces. Hardware is included for field assembly.

157" -168"	43" -48"	29"	COET2SFTA	Grade 1 Laminate	\$9594	\$15,037
				Grade 2 and 3 Laminate	\$9971	\$15,414
				Grade 1 Wood Veneer	\$16,518	\$21,961
				Grade 2 Wood Veneer	\$18,084	\$23,527

Tip: For tables with three or more bases, you must specify the entry point of the base power infeed, either an end base or a mid base location, in order to receive the correct length of base power infeed.

157" -168"	49" -54"	29"	COET2SFTA	Grade 1 Laminate	\$10,106	\$16,225
				Grade 2 and 3 Laminate	\$10,532	\$16,651
				Grade 1 Wood Veneer	\$18,173	\$24,292
				Grade 2 Wood Veneer	\$19,956	\$26,075

157" -168"	55" -60"	29"	COET2SFTA	Grade 1 Laminate	\$10,615	\$17,420
				Grade 2 and 3 Laminate	\$11,084	\$17,889
				Grade 1 Wood Veneer	\$19,827	\$26,632
				Grade 2 Wood Veneer	\$21,820	\$28,625

Tip: If you require your table top to be made into three pieces, this can be done as a special. Please contact Customer Service at 1.800.627.6770 to obtain a quote.

169" -180"	43" -48"	29"	COET2SFTA	Grade 1 Laminate	\$9647	\$15,205
				Grade 2 and 3 Laminate	\$10,051	\$15,609
				Grade 1 Wood Veneer	\$16,633	\$22,191
				Grade 2 Wood Veneer	\$18,312	\$23,870

169" -180"	49" -54"	29"	COET2SFTA	Grade 1 Laminate	\$10,181	\$16,432
				Grade 2 and 3 Laminate	\$10,635	\$16,886
				Grade 1 Wood Veneer	\$18,322	\$24,573
				Grade 2 Wood Veneer	\$20,212	\$26,463

169" -180"	55" -60"	29"	COET2SFTA	Grade 1 Laminate	\$10,708	\$17,658
				Grade 2 and 3 Laminate	\$11,211	\$18,161
				Grade 1 Wood Veneer	\$20,006	\$26,956
				Grade 2 Wood Veneer	\$22,135	\$29,085

► Product Information continued on next page

E-Table 2 Collaborative and Conference Tables

Soft Radiused Aluminum Base Tables-Working Height

► Product Information continued from previous page

Specification Information

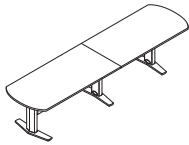

Dimensions		Style Number	Finish	Base Prices	
W	D			H	

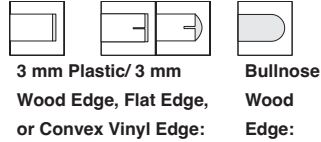

Soft Radiused Tables with Three Aluminum Bases - Working Height

181" -192"	43" -48"	29"	COET2SFTA	Grade 1 Laminate	\$9699	\$15,372
				Grade 2 and 3 Laminate	\$10,131	\$15,804
				Grade 1 Wood Veneer	\$16,749	\$22,422
				Grade 2 Wood Veneer	\$18,539	\$24,212
181" -192"	49" -54"	29"	COET2SFTA	Grade 1 Laminate	\$10,255	\$16,635
				Grade 2 and 3 Laminate	\$10,738	\$17,118
				Grade 1 Wood Veneer	\$18,470	\$24,850
				Grade 2 Wood Veneer	\$20,503	\$26,883
181" -192"	55" -60"	29"	COET2SFTA	Grade 1 Laminate	\$10,801	\$17,894
				Grade 2 and 3 Laminate	\$11,338	\$18,431
				Grade 1 Wood Veneer	\$20,185	\$27,278
				Grade 2 Wood Veneer	\$22,450	\$29,543
193" -204"	43" -48"	29"	COET2SFTA	Grade 1 Laminate	\$9869	\$15,717
				Grade 2 and 3 Laminate	\$10,326	\$16,174
				Grade 1 Wood Veneer	\$18,127	\$23,975
				Grade 2 Wood Veneer	\$20,029	\$25,877
193" -204"	49" -54"	29"	COET2SFTA	Grade 1 Laminate	\$10,455	\$17,035
				Grade 2 and 3 Laminate	\$10,969	\$17,549
				Grade 1 Wood Veneer	\$20,028	\$26,608
				Grade 2 Wood Veneer	\$22,177	\$28,757
193" -204"	55" -60"	29"	COET2SFTA	Grade 1 Laminate	\$11,040	\$18,362
				Grade 2 and 3 Laminate	\$11,610	\$18,932
				Grade 1 Wood Veneer	\$21,927	\$29,249
				Grade 2 Wood Veneer	\$24,343	\$31,665

Tip: Tables are available parametrically in 1" increments.

► Product Information continued on next page

E-Table 2 Collaborative and Conference Tables

Soft Radiused Aluminum Base Tables-Working Height

► Product Information continued from previous page

Specification Information

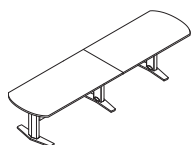

Dimensions		Style Number	Finish	Base Prices	
W	D			H	

Soft Radiused Tables with Three Aluminum Bases - Working Height

205" -216"	43" -48"	29"	COET2SFTA	Grade 1 Laminate	\$10,038	\$16,057
				Grade 2 and 3 Laminate	\$10,521	\$16,540
				Grade 1 Wood Veneer	\$19,504	\$25,523
				Grade 2 Wood Veneer	\$21,518	\$27,537
205" -216"	49" -54"	29"	COET2SFTA	Grade 1 Laminate	\$10,656	\$17,439
				Grade 2 and 3 Laminate	\$11,199	\$17,982
				Grade 1 Wood Veneer	\$21,584	\$28,367
				Grade 2 Wood Veneer	\$23,878	\$30,661
205" -216"	55" -60"	29"	COET2SFTA	Grade 1 Laminate	\$11,278	\$18,825
				Grade 2 and 3 Laminate	\$11,881	\$19,428
				Grade 1 Wood Veneer	\$23,669	\$31,216
				Grade 2 Wood Veneer	\$26,236	\$33,783
217" -228"	43" -48"	29"	COET2SFTA	Grade 1 Laminate	\$10,065	\$16,389
				Grade 2 and 3 Laminate	\$10,574	\$16,898
				Grade 1 Wood Veneer	\$20,204	\$26,528
				Grade 2 Wood Veneer	\$22,330	\$28,654
217" -228"	49" -54"	29"	COET2SFTA	Grade 1 Laminate	\$10,704	\$17,828
				Grade 2 and 3 Laminate	\$11,276	\$18,400
				Grade 1 Wood Veneer	\$22,390	\$29,514
				Grade 2 Wood Veneer	\$24,805	\$31,929
217" -228"	55" -60"	29"	COET2SFTA	Grade 1 Laminate	\$11,342	\$19,270
				Grade 2 and 3 Laminate	\$11,980	\$19,908
				Grade 1 Wood Veneer	\$24,578	\$32,506
				Grade 2 Wood Veneer	\$27,281	\$35,209

Tip: Tables are available parametrically in 1" increments.

► Product Information continued on next page

E-Table 2 Collaborative and Conference Tables

Soft Radiused Aluminum Base Tables-Working Height

► Product Information continued from previous page

Specification Information

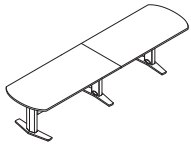

Dimensions		Style H	Style Number	Finish	Base Prices	
W	D				3 mm Plastic/ 3 mm Wood Edge, Flat Edge, or Convex Vinyl Edge:	Bullnose Wood Edge:

Soft Radiused Tables with Three Aluminum Bases - Working Height

229" -240"	43" -48"	29"	COET2SFTA	Grade 1 Laminate	\$10,091	\$16,718
				Grade 2 and 3 Laminate	\$10,627	\$17,254
				Grade 1 Wood Veneer	\$20,904	\$27,531
				Grade 2 Wood Veneer	\$23,140	\$29,767
229" -240"	49" -54"	29"	COET2SFTA	Grade 1 Laminate	\$10,752	\$18,216
				Grade 2 and 3 Laminate	\$11,353	\$18,817
				Grade 1 Wood Veneer	\$23,194	\$30,658
				Grade 2 Wood Veneer	\$25,733	\$33,197
229" 240"	55" -60"	29"	COET2SFTA	Grade 1 Laminate	\$11,406	\$19,712
				Grade 2 and 3 Laminate	\$12,079	\$20,385
				Grade 1 Wood Veneer	\$25,487	\$33,793
				Grade 2 Wood Veneer	\$28,325	\$36,631

► Product Information continued on next page

E-Table 2 Collaborative and Conference Tables

Soft Radiused Aluminum Base Tables-Working Height

► Product Information continued from previous page

Specification Information

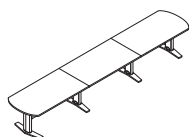

Dimensions		Style Number	Finish	Base Prices	
W	D			H	
				3 mm Plastic/ 3 mm Wood Edge, Flat Edge, or Convex Vinyl Edge:	Bullnose Wood Edge:

Soft Radiused Tables with Four Aluminum Bases - Working Height

Tip: Top ships in three pieces. Hardware is included for field assembly.

241" -252"	43" -48"	29"	COET2SFTA	Grade 1 Laminate	\$12,094	\$19,768
				Grade 2 and 3 Laminate	\$12,653	\$20,327
				Grade 1 Wood Veneer	\$24,828	\$32,502
				Grade 2 Wood Veneer	\$27,177	\$34,851

Tip: For tables with three or more bases, you must specify the entry point of the base power infeed, either an end base or a mid base location, in order to receive the correct length of base power infeed.

241" -252"	49" -54"	29"	COET2SFTA	Grade 1 Laminate	\$12,867	\$21,489
				Grade 2 and 3 Laminate	\$13,494	\$22,116
				Grade 1 Wood Veneer	\$27,467	\$36,089
				Grade 2 Wood Veneer	\$30,131	\$38,753

241" -252"	55" -60"	29"	COET2SFTA	Grade 1 Laminate	\$13,630	\$23,244
				Grade 2 and 3 Laminate	\$14,329	\$23,943
				Grade 1 Wood Veneer	\$30,105	\$39,719
				Grade 2 Wood Veneer	\$33,089	\$42,703

253" -264"	43" -48"	29"	COET2SFTA	Grade 1 Laminate	\$13,521	\$22,240
				Grade 2 and 3 Laminate	\$14,105	\$22,824
				Grade 1 Wood Veneer	\$28,178	\$36,897
				Grade 2 Wood Veneer	\$30,642	\$39,361

Tip: If you require your table top to be made into four pieces, this can be done as a special. Please contact Customer Service at 1.800.627.6770 to obtain a quote.

253" -264"	49" -54"	29"	COET2SFTA	Grade 1 Laminate	\$14,392	\$24,173
				Grade 2 and 3 Laminate	\$15,046	\$24,827
				Grade 1 Wood Veneer	\$31,147	\$40,928
				Grade 2 Wood Veneer	\$33,941	\$43,722

253" -264"	55" -60"	29"	COET2SFTA	Grade 1 Laminate	\$15,249	\$26,172
				Grade 2 and 3 Laminate	\$15,976	\$26,899
				Grade 1 Wood Veneer	\$34,119	\$45,042
				Grade 2 Wood Veneer	\$37,247	\$48,170

► Product Information continued on next page

E-Table 2 Collaborative and Conference Tables

E-Table 2 Collaborative and Conference Tables

Soft Radiused Aluminum Base Tables-Working Height

► Product Information continued from previous page

Specification Information

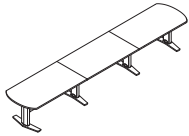

Dimensions		Style Number	Finish	Base Prices	
W	D			H	

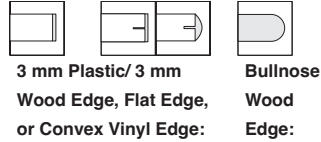

Soft Radiused Tables with Four Aluminum Bases - Working Height

Tip: Tables are available parametrically in 1" increments.

265" -276"	43" -48"	29"	COET2SFTA	Grade 1 Laminate	\$13,580	\$22,480
				Grade 2 and 3 Laminate	\$14,188	\$23,088
				Grade 1 Wood Veneer	\$28,335	\$37,235
				Grade 2 Wood Veneer	\$30,915	\$39,815
265" -276"	49" -54"	29"	COET2SFTA	Grade 1 Laminate	\$14,482	\$24,437
				Grade 2 and 3 Laminate	\$15,165	\$25,120
				Grade 1 Wood Veneer	\$31,315	\$41,270
				Grade 2 Wood Veneer	\$34,245	\$44,200
265" -276"	55" -60"	29"	COET2SFTA	Grade 1 Laminate	\$15,325	\$26,459
				Grade 2 and 3 Laminate	\$16,085	\$27,219
				Grade 1 Wood Veneer	\$34,303	\$45,437
				Grade 2 Wood Veneer	\$37,588	\$48,722
277" -288"	43" -48"	29"	COET2SFTA	Grade 1 Laminate	\$13,638	\$22,717
				Grade 2 and 3 Laminate	\$14,270	\$23,349
				Grade 1 Wood Veneer	\$28,489	\$37,568
				Grade 2 Wood Veneer	\$31,186	\$40,265
277" -288"	49" -54"	29"	COET2SFTA	Grade 1 Laminate	\$14,570	\$24,700
				Grade 2 and 3 Laminate	\$15,283	\$25,413
				Grade 1 Wood Veneer	\$31,480	\$41,610
				Grade 2 Wood Veneer	\$34,548	\$44,678
277" -288"	55" -60"	29"	COET2SFTA	Grade 1 Laminate	\$15,401	\$26,745
				Grade 2 and 3 Laminate	\$16,193	\$27,537
				Grade 1 Wood Veneer	\$34,486	\$45,830
				Grade 2 Wood Veneer	\$37,927	\$49,271

E-Table 2 Collaborative and Conference Tables

Soft Radiused Aluminum Base Tables-Working Height

E-Table 2
Collaborative and
Conference Tables

E-Table 2 Collaborative and Conference Tables

Soft Radiused Aluminum Base Tables-Standing Height

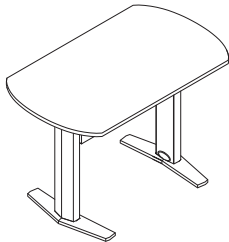

Tip: Shipped knocked down.

Tip: Soft radiused tables are not available with beveled or knife wood edge.

Tip: Utility bay quantity offering by table width is available in the understanding section.

Tip: 3 mm vinyl edge profiles on tables require a 4" radius on all corners.

Tip: A flat, plastic edge can be specified on veneer tops by selecting the "flat" edge option. Flat edge is only available in 6000 Black on veneer tops.

Tip: If you specify a wood edge on a top with woodgrain laminate, the edge and the top may not match.

Tip: Sectioned top option is a two piece top and is only available on tops 96"W-120"W.

Tip: When a wood edge is specified on a wood veneer top, the edge finish will match the top finish.

Tip: Each utility bay comes with two universal faceplate openings that accept customer-supplied faceplates in any of the following sizes: single-gang, double-gang, or triple-gang.

Standard Includes

- Top:
 - 1 1/4" particle board core with grade 1 laminate
 - parametric width in 1" increments ranging from 60"-120"
 - parametric depth in 1" increments ranging from 36"-60"
- Edge: 3 mm plastic edge, 3 mm wood edge, or convex vinyl edge
- Bases: cast and extruded aluminum with powder coat
- Wireway: painted steel side panels with powder coat and black plastic access door
- Concealed leveling glides: non-marring, black plastic
- Overall height: 40"

Options

Sectioned Top	No Sectioned Top	No cost
	With Sectioned Top	+\$569
Top Finish	Laminate Price Group 02	Price below
	Laminate Price Group 03	Price below
	Veneer Price Group 01	Price below
	Veneer Price Group 02	Price below
Edge Type	3mm Plastic Edge	Price below
	3mm Wood Edge	Price below
	Bullnose Wood Edge	Price below
	Convex Vinyl Edge	Price below
Bay Option	No Bays	No cost
	One Bay	+\$789
	Two Bays	+\$1578
	Three Bays	+\$2367
Wiring Schematic	1+1 Hardwire, 2 Circuits	No cost
	3 + 0 Wireway	No cost
	Chicago Wireway	No cost
	1+1 Hardwire,2 Circuits,USB	+\$157
	3 + 0 Wireway,USB	+\$157
Infeed	Hardwire	No cost
	NYC Hardwire Infeed	No cost
	Plug	No cost

► Product Information continued on next page

E-Table 2 Collaborative and Conference Tables

Soft Radiused Aluminum Base Tables-Standing Height

► Product Information continued from previous page

Specification Information



Dimensions		Style Number	Finish	Base Prices	
W	D			H	
					
				3 mm Plastic/ 3 mm Wood, Flat, or Convex Vinyl Edge:	Bullnose Wood Edge:

Soft Radiused Tables with Two Aluminum Bases - Standing Height

60" -71"	36"	40"	COET2SFTSTA	Grade 1 Laminate	\$4909	\$5400
				Grade 2 and 3 Laminate	\$5028	\$5519
				Grade 1 Wood Veneer	\$5774	\$6265
				Grade 2 Wood Veneer	\$6160	\$6651
60" -71"	37" -42"	40"	COET2SFTSTA	Grade 1 Laminate	\$5469	\$6521
				Grade 2 and 3 Laminate	\$5584	\$6636
				Grade 1 Wood Veneer	\$7187	\$8239
				Grade 2 Wood Veneer	\$7562	\$8614
60" -71"	43" -48"	40"	COET2SFTSTA	Grade 1 Laminate	\$5583	\$6622
				Grade 2 and 3 Laminate	\$5737	\$6776
				Grade 1 Wood Veneer	\$7215	\$8254
				Grade 2 Wood Veneer	\$7649	\$8688
60" -71"	49" -54"	40"	COET2SFTSTA	Grade 1 Laminate	\$6050	\$7119
				Grade 2 and 3 Laminate	\$6230	\$7299
				Grade 1 Wood Veneer	\$7734	\$8803
				Grade 2 Wood Veneer	\$8257	\$9326
60" -71"	55" -60"	40"	COET2SFTSTA	Grade 1 Laminate	\$6517	\$7617
				Grade 2 and 3 Laminate	\$6725	\$7825
				Grade 1 Wood Veneer	\$8253	\$9353
				Grade 2 Wood Veneer	\$8866	\$9966
72"	36"	40"	COET2SFTSTA	Grade 1 Laminate	\$5155	\$6079
				Grade 2 and 3 Laminate	\$5289	\$6213
				Grade 1 Wood Veneer	\$6712	\$7636
				Grade 2 Wood Veneer	\$7206	\$8130

Tip: Top ships in one piece.

Tip: For 60"W - 95"W tables, if you require your table top to be made into two pieces, this can be done as a special. Please contact Customer Service at 1.800.627.6770 to obtain a quote.

Tip: Tables are available parametrically in 1" increments.

► Product Information continued on next page

E-Table 2 Collaborative and Conference Tables

Soft Radiused Aluminum Base Tables-Standing Height

► Product Information continued from previous page

Specification Information

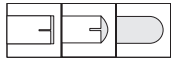

Dimensions		Style	Finish	Base Prices	
W	D	H	Number		
					
				3 mm Plastic/ 3 mm Wood, Flat, or Convex Vinyl Edge:	Bullnose Wood Edge:

Soft Radiused Tables with Two Aluminum Bases - Standing Height

W	D	H	Style Number	Finish	Price	Price
72"	37" -42"	40"	COET2SFTSTA	Grade 1 Laminate	\$5530	\$6710
				Grade 2 and 3 Laminate	\$5677	\$6857
				Grade 1 Wood Veneer	\$7469	\$8649
				Grade 2 Wood Veneer	\$7985	\$9165
72"	43" -48"	40"	COET2SFTSTA	Grade 1 Laminate	\$5644	\$6810
				Grade 2 and 3 Laminate	\$5822	\$6988
				Grade 1 Wood Veneer	\$7489	\$8655
				Grade 2 Wood Veneer	\$8057	\$9223
72"	49" -54"	40"	COET2SFTSTA	Grade 1 Laminate	\$6112	\$7309
				Grade 2 and 3 Laminate	\$6315	\$7512
				Grade 1 Wood Veneer	\$8009	\$9206
				Grade 2 Wood Veneer	\$8664	\$9861
72"	55" -60"	40"	COET2SFTSTA	Grade 1 Laminate	\$6580	\$7808
				Grade 2 and 3 Laminate	\$6810	\$8038
				Grade 1 Wood Veneer	\$8529	\$9757
				Grade 2 Wood Veneer	\$9274	\$10,502
73" -84"	36"	40"	COET2SFTSTA	Grade 1 Laminate	\$5402	\$6758
				Grade 2 and 3 Laminate	\$5550	\$6906
				Grade 1 Wood Veneer	\$7650	\$9006
				Grade 2 Wood Veneer	\$8256	\$9612

► Product Information continued on next page

E-Table 2 Collaborative and Conference Tables

Soft Radiused Aluminum Base Tables-Standing Height

► Product Information continued from previous page

Specification Information



Dimensions		Style Number	Finish	Base Prices	
W	D			H	

Soft Radiused Tables with Two Aluminum Bases - Standing Height

W	D	H	Style Number	Finish	Price	Price
73" -84"	37" -42"	40"	COET2SFTSTA	Grade 1 Laminate	\$5592	\$6899
				Grade 2 and 3 Laminate	\$5768	\$7075
				Grade 1 Wood Veneer	\$7749	\$9056
				Grade 2 Wood Veneer	\$8409	\$9716
73" -84"	43" -48"	40"	COET2SFTSTA	Grade 1 Laminate	\$5706	\$7000
				Grade 2 and 3 Laminate	\$5906	\$7200
				Grade 1 Wood Veneer	\$7764	\$9058
				Grade 2 Wood Veneer	\$8467	\$9761
73" -84"	49" -54"	40"	COET2SFTSTA	Grade 1 Laminate	\$6175	\$7502
				Grade 2 and 3 Laminate	\$6403	\$7730
				Grade 1 Wood Veneer	\$8282	\$9609
				Grade 2 Wood Veneer	\$9073	\$10,400
73" -84"	55" -60"	40"	COET2SFTSTA	Grade 1 Laminate	\$6642	\$7999
				Grade 2 and 3 Laminate	\$6896	\$8253
				Grade 1 Wood Veneer	\$8803	\$10,160
				Grade 2 Wood Veneer	\$9682	\$11,039
85"-96"	36"	40"	COET2SFTSTA	Grade 1 Laminate	\$5690	\$6967
				Grade 2 and 3 Laminate	\$5861	\$7138
				Grade 1 Wood Veneer	\$7788	\$9065
				Grade 2 Wood Veneer	\$8488	\$9765

Tip: Tables are available parametrically in 1" increments.

► Product Information continued on next page

E-Table 2 Collaborative and Conference Tables

Soft Radiused Aluminum Base Tables-Standing Height

► Product Information continued from previous page

Specification Information



Dimensions		Style	Finish	Base Prices	
W	D	H Number			

Soft Radiused Tables with Two Aluminum Bases - Standing Height

Dimensions	Style	Finish	Base Price	Edge Price
85"-96" 37" -42" 40"	COET2SFTSTA	Grade 1 Laminate	\$6157	\$7465
		Grade 2 and 3 Laminate	\$6355	\$7663
		Grade 1 Wood Veneer	\$8305	\$9613
		Grade 2 Wood Veneer	\$9096	\$10,404
85"-96" 43" -48" 40"	COET2SFTSTA	Grade 1 Laminate	\$6626	\$7956
		Grade 2 and 3 Laminate	\$6857	\$8187
		Grade 1 Wood Veneer	\$8830	\$10,160
		Grade 2 Wood Veneer	\$9716	\$11,046
85"-96" 49" -54" 40"	COET2SFTSTA	Grade 1 Laminate	\$6808	\$8309
		Grade 2 and 3 Laminate	\$7064	\$8565
		Grade 1 Wood Veneer	\$9280	\$10,781
		Grade 2 Wood Veneer	\$10,207	\$11,708
85"-96" 55" -60" 40"	COET2SFTSTA	Grade 1 Laminate	\$6984	\$8648
		Grade 2 and 3 Laminate	\$7269	\$8933
		Grade 1 Wood Veneer	\$9737	\$11,401
		Grade 2 Wood Veneer	\$10,701	\$12,365
97" -108" 36" 40"	COET2SFTSTA	Grade 1 Laminate	\$6159	\$7458
		Grade 2 and 3 Laminate	\$6362	\$7661
		Grade 1 Wood Veneer	\$8309	\$9608
		Grade 2 Wood Veneer	\$9106	\$10,405

► Product Information continued on next page

E-Table 2 Collaborative and Conference Tables

Soft Radiused Aluminum Base Tables-Standing Height

► Product Information continued from previous page

Specification Information



Dimensions		Style Number	Finish	Base Prices	
W	D			H	

Soft Radiused Tables with Two Aluminum Bases - Standing Height

97" -108"	37" -42"	40"	COET2SFTSTA	Grade 1 Laminate	\$6336	\$7815
				Grade 2 and 3 Laminate	\$6562	\$8041
				Grade 1 Wood Veneer	\$8759	\$10,238
				Grade 2 Wood Veneer	\$9587	\$11,066
97" -108"	43" -48"	40"	COET2SFTSTA	Grade 1 Laminate	\$6819	\$8706
				Grade 2 and 3 Laminate	\$7076	\$8963
				Grade 1 Wood Veneer	\$9055	\$10,942
				Grade 2 Wood Veneer	\$10,055	\$11,942
97" -108"	49" -54"	40"	COET2SFTSTA	Grade 1 Laminate	\$7057	\$9183
				Grade 2 and 3 Laminate	\$7344	\$9470
				Grade 1 Wood Veneer	\$9672	\$11,798
				Grade 2 Wood Veneer	\$10,760	\$12,886
97" -108"	55" -60"	40"	COET2SFTSTA	Grade 1 Laminate	\$7286	\$9648
				Grade 2 and 3 Laminate	\$7606	\$9968
				Grade 1 Wood Veneer	\$10,283	\$12,645
				Grade 2 Wood Veneer	\$11,468	\$13,830
109" -120"	36"	40"	COET2SFTSTA	Grade 1 Laminate	\$6293	\$8090
				Grade 2 and 3 Laminate	\$6511	\$8308
				Grade 1 Wood Veneer	\$8371	\$10,168
				Grade 2 Wood Veneer	\$9219	\$11,016

Tip: Tables are available parametrically in 1" increments.

► Product Information continued on next page

E-Table 2 Collaborative and Conference Tables

Soft Radiused Aluminum Base Tables-Standing Height

► Product Information continued from previous page

Specification Information

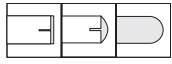

Dimensions		Style	Finish	Base Prices	
W	D	H Number			
					
				3 mm Plastic/ 3 mm Wood, Flat, or Convex Vinyl Edge:	Bullnose Wood Edge:

Soft Radiused Tables with Two Aluminum Bases - Standing Height

109" -120"	37" -42"	40"	COET2SFTSTA	Grade 1 Laminate	\$6773	\$8979
				Grade 2 and 3 Laminate	\$7024	\$9230
				Grade 1 Wood Veneer	\$8668	\$10,874
				Grade 2 Wood Veneer	\$9691	\$11,897
109" -120"	43" -48"	40"	COET2SFTSTA	Grade 1 Laminate	\$7010	\$9453
				Grade 2 and 3 Laminate	\$7292	\$9735
				Grade 1 Wood Veneer	\$9280	\$11,723
				Grade 2 Wood Veneer	\$10,394	\$12,837
109" -120"	49" -54"	40"	COET2SFTSTA	Grade 1 Laminate	\$7301	\$10,051
				Grade 2 and 3 Laminate	\$7620	\$10,370
				Grade 1 Wood Veneer	\$10,057	\$12,807
				Grade 2 Wood Veneer	\$11,316	\$14,066
109" -120"	55" -60"	40"	COET2SFTSTA	Grade 1 Laminate	\$7587	\$10,649
				Grade 2 and 3 Laminate	\$7943	\$11,005
				Grade 1 Wood Veneer	\$10,828	\$13,890
				Grade 2 Wood Veneer	\$12,233	\$15,295

E-Table 2 Collaborative and Conference Tables

Soft Radiused Aluminum Base Tables-Standing Height

E-Table 2
Collaborative and
Conference Tables

E-Table 2 Collaborative and Conference Tables

Soft Radiused Laminate Base Tables

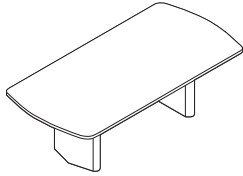

Tip: Shipped knocked down.

Tip: Soft radiused tables are not available with beveled or knife wood edge.

Tip: Utility bay quantity offering by table width is available in the understanding section.

Tip: 3 mm vinyl edge profiles on tables require a 4" radius on all corners.

Tip: A flat, plastic edge can be specified on veneer tops by selecting the "flat" edge option. Flat edge is only available in 6000 Black on veneer tops.

Tip: If you specify a wood edge on a top with woodgrain laminate, the edge and the top may not match.

Tip: Sectioned top option is a two piece top and is only available on tops 96"W-120"W.

Tip: When a wood edge is specified on a wood veneer top, the edge finish will match the top finish.

Tip: Each utility bay comes with two universal faceplate openings that accept customer-supplied faceplates in any of the following sizes: single-gang, double-gang, or triple-gang.

Standard Includes

- Top:
 - 1 1/4" particle board core with grade 1 laminate
 - parametric width in 1" increments ranging from 96"-288"
 - parametric depth in 1" increments ranging from 48"-60"
- Edge: 3 mm plastic edge, 3 mm wood edge, or convex vinyl edge
- Bases: black laminate on MDF core
- Wireway: painted steel side panels with powder coat and black plastic access door
- Concealed leveling glides: non-marring, black plastic
- Overall height: 29"

Options

Sectioned Top	No Sectioned Top	No cost
	With Sectioned Top	+\$569
Top Finish	Laminate Price Group 02	Price below
	Laminate Price Group 03	Price below
	Veneer Price Group 01	Price below
	Veneer Price Group 02	Price below
Edge Type	3mm Plastic Edge	Price below
	3mm Wood Edge	Price below
	Bullnose Wood Edge	Price below
	Convex Vinyl Edge	Price below
Base Type	Black HPL	No cost
	Curated HPL	+\$873
Bay Option	No Bays	No cost
	Two Bays	+\$1578
	Three Bays	+\$2367
	Four Bays	+\$3156
	Six Bays	+\$4734
	Seven Bays	+\$5523
Wiring Schematic	1+1 Hardwire, 2 Circuits	No cost
	3 + 0 Wireway	No cost
	Chicago Wireway	No cost
	1+1 Hardwire,2 Circuits,USB	+\$157
Infeed	3 + 0 Wireway,USB	+\$157
	Hardwire	No cost
	NYC Hardwire Infeed	No cost
Infeed Location	Plug	No cost
	End Base Power Infeed	No cost
	Mid Base Power Infeed	No cost

► **Product Information continued on next page**

E-Table 2 Collaborative and Conference Tables

Soft Radiused Laminate Base Tables

► Product Information continued from previous page

Specification Information

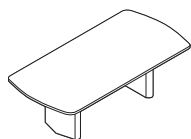

Dimensions		Style Number	Finish	Base Prices	
W	D			H	
				3 mm Plastic/ 3 mm	Bullnose
				Wood Edge, Flat Edge,	Wood
				or Convex Vinyl Edge:	Edge:

Soft Radiused Tables with Two Laminate Bases - Working Height

96"	48"	29"	COET2SFTL	Grade 1 Laminate	\$5871	\$7201
				Grade 2 and 3 Laminate	\$6103	\$7433
				Grade 1 Wood Veneer	\$8074	\$9404
				Grade 2 Wood Veneer	\$8959	\$10,289
96"	49" -54"	29"	COET2SFTL	Grade 1 Laminate	\$6047	\$7548
				Grade 2 and 3 Laminate	\$6305	\$7806
				Grade 1 Wood Veneer	\$8521	\$10,022
				Grade 2 Wood Veneer	\$9446	\$10,947
96"	55" -60"	29"	COET2SFTL	Grade 1 Laminate	\$6224	\$7888
				Grade 2 and 3 Laminate	\$6508	\$8172
				Grade 1 Wood Veneer	\$8975	\$10,639
				Grade 2 Wood Veneer	\$9940	\$11,604
97" -108"	48"	29"	COET2SFTL	Grade 1 Laminate	\$6119	\$8006
				Grade 2 and 3 Laminate	\$6374	\$8261
				Grade 1 Wood Veneer	\$8353	\$10,240
				Grade 2 Wood Veneer	\$9353	\$11,240
97" -108"	49" -54"	29"	COET2SFTL	Grade 1 Laminate	\$6353	\$8479
				Grade 2 and 3 Laminate	\$6641	\$8767
				Grade 1 Wood Veneer	\$8969	\$11,095
				Grade 2 Wood Veneer	\$10,060	\$12,186
97" -108"	55" -60"	29"	COET2SFTL	Grade 1 Laminate	\$6585	\$8947
				Grade 2 and 3 Laminate	\$6904	\$9266
				Grade 1 Wood Veneer	\$9584	\$11,946
				Grade 2 Wood Veneer	\$10,768	\$13,130

Tip: Top ships in one piece.

Tip: Tables are available parametrically in 1" increments.

E-Table 2
Collaborative and
Conference Tables

► Product Information continued on next page

E-Table 2 Collaborative and Conference Tables

Soft Radiused Laminate Base Tables

► Product Information continued from previous page

Specification Information

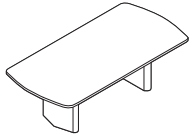

Dimensions		Style Number	Finish	Base Prices	
W	D			H	
				3 mm Plastic/ 3 mm	Bullnose
				Wood Edge, Flat Edge,	Wood
				or Convex Vinyl Edge:	Edge:

Soft Radiused Tables with Two Laminate Bases - Working Height

Dimensions	Style Number	Finish	Grade 1 Price	Grade 2 Price
109" -120" 48" 29"	COET2SFTL	Grade 1 Laminate	\$6250	\$8693
		Grade 2 and 3 Laminate	\$6531	\$8974
		Grade 1 Wood Veneer	\$8520	\$10,963
		Grade 2 Wood Veneer	\$9634	\$12,077
109" -120" 49" -54" 29"	COET2SFTL	Grade 1 Laminate	\$6539	\$9289
		Grade 2 and 3 Laminate	\$6858	\$9608
		Grade 1 Wood Veneer	\$9296	\$12,046
		Grade 2 Wood Veneer	\$10,556	\$13,306
109" -120" 55" -60" 29"	COET2SFTL	Grade 1 Laminate	\$6822	\$9884
		Grade 2 and 3 Laminate	\$7177	\$10,239
		Grade 1 Wood Veneer	\$10,064	\$13,126
		Grade 2 Wood Veneer	\$11,470	\$14,532

Tip: Tables are available parametrically in 1" increments.

► Product Information continued on next page

E-Table 2 Collaborative and Conference Tables

Soft Radiused Laminate Base Tables

► Product Information continued from previous page

Specification Information

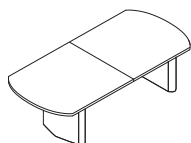

Dimensions		Style Number	Finish	Base Prices	
W	D			H	
				3 mm Plastic/ 3 mm Wood Edge, Flat Edge, or Convex Vinyl Edge:	Bullnose Wood Edge:

Soft Radiused Tables with Two Laminate Bases - Working Height

Tip: Top ships in two pieces. Hardware is included for field assembly.

Dimensions	Style Number	Finish	Grade 1 Laminate	Grade 2 and 3 Laminate	Grade 1 Wood Veneer	Grade 2 Wood Veneer
121" -132" 48" 29"	COET2SFTL	Grade 1 Laminate	\$6279	\$9290	\$9072	\$12,083
		Grade 2 and 3 Laminate	\$6589	\$9600	\$9072	\$12,083
		Grade 1 Wood Veneer	\$9072	\$12,083	\$9072	\$12,083
		Grade 2 Wood Veneer	\$10,297	\$13,308	\$9072	\$12,083

Tip: If you require your table top to be made into three pieces, this can be done as a special. Please contact Customer Service at 1.800.627.6770 to obtain a quote.

Dimensions	Style Number	Finish	Grade 1 Laminate	Grade 2 and 3 Laminate	Grade 1 Wood Veneer	Grade 2 Wood Veneer
121" -132" 49" -54" 29"	COET2SFTL	Grade 1 Laminate	\$6586	\$9974	\$9976	\$13,364
		Grade 2 and 3 Laminate	\$6939	\$10,327	\$9976	\$13,364
		Grade 1 Wood Veneer	\$9976	\$13,364	\$9976	\$13,364
		Grade 2 Wood Veneer	\$11,360	\$14,748	\$9976	\$13,364

Dimensions	Style Number	Finish	Grade 1 Laminate	Grade 2 and 3 Laminate	Grade 1 Wood Veneer	Grade 2 Wood Veneer
121" -132" 55" -60" 29"	COET2SFTL	Grade 1 Laminate	\$6888	\$10,655	\$10,872	\$14,639
		Grade 2 and 3 Laminate	\$7280	\$11,047	\$10,872	\$14,639
		Grade 1 Wood Veneer	\$10,872	\$14,639	\$10,872	\$14,639
		Grade 2 Wood Veneer	\$12,418	\$16,185	\$10,872	\$14,639

Tip: Tables are available parametrically in 1" increments.

Dimensions	Style Number	Finish	Grade 1 Laminate	Grade 2 and 3 Laminate	Grade 1 Wood Veneer	Grade 2 Wood Veneer
133" -144" 48" 29"	COET2SFTL	Grade 1 Laminate	\$6308	\$9885	\$9624	\$13,201
		Grade 2 and 3 Laminate	\$6647	\$10,224	\$9624	\$13,201
		Grade 1 Wood Veneer	\$9624	\$13,201	\$9624	\$13,201
		Grade 2 Wood Veneer	\$10,960	\$14,537	\$9624	\$13,201

Dimensions	Style Number	Finish	Grade 1 Laminate	Grade 2 and 3 Laminate	Grade 1 Wood Veneer	Grade 2 Wood Veneer
133" -144" 49" -54" 29"	COET2SFTL	Grade 1 Laminate	\$6633	\$10,658	\$10,656	\$14,681
		Grade 2 and 3 Laminate	\$7019	\$11,044	\$10,656	\$14,681
		Grade 1 Wood Veneer	\$10,656	\$14,681	\$10,656	\$14,681
		Grade 2 Wood Veneer	\$12,165	\$16,190	\$10,656	\$14,681

Dimensions	Style Number	Finish	Grade 1 Laminate	Grade 2 and 3 Laminate	Grade 1 Wood Veneer	Grade 2 Wood Veneer
133" -144" 55" -60" 29"	COET2SFTL	Grade 1 Laminate	\$6953	\$11,424	\$11,679	\$16,150
		Grade 2 and 3 Laminate	\$7381	\$11,852	\$11,679	\$16,150
		Grade 1 Wood Veneer	\$11,679	\$16,150	\$11,679	\$16,150
		Grade 2 Wood Veneer	\$13,365	\$17,836	\$11,679	\$16,150

► Product Information continued on next page

E-Table 2 Collaborative and Conference Tables

Soft Radiused Laminate Base Tables

► Product Information continued from previous page

Specification Information

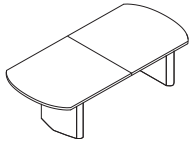

Dimensions		Style Number	Finish	Base Prices	
W	D			H	
				 3 mm Plastic/ 3 mm Wood Edge, Flat Edge, or Convex Vinyl Edge:	 Bullnose Wood Edge:

Soft Radiused Tables with Two Laminate Bases - Working Height

Dimensions	Style Number	Finish	Base Price	Working Height
145" -156" 43" -48" 29"	COET2SFTL	Grade 1 Laminate	\$7741	\$12,251
		Grade 2 and 3 Laminate	\$8098	\$12,608
		Grade 1 Wood Veneer	\$12,859	\$17,369
		Grade 2 Wood Veneer	\$14,310	\$18,820
145" -156" 49" -54" 29"	COET2SFTL	Grade 1 Laminate	\$8163	\$13,236
		Grade 2 and 3 Laminate	\$8570	\$13,643
		Grade 1 Wood Veneer	\$14,208	\$19,281
		Grade 2 Wood Veneer	\$15,854	\$20,927
145" -156" 55" -60" 29"	COET2SFTL	Grade 1 Laminate	\$8580	\$14,219
		Grade 2 and 3 Laminate	\$9032	\$14,671
		Grade 1 Wood Veneer	\$15,552	\$21,191
		Grade 2 Wood Veneer	\$17,391	\$23,030

► Product Information continued on next page

E-Table 2 Collaborative and Conference Tables

Soft Radiused Laminate Base Tables

► Product Information continued from previous page

Specification Information

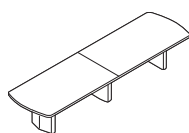

Dimensions		Style Number	Finish	Base Prices	
W	D			H	

Soft Radiused Tables with Three Laminate Bases - Working Height

Tip: Top ships in two pieces. Hardware is included for field assembly.

157" -168"	48"	29"	COET2SFTL	Grade 1 Laminate	\$9027	\$14,470
				Grade 2 and 3 Laminate	\$9404	\$14,847
				Grade 1 Wood Veneer	\$15,951	\$21,394
				Grade 2 Wood Veneer	\$17,517	\$22,960

Tip: For tables with three or more bases, you must specify the entry point of the base power infeed, either an end base or a mid base location, in order to receive the correct length of base power infeed.

157" -168"	49" -54"	29"	COET2SFTL	Grade 1 Laminate	\$9539	\$15,658
				Grade 2 and 3 Laminate	\$9965	\$16,084
				Grade 1 Wood Veneer	\$17,606	\$23,725
				Grade 2 Wood Veneer	\$19,389	\$25,508

157" -168"	55" -60"	29"	COET2SFTL	Grade 1 Laminate	\$10,048	\$16,853
				Grade 2 and 3 Laminate	\$10,517	\$17,322
				Grade 1 Wood Veneer	\$19,260	\$26,065
				Grade 2 Wood Veneer	\$21,253	\$28,058

Tip: If you require your table top to be made into three pieces, this can be done as a special. Please contact Customer Service at 1.800.627.6770 to obtain a quote.

169" -180"	48"	29"	COET2SFTL	Grade 1 Laminate	\$9080	\$14,638
				Grade 2 and 3 Laminate	\$9484	\$15,042
				Grade 1 Wood Veneer	\$16,067	\$21,625
				Grade 2 Wood Veneer	\$17,745	\$23,303

169" -180"	49" -54"	29"	COET2SFTL	Grade 1 Laminate	\$9614	\$15,865
				Grade 2 and 3 Laminate	\$10,068	\$16,319
				Grade 1 Wood Veneer	\$17,755	\$24,006
				Grade 2 Wood Veneer	\$19,640	\$25,891

169" -180"	55" -60"	29"	COET2SFTL	Grade 1 Laminate	\$10,141	\$17,091
				Grade 2 and 3 Laminate	\$10,644	\$17,594
				Grade 1 Wood Veneer	\$19,439	\$26,389
				Grade 2 Wood Veneer	\$21,568	\$28,518

► Product Information continued on next page

E-Table 2 Collaborative and Conference Tables

Soft Radiused Laminate Base Tables

► Product Information continued from previous page

Specification Information

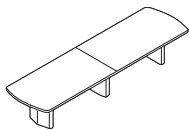

Dimensions		Style Number	Finish	Base Prices	
W	D			H	

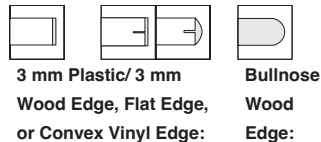

Soft Radiused Tables with Three Laminate Bases - Working Height

181" -192"	48"	29"	COET2SFTL	Grade 1 Laminate	\$9132	\$14,805
				Grade 2 and 3 Laminate	\$9564	\$15,237
				Grade 1 Wood Veneer	\$16,182	\$21,855
				Grade 2 Wood Veneer	\$17,972	\$23,645
181" -192"	49" -54"	29"	COET2SFTL	Grade 1 Laminate	\$9688	\$16,068
				Grade 2 and 3 Laminate	\$10,171	\$16,551
				Grade 1 Wood Veneer	\$17,903	\$24,283
				Grade 2 Wood Veneer	\$19,936	\$26,316
181" -192"	55" -60"	29"	COET2SFTL	Grade 1 Laminate	\$10,234	\$17,327
				Grade 2 and 3 Laminate	\$10,771	\$17,864
				Grade 1 Wood Veneer	\$19,618	\$26,711
				Grade 2 Wood Veneer	\$21,883	\$28,976
193" -204"	48"	29"	COET2SFTL	Grade 1 Laminate	\$9302	\$15,150
				Grade 2 and 3 Laminate	\$9759	\$15,607
				Grade 1 Wood Veneer	\$17,560	\$23,408
				Grade 2 Wood Veneer	\$19,462	\$25,310
193" -204"	49" -54"	29"	COET2SFTL	Grade 1 Laminate	\$9888	\$16,468
				Grade 2 and 3 Laminate	\$10,402	\$16,982
				Grade 1 Wood Veneer	\$19,461	\$26,041
				Grade 2 Wood Veneer	\$21,603	\$28,183
193" -204"	55" -60"	29"	COET2SFTL	Grade 1 Laminate	\$10,473	\$17,795
				Grade 2 and 3 Laminate	\$11,043	\$18,365
				Grade 1 Wood Veneer	\$21,361	\$28,683
				Grade 2 Wood Veneer	\$23,776	\$31,098

Tip: Tables are available parametrically in 1" increments.

► Product Information continued on next page

E-Table 2 Collaborative and Conference Tables

Soft Radiused Laminate Base Tables

► Product Information continued from previous page

Specification Information

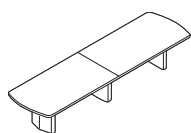

Dimensions		Style Number	Finish	Base Prices	
W	D			H	
				3 mm Plastic/ 3 mm Wood Edge, Flat Edge, or Convex Vinyl Edge:	Bullnose Wood Edge:

Soft Radiused Tables with Three Laminate Bases - Working Height

205" -216"	48"	29"	COET2SFTL	Grade 1 Laminate	\$9471	\$15,490
				Grade 2 and 3 Laminate	\$9954	\$15,973
				Grade 1 Wood Veneer	\$18,937	\$24,956
				Grade 2 Wood Veneer	\$20,951	\$26,970
205" -216"	49" -54"	29"	COET2SFTL	Grade 1 Laminate	\$10,089	\$16,872
				Grade 2 and 3 Laminate	\$10,632	\$17,415
				Grade 1 Wood Veneer	\$21,017	\$27,800
				Grade 2 Wood Veneer	\$23,311	\$30,094
205" -216"	55" -60"	29"	COET2SFTL	Grade 1 Laminate	\$10,711	\$18,258
				Grade 2 and 3 Laminate	\$11,314	\$18,861
				Grade 1 Wood Veneer	\$23,102	\$30,649
				Grade 2 Wood Veneer	\$25,669	\$33,216
217" -228"	48"	29"	COET2SFTL	Grade 1 Laminate	\$9498	\$15,822
				Grade 2 and 3 Laminate	\$10,007	\$16,331
				Grade 1 Wood Veneer	\$19,637	\$25,961
				Grade 2 Wood Veneer	\$21,763	\$28,087
217" -228"	49" -54"	29"	COET2SFTL	Grade 1 Laminate	\$10,137	\$17,261
				Grade 2 and 3 Laminate	\$10,709	\$17,833
				Grade 1 Wood Veneer	\$21,823	\$28,947
				Grade 2 Wood Veneer	\$24,238	\$31,362
217" -228"	55" -60"	29"	COET2SFTL	Grade 1 Laminate	\$10,776	\$18,704
				Grade 2 and 3 Laminate	\$11,413	\$19,341
				Grade 1 Wood Veneer	\$24,012	\$31,940
				Grade 2 Wood Veneer	\$26,714	\$34,642

Tip: Tables are available parametrically in 1" increments.

E-Table 2
Collaborative and
Conference Tables

► Product Information continued on next page

E-Table 2 Collaborative and Conference Tables

Soft Radiused Laminate Base Tables

► Product Information continued from previous page

Specification Information

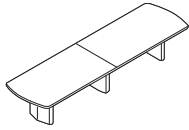

Dimensions		Style Number	Finish	Base Prices	
W	D			H	

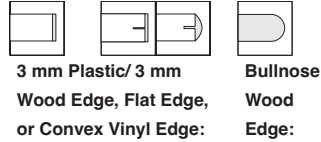

Soft Radiused Tables with Three Laminate Bases - Working Height

Dimensions	Style Number	Finish	Base Price	Working Height
229" -240" 48"	29" COET2SFTL	Grade 1 Laminate	\$9524	\$16,151
		Grade 2 and 3 Laminate	\$10,060	\$16,687
		Grade 1 Wood Veneer	\$20,337	\$26,964
		Grade 2 Wood Veneer	\$22,573	\$29,200
229" -240" 49" -54"	29" COET2SFTL	Grade 1 Laminate	\$10,185	\$17,649
		Grade 2 and 3 Laminate	\$10,786	\$18,250
		Grade 1 Wood Veneer	\$22,627	\$30,091
		Grade 2 Wood Veneer	\$25,166	\$32,630
229" -240" 55" -60"	29" COET2SFTL	Grade 1 Laminate	\$10,839	\$19,145
		Grade 2 and 3 Laminate	\$11,512	\$19,818
		Grade 1 Wood Veneer	\$24,920	\$33,226
		Grade 2 Wood Veneer	\$27,758	\$36,064

► Product Information continued on next page

E-Table 2 Collaborative and Conference Tables

Soft Radiused Laminate Base Tables

► Product Information continued from previous page

Specification Information

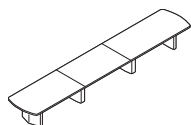

Dimensions		Style		Finish	Base Prices		
W	D	H	Number				
					3 mm Plastic/ 3 mm	Bullnose	
					Wood Edge, Flat Edge,	Wood	
					or Convex Vinyl Edge:	Edge:	

Soft Radiused Tables with Four Laminate Bases - Working Height

Tip: Top ships in three pieces. Hardware is included for field assembly.

241" -252"	48"	29"	COET2SFTL	Grade 1 Laminate	\$11,173	\$18,847
				Grade 2 and 3 Laminate	\$11,732	\$19,406
				Grade 1 Wood Veneer	\$23,908	\$31,582
				Grade 2 Wood Veneer	\$26,257	\$33,931

Tip: For tables with three or more bases, you must specify the entry point of the base power infeed, either an end base or a mid base location, in order to receive the correct length of base power infeed.

241" -252"	49" -54"	29"	COET2SFTL	Grade 1 Laminate	\$11,945	\$20,567
				Grade 2 and 3 Laminate	\$12,575	\$21,197
				Grade 1 Wood Veneer	\$26,546	\$35,168
				Grade 2 Wood Veneer	\$29,212	\$37,834

241" -252"	55" -60"	29"	COET2SFTL	Grade 1 Laminate	\$12,709	\$22,323
				Grade 2 and 3 Laminate	\$13,409	\$23,023
				Grade 1 Wood Veneer	\$29,185	\$38,799
				Grade 2 Wood Veneer	\$32,168	\$41,782

Tip: If you require your table top to be made into four pieces, this can be done as a special. Please contact Customer Service at 1.800.627.6770 to obtain a quote.

253" -264"	48"	29"	COET2SFTL	Grade 1 Laminate	\$12,610	\$21,329
				Grade 2 and 3 Laminate	\$13,194	\$21,913
				Grade 1 Wood Veneer	\$27,267	\$35,986
				Grade 2 Wood Veneer	\$29,731	\$38,450

253" -264"	49" -54"	29"	COET2SFTL	Grade 1 Laminate	\$13,481	\$23,262
				Grade 2 and 3 Laminate	\$14,135	\$23,916
				Grade 1 Wood Veneer	\$30,236	\$40,017
				Grade 2 Wood Veneer	\$33,030	\$42,811

253" -264"	55" -60"	29"	COET2SFTL	Grade 1 Laminate	\$14,338	\$25,261
				Grade 2 and 3 Laminate	\$15,065	\$25,988
				Grade 1 Wood Veneer	\$33,208	\$44,131
				Grade 2 Wood Veneer	\$36,336	\$47,259

► Product Information continued on next page

E-Table 2 Collaborative and Conference Tables

Soft Radiused Laminate Base Tables

► Product Information continued from previous page

Specification Information

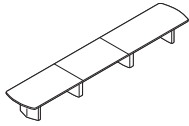

Dimensions		Style	Finish	Base Prices	
W	D	H	Number		
				3 mm Plastic/ 3 mm Wood Edge, Flat Edge, or Convex Vinyl Edge:	Bullnose Wood Edge:

Soft Radiused Tables with Four Laminate Bases - Working Height

265" -276"	48"	29"	COET2SFTL	Grade 1 Laminate	\$12,669	\$21,569
				Grade 2 and 3 Laminate	\$13,277	\$22,177
				Grade 1 Wood Veneer	\$27,423	\$36,323
				Grade 2 Wood Veneer	\$30,003	\$38,903
265" -276"	49" -54"	29"	COET2SFTL	Grade 1 Laminate	\$13,570	\$23,525
				Grade 2 and 3 Laminate	\$14,254	\$24,209
				Grade 1 Wood Veneer	\$30,403	\$40,358
				Grade 2 Wood Veneer	\$33,333	\$43,288
265" -276"	55" -60"	29"	COET2SFTL	Grade 1 Laminate	\$14,414	\$25,548
				Grade 2 and 3 Laminate	\$15,174	\$26,308
				Grade 1 Wood Veneer	\$33,392	\$44,526
				Grade 2 Wood Veneer	\$36,676	\$47,810
277" -288"	48"	29"	COET2SFTL	Grade 1 Laminate	\$12,727	\$21,806
				Grade 2 and 3 Laminate	\$13,359	\$22,438
				Grade 1 Wood Veneer	\$27,578	\$36,657
				Grade 2 Wood Veneer	\$30,275	\$39,354
277" -288"	49" -54"	29"	COET2SFTL	Grade 1 Laminate	\$13,659	\$23,789
				Grade 2 and 3 Laminate	\$14,372	\$24,502
				Grade 1 Wood Veneer	\$30,569	\$40,699
				Grade 2 Wood Veneer	\$33,637	\$43,767
277" -288"	55" -60"	29"	COET2SFTL	Grade 1 Laminate	\$14,490	\$25,834
				Grade 2 and 3 Laminate	\$15,282	\$26,626
				Grade 1 Wood Veneer	\$33,575	\$44,919
				Grade 2 Wood Veneer	\$37,016	\$48,360

Tip: Tables are available parametrically in 1" increments.

E-Table 2 Collaborative and Conference Tables

Soft Radiused Laminate Base Tables

**E-Table 2
Collaborative and
Conference Tables**

E-Table 2 Collaborative and Conference Tables

Soft Radiused Veneer Base Tables

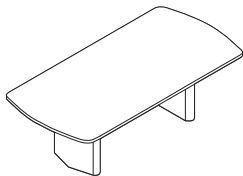

Tip: Shipped knocked down.

Tip: Soft radiused tables are not available with beveled or knife wood edge.

Tip: Utility bay quantity offering by table width is available in the understanding section.

Tip: 3 mm vinyl edge profiles on tables require a 4" radius on all corners.

Tip: A flat, plastic edge can be specified on veneer tops by selecting the "flat" edge option. Flat edge is only available in 6000 Black on veneer tops.

Tip: If you specify a wood edge on a top with woodgrain laminate, the edge and the top may not match.

Tip: Sectioned top option is a two piece top and is only available on tops 96"W-120"W.

Tip: When a wood edge is specified on a wood veneer top, the edge finish will match the top finish.

Tip: Each utility bay comes with two universal faceplate openings that accept customer-supplied faceplates in any of the following sizes: single-gang, double-gang, or triple-gang.

Standard Includes

- Top:
 - 1 1/4" particle board core with grade 1 laminate
 - parametric width in 1" increments ranging from 96"-288"
 - parametric depth in 1" increments ranging from 48"-60"
- Edge: 3 mm plastic edge, 3 mm wood edge, or convex vinyl edge
- Bases: grade 01 or grade 02 veneer on MDF core
- Wireway: painted steel side panels with powder coat and black plastic access door
- Concealed leveling glides: non-marring, black plastic
- Overall height: 29"

Options

Sectioned Top	No Sectioned Top	No cost
	With Sectioned Top	+\$569
Top Finish	Laminate Price Group 02	Price below
	Laminate Price Group 03	Price below
	Veneer Price Group 01	Price below
	Veneer Price Group 02	Price below
Edge Type	3mm Plastic Edge	Price below
	3mm Wood Edge	Price below
	Bullnose Wood Edge	Price below
	Convex Vinyl Edge	Price below
Bay Option	No Bays	No cost
	Two Bays	+\$1578
	Three Bays	+\$2367
	Four Bays	+\$3156
	Six Bays	+\$4734
	Seven Bays	+\$5523
	Wiring Schematic	1+1 Hardwire, 2 Circuits
3 + 0 Wireway		No cost
Chicago Wireway		No cost
1+1 Hardwire,2 Circuits,USB		+\$157
Infeed	3 + 0 Wireway,USB	+\$157
	Hardwire	No cost
	NYC Hardwire Infeed	No cost
Infeed Location	Plug	No cost
	End Base Power Infeed	No cost
	Mid Base Power Infeed	No cost

► Product Information continued on next page

E-Table 2 Collaborative and Conference Tables

Soft Radiused Veneer Base Tables

► Product Information continued from previous page

Specification Information

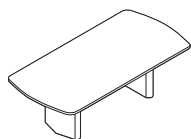

Dimensions		Style Number	Finish	Base Prices	
W	D			H	
					
				3 mm Plastic/ 3 mm Wood Edge, Flat Edge, or Convex Vinyl Edge:	Bullnose Wood Edge:

Soft Radiused Tables with Two Veneer Bases - Working Height

96"	48"	29"	COET2SFTV	Grade 1 Laminate	\$9263	\$10,593
				Grade 2 and 3 Laminate	\$9495	\$10,825
				Grade 1 Wood Veneer	\$11,466	\$12,796
				Grade 2 Wood Veneer	\$12,351	\$13,681
96"	49" -54"	29"	COET2SFTV	Grade 1 Laminate	\$9439	\$10,940
				Grade 2 and 3 Laminate	\$9697	\$11,198
				Grade 1 Wood Veneer	\$11,913	\$13,414
				Grade 2 Wood Veneer	\$12,838	\$14,339
96"	55" -60"	29"	COET2SFTV	Grade 1 Laminate	\$9616	\$11,280
				Grade 2 and 3 Laminate	\$9900	\$11,564
				Grade 1 Wood Veneer	\$12,367	\$14,031
				Grade 2 Wood Veneer	\$13,332	\$14,996
97" -108"	48"	29"	COET2SFTV	Grade 1 Laminate	\$9542	\$11,429
				Grade 2 and 3 Laminate	\$9800	\$11,687
				Grade 1 Wood Veneer	\$11,779	\$13,666
				Grade 2 Wood Veneer	\$12,780	\$14,667
97" -108"	49" -54"	29"	COET2SFTV	Grade 1 Laminate	\$9778	\$11,904
				Grade 2 and 3 Laminate	\$10,068	\$12,194
				Grade 1 Wood Veneer	\$12,392	\$14,518
				Grade 2 Wood Veneer	\$13,483	\$15,609
97" -108"	55" -60"	29"	COET2SFTV	Grade 1 Laminate	\$10,009	\$12,371
				Grade 2 and 3 Laminate	\$10,330	\$12,692
				Grade 1 Wood Veneer	\$13,007	\$15,369
				Grade 2 Wood Veneer	\$14,192	\$16,554

Tip: Top ships in one piece.

Tip: Tables are available parametrically in 1" increments.

► Product Information continued on next page

E-Table 2 Collaborative and Conference Tables

Soft Radiused Veneer Base Tables

► Product Information continued from previous page

Specification Information

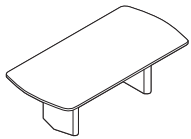

Dimensions		Style Number	Finish	Base Prices	
W	D			H	

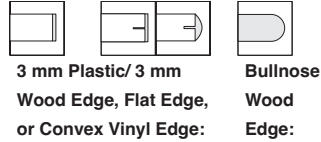

Soft Radiused Tables with Two Veneer Bases - Working Height

Dimensions (W x D x H)	Style Number	Finish	Grade 1 Price	Grade 2 Price
109" -120" x 48" x 29"	COET2SFTV	Grade 1 Laminate	\$9642	\$12,085
		Grade 2 and 3 Laminate	\$9923	\$12,366
		Grade 1 Wood Veneer	\$11,912	\$14,355
		Grade 2 Wood Veneer	\$13,026	\$15,469
109" -120" x 49" -54" x 29"	COET2SFTV	Grade 1 Laminate	\$9931	\$12,681
		Grade 2 and 3 Laminate	\$10,250	\$13,000
		Grade 1 Wood Veneer	\$12,688	\$15,438
		Grade 2 Wood Veneer	\$13,948	\$16,698
109" -120" x 55" -60" x 29"	COET2SFTV	Grade 1 Laminate	\$10,214	\$13,276
		Grade 2 and 3 Laminate	\$10,569	\$13,631
		Grade 1 Wood Veneer	\$13,456	\$16,518
		Grade 2 Wood Veneer	\$14,862	\$17,924

Tip: Tables are available parametrically in 1" increments.

► Product Information continued on next page

E-Table 2 Collaborative and Conference Tables

Soft Radiused Veneer Base Tables

► Product Information continued from previous page

Specification Information

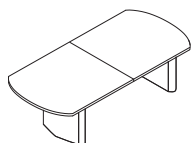

Dimensions		Style Number	Finish	Base Prices	
W	D			H	

Soft Radiused Tables with Two Veneer Bases - Working Height

Tip: Top ships in two pieces. Hardware is included for field assembly.

Dimensions	Style Number	Finish	Grade 1 Price	Grade 2 Price
121" -132" x 48" x 29"	COET2SFTV	Grade 1 Laminate	\$9672	\$12,683
		Grade 2 and 3 Laminate	\$9981	\$12,992
		Grade 1 Wood Veneer	\$12,464	\$15,475
		Grade 2 Wood Veneer	\$13,689	\$16,700

Tip: If you require your table top to be made into three pieces, this can be done as a special. Please contact Customer Service at 1.800.627.6770 to obtain a quote.

121" -132" x 49" -54" x 29"	COET2SFTV	Grade 1 Laminate	\$9978	\$13,366
		Grade 2 and 3 Laminate	\$10,331	\$13,719
		Grade 1 Wood Veneer	\$13,368	\$16,756
		Grade 2 Wood Veneer	\$14,752	\$18,140

121" -132" x 55" -60" x 29"	COET2SFTV	Grade 1 Laminate	\$10,280	\$14,047
		Grade 2 and 3 Laminate	\$10,672	\$14,439
		Grade 1 Wood Veneer	\$14,264	\$18,031
		Grade 2 Wood Veneer	\$15,810	\$19,577

Tip: Tables are available parametrically in 1" increments.

133" -144" x 48" x 29"	COET2SFTV	Grade 1 Laminate	\$9700	\$13,277
		Grade 2 and 3 Laminate	\$10,039	\$13,616
		Grade 1 Wood Veneer	\$13,016	\$16,593
		Grade 2 Wood Veneer	\$14,352	\$17,929

133" -144" x 49" -54" x 29"	COET2SFTV	Grade 1 Laminate	\$10,025	\$14,050
		Grade 2 and 3 Laminate	\$10,411	\$14,436
		Grade 1 Wood Veneer	\$14,048	\$18,073
		Grade 2 Wood Veneer	\$15,557	\$19,582

133" -144" x 55" -60" x 29"	COET2SFTV	Grade 1 Laminate	\$10,345	\$14,816
		Grade 2 and 3 Laminate	\$10,773	\$15,244
		Grade 1 Wood Veneer	\$15,071	\$19,542
		Grade 2 Wood Veneer	\$16,757	\$21,228

► Product Information continued on next page



E-Table 2 Collaborative and Conference Tables

Soft Radiused Veneer Base Tables

► Product Information continued from previous page

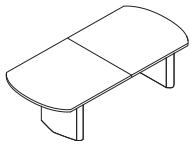
Specification Information



Dimensions		Style Number	Finish	Base Prices	
W	D			H	
				 3 mm Plastic/ 3 mm Wood Edge, Flat Edge, or Convex Vinyl Edge:	 Bullnose Wood Edge:

Soft Radiused Tables with Two Veneer Bases - Working Height

145" -156"	43" -48"	29"	COET2SFTV	Grade 1 Laminate	\$11,165	\$15,675
				Grade 2 and 3 Laminate	\$11,522	\$16,032
				Grade 1 Wood Veneer	\$16,285	\$20,795
				Grade 2 Wood Veneer	\$17,735	\$22,245
145" -156"	49" -54"	29"	COET2SFTV	Grade 1 Laminate	\$11,586	\$16,659
				Grade 2 and 3 Laminate	\$11,991	\$17,064
				Grade 1 Wood Veneer	\$17,631	\$22,704
				Grade 2 Wood Veneer	\$19,277	\$24,350
145" -156"	55" -60"	29"	COET2SFTV	Grade 1 Laminate	\$12,006	\$17,645
				Grade 2 and 3 Laminate	\$12,454	\$18,093
				Grade 1 Wood Veneer	\$18,976	\$24,615
				Grade 2 Wood Veneer	\$20,815	\$26,454

► Product Information continued on next page

E-Table 2 Collaborative and Conference Tables

Soft Radiused Veneer Base Tables

► Product Information continued from previous page

Specification Information

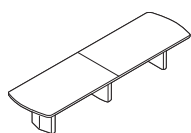

Dimensions		Style Number	Finish	Base Prices	
W	D			H	
				3 mm Plastic/ 3 mm Wood Edge, Flat Edge, or Convex Vinyl Edge:	Bullnose Wood Edge:

Soft Radiused Tables with Three Veneer Bases - Working Height

Tip: Top ships in two pieces. Hardware is included for field assembly.

157" -168"	48"	29"	COET2SFTV	Grade 1 Laminate	\$14,239	\$19,682
				Grade 2 and 3 Laminate	\$14,616	\$20,059
				Grade 1 Wood Veneer	\$21,163	\$26,606
				Grade 2 Wood Veneer	\$22,729	\$28,172

Tip: For tables with three or more bases, you must specify the entry point of the base power infeed, either an end base or a mid base location, in order to receive the correct length of base power infeed.

157" -168"	49" -54"	29"	COET2SFTV	Grade 1 Laminate	\$14,751	\$20,870
				Grade 2 and 3 Laminate	\$15,177	\$21,296
				Grade 1 Wood Veneer	\$22,818	\$28,937
				Grade 2 Wood Veneer	\$24,601	\$30,720

157" -168"	55" -60"	29"	COET2SFTV	Grade 1 Laminate	\$15,260	\$22,065
				Grade 2 and 3 Laminate	\$15,729	\$22,534
				Grade 1 Wood Veneer	\$24,472	\$31,277
				Grade 2 Wood Veneer	\$26,465	\$33,270

Tip: If you require your table top to be made into three pieces, this can be done as a special. Please contact Customer Service at 1.800.627.6770 to obtain a quote.

169" -180"	48"	29"	COET2SFTV	Grade 1 Laminate	\$14,292	\$19,850
				Grade 2 and 3 Laminate	\$14,696	\$20,254
				Grade 1 Wood Veneer	\$21,279	\$26,837
				Grade 2 Wood Veneer	\$22,958	\$28,516

169" -180"	49" -54"	29"	COET2SFTV	Grade 1 Laminate	\$14,826	\$21,077
				Grade 2 and 3 Laminate	\$15,281	\$21,532
				Grade 1 Wood Veneer	\$22,967	\$29,218
				Grade 2 Wood Veneer	\$24,875	\$31,126

169" -180"	55" -60"	29"	COET2SFTV	Grade 1 Laminate	\$15,354	\$22,304
				Grade 2 and 3 Laminate	\$15,856	\$22,806
				Grade 1 Wood Veneer	\$24,651	\$31,601
				Grade 2 Wood Veneer	\$26,780	\$33,730

► Product Information continued on next page

E-Table 2 Collaborative and Conference Tables

Soft Radiused Veneer Base Tables

► Product Information continued from previous page

Specification Information

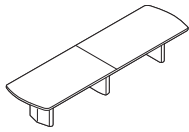

Dimensions		Style Number	Finish	Base Prices	
W	D			H	

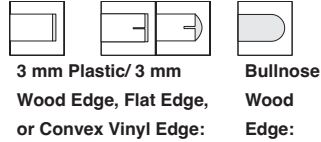

Soft Radiused Tables with Three Veneer Bases - Working Height

181" -192"	48"	29"	COET2SFTV	Grade 1 Laminate	\$14,344	\$20,017
				Grade 2 and 3 Laminate	\$14,776	\$20,449
				Grade 1 Wood Veneer	\$21,394	\$27,067
				Grade 2 Wood Veneer	\$23,184	\$28,857
181" -192"	49" -54"	29"	COET2SFTV	Grade 1 Laminate	\$14,900	\$21,280
				Grade 2 and 3 Laminate	\$15,383	\$21,763
				Grade 1 Wood Veneer	\$23,115	\$29,495
				Grade 2 Wood Veneer	\$25,148	\$31,528
181" -192"	55" -60"	29"	COET2SFTV	Grade 1 Laminate	\$15,446	\$22,539
				Grade 2 and 3 Laminate	\$15,983	\$23,076
				Grade 1 Wood Veneer	\$24,830	\$31,923
				Grade 2 Wood Veneer	\$27,095	\$34,188
193" -204"	48"	29"	COET2SFTV	Grade 1 Laminate	\$14,514	\$20,362
				Grade 2 and 3 Laminate	\$14,971	\$20,819
				Grade 1 Wood Veneer	\$22,772	\$28,620
				Grade 2 Wood Veneer	\$24,674	\$30,522
193" -204"	49" -54"	29"	COET2SFTV	Grade 1 Laminate	\$15,101	\$21,681
				Grade 2 and 3 Laminate	\$15,614	\$22,194
				Grade 1 Wood Veneer	\$24,673	\$31,253
				Grade 2 Wood Veneer	\$26,836	\$33,416
193" -204"	55" -60"	29"	COET2SFTV	Grade 1 Laminate	\$15,685	\$23,007
				Grade 2 and 3 Laminate	\$16,255	\$23,577
				Grade 1 Wood Veneer	\$26,573	\$33,895
				Grade 2 Wood Veneer	\$28,989	\$36,311

Tip: Tables are available parametrically in 1" increments.

► Product Information continued on next page



E-Table 2 Collaborative and Conference Tables

Soft Radiused Veneer Base Tables

► Product Information continued from previous page

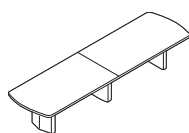
Specification Information



Dimensions		Style Number	Finish	Base Prices	
W	D			H	
					
				3 mm Plastic/ 3 mm Wood Edge, Flat Edge, or Convex Vinyl Edge:	Bullnose Wood Edge:

Soft Radiused Tables with Three Veneer Bases - Working Height

205" -216"	48"	29"	COET2SFTV	Grade 1 Laminate	\$14,683	\$20,702
				Grade 2 and 3 Laminate	\$15,166	\$21,185
				Grade 1 Wood Veneer	\$24,149	\$30,168
				Grade 2 Wood Veneer	\$26,163	\$32,182
205" -216"	49" -54"	29"	COET2SFTV	Grade 1 Laminate	\$15,301	\$22,084
				Grade 2 and 3 Laminate	\$15,844	\$22,627
				Grade 1 Wood Veneer	\$26,229	\$33,012
				Grade 2 Wood Veneer	\$28,523	\$35,306
205" -216"	55" - 60"	29"	COET2SFTV	Grade 1 Laminate	\$15,923	\$23,470
				Grade 2 and 3 Laminate	\$16,526	\$24,073
				Grade 1 Wood Veneer	\$28,314	\$35,861
				Grade 2 Wood Veneer	\$30,881	\$38,428
217" -228"	48"	29"	COET2SFTV	Grade 1 Laminate	\$14,711	\$21,035
				Grade 2 and 3 Laminate	\$15,220	\$21,544
				Grade 1 Wood Veneer	\$24,850	\$31,174
				Grade 2 Wood Veneer	\$26,975	\$33,299
217" -228"	49" -54"	29"	COET2SFTV	Grade 1 Laminate	\$15,349	\$22,473
				Grade 2 and 3 Laminate	\$15,922	\$23,046
				Grade 1 Wood Veneer	\$27,035	\$34,159
				Grade 2 Wood Veneer	\$29,451	\$36,575
217" -228"	55" -60"	29"	COET2SFTV	Grade 1 Laminate	\$15,988	\$23,916
				Grade 2 and 3 Laminate	\$16,626	\$24,554
				Grade 1 Wood Veneer	\$29,224	\$37,152
				Grade 2 Wood Veneer	\$31,926	\$39,854

Tip: Tables are available parametrically in 1" increments.

► Product Information continued on next page

E-Table 2 Collaborative and Conference Tables

Soft Radiused Veneer Base Tables

► Product Information continued from previous page

Specification Information

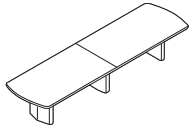

Dimensions		Style Number	Finish	Base Prices	
W	D			H	

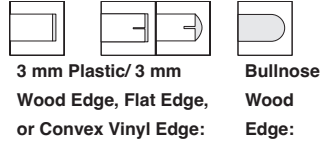

Soft Radiused Tables with Three Veneer Bases - Working Height

W	D	H	Style Number	Finish	Base Price 1	Base Price 2
229" -240"	48"	29"	COET2SFTV	Grade 1 Laminate	\$14,736	\$21,363
				Grade 2 and 3 Laminate	\$15,272	\$21,899
				Grade 1 Wood Veneer	\$25,549	\$32,176
				Grade 2 Wood Veneer	\$27,785	\$34,412
229" -240"	49" -54"	29"	COET2SFTV	Grade 1 Laminate	\$15,397	\$22,861
				Grade 2 and 3 Laminate	\$15,998	\$23,462
				Grade 1 Wood Veneer	\$27,839	\$35,303
				Grade 2 Wood Veneer	\$30,378	\$37,842
229" -240"	55" -60"	29"	COET2SFTV	Grade 1 Laminate	\$16,051	\$24,357
				Grade 2 and 3 Laminate	\$16,724	\$25,030
				Grade 1 Wood Veneer	\$30,132	\$38,438
				Grade 2 Wood Veneer	\$32,970	\$41,276

Tip: Tables are available parametrically in 1" increments.

► Product Information continued on next page



E-Table 2 Collaborative and Conference Tables

Soft Radiused Veneer Base Tables

► Product Information continued from previous page

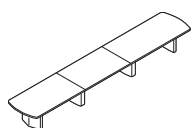
Specification Information



Dimensions		Style Number	Finish	Base Prices	
W	D			H	
					
				3 mm Plastic/ 3 mm Wood Edge, Flat Edge, or Convex Vinyl Edge:	Bullnose Wood Edge:

Soft Radiused Tables with Four Veneer Bases - Working Height

Tip: Top ships in three pieces. Hardware is included for field assembly.

241" -252"	48"	29"	COET2SFTV	Grade 1 Laminate	\$18,268	\$25,942
				Grade 2 and 3 Laminate	\$18,828	\$26,502
				Grade 1 Wood Veneer	\$31,005	\$38,679
				Grade 2 Wood Veneer	\$33,354	\$41,028

Tip: For tables with three or more bases, you must specify the entry point of the base power infeed, either an end base or a mid base location, in order to receive the correct length of base power infeed.

241" -252"	49" -54"	29"	COET2SFTV	Grade 1 Laminate	\$19,041	\$27,663
				Grade 2 and 3 Laminate	\$19,669	\$28,291
				Grade 1 Wood Veneer	\$33,642	\$42,264
				Grade 2 Wood Veneer	\$36,306	\$44,928

241" -252"	55" -60"	29"	COET2SFTV	Grade 1 Laminate	\$19,805	\$29,419
				Grade 2 and 3 Laminate	\$20,504	\$30,118
				Grade 1 Wood Veneer	\$36,280	\$45,894
				Grade 2 Wood Veneer	\$39,263	\$48,877

Tip: If you require your table top to be made into four pieces, this can be done as a special. Please contact Customer Service at 1.800.627.6770 to obtain a quote.

253" -264"	48"	29"	COET2SFTV	Grade 1 Laminate	\$19,638	\$28,357
				Grade 2 and 3 Laminate	\$20,222	\$28,941
				Grade 1 Wood Veneer	\$34,295	\$43,014
				Grade 2 Wood Veneer	\$36,759	\$45,478

253" -264"	49" -54"	29"	COET2SFTV	Grade 1 Laminate	\$20,509	\$30,290
				Grade 2 and 3 Laminate	\$21,163	\$30,944
				Grade 1 Wood Veneer	\$37,264	\$47,045
				Grade 2 Wood Veneer	\$40,058	\$49,839

253" -264"	55" -60"	29"	COET2SFTV	Grade 1 Laminate	\$21,366	\$32,289
				Grade 2 and 3 Laminate	\$22,093	\$33,016
				Grade 1 Wood Veneer	\$40,236	\$51,159
				Grade 2 Wood Veneer	\$43,364	\$54,287

► Product Information continued on next page

E-Table 2 Collaborative and Conference Tables

Soft Radiused Veneer Base Tables

► Product Information continued from previous page

Specification Information

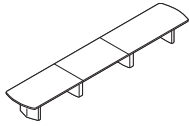

Dimensions		Style	Finish	Base Prices	
W	D	H	Number		
				3 mm Plastic/ 3 mm Wood Edge, Flat Edge, or Convex Vinyl Edge:	Bullnose Wood Edge:

Soft Radiused Tables with Four Veneer Bases - Working Height

265" -276"	48"	29"	COET2SFTV	Grade 1 Laminate	\$19,697	\$28,597
				Grade 2 and 3 Laminate	\$20,306	\$29,206
				Grade 1 Wood Veneer	\$34,452	\$43,352
				Grade 2 Wood Veneer	\$37,032	\$45,932
265" -276"	49" -54"	29"	COET2SFTV	Grade 1 Laminate	\$20,599	\$30,554
				Grade 2 and 3 Laminate	\$21,282	\$31,237
				Grade 1 Wood Veneer	\$37,432	\$47,387
				Grade 2 Wood Veneer	\$40,362	\$50,317
265" -276"	55" -60"	29"	COET2SFTV	Grade 1 Laminate	\$21,442	\$32,576
				Grade 2 and 3 Laminate	\$22,202	\$33,336
				Grade 1 Wood Veneer	\$40,420	\$51,554
				Grade 2 Wood Veneer	\$43,705	\$54,839
277" -288"	48"	29"	COET2SFTV	Grade 1 Laminate	\$19,755	\$28,834
				Grade 2 and 3 Laminate	\$20,387	\$29,466
				Grade 1 Wood Veneer	\$34,606	\$43,685
				Grade 2 Wood Veneer	\$37,303	\$46,382
277" -288"	49" -54"	29"	COET2SFTV	Grade 1 Laminate	\$20,687	\$30,817
				Grade 2 and 3 Laminate	\$21,400	\$31,530
				Grade 1 Wood Veneer	\$37,597	\$47,727
				Grade 2 Wood Veneer	\$40,665	\$50,795
277" -288"	55" -60"	29"	COET2SFTV	Grade 1 Laminate	\$21,518	\$32,862
				Grade 2 and 3 Laminate	\$22,310	\$33,654
				Grade 1 Wood Veneer	\$40,603	\$51,947
				Grade 2 Wood Veneer	\$44,044	\$55,388

Tip: Tables are available parametrically in 1" increments.

E-Table 2 Collaborative and Conference Tables

Soft Radiused Veneer Base Tables

E-Table 2
Collaborative and
Conference Tables

E-Table 2 Collaborative and Conference Tables

Trapezoid Aluminum Base Tables-Working Height

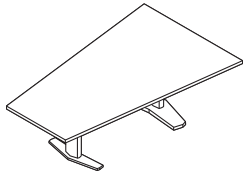

Tip: Shipped knocked down.

Tip: Utility bay quantity offering by table width is available in the understanding section.

Tip: 3 mm vinyl edge profiles on tables require a 4" radius on all corners.

Tip: If you specify a wood edge on a top with woodgrain laminate, the edge and the top may not match.

Tip: Sectioned top option is a two piece top and is only available on tops 96"W-120"W.

Tip: When a wood edge is specified on a wood veneer top, the edge finish will match the top finish.

Tip: Each utility bay comes with two universal faceplate openings that accept customer-supplied faceplates in any of the following sizes: single-gang, double-gang, or triple-gang.

Standard Includes

- Top:
 - 1 1/4" particle board core with grade 1 laminate
 - parametric width in 1" increments ranging from 60"-240"
 - For tables with widths up to 240", parametric depth is in 1" increments ranging from 36"-48" for depth right and 48"-60" for depth left
- Edge: 3 mm plastic edge, 3 mm wood edge, or convex vinyl edge
- Bases: cast and extruded aluminum with powder coat
- Wireway: painted steel side panels with powder coat and black plastic access door
- Concealed leveling glides: non-marring, black plastic
- Overall height: 29"

Options

Sectioned Top	No Sectioned Top	No cost
	With Sectioned Top	+\$569
Top Finish	Laminate Price Group 02	Price below
	Laminate Price Group 03	Price below
	Veneer Price Group 01	Price below
	Veneer Price Group 02	Price below
Edge Type	3mm Plastic Edge	Price below
	3mm Wood Edge	Price below
	Beveled Wood Edge	Price below
	Bullnose Wood Edge	Price below
	Convex Vinyl Edge	Price below
	Knife Wood Edge	Price below
Bay Option	No Bays	No cost
	One Bay	+\$789
	Two Bays	+\$1578
	Three Bays	+\$2367
	Four Bays	+\$3156
	Six Bays	+\$4734
Wiring Schematic	1+1 Hardwire, 2 Circuits	No cost
	3 + 0 Wireway	No cost
	Chicago Wireway	No cost
	1+1 Hardwire,2 Circuits,USB	+\$157
Infeed	3 + 0 Wireway,USB	+\$157
	Hardwire	No cost
	NYC Hardwire Infeed	No cost
Infeed Location	Plug	No cost
	End Base Power Infeed	No cost
	Mid Base Power Infeed	No cost

► **Product Information continued on next page**

E-Table 2 Collaborative and Conference Tables

Trapezoid Aluminum Base Tables-Working Height

► Product Information continued from previous page

Specification Information

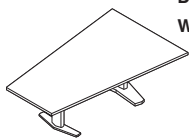

Dimensions W	Depth		H	Style Number	Finish	Base Prices			
	Right	Left				3 mm Plastic/ 3 mm Wood, Flat, or Convex Vinyl Edge:	Bullnose Wood Edge:	Beveled Wood Edge:	Knife Wood Edge:

Trapezoid Tables with Two Aluminum Bases - Working Height

Tip: Top ships in one piece.

Tip: For the specification of the depths, the "Depth Right" specification is the short end of the trapezoid table and the "Depth Left" specification is the long end of the trapezoid table.

Tip: For 60"W - 95"W tables, if you require your table top to be made into two pieces, this can be done as a special. Please contact Customer Service at 1.800.627.6770 to obtain a quote.

Tip: Tables are available parametrically in 1" increments.

60" -71"	36" -48"	48" -60"	29"	COET2TRAPA	Grade 1 Laminate	\$5855	\$6561	\$6645	\$6771
					Grade 2 and 3 Laminate	\$6034	\$6740	\$6824	\$6950
					Grade 1 Wood Veneer	\$7871	\$8577	\$8661	\$8787
					Grade 2 Wood Veneer	\$8566	\$9272	\$9356	\$9482
72"	36" -48"	48" -60"	29"	COET2TRAPA	Grade 1 Laminate	\$6156	\$7079	\$7180	\$7346
					Grade 2 and 3 Laminate	\$6370	\$7293	\$7394	\$7560
					Grade 1 Wood Veneer	\$8417	\$9340	\$9441	\$9607
					Grade 2 Wood Veneer	\$9254	\$10,177	\$10,278	\$10,444
73" -84"	36" -48"	48" -60"	29"	COET2TRAPA	Grade 1 Laminate	\$6458	\$7812	\$7955	\$8195
					Grade 2 and 3 Laminate	\$6707	\$8061	\$8204	\$8444
					Grade 1 Wood Veneer	\$8965	\$10,319	\$10,462	\$10,702
					Grade 2 Wood Veneer	\$9943	\$11,297	\$11,440	\$11,680
85" -96"	36" -48"	48" -60"	29"	COET2TRAPA	Grade 1 Laminate	\$6697	\$8361	\$8510	\$8828
					Grade 2 and 3 Laminate	\$6981	\$8645	\$8794	\$9112
					Grade 1 Wood Veneer	\$9448	\$11,112	\$11,261	\$11,579
					Grade 2 Wood Veneer	\$10,564	\$12,228	\$12,377	\$12,695
97" -108"	36" -48"	48" -60"	29"	COET2TRAPA	Grade 1 Laminate	\$7064	\$9426	\$9652	\$10,085
					Grade 2 and 3 Laminate	\$7173	\$9535	\$9761	\$10,194
					Grade 1 Wood Veneer	\$8759	\$11,121	\$11,347	\$11,780
					Grade 2 Wood Veneer	\$10,692	\$13,054	\$13,280	\$13,713

► Product Information continued on next page

E-Table 2 Collaborative and Conference Tables

E-Table 2 Collaborative and Conference Tables

Trapezoid Aluminum Base Tables-Working Height

► Product Information continued from previous page

Specification Information

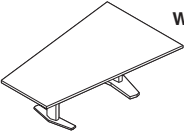
	Dimensions		H	Style Number	Finish	Base Prices			
	W	Depth Right				Depth Left	3 mm Plastic/ 3 mm Wood, Flat, or Convex Vinyl Edge:	Bullnose Wood Edge:	Beveled Wood Edge:

Trapezoid Tables with Two Aluminum Bases - Working Height

W	Depth Right	Depth Left	H	Style Number	Finish	3 mm Plastic/ 3 mm Wood, Flat, or Convex Vinyl Edge:	Bullnose Wood Edge:	Beveled Wood Edge:	Knife Wood Edge:
109" -120"	36" -48"	48" -60"	29"	COET2TRAPA	Grade 1 Laminate	\$7294	\$10,356	\$10,656	\$11,203
					Grade 2 and 3 Laminate	\$7649	\$10,711	\$11,011	\$11,558
					Grade 1 Wood Veneer	\$10,536	\$13,598	\$13,898	\$14,445
					Grade 2 Wood Veneer	\$11,934	\$14,996	\$15,296	\$15,843

► Product Information continued on next page

E-Table 2 Collaborative and Conference Tables

Trapezoid Aluminum Base Tables-Working Height

► Product Information continued from previous page

Specification Information

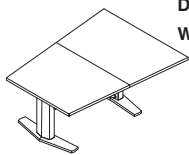

Dimensions

W

Depth
Right Depth
Left

Style
H Number

Finish

Base Prices



3 mm Plastic/
3 mm Wood,
Flat, or Convex
Vinyl Edge:

Bullnose
Wood
Edge:

Beveled
Wood
Edge:

Knife
Wood
Edge:

Trapezoid Tables with Two Aluminum Bases - Working Height

Tip: Top ships in two pieces. Hardware is included for field assembly.

Dimensions	Style	Finish	Base Prices	
121" -132"	36" -48"	48" -60"	29" COET2TRAPA	
Grade 1 Laminate	\$7364	\$11,131	\$11,462	\$12,117
Grade 2 and 3 Laminate	\$7755	\$11,522	\$11,853	\$12,508
Grade 1 Wood Veneer	\$11,348	\$15,115	\$15,446	\$16,101
Grade 2 Wood Veneer	\$12,890	\$16,657	\$16,988	\$17,643

Tip: If you require your table top to be made into three pieces, this can be done as a special. Please contact Customer Service at 1.800.627.6770 to obtain a quote.

133" -144"	36" -48"	48" -60"	29" COET2TRAPA	Grade 1 Laminate	\$7433	\$11,904	\$12,268	\$13,027
				Grade 2 and 3 Laminate	\$7861	\$12,332	\$12,696	\$13,455
				Grade 1 Wood Veneer	\$12,159	\$16,630	\$16,994	\$17,753
				Grade 2 Wood Veneer	\$13,845	\$18,316	\$18,680	\$19,439
145" -156"	36" -48"	48" -60"	29" COET2TRAPA	Grade 1 Laminate	\$9222	\$14,861	\$15,215	\$16,190
				Grade 2 and 3 Laminate	\$9673	\$15,312	\$15,666	\$16,641
				Grade 1 Wood Veneer	\$16,193	\$21,832	\$22,186	\$23,161
				Grade 2 Wood Veneer	\$18,048	\$23,687	\$24,041	\$25,016

► Product Information continued on next page

E-Table 2 Collaborative and Conference Tables

E-Table 2 Collaborative and Conference Tables

Trapezoid Aluminum Base Tables-Working Height

► Product Information continued from previous page

Specification Information

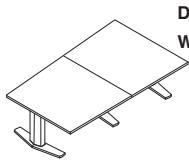

Dimensions

W

Depth
Right

Depth
Left

H

Style
Number

Finish

Base Prices

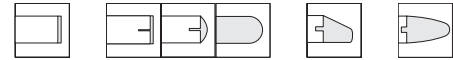

3 mm Plastic/
3 mm Wood,
Flat, or Convex
Vinyl Edge: Bullnose
Edge: Beveled
Wood
Edge: Knife
Wood
Edge:

Trapezoid Tables with Three Aluminum Bases - Working Height

Tip: Top ships in two pieces. Hardware is included for field assembly.

Dimensions	Style Number	Finish	Base Prices
157" -168" 36" -48" 48" -60" 29"	COET2TRAPA	Grade 1 Laminate	\$10,841 \$17,646 \$17,992 \$19,181
		Grade 2 and 3 Laminate	\$11,310 \$18,115 \$18,461 \$19,650
		Grade 1 Wood Veneer	\$20,053 \$26,858 \$27,204 \$28,393
		Grade 2 Wood Veneer	\$22,077 \$28,882 \$29,228 \$30,417

Tip: For tables with three or more bases, you must specify the entry point of the base power infeed, either an end base or a mid base location, in order to receive the correct length of base power infeed.

169" -180" 36" -48" 48" -60" 29"	COET2TRAPA	Grade 1 Laminate	\$11,074 \$17,960 \$18,312 \$19,515
		Grade 2 and 3 Laminate	\$11,550 \$18,436 \$18,788 \$19,991
		Grade 1 Wood Veneer	\$20,397 \$27,283 \$27,635 \$28,838
		Grade 2 Wood Veneer	\$22,444 \$29,330 \$29,682 \$30,885

181" -192" 36" -48" 48" -60" 29"	COET2TRAPA	Grade 1 Laminate	\$11,200 \$18,168 \$18,524 \$19,742
		Grade 2 and 3 Laminate	\$11,680 \$18,648 \$19,004 \$20,222
		Grade 1 Wood Veneer	\$20,636 \$27,604 \$27,960 \$29,178
		Grade 2 Wood Veneer	\$22,709 \$29,677 \$30,033 \$31,251

Tip: If you require your table top to be made into three pieces, this can be done as a special. Please contact Customer Service at 1.800.627.6770 to obtain a quote.

193" -204" 36" -48" 48" -60" 29"	COET2TRAPA	Grade 1 Laminate	\$11,455 \$18,591 \$18,955 \$20,203
		Grade 2 and 3 Laminate	\$11,949 \$19,085 \$19,449 \$20,697
		Grade 1 Wood Veneer	\$21,117 \$28,253 \$28,617 \$29,865
		Grade 2 Wood Veneer	\$23,240 \$30,376 \$30,740 \$31,988

205" -216" 36" -48" 48" -60" 29"	COET2TRAPA	Grade 1 Laminate	\$11,715 \$19,021 \$19,394 \$20,672
		Grade 2 and 3 Laminate	\$12,220 \$19,526 \$19,899 \$21,177
		Grade 1 Wood Veneer	\$21,610 \$28,916 \$29,289 \$30,567
		Grade 2 Wood Veneer	\$23,783 \$31,089 \$31,462 \$32,740

► Product Information continued on next page

E-Table 2 Collaborative and Conference Tables

Trapezoid Aluminum Base Tables-Working Height

► Product Information continued from previous page

Specification Information

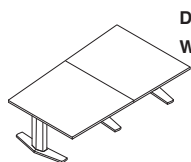

Dimensions

W

Depth
Right Depth
Left

Style
Number

Finish

Base Prices



3 mm Plastic/ 3 mm Wood, Flat, or Convex Vinyl Edge:	Bullnose Wood Edge:	Beveled Wood Edge:	Knife Wood Edge:
---	---------------------------	--------------------------	------------------------

Trapezoid Tables with Three Aluminum Bases - Working Height

Tip: Tables are available parametrically in 1" increments.

W	Depth Right	Depth Left	H	Style Number	Finish	Base Prices	Bullnose Wood Edge	Beveled Wood Edge	Knife Wood Edge
217" -228"	36" -48"	48" -60"	29"	COET2TRAPA	Grade 1 Laminate	\$11,985	\$19,468	\$19,849	\$21,157
					Grade 2 and 3 Laminate	\$12,502	\$19,985	\$20,366	\$21,674
					Grade 1 Wood Veneer	\$22,115	\$29,598	\$29,979	\$31,287
					Grade 2 Wood Veneer	\$24,340	\$31,823	\$32,204	\$33,512
229" -240"	36" -48"	48" -60"	29"	COET2TRAPA	Grade 1 Laminate	\$12,258	\$19,921	\$20,312	\$21,651
					Grade 2 and 3 Laminate	\$12,788	\$20,451	\$20,842	\$22,181
					Grade 1 Wood Veneer	\$22,631	\$30,294	\$30,685	\$32,024
					Grade 2 Wood Veneer	\$24,911	\$32,574	\$32,965	\$34,304

E-Table 2 Collaborative and Conference Tables

E-Table 2 Collaborative and Conference Tables

Trapezoid Aluminum Base Tables-Standing Height

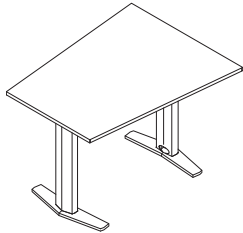

Tip: Shipped knocked down.

Tip: Utility bay quantity offering by table width is available in the understanding section.

Tip: 3 mm vinyl edge profiles on tables require a 4" radius on all corners.

Tip: If you specify a wood edge on a top with woodgrain laminate, the edge and the top may not match.

Tip: Sectioned top option is a two piece top and is only available on tops 96"W-120"W.

Tip: When a wood edge is specified on a wood veneer top, the edge finish will match the top finish.

Tip: Each utility bay comes with two universal faceplate openings that accept customer-supplied faceplates in any of the following sizes: single-gang, double-gang, or triple-gang.

Standard Includes

- Top:
 - 1 1/4" particle board core with grade 1 laminate
 - parametric depth in 1" increments ranging from 60"-120"
 - For tables with widths up to 120", parametric depth is in 1" increments ranging from 36"-48" for depth right and 48"-60" for depth left
- Edge: 3 mm plastic edge, 3 mm wood edge, or convex vinyl edge
- Bases: cast and extruded aluminum with powder coat
- Wireway: painted steel side panels with powder coat and black plastic access door
- Concealed leveling glides: non-marring, black plastic
- Overall height: 40"

Options

Sectioned Top	No Sectioned Top	No cost
	With Sectioned Top	+\$569
Top Finish	Laminate Price Group 02	Price below
	Laminate Price Group 03	Price below
	Veneer Price Group 01	Price below
	Veneer Price Group 02	Price below
Edge Type	3mm Plastic Edge	Price below
	3mm Wood Edge	Price below
	Beveled Wood Edge	Price below
	Bullnose Wood Edge	Price below
	Convex Vinyl Edge	Price below
	Knife Wood Edge	Price below
Bay Option	No Bays	No cost
	One Bay	+\$789
	Two Bays	+\$1578
	Three Bays	+\$2367
Wiring Schematic	1+1 Hardwire, 2 Circuits	No cost
	3 + 0 Wireway	No cost
	Chicago Wireway	No cost
	1+1 Hardwire,2 Circuits,USB	+\$157
Infeed	3 + 0 Wireway,USB	+\$157
	Hardwire	No cost
	NYC Hardwire Infeed	No cost
	Plug	No cost

► **Product Information continued on next page**

E-Table 2 Collaborative and Conference Tables

Trapezoid Aluminum Base Tables-Standing Height

► Product Information continued from previous page

Specification Information

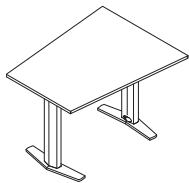

Dimensions W	Depth Right	Depth Left	H	Style Number	Finish	Base Prices			
						3 mm Plastic/ 3 mm Wood, Flat, or Convex Vinyl Edge:	Bullnose Wood Edge:	Beveled Wood Edge:	Knife Wood Edge:

Trapezoid Tables with Two Aluminum Bases - Standing Height

Tip: Top ships in one piece.

Tip: For the specification of the depths, the "Depth Right" specification is the short end of the trapezoid table and the "Depth Left" specification is the long end of the trapezoid table.

Tip: For 60"W - 95"W tables, if you require your table top to be made into two pieces, this can be done as a special. Please contact Customer Service at 1.800.627.6770 to obtain a quote.

60" -71"	36" -48"	48" -60"	40"	COET2TRAPSTA	Grade 1 Laminate	\$6342	\$7048	\$7132	\$7258
					Grade 2 and 3 Laminate	\$6520	\$7226	\$7310	\$7436
					Grade 1 Wood Veneer	\$8355	\$9061	\$9145	\$9271
					Grade 2 Wood Veneer	\$9052	\$9758	\$9842	\$9968
72"	36" -48"	48" -60"	40"	COET2TRAPSTA	Grade 1 Laminate	\$6642	\$7565	\$7666	\$7832
					Grade 2 and 3 Laminate	\$6856	\$7779	\$7880	\$8046
					Grade 1 Wood Veneer	\$8903	\$9826	\$9927	\$10,093
					Grade 2 Wood Veneer	\$9741	\$10,664	\$10,765	\$10,931
73" -84"	36" -48"	48" -60"	40"	COET2TRAPSTA	Grade 1 Laminate	\$6947	\$8301	\$8444	\$8684
					Grade 2 and 3 Laminate	\$7193	\$8547	\$8690	\$8930
					Grade 1 Wood Veneer	\$9452	\$10,806	\$10,949	\$11,189
					Grade 2 Wood Veneer	\$10,430	\$11,784	\$11,927	\$12,167

► Product Information continued on next page

E-Table 2 Collaborative and Conference Tables

E-Table 2 Collaborative and Conference Tables

Trapezoid Aluminum Base Tables-Standing Height

► Product Information continued from previous page

Specification Information

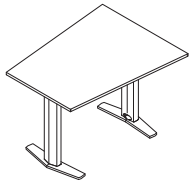

Dimensions W	Depth Right	Depth Left	H	Style Number	Finish	Base Prices			
						3 mm Plastic/ 3 mm Wood, Flat, or Convex Vinyl Edge:	Bullnose Wood Edge:	Beveled Wood Edge:	Knife Wood Edge:

Trapezoid Tables with Two Aluminum Bases - Standing Height

85" -96"	36" -48"	48" -60"	40"	COET2TRAPSTA	Grade 1 Laminate	\$7247	\$8911	\$9060	\$9378
					Grade 2 and 3 Laminate	\$7533	\$9197	\$9346	\$9664
					Grade 1 Wood Veneer	\$10,000	\$11,664	\$11,813	\$12,131
					Grade 2 Wood Veneer	\$11,117	\$12,781	\$12,930	\$13,248
					Grade 1 Laminate	\$7550	\$9912	\$10,138	\$10,571
					Grade 2 and 3 Laminate	\$7869	\$10,231	\$10,457	\$10,890
					Grade 1 Wood Veneer	\$10,546	\$12,908	\$13,134	\$13,567
					Grade 2 Wood Veneer	\$11,804	\$14,166	\$14,392	\$14,825
					Grade 1 Laminate	\$7850	\$10,912	\$11,212	\$11,759
					Grade 2 and 3 Laminate	\$8206	\$11,268	\$11,568	\$12,115
					Grade 1 Wood Veneer	\$11,093	\$14,155	\$14,455	\$15,002
					Grade 2 Wood Veneer	\$12,491	\$15,553	\$15,853	\$16,400

Tip: Tables are available parametrically in 1" increments.

E-Table 2 Collaborative and Conference Tables

Trapezoid Aluminum Base Tables-Standing Height

**E-Table 2
Collaborative and
Conference Tables**

E-Table 2 Collaborative and Conference Tables

Trapezoid Laminate Base Tables

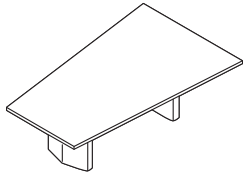

Tip: Shipped knocked down.

Tip: Utility bay quantity offering by table width is available in the understanding section.

Tip: 3 mm vinyl edge profiles on tables require a 4" radius on all corners.

Tip: If you specify a wood edge on a top with woodgrain laminate, the edge and the top may not match.

Tip: Sectioned top option is a two piece top and is only available on tops 96"W-120"W.

Tip: When a wood edge is specified on a wood veneer top, the edge finish will match the top finish.

Tip: Each utility bay comes with two universal faceplate openings that accept customer-supplied faceplates in any of the following sizes: single-gang, double-gang, or triple-gang.

Standard Includes

- Top:
 - 1 1/4" particle board core with grade 1 laminate
 - parametric width in 1" increments ranging from 96"-240"
 - For tables with widths up to 240", parametric depth is in 1" increments ranging from 36"-48" for depth right and 48"-60" for depth left
- Edge: 3 mm plastic edge, 3 mm wood edge, or convex vinyl edge
- Bases: black laminate on MDF core
- Wireway: painted steel side panels with powder coat and black plastic access door
- Concealed leveling glides: non-marring, black plastic
- Overall height: 29"

Options

Depth - Right	48"	No cost
Sectioned Top	No Sectioned Top	No cost
	With Sectioned Top	+\$569
Top Finish	Laminate Price Group 02	Price below
	Laminate Price Group 03	Price below
	Veneer Price Group 01	Price below
	Veneer Price Group 02	Price below
Edge Type	3mm Plastic Edge	Price below
	3mm Wood Edge	Price below
	Beveled Wood Edge	Price below
	Bullnose Wood Edge	Price below
	Convex Vinyl Edge	Price below
	Knife Wood Edge	Price below
Base Type	Black HPL	No cost
	Curated HPL	+\$872
Bay Option	No Bays	No cost
	Two Bays	+\$1578
	Three Bays	+\$2367
	Four Bays	+\$3156
	Six Bays	+\$4734
Wiring Schematic	1+1 Hardwire, 2 Circuits	No cost
	3 + 0 Wireway	No cost
	Chicago Wireway	No cost
	1+1 Hardwire,2 Circuits,USB	+\$157
	3 + 0 Wireway,USB	+\$157
Infeed	Hardwire	No cost
	NYC Hardwire Infeed	No cost
	Plug	No cost
Infeed Location	End Base Power Infeed	No cost
	Mid Base Power Infeed	No cost

► **Product Information continued on next page**

E-Table 2 Collaborative and Conference Tables

Trapezoid Laminate Base Tables

► Product Information continued from previous page

Specification Information

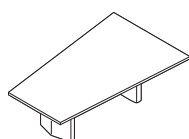

Dimensions		Style		Finish	Base Prices				
W	Depth Right	Depth Left	H		Number				
					3 mm Plastic/ 3 mm Wood, Flat, or Convex Vinyl Edge:	Bullnose Wood Edge:	Beveled Wood Edge:	Knife Wood Edge:	

Trapezoid Tables with Two Laminate Bases - Working Height

Tip: Top ships in one piece.

96"	48"	48" -60"	29"	COET2TRAPL	Grade 1 Laminate	\$6465	\$8129	\$8278	\$8596
					Grade 2 and 3 Laminate	\$6749	\$8413	\$8562	\$8880
					Grade 1 Wood Veneer	\$9216	\$10,880	\$11,029	\$11,347
					Grade 2 Wood Veneer	\$10,332	\$11,996	\$12,145	\$12,463
97" -108"	48"	48" -60"	29"	COET2TRAPL	Grade 1 Laminate	\$6830	\$9192	\$9418	\$9851
					Grade 2 and 3 Laminate	\$6942	\$9304	\$9530	\$9963
					Grade 1 Wood Veneer	\$8527	\$10,889	\$11,115	\$11,548
					Grade 2 Wood Veneer	\$10,460	\$12,822	\$13,048	\$13,481
109" -120"	48"	48" -60"	29"	COET2TRAPL	Grade 1 Laminate	\$7063	\$10,125	\$10,425	\$10,972
					Grade 2 and 3 Laminate	\$7418	\$10,480	\$10,780	\$11,327
					Grade 1 Wood Veneer	\$10,305	\$13,367	\$13,667	\$14,214
					Grade 2 Wood Veneer	\$11,703	\$14,765	\$15,065	\$15,612

Tip: For the specification of the depths, the "Depth Right" specification is the short end of the trapezoid table and the "Depth Left" specification is the long end of the trapezoid table.

► Product Information continued on next page

E-Table 2 Collaborative and Conference Tables

E-Table 2 Collaborative and Conference Tables

Trapezoid Laminate Base Tables

► Product Information continued from previous page

Specification Information

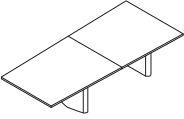
	Dimensions		Style H Number	Finish	Base Prices			
	W	Depth Right			Depth Left	3 mm Plastic/ 3 mm Wood, Flat, or Convex Vinyl Edge:	Bullnose Wood Edge:	Beveled Wood Edge:

Trapezoid Tables with Two Laminate Bases - Working Height

Tip: Top ships in two pieces. Hardware is included for field assembly.

W	Depth Right	Depth Left	H	Style Number	Finish	3 mm Plastic/ 3 mm Wood, Flat, or Convex Vinyl Edge:	Bullnose Wood Edge:	Beveled Wood Edge:	Knife Wood Edge:
121" -132"	48"	48" -60"	29"	COET2TRAPL	Grade 1 Laminate	\$7129	\$10,896	\$11,227	\$11,882
					Grade 2 and 3 Laminate	\$7520	\$11,287	\$11,618	\$12,273
					Grade 1 Wood Veneer	\$11,113	\$14,880	\$15,211	\$15,866
					Grade 2 Wood Veneer	\$12,655	\$16,422	\$16,753	\$17,408

Tip: If you require your table top to be made into three pieces, this can be done as a special. Please contact Customer Service at 1.800.627.6770 to obtain a quote.

133" -144"	48"	48" -60"	29"	COET2TRAPL	Grade 1 Laminate	\$7193	\$11,664	\$12,028	\$12,787
					Grade 2 and 3 Laminate	\$7621	\$12,092	\$12,456	\$13,215
					Grade 1 Wood Veneer	\$11,919	\$16,390	\$16,754	\$17,513
					Grade 2 Wood Veneer	\$13,605	\$18,076	\$18,440	\$19,199
145" 156"	48"	48" -60"	29"	COET2TRAPL	Grade 1 Laminate	\$8819	\$14,458	\$14,812	\$15,787
					Grade 2 and 3 Laminate	\$9268	\$14,907	\$15,261	\$16,236
					Grade 1 Wood Veneer	\$15,790	\$21,429	\$21,783	\$22,758
					Grade 2 Wood Veneer	\$17,645	\$23,284	\$23,638	\$24,613

► Product Information continued on next page

E-Table 2 Collaborative and Conference Tables

Trapezoid Laminate Base Tables

► Product Information continued from previous page

Specification Information

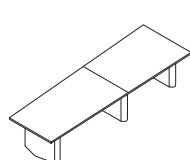

Dimensions W	Depth		H	Style Number	Finish	Base Prices			
	Right	Left				3 mm Plastic/ 3 mm Wood, Flat, or Convex Vinyl Edge:	Bullnose Wood Edge:	Beveled Wood Edge:	Knife Wood Edge:

Trapezoid Tables with Three Laminate Bases - Working Height

Tip: Top ships in two pieces. Hardware is included for field assembly.

157" -168"	48"	48" -60"	29"	COET2TRAPL	Grade 1 Laminate	\$10,280	\$17,085	\$17,431	\$18,620
					Grade 2 and 3 Laminate	\$10,749	\$17,554	\$17,900	\$19,089
					Grade 1 Wood Veneer	\$19,492	\$26,297	\$26,643	\$27,832
					Grade 2 Wood Veneer	\$21,516	\$28,321	\$28,667	\$29,856

Tip: For tables with three or more bases, you must specify the entry point of the base power infeed, either an end base or a mid base location, in order to receive the correct length of base power infeed.

169" -180"	48"	48" -60"	29"	COET2TRAPL	Grade 1 Laminate	\$10,500	\$17,386	\$17,738	\$18,941
					Grade 2 and 3 Laminate	\$10,976	\$17,862	\$18,214	\$19,417
					Grade 1 Wood Veneer	\$19,825	\$26,711	\$27,063	\$28,266
					Grade 2 Wood Veneer	\$21,873	\$28,759	\$29,111	\$30,314

181" -192"	48"	48" -60"	29"	COET2TRAPL	Grade 1 Laminate	\$10,628	\$17,596	\$17,952	\$19,170
					Grade 2 and 3 Laminate	\$11,109	\$18,077	\$18,433	\$19,651
					Grade 1 Wood Veneer	\$20,064	\$27,032	\$27,388	\$28,606
					Grade 2 Wood Veneer	\$22,138	\$29,106	\$29,462	\$30,680

Tip: If you require your table top to be made into three pieces, this can be done as a special. Please contact Customer Service at 1.800.627.6770 to obtain a quote.

193" -204"	48"	48" -60"	29"	COET2TRAPL	Grade 1 Laminate	\$10,883	\$18,019	\$18,383	\$19,631
					Grade 2 and 3 Laminate	\$11,375	\$18,511	\$18,875	\$20,123
					Grade 1 Wood Veneer	\$20,544	\$27,680	\$28,044	\$29,292
					Grade 2 Wood Veneer	\$22,665	\$29,801	\$30,165	\$31,413

205" -216"	48"	48" -60"	29"	COET2TRAPL	Grade 1 Laminate	\$11,143	\$18,449	\$18,822	\$20,100
					Grade 2 and 3 Laminate	\$11,649	\$18,955	\$19,328	\$20,606
					Grade 1 Wood Veneer	\$21,037	\$28,343	\$28,716	\$29,994
					Grade 2 Wood Veneer	\$23,210	\$30,516	\$30,889	\$32,167



► Product Information continued on next page

E-Table 2 Collaborative and Conference Tables

Trapezoid Laminate Base Tables

► Product Information continued from previous page

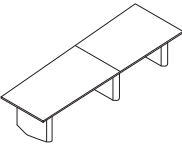
Specification Information

	Dimensions		Style	Finish	Base Prices			
	W	Depth Right			Depth Left	H	Number	

Trapezoid Tables with Three Laminate Bases - Working Height

W	Depth Right	Depth Left	H	Style	Finish	3 mm Plastic/ 3 mm Wood, Flat, or Convex Vinyl Edge:	Bullnose Wood Edge:	Beveled Wood Edge:	Knife Wood Edge:
217" -228"	48"	48" -60"	29"	COET2TRAPL	Grade 1 Laminate	\$11,411	\$18,894	\$19,275	\$20,583
					Grade 2 and 3 Laminate	\$11,928	\$19,411	\$19,792	\$21,100
					Grade 1 Wood Veneer	\$21,543	\$29,026	\$29,407	\$30,715
					Grade 2 Wood Veneer	\$23,767	\$31,250	\$31,631	\$32,939
229" -240"	48"	48" -60"	29"	COET2TRAPL	Grade 1 Laminate	\$11,685	\$19,348	\$19,739	\$21,078
					Grade 2 and 3 Laminate	\$12,212	\$19,875	\$20,266	\$21,605
					Grade 1 Wood Veneer	\$22,058	\$29,721	\$30,112	\$31,451
					Grade 2 Wood Veneer	\$24,340	\$32,003	\$32,394	\$33,733

E-Table 2 Collaborative and Conference Tables

Trapezoid Laminate Base Tables

E-Table 2
Collaborative and
Conference Tables

E-Table 2 Collaborative and Conference Tables

Trapezoid Veneer Base Tables

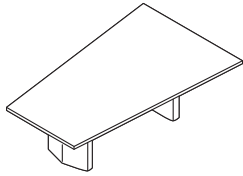

Tip: Shipped knocked down.

Tip: Utility bay quantity offering by table width is available in the understanding section.

Tip: 3 mm vinyl edge profiles on tables require a 4" radius on all corners.

Tip: If you specify a wood edge on a top with woodgrain laminate, the edge and the top may not match.

Tip: Sectioned top option is a two piece top and is only available on tops 96"W-120"W.

Tip: When a wood edge is specified on a wood veneer top, the edge finish will match the top finish.

Tip: Each utility bay comes with two universal faceplate openings that accept customer-supplied faceplates in any of the following sizes: single-gang, double-gang, or triple-gang.

Standard Includes

- Top:
 - 1 1/4" particle board core with grade 1 laminate
 - parametric width in 1" increments ranging from 96"-240"
 - For tables with widths up to 240", parametric depth is in 1" increments ranging from 36"-48" for depth right and 48"-60" for depth left
- Edge: 3 mm plastic edge, 3 mm wood edge, or convex vinyl edge
- Bases: grade 01 or grade 02 veneer on MDF core
- Wireway: painted steel side panels with powder coat and black plastic access door
- Concealed leveling glides: non-marring, black plastic
- Overall height: 29"

Options

Depth - Right	48"	No cost
Sectioned Top	No Sectioned Top	No cost
	With Sectioned Top	+\$569
Top Finish	Laminate Price Group 02	Price below
	Laminate Price Group 03	Price below
	Veneer Price Group 01	Price below
	Veneer Price Group 02	Price below
Edge Type	3mm Plastic Edge	Price below
	3mm Wood Edge	Price below
	Beveled Wood Edge	Price below
	Bullnose Wood Edge	Price below
	Convex Vinyl Edge	Price below
	Knife Wood Edge	Price below
Bay Option	No Bays	No cost
	Two Bays	+\$1578
	Three Bays	+\$2367
	Four Bays	+\$3156
	Six Bays	+\$4734
Wiring Schematic	1+1 Hardwire, 2 Circuits	No cost
	3 + 0 Wireway	No cost
	Chicago Wireway	No cost
	1+1 Hardwire,2 Circuits,USB	+\$157
	3 + 0 Wireway,USB	+\$157
Infeed	Hardwire	No cost
	NYC Hardwire Infeed	No cost
	Plug	No cost
Infeed Location	End Base Power Infeed	No cost
	Mid Base Power Infeed	No cost

► **Product Information continued on next page**

E-Table 2 Collaborative and Conference Tables

Trapezoid Veneer Base Tables

► Product Information continued from previous page

Specification Information

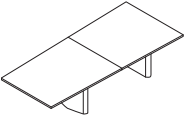
	Dimensions		Style H Number	Finish	Base Prices			
	W	Depth Right			Depth Left	3 mm Plastic/ 3 mm Wood, Flat, or Convex Vinyl Edge:	Bullnose Wood Edge:	Beveled Wood Edge:

Trapezoid Tables with Two Veneer Bases - Working Height

Tip: Top ships in two pieces. Hardware is included for field assembly.

121" -132"	48"	48" -60"	29"	COET2TRAPV	Grade 1 Laminate	\$10,521	\$14,288	\$14,619	\$15,274
					Grade 2 and 3 Laminate	\$10,912	\$14,679	\$15,010	\$15,665
					Grade 1 Wood Veneer	\$14,505	\$18,272	\$18,603	\$19,258
					Grade 2 Wood Veneer	\$16,047	\$19,814	\$20,145	\$20,800

Tip: If you require your table top to be made into three pieces, this can be done as a special. Please contact Customer Service at 1.800.627.6770 to obtain a quote.

133" -144"	48"	48" -60"	29"	COET2TRAPV	Grade 1 Laminate	\$10,585	\$15,056	\$15,420	\$16,179
					Grade 2 and 3 Laminate	\$11,013	\$15,484	\$15,848	\$16,607
					Grade 1 Wood Veneer	\$15,311	\$19,782	\$20,146	\$20,905
					Grade 2 Wood Veneer	\$16,997	\$21,468	\$21,832	\$22,591

145" -156"	48"	48" -60"	29"	COET2TRAPV	Grade 1 Laminate	\$12,243	\$17,882	\$18,236	\$19,211
					Grade 2 and 3 Laminate	\$12,694	\$18,333	\$18,687	\$19,662
					Grade 1 Wood Veneer	\$19,216	\$24,855	\$25,209	\$26,184
					Grade 2 Wood Veneer	\$21,068	\$26,707	\$27,061	\$28,036





► Product Information continued on next page

E-Table 2 Collaborative and Conference Tables

Trapezoid Veneer Base Tables

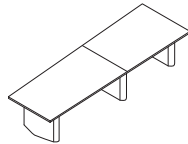
► Product Information continued from previous page

Specification Information

	Dimensions		Style H Number	Finish	Base Prices				
	W	Depth Right			Depth Left				
									
					3 mm Plastic/ 3 mm Wood, Flat, or Convex Vinyl Edge:	Bullnose Wood Edge:	Beveled Wood Edge:	Knife Wood Edge:	

Trapezoid Tables with Three Veneer Bases - Working Height

Tip: Top ships in two pieces. Hardware is included for field assembly.

Dimensions	Style	Finish	3 mm Plastic/ 3 mm Wood, Flat, or Convex Vinyl Edge:	Bullnose Wood Edge:	Beveled Wood Edge:	Knife Wood Edge:
157" -168" 48" 48" -60" 29"	COET2TRAPV	Grade 1 Laminate	\$15,492	\$22,297	\$22,643	\$23,832
		Grade 2 and 3 Laminate	\$15,961	\$22,766	\$23,112	\$24,301
		Grade 1 Wood Veneer	\$24,704	\$31,509	\$31,855	\$33,044
		Grade 2 Wood Veneer	\$26,728	\$33,533	\$33,879	\$35,068

Tip: For tables with three or more bases, you must specify the entry point of the base power infeed, either an end base or a mid base location, in order to receive the correct length of base power infeed.

Dimensions	Style	Finish	3 mm Plastic/ 3 mm Wood, Flat, or Convex Vinyl Edge:	Bullnose Wood Edge:	Beveled Wood Edge:	Knife Wood Edge:
169" -180" 48" 48" -60" 29"	COET2TRAPV	Grade 1 Laminate	\$15,765	\$22,651	\$23,003	\$24,206
		Grade 2 and 3 Laminate	\$16,238	\$23,124	\$23,476	\$24,679
		Grade 1 Wood Veneer	\$25,084	\$31,970	\$32,322	\$33,525
		Grade 2 Wood Veneer	\$27,133	\$34,019	\$34,371	\$35,574

Dimensions	Style	Finish	3 mm Plastic/ 3 mm Wood, Flat, or Convex Vinyl Edge:	Bullnose Wood Edge:	Beveled Wood Edge:	Knife Wood Edge:
181" -192" 48" 48" -60" 29"	COET2TRAPV	Grade 1 Laminate	\$15,889	\$22,857	\$23,213	\$24,431
		Grade 2 and 3 Laminate	\$16,370	\$23,338	\$23,694	\$24,912
		Grade 1 Wood Veneer	\$25,324	\$32,292	\$32,648	\$33,866
		Grade 2 Wood Veneer	\$27,397	\$34,365	\$34,721	\$35,939

Tip: If you require your table top to be made into three pieces, this can be done as a special. Please contact Customer Service at 1.800.627.6770 to obtain a quote.

Dimensions	Style	Finish	3 mm Plastic/ 3 mm Wood, Flat, or Convex Vinyl Edge:	Bullnose Wood Edge:	Beveled Wood Edge:	Knife Wood Edge:
193" -204" 48" 48" -60" 29"	COET2TRAPV	Grade 1 Laminate	\$16,144	\$23,280	\$23,644	\$24,892
		Grade 2 and 3 Laminate	\$16,637	\$23,773	\$24,137	\$25,385
		Grade 1 Wood Veneer	\$25,805	\$32,941	\$33,305	\$34,553
		Grade 2 Wood Veneer	\$27,927	\$35,063	\$35,427	\$36,675

Dimensions	Style	Finish	3 mm Plastic/ 3 mm Wood, Flat, or Convex Vinyl Edge:	Bullnose Wood Edge:	Beveled Wood Edge:	Knife Wood Edge:
205" -216" 48" 48" -60" 29"	COET2TRAPV	Grade 1 Laminate	\$16,405	\$23,711	\$24,084	\$25,362
		Grade 2 and 3 Laminate	\$16,909	\$24,215	\$24,588	\$25,866
		Grade 1 Wood Veneer	\$26,300	\$33,606	\$33,979	\$35,257
		Grade 2 Wood Veneer	\$28,472	\$35,778	\$36,151	\$37,429

► Product Information continued on next page

E-Table 2 Collaborative and Conference Tables

Trapezoid Veneer Base Tables

► Product Information continued from previous page

Specification Information

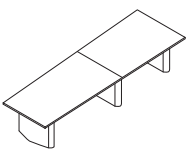
	Dimensions		Style H Number	Finish	Base Prices			
	W	Depth Right			Depth Left	3 mm Plastic/ 3 mm Wood, Flat, or Convex Vinyl Edge:	Bullnose Wood Edge:	Beveled Wood Edge:

Trapezoid Tables with Three Veneer Bases - Working Height

W	Depth Right	Depth Left	H	Style Number	Finish	3 mm Plastic/ 3 mm Wood, Flat, or Convex Vinyl Edge:	Bullnose Wood Edge:	Beveled Wood Edge:	Knife Wood Edge:
217" -228"	48"	48" -60"	29"	COET2TRAPV	Grade 1 Laminate	\$16,673	\$24,156	\$24,537	\$25,845
					Grade 2 and 3 Laminate	\$17,189	\$24,672	\$25,053	\$26,361
					Grade 1 Wood Veneer	\$26,803	\$34,286	\$34,667	\$35,975
					Grade 2 Wood Veneer	\$29,029	\$36,512	\$36,893	\$38,201
229" -240"	48"	48" -60"	29"	COET2TRAPV	Grade 1 Laminate	\$16,946	\$24,609	\$25,000	\$26,339
					Grade 2 and 3 Laminate	\$17,474	\$25,137	\$25,528	\$26,867
					Grade 1 Wood Veneer	\$27,321	\$34,984	\$35,375	\$36,714
					Grade 2 Wood Veneer	\$29,600	\$37,263	\$37,654	\$38,993

Tip: Tables are available parametrically in 1" increments.

E-Table 2 Collaborative and Conference Tables

Trapezoid Veneer Base Tables

E-Table 2
Collaborative and
Conference Tables

E-Table 2 Collaborative and Conference Tables

D-Shape Aluminum Base Tables-Working Height

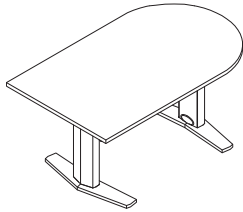

Tip: Shipped knocked down.

Tip: Utility bay quantity offering by table width is available in the understanding section.

Tip: 3 mm vinyl edge profiles on tables require a 4" radius on all corners.

Tip: A flat, plastic edge can be specified on veneer tops by selecting the "flat" edge option. Flat edge is only available in 6000 Black on veneer tops.

Tip: If you specify a wood edge on a top with woodgrain laminate, the edge and the top may not match.

Tip: Sectioned top option is a two piece top and is only available on tops 96"W-120"W.

Tip: When a wood edge is specified on a wood veneer top, the edge finish will match the top finish.

Tip: Each utility bay comes with two universal faceplate openings that accept customer-supplied faceplates in any of the following sizes: single-gang, double-gang, or triple-gang.

Standard Includes

- Top:
 - 1 1/4" particle board core with grade 1 laminate
 - parametric width in 1" increments ranging from 60"-120"
 - parametric depth in 1" increments ranging from 36"-60"
- Edge: 3 mm plastic edge, 3 mm wood edge, or convex vinyl edge
- Bases: cast and extruded aluminum with powder coat
- Wireway: painted steel side panels with powder coat and black plastic access door
- Concealed leveling glides: non-marring, black plastic
- Overall height: 29"

Options

Sectioned Top	No Sectioned Top With Sectioned Top	No cost +\$569
Top Finish	Laminate Price Group 02 Laminate Price Group 03 Veneer Price Group 01 Veneer Price Group 02	Price below Price below Price below Price below
Edge Type	3mm Plastic Edge 3mm Wood Edge Beveled Wood Edge Bullnose Wood Edge Convex Vinyl Edge Knife Wood Edge	Price below Price below Price below Price below Price below Price below
Bay Option	No Bays One Bay Two Bays Three Bays	No cost +\$789 +\$1578 +\$2367
Wiring Schematic	1+1 Hardwire, 2 Circuits 3 + 0 Wireway Chicago Wireway 1+1 Hardwire,2 Circuits,USB 3 + 0 Wireway,USB	No cost No cost No cost +\$157 +\$157
Infeed	Hardwire NYC Hardwire Infeed Plug	No cost No cost No cost

► **Product Information continued on next page**

E-Table 2 Collaborative and Conference Tables

D-Shape Aluminum Base Tables-Working Height

► Product Information continued from previous page

Specification Information

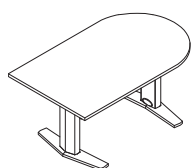

Dimensions		Style Number	Finish	Base Prices				
W	D			H	Vinyl Edge:			
				3 mm Plastic/ 3 mm Wood, Flat, or Convex	Bullnose Wood	Beveled Wood	Knife Wood	

D-Shape Tables with Two Aluminum Bases - Working Height

60" -71"	36"	29"	COET2DA	Grade 1 Laminate	\$4423	\$4914	\$4978	\$5065
				Grade 2 and 3 Laminate	\$4542	\$5033	\$5097	\$5184
				Grade 1 Wood Veneer	\$5287	\$5778	\$5842	\$5929
				Grade 2 Wood Veneer	\$5670	\$6161	\$6225	\$6312
60" -71"	37" -42"	29"	COET2DA	Grade 1 Laminate	\$4952	\$6004	\$5973	\$6191
				Grade 2 and 3 Laminate	\$5098	\$6150	\$6119	\$6337
				Grade 1 Wood Veneer	\$6702	\$7754	\$7723	\$7941
				Grade 2 Wood Veneer	\$7075	\$8127	\$8096	\$8314
60" -71"	43" -48"	29"	COET2DA	Grade 1 Laminate	\$5066	\$6105	\$6070	\$6304
				Grade 2 and 3 Laminate	\$5248	\$6287	\$6252	\$6486
				Grade 1 Wood Veneer	\$6731	\$7770	\$7735	\$7969
				Grade 2 Wood Veneer	\$7163	\$8202	\$8167	\$8401
60" -71"	49" -54"	29"	COET2DA	Grade 1 Laminate	\$5562	\$6631	\$6554	\$6792
				Grade 2 and 3 Laminate	\$5744	\$6813	\$6736	\$6974
				Grade 1 Wood Veneer	\$7250	\$8319	\$8242	\$8480
				Grade 2 Wood Veneer	\$7771	\$8840	\$8763	\$9001
60" -71"	55" -60"	29"	COET2DA	Grade 1 Laminate	\$6031	\$7131	\$7010	\$7253
				Grade 2 and 3 Laminate	\$6239	\$7339	\$7218	\$7461
				Grade 1 Wood Veneer	\$7768	\$8868	\$8747	\$8990
				Grade 2 Wood Veneer	\$8378	\$9478	\$9357	\$9600
72"	36"	29"	COET2DA	Grade 1 Laminate	\$4625	\$5549	\$5651	\$5817
				Grade 2 and 3 Laminate	\$4758	\$5682	\$5784	\$5950
				Grade 1 Wood Veneer	\$6182	\$7106	\$7208	\$7374
				Grade 2 Wood Veneer	\$6675	\$7599	\$7701	\$7867

Tip: Top ships in one piece.

Tip: For 60"W- 95"W tables, if you require your table top to be made into two pieces, this can be done as a special. Please contact Customer Service at 1.800.627.6770 to obtain a quote.

Tip: Tables are available parametrically in 1" increments.

► Product Information continued on next page

E-Table 2 Collaborative and Conference Tables

D-Shape Aluminum Base Tables-Working Height

► Product Information continued from previous page

Specification Information

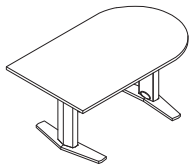

Dimensions		Style Number	Finish	Base Prices			
W	D			H	Edge:		
				3 mm Plastic/ 3 mm Wood, Flat, or Convex Vinyl Edge:	Bullnose Wood Edge:	Beveled Wood Edge:	Knife Wood Edge:

D-Shape Tables with Two Aluminum Bases - Working Height

Dimensions	Style Number	Finish	3 mm Plastic/ 3 mm Wood, Flat, or Convex Vinyl Edge:	Bullnose Wood Edge:	Beveled Wood Edge:	Knife Wood Edge:
72" 37" -42" 29"	COET2DA	Grade 1 Laminate	\$4995	\$6175	\$6214	\$6438
		Grade 2 and 3 Laminate	\$5142	\$6322	\$6361	\$6585
		Grade 1 Wood Veneer	\$6933	\$8113	\$8152	\$8376
		Grade 2 Wood Veneer	\$7467	\$8647	\$8686	\$8910
72" 43" -48" 29"	COET2DA	Grade 1 Laminate	\$5110	\$6276	\$6317	\$6558
		Grade 2 and 3 Laminate	\$5287	\$6453	\$6494	\$6735
		Grade 1 Wood Veneer	\$6954	\$8120	\$8161	\$8402
		Grade 2 Wood Veneer	\$7522	\$8688	\$8729	\$8970
72" 49" -54" 29"	COET2DA	Grade 1 Laminate	\$5627	\$6824	\$6821	\$7068
		Grade 2 and 3 Laminate	\$5830	\$7027	\$7024	\$7271
		Grade 1 Wood Veneer	\$7523	\$8720	\$8717	\$8964
		Grade 2 Wood Veneer	\$8179	\$9376	\$9373	\$9620
72" 55" -60" 29"	COET2DA	Grade 1 Laminate	\$6094	\$7322	\$7274	\$7526
		Grade 2 and 3 Laminate	\$6325	\$7553	\$7505	\$7757
		Grade 1 Wood Veneer	\$8041	\$9269	\$9221	\$9473
		Grade 2 Wood Veneer	\$8785	\$10,013	\$9965	\$10,217
73" -84" 36" 29"	COET2DA	Grade 1 Laminate	\$4870	\$6226	\$6370	\$6611
		Grade 2 and 3 Laminate	\$5016	\$6372	\$6516	\$6757
		Grade 1 Wood Veneer	\$7116	\$8472	\$8616	\$8857
		Grade 2 Wood Veneer	\$7723	\$9079	\$9223	\$9464

Tip: Tables are available parametrically in 1" increments.

► Product Information continued on next page

E-Table 2 Collaborative and Conference Tables

D-Shape Aluminum Base Tables-Working Height

► Product Information continued from previous page

Specification Information

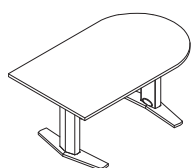

Dimensions		Style Number	Finish	Base Prices					
W	D			H	Edge:				
				3 mm Plastic/ 3 mm Wood, Flat, or Convex Vinyl Edge:	Bullnose Wood	Beveled Wood	Knife Wood		

D-Shape Tables with Two Aluminum Bases - Working Height

W	D	H	Style Number	Finish	3 mm Plastic/3 mm Wood, Flat, or Convex Vinyl Edge	Bullnose Wood	Beveled Wood	Knife Wood
73" -84"	37" -42"	29"	COET2DA	Grade 1 Laminate	\$5055	\$6362	\$6470	\$6701
				Grade 2 and 3 Laminate	\$5232	\$6539	\$6647	\$6878
				Grade 1 Wood Veneer	\$7213	\$8520	\$8628	\$8859
				Grade 2 Wood Veneer	\$7871	\$9178	\$9286	\$9517
73" -84"	43" -48"	29"	COET2DA	Grade 1 Laminate	\$5170	\$6464	\$6578	\$6827
				Grade 2 and 3 Laminate	\$5369	\$6663	\$6777	\$7026
				Grade 1 Wood Veneer	\$7227	\$8521	\$8635	\$8884
				Grade 2 Wood Veneer	\$7929	\$9223	\$9337	\$9586
73" -84"	49" -54"	29"	COET2DA	Grade 1 Laminate	\$5689	\$7016	\$7084	\$7338
				Grade 2 and 3 Laminate	\$5917	\$7244	\$7312	\$7566
				Grade 1 Wood Veneer	\$7796	\$9123	\$9191	\$9445
				Grade 2 Wood Veneer	\$8588	\$9915	\$9983	\$10,237
73" -84"	55" -60"	29"	COET2DA	Grade 1 Laminate	\$6156	\$7513	\$7538	\$7799
				Grade 2 and 3 Laminate	\$6410	\$7767	\$7792	\$8053
				Grade 1 Wood Veneer	\$8315	\$9672	\$9697	\$9958
				Grade 2 Wood Veneer	\$9195	\$10,552	\$10,577	\$10,838
85" -96"	36"	29"	COET2DA	Grade 1 Laminate	\$5155	\$6432	\$6585	\$6831
				Grade 2 and 3 Laminate	\$5326	\$6603	\$6756	\$7002
				Grade 1 Wood Veneer	\$7253	\$8530	\$8683	\$8929
				Grade 2 Wood Veneer	\$7954	\$9231	\$9384	\$9630

► Product Information continued on next page

E-Table 2 Collaborative and Conference Tables

E-Table 2 Collaborative and Conference Tables

D-Shape Aluminum Base Tables-Working Height

► Product Information continued from previous page

Specification Information

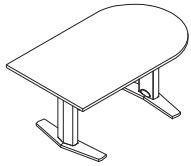

Dimensions		Style Number	Finish	Base Prices					
W	D			H	Edge:				
				3 mm Plastic/ 3 mm Wood, Flat, or Convex Vinyl Edge:	Bullnose Wood Edge:	Beveled Wood Edge:	Knife Wood Edge:		

D-Shape Tables with Two Aluminum Bases - Working Height

W	D	H	Style Number	Finish	Grade 1 Price	Grade 2 and 3 Price	Grade 1 Wood Veneer Price	Grade 2 Wood Veneer Price
85" -96"	37" -42"	29"	COET2DA	Grade 1 Laminate	\$5617	\$6925	\$7035	\$7285
				Grade 2 and 3 Laminate	\$5815	\$7123	\$7233	\$7483
				Grade 1 Wood Veneer	\$7766	\$9074	\$9184	\$9434
				Grade 2 Wood Veneer	\$8555	\$9863	\$9973	\$10,223
85" -96"	43" -48"	29"	COET2DA	Grade 1 Laminate	\$6082	\$7412	\$7533	\$7789
				Grade 2 and 3 Laminate	\$6314	\$7644	\$7765	\$8021
				Grade 1 Wood Veneer	\$8285	\$9615	\$9736	\$9992
				Grade 2 Wood Veneer	\$9180	\$10,510	\$10,631	\$10,887
85" -96"	49" -54"	29"	COET2DA	Grade 1 Laminate	\$6259	\$7760	\$7892	\$8180
				Grade 2 and 3 Laminate	\$6517	\$8018	\$8150	\$8438
				Grade 1 Wood Veneer	\$8733	\$10,234	\$10,366	\$10,654
				Grade 2 Wood Veneer	\$9657	\$11,158	\$11,290	\$11,578
85" -96"	55" -60"	29"	COET2DA	Grade 1 Laminate	\$6435	\$8099	\$8248	\$8568
				Grade 2 and 3 Laminate	\$6720	\$8384	\$8533	\$8853
				Grade 1 Wood Veneer	\$9187	\$10,851	\$11,000	\$11,320
				Grade 2 Wood Veneer	\$10,151	\$11,815	\$11,964	\$12,284
97" -108"	36"	29"	COET2DA	Grade 1 Laminate	\$5671	\$6970	\$7137	\$7384
				Grade 2 and 3 Laminate	\$5876	\$7175	\$7342	\$7589
				Grade 1 Wood Veneer	\$7822	\$9121	\$9288	\$9535
				Grade 2 Wood Veneer	\$8620	\$9919	\$10,086	\$10,333

Tip: Tables are available parametrically in 1" increments.

► Product Information continued on next page

E-Table 2 Collaborative and Conference Tables

D-Shape Aluminum Base Tables-Working Height

► Product Information continued from previous page

Specification Information

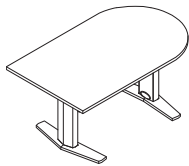

Dimensions		Style Number	Finish	Base Prices					
W	D			H	Edge:				
				3 mm Plastic/ 3 mm Wood, Flat, or Convex Vinyl Edge:	Bullnose Wood Edge:	Beveled Wood Edge:	Knife Wood Edge:		

D-Shape Tables with Two Aluminum Bases - Working Height

97" -108"	37" -42"	29"	COET2DA	Grade 1 Laminate	\$5850	\$7329	\$7448	\$7734
				Grade 2 and 3 Laminate	\$6075	\$7554	\$7673	\$7959
				Grade 1 Wood Veneer	\$8271	\$9750	\$9869	\$10,155
				Grade 2 Wood Veneer	\$9097	\$10,576	\$10,695	\$10,981
97" -108"	43" -48"	29"	COET2DA	Grade 1 Laminate	\$6331	\$8218	\$8400	\$8750
				Grade 2 and 3 Laminate	\$6588	\$8475	\$8657	\$9007
				Grade 1 Wood Veneer	\$8566	\$10,453	\$10,635	\$10,985
				Grade 2 Wood Veneer	\$9568	\$11,455	\$11,637	\$11,987
97" -108"	49" -54"	29"	COET2DA	Grade 1 Laminate	\$6567	\$8693	\$8895	\$9287
				Grade 2 and 3 Laminate	\$6855	\$8981	\$9183	\$9575
				Grade 1 Wood Veneer	\$9184	\$11,310	\$11,512	\$11,904
				Grade 2 Wood Veneer	\$10,274	\$12,400	\$12,602	\$12,994
97" -108"	55" -60"	29"	COET2DA	Grade 1 Laminate	\$6801	\$9163	\$9389	\$9819
				Grade 2 and 3 Laminate	\$7117	\$9479	\$9705	\$10,135
				Grade 1 Wood Veneer	\$9796	\$12,158	\$12,384	\$12,814
				Grade 2 Wood Veneer	\$10,981	\$13,343	\$13,569	\$13,999
109" -120"	36"	29"	COET2DA	Grade 1 Laminate	\$5808	\$7605	\$7766	\$8104
				Grade 2 and 3 Laminate	\$6024	\$7821	\$7982	\$8320
				Grade 1 Wood Veneer	\$7884	\$9681	\$9842	\$10,180
				Grade 2 Wood Veneer	\$8731	\$10,528	\$10,689	\$11,027

► Product Information continued on next page

E-Table 2 Collaborative and Conference Tables

D-Shape Aluminum Base Tables-Working Height

► Product Information continued from previous page

Specification Information

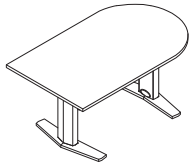

Dimensions		Style Number	Finish	Base Prices				
W	D			H	Edge:			
				3 mm Plastic/ 3 mm Wood, Flat, or Convex Vinyl Edge:	Bullnose Wood Edge:	Beveled Wood Edge:	Knife Wood Edge:	

D-Shape Tables with Two Aluminum Bases - Working Height

Dimensions	Style Number	Finish	3 mm Plastic/3 mm Wood, Flat, or Convex Vinyl Edge:	Bullnose Wood Edge:	Beveled Wood Edge:	Knife Wood Edge:
109" -120" 37" -42" 29"	COET2DA	Grade 1 Laminate	\$6287	\$8493	\$8717	\$9116
		Grade 2 and 3 Laminate	\$6538	\$8744	\$8968	\$9367
		Grade 1 Wood Veneer	\$8180	\$10,386	\$10,610	\$11,009
		Grade 2 Wood Veneer	\$9203	\$11,409	\$11,633	\$12,032
109" -120" 43" -48" 29"	COET2DA	Grade 1 Laminate	\$6462	\$8905	\$9150	\$9592
		Grade 2 and 3 Laminate	\$6743	\$9186	\$9431	\$9873
		Grade 1 Wood Veneer	\$8732	\$11,175	\$11,420	\$11,862
		Grade 2 Wood Veneer	\$9859	\$12,302	\$12,547	\$12,989
109" -120" 49" -54" 29"	COET2DA	Grade 1 Laminate	\$6750	\$9500	\$9775	\$10,267
		Grade 2 and 3 Laminate	\$7070	\$9820	\$10,095	\$10,587
		Grade 1 Wood Veneer	\$9507	\$12,257	\$12,532	\$13,024
		Grade 2 Wood Veneer	\$10,778	\$13,528	\$13,803	\$14,295
109" -120" 55" -60" 29"	COET2DA	Grade 1 Laminate	\$7034	\$10,096	\$10,396	\$10,936
		Grade 2 and 3 Laminate	\$7389	\$10,451	\$10,751	\$11,291
		Grade 1 Wood Veneer	\$10,275	\$13,337	\$13,637	\$14,177
		Grade 2 Wood Veneer	\$11,690	\$14,752	\$15,052	\$15,592

E-Table 2 Collaborative and Conference Tables

D-Shape Aluminum Base Tables-Working Height

E-Table 2
Collaborative and
Conference Tables

E-Table 2 Collaborative and Conference Tables

D-Shape Aluminum Base Tables-Standing Height

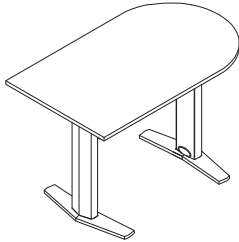

Tip: Shipped knocked down.

Tip: Utility bay quantity offering by table width is available in the understanding section.

Tip: 3 mm vinyl edge profiles on tables require a 4" radius on all corners.

Tip: A flat, plastic edge can be specified on veneer tops by selecting the "flat" edge option. Flat edge is only available in 6000 Black on veneer tops.

Tip: If you specify a wood edge on a top with woodgrain laminate, the edge and the top may not match.

Tip: Sectioned top option is a two piece top and is only available on tops 96"W-120"W.

Tip: When a wood edge is specified on a wood veneer top, the edge finish will match the top finish.

Tip: Each utility bay comes with two universal faceplate openings that accept customer-supplied faceplates in any of the following sizes: single-gang, double-gang, or triple-gang.

Standard Includes

- Top:
 - 1 1/4" particle board core with grade 1 laminate
 - parametric width in 1" increments ranging from 60"-120"
 - parametric depth in 1" increments ranging from 36"-60"
- Edge: 3 mm plastic edge, 3 mm wood edge, or convex vinyl edge
- Bases: cast and extruded aluminum with powder coat
- Wireway: painted steel side panels with powder coat and black plastic access door
- Concealed leveling glides: non-marring, black plastic
- Overall height: 40"

Options

Sectioned Top	No Sectioned Top With Sectioned Top	No cost +\$569
Top Finish	Laminate Price Group 02 Laminate Price Group 03 Veneer Price Group 01 Veneer Price Group 02	Price below Price below Price below Price below
Edge Type	3mm Plastic Edge 3mm Wood Edge Beveled Wood Edge Bullnose Wood Edge Convex Vinyl Edge Knife Wood Edge	Price below Price below Price below Price below Price below Price below
Bay Option	No Bays One Bay Two Bays Three Bays	No cost +\$789 +\$1578 +\$2367
Wiring Schematic	1+1 Hardwire, 2 Circuits 3 + 0 Wireway Chicago Wireway 1+1 Hardwire,2 Circuits,USB 3 + 0 Wireway,USB	No cost No cost No cost +\$157 +\$157
Infeed	Hardwire NYC Hardwire Infeed Plug	No cost No cost No cost

► **Product Information continued on next page**

E-Table 2 Collaborative and Conference Tables

D-Shape Aluminum Base Tables-Standing Height

► Product Information continued from previous page

Specification Information

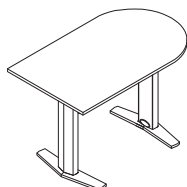

Dimensions		Style H Number	Finish	Base Prices				
W	D			3 mm Plastic/ 3 mm Wood, Flat, or Convex Vinyl Edge:	Bullnose Wood Edge:	Beveled Wood Edge:	Knife Wood Edge:	

D-Shape Tables with Two Aluminum Bases - Standing Height

60" -71"	36"	40"	COET2DSTA	Grade 1 Laminate	\$4909	\$5400	\$5464	\$5551
				Grade 2 and 3 Laminate	\$5028	\$5519	\$5583	\$5670
				Grade 1 Wood Veneer	\$5774	\$6265	\$6329	\$6416
				Grade 2 Wood Veneer	\$6160	\$6651	\$6715	\$6802
60" -71"	37" -42"	40"	COET2DSTA	Grade 1 Laminate	\$5469	\$6521	\$6490	\$6708
				Grade 2 and 3 Laminate	\$5584	\$6636	\$6605	\$6823
				Grade 1 Wood Veneer	\$7187	\$8239	\$8208	\$8426
				Grade 2 Wood Veneer	\$7562	\$8614	\$8583	\$8801
60" -71"	43" -48"	40"	COET2DSTA	Grade 1 Laminate	\$5583	\$6622	\$6587	\$6821
				Grade 2 and 3 Laminate	\$5737	\$6776	\$6741	\$6975
				Grade 1 Wood Veneer	\$7215	\$8254	\$8219	\$8453
				Grade 2 Wood Veneer	\$7649	\$8688	\$8653	\$8887
60" -71"	49" -54"	40"	COET2DSTA	Grade 1 Laminate	\$6050	\$7119	\$7042	\$7280
				Grade 2 and 3 Laminate	\$6230	\$7299	\$7222	\$7460
				Grade 1 Wood Veneer	\$7734	\$8803	\$8726	\$8964
				Grade 2 Wood Veneer	\$8257	\$9326	\$9249	\$9487
60" -71"	55" -60"	40"	COET2DSTA	Grade 1 Laminate	\$6517	\$7617	\$7496	\$7739
				Grade 2 and 3 Laminate	\$6725	\$7825	\$7704	\$7947
				Grade 1 Wood Veneer	\$8253	\$9353	\$9232	\$9475
				Grade 2 Wood Veneer	\$8866	\$9966	\$9845	\$10,088
72"	36"	40"	COET2DSTA	Grade 1 Laminate	\$5155	\$6079	\$6181	\$6347
				Grade 2 and 3 Laminate	\$5289	\$6213	\$6315	\$6481
				Grade 1 Wood Veneer	\$6712	\$7636	\$7738	\$7904
				Grade 2 Wood Veneer	\$7206	\$8130	\$8232	\$8398

Tip: Top ships in one piece.

Tip: For 60"W-95"W tables, if you require your table top to be made into two pieces, this can be done as a special. Please contact Customer Service at 1.800.627.6770 to obtain a quote.

Tip: Tables are available parametrically in 1" increments.

E-Table 2
Collaborative and
Conference Tables

► Product Information continued on next page

E-Table 2 Collaborative and Conference Tables

D-Shape Aluminum Base Tables-Standing Height

► Product Information continued from previous page

Specification Information

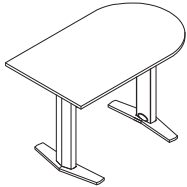

Dimensions		Style Number	Finish	Base Prices			
W	D			H	Edge:		
				3 mm Plastic/ 3 mm Wood, Flat, or Vinyl Edge:	Bullnose Wood Edge:	Beveled Wood Edge:	Knife Wood Edge:

D-Shape Tables with Two Aluminum Bases - Standing Height

W	D	H	Style Number	Finish	3 mm Plastic/ 3 mm Wood, Flat, or Vinyl Edge:	Bullnose Wood Edge:	Beveled Wood Edge:	Knife Wood Edge:
72"	37" -42"	40"	COET2DSTA	Grade 1 Laminate	\$5530	\$6710	\$6749	\$6973
				Grade 2 and 3 Laminate	\$5677	\$6857	\$6896	\$7120
				Grade 1 Wood Veneer	\$7469	\$8649	\$8688	\$8912
				Grade 2 Wood Veneer	\$7985	\$9165	\$9204	\$9428
72"	43" -48"	40"	COET2DSTA	Grade 1 Laminate	\$5644	\$6810	\$6851	\$7092
				Grade 2 and 3 Laminate	\$5822	\$6988	\$7029	\$7270
				Grade 1 Wood Veneer	\$7489	\$8655	\$8696	\$8937
				Grade 2 Wood Veneer	\$8057	\$9223	\$9264	\$9505
72"	49" -54"	40"	COET2DSTA	Grade 1 Laminate	\$6112	\$7309	\$7306	\$7553
				Grade 2 and 3 Laminate	\$6315	\$7512	\$7509	\$7756
				Grade 1 Wood Veneer	\$8009	\$9206	\$9203	\$9450
				Grade 2 Wood Veneer	\$8664	\$9861	\$9858	\$10,105
72"	55" -60"	40"	COET2DSTA	Grade 1 Laminate	\$6580	\$7808	\$7760	\$8012
				Grade 2 and 3 Laminate	\$6810	\$8038	\$7990	\$8242
				Grade 1 Wood Veneer	\$8529	\$9757	\$9709	\$9961
				Grade 2 Wood Veneer	\$9274	\$10,502	\$10,454	\$10,706
73" -84"	36"	40"	COET2DSTA	Grade 1 Laminate	\$5402	\$6758	\$6902	\$7143
				Grade 2 and 3 Laminate	\$5550	\$6906	\$7050	\$7291
				Grade 1 Wood Veneer	\$7650	\$9006	\$9150	\$9391
				Grade 2 Wood Veneer	\$8256	\$9612	\$9756	\$9997

Tip: Tables are available parametrically in 1" increments.

► Product Information continued on next page





E-Table 2 Collaborative and Conference Tables

D-Shape Aluminum Base Tables-Standing Height

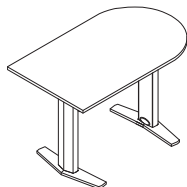
► Product Information continued from previous page

Specification Information



Dimensions		Style Number	Finish	Base Prices				
W	D			H				

D-Shape Tables with Two Aluminum Bases - Standing Height

W	D	H	Style Number	Finish	3 mm Plastic/ 3 mm Wood, Flat, or Convex Vinyl Edge:	Bullnose Wood Edge:	Beveled Wood Edge:	Knife Wood Edge:
73" -84"	37" -42"	40"	COET2DSTA	Grade 1 Laminate	\$5592	\$6899	\$7007	\$7238
				Grade 2 and 3 Laminate	\$5768	\$7075	\$7183	\$7414
				Grade 1 Wood Veneer	\$7749	\$9056	\$9164	\$9395
				Grade 2 Wood Veneer	\$8409	\$9716	\$9824	\$10,055
73" -84"	43" -48"	40"	COET2DSTA	Grade 1 Laminate	\$5706	\$7000	\$7114	\$7363
				Grade 2 and 3 Laminate	\$5906	\$7200	\$7314	\$7563
				Grade 1 Wood Veneer	\$7764	\$9058	\$9172	\$9421
				Grade 2 Wood Veneer	\$8467	\$9761	\$9875	\$10,124
73" -84"	49" -54"	40"	COET2DSTA	Grade 1 Laminate	\$6175	\$7502	\$7570	\$7824
				Grade 2 and 3 Laminate	\$6403	\$7730	\$7798	\$8052
				Grade 1 Wood Veneer	\$8282	\$9609	\$9677	\$9931
				Grade 2 Wood Veneer	\$9073	\$10,400	\$10,468	\$10,722
73" -84"	55" -60"	40"	COET2DSTA	Grade 1 Laminate	\$6642	\$7999	\$8024	\$8285
				Grade 2 and 3 Laminate	\$6896	\$8253	\$8278	\$8539
				Grade 1 Wood Veneer	\$8803	\$10,160	\$10,185	\$10,446
				Grade 2 Wood Veneer	\$9682	\$11,039	\$11,064	\$11,325
85"-96"	36"	40"	COET2DSTA	Grade 1 Laminate	\$5690	\$6967	\$7120	\$7366
				Grade 2 and 3 Laminate	\$5861	\$7138	\$7291	\$7537
				Grade 1 Wood Veneer	\$7788	\$9065	\$9218	\$9464
				Grade 2 Wood Veneer	\$8488	\$9765	\$9918	\$10,164

► Product Information continued on next page

E-Table 2 Collaborative and Conference Tables

D-Shape Aluminum Base Tables-Standing Height

► Product Information continued from previous page

Specification Information

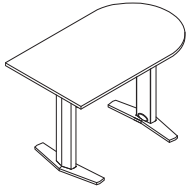

Dimensions		Style	Finish	Base Prices			
W	D	H Number		Vinyl Edge:			
				3 mm Plastic/ 3 mm Wood, Flat, or Convex	Bullnose Wood Edge:	Beveled Wood Edge:	Knife Wood Edge:

D-Shape Tables with Two Aluminum Bases - Standing Height

85"-96"	37" -42"	40"	COET2DSTA	Grade 1 Laminate	\$6157	\$7465	\$7575	\$7825
				Grade 2 and 3 Laminate	\$6355	\$7663	\$7773	\$8023
				Grade 1 Wood Veneer	\$8305	\$9613	\$9723	\$9973
				Grade 2 Wood Veneer	\$9096	\$10,404	\$10,514	\$10,764
85"-96"	43" -48"	40"	COET2DSTA	Grade 1 Laminate	\$6626	\$7956	\$8077	\$8333
				Grade 2 and 3 Laminate	\$6857	\$8187	\$8308	\$8564
				Grade 1 Wood Veneer	\$8830	\$10,160	\$10,281	\$10,537
				Grade 2 Wood Veneer	\$9716	\$11,046	\$11,167	\$11,423
85"-96"	49" -54"	40"	COET2DSTA	Grade 1 Laminate	\$6808	\$8309	\$8441	\$8729
				Grade 2 and 3 Laminate	\$7064	\$8565	\$8697	\$8985
				Grade 1 Wood Veneer	\$9280	\$10,781	\$10,913	\$11,201
				Grade 2 Wood Veneer	\$10,207	\$11,708	\$11,840	\$12,128
85"-96"	55" -60"	40"	COET2DSTA	Grade 1 Laminate	\$6984	\$8648	\$8797	\$9117
				Grade 2 and 3 Laminate	\$7269	\$8933	\$9082	\$9402
				Grade 1 Wood Veneer	\$9737	\$11,401	\$11,550	\$11,870
				Grade 2 Wood Veneer	\$10,701	\$12,365	\$12,514	\$12,834
97" -108"	36"	40"	COET2DSTA	Grade 1 Laminate	\$6159	\$7458	\$7625	\$7872
				Grade 2 and 3 Laminate	\$6362	\$7661	\$7828	\$8075
				Grade 1 Wood Veneer	\$8309	\$9608	\$9775	\$10,022
				Grade 2 Wood Veneer	\$9106	\$10,405	\$10,572	\$10,819

Tip: Tables are available parametrically in 1" increments.

► Product Information continued on next page

E-Table 2 Collaborative and Conference Tables

D-Shape Aluminum Base Tables-Standing Height

► Product Information continued from previous page

Specification Information

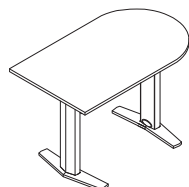

Dimensions		Style Number	Finish	Base Prices			
W	D			H			
				3 mm Plastic/ 3 mm Wood, Flat, or Convex Vinyl Edge:	Bullnose Wood Edge:	Beveled Wood Edge:	Knife Wood Edge:

D-Shape Tables with Two Aluminum Bases - Standing Height

97" -108"	37" -42"	40"	COET2DSTA	Grade 1 Laminate	\$6336	\$7815	\$7934	\$8220
				Grade 2 and 3 Laminate	\$6562	\$8041	\$8160	\$8446
				Grade 1 Wood Veneer	\$8759	\$10,238	\$10,357	\$10,643
				Grade 2 Wood Veneer	\$9587	\$11,066	\$11,185	\$11,471
97" -108"	43" -48"	40"	COET2DSTA	Grade 1 Laminate	\$6819	\$8706	\$8888	\$9238
				Grade 2 and 3 Laminate	\$7076	\$8963	\$9145	\$9495
				Grade 1 Wood Veneer	\$9055	\$10,942	\$11,124	\$11,474
				Grade 2 Wood Veneer	\$10,055	\$11,942	\$12,124	\$12,474
97" -108"	49" -54"	40"	COET2DSTA	Grade 1 Laminate	\$7057	\$9183	\$9385	\$9777
				Grade 2 and 3 Laminate	\$7344	\$9470	\$9672	\$10,064
				Grade 1 Wood Veneer	\$9672	\$11,798	\$12,000	\$12,392
				Grade 2 Wood Veneer	\$10,760	\$12,886	\$13,088	\$13,480
97" -108"	55" -60"	40"	COET2DSTA	Grade 1 Laminate	\$7286	\$9648	\$9874	\$10,304
				Grade 2 and 3 Laminate	\$7606	\$9968	\$10,194	\$10,624
				Grade 1 Wood Veneer	\$10,283	\$12,645	\$12,871	\$13,301
				Grade 2 Wood Veneer	\$11,468	\$13,830	\$14,056	\$14,486
109" -120"	36"	40"	COET2DSTA	Grade 1 Laminate	\$6293	\$8090	\$8251	\$8589
				Grade 2 and 3 Laminate	\$6511	\$8308	\$8469	\$8807
				Grade 1 Wood Veneer	\$8371	\$10,168	\$10,329	\$10,667
				Grade 2 Wood Veneer	\$9219	\$11,016	\$11,177	\$11,515

► Product Information continued on next page

E-Table 2 Collaborative and Conference Tables

D-Shape Aluminum Base Tables-Standing Height

► Product Information continued from previous page

Specification Information



Dimensions		Style	Finish	Base Prices			
W	D	H	Number	Edge:			
				3 mm Plastic/ 3 mm Wood, Flat, or Convex Vinyl Edge:	Bullnose Wood Edge:	Beveled Wood Edge:	Knife Wood Edge:

D-Shape Tables with Two Aluminum Bases - Standing Height

109" -120"	37" -42"	40"	COET2DSTA	Grade 1 Laminate	\$6773	\$8979	\$9203	\$9602
				Grade 2 and 3 Laminate	\$7024	\$9230	\$9454	\$9853
				Grade 1 Wood Veneer	\$8668	\$10,874	\$11,098	\$11,497
				Grade 2 Wood Veneer	\$9691	\$11,897	\$12,121	\$12,520
109" -120"	43" -48"	40"	COET2DSTA	Grade 1 Laminate	\$7010	\$9453	\$9698	\$10,140
				Grade 2 and 3 Laminate	\$7292	\$9735	\$9980	\$10,422
				Grade 1 Wood Veneer	\$9280	\$11,723	\$11,968	\$12,410
				Grade 2 Wood Veneer	\$10,394	\$12,837	\$13,082	\$13,524
109" -120"	49" -54"	40"	COET2DSTA	Grade 1 Laminate	\$7301	\$10,051	\$10,326	\$10,818
				Grade 2 and 3 Laminate	\$7620	\$10,370	\$10,645	\$11,137
				Grade 1 Wood Veneer	\$10,057	\$12,807	\$13,082	\$13,574
				Grade 2 Wood Veneer	\$11,316	\$14,066	\$14,341	\$14,833
109" -120"	55" -60"	40"	COET2DSTA	Grade 1 Laminate	\$7587	\$10,649	\$10,949	\$11,489
				Grade 2 and 3 Laminate	\$7943	\$11,005	\$11,305	\$11,845
				Grade 1 Wood Veneer	\$10,828	\$13,890	\$14,190	\$14,730
				Grade 2 Wood Veneer	\$12,233	\$15,295	\$15,595	\$16,135

E-Table 2 Collaborative and Conference Tables

D-Shape Aluminum Base Tables-Standing Height

**E-Table 2
Collaborative and
Conference Tables**

E-Table 2 Collaborative and Conference Tables

D-Shape Laminate Base Tables

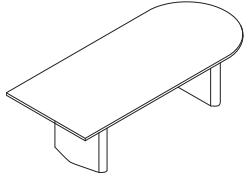

Tip: Shipped knocked down.

Tip: Utility bay quantity offering by table width is available in the understanding section.

Tip: 3 mm vinyl edge profiles on tables require a 4" radius on all corners.

Tip: A flat, plastic edge can be specified on veneer tops by selecting the "flat" edge option. Flat edge is only available in 6000 Black on veneer tops.

Tip: If you specify a wood edge on a top with woodgrain laminate, the edge and the top may not match.

Tip: Sectioned top option is a two piece top and is only available on tops 96"W-120"W.

Tip: When a wood edge is specified on a wood veneer top, the edge finish will match the top finish.

Tip: Each utility bay comes with two universal faceplate openings that accept customer-supplied faceplates in any of the following sizes: single-gang, double-gang, or triple-gang.

Standard Includes

- Top:
 - 1 1/4" particle board core with grade 1 laminate
 - parametric width in 1" increments ranging from 96"-120"
 - parametric depth in 1" increments ranging from 48"-60"
- Edge: 3 mm plastic edge, 3 mm wood edge, or convex vinyl edge
- Bases: black laminate on MDF core
- Wireway: painted steel side panels with powder coat and black plastic access door
- Concealed leveling glides: non-marring, black plastic
- Overall height: 29"

Options

Sectioned Top	No Sectioned Top With Sectioned Top	No cost +\$569
Top Finish	Laminate Price Group 02 Laminate Price Group 03 Veneer Price Group 01 Veneer Price Group 02	Price below Price below Price below Price below
Edge Type	3mm Plastic Edge 3mm Wood Edge Beveled Wood Edge Bullnose Wood Edge Convex Vinyl Edge Knife Wood Edge	Price below Price below Price below Price below Price below Price below
Base Type	Black HPL Curated HPL	No cost +\$873
Bay Option	No Bays Two Bays Three Bays	No cost +\$1578 +\$2367
Wiring Schematic	1+1 Hardwire, 2 Circuits 3 + 0 Wireway Chicago Wireway 1+1 Hardwire,2 Circuits,USB 3 + 0 Wireway,USB	No cost No cost No cost +\$157 +\$157
Infeed	Hardwire NYC Hardwire Infeed Plug	No cost No cost No cost

► **Product Information continued on next page**

E-Table 2 Collaborative and Conference Tables

D-Shape Laminate Base Tables

► Product Information continued from previous page

Specification Information

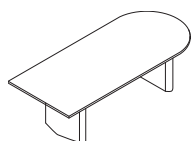

Dimensions		Style Number	Finish	Base Prices			
W	D			H			
				3 mm Plastic/ 3 mm Wood, Flat, or Convex Vinyl Edge:	Bullnose Wood Edge:	Beveled Wood Edge:	Knife Wood Edge:

D-Shape Tables with Two Laminate Bases - Working Height

96"	48"	29"	COET2DL	Grade 1 Laminate	\$5871	\$7201	\$7322	\$7578
				Grade 2 and 3 Laminate	\$6103	\$7433	\$7554	\$7810
				Grade 1 Wood Veneer	\$8074	\$9404	\$9525	\$9781
				Grade 2 Wood Veneer	\$8969	\$10,299	\$10,420	\$10,676
96"	49" -54"	29"	COET2DL	Grade 1 Laminate	\$6047	\$7548	\$7680	\$7968
				Grade 2 and 3 Laminate	\$6306	\$7807	\$7939	\$8227
				Grade 1 Wood Veneer	\$8522	\$10,023	\$10,155	\$10,443
				Grade 2 Wood Veneer	\$9446	\$10,947	\$11,079	\$11,367
96"	55" -60"	29"	COET2DL	Grade 1 Laminate	\$6224	\$7888	\$8037	\$8357
				Grade 2 and 3 Laminate	\$6508	\$8172	\$8321	\$8641
				Grade 1 Wood Veneer	\$8975	\$10,639	\$10,788	\$11,108
				Grade 2 Wood Veneer	\$9940	\$11,604	\$11,753	\$12,073
97" -108"	48"	29"	COET2DL	Grade 1 Laminate	\$6119	\$8006	\$8188	\$8538
				Grade 2 and 3 Laminate	\$6374	\$8261	\$8443	\$8793
				Grade 1 Wood Veneer	\$8353	\$10,240	\$10,422	\$10,772
				Grade 2 Wood Veneer	\$9353	\$11,240	\$11,422	\$11,772
97" -108"	49" -54"	29"	COET2DL	Grade 1 Laminate	\$6353	\$8479	\$8681	\$9073
				Grade 2 and 3 Laminate	\$6641	\$8767	\$8969	\$9361
				Grade 1 Wood Veneer	\$8969	\$11,095	\$11,297	\$11,689
				Grade 2 Wood Veneer	\$10,060	\$12,186	\$12,388	\$12,780
97" -108"	55" -60"	29"	COET2DL	Grade 1 Laminate	\$6585	\$8947	\$9173	\$9603
				Grade 2 and 3 Laminate	\$6904	\$9266	\$9492	\$9922
				Grade 1 Wood Veneer	\$9584	\$11,946	\$12,172	\$12,602
				Grade 2 Wood Veneer	\$10,768	\$13,130	\$13,356	\$13,786

Tip: Top ships in one piece.

Tip: Tables are available parametrically in 1" increments.

E-Table 2
Collaborative and
Conference Tables

► Product Information continued on next page

E-Table 2 Collaborative and Conference Tables

D-Shape Laminate Base Tables

► Product Information continued from previous page

Specification Information

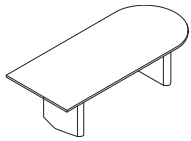

Dimensions
W D H

Style
Number

Finish

Base Prices

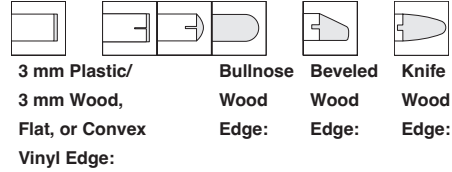

D-Shape Tables with Two Laminate Bases - Working Height

Dimensions	Style	Finish	Grade 1 Laminate	Grade 2 and 3 Laminate	Grade 1 Wood Veneer	Grade 2 Wood Veneer
109" -120" 48" 29"	COET2DL	Grade 1 Laminate	\$6250	\$8693	\$8938	\$9380
		Grade 2 and 3 Laminate	\$6531	\$8974	\$9219	\$9661
		Grade 1 Wood Veneer	\$8521	\$10,964	\$11,209	\$11,651
		Grade 2 Wood Veneer	\$9648	\$12,091	\$12,336	\$12,778
109" -120" 49" -54" 29"	COET2DL	Grade 1 Laminate	\$6539	\$9289	\$9564	\$10,056
		Grade 2 and 3 Laminate	\$6858	\$9608	\$9883	\$10,375
		Grade 1 Wood Veneer	\$9296	\$12,046	\$12,321	\$12,813
		Grade 2 Wood Veneer	\$10,566	\$13,316	\$13,591	\$14,083
109" -120" 55" -60" 29"	COET2DL	Grade 1 Laminate	\$6822	\$9884	\$10,184	\$10,724
		Grade 2 and 3 Laminate	\$7178	\$10,240	\$10,540	\$11,080
		Grade 1 Wood Veneer	\$10,064	\$13,126	\$13,426	\$13,966
		Grade 2 Wood Veneer	\$11,479	\$14,541	\$14,841	\$15,381

Tip: Tables are available parametrically in 1" increments.

E-Table 2 Collaborative and Conference Tables

D-Shape Laminate Base Tables

E-Table 2
Collaborative and
Conference Tables

E-Table 2 Collaborative and Conference Tables

D-Shape Veneer Base Tables

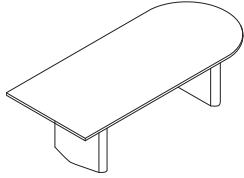

Tip: Shipped knocked down.

Tip: Utility bay quantity offering by table width is available in the understanding section.

Tip: 3 mm vinyl edge profiles on tables require a 4" radius on all corners.

Tip: A flat, plastic edge can be specified on veneer tops by selecting the "flat" edge option. Flat edge is only available in 6000 Black on veneer tops.

Tip: If you specify a wood edge on a top with woodgrain laminate, the edge and the top may not match.

Tip: Sectioned top option is a two piece top and is only available on tops 96"W-120"W.

Tip: When a wood edge is specified on a wood veneer top, the edge finish will match the top finish.

Tip: Each utility bay comes with two universal faceplate openings that accept customer-supplied faceplates in any of the following sizes: single-gang, double-gang, or triple-gang.

Standard Includes

- Top:
 - 1 1/4" particle board core with grade 1 laminate
 - parametric width in 1" increments ranging from 96"-120"
 - parametric depth in 1" increments ranging from 48"-60"
- Edge: 3 mm plastic edge, 3 mm wood edge, or convex vinyl edge
- Bases: grade 01 or grade 02 veneer on MDF core
- Wireway: painted steel side panels with powder coat and black plastic access door
- Concealed leveling glides: non-marring, black plastic
- Overall height: 29"

Options

Sectioned Top	No Sectioned Top With Sectioned Top	No cost +\$569
Top Finish	Laminate Price Group 02 Laminate Price Group 03 Veneer Price Group 01 Veneer Price Group 02	Price below Price below Price below Price below
Edge Type	3mm Plastic Edge 3mm Wood Edge Beveled Wood Edge Bullnose Wood Edge Convex Vinyl Edge Knife Wood Edge	Price below Price below Price below Price below Price below Price below
Bay Option	No Bays Two Bays Three Bays	No cost +\$1578 +\$2367
Wiring Schematic	1+1 Hardwire, 2 Circuits 3 + 0 Wireway Chicago Wireway 1+1 Hardwire,2 Circuits,USB 3 + 0 Wireway,USB	No cost No cost No cost +\$157 +\$157
Infeed	Hardwire NYC Hardwire Infeed Plug	No cost No cost No cost

► **Product Information continued on next page**

E-Table 2 Collaborative and Conference Tables

D-Shape Veneer Base Tables

► Product Information continued from previous page

Specification Information

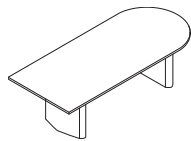

Dimensions		Style Number	Finish	Base Prices					
W	D			H	Vinyl Edge:				
				3 mm Plastic/ 3 mm Wood, Flat, or Convex	Bullnose Wood Edge:	Beveled Wood Edge:	Knife Wood Edge:		

D-Shape Tables with Two Veneer Bases - Working Height

Tip: Top ships in one piece.

96"	48"	29"	COET2DV	Grade 1 Laminate	\$9263	\$10,593	\$10,714	\$10,970
				Grade 2 and 3 Laminate	\$9495	\$10,825	\$10,946	\$11,202
				Grade 1 Wood Veneer	\$11,466	\$12,796	\$12,917	\$13,173
				Grade 2 Wood Veneer	\$12,361	\$13,691	\$13,812	\$14,068

Tip: Tables are available parametrically in 1" increments.

96"	49" -54"	29"	COET2DV	Grade 1 Laminate	\$9439	\$10,940	\$11,072	\$11,360
				Grade 2 and 3 Laminate	\$9698	\$11,199	\$11,331	\$11,619
				Grade 1 Wood Veneer	\$11,914	\$13,415	\$13,547	\$13,835
				Grade 2 Wood Veneer	\$12,838	\$14,339	\$14,471	\$14,759

96"	55" -60"	29"	COET2DV	Grade 1 Laminate	\$9616	\$11,280	\$11,429	\$11,749
				Grade 2 and 3 Laminate	\$9900	\$11,564	\$11,713	\$12,033
				Grade 1 Wood Veneer	\$12,367	\$14,031	\$14,180	\$14,500
				Grade 2 Wood Veneer	\$13,332	\$14,996	\$15,145	\$15,465

97" -108"	48"	29"	COET2DV	Grade 1 Laminate	\$9542	\$11,429	\$11,611	\$11,961
				Grade 2 and 3 Laminate	\$9800	\$11,687	\$11,869	\$12,219
				Grade 1 Wood Veneer	\$11,779	\$13,666	\$13,848	\$14,198
				Grade 2 Wood Veneer	\$12,780	\$14,667	\$14,849	\$15,199

97" -108"	49" -54"	29"	COET2DV	Grade 1 Laminate	\$9778	\$11,904	\$12,106	\$12,498
				Grade 2 and 3 Laminate	\$10,068	\$12,194	\$12,396	\$12,788
				Grade 1 Wood Veneer	\$12,392	\$14,518	\$14,720	\$15,112
				Grade 2 Wood Veneer	\$13,483	\$15,609	\$15,811	\$16,203

97" -108"	55" -60"	29"	COET2DV	Grade 1 Laminate	\$10,009	\$12,371	\$12,597	\$13,027
				Grade 2 and 3 Laminate	\$10,330	\$12,692	\$12,918	\$13,348
				Grade 1 Wood Veneer	\$13,007	\$15,369	\$15,595	\$16,025
				Grade 2 Wood Veneer	\$14,192	\$16,554	\$16,780	\$17,210

► Product Information continued on next page

E-Table 2 Collaborative and Conference Tables

D-Shape Veneer Base Tables

► Product Information continued from previous page

Specification Information

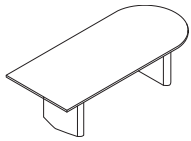

Dimensions		Style Number	Finish	Base Prices				
W	D			H				

D-Shape Tables with Two Veneer Bases - Working Height

Dimensions	Style Number	Finish	3 mm Plastic/3 mm Wood, Flat, or Convex Vinyl Edge	Bullnose Wood Edge	Beveled Wood Edge	Knife Wood Edge
109" -120" 48" 29"	COET2DV	Grade 1 Laminate	\$9642	\$12,085	\$12,330	\$12,772
		Grade 2 and 3 Laminate	\$9923	\$12,366	\$12,611	\$13,053
		Grade 1 Wood Veneer	\$11,913	\$14,356	\$14,601	\$15,043
		Grade 2 Wood Veneer	\$13,040	\$15,483	\$15,728	\$16,170
109" -120" 49" -54" 29"	COET2DV	Grade 1 Laminate	\$9931	\$12,681	\$12,956	\$13,448
		Grade 2 and 3 Laminate	\$10,250	\$13,000	\$13,275	\$13,767
		Grade 1 Wood Veneer	\$12,688	\$15,438	\$15,713	\$16,205
		Grade 2 Wood Veneer	\$13,959	\$16,709	\$16,984	\$17,476
109" -120" 55" -60" 29"	COET2DV	Grade 1 Laminate	\$10,214	\$13,276	\$13,576	\$14,116
		Grade 2 and 3 Laminate	\$10,570	\$13,632	\$13,932	\$14,472
		Grade 1 Wood Veneer	\$13,456	\$16,518	\$16,818	\$17,358
		Grade 2 Wood Veneer	\$14,871	\$17,933	\$18,233	\$18,773

Tip: Tables are available parametrically in 1" increments.

E-Table 2

Accessories

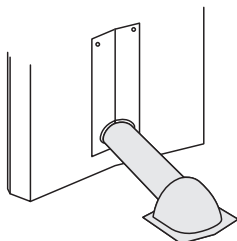

Tip: Wire manager can be cut on site to desired length.

Standard Includes

- Shell: black plastic only
- 72"L wire manager: black plastic only

Specification Information

Style Number	Price
Floor Monument Kit	
793369	\$164

E-Table 2 Collaborative and Conference Tables

Host Collaborative and Conference Tables

Understanding	334
Specifying	
Round Tables	356
Rectangular Tables	360
Soft Radiused Tables	388
Racetrack Tables	416
Boat Shaped Tables	446
Trapezoid Tables	462
Accessories	468

Host Collaborative and Conference Tables

Host is a suite of elegant furnishings for the multimedia, interactive conference room. Host's fully resolved design details speak to the need for refinement in aesthetic appeal, while every functional aspect of the table was designed to accommodate a breadth of user needs.

Tip: This product line is a collection and will be found in more than one location in this specification guide.

► See Collections, page 5

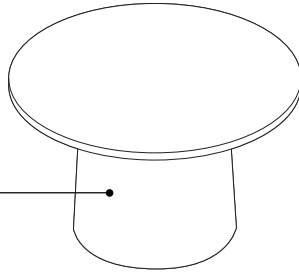

Round base is conical shaped plywood with wood veneer surface.

Top is 1/4" thick particle board with laminate or wood veneer top.

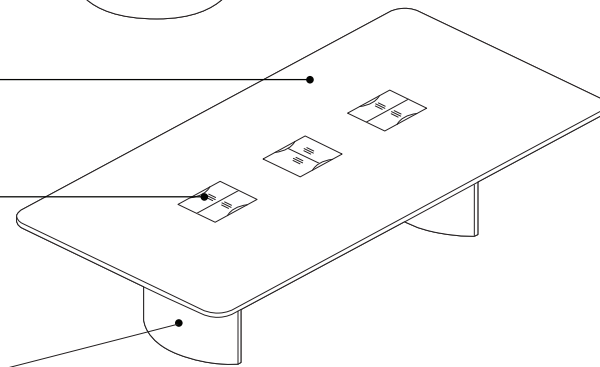

TAP trays, if selected, provide access to power, data, voice, audio, video, or any type of outlet required. Storage trays provide access to house equipment, such as, speaker phones.

Bases are available with either a flared or a slim base.

Seating Capacity Guidelines
► See page 343

Product Details

Table height is standard at 28 1/2" H.

Adjustable leveling glides have a range of 1/2" to accommodate uneven floors.



Round



Rectangular



Soft Radiused



Racetrack



Boat Shaped



Trapezoid

Table shapes include round, rectangular, soft radiused, racetrack, boat shaped, and trapezoid. A wide range of sizes up to 20'L is available to fit any room size.



Flat



Bullnose



Beveled



Horizon



Tapered

Solid wood edges are available in five profiles—flat, bullnose, beveled, horizon, or tapered. Not every edge is available on every top shape.

► Refer to the matrix on page 338 for availability.

Host Collaborative and Conference Tables



Tops with flat, bullnose and beveled wood edges will have square corners.



Tops with tapered and horizontal wood edges have 4" radius corners.

Sectioned tops

Large tops are shipped in sections with hardware for field assembly. Tops 8'L ship in one piece. Tops 10'L can ship in one or two pieces. Tops 12'L ship in two pieces. Tops 14'L, 16'L, 18'L and 20'L can ship in two or three pieces.

Tip: The style number indicates top sections.

► Refer to style number explanation, page 354.

Large tops can be difficult to move through some buildings.

Tip: Inspect the building where the table will be installed to confirm that elevators, loading docks, hallways, doorways, windows, etc. can accommodate large table tops.

Removable access door on each base allows for easy installation of utility infeeds. A toe hole allows infeeds from a floor monument outside the base.

Leveling glides on all bases adjust 1/2".

The toe hole on the slim base is 1"H x 5.25"W and the flared base toe hole is 1"H x 7.4"W.

Wood veneer bases are available in three styles—round, slim, and flared.

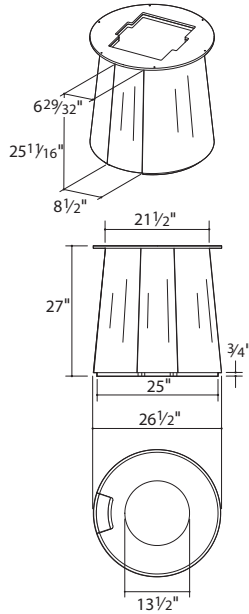

Round base is conical shaped plywood with a wood veneer surface, 26 1/2"-diameter bottom and 21 1/2"-diameter top. Underneath the round base is a 25"-diameter black painted wood inset, 3/4"H, with an opening. The 13 1/2"-diameter opening is surrounded by a 50 lb concrete weight for stability. The removable access door, 8 1/2"W at the bottom and 6.9"W at the top x 25 3/4"H, is secured with a ball catch fastener on each corner.

Tip: Round base only available on round tables.

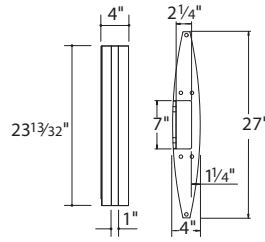

Slim base has a wood veneer surface on molded MDF with aluminum universal bracket. The removable access door, 7"W x 23 1/2"H, is secured with a ball catch fastener on each corner. Slim bases are available in one size, 4" x 27".

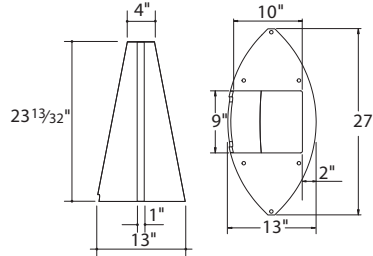
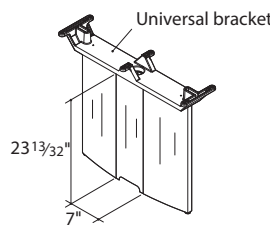

Flared base has a wood veneer surface on molded MDF with aluminum universal bracket. The removable access door, 9"W x 23 1/2"H, is secured with a ball catch fastener on each corner. Flared bases are available in one size, 13" x 27".

Style and number of bases required are determined by top shape and length. Round table tops have a single round base. Table tops 8'L through 12'L have two bases: two flared or slim and flared. Table tops 14'L through 20'L have three bases: three slim, three flared or combination of slim and flared.

Floor monuments can fit inside round and flared bases. Slim bases can be placed over some flush floor monuments.

► For dimensions to aid in locating floor monuments, see page 347.

There is a mouse hole at the floor on the access door on the slim and flared bases to allow wires to exit. The slim base mouse hole is 1"H x 5.25"W and flared base mouse hole is 1"H x 7.4"W.

Host Collaborative and Conference Tables *continued*

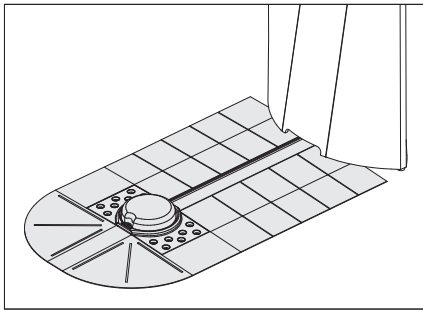

Connectrac, a floor monument kit, should be specified when a floor monument is not positioned under a base. Connectrac is a ADA compliant raceway that can be installed underneath carpet tiles or broadloom to conceal wires and cables running from a floor monument to the Host base.

Features:

- Moisture-resistant MDF transition ramps that simply glue down with liquid nails or equivalent.
- Powder-coated aluminum top cap that snaps in place.
- 25% lower overall height of wireway from previous model with same cabling capacity.

► See page 468

Tip: For detailed information about Connectrac, go to www.connectrac.com.

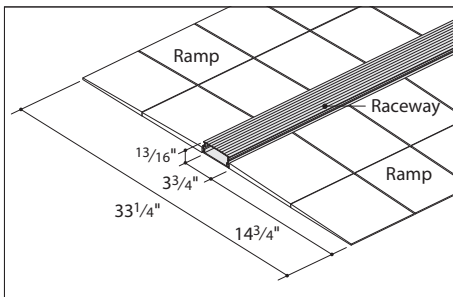
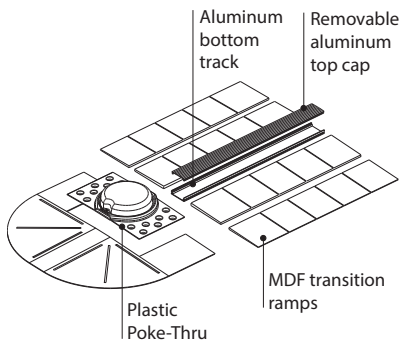

Raceway interior, 3 1/8" W x 3/4" H, provides ample room for wires and cable.

Raceway overall is 3 3/4" W x 7/8" H.

Ramps, 5/8" H at the raceway connection, transition down to 1/8" H.

Raceway and ramps overall is 3 3/4" W.

Dome interior, 5 7/8" diameter x 3" H, covers the floor monument. Dome opens allowing easy access to floor monument.

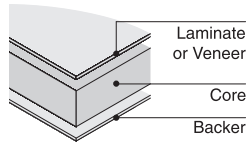

Solid core tops with 1/4" nominal edge thickness have a particle board core (45 lb cu ft density) with High-Pressure Laminate or wood veneer on the top and a backer applied to the opposite side for a balanced construction. High-Pressure Laminate, wood veneer, and backer are bonded to the core with a PVA adhesive.

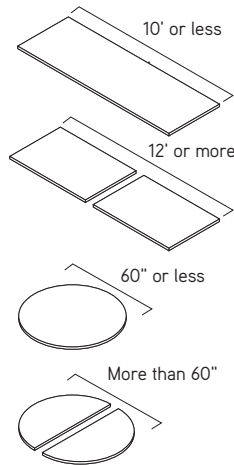

Large tops are shipped in sections with Tite-Joint fasteners for assembly on site. Table tops that are 12' and longer and table tops that are larger than 72" in diameter are always shipped in two pieces.

Large tops can be difficult to move through some buildings. Tip: *Inspect the building where the table will be installed to confirm that elevators, loading docks, hallways, doorways, windows, etc., can accommodate large table tops. You can request any one-piece top to be fabricated and shipped in two pieces to accommodate these small spaces.*

To specify sectioned tops, designate with sectioned top.

A two-piece top may be fabricated and shipped in three pieces, please contact Customer Service for a quotation, 1.800.627.6770.

Custom shapes and sizes Special table sizes and shapes are possible. To confirm practicality and obtain a quotation, contact Customer Service at 1.800.627.6770.

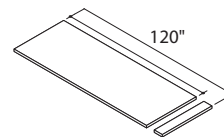

Cut-down tops, which are standard table tops with smaller dimensions, are available. Use the product number of the next larger size and specify the exact dimensions you want. Some restrictions apply, including minimum quantities. This option is not available for folding tables. Additional lead times may be required. Contact Customer Service at 1.800.627.6770.

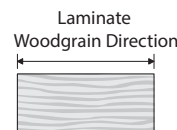

Woodgrain laminates are always oriented with the grain direction running parallel with the length of the table top.

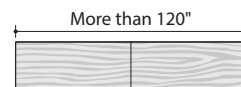

Woodgrain laminate sectioned tops cannot be guaranteed to have a perfect match of the grain pattern along the seam that joins the sections. Large tops that are more than 12' in length require two or more separate sheets of laminate. Coalesse will create the best match that is possible between two sheets of laminate, but depending on the woodgrain laminate pattern that you choose, a perfect match between sections cannot be guaranteed.

For Sectioned 3- or 4-piece tops, it is not recommended to use woodgrain laminates, as the grain pattern of each section will not match.

Wood edges are not recommended on tables with woodgrain laminates because matching of woodgrain laminate and natural, solid wood is not guaranteed. For tables with wood edge profiles, always specify either laminates in solid colors or patterns or wood veneer surfaces.

Tip: *Because of natural variations, you should know that finished solid wood edges may vary slightly in tone or character from each other or from the samples Coalesse produces. No guarantee can be made of an absolutely exact match.*

Standard veneer grain directions—grain direction on Host table tops runs parallel to the width of the top regardless of the size of the table.

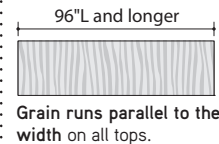

Host Collaborative and Conference Tables

Same flitch veneer is available as a special for tables that require similar graining and color, but will not be ganged. For example, specify same flitch veneer for two tables used in the same room, but spaced apart.

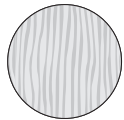
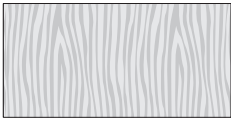

Same flitch matching is specified in cases where you want the veneer grain and pattern on two or more tops to come from the same flitch of veneer. This ensures a consistent grain pattern and coloration and should be specified when tops will be used near each other but not ganged.

TAP doors with veneer option are NOT grain matched, they are flitch matched to the table. The veneer doors will always match the finish of the table top. Veneer doors will be available on veneer tops only.

Surface Materials

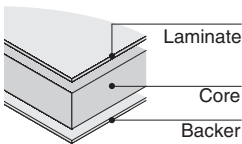

Laminates are available in two standard grades. Additional laminates from any manufacturer may also be practical—see *Other laminates* below.

Grade 1 laminates include:

- Coalesse standard laminates
- ▶ See *Coalesse Surface Materials Reference Guide*.
- Steelcase standard laminates (code 290A)
- ▶ See *Steelcase Surface Materials Reference Manual*.

- Any standard-grade Wilsonart laminate in solid color, woodgrain, or pattern finish (code 290A)

Grade 2 laminates (code 290B) include any standard-grade, solid color, woodgrain, or patterned laminate from Nevamar (includes Matrix), Formica, or Pionite. Grade 2 laminates may have extended lead times. For details, contact Customer Service at 1.800.627.6770.

Other laminates that are not included in the Grade 1 or Grade 2 offerings may also be available, such as Abet Laminati and Laminart. To determine availability and pricing, contact Customer Service at 1.800.627.6770, with the laminate manufacturer's name and the name and number of the laminate you want.

Laminate swatches are reproduced in the Surface Materials Color Palettes.

▶ See *Coalesse Surface Materials Reference Guide* for a list.

Swatch cards and actual samples of Coalesse standard laminates are available from your Coalesse Customer Service representative. For samples of laminates from other manufacturers, contact them directly:

- Wilsonart
1.800.433.3222
- Nevamar
1.800.638.4380
- Formica
1.800.FORMICA
- Pionite
1.800.285.5161

Tip: Laminate manufacturers change their offerings frequently. Always check availability before ordering.

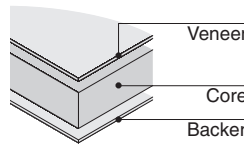

Wood veneer table tops are fabricated with Architectural Grade AA hand-selected hardwood veneer, plain sliced, book matched, and bonded to the core with a backing sheet for balance. Coalesse's primary wood finish, Clarity, is a waterborne UV topcoat, which protects the environment while providing exceptional durability and resistance to water and chemical stains. Due to natural variations in wood, finished products may vary from samples in color, texture, and grain.

Wood is a natural material; slight variations occur in veneer texture, color, grain configuration, and stain acceptance. Coalesse stains are all applied with an exacting regard for consistency and are well within traditional tolerances for wood products.

Tip: You should know that finished tops may vary slightly in tone or character from each other or from the samples Coalesse produces. No guarantee can be made of an absolutely exact match.

Additional wood veneer species are available. To confirm availability and to determine pricing, contact Customer Service at 1.800.627.6770.

Stains applied to Coalesse wood veneer table tops are standard with the same stain color applied to both the top and the solid hardwood edge profile. Coalesse strives to produce a consistently high quality product and some natural variation in color is to be expected. This is especially apparent on natural woods which have no stain applied, for example 3525 Natural Maple. This color variation is normal and reflects the unique and natural properties of wood. This should not be considered a defect.

Stain swatches are reproduced in the Surface Materials Color Palettes.

▶ See *Coalesse Surface Materials Reference Guide* for a list.

Swatch cards and actual samples of standard wood veneers are available from your Customer Service representative.

Stain-to-Match is available on this product and allows the matching of any wood finish with a one-time charge per finish.

▶ See *Coalesse Surface Materials Reference Guide* for details.

Care & Maintenance

Laminate should be cleaned with soap and water. For stubborn stains, use a non-abrasive household cleaner.











Veneers should be cleaned regularly with mild soap and water and dried with a soft cloth. To polish, use silicone-free household polishers. Use sparingly.

Tip: Never use ammonia-based cleaners or wax on wood surfaces.

Tables should be inspected and maintained regularly by tightening screws and bolts, inspecting casters and glides for damage, and inspecting all moving parts for damage and wear.

Host Collaborative and Conference Tables *continued*

Edge Alternatives

Edge Alternatives	Table Top Shape					
	Round	Soft-Radiused	Rectangular	Racetrack	Boat Shaped	Trapezoid
1/4" Tops						
 <ul style="list-style-type: none"> • 1/4" bullnose wood • 5/8"D profile 	• Available	• Available with radius corners	• Available with square corners	• Available	• Available with square corners	• Available with square corners
 <ul style="list-style-type: none"> • 1/4" beveled wood • 1/4"D profile 	• Available	• No	• Available with square corner	• Available	• No	• No
 <ul style="list-style-type: none"> • 1/4" horizon wood • 3/2"D profile 	• Available	• Available with 4" radius corners	• Available with 4" radius corners	• Available with radius corners	• No	• Available with 4" radius corners
 <ul style="list-style-type: none"> • 1/4" tapered wood • 1/4"D profile 	• No	• No	• Available with 4" radius corners	• No	• No	• No
 <ul style="list-style-type: none"> • 1/4" flat wood • 1/8"D profile 	• Available	• Available	• Available with square corners	• Available	• Available with square corners	• Available with square corners

Host Collaborative and Conference Tables

Tech Corridor

All Host tables except round shapes are equipped with a Tech Corridor.

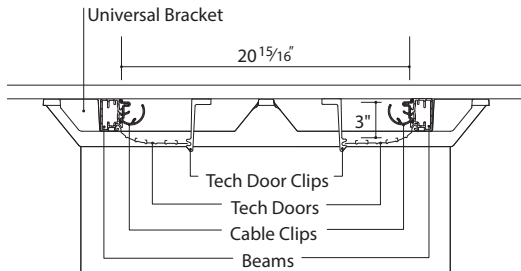

Tech corridor runs under the length of the table between the table top and the universal base brackets. Tech corridor creates a space approximately 20¹⁵/₁₆" x 3" for cables, TAP tray(s), and optional equipment shelf(s).

Tech corridor assembly consists of satin anodized aluminum twin beams and ribbed satin anodized aluminum hinged tech doors that clip shut.

Beams, 1⁵/₈" W x 2³/₈" H, with black plastic end caps provide support to the table top. Beams have a rail feature that accommodates cable clips.

Tip: One cable clip is provided for each foot of table length.

Tech doors hinge from the beams and clip shut with door clips to conceal and support wires and cables. Tech doors are approximately 5³/₄" W.

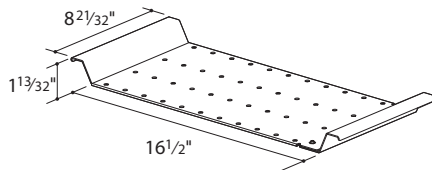

Corridor shelf is available to hold routers, hubs, line drivers, scalars and other technical equipment. Corridor shelf hangs between the beams and provides 1.5 rack units of space, 2³/₄" H.

► See page 468

Two Beam Tables:

96"L, 10'L, 12'L

Place the two bases in their approximate final locations.

Tip: End bases will be centered 24" from the end of the table top.

Tip: In most cases base access doors should face inward.

Tip: Bases can be the same style or a combination of slim and flared.

Bases are located in the same position for any given table top, regardless of table shape.

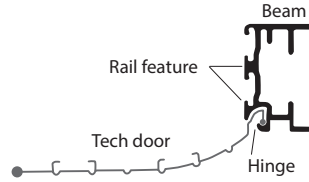

Tech Corridor Assembly:

- Remove beam end caps.
- Slide long tech doors on to hinge of each beam.
- Slide short tech doors on to each end in the same hinge.

Place beam/tech doors assemblies facing each other on to the bases with the long doors between the bases and short doors outside the bases.

Push beam end caps in to the ends of the beams. Align the second predrilled hole from each end of the two beams with the holes in the bracket castings.

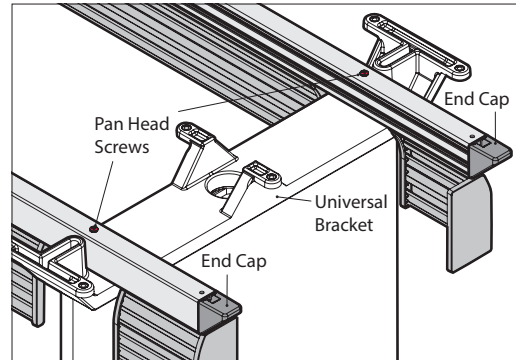

Start the Pan Head screws into each bracket casting. DO NOT tighten.

Tip: Pan Head screws remain above the beam to aid in table top alignment.

Level bases. Check the square alignment of the beams. Tighten Pan Head screws.

Four Beam Tables:

14'L, 16'L, 18'L, 20'L

Place and center the three bases where they should be in the room and assemble the Tech Corridor (See Tech Corridor Assembly in Two Beam Tables).

Tip: End bases will be centered 24" from the end of the table top.

Middle base is positioned in the center of the table top.

Rail clamp splices the two beams together at the center base.

Host Collaborative and Conference Tables *continued*

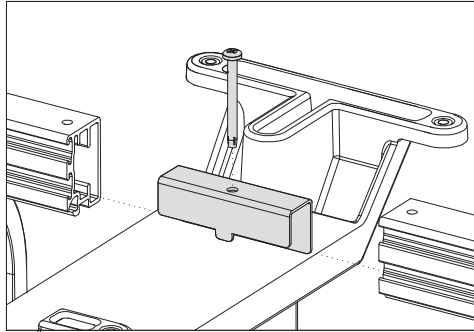

Align black rail clamps with predrilled holes in center base bracket casting. Position each clamp with the tab pointing downward, and the short side of the clamp facing inward.

Place beam/tech doors assemblies facing each on to the bases with the long doors between the bases and the short doors outside the end bases.

Slide a pair of beams on to each rail clamp. Push both beams against the tab at the bottom of the clamp, forming a 1/2" gap between the beams.

Tighten each black screw on each clamp to ensure the gap remains unchanged.

Check the square alignment of the beams. The clamped beams can pivot as needed to square the frame.

Align the second predrilled hole from each end of the two beams with the holes in the bracket castings.

Start the pan head screws into each bracket casting. **DO NOT** tighten.
Tip: Pan head screws remain above the beam to aid in table top alignment.

Level bases. Check the square alignment of the beams. Tighten pan head screws.

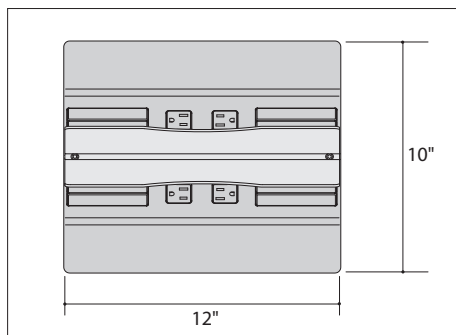
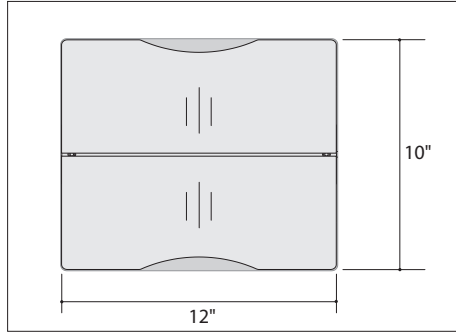

Table top opening for TAP is 12" x 10", trimmed with a flat solid wood profile. Two doors conceal dual access to a black powder coated steel tray that houses power and data outlets.

Tip: Wood trim will match the color of the wood edge.

Up to six TAPs can be specified depending on the table length. TAPs are available as an option on all Host Collection tables.

► See individual product specifying pages for TAP locations.

Tip: A storage tray may replace one TAP.

► See page 346

TAP doors are made of brushed anodized aluminum. Each TAP door has an opening that allows cables to pass when the doors are closed. TAP doors are friction hinged, opening to 77°. TAP doors are fully adjustable to maintain an even appearance with the table top when closed.

TAP doors can be silver or black anodized or with optional wood veneer.

TAP doors with veneer option are NOT grain matched, they are flitch matched to the table. The veneer doors will always match the finish of the table top. Veneer doors will be available on veneer tops only.

All doors must be the same finish—silver, black or veneer.

TAP Door Adjustments

CAUTION: TAP DOORS CAN BE EASILY SCRATCHED WITH HEX KEYS. MAKE SURE BOTH DOORS ARE FULLY OPEN BEFORE MAKING ADJUSTMENTS.

Host Collaborative and Conference Tables

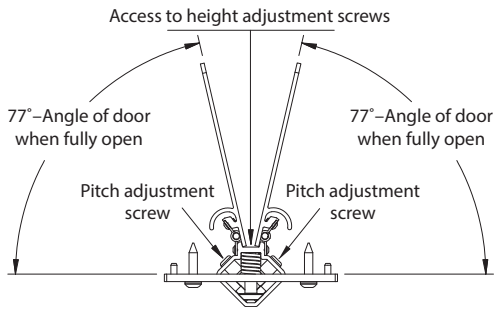

Adjust the pitch first, then adjust the height.

Adjust the pitch of each door to be level with the table surface by adjusting the Allen screw found under each door.

Adjust the height of the left and right sides of the TAP door assembly to be flush with the table surface by adjusting the Allen screws on top between the doors. There is an adjustment screw at each end of the TAP assembly. Doors must be fully open to adjust screws.

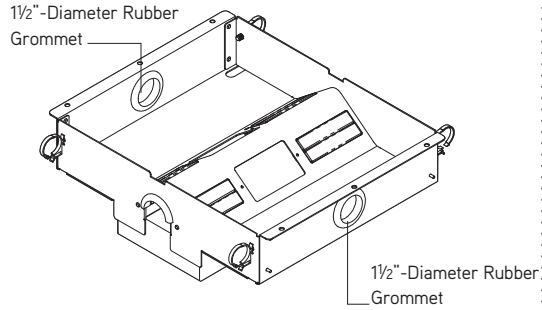
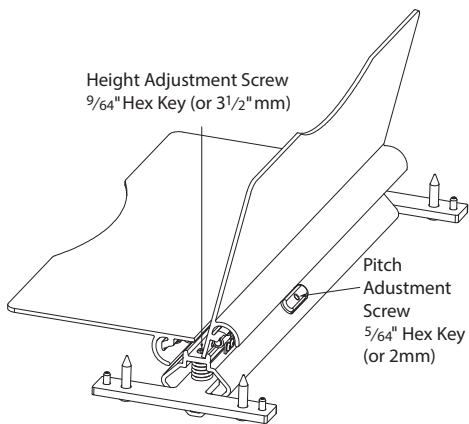

TAP trays provide access to power, data, voice, audio, video, or any type of outlet required. Each TAP tray includes a storage area for laptop computer transformers, excess wires, or other accessories. A 1 1/2"-diameter rubber grommet located in each half of the TAP tray allows cables to enter directly into the tray from the tech corridor (such as a PolyVision Multipurpose Cable). The bottom cover of the TAP tray is easily removable without tools for technician's access.

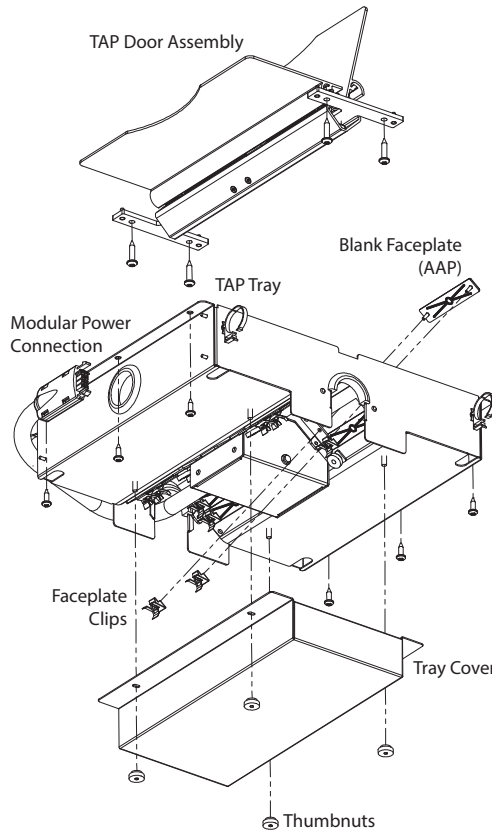

Host Collaborative and Conference Tables *continued*

TAP Tray Electrical Systems

Four choices:

*Tip: All TAP trays (except field-wired) have four 15-amp power outlets.
Tip: All TAP trays are U.L. and C.U.L. listed.*

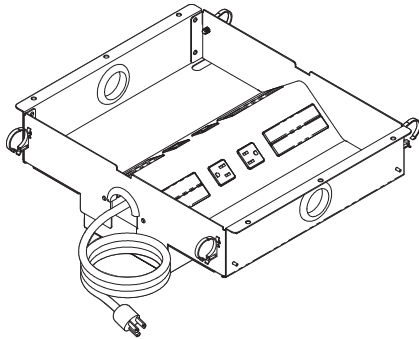

Cord and plug tray will have a 10' cord and 15-amp plug. Each TAP tray must be plugged into a floor outlet. This TAP tray cannot be daisy-chained.

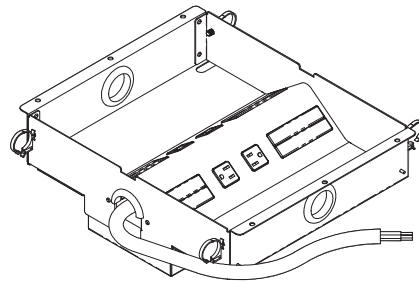

Hardwired tray will have a 6' conduit and a three-wire hardwire connection.

Tip: Hardwired TAP tray must be connected to the building power supply by a licensed electrician.

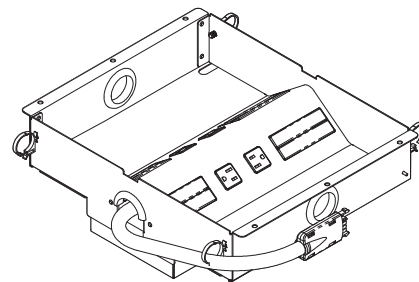

Field-wired tray will have two single-gang faceplate openings for customer's own power outlets and wiring.

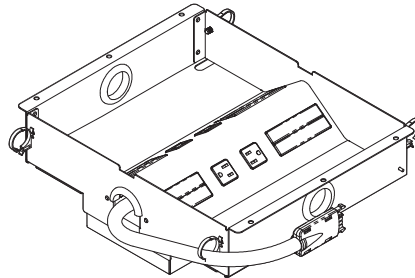
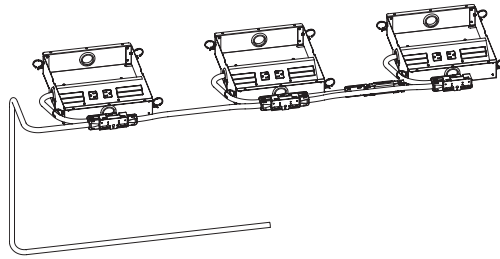

Modular tray will have a modular harness that "daisy-chains" from one TAP to the next. A two-circuit, four-wire hardwire base power infeed is included.

Tip: Modular TAP tray is a two-circuit system. Modular TAPs will alternate circuits within a table.

Tip: Lengths of the modular hardwire base power infeed will vary by table size and configuration but will be able to always reach floor monuments located anywhere underneath the table.

Tip: Power infeeds can be routed down any table base.

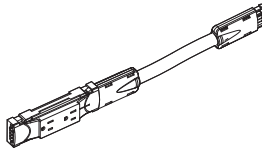

Corridor power kit, modular can be added only to modular trays. This kit adds two electrical outlets inside the tech corridor for plugging in speaker phones or other equipment that does not require frequent access.

► See page 468

Tip: A six outlet plug strip with 15' cord and plug can also be installed in the tech corridor.

Host Collaborative and Conference Tables

TAP Tray Faceplates

Architectural Adapter Plate (AAP) choices:

Tip: TAP trays utilize Extron Electronics' Architectural Adapter Plates (AAPs).

Tip: Each TAP tray can accommodate up to eight single-space AAPs.

AAPs provide access to data, audio, video, telephone, microphone, room control systems and other technologies inside TAPs. Data AAPs and Video/Audio AAPs are available with Host TAPs. Many other AAPs are available from Extron Electronics. For information on other styles of AAPs and to find an Extron Electronics dealer, call Extron at 800.633.9876 or online at www.extron.com.

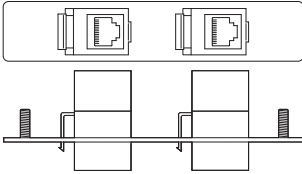

Data Architectural Adapter Plate has two CAT 5e RJ45 barrel (pass-through) outlets. It receives 2 plug-in at both ends of the barrel. Cat 5, 5e, and 6 will work with this coupler. The couplers must be 8-conductor type plug-ins on both ends.

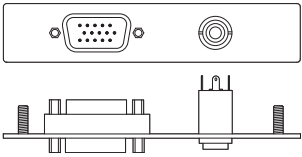

Video/Audio Architectural Adapter Plate has one VGA outlet (HD15 female to female gender changer) and one audio outlet (3 1/2 mm stereo mini jack to solder tabs).

Seating Capacity Guidelines

Depth	Width	Approximate Capacity	Depth	Width	Approximate Capacity
Round Tops			Racetrack Tops		
48"		5	96"	48"	6
60"		6	10'	48"	8
Rectangular and Soft Radiused Tops			12'	48"	8
96"	48"	6	14'	48"	12
10'	48"	8	16'	48"	14
12'	48"	10	18'	48"	16
14'	48"	12	20'	48"	18
16'	48"	14	10'	60"	12
18'	48"	16	12'	60"	12
20'	48"	18	14'	60"	14
10'	60"	12	18'	60"	14
12'	60"	12	16'	60"	16
14'	60"	14	18'	60"	18
16'	60"	16	20'	60"	20
18'	60"	18			
20'	60"	20			
Depth	Center Width	End Width	Approximate Capacity		
Boat Tops					
96"	54"	42"	8		
10'	60"	48"	10		
12'	60"	48"	10		
14'	60"	48"	12		
16'	60"	48"	14		
18'	60"	48"	16		
20'	60"	48"	18		
Trapezoid Tops					
96"	60"	42"	9		
10'	60"	42"	11		
12'	60"	42"	11		

Host Collaborative and Conference Tables Modular System TAP Trays Installation

Optional Modular Installation

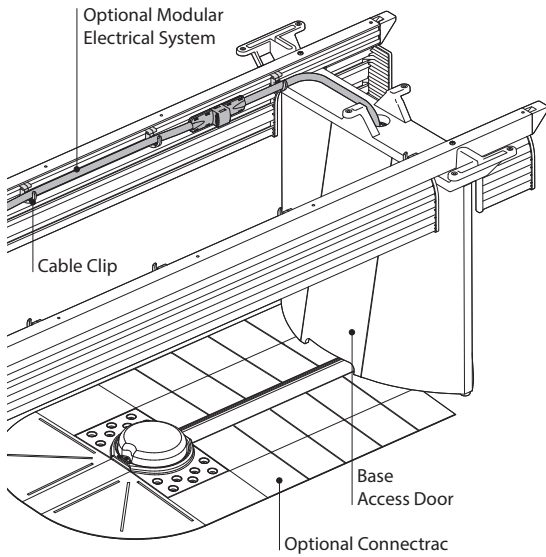







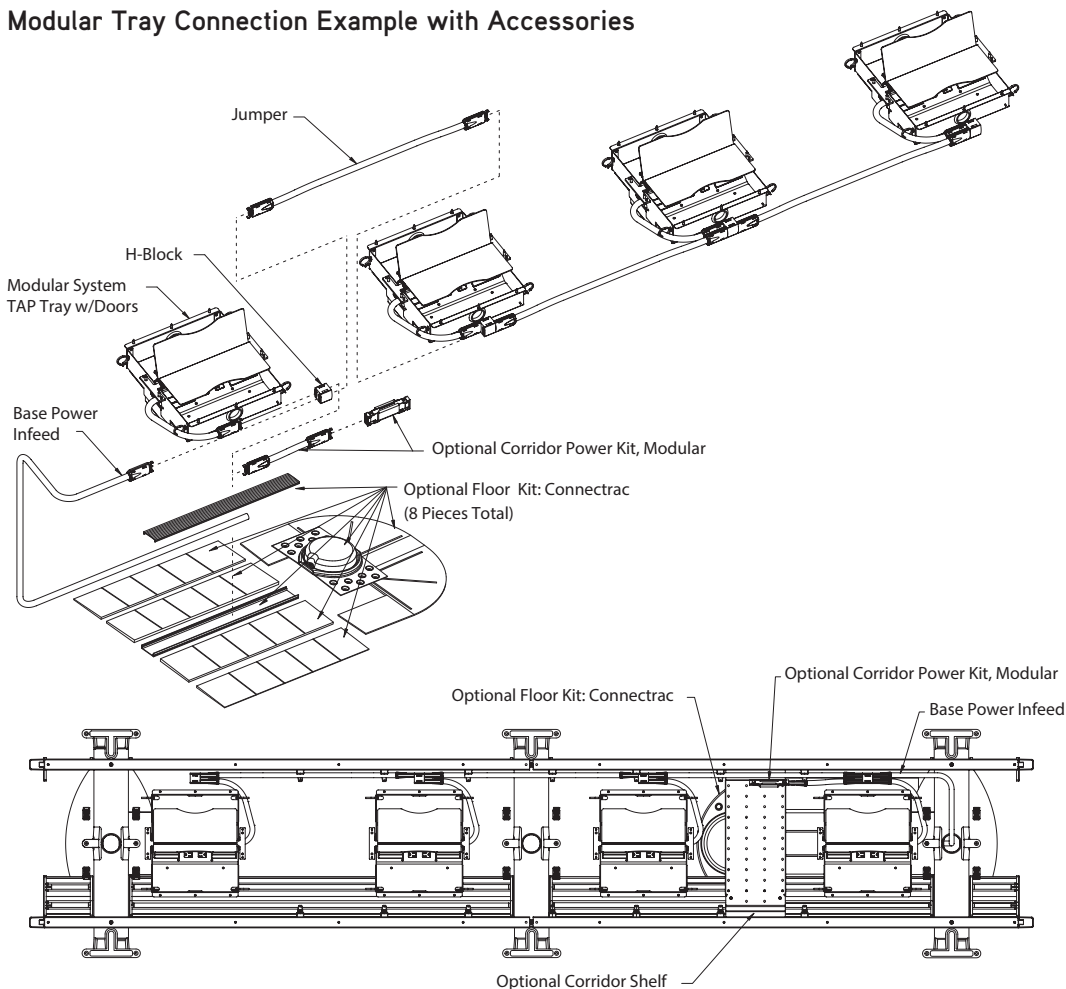

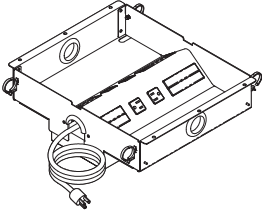
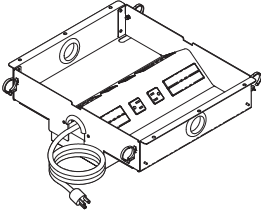

If **optional modular electrical system** is specified, bring wiring up through base from floor monument or base access door into Tech Corridor. A hardwire infeed is used for the modular electrical systems. For single TAP styles, the modular infeed is not needed. Specify the hardwired tray option. Connect electrical cables and secure with cable clips. Run data wires along opposite beam and secure with cable clips as required.

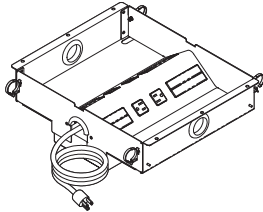
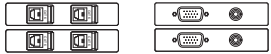
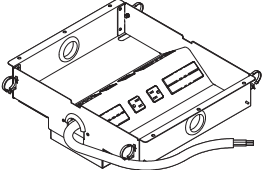
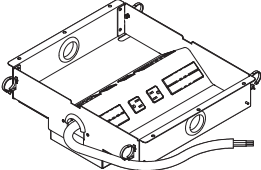
Note: A licensed electrician must connect the power infeed(s) to the building power source in accordance with all national and local electrical codes. These electrical assemblies are intended for installation in accessible, dry locations in accordance with Article 604 of the National Electric Code NFPA70. If you have any concerns about a specific application, please consult the local authority having jurisdiction. This system is rated for a maximum of 20 amps, 125/250 V, 1-Phase, 60Hz or 120/208 V, 3-Phase, 60Hz.

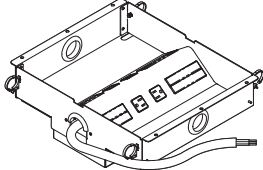
Modular Tray Connection Example with Accessories

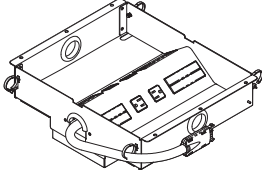
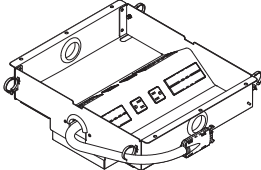

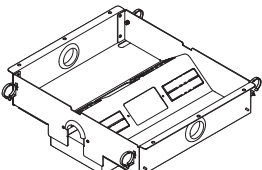
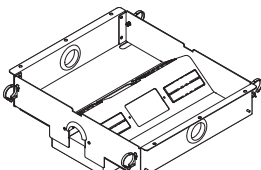
Host Collaborative and Conference Tables TAP Tray Electrical System and Faceplate Matrix

	Faceplate Option— Blank AAPs	Data AAPs	Data/Audio/Video AAPs	
	<ul style="list-style-type: none"> • Eight spaces for customer-supplied Extron AAP plates 	<ul style="list-style-type: none"> • Four CAT 5e data outlets • Six spaces for customer-supplied Extron AAP plates 	<ul style="list-style-type: none"> • Four CAT 5e data outlets • Two stereo mini jacks • Two VGA video outlets • Four spaces for customer-supplied Extron AAP plates 	
Electrical System—				
Cord and Plug Tray includes 10' cord and 15-amp plug <ul style="list-style-type: none"> • Four power outlets 	Option PACP 	Option PDCP  	Option PAVC  	
	Hard-Wired Tray includes 6' conduit <ul style="list-style-type: none"> • Four power outlets 	Option PAHW 	Option PDHW  	Option PAVH  
		Modular Tray includes hardwire base power infeed and jumpers <ul style="list-style-type: none"> • Four power outlets • Trays will alternate from Circuit 1 to Circuit 2 	Option PAMH 	Option PDMH  
Field-Wired Tray includes single gang opening <ul style="list-style-type: none"> • No electrical <i>Tip: Electrician provides all electrical parts.</i>			Option PAFW 	Option PDFW  

Host Collaborative and Conference Tables

Host Collaborative and Conference Tables Storage Tray

Storage Tray

Call Customer Service for availability,
1.800.627.6770

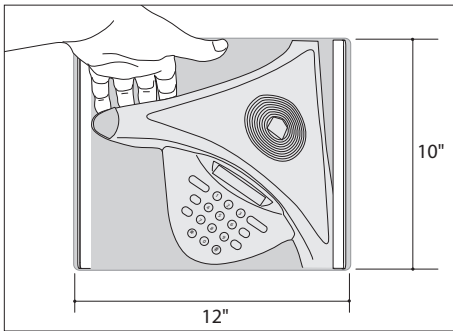
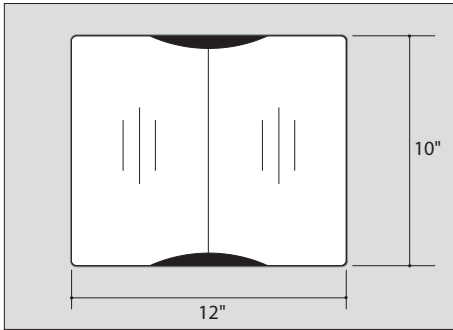

Table top opening for storage tray is 12" x 10", trimmed with a flat solid wood profile. Two doors conceal access to a black powder coated steel tray that can house equipment, such as most common speaker phones. The inside dimensions for the storage tray are 15⁷/₈" x 13³/₄" x 2¹³/₁₆".

Tip: Wood trim will match the color of the wood edge.

Only one storage tray can be specified for each table. Storage tray, if chosen, will replace one TAP on the table. If the specified table has multiple TAPs, any one of the TAPs can be replaced with a storage tray. The location of the storage tray can be determined in the field.

► See individual product specifying pages for TAP locations.

Storage tray doors are made of brushed anodized aluminum. storage tray doors are friction hinged, opening to 90°. Storage tray doors are fully adjustable to maintain an even appearance with the table top when closed.

Storage tray doors can be silver or black anodized or with optional wood veneer.

Storage tray doors with veneer options are NOT grain matched, they are flitch matched to the table. The veneer doors will always match the finish of the table top. Veneer doors will be available on veneer tops only. Veneer doors will always be cross grain.

If storage tray is specified with TAP(s), the finish on the doors will match—silver, black or veneer.

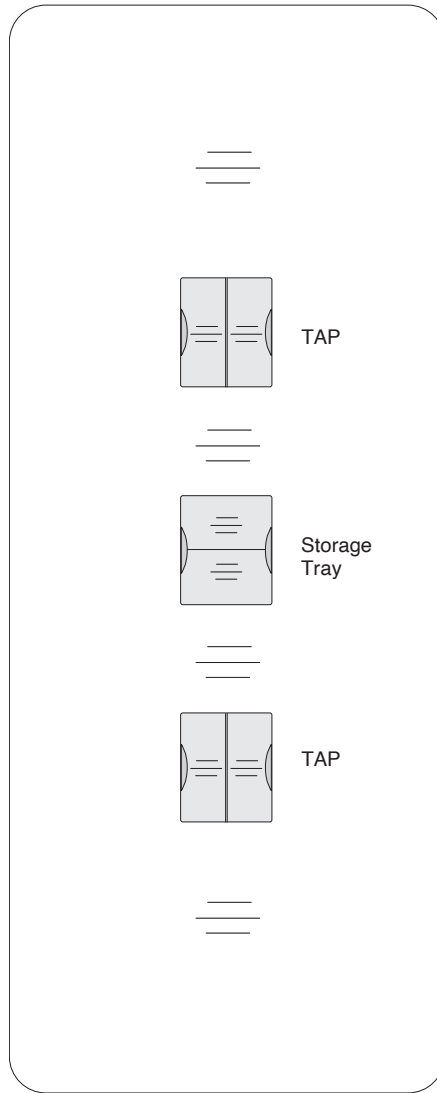

Veneer direction

26 1/2" Round Bases

►Page 335

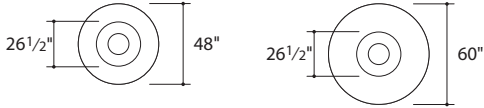

Veneer direction

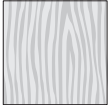



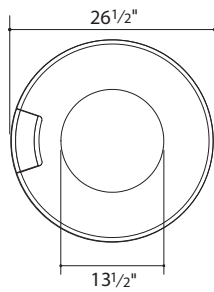



26 1/2" Round Base Footprint

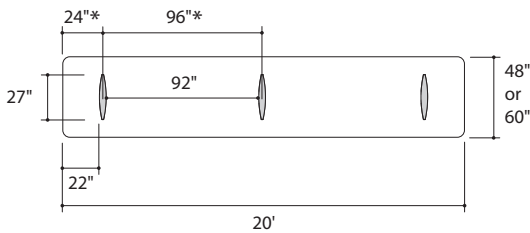
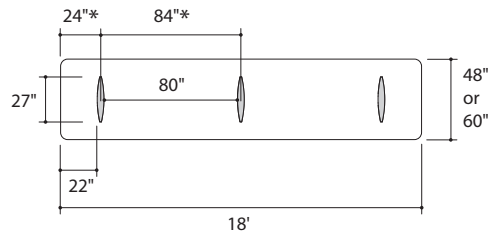
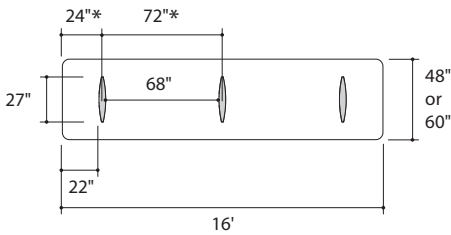
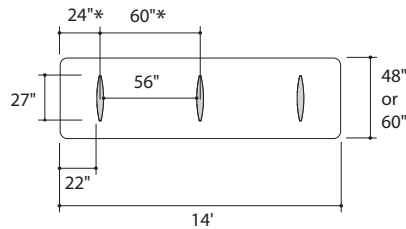
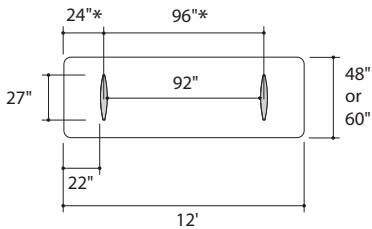
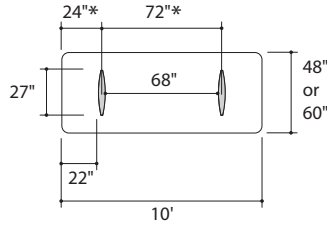
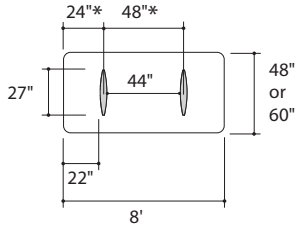

Slim Bases

►Page 335



- Rectangle (R) 
- Soft Radiused (S) 
- Racetrack (C) 
- Boat Shaped (B) 
- Trapezoid (T) 

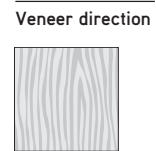

*Dimensions reference center line of base.

Bases are located in the same position for any given table top size, regardless of table shape.

27" x 4" Slim Base Footprint

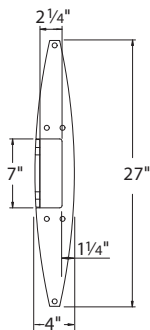

Host Collaborative and Conference Tables Base Locations

Flared Bases

► Page 335

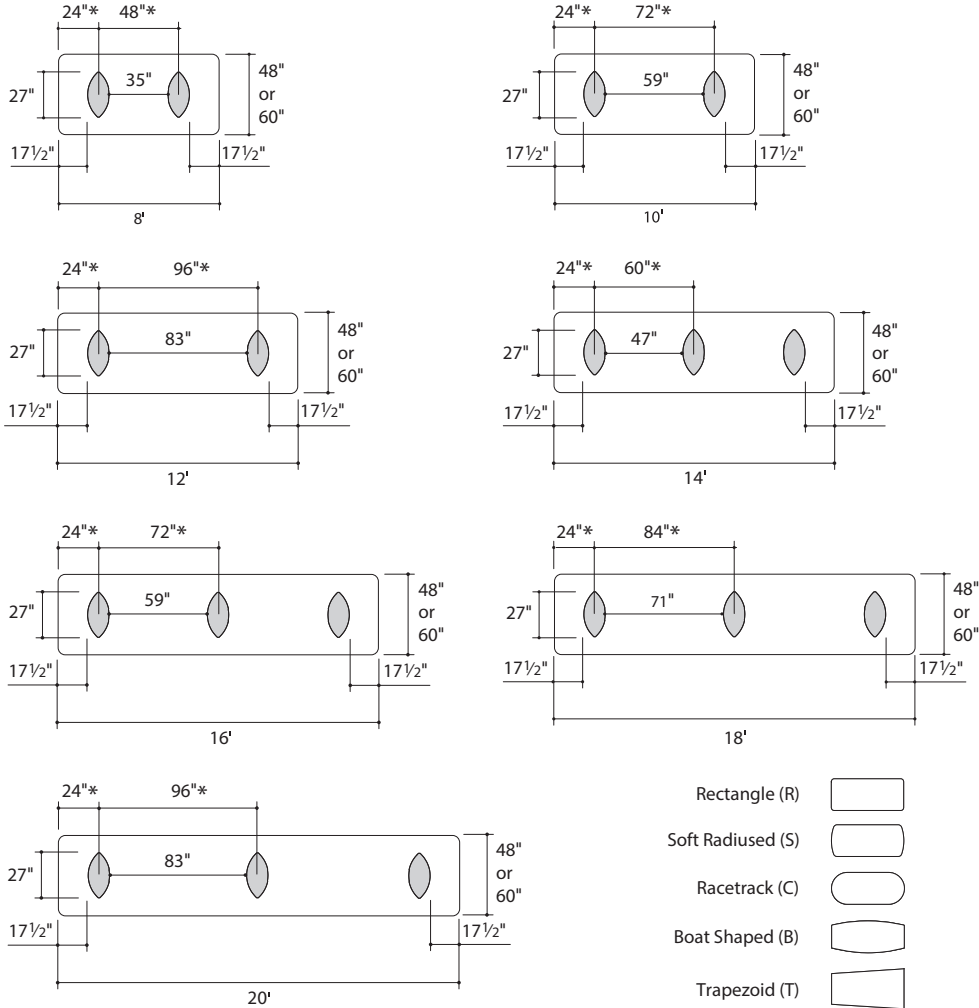

*Dimensions reference center line of base.

Bases are located in the same position for any given table top size, regardless of table shape.



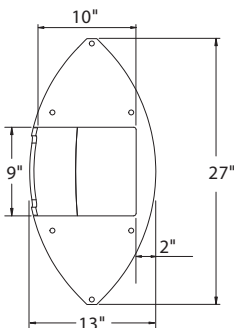

27" x 13" Flared Base Footprint

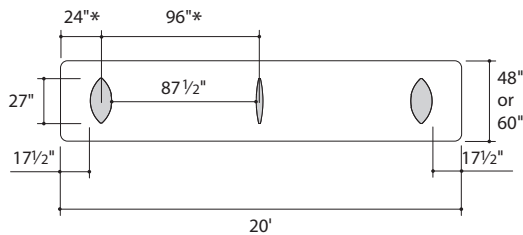
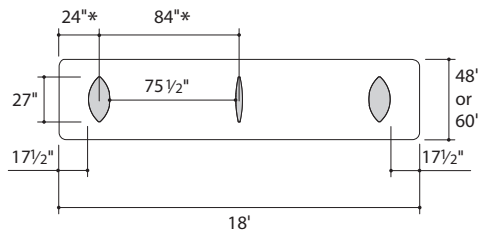
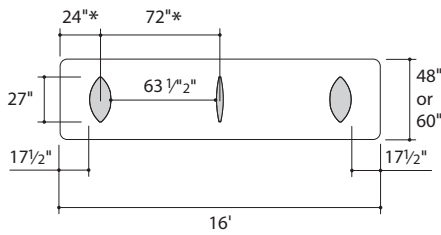
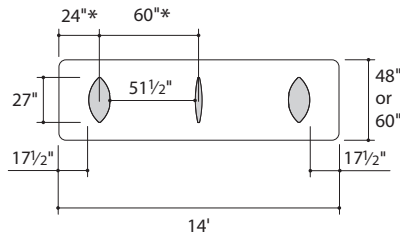
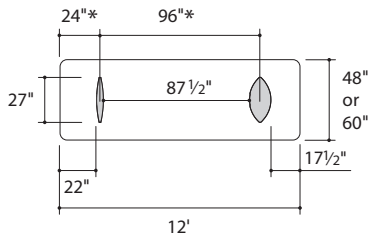
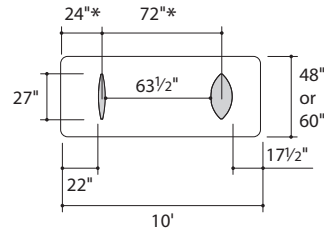
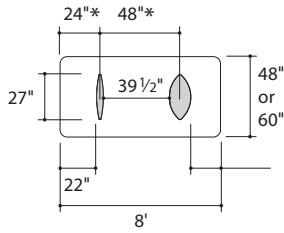

Combination Bases: Slim and Flared

►Page 335



- Rectangle (R) 
- Soft Radiused (S) 
- Racetrack (C) 
- Boat Shaped (B) 
- Trapezoid (T) 

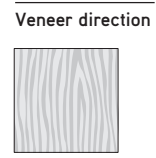

*Dimensions reference center line of base.

Bases are located in the same position for any given table top size, regardless of table shape.

27" x 4" Slim Base Footprint

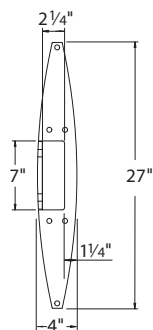

27" x 13" Flared Base Footprint

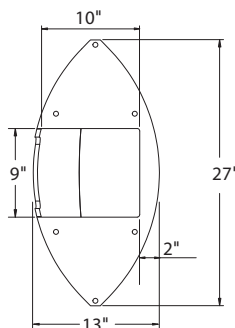

Combination Bases: Slim and Flared

► Page 335

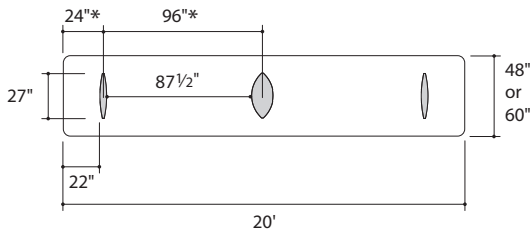
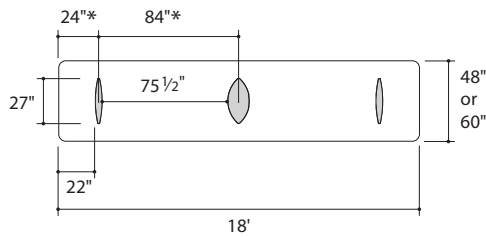
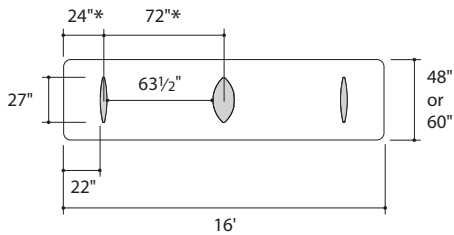
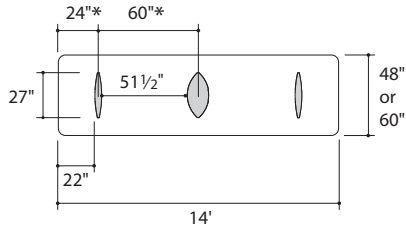

- Rectangle (R)
- Soft Radiused (S)
- Racetrack (C)
- Boat Shaped (B)
- Trapezoid (T)

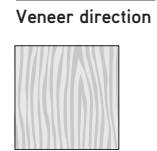

*Dimensions reference center line of base.

Bases are located in the same position for any given table top size, regardless of table shape.

27" x 4" Slim Base Footprint

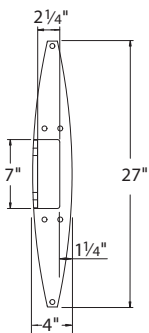

27" x 13" Flared Base Footprint

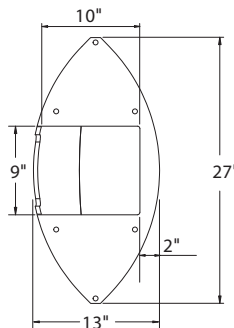

Host Collaborative and Conference Tables One Piece Top

One Piece Top Pilot Holes

C Alignment index holes D Beam mounting holes E Base bracket mounting holes F Tech door clip mounting holes

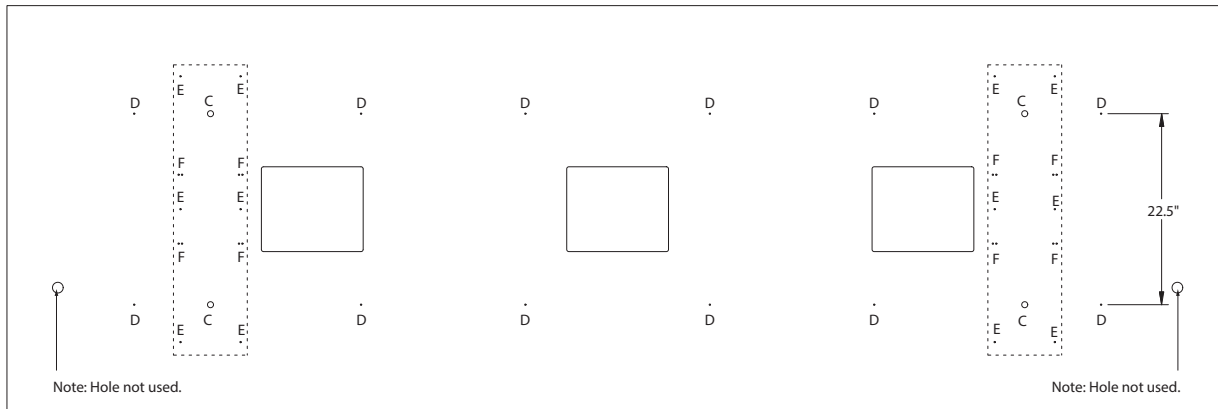

Fig. 1

Place table top on to assembled base/tech corridor.

Align the counter bored holes (C) underneath the top on to the pan head screws (C) used to secure the beams to the bracket castings. Pan head screws (C) used to secure the beams to the bracket castings.

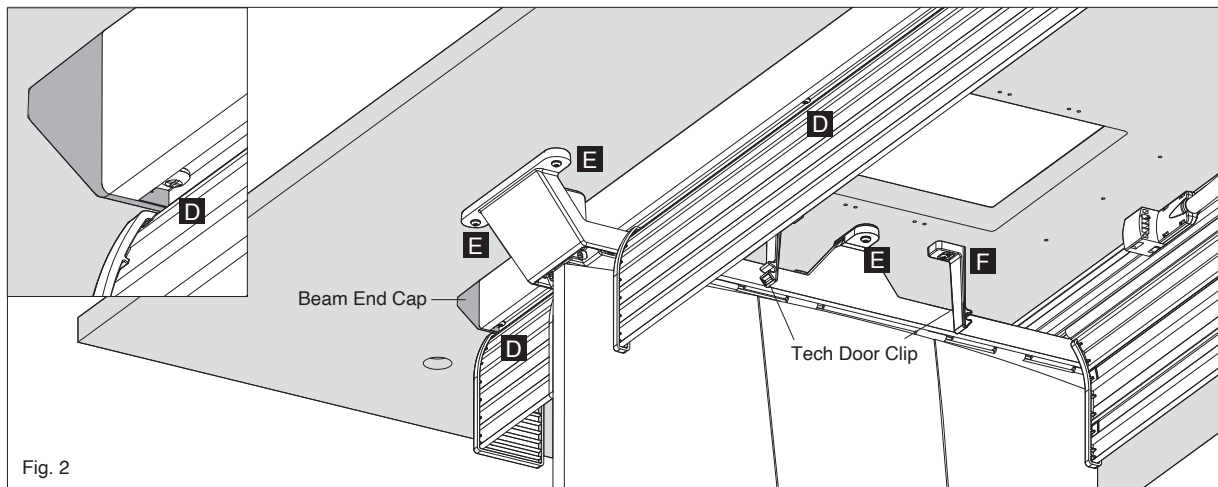

Fig. 2

Top Installation

Tip: Check to make sure all beam end caps have been inserted into all beam ends before securing top to beams.

Tip: Check to ensure that the bases and beams are squared and leveled before the top is attached.

Check top alignment. Counter bored holes on underside of top fit on to the Pan Head screws on each end base. See Fig. 1.

Start screws (D) through beam end caps and beams in to pilot holes in the table top. After all beam screws are started, finish tightening all beams screws from the center to the ends. See Fig. 2.

Install screws (E) through bracket casting holes into pilot holes in the table top. (6 screws/bracket). See Fig. 2.

Tech Door Clip Installation

Install each door clip with screws (F) into pilot holes in the table top. (2 screws/clip). See Fig. 2.

Tip: One clip/short tech door. Four clips/long tech door.

Host Collaborative and Conference Tables Sectioned Tops

Sectioned Tops Pilot Holes

C Alignment index holes

D Beam mounting holes

E Base bracket mounting holes

F Tech door clip mounting holes

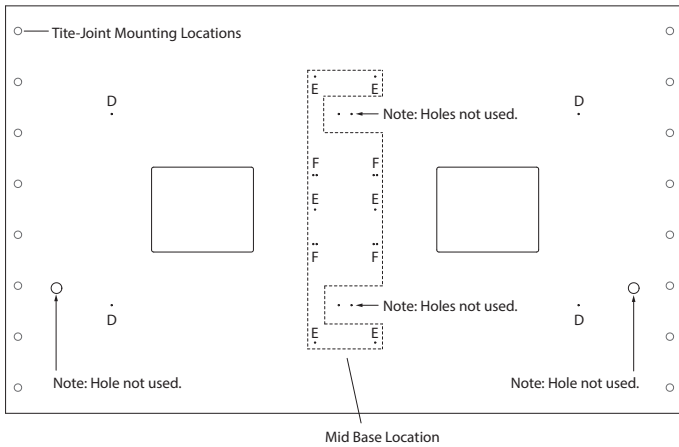
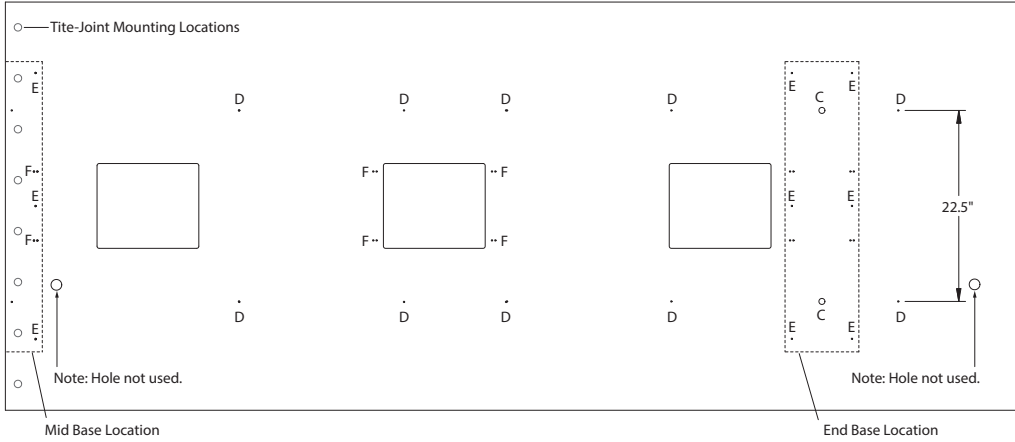

Bases are located in the same position for any given table top, regardless of table shape. Bases can be the same style or a combination of slim and flared.

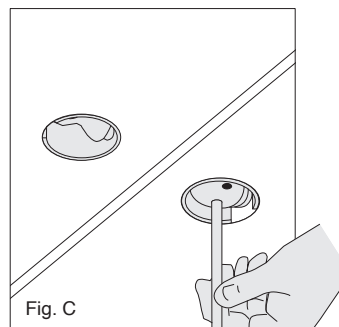
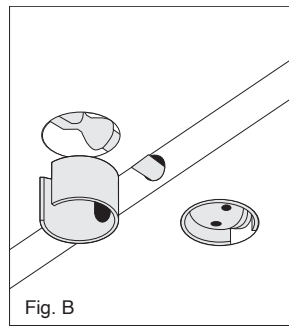
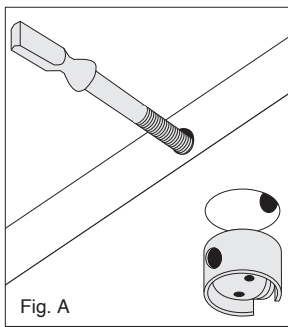

Insert tightening nuts in to alternating holes in table top sections with threaded ends towards the joint. Fig. A

Insert the draw bolts and thread each into the nut leaving 1/8" of bolt to fit into joining section. Fig. B

Insert locking sleeves into remaining holes to engage the head of the draw bolt. Fig. B
Tighten nut with tightening tool thus drawing joints together. Fig. C

Joining Sectioned Tops

Tip: For grain matching, top sections are in numbered sequence on the underside.

Align end top section with pan head screws on end base.

Insert Tite-Joint fasteners. Locate alignment bullets to aid in joining sectioned tops.

Alternate tightening tite-joint fasteners to join one section with another section. Begin with the center fastener and alternating left and right toward the outside of the top. As top sections come together, adjust tite-joints for a leveled, even seam between sections.

Level the bases.

Check alignment of the joined top on the bases.

Attach beams and bases to top.





Attach TAP doors and trays, if any, to top.

Host Collaborative and Conference Tables Product Number Logic



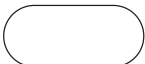

H S 9 6 4 8 R 1 2

"HOST SERIES"

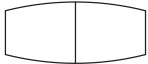
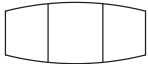
TOP LENGTH		TOP WIDTH	
96"	96 IN	42"	
10'	120 IN	48"	
12'	144 IN	54"	
14'	168 IN	60"	
16'	192 IN	00" (Round)	
18'	216 IN		
20'	240 IN		
48" dia.	48 IN		
60" dia.	60 IN		

TOP SHAPE	
"B" (Boat)	
"C" (Racetrack)	
"D" (Round)	
"R" (Rectangle)	
"S" (Soft Radiused)	
"T" (Trapezoid)	

TOP SECTIONS	
"1"	
"2"	
"3"	

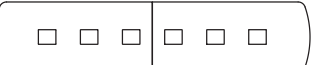
TAPS PER TOP	
"0"	
"1"	
"2"	
"3"	
"4"	
"6"	

Host Collaborative and Conference Tables Product Number Logic

Host Collaborative and Conference Tables Round Tables

DESIGN F/P DESIGN AND VECTA DESIGN TEAM



Tip: Shipped knocked down and top ships in one piece.

Tip: The wood edge on a table top with woodgrain laminate may not match the top.

Standard Includes	Required to Specify
<ul style="list-style-type: none"> ▶ Need help? Product details, page 334 • Top: 1¼" particle board core with laminate • Flat wood edge • TAP, if selected: 10"W x 12"L opening(s) trimmed with a flat solid wood profile and with brushed anodized aluminum doors • Base: <ul style="list-style-type: none"> - Wood veneer - Concealed leveling glides: non-marring, black plastic 	<ol style="list-style-type: none"> 1 Top Style number 2 Wood color number for base 3 Laminate color number for table top, if selected 4 Wood color number for wood edge 5 Door color number for storage tray or TAP doors, if selected <ul style="list-style-type: none"> - 8044 Black - 8047 Silver 6 Options, if selected (see below) <p>▶ See <i>Coalesse Surface Materials Reference Guide</i>.</p>

Veneer direction



Options	U.S. Price	Required to Specify
Surface Materials Top <ul style="list-style-type: none"> • Grade 2 laminate • Grade 3 laminate • Grade 1 wood veneer • Grade 2 wood veneer 	<p>Prices at right</p> <p>Prices at right</p> <p>Prices at right</p> <p>Prices at right</p>	<p>Specify with <i>Grade 2 laminate</i> and select color number.</p> <p>Specify with <i>Grade 3 laminate</i> and select color number.</p> <p>Specify with <i>Grade 1 wood veneer</i> and select color number.</p> <p>Specify with <i>Grade 2 wood veneer</i> and select color number.</p>
Edges Wood <ul style="list-style-type: none"> • Bullnose wood edge • Beveled wood edge • Horizon wood edge 	<p>Prices at right</p> <p>Prices at right</p> <p>Prices at right</p>	<p>Specify with <i>bullnose wood edge</i>.</p> <p>Specify with <i>beveled wood edge</i>.</p> <p>Specify with <i>horizon wood edge</i>.</p>

TAP Location

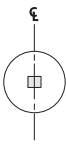

Tip: Tables available with zero or one TAP.

Tip: In addition to the data and audio/video AAPs available from Coalesse, other styles of AAPs are available through Extron Electronics. For an Extron dealer, call 1.800.633.9876.

Tip: See TAP options for electrical systems and faceplate list.

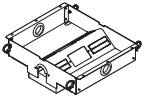
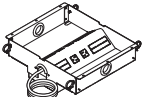
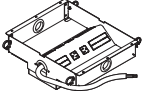
TAP Electrical System with Faceplate Options	U.S. Price	Required to Specify
▶ Page 345  Field Wired	No cost	Specify with <i>power data</i> , and select TAP type and TAP door color number.
 Cord and Plug	No cost	Specify with <i>power data</i> , and select TAP type and TAP door color number.
 Hardwired	No cost	Specify with <i>power data</i> , and select TAP type and TAP door color number.

▶ Options, continued on next page



For Canadian Pricing
 Multiply U.S. Price by the Canadian price factor.
 ▶ See page 1 for details.

Host Collaborative and Conference Tables Round Tables

DESIGN F/P DESIGN AND VECTA DESIGN TEAM

Tip: Wood veneer doors for storage tray or TAP will always be cross grain.





Tip: Connectrac must be the same wiring schematic as the table.

Tip: Last digit of style number indicates number of TAP(s).

► Options, continued from previous page

Options	U.S. Price	Required to Specify
Storage Tray ► Page 346	• Storage tray -\$875	Specify with storage tray and select door color number.
Doors	• Storage tray wood veneer doors +\$438 per door	Specify with wood doors.
	• TAP wood veneer doors +\$438 per door	Specify with wood doors.
Related Products	• Floor kit: Connectrac • Power strip	► Page 468 ► Page 739

Specification Information

Style Number	Finish	U.S. Base Prices			
					
		Flat Wood Edge:	Bullnose Wood Edge:	Beveled Wood Edge:	Horizon Wood Edge:

48"W Diameter One Piece Top

0 TAP

HS4800D10	Grade 1 Laminate	\$6413	\$6490	\$6598	\$ 7270
	Grade 2 and 3 Laminate	\$6487	\$6564	\$6672	\$ 7344
	Grade 1 Veneer	\$7014	\$7091	\$7199	\$ 7871
	Grade 2 Veneer	\$7386	\$7463	\$7571	\$ 8243

1 TAP

HS4800D11	Grade 1 Laminate	\$8756	\$8833	\$8941	\$ 9613
	Grade 2 and 3 Laminate	\$8830	\$8907	\$9015	\$ 9687
	Grade 1 Veneer	\$9357	\$9434	\$9542	\$10,214
	Grade 2 Veneer	\$9729	\$9806	\$9914	\$10,586

60" Diameter One Piece Top

0 TAP

HS6000D10	Grade 1 Laminate	\$6913	\$7010	\$7140	\$ 7837
	Grade 2 and 3 Laminate	\$7020	\$7117	\$7247	\$ 7944
	Grade 1 Veneer	\$8046	\$8143	\$8273	\$ 8970
	Grade 2 Veneer	\$8619	\$8716	\$8846	\$ 9543

► Specification Information, continued on next page



For Canadian Pricing
Multiply U.S. Price by the Canadian price factor.
► See page 1 for details.





Host Collaborative and Conference Tables Round Tables *continued*

DESIGN F/P DESIGN AND VECTA DESIGN TEAM

► Specification Information, continued from previous page

Tip: Last digit of style number indicates number of TAP(s).

Specification Information

Style Number	Finish	U.S. Base Prices			
					
		Flat Wood Edge:	Bullnose Wood Edge:	Beveled Wood Edge:	Horizon Wood Edge:



60" Diameter One Piece Top

1 TAP

Style Number	Finish	Flat Wood Edge	Bullnose Wood Edge	Beveled Wood Edge	Horizon Wood Edge
HS6000D11	Grade 1 Laminate	\$ 9253	\$ 9350	\$ 9480	\$10,177
	Grade 2 and 3 Laminate	\$ 9360	\$ 9457	\$ 9587	\$10,284
	Grade 1 Veneer	\$10,386	\$10,483	\$10,613	\$11,310
	Grade 2 Veneer	\$10,959	\$11,056	\$11,186	\$11,883



For Canadian Pricing
 Multiply U.S. Price by the Canadian price factor.
 ► See page 1 for details.

Coalesse

Host Collaborative and Conference Tables Round Tables

DESIGN F/P DESIGN AND VECTA DESIGN TEAM

Host Collaborative and Conference Tables Rectangular Tables with Two Bases

DESIGN F/P DESIGN AND VECTA DESIGN TEAM

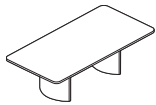

Tip: Shipped knocked down and top ships in one piece.

Tip: Grain direction for wood-grain laminate runs the length of the table.

Tip: Clips are provided with table: One clip per foot of table length.

Tip: The wood edge on a table top with woodgrain laminate may not match the top.

Tip: 96"L tables available with zero, one, or two TAP(s). 10'L and 12'L tables available with zero, one, two, or three TAP(s).

Tip: In addition to the data and audio/video AAPs available from Coalesse, other styles of AAPs are available through Extron Electronics. For an Extron dealer, call 1.800.633.9876.

Tip: See TAP options for electrical systems and faceplate list.

Veneer direction



For Canadian Pricing
Multiply U.S. Price by the Canadian price factor.
▶ See page 1 for details.

Standard Includes	Required to Specify
-------------------	---------------------

- ▶ Need help? Product details, page 334
- Top: 1/4" particle board core with laminate
- TAP(s) or storage tray, if selected: 10"W x 12"L opening(s) trimmed with a flat solid wood profile and with brushed anodized aluminum doors
- Tech corridor: two aluminum beams for top support provide tracks for hinged aluminum doors that clip shut: satin anodized finish
- Universal clip: black plastic
- Two 27"W bases: wood veneer on MDF with aluminum universal bracket
- Concealed leveling glides: non-marring, black plastic

- 1 Style number
 - 2 Base selection (see below) and wood color number for base
 - 3 Laminate color number for table top, if selected
 - 4 Wood color number for wood edge
 - 5 Door color number for storage tray or TAP doors, if selected:
 - 8044 Black
 - 8047 Silver
 - 6 Options, if selected (see below)
- ▶ See *Coalesse Surface Materials Reference Guide*.

Options	U.S. Price	Required to Specify
---------	------------	---------------------

Surface Materials	Top	U.S. Price	Required to Specify
	• Grade 2 laminate	Prices at right	Specify with <i>Grade 2 laminate</i> and select color number.
	• Grade 3 laminate	Prices at right	Specify with <i>Grade 3 laminate</i> and select color number.
	• Grade 1 wood veneer	Prices at right	Specify with <i>Grade 1 wood veneer</i> and select color number.
	• Grade 2 wood veneer	Prices at right	Specify with <i>Grade 2 wood veneer</i> and select color number.

Edges	Wood	U.S. Price	Required to Specify
	• Bullnose wood edge	Prices at right	Specify with <i>bullnose wood edge</i> .
	• Beveled wood edge	Prices at right	Specify with <i>beveled wood edge</i> .
	• Tapered wood edge	Prices at right	Specify with <i>tapered wood edge</i> .
	• Horizon wood edge	Prices at right	Specify with <i>horizon wood edge</i> .

Bases	Options	U.S. Price	Required to Specify
<p>Slim Flared</p>	• Two slim bases	No cost	Specify with <i>two slim bases</i> .
	• One slim and one flared base	+\$1219	Specify with <i>one slim base and one flared base</i> .
	• Two flared bases	+\$2441	Specify with <i>two flared bases</i> .

TAP Electrical System with Faceplate Options	Options	U.S. Price	Required to Specify
<p>Field Wired</p>	• Field-wired tray (no electrical) - PAFW field-wired tray (no electrical) with blank AAPs - PDFW field-wired tray (no electrical) with two data AAPs - PVFW field-wired tray (no electrical) with two of each video/audio and data AAPs	No cost	Specify with <i>power data</i> , and select TAP type and TAP door color number.
	▶ Page 345		

<p>Cord and Plug</p>	• Cord and plug tray (10' cord) - PACP cord and plug tray with outlets and blank AAPs - PDCP cord and plug tray with outlets and two data AAPs - PAVC cord and plug tray with outlets and two of each video/audio and data AAPs	No cost	Specify with <i>power data</i> , and select TAP type and TAP door color number.
----------------------	---	---------	---

<p>Hardwired</p>	• Hard-wired tray (6' conduit) - PAHW hard-wired tray with outlets and blank AAPs - PDHW hard-wired tray with outlets and two data AAPs - PAVH hard-wired tray with outlets and two of each video/audio and data AAPs	No cost	Specify with <i>power data</i> , and select TAP type and TAP door color number.
------------------	---	---------	---

▶ Options, continued on next page

Host Collaborative and Conference Tables Rectangular Tables with Two Bases

DESIGN F/P DESIGN AND VECTA DESIGN TEAM

► Options, continued from previous page

Tip: For single TAP style numbers, the modular system tray is not available. Specify the hard-wired tray option.

Tip: If the specified table has multiple TAPs, any one TAP can be replaced with a storage tray.

Tip: Wood veneer doors for storage tray and TAP will always be cross grain.

Tip: Connectrac must be the same wiring schematic as the table.

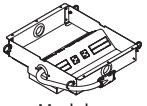
Options	U.S. Price	Required to Specify
TAP Electrical System with Faceplate Options ► Page 345  Modular	<ul style="list-style-type: none"> • Modular system tray (hardwire base power infeed) <ul style="list-style-type: none"> - PAMH modular system tray with outlets and blank AAPs - PDMH modular system tray with outlets and two data AAPs - PVMH modular system tray with outlets and two of each video/audio and data AAPs 	+\$208 each tray Specify with modular power data, and select TAP type and TAP door color number.
Storage Tray ► Page 346	<ul style="list-style-type: none"> • Storage tray 	-\$875 Specify with storage tray and select door color number.
Doors	<ul style="list-style-type: none"> • Storage tray wood veneer doors • TAP wood veneer doors 	+\$438 per door +\$438 per door Specify with wood doors.
Related Products	<ul style="list-style-type: none"> • Floor kit: Connectrac • Corridor shelf • Power strip 	► Page 468 ► Page 468 ► Page 739

TAP Locations

96"L x 48"W TAP Locations—One piece top

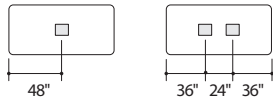

10"L x 48"W TAP Locations—One piece top

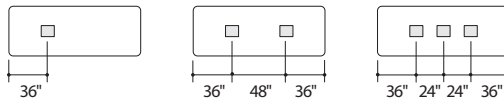

10"L x 48"W TAP Locations—Two piece top

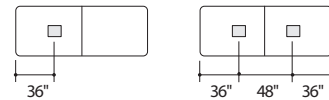

10"L x 60"W TAP Locations—One piece top

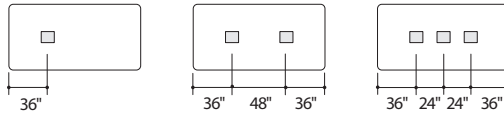

10"L x 60"W TAP Locations—Two piece top

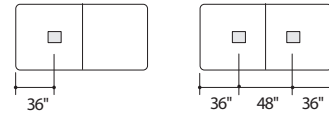

12"L x 48"W TAP Locations—Two piece top

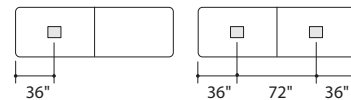

12"L x 60"W TAP Locations—Two piece top

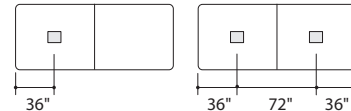

► Specification Information, on next page

Host Collaborative and Conference Tables

For Canadian Pricing
 Multiply U.S. Price by the Canadian price factor.
 ► See page 1 for details.

Host Collaborative and Conference Tables Rectangular Tables with Two Bases *continued*





DESIGN F/P DESIGN AND VECTA DESIGN TEAM

►Options, on previous page

Tip: Prices shown include top, TAP(s), and slim bases.
►See base options for flared bases, page 360

Tip: Last digit of style number indicates number of TAP(s).

Specification Information

Style Number	Finish	U.S. Base Prices			
					
		Flat Wood Edge:	Bullnose Wood Edge:	Beveled Wood Edge, Tapered Wood Edge:	Horizon Wood Edge:

96"L x 48"W One Piece Top

0 TAP

HS9648R10	Grade 1 Laminate	\$ 9952	\$10,098	\$10,303	\$12,231
	Grade 2 and 3 Laminate	\$10,126	\$10,272	\$10,477	\$12,405
	Grade 1 Veneer	\$10,699	\$10,845	\$11,050	\$12,978
	Grade 2 Veneer	\$11,589	\$11,735	\$11,940	\$13,868

1 TAP

HS9648R11	Grade 1 Laminate	\$12,290	\$12,436	\$12,641	\$14,569
	Grade 2 and 3 Laminate	\$12,464	\$12,610	\$12,815	\$14,743
	Grade 1 Veneer	\$13,037	\$13,183	\$13,388	\$15,316
	Grade 2 Veneer	\$13,927	\$14,073	\$14,278	\$16,206

2 TAPS

HS9648R12	Grade 1 Laminate	\$14,631	\$14,777	\$14,982	\$16,910
	Grade 2 and 3 Laminate	\$14,805	\$14,951	\$15,156	\$17,084
	Grade 1 Veneer	\$15,378	\$15,524	\$15,729	\$17,657
	Grade 2 Veneer	\$16,268	\$16,414	\$16,619	\$18,547

10'L x 48"W One Piece Top

0 TAP

HS1048R10	Grade 1 Laminate	\$10,733	\$10,902	\$11,138	\$13,105
	Grade 2 and 3 Laminate	\$10,956	\$11,125	\$11,361	\$13,328
	Grade 1 Veneer	\$11,645	\$11,814	\$12,050	\$14,017
	Grade 2 Veneer	\$12,754	\$12,923	\$13,159	\$15,126

1 TAP X4/24

HS1048R11	Grade 1 Laminate	\$13,073	\$13,242	\$13,478	\$15,445
	Grade 2 and 3 Laminate	\$13,296	\$13,465	\$13,701	\$15,668
	Grade 1 Veneer	\$13,985	\$14,154	\$14,390	\$16,357
	Grade 2 Veneer	\$15,094	\$15,263	\$15,499	\$17,466

2 TAPS

HS1048R12	Grade 1 Laminate	\$15,415	\$15,584	\$15,820	\$17,787
	Grade 2 and 3 Laminate	\$15,638	\$15,807	\$16,043	\$18,010
	Grade 1 Veneer	\$16,327	\$16,496	\$16,732	\$18,699
	Grade 2 Veneer	\$17,436	\$17,605	\$17,841	\$19,808

►Specification Information, continued on next page



Tip: For tech corridor, 96"L tables have two long doors and four short doors.

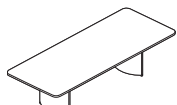
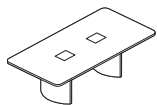
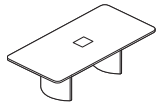

Tip: For tech corridor, 10'L tables have four long doors and four short doors.

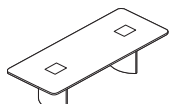
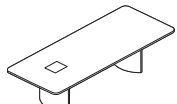

For Canadian Pricing
Multiply U.S. Price by the Canadian price factor.
►See page 1 for details.

X4/24 = Last order entry
April 14, 2024

Host Collaborative and Conference Tables Rectangular Tables with Two Bases





DESIGN F/P DESIGN AND VECTA DESIGN TEAM

Tip: Prices shown include top, TAP(s), and slim bases.
 ▶ See base options for flared bases, page 360

Tip: Last digit of style number indicates number of TAP(s).

▶ Specification Information, continued from previous page

Specification Information

Style Number	Finish	U.S. Base Prices			
					
		Flat Wood Edge:	Bullnose Wood Edge:	Beveled Wood Edge, Tapered Wood Edge:	Horizon Wood Edge:

10'L x 48"W One Piece Top

3 TAPS

HS1048R13	Grade 1 Laminate	\$17,759	\$17,928	\$18,164	\$20,131
	Grade 2 and 3 Laminate	\$17,982	\$18,151	\$18,387	\$20,354
	Grade 1 Veneer	\$18,671	\$18,840	\$19,076	\$21,043
	Grade 2 Veneer	\$19,780	\$19,949	\$20,185	\$22,152

10'L x 48"W Two Piece Top

0 TAP

HS1048R20	Grade 1 Laminate	\$11,295	\$11,464	\$11,700	\$13,667
	Grade 2 and 3 Laminate	\$11,518	\$11,687	\$11,923	\$13,890
	Grade 1 Veneer	\$12,207	\$12,376	\$12,612	\$14,579
	Grade 2 Veneer	\$13,316	\$13,485	\$13,721	\$15,688

1 TAP X4/24

HS1048R21	Grade 1 Laminate	\$13,637	\$13,806	\$14,042	\$16,009
	Grade 2 and 3 Laminate	\$13,860	\$14,029	\$14,265	\$16,232
	Grade 1 Veneer	\$14,549	\$14,718	\$14,954	\$16,921
	Grade 2 Veneer	\$15,658	\$15,827	\$16,063	\$18,030

2 TAPS

HS1048R22	Grade 1 Laminate	\$15,976	\$16,145	\$16,381	\$18,348
	Grade 2 and 3 Laminate	\$16,199	\$16,368	\$16,604	\$18,571
	Grade 1 Veneer	\$16,888	\$17,057	\$17,293	\$19,260
	Grade 2 Veneer	\$17,997	\$18,166	\$18,402	\$20,369

10'L x 60"W One Piece Top

0 TAP

HS1060R10	Grade 1 Laminate	\$11,026	\$11,209	\$11,461	\$13,447
	Grade 2 and 3 Laminate	\$11,294	\$11,477	\$11,729	\$13,715
	Grade 1 Veneer	\$12,630	\$12,813	\$13,065	\$15,051
	Grade 2 Veneer	\$14,035	\$14,218	\$14,470	\$16,456

1 TAP X4/24

HS1060R11	Grade 1 Laminate	\$13,368	\$13,551	\$13,803	\$15,789
	Grade 2 and 3 Laminate	\$13,636	\$13,819	\$14,071	\$16,057
	Grade 1 Veneer	\$14,972	\$15,155	\$15,407	\$17,393
	Grade 2 Veneer	\$16,377	\$16,560	\$16,812	\$18,798

▶ Specification Information, continued on next page

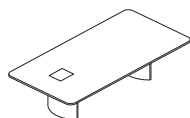
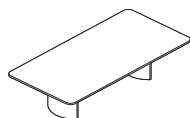
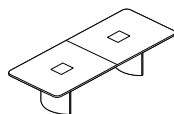
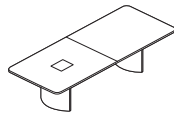
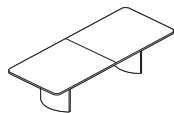
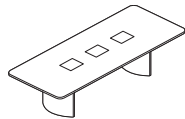

 **For Canadian Pricing**
 Multiply U.S. Price by the Canadian price factor.
 ▶ See page 1 for details.

X4/24 = Last order entry
 April 14, 2024

Host Collaborative and Conference Tables Rectangular Tables with Two Bases *continued*





DESIGN F/P DESIGN AND VECTA DESIGN TEAM

Tip: Prices shown include top, TAP(s), and slim bases.
 ▶ See base options for flared bases, page 360

Tip: Last digit of style number indicates number of TAP(s).

▶ Specification Information, continued from previous page

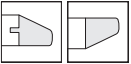
Specification Information

Style Number	Finish	U.S. Base Prices			
					
		Flat Wood Edge:	Bullnose Wood Edge:	Beveled Wood Edge, Tapered Wood Edge:	Horizon Wood Edge:

10'L x 60"W One Piece Top, continued

2 TAPS

HS1060R12	Grade 1 Laminate	\$15,251	\$15,434	\$15,686	\$17,672
	Grade 2 and 3 Laminate	\$15,519	\$15,702	\$15,954	\$17,940
	Grade 1 Veneer	\$16,855	\$17,038	\$17,290	\$19,276
	Grade 2 Veneer	\$18,260	\$18,443	\$18,695	\$20,681

3 TAPS

HS1060R13	Grade 1 Laminate	\$18,052	\$18,235	\$18,487	\$20,473
	Grade 2 and 3 Laminate	\$18,320	\$18,503	\$18,755	\$20,741
	Grade 1 Veneer	\$19,656	\$19,839	\$20,091	\$22,077
	Grade 2 Veneer	\$21,061	\$21,244	\$21,496	\$23,482

10'L x 60"W Two Piece Top

0 TAP

HS1060R20	Grade 1 Laminate	\$11,585	\$11,768	\$12,020	\$14,006
	Grade 2 and 3 Laminate	\$11,853	\$12,036	\$12,288	\$14,274
	Grade 1 Veneer	\$13,189	\$13,372	\$13,624	\$15,610
	Grade 2 Veneer	\$14,594	\$14,777	\$15,029	\$17,015

1 TAP ✕4/24

HS1060R21	Grade 1 Laminate	\$13,929	\$14,112	\$14,364	\$16,350
	Grade 2 and 3 Laminate	\$14,197	\$14,380	\$14,632	\$16,618
	Grade 1 Veneer	\$15,533	\$15,716	\$15,968	\$17,954
	Grade 2 Veneer	\$16,938	\$17,121	\$17,373	\$19,359

2 TAPS

HS1060R22	Grade 1 Laminate	\$16,271	\$16,454	\$16,706	\$18,692
	Grade 2 and 3 Laminate	\$16,539	\$16,722	\$16,974	\$18,960
	Grade 1 Veneer	\$17,875	\$18,058	\$18,310	\$20,296
	Grade 2 Veneer	\$19,280	\$19,463	\$19,715	\$21,701

▶ Specification Information, continued on next page

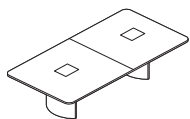
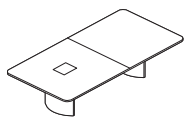
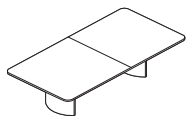
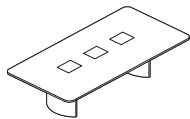
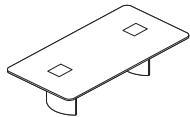

For Canadian Pricing
 Multiply U.S. Price by the
 Canadian price factor.
 ▶ See page 1 for details.

✕4/24 = Last order entry
 April 14, 2024

Host Collaborative and Conference Tables Rectangular Tables with Two Bases





DESIGN F/P DESIGN AND VECTA DESIGN TEAM

Tip: Prices shown include top, TAP(s), and slim bases.
 ▶ See base options for flared bases, page 360

Tip: Last digit of style number indicates number of TAP(s).

▶ Specification Information, continued from previous page

Specification Information

Style Number	Finish	U.S. Base Prices			
					
		Flat Wood Edge:	Bullnose Wood Edge:	Beveled Wood Edge, Tapered Wood Edge:	Horizon Wood Edge:

12'L x 48"W Two Piece Top

0 TAP

HS1248R20	Grade 1 Laminate	\$11,991	\$12,186	\$12,452	\$14,458
	Grade 2 and 3 Laminate	\$12,253	\$12,448	\$12,714	\$14,720
	Grade 1 Veneer	\$13,194	\$13,389	\$13,655	\$15,661
	Grade 2 Veneer	\$14,533	\$14,728	\$14,994	\$17,000

1 TAP X4/24

HS1248R21	Grade 1 Laminate	\$14,338	\$14,533	\$14,799	\$16,805
	Grade 2 and 3 Laminate	\$14,600	\$14,795	\$15,061	\$17,067
	Grade 1 Veneer	\$15,541	\$15,736	\$16,002	\$18,008
	Grade 2 Veneer	\$16,880	\$17,075	\$17,341	\$19,347

2 TAPS

HS1248R22	Grade 1 Laminate	\$16,679	\$16,874	\$17,140	\$19,146
	Grade 2 and 3 Laminate	\$16,941	\$17,136	\$17,402	\$19,408
	Grade 1 Veneer	\$17,882	\$18,077	\$18,343	\$20,349
	Grade 2 Veneer	\$19,221	\$19,416	\$19,682	\$21,688

▶ Specification Information, continued on next page

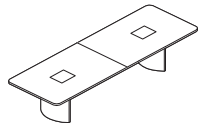
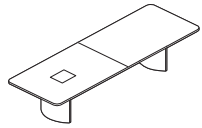
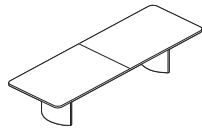

For Canadian Pricing
 Multiply U.S. Price by the Canadian price factor.
 ▶ See page 1 for details.

X4/24 = Last order entry
 April 14, 2024

Host Collaborative and Conference Tables Rectangular Tables with Two Bases *continued*





DESIGN F/P DESIGN AND VECTA DESIGN TEAM

► Specification Information, continued from previous page

Tip: Prices shown include top, TAP(s), and slim bases.
 ► See base options for flared bases, page 360

Tip: Last digit of style number indicates number of TAP(s).

Specification Information

Style Number	Finish	U.S. Base Prices			
					
		Flat Wood Edge:	Bullnose Wood Edge:	Beveled Wood Edge, Tapered Wood Edge:	Horizon Wood Edge:

12'L x 60"W Two Piece Top

0 TAP

HS1260R20	Grade 1 Laminate	\$12,297	\$12,501	\$12,789	\$14,813
	Grade 2 and 3 Laminate	\$12,625	\$12,829	\$13,117	\$15,141
	Grade 1 Veneer	\$14,271	\$14,475	\$14,763	\$16,787
	Grade 2 Veneer	\$15,957	\$16,161	\$16,449	\$18,473

1 TAP X4/24

HS1260R21	Grade 1 Laminate	\$14,639	\$14,843	\$15,131	\$17,155
	Grade 2 and 3 Laminate	\$14,967	\$15,171	\$15,459	\$17,483
	Grade 1 Veneer	\$16,613	\$16,817	\$17,105	\$19,129
	Grade 2 Veneer	\$18,299	\$18,503	\$18,791	\$20,815

2 TAPS

HS1260R22	Grade 1 Laminate	\$16,984	\$17,188	\$17,476	\$19,500
	Grade 2 and 3 Laminate	\$17,312	\$17,516	\$17,804	\$19,828
	Grade 1 Veneer	\$18,958	\$19,162	\$19,450	\$21,474
	Grade 2 Veneer	\$20,644	\$20,848	\$21,136	\$23,160

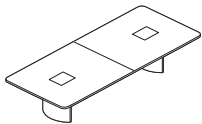
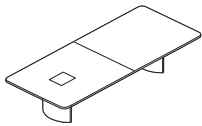
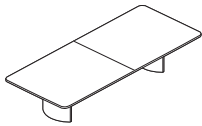

For Canadian Pricing
 Multiply U.S. Price by the Canadian price factor.
 ► See page 1 for details.

X4/24 = Last order entry
 April 14, 2024

Coalesse

Host Collaborative and Conference Tables

Rectangular Tables with Two Bases

DESIGN F/P DESIGN AND VECTA DESIGN TEAM

Host Collaborative and
Conference Tables

Host Collaborative and Conference Tables Rectangular Tables with Three Bases

DESIGN F/P DESIGN AND VECTA DESIGN TEAM

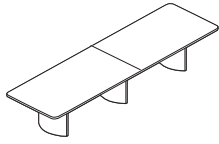

Tip: Shipped knocked down and top ships in one piece.

Tip: Grain direction for wood-grain laminate runs the length of the table.

Tip: Clips are provided with table: One clip per foot of table length.

Tip: The wood edge on a table top with woodgrain laminate may not match the top.

Tip: 14'L and 16'L tables available with zero, one, two, or four TAP(s). 18'L and 20'L tables available with zero, one, two, four, or six TAP(s).

Tip: In addition to the data and audio/video AAPs available from Coalesse, other styles of AAPs are available through Extron Electronics. For an Extron dealer, call 1.800.633.9876.

Tip: See TAP options for electrical systems and faceplate list.

Veneer direction

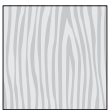

For Canadian Pricing
 Multiply U.S. Price by the Canadian price factor.
 ▶ See page 1 for details.

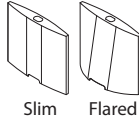
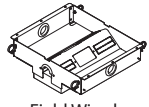
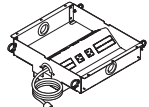
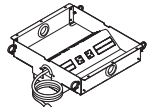
Standard Includes		Required to Specify		
<p>▶ Need help? Product details, page 334</p> <ul style="list-style-type: none"> • Top: 1/4" particle board core with laminate • Flat wood edge • TAP(s), if selected: 10"W x 12"L opening(s) trimmed with a flat solid wood profile and with brushed anodized aluminum TAP doors • Tech corridor: four aluminum beams for top support provide tracks for hinged aluminum doors that clip shut: satin anodized finish • Universal clip: black plastic • Three 27"W bases: wood veneer on MDF with aluminum universal bracket • Concealed leveling glides: non-marring, black plastic 		<ol style="list-style-type: none"> 1 Style number 2 Base selection (see below) and wood color number for base 3 Laminate color number for table top, if selected 4 Wood color number for wood edge 5 Door color number for storage tray or TAP door, if selected: <ul style="list-style-type: none"> - 8044 Black - 8047 Silver 6 Options, if selected (see below) <p>▶ See <i>Coalesse Surface Materials Reference Guide</i>.</p>		
Options		U.S. Price	Required to Specify	
Surface Materials	<p>Top</p> <ul style="list-style-type: none"> • Grade 2 laminate • Grade 3 laminate • Grade 1 wood veneer • Grade 2 wood veneer 	<p>Prices at right</p> <p>Prices at right</p> <p>Prices at right</p> <p>Prices at right</p>	<p>Specify with <i>Grade 2 laminate</i> and select color number.</p> <p>Specify with <i>Grade 3 laminate</i> and select color number.</p> <p>Specify with <i>Grade 1 wood veneer</i> and select color number.</p> <p>Specify with <i>Grade 2 wood veneer</i> and select color number.</p>	
Edges	<p>Wood</p> <ul style="list-style-type: none"> • Bullnose wood edge • Beveled wood edge • Tapered wood edge • Horizon wood edge 	<p>Prices at right</p> <p>Prices at right</p> <p>Prices at right</p> <p>Prices at right</p>	<p>Specify with <i>bullnose wood edge</i>.</p> <p>Specify with <i>beveled wood edge</i>.</p> <p>Specify with <i>tapered wood edge</i>.</p> <p>Specify with <i>horizon wood edge</i>.</p>	
Bases	 <ul style="list-style-type: none"> • Three slim bases • Two slim and one flared bases • One slim and two flared bases • Three flared bases 	<p>No cost</p> <p>+\$1217</p> <p>+\$2438</p> <p>+\$3652</p>	<p>Specify with <i>three slim bases</i>.</p> <p>Specify with <i>two slim and one flared bases</i>.</p> <p>Specify with <i>one slim and two flared bases</i>.</p> <p>Specify with <i>three flared bases</i>.</p>	
TAP Electrical System with Faceplate Options	<p>▶ Page 345</p>  <p>Field Wired</p>  <p>Cord and Plug</p>  <p>Cord and Plug</p>	<ul style="list-style-type: none"> • Field-wired tray (no electrical) <ul style="list-style-type: none"> - PAFW field-wired tray (no electrical) with blank AAPs - PDFW field-wired tray (no electrical) with two data AAPs - PVFW field-wired tray (no electrical) with two of each video/audio and data AAPs • Cord and plug tray (10' cord) <ul style="list-style-type: none"> - PACP cord and plug tray with outlets and blank AAPs - PDCP cord and plug tray with outlets and two data AAPs - PAVC cord and plug tray with outlets and two of each video/audio and data AAPs • Hard-wired tray (6' conduit) <ul style="list-style-type: none"> - PAHW hard-wired tray with outlets and blank AAPs - PDHW hard-wired tray with outlets and two data AAPs - PAVH hard-wired tray with outlets and two of each video/audio and data AAPs 	<p>No cost</p> <p>No cost</p> <p>No cost</p>	<p>Specify with <i>power data</i>, and select TAP type and TAP door color number.</p> <p>Specify with <i>power data</i>, and select TAP type and TAP door color number.</p> <p>Specify with <i>power data</i>, and select TAP type and TAP door color number.</p>

▶ Options, continued on next page

Host Collaborative and Conference Tables Rectangular Tables with Three Bases

DESIGN F/P DESIGN AND VECTA DESIGN TEAM

Tip: For single TAP style numbers, the modular system tray is not available. Specify the hard-wired tray option.

Tip: If the specified table has multiple TAP(s), any one TAP can be replaced with a storage tray.

Tip: Wood veneer doors for storage tray and TAP will always be cross grain.

Tip: Connectrac must be the same wiring schematic as the table.

►Options, continued from previous page

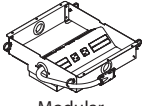
Options	U.S. Price	Required to Specify
TAP Electrical System with Faceplate Options ► Page 345  Modular	<ul style="list-style-type: none"> • Modular system tray (hardwire base power infeed) +\$208 each tray - PAMH modular system tray with outlets and blank AAPs - PDMH modular system tray with outlets and two data AAPs - PVMH modular system tray with outlets and two of each video/audio and data AAPs 	Specify with modular power data, and select TAP type and TAP door color number.
Storage Tray ► Page 346	<ul style="list-style-type: none"> • Storage tray -\$875 	Specify with storage tray and select door color number.
Doors	<ul style="list-style-type: none"> • Storage tray wood veneer doors +\$438 per door • TAP wood veneer doors +\$438 per door 	Specify with wood doors.
Related Products	<ul style="list-style-type: none"> • Floor kit: Connectrac • Corridor shelf • Power strip 	► Page 468 ► Page 468 ► Page 739

TAP Locations

14'L x 48"W TAP Locations—Two piece top

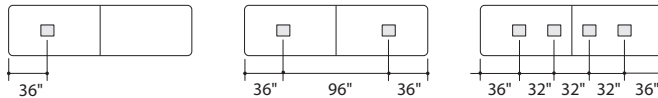

14'L x 48"W TAP Locations—Three piece top

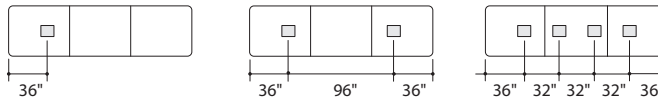

14'L x 60"W TAP Locations—Two piece top

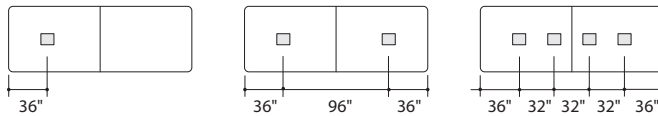

14'L x 60"W TAP Locations—Three piece top

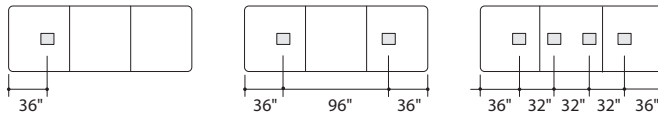

►Options, continued on next page

For Canadian Pricing
 Multiply U.S. Price by the Canadian price factor.
 ► See page 1 for details.

Host Collaborative and Conference Tables

Rectangular Tables with Three Bases *continued*

DESIGN F/P DESIGN AND VECTA DESIGN TEAM

►Options, continued from previous page

TAP Locations

16'L x 48"W TAP Locations—Two piece top



16'L x 48"W TAP Locations—Three piece top



16'L x 60"W TAP Locations—Two piece top

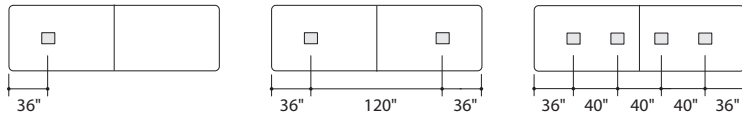

16'L x 60"W TAP Locations—Three piece top

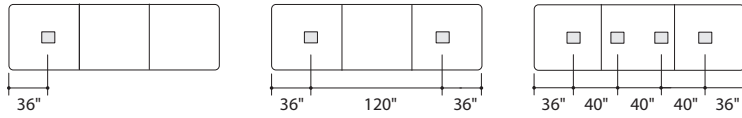

18'L x 48"W TAP Locations—Two piece top

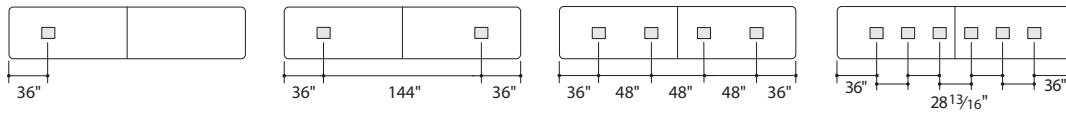

18'L x 48"W TAP Locations—Three piece top

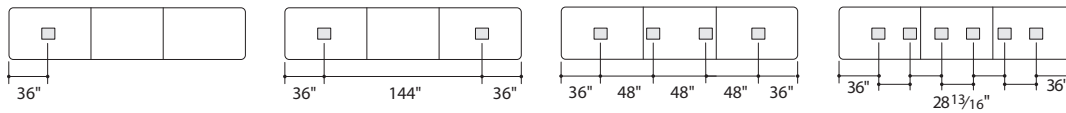

18'L x 60"W TAP Locations—Two piece top

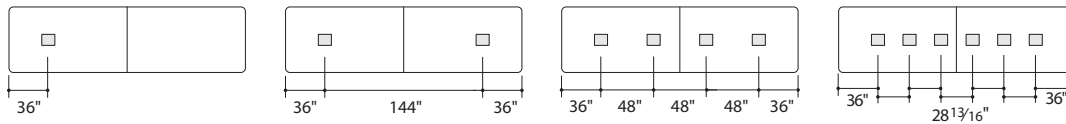

18'L x 60"W TAP Locations—Three piece top

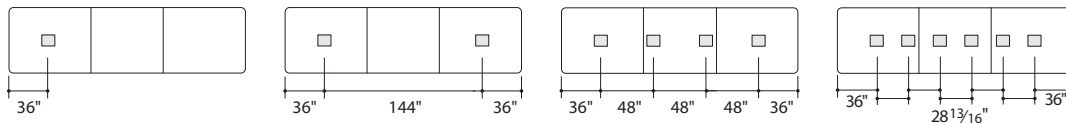

►Options, continued on next page

Host Collaborative and Conference Tables Rectangular Tables with Three Bases

DESIGN F/P DESIGN AND VECTA DESIGN TEAM

► Options, continued from previous page

TAP Locations

20'L x 48"W TAP Locations—Two piece top

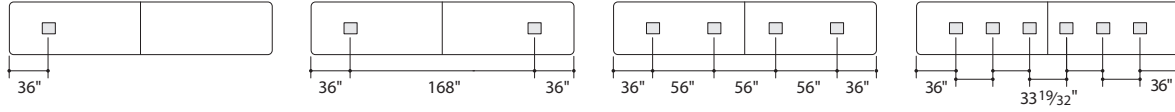

20'L x 48"W TAP Locations—Three piece top

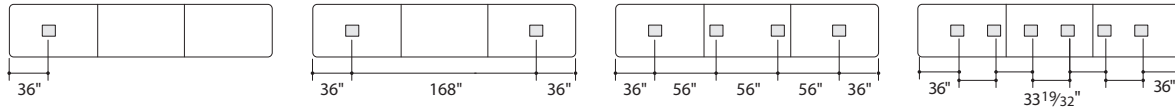

20'L x 60"W TAP Locations—Two piece top

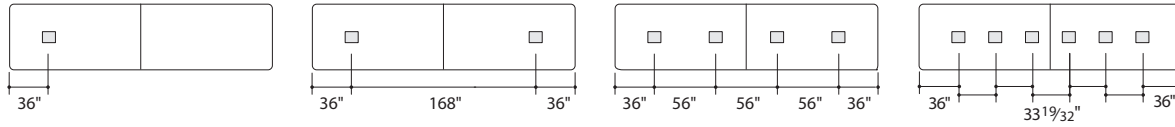

20'L x 60"W TAP Locations—Three piece top

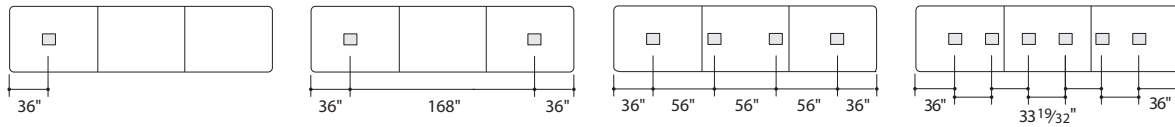

► Specification Information, on next page

Host Collaborative and Conference Tables Rectangular Tables with Three Bases *continued*

DESIGN F/P DESIGN AND VECTA DESIGN TEAM

Tip: Prices shown include top, TAP(s), and slim bases.
 ▶ See base options for flared bases, page 368

Tip: Last digit of style number indicates number of TAP(s).

Tip: For tech corridor, 14'L tables have four long doors and four short doors.

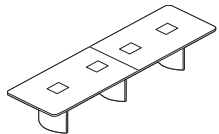
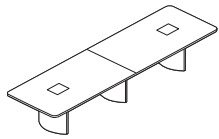
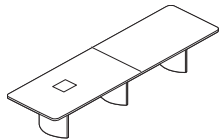
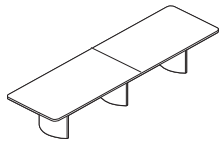

▶ Options, on previous page

Specification Information

Style Number	Finish	U.S. Base Prices			
		Flat Wood Edge:	Bullnose Wood Edge:	Beveled Wood Edge, Tapered Wood Edge:	Horizon Wood Edge:

14'L x 48''W Two Piece Top

0 TAP

Style Number	Finish	Flat Wood Edge	Bullnose Wood Edge	Beveled Wood Edge, Tapered Wood Edge	Horizon Wood Edge
HS1448R20	Grade 1 Laminate	\$15,531	\$15,753	\$16,049	\$18,093
	Grade 2 and 3 Laminate	\$15,838	\$16,060	\$16,356	\$18,400
	Grade 1 Veneer	\$17,223	\$17,445	\$17,741	\$19,785
	Grade 2 Veneer	\$18,792	\$19,014	\$19,310	\$21,354

1 TAP X3/24

Style Number	Finish	Flat Wood Edge	Bullnose Wood Edge	Beveled Wood Edge, Tapered Wood Edge	Horizon Wood Edge
HS1448R21	Grade 1 Laminate	\$17,873	\$18,095	\$18,391	\$20,435
	Grade 2 and 3 Laminate	\$18,180	\$18,402	\$18,698	\$20,742
	Grade 1 Veneer	\$19,565	\$19,787	\$20,083	\$22,127
	Grade 2 Veneer	\$21,134	\$21,356	\$21,652	\$23,696

2 TAPS

Style Number	Finish	Flat Wood Edge	Bullnose Wood Edge	Beveled Wood Edge, Tapered Wood Edge	Horizon Wood Edge
HS1448R22	Grade 1 Laminate	\$20,217	\$20,439	\$20,735	\$22,779
	Grade 2 and 3 Laminate	\$20,524	\$20,746	\$21,042	\$23,086
	Grade 1 Veneer	\$21,909	\$22,131	\$22,427	\$24,471
	Grade 2 Veneer	\$23,478	\$23,700	\$23,996	\$26,040

4 TAPS

Style Number	Finish	Flat Wood Edge	Bullnose Wood Edge	Beveled Wood Edge, Tapered Wood Edge	Horizon Wood Edge
HS1448R24	Grade 1 Laminate	\$24,898	\$25,120	\$25,416	\$27,460
	Grade 2 and 3 Laminate	\$25,205	\$25,427	\$25,723	\$27,767
	Grade 1 Veneer	\$26,590	\$26,812	\$27,108	\$29,152
	Grade 2 Veneer	\$28,159	\$28,381	\$28,677	\$30,721

▶ Specification Information, continued on next page



For Canadian Pricing
 Multiply U.S. Price by the Canadian price factor.
 ▶ See page 1 for details.

X3/24 = Last order entry
 April 14, 2024

Host Collaborative and Conference Tables Rectangular Tables with Three Bases

DESIGN F/P DESIGN AND VECTA DESIGN TEAM

Tip: Prices shown include top, TAP(s), and slim bases.
 ▶ See base options for flared bases, page 368

Tip: Last digit of style number indicates number of TAP(s).

Tip: For tech corridor, 14'L tables have four long doors and four short doors.

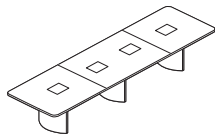
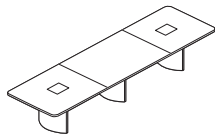
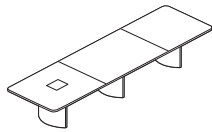
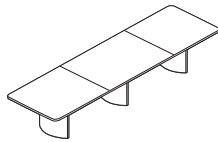

▶ Specification Information, continued from previous page

Specification Information

Style Number	Finish	U.S. Base Prices			
		Flat Wood Edge:	Bullnose Wood Edge:	Beveled Wood Edge, Tapered Wood Edge:	Horizon Wood Edge:

14'L x 48''W Three Piece Top

0 TAP

HS1448R30	Grade 1 Laminate	\$16,092	\$16,314	\$16,610	\$18,654
	Grade 2 and 3 Laminate	\$16,399	\$16,621	\$16,917	\$18,961
	Grade 1 Veneer	\$17,784	\$18,006	\$18,302	\$20,346
	Grade 2 Veneer	\$19,353	\$19,575	\$19,871	\$21,915

1 TAP X4/24

HS1448R31	Grade 1 Laminate	\$18,435	\$18,657	\$18,953	\$20,997
	Grade 2 and 3 Laminate	\$18,742	\$18,964	\$19,260	\$21,304
	Grade 1 Veneer	\$20,127	\$20,349	\$20,645	\$22,689
	Grade 2 Veneer	\$21,696	\$21,918	\$22,214	\$24,258

2 TAPS

HS1448R32	Grade 1 Laminate	\$20,778	\$21,000	\$21,296	\$23,340
	Grade 2 and 3 Laminate	\$21,085	\$21,307	\$21,603	\$23,647
	Grade 1 Veneer	\$22,470	\$22,692	\$22,988	\$25,032
	Grade 2 Veneer	\$24,039	\$24,261	\$24,557	\$26,601

4 TAPS

HS1448R34	Grade 1 Laminate	\$25,067	\$25,289	\$25,585	\$27,629
	Grade 2 and 3 Laminate	\$25,374	\$25,596	\$25,892	\$27,936
	Grade 1 Veneer	\$26,759	\$26,981	\$27,277	\$29,321
	Grade 2 Veneer	\$28,328	\$28,550	\$28,846	\$30,890

▶ Specification Information, continued on next page



For Canadian Pricing
 Multiply U.S. Price by the Canadian price factor.
 ▶ See page 1 for details.

X4/24 = Last order entry
 April 14, 2024

Host Collaborative and Conference Tables Rectangular Tables with Three Bases *continued*

DESIGN F/P DESIGN AND VECTA DESIGN TEAM

Tip: Prices shown include top, TAP(s), and slim bases.
 ▶ See base options for flared bases, page 368

Tip: Last digit of style number indicates number of TAP(s).

Tip: For tech corridor, 14'L tables have four long doors and four short doors.

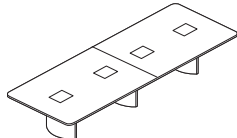
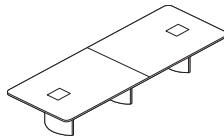
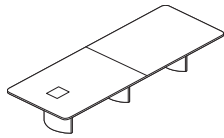
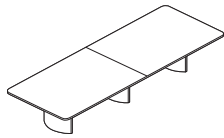

▶ Specification Information, continued from previous page

Specification Information

Style Number	Finish	U.S. Base Prices			
		Flat Wood Edge:	Bullnose Wood Edge:	Beveled Wood Edge, Tapered Wood Edge:	Horizon Wood Edge:

14'L x 60''W Two Piece Top

0 TAP

Style Number	Finish	Flat Wood Edge	Bullnose Wood Edge	Beveled Wood Edge, Tapered Wood Edge	Horizon Wood Edge
HS1460R20	Grade 1 Laminate	\$16,224	\$16,455	\$16,770	\$18,832
	Grade 2 and 3 Laminate	\$16,609	\$16,840	\$17,155	\$19,217
	Grade 1 Veneer	\$19,335	\$19,566	\$19,881	\$21,943
	Grade 2 Veneer	\$21,327	\$21,558	\$21,873	\$23,935

1 TAP X34/24

Style Number	Finish	Flat Wood Edge	Bullnose Wood Edge	Beveled Wood Edge, Tapered Wood Edge	Horizon Wood Edge
HS1460R21	Grade 1 Laminate	\$18,567	\$18,798	\$19,113	\$21,175
	Grade 2 and 3 Laminate	\$18,952	\$19,183	\$19,498	\$21,560
	Grade 1 Veneer	\$21,678	\$21,909	\$22,224	\$24,286
	Grade 2 Veneer	\$23,670	\$23,901	\$24,216	\$26,278

2 TAPS

Style Number	Finish	Flat Wood Edge	Bullnose Wood Edge	Beveled Wood Edge, Tapered Wood Edge	Horizon Wood Edge
HS1460R22	Grade 1 Laminate	\$20,906	\$21,137	\$21,452	\$23,514
	Grade 2 and 3 Laminate	\$21,291	\$21,522	\$21,837	\$23,899
	Grade 1 Veneer	\$24,017	\$24,248	\$24,563	\$26,625
	Grade 2 Veneer	\$26,009	\$26,240	\$26,555	\$28,617

4 TAPS

Style Number	Finish	Flat Wood Edge	Bullnose Wood Edge	Beveled Wood Edge, Tapered Wood Edge	Horizon Wood Edge
HS1460R24	Grade 1 Laminate	\$25,595	\$25,826	\$26,141	\$28,203
	Grade 2 and 3 Laminate	\$25,980	\$26,211	\$26,526	\$28,588
	Grade 1 Veneer	\$28,706	\$28,937	\$29,252	\$31,314
	Grade 2 Veneer	\$30,698	\$30,929	\$31,244	\$33,306

▶ Specification Information, continued on next page



For Canadian Pricing
 Multiply U.S. Price by the Canadian price factor.
 ▶ See page 1 for details.

X34/24 = Last order entry
 April 14, 2024

Host Collaborative and Conference Tables Rectangular Tables with Three Bases

DESIGN F/P DESIGN AND VECTA DESIGN TEAM

Tip: Prices shown include top, TAP(s), and slim bases.
 ▶ See base options for flared bases, page 368

Tip: Last digit of style number indicates number of TAP(s).

Tip: For tech corridor, tables have four long doors and four short doors.

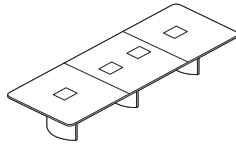
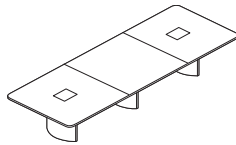
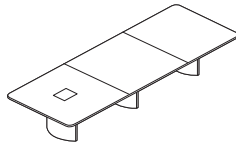
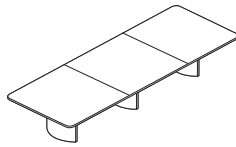

▶ Specification Information, continued from previous page

Specification Information

Style Number	Finish	U.S. Base Prices			
		Flat Wood Edge:	Bullnose Wood Edge:	Beveled Wood Edge, Tapered Wood Edge:	Horizon Wood Edge:

14'L x 60"W Three Piece Top

0 TAP

HS1460R30	Grade 1 Laminate	\$16,784	\$17,015	\$17,330	\$19,392
	Grade 2 and 3 Laminate	\$17,169	\$17,400	\$17,715	\$19,777
	Grade 1 Veneer	\$19,895	\$20,126	\$20,441	\$22,503
	Grade 2 Veneer	\$21,887	\$22,118	\$22,433	\$24,495

1 TAP X4/24

HS1460R31	Grade 1 Laminate	\$19,125	\$19,356	\$19,671	\$21,733
	Grade 2 and 3 Laminate	\$19,510	\$19,741	\$20,056	\$22,118
	Grade 1 Veneer	\$22,236	\$22,467	\$22,782	\$24,844
	Grade 2 Veneer	\$24,228	\$24,459	\$24,774	\$26,836

2 TAPS

HS1460R32	Grade 1 Laminate	\$21,470	\$21,701	\$22,016	\$24,078
	Grade 2 and 3 Laminate	\$21,855	\$22,086	\$22,401	\$24,463
	Grade 1 Veneer	\$24,581	\$24,812	\$25,127	\$27,189
	Grade 2 Veneer	\$26,573	\$26,804	\$27,119	\$29,181

4 TAPS

HS1460R34	Grade 1 Laminate	\$25,744	\$25,975	\$26,290	\$28,352
	Grade 2 and 3 Laminate	\$26,129	\$26,360	\$26,675	\$28,737
	Grade 1 Veneer	\$28,855	\$29,086	\$29,401	\$31,463
	Grade 2 Veneer	\$30,847	\$31,078	\$31,393	\$33,455

▶ Specification Information, continued on next page



For Canadian Pricing
 Multiply U.S. Price by the Canadian price factor.
 ▶ See page 1 for details.

X4/24 = Last order entry
 April 14, 2024

Host Collaborative and Conference Tables Rectangular Tables with Three Bases *continued*

DESIGN F/P DESIGN AND VECTA DESIGN TEAM

Tip: Prices shown include top, TAP(s), and slim bases.
 ▶ See base options for flared bases, page 368



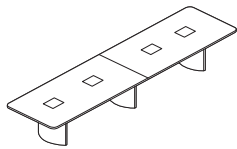
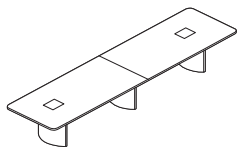
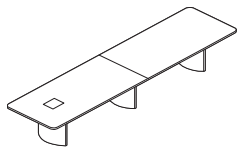
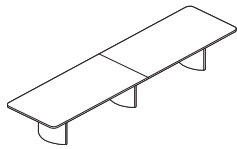

Tip: Last digit of style number indicates number of TAP(s).

Tip: For tech corridor, 16'L tables have eight long doors and four short doors.



▶ Specification Information, continued from previous page

Specification Information

Style Number	Finish	U.S. Base Prices			
					
		Flat Wood Edge:	Bullnose Wood Edge:	Beveled Wood Edge, Tapered Wood Edge:	Horizon Wood Edge:

16'L x 48''W Two Piece Top

0 TAP

HS1648R20	Grade 1 Laminate	\$16,168	\$16,407	\$16,744	\$18,823
	Grade 2 and 3 Laminate	\$16,519	\$16,758	\$17,095	\$19,174
	Grade 1 Veneer	\$17,851	\$18,090	\$18,427	\$20,506
	Grade 2 Veneer	\$19,644	\$19,883	\$20,220	\$22,299

1 TAP X34/24

HS1648R21	Grade 1 Laminate	\$18,511	\$18,750	\$19,087	\$21,166
	Grade 2 and 3 Laminate	\$18,862	\$19,101	\$19,438	\$21,517
	Grade 1 Veneer	\$20,194	\$20,433	\$20,770	\$22,849
	Grade 2 Veneer	\$21,987	\$22,226	\$22,563	\$24,642

2 TAPS

HS1648R22	Grade 1 Laminate	\$20,851	\$21,090	\$21,427	\$23,506
	Grade 2 and 3 Laminate	\$21,202	\$21,441	\$21,778	\$23,857
	Grade 1 Veneer	\$22,534	\$22,773	\$23,110	\$25,189
	Grade 2 Veneer	\$24,327	\$24,566	\$24,903	\$26,982

4 TAPS

HS1648R24	Grade 1 Laminate	\$25,534	\$25,773	\$26,110	\$28,189
	Grade 2 and 3 Laminate	\$25,885	\$26,124	\$26,461	\$28,540
	Grade 1 Veneer	\$27,217	\$27,456	\$27,793	\$29,872
	Grade 2 Veneer	\$29,010	\$29,249	\$29,586	\$31,665

▶ Specification Information, continued on next page



For Canadian Pricing
 Multiply U.S. Price by the Canadian price factor.
 ▶ See page 1 for details.

X34/24 = Last order entry
 April 14, 2024

Host Collaborative and Conference Tables Rectangular Tables with Three Bases

DESIGN F/P DESIGN AND VECTA DESIGN TEAM

Tip: Prices shown include top, TAP(s), and slim bases.
 ▶ See base options for flared bases, page 368



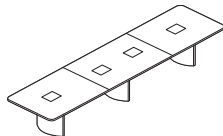
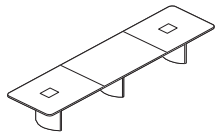
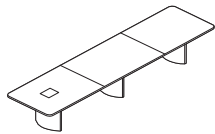
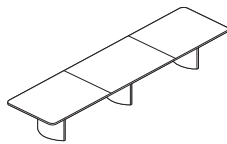

Tip: Last digit of style number indicates number of TAP(s).

Tip: For tech corridor, 16'L tables have eight long doors and four short doors.



▶ Specification Information, continued from previous page

Specification Information

Style Number	Finish	U.S. Base Prices			
					
		Flat Wood Edge:	Bullnose Wood Edge:	Beveled Wood Edge, Tapered Wood Edge:	Horizon Wood Edge:

16'L x 48''W Three Piece Top

0 TAP

HS1648R30	Grade 1 Laminate	\$16,730	\$16,969	\$17,306	\$19,385
	Grade 2 and 3 Laminate	\$17,081	\$17,320	\$17,657	\$19,736
	Grade 1 Veneer	\$18,413	\$18,652	\$18,989	\$21,068
	Grade 2 Veneer	\$20,206	\$20,445	\$20,782	\$22,861

1 TAP X4/24

HS1648R31	Grade 1 Laminate	\$19,072	\$19,311	\$19,648	\$21,727
	Grade 2 and 3 Laminate	\$19,423	\$19,662	\$19,999	\$22,078
	Grade 1 Veneer	\$20,755	\$20,994	\$21,331	\$23,410
	Grade 2 Veneer	\$22,548	\$22,787	\$23,124	\$25,203

2 TAPS

HS1648R32	Grade 1 Laminate	\$21,406	\$21,645	\$21,982	\$24,061
	Grade 2 and 3 Laminate	\$21,757	\$21,996	\$22,333	\$24,412
	Grade 1 Veneer	\$23,089	\$23,328	\$23,665	\$25,744
	Grade 2 Veneer	\$24,882	\$25,121	\$25,458	\$27,537

4 TAPS

HS1648R34	Grade 1 Laminate	\$26,094	\$26,333	\$26,670	\$28,749
	Grade 2 and 3 Laminate	\$26,445	\$26,684	\$27,021	\$29,100
	Grade 1 Veneer	\$27,777	\$28,016	\$28,353	\$30,432
	Grade 2 Veneer	\$29,570	\$29,809	\$30,146	\$32,225

▶ Specification Information, continued on next page



For Canadian Pricing
 Multiply U.S. Price by the Canadian price factor.
 ▶ See page 1 for details.

X4/24 = Last order entry
 April 14, 2024

Host Collaborative and Conference Tables Rectangular Tables with Three Bases *continued*

DESIGN F/P DESIGN AND VECTA DESIGN TEAM

Tip: Prices shown include top, TAP(s), and slim bases.
 ▶ See base options for flared bases, page 368

Tip: Last digit of style number indicates number of TAP(s).

Tip: For tech corridor, 16'L tables have eight long doors and four short doors.

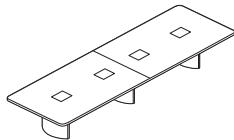
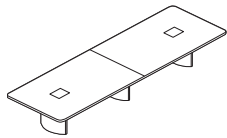
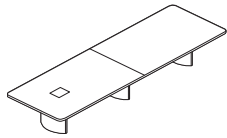
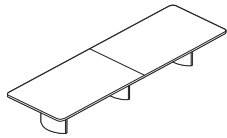

▶ Specification Information, continued from previous page

Specification Information

Style Number	Finish	U.S. Base Prices			
		Flat Wood Edge:	Bullnose Wood Edge:	Beveled Wood Edge, Tapered Wood Edge:	Horizon Wood Edge:

16'L x 60"W Two Piece Top

0 TAP

Style Number	Finish	Flat Wood Edge	Bullnose Wood Edge	Beveled Wood Edge, Tapered Wood Edge	Horizon Wood Edge
HS1660R20	Grade 1 Laminate	\$16,858	\$17,112	\$17,460	\$19,561
	Grade 2 and 3 Laminate	\$17,295	\$17,549	\$17,897	\$19,998
	Grade 1 Veneer	\$19,962	\$20,216	\$20,564	\$22,665
	Grade 2 Veneer	\$22,227	\$22,481	\$22,829	\$24,930

1 TAP X4/24

Style Number	Finish	Flat Wood Edge	Bullnose Wood Edge	Beveled Wood Edge, Tapered Wood Edge	Horizon Wood Edge
HS1660R21	Grade 1 Laminate	\$19,201	\$19,455	\$19,803	\$21,904
	Grade 2 and 3 Laminate	\$19,638	\$19,892	\$20,240	\$22,341
	Grade 1 Veneer	\$22,305	\$22,559	\$22,907	\$25,008
	Grade 2 Veneer	\$24,570	\$24,824	\$25,172	\$27,273

2 TAPS

Style Number	Finish	Flat Wood Edge	Bullnose Wood Edge	Beveled Wood Edge, Tapered Wood Edge	Horizon Wood Edge
HS1660R22	Grade 1 Laminate	\$21,544	\$21,798	\$22,146	\$24,247
	Grade 2 and 3 Laminate	\$21,981	\$22,235	\$22,583	\$24,684
	Grade 1 Veneer	\$24,648	\$24,902	\$25,250	\$27,351
	Grade 2 Veneer	\$26,913	\$27,167	\$27,515	\$29,616

4 TAPS

Style Number	Finish	Flat Wood Edge	Bullnose Wood Edge	Beveled Wood Edge, Tapered Wood Edge	Horizon Wood Edge
HS1660R24	Grade 1 Laminate	\$26,225	\$26,479	\$26,827	\$28,928
	Grade 2 and 3 Laminate	\$26,662	\$26,916	\$27,264	\$29,365
	Grade 1 Veneer	\$29,329	\$29,583	\$29,931	\$32,032
	Grade 2 Veneer	\$31,594	\$31,848	\$32,196	\$34,297

▶ Specification Information, continued on next page



For Canadian Pricing
 Multiply U.S. Price by the Canadian price factor.
 ▶ See page 1 for details.

X4/24 = Last order entry
 April 14, 2024

Host Collaborative and Conference Tables Rectangular Tables with Three Bases

DESIGN F/P DESIGN AND VECTA DESIGN TEAM

Tip: Prices shown include top, TAP(s), and slim bases.
 ▶ See base options for flared bases, page 368

Tip: Last digit of style number indicates number of TAP(s).

Tip: For tech corridor, 16'L tables have eight long doors and four short doors.

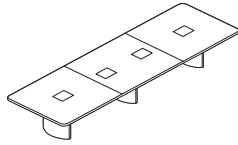
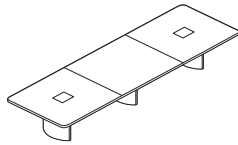
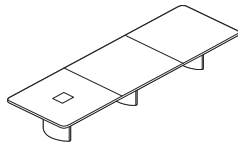
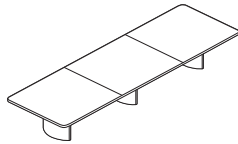

▶ Specification Information, continued from previous page

Specification Information

Style Number	Finish	U.S. Base Prices			
		Flat Wood Edge:	Bullnose Wood Edge:	Beveled Wood Edge, Tapered Wood Edge:	Horizon Wood Edge:

16'L x 60"W Three Piece Top

0 TAP					
HS1660R30	Grade 1 Laminate	\$17,420	\$17,674	\$18,022	\$20,123
	Grade 2 and 3 Laminate	\$17,857	\$18,111	\$18,459	\$20,560
	Grade 1 Veneer	\$20,524	\$20,778	\$21,126	\$23,227
	Grade 2 Veneer	\$22,789	\$23,043	\$23,391	\$25,492
1 TAP X4/24					
HS1660R31	Grade 1 Laminate	\$19,761	\$20,015	\$20,363	\$22,464
	Grade 2 and 3 Laminate	\$20,198	\$20,452	\$20,800	\$22,901
	Grade 1 Veneer	\$22,865	\$23,119	\$23,467	\$25,568
	Grade 2 Veneer	\$25,130	\$25,384	\$25,732	\$27,833
2 TAPS					
HS1660R32	Grade 1 Laminate	\$22,104	\$22,358	\$22,706	\$24,807
	Grade 2 and 3 Laminate	\$22,541	\$22,795	\$23,143	\$25,244
	Grade 1 Veneer	\$25,208	\$25,462	\$25,810	\$27,911
	Grade 2 Veneer	\$27,473	\$27,727	\$28,075	\$30,176
4 TAPS					
HS1660R34	Grade 1 Laminate	\$26,784	\$27,038	\$27,386	\$29,487
	Grade 2 and 3 Laminate	\$27,221	\$27,475	\$27,823	\$29,924
	Grade 1 Veneer	\$29,888	\$30,142	\$30,490	\$32,591
	Grade 2 Veneer	\$32,153	\$32,407	\$32,755	\$34,856

▶ Specification Information, continued on next page

For Canadian Pricing
 Multiply U.S. Price by the Canadian price factor.
 ▶ See page 1 for details.

X4/24 = Last order entry
 April 14, 2024

Host Collaborative and Conference Tables Rectangular Tables with Three Bases *continued*

DESIGN F/P DESIGN AND VECTA DESIGN TEAM





Tip: Prices shown include top, TAP(s), and slim bases.
 ▶ See base options for flared bases, page 368

Tip: Last digit of style number indicates number of TAP(s).

Tip: For tech corridor, 18'L tables have eight long doors and four short doors.

▶ Specification Information, continued from previous page

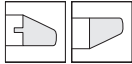
Specification Information

Style Number	Finish	U.S. Base Prices			
					
		Flat Wood Edge:	Bullnose Wood Edge:	Beveled Wood Edge, Tapered Wood Edge:	Horizon Wood Edge:

18'L x 48"W Two Piece Top

0 TAP

HS1848R20	Grade 1 Laminate	\$17,172	\$17,435	\$17,799	\$19,923
	Grade 2 and 3 Laminate	\$17,568	\$17,831	\$18,195	\$20,319
	Grade 1 Veneer	\$19,324	\$19,587	\$19,951	\$22,075
	Grade 2 Veneer	\$21,338	\$21,601	\$21,965	\$24,089

1 TAP X34/24

HS1848R21	Grade 1 Laminate	\$19,513	\$19,776	\$20,140	\$22,264
	Grade 2 and 3 Laminate	\$19,909	\$20,172	\$20,536	\$22,660
	Grade 1 Veneer	\$21,665	\$21,928	\$22,292	\$24,416
	Grade 2 Veneer	\$23,679	\$23,942	\$24,306	\$26,430

2 TAPS

HS1848R22	Grade 1 Laminate	\$21,857	\$22,120	\$22,484	\$24,608
	Grade 2 and 3 Laminate	\$22,253	\$22,516	\$22,880	\$25,004
	Grade 1 Veneer	\$24,009	\$24,272	\$24,636	\$26,760
	Grade 2 Veneer	\$26,023	\$26,286	\$26,650	\$28,774

4 TAPS

HS1848R24	Grade 1 Laminate	\$26,539	\$26,802	\$27,166	\$29,290
	Grade 2 and 3 Laminate	\$26,935	\$27,198	\$27,562	\$29,686
	Grade 1 Veneer	\$28,691	\$28,954	\$29,318	\$31,442
	Grade 2 Veneer	\$30,705	\$30,968	\$31,332	\$33,456

6 TAPS

HS1848R26	Grade 1 Laminate	\$31,224	\$31,487	\$31,851	\$33,975
	Grade 2 and 3 Laminate	\$31,620	\$31,883	\$32,247	\$34,371
	Grade 1 Veneer	\$33,376	\$33,639	\$34,003	\$36,127
	Grade 2 Veneer	\$35,390	\$35,653	\$36,017	\$38,141

▶ Specification Information, continued on next page

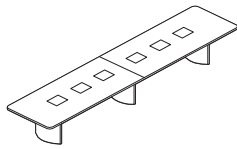
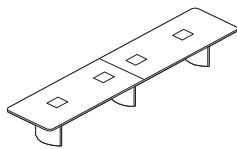
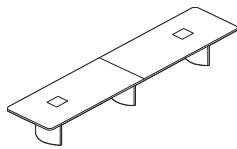
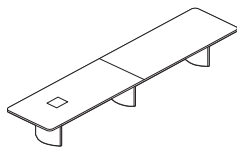
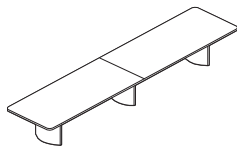

For Canadian Pricing
 Multiply U.S. Price by the Canadian price factor.
 ▶ See page 1 for details.

X34/24 = Last order entry
 April 14, 2024

Host Collaborative and Conference Tables

Rectangular Tables with Three Bases

DESIGN F/P DESIGN AND VECTA DESIGN TEAM





Tip: Prices shown include top, TAP(s), and slim bases.
 ▶ See base options for flared bases, page 368

Tip: Last digit of style number indicates number of TAP(s).

Tip: For tech corridor, 18'L tables have eight long doors and four short doors.

▶ Specification Information, continued from previous page

Specification Information

Style Number	Finish	U.S. Base Prices			
					
		Flat Wood Edge:	Bullnose Wood Edge:	Beveled Wood Edge, Tapered Wood Edge:	Horizon Wood Edge:

18'L x 48"W Three Piece Top

0 TAP

HS1848R30	Grade 1 Laminate	\$17,736	\$17,999	\$18,363	\$20,487
	Grade 2 and 3 Laminate	\$18,132	\$18,395	\$18,759	\$20,883
	Grade 1 Veneer	\$19,888	\$20,151	\$20,515	\$22,639
	Grade 2 Veneer	\$21,902	\$22,165	\$22,529	\$24,653

1 TAP X4/24

HS1848R31	Grade 1 Laminate	\$20,074	\$20,337	\$20,701	\$22,825
	Grade 2 and 3 Laminate	\$20,470	\$20,733	\$21,097	\$23,221
	Grade 1 Veneer	\$22,226	\$22,489	\$22,853	\$24,977
	Grade 2 Veneer	\$24,240	\$24,503	\$24,867	\$26,991

2 TAPS

HS1848R32	Grade 1 Laminate	\$22,416	\$22,679	\$23,043	\$25,167
	Grade 2 and 3 Laminate	\$22,812	\$23,075	\$23,439	\$25,563
	Grade 1 Veneer	\$24,568	\$24,831	\$25,195	\$27,319
	Grade 2 Veneer	\$26,582	\$26,845	\$27,209	\$29,333

4 TAPS

HS1848R34	Grade 1 Laminate	\$27,099	\$27,362	\$27,726	\$29,850
	Grade 2 and 3 Laminate	\$27,495	\$27,758	\$28,122	\$30,246
	Grade 1 Veneer	\$29,251	\$29,514	\$29,878	\$32,002
	Grade 2 Veneer	\$31,265	\$31,528	\$31,892	\$34,016

6 TAPS

HS1848R36	Grade 1 Laminate	\$31,785	\$32,048	\$32,412	\$34,536
	Grade 2 and 3 Laminate	\$32,181	\$32,444	\$32,808	\$34,932
	Grade 1 Veneer	\$33,937	\$34,200	\$34,564	\$36,688
	Grade 2 Veneer	\$35,951	\$36,214	\$36,578	\$38,702

▶ Specification Information, continued on next page

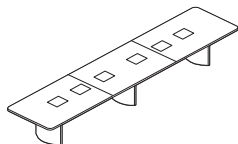
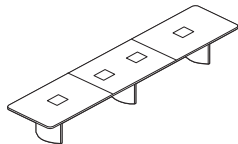
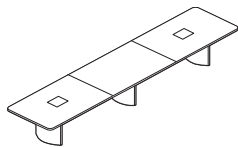
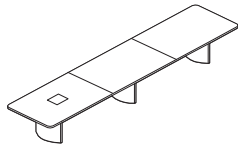
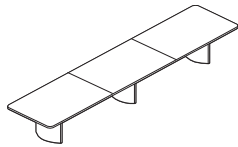

For Canadian Pricing
 Multiply U.S. Price by the Canadian price factor.
 ▶ See page 1 for details.

X4/24 = Last order entry
 April 14, 2024

Host Collaborative and Conference Tables Rectangular Tables with Three Bases *continued*

DESIGN F/P DESIGN AND VECTA DESIGN TEAM

Tip: Prices shown include top, TAP(s), and slim bases.
 ▶ See base options for flared bases, page 368

Tip: Last digit of style number indicates number of TAP(s).

Tip: For tech corridor, 18'L tables have eight long doors and four short doors.

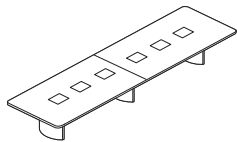
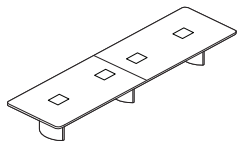
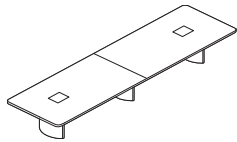
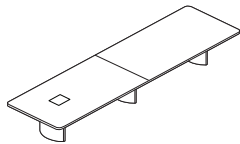
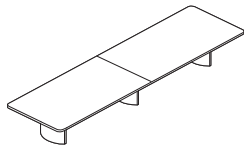

▶ Specification Information, continued from previous page

Specification Information

Style Number	Finish	U.S. Base Prices			
		Flat Wood Edge:	Bullnose Wood Edge:	Beveled Wood Edge, Tapered Wood Edge:	Horizon Wood Edge:

18'L x 60"W Two Piece Top

0 TAP

Style Number	Finish	Flat Wood Edge	Bullnose Wood Edge	Beveled Wood Edge, Tapered Wood Edge	Horizon Wood Edge
HS1860R20	Grade 1 Laminate	\$17,542	\$17,817	\$18,201	\$20,341
	Grade 2 and 3 Laminate	\$18,035	\$18,310	\$18,694	\$20,834
	Grade 1 Veneer	\$21,693	\$21,968	\$22,352	\$24,492
	Grade 2 Veneer	\$24,263	\$24,538	\$24,922	\$27,062

1 TAP X3/24

Style Number	Finish	Flat Wood Edge	Bullnose Wood Edge	Beveled Wood Edge, Tapered Wood Edge	Horizon Wood Edge
HS1860R21	Grade 1 Laminate	\$19,884	\$20,159	\$20,543	\$22,683
	Grade 2 and 3 Laminate	\$20,377	\$20,652	\$21,036	\$23,176
	Grade 1 Veneer	\$24,035	\$24,310	\$24,694	\$26,834
	Grade 2 Veneer	\$26,605	\$26,880	\$27,264	\$29,404

2 TAPS

Style Number	Finish	Flat Wood Edge	Bullnose Wood Edge	Beveled Wood Edge, Tapered Wood Edge	Horizon Wood Edge
HS1860R22	Grade 1 Laminate	\$22,230	\$22,505	\$22,889	\$25,029
	Grade 2 and 3 Laminate	\$22,723	\$22,998	\$23,382	\$25,522
	Grade 1 Veneer	\$26,381	\$26,656	\$27,040	\$29,180
	Grade 2 Veneer	\$28,951	\$29,226	\$29,610	\$31,750

4 TAPS

Style Number	Finish	Flat Wood Edge	Bullnose Wood Edge	Beveled Wood Edge, Tapered Wood Edge	Horizon Wood Edge
HS1860R24	Grade 1 Laminate	\$26,910	\$27,185	\$27,569	\$29,709
	Grade 2 and 3 Laminate	\$27,403	\$27,678	\$28,062	\$30,202
	Grade 1 Veneer	\$31,061	\$31,336	\$31,720	\$33,860
	Grade 2 Veneer	\$33,631	\$33,906	\$34,290	\$36,430

6 TAPS

Style Number	Finish	Flat Wood Edge	Bullnose Wood Edge	Beveled Wood Edge, Tapered Wood Edge	Horizon Wood Edge
HS1860R26	Grade 1 Laminate	\$31,594	\$31,869	\$32,253	\$34,393
	Grade 2 and 3 Laminate	\$32,087	\$32,362	\$32,746	\$34,886
	Grade 1 Veneer	\$35,745	\$36,020	\$36,404	\$38,544
	Grade 2 Veneer	\$38,315	\$38,590	\$38,974	\$41,114

▶ Specification Information, continued on next page

For Canadian Pricing
 Multiply U.S. Price by the Canadian price factor.
 ▶ See page 1 for details.

X3/24 = Last order entry
 April 14, 2024

Host Collaborative and Conference Tables Rectangular Tables with Three Bases

DESIGN F/P DESIGN AND VECTA DESIGN TEAM

Tip: Prices shown include top, TAP(s), and slim bases.
 ▶ See base options for flared bases, page 368

Tip: Last digit of style number indicates number of TAP(s).

Tip: For tech corridor, 18'L tables have eight long doors and four short doors.

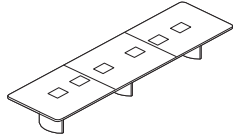
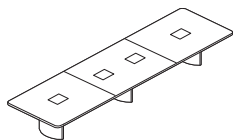
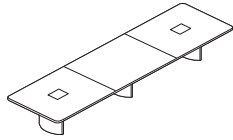
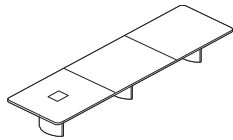
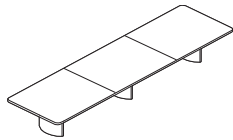

▶ Specification Information, continued from previous page

Specification Information

Style Number	Finish	U.S. Base Prices			
		Flat Wood Edge:	Bullnose Wood Edge:	Beveled Wood Edge, Tapered Wood Edge:	Horizon Wood Edge:

18'L x 60"W Three Piece Top

0 TAP

HS1860R30	Finish	Flat Wood Edge	Bullnose Wood Edge	Beveled Wood Edge, Tapered Wood Edge	Horizon Wood Edge
	Grade 1 Laminate	\$18,105	\$18,380	\$18,764	\$20,904
	Grade 2 and 3 Laminate	\$18,598	\$18,873	\$19,257	\$21,397
	Grade 1 Veneer	\$22,256	\$22,531	\$22,915	\$25,055
	Grade 2 Veneer	\$24,826	\$25,101	\$25,485	\$27,625

1 TAP X4/24

HS1860R31	Finish	Flat Wood Edge	Bullnose Wood Edge	Beveled Wood Edge, Tapered Wood Edge	Horizon Wood Edge
	Grade 1 Laminate	\$20,449	\$20,724	\$21,108	\$23,248
	Grade 2 and 3 Laminate	\$20,942	\$21,217	\$21,601	\$23,741
	Grade 1 Veneer	\$24,600	\$24,875	\$25,259	\$27,399
	Grade 2 Veneer	\$27,170	\$27,445	\$27,829	\$29,969

2 TAPs

HS1860R32	Finish	Flat Wood Edge	Bullnose Wood Edge	Beveled Wood Edge, Tapered Wood Edge	Horizon Wood Edge
	Grade 1 Laminate	\$22,789	\$23,064	\$23,448	\$25,588
	Grade 2 and 3 Laminate	\$23,282	\$23,557	\$23,941	\$26,081
	Grade 1 Veneer	\$26,940	\$27,215	\$27,599	\$29,739
	Grade 2 Veneer	\$29,510	\$29,785	\$30,169	\$32,309

4 TAPs

HS1860R34	Finish	Flat Wood Edge	Bullnose Wood Edge	Beveled Wood Edge, Tapered Wood Edge	Horizon Wood Edge
	Grade 1 Laminate	\$27,473	\$27,748	\$28,132	\$30,272
	Grade 2 and 3 Laminate	\$27,966	\$28,241	\$28,625	\$30,765
	Grade 1 Veneer	\$31,624	\$31,899	\$32,283	\$34,423
	Grade 2 Veneer	\$34,194	\$34,469	\$34,853	\$36,993

6 TAPs

HS1860R36	Finish	Flat Wood Edge	Bullnose Wood Edge	Beveled Wood Edge, Tapered Wood Edge	Horizon Wood Edge
	Grade 1 Laminate	\$32,155	\$32,430	\$32,814	\$34,954
	Grade 2 and 3 Laminate	\$32,648	\$32,923	\$33,307	\$35,447
	Grade 1 Veneer	\$36,306	\$36,581	\$36,965	\$39,105
	Grade 2 Veneer	\$38,876	\$39,151	\$39,535	\$41,675

▶ Specification Information, continued on next page

Host Collaborative and Conference Tables

For Canadian Pricing
 Multiply U.S. Price by the Canadian price factor.
 ▶ See page 1 for details.

X4/24 = Last order entry
 April 14, 2024

Host Collaborative and Conference Tables Rectangular Tables with Three Bases *continued*

DESIGN F/P DESIGN AND VECTA DESIGN TEAM





► Specification Information, continued from previous page

Tip: Prices shown include top, TAP(s), and slim bases.
 ► See base options for flared bases, page 368

Tip: Last digit of style number indicates number of TAP(s).

Tip: For tech corridor, 20'L tables have eight long doors and four short doors.

Specification Information

Style Number	Finish	U.S. Base Prices			
					
		Flat Wood Edge:	Bullnose Wood Edge:	Beveled Wood Edge, Tapered Wood Edge:	Horizon Wood Edge:

20'L x 48"W Two Piece Top

0 TAP

HS2048R20	Grade 1 Laminate	\$17,807	\$18,095	\$18,494	\$20,656
	Grade 2 and 3 Laminate	\$18,244	\$18,532	\$18,931	\$21,093
	Grade 1 Veneer	\$19,954	\$20,242	\$20,641	\$22,803
	Grade 2 Veneer	\$22,190	\$22,478	\$22,877	\$25,039

1 TAP X34/24

HS2048R21	Grade 1 Laminate	\$20,150	\$20,438	\$20,837	\$22,999
	Grade 2 and 3 Laminate	\$20,587	\$20,875	\$21,274	\$23,436
	Grade 1 Veneer	\$22,297	\$22,585	\$22,984	\$25,146
	Grade 2 Veneer	\$24,533	\$24,821	\$25,220	\$27,382

2 TAPS

HS2048R22	Grade 1 Laminate	\$22,489	\$22,777	\$23,176	\$25,338
	Grade 2 and 3 Laminate	\$22,926	\$23,214	\$23,613	\$25,775
	Grade 1 Veneer	\$24,636	\$24,924	\$25,323	\$27,485
	Grade 2 Veneer	\$26,872	\$27,160	\$27,559	\$29,721

4 TAPS

HS2048R24	Grade 1 Laminate	\$27,178	\$27,466	\$27,865	\$30,027
	Grade 2 and 3 Laminate	\$27,615	\$27,903	\$28,302	\$30,464
	Grade 1 Veneer	\$29,325	\$29,613	\$30,012	\$32,174
	Grade 2 Veneer	\$31,561	\$31,849	\$32,248	\$34,410

6 TAPS

HS2048R26	Grade 1 Laminate	\$31,859	\$32,147	\$32,546	\$34,708
	Grade 2 and 3 Laminate	\$32,296	\$32,584	\$32,983	\$35,145
	Grade 1 Veneer	\$34,006	\$34,294	\$34,693	\$36,855
	Grade 2 Veneer	\$36,242	\$36,530	\$36,929	\$39,091

► Specification Information, continued on next page

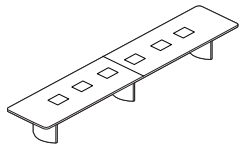
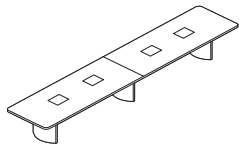
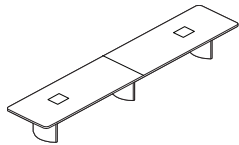
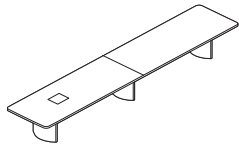
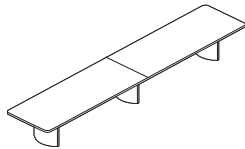

For Canadian Pricing
 Multiply U.S. Price by the Canadian price factor.
 ► See page 1 for details.

X34/24 = Last order entry
 April 14, 2024

Host Collaborative and Conference Tables Rectangular Tables with Three Bases

DESIGN F/P DESIGN AND VECTA DESIGN TEAM

Tip: Prices shown include top, TAP(s), and slim bases.
 ▶ See base options for flared bases, page 368

Tip: Last digit of style number indicates number of TAP(s).

Tip: For tech corridor, 20'L tables have eight long doors and four short doors.

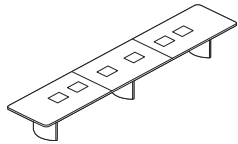
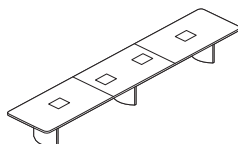
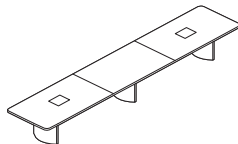
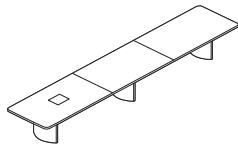
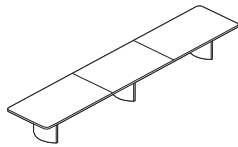

▶ Specification Information, continued from previous page

Specification Information

Style Number	Finish	U.S. Base Prices			
		Flat Wood Edge:	Bullnose Wood Edge:	Beveled Wood Edge, Tapered Wood Edge:	Horizon Wood Edge:

20'L x 48''W Three Piece Top

0 TAP					
HS2048R30	Grade 1 Laminate	\$18,365	\$18,653	\$19,052	\$21,214
	Grade 2 and 3 Laminate	\$18,802	\$19,090	\$19,489	\$21,651
	Grade 1 Veneer	\$20,512	\$20,800	\$21,199	\$23,361
	Grade 2 Veneer	\$22,748	\$23,036	\$23,435	\$25,597
1 TAP X4/24					
HS2048R31	Grade 1 Laminate	\$20,709	\$20,997	\$21,396	\$23,558
	Grade 2 and 3 Laminate	\$21,146	\$21,434	\$21,833	\$23,995
	Grade 1 Veneer	\$22,856	\$23,144	\$23,543	\$25,705
	Grade 2 Veneer	\$25,092	\$25,380	\$25,779	\$27,941
2 TAPS					
HS2048R32	Grade 1 Laminate	\$23,052	\$23,340	\$23,739	\$25,901
	Grade 2 and 3 Laminate	\$23,489	\$23,777	\$24,176	\$26,338
	Grade 1 Veneer	\$25,199	\$25,487	\$25,886	\$28,048
	Grade 2 Veneer	\$27,435	\$27,723	\$28,122	\$30,284
4 TAPS					
HS2048R34	Grade 1 Laminate	\$27,736	\$28,024	\$28,423	\$30,585
	Grade 2 and 3 Laminate	\$28,173	\$28,461	\$28,860	\$31,022
	Grade 1 Veneer	\$29,883	\$30,171	\$30,570	\$32,732
	Grade 2 Veneer	\$32,119	\$32,407	\$32,806	\$34,968
6 TAPS					
HS2048R36	Grade 1 Laminate	\$32,420	\$32,708	\$33,107	\$35,269
	Grade 2 and 3 Laminate	\$32,857	\$33,145	\$33,544	\$35,706
	Grade 1 Veneer	\$34,567	\$34,855	\$35,254	\$37,416
	Grade 2 Veneer	\$36,803	\$37,091	\$37,490	\$39,652

▶ Specification Information, continued on next page

Host Collaborative and Conference Tables

For Canadian Pricing
 Multiply U.S. Price by the Canadian price factor.
 ▶ See page 1 for details.

X4/24 = Last order entry
 April 14, 2024

Host Collaborative and Conference Tables Rectangular Tables with Three Bases *continued*

DESIGN F/P DESIGN AND VECTA DESIGN TEAM





Tip: Prices shown include top, TAP(s), and slim bases.
 ▶ See base options for flared bases, page 368

Tip: Last digit of style number indicates number of TAP(s).

Tip: For tech corridor, 20'L tables have eight long doors and four short doors.

▶ Specification Information, continued from previous page

Specification Information

Style Number	Finish	U.S. Base Prices			
					
		Flat Wood Edge:	Bullnose Wood Edge:	Beveled Wood Edge, Tapered Wood Edge:	Horizon Wood Edge:

20'L x 60"W Two Piece Top

0 TAP

HS2060R20	Grade 1 Laminate	\$18,179	\$18,480	\$18,896	\$21,071
	Grade 2 and 3 Laminate	\$18,725	\$19,026	\$19,442	\$21,617
	Grade 1 Veneer	\$22,325	\$22,626	\$23,042	\$25,217
	Grade 2 Veneer	\$25,164	\$25,465	\$25,881	\$28,056

1 TAP X34/24

HS2060R21	Grade 1 Laminate	\$20,520	\$20,821	\$21,237	\$23,412
	Grade 2 and 3 Laminate	\$21,066	\$21,367	\$21,783	\$23,958
	Grade 1 Veneer	\$24,666	\$24,967	\$25,383	\$27,558
	Grade 2 Veneer	\$27,505	\$27,806	\$28,222	\$30,397

2 TAPS

HS2060R22	Grade 1 Laminate	\$22,860	\$23,161	\$23,577	\$25,752
	Grade 2 and 3 Laminate	\$23,406	\$23,707	\$24,123	\$26,298
	Grade 1 Veneer	\$27,006	\$27,307	\$27,723	\$29,898
	Grade 2 Veneer	\$29,845	\$30,146	\$30,562	\$32,737

4 TAPS

HS2060R24	Grade 1 Laminate	\$27,545	\$27,846	\$28,262	\$30,437
	Grade 2 and 3 Laminate	\$28,091	\$28,392	\$28,808	\$30,983
	Grade 1 Veneer	\$31,691	\$31,992	\$32,408	\$34,583
	Grade 2 Veneer	\$34,530	\$34,831	\$35,247	\$37,422

6 TAPS

HS2060R26	Grade 1 Laminate	\$32,228	\$32,529	\$32,945	\$35,120
	Grade 2 and 3 Laminate	\$32,774	\$33,075	\$33,491	\$35,666
	Grade 1 Veneer	\$36,374	\$36,675	\$37,091	\$39,266
	Grade 2 Veneer	\$39,213	\$39,514	\$39,930	\$42,105

▶ Specification Information, continued on next page

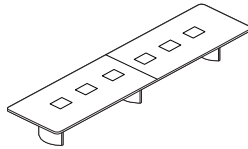
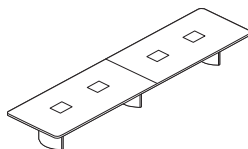
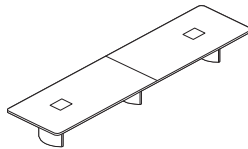
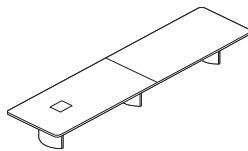
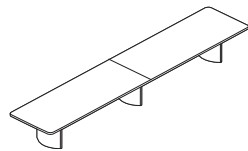

For Canadian Pricing
 Multiply U.S. Price by the Canadian price factor.
 ▶ See page 1 for details.

X34/24 = Last order entry
 April 14, 2024

Host Collaborative and Conference Tables Rectangular Tables with Three Bases

DESIGN F/P DESIGN AND VECTA DESIGN TEAM





► Specification Information, continued from previous page

Tip: Prices shown include top, TAP(s), and slim bases.
 ► See base options for flared bases, page 368

Tip: Last digit of style number indicates number of TAP(s).

Tip: For tech corridor, 20'L tables have eight long doors and four short doors.

Specification Information

Style Number	Finish	U.S. Base Prices			
					
		Flat Wood Edge:	Bullnose Wood Edge:	Beveled Wood Edge, Tapered Wood Edge:	Horizon Wood Edge:

20'L x 60"W Three Piece Top

0 TAP

HS2060R30	Grade 1 Laminate	\$18,737	\$19,038	\$19,454	\$21,629
	Grade 2 and 3 Laminate	\$19,283	\$19,584	\$20,000	\$22,175
	Grade 1 Veneer	\$22,883	\$23,184	\$23,600	\$25,775
	Grade 2 Veneer	\$25,722	\$26,023	\$26,439	\$28,614

1 TAP X4/24

HS2060R31	Grade 1 Laminate	\$21,080	\$21,381	\$21,797	\$23,972
	Grade 2 and 3 Laminate	\$21,626	\$21,927	\$22,343	\$24,518
	Grade 1 Veneer	\$25,226	\$25,527	\$25,943	\$28,118
	Grade 2 Veneer	\$28,065	\$28,366	\$28,782	\$30,957

2 TAPS

HS2060R32	Grade 1 Laminate	\$23,423	\$23,724	\$24,140	\$26,315
	Grade 2 and 3 Laminate	\$23,969	\$24,270	\$24,686	\$26,861
	Grade 1 Veneer	\$27,569	\$27,870	\$28,286	\$30,461
	Grade 2 Veneer	\$30,408	\$30,709	\$31,125	\$33,300

4 TAPS

HS2060R34	Grade 1 Laminate	\$28,106	\$28,407	\$28,823	\$30,998
	Grade 2 and 3 Laminate	\$28,652	\$28,953	\$29,369	\$31,544
	Grade 1 Veneer	\$32,252	\$32,553	\$32,969	\$35,144
	Grade 2 Veneer	\$35,091	\$35,392	\$35,808	\$37,983

6 TAPS

HS2060R36	Grade 1 Laminate	\$32,790	\$33,091	\$33,507	\$35,682
	Grade 2 and 3 Laminate	\$33,336	\$33,637	\$34,053	\$36,228
	Grade 1 Veneer	\$36,936	\$37,237	\$37,653	\$39,828
	Grade 2 Veneer	\$39,775	\$40,076	\$40,492	\$42,667

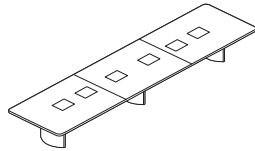
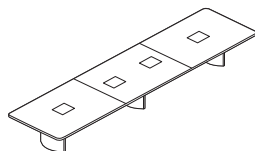
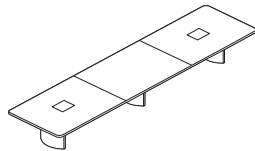
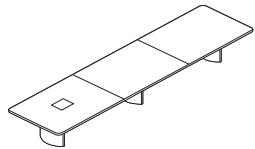
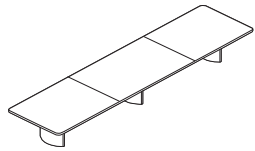

 **For Canadian Pricing**
 Multiply U.S. Price by the Canadian price factor.
 ► See page 1 for details.

X4/24 = Last order entry
 April 14, 2024

Host Collaborative and Conference Tables Soft Radiused Tables with Two Bases **X4/24**

DESIGN F/P DESIGN AND VECTA DESIGN TEAM

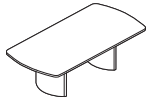

Tip: Shipped knocked down and top ships in one piece.

Tip: Grain direction for wood-grain laminate runs the length of the table.

Tip: Clips are provided with table: One clip per foot of table length.

Tip: The wood edge on a table top with woodgrain laminate may not match the top.

Tip: 96"L tables available with zero, one, or two TAP(s). 10'L and 12'L tables available with zero, one, two, or three TAP(s).

Tip: In addition to the data and audio/video AAPs available from Coalesse, other styles of AAPs are available through Extron Electronics. For an Extron dealer, call 1-800-633-9876.

Tip: See TAP options for electrical systems and faceplate list.

Standard Includes	Required to Specify
-------------------	---------------------

<p>► Need help? Product details, page 334</p> <ul style="list-style-type: none"> • Top: 1¼" particle board core with laminate • Flat wood edge • TAP(s), if selected: 10"W x 12"L opening(s) trimmed with a flat solid wood profile and with brushed anodized aluminum TAP doors • Tech corridor: two aluminum beams for top support provide tracks for hinged aluminum doors that clip shut: satin anodized finish • Universal clip: black plastic • Two 27"W bases: wood veneer on MDF with aluminum universal bracket • Concealed leveling glides: non-marring, black plastic 	<ol style="list-style-type: none"> 1 Style number 2 Base selection (see below) and wood color number for base 3 Laminate color number for table top, if selected 4 Wood color number for wood edge 5 Door color number for storage tray or TAP door, if selected: <ul style="list-style-type: none"> - 8044 Black - 8047 Silver 6 Options, if selected (see below) <p>► See <i>Coalesse Surface Materials Reference Guide</i>.</p>
---	---

Options	U.S. Price	Required to Specify
---------	------------	---------------------

<p>Surface Materials</p> <ul style="list-style-type: none"> • Grade 2 laminate • Grade 3 laminate • Grade 1 wood veneer • Grade 2 wood veneer 	<p>Top</p> <p>Prices at right</p> <p>Prices at right</p> <p>Prices at right</p> <p>Prices at right</p>	<p>Specify with <i>Grade 2 laminate</i> and select color number.</p> <p>Specify with <i>Grade 3 laminate</i> and select color number.</p> <p>Specify with <i>Grade 1 wood veneer</i> and select color number.</p> <p>Specify with <i>Grade 2 wood veneer</i> and select color number.</p>
<p>Edges</p>	<p>Wood</p> <ul style="list-style-type: none"> • Bullnose wood edge • Horizon wood edge <p>Prices at right</p> <p>Prices at right</p>	<p>Specify with <i>bullnose wood edge</i>.</p> <p>Specify with <i>horizon wood edge</i>.</p>
<p>Bases</p> <p>Slim Flared</p>	<ul style="list-style-type: none"> • Two slim bases • One slim and one flared base • Two flared bases <p>No cost</p> <p>+\$1219</p> <p>+\$2441</p>	<p>Specify with <i>two slim bases</i>.</p> <p>Specify with <i>one slim base and one flared base</i>.</p> <p>Specify with <i>two flared bases</i>.</p>

TAP Electrical System with Faceplate Options	U.S. Price	Required to Specify
--	------------	---------------------

<p>► Page 345</p> <p>Field Wired</p>	<ul style="list-style-type: none"> • Field-wired tray (no electrical) <ul style="list-style-type: none"> - PAFW field-wired tray (no electrical) with blank AAPs - PDFW field-wired tray (no electrical) with two data AAPs - PVFW field-wired tray (no electrical) with two of each video/audio and data AAPs <p>No cost</p>	<p>Specify with <i>power data</i>, and select TAP type and TAP door color number.</p>
<p>Cord and Plug</p>	<ul style="list-style-type: none"> • Cord and plug tray (10' cord) <ul style="list-style-type: none"> - PACP cord and plug tray with outlets and blank AAPs - PDCP cord and plug tray with outlets and two data AAPs - PAVC cord and plug tray with outlets and two of each video/audio and data AAPs <p>No cost</p>	<p>Specify with <i>power data</i>, and select TAP type and TAP door color number.</p>
<p>Cord and Plug</p>	<ul style="list-style-type: none"> • Hard-wired tray (6' conduit) <ul style="list-style-type: none"> - PAHW hard-wired tray with outlets and blank AAPs - PDHW hard-wired tray with outlets and two data AAPs - PAVH hard-wired tray with outlets and two of each video/audio and data AAPs <p>No cost</p>	<p>Specify with <i>power data</i>, and select TAP type and TAP door color number.</p>

► Options, continued on next page

For Canadian Pricing
 Multiply U.S. Price by the Canadian price factor.
 ► See page 1 for details.

X4/24 = Last order entry
 April 14, 2024

Host Collaborative and Conference Tables Soft Radiused Tables with Two Bases

DESIGN F/P DESIGN AND VECTA DESIGN TEAM

► Options, continued from previous page

Tip: For single TAP style numbers, the modular system tray is not available. Specify the hard-wired tray option.

Tip: If the specified table has multiple TAP(s), any one TAP can be replaced with a storage tray.

Tip: Wood veneer doors for storage tray and TAP will always be cross grain.

Tip: Connectrac must be the same wiring schematic as the table.

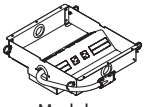
Options	U.S. Price	Required to Specify
TAP Electrical System with Faceplate Options ► Page 345  Modular	<ul style="list-style-type: none"> Modular system tray (hardwire base power infeed) <ul style="list-style-type: none"> - PAMH modular system tray with outlets and blank AAPs - PDMH modular system tray with outlets and two data AAPs - PVMH modular system tray with outlets and two of each video/audio and data AAPs 	+\$208 each tray Specify with modular power data, and select TAP type and TAP door color number.
Storage Tray ► Page 346	<ul style="list-style-type: none"> Storage tray 	-\$875 Specify with storage tray and select door color number.
Doors	<ul style="list-style-type: none"> Storage tray wood veneer doors TAP wood veneer doors 	+\$438 per door +\$438 per door Specify with wood doors.
Related Products	<ul style="list-style-type: none"> Floor kit: Connectrac Corridor shelf Power strip 	► Page 468 ► Page 468 ► Page 739

TAP Locations

96"L x 48"W TAP Locations—One piece top

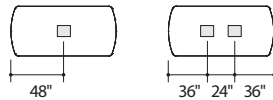

10'L x 48"W TAP Locations—One piece top

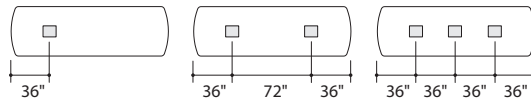

10'L x 48"W TAP Locations—Two piece top

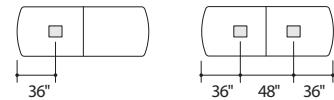

10'L x 60"W TAP Locations—One piece top

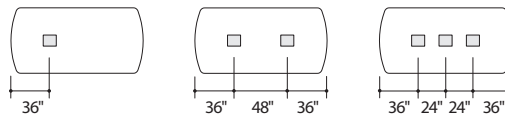

10'L x 60"W TAP Locations—Two piece top

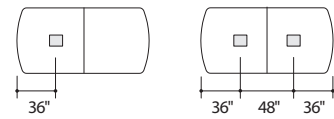

12'L x 48"W TAP Locations—Two piece top

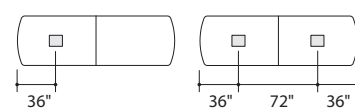

12'L x 60"W TAP Locations—Two piece top

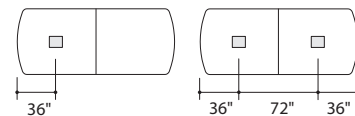

► Specification Information, on next page



For Canadian Pricing
 Multiply U.S. Price by the Canadian price factor.
 ► See page 1 for details.

Host Collaborative and Conference Tables Soft Radiused Tables with Two Bases *continued*



DESIGN F/P DESIGN AND VECTA DESIGN TEAM

Tip: Prices shown include top, TAP(s), and slim bases.
 ▶ See base options for flared bases, page 388

Tip: Last digit of style number indicates number of TAP(s).

▶ Options, on previous page

Specification Information

Style Number	Finish	U.S. Base Prices		
				
		Flat Wood Edge:	Bullnose Wood Edge:	Horizon Wood Edge:

96"L x 48"W One Piece Top

0 TAP X34/24

HS9648S10	Grade 1 Laminate	\$ 9952	\$10,098	\$13,011
	Grade 2 and 3 Laminate	\$10,126	\$10,272	\$13,185
	Grade 1 Veneer	\$10,699	\$10,845	\$13,758
	Grade 2 Veneer	\$11,589	\$11,735	\$14,648

1 TAP X34/24

HS9648S11	Grade 1 Laminate	\$12,290	\$12,436	\$15,349
	Grade 2 and 3 Laminate	\$12,464	\$12,610	\$15,523
	Grade 1 Veneer	\$13,037	\$13,183	\$16,096
	Grade 2 Veneer	\$13,927	\$14,073	\$16,986

2 TAPS X34/24

HS9648S12	Grade 1 Laminate	\$14,631	\$14,777	\$17,688
	Grade 2 and 3 Laminate	\$14,805	\$14,951	\$17,862
	Grade 1 Veneer	\$15,378	\$15,524	\$18,435
	Grade 2 Veneer	\$16,268	\$16,414	\$19,325

▶ Specification Information, continued on next page

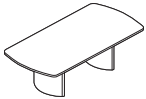

Tip: For tech corridor, 96"L tables have two long doors and four short doors.

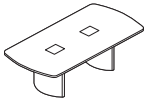
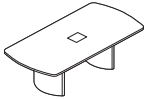

For Canadian Pricing
 Multiply U.S. Price by the Canadian price factor.
 ▶ See page 1 for details.

X34/24 = Last order entry
 April 14, 2024

Host Collaborative and Conference Tables Soft Radiused Tables with Two Bases



DESIGN F/P DESIGN AND VECTA DESIGN TEAM

Tip: Prices shown include top, TAP(s), and slim bases.
 ▶ See base options for flared bases, page 388

Tip: Last digit of style number indicates number of TAP(s).

▶ Specification Information, continued from previous page

Specification Information

Style Number	Finish	U.S. Base Prices		
				
		Flat Wood Edge:	Bullnose Wood Edge:	Horizon Wood Edge:

10'L x 48"W One Piece Top

0 TAP X4/24

HS1048S10	Grade 1 Laminate	\$10,733	\$10,902	\$14,020
	Grade 2 and 3 Laminate	\$10,956	\$11,125	\$14,243
	Grade 1 Veneer	\$11,645	\$11,814	\$14,932
	Grade 2 Veneer	\$12,754	\$12,923	\$16,041

1 TAP X4/24

HS1048S11	Grade 1 Laminate	\$13,073	\$13,242	\$16,360
	Grade 2 and 3 Laminate	\$13,296	\$13,465	\$16,583
	Grade 1 Veneer	\$13,985	\$14,154	\$17,272
	Grade 2 Veneer	\$15,094	\$15,263	\$18,381

2 TAPS X4/24

HS1048S12	Grade 1 Laminate	\$15,415	\$15,584	\$18,702
	Grade 2 and 3 Laminate	\$15,638	\$15,807	\$18,925
	Grade 1 Veneer	\$16,327	\$16,496	\$19,614
	Grade 2 Veneer	\$17,436	\$17,605	\$20,723

3 TAPS X4/24

HS1048S13	Grade 1 Laminate	\$17,759	\$17,928	\$21,046
	Grade 2 and 3 Laminate	\$17,982	\$18,151	\$21,269
	Grade 1 Veneer	\$18,671	\$18,840	\$21,958
	Grade 2 Veneer	\$19,780	\$19,949	\$23,067

▶ Specification Information, continued on next page

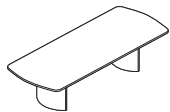

Tip: For tech corridor, 10'L tables have four long doors and four short doors.

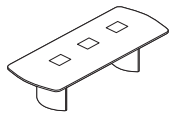
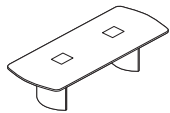
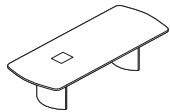

For Canadian Pricing
 Multiply U.S. Price by the Canadian price factor.
 ▶ See page 1 for details.

X4/24 = Last order entry
 April 14, 2024

Host Collaborative and Conference Tables Soft Radiused Tables with Two Bases *continued*



DESIGN F/P DESIGN AND VECTA DESIGN TEAM

► Specification Information, continued from previous page

Tip: Prices shown include top, TAP(s), and slim bases.
 ► See base options for flared bases, page 388

Tip: Last digit of style number indicates number of TAP(s).

Specification Information

Style Number	Finish	U.S. Base Prices		
				
		Flat Wood Edge:	Bullnose Wood Edge:	Horizon Wood Edge:

10'L x 48"W Two Piece Top

0 TAP **3/4/24**

HS1048S20	Grade 1 Laminate	\$11,295	\$11,464	\$14,582
	Grade 2 and 3 Laminate	\$11,518	\$11,687	\$14,805
	Grade 1 Veneer	\$12,207	\$12,376	\$15,494
	Grade 2 Veneer	\$13,316	\$13,485	\$16,603

1 TAP **3/4/24**

HS1048S21	Grade 1 Laminate	\$13,637	\$13,806	\$16,924
	Grade 2 and 3 Laminate	\$13,860	\$14,029	\$17,147
	Grade 1 Veneer	\$14,549	\$14,718	\$17,836
	Grade 2 Veneer	\$15,658	\$15,827	\$18,945

2 TAPS **3/4/24**

HS1048S22	Grade 1 Laminate	\$15,976	\$16,145	\$19,263
	Grade 2 and 3 Laminate	\$16,199	\$16,368	\$19,486
	Grade 1 Veneer	\$16,888	\$17,057	\$20,175
	Grade 2 Veneer	\$17,997	\$18,166	\$21,284

10'L x 60"W One Piece Top

0 TAP **3/4/24**

HS1060S10	Grade 1 Laminate	\$11,026	\$11,209	\$14,348
	Grade 2 and 3 Laminate	\$11,294	\$11,477	\$14,616
	Grade 1 Veneer	\$12,630	\$12,813	\$15,952
	Grade 2 Veneer	\$14,035	\$14,218	\$17,357

1 TAP **3/4/24**

HS1060S11	Grade 1 Laminate	\$13,368	\$13,551	\$16,690
	Grade 2 and 3 Laminate	\$13,636	\$13,819	\$16,958
	Grade 1 Veneer	\$14,972	\$15,155	\$18,294
	Grade 2 Veneer	\$16,377	\$16,560	\$19,699

2 TAPS **3/4/24**

HS1060S12	Grade 1 Laminate	\$15,709	\$15,892	\$19,031
	Grade 2 and 3 Laminate	\$15,977	\$16,160	\$19,299
	Grade 1 Veneer	\$17,313	\$17,496	\$20,635
	Grade 2 Veneer	\$18,718	\$18,901	\$22,040

► Specification Information, continued on next page

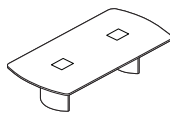
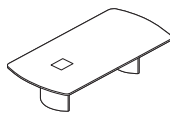
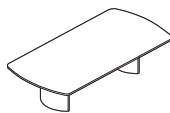
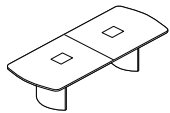
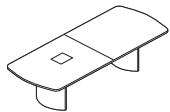
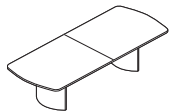

For Canadian Pricing
 Multiply U.S. Price by the Canadian price factor.
 ► See page 1 for details.

3/4/24 = Last order entry
 April 14, 2024

Host Collaborative and Conference Tables Soft Radiused Tables with Two Bases

DESIGN F/P DESIGN AND VECTA DESIGN TEAM



Tip: Prices shown include top, TAP(s), and slim bases.

► See base options for flared bases, page 388

Tip: Last digit of style number indicates number of TAP(s).

► Specification Information, continued from previous page

Specification Information

Style Number	Finish	U.S. Base Prices		
				
		Flat Wood Edge:	Bullnose Wood Edge:	Horizon Wood Edge:

10'L x 60"W One Piece Top, continued

3 TAPS X4/24

HS1060S13	Grade 1 Laminate	\$18,052	\$18,235	\$21,374
	Grade 2 and 3 Laminate	\$18,320	\$18,503	\$21,642
	Grade 1 Veneer	\$19,656	\$19,839	\$22,978
	Grade 2 Veneer	\$21,061	\$21,244	\$24,383

10'L x 60"W Two Piece Top

0 TAP X4/24

HS1060S20	Grade 1 Laminate	\$11,585	\$11,768	\$14,907
	Grade 2 and 3 Laminate	\$11,853	\$12,036	\$15,175
	Grade 1 Veneer	\$13,189	\$13,372	\$16,511
	Grade 2 Veneer	\$14,594	\$14,777	\$17,916

1 TAP X4/24

HS1060S21	Grade 1 Laminate	\$13,929	\$14,112	\$17,251
	Grade 2 and 3 Laminate	\$14,197	\$14,380	\$17,519
	Grade 1 Veneer	\$15,533	\$15,716	\$18,855
	Grade 2 Veneer	\$16,938	\$17,121	\$20,260

2 TAPS X4/24

HS1060S22	Grade 1 Laminate	\$16,271	\$16,454	\$19,593
	Grade 2 and 3 Laminate	\$16,539	\$16,722	\$19,861
	Grade 1 Veneer	\$17,875	\$18,058	\$21,197
	Grade 2 Veneer	\$19,280	\$19,463	\$22,602

► Specification Information, continued on next page

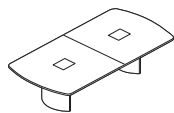
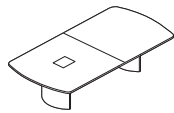
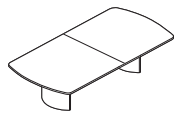
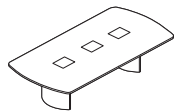

For Canadian Pricing
 Multiply U.S. Price by the Canadian price factor.
 ► See page 1 for details.

X4/24 = Last order entry
 April 14, 2024

Host Collaborative and Conference Tables Soft Radiused Tables with Two Bases *continued*

DESIGN F/P DESIGN AND VECTA DESIGN TEAM

Tip: Prices shown include top, TAP(s), and slim bases.
 ▶ See base options for flared bases, page 388

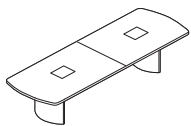
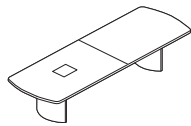
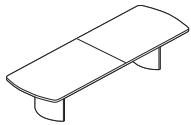

Tip: Last digit of style number indicates number of TAP(s).

Tip: For tech corridor, 12'L tables have four long doors and four short doors.



▶ Specification Information, continued from previous page

Specification Information

Style Number	Finish	U.S. Base Prices		
				
		Flat Wood Edge:	Bullnose Wood Edge:	Horizon Wood Edge:

12'L x 48"W Two Piece Top

0 TAP X34/24

HS1248S20	Grade 1 Laminate	\$11,991	\$12,186	\$15,336
	Grade 2 and 3 Laminate	\$12,253	\$12,448	\$15,598
	Grade 1 Veneer	\$13,194	\$13,389	\$16,539
	Grade 2 Veneer	\$14,533	\$14,728	\$17,878

1 TAP X34/24

HS1248S21	Grade 1 Laminate	\$14,338	\$14,533	\$17,683
	Grade 2 and 3 Laminate	\$14,600	\$14,795	\$17,945
	Grade 1 Veneer	\$15,541	\$15,736	\$18,886
	Grade 2 Veneer	\$16,880	\$17,075	\$20,225

2 TAPS X34/24

HS1248S22	Grade 1 Laminate	\$16,679	\$16,874	\$20,024
	Grade 2 and 3 Laminate	\$16,941	\$17,136	\$20,286
	Grade 1 Veneer	\$17,882	\$18,077	\$21,227
	Grade 2 Veneer	\$19,221	\$19,416	\$22,566

▶ Specification Information, continued on next page



For Canadian Pricing
 Multiply U.S. Price by the Canadian price factor.
 ▶ See page 1 for details.

X34/24 = Last order entry
 April 14, 2024

Host Collaborative and Conference Tables Soft Radiused Tables with Two Bases



DESIGN F/P DESIGN AND VECTA DESIGN TEAM

Tip: Prices shown include top, TAP(s), and slim bases.
 ▶ See base options for flared bases, page 388

Tip: Last digit of style number indicates number of TAP(s).

▶ Specification Information, continued from previous page

Specification Information

Style Number	Finish	U.S. Base Prices		
		 Flat Wood Edge:	 Bullnose Wood Edge:	 Horizon Wood Edge:

12'L x 60"W Two Piece Top

0 TAP X4/24

HS1260S20	Grade 1 Laminate	\$12,297	\$12,501	\$15,680
	Grade 2 and 3 Laminate	\$12,625	\$12,829	\$16,008
	Grade 1 Veneer	\$14,271	\$14,475	\$17,654
	Grade 2 Veneer	\$15,957	\$16,161	\$19,340

1 TAP X4/24

HS1260S21	Grade 1 Laminate	\$14,639	\$14,843	\$18,022
	Grade 2 and 3 Laminate	\$14,967	\$15,171	\$18,350
	Grade 1 Veneer	\$16,613	\$16,817	\$19,996
	Grade 2 Veneer	\$18,299	\$18,503	\$21,682

2 TAPS X4/24

HS1260S22	Grade 1 Laminate	\$16,984	\$17,188	\$20,367
	Grade 2 and 3 Laminate	\$17,312	\$17,516	\$20,695
	Grade 1 Veneer	\$18,958	\$19,162	\$22,341
	Grade 2 Veneer	\$20,644	\$20,848	\$24,027

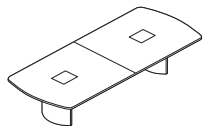
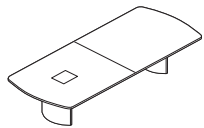
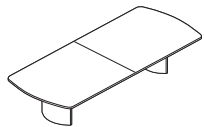

For Canadian Pricing
 Multiply U.S. Price by the Canadian price factor.
 ▶ See page 1 for details.

X4/24 = Last order entry
 April 14, 2024

Host Collaborative and Conference Tables Soft Radiused Tables with Three Bases **X4/24**

DESIGN F/P DESIGN AND VECTA DESIGN TEAM

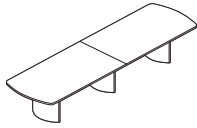

Tip: Shipped knocked down and top ships in one piece.

Tip: Grain direction for wood-grain laminate runs the length of the table.

Tip: Clips are provided with table: One clip per foot of table length.

Tip: The wood edge on a table top with woodgrain laminate may not match the top.

Standard Includes	Required to Specify
<p>► Need help? Product details, page 334</p> <ul style="list-style-type: none"> • Top: 1/4" particle board core with laminate • Flat wood edge • TAP(s), if selected: 10"W x 12"L opening(s) trimmed with a flat solid wood profile and with brushed anodized aluminum TAP doors • Tech corridor: four aluminum beams for top support provide tracks for hinged aluminum doors that clip shut: satin anodized finish • Universal clip: black plastic • Three 27"W bases: wood veneer on MDF with aluminum universal bracket, see below • Concealed leveling glides: non-marring, black plastic 	<ol style="list-style-type: none"> 1 Style number 2 Base selection (see below) and wood color number for base 3 Laminate color number for table top, if selected 4 Wood color number for wood edge 5 Door color number for storage tray or TAP door, if selected: <ul style="list-style-type: none"> - 8044 Black - 8047 Silver 6 Options, if selected (see below) <p>► See <i>Coalesse Surface Materials Reference Guide</i>.</p>

Options	U.S. Price	Required to Specify
<p>Surface Materials</p> <p>Top</p> <ul style="list-style-type: none"> • Grade 2 laminate • Grade 3 laminate • Grade 1 wood veneer • Grade 2 wood veneer 	<p>Prices at right</p> <p>Prices at right</p> <p>Prices at right</p> <p>Prices at right</p>	<p>Specify with <i>Grade 2 laminate</i> and select color number.</p> <p>Specify with <i>Grade 3 laminate</i> and select color number.</p> <p>Specify with <i>Grade 1 wood veneer</i> and select color number.</p> <p>Specify with <i>Grade 2 wood veneer</i> and select color number.</p>

<p>Edges</p> <p>Wood</p> <ul style="list-style-type: none"> • Bullnose wood edge • Horizon wood edge 	<p>Prices at right</p> <p>Prices at right</p>	<p>Specify with <i>bullnose wood edge</i>.</p> <p>Specify with <i>horizon wood edge</i>.</p>
--	---	--

<p>Bases</p> <p>Slim Flared</p>	<ul style="list-style-type: none"> • Three slim bases • Two slim and one flared bases • One slim and two flared bases • Three flared bases <p>No cost</p> <p>+\$1217</p> <p>+\$2438</p> <p>+\$3652</p>	<p>Specify with <i>three slim bases</i>.</p> <p>Specify with <i>two slim and one flared bases</i>.</p> <p>Specify with <i>one slim and two flared bases</i>.</p> <p>Specify with <i>three flared bases</i>.</p>
--	--	---

Tip: 14'L and 16'L tables available with zero, one, two, or four TAP(s). 18'L and 20'L tables available with zero, one, two, four, or six TAP(s).

Tip: In addition to the data and audio/video AAPs available from Coalesse, other styles of AAPs are available through Extron Electronics. For an Extron dealer, call 1-800-633-9876.

Tip: See TAP options for electrical systems and faceplate list.

<p>TAP Electrical System with Faceplate Options</p> <p>► Page 345</p> <p>Field Wired</p> <p>Cord and Plug</p> <p>Cord and Plug</p>	<ul style="list-style-type: none"> • Field-wired tray (no electrical) <ul style="list-style-type: none"> - PAFW field-wired tray (no electrical) with blank AAPs - PDFW field-wired tray (no electrical) with two data AAPs - PVFW field-wired tray (no electrical) with two of each video/audio and data AAPs • Cord and plug tray (10' cord) <ul style="list-style-type: none"> - PACP cord and plug tray with outlets and blank AAPs - PDCP cord and plug tray with outlets and two data AAPs - PAVC cord and plug tray with outlets and two of each video/audio and data AAPs • Hard-wired tray (6' conduit) <ul style="list-style-type: none"> - PAHW hard-wired tray with outlets and blank AAPs - PDHW hard-wired tray with outlets and two data AAPs - PAVH hard-wired tray with outlets and two of each video/audio and data AAPs <p>No cost</p> <p>No cost</p> <p>No cost</p>	<p>Specify with <i>power data</i>, and select TAP type and TAP door color number.</p> <p>Specify with <i>power data</i>, and select TAP type and TAP door color number.</p> <p>Specify with <i>power data</i>, and select TAP type and TAP door color number.</p>
---	--	---

► Options, continued on next page

Veneer direction



For Canadian Pricing
 Multiply U.S. Price by the Canadian price factor.
 ► See page 1 for details.

X4/24 = Last order entry
 April 14, 2024

Host Collaborative and Conference Tables Soft Radiused Tables with Three Bases

DESIGN F/P DESIGN AND VECTA DESIGN TEAM

Tip: For single TAP style numbers, the modular system tray is not available. Specify the hard-wired tray option.

Tip: If the specified table has multiple TAPs, any one TAP can be replaced with a storage tray.

Tip: Wood veneer doors for storage tray or TAP will always be cross grain.

Tip: Connectrac must be the same wiring schematic as the table.

► Options, continued from previous page

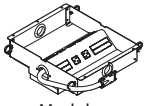
Options	U.S. Price	Required to Specify
TAP Electrical System with Faceplate Options ► Page 345 	<ul style="list-style-type: none"> Modular system tray (hardwire base power infeed) <ul style="list-style-type: none"> - PAMH modular system tray with outlets and blank AAPs - PDMH modular system tray with outlets and two data AAPs - PVMH modular system tray with outlets and two of each video/audio and data AAPs 	+\$208 each tray Specify with modular power data, and select TAP type and TAP door color number.
Storage Tray ► Page 346	<ul style="list-style-type: none"> Storage tray 	-\$875 Specify with storage tray and select door color number.
Doors	<ul style="list-style-type: none"> Storage tray wood veneer doors TAP wood veneer doors 	+\$438 per door +\$438 per door Specify with wood doors. Specify with wood doors.
Related Products	<ul style="list-style-type: none"> Floor kit: Connectrac Corridor shelf Power strip 	► Page 468 ► Page 468 ► Page 739

TAP Locations

14'L x 48"W TAP Locations—Two piece top

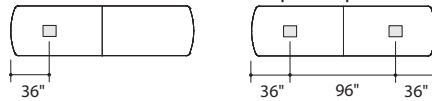

14'L x 48"W TAP Locations—Three piece top

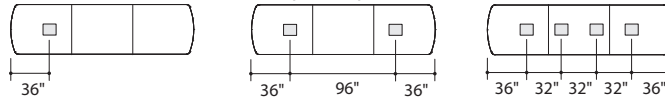

14'L x 60"W TAP Locations—Two piece top

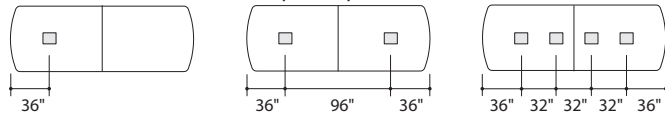

14'L x 60"W TAP Locations—Three piece top

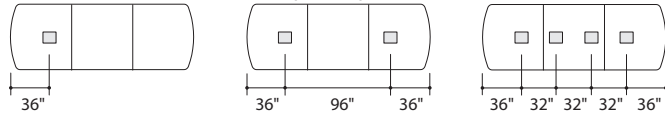

16'L x 48"W TAP Locations—Two piece top

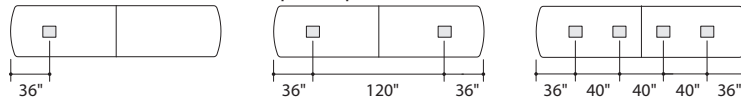

16'L x 48"W TAP Locations—Three piece top

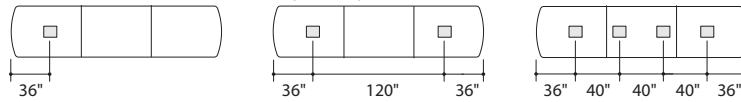

16'L x 60"W TAP Locations—Two piece top

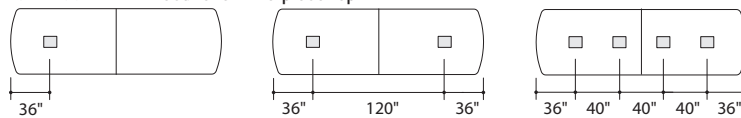

► Options, continued on next page

For Canadian Pricing
 Multiply U.S. Price by the Canadian price factor.
 ► See page 1 for details.

Host Collaborative and Conference Tables Soft Radiused Tables with Three Bases *continued*

DESIGN F/P DESIGN AND VECTA DESIGN TEAM

►Options, continued from previous page

TAP Locations

16'L x 60"W TAP Locations—Three piece top

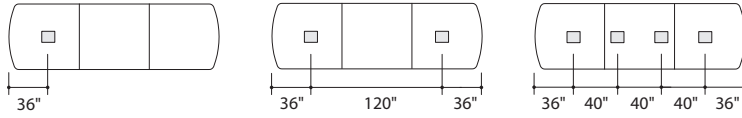

18'L x 48"W TAP Locations—Two piece top

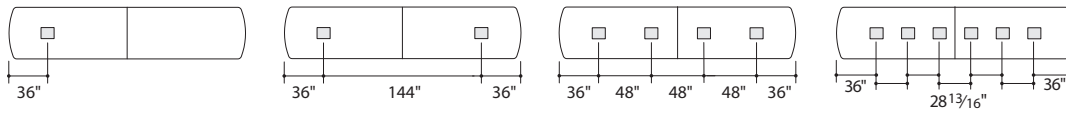

18'L x 48"W TAP Locations—Three piece top

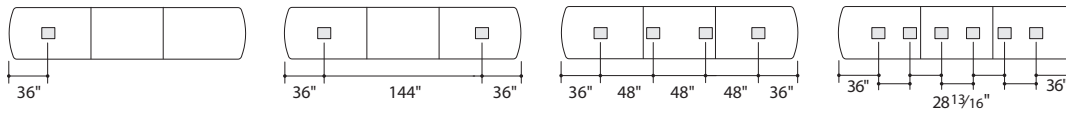

18'L x 60"W TAP Locations—Two piece top

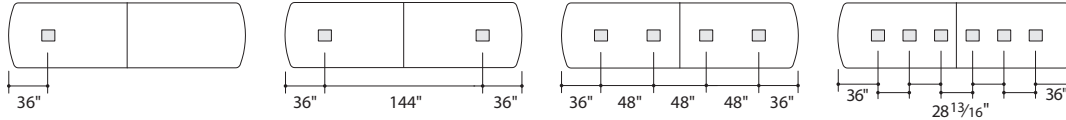

18'L x 60"W TAP Locations—Three piece top

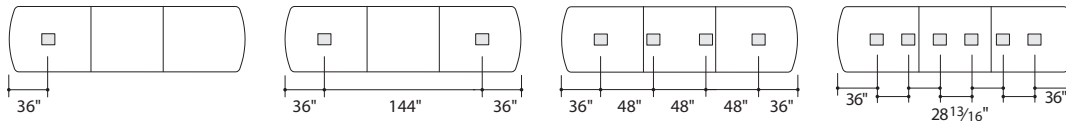

20'L x 48"W TAP Locations—Two piece top

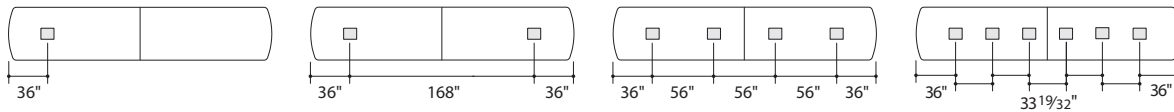

20'L x 48"W TAP Locations—Three piece top

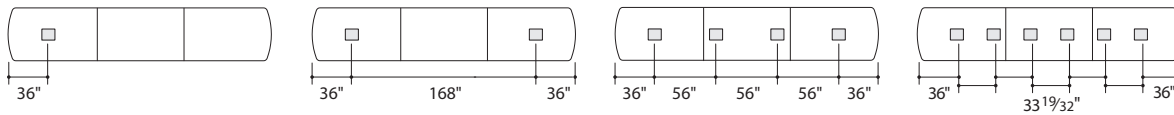

20'L x 60"W TAP Locations—Two piece top

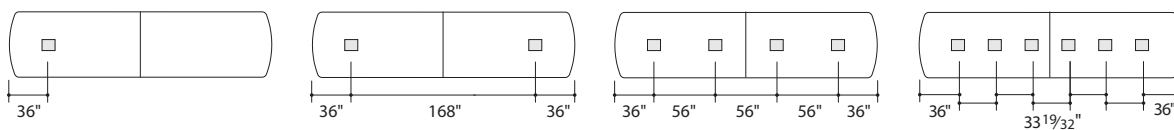

20'L x 60"W TAP Locations—Three piece top

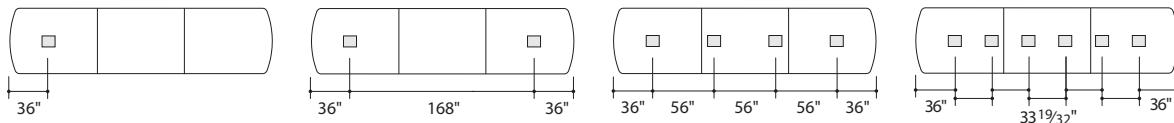

Host Collaborative and Conference Tables Soft Radiused Tables with Three Bases

DESIGN F/P DESIGN AND VECTA DESIGN TEAM

Tip: Prices shown include top, TAP(s), and slim bases.
 ▶ See base options for flared bases, page 396

Tip: Last digit of style number indicates number of TAP(s).

Tip: For tech corridor, 14'L tables have four long doors and four short doors.

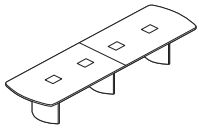
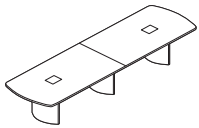
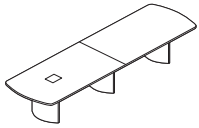
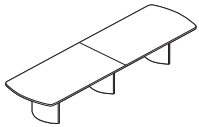

Specification Information

Style Number	Finish	U.S. Base Prices		
		Flat Wood Edge:	Bullnose Wood Edge:	Horizon Wood Edge:

14'L x 48''W Two Piece Top

0 TAP X4/24

HS1448S20	Grade 1 Laminate	\$15,531	\$15,753	\$18,935
	Grade 2 and 3 Laminate	\$15,838	\$16,060	\$19,242
	Grade 1 Veneer	\$17,223	\$17,445	\$20,627
	Grade 2 Veneer	\$18,792	\$19,014	\$22,196

1 TAP X4/24

HS1448S21	Grade 1 Laminate	\$17,873	\$18,095	\$21,277
	Grade 2 and 3 Laminate	\$18,180	\$18,402	\$21,584
	Grade 1 Veneer	\$19,565	\$19,787	\$22,969
	Grade 2 Veneer	\$21,134	\$21,356	\$24,538

2 TAPS X4/24

HS1448S22	Grade 1 Laminate	\$20,217	\$20,439	\$23,621
	Grade 2 and 3 Laminate	\$20,524	\$20,746	\$23,928
	Grade 1 Veneer	\$21,909	\$22,131	\$25,313
	Grade 2 Veneer	\$23,478	\$23,700	\$26,882

4 TAPS X4/24

HS1448S24	Grade 1 Laminate	\$24,898	\$25,120	\$28,302
	Grade 2 and 3 Laminate	\$25,205	\$25,427	\$28,609
	Grade 1 Veneer	\$26,590	\$26,812	\$29,994
	Grade 2 Veneer	\$28,159	\$28,381	\$31,563

▶ Specification Information, continued on next page



For Canadian Pricing
 Multiply U.S. Price by the Canadian price factor.
 ▶ See page 1 for details.

X4/24 = Last order entry
 April 14, 2024

Host Collaborative and Conference Tables Soft Radiused Tables with Three Bases *continued*

DESIGN F/P DESIGN AND VECTA DESIGN TEAM

► Specification Information, continued from previous page

Tip: Prices shown include top, TAP(s), and slim bases.
 ► See base options for flared bases, page 396

Tip: Last digit of style number indicates number of TAP(s).

Tip: For tech corridor, 14'L tables have four long doors and four short doors.

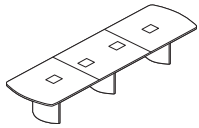
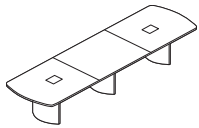
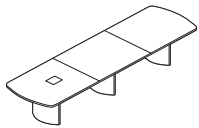
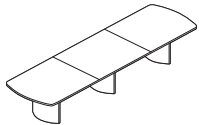

Specification Information

Style Number	Finish	U.S. Base Prices		
		Flat Wood Edge:	Bullnose Wood Edge:	Horizon Wood Edge:

14'L x 48"W Three Piece Top

0 TAP X34/24

Style Number	Finish	Flat Wood Edge	Bullnose Wood Edge	Horizon Wood Edge
HS1448S30	Grade 1 Laminate	\$16,092	\$16,314	\$19,496
	Grade 2 and 3 Laminate	\$16,399	\$16,621	\$19,803
	Grade 1 Veneer	\$17,784	\$18,006	\$21,188
	Grade 2 Veneer	\$19,353	\$19,575	\$22,757

1 TAP X34/24

Style Number	Finish	Flat Wood Edge	Bullnose Wood Edge	Horizon Wood Edge
HS1448S31	Grade 1 Laminate	\$18,435	\$18,657	\$21,839
	Grade 2 and 3 Laminate	\$18,742	\$18,964	\$22,146
	Grade 1 Veneer	\$20,127	\$20,349	\$23,531
	Grade 2 Veneer	\$21,696	\$21,918	\$25,100

2 TAPS X34/24

Style Number	Finish	Flat Wood Edge	Bullnose Wood Edge	Horizon Wood Edge
HS1448S32	Grade 1 Laminate	\$20,778	\$21,000	\$24,182
	Grade 2 and 3 Laminate	\$21,085	\$21,307	\$24,489
	Grade 1 Veneer	\$22,470	\$22,692	\$25,874
	Grade 2 Veneer	\$24,039	\$24,261	\$27,443

4 TAPS X34/24

Style Number	Finish	Flat Wood Edge	Bullnose Wood Edge	Horizon Wood Edge
HS1448S34	Grade 1 Laminate	\$25,461	\$25,683	\$28,865
	Grade 2 and 3 Laminate	\$25,768	\$25,990	\$29,172
	Grade 1 Veneer	\$27,153	\$27,375	\$30,557
	Grade 2 Veneer	\$28,722	\$28,944	\$32,126

► Specification Information, continued on next page



For Canadian Pricing
 Multiply U.S. Price by the Canadian price factor.
 ► See page 1 for details.

X34/24 = Last order entry
 April 14, 2024

Host Collaborative and Conference Tables Soft Radiused Tables with Three Bases

DESIGN F/P DESIGN AND VECTA DESIGN TEAM

Tip: Prices shown include top, TAP(s), and slim bases.
 ▶ See base options for flared bases, page 396

Tip: Last digit of style number indicates number of TAP(s).

Tip: For tech corridor, 14'L tables have four long doors and four short doors.

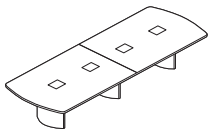
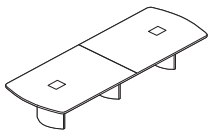
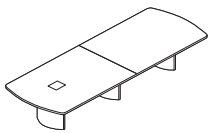
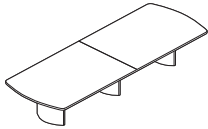

▶ Specification Information, continued from previous page

Specification Information

Style Number	Finish	U.S. Base Prices		
		Flat Wood Edge:	Bullnose Wood Edge:	Horizon Wood Edge:

14'L x 60"W Two Piece Top

0 TAP X4/24

Style Number	Finish	Flat Wood Edge	Bullnose Wood Edge	Horizon Wood Edge
HS1460S20	Grade 1 Laminate	\$16,224	\$16,455	\$19,654
	Grade 2 and 3 Laminate	\$16,609	\$16,840	\$20,039
	Grade 1 Veneer	\$19,335	\$19,566	\$22,765
	Grade 2 Veneer	\$21,327	\$21,558	\$24,757

1 TAP X4/24

Style Number	Finish	Flat Wood Edge	Bullnose Wood Edge	Horizon Wood Edge
HS1460S21	Grade 1 Laminate	\$18,567	\$18,798	\$21,997
	Grade 2 and 3 Laminate	\$18,952	\$19,183	\$22,382
	Grade 1 Veneer	\$21,678	\$21,909	\$25,108
	Grade 2 Veneer	\$23,670	\$23,901	\$27,100

2 TAPS X4/24

Style Number	Finish	Flat Wood Edge	Bullnose Wood Edge	Horizon Wood Edge
HS1460S22	Grade 1 Laminate	\$20,906	\$21,137	\$24,336
	Grade 2 and 3 Laminate	\$21,291	\$21,522	\$24,721
	Grade 1 Veneer	\$24,017	\$24,248	\$27,447
	Grade 2 Veneer	\$26,009	\$26,240	\$29,439

4 TAPS X4/24

Style Number	Finish	Flat Wood Edge	Bullnose Wood Edge	Horizon Wood Edge
HS1460S24	Grade 1 Laminate	\$25,595	\$25,826	\$29,025
	Grade 2 and 3 Laminate	\$25,980	\$26,211	\$29,410
	Grade 1 Veneer	\$28,706	\$28,937	\$32,136
	Grade 2 Veneer	\$30,698	\$30,929	\$34,128

▶ Specification Information, continued on next page

For Canadian Pricing
 Multiply U.S. Price by the Canadian price factor.
 ▶ See page 1 for details.

X4/24 = Last order entry
 April 14, 2024

Host Collaborative and Conference Tables Soft Radiused Tables with Three Bases *continued*

DESIGN F/P DESIGN AND VECTA DESIGN TEAM

Tip: Prices shown include top, TAP(s), and slim bases.

► See base options for flared bases, page 396

Tip: Last digit of style number indicates number of TAP(s).

Tip: For tech corridor, 14'L tables have four long doors and four short doors.

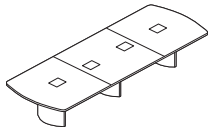
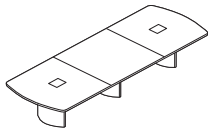
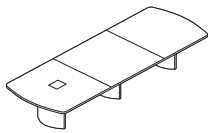
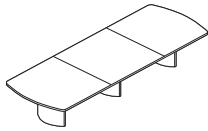

► Specification Information, continued from previous page

Specification Information

Style Number	Finish	U.S. Base Prices		
		Flat Wood Edge:	Bullnose Wood Edge:	Horizon Wood Edge:

14'L x 60"W Three Piece Top

0 TAP ~~3~~4/24

HS1460S30	Grade 1 Laminate	\$16,784	\$17,015	\$20,214
	Grade 2 and 3 Laminate	\$17,169	\$17,400	\$20,599
	Grade 1 Veneer	\$19,895	\$20,126	\$23,325
	Grade 2 Veneer	\$21,887	\$22,118	\$25,317

1 TAP ~~3~~4/24

HS1460S31	Grade 1 Laminate	\$19,125	\$19,356	\$22,555
	Grade 2 and 3 Laminate	\$19,510	\$19,741	\$22,940
	Grade 1 Veneer	\$22,236	\$22,467	\$25,666
	Grade 2 Veneer	\$24,228	\$24,459	\$27,658

2 TAPS ~~3~~4/24

HS1460S32	Grade 1 Laminate	\$21,470	\$21,701	\$24,900
	Grade 2 and 3 Laminate	\$21,855	\$22,086	\$25,285
	Grade 1 Veneer	\$24,581	\$24,812	\$28,011
	Grade 2 Veneer	\$26,573	\$26,804	\$30,003

4 TAPS ~~3~~4/24

HS1460S34	Grade 1 Laminate	\$26,156	\$26,387	\$29,586
	Grade 2 and 3 Laminate	\$26,541	\$26,772	\$29,971
	Grade 1 Veneer	\$29,267	\$29,498	\$32,697
	Grade 2 Veneer	\$31,259	\$31,490	\$34,689

► Specification Information, continued on next page



For Canadian Pricing
Multiply U.S. Price by the Canadian price factor.
► See page 1 for details.

~~3~~4/24 = Last order entry
April 14, 2024

Host Collaborative and Conference Tables Soft Radiused Tables with Three Bases

DESIGN F/P DESIGN AND VECTA DESIGN TEAM

Tip: Prices shown include top, TAP(s), and slim bases.
 ▶ See base options for flared bases, page 396

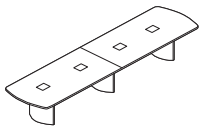
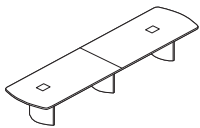
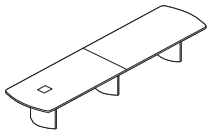
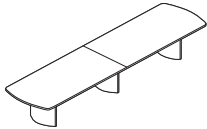

Tip: Last digit of style number indicates number of TAP(s).

Tip: For tech corridor, 16'L tables have eight long doors and four short doors.



▶ Specification Information, continued from previous page

Specification Information

Style Number	Finish	U.S. Base Prices		
				
		Flat Wood Edge:	Bullnose Wood Edge:	Horizon Wood Edge:

16'L x 48"W Two Piece Top

0 TAP X4/24

HS1648S20	Grade 1 Laminate	\$16,168	\$16,407	\$19,632
	Grade 2 and 3 Laminate	\$16,519	\$16,758	\$19,983
	Grade 1 Veneer	\$17,851	\$18,090	\$21,315
	Grade 2 Veneer	\$19,644	\$19,883	\$23,108

1 TAP X4/24

HS1648S21	Grade 1 Laminate	\$18,511	\$18,750	\$21,975
	Grade 2 and 3 Laminate	\$18,862	\$19,101	\$22,326
	Grade 1 Veneer	\$20,194	\$20,433	\$23,658
	Grade 2 Veneer	\$21,987	\$22,226	\$25,451

2 TAPS X4/24

HS1648S22	Grade 1 Laminate	\$20,851	\$21,090	\$24,315
	Grade 2 and 3 Laminate	\$21,202	\$21,441	\$24,666
	Grade 1 Veneer	\$22,534	\$22,773	\$25,998
	Grade 2 Veneer	\$24,327	\$24,566	\$27,791

4 TAPS X4/24

HS1648S24	Grade 1 Laminate	\$25,534	\$25,773	\$28,998
	Grade 2 and 3 Laminate	\$25,885	\$26,124	\$29,349
	Grade 1 Veneer	\$27,217	\$27,456	\$30,681
	Grade 2 Veneer	\$29,010	\$29,249	\$32,474

▶ Specification Information, continued on next page



For Canadian Pricing
 Multiply U.S. Price by the Canadian price factor.
 ▶ See page 1 for details.

X4/24 = Last order entry
 April 14, 2024

Host Collaborative and Conference Tables Soft Radiused Tables with Three Bases *continued*

DESIGN F/P DESIGN AND VECTA DESIGN TEAM

Tip: Prices shown include top, TAP(s), and slim bases.

► See base options for flared bases, page 396

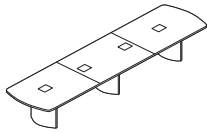
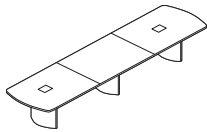
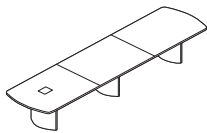
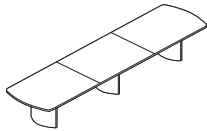

Tip: Last digit of style number indicates number of TAP(s).

Tip: For tech corridor, 16'L tables have eight long doors and four short doors.



► Specification Information, continued from previous page

Specification Information

Style Number	Finish	U.S. Base Prices		
				
		Flat Wood Edge:	Bullnose Wood Edge:	Horizon Wood Edge:

16'L x 48"W Three Piece Top

0 TAP X34/24

HS1648S30	Grade 1 Laminate	\$16,730	\$16,969	\$20,194
	Grade 2 and 3 Laminate	\$17,081	\$17,320	\$20,545
	Grade 1 Veneer	\$18,413	\$18,652	\$21,877
	Grade 2 Veneer	\$20,206	\$20,445	\$23,670

1 TAP X34/24

HS1648S31	Grade 1 Laminate	\$19,072	\$19,311	\$22,536
	Grade 2 and 3 Laminate	\$19,423	\$19,662	\$22,887
	Grade 1 Veneer	\$20,755	\$20,994	\$24,219
	Grade 2 Veneer	\$22,548	\$22,787	\$26,012

2 TAPS X34/24

HS1648S32	Grade 1 Laminate	\$21,406	\$21,645	\$24,870
	Grade 2 and 3 Laminate	\$21,757	\$21,996	\$25,221
	Grade 1 Veneer	\$23,089	\$23,328	\$26,553
	Grade 2 Veneer	\$24,882	\$25,121	\$28,346

4 TAPS X34/24

HS1648S34	Grade 1 Laminate	\$26,094	\$26,333	\$29,558
	Grade 2 and 3 Laminate	\$26,445	\$26,684	\$29,909
	Grade 1 Veneer	\$27,777	\$28,016	\$31,241
	Grade 2 Veneer	\$29,570	\$29,809	\$33,034

► Specification Information, continued on next page



For Canadian Pricing
Multiply U.S. Price by the Canadian price factor.
► See page 1 for details.

X34/24 = Last order entry
April 14, 2024

Host Collaborative and Conference Tables Soft Radiused Tables with Three Bases

DESIGN F/P DESIGN AND VECTA DESIGN TEAM

Tip: Prices shown include top, TAP(s), and slim bases.
 ▶ See base options for flared bases, page 396

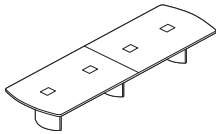
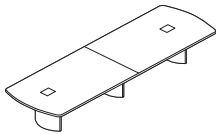
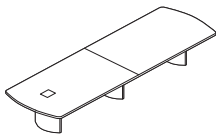
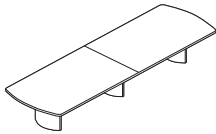

Tip: Last digit of style number indicates number of TAP(s).

Tip: For tech corridor, 16'L tables have eight long doors and four short doors.



▶ Specification Information, continued from previous page

Specification Information

Style Number	Finish	U.S. Base Prices		
		 Flat Wood Edge:	 Bullnose Wood Edge:	 Horizon Wood Edge:

16'L x 60"W Two Piece Top

0 TAP X4/24

HS1660S20	Grade 1 Laminate	\$16,858	\$17,112	\$20,387
	Grade 2 and 3 Laminate	\$17,295	\$17,549	\$20,824
	Grade 1 Veneer	\$19,962	\$20,216	\$23,491
	Grade 2 Veneer	\$22,227	\$22,481	\$25,756

1 TAP X4/24

HS1660S21	Grade 1 Laminate	\$19,201	\$19,455	\$22,730
	Grade 2 and 3 Laminate	\$19,638	\$19,892	\$23,167
	Grade 1 Veneer	\$22,305	\$22,559	\$25,834
	Grade 2 Veneer	\$24,570	\$24,824	\$28,099

2 TAPS X4/24

HS1660S22	Grade 1 Laminate	\$21,544	\$21,798	\$25,073
	Grade 2 and 3 Laminate	\$21,981	\$22,235	\$25,510
	Grade 1 Veneer	\$24,648	\$24,902	\$28,177
	Grade 2 Veneer	\$26,913	\$27,167	\$30,442

4 TAPS X4/24

HS1660S24	Grade 1 Laminate	\$26,225	\$26,479	\$29,754
	Grade 2 and 3 Laminate	\$26,662	\$26,916	\$30,191
	Grade 1 Veneer	\$29,329	\$29,583	\$32,858
	Grade 2 Veneer	\$31,594	\$31,848	\$35,123

▶ Specification Information, continued on next page



For Canadian Pricing
 Multiply U.S. Price by the Canadian price factor.
 ▶ See page 1 for details.

X4/24 = Last order entry
 April 14, 2024

Host Collaborative and Conference Tables Soft Radiused Tables with Three Bases *continued*

DESIGN F/P DESIGN AND VECTA DESIGN TEAM

► Specification Information, continued from previous page



Tip: Prices shown include top, TAP(s), and slim bases.
 ► See base options for flared bases, page 396

Tip: Last digit of style number indicates number of TAP(s).

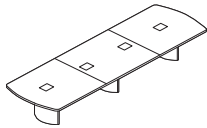
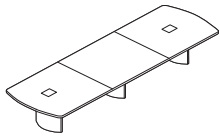
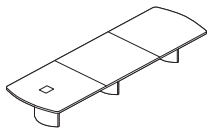
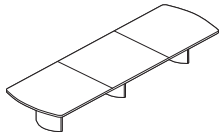
Tip: For tech corridor, 16'L tables have eight long doors and four short doors.



Specification Information

Style Number	Finish	U.S. Base Prices		
				
		Flat Wood Edge:	Bullnose Wood Edge:	Horizon Wood Edge:

16'L x 60"W Three Piece Top

0 TAP X4/24

HS1660S30	Grade 1 Laminate	\$17,420	\$17,674	\$20,949
	Grade 2 and 3 Laminate	\$17,857	\$18,111	\$21,386
	Grade 1 Veneer	\$20,524	\$20,778	\$24,053
	Grade 2 Veneer	\$22,789	\$23,043	\$26,318

1 TAP X4/24

HS1660S31	Grade 1 Laminate	\$19,761	\$20,015	\$23,290
	Grade 2 and 3 Laminate	\$20,198	\$20,452	\$23,727
	Grade 1 Veneer	\$22,865	\$23,119	\$26,394
	Grade 2 Veneer	\$25,130	\$25,384	\$28,659

2 TAPS X4/24

HS1660S32	Grade 1 Laminate	\$22,104	\$22,358	\$25,633
	Grade 2 and 3 Laminate	\$22,541	\$22,795	\$26,070
	Grade 1 Veneer	\$25,208	\$25,462	\$28,737
	Grade 2 Veneer	\$27,473	\$27,727	\$31,002

4 TAPS X4/24

HS1660S34	Grade 1 Laminate	\$26,784	\$27,038	\$30,313
	Grade 2 and 3 Laminate	\$27,221	\$27,475	\$30,750
	Grade 1 Veneer	\$29,888	\$30,142	\$33,417
	Grade 2 Veneer	\$32,153	\$32,407	\$35,682

► Specification Information, continued on next page



For Canadian Pricing
 Multiply U.S. Price by the Canadian price factor.
 ► See page 1 for details.

X4/24 = Last order entry
 April 14, 2024

Host Collaborative and Conference Tables Soft Radiused Tables with Three Bases

DESIGN F/P DESIGN AND VECTA DESIGN TEAM

Tip: Prices shown include top, TAP(s), and slim bases.
 ▶ See base options for flared bases, page 396

Tip: Last digit of style number indicates number of TAP(s).

Tip: For tech corridor, 18'L tables have eight long doors and four short doors.

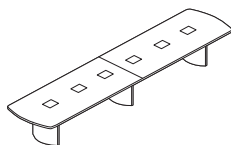
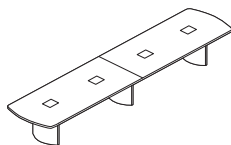
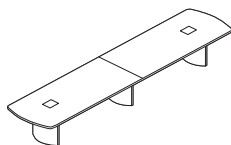
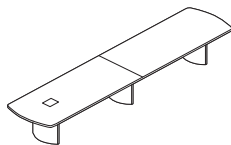
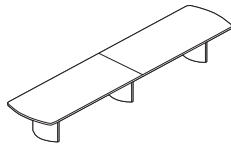

▶ Specification Information, continued from previous page

Specification Information

Style Number	Finish	U.S. Base Prices		
		Flat Wood Edge:	Bullnose Wood Edge:	Horizon Wood Edge:

18'L x 48"W Two Piece Top

0 TAP X4/24

HS1848S20	Grade 1 Laminate	\$17,172	\$17,435	\$20,719
	Grade 2 and 3 Laminate	\$17,568	\$17,831	\$21,115
	Grade 1 Veneer	\$19,324	\$19,587	\$22,871
	Grade 2 Veneer	\$21,338	\$21,601	\$24,885

1 TAP X4/24

HS1848S21	Grade 1 Laminate	\$19,513	\$19,776	\$23,060
	Grade 2 and 3 Laminate	\$19,909	\$20,172	\$23,456
	Grade 1 Veneer	\$21,665	\$21,928	\$25,212
	Grade 2 Veneer	\$23,679	\$23,942	\$27,226

2 TAPS X4/24

HS1848S22	Grade 1 Laminate	\$21,857	\$22,120	\$25,404
	Grade 2 and 3 Laminate	\$22,253	\$22,516	\$25,800
	Grade 1 Veneer	\$24,009	\$24,272	\$27,556
	Grade 2 Veneer	\$26,023	\$26,286	\$29,570

4 TAPS X4/24

HS1848S24	Grade 1 Laminate	\$26,539	\$26,802	\$30,086
	Grade 2 and 3 Laminate	\$26,935	\$27,198	\$30,482
	Grade 1 Veneer	\$28,691	\$28,954	\$32,238
	Grade 2 Veneer	\$30,705	\$30,968	\$34,252

6 TAPS X4/24

HS1848S26	Grade 1 Laminate	\$31,224	\$31,487	\$34,771
	Grade 2 and 3 Laminate	\$31,620	\$31,883	\$35,167
	Grade 1 Veneer	\$33,376	\$33,639	\$36,923
	Grade 2 Veneer	\$35,390	\$35,653	\$38,937

▶ Specification Information, continued on next page

Host Collaborative and Conference Tables



For Canadian Pricing
 Multiply U.S. Price by the Canadian price factor.
 ▶ See page 1 for details.

X4/24 = Last order entry
 April 14, 2024

Host Collaborative and Conference Tables Soft Radiused Tables with Three Bases *continued*

DESIGN F/P DESIGN AND VECTA DESIGN TEAM

► Specification Information, continued from previous page

Tip: Prices shown include top, TAP(s), and slim bases.

► See base options for flared bases, page 396

Tip: Last digit of style number indicates number of TAP(s).

Tip: For tech corridor, 18'L tables have eight long doors and four short doors.

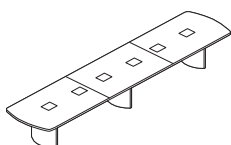
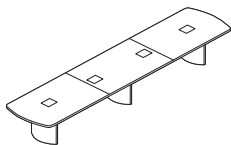
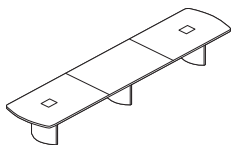
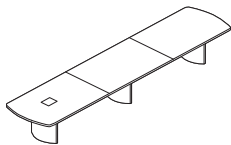
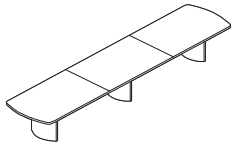

Specification Information

Style Number	Finish	U.S. Base Prices		
		Flat Wood Edge:	Bullnose Wood Edge:	Horizon Wood Edge:

18'L x 48"W Three Piece Top

0 TAP ~~34/24~~

Style Number	Finish	Flat Wood Edge	Bullnose Wood Edge	Horizon Wood Edge
HS1848S30	Grade 1 Laminate	\$17,736	\$17,999	\$21,283
	Grade 2 and 3 Laminate	\$18,132	\$18,395	\$21,679
	Grade 1 Veneer	\$19,888	\$20,151	\$23,435
	Grade 2 Veneer	\$21,902	\$22,165	\$25,449

1 TAP ~~34/24~~

Style Number	Finish	Flat Wood Edge	Bullnose Wood Edge	Horizon Wood Edge
HS1848S31	Grade 1 Laminate	\$20,074	\$20,337	\$23,621
	Grade 2 and 3 Laminate	\$20,470	\$20,733	\$24,017
	Grade 1 Veneer	\$22,226	\$22,489	\$25,773
	Grade 2 Veneer	\$24,240	\$24,503	\$27,787

2 TAPS ~~34/24~~

Style Number	Finish	Flat Wood Edge	Bullnose Wood Edge	Horizon Wood Edge
HS1848S32	Grade 1 Laminate	\$22,416	\$22,679	\$25,963
	Grade 2 and 3 Laminate	\$22,812	\$23,075	\$26,359
	Grade 1 Veneer	\$24,568	\$24,831	\$28,115
	Grade 2 Veneer	\$26,582	\$26,845	\$30,129

4 TAPS ~~34/24~~

Style Number	Finish	Flat Wood Edge	Bullnose Wood Edge	Horizon Wood Edge
HS1848S34	Grade 1 Laminate	\$27,099	\$27,362	\$30,646
	Grade 2 and 3 Laminate	\$27,495	\$27,758	\$31,042
	Grade 1 Veneer	\$29,251	\$29,514	\$32,798
	Grade 2 Veneer	\$31,265	\$31,528	\$34,812

6 TAPS ~~34/24~~

Style Number	Finish	Flat Wood Edge	Bullnose Wood Edge	Horizon Wood Edge
HS1848S36	Grade 1 Laminate	\$31,785	\$32,048	\$35,332
	Grade 2 and 3 Laminate	\$32,181	\$32,444	\$35,728
	Grade 1 Veneer	\$33,937	\$34,200	\$37,484
	Grade 2 Veneer	\$35,951	\$36,214	\$39,498

► Specification Information, continued on next page



For Canadian Pricing
Multiply U.S. Price by the Canadian price factor.
► See page 1 for details.

~~34/24~~ = Last order entry
April 14, 2024

Host Collaborative and Conference Tables Soft Radiused Tables with Three Bases

DESIGN F/P DESIGN AND VECTA DESIGN TEAM

Tip: Prices shown include top, TAP(s), and slim bases.
 ▶ See base options for flared bases, page 396

Tip: Last digit of style number indicates number of TAP(s).

Tip: For tech corridor, 18'L tables have eight long doors and four short doors.

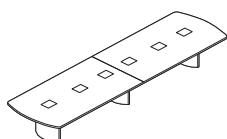
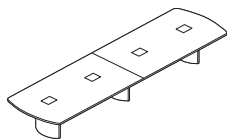
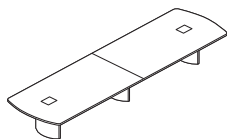
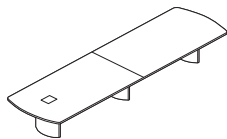
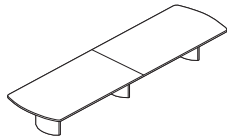

▶ Specification Information, continued from previous page

Specification Information

Style Number	Finish	U.S. Base Prices		
		Flat Wood Edge:	Bullnose Wood Edge:	Horizon Wood Edge:

18'L x 60"W Two Piece Top

0 TAP X4/24

HS1860S20	Grade 1 Laminate	\$17,542	\$17,817	\$21,147
	Grade 2 and 3 Laminate	\$18,035	\$18,310	\$21,640
	Grade 1 Veneer	\$21,693	\$21,968	\$25,298
	Grade 2 Veneer	\$24,263	\$24,538	\$27,868

1 TAP X4/24

HS1860S21	Grade 1 Laminate	\$19,884	\$20,159	\$23,489
	Grade 2 and 3 Laminate	\$20,377	\$20,652	\$23,982
	Grade 1 Veneer	\$24,035	\$24,310	\$27,640
	Grade 2 Veneer	\$26,605	\$26,880	\$30,210

2 TAPS X4/24

HS1860S22	Grade 1 Laminate	\$22,230	\$22,505	\$25,835
	Grade 2 and 3 Laminate	\$22,723	\$22,998	\$26,328
	Grade 1 Veneer	\$26,381	\$26,656	\$29,986
	Grade 2 Veneer	\$28,951	\$29,226	\$32,556

4 TAPS X4/24

HS1860S24	Grade 1 Laminate	\$26,910	\$27,185	\$30,515
	Grade 2 and 3 Laminate	\$27,403	\$27,678	\$31,008
	Grade 1 Veneer	\$31,061	\$31,336	\$34,666
	Grade 2 Veneer	\$33,631	\$33,906	\$37,236

6 TAPS X4/24

HS1860S26	Grade 1 Laminate	\$31,594	\$31,869	\$35,199
	Grade 2 and 3 Laminate	\$32,087	\$32,362	\$35,692
	Grade 1 Veneer	\$35,745	\$36,020	\$39,350
	Grade 2 Veneer	\$38,315	\$38,590	\$41,920

▶ Specification Information, continued on next page

Host Collaborative and Conference Tables



For Canadian Pricing
 Multiply U.S. Price by the Canadian price factor.
 ▶ See page 1 for details.

X4/24 = Last order entry
 April 14, 2024

Host Collaborative and Conference Tables Soft Radiused Tables with Three Bases *continued*

DESIGN F/P DESIGN AND VECTA DESIGN TEAM



Tip: Prices shown include top, TAP(s), and slim bases.
 ▶ See base options for flared bases, page 396

Tip: Last digit of style number indicates number of TAP(s).

Tip: For tech corridor, 18'L tables have eight long doors and four short doors.

▶ Specification Information, continued from previous page

Specification Information

Style Number	Finish	U.S. Base Prices		
				
		Flat Wood Edge:	Bullnose Wood Edge:	Horizon Wood Edge:

18'L x 60"W Three Piece Top

0 TAP X4/24

HS1860S30	Grade 1 Laminate	\$18,105	\$18,380	\$21,710
	Grade 2 and 3 Laminate	\$18,598	\$18,873	\$22,203
	Grade 1 Veneer	\$22,256	\$22,531	\$25,861
	Grade 2 Veneer	\$24,826	\$25,101	\$28,431

1 TAP X4/24

HS1860S31	Grade 1 Laminate	\$20,449	\$20,724	\$24,054
	Grade 2 and 3 Laminate	\$20,942	\$21,217	\$24,547
	Grade 1 Veneer	\$24,600	\$24,875	\$28,205
	Grade 2 Veneer	\$27,170	\$27,445	\$30,775

2 TAPS X4/24

HS1860S32	Grade 1 Laminate	\$22,789	\$23,064	\$26,394
	Grade 2 and 3 Laminate	\$23,282	\$23,557	\$26,887
	Grade 1 Veneer	\$26,940	\$27,215	\$30,545
	Grade 2 Veneer	\$29,510	\$29,785	\$33,115

4 TAPS X4/24

HS1860S34	Grade 1 Laminate	\$27,473	\$27,748	\$31,078
	Grade 2 and 3 Laminate	\$27,966	\$28,241	\$31,571
	Grade 1 Veneer	\$31,624	\$31,899	\$35,229
	Grade 2 Veneer	\$34,194	\$34,469	\$37,799

6 TAPS X4/24

HS1860S36	Grade 1 Laminate	\$32,155	\$32,430	\$35,760
	Grade 2 and 3 Laminate	\$32,648	\$32,923	\$36,253
	Grade 1 Veneer	\$36,306	\$36,581	\$39,911
	Grade 2 Veneer	\$38,876	\$39,151	\$42,481

▶ Specification Information, continued on next page

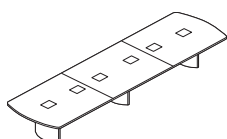
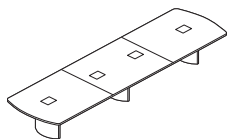
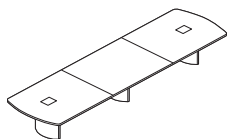
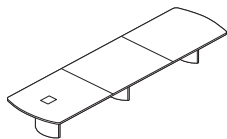
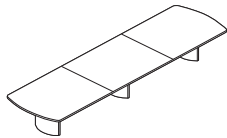

For Canadian Pricing
 Multiply U.S. Price by the Canadian price factor.
 ▶ See page 1 for details.

X4/24 = Last order entry
 April 14, 2024

Host Collaborative and Conference Tables Soft Radiused Tables with Three Bases

DESIGN F/P DESIGN AND VECTA DESIGN TEAM

Tip: Prices shown include top, TAP(s), and slim bases.
 ▶ See base options for flared bases, page 396

Tip: Last digit of style number indicates number of TAP(s).

Tip: For tech corridor, 20'L tables have eight long doors and four short doors.

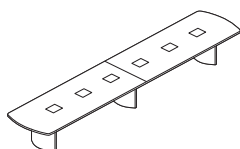
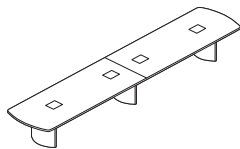
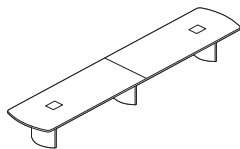
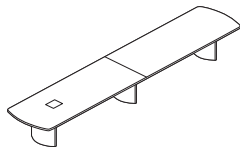
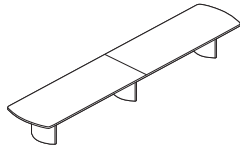

▶ Specification Information, continued from previous page

Specification Information

Style Number	Finish	U.S. Base Prices		
		Flat Wood Edge:	Bullnose Wood Edge:	Horizon Wood Edge:

20'L x 48"W Two Piece Top

0 TAP X4/24

HS2048S20	Grade 1 Laminate	\$17,807	\$18,095	\$21,597
	Grade 2 and 3 Laminate	\$18,244	\$18,532	\$22,034
	Grade 1 Veneer	\$19,954	\$20,242	\$23,744
	Grade 2 Veneer	\$22,190	\$22,478	\$25,980

1 TAP X4/24

HS2048S21	Grade 1 Laminate	\$20,150	\$20,438	\$23,940
	Grade 2 and 3 Laminate	\$20,587	\$20,875	\$24,377
	Grade 1 Veneer	\$22,297	\$22,585	\$26,087
	Grade 2 Veneer	\$24,533	\$24,821	\$28,323

2 TAPS X4/24

HS2048S22	Grade 1 Laminate	\$22,489	\$22,777	\$26,279
	Grade 2 and 3 Laminate	\$22,926	\$23,214	\$26,716
	Grade 1 Veneer	\$24,636	\$24,924	\$28,426
	Grade 2 Veneer	\$26,872	\$27,160	\$30,662

4 TAPS X4/24

HS2048S24	Grade 1 Laminate	\$27,178	\$27,466	\$30,968
	Grade 2 and 3 Laminate	\$27,615	\$27,903	\$31,405
	Grade 1 Veneer	\$29,325	\$29,613	\$33,115
	Grade 2 Veneer	\$31,561	\$31,849	\$35,351

6 TAPS X4/24

HS2048S26	Grade 1 Laminate	\$31,859	\$32,147	\$35,649
	Grade 2 and 3 Laminate	\$32,296	\$32,584	\$36,086
	Grade 1 Veneer	\$34,006	\$34,294	\$37,796
	Grade 2 Veneer	\$36,242	\$36,530	\$40,032

▶ Specification Information, continued on next page

Host Collaborative and Conference Tables

For Canadian Pricing
 Multiply U.S. Price by the Canadian price factor.
 ▶ See page 1 for details.

X4/24 = Last order entry
 April 14, 2024

Host Collaborative and Conference Tables Soft Radiused Tables with Three Bases *continued*

DESIGN F/P DESIGN AND VECTA DESIGN TEAM

Tip: Prices shown include top, TAP(s), and slim bases.
 ▶ See base options for flared bases, page 396

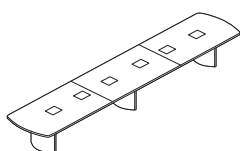
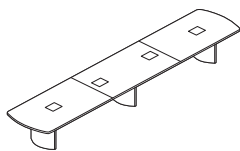
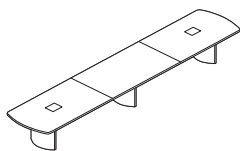
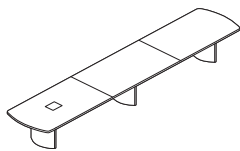
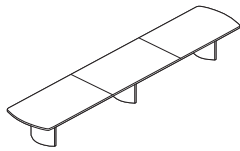

Tip: Last digit of style number indicates number of TAP(s).

Tip: For tech corridor, 20'L tables have eight long doors and four short doors.



▶ Specification Information, continued from previous page

Specification Information

Style Number	Finish	U.S. Base Prices		
				
		Flat Wood Edge:	Bullnose Wood Edge:	Horizon Wood Edge:

20'L x 48"W Three Piece Top

0 TAP ~~34/24~~

Style Number	Finish	Flat Wood Edge	Bullnose Wood Edge	Horizon Wood Edge
HS2048S30	Grade 1 Laminate	\$18,365	\$18,653	\$22,155
	Grade 2 and 3 Laminate	\$18,802	\$19,090	\$22,592
	Grade 1 Veneer	\$20,512	\$20,800	\$24,302
	Grade 2 Veneer	\$22,748	\$23,036	\$26,538

1 TAP ~~34/24~~

Style Number	Finish	Flat Wood Edge	Bullnose Wood Edge	Horizon Wood Edge
HS2048S31	Grade 1 Laminate	\$20,709	\$20,997	\$24,499
	Grade 2 and 3 Laminate	\$21,146	\$21,434	\$24,936
	Grade 1 Veneer	\$22,856	\$23,144	\$26,646
	Grade 2 Veneer	\$25,092	\$25,380	\$28,882

2 TAPS ~~34/24~~

Style Number	Finish	Flat Wood Edge	Bullnose Wood Edge	Horizon Wood Edge
HS2048S32	Grade 1 Laminate	\$23,052	\$23,340	\$26,842
	Grade 2 and 3 Laminate	\$23,489	\$23,777	\$27,279
	Grade 1 Veneer	\$25,199	\$25,487	\$28,989
	Grade 2 Veneer	\$27,435	\$27,723	\$31,225

4 TAPS ~~34/24~~

Style Number	Finish	Flat Wood Edge	Bullnose Wood Edge	Horizon Wood Edge
HS2048S34	Grade 1 Laminate	\$27,736	\$28,024	\$31,524
	Grade 2 and 3 Laminate	\$28,173	\$28,461	\$31,961
	Grade 1 Veneer	\$29,883	\$30,171	\$33,671
	Grade 2 Veneer	\$32,119	\$32,407	\$35,907

6 TAPS ~~34/24~~

Style Number	Finish	Flat Wood Edge	Bullnose Wood Edge	Horizon Wood Edge
HS2048S36	Grade 1 Laminate	\$32,420	\$32,708	\$36,208
	Grade 2 and 3 Laminate	\$32,857	\$33,145	\$36,645
	Grade 1 Veneer	\$34,567	\$34,855	\$38,355
	Grade 2 Veneer	\$36,803	\$37,091	\$40,591

▶ Specification Information, continued on next page



For Canadian Pricing
 Multiply U.S. Price by the Canadian price factor.
 ▶ See page 1 for details.

~~34/24~~ = Last order entry
 April 14, 2024

Host Collaborative and Conference Tables Soft Radiused Tables with Three Bases

DESIGN F/P DESIGN AND VECTA DESIGN TEAM

Tip: Prices shown include top, TAP(s), and slim bases.
 ▶ See base options for flared bases, page 396

Tip: Last digit of style number indicates number of TAP(s).

Tip: For tech corridor, 20'L tables have eight long doors and four short doors.

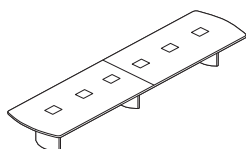
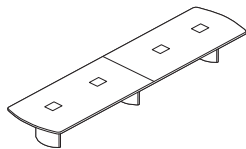
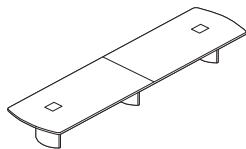
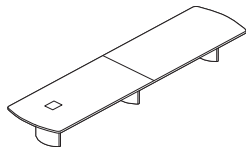
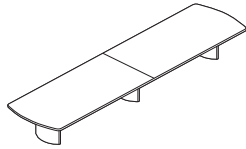

▶ Specification Information, continued from previous page

Specification Information

Style Number	Finish	U.S. Base Prices		
		Flat Wood Edge:	Bullnose Wood Edge:	Horizon Wood Edge:

20'L x 60"W Two Piece Top

0 TAP X4/24

Style Number	Finish	Flat Wood Edge	Bullnose Wood Edge	Horizon Wood Edge
HS2060S20	Grade 1 Laminate	\$18,179	\$18,480	\$22,049
	Grade 2 and 3 Laminate	\$18,725	\$19,026	\$22,595
	Grade 1 Veneer	\$22,325	\$22,626	\$26,195
	Grade 2 Veneer	\$25,164	\$25,465	\$29,034

1 TAP X4/24

Style Number	Finish	Flat Wood Edge	Bullnose Wood Edge	Horizon Wood Edge
HS2060S21	Grade 1 Laminate	\$20,520	\$20,821	\$24,390
	Grade 2 and 3 Laminate	\$21,066	\$21,367	\$24,936
	Grade 1 Veneer	\$24,666	\$24,967	\$28,536
	Grade 2 Veneer	\$27,505	\$27,806	\$31,375

2 TAPS X4/24

Style Number	Finish	Flat Wood Edge	Bullnose Wood Edge	Horizon Wood Edge
HS2060S22	Grade 1 Laminate	\$22,860	\$23,161	\$26,730
	Grade 2 and 3 Laminate	\$23,406	\$23,707	\$27,276
	Grade 1 Veneer	\$27,006	\$27,307	\$30,876
	Grade 2 Veneer	\$29,845	\$30,146	\$33,715

4 TAPS X4/24

Style Number	Finish	Flat Wood Edge	Bullnose Wood Edge	Horizon Wood Edge
HS2060S24	Grade 1 Laminate	\$27,545	\$27,846	\$31,415
	Grade 2 and 3 Laminate	\$28,091	\$28,392	\$31,961
	Grade 1 Veneer	\$31,691	\$31,992	\$35,561
	Grade 2 Veneer	\$34,530	\$34,831	\$38,400

6 TAPS X4/24

Style Number	Finish	Flat Wood Edge	Bullnose Wood Edge	Horizon Wood Edge
HS2060S26	Grade 1 Laminate	\$32,228	\$32,529	\$36,098
	Grade 2 and 3 Laminate	\$32,774	\$33,075	\$36,644
	Grade 1 Veneer	\$36,374	\$36,675	\$40,244
	Grade 2 Veneer	\$39,213	\$39,514	\$43,083

▶ Specification Information, continued on next page

Host Collaborative and Conference Tables

For Canadian Pricing
 Multiply U.S. Price by the Canadian price factor.
 ▶ See page 1 for details.

X4/24 = Last order entry
 April 14, 2024

Host Collaborative and Conference Tables Soft Radiused Tables with Three Bases *continued*

DESIGN F/P DESIGN AND VECTA DESIGN TEAM

► Specification Information, continued from previous page

Tip: Prices shown include top, TAP(s), and slim bases.



► See base options for flared bases, page 396

Tip: Last digit of style number indicates number of TAP(s).

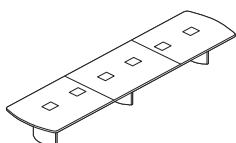
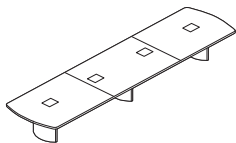
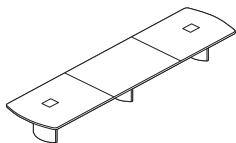
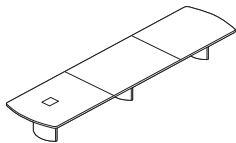
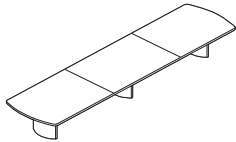
Tip: For tech corridor, 20'L tables have eight long doors and four short doors.



Specification Information

Style Number	Finish	U.S. Base Prices		
				
		Flat Wood Edge:	Bullnose Wood Edge:	Horizon Wood Edge:

20'L x 60" W Three Piece Top

0 TAP ~~3~~4/24

Style Number	Finish	Flat Wood Edge	Bullnose Wood Edge	Horizon Wood Edge
HS2060S30	Grade 1 Laminate	\$18,737	\$19,038	\$22,607
	Grade 2 and 3 Laminate	\$19,283	\$19,584	\$23,153
	Grade 1 Veneer	\$22,883	\$23,184	\$26,753
	Grade 2 Veneer	\$25,722	\$26,023	\$29,592

1 TAP ~~3~~4/24

Style Number	Finish	Flat Wood Edge	Bullnose Wood Edge	Horizon Wood Edge
HS2060S31	Grade 1 Laminate	\$21,080	\$21,381	\$24,950
	Grade 2 and 3 Laminate	\$21,626	\$21,927	\$25,496
	Grade 1 Veneer	\$25,226	\$25,527	\$29,096
	Grade 2 Veneer	\$28,065	\$28,366	\$31,935

2 TAPS ~~3~~4/24

Style Number	Finish	Flat Wood Edge	Bullnose Wood Edge	Horizon Wood Edge
HS2060S32	Grade 1 Laminate	\$23,423	\$23,724	\$27,293
	Grade 2 and 3 Laminate	\$23,969	\$24,270	\$27,839
	Grade 1 Veneer	\$27,569	\$27,870	\$31,439
	Grade 2 Veneer	\$30,408	\$30,709	\$34,278

4 TAPS ~~3~~4/24

Style Number	Finish	Flat Wood Edge	Bullnose Wood Edge	Horizon Wood Edge
HS2060S34	Grade 1 Laminate	\$28,106	\$28,407	\$31,976
	Grade 2 and 3 Laminate	\$28,652	\$28,953	\$32,522
	Grade 1 Veneer	\$32,252	\$32,553	\$36,122
	Grade 2 Veneer	\$35,091	\$35,392	\$38,961

6 TAPS ~~3~~4/24

Style Number	Finish	Flat Wood Edge	Bullnose Wood Edge	Horizon Wood Edge
HS2060S36	Grade 1 Laminate	\$32,790	\$33,091	\$36,660
	Grade 2 and 3 Laminate	\$33,336	\$33,637	\$37,206
	Grade 1 Veneer	\$36,936	\$37,237	\$40,806
	Grade 2 Veneer	\$39,775	\$40,076	\$43,645



For Canadian Pricing
 Multiply U.S. Price by the Canadian price factor.
 ► See page 1 for details.

~~3~~4/24 = Last order entry
 April 14, 2024

Coalesse

Host Collaborative and Conference Tables

Soft Radiused Tables with Three Bases

DESIGN F/P DESIGN AND VECTA DESIGN TEAM

Host Collaborative and
Conference Tables

Host Collaborative and Conference Tables Racetrack Tables with Two Bases X4/24

DESIGN F/P DESIGN AND VECTA DESIGN TEAM

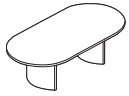

Tip: Shipped knocked down.

Tip: Grain direction for wood-grain laminate runs the length of the table.

Tip: Clips are provided with table: one clip per foot of table length.

Tip: The wood edge on a table top with woodgrain laminate may not match the top.

Standard Includes		Required to Specify
<p>► Need help? Product details, page 334</p> <ul style="list-style-type: none"> • Top: 1¼" particle board core with laminate • Flat wood edge • TAP(s), if selected: 10"W x 12"L opening(s) trimmed with a flat solid wood profile and with brushed anodized aluminum TAP doors • Tech corridor: two aluminum beams for top support provide tracks for hinged aluminum doors that clip shut: satin anodized finish • Universal clip: black plastic • Two 27"W bases: wood veneer on MDF with aluminum universal bracket • Concealed leveling glides: non-marring, black plastic 		<ol style="list-style-type: none"> 1 Style number 2 Base selection (see below) and wood color number for base 3 Laminate color number for table top, if selected 4 Wood color number for wood edge 5 Door color number for storage tray or TAP door, if selected: <ul style="list-style-type: none"> - 8044 Black - 8047 Silver 6 Options, if selected (see below) <p>► See <i>Coalesse Surface Materials Reference Guide</i>.</p>

	Options	U.S. Price	Required to Specify
Surface Materials	<p>Top</p> <ul style="list-style-type: none"> • Grade 2 laminate • Grade 3 laminate • Grade 1 wood veneer • Grade 2 wood veneer 	<p>Prices at right</p> <p>Prices at right</p> <p>Prices at right</p> <p>Prices at right</p>	<p>Specify with <i>Grade 2 laminate</i> and select color number.</p> <p>Specify with <i>Grade 3 laminate</i> and select color number.</p> <p>Specify with <i>Grade 1 wood veneer</i> and select color number.</p> <p>Specify with <i>Grade 2 wood veneer</i> and select color number.</p>

Edges	<p>Wood</p> <ul style="list-style-type: none"> • Bullnose wood edge • Beveled wood edge • Horizon wood edge 	<p>Prices at right</p> <p>Prices at right</p> <p>Prices at right</p>	<p>Specify with <i>bullnose wood edge</i>.</p> <p>Specify with <i>beveled wood edge</i>.</p> <p>Specify with <i>horizon wood edge</i>.</p>
--------------	---	--	--

<p>Bases</p> <p>Slim Flared</p>	<ul style="list-style-type: none"> • Two slim bases • One slim and one flared base • Two flared bases 	<p>No cost</p> <p>+\$1219</p> <p>+\$2441</p>	<p>Specify with <i>two slim bases</i>.</p> <p>Specify with <i>one slim base and one flared base</i>.</p> <p>Specify with <i>two flared bases</i>.</p>
--	--	--	---

Tip: 96"L tables available with zero, one, or two TAP(s). 10'L and 12'L tables available with zero, one, two, or three TAP(s).

Tip: In addition to the data and audio/video AAPs available from Coalesse, other styles of AAPs are available through Extron Electronics. For an Extron dealer, call 1-800-633-9876.

Tip: See TAP options for electrical systems and faceplate list.

<p>TAP Electrical System with Faceplate Options</p> <p>► Page 345</p> <p>Field Wired</p> <p>Cord and Plug</p> <p>Hardwired</p>	<ul style="list-style-type: none"> • Field-wired tray (no electrical) <ul style="list-style-type: none"> - PAFW field-wired tray (no electrical) with blank AAPs - PDFW field-wired tray (no electrical) with two data AAPs - PVFW field-wired tray (no electrical) with two of each video/audio and data AAPs • Cord and plug tray (10' cord) <ul style="list-style-type: none"> - PACP cord and plug tray with outlets and blank AAPs - PDCP cord and plug tray with outlets and two data AAPs - PAVC cord and plug tray with outlets and two of each video/audio and data AAPs • Hard-wired tray (6' conduit) <ul style="list-style-type: none"> - PAHW hard-wired tray with outlets and blank AAPs - PDHW hard-wired tray with outlets and two data AAPs - PAVH hard-wired tray with outlets and two of each video/audio and data AAPs 	<p>No cost</p> <p>No cost</p> <p>No cost</p>	<p>Specify with <i>power data</i>, and select TAP type and TAP door color number.</p> <p>Specify with <i>power data</i>, and select TAP type and TAP door color number.</p> <p>Specify with <i>power data</i>, and select TAP type and TAP door color number.</p>
---	---	--	---

► Options, continued on next page



For Canadian Pricing
 Multiply U.S. Price by the Canadian price factor.
 ► See page 1 for details.

X4/24 = Last order entry
 April 14, 2024

Host Collaborative and Conference Tables Racetrack Tables with Two Bases

DESIGN F/P DESIGN AND VECTA DESIGN TEAM

Tip: For single TAP style numbers, the modular system tray is not available. Specify the hard-wired tray option.

Tip: If the specified table has multiple TAP(s), any one TAP can be replaced with a storage tray.

Tip: Wood veneer doors for storage tray and TAP will always be cross grain.

Tip: Connectrac must be the same wiring schematic as the table.

► Options, continued from previous page

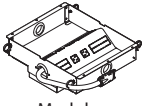
Options	U.S. Price	Required to Specify
TAP Electrical System with Faceplate Options ► Page 345  Modular	<ul style="list-style-type: none"> • Modular system tray (hardwire base power infeed) <ul style="list-style-type: none"> - PAMH modular system tray with outlets and blank AAPs - PDMH modular system tray with outlets and two data AAPs - PVMH modular system tray with outlets and two of each video/audio and data AAPs 	+\$208 each tray Specify with modular power data, and select TAP type and TAP door color number.
Storage Tray ► Page 346	<ul style="list-style-type: none"> • Storage tray 	-\$875 Specify with storage tray and select door color number.
Doors	<ul style="list-style-type: none"> • Storage tray wood veneer doors • TAP wood veneer doors 	+\$438 per door +\$438 per door Specify with wood doors. Specify with wood doors.
Related Products	<ul style="list-style-type: none"> • Floor kit: Connectrac • Corridor shelf • Power strip 	► Page 468 ► Page 468 ► Page 739

TAP Locations

96"L x 48"W TAP Locations—One piece top

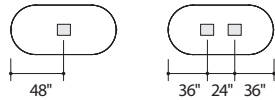

10'L x 48"W TAP Locations—One piece top

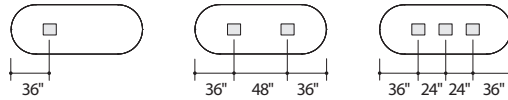

10'L x 48"W TAP Locations—Two piece top

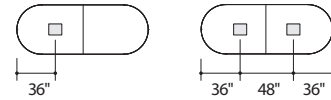

10'L x 60"W TAP Locations—One piece top

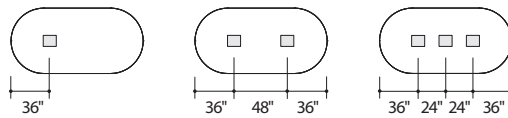

10'L x 60"W TAP Locations—Two piece top

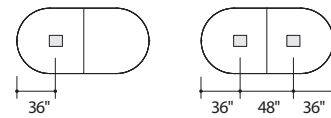

12'L x 48"W TAP Locations—Two piece top

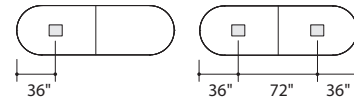

12'L x 60"W TAP Locations—Two piece top

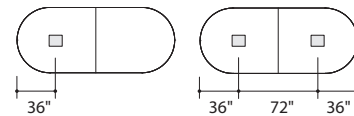

► Specification Information, on next page

Host Collaborative and Conference Tables

For Canadian Pricing
 Multiply U.S. Price by the Canadian price factor.
 ► See page 1 for details.

Host Collaborative and Conference Tables Racetrack Tables with Two Bases *continued*

DESIGN F/P DESIGN AND VECTA DESIGN TEAM

► Options, on previous page

Tip: Prices shown include top, TAP(s), and slim bases.



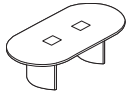
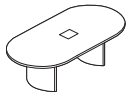
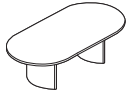

► See base options for flared bases, page 416

Tip: Last digit of style number indicates number of TAP(s).

Tip: For tech corridor, 96"L tables have two long doors and four short doors.



Specification Information

Style Number	Finish	U.S. Base Prices			
					
		Flat Wood Edge:	Bullnose Wood Edge:	Beveled Wood Edge:	Horizon Wood Edge:

96"L x 48"W One Piece Top

0 TAP X34/24

HS9648C10	Grade 1 Laminate	\$10,142	\$10,288	\$10,493	\$13,249
	Grade 2 and 3 Laminate	\$10,316	\$10,462	\$10,667	\$13,423
	Grade 1 Veneer	\$11,172	\$11,318	\$11,523	\$14,279
	Grade 2 Veneer	\$12,069	\$12,215	\$12,420	\$15,176

1 TAP X34/24

HS9648C11	Grade 1 Laminate	\$12,483	\$12,629	\$12,834	\$15,590
	Grade 2 and 3 Laminate	\$12,657	\$12,803	\$13,008	\$15,764
	Grade 1 Veneer	\$13,513	\$13,659	\$13,864	\$16,620
	Grade 2 Veneer	\$14,410	\$14,556	\$14,761	\$17,517

2 TAPS X34/24

HS9648C12	Grade 1 Laminate	\$14,825	\$14,971	\$15,176	\$17,932
	Grade 2 and 3 Laminate	\$14,999	\$15,145	\$15,350	\$18,106
	Grade 1 Veneer	\$15,855	\$16,001	\$16,206	\$18,962
	Grade 2 Veneer	\$16,752	\$16,898	\$17,103	\$19,859

► Specification Information, continued on next page



For Canadian Pricing
 Multiply U.S. Price by the Canadian price factor.
 ► See page 1 for details.

X34/24 = Last order entry
 April 14, 2024

Host Collaborative and Conference Tables Racetrack Tables with Two Bases

DESIGN F/P DESIGN AND VECTA DESIGN TEAM

Tip: Prices shown include top, TAP(s), and slim bases.
 ▶ See base options for flared bases, page 416

Tip: Last digit of style number indicates number of TAP(s).

Tip: For tech corridor, 10'L tables have four long doors and four short doors.

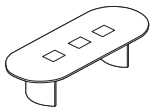
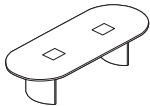
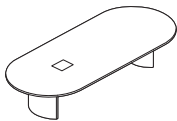
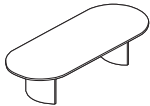

▶ Specification Information, continued from previous page

Specification Information

Style Number	Finish	U.S. Base Prices			
		Flat Wood Edge:	Bullnose Wood Edge:	Beveled Wood Edge:	Horizon Wood Edge:

10'L x 48''W One Piece Top

0 TAP X4/24

HS1048C10	Grade 1 Laminate	\$10,916	\$11,085	\$11,321	\$14,078
	Grade 2 and 3 Laminate	\$11,139	\$11,308	\$11,544	\$14,301
	Grade 1 Veneer	\$12,160	\$12,329	\$12,565	\$15,322
	Grade 2 Veneer	\$13,285	\$13,454	\$13,690	\$16,447

1 TAP X4/24

HS1048C11	Grade 1 Laminate	\$13,376	\$13,545	\$13,781	\$16,538
	Grade 2 and 3 Laminate	\$13,599	\$13,768	\$14,004	\$16,761
	Grade 1 Veneer	\$14,620	\$14,789	\$15,025	\$17,782
	Grade 2 Veneer	\$15,745	\$15,914	\$16,150	\$18,907

2 TAPS X4/24

HS1048C12	Grade 1 Laminate	\$15,718	\$15,887	\$16,123	\$18,880
	Grade 2 and 3 Laminate	\$15,941	\$16,110	\$16,346	\$19,103
	Grade 1 Veneer	\$16,963	\$17,132	\$17,368	\$20,125
	Grade 2 Veneer	\$18,087	\$18,256	\$18,492	\$21,249

3 TAPS X4/24

HS1048C13	Grade 1 Laminate	\$18,061	\$18,230	\$18,466	\$21,223
	Grade 2 and 3 Laminate	\$18,284	\$18,453	\$18,689	\$21,446
	Grade 1 Veneer	\$19,305	\$19,474	\$19,710	\$22,467
	Grade 2 Veneer	\$20,430	\$20,599	\$20,835	\$23,592

▶ Specification Information, continued on next page

For Canadian Pricing
 Multiply U.S. Price by the Canadian price factor.
 ▶ See page 1 for details.

X4/24 = Last order entry
 April 14, 2024

Host Collaborative and Conference Tables Racetrack Tables with Two Bases *continued*

DESIGN F/P DESIGN AND VECTA DESIGN TEAM

► Specification Information, continued from previous page

Tip: Prices shown include top, TAP(s), and slim bases.

► See base options for flared bases, page 416

Tip: Last digit of style number indicates number of TAP(s).

Tip: For tech corridor, 10'L tables have four long doors and four short doors.

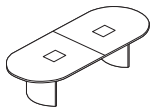
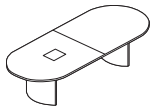
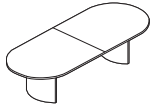

Specification Information

Style Number	Finish	U.S. Base Prices			
		Flat Wood Edge:	Bullnose Wood Edge:	Beveled Wood Edge:	Horizon Wood Edge:

10'L x 48"W Two Piece Top

0 TAP ~~3~~4/24

Style Number	Finish	Flat Wood Edge	Bullnose Wood Edge	Beveled Wood Edge	Horizon Wood Edge
HS1048C20	Grade 1 Laminate	\$11,596	\$11,765	\$12,001	\$14,758
	Grade 2 and 3 Laminate	\$11,819	\$11,988	\$12,224	\$14,981
	Grade 1 Veneer	\$12,840	\$13,009	\$13,245	\$16,002
	Grade 2 Veneer	\$13,965	\$14,134	\$14,370	\$17,127

1 TAP ~~3~~4/24

Style Number	Finish	Flat Wood Edge	Bullnose Wood Edge	Beveled Wood Edge	Horizon Wood Edge
HS1048C21	Grade 1 Laminate	\$13,938	\$14,107	\$14,343	\$17,100
	Grade 2 and 3 Laminate	\$14,161	\$14,330	\$14,566	\$17,323
	Grade 1 Veneer	\$15,182	\$15,351	\$15,587	\$18,344
	Grade 2 Veneer	\$16,307	\$16,476	\$16,712	\$19,469

2 TAPS ~~3~~4/24

Style Number	Finish	Flat Wood Edge	Bullnose Wood Edge	Beveled Wood Edge	Horizon Wood Edge
HS1048C22	Grade 1 Laminate	\$16,279	\$16,448	\$16,684	\$19,441
	Grade 2 and 3 Laminate	\$16,502	\$16,671	\$16,907	\$19,664
	Grade 1 Veneer	\$17,523	\$17,692	\$17,928	\$20,685
	Grade 2 Veneer	\$18,648	\$18,817	\$19,053	\$21,810

► Specification Information, continued on next page



For Canadian Pricing
Multiply U.S. Price by the Canadian price factor.
► See page 1 for details.

~~3~~4/24 = Last order entry
April 14, 2024

Host Collaborative and Conference Tables Racetrack Tables with Two Bases

DESIGN F/P DESIGN AND VECTA DESIGN TEAM

► Specification Information, continued from previous page

Tip: Prices shown include top, TAP(s), and slim bases.
 ► See base options for flared bases, page 416

Tip: Last digit of style number indicates number of TAP(s).

Tip: For tech corridor, 10'L tables have four long doors and four short doors.

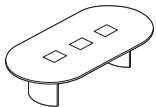
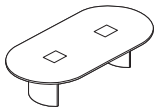
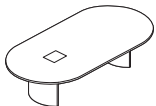
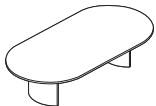

Specification Information

Style Number	Finish	U.S. Base Prices			
		Flat Wood Edge:	Bullnose Wood Edge:	Beveled Wood Edge:	Horizon Wood Edge:

10'L x 60"W One Piece Top

0 TAP X4/24

Style Number	Finish	Flat Wood Edge	Bullnose Wood Edge	Beveled Wood Edge	Horizon Wood Edge
HS1060C10	Grade 1 Laminate	\$11,264	\$11,447	\$11,699	\$14,454
	Grade 2 and 3 Laminate	\$11,532	\$11,715	\$11,967	\$14,722
	Grade 1 Veneer	\$13,224	\$13,407	\$13,659	\$16,414
	Grade 2 Veneer	\$14,641	\$14,824	\$15,076	\$17,831

1 TAP X4/24

Style Number	Finish	Flat Wood Edge	Bullnose Wood Edge	Beveled Wood Edge	Horizon Wood Edge
HS1060C11	Grade 1 Laminate	\$13,607	\$13,790	\$14,042	\$16,797
	Grade 2 and 3 Laminate	\$13,875	\$14,058	\$14,310	\$17,065
	Grade 1 Veneer	\$15,567	\$15,750	\$16,002	\$18,757
	Grade 2 Veneer	\$16,984	\$17,167	\$17,419	\$20,174

2 TAPS X4/24

Style Number	Finish	Flat Wood Edge	Bullnose Wood Edge	Beveled Wood Edge	Horizon Wood Edge
HS1060C12	Grade 1 Laminate	\$15,951	\$16,134	\$16,386	\$19,141
	Grade 2 and 3 Laminate	\$16,219	\$16,402	\$16,654	\$19,409
	Grade 1 Veneer	\$17,911	\$18,094	\$18,346	\$21,101
	Grade 2 Veneer	\$19,328	\$19,511	\$19,763	\$22,518

3 TAPS X4/24

Style Number	Finish	Flat Wood Edge	Bullnose Wood Edge	Beveled Wood Edge	Horizon Wood Edge
HS1060C13	Grade 1 Laminate	\$18,292	\$18,475	\$18,727	\$21,482
	Grade 2 and 3 Laminate	\$18,560	\$18,743	\$18,995	\$21,750
	Grade 1 Veneer	\$20,252	\$20,435	\$20,687	\$23,442
	Grade 2 Veneer	\$21,669	\$21,852	\$22,104	\$24,859

► Specification Information, continued on next page

For Canadian Pricing
 Multiply U.S. Price by the Canadian price factor.
 ► See page 1 for details.

X4/24 = Last order entry
 April 14, 2024

Host Collaborative and Conference Tables Racetrack Tables with Two Bases *continued*

DESIGN F/P DESIGN AND VECTA DESIGN TEAM

► Specification Information, continued from previous page

Tip: Prices shown include top, TAP(s), and slim bases.

► See base options for flared bases, page 416

Tip: Last digit of style number indicates number of TAP(s).

Tip: For tech corridor, 10'L tables have four long doors and four short doors.

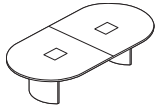
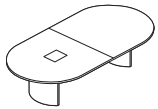
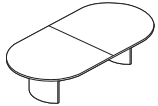

Specification Information

Style Number	Finish	U.S. Base Prices			
		Flat Wood Edge:	Bullnose Wood Edge:	Beveled Wood Edge:	Horizon Wood Edge:

10'L x 60"W Two Piece Top

0 TAP ~~3~~4/24

Style Number	Finish	Flat Wood Edge	Bullnose Wood Edge	Beveled Wood Edge	Horizon Wood Edge
HS1060C20	Grade 1 Laminate	\$11,829	\$12,012	\$12,264	\$15,019
	Grade 2 and 3 Laminate	\$12,097	\$12,280	\$12,532	\$15,287
	Grade 1 Veneer	\$13,789	\$13,972	\$14,224	\$16,979
	Grade 2 Veneer	\$15,206	\$15,389	\$15,641	\$18,396

1 TAP ~~3~~4/24

Style Number	Finish	Flat Wood Edge	Bullnose Wood Edge	Beveled Wood Edge	Horizon Wood Edge
HS1060C21	Grade 1 Laminate	\$14,170	\$14,353	\$14,605	\$17,360
	Grade 2 and 3 Laminate	\$14,438	\$14,621	\$14,873	\$17,628
	Grade 1 Veneer	\$16,130	\$16,313	\$16,565	\$19,320
	Grade 2 Veneer	\$17,547	\$17,730	\$17,982	\$20,737

2 TAPS ~~3~~4/24

Style Number	Finish	Flat Wood Edge	Bullnose Wood Edge	Beveled Wood Edge	Horizon Wood Edge
HS1060C22	Grade 1 Laminate	\$16,510	\$16,693	\$16,945	\$19,700
	Grade 2 and 3 Laminate	\$16,778	\$16,961	\$17,213	\$19,968
	Grade 1 Veneer	\$18,470	\$18,653	\$18,905	\$21,660
	Grade 2 Veneer	\$19,887	\$20,070	\$20,322	\$23,077

► Specification Information, continued on next page



For Canadian Pricing
Multiply U.S. Price by the Canadian price factor.
► See page 1 for details.

~~3~~4/24 = Last order entry
April 14, 2024

Host Collaborative and Conference Tables Racetrack Tables with Two Bases *continued*

DESIGN F/P DESIGN AND VECTA DESIGN TEAM

► Specification Information, continued from previous page

Tip: Prices shown include top, TAP(s), and slim bases.
 ► See base options for flared bases, page 416

Tip: Last digit of style number indicates number of TAP(s).

Tip: For tech corridor, 12'L tables have four long doors and four short doors.

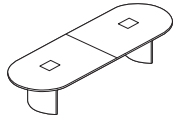
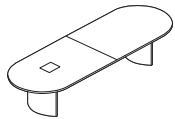
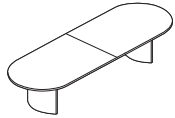

Specification Information

Style Number	Finish	U.S. Base Prices			
		Flat Wood Edge:	Bullnose Wood Edge:	Beveled Wood Edge:	Horizon Wood Edge:

12'L x 48"W Two Piece Top

0 TAP **X4/24**

HS1248C20	Grade 1 Laminate	\$12,403	\$12,598	\$12,864	\$15,624
	Grade 2 and 3 Laminate	\$12,665	\$12,860	\$13,126	\$15,886
	Grade 1 Veneer	\$13,997	\$14,192	\$14,458	\$17,218
	Grade 2 Veneer	\$15,353	\$15,548	\$15,814	\$18,574

1 TAP **X4/24**

HS1248C21	Grade 1 Laminate	\$14,745	\$14,940	\$15,206	\$17,966
	Grade 2 and 3 Laminate	\$15,007	\$15,202	\$15,468	\$18,228
	Grade 1 Veneer	\$16,339	\$16,534	\$16,800	\$19,560
	Grade 2 Veneer	\$17,695	\$17,890	\$18,156	\$20,916

2 TAPS **X4/24**

HS1248C22	Grade 1 Laminate	\$17,086	\$17,281	\$17,547	\$20,307
	Grade 2 and 3 Laminate	\$17,348	\$17,543	\$17,809	\$20,569
	Grade 1 Veneer	\$18,680	\$18,875	\$19,141	\$21,901
	Grade 2 Veneer	\$20,036	\$20,231	\$20,497	\$23,257

► Specification Information, continued on next page



For Canadian Pricing
 Multiply U.S. Price by the Canadian price factor.
 ► See page 1 for details.

X4/24 = Last order entry
 April 14, 2024

Host Collaborative and Conference Tables Racetrack Tables with Two Bases *continued*

DESIGN F/P DESIGN AND VECTA DESIGN TEAM

► Specification Information, continued from previous page

Tip: Prices shown include top, TAP(s), and slim bases.

► See base options for flared bases, page 416

Tip: Last digit of style number indicates number of TAP(s).

Tip: For tech corridor, 12'L tables have four long doors and four short doors.

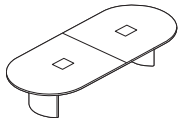
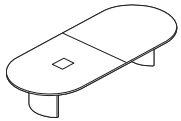
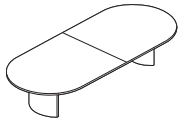

Specification Information

Style Number	Finish	U.S. Base Prices			
		Flat Wood Edge:	Bullnose Wood Edge:	Beveled Wood Edge:	Horizon Wood Edge:

12'L x 60"W Two Piece Top

0 TAP X3/4/24

Style Number	Finish	Flat Wood Edge:	Bullnose Wood Edge:	Beveled Wood Edge:	Horizon Wood Edge:
HS1260C20	Grade 1 Laminate	\$12,651	\$12,855	\$13,143	\$15,899
	Grade 2 and 3 Laminate	\$12,979	\$13,183	\$13,471	\$16,227
	Grade 1 Veneer	\$15,028	\$15,232	\$15,520	\$18,276
	Grade 2 Veneer	\$16,731	\$16,935	\$17,223	\$19,979

1 TAP X3/4/24

Style Number	Finish	Flat Wood Edge:	Bullnose Wood Edge:	Beveled Wood Edge:	Horizon Wood Edge:
HS1260C21	Grade 1 Laminate	\$14,993	\$15,197	\$15,485	\$18,241
	Grade 2 and 3 Laminate	\$15,321	\$15,525	\$15,813	\$18,569
	Grade 1 Veneer	\$17,370	\$17,574	\$17,862	\$20,618
	Grade 2 Veneer	\$19,073	\$19,277	\$19,565	\$22,321

2 TAPS X3/4/24

Style Number	Finish	Flat Wood Edge:	Bullnose Wood Edge:	Beveled Wood Edge:	Horizon Wood Edge:
HS1260C22	Grade 1 Laminate	\$17,334	\$17,538	\$17,826	\$20,582
	Grade 2 and 3 Laminate	\$17,662	\$17,866	\$18,154	\$20,910
	Grade 1 Veneer	\$19,711	\$19,915	\$20,203	\$22,959
	Grade 2 Veneer	\$21,414	\$21,618	\$21,906	\$24,662



For Canadian Pricing
 Multiply U.S. Price by the Canadian price factor.
 ► See page 1 for details.

X3/4/24 = Last order entry
 April 14, 2024

Coalesse

Host Collaborative and Conference Tables Racetrack Tables with Two Bases

DESIGN F/P DESIGN AND VECTA DESIGN TEAM

Host Collaborative and Conference Tables Racetrack Tables with Three Bases X4/24

DESIGN F/P DESIGN AND VECTA DESIGN TEAM

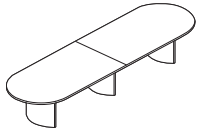

Tip: Shipped knocked down.

Tip: Grain direction for wood-grain laminate runs the length of the table.

Tip: Clips are provided with table: One clip per foot of table length.

Tip: The wood edge on a table top with woodgrain laminate may not match the top.

Standard Includes		Required to Specify
<p>► Need help? Product details, page 334</p> <ul style="list-style-type: none"> • Top: 1¼" particle board core with laminate • Flat wood edge • TAP(s), if selected: 10"W x 12"L opening(s) trimmed with a flat solid wood profile and with brushed anodized aluminum TAP doors • Tech corridor: four aluminum beams for top support provide tracks for hinged aluminum doors that clip shut: satin anodized finish • Universal clip: black plastic • Three 27"W bases: wood veneer on MDF with aluminum universal bracket, see below • Concealed leveling glides: non-marring, black plastic 		<ol style="list-style-type: none"> 1 Style number 2 Base selection (see below) and wood color number for base 3 Laminate color number for table top, if selected 4 Wood color number for wood edge 5 Door color number for storage tray or TAP door, if selected: <ul style="list-style-type: none"> - 8044 Black - 8047 Silver 6 Options, if selected (see below) <p>► See <i>Coalesse Surface Materials Reference Guide</i>.</p>

Options	U.S. Price	Required to Specify
<p>Surface Materials</p> <p>Top</p> <ul style="list-style-type: none"> • Grade 2 laminate • Grade 3 laminate • Grade 1 wood veneer • Grade 2 wood veneer 	<p>Prices at right</p> <p>Prices at right</p> <p>Prices at right</p> <p>Prices at right</p>	<p>Specify with <i>Grade 2 laminate</i> and select color number.</p> <p>Specify with <i>Grade 3 laminate</i> and select color number.</p> <p>Specify with <i>Grade 1 wood veneer</i> and select color number.</p> <p>Specify with <i>Grade 2 wood veneer</i> and select color number.</p>
<p>Edges</p> <p>Wood</p> <ul style="list-style-type: none"> • Bullnose wood edge • Beveled wood edge • Horizon wood edge 	<p>Prices at right</p> <p>Prices at right</p> <p>Prices at right</p>	<p>Specify with <i>bullnose wood edge</i>.</p> <p>Specify with <i>beveled wood edge</i>.</p> <p>Specify with <i>horizon wood edge</i>.</p>
<p>Bases</p> <p>Slim Flared</p> <ul style="list-style-type: none"> • Three slim bases • Two slim and one flared bases • One slim and Two flared bases • Three flared bases 	<p>No cost</p> <p>+\$1217</p> <p>+\$2438</p> <p>+\$3652</p>	<p>Specify with <i>three slim bases</i>.</p> <p>Specify with <i>two slim and one flared bases</i>.</p> <p>Specify with <i>one slim and two flared bases</i>.</p> <p>Specify with <i>three flared bases</i>.</p>

Tip: 14'L and 16'L tables available with zero, one, two, or four TAP(s). 18'L and 20'L tables available with zero, one, two, four, or six TAP(s).

Tip: In addition to the data and audio/video AAPs available from Coalesse, other styles of AAPs are available through Extron Electronics. For an Extron dealer, call 1.800.633.9876.

Tip: See TAP options for electrical systems and faceplate list.

TAP Electrical System with Faceplate Options	U.S. Price	Required to Specify
<p>► Page 345</p> <p>Field Wired</p> <ul style="list-style-type: none"> • Field-wired tray (no electrical) <ul style="list-style-type: none"> - PAFW field-wired tray (no electrical) with blank AAPs - PDFW field-wired tray (no electrical) with two data AAPs - PVFW field-wired tray (no electrical) with two of each video/audio and data AAPs 	No cost	Specify with <i>power data</i> , and select TAP type and TAP door color number.
<p>Cord and Plug</p> <ul style="list-style-type: none"> • Cord and plug tray (10' cord) <ul style="list-style-type: none"> - PACP cord and plug tray with outlets and blank AAPs - PDCP cord and plug tray with outlets and two data AAPs - PAVC cord and plug tray with outlets and two of each video/audio and data AAPs 	No cost	Specify with <i>power data</i> , and select TAP type and TAP door color number.
<p>Hardwired</p> <ul style="list-style-type: none"> • Hard-wired tray (6' conduit) <ul style="list-style-type: none"> - PAHW hard-wired tray with outlets and blank AAPs - PDHW hard-wired tray with outlets and two data AAPs - PAVH hard-wired tray with outlets and two of each video/audio and data AAPs 	No cost	Specify with <i>power data</i> , and select TAP type and TAP door color number.

► Options, continued on next page



For Canadian Pricing
 Multiply U.S. Price by the Canadian price factor.
 ► See page 1 for details.

X4/24 = Last order entry
 April 14, 2024

Host Collaborative and Conference Tables Racetrack Tables with Three Bases

DESIGN F/P DESIGN AND VECTA DESIGN TEAM

Tip: For single TAP style numbers, the modular system tray is not available. Specify the hard-wired tray option.

Tip: If the specified table has multiple TAP(s), any one TAP can be replaced with a storage tray.

Tip: Wood veneer doors for storage tray and TAP will always be cross grain.

Tip: Connectrac must be the same wiring schematic as the table.

► Options, continued from previous page

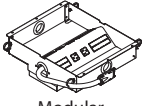
Options	U.S. Price	Required to Specify
TAP Electrical System with Faceplate Options ► Page 345  Modular	<ul style="list-style-type: none"> Modular system tray (hardwire base power infeed) <ul style="list-style-type: none"> - PAMH modular system tray with outlets and blank AAPs - PDMH modular system tray with outlets and two data AAPs - PVMH modular system tray with outlets and two of each video/audio and data AAPs 	+\$208 each tray Specify with modular power data, and select TAP type and TAP door color number.
Storage Tray ► Page 346	<ul style="list-style-type: none"> Storage tray 	-\$875 Specify with storage tray and select door color number.
Doors	<ul style="list-style-type: none"> Storage tray wood veneer doors per door TAP wood veneer doors per door 	+\$438 +\$438 Specify with wood doors. Specify with wood doors.
Related Products	<ul style="list-style-type: none"> Floor kit: Connectrac Corridor shelf Power strip 	► Page 468 ► Page 468 ► Page 739

TAP Locations

14'L x 48"W TAP Locations—Two piece top

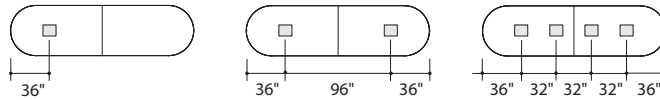

14'L x 48"W TAP Locations—Three piece top

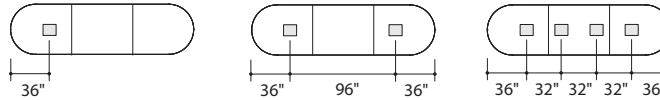

14'L x 60"W TAP Locations—Two piece top

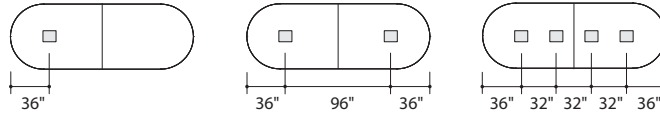

14'L x 60"W TAP Locations—Three piece top

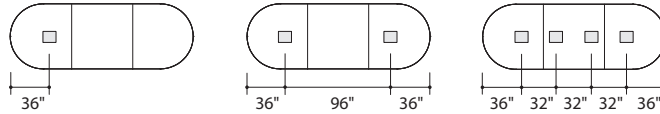

► Options, continued on next page

For Canadian Pricing
 Multiply U.S. Price by the Canadian price factor.
 ► See page 1 for details.

Host Collaborative and Conference Tables Racetrack Tables with Three Bases *continued*

DESIGN F/P DESIGN AND VECTA DESIGN TEAM

► Options, continued from previous page

TAP Locations

16'L x 48"W TAP Locations—Two piece top

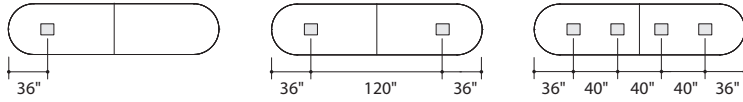

16'L x 48"W TAP Locations—Three piece top

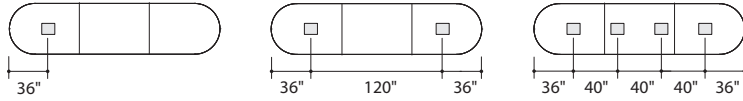

16'L x 60"W TAP Locations—Two piece top

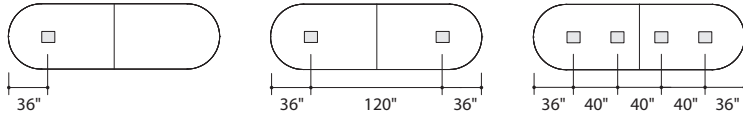

16'L x 60"W TAP Locations—Three piece top

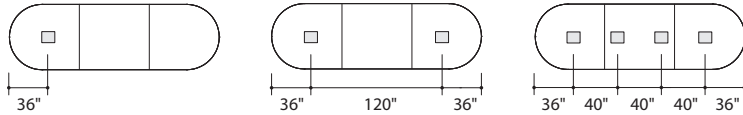

18'L x 48"W TAP Locations—Two piece top

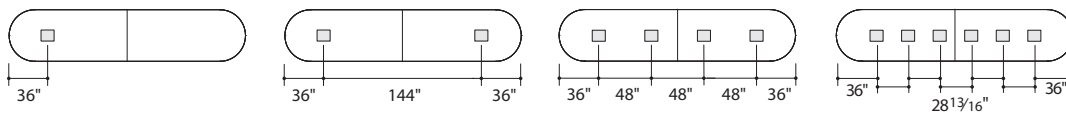

18'L x 48"W TAP Locations—Three piece top

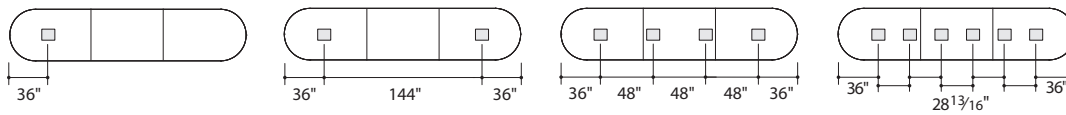

18'L x 60"W TAP Locations—Two piece top

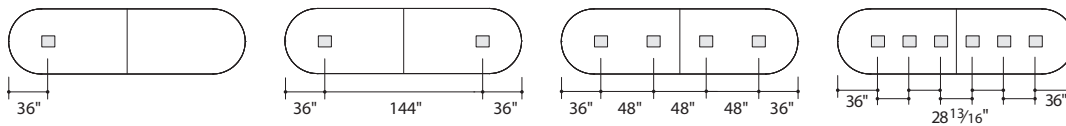

18'L x 60"W TAP Locations—Three piece top

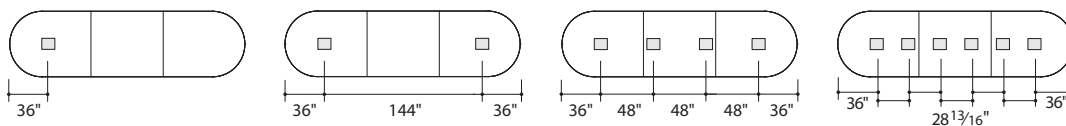

► Options, continued on next page

Host Collaborative and Conference Tables Racetrack Tables with Three Bases

DESIGN F/P DESIGN AND VECTA DESIGN TEAM

► Options, continued from previous page

TAP Locations

20'L x 48"W TAP Locations—Two piece top

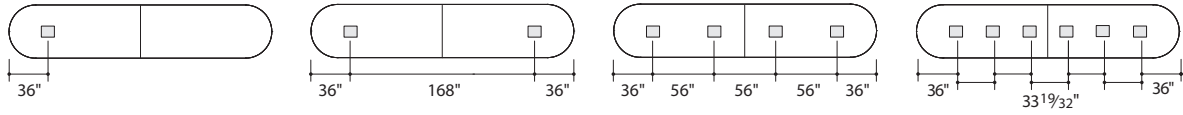

20'L x 48"W TAP Locations—Three piece top

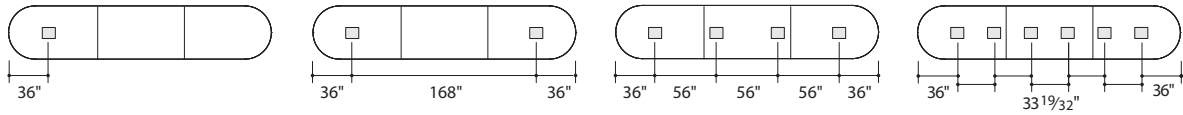

20'L x 60"W TAP Locations—Two piece top

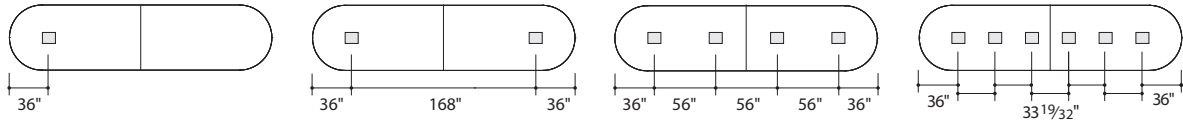

20'L x 60"W TAP Locations—Three piece top

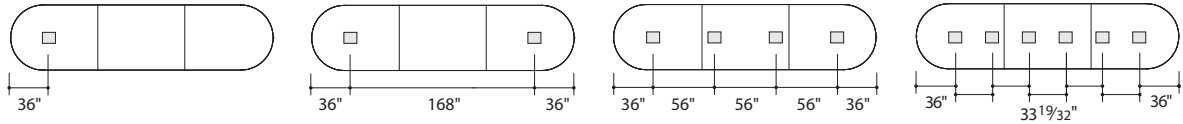

► Specification Information, on next page

Host Collaborative and Conference Tables Racetrack Tables with Three Bases *continued*

DESIGN F/P DESIGN AND VECTA DESIGN TEAM

► Options, on previous page

Tip: Prices shown include top, TAP(s), and slim bases.
► See base options for flared bases, page 426

Tip: Last digit of style number indicates number of TAP(s).

Tip: For tech corridor, 14'L tables have four long doors and four short doors.

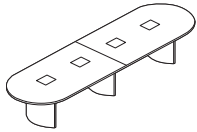
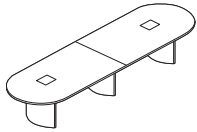
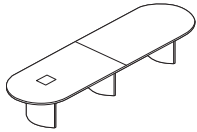
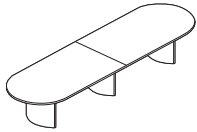

Specification Information

Style Number	Finish	U.S. Base Prices			
		Flat Wood Edge:	Bullnose Wood Edge:	Beveled Wood Edge:	Horizon Wood Edge:

14'L x 48''W Two Piece Top

0 TAP ~~3~~4/24

HS1448C20	Grade 1 Laminate	\$16,036	\$16,258	\$16,554	\$19,319
	Grade 2 and 3 Laminate	\$16,343	\$16,565	\$16,861	\$19,626
	Grade 1 Veneer	\$18,173	\$18,395	\$18,691	\$21,456
	Grade 2 Veneer	\$19,758	\$19,980	\$20,276	\$23,041

1 TAP ~~3~~4/24

HS1448C21	Grade 1 Laminate	\$18,372	\$18,594	\$18,890	\$21,655
	Grade 2 and 3 Laminate	\$18,679	\$18,901	\$19,197	\$21,962
	Grade 1 Veneer	\$20,509	\$20,731	\$21,027	\$23,792
	Grade 2 Veneer	\$22,094	\$22,316	\$22,612	\$25,377

2 TAPS ~~3~~4/24

HS1448C22	Grade 1 Laminate	\$20,717	\$20,939	\$21,235	\$24,000
	Grade 2 and 3 Laminate	\$21,024	\$21,246	\$21,542	\$24,307
	Grade 1 Veneer	\$22,854	\$23,076	\$23,372	\$26,137
	Grade 2 Veneer	\$24,439	\$24,661	\$24,957	\$27,722

4 TAPS ~~3~~4/24

HS1448C24	Grade 1 Laminate	\$25,401	\$25,623	\$25,919	\$28,684
	Grade 2 and 3 Laminate	\$25,708	\$25,930	\$26,226	\$28,991
	Grade 1 Veneer	\$27,538	\$27,760	\$28,056	\$30,821
	Grade 2 Veneer	\$29,123	\$29,345	\$29,641	\$32,406

► Specification Information, continued on next page



For Canadian Pricing
Multiply U.S. Price by the Canadian price factor.
► See page 1 for details.

~~3~~4/24 = Last order entry
April 14, 2024

Host Collaborative and Conference Tables Racetrack Tables with Three Bases

DESIGN F/P DESIGN AND VECTA DESIGN TEAM

Tip: Prices shown include top, TAP(s), and slim bases.
 ▶ See base options for flared bases, page 426

Tip: Last digit of style number indicates number of TAP(s).

Tip: For tech corridor, 14'L tables have four long doors and four short doors.

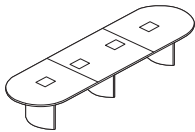
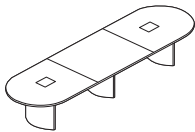
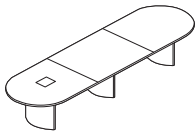
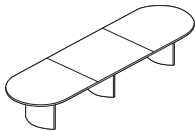

▶ Specification Information, continued from previous page

Specification Information

Style Number	Finish	U.S. Base Prices			
		Flat Wood Edge:	Bullnose Wood Edge:	Beveled Wood Edge:	Horizon Wood Edge:

14'L x 48"W Three Piece Top

0 TAP X4/24

HS1448C30	Grade 1 Laminate	\$16,594	\$16,816	\$17,112	\$19,877
	Grade 2 and 3 Laminate	\$16,901	\$17,123	\$17,419	\$20,184
	Grade 1 Veneer	\$18,731	\$18,953	\$19,249	\$22,014
	Grade 2 Veneer	\$20,316	\$20,538	\$20,834	\$23,599

1 TAP X4/24

HS1448C31	Grade 1 Laminate	\$18,936	\$19,158	\$19,454	\$22,219
	Grade 2 and 3 Laminate	\$19,243	\$19,465	\$19,761	\$22,526
	Grade 1 Veneer	\$21,073	\$21,295	\$21,591	\$24,356
	Grade 2 Veneer	\$22,658	\$22,880	\$23,176	\$25,941

2 TAPS X4/24

HS1448C32	Grade 1 Laminate	\$21,276	\$21,498	\$21,794	\$24,559
	Grade 2 and 3 Laminate	\$21,583	\$21,805	\$22,101	\$24,866
	Grade 1 Veneer	\$23,413	\$23,635	\$23,931	\$26,696
	Grade 2 Veneer	\$24,998	\$25,220	\$25,516	\$28,281

4 TAPS X4/24

HS1448C34	Grade 1 Laminate	\$25,959	\$26,181	\$26,477	\$29,242
	Grade 2 and 3 Laminate	\$26,266	\$26,488	\$26,784	\$29,549
	Grade 1 Veneer	\$28,096	\$28,318	\$28,614	\$31,379
	Grade 2 Veneer	\$29,681	\$29,903	\$30,199	\$32,964

▶ Specification Information, continued on next page



For Canadian Pricing
 Multiply U.S. Price by the Canadian price factor.
 ▶ See page 1 for details.

X4/24 = Last order entry
 April 14, 2024

Host Collaborative and Conference Tables Racetrack Tables with Three Bases *continued*

DESIGN F/P DESIGN AND VECTA DESIGN TEAM

► Specification Information, continued from previous page

Tip: Prices shown include top, TAP(s), and slim bases.
 ► See base options for flared bases, page 426

Tip: Last digit of style number indicates number of TAP(s).

Tip: For tech corridor, 14'L tables have four long doors and four short doors.

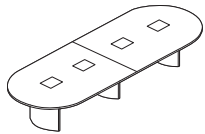
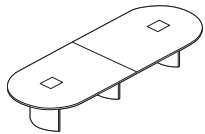
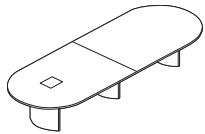
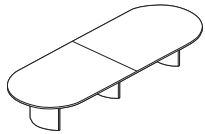

Specification Information

Style Number	Finish	U.S. Base Prices			
		Flat Wood Edge:	Bullnose Wood Edge:	Beveled Wood Edge:	Horizon Wood Edge:

14'L x 60"W Two Piece Top

0 TAP X3/4/24

HS1460C20	Grade 1 Laminate	\$16,664	\$16,895	\$17,210	\$19,975
	Grade 2 and 3 Laminate	\$17,049	\$17,280	\$17,595	\$20,360
	Grade 1 Veneer	\$20,235	\$20,466	\$20,781	\$23,546
	Grade 2 Veneer	\$22,244	\$22,475	\$22,790	\$25,555

1 TAP X3/4/24

HS1460C21	Grade 1 Laminate	\$19,006	\$19,237	\$19,552	\$22,317
	Grade 2 and 3 Laminate	\$19,391	\$19,622	\$19,937	\$22,702
	Grade 1 Veneer	\$22,577	\$22,808	\$23,123	\$25,888
	Grade 2 Veneer	\$24,586	\$24,817	\$25,132	\$27,897

2 TAPS X3/4/24

HS1460C22	Grade 1 Laminate	\$21,348	\$21,579	\$21,894	\$24,659
	Grade 2 and 3 Laminate	\$21,733	\$21,964	\$22,279	\$25,044
	Grade 1 Veneer	\$24,919	\$25,150	\$25,465	\$28,230
	Grade 2 Veneer	\$26,928	\$27,159	\$27,474	\$30,239

4 TAPS X3/4/24

HS1460C24	Grade 1 Laminate	\$26,033	\$26,264	\$26,579	\$29,344
	Grade 2 and 3 Laminate	\$26,418	\$26,649	\$26,964	\$29,729
	Grade 1 Veneer	\$29,604	\$29,835	\$30,150	\$32,915
	Grade 2 Veneer	\$31,613	\$31,844	\$32,159	\$34,924

► Specification Information, continued on next page



For Canadian Pricing
 Multiply U.S. Price by the Canadian price factor.
 ► See page 1 for details.

X3/4/24 = Last order entry
 April 14, 2024

Host Collaborative and Conference Tables Racetrack Tables with Three Bases

DESIGN F/P DESIGN AND VECTA DESIGN TEAM

Tip: Prices shown include top, TAP(s), and slim bases.
 ▶ See base options for flared bases, page 426

Tip: Last digit of style number indicates number of TAP(s).

Tip: For tech corridor, 14'L tables have four long doors and four short doors.

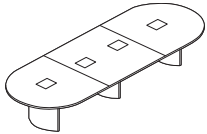
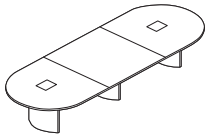
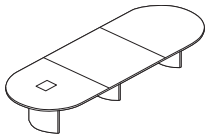
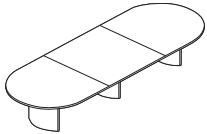

▶ Specification Information, continued from previous page

Specification Information

Style Number	Finish	U.S. Base Prices			
		Flat Wood Edge:	Bullnose Wood Edge:	Beveled Wood Edge:	Horizon Wood Edge:

14'L x 60"W Three Piece Top

0 TAP X4/24

HS1460C30	Grade 1 Laminate	\$17,226	\$17,457	\$17,772	\$20,537
	Grade 2 and 3 Laminate	\$17,611	\$17,842	\$18,157	\$20,922
	Grade 1 Veneer	\$20,797	\$21,028	\$21,343	\$24,108
	Grade 2 Veneer	\$22,806	\$23,037	\$23,352	\$26,117

1 TAP X4/24

HS1460C31	Grade 1 Laminate	\$19,567	\$19,798	\$20,113	\$22,878
	Grade 2 and 3 Laminate	\$19,952	\$20,183	\$20,498	\$23,263
	Grade 1 Veneer	\$23,138	\$23,369	\$23,684	\$26,449
	Grade 2 Veneer	\$25,147	\$25,378	\$25,693	\$28,458

2 TAPS X4/24

HS1460C32	Grade 1 Laminate	\$21,909	\$22,140	\$22,455	\$25,220
	Grade 2 and 3 Laminate	\$22,294	\$22,525	\$22,840	\$25,605
	Grade 1 Veneer	\$25,480	\$25,711	\$26,026	\$28,791
	Grade 2 Veneer	\$27,489	\$27,720	\$28,035	\$30,800

4 TAPS X4/24

HS1460C34	Grade 1 Laminate	\$26,593	\$26,824	\$27,139	\$29,904
	Grade 2 and 3 Laminate	\$26,978	\$27,209	\$27,524	\$30,289
	Grade 1 Veneer	\$30,164	\$30,395	\$30,710	\$33,475
	Grade 2 Veneer	\$32,173	\$32,404	\$32,719	\$35,484

▶ Specification Information, continued on next page



For Canadian Pricing
 Multiply U.S. Price by the Canadian price factor.
 ▶ See page 1 for details.

X4/24 = Last order entry
 April 14, 2024

Host Collaborative and Conference Tables Racetrack Tables with Three Bases *continued*

DESIGN F/P DESIGN AND VECTA DESIGN TEAM

► Specification Information, continued from previous page

Tip: Prices shown include top, TAP(s), and slim bases.

► See base options for flared bases, page 426

Tip: Last digit of style number indicates number of TAP(s).

Tip: For tech corridor, 16'L tables have eight long doors and four short doors.

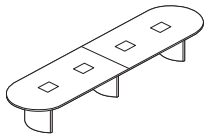
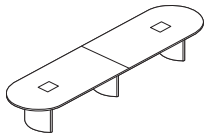
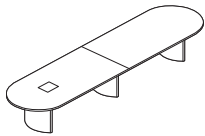
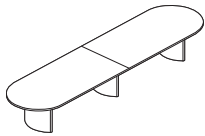

Specification Information

Style Number	Finish	U.S. Base Prices			
		Flat Wood Edge:	Bullnose Wood Edge:	Beveled Wood Edge:	Horizon Wood Edge:

16'L x 48''W Two Piece Top

0 TAP ~~3~~4/24

HS1648C20	Grade 1 Laminate	\$16,776	\$17,015	\$17,352	\$20,115
	Grade 2 and 3 Laminate	\$17,127	\$17,366	\$17,703	\$20,466
	Grade 1 Veneer	\$18,961	\$19,200	\$19,537	\$22,300
	Grade 2 Veneer	\$20,764	\$21,003	\$21,340	\$24,103

1 TAP ~~3~~4/24

HS1648C21	Grade 1 Laminate	\$19,113	\$19,352	\$19,689	\$22,452
	Grade 2 and 3 Laminate	\$19,464	\$19,703	\$20,040	\$22,803
	Grade 1 Veneer	\$21,298	\$21,537	\$21,874	\$24,637
	Grade 2 Veneer	\$23,101	\$23,340	\$23,677	\$26,440

2 TAPS ~~3~~4/24

HS1648C22	Grade 1 Laminate	\$21,456	\$21,695	\$22,032	\$24,795
	Grade 2 and 3 Laminate	\$21,807	\$22,046	\$22,383	\$25,146
	Grade 1 Veneer	\$23,641	\$23,880	\$24,217	\$26,980
	Grade 2 Veneer	\$25,444	\$25,683	\$26,020	\$28,783

4 TAPS ~~3~~4/24

HS1648C24	Grade 1 Laminate	\$26,140	\$26,379	\$26,716	\$29,479
	Grade 2 and 3 Laminate	\$26,491	\$26,730	\$27,067	\$29,830
	Grade 1 Veneer	\$28,325	\$28,564	\$28,901	\$31,664
	Grade 2 Veneer	\$30,128	\$30,367	\$30,704	\$33,467

► Specification Information, continued on next page



For Canadian Pricing
 Multiply U.S. Price by the Canadian price factor.
 ► See page 1 for details.

~~3~~4/24 = Last order entry
 April 14, 2024

Host Collaborative and Conference Tables Racetrack Tables with Three Bases

DESIGN F/P DESIGN AND VECTA DESIGN TEAM

Tip: Prices shown include top, TAP(s), and slim bases.
 ▶ See base options for flared bases, page 426

Tip: Last digit of style number indicates number of TAP(s).

Tip: For tech corridor, 16'L tables have eight long doors and four short doors.

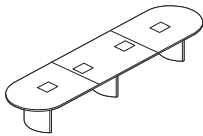
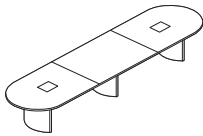
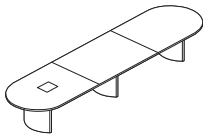
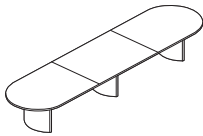

▶ Specification Information, continued from previous page

Specification Information

Style Number	Finish	U.S. Base Prices			
		Flat Wood Edge:	Bullnose Wood Edge:	Beveled Wood Edge:	Horizon Wood Edge:

16'L x 48"W Three Piece Top

0 TAP X4/24

HS1648C30	Grade 1 Laminate	\$17,335	\$17,574	\$17,911	\$20,674
	Grade 2 and 3 Laminate	\$17,686	\$17,925	\$18,262	\$21,025
	Grade 1 Veneer	\$19,520	\$19,759	\$20,096	\$22,859
	Grade 2 Veneer	\$21,323	\$21,562	\$21,899	\$24,662

1 TAP X4/24

HS1648C31	Grade 1 Laminate	\$19,678	\$19,917	\$20,254	\$23,017
	Grade 2 and 3 Laminate	\$20,029	\$20,268	\$20,605	\$23,368
	Grade 1 Veneer	\$21,863	\$22,102	\$22,439	\$25,202
	Grade 2 Veneer	\$23,666	\$23,905	\$24,242	\$27,005

2 TAPS X4/24

HS1648C32	Grade 1 Laminate	\$22,019	\$22,258	\$22,595	\$25,358
	Grade 2 and 3 Laminate	\$22,370	\$22,609	\$22,946	\$25,709
	Grade 1 Veneer	\$24,204	\$24,443	\$24,780	\$27,543
	Grade 2 Veneer	\$26,007	\$26,246	\$26,583	\$29,346

4 TAPS X4/24

HS1648C34	Grade 1 Laminate	\$26,702	\$26,941	\$27,278	\$30,041
	Grade 2 and 3 Laminate	\$27,053	\$27,292	\$27,629	\$30,392
	Grade 1 Veneer	\$28,887	\$29,126	\$29,463	\$32,226
	Grade 2 Veneer	\$30,690	\$30,929	\$31,266	\$34,029

▶ Specification Information, continued on next page

For Canadian Pricing
 Multiply U.S. Price by the Canadian price factor.
 ▶ See page 1 for details.

X4/24 = Last order entry
 April 14, 2024

Host Collaborative and Conference Tables Racetrack Tables with Three Bases *continued*

DESIGN F/P DESIGN AND VECTA DESIGN TEAM

Tip: Prices shown include top, TAP(s), and slim bases.

► See base options for flared bases, page 426



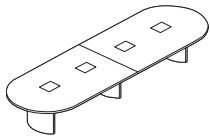
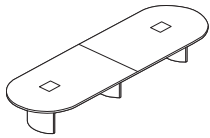
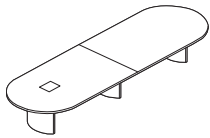
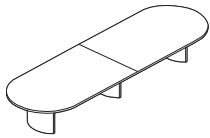

Tip: Last digit of style number indicates number of TAP(s).

Tip: For tech corridor, 16'L tables have eight long doors and four short doors.



► Specification Information, continued from previous page

Specification Information

Style Number	Finish	U.S. Base Prices			
					
		Flat Wood Edge:	Bullnose Wood Edge:	Beveled Wood Edge:	Horizon Wood Edge:

16'L x 60''W Two Piece Top

0 TAP ~~3~~4/24

Style Number	Finish	Flat Wood Edge	Bullnose Wood Edge	Beveled Wood Edge	Horizon Wood Edge
HS1660C20	Grade 1 Laminate	\$17,403	\$17,657	\$18,005	\$20,780
	Grade 2 and 3 Laminate	\$17,840	\$18,094	\$18,442	\$21,217
	Grade 1 Veneer	\$21,023	\$21,277	\$21,625	\$24,400
	Grade 2 Veneer	\$23,303	\$23,557	\$23,905	\$26,680

1 TAP ~~3~~4/24

Style Number	Finish	Flat Wood Edge	Bullnose Wood Edge	Beveled Wood Edge	Horizon Wood Edge
HS1660C21	Grade 1 Laminate	\$19,745	\$19,999	\$20,347	\$23,122
	Grade 2 and 3 Laminate	\$20,182	\$20,436	\$20,784	\$23,559
	Grade 1 Veneer	\$23,365	\$23,619	\$23,967	\$26,742
	Grade 2 Veneer	\$25,645	\$25,899	\$26,247	\$29,022

2 TAPS ~~3~~4/24

Style Number	Finish	Flat Wood Edge	Bullnose Wood Edge	Beveled Wood Edge	Horizon Wood Edge
HS1660C22	Grade 1 Laminate	\$22,087	\$22,341	\$22,689	\$25,464
	Grade 2 and 3 Laminate	\$22,524	\$22,778	\$23,126	\$25,901
	Grade 1 Veneer	\$25,707	\$25,961	\$26,309	\$29,084
	Grade 2 Veneer	\$27,987	\$28,241	\$28,589	\$31,364

4 TAPS ~~3~~4/24

Style Number	Finish	Flat Wood Edge	Bullnose Wood Edge	Beveled Wood Edge	Horizon Wood Edge
HS1660C24	Grade 1 Laminate	\$26,773	\$27,027	\$27,375	\$30,150
	Grade 2 and 3 Laminate	\$27,210	\$27,464	\$27,812	\$30,587
	Grade 1 Veneer	\$30,393	\$30,647	\$30,995	\$33,770
	Grade 2 Veneer	\$32,673	\$32,927	\$33,275	\$36,050

► Specification Information, continued on next page



For Canadian Pricing
 Multiply U.S. Price by the Canadian price factor.
 ► See page 1 for details.

~~3~~4/24 = Last order entry
 April 14, 2024

Host Collaborative and Conference Tables Racetrack Tables with Three Bases

DESIGN F/P DESIGN AND VECTA DESIGN TEAM

Tip: Prices shown include top, TAP(s), and slim bases.
 ▶ See base options for flared bases, page 426

Tip: Last digit of style number indicates number of TAP(s).

Tip: For tech corridor, 16'L tables have eight long doors and four short doors.

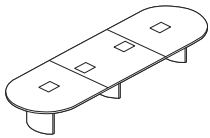
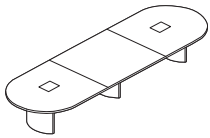
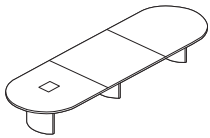
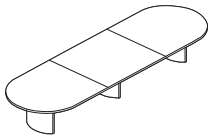

▶ Specification Information, continued from previous page

Specification Information

Style Number	Finish	U.S. Base Prices			
		Flat Wood Edge:	Bullnose Wood Edge:	Beveled Wood Edge:	Horizon Wood Edge:

16'L x 60"W Three Piece Top

0 TAP X4/24

HS1660C30	Grade 1 Laminate	\$17,963	\$18,217	\$18,565	\$21,340
	Grade 2 and 3 Laminate	\$18,400	\$18,654	\$19,002	\$21,777
	Grade 1 Veneer	\$21,583	\$21,837	\$22,185	\$24,960
	Grade 2 Veneer	\$23,863	\$24,117	\$24,465	\$27,240

1 TAP X4/24

HS1660C31	Grade 1 Laminate	\$20,306	\$20,560	\$20,908	\$23,683
	Grade 2 and 3 Laminate	\$20,743	\$20,997	\$21,345	\$24,120
	Grade 1 Veneer	\$23,926	\$24,180	\$24,528	\$27,303
	Grade 2 Veneer	\$26,206	\$26,460	\$26,808	\$29,583

2 TAPS X4/24

HS1660C32	Grade 1 Laminate	\$22,648	\$22,902	\$23,250	\$26,025
	Grade 2 and 3 Laminate	\$23,085	\$23,339	\$23,687	\$26,462
	Grade 1 Veneer	\$26,268	\$26,522	\$26,870	\$29,645
	Grade 2 Veneer	\$28,548	\$28,802	\$29,150	\$31,925

4 TAPS X4/24

HS1660C34	Grade 1 Laminate	\$27,334	\$27,588	\$27,936	\$30,711
	Grade 2 and 3 Laminate	\$27,771	\$28,025	\$28,373	\$31,148
	Grade 1 Veneer	\$30,954	\$31,208	\$31,556	\$34,331
	Grade 2 Veneer	\$33,234	\$33,488	\$33,836	\$36,611

▶ Specification Information, continued on next page



For Canadian Pricing
 Multiply U.S. Price by the Canadian price factor.
 ▶ See page 1 for details.

X4/24 = Last order entry
 April 14, 2024

Host Collaborative and Conference Tables Racetrack Tables with Three Bases *continued*

DESIGN F/P DESIGN AND VECTA DESIGN TEAM

► Specification Information, continued from previous page

Tip: Prices shown include top, TAP(s), and slim bases.

► See base options for flared bases, page 426

Tip: Last digit of style number indicates number of TAP(s).

Tip: For tech corridor, 18'L tables have eight long doors and four short doors.

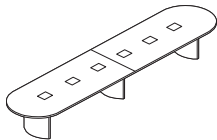
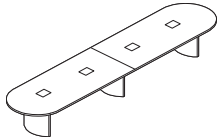
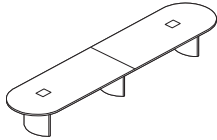
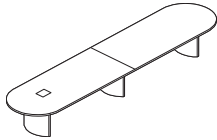
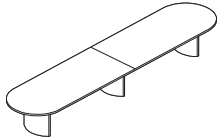

Specification Information

Style Number	Finish	U.S. Base Prices			
		Flat Wood Edge:	Bullnose Wood Edge:	Beveled Wood Edge:	Horizon Wood Edge:

18'L x 48"W Two Piece Top

0 TAP ~~3~~4/24

Style Number	Finish	Flat Wood Edge	Bullnose Wood Edge	Beveled Wood Edge	Horizon Wood Edge
HS1848C20	Grade 1 Laminate	\$17,890	\$18,153	\$18,517	\$21,320
	Grade 2 and 3 Laminate	\$18,286	\$18,549	\$18,913	\$21,716
	Grade 1 Veneer	\$20,593	\$20,856	\$21,220	\$24,023
	Grade 2 Veneer	\$22,633	\$22,896	\$23,260	\$26,063

1 TAP ~~3~~4/24

Style Number	Finish	Flat Wood Edge	Bullnose Wood Edge	Beveled Wood Edge	Horizon Wood Edge
HS1848C21	Grade 1 Laminate	\$20,233	\$20,496	\$20,860	\$23,663
	Grade 2 and 3 Laminate	\$20,629	\$20,892	\$21,256	\$24,059
	Grade 1 Veneer	\$22,936	\$23,199	\$23,563	\$26,366
	Grade 2 Veneer	\$24,976	\$25,239	\$25,603	\$28,406

2 TAPS ~~3~~4/24

Style Number	Finish	Flat Wood Edge	Bullnose Wood Edge	Beveled Wood Edge	Horizon Wood Edge
HS1848C22	Grade 1 Laminate	\$22,573	\$22,836	\$23,200	\$26,003
	Grade 2 and 3 Laminate	\$22,969	\$23,232	\$23,596	\$26,399
	Grade 1 Veneer	\$25,276	\$25,539	\$25,903	\$28,706
	Grade 2 Veneer	\$27,316	\$27,579	\$27,943	\$30,746

4 TAPS ~~3~~4/24

Style Number	Finish	Flat Wood Edge	Bullnose Wood Edge	Beveled Wood Edge	Horizon Wood Edge
HS1848C24	Grade 1 Laminate	\$27,258	\$27,521	\$27,885	\$30,688
	Grade 2 and 3 Laminate	\$27,654	\$27,917	\$28,281	\$31,084
	Grade 1 Veneer	\$29,961	\$30,224	\$30,588	\$33,391
	Grade 2 Veneer	\$32,001	\$32,264	\$32,628	\$35,431

6 TAPS ~~3~~4/24

Style Number	Finish	Flat Wood Edge	Bullnose Wood Edge	Beveled Wood Edge	Horizon Wood Edge
HS1848C26	Grade 1 Laminate	\$31,943	\$32,206	\$32,570	\$35,373
	Grade 2 and 3 Laminate	\$32,339	\$32,602	\$32,966	\$35,769
	Grade 1 Veneer	\$34,646	\$34,909	\$35,273	\$38,076
	Grade 2 Veneer	\$36,686	\$36,949	\$37,313	\$40,116

► Specification Information, continued on next page



For Canadian Pricing
Multiply U.S. Price by the Canadian price factor.
► See page 1 for details.

~~3~~4/24 = Last order entry
April 14, 2024

Host Collaborative and Conference Tables Racetrack Tables with Three Bases

DESIGN F/P DESIGN AND VECTA DESIGN TEAM

Tip: Prices shown include top, TAP(s), and slim bases.
 ▶ See base options for flared bases, page 426

Tip: Last digit of style number indicates number of TAP(s).

Tip: For tech corridor, 18'L tables have eight long doors and four short doors.

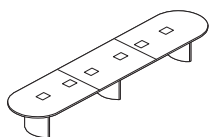
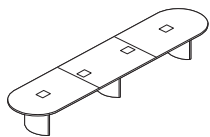
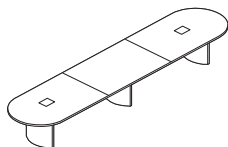
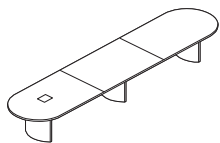
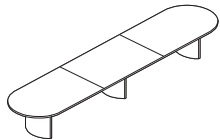

▶ Specification Information, continued from previous page

Specification Information

Style Number	Finish	U.S. Base Prices			
		Flat Wood Edge:	Bullnose Wood Edge:	Beveled Wood Edge:	Horizon Wood Edge:

18'L x 48"W Three Piece Top

0 TAP X4/24

HS1848C30	Grade 1 Laminate	\$18,451	\$18,714	\$19,078	\$21,881
	Grade 2 and 3 Laminate	\$18,847	\$19,110	\$19,474	\$22,277
	Grade 1 Veneer	\$21,154	\$21,417	\$21,781	\$24,584
	Grade 2 Veneer	\$23,194	\$23,457	\$23,821	\$26,624

1 TAP X4/24

HS1848C31	Grade 1 Laminate	\$20,792	\$21,055	\$21,419	\$24,222
	Grade 2 and 3 Laminate	\$21,188	\$21,451	\$21,815	\$24,618
	Grade 1 Veneer	\$23,495	\$23,758	\$24,122	\$26,925
	Grade 2 Veneer	\$25,535	\$25,798	\$26,162	\$28,965

2 TAPS X4/24

HS1848C32	Grade 1 Laminate	\$23,136	\$23,399	\$23,763	\$26,566
	Grade 2 and 3 Laminate	\$23,532	\$23,795	\$24,159	\$26,962
	Grade 1 Veneer	\$25,839	\$26,102	\$26,466	\$29,269
	Grade 2 Veneer	\$27,879	\$28,142	\$28,506	\$31,309

4 TAPS X4/24

HS1848C34	Grade 1 Laminate	\$27,820	\$28,083	\$28,447	\$31,250
	Grade 2 and 3 Laminate	\$28,216	\$28,479	\$28,843	\$31,646
	Grade 1 Veneer	\$30,523	\$30,786	\$31,150	\$33,953
	Grade 2 Veneer	\$32,563	\$32,826	\$33,190	\$35,993

6 TAPS X4/24

HS1848C36	Grade 1 Laminate	\$32,504	\$32,767	\$33,131	\$35,934
	Grade 2 and 3 Laminate	\$32,900	\$33,163	\$33,527	\$36,330
	Grade 1 Veneer	\$35,207	\$35,470	\$35,834	\$38,637
	Grade 2 Veneer	\$37,247	\$37,510	\$37,874	\$40,677

▶ Specification Information, continued on next page



For Canadian Pricing
 Multiply U.S. Price by the Canadian price factor.
 ▶ See page 1 for details.

X4/24 = Last order entry
 April 14, 2024

Host Collaborative and Conference Tables Racetrack Tables with Three Bases *continued*

DESIGN F/P DESIGN AND VECTA DESIGN TEAM

► Specification Information, continued from previous page





Tip: Prices shown include top, TAP(s), and slim bases.

► See base options for flared bases, page 426

Tip: Last digit of style number indicates number of TAP(s).

Tip: For tech corridor, 18'L tables have eight long doors and four short doors.

Specification Information

Style Number	Finish	U.S. Base Prices			
					
		Flat Wood Edge:	Bullnose Wood Edge:	Beveled Wood Edge:	Horizon Wood Edge:

18'L x 60"W Two Piece Top

0 TAP ~~3~~4/24

HS1860C20	Grade 1 Laminate	\$18,196	\$18,471	\$18,855	\$21,652
	Grade 2 and 3 Laminate	\$18,689	\$18,964	\$19,348	\$22,145
	Grade 1 Veneer	\$22,918	\$23,193	\$23,577	\$26,374
	Grade 2 Veneer	\$25,502	\$25,777	\$26,161	\$28,958

1 TAP ~~3~~4/24

HS1860C21	Grade 1 Laminate	\$20,540	\$20,815	\$21,199	\$23,996
	Grade 2 and 3 Laminate	\$21,033	\$21,308	\$21,692	\$24,489
	Grade 1 Veneer	\$25,262	\$25,537	\$25,921	\$28,718
	Grade 2 Veneer	\$27,846	\$28,121	\$28,505	\$31,302

2 TAPS ~~3~~4/24

HS1860C22	Grade 1 Laminate	\$22,882	\$23,157	\$23,541	\$26,338
	Grade 2 and 3 Laminate	\$23,375	\$23,650	\$24,034	\$26,831
	Grade 1 Veneer	\$27,604	\$27,879	\$28,263	\$31,060
	Grade 2 Veneer	\$30,188	\$30,463	\$30,847	\$33,644

4 TAPS ~~3~~4/24

HS1860C24	Grade 1 Laminate	\$27,563	\$27,838	\$28,222	\$31,019
	Grade 2 and 3 Laminate	\$28,056	\$28,331	\$28,715	\$31,512
	Grade 1 Veneer	\$32,285	\$32,560	\$32,944	\$35,741
	Grade 2 Veneer	\$34,869	\$35,144	\$35,528	\$38,325

6 TAPS ~~3~~4/24

HS1860C26	Grade 1 Laminate	\$32,252	\$32,527	\$32,911	\$35,708
	Grade 2 and 3 Laminate	\$32,745	\$33,020	\$33,404	\$36,201
	Grade 1 Veneer	\$36,974	\$37,249	\$37,633	\$40,430
	Grade 2 Veneer	\$39,558	\$39,833	\$40,217	\$43,014

► Specification Information, continued on next page

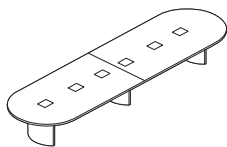
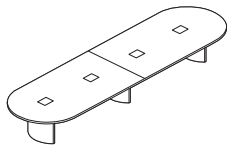
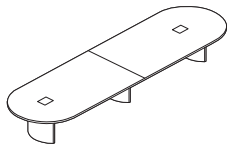
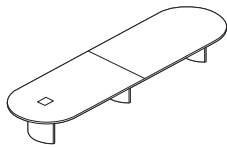
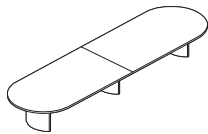

For Canadian Pricing
Multiply U.S. Price by the Canadian price factor.
► See page 1 for details.

~~3~~4/24 = Last order entry
April 14, 2024

Host Collaborative and Conference Tables Racetrack Tables with Three Bases

DESIGN F/P DESIGN AND VECTA DESIGN TEAM

Tip: Prices shown include top, TAP(s), and slim bases.
 ▶ See base options for flared bases, page 426

Tip: Last digit of style number indicates number of TAP(s).

Tip: For tech corridor, 18'L tables have eight long doors and four short doors.

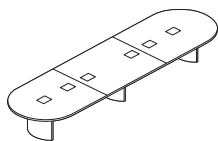
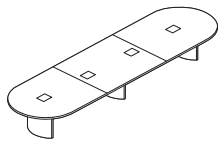
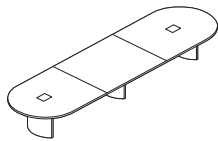
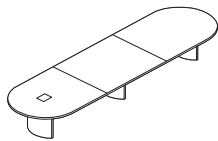
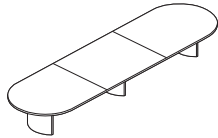

▶ Specification Information, continued from previous page

Specification Information

Style Number	Finish	U.S. Base Prices			
		Flat Wood Edge:	Bullnose Wood Edge:	Beveled Wood Edge:	Horizon Wood Edge:

18'L x 60"W Three Piece Top

0 TAP ~~4/24~~

HS1860C30	Grade 1 Laminate	\$18,762	\$19,037	\$19,421	\$22,218
	Grade 2 and 3 Laminate	\$19,255	\$19,530	\$19,914	\$22,711
	Grade 1 Veneer	\$23,484	\$23,759	\$24,143	\$26,940
	Grade 2 Veneer	\$26,068	\$26,343	\$26,727	\$29,524

1 TAP ~~4/24~~

HS1860C31	Grade 1 Laminate	\$21,101	\$21,376	\$21,760	\$24,557
	Grade 2 and 3 Laminate	\$21,594	\$21,869	\$22,253	\$25,050
	Grade 1 Veneer	\$25,823	\$26,098	\$26,482	\$29,279
	Grade 2 Veneer	\$28,407	\$28,682	\$29,066	\$31,863

2 TAPS ~~4/24~~

HS1860C32	Grade 1 Laminate	\$23,444	\$23,719	\$24,103	\$26,900
	Grade 2 and 3 Laminate	\$23,937	\$24,212	\$24,596	\$27,393
	Grade 1 Veneer	\$28,166	\$28,441	\$28,825	\$31,622
	Grade 2 Veneer	\$30,750	\$31,025	\$31,409	\$34,206

4 TAPS ~~4/24~~

HS1860C34	Grade 1 Laminate	\$28,127	\$28,402	\$28,786	\$31,583
	Grade 2 and 3 Laminate	\$28,620	\$28,895	\$29,279	\$32,076
	Grade 1 Veneer	\$32,849	\$33,124	\$33,508	\$36,305
	Grade 2 Veneer	\$35,433	\$35,708	\$36,092	\$38,889

6 TAPS ~~4/24~~

HS1860C36	Grade 1 Laminate	\$32,810	\$33,085	\$33,469	\$36,266
	Grade 2 and 3 Laminate	\$33,303	\$33,578	\$33,962	\$36,759
	Grade 1 Veneer	\$37,532	\$37,807	\$38,191	\$40,988
	Grade 2 Veneer	\$40,116	\$40,391	\$40,775	\$43,572

▶ Specification Information, continued on next page



For Canadian Pricing
 Multiply U.S. Price by the Canadian price factor.
 ▶ See page 1 for details.

~~4/24~~ = Last order entry
 April 14, 2024

Host Collaborative and Conference Tables Racetrack Tables with Three Bases *continued*

DESIGN F/P DESIGN AND VECTA DESIGN TEAM

Tip: Prices shown include top, TAP(s), and slim bases.
 ▶ See base options for flared bases, page 426

Tip: Last digit of style number indicates number of TAP(s).

Tip: For tech corridor, 20'L tables have eight long doors and four short doors.

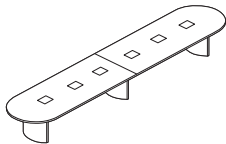
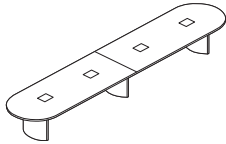
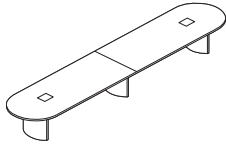
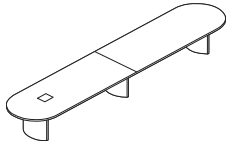
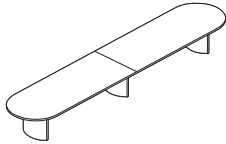

► Specification Information, continued from previous page

Specification Information

Style Number	Finish	U.S. Base Prices			
		Flat Wood Edge:	Bullnose Wood Edge:	Beveled Wood Edge:	Horizon Wood Edge:

20'L x 48"W Two Piece Top

0 TAP ~~3~~4/24

Style Number	Finish	Flat Wood Edge	Bullnose Wood Edge	Beveled Wood Edge	Horizon Wood Edge
HS2048C20	Grade 1 Laminate	\$18,634	\$18,922	\$19,321	\$22,121
	Grade 2 and 3 Laminate	\$19,071	\$19,359	\$19,758	\$22,558
	Grade 1 Veneer	\$21,388	\$21,676	\$22,075	\$24,875
	Grade 2 Veneer	\$23,641	\$23,929	\$24,328	\$27,128

1 TAP ~~3~~4/24

Style Number	Finish	Flat Wood Edge	Bullnose Wood Edge	Beveled Wood Edge	Horizon Wood Edge
HS2048C21	Grade 1 Laminate	\$20,973	\$21,261	\$21,660	\$24,460
	Grade 2 and 3 Laminate	\$21,410	\$21,698	\$22,097	\$24,897
	Grade 1 Veneer	\$23,727	\$24,015	\$24,414	\$27,214
	Grade 2 Veneer	\$25,980	\$26,268	\$26,667	\$29,467

2 TAPS ~~3~~4/24

Style Number	Finish	Flat Wood Edge	Bullnose Wood Edge	Beveled Wood Edge	Horizon Wood Edge
HS2048C22	Grade 1 Laminate	\$23,315	\$23,603	\$24,002	\$26,802
	Grade 2 and 3 Laminate	\$23,752	\$24,040	\$24,439	\$27,239
	Grade 1 Veneer	\$26,069	\$26,357	\$26,756	\$29,556
	Grade 2 Veneer	\$28,322	\$28,610	\$29,009	\$31,809

4 TAPS ~~3~~4/24

Style Number	Finish	Flat Wood Edge	Bullnose Wood Edge	Beveled Wood Edge	Horizon Wood Edge
HS2048C24	Grade 1 Laminate	\$28,002	\$28,290	\$28,689	\$31,489
	Grade 2 and 3 Laminate	\$28,439	\$28,727	\$29,126	\$31,926
	Grade 1 Veneer	\$30,756	\$31,044	\$31,443	\$34,243
	Grade 2 Veneer	\$33,009	\$33,297	\$33,696	\$36,496

6 TAPS ~~3~~4/24

Style Number	Finish	Flat Wood Edge	Bullnose Wood Edge	Beveled Wood Edge	Horizon Wood Edge
HS2048C26	Grade 1 Laminate	\$32,686	\$32,974	\$33,373	\$36,173
	Grade 2 and 3 Laminate	\$33,123	\$33,411	\$33,810	\$36,610
	Grade 1 Veneer	\$35,440	\$35,728	\$36,127	\$38,927
	Grade 2 Veneer	\$37,693	\$37,981	\$38,380	\$41,180

► Specification Information, continued on next page



For Canadian Pricing
 Multiply U.S. Price by the Canadian price factor.
 ▶ See page 1 for details.

~~3~~4/24 = Last order entry
 April 14, 2024

Host Collaborative and Conference Tables Racetrack Tables with Three Bases

DESIGN F/P DESIGN AND VECTA DESIGN TEAM

Tip: Prices shown include top, TAP(s), and slim bases.
 ▶ See base options for flared bases, page 426

Tip: Last digit of style number indicates number of TAP(s).

Tip: For tech corridor, 20'L tables have eight long doors and four short doors.

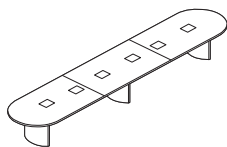
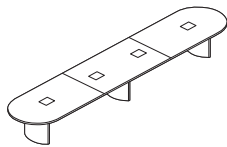
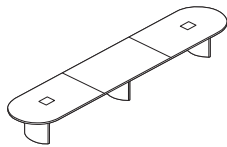
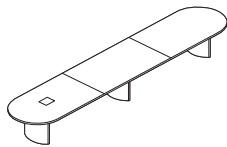
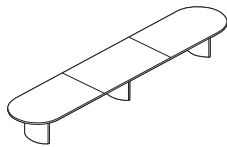

▶ Specification Information, continued from previous page

Specification Information

Style Number	Finish	U.S. Base Prices			
		Flat Wood Edge:	Bullnose Wood Edge:	Beveled Wood Edge:	Horizon Wood Edge:

20'L x 48''W Three Piece Top

0 TAP ~~4/24~~

Style Number	Finish	Flat Wood Edge	Bullnose Wood Edge	Beveled Wood Edge	Horizon Wood Edge
HS2048C30	Grade 1 Laminate	\$19,195	\$19,483	\$19,882	\$22,682
	Grade 2 and 3 Laminate	\$19,632	\$19,920	\$20,319	\$23,119
	Grade 1 Veneer	\$21,949	\$22,237	\$22,636	\$25,436
	Grade 2 Veneer	\$24,202	\$24,490	\$24,889	\$27,689

1 TAP ~~4/24~~

Style Number	Finish	Flat Wood Edge	Bullnose Wood Edge	Beveled Wood Edge	Horizon Wood Edge
HS2048C31	Grade 1 Laminate	\$21,534	\$21,822	\$22,221	\$25,021
	Grade 2 and 3 Laminate	\$21,971	\$22,259	\$22,658	\$25,458
	Grade 1 Veneer	\$24,288	\$24,576	\$24,975	\$27,775
	Grade 2 Veneer	\$26,541	\$26,829	\$27,228	\$30,028

2 TAPS ~~4/24~~

Style Number	Finish	Flat Wood Edge	Bullnose Wood Edge	Beveled Wood Edge	Horizon Wood Edge
HS2048C32	Grade 1 Laminate	\$23,877	\$24,165	\$24,564	\$27,364
	Grade 2 and 3 Laminate	\$24,314	\$24,602	\$25,001	\$27,801
	Grade 1 Veneer	\$26,631	\$26,919	\$27,318	\$30,118
	Grade 2 Veneer	\$28,884	\$29,172	\$29,571	\$32,371

4 TAPS ~~4/24~~

Style Number	Finish	Flat Wood Edge	Bullnose Wood Edge	Beveled Wood Edge	Horizon Wood Edge
HS2048C34	Grade 1 Laminate	\$28,562	\$28,850	\$29,249	\$32,049
	Grade 2 and 3 Laminate	\$28,999	\$29,287	\$29,686	\$32,486
	Grade 1 Veneer	\$31,316	\$31,604	\$32,003	\$34,803
	Grade 2 Veneer	\$33,569	\$33,857	\$34,256	\$37,056

6 TAPS ~~4/24~~

Style Number	Finish	Flat Wood Edge	Bullnose Wood Edge	Beveled Wood Edge	Horizon Wood Edge
HS2048C36	Grade 1 Laminate	\$33,245	\$33,533	\$33,932	\$36,732
	Grade 2 and 3 Laminate	\$33,682	\$33,970	\$34,369	\$37,169
	Grade 1 Veneer	\$35,999	\$36,287	\$36,686	\$39,486
	Grade 2 Veneer	\$38,252	\$38,540	\$38,939	\$41,739

▶ Specification Information, continued on next page



For Canadian Pricing
 Multiply U.S. Price by the Canadian price factor.
 ▶ See page 1 for details.

~~4/24~~ = Last order entry
 April 14, 2024

Host Collaborative and Conference Tables Racetrack Tables with Three Bases *continued*

DESIGN F/P DESIGN AND VECTA DESIGN TEAM

Tip: Prices shown include top, TAP(s), and slim bases.
 ▶ See base options for flared bases, page 426



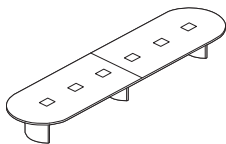
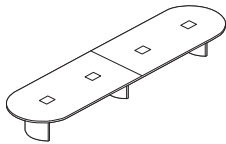
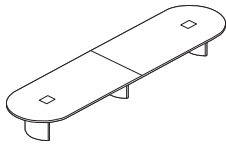
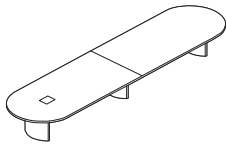
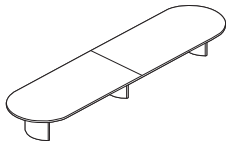

Tip: Last digit of style number indicates number of TAP(s).

Tip: For tech corridor, 20'L tables have eight long doors and four short doors.



▶ Specification Information, continued from previous page

Specification Information

Style Number	Finish	U.S. Base Prices			
		 Flat Wood Edge:	 Bullnose Wood Edge:	 Beveled Wood Edge:	 Horizon Wood Edge:

20'L x 60"W Two Piece Top

0 TAP ~~3~~4/24

Style Number	Finish	Flat Wood Edge:	Bullnose Wood Edge:	Beveled Wood Edge:	Horizon Wood Edge:
HS2060C20	Grade 1 Laminate	\$18,940	\$19,241	\$19,657	\$22,452
	Grade 2 and 3 Laminate	\$19,486	\$19,787	\$20,203	\$22,998
	Grade 1 Veneer	\$23,712	\$24,013	\$24,429	\$27,224
	Grade 2 Veneer	\$26,566	\$26,867	\$27,283	\$30,078

1 TAP ~~3~~4/24

Style Number	Finish	Flat Wood Edge:	Bullnose Wood Edge:	Beveled Wood Edge:	Horizon Wood Edge:
HS2060C21	Grade 1 Laminate	\$21,278	\$21,579	\$21,995	\$24,790
	Grade 2 and 3 Laminate	\$21,824	\$22,125	\$22,541	\$25,336
	Grade 1 Veneer	\$26,050	\$26,351	\$26,767	\$29,562
	Grade 2 Veneer	\$28,904	\$29,205	\$29,621	\$32,416

2 TAPS ~~3~~4/24

Style Number	Finish	Flat Wood Edge:	Bullnose Wood Edge:	Beveled Wood Edge:	Horizon Wood Edge:
HS2060C22	Grade 1 Laminate	\$23,622	\$23,923	\$24,339	\$27,134
	Grade 2 and 3 Laminate	\$24,168	\$24,469	\$24,885	\$27,680
	Grade 1 Veneer	\$28,394	\$28,695	\$29,111	\$31,906
	Grade 2 Veneer	\$31,248	\$31,549	\$31,965	\$34,760

4 TAPS ~~3~~4/24

Style Number	Finish	Flat Wood Edge:	Bullnose Wood Edge:	Beveled Wood Edge:	Horizon Wood Edge:
HS2060C24	Grade 1 Laminate	\$28,305	\$28,606	\$29,022	\$31,817
	Grade 2 and 3 Laminate	\$28,851	\$29,152	\$29,568	\$32,363
	Grade 1 Veneer	\$33,077	\$33,378	\$33,794	\$36,589
	Grade 2 Veneer	\$35,931	\$36,232	\$36,648	\$39,443

6 TAPS ~~3~~4/24

Style Number	Finish	Flat Wood Edge:	Bullnose Wood Edge:	Beveled Wood Edge:	Horizon Wood Edge:
HS2060C26	Grade 1 Laminate	\$32,991	\$33,292	\$33,708	\$36,503
	Grade 2 and 3 Laminate	\$33,537	\$33,838	\$34,254	\$37,049
	Grade 1 Veneer	\$37,763	\$38,064	\$38,480	\$41,275
	Grade 2 Veneer	\$40,617	\$40,918	\$41,334	\$44,129

▶ Specification Information, continued on next page



For Canadian Pricing
 Multiply U.S. Price by the Canadian price factor.
 ▶ See page 1 for details.

~~3~~4/24 = Last order entry
 April 14, 2024

Host Collaborative and Conference Tables Racetrack Tables with Three Bases

DESIGN F/P DESIGN AND VECTA DESIGN TEAM

Tip: Prices shown include top, TAP(s), and slim bases.
 ▶ See base options for flared bases, page 426

Tip: Last digit of style number indicates number of TAP(s).

Tip: For tech corridor, 20'L tables have eight long doors and four short doors.

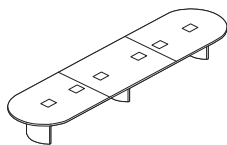
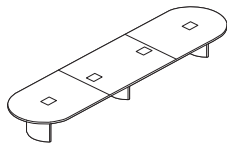
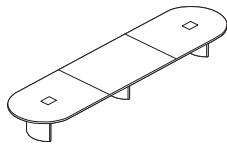
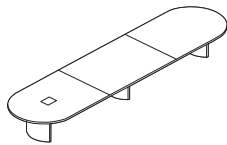
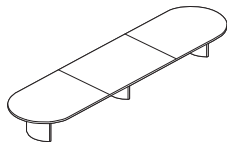

▶ Specification Information, continued from previous page

Specification Information

Style Number	Finish	U.S. Base Prices			
		Flat Wood Edge:	Bullnose Wood Edge:	Beveled Wood Edge:	Horizon Wood Edge:

20'L x 60"W Three Piece Top

0 TAP ~~3~~4/24

Style Number	Finish	Flat Wood Edge	Bullnose Wood Edge	Beveled Wood Edge	Horizon Wood Edge
HS2060C30	Grade 1 Laminate	\$19,501	\$19,802	\$20,218	\$23,013
	Grade 2 and 3 Laminate	\$20,047	\$20,348	\$20,764	\$23,559
	Grade 1 Veneer	\$24,273	\$24,574	\$24,990	\$27,785
	Grade 2 Veneer	\$27,127	\$27,428	\$27,844	\$30,639

1 TAP ~~3~~4/24

Style Number	Finish	Flat Wood Edge	Bullnose Wood Edge	Beveled Wood Edge	Horizon Wood Edge
HS2060C31	Grade 1 Laminate	\$21,840	\$22,141	\$22,557	\$25,352
	Grade 2 and 3 Laminate	\$22,386	\$22,687	\$23,103	\$25,898
	Grade 1 Veneer	\$26,612	\$26,913	\$27,329	\$30,124
	Grade 2 Veneer	\$29,466	\$29,767	\$30,183	\$32,978

2 TAPS ~~3~~4/24

Style Number	Finish	Flat Wood Edge	Bullnose Wood Edge	Beveled Wood Edge	Horizon Wood Edge
HS2060C32	Grade 1 Laminate	\$24,184	\$24,485	\$24,901	\$27,696
	Grade 2 and 3 Laminate	\$24,730	\$25,031	\$25,447	\$28,242
	Grade 1 Veneer	\$28,956	\$29,257	\$29,673	\$32,468
	Grade 2 Veneer	\$31,810	\$32,111	\$32,527	\$35,322

4 TAPS ~~3~~4/24

Style Number	Finish	Flat Wood Edge	Bullnose Wood Edge	Beveled Wood Edge	Horizon Wood Edge
HS2060C34	Grade 1 Laminate	\$28,867	\$29,168	\$29,584	\$32,379
	Grade 2 and 3 Laminate	\$29,413	\$29,714	\$30,130	\$32,925
	Grade 1 Veneer	\$33,639	\$33,940	\$34,356	\$37,151
	Grade 2 Veneer	\$36,493	\$36,794	\$37,210	\$40,005

6 TAPS ~~3~~4/24

Style Number	Finish	Flat Wood Edge	Bullnose Wood Edge	Beveled Wood Edge	Horizon Wood Edge
HS2060C36	Grade 1 Laminate	\$33,548	\$33,849	\$34,265	\$37,060
	Grade 2 and 3 Laminate	\$34,094	\$34,395	\$34,811	\$37,606
	Grade 1 Veneer	\$38,320	\$38,621	\$39,037	\$41,832
	Grade 2 Veneer	\$41,174	\$41,475	\$41,891	\$44,686

Host Collaborative and Conference Tables

For Canadian Pricing
 Multiply U.S. Price by the Canadian price factor.
 ▶ See page 1 for details.

~~3~~4/24 = Last order entry
 April 14, 2024

Host Collaborative and Conference Tables Boat Shaped Tables with Two Bases

DESIGN F/P DESIGN AND VECTA DESIGN TEAM

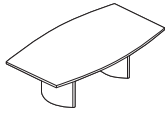

Tip: Shipped knocked down.

Tip: Grain direction for wood-grain laminate runs the length of the table.

Tip: Clips are provided with table: One clip per foot of table length.

Tip: The wood edge on a table top with woodgrain laminate may not match the top.

Standard Includes		Required to Specify
<ul style="list-style-type: none"> ▶ Need help? Product details, page 334 	<ul style="list-style-type: none"> • Top: 1/4" particle board core with laminate • Flat wood edge • TAP(s), if selected: 10"W x 12"L opening(s) trimmed with a flat solid wood profile and with brushed anodized aluminum TAP doors • Tech corridor: two aluminum beams for top support provide tracks for hinged aluminum doors that clip shut: satin anodized finish • Universal clip: black plastic • Two 27"W bases: wood veneer on MDF with aluminum universal bracket • Concealed leveling glides: non-marring, black plastic 	<ol style="list-style-type: none"> 1 Style number 2 Base section (see below) and wood color number for base 3 Laminate color number for table top, if selected 4 Wood color number for wood edge 5 Door color number for storage tray or TAP door, if selected: <ul style="list-style-type: none"> - 8044 Black - 8047 Silver 6 Options, if selected (see below) <p>▶ See <i>Coalesse Surface Materials Reference Guide</i>.</p>

Options	U.S. Price	Required to Specify
Surface Materials <ul style="list-style-type: none"> • Top • Grade 2 laminate • Grade 3 laminate • Grade 1 wood veneer • Grade 2 wood veneer 	<ul style="list-style-type: none"> Prices at right Prices at right Prices at right Prices at right 	<ul style="list-style-type: none"> Specify with <i>Grade 2 laminate</i> and select color number. Specify with <i>Grade 3 laminate</i> and select color number. Specify with <i>Grade 1 wood veneer</i> and select color number. Specify with <i>Grade 2 wood veneer</i> and select color number.

Edges <ul style="list-style-type: none"> • Wood • Bullnose wood edge 	<ul style="list-style-type: none"> Prices at right 	<ul style="list-style-type: none"> Specify with <i>bullnose wood edge</i>.
--	---	---

Bases <p>Slim Flared</p>	<ul style="list-style-type: none"> • Two slim bases • One slim and one flared base • Two flared bases 	<ul style="list-style-type: none"> No cost +\$1219 +\$2441 	<ul style="list-style-type: none"> Specify with <i>two slim bases</i>. Specify with <i>one slim base and one flared base</i>. Specify with <i>two flared bases</i>.
---------------------------------	--	---	--

Tip: 96"L tables available with zero, one, or two TAP(s). 10'L and 12'L tables available with zero, one, two, or three TAP(s).

Tip: Last digit of style number indicates number of TAP(s).

Tip: In addition to the data and audio/video AAPs available from Coalesse, other styles of AAPs are available through Extron Electronics. For an Extron dealer, call 1-800-633-9876.

Tip: See TAP options for electrical systems and faceplate list.

TAP Electrical System with Faceplate Options ▶ Page 345	<p>Field Wired</p> <p>Cord and Plug</p> <p>Hardwired</p>	<ul style="list-style-type: none"> • Field-wired tray (no electrical) <ul style="list-style-type: none"> - PAFW field-wired tray (no electrical) with blank AAPs - PDFW field-wired tray (no electrical) with two data AAPs - PVFW field-wired tray (no electrical) with two of each video/audio and data AAPs • Cord and plug tray (10' cord) <ul style="list-style-type: none"> - PACP cord and plug tray with outlets and blank AAPs - PDPC cord and plug tray with outlets and two data AAPs - PAVC cord and plug tray with outlets and two of each video/audio and data AAPs • Hard-wired tray (6' conduit) <ul style="list-style-type: none"> - PAHW hard-wired tray with outlets and blank AAPs - PDHW hard-wired tray with outlets and two data AAPs - PAVH hard-wired tray with outlets and two of each video/audio and data AAPs 	<ul style="list-style-type: none"> No cost No cost No cost 	<ul style="list-style-type: none"> Specify with <i>power data</i>, and select TAP type and TAP door color number. Specify with <i>power data</i>, and select TAP type and TAP door color number. Specify with <i>power data</i>, and select TAP type and TAP door color number.
---	--	---	---	--

▶ Options, continued on next page



For Canadian Pricing
 Multiply U.S. Price by the Canadian price factor.
 ▶ See page 1 for details.

Host Collaborative and Conference Tables Boat Shaped Tables with Two Bases

DESIGN F/P DESIGN AND VECTA DESIGN TEAM

Tip: For single TAP style numbers, the modular system tray is not available. Specify the hard-wired tray option.

Tip: If the specified table has multiple TAP(s), any one TAP can be replaced with a storage tray.

Tip: Wood veneer doors for storage tray and TAP(s) will always be cross grain.

Tip: Connectrac must be the same wiring schematic as the table.

► Options, continued from previous page

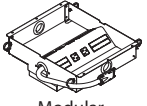
Options	U.S. Price	Required to Specify
TAP Electrical System with Faceplate Options ► Page 345  Modular	<ul style="list-style-type: none"> • Modular system tray (hardwire base power infeed) <ul style="list-style-type: none"> - PAMH modular system tray with outlets and blank AAPs - PDMH modular system tray with outlets and two data AAPs - PVMH modular system tray with outlets and two of each video/audio and data AAPs 	+\$208 each tray Specify with modular power data, and select TAP type and TAP door color number.
Storage Tray ► Page 346	<ul style="list-style-type: none"> • Storage tray 	-\$875 Specify with storage tray and select door color number.
Doors	<ul style="list-style-type: none"> • Storage tray wood veneer doors • TAP wood veneer doors 	+\$438 per door +\$438 per door Specify with wood doors.
Related Products	<ul style="list-style-type: none"> • Floor kit: Connectrac • Corridor shelf • Power strip 	► Page 468 ► Page 468 ► Page 739

TAP Locations

96"L, 54"W Center, 42"W End TAP Locations—One piece top

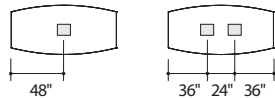

10'L, 60"W Center, 48"W End TAP Locations—One piece top

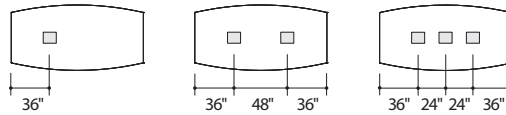

10'L, 60"W Center, 48"W End TAP Locations—Two piece top

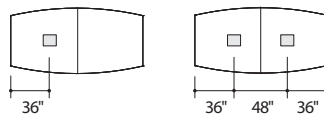

12'L, 60"W Center, 48"W Ends TAP Locations—Two piece top

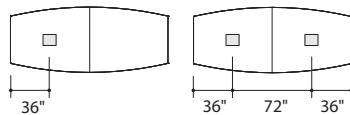

► Specification Information, on next page

Host Collaborative and Conference Tables

For Canadian Pricing
 Multiply U.S. Price by the Canadian price factor.
 ► See page 1 for details.

Host Collaborative and Conference Tables Boat Shaped Tables with Two Bases *continued*

DESIGN F/P DESIGN AND VECTA DESIGN TEAM

► Options, on previous page



Tip: Prices shown include top, TAP(s), and slim bases.

► See base options for flared bases, page 446

Tip: Last digit of style number indicates number of TAP(s).

Tip: For tech corridor, 96"L tables have two long doors and four short doors.

Specification Information

Style Number	Finish	U.S. Base Prices	
			
		Flat Wood Edge:	Bullnose Wood Edge:

96"L, 54"W Center, 42"W End One Piece Top

0 TAP

HS9654B10	Grade 1 Laminate	\$10,142	\$10,288
	Grade 2 and 3 Laminate	\$10,316	\$10,462
	Grade 1 Veneer	\$11,172	\$11,318
	Grade 2 Veneer	\$12,069	\$12,215

1 TAP

HS9654B11	Grade 1 Laminate	\$12,483	\$12,629
	Grade 2 and 3 Laminate	\$12,657	\$12,803
	Grade 1 Veneer	\$13,513	\$13,659
	Grade 2 Veneer	\$14,410	\$14,556

2 TAPS

HS9654B12	Grade 1 Laminate	\$14,825	\$14,971
	Grade 2 and 3 Laminate	\$14,999	\$15,145
	Grade 1 Veneer	\$15,855	\$16,001
	Grade 2 Veneer	\$16,752	\$16,898

10'L, 60"W Center, 48"W End One Piece Top

0 TAP

HS1060B10	Grade 1 Laminate	\$11,264	\$11,447
	Grade 2 and 3 Laminate	\$11,532	\$11,715
	Grade 1 Veneer	\$13,224	\$13,407
	Grade 2 Veneer	\$14,641	\$14,824

1 TAP ✕34/24

HS1060B11	Grade 1 Laminate	\$13,607	\$13,790
	Grade 2 and 3 Laminate	\$13,875	\$14,058
	Grade 1 Veneer	\$15,567	\$15,750
	Grade 2 Veneer	\$16,984	\$17,167

2 TAPS

HS1060B12	Grade 1 Laminate	\$15,951	\$16,134
	Grade 2 and 3 Laminate	\$16,219	\$16,402
	Grade 1 Veneer	\$17,911	\$18,094
	Grade 2 Veneer	\$19,328	\$19,511

3 TAPS

HS1060B13	Grade 1 Laminate	\$18,292	\$18,475
	Grade 2 and 3 Laminate	\$18,560	\$18,743
	Grade 1 Veneer	\$20,252	\$20,435
	Grade 2 Veneer	\$21,669	\$21,852

► Specification Information, continued on next page

✕34/24 = Last order entry
April 14, 2024

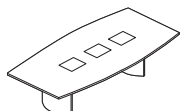
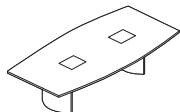
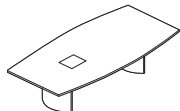
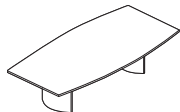
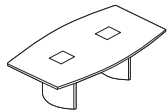
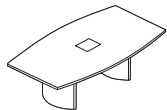
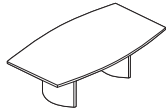

Host Collaborative and Conference Tables Boat Shaped Tables with Two Bases

DESIGN F/P DESIGN AND VECTA DESIGN TEAM

Tip: Prices shown include top, TAP(s), and slim bases.
 ▶ See base options for flared bases, page 446

Tip: Last digit of style number indicates number of TAP(s).

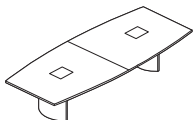
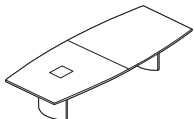
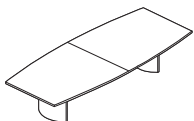
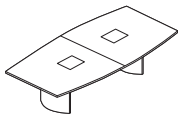
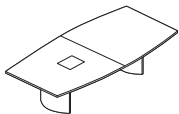
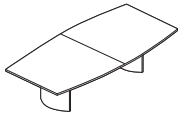

Tip: For tech corridor, 10'L tables have four long doors and four short doors.



For Canadian Pricing
 Multiply U.S. Price by the Canadian price factor.
 ▶ See page 1 for details.

▶ Specification Information, continued from previous page

Specification Information

Style Number	Finish	U.S. Base Prices	
			
		Flat Wood Edge:	Bullnose Wood Edge:

10'L, 60"W Center, 48"W End Two Piece Top

0 TAP			
HS1060B20	Grade 1 Laminate	\$11,829	\$12,012
	Grade 2 and 3 Laminate	\$12,097	\$12,280
	Grade 1 Veneer	\$13,789	\$13,972
	Grade 2 Veneer	\$15,206	\$15,389
1 TAP X4/24			
HS1060B21	Grade 1 Laminate	\$14,170	\$14,353
	Grade 2 and 3 Laminate	\$14,438	\$14,621
	Grade 1 Veneer	\$16,130	\$16,313
	Grade 2 Veneer	\$17,547	\$17,730
2 TAPS			
HS1060B22	Grade 1 Laminate	\$16,510	\$16,693
	Grade 2 and 3 Laminate	\$16,778	\$16,961
	Grade 1 Veneer	\$18,470	\$18,653
	Grade 2 Veneer	\$19,887	\$20,070

12'L, 60"W Center, 48"W End Two Piece Top

0 TAP			
HS1260B20	Grade 1 Laminate	\$12,651	\$12,855
	Grade 2 and 3 Laminate	\$12,979	\$13,183
	Grade 1 Veneer	\$15,028	\$15,232
	Grade 2 Veneer	\$16,731	\$16,935
1 TAP X4/24			
HS1260B21	Grade 1 Laminate	\$14,993	\$15,197
	Grade 2 and 3 Laminate	\$15,321	\$15,525
	Grade 1 Veneer	\$17,370	\$17,574
	Grade 2 Veneer	\$19,073	\$19,277
2 TAPS			
HS1260B22	Grade 1 Laminate	\$17,334	\$17,538
	Grade 2 and 3 Laminate	\$17,662	\$17,866
	Grade 1 Veneer	\$19,711	\$19,915
	Grade 2 Veneer	\$21,414	\$21,618

X4/24 = Last order entry
 April 14, 2024

Host Collaborative and Conference Tables Boat Shaped Tables with Three Bases

DESIGN F/P DESIGN AND VECTA DESIGN TEAM

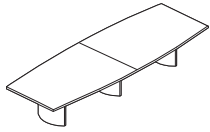

Tip: Shipped knocked down.

Tip: Grain direction for wood-grain laminate runs the length of the table.

Tip: Clips are provided with table: One clip per foot of table length.

Tip: The wood edge on a table top with woodgrain laminate may not match the top.

Standard Includes	Required to Specify
<p>► Need help? Product details, page 334</p> <ul style="list-style-type: none"> • Top: 1/4" particle board core with laminate • Flat wood edge • TAP(s), if selected: 10"W x 12"L opening(s) trimmed with a flat solid wood profile and with brushed anodized aluminum TAP doors • Tech corridor: four aluminum beams for top support provide tracks for hinged aluminum doors that clip shut: satin anodized finish • Universal clip: black plastic • Three 27"W bases: wood veneer on MDF with aluminum universal bracket • Concealed leveling glides: non-marring, black plastic 	<ol style="list-style-type: none"> 1 Style number 2 Base selection 3 Laminate color number for table top, if selected 4 Wood color number for wood edge 5 Laminate color number for table top 6 Door color number for storage tray or TAP door, if selected: <ul style="list-style-type: none"> - 8044 Black - 8047 Silver 7 Options, if selected (see below) <p>► See <i>Coalesse Surface Materials Reference Guide</i>.</p>

Options	U.S. Price	Required to Specify
<p>Surface Materials</p> <ul style="list-style-type: none"> • Grade 2 laminate • Grade 3 laminate • Grade 1 wood veneer • Grade 2 wood veneer 	<p>Prices at right</p> <p>Prices at right</p> <p>Prices at right</p> <p>Prices at right</p>	<p>Specify with <i>Grade 2 laminate</i> and select color number.</p> <p>Specify with <i>Grade 3 laminate</i> and select color number.</p> <p>Specify with <i>Grade 1 wood veneer</i> and select color number.</p> <p>Specify with <i>Grade 2 wood veneer</i> and select color number.</p>
<p>Edges</p> <ul style="list-style-type: none"> • Bullnose wood edge 	<p>Prices at right</p>	<p>Specify with <i>bullnose wood edge</i>.</p>
<p>Bases</p> <p>Slim Flared</p> <ul style="list-style-type: none"> • Three slim bases • Two slim and one flared bases • One slim and two flared bases • Three flared bases 	<p>No cost</p> <p>+\$1217</p> <p>+\$2438</p> <p>+\$3652</p>	<p>Specify with <i>three slim bases</i>.</p> <p>Specify with <i>two slim and one flared bases</i>.</p> <p>Specify with <i>one slim and two flared bases</i>.</p> <p>Specify with <i>three flared bases</i>.</p>

Tip: 14'L and 16'L tables available with zero, one, two, or four TAP(s). 18'L and 20'L tables available with zero, one, two, four, or six TAP(s).

Tip: In addition to the data and audio/video AAPs available from Coalesse, other styles of AAPs are available through Extron Electronics. For an Extron dealer, call 1.800.633.9876.

Tip: See TAP options for electrical systems and faceplate list.

TAP Electrical System with Faceplate Options	U.S. Price	Required to Specify
<p>► Page 345</p> <p>Field Wired</p> <ul style="list-style-type: none"> • Field-wired tray (no electrical) <ul style="list-style-type: none"> - PAFW field-wired tray (no electrical) with blank AAPs - PDFW field-wired tray (no electrical) with two data AAPs - PVFW field-wired tray (no electrical) with two of each video/audio and data AAPs 	<p>No cost</p>	<p>Specify with <i>power data</i>, and select TAP type and TAP door color number.</p>
<p>Cord and Plug</p> <ul style="list-style-type: none"> • Cord and plug tray (10' cord) <ul style="list-style-type: none"> - PACP cord and plug tray with outlets and blank AAPs - PDCCP cord and plug tray with outlets and two data AAPs - PAVC cord and plug tray with outlets and two of each video/audio and data AAPs 	<p>No cost</p>	<p>Specify with <i>power data</i>, and select TAP type and TAP door color number.</p>
<p>Hardwired</p> <ul style="list-style-type: none"> • Hard-wired tray (6' conduit) <ul style="list-style-type: none"> - PAHW hard-wired tray with outlets and blank AAPs - PDHW hard-wired tray with outlets and two data AAPs - PAVH hard-wired tray with outlets and two of each video/audio and data AAPs 	<p>No cost</p>	<p>Specify with <i>power data</i>, and select TAP type and TAP door color number.</p>

► Options, continued on next page



For Canadian Pricing
 Multiply U.S. Price by the Canadian price factor.
 ► See page 1 for details.

Host Collaborative and Conference Tables Boat Shaped Tables with Three Bases

DESIGN F/P DESIGN AND VECTA DESIGN TEAM

Tip: For single TAP style numbers, the modular system tray is not available. Specify the hard-wired tray option.

Tip: If the specified table has multiple TAP(s), any one TAP can be replaced with a storage tray.

Tip: Wood veneer doors for storage tray or TAP will always be cross grain.

Tip: Connectrac must be the same wiring schematic as the table.

► Options, continued from previous page

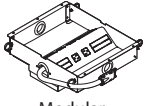
Options	U.S. Price	Required to Specify
TAP Electrical System with Faceplate Options ► Page 345  Modular	<ul style="list-style-type: none"> Modular system tray (hardwire base power infeed) <ul style="list-style-type: none"> - PAMH modular system tray with outlets and blank AAPs - PDMH modular system tray with outlets and two data AAPs - PVMH modular system tray with outlets and two of each video/audio and data AAPs +\$208 each tray	Specify with modular power data, and select TAP type and TAP door color number.
Storage Tray ► Page 346	<ul style="list-style-type: none"> Storage tray -\$875	Specify with storage tray and select door color number.
Doors	<ul style="list-style-type: none"> Storage tray wood veneer doors TAP wood veneer doors +\$438 per door +\$438 per door	Specify with wood doors. Specify with wood doors.
Related Products	<ul style="list-style-type: none"> Floor kit: Connectrac Corridor shelf Power strip 	► Page 468 ► Page 468 ► Page 739

TAP Locations

14'L, 60"W Center, 48"W End TAP Locations—Two piece top

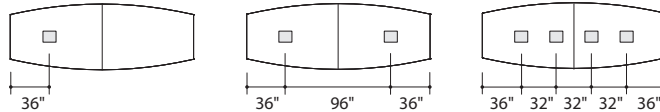

14'L, 60"W Center, 48"W End TAP Locations—Three piece top

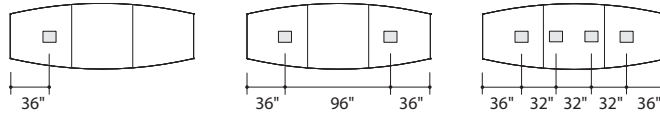

16'L, 60"W Center, 48"W End TAP Locations—Two piece top

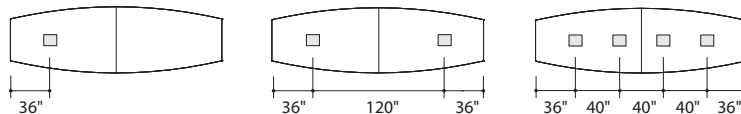

16'L, 60"W Center, 48"W End TAP Locations—Three piece top

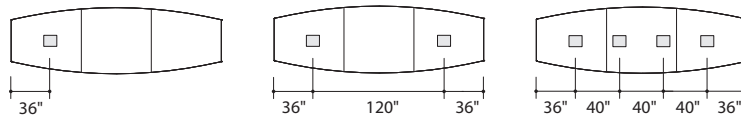

► Options, continued on next page

For Canadian Pricing
 Multiply U.S. Price by the Canadian price factor.
 ► See page 1 for details.

Host Collaborative and Conference Tables Boat Shaped Tables with Three Bases *continued*

DESIGN F/P DESIGN AND VECTA DESIGN TEAM

► Options, continued from previous page

TAP Locations

18'L, 60"W Center, 48"W End TAP Locations—Two piece top

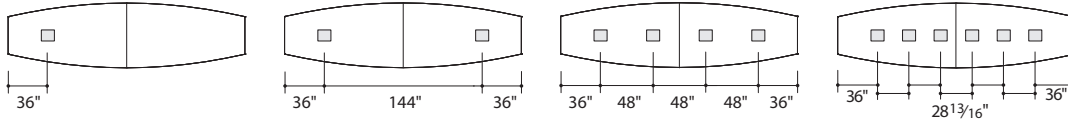

18'L, 60"W Center, 48"W End TAP Locations—Three piece top

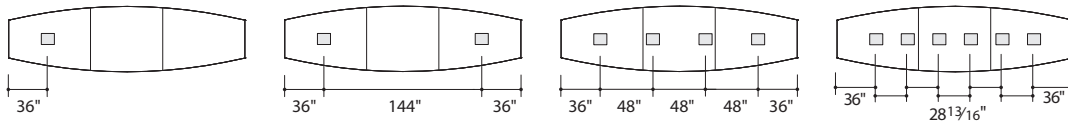

20'L, 60"W Center, 48"W End TAP Locations—Two piece top

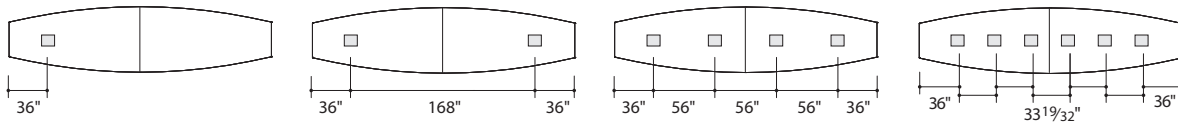

20'L, 60"W Center, 48"W End TAP Locations—Three piece top

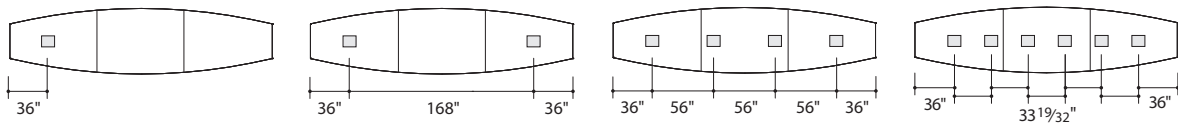

Host Collaborative and Conference Tables Boat Shaped Tables with Three Bases

DESIGN F/P DESIGN AND VECTA DESIGN TEAM



Tip: Prices shown include top, TAP(s), and slim bases.
 ▶ See base options for flared bases, page 450

Tip: Last digit of style number indicates number of TAP(s).

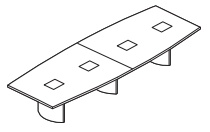
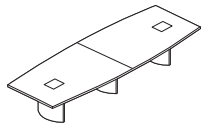
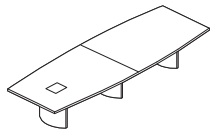
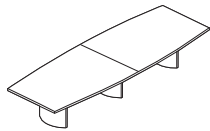
Tip: For tech corridor, 14'L tables have four long doors and four short doors.



Specification Information

Style Number	Finish	U.S. Base Prices	
			
		Flat Wood Edge:	Bullnose Wood Edge:

14'L, 60"W Center, 48"W End Two Piece Top

0 TAP			
HS1460B20	Grade 1 Laminate	\$16,664	\$16,895
	Grade 2 and 3 Laminate	\$17,049	\$17,280
	Grade 1 Veneer	\$20,235	\$20,466
	Grade 2 Veneer	\$22,244	\$22,475
1 TAP X4/24			
HS1460B21	Grade 1 Laminate	\$19,006	\$19,237
	Grade 2 and 3 Laminate	\$19,391	\$19,622
	Grade 1 Veneer	\$22,577	\$22,808
	Grade 2 Veneer	\$24,586	\$24,817
2 TAPS			
HS1460B22	Grade 1 Laminate	\$21,348	\$21,579
	Grade 2 and 3 Laminate	\$21,733	\$21,964
	Grade 1 Veneer	\$24,919	\$25,150
	Grade 2 Veneer	\$26,928	\$27,159
4 TAPS			
HS1460B24	Grade 1 Laminate	\$26,033	\$26,264
	Grade 2 and 3 Laminate	\$26,418	\$26,649
	Grade 1 Veneer	\$29,604	\$29,835
	Grade 2 Veneer	\$31,613	\$31,844

▶ Specification Information, continued on next page



For Canadian Pricing
 Multiply U.S. Price by the Canadian price factor.
 ▶ See page 1 for details.

X4/24 = Last order entry
 April 14, 2024

Host Collaborative and Conference Tables Boat Shaped Tables with Three Bases *continued*

DESIGN F/P DESIGN AND VECTA DESIGN TEAM

► Specification Information, continued from previous page



Tip: Prices shown include top, TAP(s), and slim bases.
 ► See base options for flared bases, page 450

Tip: Last digit of style number indicates number of TAP(s).

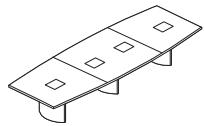
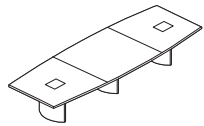
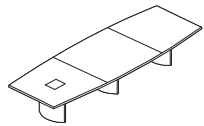
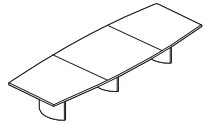
Tip: For tech corridor, 14'L tables have four long doors and four short doors.



Specification Information

Style Number	Finish	U.S. Base Prices	
		Flat Wood Edge:	Bullnose Wood Edge:
			

14'L, 60"W Center, 48"W End Three Piece Top

0 TAP

HS1460B30	Grade 1 Laminate	\$17,226	\$17,457
	Grade 2 and 3 Laminate	\$17,611	\$17,842
	Grade 1 Veneer	\$20,797	\$21,028
	Grade 2 Veneer	\$22,806	\$23,037

1 TAP X4/24

HS1460B31	Grade 1 Laminate	\$19,567	\$19,798
	Grade 2 and 3 Laminate	\$19,952	\$20,183
	Grade 1 Veneer	\$23,138	\$23,369
	Grade 2 Veneer	\$25,147	\$25,378

2 TAPS

HS1460B32	Grade 1 Laminate	\$21,909	\$22,140
	Grade 2 and 3 Laminate	\$22,294	\$22,525
	Grade 1 Veneer	\$25,480	\$25,711
	Grade 2 Veneer	\$27,489	\$27,720

4 TAPS

HS1460B34	Grade 1 Laminate	\$26,593	\$26,824
	Grade 2 and 3 Laminate	\$26,978	\$27,209
	Grade 1 Veneer	\$30,164	\$30,395
	Grade 2 Veneer	\$32,173	\$32,404

► Specification Information, continued on next page



For Canadian Pricing
 Multiply U.S. Price by the Canadian price factor.
 ► See page 1 for details.

X4/24 = Last order entry
 April 14, 2024

Host Collaborative and Conference Tables Boat Shaped Tables with Three Bases

DESIGN F/P DESIGN AND VECTA DESIGN TEAM

Tip: Prices shown include top, TAP(s), and slim bases.
 ▶ See base options for flared bases, page 450

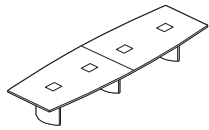
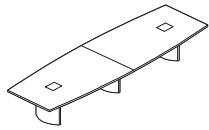
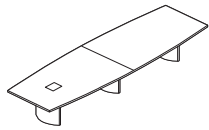
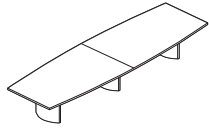

Tip: Last digit of style number indicates number of TAP(s).

Tip: For tech corridor, 16'L tables have eight long doors and four short doors.



▶ Specification Information, continued from previous page

Specification Information

Style Number	Finish	U.S. Base Prices	
		 Flat Wood Edge:	 Bullnose Wood Edge:

16'L, 60"W Center, 48"W End Two Piece Top

0 TAP			
HS1660B20	Grade 1 Laminate	\$17,403	\$17,657
	Grade 2 and 3 Laminate	\$17,840	\$18,094
	Grade 1 Veneer	\$21,023	\$21,277
	Grade 2 Veneer	\$23,303	\$23,557
1 TAP X4/24			
HS1660B21	Grade 1 Laminate	\$19,745	\$19,999
	Grade 2 and 3 Laminate	\$20,182	\$20,436
	Grade 1 Veneer	\$23,365	\$23,619
	Grade 2 Veneer	\$25,645	\$25,899
2 TAPS			
HS1660B22	Grade 1 Laminate	\$22,087	\$22,341
	Grade 2 and 3 Laminate	\$22,524	\$22,778
	Grade 1 Veneer	\$25,707	\$25,961
	Grade 2 Veneer	\$27,987	\$28,241
4 TAPS			
HS1660B24	Grade 1 Laminate	\$26,773	\$27,027
	Grade 2 and 3 Laminate	\$27,210	\$27,464
	Grade 1 Veneer	\$30,393	\$30,647
	Grade 2 Veneer	\$32,673	\$32,927

▶ Specification Information, continued on next page



For Canadian Pricing
 Multiply U.S. Price by the Canadian price factor.
 ▶ See page 1 for details.

X4/24 = Last order entry
 April 14, 2024

Host Collaborative and Conference Tables Boat Shaped Tables with Three Bases *continued*

DESIGN F/P DESIGN AND VECTA DESIGN TEAM

Tip: Prices shown include top, TAP(s), and slim bases.

► See base options for flared bases, page 450

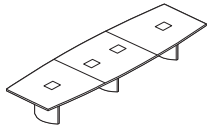
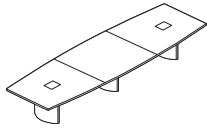
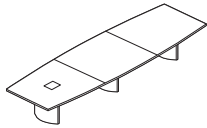
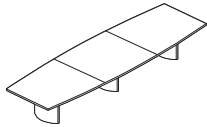

Tip: Last digit of style number indicates number of TAP(s).

Tip: For tech corridor, 16'L tables have eight long doors and four short doors.



► Specification Information, continued from previous page

Specification Information

Style Number	Finish	U.S. Base Prices	
			
		Flat Wood Edge:	Bullnose Wood Edge:

16'L, 60"W Center, 48"W End Three Piece Top

0 TAP

HS1660B30	Grade 1 Laminate	\$17,963	\$18,217
	Grade 2 and 3 Laminate	\$18,400	\$18,654
	Grade 1 Veneer	\$21,583	\$21,837
	Grade 2 Veneer	\$23,863	\$24,117

1 TAP X34/24

HS1660B31	Grade 1 Laminate	\$20,306	\$20,560
	Grade 2 and 3 Laminate	\$20,743	\$20,997
	Grade 1 Veneer	\$23,926	\$24,180
	Grade 2 Veneer	\$26,206	\$26,460

2 TAPS

HS1660B32	Grade 1 Laminate	\$22,648	\$22,902
	Grade 2 and 3 Laminate	\$23,085	\$23,339
	Grade 1 Veneer	\$26,268	\$26,522
	Grade 2 Veneer	\$28,548	\$28,802

4 TAPS

HS1660B34	Grade 1 Laminate	\$27,334	\$27,588
	Grade 2 and 3 Laminate	\$27,771	\$28,025
	Grade 1 Veneer	\$30,954	\$31,208
	Grade 2 Veneer	\$33,234	\$33,488

► Specification Information, continued on next page



For Canadian Pricing
Multiply U.S. Price by the Canadian price factor.
► See page 1 for details.

X34/24 = Last order entry
April 14, 2024

Host Collaborative and Conference Tables Boat Shaped Tables with Three Bases

DESIGN F/P DESIGN AND VECTA DESIGN TEAM

Tip: Prices shown include top, TAP(s), and slim bases.
 ▶ See base options for flared bases, page 450

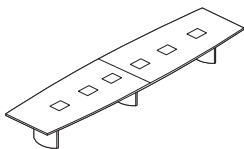
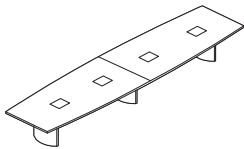
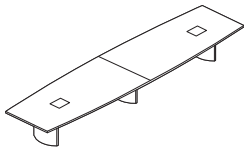
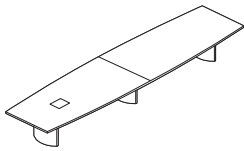
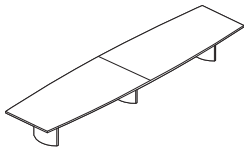

Tip: Last digit of style number indicates number of TAP(s).

Tip: For tech corridor, 18'L tables have eight long doors and four short doors.



▶ Specification Information, continued from previous page

Specification Information

Style Number	Finish	U.S. Base Prices	
			
		Flat Wood Edge:	Bullnose Wood Edge:

18'L, 60"W Center, 48"W End Two Piece Top

0 TAP			
HS1860B20	Grade 1 Laminate	\$18,196	\$18,471
	Grade 2 and 3 Laminate	\$18,689	\$18,964
	Grade 1 Veneer	\$22,918	\$23,193
	Grade 2 Veneer	\$25,502	\$25,777
1 TAP X4/24			
HS1860B21	Grade 1 Laminate	\$20,540	\$20,815
	Grade 2 and 3 Laminate	\$21,033	\$21,308
	Grade 1 Veneer	\$25,262	\$25,537
	Grade 2 Veneer	\$27,846	\$28,121
2 TAPS			
HS1860B22	Grade 1 Laminate	\$22,882	\$23,157
	Grade 2 and 3 Laminate	\$23,375	\$23,650
	Grade 1 Veneer	\$27,604	\$27,879
	Grade 2 Veneer	\$30,188	\$30,463
4 TAPS			
HS1860B24	Grade 1 Laminate	\$27,563	\$27,838
	Grade 2 and 3 Laminate	\$28,056	\$28,331
	Grade 1 Veneer	\$32,285	\$32,560
	Grade 2 Veneer	\$34,869	\$35,144
6 TAPS			
HS1860B26	Grade 1 Laminate	\$32,252	\$32,527
	Grade 2 and 3 Laminate	\$32,745	\$33,020
	Grade 1 Veneer	\$36,974	\$37,249
	Grade 2 Veneer	\$39,558	\$39,833

▶ Specification Information, continued on next page

Host Collaborative and Conference Tables

For Canadian Pricing
 Multiply U.S. Price by the Canadian price factor.
 ▶ See page 1 for details.

X4/24 = Last order entry
 April 14, 2024

Host Collaborative and Conference Tables Boat Shaped Tables with Three Bases *continued*

DESIGN F/P DESIGN AND VECTA DESIGN TEAM

Tip: Prices shown include top, TAP(s), and slim bases.

► See base options for flared bases, page 450

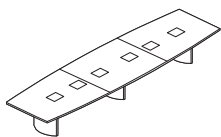
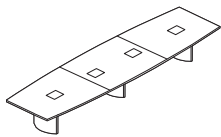
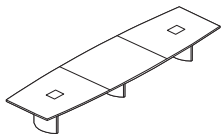
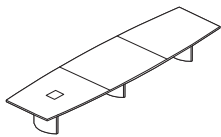
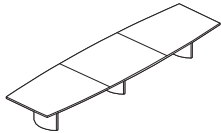

Tip: Last digit of style number indicates number of TAP(s).

Tip: For tech corridor, 18'L tables have eight long doors and four short doors.



► Specification Information, continued from previous page

Specification Information

Style Number	Finish	U.S. Base Prices	
			
		Flat Wood Edge:	Bullnose Wood Edge:

18'L, 60"W Center, 48"W End Three Piece Top

0 TAP

HS1860B30	Grade 1 Laminate	\$18,762	\$19,037
	Grade 2 and 3 Laminate	\$19,255	\$19,530
	Grade 1 Veneer	\$23,484	\$23,759
	Grade 2 Veneer	\$26,068	\$26,343

1 TAP X34/24

HS1860B31	Grade 1 Laminate	\$21,101	\$21,376
	Grade 2 and 3 Laminate	\$21,594	\$21,869
	Grade 1 Veneer	\$25,823	\$26,098
	Grade 2 Veneer	\$28,407	\$28,682

2 TAPS

HS1860B32	Grade 1 Laminate	\$23,444	\$23,719
	Grade 2 and 3 Laminate	\$23,937	\$24,212
	Grade 1 Veneer	\$28,166	\$28,441
	Grade 2 Veneer	\$30,750	\$31,025

4 TAPS

HS1860B34	Grade 1 Laminate	\$28,127	\$28,402
	Grade 2 and 3 Laminate	\$28,620	\$28,895
	Grade 1 Veneer	\$32,849	\$33,124
	Grade 2 Veneer	\$35,433	\$35,708

6 TAPS

HS1860B36	Grade 1 Laminate	\$32,810	\$33,085
	Grade 2 and 3 Laminate	\$33,303	\$33,578
	Grade 1 Veneer	\$37,532	\$37,807
	Grade 2 Veneer	\$40,116	\$40,391

► Specification Information, continued on next page



For Canadian Pricing
Multiply U.S. Price by the Canadian price factor.
► See page 1 for details.

X34/24 = Last order entry
April 14, 2024

Host Collaborative and Conference Tables Boat Shaped Tables with Three Bases

DESIGN F/P DESIGN AND VECTA DESIGN TEAM

Tip: Prices shown include top, TAP(s), and slim bases.
 ▶ See base options for flared bases, page 450

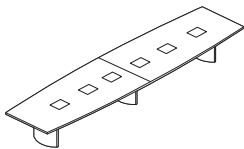
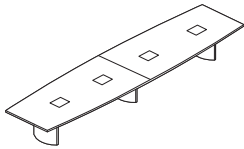
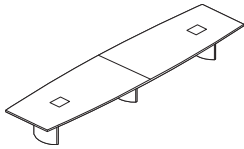
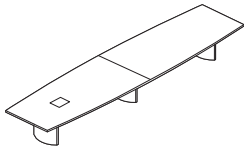
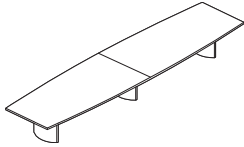

Tip: Last digit of style number indicates number of TAP(s).

Tip: For tech corridor, 20'L tables have eight long doors and four short doors.



▶ Specification Information, continued from previous page

Specification Information

Style Number	Finish	U.S. Base Prices	
			
		Flat Wood Edge:	Bullnose Wood Edge:

20'L, 60"W Center, 48"W End Two Piece Top

0 TAP			
HS2060B20	Grade 1 Laminate	\$18,940	\$19,241
	Grade 2 and 3 Laminate	\$19,486	\$19,787
	Grade 1 Veneer	\$23,712	\$24,013
	Grade 2 Veneer	\$26,566	\$26,867
1 TAP X4/24			
HS2060B21	Grade 1 Laminate	\$21,278	\$21,579
	Grade 2 and 3 Laminate	\$21,824	\$22,125
	Grade 1 Veneer	\$26,050	\$26,351
	Grade 2 Veneer	\$28,904	\$29,205
2 TAPS			
HS2060B22	Grade 1 Laminate	\$23,622	\$23,923
	Grade 2 and 3 Laminate	\$24,168	\$24,469
	Grade 1 Veneer	\$28,394	\$28,695
	Grade 2 Veneer	\$31,248	\$31,549
4 TAPS			
HS2060B24	Grade 1 Laminate	\$28,305	\$28,606
	Grade 2 and 3 Laminate	\$28,851	\$29,152
	Grade 1 Veneer	\$33,077	\$33,378
	Grade 2 Veneer	\$35,931	\$36,232
6 TAPS			
HS2060B26	Grade 1 Laminate	\$32,991	\$33,292
	Grade 2 and 3 Laminate	\$33,537	\$33,838
	Grade 1 Veneer	\$37,763	\$38,064
	Grade 2 Veneer	\$40,617	\$40,918

▶ Specification Information, continued on next page

Host Collaborative and Conference Tables

For Canadian Pricing
 Multiply U.S. Price by the Canadian price factor.
 ▶ See page 1 for details.

X4/24 = Last order entry
 April 14, 2024

Host Collaborative and Conference Tables Boat Shaped Tables with Three Bases *continued*

DESIGN F/P DESIGN AND VECTA DESIGN TEAM

► Specification Information, continued from previous page



Tip: Prices shown include top, TAP(s), and slim bases.

► See base options for flared bases, page 450

Tip: Last digit of style number indicates number of TAP(s).

Tip: For tech corridor, 20'L tables have eight long doors and four short doors.

Specification Information

Style Number	Finish	U.S. Base Prices	
			
		Flat Wood Edge:	Bullnose Wood Edge:

20'L, 60"W Center, 48"W End Three Piece Top

0 TAP

HS2060B30	Grade 1 Laminate	\$19,501	\$19,802
	Grade 2 and 3 Laminate	\$20,047	\$20,348
	Grade 1 Veneer	\$24,273	\$24,574
	Grade 2 Veneer	\$27,127	\$27,428

1 TAP X34/24

HS2060B31	Grade 1 Laminate	\$21,840	\$22,141
	Grade 2 and 3 Laminate	\$22,386	\$22,687
	Grade 1 Veneer	\$26,612	\$26,913
	Grade 2 Veneer	\$29,466	\$29,767

2 TAPS

HS2060B32	Grade 1 Laminate	\$24,184	\$24,485
	Grade 2 and 3 Laminate	\$24,730	\$25,031
	Grade 1 Veneer	\$28,956	\$29,257
	Grade 2 Veneer	\$31,810	\$32,111

4 TAPS

HS2060B34	Grade 1 Laminate	\$28,867	\$29,168
	Grade 2 and 3 Laminate	\$29,413	\$29,714
	Grade 1 Veneer	\$33,639	\$33,940
	Grade 2 Veneer	\$36,493	\$36,794

6 TAPS

HS2060B36	Grade 1 Laminate	\$33,548	\$33,849
	Grade 2 and 3 Laminate	\$34,094	\$34,395
	Grade 1 Veneer	\$38,320	\$38,621
	Grade 2 Veneer	\$41,174	\$41,475

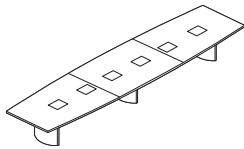
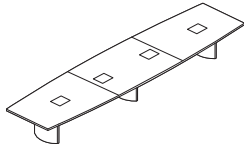
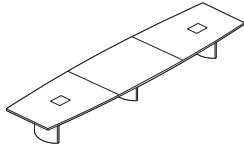
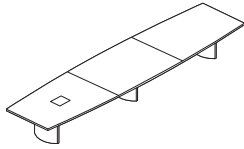
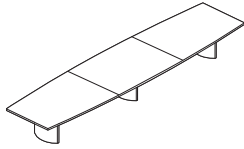

For Canadian Pricing
 Multiply U.S. Price by the Canadian price factor.
 ► See page 1 for details.

X34/24 = Last order entry
 April 14, 2024

Coalesse

Host Collaborative and Conference Tables Boat Shaped Tables with Three Bases

DESIGN F/P DESIGN AND VECTA DESIGN TEAM

Host Collaborative and
Conference Tables

Host Collaborative and Conference Tables Trapezoid Tables with Two Bases

DESIGN F/P DESIGN AND VECTA DESIGN TEAM

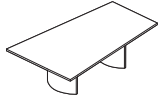

Tip: Shipped knocked down.

Tip: Grain direction for wood-grain laminate runs the length of the table.

Tip: See TAP options for electrical systems and faceplate list.

Tip: Clips are provided with table: One clip per foot of table length.

Tip: The wood edge on a table top with woodgrain laminate may not match the top.

Standard Includes	Required to Specify
<p>► Need help? Product details, page 334</p> <ul style="list-style-type: none"> • Top: 1¼" particle board core with laminate • Flat wood edge • TAP(s), if selected: 10"W x 12"L opening(s) trimmed with a flat solid wood profile and with brushed anodized aluminum TAP doors • Tech corridor: two aluminum beams for top support provide tracks for hinged aluminum doors that clip shut: satin anodized finish • Universal clip: black plastic • Two 27"W bases: wood veneer on MDF with aluminum universal bracket • Concealed leveling glides: non-marring, black plastic 	<ol style="list-style-type: none"> 1 Style number 2 Base selection (see below) and wood color number for base 3 Laminate color number for table top, if selected 4 Wood color number for wood edge 5 Door color number for storage tray or TAP door, if selected: <ul style="list-style-type: none"> - 8044 Black - 8047 Silver 6 Options, if selected (see below) <p>► See <i>Coalesse Surface Materials Reference Guide</i>.</p>

Options	U.S. Price	Required to Specify
<p>Surface Materials</p> <p>Top</p> <ul style="list-style-type: none"> • Grade 2 laminate • Grade 3 laminate • Grade 1 Wood veneer • Grade 2 wood veneer 	<p>Prices at right</p> <p>Prices at right</p> <p>Prices at right</p> <p>Prices at right</p>	<p>Specify with <i>Grade 2 laminate</i> and select color number.</p> <p>Specify with <i>Grade 3 laminate</i> and select color number.</p> <p>Specify with <i>Grade 1 wood veneer</i> and select color number.</p> <p>Specify with <i>Grade 2 wood veneer</i> and select color number.</p>
<p>Edges</p> <p>Wood</p> <ul style="list-style-type: none"> • Bullnose wood edge • Horizon wood edge 	<p>Prices at right</p> <p>Prices at right</p>	<p>Specify with <i>bullnose wood edge</i>.</p> <p>Specify with <i>horizon wood edge</i>.</p>
<p>Bases</p> <p>Slim Flared</p>	<ul style="list-style-type: none"> • Two slim bases • One slim and one flared base • Two flared bases <p>No cost</p> <p>+\$1219</p> <p>+\$2441</p>	<p>Specify with <i>two slim bases</i>.</p> <p>Specify with <i>one slim base and one flared base</i>.</p> <p>Specify with <i>two flared bases</i>.</p>

Tip: 96"L tables available with zero, one, or two TAP(s). 10'L and 12'L tables available with zero, one, two, or three TAP(s).

Tip: In addition to the data and audio/video AAPs available from Coalesse, other styles of AAPs are available through Extron Electronics. For an Extron dealer, call 1-800-633-9876.

Tip: See TAP options for electrical systems and faceplate list.

TAP Electrical System with Faceplate Options	U.S. Price	Required to Specify
<p>► Page 345</p> <p>Field Wired</p>	<ul style="list-style-type: none"> • Field-wired tray (no electrical) <ul style="list-style-type: none"> - PAFW field-wired tray (no electrical) with blank AAPs - PDFW field-wired tray (no electrical) with two data AAPs - PVFW field-wired tray (no electrical) with two of each video/audio and data AAPs <p>No cost</p>	<p>Specify with <i>power data</i>, and select TAP type and TAP door color number.</p>
<p>Cord and Plug</p>	<ul style="list-style-type: none"> • Cord and plug tray (10' cord) <ul style="list-style-type: none"> - PACP cord and plug tray with outlets and blank AAPs - PDCP cord and plug tray with outlets and two data AAPs - PAVC cord and plug tray with outlets and two of each video/audio and data AAPs <p>No cost</p>	<p>Specify with <i>power data</i>, and select TAP type and TAP door color number.</p>
<p>Hardwired</p>	<ul style="list-style-type: none"> • Hard-wired tray (6' conduit) <ul style="list-style-type: none"> - PAHW hard-wired tray with outlets and blank AAPs - PDHW hard-wired tray with outlets and two data AAPs - PAVH hard-wired tray with outlets and two of each video/audio and data AAPs <p>No cost</p>	<p>Specify with <i>power data</i>, and select TAP type and TAP door color number.</p>

► Options, continued on next page



For Canadian Pricing
 Multiply U.S. Price by the Canadian price factor.
 ► See page 1 for details.

Host Collaborative and Conference Tables Trapezoid Tables with Two Bases

DESIGN F/P DESIGN AND VECTA DESIGN TEAM

► Options, continued from previous page

Tip: For single TAP style numbers, the modular system tray is not available. Specify the hard-wired tray option.

Tip: If the specified table has multiple TAP(s), any one TAP can be replaced with a storage tray.

Tip: Wood veneer doors for storage tray or TAP will always be cross grain.

Tip: Connectrac must be the same wiring schematic as the table.

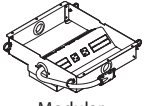
Options	U.S. Price	Required to Specify
TAP Electrical System with Faceplate Options ► Page 345  Modular	<ul style="list-style-type: none"> • Modular system tray (hardwire base power infeed) <ul style="list-style-type: none"> - PAMH modular system tray with outlets and blank AAPs - PDMH modular system tray with outlets and two data AAPs - PVMH modular system tray with outlets and two of each video/audio and data AAPs 	+\$208 each tray Specify with modular power data, and select TAP type and TAP door color number.
Storage Tray ► Page 346	<ul style="list-style-type: none"> • Storage tray 	-\$875 Specify with storage tray and select door color number.
Doors	<ul style="list-style-type: none"> • Storage tray wood veneer doors • TAP wood veneer doors 	+\$438 per door +\$438 per door Specify with wood doors.
Related Products	<ul style="list-style-type: none"> • Floor kit: Connectrac • Corridor shelf • Power strip 	► Page 468 ► Page 468 ► Page 739

TAP Locations

96"L x 42"W x 60"W TAP Locations—One piece top

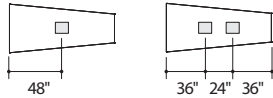

10'L x 42"W x 60"W TAP Locations—One piece top

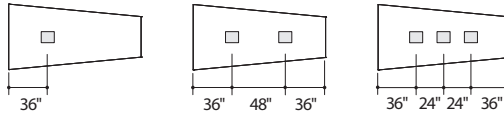

10'L x 42"W x 60"W TAP Locations—Two piece top

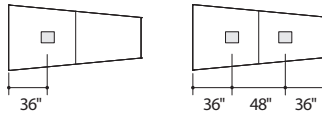

12'L x 42"W x 60"W TAP Locations—Two piece top

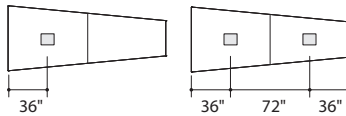

► Specification Information, on next page

For Canadian Pricing
 Multiply U.S. Price by the Canadian price factor.
 ► See page 1 for details.

Host Collaborative and Conference Tables Trapezoid Tables with Two Bases *continued*

DESIGN F/P DESIGN AND VECTA DESIGN TEAM

Tip: Prices shown include top, TAP(s), and slim bases.
 ▶ See base options for flared bases, page 462

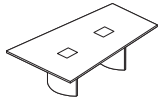
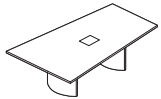
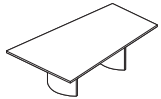

Tip: Last digit of style number indicates number of TAP(s).

Tip: For tech corridor, 96"L tables have two long doors and four short doors.



▶ Options, on previous page

Specification Information

Style Number	Finish	U.S. Base Prices		
				
		Flat Wood Edge:	Bullnose Wood Edge:	Horizon Wood Edge:

96"L x 42"W x 60"W One Piece Top

0 TAP

HS9660T10	Grade 1 Laminate	\$10,184	\$10,330	\$12,242
	Grade 2 and 3 Laminate	\$10,407	\$10,553	\$12,465
	Grade 1 Veneer	\$11,214	\$11,360	\$13,272
	Grade 2 Veneer	\$12,333	\$12,479	\$14,391

1 TAP

HS9660T11	Grade 1 Laminate	\$12,524	\$12,670	\$14,582
	Grade 2 and 3 Laminate	\$12,747	\$12,893	\$14,805
	Grade 1 Veneer	\$13,554	\$13,700	\$15,612
	Grade 2 Veneer	\$14,673	\$14,819	\$16,731

2 TAPS

HS9660T12	Grade 1 Laminate	\$14,867	\$15,013	\$16,925
	Grade 2 and 3 Laminate	\$15,090	\$15,236	\$17,148
	Grade 1 Veneer	\$15,897	\$16,043	\$17,955
	Grade 2 Veneer	\$17,016	\$17,162	\$19,074

▶ Specification Information, continued on next page



For Canadian Pricing
 Multiply U.S. Price by the Canadian price factor.
 ▶ See page 1 for details.

Host Collaborative and Conference Tables Trapezoid Tables with Two Bases

DESIGN F/P DESIGN AND VECTA DESIGN TEAM

Tip: Prices shown include top, TAP(s), and slim bases.
 ▶ See base options for flared bases, page 462

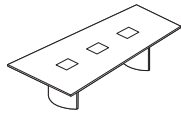
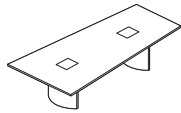
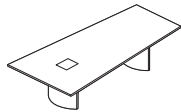
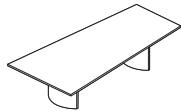

Tip: Last digit of style number indicates number of TAP(s).

Tip: For tech corridor, 10'L tables have four long doors and four short doors.



▶ Specification Information, continued from previous page

Specification Information

Style Number	Finish	U.S. Base Prices		
				
		Flat Wood Edge:	Bullnose Wood Edge:	Horizon Wood Edge:

10'L x 42"W x 60"W One Piece Top

0 TAP

HS1060T10	Grade 1 Laminate	\$10,870	\$11,053	\$12,987
	Grade 2 and 3 Laminate	\$11,138	\$11,321	\$13,255
	Grade 1 Veneer	\$12,115	\$12,298	\$14,232
	Grade 2 Veneer	\$13,510	\$13,693	\$15,627

1 TAP X4/24

HS1060T11	Grade 1 Laminate	\$13,208	\$13,391	\$15,325
	Grade 2 and 3 Laminate	\$13,476	\$13,659	\$15,593
	Grade 1 Veneer	\$14,453	\$14,636	\$16,570
	Grade 2 Veneer	\$15,848	\$16,031	\$17,965

2 TAPS

HS1060T12	Grade 1 Laminate	\$15,551	\$15,734	\$17,668
	Grade 2 and 3 Laminate	\$15,819	\$16,002	\$17,936
	Grade 1 Veneer	\$16,796	\$16,979	\$18,913
	Grade 2 Veneer	\$18,191	\$18,374	\$20,308

3 TAPS

HS1060T13	Grade 1 Laminate	\$17,894	\$18,077	\$20,011
	Grade 2 and 3 Laminate	\$18,162	\$18,345	\$20,279
	Grade 1 Veneer	\$19,139	\$19,322	\$21,256
	Grade 2 Veneer	\$20,534	\$20,717	\$22,651

▶ Specification Information, continued on next page



For Canadian Pricing
 Multiply U.S. Price by the Canadian price factor.
 ▶ See page 1 for details.

X4/24 = Last order entry
 April 14, 2024

Host Collaborative and Conference Tables Trapezoid Tables with Two Bases *continued*

DESIGN F/P DESIGN AND VECTA DESIGN TEAM

► Specification Information, continued from previous page

Tip: Prices shown include top, TAP(s), and slim bases.



► See base options for flared bases, page 462

Tip: Last digit of style number indicates number of TAP(s).

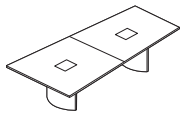
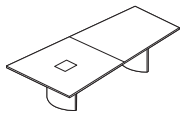
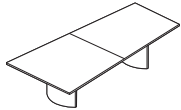
Tip: For tech corridor, 10'L tables have four long doors and four short doors.



Specification Information

Style Number	Finish	U.S. Base Prices		
				
		Flat Wood Edge:	Bullnose Wood Edge:	Horizon Wood Edge:

10'L x 42"W x 60"W Two Piece Top

0 TAP

HS1060T20	Grade 1 Laminate	\$11,425	\$11,608	\$13,542
	Grade 2 and 3 Laminate	\$11,693	\$11,876	\$13,810
	Grade 1 Veneer	\$12,670	\$12,853	\$14,787
	Grade 2 Veneer	\$14,065	\$14,248	\$16,182

1 TAP X3/24

HS1060T21	Grade 1 Laminate	\$13,771	\$13,954	\$15,888
	Grade 2 and 3 Laminate	\$14,039	\$14,222	\$16,156
	Grade 1 Veneer	\$15,016	\$15,199	\$17,133
	Grade 2 Veneer	\$16,411	\$16,594	\$18,528

2 TAPS

HS1060T22	Grade 1 Laminate	\$16,110	\$16,293	\$18,227
	Grade 2 and 3 Laminate	\$16,378	\$16,561	\$18,495
	Grade 1 Veneer	\$17,355	\$17,538	\$19,472
	Grade 2 Veneer	\$18,750	\$18,933	\$20,867

► Specification Information, continued on next page



For Canadian Pricing
Multiply U.S. Price by the Canadian price factor.
► See page 1 for details.

X3/24 = Last order entry
April 14, 2024

Host Collaborative and Conference Tables Trapezoid Tables with Two Bases

DESIGN F/P DESIGN AND VECTA DESIGN TEAM

► Specification Information, continued from previous page

Tip: Prices shown include top, TAP(s), and slim bases.
 ► See base options for flared bases, page 462

Tip: Last digit of style number indicates number of TAP(s).

Tip: For tech corridor, 12'L tables have four long doors and four short doors.

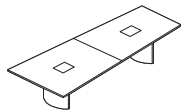
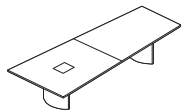
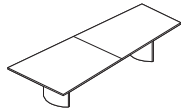

Specification Information

Style Number	Finish	U.S. Base Prices		
		Flat Wood Edge:	Bullnose Wood Edge:	Horizon Wood Edge:

12'L x 42"W x 60"W Two Piece Top

0 TAP

Style Number	Finish	Flat Wood Edge	Bullnose Wood Edge	Horizon Wood Edge
HS1260T20	Grade 1 Laminate	\$12,142	\$12,346	\$14,314
	Grade 2 and 3 Laminate	\$12,470	\$12,674	\$14,642
	Grade 1 Veneer	\$14,102	\$14,306	\$16,274
	Grade 2 Veneer	\$15,787	\$15,991	\$17,959

1 TAP X4/24

Style Number	Finish	Flat Wood Edge	Bullnose Wood Edge	Horizon Wood Edge
HS1260T21	Grade 1 Laminate	\$14,482	\$14,686	\$16,654
	Grade 2 and 3 Laminate	\$14,810	\$15,014	\$16,982
	Grade 1 Veneer	\$16,442	\$16,646	\$18,614
	Grade 2 Veneer	\$18,127	\$18,331	\$20,299

2 TAPS

Style Number	Finish	Flat Wood Edge	Bullnose Wood Edge	Horizon Wood Edge
HS1260T22	Grade 1 Laminate	\$16,824	\$17,028	\$18,996
	Grade 2 and 3 Laminate	\$17,152	\$17,356	\$19,324
	Grade 1 Veneer	\$18,784	\$18,988	\$20,956
	Grade 2 Veneer	\$20,469	\$20,673	\$22,641



For Canadian Pricing
 Multiply U.S. Price by the Canadian price factor.
 ► See page 1 for details.

X4/24 = Last order entry
 April 14, 2024

Host Collaborative and Conference Tables Accessories

DESIGN F/P DESIGN AND VECTA DESIGN TEAM

Floor Kit: Connectrac

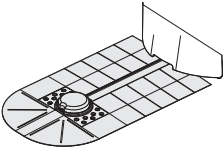

Tip: Shipped knocked down.

Standard Includes	Required to Specify
<p>► Need help? Product details, page 336</p> <ul style="list-style-type: none"> • Dome to cover floor monument (maximum size 5⁹/₁₀"W x 5⁹/₁₀"L x 3"H): black plastic • Low profile aluminum/PVC raceway to conceal wires from the dome to the table base <ul style="list-style-type: none"> - Aluminum bottom track and removable black powder-coated aluminum top cap for carpet strip: natural - Moisture-resistant MDF transition ramps run along both sides of raceway - Standard 4 foot length - Raceway can be field-cut to desired length • ADA compliant 	<p>Style number</p>

Specification Information

Style Number	U.S. Price
--------------	------------

HSFCONPT	\$837
----------	-------

Corridor Shelf

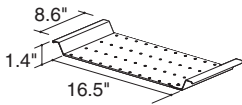

Standard Includes	Required to Specify
<p>► Need help? Product details, page 339</p> <ul style="list-style-type: none"> • Perforated steel shelf in silver power coat • Hangs from the lower rail on the beams to hold routers, hubs, line drivers, scalers and other technical equipment • 1¹/₂" rack units of space, 2³/₄"H • Shipped assembled with adjustment screws 	<p>Style number</p>

Specification Information

Style Number	U.S. Price
--------------	------------

HSFSHLF	\$143
---------	-------

Corridor Power Kit, Modular

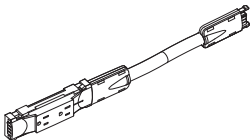

Tip: Corridor power kit can only be used when modular TAPs are specified.

Standard Includes	Required to Specify
<p>► Need help? Product details, page 342</p> <ul style="list-style-type: none"> • Modular duplex receptacle • Dual lock adhesive strip 	<p>Style number</p>

Specification Information

Style Number	U.S. Price
--------------	------------

HS4WXFRM	\$153
----------	-------



For Canadian Pricing
 Multiply U.S. Price by the Canadian price factor.
 ► See page 1 for details.

Coalesse

Host Collaborative and Conference Tables Accessories

DESIGN F/P DESIGN AND VECTA DESIGN TEAM

Lagunitas Lounge System

DESIGN TOAN NGUYEN

The Lagunitas lounge system

offers a wide range of highly customizable settings, bringing a new level of versatility to all the ways we work. Lagunitas adapts to changing work styles and shifting postures. Lagunitas utilizes a full range of design expressions with benches, lounge pieces, and tables. Work, occasional, and personal tables are curated to work specifically with Lagunitas lounges and benches. Integrated power options for the lounges, benches, and tables are available. Lagunitas supports existing and emerging work activities in an endless number of social, collaborative, and personal settings.

Tip: This product line is part of a collection and will be found in multiple locations in this specification guide

► See *Collections*, page 5.

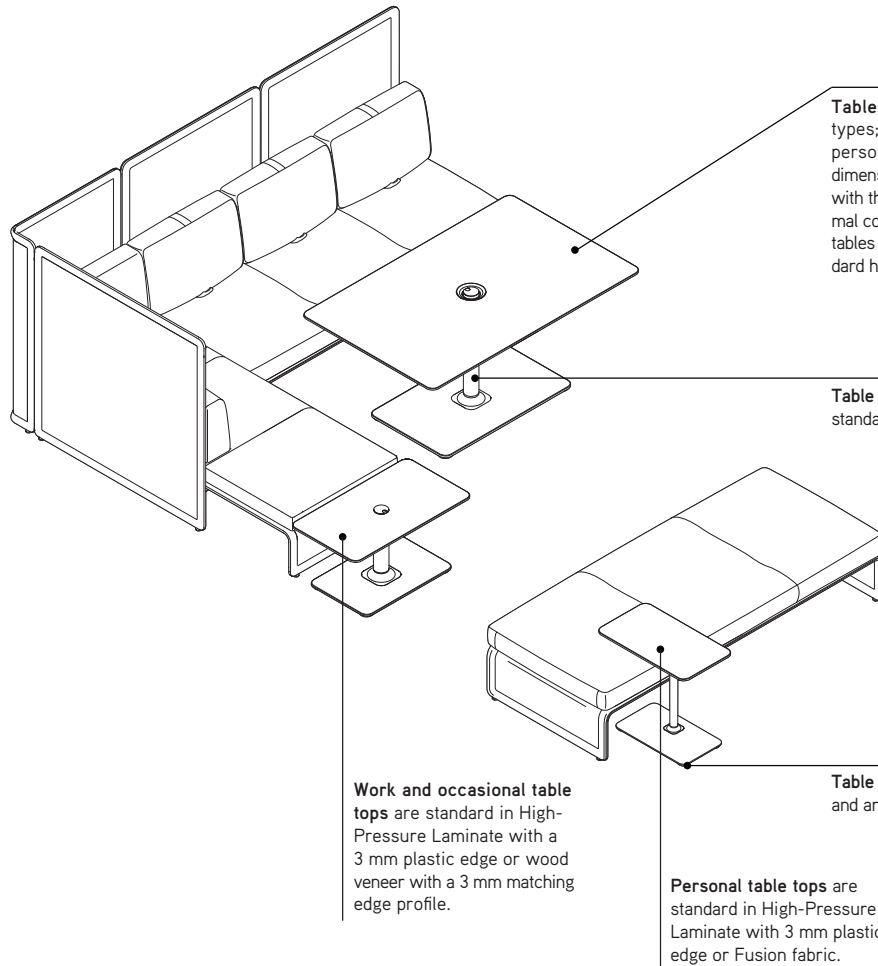

Tables are offered in three types; work, occasional, and personal tables. 26"H table dimensions are curated to work with the lounge pieces for optimal compatibility. 28½"H work tables are compatible with standard height seating.

Table bases and columns are standard in powder coat paint.

Work and occasional table tops are standard in High-Pressure Laminate with a 3 mm plastic edge or wood veneer with a 3 mm matching edge profile.

Table glides are non-adjustable and are clear plastic.

Personal table tops are standard in High-Pressure Laminate with 3 mm plastic edge or Fusion fabric.

Lagunitas Lounge System

DESIGN TOAN NGUYEN

Product Details

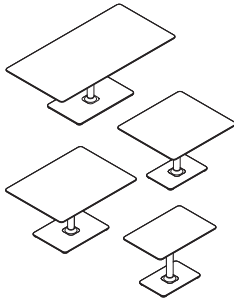

Work tables are available in six differing sizes, ranging from 30"W to 72"W that coordinate with the lounge dimensions to create a variety of social, collaborative, and personal applications. The work tables are available in two heights: 26"H and 28½"H. The work tables are comprised of a single column rectangular base in powder coat paint and a rectangular table top in laminate with matching or complementing 3 mm flat edge band profile or wood veneer with matching 3 mm flat wood edge band.

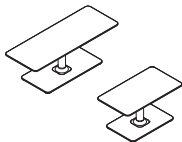

Occasional tables are available in two sizes, 32"W and 48"W, that coordinate with the lounge, chaise, and bench dimensions. The occasional tables are comprised of a single column with rectangular base available in powder coat paint and a rectangular table top in laminate with matching or complementing 3 mm flat edge band profile or wood veneer with matching 3 mm flat wood edge band.



Personal table is available in one size. It can easily be moved to your desired location for short term laptop work or simply used to set your coffee. The personal table is comprised of a single column with rectangular base available in powder coat paint and a rectangular table top in laminate with matching or complementing 3 mm flat edge band profile or a Fusion fabric-wrapped surface.

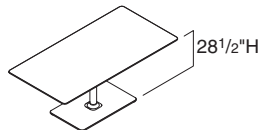
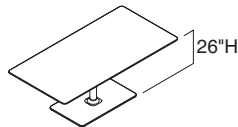

Work tables are available in two heights: 26"H tables are optimized to work with the lounge seat height, while 28½"H tables work with standard height seating.

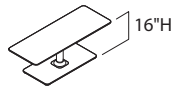

Occasional tables are available in one optimized height, 16"H, to work with the lounge seat height.

All work and occasional tables have a rectangular metal base with a centered column. The 3" column includes a cone at the top that attaches to the work surface. There are five rectangular base dimensions:
 16"D x 23⅝"W x ⅜"H for 18"D x 32"W, 24"D X 30"W, and 24"D X 36"W work tables;
 16"D x 31⅝"W x ⅜"H for 18"D x 48"W occasional table;
 21"D x 28½"W x ⅜"H for 36"D x 40"W and 36"D x 48"W work tables;
 21"D x 35"W x ⅜"H for 36"D x 57"W x work table; and
 21"D x 35"W x ½"H for 36"D x 72"W x work table

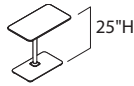

The **personal table** is available in one height, 25"H, to work with the lounge seat height.

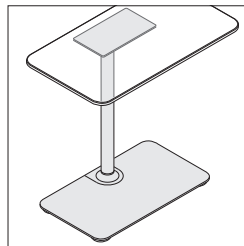

The **personal table** has a rectangular metal base with the column centered at the back of the base. The 1¼" column includes a flat plate at the top that attaches to the underside of the top. The base plate dimension is 10¾"D x 15¾"W x ⅜"H.

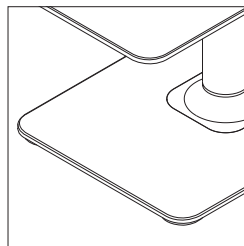

Non-adjustable 3" diameter plastic glides are standard on all tables. Glides are ⅜" thick for the 36"D x 72"W table; ½" thick for all other work and occasional tables; and ¼" thick for the personal table. For all work and occasional tables the glide height is needed to route cords.

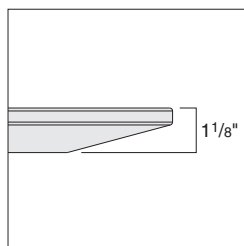

Tables are standard with a knife edge profile, that has the appearance of a ½" thick top that tapers to an overall top thickness of 1/8".

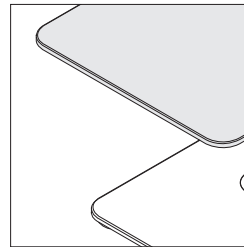

High-Pressure Laminate tables are standard with a matching or complementing 3 mm flat edge band. Wood veneer tables are standard with a matching wood 3 mm flat edge band. The underside of the table top is finished in black.

Specials are possible with Lagunitas. To confirm practicality and obtain a quotation, contact Customer Service at 1.800.627.6770.

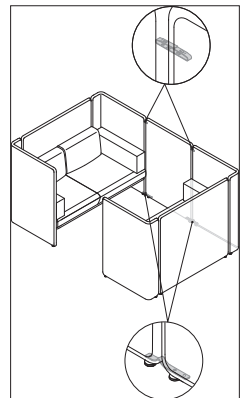

Lounge booth connector screen comes with two bottom brackets and two screen ganging alignment clips. The bottom brackets can be specified in either 4710 Low Gloss Black Paint or 4141 Platinum Matte Paint. The paint should match the bracket specification of the lounge.

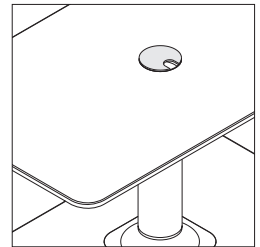

A **metal grommet** is an option on all work and occasional tables. The 3" grommet is flush-mounted and located in the center of the table top over the cone and column. The metal grommet is available in anodized silver only.

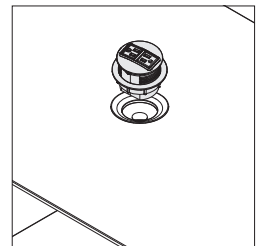

Round power modules are available on the focus nook, and all work and occasional tables. On the focus nook worksurface, the power module is specifiable on the back right or left side. On the tables, the power module is located in the center of the table top over the cone/column. The 3" power module features tamper resistant power simplex, an 8'L power cord with 15-amp plug, and is available in four colors.

The **round power modules** are available in three configurations:

- Two TR simplex receptacles
- One TR simplex receptacle and two USB A charging ports
- One TR simplex receptacle, one USB A charging port, and one USB C charging port

Tip: USB receptacles conveniently charge a range of electronic devices. Some devices may not be compatible.

Lagunitas Lounge System *continued*

DESIGN TOAN NGUYEN

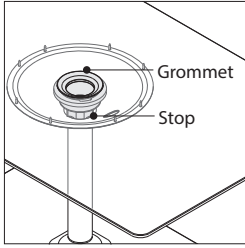

PowerPod grommet and stop is an option on all work and occasional tables. The grommet is located in the center of the table top over the cone/column. The stop attaches to the column to help hold and route cords and cables through the column. The grommet and stop cap are available in black or milk.

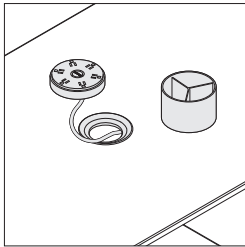

The grommet allows for pass through of cords and cables at the desktop. The grommet is open to allow for the PowerPod to be housed over or stored on the table. The grommet inside dimension is 3 1/2" and outside dimension is 5 1/16".

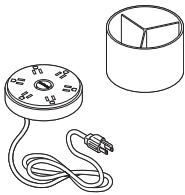

PowerPod includes six 15 amp outlets with an energy saving illuminated on/off switch. It comes with a 6' cord with three prong plug. The top tray is milk and the power source is silver with a milk face. It is UL and CSA listed.

Tip: PowerPod is sold separately.

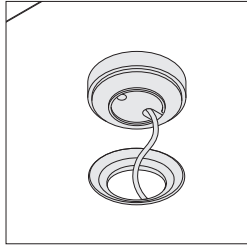

The contour of the PowerPod bottom cradle is designed to work in conjunction with the grommet for a snug fit or can be used independently without a grommet.

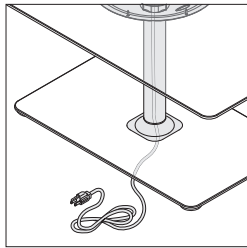

Work and occasional tables route cables and cords from the desktop through the column out through the base. Cords can be concealed in the cone.

Tip: A powerstrip cannot fit inside the cone.

Tip: If a desktop device is desired, other than the standard PowerPod or power module, consult Specials engineering for capability.

Surface Materials

Screen(s) and seat deck:

- Knit
- Fabric (contrasting and non-contrasting - contrasting must be same fabric family)

Seat and back cushion(s), contrasting and non-contrasting:

- Fabric
- Leather

Lounge attachment brackets and frame:

- Paint

Lounge glides:

- Non-specifiable plated metal

Lounge power and USB power modules (options):

- Black powder paint with black receptacles

Work and occasional table top surface:

- Laminated with matching or complementing 3 mm plastic edge band
- Wood veneer with matching 3 mm wood edge
- Custom wood finish (option)

Table base (cone or plate, column, and bottom plate):

- Paint

Table glides:

- Non-specifiable clear plastic

Metal grommet (option):

- Non-specifiable (anodized silver)

PowerPod grommet and stop cover (option):

- 6000 Black plastic
- 6052 Milk plastic

Table power modules:

- 4013 Silver/Black (silver powder paint with black receptacles)
- 4180 Graphite Matte
- 4242 Milk Matte
- 4710 Low Gloss Black

Personal table top surface:

- Laminate with matching or complementing 3 mm plastic edge band
- Fusion fabric

Tip: Refer to the Coalesse Surface Materials Reference Guide for additional surface materials information.

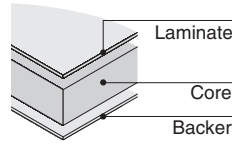

Laminates are available in two standard grades. Additional laminates from any manufacturer may also be practical—see *Other laminates* below.

Grade 1 laminates include:

- Coalesse standard laminates
- ▶ See *Coalesse Surface Materials Reference Guide*.
- Steelcase standard laminates (code 290A)
- ▶ See *Steelcase Surface Materials Reference Manual*.
- Any standard-grade Wilsonart laminate in solid color, woodgrain, or pattern finish (code 290A)

Grade 2 laminates

(code 290B) include any standard-grade, solid color, woodgrain, or patterned laminate from Nevamar (includes Matrix), Formica, or Pionite. Grade 2 laminates may have extended lead times. For details, contact Customer Service at 1.800.627.6770.

Other laminates that are not included in the Grade 1 or Grade 2 offerings may also be available, such as Abet Laminati and Laminart. To determine availability and pricing, contact Customer Service at 1.800.627.6770, with the laminate manufacturer's name and the name and number of the laminate you want.

Laminate swatches are reproduced in the Surface Materials Color Palettes.

▶ See *Coalesse Surface Materials Reference Guide* for a list.

Swatch cards and actual samples of Coalesse standard laminates are available from your Coalesse Customer Service representative. For samples of laminates from other manufacturers, contact them directly:

Wilsonart
1.800.433.3222
Nevamar
1.800.638.4380

Formica
1.800.FORMICA
Pionite
1.800.285.5161

Tip: Laminate manufacturers change their offerings frequently. Always check availability before ordering.

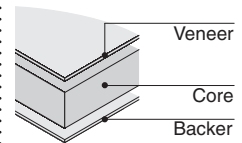

Wood veneer table tops are fabricated with Architectural Grade AA hand-selected hardwood veneer, plain sliced, book matched, and bonded to the core with a backing sheet for balance. Coalesse's primary wood finish, Clarity, is a water-borne UV topcoat, which protects the environment while providing exceptional durability and resistance to water and chemical stains. Due to natural variations in wood, finished products may vary from samples in color, texture, and grain.

Wood is a natural material; slight variations occur in veneer texture, color, grain configuration, and stain acceptance. Coalesse stains are all applied with an exacting regard for consistency and are well within traditional tolerances for wood products.

Tip: You should know that finished tops may vary slightly in tone or character from each other or from the samples Coalesse produces. No guarantee can be made of an absolutely exact match.

Wood veneer swatches are reproduced in the Surface Materials Color Palettes.

▶ See *Coalesse Surface Materials Reference Guide* for a list.

Lagunitas Lounge System

DESIGN TOAN NGUYEN

Swatch cards and actual samples of Coalesse standard wood veneers are available from your Coalesse Customer Service representative.

Additional wood veneer species are available. To confirm availability and to determine pricing, contact Customer Service at 1.800.627.6770.

Stains applied to Coalesse wood veneer table tops are standard with the same stain color applied to both the top and the solid hardwood edge profile. Coalesse strives to produce a consistently high quality product and some natural variation in color is to be expected. This is especially apparent on natural woods which have no stain applied, for example 3525 Natural Maple. This color variation is normal and reflects the unique and natural properties of wood. This should not be considered a defect.

Stain swatches are reproduced in the Surface Materials Color Palettes.
▶ See *Coalesse Surface Materials Reference Guide* for a list.

Swatch cards and actual samples of standard wood veneers are available from your Customer Service representative.

Stain-to-Match is available on this product and allows the matching of any wood finish with a one-time charge per finish.
▶ See *Coalesse Surface Materials Reference Guide* for details.

Programs & Services

Customer's Own Material/Leather (COM/COL) Program is available.

▶ See *Coalesse Surface Materials Reference Guide* for additional information.

Lagunitas Collaborative and Conference Tables Work Tables

DESIGN TOAN NGUYEN

Standard Includes	Required to Specify
<p>► Need help? Product details, page 470</p> <ul style="list-style-type: none"> Table top: <ul style="list-style-type: none"> Grade 1 laminate with 3 mm flat plastic edge Grade 1 wood with matching flat wood edge Base with column: grade 1 paint Six non-adjustable glides Ships ready to assemble 	<ol style="list-style-type: none"> Style number Table top width Laminate or wood color number for table top Plastic edge color number for laminate table top, if selected Paint color number for base with column Options, if selected (see below) <p>► See <i>Coalesse Surface Materials Reference Guide</i>.</p>

Options	U.S. Price	Required to Specify
<p>Surface Materials</p> <p>Work table top</p> <ul style="list-style-type: none"> Grade 2 laminate Grade 3 laminate Grade 2 wood veneer <p>Work table base</p> <ul style="list-style-type: none"> Grade 3 paint 	<p>Prices below and at right</p> <p>Prices below and at right</p> <p>Prices below and at right</p> <p>+\$145</p>	<p>Specify with <i>grade 2 laminate</i> and select color number.</p> <p>Specify with <i>grade 3 laminate</i> and select color number.</p> <p>Specify with <i>grade 2 wood veneer</i> and select color number.</p> <p>Specify paint color number.</p>
<p>Power/USB Configuration and Grommets</p> <ul style="list-style-type: none"> Power module <ul style="list-style-type: none"> Two TR simplex receptacles One TR simplex receptacle and 2 USB A charging ports One TR simplex receptacle, one USB A charging port, and one USB C charging port 3" metal grommet <ul style="list-style-type: none"> One metal grommet in anodized silver finish (center only) PowerPod grommet <ul style="list-style-type: none"> One PowerPod grommet in 6052 Milk or 6000 Black plastic finish (center only) 	<p>+\$380</p> <p>No cost</p> <p>+\$149</p> <p>+\$149</p> <p>+\$116</p> <p>+\$ 76</p>	<p>Specify with <i>power module</i>.</p> <p>Specify with <i>two power</i>.</p> <p>Specify with <i>one power, two USB A</i>.</p> <p>Specify with <i>one power, one USB A, one USB C</i>.</p> <p>Specify with <i>3" metal grommet</i>.</p> <p>Specify with <i>PowerPod grommet</i> and select color number.</p>
<p>Related Products</p> <ul style="list-style-type: none"> Occasional tables Lounge seating 		<p>► Page 693</p> <p>► See <i>Coalesse Seating Specification Guide</i>.</p>

Tip: Power module plug includes a built-in circuit breaker measuring 2 1/4"D x 1 1/2"W x 1 1/2"H. Ensure building can accommodate prior to ordering.

Tip: Column routes cables and wires when optional power or grommet are selected and exits through the base.

Tip: Devices and grommets are center location only to allow for routing of cords through the column and exits through the base.

Tip: Round power module is available in 4013 Silver/Black, 4180 Graphite Matte, 4242 Milk Smooth, or 4710 Low Gloss Black.

Tip: Power module configuration upcharges are in addition to the power module upcharge.

Specification Information

Style Number	Dimensions			U.S. Base Prices			
	D	W	H	Flat Vinyl Edge on Laminate Top		Flat Wood Edge on Wood Top	
				Grade 1	Grade 2 and 3	Grade 1	Grade 2

26"H Work Tables

COLAGTRECT	24"	30"	26"	\$2277	\$2383	\$4258	\$4526
	24"	36"	26"	\$2429	\$2541	\$4442	\$4732
	36"	40"	26"	\$2582	\$2708	\$5213	\$5557
	36"	48"	26"	\$3189	\$3343	\$5663	\$6073
	36"	57"	26"	\$3344	\$3506	\$5898	\$6326
	36"	72"	26"	\$3877	\$4066	\$6582	\$7049

► Specification Information, continued on next page

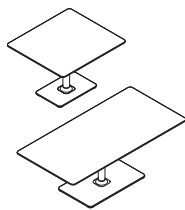

Tip: 26"H work tables are compatible with all Lagunitas seating.

Lagunitas Collaborative and Conference Tables Work Tables

DESIGN TOAN NGUYEN

► Specification Information, continued from previous page

Specification Information

Style Number	Dimensions			U.S. Base Prices			
	D	W	H	Flat Vinyl Edge on Laminate Top		Flat Wood Edge on Wood Top	
				Grade 1	Grade 2 and 3	Grade 1	Grade 2

28½"H Work Tables

COLAGTW	24"	30"	28½"	\$2308	\$2414	\$4289	\$4557
	24"	36"	28½"	\$2460	\$2572	\$4473	\$4763
	36"	40"	28½"	\$2613	\$2739	\$5244	\$5588
	36"	48"	28½"	\$3220	\$3374	\$5694	\$6104
	36"	57"	28½"	\$3375	\$3537	\$5929	\$6357
	36"	72"	28½"	\$3908	\$4097	\$6613	\$7080

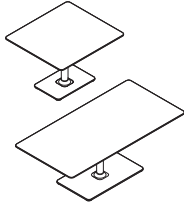

Tip: 28½"H work tables are incompatible with Lagunitas seating, but are compatible with standard height seating.



For Canadian Pricing
 Multiply U.S. Price by the Canadian price factor.
 ► See page 1 for details.

MoreThanFive Collaborative and Conference Tables

Understanding	478
Specifying	
Round and Square Tables	482
Rectangular Tables	483

MoreThanFive Collaborative and Conference Tables

DESIGN COALESSE DESIGN GROUP and Michael Young

MoreThanFive provides a solid foundation around which to meet, anchoring collaborative and social spaces with cast iron legs and range of crafted top materials designed to inspire and differentiate.

Power modules with braided cord detail are available on rectangular tables for easy access to power.

Cable management tray can be specified on rectangular tables to conceal and route cables from power modules.

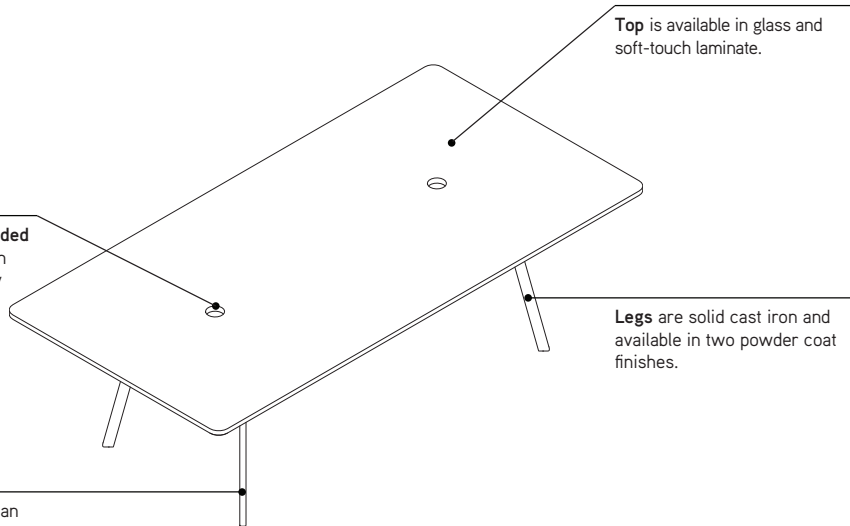

Top is available in glass and soft-touch laminate.

Legs are solid cast iron and available in two powder coat finishes.

Product Details

Tables are available in 28½" H working height.



Round



Square



Rectangular

Table shapes include: round, square, and rectangular.

A range of sizes are available to support a variety of applications.

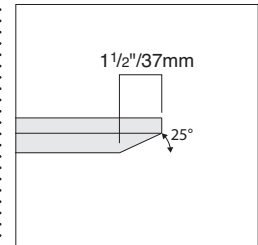

Laminate tops are standard with a knife edge profile that has the appearance of a 1/2" thick top, which tapers to an overall top thickness of 1 1/8".

Tops with a laminate surface have 3 mm plastic edge and finish selection.

Seating Capacity Guidelines
▶ See page 481

More Than Five Collaborative and Conference Tables

DESIGN COALESSE DESIGN GROUP and Michael Young

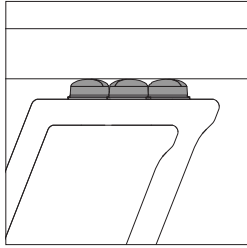

Glass tops rest directly on rubber bumpers attached to the base and are available in two tinted, acid-etched finishes. The glass is 1/2" thick.

Tip: Glass tops are not secured to the base. Glass tops are placed on rubber bumpers that are adhered to the base assembly. If glass tables need to be moved, remove the glass top prior to moving the table.

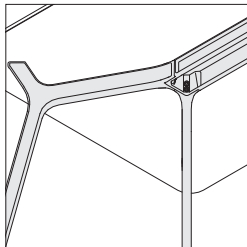

Legs are a single piece of cast iron and finished in 7207 Black or 7245 Carbon Metallic powder coat. When leg finish is specified, the table's center beam or connector is painted to match.

Adjustable glides have a range of 1/2" to accommodate for uneven floors.

Power Data, Wiring & Cabling

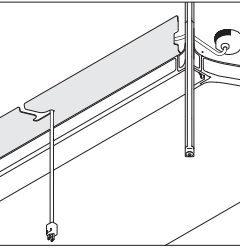

Power modules are available to specify on rectangular tables with laminate tops.

Modules can be placed on one or both ends of the tables. The 3" power module is available in four color options and features tamper resistant power simplex and an 8'L braided power cord with 15-amp plug. Power modules can be specified in three configurations:

- Two TR simplex receptacles
- One TR simplex receptacle and one dual USB A charging port
- One TR simplex receptacle, one USB A charging port, and one USB C charging port.

Tip: USB receptacles conveniently charge a range of electronic devices. Some devices may not be compatible.

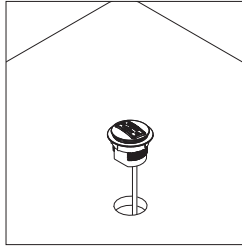

Braided power cord offers a range of unique finishes in solid and striped patterns. Cord finish is specified independently of power unit finish.

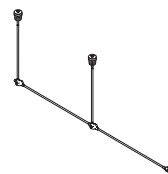

When two power module units are specified, they are connected by a corded system and have a single infeed with a 15-amp plug. After exiting the leg, there is at least 60" of cord length available to connect to power source.

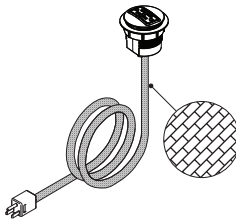

Cable management tray is painted to match the legs and attaches to the underside of the table surface to conceal power cords and route them to cutouts for connection to building power. The tray measures 50 1/5"W x 10 1/5"D and features center and side cutouts to allow cord to drop down to floor at desired location. Cable tray can be attached to either side of central support beam on underside of surface.

Surface Materials

Legs:

- 7207 Textured Black
- 7245 Carbon Metallic

Laminate Worksurface:

- 24H1 Satin White
- 24H2 Satin Black
- 24H3 Satin Stone
- 24H4 Satin Mocha

Glass Worksurface:

- 6511 Acid Etched
- 651A Acid Etched Smoked

Power Module:

- 4013 Silver/Black
- 4180 Graphite Matte
- 4242 Milk Smooth
- 4710 Low Gloss Black

Woven Cords:

- 9005 White
- 9006 Chili
- 9007 Sterling
- 9008 Honey
- 9009 Black
- 9011 Seagull
- 9014 Black/White Stripe
- 9015 White/Seagull Stripe
- 9018 Seagull/Chili Stripe
- 9019 Seagull/Honey Stripe
- 9020 Seagull/Sterling Stripe
- 9021 Seagull/White Stripe

► See *Coalesse Surface Materials Reference Guide* for more information.

More Than Five Collaborative and Conference Tables Base Locations

DESIGN COALESSE DESIGN GROUP and Michael Young

Round

Base Locations

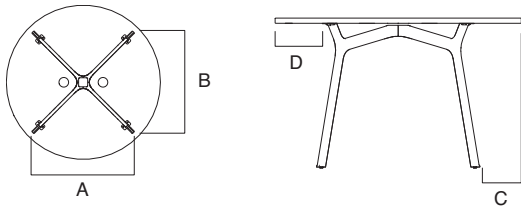

Metal Legs	A	B	C	D
48" diameter	30"	30"	2¾"	4¾"

Tip: Dimensions between legs are measured where legs contact the floor, with glides fully retracted. Dimensions will grow slightly when glides are adjusted outward.

Square

Base Locations

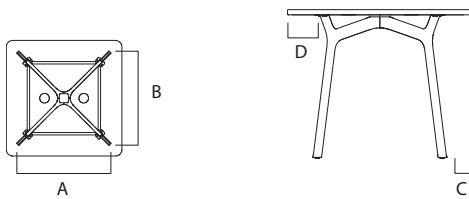

Metal Legs	A	B	C	D
36"D x 36"W	30"	30"	4¼"	6¼"
42"D x 42"W	30"	30"	8½"	10½"
48"D x 48"W	30"	30"	12¾"	14¾"

Tip: Dimensions between legs are measured where legs contact the floor, with glides fully retracted. Dimensions will grow slightly when glides are adjusted outward.

More Than Five Collaborative and Conference Tables Base Locations

DESIGN COALESSE DESIGN GROUP and Michael Young

Rectangular

Base Locations

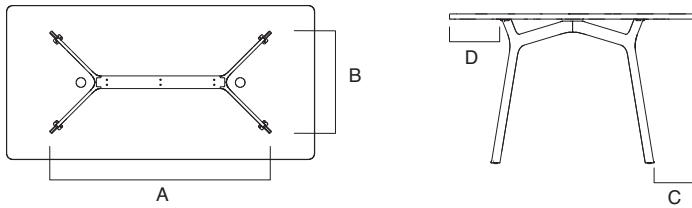

Tip: Leg locations for rectangular tables fall to the corners of the table and just inset of the top.

Metal Legs	A	B	C	D
36"D x 72"W	67"	30"	3½"	5¼"
36"D x 84"W	67"	30"	9"	10¾"
42"D x 72"W	67"	30"	5"	6¾"
42"D x 84"W	67"	30"	10¼"	12"
48"D x 72"W	67"	30"	6½"	8¼"
48"D x 84"W	67"	30"	11¾"	13½"
48"D x 96"W	67"	30"	17"	18¾"

Tip: Dimensions between legs are measured where legs contact the floor, with glides fully retracted. Dimensions will grow slightly when glides are adjusted outward.

Seating Capacity Guidelines

Depth	Width	Seating Capacity
Round Tops		
48"		4
Square Tops		
36"	36"	4
42"	42"	4
48"	48"	4
Rectangular Tops		
36"	72"	6
36"	84"	6
42"	72"	6
42"	84"	6
48"	72"	6
48"	84"	6
48"	96"	8

Tip: Actual capacity is determined by width of chair selected.

Collaborative and Conference Tables

MoreThanFive

Tip: Power is available on rectangular laminate tables only.

Standard Includes

- Table top: laminate price group 03
- Legs and frame: paint price group 01
- Ships ready to assemble

Options

Top Finish	Glass Price Group 06	See below
	Laminate Price Group 03	See below
Base Finish	Paint Price Group 01	No cost
	Paint Price Group 02	No cost

Specification Information

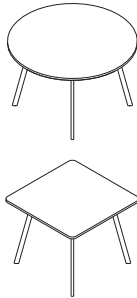

Style Number	Dimensions			Base Prices	
	Depth	Width	Height	Laminate	Glass

Round MoreThanFive Tables

COMT5RDL	48" Diameter		28 1/2"	\$3381	N.A.
COMT5RDG	48" Diameter		28 1/2"	N.A.	\$6504

Square MoreThanFive Tables

COMT5SQL	36"	36"	28 1/2"	\$2880	N.A.
	42"	42"	28 1/2"	\$3131	N.A.
	48"	48"	28 1/2"	\$3381	N.A.
COMT5SQG	36"	36"	28 1/2"	N.A.	\$5398
	42"	42"	28 1/2"	N.A.	\$5462
	48"	48"	28 1/2"	N.A.	\$6504

Collaborative and Conference Tables

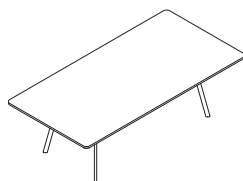
MoreThanFive

Tip: Power is available on rectangular laminate tables only.

Tip: When two power modules are specified, configuration and finish selections will match.

Tip: Power module is available in black, white, graphite, and black/silver.

Tip: Cable tray conceals cords and cables and provides a clean visual.

Standard Includes

- Table top: laminate price group 03
- Legs and frame: paint price group 01
- Ships ready to assemble

Options

Top Finish	Glass Price Group 06 Laminate Price Group 03	See below See below
Base Finish	Paint Price Group 01 Paint Price Group 02	No cost No cost
Devices	No Device Power Mod	No cost See Device Location
Device Location	Left Left and Right Right	2PWR: +\$343 1PWR, 1USBA: +\$477 1PWR, 1USBA, 1USBC: +\$477 2PWR: +\$687 1PWR, 1USBA: +\$955 1PWR, 1USBA, 1USBC: +\$955 2PWR: +\$343 1PWR, 1USBA: +\$477 1PWR, 1USBA, 1USBC: +\$477
Device Finish	Smooth Paint	No cost
Power Plug Type	Standard NEMA 5-15 3-Prong	No cost
Power Cord Finish	Cotton	No cost
Cable Tray	Without Tray With Tray	No cost +\$213

Specification Information

Style Number	Dimensions			Base Prices	
	Depth	Width	Height	Laminate	Glass

Rectangle MoreThanFive Tables

COMT5RECL	36"	72"	28 1/2"	\$3339	N.A.
	36"	84"	28 1/2"	\$3550	N.A.
	42"	72"	28 1/2"	\$3431	N.A.
	42"	84"	28 1/2"	\$3649	N.A.
	48"	72"	28 1/2"	\$3524	N.A.
	48"	84"	28 1/2"	\$3749	N.A.
	48"	96"	28 1/2"	\$3974	N.A.

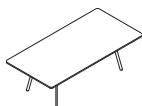

► Product Information continued on next page

Collaborative and Conference Tables

MoreThanFive

► Product Information continued from previous page

Specification Information

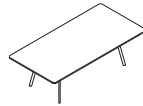

Style Number	Dimensions			Base Prices	
	Depth	Width	Height	Laminate	Glass
COMT5RECG	36"	72"	28 1/2"	N.A.	\$8118
	36"	84"	28 1/2"	N.A.	\$8648
	42"	72"	28 1/2"	N.A.	\$8361
	42"	84"	28 1/2"	N.A.	\$8907
	48"	72"	28 1/2"	N.A.	\$8612
	48"	84"	28 1/2"	N.A.	\$9174
	48"	96"	28 1/2"	N.A.	\$9762

Potrero415

Collaborative and Conference Tables

Understanding	486
Specifying	
Round and Square Tables with Metal Legs	500
Rectangular Tables with Metal Legs	502
Boat Shaped Tables with Metal Legs	512
Round and Square Tables with Wood Legs	522
Rectangular Tables with Wood Legs	524
Boat Shaped Tables with Wood Legs	534
Cable Management	544

Potrero415 Collaborative and Conference Tables

DESIGN COALESSE DESIGN GROUP

Potrero415 responds to the demand for more collaborative settings throughout the work-space, setting a new standard for one table series that fits wherever people gather.

Potrero415 spans a wide range of spaces and offers a breadth of materials and finish options to personalize every setting. Tables are available with metal or solid oak legs in work or standing heights. Technology and power options accommodate today's needs for connectivity.

Technology devices and grommets are available for easy access to power and data.

Cables can be neatly managed through metal legs, or outside of wood and metal legs through the cutouts in the bottom tray using one of the cable management solutions available.

Legs are available in aluminum metal or solid wood. Metal legs are available in powder coat or polished aluminum finishes.

Tables are also offered as standing height, 40"H.

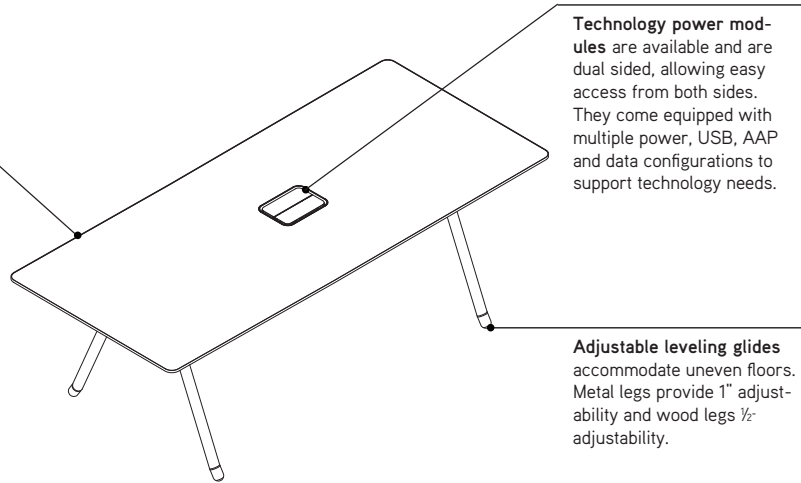
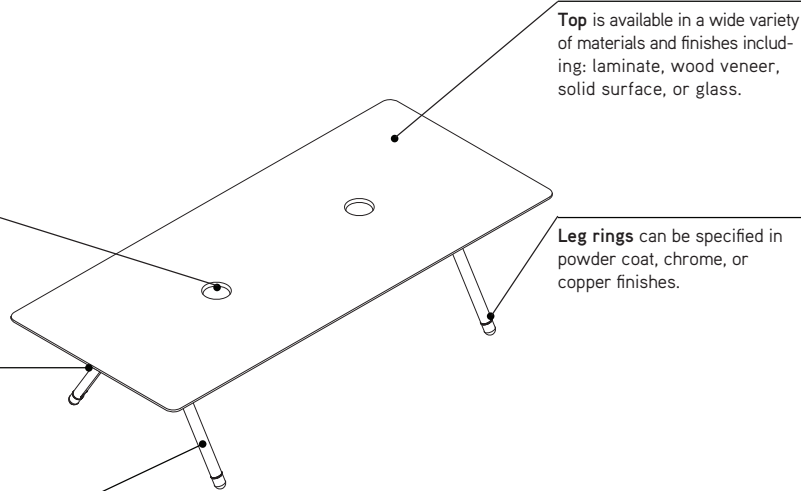

Product Details

Tables are available in two heights:
 - work height, 28½"H
 - standing height, 40"H



Round



Square



Rectangular



Boat

Table shapes include: round, square, rectangular, and boat. A range of sizes are available to support a variety of applications.

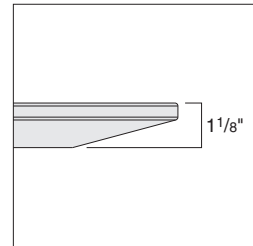

Laminate and wood veneer tops are standard with a knife edge profile that has the appearance of a ½" thick top, which tapers to an overall top thickness of 1 1/8".

Tops with a laminate surface have 3 mm plastic edge and finish selection. Wood veneer tops have a matching 3 mm edge. All corners have a radius.

Seating Capacity Guidelines
 ▶ See page 343

Potrero415 Collaborative and Conference Tables

DESIGN COALESSE DESIGN GROUP

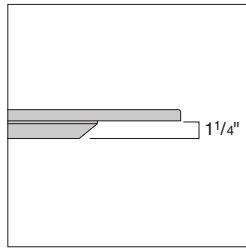

Solid surface and glass tops are built with a substructure (bottom) and top construction. The substructure is 1 1/4" in thickness and is available in black or white. The glass or solid surface top is 1/2" thick. *Tip: Glass tops are not secured to the substructure. Glass tops are placed on rubber pads that are adhered to the substructure. If the glass tables need to be moved, remove the glass top prior to moving the table.*

Tip: Solid surface and glass tops are not available on tables with standing-height wood legs or tables with seated-height wood legs exceeding lengths of 168".

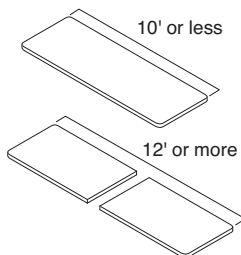

Large tops are shipped in sections with hardware for field assembly. Tops 12' and larger are shipped in two or more pieces.

Large tops can be difficult to move through some buildings. If top dimensions are too large for installation site, please contact Specials for assistance with creating smaller top sections.

Tip: Inspect the building where the table will be installed to confirm that elevators, loading docks, hallways, doorways, windows, etc., can accommodate large table tops.

Laminate
Woodgrain Direction



Woodgrain laminates are always oriented with the grain direction running parallel with the length of the table top.

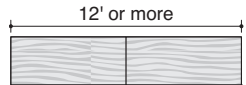

Woodgrain laminate sectioned tops cannot be guaranteed to have a perfect match of the grain pattern along the seam that joins the sections. Large tops that are 12' and longer in length in length require two or more separate sheets of laminate. Coalesse will create the best match that is possible between two sheets of laminate, but depending on the woodgrain laminate pattern that you choose, a perfect match between sections cannot be guaranteed.

Standard Veneer
Grain Direction



Veneer woodgrain runs parallel to the depth on all tops.

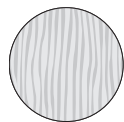

Same flitch matching is specified in cases where you want the veneer grain and pattern on two or more tops to come from the same flitch of veneer. This ensures a consistent grain pattern and coloration and should be specified when tops will be used near each other but not ganged.

Metal Legs

Metal legs are cast aluminum and are painted in powder coat finishes. Polished aluminum is available as an option.

Bottom tray conceals all cables and creates a clean visual. Bottom tray and frame matches the paint finish of the legs. If 8046 Polished Aluminum legs are specified, bottom tray and frame are 4142 Platinum Gloss. Inner dimensions of the bottom tray are: 33 3/32" H x 9 9/32".

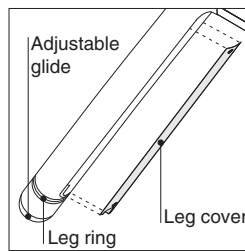

Cable routing is accommodated through the metal legs and can be accessed through the removable cover.

Leg rings can be specified in powder coat, chrome, or copper finishes. If contrasting finish from the leg is selected, more or less can be shown by adjusting the glide.

Adjustable glides have a range of 1" on metal legs to accommodate uneven floors.

Wood Legs

Wood legs are solid oak and available in standard finishes or stain-to-match.

Frame powder coat paint finish must be specified on tables with wood legs and includes the frame, leg castings, and bottom tray.

Bottom tray conceals all cables and creates a clean visual. Inner dimensions of the bottom tray are: 33 3/32" H x 9 9/32" D.

Leg rings can be specified in powder coat, chrome, or copper finishes. The leg rings on wood legs are decorative and non-adjustable.

Adjustable glides have a range of 1/2" on wood legs to accommodate uneven floors.

Power Infeed

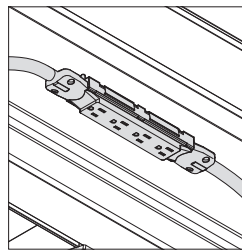

A power harness is concealed within the bottom tray and is specifically designed for each length of table. Drop in technology devices plug into the power harness.

- 60" round / 48", 60" square tables: One duplex receptacle
- 72"-144" tables: Two 15-amp duplex receptacles
- 168"-288" tables: Two 15-amp quadplex receptacles

Chicago hardwire option is also available. If selected, the power harness is eliminated and each device is supplied with 6' conduit for onsite wiring.

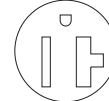
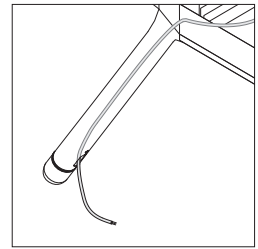

NEMA
5-20R Outlet

Connection to the building power supply is typically hardwired. A licensed electrician must make the connection. A single circuit, 20-amp plug connection is also available. This offers quick, easy connection to building power. An electrician must provide a dedicated NEMA 5-20R outlet within 12" of the infeed location. After the hardwire infeed exits the metal leg or cable manager, there is 36" (work height) and 24" (standing height) of conduit to connect to a power source. After the 20-amp plug infeed exits the metal leg or cable manager, there is 24" of cord length for both work-height and standing-height tables.

If the Chicago hardwire option is selected, the infeed is eliminated and each device is supplied with 6' conduit for onsite hardwiring to the building's power supply by a licensed electrician.

Potrero415 Collaborative and Conference Tables *continued*

DESIGN COALESSE DESIGN GROUP

Cable Management Options

Cutouts in the bottom tray provide an alternate way to route cords and cables to and from tables using a cable manager. Cutouts are 3½" by 5¾" and are located on end and center locations.

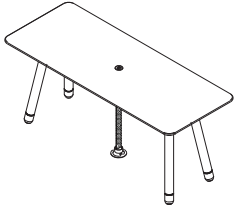

The mesh cable manager provides pass-through cable management and is designed to be used with Potrero415 tables. The mesh and steel components are black. The opening for cables measures 2" x 2½".

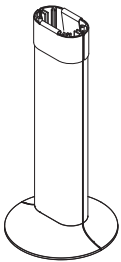

The cable manager column provides lay-in, high capacity, and concealed cable management. Designed to be used with Potrero415 table cutouts, the aluminum column is available in painted finishes.

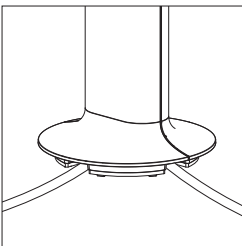

Cables can be concealed and run straight through the column to the floor, or out any side of the bottom, depending on location of building power supply.



Riser option is available and provides .906" clearance for field wired conduit when routing out the bottom.

Technology Devices

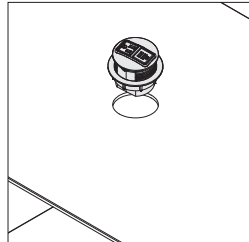

Round power module is only available on round and square tables and is centered. The 3" module is available in silver, milk, black, and graphite finishes. It comes with a 8'L power cord with 15-amp plug. Plug includes a built-in circuit breaker measuring 2¼"D x 1½"W x 1½"H. Round power module is available with two simplex receptacles or one simple/2 USB charging ports. USB receptacles conveniently charge a range of electric devices. Some devices may not be compatible.

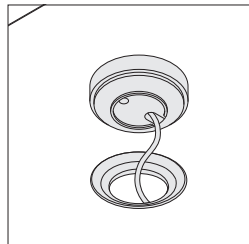

PowerPod grommet is an option on all tables. The grommet allows for pass through of cords and cables at the desk. The grommet is available in black or milk.

The grommet is open to allow the PowerPod to be housed over or stored on the table top.

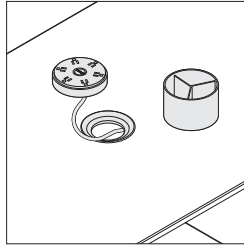

The contour of the PowerPod bottom cradle is designed to work in conjunction with the grommet for a snug fit.

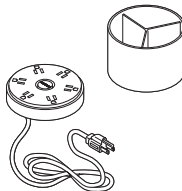

PowerPod includes six 15-amp outlets with an energy saving illuminated on/off switch. It comes with a 6' cord with three prong plug. The top tray is milk and the power source is silver with a milk face. It is UL and CSA listed.
Tip: PowerPod is sold separately.

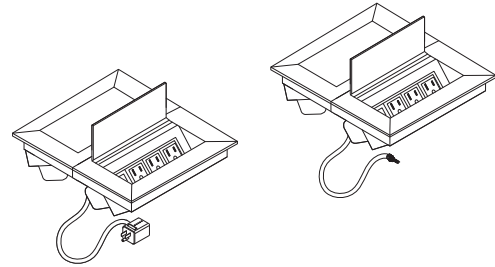

The square power module is available on 60" round and square tops, and all rectangular and boat shaped tops. Overall dimensions are 10½" x 10½". This unit is also called E2X square unit.

The unit is dual sided, providing access from both sides. The square power module is available in silver or black anodized aluminum. It comes with a 10'L power cord with a 15-amp plug, with circuit breaker. The unit is also available with Chicago hardwire option with 6' conduit for hardwiring in the field.

The square power module is available in the following configurations.

Note: Image represents one side of unit. The other side is the same configuration.

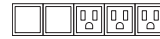

3 Power, 2 Blank Data—per side

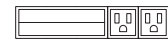

2 Power, 1 Blank AAP—per side

Tip: Architectural Adapter Plates "AAPs" provide access to data, audio, video, and other technologies. The blank "AAPs" are compatible with Extron Electronics and accommodate two single spaces or one double space per side.



3 Power, 2 USB—per side



3 Power, 1 USB, 1 Blank Data—per side

Tip: USB receptacles conveniently charge a range of electric devices. Some devices may not be compatible. Each USB has two USB-A charging ports.

Potrero415 Collaborative and Conference Tables

DESIGN COALESSE DESIGN GROUP

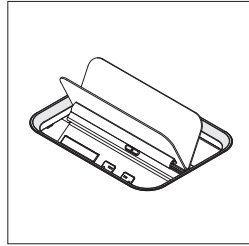

The refined technology module for laminate and veneer tops includes a one-piece cast bezel available in painted finishes. Overall size is 10" x 13".

Sometimes the refined power technology unit is shortened to and referred to as power unit.

For laminate tops, a metal door is available and will be painted to match the bezel. For veneer tops, metal or veneer doors are available. The metal will match the bezel finish, and the veneer will match the veneer top.

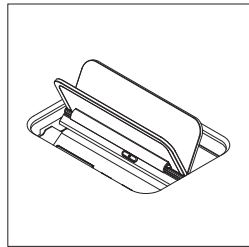

The refined technology module for solid surface and glass tops are an under mount solution with no bezel, providing a seamless aesthetic. Overall size is 9" x 12".

For solid surface tops, metal or solid surface doors can be specified. For glass tops, metal doors are available.

The technology module is available on 60" round and square tops, as well as all rectangular and boat shaped tops. The unit is dual sided, providing access from both sides. It comes with a 10' L cord with a 15-amp plug with circuit breaker. The unit is also available with Chicago hardwire option with 6' conduit for hardwiring in the field.

The technology module is available in the following configurations:



3 Power, 1 Blank AAP – per side



2 Power, 1 Blank AAP, 1 USB – per side



2 Power, 2 USB – per side

Tip: Image represents one side of the unit, the other side is the same configuration.

Tip: Architectural Adapter Plates (AAPs) provide access to data, video, and other technologies. The blank "AAPs" are compatible with Extron Electronics and accommodate two single spaces or one double space per side.

Tip: Each USB has a dual, 5V charging port with one USB-A and one USB-C.

Tip: The refined technology unit cannot be positioned in center position when it is over a middle leg.

Potrero415 Collaborative and Conference Tables Technology Module Matrix

DESIGN COALESSE DESIGN GROUP

Refined Technology Module Matrix

Top	Metal Bezel	No Bezel (undermount)	Metal Door	Veneer Door	Solid Surface Door
Laminate	•		•		
Wood Veneer	•		•	•	
Solid Surface		•	•		•
Glass		•	•		

Coalesse

Potrero415 Collaborative and Conference Tables

Technology Module Matrix

DESIGN COALESSE DESIGN GROUP

Potrero415 Collaborative
and Conference Tables

Potrero415 Collaborative and Conference Tables Technology Distribution and Support

DESIGN COALESSE DESIGN GROUP

Building power interface.

Both hardwire and 20-amp infeeds are available.

One infeed powers each table.

The infeed can enter through any metal leg, or can be routed and concealed through the cutouts in the bottom tray to the floor using cable manager solutions.

Tip: When using the refined technology unit (power unit), the cutout directly below the power unit cannot be used to route cables with a cable manager. Instead, use a cutout that is off-set to ensure enough space for cables and manager.

Tip: If the Chicago hardwire option is selected, the power harness and infeed are eliminated and conduit is provided with each device for wiring in the field.

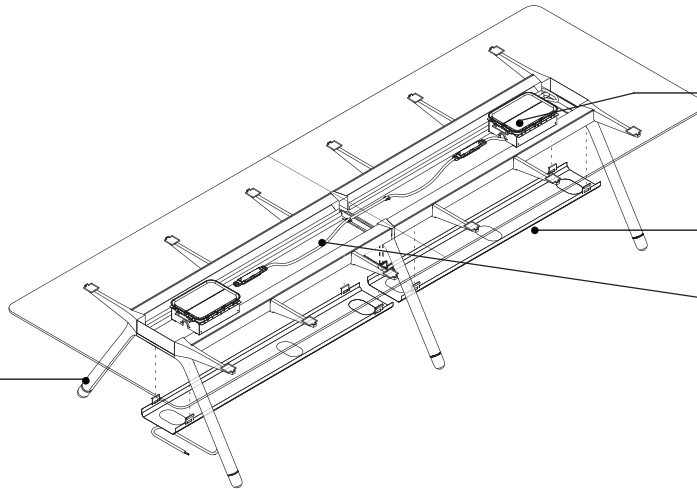

Surface mounted technology devices are available and support power, data and technology needs.

Bottom tray conceals all cords, cables and conduit.

A power harness is concealed within the bottom tray. Drop in technology devices plug into the power harness receptacles.

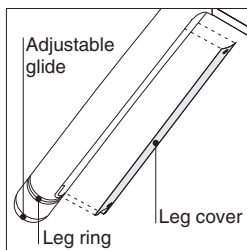

Removable cover on metal leg allows easy access and installation of technology cords.

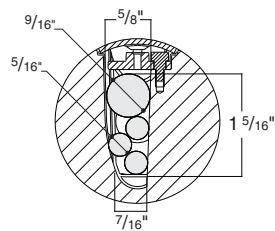

Cross-section view showing conduit and cable routing capacity through the leg. Every metal leg has cable routing capability.

Tip: Wires are unable to be routed through the wood leg. A cable manager must be used to route cables with wood leg.

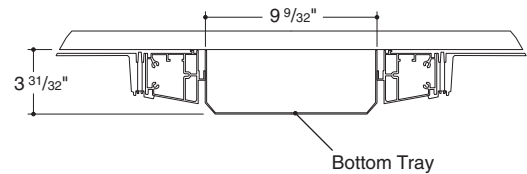

Note: Inside tray dimensions on rectangular and boat tops are 3³¹/₃₂"H x 9⁹/₃₂".

Note: Capacity is reduced slightly over center legs.

Note: Deeper bottom tray is available through Specials to support greater A/V customization, including cable retractors.

Potrero415 Collaborative and Conference Tables Technology Distribution and Support

DESIGN COALESSE DESIGN GROUP

Managing cables outside the leg

• **Cutouts in the bottom tray** provide an alternate way to route cords and cables to/from the tables using a cable manager.

• **The cable manager column** (shown) provides robust, lay-in cable capacity management and concealment. Aluminum column is available in painted finishes.

• **The mesh cable manager**, an option for simple cable management, offers pass-through cable management. The mesh and steel components are black.

• **Cutouts** are 3½"W x 5⅝"H and are located near table legs and center locations.

▶ See page 495 for cutout locations.

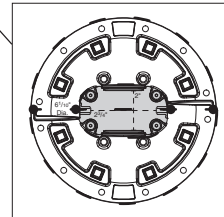
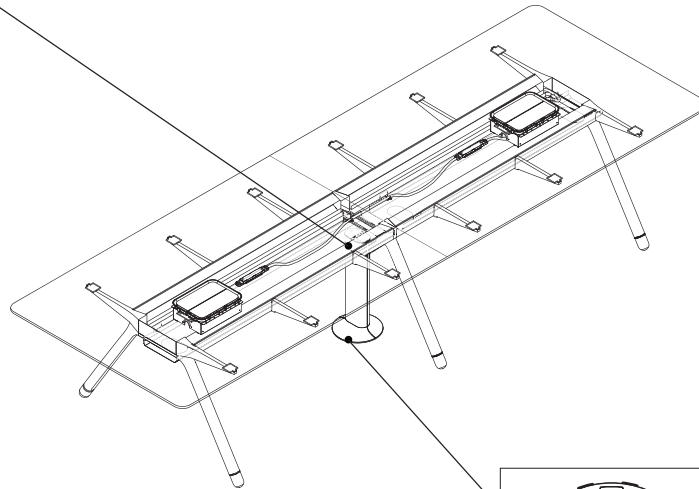

Cable manager column (bottom view)

Cable capacity and dimensions-
 Outside diameter: 9¾"
 Insider diameter: 6⅝"
 Cable routing bottom opening: 2¾" x 2"

Potrero415 Collaborative and Conference Tables Base Locations

DESIGN COALESSE DESIGN GROUP

Round

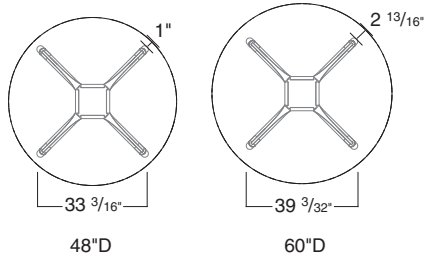

Note: Dimensions between legs are measured where legs contact the floor, with glides fully retracted. Dimensions will grow slightly when glides are adjusted outward.

Square

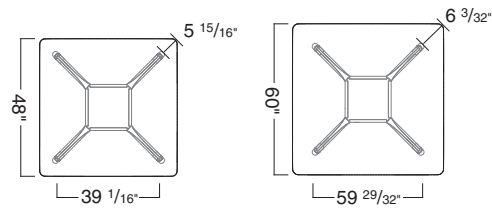

Note: Dimensions between legs are measured where legs contact the floor, with glides fully retracted. Dimensions will grow slightly when glides are adjusted outward.

Potrero415 Collaborative and Conference Tables Base Locations

DESIGN COALESSE DESIGN GROUP

Rectangular and Boat

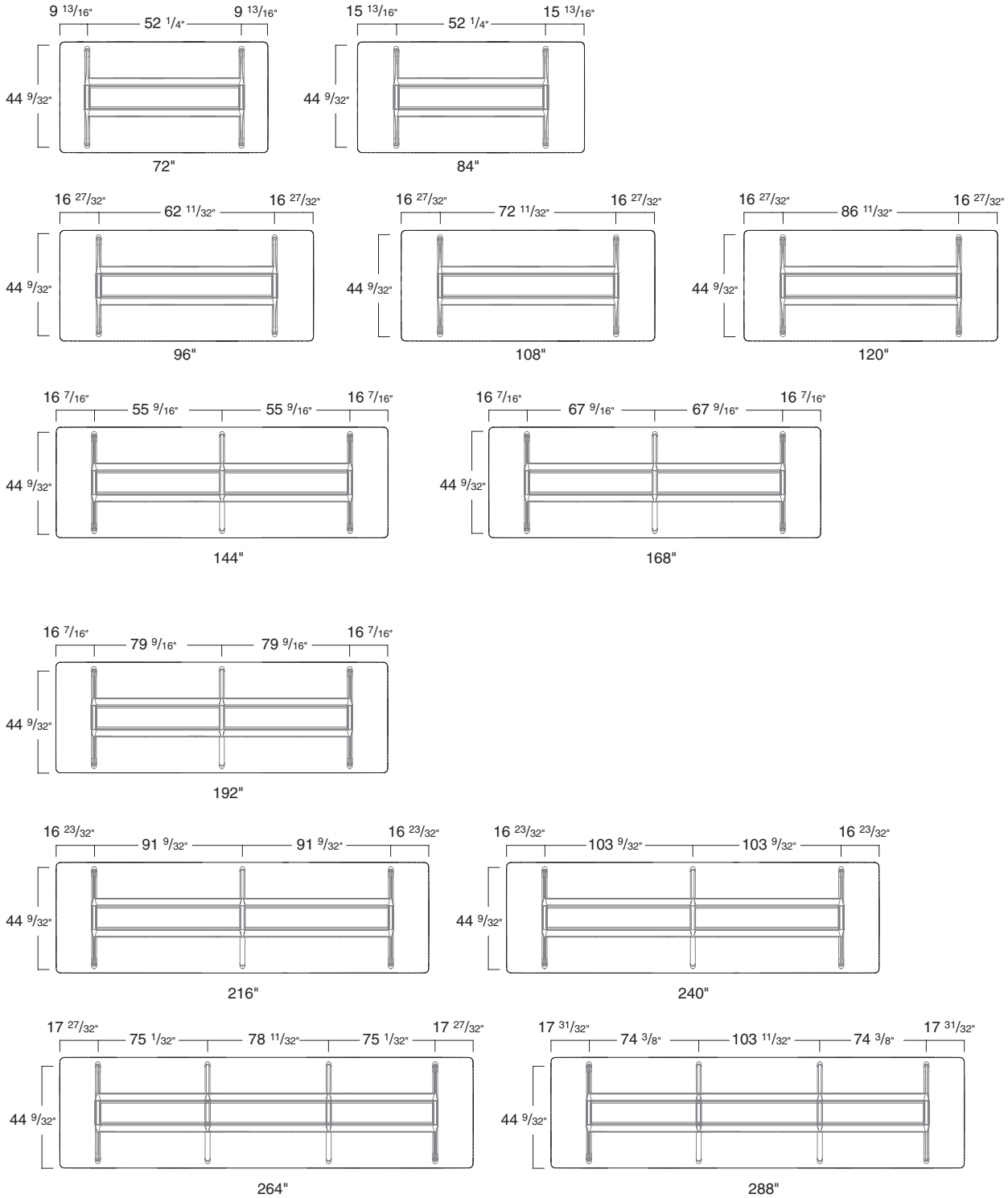

Note: 44 9/32" is the distance between the legs measured to the outside of the leg where the legs contact the floor; 40" is the inside dimension.

Potrero415 Collaborative and Conference Tables

Cutout Locations

DESIGN COALESSE DESIGN GROUP

Rectangular and Boat

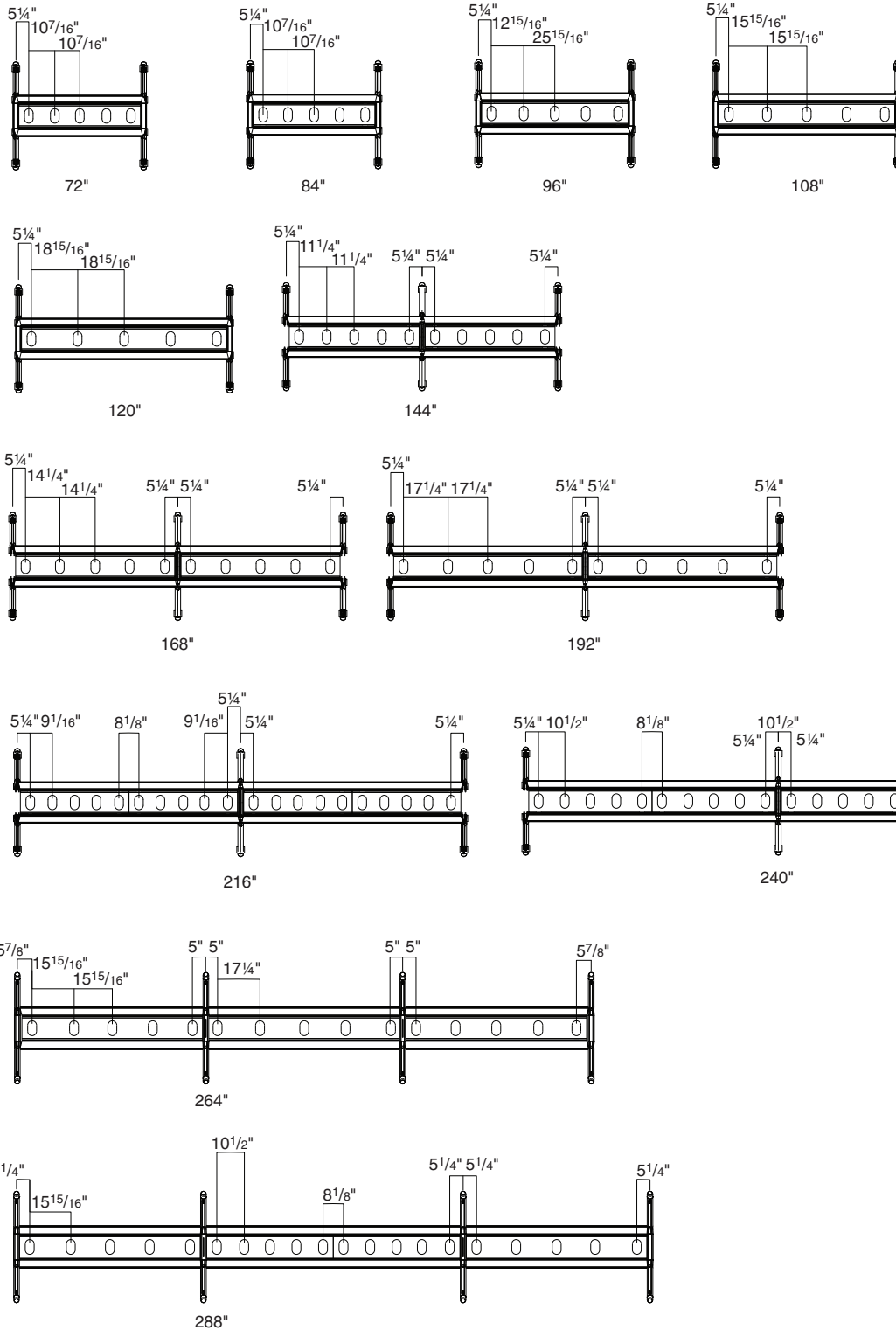

Tip: For square and round tables, cutouts are located in the center of the bottom tray.

Coalesse

Potrero415 Collaborative and Conference Tables Cutout Locations

DESIGN COALESSE DESIGN GROUP

Potrero415 Collaborative
and Conference Tables

Potrero415 Collaborative and Conference Tables

DESIGN COALESSE DESIGN GROUP

Seating Capacity Guidelines

Depth	Width	Seating Capacity	Depth	Middle Depth	Width	Seating Capacity
Capacity			Capacity			
Round Tops			Boat Tops			
48"		4	42"	54"	96"	6-8
60"		6	42"	54"	108"	8-10
Square Tops			42"	54"	120"	8-10
48"	48"	4	42"	54"	144"	10-12
60"	60"	8	42"	54"	168"	10-12
Rectangular Tops			42"	54"	192"	14-16
48"	72"	6	42"	54"	216"	14-16
48"	84"	6	42"	54"	240"	16-18
48"	96"	6-8	42"	54"	264"	16-18
48"	108"	8-10	42"	54"	288"	20
48"	120"	8-10	48"	60"	96"	6-8
48"	144"	10-12	48"	60"	108"	8-10
48"	168"	10-12	48"	60"	120"	8-10
48"	192"	14-16	48"	60"	144"	10-12
48"	216"	14-16	48"	60"	168"	10-12
48"	240"	16-18	48"	60"	192"	14-16
48"	264"	16-18	48"	60"	216"	14-16
48"	288"	20	48"	60"	240"	16-18
60"	84"	6-8	48"	60"	264"	6-18
60"	96"	10	48"	60"	288"	20
60"	108"	12				
60"	120"	12				
60"	144"	14				
60"	168"	16				
60"	192"	18				
60"	216"	18				
60"	240"	20				
60"	264"	20				
60"	288"	22				

Tip: Actual capacity is determined by width of chair selected.

Potrero415 Collaborative and Conference Tables

DESIGN COALESSE DESIGN GROUP

Surface Materials

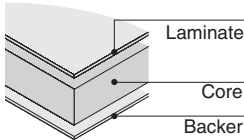

Laminates are available in two standard grades. Additional laminates from any manufacturer may also be practical—see *Other laminates* below.

Grade 1 laminates include:

- Coalesse standard laminates
- ▶ See *Coalesse Surface Materials Reference Guide*.
- Steelcase standard laminates (code 290A)
- ▶ See *Steelcase Surface Materials Reference Manual*.
- Any standard-grade Wilsonart laminate in solid color, woodgrain, or pattern finish (code 290A)

Grade 2 laminates (code 290B) include any standard-grade, solid color, woodgrain, or patterned laminate from Nevamar (includes Matrix), Formica, or Pionite. Grade 2 laminates may have extended lead times. For details, contact Customer Service at 1.800.627.6770.

Other laminates that are not included in the Grade 1 or Grade 2 offerings may also be available, such as Abet Laminati and Laminart. To determine availability and pricing, contact Customer Service at 1.800.627.6770, with the laminate manufacturer's name and the name and number of the laminate you want.

Laminate swatches are reproduced in the Surface Materials Color Palettes.

- ▶ See *Coalesse Surface Materials Reference Guide* for a list.

Swatch cards and actual samples of Coalesse standard laminates are available from your Coalesse Customer Service representative. For samples of laminates from other manufacturers, contact them directly:

Wilsonart
1.800.433.3222
Nevamar
1.800.638.4380
Formica
1.800.FORMICA
Pionite
1.800.285.5161

Tip: Laminate manufacturers change their offerings frequently. Always check availability before ordering.

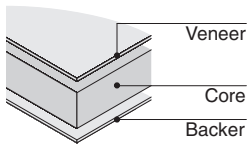

Wood veneer table tops are fabricated with Architectural Grade AA hand-selected hardwood veneer, plain sliced, book matched, and bonded to the core with a backing sheet for balance. Coalesse's primary wood finish, Clarity, is a water-borne UV topcoat, which protects the environment while providing exceptional durability and resistance to water and chemical stains. Due to natural variations in wood, finished products may vary from samples in color, texture, and grain.

Wood is a natural material; slight variations occur in veneer texture, color, grain configuration, and stain acceptance. Coalesse stains are all applied with an exacting regard for consistency and are well within traditional tolerances for wood products.

Tip: You should know that finished tops may vary slightly in tone or character from each other or from the samples Coalesse produces. No guarantee can be made of an absolutely exact match.

Wood veneer swatches are reproduced in the Surface Materials Color Palettes.

- ▶ See *Coalesse Surface Materials Reference Guide* for a list.

Swatch cards and actual samples of Coalesse standard wood veneers are available from your Coalesse Customer Service representative.

Additional wood veneer species are available. To confirm availability and to determine pricing, contact Customer Service at 1.800.627.6770.

Stains applied to Coalesse wood veneer table tops are standard with the same stain color applied to both the top and the solid hardwood edge profile. Coalesse strives to produce a consistently high quality product and some natural variation in color is to be expected. This is especially apparent on natural woods which have no stain applied, for example 3525 Natural Maple. This color variation is normal and reflects the unique and natural properties of wood. This should not be considered a defect.

Stain swatches are reproduced in the Surface Materials Color Palettes.

- ▶ See *Coalesse Surface Materials Reference Guide* for a list.

Swatch cards and actual samples of standard wood veneers are available from your Customer Service representative.

Stain-to-Match is available on this product and allows the matching of any wood finish with a one-time charge per finish.

- ▶ See *Coalesse Surface Materials Reference Guide* for details.

Solid surface tops are ½" thick on top of a 1¼" substructure. Solid surface is available in 2801 Glacier White.

Glass tops are ½" thick on top of a 1¼" substructure. Tops are tempered, low-iron glass available in multiple painted finishes.

Potrero415 Collaborative and Conference Tables

DESIGN COALESSE DESIGN GROUP

Round and Square Tables with Metal Legs

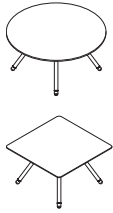

Tip: Glass tops are not secured to the substructure. Glass tops are placed on rubber pads that are adhered to the substructure. If the glass tables need to be moved, remove the glass top prior to moving the table.

Tip: For tables with solid surface and glass tops, overall height is 1/2" taller.

Tip: When polished aluminum leg is specified, frame is platinum gloss.

Tip: When "no infeed" is selected, each technology device is equipped with a 6' conduit to be hardwired on site. Square power and refined technology module support this option.

Tip: PowerPod grommet is available in 6000 Black or 6052 Milk.

Tip: Round power module is available in silver, milk, black and graphite finishes.

Tip: Square power module/E2X square unit is available in 8044 Black Anodized Aluminum or 8047 Silver Anodized Aluminum.

Tip: When technology is specified on 48" round tables only, the 15-amp power module cord can be managed from the desk top through a leg. Order leg cover thumb screws through Service Parts (1025537001SR) to allow for tool-free access.

Standard Includes	Required to Specify
<ul style="list-style-type: none"> ▶ Need help? Product details, page 486 • Table top: grade 1 laminate with 3 mm flat plastic edge • Legs and frame: grade 1 paint • Leg ring: paint • Four adjustable glides • Ships ready to assemble 	<ol style="list-style-type: none"> 1 Style number 2 Table top width for square table 3 Table top diameter for round table 4 Laminate color number for table top 5 Plastic edge color number for laminate table top, if selected 6 Paint color number for legs and frame 7 Paint color number for leg ring 8 Options, if selected (see below) <p>▶ See <i>Coalesse Surface Materials Reference Guide</i>.</p>

Options	U.S. Price	Required to Specify
Surface Materials <ul style="list-style-type: none"> • Table top • Grade 2 laminate • Grade 3 laminate • Grade 2 wood veneer • Solid Surface • Back-painted glass 	<ul style="list-style-type: none"> Prices at right Prices at right Prices at right Prices at right Prices at right 	<ul style="list-style-type: none"> Specify with <i>grade 2 laminate</i> and select color number. Specify with <i>grade 3 laminate</i> and select color number. Specify with <i>grade 2 wood veneer</i> and select color number. Specify with <i>solid surface group 1</i> and select color number for substructure (6000 Black or 6052 Milk). Specify back-painted glass, select color number, and select color number for substructure (6000 Black or 6052 Milk).
Legs on work-height tables <ul style="list-style-type: none"> • Grade 3 paint • Polished aluminum 	<ul style="list-style-type: none"> +\$ 313 +\$ 440 	<ul style="list-style-type: none"> Specify paint color number. Specify with <i>8046 Polished Aluminum</i>.
Legs on standing-height tables <ul style="list-style-type: none"> • Grade 3 paint • Polished aluminum 	<ul style="list-style-type: none"> +\$ 313 +\$ 655 	<ul style="list-style-type: none"> Specify paint color number. Specify with <i>8046 Polished Aluminum</i>.
Leg ring <ul style="list-style-type: none"> • Chrome or copper plating 	<ul style="list-style-type: none"> +\$ 292 	<ul style="list-style-type: none"> Specify 9201 Chrome, 9260 Black Chrome, or 9261 Copper.
Power Infeed <ul style="list-style-type: none"> • 60" round, 48"/60" square • No infeed – Chicago hardwired tech device • Hardwire • 20-amp plug 	<ul style="list-style-type: none"> No cost +\$ 146 +\$ 185 	<ul style="list-style-type: none"> Specify with <i>no infeed</i>. Specify with <i>hardwire power infeed</i>. Specify with <i>20-amp plug power infeed</i>.
Technology Devices and Grommets <ul style="list-style-type: none"> • PowerPod grommet for 48" and 60" tables • PowerPod grommet 	<ul style="list-style-type: none"> +\$ 172 	<ul style="list-style-type: none"> Specify with <i>PowerPod grommet</i> and select finish.
<ul style="list-style-type: none"> • Round power module for 48" and 60" tables • Two receptacles • One receptacle/one USB 	<ul style="list-style-type: none"> +\$ 375 +\$ 521 	<ul style="list-style-type: none"> Specify with <i>round power module with two receptacles</i> and select finish. Specify with <i>round power module with one receptacle/one USB</i> and select finish.
<ul style="list-style-type: none"> • Square power module/E2X power unit for 60" tables • Six power/four data • Four power/two blank AAP • Six power/two USB/two data • Six power/four USB 	<ul style="list-style-type: none"> +\$1100 +\$1100 +\$1393 +\$1465 	<ul style="list-style-type: none"> Specify with <i>square power module with six power/four data</i> and select finish. Specify with <i>square power module with four power/two blank AAP</i> and select finish. Specify with <i>square power module with six power/two USB/two data</i> and select finish. Specify with <i>square power module with six power/four USB</i> and select finish.

▶ Options, continued on next page

Potrero415 Collaborative and Conference Tables

DESIGN COALESSE DESIGN GROUP

Round and Square Tables with Metal Legs

Potrero415 Collaborative and Conference Tables

► Options, continued from previous page

Options	U.S. Price	Required to Specify
Technology Devices and Grommets, continued	Refined technology module (power unit) for 60" table	
• Laminate and veneer tops with bezel—metal doors		
– Six power/two AAP	+\$1930	Specify with power unit with six power/two AAP and select finish.
– Four power/two AAP/two USB	+\$2281	Specify with power unit with four power/two AAP/two USB and select finish.
– Four power/four USB	+\$2562	Specify with power unit with four power/four USB and select finish.
• Solid surface and glass tops—metal doors		
– Six power/two AAP	+\$1650	Specify with power unit with six power/two AAP and select finish.
– Four power/two AAP/two USB	+\$2001	Specify with power unit with four power/two AAP/two USB and select finish.
– Four power/four USB	+\$2282	Specify with power unit with four power/four USB and select finish.
• Doors for technology module (power unit)		
– Solid surface doors	+\$ 346	Specify with power unit with solid surface doors.
– Wood veneer doors	+\$ 703	Specify with power unit with wood veneer doors.

Related Products • PowerPod

► Page 739

Specification Information

Style Number	Dimensions			U.S. Base Prices				
	D	W	H	Laminate Grade 1	Laminate Grade 2 and 3	Wood Veneer Grade 1	Wood Veneer Grade 2	Solid Surface

Work-Height Round Tables

COFOFRD	48" diameter	28 1/2"	\$4187	\$4294	\$5857	\$6275	\$ 8159	\$10,198
	60" diameter	28 1/2"	\$5217	\$5385	\$7294	\$7813	\$10,160	\$12,698

Work-Height Square Tables

COFOFSQ	48" 48"	28 1/2"	\$4187	\$4294	\$5857	\$6275	\$ 8159	\$10,198
	60" 60"	28 1/2"	\$5217	\$5385	\$7294	\$7813	\$10,160	\$12,698

Standing-Height Round Tables

COFOFRDST	48" diameter	40"	\$4758	\$4865	\$6428	\$6846	\$ 8730	\$10,769
	60" diameter	40"	\$5788	\$5956	\$7865	\$8384	\$10,731	\$13,269

Standing-Height Square Tables

COFOFSQST	48" 48"	40"	\$4758	\$4865	\$6428	\$6846	\$ 8730	\$10,769
	60" 60"	40"	\$5788	\$5956	\$7865	\$8384	\$10,731	\$13,269

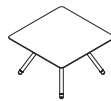

Veneer direction |||

 **For Canadian Pricing**
Multiply U.S. Price by the Canadian price factor.
► See page 1 for details.

Potrero415 Collaborative and Conference Tables

DESIGN COALESSE DESIGN GROUP

72"L, 84"L, 96"L, 108"L, and 120"L
Rectangular Tables with Metal Legs

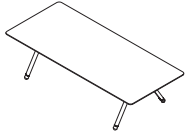

Tip: Glass tops are not secured to the substructure. Glass tops are placed on rubber pads that are adhered to the substructure. If the glass tables need to be moved, remove the glass top prior to moving the table.

Tip: Large tops can be difficult to move through some buildings. If top dimensions are too large for installation site, please contact Specials for assistance with creating smaller top sections.

Tip: For tables with solid surface and glass tops, overall height is 1/2" taller.

Tip: When polished aluminum leg is specified, frame is platinum gloss.

Tip: When "no infeed" is selected, each technology device is equipped with a 6' conduit to be hardwired on site. Square power and refined technology module support this option.

Tip: PowerPod grommet is available in 6000 Black or 6052 Milk.

Tip: Square power module is available in 8044 Black Anodized Aluminum or 8047 Silver Anodized Aluminum.

Standard Includes	Required to Specify
<ul style="list-style-type: none"> ▶ Need help? Product details, page 486 • Table top: grade 1 laminate with 3 mm flat plastic edge • Legs and frame: grade 1 paint • Leg ring: paint • Four adjustable glides • Ships ready to assemble 	<ol style="list-style-type: none"> 1 Style number 2 Table top depth and width 3 Laminate color number for table top 4 Plastic edge color number for laminate table top, if selected 5 Paint color number for legs and frame 6 Paint color number for leg ring 7 Options, if selected (see below) <p>▶ See <i>Coalesse Surface Materials Reference Guide</i>.</p>

Options	U.S. Price	Required to Specify
Surface Materials <ul style="list-style-type: none"> • Table top • Grade 2 laminate • Grade 3 laminate • Grade 2 wood veneer • Solid surface • Back-painted glass 	<ul style="list-style-type: none"> Prices at right Prices at right Prices at right Prices at right Prices at right 	<ul style="list-style-type: none"> Specify with <i>grade 2 laminate</i> and select color number. Specify with <i>grade 3 laminate</i> and select color number. Specify with <i>grade 2 wood veneer</i> and select color number. Specify with <i>solid surface group 1</i> and select color number for substructure (6000 Black or 6052 Milk). Specify back-painted glass, select color number, and select color number for substructure (6000 Black or 6052 Milk).
Legs on work-height tables <ul style="list-style-type: none"> • Grade 3 paint • Polished aluminum 	<ul style="list-style-type: none"> +\$ 313 +\$ 440 	<ul style="list-style-type: none"> Specify paint color number. Specify with <i>8046 Polished Aluminum</i>.
Legs on standing-height tables <ul style="list-style-type: none"> • Grade 3 paint • Polished aluminum 	<ul style="list-style-type: none"> +\$ 313 +\$ 655 	<ul style="list-style-type: none"> Specify paint color number. Specify with <i>8046 Polished Aluminum</i>.
Leg ring <ul style="list-style-type: none"> • Chrome or copper plating 	<ul style="list-style-type: none"> +\$ 292 	<ul style="list-style-type: none"> Specify 9201 Chrome, 9260 Black Chrome, or 9261 Copper.
Power Infeed <ul style="list-style-type: none"> • No infeed – Chicago hardwired tech device • Hardwire • 20-amp plug 	<ul style="list-style-type: none"> No cost +\$ 293 +\$ 331 	<ul style="list-style-type: none"> Specify with <i>no infeed</i>. Specify with <i>hardwire power infeed</i>. Specify with <i>20-amp plug power infeed</i>.
Technology Devices and Grommets <ul style="list-style-type: none"> • PowerPod grommet • PowerPod grommet 	<ul style="list-style-type: none"> +\$ 172 each grommet 	<ul style="list-style-type: none"> Specify with <i>PowerPod grommet</i>, select finish, device count, and device location (see next page for location options).
Square power module/E2X power unit <ul style="list-style-type: none"> • Six power/four data • Four power/two blank AAP • Six power/two USB/two data • Six power/four USB 	<ul style="list-style-type: none"> +\$1100 each module +\$1100 each module +\$1393 each module +\$1465 each module 	<ul style="list-style-type: none"> Specify with <i>square power module with six power/four data, device count, device location, and select finish</i>. Specify with <i>square power module with four power/two blank AAP, device count, device location, and select finish</i>. Specify with <i>square power module with six power/two USB/two data, device count, device location, and select finish</i>. Specify with <i>square power module with six power/four USB, device count, device location, and select finish</i>.

▶ Options, continued on next page



For Canadian Pricing
Multiply U.S. Price by the Canadian price factor.
▶ See page 1 for details.

Potrero415 Collaborative and Conference Tables

DESIGN COALESSE DESIGN GROUP

72"L, 84"L, 96"L, 108"L, and 120"L
Rectangular Tables with Metal Legs

Potrero415 Collaborative
and Conference Tables

► Options, continued from previous page

Options	U.S. Price	Required to Specify
Technology Devices and Grommets, continued		
Refined technology module (power unit)		
• Laminate and veneer tops with bezel—metal doors		
– Six power/two AAP	+\$1930	Specify with power unit with six power/two AAP and select finish.
– Four power/two AAP/two USB	+\$2281	
– Four power/four USB	+\$2562	
• Solid surface and glass tops—metal doors		
– Six power/two AAP	+\$1650	Specify with power unit with four power/two AAP/two USB and select finish.
– Four power/two AAP/two USB	+\$2001	
– Four power/four USB	+\$2282	
• Doors for technology module (power unit)		
– Solid surface doors	+\$ 346	Specify with power unit with solid surface doors.
– Wood veneer doors	+\$ 703	

Related Products • PowerPod

► Page 739

Device Locations



Veneer direction |||

► Specification Information, on next page

 **For Canadian Pricing**
Multiply U.S. Price by the
Canadian price factor.
► See page 1 for details.

Potrero415 Collaborative and Conference Tables

DESIGN COALESSE DESIGN GROUP

72"L, 84"L, 96"L, 108"L, and 120"L
Rectangular Tables with Metal Legs
continued

► Options, on previous page

Specification Information

Style Number	Dimensions			U.S. Base Prices					
	D	W	H	Laminate		Wood Veneer		Solid Surface	Glass
				Grade 1	Grade 2 and 3	Grade 1	Grade 2		

Work-Height Rectangular Tables

COFOFREC	D	W	H	Laminate Grade 1	Laminate Grade 2 and 3	Wood Veneer Grade 1	Wood Veneer Grade 2	Solid Surface	Glass
	48"	72"	28 1/2"	\$4960	\$5120	\$ 6941	\$ 7434	\$ 9668	\$12,081
	48"	84"	28 1/2"	\$5474	\$5661	\$ 7658	\$ 8203	\$10,669	\$13,330
	48"	96"	28 1/2"	\$5987	\$6202	\$ 8377	\$ 8975	\$11,671	\$14,585
	48"	108"	28 1/2"	\$6506	\$6746	\$ 9101	\$ 9749	\$12,678	\$15,841
	48"	120"	28 1/2"	\$7167	\$7433	\$10,026	\$10,740	\$13,963	\$17,452
	60"	84"	28 1/2"	\$6388	\$6622	\$ 8940	\$ 9574	\$12,453	\$15,561
	60"	96"	28 1/2"	\$6906	\$7172	\$ 9660	\$10,351	\$13,458	\$16,817
	60"	108"	28 1/2"	\$7491	\$7793	\$10,480	\$11,228	\$14,600	\$18,245
	60"	120"	28 1/2"	\$8082	\$8417	\$11,305	\$12,112	\$15,750	\$19,681

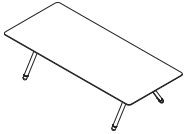

Standing-Height Rectangular Tables

COFOFRECST	D	W	H	Laminate Grade 1	Laminate Grade 2 and 3	Wood Veneer Grade 1	Wood Veneer Grade 2	Solid Surface	Glass
	48"	72"	40"	\$5819	\$5979	\$ 7800	\$ 8293	\$10,527	\$12,940
	48"	84"	40"	\$6333	\$6520	\$ 8517	\$ 9062	\$11,528	\$14,189
	48"	96"	40"	\$6846	\$7061	\$ 9236	\$ 9834	\$12,530	\$15,444
	48"	108"	40"	\$7365	\$7605	\$ 9960	\$10,608	\$13,537	\$16,700
	48"	120"	40"	\$8026	\$8292	\$10,885	\$11,599	\$14,822	\$18,311
	60"	84"	40"	\$7247	\$7481	\$ 9799	\$10,433	\$13,312	\$16,420
	60"	96"	40"	\$7765	\$8031	\$10,519	\$11,210	\$14,317	\$17,676
	60"	108"	40"	\$8350	\$8652	\$11,339	\$12,087	\$15,459	\$19,104
	60"	120"	40"	\$8941	\$9276	\$12,164	\$12,971	\$16,609	\$20,540

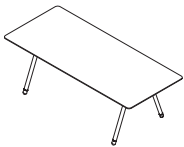

Veneer direction |||



For Canadian Pricing
Multiply U.S. Price by the
Canadian price factor.
► See page 1 for details.

Coalesse

Potrero415 Collaborative and Conference Tables

DESIGN COALESSE DESIGN GROUP

72"L, 84"L, 96"L, 108"L, and 120"L
Rectangular Tables with Metal Legs

Potrero415 Collaborative
and Conference Tables

Potrero415 Collaborative and Conference Tables

DESIGN COALESSE DESIGN GROUP

144"L, 168"L, 192"L, 216"L, and 240"L
Rectangular Tables with Metal Legs

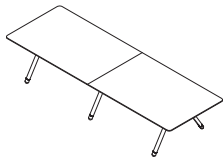

Tip: Glass tops are not secured to the substructure. Glass tops are placed on rubber pads that are adhered to the substructure. If the glass tables need to be moved, remove the glass top prior to moving the table.

Tip: Large tops can be difficult to move through some buildings. If top dimensions are too large for installation site, please contact Specials for assistance with creating smaller top sections.

Tip: Woodgrain laminate sectioned tops cannot be guaranteed to have a perfect match of the grain pattern along the seam that joins the sections.

Tip: For tables with solid surface and glass tops, overall height is 1/2" taller.

Tip: When polished aluminum leg is specified, frame is platinum gloss.

Tip: When "no infeed" is selected, each technology device is equipped with a 6' conduit to be hardwired on site. Square power and refined technology module support this option.

Tip: PowerPod grommet is available in 6000 Black or 6052 Milk.

Tip: Square power module is available in 8044 Black Anodized Aluminum or 8047 Silver Anodized Aluminum.



For Canadian Pricing
Multiply U.S. Price by the Canadian price factor.
▶ See page 1 for details.

Standard Includes	Required to Specify
<ul style="list-style-type: none"> ▶ Need help? Product details, page 486 • Table top: grade 1 laminate with 3 mm flat plastic edge • Legs and frame: grade 1 paint • Leg ring: paint • Six adjustable glides • Ships ready to assemble 	<ol style="list-style-type: none"> 1 Style number 2 Table top depth and width 3 Laminate color number for table top 4 Plastic edge color number for laminate table top, if selected 5 Paint color number for legs and frame 6 Paint color number for leg ring 7 Options, if selected (see below) <p>▶ See <i>Coalesse Surface Materials Reference Guide</i>.</p>

Surface Materials	Options	U.S. Price	Required to Specify
	Table top		
	• Grade 2 laminate	Prices at right	Specify with <i>grade 2 laminate</i> and select color number.
	• Grade 3 laminate	Prices at right	Specify with <i>grade 3 laminate</i> and select color number.
	• Grade 2 wood veneer	Prices at right	Specify with <i>grade 2 wood veneer</i> and select color number.
	• Solid surface	Prices at right	Specify with <i>solid surface group 1</i> and select color number for substructure (6000 Black or 6052 Milk).
	• Back-painted glass	Prices at right	Specify back-painted glass, select color number, and select color number for substructure (6000 Black or 6052 Milk).
	Legs on work-height tables		
	• Grade 3 paint	+\$ 380	Specify paint color number.
	• Polished aluminum	+\$ 659	Specify with <i>8046 Polished Aluminum</i> .
	Legs on standing-height tables		
	• Grade 3 paint	+\$ 380	Specify paint color number.
	• Polished aluminum	+\$ 945	Specify with <i>8046 Polished Aluminum</i> .
	Leg ring		
	• Chrome or copper plating	+\$ 402	Specify 9201 Chrome, 9260 Black Chrome, or 9261 Copper.
Power Infeed	• No infeed – Chicago hardwired tech device	No cost	Specify with <i>no infeed</i> .
	• Hardwire	+\$ 552	Specify with <i>hardwire power infeed</i> .
	• 20-amp plug	+\$ 625	Specify with <i>20-amp plug power infeed</i> .
Technology Devices and Grommets	PowerPod grommet		
	• PowerPod grommet	+\$ 172 each grommet	Specify with <i>PowerPod grommet</i> , select finish, device count, and device location (see next page for location options).
	Square power module/E2X power unit		
	• Six power/four data	+\$1100 each module	Specify with <i>square power module with six power/four data</i> , device count, device location, and select finish.
	• Four power/two blank AAP	+\$1100 each module	Specify with <i>square power module with four power/two blank AAP</i> , device count, device location, and select finish.
	• Six power/two USB/two data	+\$1393 each module	Specify with <i>square power module with six power/two USB/two data</i> , device count, device location, and select finish.
	• Six power/four USB	+\$1465 each module	Specify with <i>square power module with six power/four USB</i> , device count, device location, and select finish.

▶ Options, continued on next page

Potrero415 Collaborative and Conference Tables

DESIGN COALESSE DESIGN GROUP

144"L, 168"L, 192"L, 216"L, and 240"L
Rectangular Tables with Metal Legs

Potrero415 Collaborative
and Conference Tables

►Options, continued from previous page

Options	U.S. Price	Required to Specify
Technology Devices and Grommets, continued		
Refined technology module (power unit)		
• Laminate and veneer tops with bezel—metal doors		
– Six power/two AAP	+\$1930	Specify with power unit with six power/two AAP and select finish.
– Four power/two AAP/two USB	+\$2281	
– Four power/four USB	+\$2562	
• Solid surface and glass tops—metal doors		
– Six power/two AAP	+\$1650	Specify with power unit with six power/two AAP and select finish.
– Four power/two AAP/two USB	+\$2001	
– Four power/four USB	+\$2282	
• Doors for technology module (power unit)		
– Solid surface doors	+\$ 346	Specify with power unit with solid surface doors.
– Wood veneer doors	+\$ 703	Specify with power unit with wood veneer doors.

Related Products • PowerPod

► Page 739

Device Locations

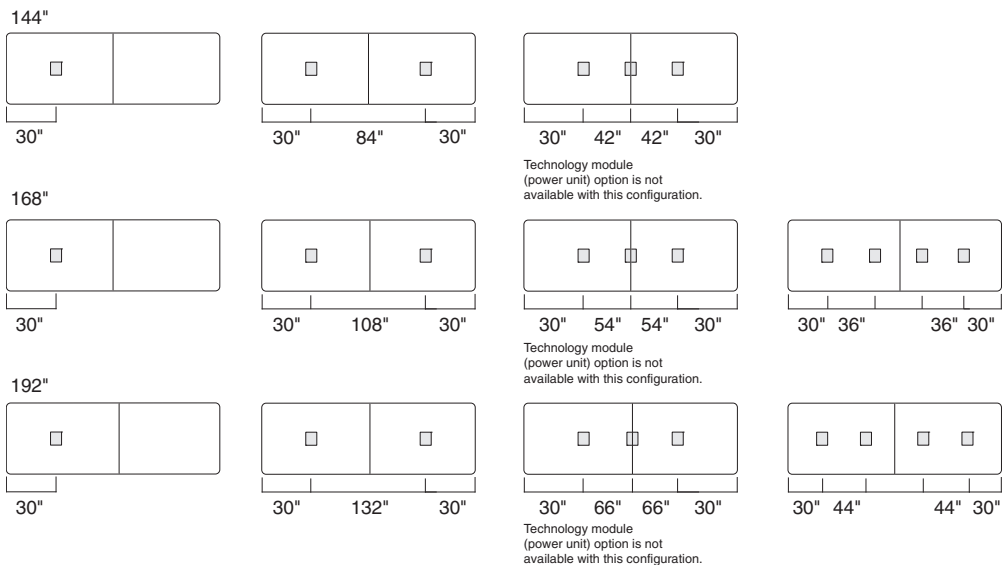

►Options, continued on next page

Veneer direction |||



For Canadian Pricing
Multiply U.S. Price by the
Canadian price factor.
► See page 1 for details.

Potrero415 Collaborative and Conference Tables

DESIGN COALESSE DESIGN GROUP

144"L, 168"L, 192"L, 216"L, and 240"L
Rectangular Tables with Metal Legs
continued

► Options, continued from previous page

Device Locations

Tip: Tables specified with glass tops for 216" and 240" tables are produced with three piece tops. The sub-top is two pieces.

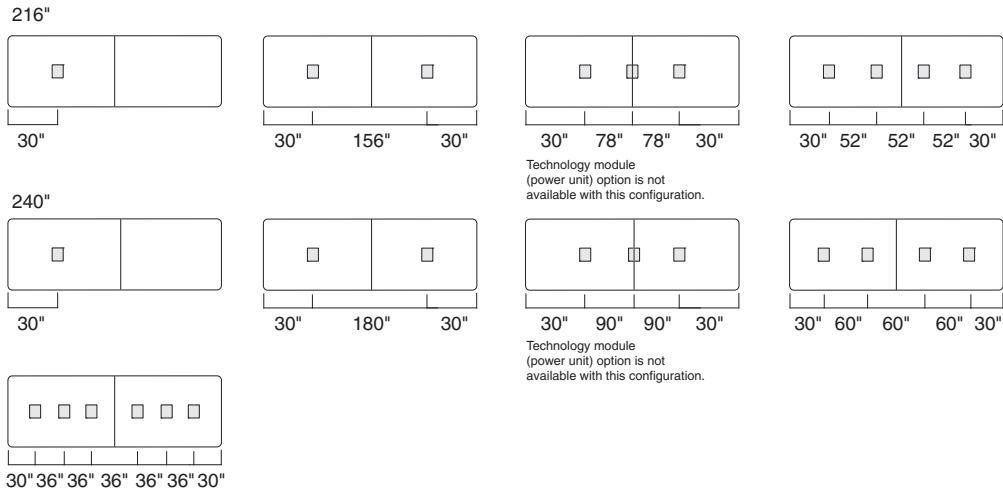

Specification Information

Style Number	Dimensions			U.S. Base Prices					
	D	W	H	Laminate		Wood Veneer		Solid Surface	Glass
				Grade 1	Grade 2 and 3	Grade 1	Grade 2		

Work-Height Rectangular Tables

COFOFREC	D	W	H	Laminate Grade 1	Laminate Grade 2 and 3	Wood Veneer Grade 1	Wood Veneer Grade 2	Solid Surface	Glass
	48"	144"	28 1/2"	\$ 9074	\$ 9394	\$12,521	\$13,381	\$17,684	\$22,100
	48"	168"	28 1/2"	\$10,251	\$10,626	\$14,164	\$15,059	\$19,973	\$24,963
	48"	192"	28 1/2"	\$11,570	\$11,998	\$16,014	\$17,122	\$22,548	\$28,181
	48"	216"	28 1/2"	\$12,436	\$12,918	\$17,224	\$18,424	\$24,840	\$31,043
	48"	240"	28 1/2"	\$13,582	\$14,118	\$18,829	\$20,142	\$27,131	\$33,905
	60"	144"	28 1/2"	\$10,136	\$10,537	\$14,003	\$14,971	\$19,752	\$24,686
	60"	168"	28 1/2"	\$11,313	\$11,780	\$15,651	\$16,736	\$22,047	\$27,550
	60"	192"	28 1/2"	\$12,633	\$13,169	\$17,498	\$18,714	\$24,621	\$30,766
	60"	216"	28 1/2"	\$13,472	\$14,073	\$18,677	\$19,978	\$26,910	\$33,629
	60"	240"	28 1/2"	\$14,618	\$15,287	\$20,279	\$21,694	\$29,200	\$36,491

► Specification Information, continued on next page

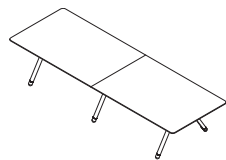

Veneer direction |||

 **For Canadian Pricing**
Multiply U.S. Price by the Canadian price factor.
► See page 1 for details.

Potrero415 Collaborative and Conference Tables

DESIGN COALESSE DESIGN GROUP

144"L, 168"L, 192"L, 216"L, and 240"L
Rectangular Tables with Metal Legs

► Specification Information, continued from previous page

Specification Information

Style Number	Dimensions			U.S. Base Prices					
	D	W	H	Laminate		Wood Veneer		Solid Surface	Glass
				Grade 1	Grade 2 and 3	Grade 1	Grade 2		

Standing-Height Rectangular Tables

COFOFRECST	48"	144"	40"	\$10,221	\$10,541	\$13,668	\$14,528	\$18,831	\$23,247
	48"	168"	40"	\$11,398	\$11,773	\$15,311	\$16,206	\$21,120	\$26,110
	48"	192"	40"	\$12,717	\$13,145	\$17,161	\$18,269	\$23,695	\$29,328
	60"	144"	40"	\$11,283	\$11,684	\$15,150	\$16,118	\$20,899	\$25,833
	60"	168"	40"	\$12,460	\$12,927	\$16,798	\$17,883	\$23,194	\$28,697
	60"	192"	40"	\$13,780	\$14,316	\$18,645	\$19,861	\$25,768	\$31,913

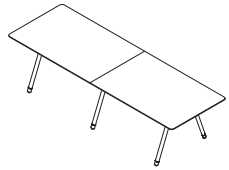

Potrero415 Collaborative and Conference Tables

Veneer direction |||

 **For Canadian Pricing**
Multiply U.S. Price by the Canadian price factor.
► See page 1 for details.

Potrero415 Collaborative and Conference Tables

DESIGN COALESSE DESIGN GROUP

264"L and 288"L Rectangular
Tables with Metal Legs

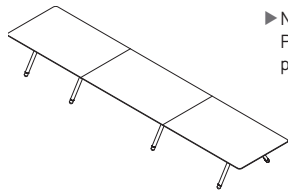

► Need help?
Product details,
page 486

Tip: Glass tops are not secured to the substructure. Glass tops are placed on rubber pads that are adhered to the substructure. If the glass tables need to be moved, remove the glass top prior to moving the table.

Tip: Large tops can be difficult to move through some buildings. If top dimensions are too large for installation site, please contact Specials for assistance with creating smaller top sections.

Tip: Woodgrain laminate sectioned tops cannot be guaranteed to have a perfect match of the grain pattern along the seam that joins the sections.

Tip: For tables with solid surface and glass tops, overall height is 1/2" taller.

Tip: When polished aluminum leg is specified, frame is platinum gloss.

Tip: When "no infeed" is selected, each technology device is equipped with a 6' conduit to be hardwired on site. Square power and refined technology module support this option.

Tip: PowerPod grommet is available in 6000 Black or 6052 Milk.

Tip: Square power module is available in 8044 Black Anodized Aluminum or 8047 Silver Anodized Aluminum.



For Canadian Pricing
Multiply U.S. Price by the Canadian price factor.
► See page 1 for details.

Standard Includes	Required to Specify
-------------------	---------------------

<ul style="list-style-type: none"> Table top: grade 1 laminate with 3 mm flat plastic edge Legs and frame: grade 1 paint Leg ring: paint Eight adjustable glides Ships ready to assemble 	<ol style="list-style-type: none"> Style number Table top depth and width Laminate color number for table top Plastic edge color number for laminate table top, if selected Paint color number for legs and frame Paint color number for leg ring Options, if selected (see below) <p>► See <i>Coalesse Surface Materials Reference Guide</i>.</p>
---	---

Options	U.S. Price	Required to Specify
---------	------------	---------------------

Surface Materials	<ul style="list-style-type: none"> Table top Grade 2 laminate Grade 3 laminate Grade 2 wood veneer Solid surface Back-painted glass 	<p>Prices at right</p> <p>Prices at right</p> <p>Prices at right</p> <p>Prices at right</p> <p>Prices at right</p>	<p>Specify with <i>grade 2 laminate</i> and select color number.</p> <p>Specify with <i>grade 3 laminate</i> and select color number.</p> <p>Specify with <i>grade 2 wood veneer</i> and select color number.</p> <p>Specify with <i>solid surface group 1</i> and select color number for substructure (6000 Black or 6052 Milk).</p> <p>Specify back-painted glass, select color number, and select color number for substructure (6000 Black or 6052 Milk).</p>
	<ul style="list-style-type: none"> Legs on work-height tables Grade 3 paint Polished aluminum 	<p>+\$ 416</p> <p>+\$ 879</p>	<p>Specify paint color number.</p> <p>Specify with <i>8046 Polished Aluminum</i>.</p>
	<ul style="list-style-type: none"> Leg ring Chrome or copper plating 	<p>+\$ 512</p>	<p>Specify 9201 Chrome, 9260 Black Chrome, or 9261 Copper.</p>
Power Infeed	<ul style="list-style-type: none"> No infeed — Chicago hardwired tech device Hardwire 20-amp plug 	<p>No cost</p> <p>+\$ 605</p> <p>+\$ 681</p>	<p>Specify with <i>no infeed</i>.</p> <p>Specify with <i>hardwire power infeed</i>.</p> <p>Specify with <i>20-amp plug power infeed</i>.</p>
Technology Devices and Grommets	<ul style="list-style-type: none"> PowerPod grommet PowerPod grommet 	<p>+\$ 172 each grommet</p>	<p>Specify with <i>PowerPod grommet</i>, select finish, device count, and device location (see next page for location options).</p>
	<ul style="list-style-type: none"> Square power module/E2X power unit Six power/four data Four power/two blank AAP Six power/two USB/two data Six power/four USB 	<p>+\$1100 each module</p> <p>+\$1100 each module</p> <p>+\$1393 each module</p> <p>+\$1465 each module</p>	<p>Specify with <i>square power module with six power/four data</i>, device count, device location, and select finish.</p> <p>Specify with <i>square power module with four power/two blank AAP</i>, device count, device location, and select finish.</p> <p>Specify with <i>square power module with six power/two USB/two data</i>, device count, device location, and select finish.</p> <p>Specify with <i>square power module with six power/four USB</i>, device count, device location, and select finish.</p>
	<ul style="list-style-type: none"> Refined technology module (power unit) Laminate and veneer tops with bezel—metal doors Six power/two AAP Four power/two AAP/two USB Four power/four USB 	<p>+\$1930</p> <p>+\$2281</p> <p>+\$2562</p>	<p>Specify with <i>power unit with six power/two AAP</i> and select finish.</p> <p>Specify with <i>power unit with four power/two AAP/two USB</i> and select finish.</p> <p>Specify with <i>power unit with four power/four USB</i> and select finish.</p>

► Options, continued on next page

Potrero415 Collaborative and Conference Tables

DESIGN COALESSE DESIGN GROUP

264"L and 288"L Rectangular Tables with Metal Legs

► Options, continued from previous page

Options	U.S. Price	Required to Specify
Technology Devices and Grommets, continued	Refined technology module (power unit), continued	
• Solid surface and glass tops—metal doors		
– Six power/two AAP	+\$1650	Specify with power unit with six power/two AAP and select finish.
– Four power/two AAP /two USB	+\$2001	
– Four power/four USB	+\$2282	
• Doors for technology module (power unit)		Specify with power unit with four power/two AAP/two USB and select finish. Specify with power unit with four power/four USB and select finish.
– Solid surface doors	+\$ 346	
– Wood veneer doors	+\$ 703	

Related Products • PowerPod

► Page 739

Device Locations

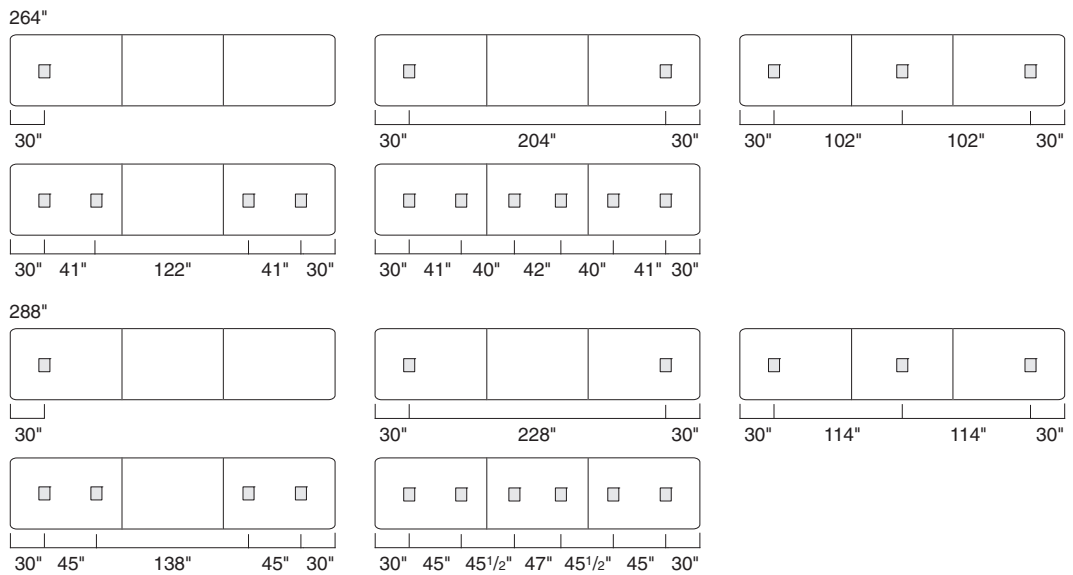

Specification Information

Style Number	Dimensions			U.S. Base Prices					
	D	W	H	Laminate		Wood Veneer		Solid Surface	Glass
				Grade 1	Grade 2 and 3	Grade 1	Grade 2		

Work-Height Rectangular Tables

COFOFREC	D	W	H	Laminate Grade 1	Laminate Grade 2 and 3	Wood Veneer Grade 1	Wood Veneer Grade 2	Solid Surface	Glass
	48"	264"	28 1/2"	\$15,301	\$15,890	\$21,234	\$22,718	\$30,564	\$38,196
	48"	288"	28 1/2"	\$16,449	\$17,091	\$22,841	\$24,440	\$32,857	\$41,060
	60"	264"	28 1/2"	\$16,340	\$17,076	\$22,688	\$24,274	\$32,638	\$40,787
	60"	288"	28 1/2"	\$17,486	\$18,288	\$24,292	\$25,992	\$34,926	\$43,646

Veneer direction |||

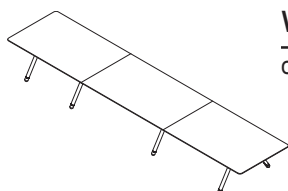

For Canadian Pricing
Multiply U.S. Price by the Canadian price factor.
► See page 1 for details.

Potrero415 Collaborative and Conference Tables

96"L, 108"L, and 120"L
Boat Shaped Tables with Metal Legs

DESIGN COALESSE DESIGN GROUP

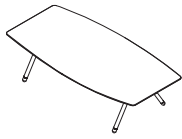

Tip: Glass tops are not secured to the substructure. Glass tops are placed on rubber pads that are adhered to the substructure. If the glass tables need to be moved, remove the glass top prior to moving the table.

Tip: Large tops can be difficult to move through some buildings. If top dimensions are too large for installation site, please contact Specials for assistance with creating smaller top sections.

Tip: For tables with solid surface and glass tops, overall height is 1/2" taller.

Tip: When polished aluminum leg is specified, frame is platinum gloss.

Tip: When "no infeed" is selected, each technology device is equipped with a 6' conduit to be hardwired on site. Square power and refined technology module support this option.

Tip: PowerPod grommet is available in 6000 Black or 6052 Milk.

Tip: Square power module is available in 8044 Black Anodized Aluminum or 8047 Silver Anodized Aluminum.

Standard Includes	Required to Specify
<ul style="list-style-type: none"> ▶ Need help? Product details, page 486 • Table top: grade 1 laminate with 3 mm flat plastic edge • Legs and frame: grade 1 paint • Leg ring: grade 1 paint • Four adjustable glides • Ships ready to assemble 	<ol style="list-style-type: none"> 1 Style number 2 Table top depth and width 3 Laminate color number for table top 4 Plastic edge color number for laminate table top, if selected 5 Paint color number for legs and frame 6 Paint color number for leg ring 7 Options, if selected (see below) <p>▶ See <i>Coalesse Surface Materials Reference Guide</i>.</p>

Options	U.S. Price	Required to Specify
Surface Materials <ul style="list-style-type: none"> • Table top • Grade 2 laminate • Grade 3 laminate • Grade 2 wood veneer • Solid surface • Back-painted glass 	<ul style="list-style-type: none"> Prices at right Prices at right Prices at right Prices at right Prices at right 	<ul style="list-style-type: none"> Specify with <i>grade 2 laminate</i> and select color number. Specify with <i>grade 3 laminate</i> and select color number. Specify with <i>grade 2 wood veneer</i> and select color number. Specify with <i>solid surface group 1</i> and select color number for substructure (6000 Black or 6052 Milk). Specify back-painted glass, select color number, and select color number for substructure (6000 Black or 6052 Milk).
Legs on work-height tables <ul style="list-style-type: none"> • Grade 3 paint • Polished aluminum 	<ul style="list-style-type: none"> +\$ 313 +\$ 440 	<ul style="list-style-type: none"> Specify paint color number. Specify with <i>8046 Polished Aluminum</i>.
Legs on standing-height tables <ul style="list-style-type: none"> • Grade 3 paint • Polished aluminum 	<ul style="list-style-type: none"> +\$ 313 +\$ 659 	<ul style="list-style-type: none"> Specify paint color number. Specify with <i>8046 Polished Aluminum</i>.
Leg ring <ul style="list-style-type: none"> • Chrome or copper plating 	<ul style="list-style-type: none"> +\$ 292 	<ul style="list-style-type: none"> Specify 9201 Chrome, 9260 Black Chrome, or 9261 Copper.
Power Infeed <ul style="list-style-type: none"> • No infeed – Chicago hardwired tech device • Hardwire • 20-amp plug 	<ul style="list-style-type: none"> No cost +\$ 293 +\$ 331 	<ul style="list-style-type: none"> Specify with <i>no infeed</i>. Specify with <i>hardwire power infeed</i>. Specify with <i>20-amp plug power infeed</i>.
Technology Devices and Grommets <ul style="list-style-type: none"> • PowerPod grommet 	<ul style="list-style-type: none"> +\$ 172 each grommet 	<ul style="list-style-type: none"> Specify with <i>PowerPod grommet</i>, select finish, device count, and device location (see next page for location options).
Square power module/E2X power unit <ul style="list-style-type: none"> • Six power/four data • Four power/two blank AAP • Six power/two USB/two data • Six power/four USB 	<ul style="list-style-type: none"> +\$1100 each module +\$1100 each module +\$1393 each module +\$1465 each module 	<ul style="list-style-type: none"> Specify with <i>square power module with six power/four data</i>, device count, device location, and select finish. Specify with <i>square power module with four power/two blank AAP</i>, device count, device location, and select finish. Specify with <i>square power module with six power/two USB/two data</i>, device count, device location, and select finish. Specify with <i>square power module with six power/four USB</i>, device count, device location, and select finish.

▶ Options, continued on next page



For Canadian Pricing
Multiply U.S. Price by the Canadian price factor.
▶ See page 1 for details.

Potrero415 Collaborative and Conference Tables

DESIGN COALESSE DESIGN GROUP

96"L, 108"L, and 120"L
Boat Shaped Tables with Metal Legs

► Options, continued from previous page

Options	U.S. Price	Required to Specify
Technology Devices and Grommets, continued		
Refined technology module (power unit)		
• Laminate and veneer tops with bezel—metal doors		
– Six power/two AAP	+\$1930	Specify with power unit with six power/two AAP and select finish.
– Four power/two AAP/two USB	+\$2281	
– Four power/four USB	+\$2652	
• Solid surface and glass tops—metal doors		
– Six power/two AAP	+\$1650	Specify with power unit with six power/two AAP and select finish.
– Four power/two AAP/two USB	+\$2001	
– Four power/four USB	+\$2282	
• Doors for technology module (power unit)		
– Solid surface doors	+\$ 346	Specify with power unit with solid surface doors.
– Wood veneer doors	+\$ 703	

Related Products • PowerPod

► Page 739

Device Locations

96"

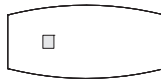

30"

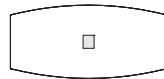

48"

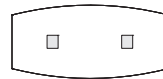

30" 36" 30"

108"

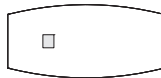

30"

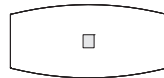

54"

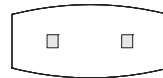

30" 48" 30"

120"

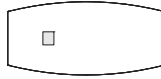

30"

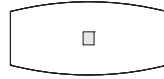

60"

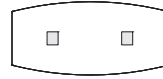

30" 60" 30"

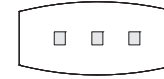

30" 30" 30" 30"

► Specification Information, on next page



For Canadian Pricing
Multiply U.S. Price by the
Canadian price factor.
► See page 1 for details.

Potrero415 Collaborative and Conference Tables

DESIGN COALESSE DESIGN GROUP

96"L, 108"L, and 120"L
Boat Shaped Tables with Metal Legs
continued

► Options, on previous page

Specification Information

Style Number	Dimensions			U.S. Base Prices					
	D	W	H	Laminate		Wood Veneer		Solid Surface	Glass
				Grade 1	Grade 2 and 3	Grade 1	Grade 2		

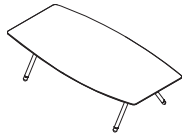

Work-Height Boat-Shaped Tables

COFOFBT	D	W	H	Laminate Grade 1	Laminate Grade 2 and 3	Wood Veneer Grade 1	Wood Veneer Grade 2	Solid Surface	Glass
	54"	96"	28 1/2"	\$6520	\$6760	\$ 9120	\$ 9769	\$12,704	\$15,877
	54"	108"	28 1/2"	\$7050	\$7323	\$ 9686	\$10,345	\$13,737	\$17,165
	54"	120"	28 1/2"	\$7547	\$7849	\$10,558	\$11,312	\$14,706	\$18,379
	60"	96"	28 1/2"	\$7251	\$7517	\$10,142	\$10,870	\$14,129	\$17,659
	60"	108"	28 1/2"	\$7839	\$8141	\$10,791	\$11,526	\$15,276	\$19,089
	60"	120"	28 1/2"	\$8425	\$8760	\$11,787	\$12,628	\$16,419	\$20,520

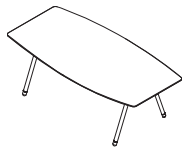

Standing-Height Boat-Shaped Tables

COFOBTST	D	W	H	Laminate Grade 1	Laminate Grade 2 and 3	Wood Veneer Grade 1	Wood Veneer Grade 2	Solid Surface	Glass
	54"	96"	40"	\$7379	\$7619	\$ 9979	\$10,628	\$13,563	\$16,736
	54"	108"	40"	\$7909	\$8182	\$10,545	\$11,204	\$14,596	\$18,024
	54"	120"	40"	\$8406	\$8708	\$11,417	\$12,171	\$15,565	\$19,238
	60"	96"	40"	\$8110	\$8376	\$11,001	\$11,729	\$14,988	\$18,518
	60"	108"	40"	\$8698	\$9000	\$11,650	\$12,385	\$16,135	\$19,948
	60"	120"	40"	\$9284	\$9619	\$12,646	\$13,487	\$17,278	\$21,379

Veneer direction |||



For Canadian Pricing
Multiply U.S. Price by the Canadian price factor.
► See page 1 for details.

Coalesse

Potrero415 Collaborative and Conference Tables

DESIGN COALESSE DESIGN GROUP

96"L, 108"L, and 120"L
Boat Shaped Tables with Metal Legs

Potrero415 Collaborative
and Conference Tables

Potrero415 Collaborative and Conference Tables

DESIGN COALESSE DESIGN GROUP

144"L, 168"L, 192"L, 216"L, and 240"L
Boat Shaped Tables with Metal Legs

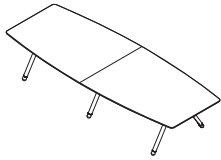

Tip: Glass tops are not secured to the substructure. Glass tops are placed on rubber pads that are adhered to the substructure. If the glass tables need to be moved, remove the glass top prior to moving the table.

Tip: Large tops can be difficult to move through some buildings. If top dimensions are too large for installation site, please contact Specials for assistance with creating smaller top sections.

Tip: For tables with solid surface and glass tops, overall height is 1/2" taller.

Tip: When polished aluminum leg is specified, frame is platinum gloss.

Tip: When "no infeed" is selected, each technology device is equipped with a 6' conduit to be hardwired on site. Square power and refined technology module support this option.

Tip: PowerPod grommet is available in 6000 Black or 6052 Milk.

Tip: Square power module is available in 8044 Black Anodized Aluminum or 8047 Silver Anodized Aluminum.

Standard Includes	Required to Specify
<p>► Need help? Product details, page 486</p> <ul style="list-style-type: none"> • Table top: grade 1 laminate with 3 mm flat plastic edge • Legs and frame: grade 1 paint • Leg ring: grade 1 paint • Six adjustable glides • Ships ready to assemble 	<ol style="list-style-type: none"> 1 Style number 2 Table top depth and width 3 Laminate color number for table top 4 Plastic edge color number for laminate table top, if selected 5 Paint color number for legs and frame 6 Paint color number for leg ring 7 Options, if selected (see below) <p>► See <i>Coalesse Surface Materials Reference Guide</i>.</p>

Options	U.S. Price	Required to Specify
<p>Surface Materials</p> <ul style="list-style-type: none"> • Table top • Grade 2 laminate • Grade 3 laminate • Grade 2 wood veneer • Solid surface • Back-painted glass 	<p>Prices at right</p> <p>Prices at right</p> <p>Prices at right</p> <p>Prices at right</p> <p>Prices at right</p>	<p>Specify with <i>grade 2 laminate</i> and select color number.</p> <p>Specify with <i>grade 3 laminate</i> and select color number.</p> <p>Specify with <i>grade 2 wood veneer</i> and select color number.</p> <p>Specify with <i>solid surface group 1</i> and select color number for substructure (6000 Black or 6052 Milk).</p> <p>Specify back-painted glass, select color number, and select color number for substructure (6000 Black or 6052 Milk).</p>
<p>Legs on work-height tables</p> <ul style="list-style-type: none"> • Grade 3 paint • Polished aluminum 	<p>+\$ 380</p> <p>+\$ 659</p>	<p>Specify paint color number.</p> <p>Specify with <i>8046 Polished Aluminum</i>.</p>
<p>Legs on standing-height tables</p> <ul style="list-style-type: none"> • Grade 3 paint • Polished aluminum 	<p>+\$ 380</p> <p>+\$ 945</p>	<p>Specify paint color number.</p> <p>Specify with <i>8046 Polished Aluminum</i>.</p>
<p>Leg ring</p> <ul style="list-style-type: none"> • Chrome or copper plating 	<p>+\$ 402</p>	<p>Specify 9201 Chrome, 9260 Black Chrome, or 9261 Copper.</p>
<p>Power Infeed</p> <ul style="list-style-type: none"> • No infeed – Chicago hardwired tech device • Hardwire • 20-amp plug 	<p>No cost</p> <p>+\$ 552</p> <p>+\$ 625</p>	<p>Specify with <i>no infeed</i>.</p> <p>Specify with <i>hardwire power infeed</i>.</p> <p>Specify with <i>20-amp plug power infeed</i>.</p>
<p>Technology Devices and Grommets</p> <ul style="list-style-type: none"> • PowerPod grommet • PowerPod grommet 	<p>+\$ 172 each grommet</p>	<p>Specify with <i>PowerPod grommet</i>, select finish, device count, and device location (see next page for location options).</p>
<p>Square power module/E2X power unit</p> <ul style="list-style-type: none"> • Six power/four data • Four power/two blank AAP • Six power/two USB/two data • Six power/four USB 	<p>+\$1100 each module</p> <p>+\$1100 each module</p> <p>+\$1393 each module</p> <p>+\$1465 each module</p>	<p>Specify with <i>square power module with six power/four data, device count, device location, and select finish</i>.</p> <p>Specify with <i>square power module with four power/two blank AAP, device count, device location, and select finish</i>.</p> <p>Specify with <i>square power module with six power/two USB/two data, device count, device location, and select finish</i>.</p> <p>Specify with <i>square power module with six power/four USB, device count, device location, and select finish</i>.</p>

► Options, continued on next page



For Canadian Pricing
Multiply U.S. Price by the Canadian price factor.
► See page 1 for details.

Potrero415 Collaborative and Conference Tables

DESIGN COALESSE DESIGN GROUP

144"L, 168"L, 192"L, 216"L, and 240"L
Boat Shaped Tables with Metal Legs

Potrero415 Collaborative
and Conference Tables

► Options, continued from previous page

Options	U.S. Price	Required to Specify
Technology Devices and Grommets, continued	Refined technology module (power unit)	
• Laminate and veneer tops with bezel—metal doors – Six power/two AAP	+\$1930	Specify with power unit with six power/two AAP and select finish.
– Four power/two AAP/two USB	+\$2281	Specify with power unit with four power/two AAP/two USB and select finish.
– Four power/four USB	+\$2562	Specify with power unit with four power/four USB and select finish.
• Solid surface and glass tops—metal doors – Six power/two AAP	+\$1650	Specify with power unit with six power/two AAP and select finish.
– Four power/two AAP/two USB	+\$2001	Specify with power unit with four power/two AAP/two USB and select finish.
– Four power/four USB	+\$2282	Specify with power unit with four power/four USB and select finish.
• Doors for technology module (power unit) – Solid surface doors	+\$ 346	Specify with power unit with solid surface doors.
– Wood veneer doors	+\$ 703	Specify with power unit with wood veneer doors.

Related Products • PowerPod

► Page 739

Device Locations

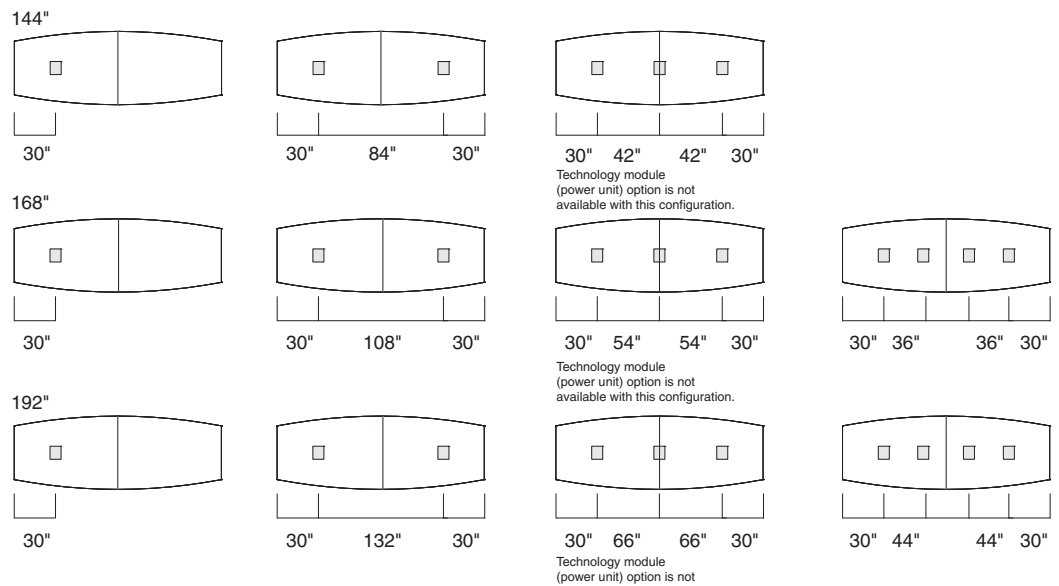

► Options, continued on next page

For Canadian Pricing
Multiply U.S. Price by the
Canadian price factor.
► See page 1 for details.

Potrero415 Collaborative and Conference Tables

DESIGN COALESSE DESIGN GROUP

144"L, 168"L, 192"L, 216"L, and 240"L
Boat Shaped Tables with Metal Legs
continued

► Options, continued from previous page

Tip: Tables specified with glass tops for 216" and 240" tables are produced with three piece tops. The sub-top is two pieces.

Device Locations

216"

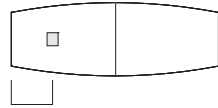

30"

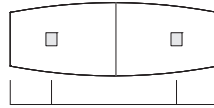

30" 156" 30"

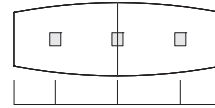

30" 78" 78" 30"

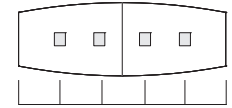

30" 52" 52" 30"

240"

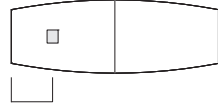

30"

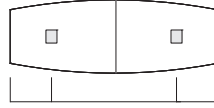

30" 180" 30"

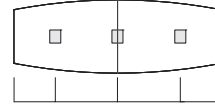

30" 90" 90" 30"

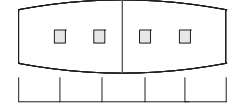

30" 60" 60" 30"

Technology module (power unit) option is not available with this configuration.

Technology module (power unit) option is not available with this configuration.

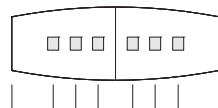

30" 36" 36" 36" 36" 30"

Specification Information

Style Number	Dimensions			U.S. Base Prices					
	D	W	H	Laminate		Wood Veneer		Solid Surface	Glass
				Grade 1	Grade 2 and 3	Grade 1	Grade 2		

Work-Height Boat-Shaped Tables

Style Number	D	W	H	Laminate Grade 1	Laminate Grade 2 and 3	Wood Veneer Grade 1	Wood Veneer Grade 2	Solid Surface	Glass
COFOFBT	54"	144"	28 1/2"	\$ 9606	\$ 9967	\$13,262	\$14,175	\$18,716	\$23,389
	54"	168"	28 1/2"	\$10,779	\$11,201	\$14,904	\$15,935	\$21,006	\$26,248
	54"	192"	28 1/2"	\$12,104	\$12,586	\$16,755	\$17,919	\$23,583	\$29,473
	54"	216"	28 1/2"	\$12,953	\$13,495	\$17,947	\$19,199	\$25,873	\$32,332
	54"	240"	28 1/2"	\$14,103	\$14,704	\$19,555	\$20,921	\$28,166	\$35,198
	60"	144"	28 1/2"	\$10,484	\$10,885	\$14,489	\$15,493	\$20,430	\$25,530
	60"	168"	28 1/2"	\$11,658	\$12,125	\$16,135	\$17,250	\$22,718	\$28,388
	60"	192"	28 1/2"	\$12,982	\$13,518	\$17,982	\$19,236	\$25,297	\$31,610
	60"	216"	28 1/2"	\$13,811	\$14,412	\$19,150	\$20,483	\$27,583	\$34,473
	60"	240"	28 1/2"	\$14,958	\$15,627	\$20,752	\$22,203	\$29,876	\$37,335

Standing-Height Boat-Shaped Tables

Style Number	D	W	H	Laminate Grade 1	Laminate Grade 2 and 3	Wood Veneer Grade 1	Wood Veneer Grade 2	Solid Surface	Glass
COFOBTST	54"	144"	40"	\$10,753	\$11,114	\$14,409	\$15,322	\$19,863	\$24,536
	54"	168"	40"	\$11,926	\$12,348	\$16,051	\$17,082	\$22,153	\$27,395
	54"	192"	40"	\$13,251	\$13,733	\$17,902	\$19,066	\$24,730	\$30,620
	60"	144"	40"	\$11,631	\$12,032	\$15,636	\$16,640	\$21,577	\$26,677
	60"	168"	40"	\$12,805	\$13,272	\$17,282	\$18,397	\$23,865	\$29,535
	60"	192"	40"	\$14,129	\$14,665	\$19,129	\$20,383	\$26,444	\$32,757

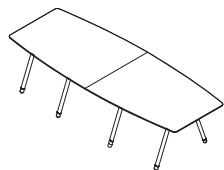
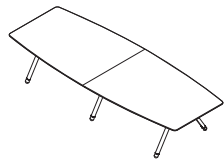

Veneer direction |||



For Canadian Pricing
Multiply U.S. Price by the Canadian price factor.

► See page 1 for details.

Coalesse

Potrero415 Collaborative and Conference Tables

DESIGN COALESSE DESIGN GROUP

144"L, 168"L, 192"L, 216"L, and 240"L
Boat Shaped Tables with Metal Legs

Potrero415 Collaborative
and Conference Tables

Potrero415 Collaborative and Conference Tables

264"L and 288"L Boat Shaped
Tables with Metal Legs

DESIGN COALESSE DESIGN GROUP

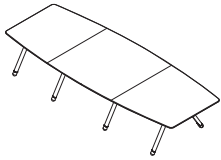

Tip: Glass tops are not secured to the substructure. Glass tops are placed on rubber pads that are adhered to the substructure. If the glass tables need to be moved, remove the glass top prior to moving the table.

Tip: Large tops can be difficult to move through some buildings. If top dimensions are too large for installation site, please contact Specials for assistance with creating smaller top sections.

Tip: For tables with solid surface and glass tops, overall height is 1/2" taller.

Tip: When polished aluminum leg is specified, frame is platinum gloss.

Tip: When "no infeed" is selected, each technology device is equipped with a 6' conduit to be hardwired on site. Square power and refined technology module support this option.

Tip: PowerPod grommet is available in 6000 Black or 6052 Milk.

Tip: Square power module is available in 8044 Black Anodized Aluminum or 8047 Silver Anodized Aluminum.



For Canadian Pricing
Multiply U.S. Price by the Canadian price factor.
▶ See page 1 for details.

Standard Includes	Required to Specify
<p>▶ Need help? Product details, page 486</p> <ul style="list-style-type: none"> • Table top: grade 1 laminate with 3 mm flat plastic edge • Legs and frame: grade 1 paint • Leg ring: grade 1 paint • Eight adjustable glides • Ships ready to assemble 	<ol style="list-style-type: none"> 1 Style number 2 Table top depth and width 3 Laminate color number for table top 4 Plastic edge color number for laminate table top, if selected 5 Paint color number for legs and frame 6 Paint color number for leg ring 7 Options, if selected (see below) <p>▶ See <i>Coalesse Surface Materials Reference Guide</i>.</p>

Options	U.S. Price	Required to Specify
<p>Surface Materials</p> <ul style="list-style-type: none"> • Table top • Grade 2 laminate • Grade 3 laminate • Grade 2 wood veneer • Solid surface • Back-painted glass 	<p>Prices at right</p> <p>Prices at right</p> <p>Prices at right</p> <p>Prices at right</p> <p>Prices at right</p>	<p>Specify with <i>grade 2 laminate</i> and select color number.</p> <p>Specify with <i>grade 3 laminate</i> and select color number.</p> <p>Specify with <i>grade 2 wood veneer</i> and select color number.</p> <p>Specify with <i>solid surface group 1</i> and select color number for substructure (6000 Black or 6052 Milk).</p> <p>Specify back-painted glass, select color number, and select color number for substructure (6000 Black or 6052 Milk).</p>
<p>Legs on work-height tables</p> <ul style="list-style-type: none"> • Grade 3 paint • Polished aluminum 	<p>+\$ 416</p> <p>+\$ 879</p>	<p>Specify paint color number.</p> <p>Specify with <i>8046 Polished Aluminum</i>.</p>
<p>Leg ring</p> <ul style="list-style-type: none"> • Chrome or copper plating 	<p>+\$ 512</p>	<p>Specify 9201 Chrome, 9260 Black Chrome, or 9261 Copper.</p>
<p>Power Infeed</p> <ul style="list-style-type: none"> • No infeed – Chicago hardwired tech device • Hardwire • 20-amp plug 	<p>No cost</p> <p>+\$ 605</p> <p>+\$ 681</p>	<p>Specify with <i>no infeed</i>.</p> <p>Specify with <i>hardwire power infeed</i>.</p> <p>Specify with <i>20-amp plug power infeed</i>.</p>
<p>Technology Devices and Grommets</p> <ul style="list-style-type: none"> • PowerPod grommet • PowerPod grommet 	<p>+\$ 172 each grommet</p>	<p>Specify with <i>PowerPod grommet</i>, select finish, device count, and device location (see next page for location options).</p>
<p>Square power module/E2X power unit</p> <ul style="list-style-type: none"> • Six power/four data • Four power/two blank AAP • Six power/two USB/two data • Six power/four USB 	<p>+\$1100 each module</p> <p>+\$1100 each module</p> <p>+\$1393 each module</p> <p>+\$1465 each module</p>	<p>Specify with <i>square power module with six power/four data, device count, device location, and select finish</i>.</p> <p>Specify with <i>square power module with four power/two blank AAP, device count, device location, and select finish</i>.</p> <p>Specify with <i>square power module with six power/two USB/two data, device count, device location, and select finish</i>.</p> <p>Specify with <i>square power module with six power/four USB, device count, device location, and select finish</i>.</p>
<p>Refined technology module (power unit)</p> <ul style="list-style-type: none"> • Laminate and veneer tops with bezel—metal doors – Six power/two AAP – Four power/two AAP/two USB – Four power/four USB 	<p>+\$1930</p> <p>+\$2281</p> <p>+\$2562</p>	<p>Specify with <i>power unit with six power/two AAP</i> and select finish.</p> <p>Specify with <i>power unit with four power/two AAP/two USB</i> and select finish.</p> <p>Specify with <i>power unit with four power/four USB</i> and select finish.</p>

▶ Options, continued on next page

Potrero415 Collaborative and Conference Tables

DESIGN COALESSE DESIGN GROUP

264"L and 288"L Boat Shaped Tables with Metal Legs

Potrero415 Collaborative and Conference Tables

► Options, continued from previous page

Options	U.S. Price	Required to Specify
Technology Devices and Grommets, continued		
Refined technology module (power unit), continued		
• Solid surface and glass tops—metal doors		
– Six power/two AAP	+\$1650	Specify with power unit with six power/two AAP and select finish.
– Four power/two AAP/two USB	+\$2001	Specify with power unit with four power/two AAP/two USB and select finish.
– Four power/four USB	+\$2282	Specify with power unit with four power/four USB and select finish.
• Doors for technology module (power unit)		
– Solid surface doors	+\$ 346	Specify with power unit with solid surface doors.
– Wood veneer doors	+\$ 703	Specify with power unit with wood veneer doors.

Related Products • PowerPod

► Page 739

Device Locations

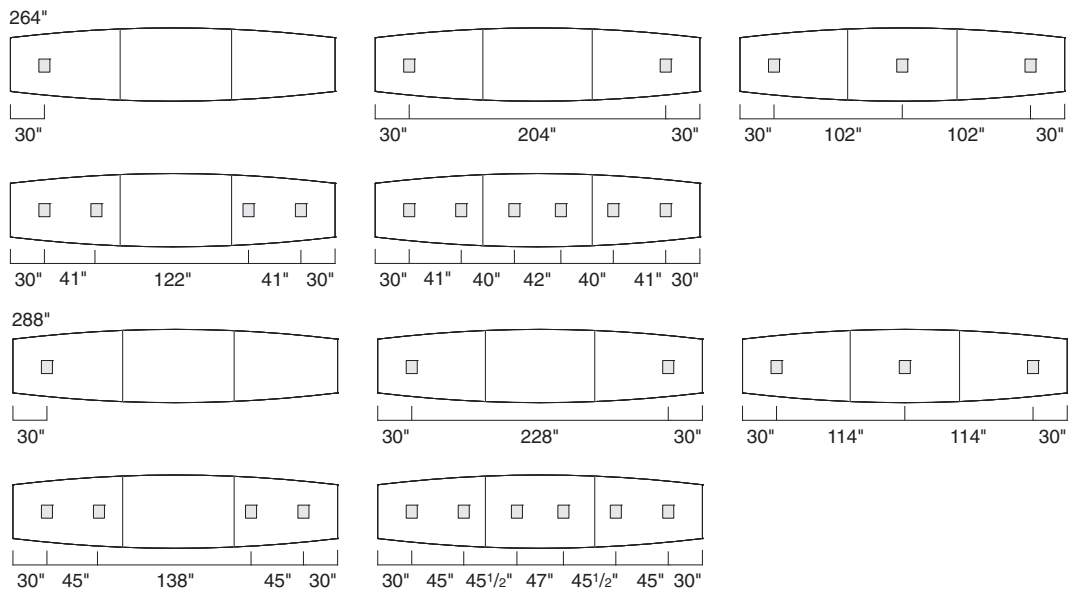

Specification Information

Style Number	Dimensions			U.S. Base Prices				
	D	W	H	Laminate Grade 1	Grade 2 and 3	Wood Veneer Grade 1	Grade 2	Solid Surface

Work-Height Boat-Shaped Tables

COFOFBT	D	W	H	Laminate Grade 1	Grade 2 and 3	Wood Veneer Grade 1	Grade 2	Solid Surface	Glass
	54"	264"	28 1/2"	\$15,821	\$16,484	\$21,963	\$23,496	\$31,600	\$39,489
	54"	288"	28 1/2"	\$16,968	\$17,690	\$23,564	\$25,216	\$33,890	\$42,354
	60"	264"	28 1/2"	\$16,678	\$17,414	\$23,160	\$24,781	\$33,311	\$41,628
	60"	288"	28 1/2"	\$17,824	\$18,626	\$24,765	\$26,497	\$35,601	\$44,489

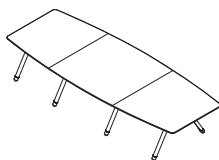

Veneer direction

For Canadian Pricing
 Multiply U.S. Price by the Canadian price factor.
 ► See page 1 for details.

Potrero415 Collaborative and Conference Tables

DESIGN COALESSE DESIGN GROUP

Round and Square Tables
with Wood Legs

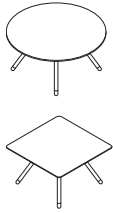

Tip: Glass tops are not secured to the substructure. Glass tops are placed on rubber pads that are adhered to the substructure. If the glass tables need to be moved, remove the glass top prior to moving the table.

Tip: Solid surface and glass tops are not available on tables with standing-height wood legs or tables with seated-height wood legs exceeding lengths of 168".

Tip: For tables with solid surface and glass tops, overall height is 1/2" taller.

Tip: When "no infeed" is selected, each technology device is equipped with a 6' conduit to be hardwired on site. Square power and refined technology module support this option.

Tip: PowerPod grommet is available in 6000 Black or 6052 Milk.

Tip: Round power module is available in silver, milk, black and graphite finishes.

Tip: Square power module is available in 8044 Black Anodized Aluminum or 8047 Silver Anodized Aluminum.



For Canadian Pricing
Multiply U.S. Price by the Canadian price factor.
▶ See page 1 for details.

Standard Includes	Required to Specify
▶ Need help? Product details, page 486	1 Style number 2 Table top width for square table 3 Table top diameter for round table 4 Laminate color number for table top 5 Plastic edge color number for laminate table top, if selected 6 Paint color number for frame and leg ring 7 Wood veneer color number for legs 8 Options, if selected (see below) ▶ See <i>Coalesse Surface Materials Reference Guide</i> .

Options	U.S. Price	Required to Specify
Surface Materials <ul style="list-style-type: none"> Table top Grade 2 laminate Grade 3 laminate Grade 2 wood veneer Solid surface Back-painted glass 	Prices at right Prices at right Prices at right Prices at right Prices at right	Specify with <i>grade 2 laminate</i> and select color number. Specify with <i>grade 3 laminate</i> and select color number. Specify with <i>grade 2 wood veneer</i> and select color number. Specify with <i>solid surface group 1</i> and select color number for substructure (6000 Black or 6052 Milk). Specify back-painted glass, select color number, and select color number for substructure (6000 Black or 6052 Milk).
Table frame <ul style="list-style-type: none"> Grade 3 paint 	+\$ 242	Specify paint color number.
Wood legs <ul style="list-style-type: none"> Grade 2 wood veneer 	+\$ 88	Specify with <i>VPO2 Smoked Oak</i> or <i>VPO4 Grey Oak</i> .
Leg ring <ul style="list-style-type: none"> Chrome or copper plating 	+\$ 292	Specify 9201 Chrome, 9260 Black Chrome, or 9261 Copper.
Power Infeed <ul style="list-style-type: none"> 60" round, 48"/60" square No infeed - Chicago hardwired tech device Hardwire 20-amp plug 	No cost +\$ 146 +\$ 185	Specify with <i>no infeed</i> . Specify with <i>hardwire power infeed</i> . Specify with <i>20-amp plug power infeed</i> .
Technology Devices and Grommets <ul style="list-style-type: none"> PowerPod grommet for 48" and 60" tables PowerPod grommet 	+\$ 172	Specify with <i>PowerPod grommet</i> and select finish.
<ul style="list-style-type: none"> Round power module for 48" and 60" tables Two receptacles One receptacle/one USB 	+\$ 375 +\$ 521	Specify with <i>round power module with two receptacles</i> and select finish. Specify with <i>round power module with one receptacle/one USB</i> and select finish.
<ul style="list-style-type: none"> Square power module/E2X power unit for 60" tables Six power/four data Four power/two blank AAP Six power/two USB/two data Six power/four USB 	+\$1100 +\$1100 +\$1393 +\$1465	Specify with <i>square power module with six power/four data</i> and select finish. Specify with <i>square power module with four power/two blank AAP</i> and select finish. Specify with <i>square power module with six power/two USB/two data</i> and select finish. Specify with <i>square power module with six power/four USB</i> and select finish.

▶ Options, continued on next page

Potrero415 Collaborative and Conference Tables

DESIGN COALESSE DESIGN GROUP

Round and Square Tables with Wood Legs

Potrero415 Collaborative and Conference Tables

► Options, continued from previous page

Options	U.S. Price	Required to Specify
Technology Devices and Grommets, continued	Refined technology module (power unit) for 60" table	
• Laminate and veneer tops with bezel—metal doors		
– Six power/two AAP	+\$1930	Specify with power unit with six power/two AAP and select finish.
– Four power/two AAP/two USB	+\$2281	Specify with power unit with four power/two AAP/two USB and select finish.
– Four power/four USB	+\$2562	Specify with power unit with four power/four USB and select finish.
• Solid surface and glass tops—metal doors		
– Six power/two AAP	+\$1650	Specify with power unit with six power/two AAP and select finish.
– Four power/two AAP/two USB	+\$2001	Specify with power unit with four power/two AAP/two USB and select finish.
– Four power/four USB	+\$2282	Specify with power unit with four power/four USB and select finish.
• Doors for technology module (power unit)		
– Solid surface doors	+\$ 346	Specify with power unit with solid surface doors.
– Wood veneer doors	+\$ 703	Specify with power unit with wood veneer doors.

Related Products • PowerPod

► Page 739

Specification Information

Style Number	Dimensions			U.S. Base Prices				
	D	W	H	Laminate Grade 1	Laminate Grade 2 and 3	Wood Veneer Grade 1	Wood Veneer Grade 2	Solid Surface

Work-Height Round Tables

COFOFRDW	48" diameter	28 1/2"	\$4726	\$4833	\$6396	\$6814	\$ 8698	\$10,737
	60" diameter	28 1/2"	\$5756	\$5924	\$7833	\$8352	\$10,699	\$13,237

Work-Height Square Tables

COFOFSQW	48" 48"	28 1/2"	\$4726	\$4833	\$6396	\$6814	\$ 8698	\$10,737
	60" 60"	28 1/2"	\$5756	\$5924	\$7833	\$8352	\$10,699	\$13,237

Standing-Height Round Tables

COFOFRDSTW	48" diameter	40"	\$5297	\$5404	\$6967	\$7385	N.A.	N.A.
	60" diameter	40"	\$6327	\$6495	\$8404	\$8923	N.A.	N.A.

Standing-Height Square Tables

COFOFSQSTW	48" 48"	40"	\$5297	\$5404	\$6967	\$7385	N.A.	N.A.
	60" 60"	40"	\$6327	\$6495	\$8404	\$8923	N.A.	N.A.

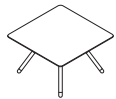

Veneer direction |||

 **For Canadian Pricing**
Multiply U.S. Price by the Canadian price factor.
► See page 1 for details.

Potrero415 Collaborative and Conference Tables

DESIGN COALESSE DESIGN GROUP

72"L, 84"L, 96"L, 108"L, and 120"L
Rectangular Tables with Wood Legs

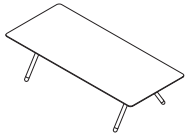

Tip: Glass tops are not secured to the substructure. Glass tops are placed on rubber pads that are adhered to the substructure. If the glass tables need to be moved, remove the glass top prior to moving the table.

Tip: Large tops can be difficult to move through some buildings. If top dimensions are too large for installation site, please contact Specials for assistance with creating smaller top sections.

Tip: Solid surface and glass tops are not available on tables with standing-height wood legs or tables with seated-height wood legs exceeding lengths of 168".

Tip: For tables with solid surface and glass tops, overall height is 1/2" taller.

Tip: When polished aluminum leg is specified, frame is platinum gloss.

Tip: When "no infeed" is selected, each technology device is equipped with a 6' conduit to be hardwired on site. Square power and refined technology module support this option.

Tip: PowerPod grommet is available in 6000 Black or 6052 Milk.

Tip: Square power module is available in 8044 Black Anodized Aluminum or 8047 Silver Anodized Aluminum.

Standard Includes	Required to Specify
<ul style="list-style-type: none"> ▶ Need help? Product details, page 486 • Table top: grade 1 laminate with 3 mm flat plastic edge • Frame: grade 1 paint • Legs: solid oak • Leg ring: grade 1 paint • Four adjustable glides • Ships ready to assemble 	<ol style="list-style-type: none"> 1 Style number 2 Table top depth and width 3 Laminate color number for table top 4 Plastic edge color number for laminate table top, if selected 5 Paint color number for frame and leg ring 6 Wood veneer color number for legs 7 Options, if selected (see below) <p>▶ See <i>Coalesse Surface Materials Reference Guide</i>.</p>

Options	U.S. Price	Required to Specify
Surface Materials <ul style="list-style-type: none"> • Table top • Grade 2 laminate • Grade 3 laminate • Grade 2 wood veneer • Solid surface • Back-painted glass 	<ul style="list-style-type: none"> Prices at right Prices at right Prices at right Prices at right Prices at right 	<ul style="list-style-type: none"> Specify with <i>grade 2 laminate</i> and select color number. Specify with <i>grade 3 laminate</i> and select color number. Specify with <i>grade 2 wood veneer</i> and select color number. Specify with <i>solid surface group 1</i> and select color number for substructure (6000 Black or 6052 Milk). Specify back-painted glass, select color number, and select color number for substructure (6000 Black or 6052 Milk).
<ul style="list-style-type: none"> • Table frame • Grade 3 paint 	<ul style="list-style-type: none"> +\$ 242 	<ul style="list-style-type: none"> Specify paint color number.
<ul style="list-style-type: none"> • Wood legs • Grade 2 wood veneer 	<ul style="list-style-type: none"> +\$ 88 	<ul style="list-style-type: none"> Specify with <i>VPO2 Smoked Oak</i> or <i>VPO4 Grey Oak</i>.
<ul style="list-style-type: none"> • Leg ring • Chrome or copper plating 	<ul style="list-style-type: none"> +\$ 292 	<ul style="list-style-type: none"> Specify 9201 Chrome, 9260 Black Chrome, or 9261 Copper.
Power Infeed <ul style="list-style-type: none"> • No infeed - Chicago hardwired tech device • Hardwire • 20-amp plug 	<ul style="list-style-type: none"> No cost +\$ 293 +\$ 331 	<ul style="list-style-type: none"> Specify with <i>no infeed</i>. Specify with <i>hardwire power infeed</i>. Specify with <i>20-amp plug power infeed</i>.
Technology Devices and Grommets <ul style="list-style-type: none"> • PowerPod grommet • PowerPod grommet 	<ul style="list-style-type: none"> +\$ 172 each grommet 	<ul style="list-style-type: none"> Specify with <i>PowerPod grommet</i>, select finish, device count, and device location (see next page for location options).
<ul style="list-style-type: none"> • Square power module/E2X power unit • Six power/four data • Four power/two blank AAP • Six power/two USB/two data • Six power/four USB 	<ul style="list-style-type: none"> +\$1100 each module +\$1100 each module +\$1393 each module +\$1465 each module 	<ul style="list-style-type: none"> Specify with <i>square power module with six power/four data, device count, device location, and select finish</i>. Specify with <i>square power module with four power/two blank AAP, device count, device location, and select finish</i>. Specify with <i>square power module with six power/two USB/two data, device count, device location, and select finish</i>. Specify with <i>square power module with six power/four USB, device count, device location, and select finish</i>.

▶ Options, continued on next page



For Canadian Pricing
Multiply U.S. Price by the Canadian price factor.
▶ See page 1 for details.

Potrero415 Collaborative and Conference Tables

DESIGN COALESSE DESIGN GROUP

72"L, 84"L, 96"L, 108"L, and 120"L
Rectangular Tables with Wood Legs

Potrero415 Collaborative
and Conference Tables

► Options, continued from previous page

Options	U.S. Price	Required to Specify
Technology Devices and Grommets, continued		
Refined technology module (power unit)		
• Laminate and veneer tops with bezel—metal doors		
– Six power/two AAP	+\$1930	Specify with power unit with six power/two AAP and select finish.
– Four power/two AAP/two USB	+\$2281	
– Four power/four USB	+\$2562	
• Solid surface and glass tops—metal doors		
– Six power/two AAP	+\$1650	Specify with power unit with six power/two AAP and select finish.
– Four power/two AAP/two USB	+\$2001	
– Four power/four USB	+\$2282	
• Doors for technology module (power unit)		
– Solid surface doors	+\$ 346	Specify with power unit with solid surface doors.
– Wood veneer doors	+\$ 703	

Related Products • PowerPod

► Page 739

Device Locations

72"

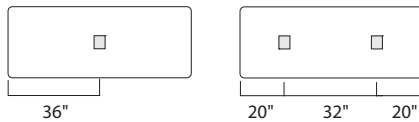

84"

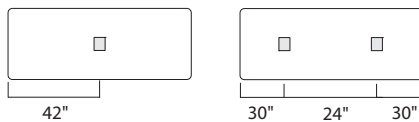

96"

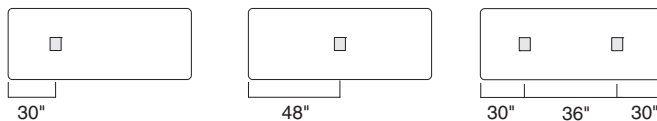

108"

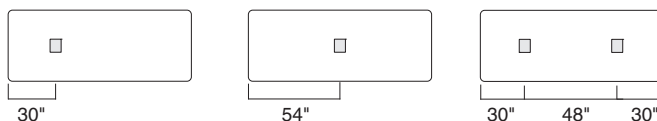

120"

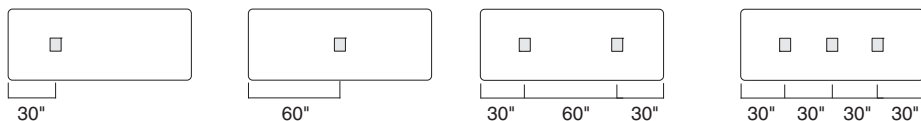

Veneer direction |||

► Specification Information, on next page



For Canadian Pricing
Multiply U.S. Price by the
Canadian price factor.
► See page 1 for details.

Potrero415 Collaborative and Conference Tables

DESIGN COALESSE DESIGN GROUP

72"L, 84"L, 96"L, 108"L, and 120"L
Rectangular Tables with Wood Legs
continued

► Options, on previous page

Specification Information

Style Number	Dimensions			U.S. Base Prices				Solid Surface	Glass
	D	W	H	Laminate		Wood Veneer			
				Grade 1	Grade 2 and 3	Grade 1	Grade 2		

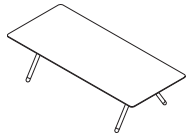

Work-Height Rectangular Tables

COFOFRECW	D	W	H	Laminate Grade 1	Laminate Grade 2 and 3	Wood Veneer Grade 1	Wood Veneer Grade 2	Solid Surface	Glass
	48"	72"	28 1/2"	\$5500	\$5660	\$ 7481	\$ 7974	N.A.	N.A.
	48"	84"	28 1/2"	\$6014	\$6201	\$ 8198	\$ 8743	N.A.	N.A.
	48"	96"	28 1/2"	\$6527	\$6742	\$ 8917	\$ 9515	\$12,211	\$15,125
	48"	108"	28 1/2"	\$7046	\$7286	\$ 9641	\$10,289	\$13,218	\$16,381
	48"	120"	28 1/2"	\$7707	\$7973	\$10,566	\$11,280	\$14,503	\$17,992
	60"	84"	28 1/2"	\$6928	\$7162	\$ 9480	\$10,114	N.A.	N.A.
	60"	96"	28 1/2"	\$7446	\$7712	\$10,200	\$10,891	\$13,998	\$17,357
	60"	108"	28 1/2"	\$8031	\$8333	\$11,020	\$11,768	\$15,140	\$18,785
	60"	120"	28 1/2"	\$8622	\$8957	\$11,845	\$12,652	\$16,290	\$20,221

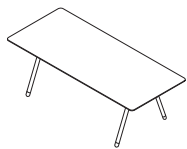

Standing-Height Rectangular Tables

COFOFRECSTW	D	W	H	Laminate Grade 1	Laminate Grade 2 and 3	Wood Veneer Grade 1	Wood Veneer Grade 2	Solid Surface	Glass
	48"	72"	40"	\$6359	\$6519	\$ 8340	\$ 8833	N.A.	N.A.
	48"	84"	40"	\$6873	\$7060	\$ 9057	\$ 9602	N.A.	N.A.
	48"	96"	40"	\$7386	\$7601	\$ 9776	\$10,374	N.A.	N.A.
	48"	108"	40"	\$7905	\$8145	\$10,500	\$11,148	N.A.	N.A.
	48"	120"	40"	\$8566	\$8832	\$11,425	\$12,139	N.A.	N.A.
	60"	84"	40"	\$7787	\$8021	\$10,339	\$10,973	N.A.	N.A.
	60"	96"	40"	\$8305	\$8571	\$11,059	\$11,750	N.A.	N.A.
	60"	108"	40"	\$8890	\$9192	\$11,879	\$12,627	N.A.	N.A.
	60"	120"	40"	\$9481	\$9816	\$12,704	\$13,511	N.A.	N.A.

Veneer direction |||



For Canadian Pricing
Multiply U.S. Price by the
Canadian price factor.
► See page 1 for details.

Coalesse

Potrero415 Collaborative and Conference Tables

DESIGN COALESSE DESIGN GROUP

72"L, 84"L, 96"L, 108"L, and 120"L
Rectangular Tables with Wood Legs

Potrero415 Collaborative
and Conference Tables

Potrero415 Collaborative and Conference Tables

DESIGN COALESSE DESIGN GROUP

144"L, 168"L, 192"L, 216"L, and 240"L
Rectangular Tables with Wood Legs

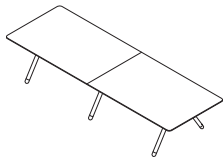

Tip: Glass tops are not secured to the substructure. Glass tops are placed on rubber pads that are adhered to the substructure. If the glass tables need to be moved, remove the glass top prior to moving the table.

Tip: Large tops can be difficult to move through some buildings. If top dimensions are too large for installation site, please contact Specials for assistance with creating smaller top sections.

Tip: Woodgrain laminate sectioned tops cannot be guaranteed to have a perfect match of the grain pattern along the seam that joins the sections.

Tip: Solid surface and glass tops are not available on tables with standing-height wood legs or tables with seated-height wood legs exceeding lengths of 168".

Tip: For tables with solid surface and glass tops, overall height is 1/2" taller.

Tip: When "no infeed" is selected, each technology device is equipped with a 6' conduit to be hardwired on site. Square power and refined technology module support this option.

Tip: PowerPod grommet is available in 6000 Black or 6052 Milk.

Tip: Square power module is available in 8044 Black Anodized Aluminum or 8047 Silver Anodized Aluminum.

Standard Includes	Required to Specify
<p>► Need help? Product details, page 486</p> <ul style="list-style-type: none"> • Table top: grade 1 laminate with 3 mm flat plastic edge • Legs: solid oak • Frame: grade 1 paint • Leg ring: grade 1 paint • Six adjustable glides • Ships ready to assemble 	<ol style="list-style-type: none"> 1 Style number 2 Table top depth and width 3 Laminate color number for table top 4 Plastic edge color number for laminate table top, if selected 5 Paint color number for frame and leg ring 6 Wood veneer color number for legs 7 Options, if selected (see below) <p>► See <i>Coalesse Surface Materials Reference Guide</i>.</p>

Options	U.S. Price	Required to Specify
<p>Surface Materials</p> <ul style="list-style-type: none"> • Table top • Grade 2 laminate • Grade 3 laminate • Grade 2 wood veneer • Solid surface • Back-painted glass 	<p>Prices at right</p> <p>Prices at right</p> <p>Prices at right</p> <p>Prices at right</p> <p>Prices at right</p>	<p>Specify with <i>grade 2 laminate</i> and select color number.</p> <p>Specify with <i>grade 3 laminate</i> and select color number.</p> <p>Specify with <i>grade 2 wood veneer</i> and select color number.</p> <p>Specify with <i>solid surface group 1</i> and select color number for substructure (6000 Black or 6052 Milk).</p> <p>Specify back-painted glass, select color number, and select color number for substructure (6000 Black or 6052 Milk).</p>
<ul style="list-style-type: none"> • Table frame • Grade 3 paint 	<p>+\$ 242</p>	<p>Specify paint color number.</p>
<ul style="list-style-type: none"> • Wood legs • Grade 2 wood veneer 	<p>+\$ 88</p>	<p>Specify with <i>VP02 Smoked Oak</i> or <i>VP04 Grey Oak</i>.</p>
<ul style="list-style-type: none"> • Leg ring • Chrome or copper plating 	<p>+\$ 402</p>	<p>Specify 9201 Chrome, 9260 Black Chrome, or 9261 Copper.</p>
<p>Power Infeed</p> <ul style="list-style-type: none"> • No infeed- Chicago hardwired tech device • Hardwire • 20-amp plug 	<p>No cost</p> <p>+\$ 552</p> <p>+\$ 625</p>	<p>Specify with <i>no infeed</i>.</p> <p>Specify with <i>hardwire power infeed</i>.</p> <p>Specify with <i>20-amp plug power infeed</i>.</p>
<p>Technology Devices and Grommets</p> <ul style="list-style-type: none"> • PowerPod grommet • PowerPod grommet 	<p>+\$ 172 each grommet</p>	<p>Specify with <i>PowerPod grommet</i>, select finish, device count, and device location (see next page for location options).</p>
<ul style="list-style-type: none"> • Square power module/E2X power unit • Six power/four data • Four power/two blank AAP • Six power/two USB/two data • Six power/four USB 	<p>+\$1100 each module</p> <p>+\$1100 each module</p> <p>+\$1393 each module</p> <p>+\$1465 each module</p>	<p>Specify with <i>square power module with six power/four data, device count, device location, and select finish</i>.</p> <p>Specify with <i>square power module with four power/two blank AAP, device count, device location, and select finish</i>.</p> <p>Specify with <i>square power module with six power/two USB/two data, device count, device location, and select finish</i>.</p> <p>Specify with <i>square power module with six power/four USB, device count, device location, and select finish</i>.</p>

► Options, continued on next page



For Canadian Pricing
Multiply U.S. Price by the Canadian price factor.
► See page 1 for details.

Potrero415 Collaborative and Conference Tables

DESIGN COALESSE DESIGN GROUP

144"L, 168"L, 192"L, 216"L, and 240"L
Rectangular Tables with Wood Legs

Potrero415 Collaborative
and Conference Tables

►Options, continued from previous page

Options	U.S. Price	Required to Specify
Technology Devices and Grommets, continued		
Refined technology module (power unit)		
• Laminate and veneer tops with bezel—metal doors		
– Six power/two AAP	+\$1930	Specify with power unit with six power/two AAP and select finish.
– Four power/two AAP/two USB	+\$2281	
– Four power/four USB	+\$2562	
• Solid surface and glass tops—metal doors		
– Six power/two AAP	+\$1650	Specify with power unit with six power/two AAP and select finish.
– Four power/two AAP/two USB	+\$2001	
– Four power/four USB	+\$2282	
• Doors for technology module (power unit)		
– Solid surface doors	+\$ 346	Specify with power unit with solid surface doors.
– Wood veneer doors	+\$ 703	Specify with power unit with wood veneer doors.

Related Products • PowerPod

► Page 739

Device Locations

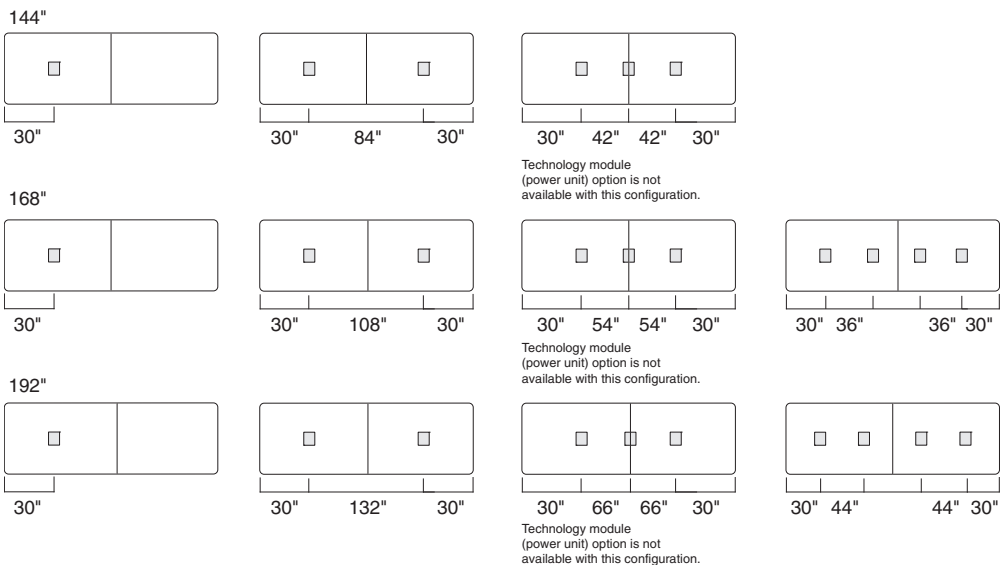

►Options, continued on next page

Veneer direction |||



For Canadian Pricing
Multiply U.S. Price by the
Canadian price factor.
► See page 1 for details.

Potrero415 Collaborative and Conference Tables

DESIGN COALESSE DESIGN GROUP

144"L, 168"L, 192"L, 216"L, and 240"L
Rectangular Tables with Wood Legs
continued

► Options, continued from previous page

Device Locations

Tip: Tables specified with glass tops for 216" and 240" tables are produced with three piece tops. The sub-top is two pieces.

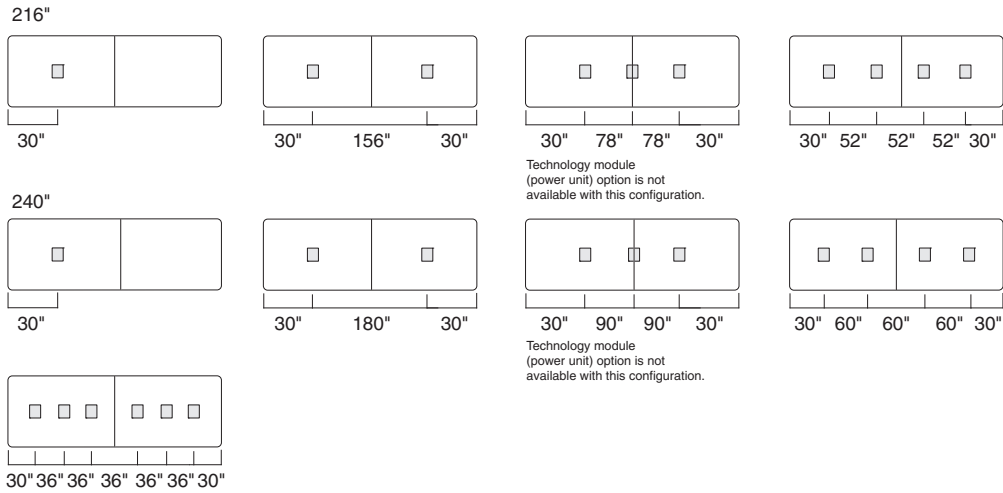

Specification Information

Style Number	Dimensions			U.S. Base Prices					
	D	W	H	Laminate		Wood Veneer		Solid Surface	Glass
				Grade 1	Grade 2 and 3	Grade 1	Grade 2		

Work-Height Rectangular Tables

COFOFRECW	D	W	H	Laminate Grade 1	Laminate Grade 2 and 3	Wood Veneer Grade 1	Wood Veneer Grade 2	Solid Surface	Glass
	48"	144"	28 1/2"	\$ 9884	\$10,204	\$13,331	\$14,191	\$18,494	\$22,910
	48"	168"	28 1/2"	\$11,060	\$11,435	\$14,973	\$15,868	\$20,782	\$25,772
	48"	192"	28 1/2"	\$12,381	\$12,809	\$16,825	\$17,933	N.A.	N.A.
	48"	216"	28 1/2"	\$13,246	\$13,728	\$18,034	\$19,234	N.A.	N.A.
	48"	240"	28 1/2"	\$14,393	\$14,929	\$19,640	\$20,953	N.A.	N.A.
	60"	144"	28 1/2"	\$10,947	\$11,348	\$14,814	\$15,782	\$20,563	\$25,497
	60"	168"	28 1/2"	\$12,124	\$12,591	\$16,462	\$17,547	\$22,858	\$28,361
	60"	192"	28 1/2"	\$13,444	\$13,980	\$18,309	\$19,525	N.A.	N.A.
	60"	216"	28 1/2"	\$14,283	\$14,884	\$19,488	\$20,789	N.A.	N.A.
	60"	240"	28 1/2"	\$15,429	\$16,098	\$21,090	\$22,505	N.A.	N.A.

► Specification Information, continued on next page

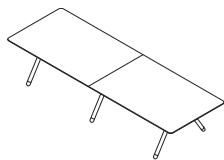

Veneer direction |||



For Canadian Pricing
Multiply U.S. Price by the Canadian price factor.
► See page 1 for details.

Potrero415 Collaborative and Conference Tables

DESIGN COALESSE DESIGN GROUP

144"L, 168"L, 192"L, 216"L, and 240"L
Rectangular Tables with Wood Legs

► Specification Information, continued from previous page

Specification Information

Style Number	Dimensions			U.S. Base Prices				Solid Surface	Glass
	D	W	H	Laminate		Wood Veneer			
				Grade 1	Grade 2 and 3	Grade 1	Grade 2		

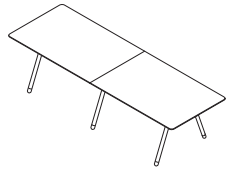

Standing-Height Rectangular Tables

COFOFRECSTW	D	W	H	Laminate Grade 1	Laminate Grade 2 and 3	Wood Veneer Grade 1	Wood Veneer Grade 2	Solid Surface	Glass
	48"	144"	40"	\$11,031	\$11,351	\$14,478	\$15,338	N.A.	N.A.
	48"	168"	40"	\$12,207	\$12,582	\$16,120	\$17,015	N.A.	N.A.
	48"	192"	40"	\$13,528	\$13,956	\$17,972	\$19,080	N.A.	N.A.
	60"	144"	40"	\$12,094	\$12,495	\$15,961	\$16,929	N.A.	N.A.
	60"	168"	40"	\$13,271	\$13,738	\$17,609	\$18,694	N.A.	N.A.
	60"	192"	40"	\$14,591	\$15,127	\$19,456	\$20,672	N.A.	N.A.

Potrero415 Collaborative and Conference Tables

Veneer direction |||



For Canadian Pricing
Multiply U.S. Price by the Canadian price factor.
► See page 1 for details.

Potrero415 Collaborative and Conference Tables

DESIGN COALESSE DESIGN GROUP

264"L and 288"L Rectangular Tables with Wood Legs

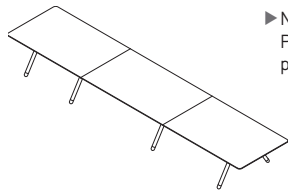

Tip: Woodgrain laminate sectioned tops cannot be guaranteed to have a perfect match of the grain pattern along the seam that joins the sections.

Tip: Large tops can be difficult to move through some buildings. If top dimensions are too large for installation site, please contact Specials for assistance with creating smaller top sections.

Tip: Solid surface and glass tops are not available on tables with standing-height wood legs or tables with seated-height wood legs exceeding lengths of 168".

Tip: When "no infeed" is selected, each technology device is equipped with a 6' conduit to be hardwired on site. Square power and refined technology module support this option.

Tip: PowerPod grommet is available in 6000 Black or 6052 Milk.

Tip: Square power module is available in 8044 Black Anodized Aluminum or 8047 Silver Anodized Aluminum.

Standard Includes	Required to Specify
<p>► Need help? Product details, page 486</p> <ul style="list-style-type: none"> Table top: grade 1 laminate with 3 mm flat plastic edge Frame: grade 1 paint Legs: solid oak Leg ring: grade 1 Eight adjustable glides Ships ready to assemble 	<ol style="list-style-type: none"> Style number Table top depth and width Laminate color number for table top Plastic edge color number for laminate table top, if selected Paint color number for frame and leg ring Wood veneer color number for legs Options, if selected (see below) <p>► See <i>Coalesse Surface Materials Reference Guide</i>.</p>

Options	U.S. Price	Required to Specify
<p>Surface Materials</p> <p>Table top</p> <ul style="list-style-type: none"> Grade 2 laminate Grade 3 laminate Grade 2 wood veneer <hr/> <p>Table frame</p> <ul style="list-style-type: none"> Grade 3 paint <hr/> <p>Wood legs</p> <ul style="list-style-type: none"> Grade 2 wood veneer <hr/> <p>Leg ring</p> <ul style="list-style-type: none"> Chrome or copper plating 	<p>Prices at right</p> <p>Prices at right</p> <p>Prices at right</p> <hr/> <p>+\$ 242</p> <hr/> <p>+\$ 88</p> <hr/> <p>+\$ 512</p>	<p>Specify with <i>grade 2 laminate</i> and select color number.</p> <p>Specify with <i>grade 3 laminate</i> and select color number.</p> <p>Specify with <i>grade 2 wood veneer</i> and select color number.</p> <hr/> <p>Specify paint color number.</p> <hr/> <p>Specify with <i>VP02 Smoked Oak</i> or <i>VP04 Grey Oak</i>.</p> <hr/> <p>Specify 9201 Chrome, 9260 Black Chrome, or 9261 Copper.</p>
<p>Power Infeed</p> <ul style="list-style-type: none"> No infeed - Chicago hardwired tech device Hardwire 20-amp plug 	<p>No cost</p> <p>+\$ 605</p> <p>+\$ 681</p>	<p>Specify with <i>no infeed</i>.</p> <p>Specify with <i>hardwire power infeed</i>.</p> <p>Specify with <i>20-amp plug power infeed</i>.</p>
<p>Technology Devices and Grommets</p> <p>PowerPod grommet</p> <ul style="list-style-type: none"> PowerPod grommet <hr/> <p>Square power module/E2X power unit</p> <ul style="list-style-type: none"> Six power/four data Four power/two blank AAP Six power/two USB/two data Six power/four USB <hr/> <p>Refined technology module (power unit)</p> <ul style="list-style-type: none"> Laminate and veneer tops with bezel—metal doors <ul style="list-style-type: none"> Six power/two AAP Four power/two AAP/two USB Four power/four USB 	<p>+\$ 172 each grommet</p> <hr/> <p>+\$1100 each module</p> <p>+\$1100 each module</p> <p>+\$1393 each module</p> <p>+\$1465 each module</p> <hr/> <p>+\$1930</p> <p>+\$2281</p> <p>+\$2562</p>	<p>Specify with <i>PowerPod grommet</i>, select finish, device count, and device location (see next page for location options).</p> <hr/> <p>Specify with <i>square power module with six power/four data</i>, device count, device location, and select finish.</p> <p>Specify with <i>square power module with four power/two blank AAP</i>, device count, device location, and select finish.</p> <p>Specify with <i>square power module with six power/two USB/two data</i>, device count, device location, and select finish.</p> <p>Specify with <i>square power module with six power/four USB</i>, device count, device location, and select finish.</p> <hr/> <p>Specify with <i>power unit with six power/two AAP</i> and select finish.</p> <p>Specify with <i>power unit with four power/two AAP/two USB</i> and select finish.</p> <p>Specify with <i>power unit with four power/four USB</i> and select finish.</p>

► Options, continued on next page

 **For Canadian Pricing**
 Multiply U.S. Price by the Canadian price factor.
 ► See page 1 for details.

Potrero415 Collaborative and Conference Tables

DESIGN COALESSE DESIGN GROUP

264"L and 288"L Rectangular Tables with Wood Legs

► Options, continued from previous page

Options	U.S. Price	Required to Specify
Technology Devices and Grommets, continued	Refined technology module (power unit), continued	
• Solid surface and glass tops—metal doors		
– Six power/two AAP	+\$1650	Specify with power unit with six power/two AAP and select finish.
– Four power/two AAP /two USB	+\$2001	Specify with power unit with four power/two AAP/two USB and select finish.
– Four power/four USB	+\$2282	Specify with power unit with four power/four USB and select finish.
• Doors for technology module (power unit)		
– Solid surface doors	+\$ 346	Specify with power unit with solid surface doors.
– Wood veneer doors	+\$ 703	Specify with power unit with wood veneer doors.

Related Products • PowerPod

► Page 739

Device Locations

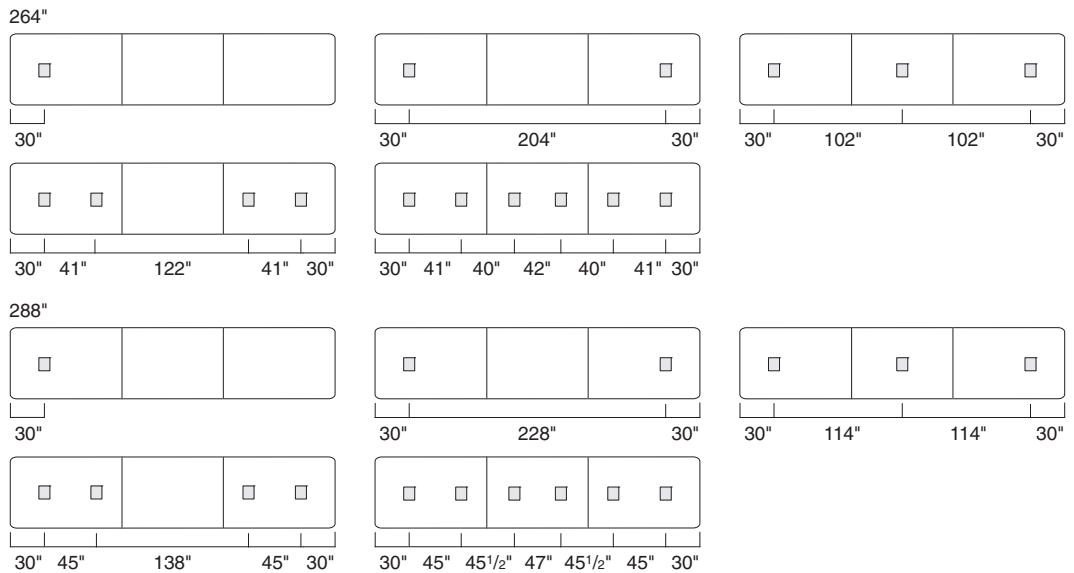

Specification Information

Veneer direction |||

Style Number	Dimensions			U.S. Base Prices			
	D	W	H	Laminate		Wood Veneer	
				Grade 1	Grade 2 and 3	Grade 1	Grade 2

Work-Height Rectangular Tables

COFOFRECW	D	W	H	Grade 1	Grade 2 and 3	Grade 1	Grade 2
48"	264"	28 1/2"		\$16,381	\$16,970	\$22,314	\$23,798
48"	288"	28 1/2"		\$17,528	\$18,170	\$23,920	\$25,519
60"	264"	28 1/2"		\$17,420	\$18,156	\$23,768	\$25,354
60"	288"	28 1/2"		\$18,566	\$19,368	\$25,372	\$27,072

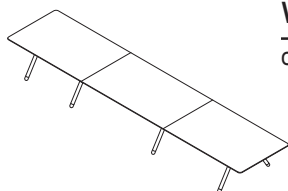

For Canadian Pricing
 Multiply U.S. Price by the Canadian price factor.
 ► See page 1 for details.

Potrero415 Collaborative and Conference Tables

96"L, 108"L, and 120"L
Boat Shaped Tables with Wood Legs

DESIGN COALESSE DESIGN GROUP

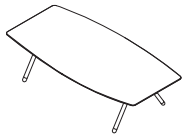

Tip: Glass tops are not secured to the substructure. Glass tops are placed on rubber pads that are adhered to the substructure. If the glass tables need to be moved, remove the glass top prior to moving the table.

Tip: Large tops can be difficult to move through some buildings. If top dimensions are too large for installation site, please contact Specials for assistance with creating smaller top sections.

Tip: Solid surface and glass tops are not available on tables with standing-height wood legs or tables with seated-height wood legs exceeding lengths of 168".

Tip: For tables with solid surface and glass tops, overall height is 1/2" taller.

Tip: When "no infeed" is selected, each technology device is equipped with a 6' conduit to be hardwired on site. Square power and refined technology module support this option.

Tip: PowerPod grommet is available in 6000 Black or 6052 Milk.

Tip: Square power module is available in 8044 Black Anodized Aluminum or 8047 Silver Anodized Aluminum.

Standard Includes		Required to Specify
<ul style="list-style-type: none"> ▶ Need help? Product details, page 486 	<ul style="list-style-type: none"> • Table top: grade 1 laminate with 3 mm flat plastic edge • Frame: grade 1 paint • Legs: solid oak • Leg ring: grade 1 paint • Four adjustable glides • Ships ready to assemble 	<ol style="list-style-type: none"> 1 Style number 2 Table top depth and width 3 Laminate color number for table top 4 Plastic edge color number for laminate table top, if selected 5 Paint color number for frame and leg ring 6 Wood veneer color number for legs 7 Options, if selected (see below) <p>▶ See <i>Coalesse Surface Materials Reference Guide</i>.</p>

Options	U.S. Price	Required to Specify
Surface Materials <ul style="list-style-type: none"> • Grade 2 laminate • Grade 3 laminate • Grade 2 wood veneer • Solid surface • Back painted glass 	<ul style="list-style-type: none"> Prices at right Prices at right Prices at right Prices at right Prices at right 	<ul style="list-style-type: none"> Specify with <i>grade 2 laminate</i> and select color number. Specify with <i>grade 3 laminate</i> and select color number. Specify with <i>grade 2 wood veneer</i> and select color number. Specify with <i>solid surface group 1</i> and select color number for substructure (6000 Black or 6052 Milk). Specify back painted glass, select color number, and select color number for substructure (6000 Black or 6052 Milk).
Table frame <ul style="list-style-type: none"> • Grade 3 paint 	<ul style="list-style-type: none"> +\$ 242 	<ul style="list-style-type: none"> Specify paint color number.
Wood legs <ul style="list-style-type: none"> • Grade 2 wood veneer 	<ul style="list-style-type: none"> +\$ 88 	<ul style="list-style-type: none"> Specify with <i>VPO2 Smoked Oak</i> or <i>VPO4 Grey Oak</i>
Leg ring <ul style="list-style-type: none"> • Chrome or copper plating 	<ul style="list-style-type: none"> +\$ 292 	<ul style="list-style-type: none"> Specify 9201 Chrome, 9260 Black Chrome, or 9261 Copper.
Power Infeed <ul style="list-style-type: none"> • No infeed - Chicago hardwired tech device • Hardwire • 20-amp plug 	<ul style="list-style-type: none"> No cost +\$ 293 +\$ 331 	<ul style="list-style-type: none"> Specify with <i>no infeed</i>. Specify with <i>hardwire power infeed</i>. Specify with <i>20-amp plug power infeed</i>.
Technology Devices and Grommets <ul style="list-style-type: none"> • PowerPod grommet 	<ul style="list-style-type: none"> +\$ 172 each grommet 	<ul style="list-style-type: none"> Specify with <i>PowerPod grommet</i>, select finish, device count, and device location (see next page for location options).
Square power module/E2X power unit <ul style="list-style-type: none"> • Six power/four data • Four power/two blank AAP • Six power/two USB/two data • Six power/four USB 	<ul style="list-style-type: none"> +\$1100 each module +\$1100 each module +\$1393 each module +\$1465 each module 	<ul style="list-style-type: none"> Specify with <i>square power module with six power/four data</i>, device count, device location, and select finish. Specify with <i>square power module with four power/two blank AAP</i>, device count, device location, and select finish. Specify with <i>square power module with six power/two USB/two data</i>, device count, device location, and select finish. Specify with <i>square power module with six power/four USB</i>, device count, device location, and select finish.

▶ Options, continued on next page



For Canadian Pricing
Multiply U.S. Price by the Canadian price factor.
▶ See page 1 for details.

Potrero415 Collaborative and Conference Tables

DESIGN COALESSE DESIGN GROUP

96"L, 108"L, and 120"L
Boat Shaped Tables with Wood Legs

► Options, continued from previous page

Options	U.S. Price	Required to Specify
Technology Devices and Grommets, continued		
Refined technology module (power unit)		
• Laminate and veneer tops with bezel—metal doors		
– Six power/two AAP	+\$1930	Specify with power unit with six power/two AAP and select finish.
– Four power/two AAP/two USB	+\$2281	
– Four power/four USB	+\$2562	
• Solid surface and glass tops—metal doors		
– Six power/two AAP	+\$1650	Specify with power unit with six power/two AAP and select finish.
– Four power/two AAP/two USB	+\$2001	
– Four power/four USB	+\$2282	
• Doors for technology module (power unit)		
– Solid surface doors	+\$ 346	Specify with power unit with solid surface doors.
– Wood veneer doors	+\$ 703	

Related Products • PowerPod

► Page 739

Device Locations

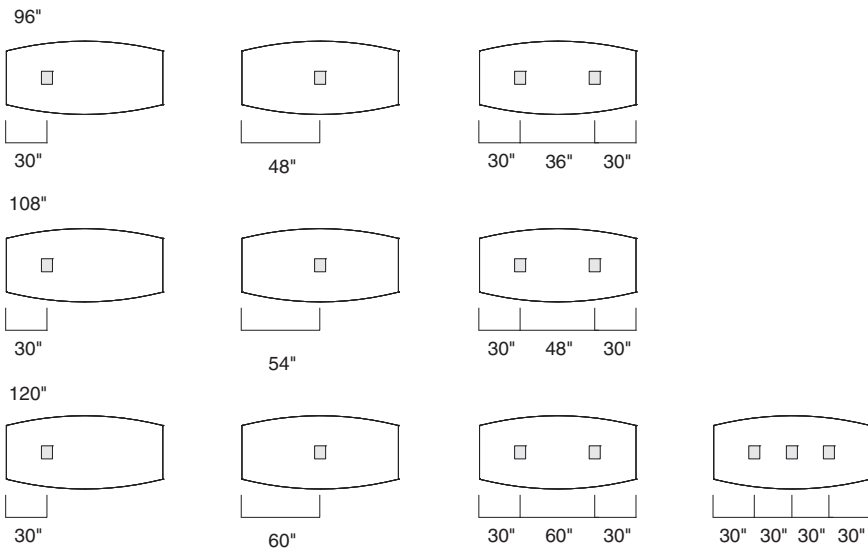

► Specification Information, on next page



For Canadian Pricing
Multiply U.S. Price by the
Canadian price factor.
► See page 1 for details.

Potrero415 Collaborative and Conference Tables

DESIGN COALESSE DESIGN GROUP

96"L, 108"L, and 120"L
Boat Shaped Tables with Wood Legs
continued

► Options, on previous page

Specification Information

Style Number	Dimensions			U.S. Base Prices					
	D	W	H	Laminate		Wood Veneer		Solid Surface	Glass
				Grade 1	Grade 2 and 3	Grade 1	Grade 2		

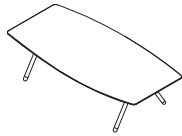

Work-Height Boat-Shaped Tables

Style Number	D	W	H	Laminate Grade 1	Laminate Grade 2 and 3	Wood Veneer Grade 1	Wood Veneer Grade 2	Solid Surface	Glass
COFOFBTW	54"	96"	28 1/2"	\$7060	\$ 7300	\$ 9660	\$10,309	\$13,244	\$16,417
	54"	108"	28 1/2"	\$7590	\$ 7863	\$10,226	\$10,885	\$14,277	\$17,705
	54"	120"	28 1/2"	\$8087	\$ 8389	\$11,098	\$11,852	\$15,246	\$18,919
	60"	96"	28 1/2"	\$7791	\$ 8057	\$10,682	\$11,410	\$14,669	\$18,199
	60"	108"	28 1/2"	\$8379	\$ 8681	\$11,331	\$12,066	\$15,816	\$19,629
	60"	120"	28 1/2"	\$8965	\$ 9300	\$12,327	\$13,168	\$16,959	\$21,060

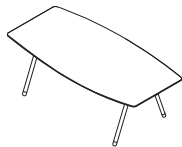

Standing-Height Boat-Shaped Tables

Style Number	D	W	H	Laminate Grade 1	Laminate Grade 2 and 3	Wood Veneer Grade 1	Wood Veneer Grade 2	Solid Surface	Glass
COFOBTSTW	54"	96"	40"	\$7919	\$ 8159	\$10,519	\$11,168	N.A.	N.A.
	54"	108"	40"	\$8449	\$ 8722	\$11,085	\$11,744	N.A.	N.A.
	54"	120"	40"	\$8946	\$ 9248	\$11,957	\$12,711	N.A.	N.A.
	60"	96"	40"	\$8650	\$ 8916	\$11,541	\$12,269	N.A.	N.A.
	60"	108"	40"	\$9238	\$ 9540	\$12,190	\$12,925	N.A.	N.A.
	60"	120"	40"	\$9824	\$10,159	\$13,186	\$14,027	N.A.	N.A.

Veneer direction |||



For Canadian Pricing
Multiply U.S. Price by the Canadian price factor.
► See page 1 for details.

Coalesse

Potrero415 Collaborative and Conference Tables

DESIGN COALESSE DESIGN GROUP

96"L, 108"L, and 120"L
Boat Shaped Tables with Wood Legs

Potrero415 Collaborative
and Conference Tables

Potrero415 Collaborative and Conference Tables

DESIGN COALESSE DESIGN GROUP

144"L, 168"L, 192"L, 216"L, and 240"L
Boat Shaped Tables with Wood Legs

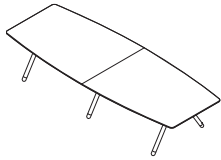

Tip: Glass tops are not secured to the substructure. Glass tops are placed on rubber pads that are adhered to the substructure. If the glass tables need to be moved, remove the glass top prior to moving the table.

Tip: Large tops can be difficult to move through some buildings. If top dimensions are too large for installation site, please contact Specials for assistance with creating smaller top sections.

Tip: Solid surface and glass tops are not available on tables with standing-height wood legs or tables with seated-height wood legs exceeding lengths of 168".

Tip: For tables with solid surface and glass tops, overall height is 1/2" taller.

Tip: When "no infeed" is selected, each technology device is equipped with a 6' conduit to be hardwired on site. Square power and refined technology module support this option.

Tip: PowerPod grommet is available in 6000 Black or 6052 Milk.

Tip: Square power module is available in 8044 Black Anodized Aluminum or 8047 Silver Anodized Aluminum.

Standard Includes	Required to Specify
<p>► Need help? Product details, page 486</p> <ul style="list-style-type: none"> Table top: grade 1 laminate with 3 mm flat plastic edge Frame: grade 1 paint Legs: solid oak Leg ring: grade 1 paint Six adjustable glides Ships ready to assemble 	<ol style="list-style-type: none"> Style number Table top depth and width Laminate color number for table top Plastic edge color number for laminate table top, if selected Paint color number for frame and leg ring Wood veneer color number for legs Options, if selected (see below) <p>► See <i>Coalesse Surface Materials Reference Guide</i>.</p>

Options	U.S. Price	Required to Specify
<p>Surface Materials</p> <ul style="list-style-type: none"> Table top <ul style="list-style-type: none"> Grade 2 laminate: Prices at right Grade 3 laminate: Prices at right Grade 2 wood veneer: Prices at right Solid surface: Prices at right Back-painted glass: Prices at right Table frame <ul style="list-style-type: none"> Grade 3 paint: +\$ 242 Wood legs <ul style="list-style-type: none"> Grade 2 wood veneer: +\$ 88 Leg ring <ul style="list-style-type: none"> Chrome or copper plating: +\$ 402 		<p>Specify with <i>grade 2 laminate</i> and select color number. Specify with <i>grade 3 laminate</i> and select color number. Specify with <i>grade 2 wood veneer</i> and select color number. Specify with <i>solid surface group 1</i> and select color number for substructure (6000 Black or 6052 Milk). Specify back-painted glass, select color number, and select color number for substructure (6000 Black or 6052 Milk).</p> <hr/> <p>Specify paint color number.</p> <hr/> <p>Specify with <i>VP02 Smoked Oak</i> or <i>VP04 Grey Oak</i>.</p> <hr/> <p>Specify 9201 Chrome, 9260 Black Chrome, or 9261 Copper.</p> <hr/>
<p>Power Infeed</p> <ul style="list-style-type: none"> No infeed - Chicago hardwired tech device: No cost Hardwire: +\$ 552 20-amp plug: +\$ 625 		<p>Specify with <i>no infeed</i>. Specify with <i>hardwire power infeed</i>. Specify with <i>20-amp plug power infeed</i>.</p> <hr/>
<p>Technology Devices and Grommets</p> <ul style="list-style-type: none"> PowerPod grommet <ul style="list-style-type: none"> PowerPod grommet: +\$ 172 each grommet Square power module/E2X power unit <ul style="list-style-type: none"> Six power/four data: +\$1100 each module Four power/two blank AAP: +\$1100 each module Six power/two USB/two data: +\$1393 each module Six power/four USB: +\$1465 each module 		<p>Specify with <i>PowerPod grommet</i>, select finish, device count, and device location (see next page for location options).</p> <hr/> <p>Specify with <i>square power module with six power/four data</i>, device count, device location, and select finish. Specify with <i>square power module with four power/two blank AAP</i>, device count, device location, and select finish. Specify with <i>square power module with six power/two USB/two data</i>, device count, device location, and select finish. Specify with <i>square power module with six power/four USB</i>, device count, device location, and select finish.</p>

► Options, continued on next page



For Canadian Pricing
Multiply U.S. Price by the Canadian price factor.
► See page 1 for details.

Potrero415 Collaborative and Conference Tables

DESIGN COALESSE DESIGN GROUP

144"L, 168"L, 192"L, 216"L, and 240"L
Boat Shaped Tables with Wood Legs

Potrero415 Collaborative
and Conference Tables

► Options, continued from previous page

Options	U.S. Price	Required to Specify
Technology Devices and Grommets, continued		
Refined technology module (power unit)		
• Laminate and veneer tops with bezel—metal doors		
– Six power/two AAP	+\$1930	Specify with power unit with six power/two AAP and select finish.
– Four power/two AAP/two USB	+\$2281	
– Four power/four USB	+\$2562	Specify with power unit with four power/two AAP/two USB and select finish.
• Solid surface and glass tops—metal doors		
– Six power/two AAP	+\$1650	Specify with power unit with six power/two AAP and select finish.
– Four power/two AAP/two USB	+\$2001	
– Four power/four USB	+\$2282	Specify with power unit with four power/four USB and select finish.
• Doors for technology module (power unit)		
– Solid surface doors	+\$ 346	Specify with power unit with solid surface doors.
– Wood veneer doors	+\$ 703	Specify with power unit with wood veneer doors.

Related Products • PowerPod

► Page 739

Device Locations

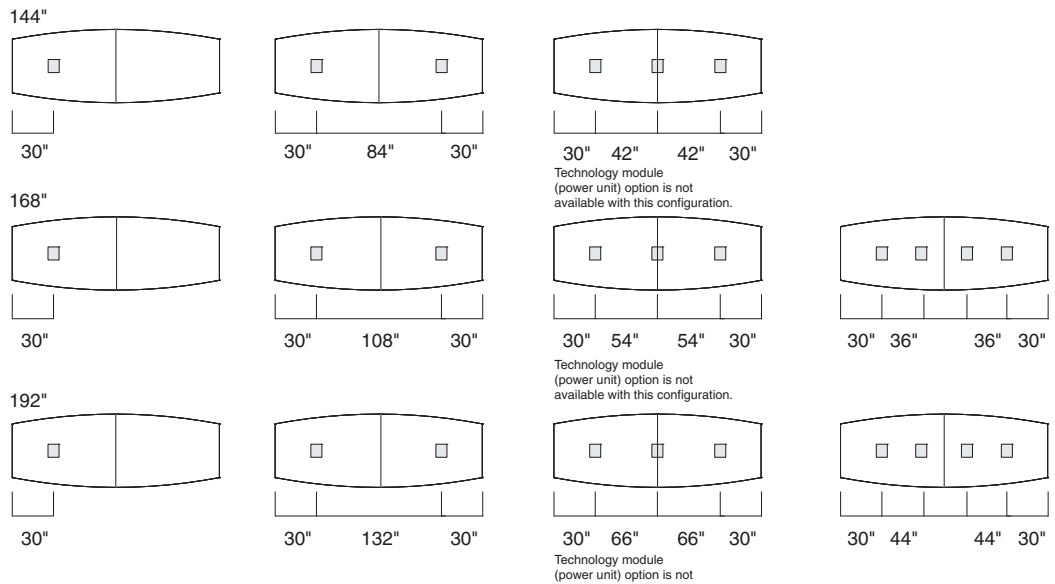

► Options, continued on next page

 **For Canadian Pricing**
Multiply U.S. Price by the
Canadian price factor.
► See page 1 for details.

Potrero415 Collaborative and Conference Tables

DESIGN COALESSE DESIGN GROUP

144"L, 168"L, 192"L, 216"L, and 240"L
Boat Shaped Tables with Wood Legs
continued

► Options, continued from previous page

Tip: Tables specified with glass tops for 216" and 240" tables are produced with three piece tops. The sub-top is two pieces.

Device Locations

216"

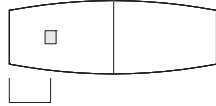

30"

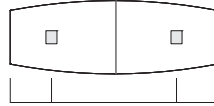

30" 156" 30"

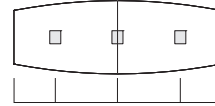

30" 78" 78" 30"

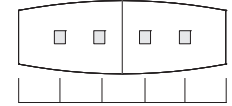

30" 52" 52" 30"

Technology module (power unit) option is not available with this configuration.

240"

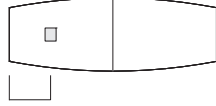

30"

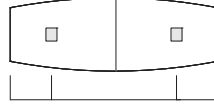

30" 180" 30"

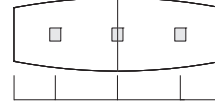

30" 90" 90" 30"

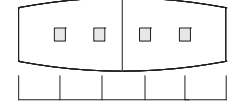

30" 60" 60" 30"

Technology module (power unit) option is not available with this configuration.

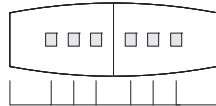

30" 36" 36" 36" 36" 30"

Specification Information

Style Number	Dimensions			U.S. Base Prices					
	D	W	H	Laminate		Wood Veneer		Solid Surface	Glass
				Grade 1	Grade 2 and 3	Grade 1	Grade 2		

Work-Height Boat-Shaped Tables

Style	D	W	H	Laminate Grade 1	Laminate Grade 2 and 3	Wood Veneer Grade 1	Wood Veneer Grade 2	Solid Surface	Glass
COFOFBTW	54"	144"	28 1/2"	\$10,417	\$10,778	\$14,073	\$14,986	\$19,527	\$24,200
	54"	168"	28 1/2"	\$11,590	\$12,012	\$15,715	\$16,746	\$21,817	\$27,059
	54"	192"	28 1/2"	\$12,914	\$13,396	\$17,565	\$18,729	N.A.	N.A.
	54"	216"	28 1/2"	\$13,765	\$14,307	\$18,759	\$20,011	N.A.	N.A.
	54"	240"	28 1/2"	\$14,911	\$15,512	\$20,363	\$21,729	N.A.	N.A.
	60"	144"	28 1/2"	\$11,292	\$11,693	\$15,297	\$16,301	\$21,238	\$26,338
	60"	168"	28 1/2"	\$12,467	\$12,934	\$16,944	\$18,059	\$23,527	\$29,197
	60"	192"	28 1/2"	\$13,792	\$14,328	\$18,792	\$20,046	N.A.	N.A.
	60"	216"	28 1/2"	\$14,624	\$15,225	\$19,963	\$21,296	N.A.	N.A.
	60"	240"	28 1/2"	\$15,768	\$16,437	\$21,562	\$23,013	N.A.	N.A.

Standing-Height Boat-Shaped Tables

Style	D	W	H	Laminate Grade 1	Laminate Grade 2 and 3	Wood Veneer Grade 1	Wood Veneer Grade 2	Solid Surface	Glass
COFOBTSTW	54"	144"	40"	\$11,564	\$11,925	\$15,220	\$16,133	N.A.	N.A.
	54"	168"	40"	\$12,737	\$13,159	\$16,862	\$17,893	N.A.	N.A.
	54"	192"	40"	\$14,061	\$14,543	\$18,712	\$19,876	N.A.	N.A.
	60"	144"	40"	\$12,439	\$12,840	\$16,444	\$17,448	N.A.	N.A.
	60"	168"	40"	\$13,614	\$14,081	\$18,091	\$19,206	N.A.	N.A.
	60"	192"	40"	\$14,939	\$15,475	\$19,939	\$21,193	N.A.	N.A.

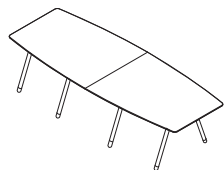
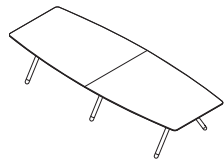

Veneer direction |||

 For Canadian Pricing
Multiply U.S. Price by the
Canadian price factor.
► See page 1 for details.

Coalesse

Potrero415 Collaborative and Conference Tables

DESIGN COALESSE DESIGN GROUP

144"L, 168"L, 192"L, 216"L, and 240"L
Boat Shaped Tables with Wood Legs

Potrero415 Collaborative
and Conference Tables

Potrero415 Collaborative and Conference Tables

264"L and 288"L Boat Shaped Tables with Wood Legs

DESIGN COALESSE DESIGN GROUP

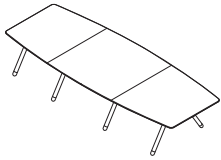

Tip: Large tops can be difficult to move through some buildings. If top dimensions are too large for installation site, please contact Specials for assistance with creating smaller top sections.

Tip: Solid surface and glass tops are not available on tables with standing-height wood legs or tables with seated-height wood legs exceeding lengths of 168".

Tip: When "no infeed" is selected, each technology device is equipped with a 6' conduit to be hardwired on site. Square power and refined technology module support this option.

Tip: PowerPod grommet is available in 6000 Black or 6052 Milk.

Tip: Square power module is available in 8044 Black Anodized Aluminum or 8047 Silver Anodized Aluminum.

Standard Includes		Required to Specify
<p>► Need help? Product details, page 486</p> <ul style="list-style-type: none"> Table top: grade 1 laminate with 3 mm flat plastic edge Frame: grade 1 paint Legs: solid oak Leg ring: grade 1 paint Eight adjustable glides Ships ready to assemble 		<ol style="list-style-type: none"> Style number Table top depth and width Laminate color number for table top Plastic edge color number for laminate table top, if selected Paint color number for frame and leg ring Wood veneer color number for legs Options, if selected (see below) <p>► See <i>Coalesse Surface Materials Reference Guide</i>.</p>

	Options	U.S. Price	Required to Specify
Surface Materials	Table top		
	• Grade 2 laminate	Prices at right	Specify with <i>grade 2 laminate</i> and select color number.
	• Grade 3 laminate	Prices at right	Specify with <i>grade 3 laminate</i> and select color number.
	• Grade 2 wood veneer	Prices at right	Specify with <i>grade 2 wood veneer</i> and select color number.
	Table frame		
	• Grade 3 paint	+\$ 242	Specify paint color number.
	Wood legs		
	• Grade 2 wood veneer	+\$ 88	Specify with <i>VP02 Smoked Oak</i> or <i>VP04 Grey Oak</i> .
Power Infeed	• No infeed - Chicago hardwired tech device	No cost	Specify with <i>no infeed</i> .
	• Hardwire	+\$ 605	Specify with <i>hardwire power infeed</i> .
	• 20-amp plug	+\$ 681	Specify with <i>20-amp plug power infeed</i> .
Technology Devices and Grommets	PowerPod grommet		
	• PowerPod grommet	+\$ 172 each grommet	Specify with <i>PowerPod grommet</i> , select finish, device count, and device location (see next page for location options).
	Square power module/E2X power unit		
	• Six power/four data	+\$1100 each module	Specify with <i>square power module with six power/four data</i> , device count, device location, and select finish.
	• Four power/two blank AAP	+\$1100 each module	Specify with <i>square power module with four power/two blank AAP</i> , device count, device location, and select finish.
	• Six power/two USB/two data	+\$1393 each module	Specify with <i>square power module with six power/two USB/two data</i> , device count, device location, and select finish.
	• Six power/four USB	+\$1465 each module	Specify with <i>square power module with six power/four USB</i> , device count, device location, and select finish.
	Refined technology module		
	• Laminate and veneer tops with bezel—metal doors		
	– Six power/two AAP	+\$1930	Specify with <i>power unit with six power/two AAP</i> and select finish.
	– Four power/two AAP/two USB	+\$2281	Specify with <i>power unit with four power/two AAP/two USB</i> and select finish.
	– Four power/four USB	+\$2562	Specify with <i>power unit with four power/four USB</i> and select finish.

► Options, continued on next page



For Canadian Pricing
Multiply U.S. Price by the Canadian price factor.
► See page 1 for details.

Potrero415 Collaborative and Conference Tables

DESIGN COALESSE DESIGN GROUP

264"L and 288"L Boat Shaped Tables with Wood Legs

Potrero415 Collaborative and Conference Tables

► Options, continued from previous page

Options	U.S. Price	Required to Specify
Technology Devices and Grommets, continued	Refined technology module (power unit), continued	
• Solid surface and glass tops—metal doors		
– Six power/two AAP	+\$1650	Specify with power unit with six power/two AAP and select finish.
– Four power/two AAP/two USB	+\$2001	Specify with power unit with four power/two AAP/two USB and select finish.
– Four power/four USB	+\$2282	Specify with power unit with four power/four USB and select finish.
• Doors for technology module (power unit)		
– Solid surface doors	+\$ 346	Specify with power unit with solid surface doors.
– Wood veneer doors	+\$ 703	Specify with power unit with wood veneer doors.

Related Products • PowerPod

► Page 739

Device Locations

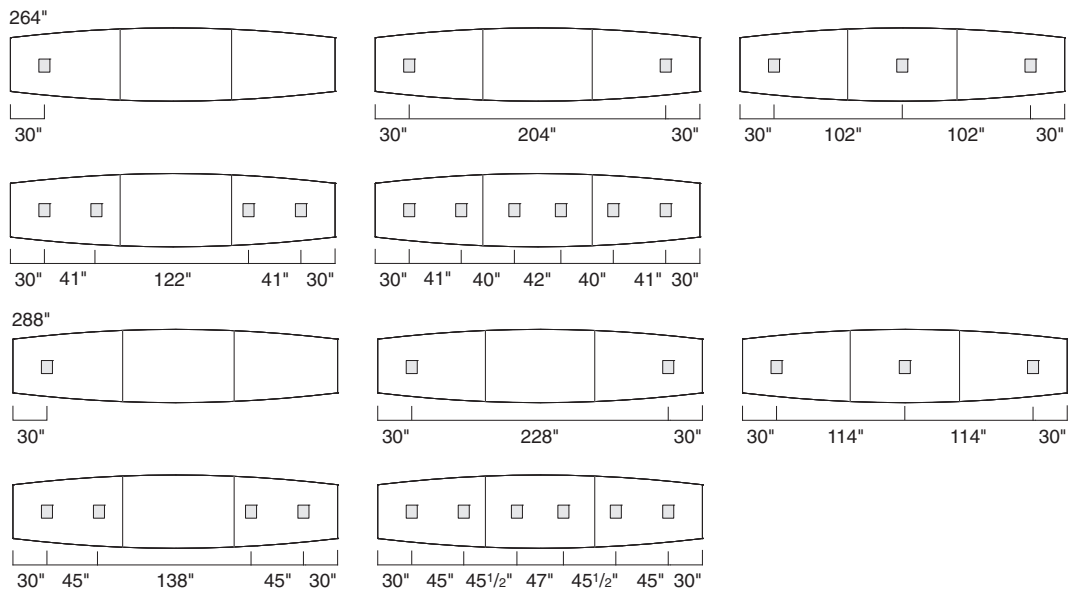

Specification Information

Style Number	Dimensions			U.S. Base Prices			
	D	W	H	Laminate		Wood Veneer	
				Grade 1	Grade 2 and 3	Grade 1	Grade 2

Work-Height Boat-Shaped Tables

COFOFBTW	D	W	H	Laminate Grade 1	Laminate Grade 2 and 3	Wood Veneer Grade 1	Wood Veneer Grade 2
	54"	264"	28 1/2"	\$16,901	\$17,564	\$23,043	\$24,576
	54"	288"	28 1/2"	\$18,048	\$18,770	\$24,644	\$26,296
	60"	264"	28 1/2"	\$17,756	\$18,492	\$24,238	\$25,859
	60"	288"	28 1/2"	\$18,905	\$19,707	\$25,846	\$27,578

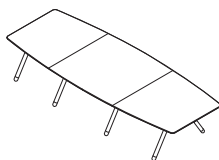

Veneer direction |||

For Canadian Pricing
 Multiply U.S. Price by the Canadian price factor.
 ► See page 1 for details.

Potrero415 Collaborative and Conference Tables Cable Management

DESIGN COALESSE DESIGN GROUP

Standard Includes	Required to Specify
<ul style="list-style-type: none"> ▶ Need help? Product details, page 486 • Mesh cable manager: black mesh and 7202 Black paint 	<ul style="list-style-type: none"> Style number

Related Products	
<ul style="list-style-type: none"> • Potrero415 light tables 	▶ Pages 558–568

Specification Information	
Style Number	U.S. Price

Cable Manager, Mesh, For Work-Height Tables

COFOFCABLM \$373

Cable Manager, Mesh, For Standing-Height Tables

COFOFCABLMST \$542



Tip: This cable manager was designed to be used with the cutouts in the bottom tray to manage cables from trough to floor.

Tip: If using this cable manager with the refined technology module (power unit), the cable manager cannot be positioned in the cutout located directly below the unit. Instead, use one of the other cutouts.



For Canadian Pricing
 Multiply U.S. Price by the Canadian price factor.
 ▶ See page 1 for details.

Potrero415 Collaborative and Conference Tables Cable Management Columns

DESIGN COALESSE DESIGN GROUP

Standard Includes		Required to Specify
<ul style="list-style-type: none"> ▶ Need help? Product details, page 487 	<ul style="list-style-type: none"> • Aluminum cable manager column: paint • Ships ready to assemble 	<ol style="list-style-type: none"> 1 Style number 2 Paint color number for cable manager column 3 Options, if selected (see below) <ul style="list-style-type: none"> ▶ See <i>Coalesse Surface Materials Reference Guide</i>.

Tip: Riser option is available and provides .906" clearance for field wired conduit when routing out the bottom.

Options	U.S. Price	Required to Specify
Riser	• Riser for cable manager column	No cost
Related Products	• Potrero415 tables	▶ Pages 558–568

Specification Information

Style Number	U.S. Price
--------------	------------

Cable Manager Column, For Work-Height Tables

COFOFCABL	\$1015
-----------	--------

Cable Manager Column, For Standing-Height Tables

COFOFCABLST	\$1150
-------------	--------

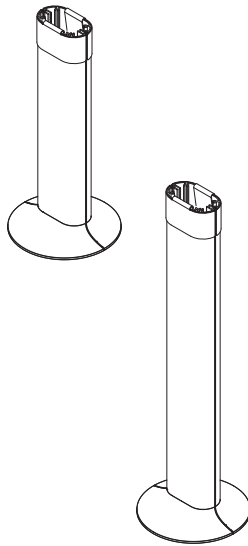

Tip: This cable manager was designed to be used with the cutouts in the bottom tray to manage cables from trough to floor.

Tip: If using this cable manager with the refined technology module (power unit), the cable manager cannot be positioned in the cutout located directly below the unit. Instead, use one of the other cutouts.

 **For Canadian Pricing**
 Multiply U.S. Price by the Canadian price factor.
 ▶ See page 1 for details.

Potrero415 Light Collaborative and Conference Tables

Understanding	548
Specifying	
Round and Square Light Tables with Metal Legs	558
Rectangular Light Tables with Metal Legs	560
Round and Square Light Tables with Wood Legs	566
Rectangular Light Tables with Wood Legs	568
Cable Management	573

Potrero415 Light Collaborative and Conference Tables

DESIGN COALESSE DESIGN GROUP

Potrero415 Light tables are designed to support both collaborative and social applications in smaller, more personal meeting and in-between spaces. The tables have a broad range of materials, options, and customizable details to invite designers to create inspiring settings that encourage great work.

Tables are available with metal or solid oak legs, work or standing height, and a wide range of laminate, veneer, solid surface, or glass tops. Simple plug-and-play technology options keep mobile devices charged.

Top is available in a wide variety of materials and finishes including: laminate, wood veneer, solid surface, or glass.

Legs are available in aluminum metal or solid wood, in both work and standing height. Metal legs are available in powder coat or polished aluminum finishes. Solid wood legs are oak.

Leg rings can be specified in powder coat, chrome, or copper finishes.

Power modules and grommets are available for easy access to power.

Cables can be neatly managed through metal legs. Cable manager for wood legs is also available.

Adjustable leveling glides accommodate uneven floors. Metal legs provide 1" adjustability and wood legs 1/2" adjustability.

Seating Capacity Guidelines
▶ See page 556

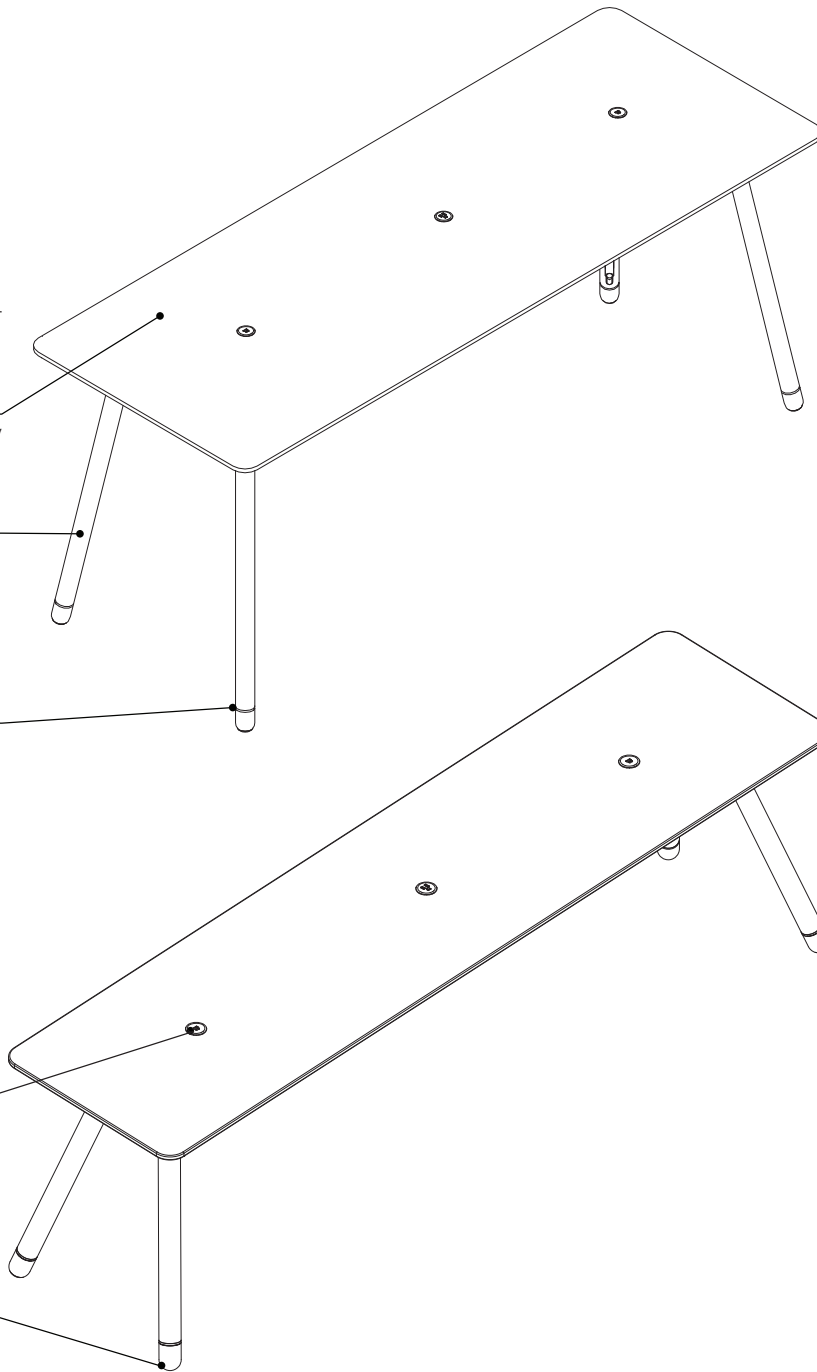

Product Details

Tables are available in two heights:
- work height, 28 1/2"H
- standing height, 40"H



Round



Square



Rectangular

Table shapes include: round, square, and rectangular. A range of sizes are available to support a variety of applications.

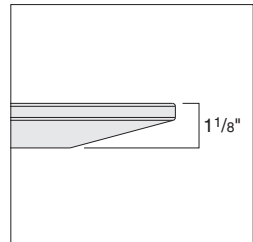

Laminate and wood veneer tops are standard with a knife edge profile that has the appearance of a 1/2" thick top, which tapers to an overall top thickness of 1 1/8".

Tops with a laminate surface have 3 mm plastic edge and finish selection. Wood veneer tops have a matching 3 mm edge. All corners have a radius.

Potrero415 Light Collaborative and Conference Tables

DESIGN COALESSE DESIGN GROUP

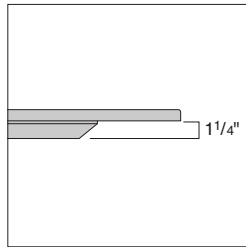

Solid surface and glass tops are built with a substructure (bottom) and top construction. The substructure is 1 1/4" in thickness and is available in black or white. The glass or solid surface top is 1/2" thick.
Tip: Glass tops are not secured to the substructure. Glass tops are placed on rubber pads that are adhered to the substructure. If the glass tables need to be moved, remove the glass top prior to moving the table.

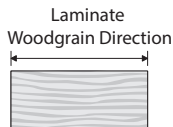

Woodgrain laminates are always oriented with the grain direction running parallel with the length of the table.



Veneer woodgrain runs parallel to the width on all tops.

Metal Legs

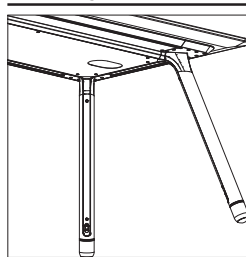

Metal legs are painted in powder coat finishes. Polished aluminum is available as an option.

Bottom tray conceals all cables and creates a clean visual. Bottom tray and frame match the paint finish of the legs. If 8046 Polished Aluminum legs are specified, bottom tray and frame are painted in 4142 Platinum Gloss. Bottom tray may be removed as an option.

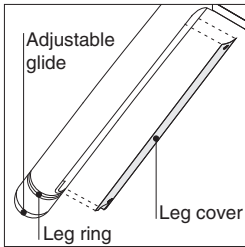

Cable routing is accommodated through the legs and can be accessed through the removable cover.

Leg rings can be specified in powder coat, chrome, or copper finishes. If contrasting finish from the leg is selected, more or less can be shown by adjusting the glide.

Adjustable glides have a range of 1" to accommodate uneven floors. The leg ring provides height adjustment capability.

Wood Legs

Solid wood legs are oak and available in standard finishes or stain-to-match.

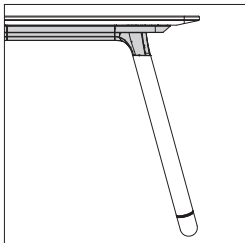

Frame powder coat paint finish must be specified and includes the frame, leg castings, and bottom tray.

Bottom tray cover conceals all cables and creates a clean visual. Bottom tray may be removed as an option.

Leg rings can be specified in powder coat, chrome, or copper finishes. The leg rings are decorative and non-adjustable.

Adjustable glides have a range of 1/2" to accommodate uneven floors.

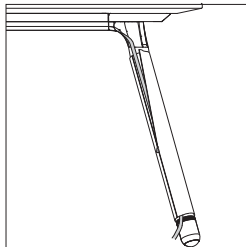

Cables can be managed down the wood legs with a cable management cover that zips around the leg. Cover is ordered separately and is available in a curated palette of Elmosoft leather colors for work and standing height tables.

Power, Data, Wiring & Cabling

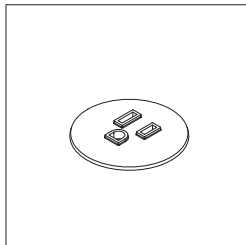
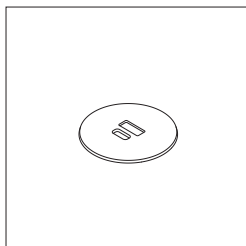

Single power or USB module are available and can be specified in end or center locations. It comes with a 120°L power cord with 15-amp plug. The USB module has one USB A and one USB C 5V charging port. After exiting the leg, there is at least 30" of cord length available to connect to power source. If a single USB module is specified, the 15-amp plug includes a built-in transformer measuring 2 1/8"D x 1 1/4"W x 3 1/2"H. The power modules are available in milk, black, or graphite.

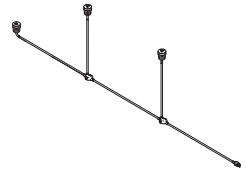

When two or three power module units are specified, they are connected by a corded system and have a single infeed with a 15-amp plug. After exiting the leg, there is at least 60" of cord length available to connect to power source. Power and USB modules available. The USB module has one USB A and one USB C 5V charging port. The power modules are available in milk, black, or graphite.

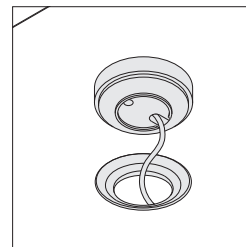

PowerPod grommet is an option available on 30"D and 36"D tables. The grommet allows for pass through of cords and cables. The grommet is available in black or milk.

The grommet is open to allow the PowerPod to be housed over or stored on the table top.

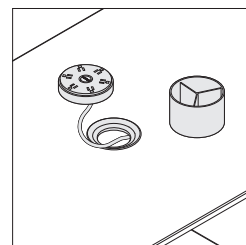

The contour of the PowerPod bottom cradle is designed to work in conjunction with the grommet for a snug fit.

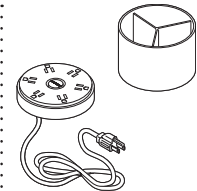

PowerPod includes six 15-amp outlets with an energy saving illuminated on/off switch. It comes with a 6' cord with three prong plug. To ensure adequate cord length from table to building power, consider the placement of the PowerPod. The top tray is milk and the power source is silver with a milk face. It is UL and CSA listed.
Tip: PowerPod is sold separately.

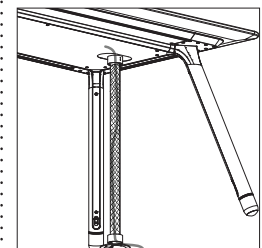

Cutouts in the bottom tray provide an alternate way to route cords and cables to and from tables using a cable manager. Cutouts are located on end and center locations and measure: 24"D tables, 2 1/2" x 4 23/32"; 30"D and 36"D tables, 3 1/2" x 5 1/8".

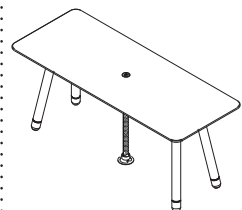

The mesh cable manager provides pass-through cable management and can be used with 30"D and 36"D Potrero415 light tables, with bottom tray specified. The mesh and steel components are black. The opening for cables measures 2" x 2 1/2".

Steelcase vertical cable carrier (AHCC) is also compatible with all Potrero415 light tables.

Potrero415 Light Collaborative and Conference Tables

DESIGN COALESSE DESIGN GROUP

Technology Distribution and Support

Surface mounted technology devices are available and support power.

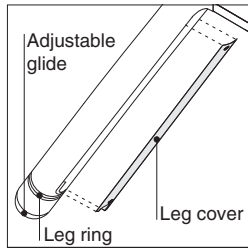

Removable cover on metal legs allows easy access and installation of technology cords.

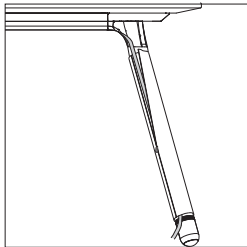

Cables can be managed down the wood legs with a cable management cover that zips around the leg. Cover is ordered separately and is available in a curated palette of Elmosoft leather colors for work and standing height tables.

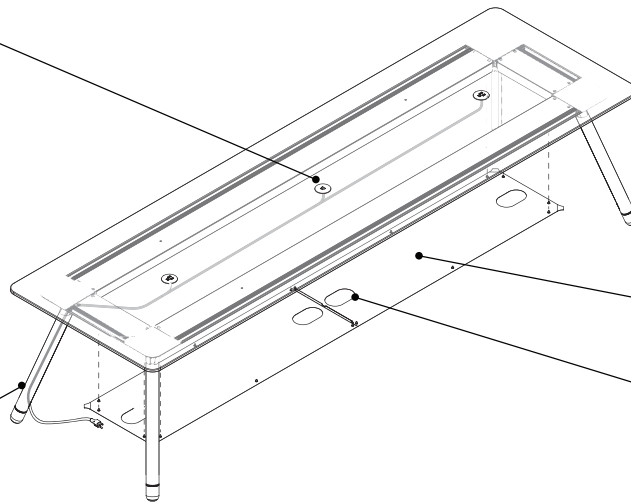

Bottom tray conceals all cords and cables.

Cutouts in the bottom tray provide an alternate way to route cords and cables to/from tables using a cable manager. Cutouts measure $2\frac{1}{2}'' \times 4\frac{23}{32}''$ on 24"D tables and $3\frac{1}{2}'' \times 5\frac{9}{16}''$ on 30"D and 36"D tables. Cutouts are located at end and center locations.

The Potrero415 mesh cable manager is recommended for 30"D and 36"D deep tables. The Steelcase vertical cable carrier (AHCC) is also compatible on all tables.

Potrero415 Light Collaborative and Conference Tables Base Locations

DESIGN COALESSE DESIGN GROUP

Round

Base Locations

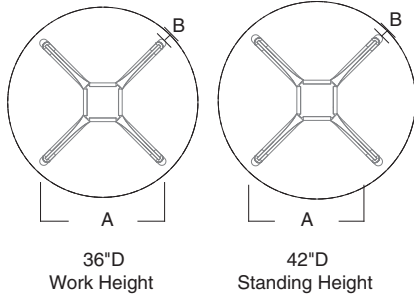

Metal Legs	A	B
36" diameter, work height	21½"	½"
36" diameter, standing height	18½"	2⅛"
42" diameter, work height	25¾"	⅛"
42" diameter, standing height	22¾"	2¼"

Wood Legs

36" diameter, work height	21½"	½"
36" diameter, standing height	18½"	2⅛"
42" diameter, work height	25¾"	⅛"
42" diameter, standing height	22¾"	2¼"

Tip: Dimensions between legs are measured where legs contact the floor, with glides fully retracted. Dimensions will grow slightly when glides are adjusted outward.

Square

Base Locations

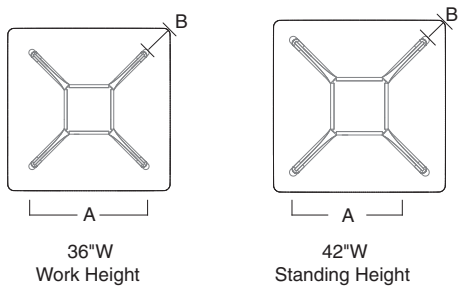

Metal Legs	A	B
36"Dx36"W, work height	31"	just inset
36"Dx36"W, standing height	28"	2⅛"
42"Dx42"W, work height	37"	just inset
42"Dx42"W, standing height	34"	2⅛"

Wood Legs

36"Dx36"W, work height	26½"	3⅛"
36"Dx36"W, standing height	30½"	¼"
42"Dx42"W, work height	32½"	3⅛"
42"Dx42"W, standing height	36½"	¼"

Tip: Dimensions between legs are measured where legs contact the floor, with glides fully retracted. Dimensions will grow slightly when glides are adjusted outward.

Potrero415 Light Collaborative and Conference Tables Base Locations *continued*

DESIGN COALESSE DESIGN GROUP

Rectangular

Base Locations



Tip: Leg locations for rectangular tables fall to the corners of the table and just inset of the top.

Metal Legs	Work Height	Standing Height
A (Inside dimensions)		
54"	46"	49"
60	52"	55"
72"	64"	67"
84"	76"	79"
96"	88"	91"
108"	100"	103"
120"	112"	115"
B		
	Just inset	2 1/8"
C (Inside dimensions)		
24"	19"	16"
30"	25"	22"
36"	31"	28"
Wood Legs	Work Height	Standing Height
A (Inside dimensions)		
54"	44 1/2"	48 1/2"
60	50 1/2"	54 1/2"
72"	62 1/2"	66 1/2"
84"	74 1/2"	78 1/2"
96"	86 1/2"	90 1/2"
108"	98 1/2"	102 1/2"
120"	110 1/2"	114 1/2"
B		
	3 1/8"	1/4"
C (Inside dimensions)		
24"	14 1/2"	18 1/2"
30"	20 1/2"	24 1/2"
36"	26 1/2"	30 1/2"

Potrero415 Light Collaborative and Conference Tables Cutout Locations

DESIGN COALESSE DESIGN GROUP

Round

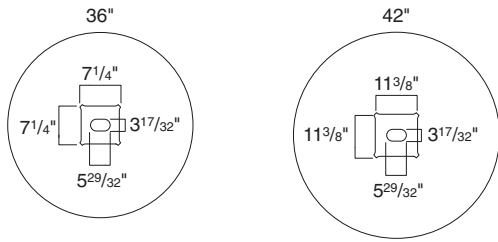

Square

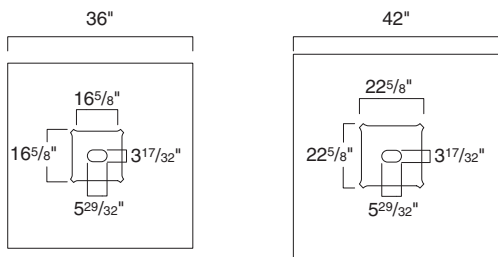

Rectangular

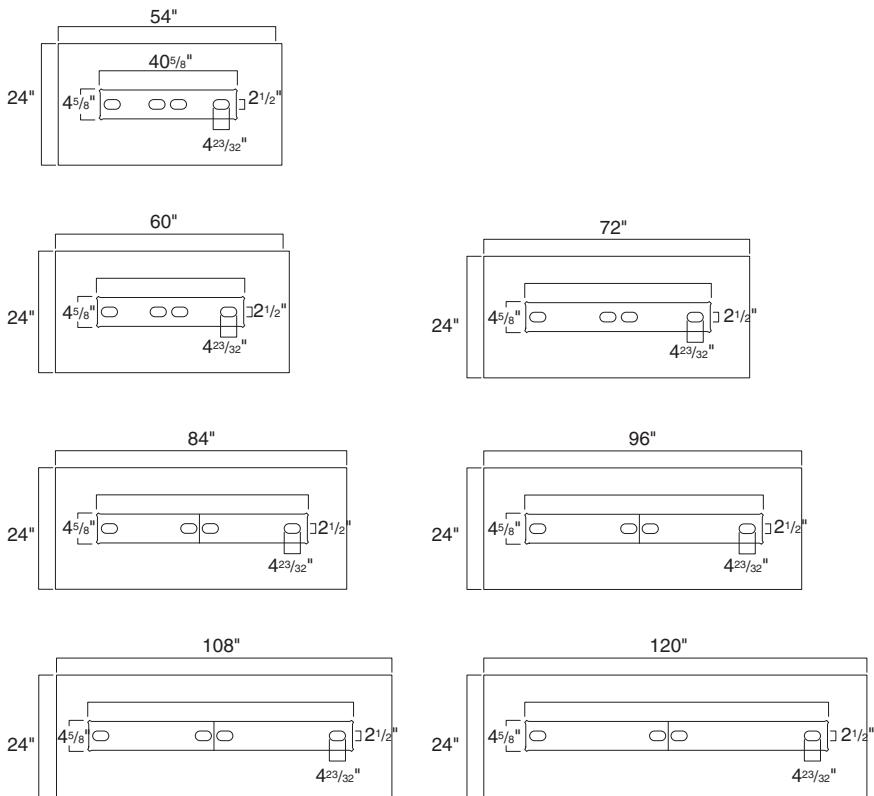

Potrero415 Light Collaborative and Conference Tables Cutout Locations *continued*

DESIGN COALESSE DESIGN GROUP

Rectangular, continued

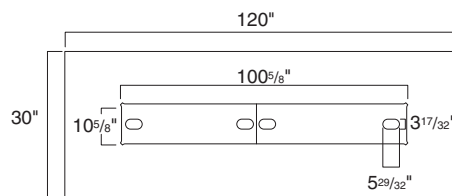
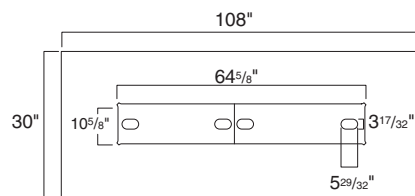
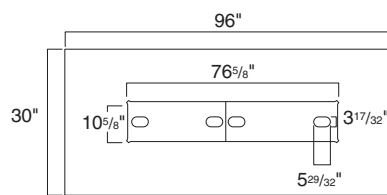
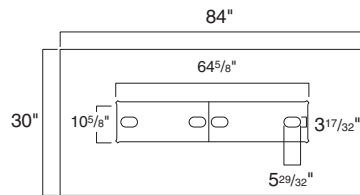
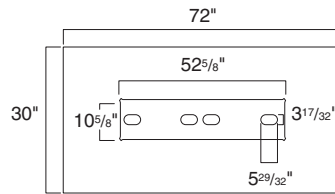
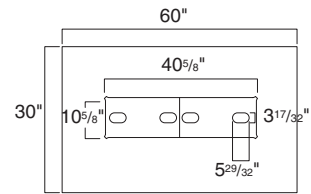
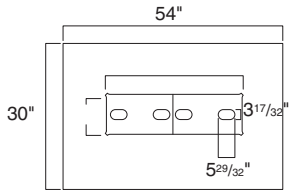

Potrero415 Light Collaborative and Conference Tables

Cutout Locations

DESIGN COALESSE DESIGN GROUP

Rectangular, continued

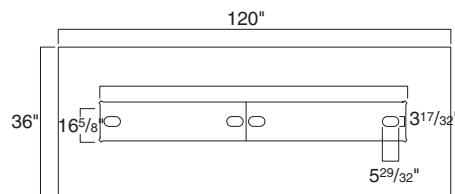
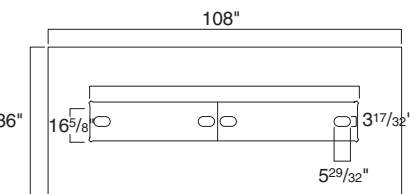
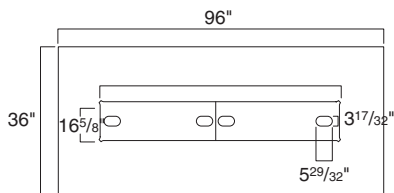
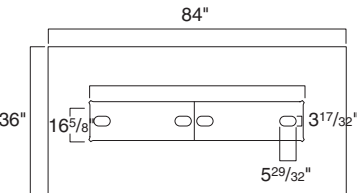
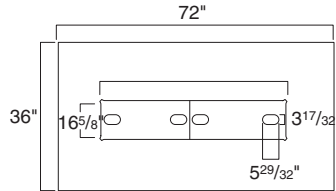
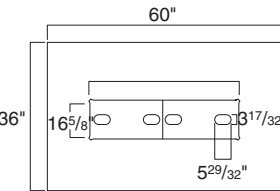
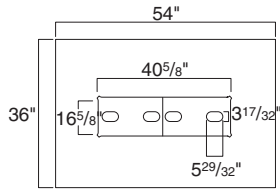

Potrero415 Light
Collaborative and
Conference Tables

Potrero415 Light Collaborative and Conference Tables

DESIGN COALESSE DESIGN GROUP

Seating Capacity Guidelines

Depth	Width	Seating Capacity
Round Tops		
36"		4
42"		4
Square Tops		
36"	36"	4
42"	42"	4
Rectangular Tops		
24"	54"	6
24"	60"	6
24"	72"	6
24"	84"	6
24"	96"	8
24"	108"	8
24"	120"	10
30"	54"	6
30"	60"	6
30"	72"	6
30"	84"	6
30"	96"	8
30"	108"	8
30"	120"	10
36"	54"	6
36"	60"	6
36"	72"	6
36"	84"	6
36"	96"	8
36"	108"	8
36"	120"	10

Tip: Actual capacity is determined by width of chair selected.

Potrero415 Light Collaborative and Conference Tables

DESIGN COALESSE DESIGN GROUP

Surface Materials

Top:

- High-Pressure Laminate
- Wood veneer

Top with subtop:

- Solid surface
- Back-painted glass

Subtop:

- 6000 Black
- 6052 Milk

Edge:

- 3 mm plastic edge on laminate
- 3 mm wood edge veneer edge matches top

Metal legs, frame, and bottom tray:

- Paint
- Polished aluminum

Wood legs:

- Solid oak

Wood leg frame and bottom tray:

- Paint

Leg rings:

- Paint
- 9201 Chrome
- 9260 Black Chrome
- 9261 Copper

Power modules:

- 6000 Black
- 6052 Milk
- 6D03 Graphite

PowerPod grommet:

- 6000 Black
- 6052 Milk

Cable manager for wood leg:

Curated palette of Elmosoft leather:

- L112 Ebony
- L122 Truffle
- L139 Cinder
- L147 Saddle
- L709 Sugar
- L755 Peanut Butter
- L775 Coyote

Cable manager, mesh:

- 7207 Black

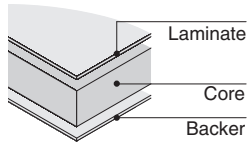

Laminates are available in two standard grades. Additional laminates from any manufacturer may also be practical—see *Other laminates* below.

Grade 1 laminates include:

- Coalesse standard laminates
 - ▶ See *Coalesse Surface Materials Reference Guide*.
- Steelcase standard laminates (code 290A)
 - ▶ See *Steelcase Surface Materials Reference Manual*.
- Any standard-grade Wilsonart laminate in solid color, woodgrain, or pattern finish (code 290A)

Grade 2 laminates (code 290B)

include any standard-grade, solid color, woodgrain, or patterned laminate from Nevamar (includes Matrix), Formica, or Pionite. Grade 2 laminates may have extended lead times. For details, contact Customer Service at 1.800.627.6770.

Other laminates that are not included in the Grade 1 or Grade 2 offerings may also be available, such as Abet Laminati and Laminart. To determine availability and pricing, contact Customer Service at 1.800.627.6770, with the laminate manufacturer's name and the name and number of the laminate you want.

Laminate swatches are reproduced in the Surface Materials Color Palettes.

▶ See *Coalesse Surface Materials Reference Guide* for a list.

Swatch cards and actual samples of Coalesse standard laminates are available from your Coalesse Customer Service representative. For samples of laminates from other manufacturers, contact them directly:

Wilsonart
1.800.433.3222
Nevamar
1.800.638.4380

Formica
1.800.FORMICA
Pionite
1.800.285.5161

Tip: Laminate manufacturers change their offerings frequently. Always check availability before ordering.

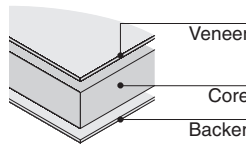

Wood veneer table tops are fabricated with Architectural Grade AA hand-selected hardwood veneer, plain sliced, book matched, and bonded to the core with a backing sheet for balance. Coalesse's primary wood finish, Clarity, is a water-borne UV topcoat, which protects the environment while providing exceptional durability and resistance to water and chemical stains. Due to natural variations in wood, finished products may vary from samples in color, texture, and grain.

Wood is a natural material; slight variations occur in veneer texture, color, grain configuration, and stain acceptance. Coalesse stains are all applied with an exacting regard for consistency and are well within traditional tolerances for wood products.

Tip: You should know that finished tops may vary slightly in tone or character from each other or from the samples Coalesse produces. No guarantee can be made of an absolutely exact match.

Wood veneer swatches are reproduced in the Surface Materials Color Palettes.

▶ See *Coalesse Surface Materials Reference Guide* for a list.

Swatch cards and actual samples of Coalesse standard wood veneers are available from your Coalesse Customer Service representative.

Additional wood veneer species are available. To confirm availability and to determine pricing, contact Customer Service at 1.800.627.6770.

Stains applied to Coalesse wood veneer table tops are standard with the same stain color applied to both the top and the solid hardwood edge profile. Coalesse strives to produce a consistently high quality product and some natural variation in color is to be expected. This is especially apparent on natural woods which have no stain applied, for example 3525 Natural Maple. This color variation is normal and reflects the unique and natural properties of wood. This should not be considered a defect.

Stain swatches are reproduced in the Surface Materials Color Palettes.

▶ See *Coalesse Surface Materials Reference Guide* for a list.

Swatch cards and actual samples of standard wood veneers are available from your Customer Service representative.

Stain-to-Match is available on this product and allows the matching of any wood finish with a one-time charge per finish.

▶ See *Coalesse Surface Materials Reference Guide* for details.

Solid surface tops are 1/2" thick on top of a 1/4" substructure. Solid surface is available in 2801 Glacier White.

Glass tops are 1/2" thick on top of a 1/4" substructure. Tops are tempered, low-iron glass available in multiple painted finishes.

Potrero415 Light Collaborative and Conference Tables

DESIGN COALESSE DESIGN GROUP

Round and Square Tables with Metal Legs

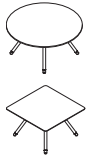

Tip: Glass tops are not secured to the substructure. Glass tops are placed on rubber pads that are adhered to the substructure. If the glass tables need to be moved, remove the glass top prior to moving the table.

Tip: For tables with solid surface and glass tops, overall height is 1/2" taller.

Tip: When polished aluminum leg is specified, frame is platinum gloss.

Tip: If PowerPod is specified, consider cable routing details to ensure cord length is adequate to reach building power.

Tip: Bottom tray conceals cords and provides a clean visual.

Tip: PowerPod grommet is available in 6000 Black or 6052 Milk.

Tip: Power and USB modules are available in 6000 Black, 6052 Milk, or 6D03 Graphite.

Standard Includes		Required to Specify	
<ul style="list-style-type: none"> ▶ Need help? Product details, page 548 	<ul style="list-style-type: none"> • Table top: grade 1 laminate with 3 mm flat plastic edge • Legs and frame: grade 1 paint • Leg rings, height adjustable: grade 1 paint • Ships ready to assemble • Bottom tray with cutouts 	<ol style="list-style-type: none"> 1 Style number 2 Table top width for square table 3 Table top diameter for round table 4 Laminate color number for table top 5 Plastic edge color number for laminate table top, if selected 6 Paint color number for legs and frame 7 Paint color number for leg ring 8 Options, if selected (see below) <p>▶ See <i>Coalesse Surface Materials Reference Guide</i>.</p>	
Surface Materials	Options	U.S. Price	Required to Specify
	Table top <ul style="list-style-type: none"> • Grade 2 laminate • Grade 3 laminate • Grade 2 wood veneer • Solid surface • Back-painted glass 	<ul style="list-style-type: none"> Prices at right Prices at right Prices at right Prices at right Prices at right 	<ul style="list-style-type: none"> Specify with <i>grade 2 laminate</i> and select color number. Specify with <i>grade 3 laminate</i> and select color number. Specify with <i>grade 2 wood veneer</i> and select color number. Specify with <i>solid surface group 1</i> and select color number for substructure (6000 Black or 6052 Milk). Specify back-painted glass, select color number, and select color number for substructure (6000 Black or 6052 Milk).
	Legs on work-height tables <ul style="list-style-type: none"> • Grade 3 paint • Polished aluminum 	<ul style="list-style-type: none"> +\$313 +\$440 	<ul style="list-style-type: none"> Specify paint color number. Specify with <i>8046 Polished Aluminum</i>.
	Legs on standing-height tables <ul style="list-style-type: none"> • Grade 3 paint • Polished aluminum 	<ul style="list-style-type: none"> +\$313 +\$606 	<ul style="list-style-type: none"> Specify paint color number. Specify with <i>8046 Polished Aluminum</i>.
	Leg ring <ul style="list-style-type: none"> • Chrome or copper plating 	<ul style="list-style-type: none"> +\$292 	<ul style="list-style-type: none"> Specify 9201 Chrome, 9260 Black Chrome, or 9261 Copper.
	Bottom Tray <ul style="list-style-type: none"> • Without bottom tray 	<ul style="list-style-type: none"> -\$ 69 	<ul style="list-style-type: none"> Specify with <i>no bottom tray</i>.
	Technology Devices and Grommets <ul style="list-style-type: none"> • PowerPod grommet • PowerPod grommet 	<ul style="list-style-type: none"> +\$172 	<ul style="list-style-type: none"> Specify with <i>PowerPod grommet</i> and select finish.
	Power and USB module <ul style="list-style-type: none"> • One power • One USB A/C 	<ul style="list-style-type: none"> +\$196 +\$412 	<ul style="list-style-type: none"> Specify with <i>power module with one power</i> and select finish. Specify with <i>power module with one USB</i> and select finish.
Related Products <ul style="list-style-type: none"> • PowerPod • Mesh cable manager 			<ul style="list-style-type: none"> ▶ Page 739 ▶ Page 573



For Canadian Pricing
 Multiply U.S. Price by the Canadian price factor.
 ▶ See page 1 for details.

Potrero415 Light Collaborative and Conference Tables

DESIGN COALESSE DESIGN GROUP

Round and Square Tables with Metal Legs

Specification Information

Style Number	Dimensions			U.S. Base Prices					
	D	W	H	Laminate		Wood Veneer		Solid Surface	Glass
				Grade 1	Grade 2 and 3	Grade 1	Grade 2		



Work-Height Round Light Tables, Metal Legs

COFOFLRD	36" diameter	28 1/2"	\$2805	\$2865	\$3934	\$4290	\$4883	\$5476
	42" diameter	28 1/2"	\$3092	\$3173	\$4328	\$4719	\$5692	\$6668



Work-Height Square Light Tables, Metal Legs

COFOFLSQ	36"	36"	28 1/2"	\$2805	\$2865	\$3934	\$4290	\$4883	\$5476
	42"	42"	28 1/2"	\$3092	\$3173	\$4328	\$4719	\$5692	\$6668



Standing-Height Round Light Tables, Metal Legs

COFOFLRDST	36" diameter	40"	\$3209	\$3269	\$4338	\$4694	\$5287	\$5880
	42" diameter	40"	\$3496	\$3577	\$4732	\$5123	\$6096	\$7072



Standing-Height Square Light Tables, Metal Legs

COFOFLSQST	36"	36"	40"	\$3209	\$3269	\$4338	\$4694	\$5287	\$5880
	42"	42"	40"	\$3496	\$3577	\$4732	\$5123	\$6096	\$7072

Veneer and woodgrain laminate direction



For Canadian Pricing
 Multiply U.S. Price by the Canadian price factor.
 ▶ See page 1 for details.

Potrero415 Light Collaborative and Conference Tables

Rectangular Tables with Metal Legs

DESIGN COALESSE DESIGN GROUP

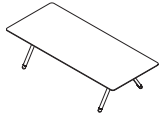

Tip: Glass tops are not secured to the substructure. Glass tops are placed on rubber pads that are adhered to the substructure. If the glass tables need to be moved, remove the glass top prior to moving the table.

Tip: For tables with solid surface and glass tops, overall height is 1/2" taller.

Tip: When polished aluminum leg is specified, frame is platinum gloss.

Tip: If PowerPod is specified, consider cable routing details to ensure cord length is adequate to reach building power.

Tip: Bottom tray conceals cords and provides a clean visual.

Tip: PowerPod grommet is available in 6000 Black or 6052 Milk.

Tip: Power and USB modules are available in 6000 Black, 6052 Milk, or 6D03 Graphite.

Standard Includes	Required to Specify
<ul style="list-style-type: none"> ▶ Need help? Product details, page 548 • Table top: grade 1 laminate with 3 mm flat plastic edge • Legs and frame: grade 1 paint • Leg rings, height adjustable: grade 1 paint • Ships ready to assemble • Bottom tray with cutouts 	<ol style="list-style-type: none"> 1 Style number 2 Table top depth and width 3 Laminate color number for table top 4 Plastic edge color number for laminate table top, if selected 5 Paint color number for legs and frame 6 Paint color number for leg ring 7 Options, if selected (see below) <p>▶ See <i>Coalesse Surface Materials Reference Guide</i>.</p>

Options	U.S. Price	Required to Specify
Surface Materials <ul style="list-style-type: none"> • Table top • Grade 2 laminate • Grade 3 laminate • Grade 2 wood veneer • Solid surface • Back-painted glass 	<ul style="list-style-type: none"> Prices at right Prices at right Prices at right Prices at right Prices at right 	<ul style="list-style-type: none"> Specify with <i>grade 2 laminate</i> and select color number. Specify with <i>grade 3 laminate</i> and select color number. Specify with <i>grade 2 wood veneer</i> and select color number. Specify with <i>solid surface group 1</i> and select color number for substructure (6000 Black or 6052 Milk). Specify back-painted glass, select color number, and select color number for substructure (6000 Black or 6052 Milk).
<ul style="list-style-type: none"> • Legs on work-height tables • Grade 3 paint • Polished aluminum 	<ul style="list-style-type: none"> +\$313 +\$440 	<ul style="list-style-type: none"> Specify paint color number. Specify with <i>8046 Polished Aluminum</i>.
<ul style="list-style-type: none"> • Legs on standing-height tables • Grade 3 paint • Polished aluminum 	<ul style="list-style-type: none"> +\$313 +\$606 	<ul style="list-style-type: none"> Specify paint color number. Specify with <i>8046 Polished Aluminum</i>.
<ul style="list-style-type: none"> • Leg ring • Chrome or copper plating 	<ul style="list-style-type: none"> +\$292 	<ul style="list-style-type: none"> Specify 9201 Chrome, 9260 Black Chrome, or 9261 Copper.
Bottom Tray <ul style="list-style-type: none"> • 60"W and 72"W tables • Without bottom tray 	<ul style="list-style-type: none"> -\$102 	<ul style="list-style-type: none"> Specify with <i>no bottom tray</i>.
<ul style="list-style-type: none"> • 84"W, 96"W, 108"W, and 120"W tables • Without bottom tray 	<ul style="list-style-type: none"> -\$135 	<ul style="list-style-type: none"> Specify with <i>no bottom tray</i>.
Power Module and Grommets <ul style="list-style-type: none"> • PowerPod grommet for 30"D and 36"D tables • PowerPod grommet 	<ul style="list-style-type: none"> +\$172 	<ul style="list-style-type: none"> Specify with <i>PowerPod grommet</i> and select finish.
<ul style="list-style-type: none"> • One power module, centered or end location • One power • One USB A/C 	<ul style="list-style-type: none"> +\$196 +\$412 	<ul style="list-style-type: none"> Specify with <i>power module, one power, device location</i>, and select finish. Specify with <i>power module, one USB, device location</i>, and select finish.
<ul style="list-style-type: none"> • Two power modules, end locations • Two power • One power, one USB A/C • Two USB A/C 	<ul style="list-style-type: none"> +\$392 +\$608 +\$824 	<ul style="list-style-type: none"> Specify with <i>power module, two power</i>, and select finish. Specify with <i>power module, one power and one USB</i>, and select finish. Specify with <i>power module, two USB</i>, and select finish.

▶ Options, continued on next page



For Canadian Pricing
 Multiply U.S. Price by the Canadian price factor.
 ▶ See page 1 for details.

Potrero415 Light Collaborative and Conference Tables

Rectangular Tables with Metal Legs

DESIGN COALESSE DESIGN GROUP

Tip: Power and USB modules are available in 6000 Black, 6052 Milk, or 6D03 Graphite.

► Options, continued from previous page

Options	U.S. Price	Required to Specify
Power Module and Grommets, continued	Three power modules, centered and end locations	
• Three power	+\$ 588	Specify with power module, three power, and select finish.
• Two power, one USB A/C	+\$ 804	Specify with power module, two power and one USB, and select finish.
• Two USB A/C, one power	+\$1020	Specify with power module, two USB and one power, and select finish.
• Three USB A/C	+\$1236	Specify with power module, three USB, and select finish.

Related Products

- PowerPod
- Mesh cable manager

► Page 739
► Page 573

Device Locations

PowerPod Locations

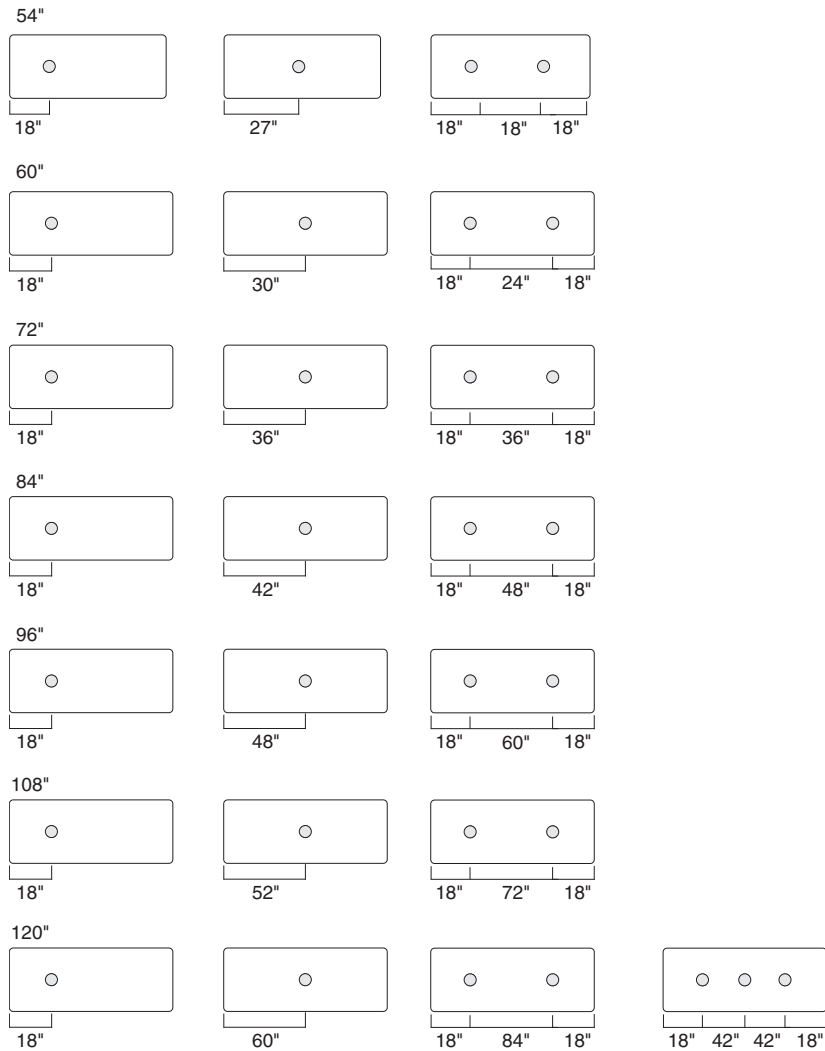

► Options, continued on next page

Potrero415 Light Collaborative and Conference Tables



For Canadian Pricing
Multiply U.S. Price by the Canadian price factor.
► See page 1 for details.

Potrero415 Light Collaborative and Conference Tables

Rectangular Tables with Metal Legs *continued*

DESIGN COALESSE DESIGN GROUP

► Options, continued from previous page

Device Locations

Power Module Locations

54"

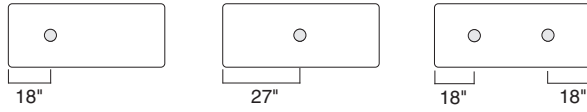

60"

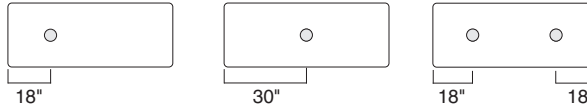

72"

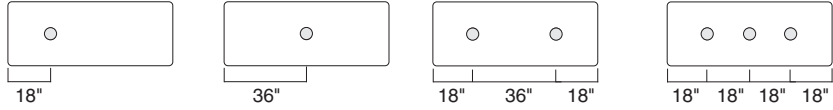

84"

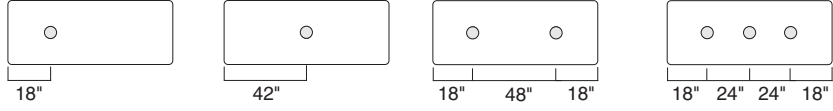

96"

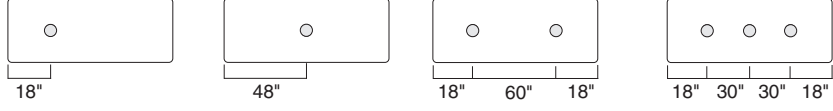

108"

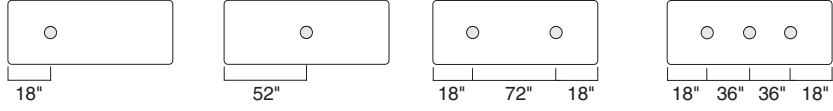

120"

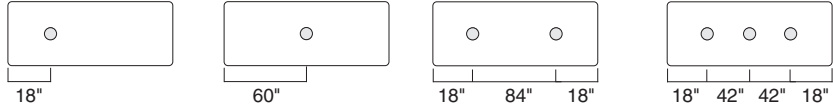

Potrero415 Light Collaborative and Conference Tables

DESIGN COALESSE DESIGN GROUP

Rectangular Tables with Metal Legs

Specification Information

Style Number	Dimensions			U.S. Base Prices					
	D	W	H	Laminate		Wood Veneer		Solid Surface	Glass
				Grade 1	Grade 2 and 3	Grade 1	Grade 2		

Work-Height Rectangular Light Tables, Metal Legs

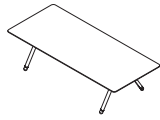

COFOFLREC	D	W	H	Laminate Grade 1	Laminate Grade 2 and 3	Wood Veneer Grade 1	Wood Veneer Grade 2	Solid Surface	Glass
	24"	54"	28½"	\$2747	\$2807	\$3853	\$4202	\$5658	\$ 7114
	24"	60"	28½"	\$2872	\$2940	\$4027	\$4391	\$5909	\$ 7426
	24"	72"	28½"	\$3124	\$3204	\$4372	\$4768	\$6409	\$ 8054
	24"	84"	28½"	\$3370	\$3466	\$4712	\$5140	\$6906	\$ 8675
	24"	96"	28½"	\$3624	\$3731	\$5060	\$5513	\$7407	\$ 9301
	24"	108"	28½"	\$3982	\$4102	\$5552	\$6051	\$8121	\$10,194
	24"	120"	28½"	\$4342	\$4474	\$6045	\$6586	\$8836	\$11,088
	30"	54"	28½"	\$2853	\$2928	\$4002	\$4366	\$5874	\$ 7381
	30"	60"	28½"	\$2979	\$3064	\$4175	\$4552	\$6121	\$ 7696
	30"	72"	28½"	\$3232	\$3332	\$4519	\$4926	\$6623	\$ 8320
	30"	84"	28½"	\$3479	\$3598	\$4864	\$5301	\$7122	\$ 8945
	30"	96"	28½"	\$3731	\$3865	\$5205	\$5675	\$7621	\$ 9568
	30"	108"	28½"	\$4090	\$4240	\$5702	\$6209	\$8335	\$10,462
	30"	120"	28½"	\$4448	\$4614	\$6194	\$6746	\$9052	\$11,354
	36"	54"	28½"	\$2960	\$3049	\$4149	\$4522	\$6088	\$ 7651
	36"	60"	28½"	\$3088	\$3188	\$4321	\$4713	\$6336	\$ 7963
	36"	72"	28½"	\$3337	\$3460	\$4668	\$5088	\$6837	\$ 8588
	36"	84"	28½"	\$3587	\$3727	\$5009	\$5461	\$7334	\$ 9212
	36"	96"	28½"	\$3839	\$4000	\$5355	\$5835	\$7836	\$ 9838
	36"	108"	28½"	\$4199	\$4379	\$5849	\$6370	\$8550	\$10,730
	36"	120"	28½"	\$4555	\$4758	\$6342	\$6907	\$9265	\$11,624

► Specification Information, continued on next page

Potrero415 Light Collaborative and Conference Tables

Veneer and woodgrain laminate direction

For Canadian Pricing
 Multiply U.S. Price by the Canadian price factor.
 ► See page 1 for details.

Potrero415 Light Collaborative and Conference Tables

DESIGN COALESSE DESIGN GROUP

Rectangular Tables with Metal Legs *continued*

► Specification Information, continued from previous page

Specification Information

Style Number	Dimensions			U.S. Base Prices					
	D	W	H	Laminate		Wood Veneer		Solid Surface	Glass
				Grade 1	Grade 2 and 3	Grade 1	Grade 2		

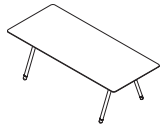

Standing-Height Rectangular Light Tables, Metal Legs

COFOFLRECST	D	W	H	Laminate Grade 1	Laminate Grade 2 and 3	Wood Veneer Grade 1	Wood Veneer Grade 2	Solid Surface	Glass
	24"	54"	40"	\$3151	\$3211	\$4257	\$4606	\$6062	\$ 7518
	24"	60"	40"	\$3276	\$3344	\$4431	\$4795	\$6313	\$ 7830
	24"	72"	40"	\$3528	\$3608	\$4776	\$5172	\$6813	\$ 8458
	24"	84"	40"	\$3774	\$3870	\$5116	\$5544	\$7310	\$ 9079
	24"	96"	40"	\$4028	\$4135	\$5464	\$5917	\$7811	\$ 9705
	24"	108"	40"	\$4386	\$4506	\$5956	\$6455	\$8525	\$10,598
	24"	120"	40"	\$4746	\$4878	\$6449	\$6990	\$9240	\$11,492
	30"	54"	40"	\$3257	\$3332	\$4406	\$4770	\$6278	\$ 7785
	30"	60"	40"	\$3383	\$3468	\$4579	\$4956	\$6525	\$ 8100
	30"	72"	40"	\$3636	\$3736	\$4923	\$5330	\$7027	\$ 8724
	30"	84"	40"	\$3883	\$4002	\$5268	\$5705	\$7526	\$ 9349
	30"	96"	40"	\$4135	\$4269	\$5609	\$6079	\$8025	\$ 9972
	30"	108"	40"	\$4494	\$4644	\$6106	\$6613	\$8739	\$10,866
	30"	120"	40"	\$4852	\$5018	\$6598	\$7150	\$9456	\$11,758
	36"	54"	40"	\$3364	\$3453	\$4553	\$4926	\$6492	\$ 8055
	36"	60"	40"	\$3492	\$3592	\$4725	\$5117	\$6740	\$ 8367
	36"	72"	40"	\$3741	\$3864	\$5072	\$5492	\$7241	\$ 8992
	36"	84"	40"	\$3991	\$4131	\$5413	\$5865	\$7738	\$ 9616
	36"	96"	40"	\$4243	\$4404	\$5759	\$6239	\$8240	\$10,242
	36"	108"	40"	\$4603	\$4783	\$6253	\$6774	\$8954	\$11,134
	36"	120"	40"	\$4959	\$5162	\$6746	\$7311	\$9669	\$12,028

Veneer and woodgrain laminate direction 



For Canadian Pricing
 Multiply U.S. Price by the Canadian price factor.
 ► See page 1 for details.

Coalesse

Potrero415 Light Collaborative and Conference Tables

DESIGN COALESSE DESIGN GROUP

Rectangular Tables with
Metal Legs

Potrero415 Light
Collaborative and
Conference Tables

Potrero415 Light Collaborative and Conference Tables

DESIGN COALESSE DESIGN GROUP

Round and Square Tables with Wood Legs

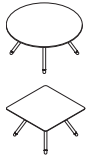

Tip: Glass tops are not secured to the substructure. Glass tops are placed on rubber pads that are adhered to the substructure. If the glass tables need to be moved, remove the glass top prior to moving the table.

Tip: For tables with solid surface and glass tops, overall height is 1/2" taller.

Tip: If PowerPod is specified, consider cable routing details to ensure cord length is adequate to reach building power.

Tip: Bottom tray conceals cords and provides a clean visual.

Tip: PowerPod grommet is available in 6000 Black or 6052 Milk.

Tip: Power and USB modules are available in 6000 Black, 6052 Milk, or 6D03 Graphite.

Standard Includes	Required to Specify
-------------------	---------------------

- | | |
|--|--|
| <ul style="list-style-type: none"> ▶ Need help? Product details, page 548 • Table top: grade 1 laminate with 3 mm flat plastic edge • Legs: solid oak • Leg rings: grade 1 paint • Frame: grade 1 paint • Four height-adjustable glides • Ships ready to assemble • Bottom tray with cutouts | <ol style="list-style-type: none"> 1 Style number 2 Table top width for square table 3 Table top diameter for round table 4 Laminate color number for table top 5 Plastic edge color number for laminate table top, if selected 6 Wood veneer color number for legs 7 Paint color number for leg ring 8 Paint color number for frame 9 Options, if selected (see below) <p>▶ See <i>Coalesse Surface Materials Reference Guide</i>.</p> |
|--|--|

Options	U.S. Price	Required to Specify
---------	------------	---------------------

Surface Materials	Table top <ul style="list-style-type: none"> • Grade 2 laminate • Grade 3 laminate • Grade 2 wood veneer • Solid surface • Back-painted glass 	Prices at right Prices at right Prices at right Prices at right Prices at right	Specify with <i>grade 2 laminate</i> and select color number. Specify with <i>grade 3 laminate</i> and select color number. Specify with <i>grade 2 wood veneer</i> and select color number. Specify with <i>solid surface group 1</i> and select color number for substructure (6000 Black or 6052 Milk). Specify back-painted glass, select color number, and select color number for substructure (6000 Black or 6052 Milk).
	Table frame <ul style="list-style-type: none"> • Grade 3 paint 	+\$242	Specify paint color number.
	Wood leg <ul style="list-style-type: none"> • Grade 2 wood veneer 	+\$ 88	Specify with <i>VP02 Smoked Oak</i> or <i>VP04 Grey Oak</i> .
	Leg ring <ul style="list-style-type: none"> • Chrome or copper plating 	+\$292	Specify 9201 Chrome, 9260 Black Chrome, or 9261 Copper.
	Bottom tray <ul style="list-style-type: none"> • Without bottom tray 	-\$ 69	Specify with <i>with no bottom tray</i> .
Technology Devices and Grommets	PowerPod grommet <ul style="list-style-type: none"> • PowerPod grommet 	+\$172	Specify with <i>PowerPod grommet</i> and select finish.
	Power and USB module <ul style="list-style-type: none"> • One power • One USB A/C 	+\$196 +\$412	Specify with <i>power module with one power</i> and select finish. Specify with <i>power module with one USB</i> and select finish.
Related Products	<ul style="list-style-type: none"> • PowerPod • Wood leg cable manager 		▶ Page 739 ▶ Page 573



For Canadian Pricing
 Multiply U.S. Price by the Canadian price factor.
 ▶ See page 1 for details.

Potrero415 Light Collaborative and Conference Tables

DESIGN COALESSE DESIGN GROUP

Round and Square Tables with Wood Legs

Specification Information

Style Number	Dimensions			U.S. Base Prices				
	D	W	H	Laminate Grade 1	Laminate Grade 2 and 3	Wood Veneer Grade 1	Wood Veneer Grade 2	Solid Surface



Work-Height Round Light Tables, Wood Legs

COFOFLRDW	36" diameter		28 1/2"	\$3346	\$3406	\$4475	\$4831	\$5424	\$6017
	42" diameter		28 1/2"	\$3633	\$3714	\$4869	\$5260	\$6233	\$7209



Work-Height Square Light Tables, Wood Legs

COFOFLSQW	36"	36"	28 1/2"	\$3346	\$3406	\$4475	\$4831	\$5424	\$6017
	42"	42"	28 1/2"	\$3633	\$3714	\$4869	\$5260	\$6233	\$7209



Standing-Height Round Light Tables, Wood Legs

COFOFLRDSTW	36" diameter		40"	\$3750	\$3810	\$4879	\$5235	\$5828	\$6421
	42" diameter		40"	\$4037	\$4118	\$5273	\$5664	\$6637	\$7613



Standing-Height Square Light Tables, Wood Legs

COFOFLSQSTW	36"	36"	40"	\$3750	\$3810	\$4879	\$5235	\$5828	\$6421
	42"	42"	40"	\$4037	\$4118	\$5273	\$5664	\$6637	\$7613

Potrero415 Light Collaborative and Conference Tables

Veneer and woodgrain laminate direction



For Canadian Pricing
 Multiply U.S. Price by the Canadian price factor.
 ▶ See page 1 for details.

Potrero415 Light Collaborative and Conference Tables

Rectangular Tables with Wood Legs

DESIGN COALESSE DESIGN GROUP

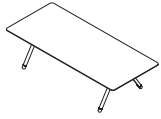

Tip: Glass tops are not secured to the substructure. Glass tops are placed on rubber pads that are adhered to the substructure. If the glass tables need to be moved, remove the glass top prior to moving the table.

Standard Includes	Required to Specify
<ul style="list-style-type: none"> ▶ Need help? Product details, page 548 • Table top: grade 1 laminate with 3 mm flat plastic edge • Legs: solid oak • Leg rings: grade 1 paint • Frame: grade 1 paint • Four height-adjustable glides • Ships ready to assemble • Bottom tray with cutouts 	<ol style="list-style-type: none"> 1 Style number 2 Table top depth and width 3 Laminate color number for table top 4 Plastic edge color number for laminate table top, if selected 5 Wood veneer color number for legs 6 Paint color number for leg ring 7 Paint color number for frame 8 Options, if selected (see below) <p>▶ See <i>Coalesse Surface Materials Reference Guide</i>.</p>

Tip: For tables with solid surface and glass tops, overall height is 1/2" taller.

Options	U.S. Price	Required to Specify
Surface Materials <ul style="list-style-type: none"> • Table top • Grade 2 laminate • Grade 3 laminate • Grade 2 wood veneer • Solid surface • Back-painted glass 	<ul style="list-style-type: none"> Prices at right Prices at right Prices at right Prices at right Prices at right 	<ul style="list-style-type: none"> Specify with <i>grade 2 laminate</i> and select color number. Specify with <i>grade 3 laminate</i> and select color number. Specify with <i>grade 2 wood veneer</i> and select color number. Specify with <i>solid surface group 1</i> and select color number for substructure (6000 Black or 6052 Milk). Specify back-painted glass, select color number, and select color number for substructure (6000 Black or 6052 Milk).
<ul style="list-style-type: none"> • Table frame • Grade 3 paint 	<ul style="list-style-type: none"> +\$242 	<ul style="list-style-type: none"> Specify paint color number.
<ul style="list-style-type: none"> • Wood leg • Grade 2 wood veneer 	<ul style="list-style-type: none"> +\$ 88 	<ul style="list-style-type: none"> Specify with <i>VPO2 Smoked Oak</i> or <i>VPO4 Grey Oak</i>.
<ul style="list-style-type: none"> • Leg ring • Chrome or copper plating 	<ul style="list-style-type: none"> +\$292 	<ul style="list-style-type: none"> Specify 9201 Chrome, 9260 Black Chrome, or 9261 Copper.
Bottom tray <ul style="list-style-type: none"> • 60"W and 72"W tables • Without bottom tray 	<ul style="list-style-type: none"> -\$102 	<ul style="list-style-type: none"> Specify with <i>no bottom tray</i>.
<ul style="list-style-type: none"> • 84"W, 96"W, 108"W, and 120"W tables • Without bottom tray 	<ul style="list-style-type: none"> -\$135 	<ul style="list-style-type: none"> Specify with <i>no bottom tray</i>.
Power Module and Grommets <ul style="list-style-type: none"> • PowerPod grommet for 30"D and 36"D tables • PowerPod grommet 	<ul style="list-style-type: none"> +\$172 	<ul style="list-style-type: none"> Specify with <i>PowerPod grommet</i> and select finish.
<ul style="list-style-type: none"> • One power module, centered or end location • One power • One USB A/C 	<ul style="list-style-type: none"> +\$196 +\$412 	<ul style="list-style-type: none"> Specify with <i>power module, one power, device location</i>, and select finish. Specify with <i>power module, one USB, device location</i>, and select finish.
<ul style="list-style-type: none"> • Two power modules, end locations • Two power • One power, one USB A/C • Two USB A/C 	<ul style="list-style-type: none"> +\$392 +\$608 +\$824 	<ul style="list-style-type: none"> Specify with <i>power module, two power</i>, and select finish. Specify with <i>power module, one power and one USB</i>, and select finish. Specify with <i>power module, two USB</i>, and select finish.

Tip: If PowerPod is specified, consider cable routing details to ensure cord length is adequate to reach building power.

Tip: Bottom tray conceals cords and provides a clean visual.

Tip: PowerPod grommet is available in 6000 Black or 6052 Milk.

Tip: Power and USB modules are available in 6000 Black, 6052 Milk, or 6D03 Graphite.

▶ Options, continued on next page



For Canadian Pricing
 Multiply U.S. Price by the Canadian price factor.
 ▶ See page 1 for details.

Potrero415 Light Collaborative and Conference Tables

Rectangular Tables with Wood Legs

DESIGN COALESSE DESIGN GROUP

Tip: Power and USB modules are available in 6000 Black, 6052 Milk, or 6D03 Graphite.

► Options, continued from previous page

Options	Required to Specify
Power Module and Grommets, continued <ul style="list-style-type: none"> Three power modules, centered and end locations • Three power +\$ 588 • Two power, one USB A/C +\$ 804 • Two USB A/C, one power +\$1020 • Three USB A/C +\$1236 	Specify with power module, three power, and select finish. Specify with power module, two power and one USB, and select finish. Specify with power module, two USB and one power, and select finish. Specify with power module, three USB, and select finish.

Related Products

- PowerPod
- Wood leg cable manager

► Page 739
► Page 573

Device Locations

PowerPod Locations

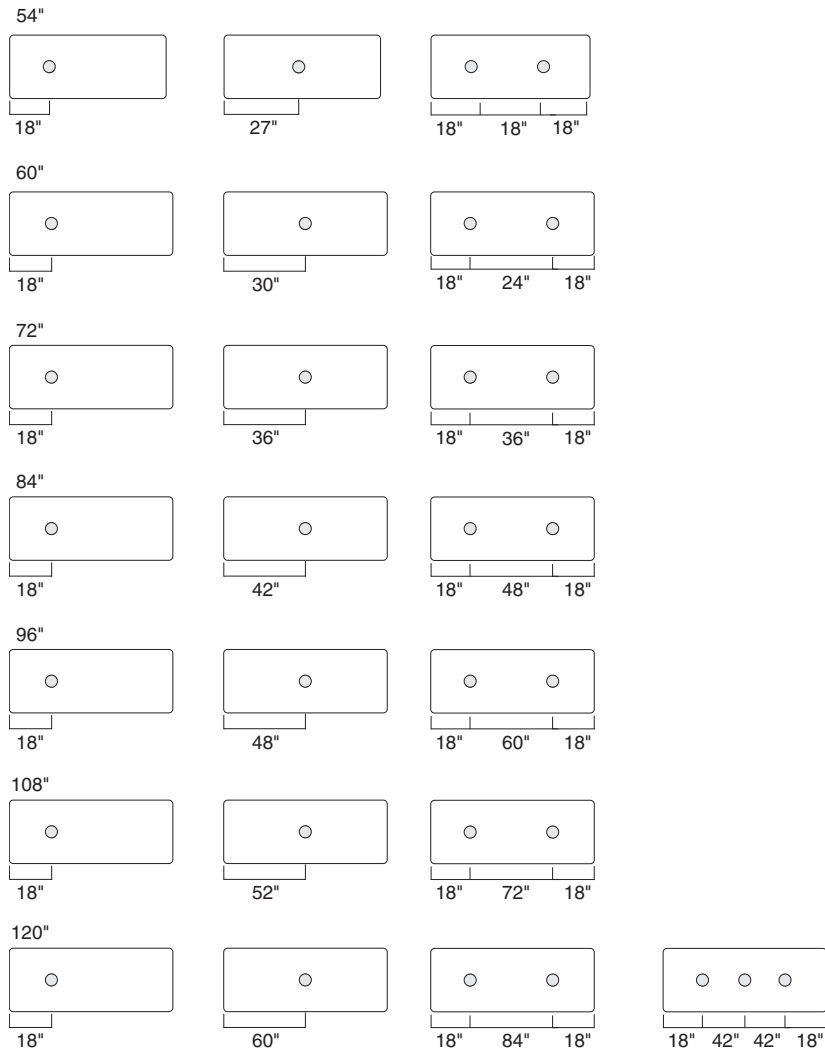

► Options, continued on next page

Potrero415 Light Collaborative and Conference Tables

 **For Canadian Pricing**
Multiply U.S. Price by the Canadian price factor.
► See page 1 for details.

Potrero415 Light Collaborative and Conference Tables

DESIGN COALESSE DESIGN GROUP

Rectangular Tables with Wood Legs *continued*

► Options, continued from previous page

Device Locations

Power Module Locations

54"



18"

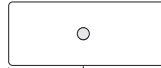

27"



18" 18" 18"

60"



18"



30"



18" 24" 18"

72"



18"



36"



18" 36" 18"

84"



18"



42"



18" 48" 18"

96"



18"



48"



18" 60" 18"

108"



18"



52"



18" 72" 18"

120"



18"

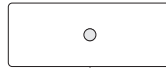

60"



18" 84" 18"

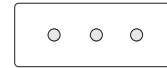

18" 42" 42" 18"

Potrero415 Light Collaborative and Conference Tables

Rectangular Tables with Wood Legs

DESIGN COALESSE DESIGN GROUP

Specification Information

Style Number	Dimensions			U.S. Base Prices					
	D	W	H	Laminate		Wood Veneer		Solid Surface	Glass
				Grade 1	Grade 2 and 3	Grade 1	Grade 2		

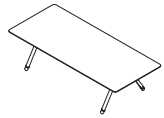

Work-Height Rectangular Light Tables, Wood Legs

COFOFLRECW	D	W	H	Laminate Grade 1	Laminate Grade 2 and 3	Wood Veneer Grade 1	Wood Veneer Grade 2	Solid Surface	Glass
	24"	54"	28½"	\$3288	\$3348	\$4394	\$4743	\$6199	\$ 7655
	24"	60"	28½"	\$3413	\$3481	\$4568	\$4932	\$6450	\$ 7967
	24"	72"	28½"	\$3665	\$3745	\$4913	\$5309	\$6950	\$ 8595
	24"	84"	28½"	\$3911	\$4007	\$5253	\$5681	\$7447	\$ 9216
	24"	96"	28½"	\$4165	\$4272	\$5601	\$6054	\$7948	\$ 9842
	24"	108"	28½"	\$4523	\$4643	\$6093	\$6592	\$8662	\$10,735
	24"	120"	28½"	\$4883	\$5015	\$6586	\$7127	\$9377	\$11,629
	30"	54"	28½"	\$3394	\$3469	\$4543	\$4907	\$6415	\$ 7922
	30"	60"	28½"	\$3520	\$3605	\$4716	\$5093	\$6662	\$ 8237
	30"	72"	28½"	\$3773	\$3873	\$5060	\$5467	\$7164	\$ 8861
	30"	84"	28½"	\$4020	\$4139	\$5405	\$5842	\$7663	\$ 9486
	30"	96"	28½"	\$4272	\$4406	\$5746	\$6216	\$8162	\$10,109
	30"	108"	28½"	\$4631	\$4781	\$6243	\$6750	\$8876	\$11,003
	30"	120"	28½"	\$4989	\$5155	\$6735	\$7287	\$9593	\$11,895
	36"	54"	28½"	\$3501	\$3590	\$4690	\$5063	\$6629	\$ 8192
	36"	60"	28½"	\$3629	\$3729	\$4862	\$5254	\$6877	\$ 8504
	36"	72"	28½"	\$3878	\$4001	\$5209	\$5629	\$7378	\$ 9129
	36"	84"	28½"	\$4128	\$4268	\$5550	\$6002	\$7875	\$ 9753
	36"	96"	28½"	\$4380	\$4541	\$5896	\$6376	\$8377	\$10,379
	36"	108"	28½"	\$4740	\$4920	\$6390	\$6911	\$9091	\$11,271
	36"	120"	28½"	\$5096	\$5299	\$6883	\$7448	\$9806	\$12,165

► Specification Information, continued on next page

Potrero415 Light Collaborative and Conference Tables

Veneer and woodgrain laminate direction



For Canadian Pricing
 Multiply U.S. Price by the Canadian price factor.
 ► See page 1 for details.

Potrero415 Light Collaborative and Conference Tables

DESIGN COALESSE DESIGN GROUP

Rectangular Tables with Wood Legs *continued*

► Specification Information, continued from previous page

Specification Information

Style Number	Dimensions			U.S. Base Prices					
	D	W	H	Laminate		Wood Veneer		Solid Surface	Glass
				Grade 1	Grade 2 and 3	Grade 1	Grade 2		

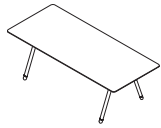

Standing-Height Rectangular Light Tables, Wood Legs

COFOFLRECSTW	D	W	H	Laminate Grade 1	Laminate Grade 2 and 3	Wood Veneer Grade 1	Wood Veneer Grade 2	Solid Surface	Glass
	24"	54"	40"	\$3692	\$3752	\$4798	\$5147	\$ 6603	\$ 8059
	24"	60"	40"	\$3817	\$3885	\$4972	\$5336	\$ 6854	\$ 8371
	24"	72"	40"	\$4069	\$4149	\$5317	\$5713	\$ 7354	\$ 8999
	24"	84"	40"	\$4315	\$4411	\$5657	\$6085	\$ 7851	\$ 9620
	24"	96"	40"	\$4569	\$4676	\$6005	\$6458	\$ 8352	\$10,246
	24"	108"	40"	\$4927	\$5047	\$6497	\$6996	\$ 9066	\$11,139
	24"	120"	40"	\$5287	\$5419	\$6990	\$7531	\$ 9781	\$12,033
	30"	54"	40"	\$3798	\$3873	\$4947	\$5311	\$ 6819	\$ 8326
	30"	60"	40"	\$3924	\$4009	\$5120	\$5497	\$ 7066	\$ 8641
	30"	72"	40"	\$4177	\$4277	\$5464	\$5871	\$ 7568	\$ 9265
	30"	84"	40"	\$4424	\$4543	\$5809	\$6246	\$ 8067	\$ 9890
	30"	96"	40"	\$4676	\$4810	\$6150	\$6620	\$ 8566	\$10,513
	30"	108"	40"	\$5035	\$5185	\$6647	\$7154	\$ 9280	\$11,407
	30"	120"	40"	\$5393	\$5559	\$7139	\$7691	\$ 9997	\$12,299
	36"	54"	40"	\$3905	\$3994	\$5094	\$5467	\$ 7033	\$ 8596
	36"	60"	40"	\$4033	\$4133	\$5266	\$5658	\$ 7281	\$ 8908
	36"	72"	40"	\$4282	\$4405	\$5613	\$6033	\$ 7782	\$ 9533
	36"	84"	40"	\$4532	\$4672	\$5954	\$6406	\$ 8279	\$10,157
	36"	96"	40"	\$4784	\$4945	\$6300	\$6780	\$ 8781	\$10,783
	36"	108"	40"	\$5144	\$5324	\$6794	\$7315	\$ 9495	\$11,675
	36"	120"	40"	\$5500	\$5703	\$7287	\$7852	\$10,210	\$12,569

Veneer and woodgrain laminate direction



For Canadian Pricing
Multiply U.S. Price by the Canadian price factor.

► See page 1 for details.

Potrero415 Light Collaborative and Conference Tables Cable Management

DESIGN COALESSE DESIGN GROUP

Standard Includes		Required to Specify
<ul style="list-style-type: none"> ▶ Need help? Product details, page 549 	<ul style="list-style-type: none"> • Cable manager for wood legs: Elmosoft leather • Mesh cable manager: black mesh and 7202 Black paint 	<ul style="list-style-type: none"> 1 Style number 2 Leather color number for wood leg cable manager, if selected: <ul style="list-style-type: none"> • L112 Ebony • L122 Truffle • L139 Cinder • L147 Saddle • L709 Sugar • L755 Peanut Butter • L775 Coyote

Specification Information

Style Number	U.S. Price
--------------	------------

Cable Manager for Wood Legs—Leather, Work Height

COFOFLCMCW	\$339
------------	-------

Cable Manager for Wood Legs—Leather, Standing Height

COFOFLCMCWST	\$433
--------------	-------

Cable Manager, Mesh, Work Height

COFOCABLM	\$373
-----------	-------

Cable Manager, Mesh, Standing Height

COFOCABLMST	\$542
-------------	-------



Tip: This cable manager was designed to be used with the cut-outs in the bottom tray to manage cables from trough to floor. It is compatible with the 30"D and 36"D Potrero415 light tables, with bottom tray specified.

 **For Canadian Pricing**
 Multiply U.S. Price by the Canadian price factor.
 ▶ See page 1 for details.

SW_1 Collaborative and Conference Tables

Understanding	576
Specifying	
Low Collaborative Conference Tables	592
Conference Tables	596
Round, Square, and Super-Square Tables	600
Work Tables	602
PowerPod	604
Accessories	605

SW_1 Collaborative and Conference Tables

SW_1 is a clear alternative to the generic conference room. Enhancing social connectivity and fostering engagement, SW_1 promotes the healthful freedom of movement users deserve in collaborative settings, while offering the tools and features they need for productive meetings.

Tip: This product line is a collection and will be found in multiple locations in this specification guide and/or Coalesse Seating Specification Guide.

► See *Collections*, page 5



Lounge chair supports the "lean back" activity, while offering more space for postural changes than the conventional conference chair.
► See *Coalesse Seating and Outdoor Specification Guide*

The top is available in four materials: laminate, veneer, glass, and solid surface.

The pull-out tablet allows the user to bring work up close. Tablets are available in black or arctic white and are only available on the 26"H collaborative height tables.

Bases come in a 4-star base for round and square tables or V-bases with or without in-line legs for rectangular and super-elliptical tables. The cone at the top of the base has a hole for routing cables from power modules or PowerPod grommets to the wire manager. Bases are available in aluminum matte polished.

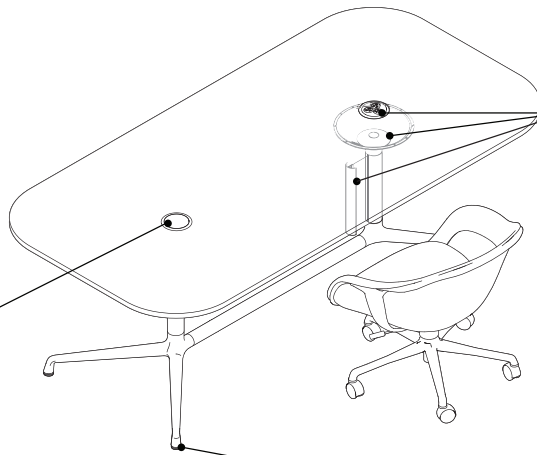

Wire manager comes standard with all power options and routes cords and cables from the cone to the floor. It is a separate piece that attaches to the column, available in black or milk. Additional wire manager options including cable tray are also available.

Power is available as an option. Power includes simple or performance power module options, as well as PowerPod grommet.

Adjustable glides are available for leveling on uneven floors. The adjustment range is 3/4".

Seating Capacity Guidelines
► See page 579

Product Details

Tables are available in the following heights:

- 28 1/2"H standard table height
 - 26"H collaborative table height
 - 15"H occasional table height
- Page 702

Adjustable leveling glides have a range of 3/4" to accommodate uneven floors.

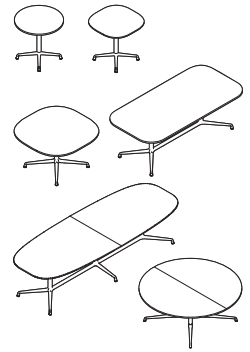
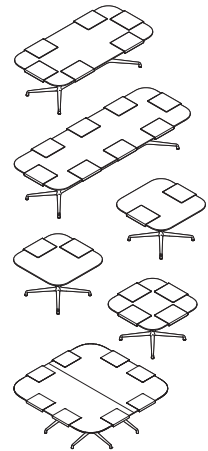
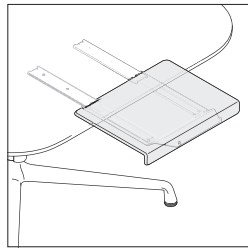

Table shapes include round, square, super-square, rectangular, and super-elliptical. A wide range of sizes up to 20'L is available to fit any room size.



Tablets are available only on 26"H collaborative table heights. They are optional on the 42"Wx84"Lx26"H and 42"Wx120"Lx26"H rectangular tables and on the 42"Wx42"Lx26"H and 84"Wx84"Lx26"H square table.

SW_1 Collaborative and Conference Tables



The tablets pull-out 10" from the worksurface and utilize two ball bearing slides.

The tablets are available in black or milk plastic over-molded material.

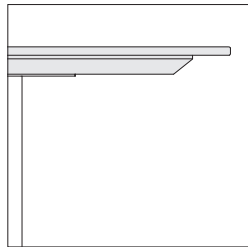

The table top is built into two sections, the substructure (bottom) and the table top. The substructure is a solid core of 45 lb median-density particle board, 1 1/4" thick, available in black or milk. The 1/2" thick top is available in the following:

- High-Pressure Laminate with backer with flat 3 mm vinyl edge banding
- Wood veneer with backer with matching flat 3 mm wood edge banding
- Glass with flat edge

Tip: Glass tops are not secured to the substructure. Glass tops are placed on rubber pads that are adhered to the substructure. If the glass tables need to be moved, remove the glass top prior to moving the table.

- White solid surface with flat edge



4-star base, no power options



4-star base with power options (cone)

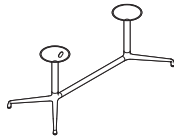

V-base, no in-line leg(s) with power options

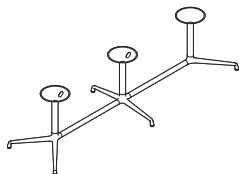

V-base with in-line leg(s) with power options

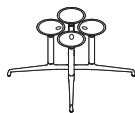

Large round/square base with single-leg configuration with power options (cone)

Tip: Due to the cone locations, grommets and power modules are not centered on these base configurations.

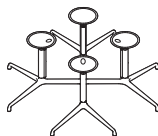

Large round/square with v-leg configuration with power options (cone)

Tip: Due to the cone locations, grommets and power modules are not centered on these base configurations.

Bases are available in six configurations:

- 4-star base, no power options
- 4-star base with power options (cone)
- V-base, no in-line leg(s) with power options
- V-base with in-line leg(s) with power options
- Large round/square base with single-leg configuration with power options (cone)
- Large round/square base with v-leg configuration with power options (cone)

Bases are aluminum with a 2 1/2" diameter column. The column has a groove to accept the wire manager.

► See page 590 for leg locations.

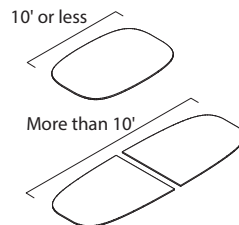

Large tops are shipped in sections. The 1/2" top and 1/4" bottom substructure are shipped separately and are assembled in the field. Tite-joint fasteners are used for the bottom substructure and other hardware is used to assembly the 1/2" top to the substructure. Tables that are 12' L and larger always ship in two or three pieces.

Custom shapes and sizes
Special table sizes and shapes are possible. To confirm practicality and obtain a quotation, contact Customer Service at 1.800.627.6770.

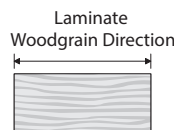

Woodgrain laminates are always oriented with the grain direction running parallel with the length of the table top.

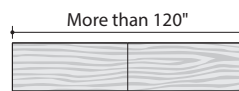

Woodgrain laminate sectioned tops cannot be guaranteed to have a perfect match of the grain pattern along the seam that joins the sections. Large tops that are more than 12' in length require two or more separate sheets of laminate. Coalesse will create the best match that is possible between two sheets of laminate, but depending on the woodgrain laminate pattern that you choose, a perfect match between sections cannot be guaranteed.

For sectioned 3- or 4-piece tops, it is not recommended to use wood grain laminates, as the grain pattern of each section will not match.

Standard veneer grain directions—grain directions are determined by the size and shape of the table top. Refer to the following guidelines for standard grain directions.

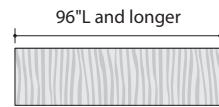

Grain runs parallel to the width of the rectangular and super-elliptical table tops.

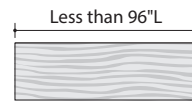

Tops 96" L and less have a choice of an optional grain pattern that runs the length of the top.

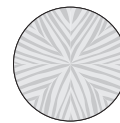

Wedge lay-up veneers radiate from the center on round tops and super-elliptical tops.

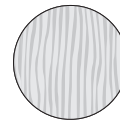

Same flitch matching is available through specials and can be specified in cases where you want the veneer grain and pattern on two or more tops to come from the same flitch of veneer. This ensures a consistent grain pattern and coloration and should be specified when tops will be used near each other but not ganged.

Technology Devices



Simple power module measures 4 1/8" in diameter and is available in soft-touch milk and black finishes. The module's face can flip to conceal power when not in use. The simple power module comes with a 10' power cord with 15-amp plug and can only be specified above table legs (cones). It is available with three simplex receptacles or two simplex receptacles and one USB receptacle.

Tip: USB receptacles conveniently charge a range of electronic devices. Some devices may not be compatible. Each USB has 1 USB A and 1 USB C charging port.

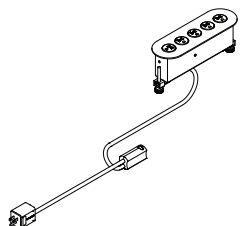

Performance power module measures 10 1/2" x 3 3/8" and is available in milk, black, and platinum matte. It comes with a 10' power cord with 15-amp plug or hardwire infeed with 8' of cord. Performance power can be specified between legs of most rectangle and super-elliptical tables and is available in the following configurations (plug orientation as shown):

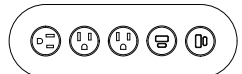

3 Power, 2 USB

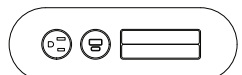

2 Power, 1 Blank AAP

Tip: Architectural Adapter Plates "AAPs" provide access to data, audio, video, and other technologies. The blank "AAPs" are compatible with Extron Electronics and accommodate two single spaces or one double space per side.

SW_1 Collaborative and Conference Tables *continued*

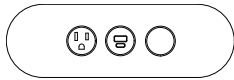

1 Power, 1 USB, and 1 Blank AAP

Tip: USB receptacles conveniently charge a range of electronic devices. Some devices may not be compatible. Each USB has 1 USB A and 1 USB C charging port.

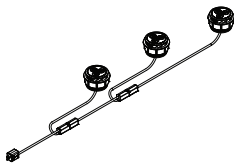

When two or more simple or performance power modules are specified, the ganging power option connects all units by a corded system and has a single infeed with 15-amp plug.
Tip: If two or more performance power modules are selected, the ganging power option is forced.

Tip: Ganging option is not available when hardwire infeed is selected. When ganging power is specified, only one vertical wire manager is supplied.

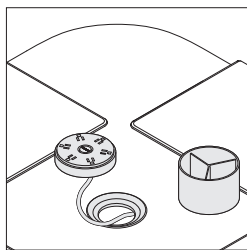

PowerPod grommet accommodates PowerPod or the pass through of cords and tables to the desktop. When specified, PowerPod grommets come with an inside barrier in the cone, and are available in milk and black finishes. PowerPod grommets can only be located above table legs.

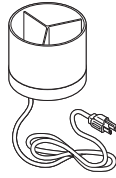

PowerPod is a design conscious, portable power source and accessory all in one. It can be used on any table top for easy access to power.

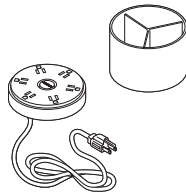

PowerPod includes six 15-amp outlets with an energy saving illuminated on/off switch. It comes with a 6' cord with three prong plug. The top tray is milk and the power source is silver with a milk face. It is UL and CSA listed.

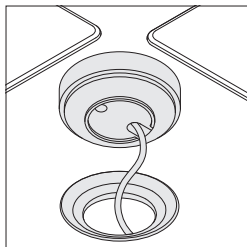

The contour of the PowerPod bottom cradle is designed to work in conjunction with the grommet for a snug fit or can be used independently without a grommet.

Tip: Simple power cannot be added retroactively to a top that already has a cut out for PowerPod.

Cable Management Options

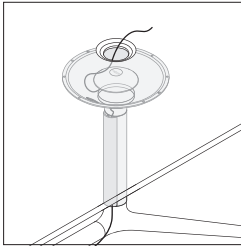

The cone at the top of the base attaches to the work surface and accommodates the simple power module and PowerPod grommet. The cone allows cords and cables to be passed through and coiled for storage. If specified with PowerPod grommet, a barrier attaches to the inside of the column to help hold and conceal cords and cables. The barrier comes in black or milk to match the grommet.

Tip: A power strip cannot fit inside the cone.

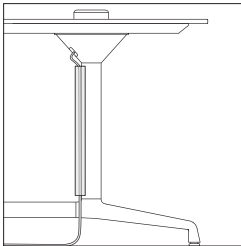

The SW_1 vertical wire manager is supplied when a any non-hardwired power module is specified. It attaches to the groove in the base column to conceal and hold power cords and voice/data cables routed vertically from the floor to the worksurface. The wire manager is available in black or milk and automatically matches chosen subtop color.
 Note: For any occasional tables that can be specified with a PowerPod grommet or simple power unit, no vertical wire manager is supplied.

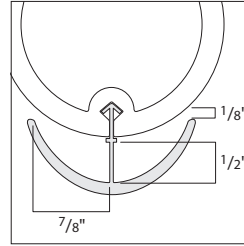

The vertical wire manager is divided into two sections for cord and cable management. Three cords/cables can be routed per section.

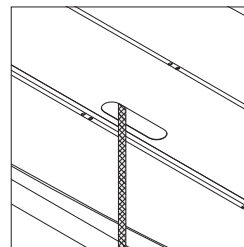

Mesh power cord cover is supplied when a power module is specified with hardwire infeed. The cover wraps around and conceals cords, allowing them to exit out of the center and down to the floor. The cover is black, measures 72" in length, and can accommodate up to 7/8" diameter of wiring.
Tip: Mesh power cord cover can be trimmed to the desired length.

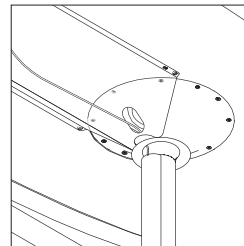

Cable tray is standard in platinum powder coat and attaches to the work surface between the legs, disguising the performance power module and ganged power system. The tray clearly routes wires and cables from the worksurface to the vertical wire manager or through the opening in the center of the tray, measuring 2" by 7/8" inches. The tray is available to specify on most rectangle and super-elliptical tables.



Horizontal wire management velcro clips are available as an alternative or accompaniment to the cable tray and manage wires from one end of the table to the other, if desired. They come in a package of six and are attached under the worksurface with the provided screws.

Surface Materials

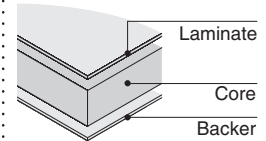

Solid core tops with 1/2" nominal edge thickness have a particle board core (45 lb cu ft density) with High-Pressure Laminate or wood veneer on the top and a backer applied to the opposite side for a balanced construction. High-Pressure Laminate, wood veneer, and backer are bonded to the core with a PVA adhesive.

Laminates are available in two standard grades. Additional laminates from any manufacturer may also be practical—see Other laminates in the following column.

Grade 1 laminates include:

- Coalesse standard laminates
- ▶ See *Coalesse Surface Materials Reference Guide*.
- Steelcase standard laminates (code 290A)
- ▶ See *Steelcase Surface Materials Reference Manual*.
- Any standard-grade Wilsonart laminate in solid color, woodgrain, or pattern finish (code 290A).

Grade 2 laminates (code 290B)

include any standard-grade, solid color, woodgrain, or patterned laminate from Nevamar (includes Matrix), Formica, or Pionite. Grade 2 laminates may have extended lead times. For details, contact Customer Service at 1.800.627.6770.

SW_1 Collaborative and Conference Tables

Other laminates that are not included in the Grade 1 or Grade 2 offerings may also be available, such as Abet Laminati and Laminart. To determine availability and pricing, contact Customer Service at 1.800.627.6770, with the laminate manufacturer's name and the name and number of the laminate you want.

Laminate swatches are reproduced in the Surface Materials Color Palettes.

▶ See *Coalesse Surface Materials Reference Guide* for a list.

Swatch cards and actual samples of Coalesse standard laminates are available from your Coalesse Customer Service representative. For samples of laminates from other manufacturers, contact them directly:

Wilsonart 1.800.433.3222

Nevamar 1.800.638.4380

Formica 1.800.FORMICA

Pionite 1.800.285.5161

Tip: Laminate manufacturers change their offerings frequently. Always check availability before ordering.

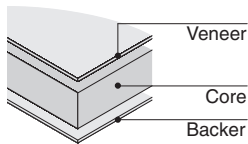

Wood veneer table tops are fabricated with Architectural Grade AA hand-selected hardwood veneer, plain sliced, book matched, and bonded to the core with a backing sheet for balance. Coalesse's primary wood finish, Clarity, is a waterborne UV topcoat, which protects the environment while providing exceptional durability and resistance to water and chemical stains. Due to natural variations in wood, finished products may vary from samples in color, texture, and grain.

Wood is a natural material; slight variations occur in veneer texture, color, grain configuration, and stain acceptance. Coalesse stains are all applied with an exacting regard for consistency and are well within traditional tolerances for wood products.

Tip: You should know that finished tops may vary slightly in tone or character from each other or from the samples Coalesse produces. No guarantee can be made of an absolutely exact match.

Additional wood veneer species are available. To confirm availability and to determine pricing, contact Customer Service at 1.800.627.6770.

Stains applied to Coalesse wood veneer table tops are standard with the same stain color applied to both the top and the solid hardwood edge profile. Coalesse strives to produce a consistently high quality product and some natural variation in color is to be expected. This is especially apparent on natural woods which have no stain applied, for example 3525 Natural Maple. This color variation is normal and reflects the unique and natural properties of wood. This should not be considered a defect.

Stain swatches are reproduced in the Surface Materials Color Palettes.

▶ See *Coalesse Surface Materials Reference Guide* for a list.

Swatch cards and actual samples of standard wood veneers are available from your Customer Service representative.

Stain-to-Match is available on this product and allows the matching of any wood finish with a one-time charge per finish.

▶ See *Coalesse Surface Materials Reference Guide* for details.

Solid surface is available in white solid.

Glass is available in six colors.

Table bases are available in polished matte aluminum. Refer to the individual product specifying pages for availability.

Cable trays are painted 4141 Platinum Matte to coordinate with the table bases in polished aluminum. Simple power is available in 6000 Black plastic and 6052 Milk plastic. Performance power is a painted plate and corresponding plastic receptacles. Paint available is 4242 Milk, 4710 Low Gloss Black, and 4141 Platinum Matte.

Care and Maintenance

Laminate should be cleaned with soap and water. For stubborn stains, use a non-abrasive household cleaner.

Veneers should be cleaned regularly with mild soap and water and dried with a soft cloth. To polish, use silicone-free household polishers. Use sparingly.

Tip: Never use ammonia-based cleaners or wax on wood surfaces.

Polished aluminum finishes on table bases should be cleaned with a commercial powder, liquid, or paste metal cleaner and polish. Follow the manufacturer's directions.

Tables should be inspected and maintained regularly by tightening screws and bolts, inspecting glides for damage, and inspecting all moving parts for damage and wear.

Solid surface should be cleaned regularly with mild soap and water. Dry with a soft cloth.

SW_1 Table and Tablet Surfaces:

Clean with soft cloth dampened with water and soap, if needed. The use of general purpose cleaners are acceptable but must be void of citric content that has butoxyethanol in the formulation listing.

Seating Capacity Guidelines

Length	Width	Approximate Capacity Chairs and Lounges (Unless Noted)
Round Tops		
30" dia.		3
36" dia.		4
42" dia.		4
48" dia.		5
60" dia.		5
72" dia.		6
84" dia.		7
96" dia.		8
Square Tops		
30"	30"	4
36"	36"	4
42"	42"	4
60"	60"	8
72"	72"	8
84"	84"	8
96"	96"	12 chairs, 8 lounge
Rectangular Tops		
60"	30"	6
72"	36"	6
60"	36"	6
72"	36"	6
84"	42"	6
96"	42"	8
120"	42"	8 lounge
96"	48"	8
120"	48"	10
144"	48"	10
Super-Elliptical Tops		
60"	40"	6
72"	40"	6
84"	40"	6
96"	40"	8 chairs, 6 lounge
120"	44"	8
144"	48"	10
168"	52"	12
192"	56"	12
216"	60"	14
240"	60"	16

- **Low conference configuration with lounge seating** challenges the conventional relationship between the lounge chair and table. The lowered table height creates a more casual and social work setting which encourages collaboration and comfort.



- **The diamond shape configuration** creates a collaborative lounge instead of a conference room. Everyone is on a corner, there are no middle seats. The smaller tables are easier to reconfigure and expand, which simplifies facility planning.

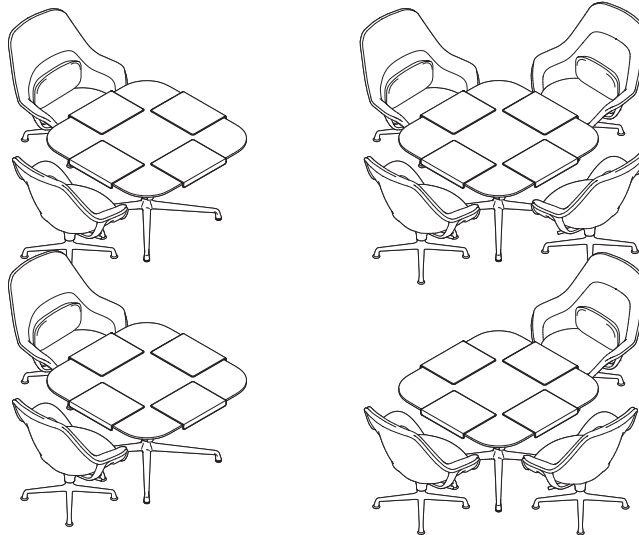

SW_1 Collaborative and Conference Tables Applications

- **Occasional table configuration** works in lobbys, enclaves, or small meeting areas.

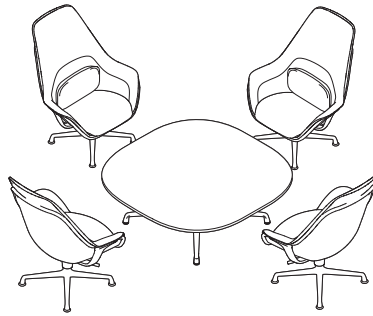

- **Work tables** can be placed into any setting as the main work or meeting area.

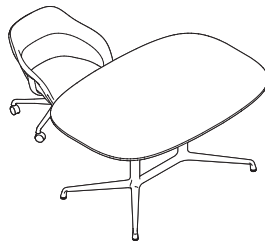

- **Standard height conference tables** are an elegant way to host meetings with a range of technology needs.

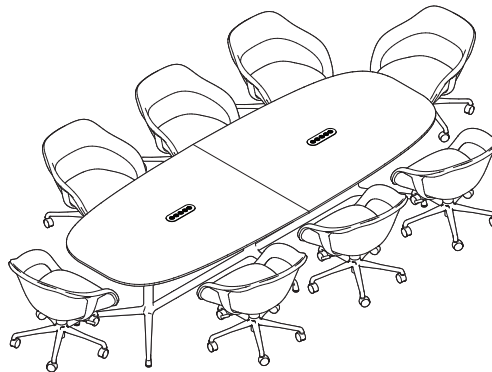





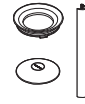

SW_1 Collaborative and Conference Tables Base Matrix

Base Matrix





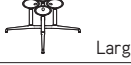



Size **Base Type** **PowerPod Grommet with Wire Manager**

Round

30" diameter	 4-star without cone	N.A.
36" diameter	 4-star without cone	N.A.
42" diameter	 4-star	1 (center) ☉
48" diameter	 4-star	1 (center) ☉
60" diameter	 Large round/square base with single leg configuration	1 or 2 ☉ or ☺
72" diameter	 Large round/square base with single leg configuration	1 or 2 ☉ or ☺
84" diameter	 Large round/square base with V-leg configuration	2 or 4 ☺ or ☻
96" diameter	 Large round/square base with V-leg configuration	2 or 4 ☺ or ☻

Square

30" x 30"	 4-star without cone	N.A.
36" x 36"	 4-star without cone	N.A.
42" x 42"	 4-star	1 (center) ☐
60" x 60"	 Large round/square base with single leg configuration	1 or 2 ☐ or ☑
72" x 72"	 Large round/square base with single leg configuration	1 or 2 ☐ or ☑
84" x 84"	 Large round/square base with V-leg configuration	2 or 4 ☑ or ☒
96" x 96"	 Large round/square base with V-leg configuration	2 or 4 ☑ or ☒

Square-Square

45½" x 45½"	 4-star	1 (center) ☉
-------------	--	--------------

SW_1 Collaborative and Conference Tables Base Matrix

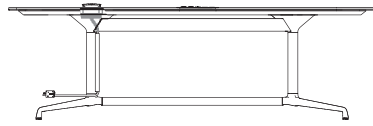

Simple Power Module with Wire Manager

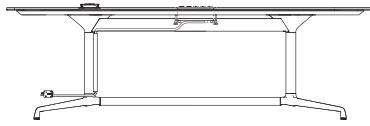

Performance Power Module with Wire Manager or Mesh Cord Cover

N.A.

N.A.

N.A.

N.A.

1 (center) ☉

N.A.

1 (center) ☉

N.A.

1 or 2 ☺ or ☻

N.A.

1 or 2 ☺ or ☻

N.A.

2 or 4 ☺ or ☻

N.A.

2 or 4 ☺ or ☻

N.A.

N.A.

N.A.

N.A.

N.A.

1 (center) ☐

N.A.

1 or 2 ☐ or ☐

N.A.

1 or 2 ☐ or ☐

N.A.

2 or 4 ☐ or ☐

N.A.

2 or 4 ☐ or ☐

N.A.

1 (center) ☉

N.A.

Base Matrix

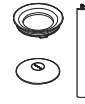





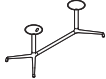
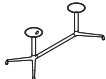
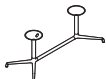
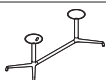
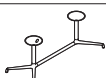
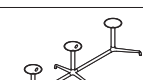

PowerPod Grommet with Wire Manager

Size

Base Type

Rectangular

30" x 60"	 2 V-bases	1 (end) or 2 (outer ends) <input type="checkbox"/> or <input type="checkbox"/>
30" x 72"	 2 V-bases	1 (end) or 2 (outer ends) <input type="checkbox"/> or <input type="checkbox"/>
36" x 60"	 2 V-bases	1 (end) or 2 (outer ends) <input type="checkbox"/> or <input type="checkbox"/>
36" x 72"	 2 V-bases	1 (end) or 2 (outer ends) <input type="checkbox"/> or <input type="checkbox"/>
42" x 84"	 2 V-bases	1 (end) or 2 (outer ends) <input type="checkbox"/> or <input type="checkbox"/>
42" x 120" (laminated, veneer, and solid surface)	 2 V-bases, 1 in-line	1 (center) or 2 (outer ends) <input type="checkbox"/> or <input type="checkbox"/>
42" x 120" (glass)	 2 V-bases, 1 in-line	1 (center) or 2 (outer ends) <input type="checkbox"/> or <input type="checkbox"/>
48" x 96" (laminated and veneer)	 2 V-bases	1 (end) or 2 (outer ends) <input type="checkbox"/> or <input type="checkbox"/>
48" x 96" (solid surface and glass)	 2 V-bases, 1 in-line	1 (center) or 2 (outer ends) <input type="checkbox"/> or <input type="checkbox"/>
48" x 120" (laminated, veneer, and solid surface)	 2 V-bases, 1 in-line	1 (center) or 2 (outer ends) <input type="checkbox"/> or <input type="checkbox"/>
48" x 120" (glass)	 2 V-bases, 1 in-line	1 (center) or 2 (outer ends) <input type="checkbox"/> or <input type="checkbox"/>
48" x 144" (laminated and veneer)	 2 V-bases, 1 in-line	1 (center) or 2 (outer ends) <input type="checkbox"/> or <input type="checkbox"/>

SW_1 Collaborative and Conference Tables Base Matrix

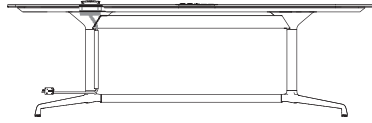

Simple Power Module with Wire Manager

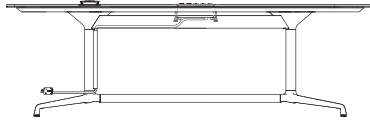

Performance Power Module with Wire Manager or Mesh Cord Cover

1 (end) or 2 (outer ends) or

N.A.

1 (end) or 2 (outer ends) or

1 (center)

1 (end) or 2 (outer ends) or

N.A.

1 (end) or 2 (outer ends) or

1 (center)

1 (end) or 2 (outer ends) or

1 (center)

1 (center) or 2 (outer ends) or

1 (end) or 2 (center) or

1 (center) or 2 (outer ends) or

2 (center)

1 (end) or 2 (outer ends) or

1 (center)

1 (center) or 2 (outer ends) or

N.A.

1 (center) or 2 (outer ends) or

1 (end) or 2 (center) or

1 (center) or 2 (outer ends) or

2 (center)

1 (center) or 2 (outer ends) or

1 (center) or 2 (center) or

Base Matrix

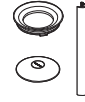

Size

Base Type

PowerPod Grommet with Wire Manager

Rectangular, continued

48" x 144" (solid surface and glass)		2 V-bases, 2 in-line	2 (in-line) or 2 (outer ends)  or 
--------------------------------------	---	----------------------	--

Super-Elliptical

40" x 60"		2 V-bases	1 (end) or 2 (outer ends)  or 
-----------	---	-----------	--

40" x 72"		2 V-bases	1 (end) or 2 (outer ends)  or 
-----------	---	-----------	--



40" x 84"		2 V-bases	1 (end) or 2 (outer ends)  or 
-----------	--	-----------	--

40" x 96" (laminated and veneer)		2 V-bases	1 (end) or 2 (outer ends)  or 
----------------------------------	---	-----------	--

40" x 96" (solid surface and glass)		2 V-bases, 1 in-line	1 (center) or 2 (outer ends)  or 
-------------------------------------	---	----------------------	---

44" x 120" (laminated, veneer and solid surface)		2 V-bases, 1 in-line	1 (center) or 2 (outer ends)  or 
--	---	----------------------	---

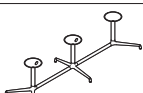
44" x 120" (glass)		2 V-bases, 1 in-line	1 (center) or 2 (outer ends)  or 
--------------------	---	----------------------	---

48" x 144" (laminated and veneer)		2 V-bases, 1 in-line	1 (center) or 2 (outer ends)  or 
-----------------------------------	---	----------------------	---

SW_1 Collaborative and Conference Tables Base Matrix

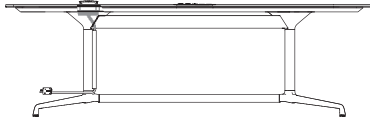

Simple Power Module with Wire Manager

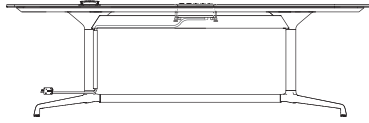

Performance Power Module with Wire Manager or Mesh Cord Cover

2 (in-line) or 2 (outer ends) or

1 (center) or 2 (outer ends) or 3 (outer ends and center) or or

1 (end) or 2 (outer ends) or

N.A.

1 (end) or 2 (outer ends) or

N.A.

1 (end) or 2 (outer ends) or

1 (center)

1 (end) or 2 (outer ends) or

1 (center)

1 (center) or 2 (outer ends) or

N.A.

1 (center) or 2 (outer ends) or

1 (end) or 2 (center) or

1 (center) or 2 (outer ends) or

2 (center)

1 (center) or 2 (outer ends) or

1 (end) or 2 (center) or

Base Matrix

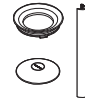

Size

Base Type

PowerPod Grommet with Wire Manager

Super-Elliptical, continued

48" x 144" (solid surface and glass)		2 V-bases, 2 in-line	2 (in-line) or 2 (outer ends) or
--------------------------------------	--	----------------------	-----------------------------------

52" x 168"		2 V-bases, 2 in-line	2 (in-line) or 2 (outer ends) or
------------	--	----------------------	-----------------------------------

56" x 192"		2 V-bases, 2 in-line	2 (in-line) or 2 (outer ends) or
------------	--	----------------------	-----------------------------------

60" x 216"		2 V-bases, 3 in-line	2 (in-line) or 2 (outer ends) or 3 (outer ends and center) or or
------------	--	----------------------	--

60" x 240"		2 V-bases, 3 in-line	2 (in-line) or 2 (outer ends) or 3 (outer ends and center) or or
------------	--	----------------------	--

SW_1 Collaborative and Conference Tables Base Matrix

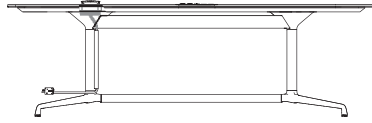

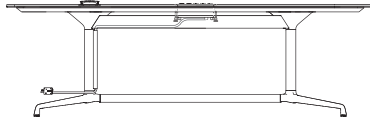

Simple Power Module with Wire Manager





Performance Power Module with Wire Manager or Mesh Cord Cover



2 (in-line) or 2 (outer ends)  or 



1 (center) or 2(outer ends) or 3 (outer ends and center)  or  or 



2 (in-line) or 2 (outer ends)  or 



1 (center) or 2(outer ends) or 3 (outer ends and center)  or  or 



2 (in-line) or 2 (outer ends)  or 

1 (center) or 2(outer ends) or 3 (outer ends and center)  or  or 

2 (in-line) or 2 (outer ends) or 3 (outer ends and center)  or  or 

1 (end) or 2 (outer ends) or 4 (outer ends and center)  or  or 

2 (in-line) or 2 (outer ends) or 3 (outer ends and center)  or  or 

1 (end) or 2 (outer ends) or 4 (outer ends and center)  or  or 

SW_1 Collaborative and Conference Tables Leg Locations

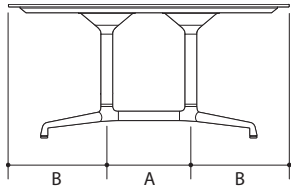

Style Number A B C

COW_RT3060	18"	21"	N.A.
COW_RT3072	30"	21"	N.A.
COW_RT3660	18"	21"	N.A.
COW_RT3672	30"	21"	N.A.
COW_RC4284	42"	21"	N.A.
COWX_R4284	42"	21"	N.A.
COWLRC4896	54"	21"	N.A.
COWVRC4896	54"	21"	N.A.
COW_SE4060	13 ¹ / ₄ "	23 ³ / ₈ "	N.A.
COW_SE4072	25 ¹ / ₈ "	23 ⁷ / ₁₆ "	N.A.
COWX_SE4072	25 ¹ / ₈ "	23 ⁷ / ₁₆ "	N.A.
COW_SEC84	37 ¹ / ₈ "	23 ⁷ / ₁₆ "	N.A.
COWX_SE4084	37 ¹ / ₈ "	23 ⁷ / ₁₆ "	N.A.
COWXLSE4096	48 ¹³ / ₁₆ "	23 ¹⁹ / ₃₂ "	N.A.
COWXVSE4096	48 ¹³ / ₁₆ "	23 ¹⁹ / ₃₂ "	N.A.
COWLSEC96	48 ¹³ / ₁₆ "	23 ¹⁹ / ₃₂ "	N.A.
COWVSEC96	48 ¹³ / ₁₆ "	23 ¹⁹ / ₃₂ "	N.A.

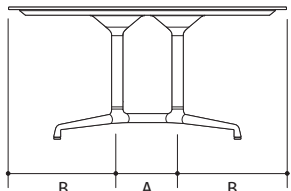

Style Number A B

COW_RND60	13 ¹ / ₁₆ "	23 ¹⁵ / ₃₂ "
COWX_RND60	13 ¹ / ₁₆ "	23 ¹⁵ / ₃₂ "
COW_RND72	21 ²³ / ₃₂ "	25 ⁹ / ₆₄ "
COWX_RND72	21 ²³ / ₃₂ "	25 ⁹ / ₆₄ "
COW_SQ60	13 ¹ / ₁₆ "	23 ¹⁵ / ₃₂ "
COWX_SQ60	13 ¹ / ₁₆ "	23 ¹⁵ / ₃₂ "
COW_SQ72	26 ⁵ / ₁₆ "	22 ²⁷ / ₃₂ "
COWX_SQ72	26 ⁵ / ₁₆ "	22 ²⁷ / ₃₂ "

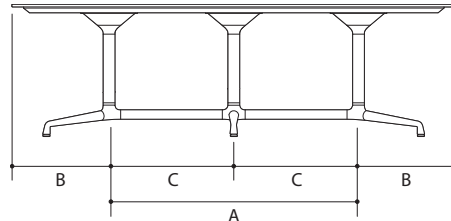

Style Number A B C

COWCRC4896	54"	21"	27"
COWGRC4896	54"	21"	27"
COWXCSE4096	50 ¹ / ₄ "	22 ⁷ / ₈ "	25 ¹ / ₈ "
COWXGSE4096	50 ¹ / ₄ "	22 ⁷ / ₈ "	25 ¹ / ₈ "
COWCSEC96	50 ¹ / ₄ "	22 ⁷ / ₈ "	25 ¹ / ₈ "
COWGSEC96	50 ¹ / ₄ "	22 ⁷ / ₈ "	25 ¹ / ₈ "
COW_RC48120	78"	21"	39"
COW_RC48122	78"	21"	39"
COWX_R4120	78"	21"	39"
COW_SEC120	74 ¹ / ₄ "	22 ⁷ / ₈ "	37 ¹ / ₈ "
COWX_SE4120	74 ¹ / ₄ "	22 ⁷ / ₈ "	37 ¹ / ₈ "
COW_SEC122	74 ¹ / ₄ "	22 ⁷ / ₈ "	37 ¹ / ₈ "
COWX_SE4122	74 ¹ / ₄ "	22 ⁷ / ₈ "	37 ¹ / ₈ "
COWLRC48144	102"	21"	51"
COWVRC43144	102"	21"	51"
COWLSEC144	97 ⁵ / ₈ "	23 ³ / ₁₆ "	48 ¹³ / ₁₆ "
COWVSEC144	97 ⁵ / ₈ "	23 ³ / ₁₆ "	48 ¹³ / ₁₆ "

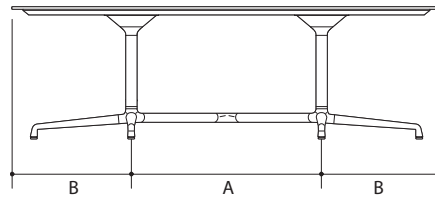

Style Number A B

COW_RND84	29 ¹³ / ₆₄ "	35 ¹⁹ / ₃₂ "
COWX_RND84	29 ¹³ / ₆₄ "	35 ¹⁹ / ₃₂ "
COW_RND96	30 ¹⁵ / ₃₂ "	35 ³ / ₆₄ "
COWX_RND96	30 ¹⁵ / ₃₂ "	35 ³ / ₆₄ "
COW_SQ84	23 ⁵ / ₈ "	36 ³ / ₄ "
COWX_SQ84	23 ⁵ / ₈ "	36 ³ / ₄ "
COW_SQ96	26 ³ / ₆₄ "	43"
COWX_SQ96	26 ³ / ₆₄ "	43"

SW_1 Collaborative and Conference Tables Leg Locations

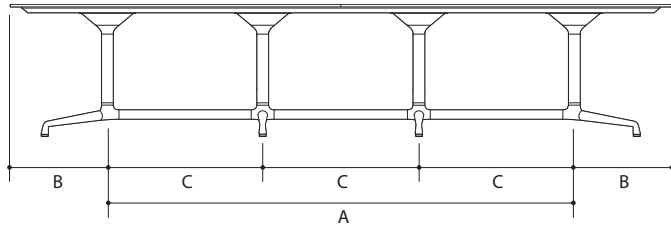

Style Number	A	B	C
COWCRC48144	102"	21"	34"
COWGRC48144	102"	21"	34"
COWCSEC144	98 ¹ / ₄ "	22 ⁷ / ₈ "	32 ³ / ₄ "
COWGSEC144	98 ¹ / ₄ "	22 ⁷ / ₈ "	32 ³ / ₄ "
COWLSEC168	126"	21"	42"
COWVSEC168	126"	21"	42"
COWLSEC192	146 ⁷ / ₁₆ "	22 ²⁵ / ₃₂ "	48 ¹³ / ₁₆ "
COWVSEC192	146 ⁷ / ₁₆ "	22 ²⁵ / ₃₂ "	48 ¹³ / ₁₆ "

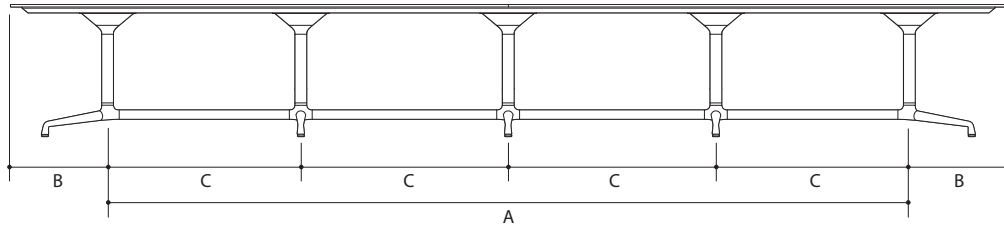

Style Number	A	B	C
COWLSEC216	168"	24"	42"
COWVSEC216	168"	24"	42"
COWLSEC213	168"	24"	42"
COWVSEC213	168"	24"	42"
COWLSEC240	195 ¹ / ₄ "	22 ³ / ₈ "	48 ¹³ / ₁₆ "
COWVSEC240	195 ¹ / ₄ "	22 ³ / ₈ "	48 ¹³ / ₁₆ "
COWLSEC243	195 ¹ / ₄ "	22 ³ / ₈ "	48 ¹³ / ₁₆ "
COWVSEC243	195 ¹ / ₄ "	22 ³ / ₈ "	48 ¹³ / ₁₆ "

SW_1 Collaborative and Conference Tables

SW_1 Collaborative and Conference Tables Low Collaborative Conference Tables

DESIGN SCOTT WILSON & MINIMAL



Tip: Your specification is not complete until you add the fifth letter to the style number to define top surface.

- L** - Laminate top
- V** - Wood veneer top
- C** - Solid surface top
- G** - Glass top

Tip: Glass tops are not secured to the substructure. Glass tops are placed on rubber pads that are adhered to the substructure. If the glass tables need to be moved, remove the glass top prior to moving the table.

Tip: Performance power available on select tables.
 ▶ See Base Matrix on page 582 for details.

Tip: Standard grain direction runs the width of the table (front-to back).

Tip: The wire manager finish is not selectable, it will be the same as the substructure finish choice.

Tip: Multiple power units of the same type can be specified with independent power configurations.

Tip: Power ganging is only available when two or more simple or performance power modules are specified.

Veneer direction



For Canadian Pricing
 Multiply U.S. Price by the Canadian price factor.
 ▶ See page 1 for details.

Standard Includes	Required to Specify
<ul style="list-style-type: none"> ▶ Need help? Product details, page 576 • 1/2" thick top surface: <ul style="list-style-type: none"> - Laminate (grade 1) with 3 mm edge band, if selected - Wood veneer (grade 1) with matching 3 mm edge band, if selected - Solid surface, if selected: white only - Glass, if selected • 1/4" thick bottom substructure: black or milk • Base, column, and cone: 8040 Polished Matte Aluminum • Glides • Ships ready-to-assemble 	<ol style="list-style-type: none"> 1 Style number with appropriate top series letter indicated in the space provided. (For example: COWX_Q42 becomes COWXLQ42 for a laminate top surface): <ul style="list-style-type: none"> L - Laminate top V - Wood veneer top C - Solid surface top G - Glass top 2 Laminate, wood, or glass color number for top, if selected 3 Plastic color for edge band of laminate top, if selected 4 Bottom substructure: <ul style="list-style-type: none"> 6000 Black 6052 Milk 5 Options, if selected (see below) ▶ See <i>Coalesse Surface Materials Reference Guide</i> .

Options	U.S. Price	Required to Specify
Surface Materials <ul style="list-style-type: none"> Laminate <ul style="list-style-type: none"> • Grade 2 laminate • Grade 3 laminate Wood <ul style="list-style-type: none"> • Grade 2 wood veneer Performance Power Module <ul style="list-style-type: none"> • Brushed metal finish 	Prices at right Prices at right Prices at right +\$ 85	Specify with <i>grade 2 laminate</i> and select color number. Specify with <i>grade 3 laminate</i> and select color number. Specify with <i>grade 2 wood veneer</i> and select color number. Specify with <i>9242 Brushed Metal</i> .
Wood Veneer Grain Direction <ul style="list-style-type: none"> • Lengthwise grain direction for tops up to 96"L 	No cost	Specify with <i>lengthwise grain direction</i> .
Technology Devices and Grommets <ul style="list-style-type: none"> Power Grommet with Wire Manager <ul style="list-style-type: none"> • PowerPod grommet Simple Power Module with Wire Manager <ul style="list-style-type: none"> • Three power • Two power/one USB Performance Power Module with Wire Manager <ul style="list-style-type: none"> • Two power/one AAP • One power/one USB/one AAP • Three power/two USB 	+\$ 301 each grommet +\$ 469 each module +\$ 588 each module +\$ 826 each module +\$ 945 each module +\$1063 each module	Specify with <i>PowerPod</i> and select count, location, and finish. ▶ See page 580 for count and location options. Specify with <i>three power, device count, device location</i> and select finish. ▶ See page 580 for count and location options. Specify with <i>two power/one USB, device count, device location</i> and select finish. ▶ See page 580 for count and location options. Specify with <i>two power/one AAP, device count, device location</i> and select finish. ▶ See page 580 for count and location options. Specify with <i>two power/one USB/one AAP, device count, device location</i> and select finish. ▶ See page 580 for count and location options. Specify with <i>three power/two USB, device count, device location</i> and select finish. ▶ See page 580 for count and location options.
Power Infeed <ul style="list-style-type: none"> Performance and Power Module <ul style="list-style-type: none"> • Hardwire • 15-amp plug 	+\$ 77 No cost	Specify with <i>hardwire infeed</i> . Specify with <i>plug infeed</i> .

▶ Options, continued on next page

SW_1 Collaborative and Conference Tables Low Collaborative Conference Tables

DESIGN SCOTT WILSON & MINIMAL

Tip: When power ganging is specified, only one vertical wire manager is supplied.

Tip: Cable management tray is only available when power is specified.

Tip: If the table has a cable tray, it will be painted 4141 Platinum Matte to coordinate with the base.

Tip: Tablets are an optional pick for the 42" and 84" square and 84"L and 120"L rectangular tables only. Tablets are available in black or milk finish.

► Options, continued from previous page

	Options	U.S. Price	Required to Specify
Power Ganging	<ul style="list-style-type: none"> Performance and Simple Power Module Ganged Individual 	<ul style="list-style-type: none"> No cost No cost 	<ul style="list-style-type: none"> Specify with ganged power. Specify with individual power.
Cable Management Tray	<ul style="list-style-type: none"> Rectangular Tables 84"L rectangular table 120"L rectangular table Super-Elliptical Tables 72"L super-elliptical table 84"L super-elliptical table 96"L super-elliptical table 120"L super-elliptical table 	<ul style="list-style-type: none"> +\$ 268 +\$ 470 +\$ 244 +\$ 268 +\$ 327 +\$ 470 	<ul style="list-style-type: none"> Specify with cable management tray. Specify with cable management tray. Specify with cable management tray. Specify with cable management tray. Specify with cable management tray. Specify with cable management tray.
Tablets	<ul style="list-style-type: none"> 42" square tables Two tablets: black or milk plastic Four tablets: black or milk plastic 84"L rectangular tables Six tablets: black or milk plastic 84" square table and 120"L rectangular tables Eight tablets: black or milk plastic 	<ul style="list-style-type: none"> +\$1424 +\$2847 +\$4271 +\$5694 	<ul style="list-style-type: none"> Specify with two tablets and select plastic color number. Specify with four tablets and select plastic color number. Specify with six tablets and select plastic color number. Specify with eight tablets and select plastic color number.
Related Products	<ul style="list-style-type: none"> Accessories PowerPod Occasional tables Lounge seating Collaboration seating Guest seating 		<ul style="list-style-type: none"> ► Page 605 ► Page 604 ► Page 702 ► See Coalesse Seating Specification Guide. ► See Coalesse Seating Specification Guide. ► See Coalesse Seating Specification Guide.

► Specification Information, on next page

Veneer direction

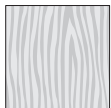

For Canadian Pricing
 Multiply U.S. Price by the Canadian price factor.
 ► See page 1 for details.

SW_1 Collaborative and Conference Tables Low Collaborative Conference Tables *continued*

DESIGN SCOTT WILSON & MINIMAL

► Options, on previous page

Specification Information

Tip: Your specification is not complete until you add the fifth letter to the style number to define top surface.

- L** - Laminate top
- V** - Wood veneer top
- C** - Solid surface top
- G** - Glass top

Tip: Glass tops are not secured to the substructure. Glass tops are placed on rubber pads that are adhered to the substructure. If the glass tables need to be moved, remove the glass top prior to moving the table.

Tip: 60" round table top is 59 1/2"D when solid surface is selected.

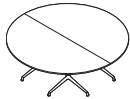
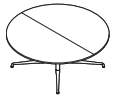

Tip: 60" and 72" round and square table base consists of four single legs. The 84" and 96" round and square table base consists of four v-legs.



Tip: Tablets are an optional pick for the 42" square tables only.

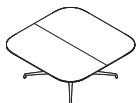

Dimensions		Style Number	# of (optional) Tablets	U.S. Base Prices							
L	W H			Laminate		Veneer		Wedge Veneer Layout		Solid Surface	Glass
				Grade 1	Grade 2 and 3	Grade 1	Grade 2	Grade 1	Grade 2		

Large-Round Tables

One-Piece Top

60" dia	26"	COWX_RND60	N.A.	\$4685	\$4847	\$ 6568	\$ 7145	\$11,050	\$11,590	\$ 9841	\$11,732
---------	-----	------------	------	--------	--------	---------	---------	----------	----------	---------	----------

Two-Piece Top

72" dia	26"	COWX_RND72	N.A.	\$6003	\$6207	\$ 8636	\$ 9392	\$14,527	\$15,238	\$12,609	\$15,008
---------	-----	------------	------	--------	--------	---------	---------	----------	----------	----------	----------

84" dia	26"	COWX_RND84	N.A.	\$7481	\$7738	\$10,905	\$11,866	\$18,351	\$19,272	\$17,944	\$20,567
---------	-----	------------	------	--------	--------	----------	----------	----------	----------	----------	----------

96" dia	26"	COWX_RND96	N.A.	\$9371	\$9694	\$13,808	\$15,022	\$23,235	\$24,367	\$19,673	\$23,422
---------	-----	------------	------	--------	--------	----------	----------	----------	----------	----------	----------

Square Table

42"	42"	26"	COWX_Q42	2 or 4	\$3023	\$3110	\$ 4317	\$ 4669	N.A.	N.A.	\$ 4495	\$ 6118
-----	-----	-----	----------	--------	--------	--------	---------	---------	------	------	---------	---------

Large-Square Tables

One-Piece Top

60"	60"	26"	COWX_SQ60	N.A.	\$4822	\$4987	\$ 6750	\$ 7344	N.A.	N.A.	\$10,114	\$12,280
-----	-----	-----	-----------	------	--------	--------	---------	---------	------	------	----------	----------

Two-Piece Top

72"	72"	26"	COWX_SQ72	N.A.	\$6140	\$6354	\$ 8815	\$ 9590	N.A.	N.A.	\$12,883	\$15,553
-----	-----	-----	-----------	------	--------	--------	---------	---------	------	------	----------	----------

84"	84"	26"	COWX_SQ84	8	\$7616	\$7877	\$11,090	\$12,063	N.A.	N.A.	\$18,220	\$21,111
-----	-----	-----	-----------	---	--------	--------	----------	----------	------	------	----------	----------

96"	96"	26"	COWX_SQ96	N.A.	\$9505	\$9832	\$13,989	\$15,215	N.A.	N.A.	\$19,947	\$23,968
-----	-----	-----	-----------	------	--------	--------	----------	----------	------	------	----------	----------

► Specification Information, continued on next page

SW_1 Collaborative and Conference Tables Low Collaborative Conference Tables

DESIGN SCOTT WILSON & MINIMAL

Tip: Your specification is not complete until you add the fifth letter to the style number to define top surface.

- L** - Laminate top
- V** - Wood veneer top
- C** - Solid surface top
- G** - Glass top

Tip: Glass tops are not secured to the substructure. Glass tops are placed on rubber pads that are adhered to the substructure. If the glass tables need to be moved, remove the glass top prior to moving the table.



Tip: 96"L solid surface and glass tables require a center in-line leg as standard. The 96"L laminate and veneer tables do not require a center in-line leg for support. Refer to base matrix, page 582.

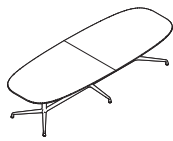

► Specification Information, continued from previous page

Specification Information

Dimensions			Style Number	# of (optional) Tablets	U.S. Base Prices				
L	W	H			Laminate Grade 1	Grade 2 and 3	Veneer Grade 1	Grade 2	Solid Surface

Rectangular Tables

84"	42"	26"	COWX_R4284	6	\$4367	\$4544	\$ 5910	\$ 6569	\$10,192	\$11,992
120"	42"	26"	COWX_R4120	8	\$6083	\$6330	\$ 9720	\$10,688	\$17,113	\$21,072

Super-Elliptical Tables

One-Piece Top

72"	40"	26"	COWX_SE4072	N.A.	\$3468	\$3608	\$ 5125	\$ 5661	\$ 9921	\$11,722
84"	40"	26"	COWX_SE4084	N.A.	\$4458	\$4635	\$ 6118	\$ 6777	\$10,457	\$12,261
96"	40"	26"	COWX_SE4096	N.A.	\$5090	\$5283	\$ 6750	\$ 7540	\$11,001	\$13,162
120"	44"	26"	COWX_SE4120	N.A.	\$6261	\$6529	\$ 9902	\$10,955	\$17,474	\$21,433

*Tables are only available as an option on square tables.

Two-Piece Top

120"	44"	26"	COWX_SE4122	N.A.	\$6804	\$7072	\$10,444	\$11,497	\$18,011	\$21,972
------	-----	-----	-------------	------	--------	--------	----------	----------	----------	----------



For Canadian Pricing
 Multiply U.S. Price by the Canadian price factor.
 ► See page 1 for details.

SW_1 Collaborative and Conference Tables Conference Tables

DESIGN SCOTT WILSON & MINIMAL



Tip: Your specification is not complete until you add the fifth letter to the style number to define top surface.

- L - Laminate top
- V - Wood veneer top
- C - Solid surface top
- G - Glass top

Tip: Glass tops are not secured to the substructure. Glass tops are placed on rubber pads that are adhered to the substructure. If the glass tables need to be moved, remove the glass top prior to moving the table.

Veneer direction



Tip: Standard grain direction runs the width of the table (front-to-back).

Tip: The wire manager finish is not selectable, it will be the same as the substructure finish choice.

Tip: Performance power available on select tables.
▶ See Base Matrix on page 582 for details.

Tip: Power ganging is only available when two or more simple or performance power modules are specified.

Tip: When power ganging is specified, only one vertical wire manager is supplied.

Standard Includes	Required to Specify
<p>▶ Need help? Product details, page 576</p> <ul style="list-style-type: none"> 1/2" thick top surface: <ul style="list-style-type: none"> - Laminate (grade 1) with 3 mm edge band, if selected - Wood veneer (grade 1) with matching 3 mm edge band, if selected - Solid surface, if selected: white only - Glass, if selected 1/4" thick bottom substructure: black or milk Base, column and cone: 8040 Polished Matte Aluminum Glides Ships ready-to assemble 	<ol style="list-style-type: none"> 1 Style number with appropriate top series letter indicated in the space provided. (For example: COW_RC4284 becomes COWLRC4284 for a laminate top surface): <ul style="list-style-type: none"> L - Laminate top V - Wood veneer top C - Solid surface top G - Glass top 2 Laminate, wood, or glass color number for top, if selected 3 Plastic color for edge band of laminate top, if selected 4 Bottom substructure: <ul style="list-style-type: none"> 6000 Black 6052 Milk 5 Options, if selected (see below) <p>▶ See <i>Coalesse Surface Materials Reference Guide</i>.</p>

Options	U.S. Price	Required to Specify
<p>Surface Materials</p> <ul style="list-style-type: none"> Grade 2 laminate Grade 3 laminate <p>Wood</p> <ul style="list-style-type: none"> Grade 2 wood veneer <p>Performance Power Module</p> <ul style="list-style-type: none"> Brushed metal finish 	<p>Prices at right</p> <p>Prices at right</p> <p>Prices at right</p> <p>+\$ 85</p>	<p>Specify with <i>grade 2 laminate</i> and select color number.</p> <p>Specify with <i>grade 3 laminate</i> and select color number.</p> <p>Specify with <i>grade 2 wood veneer</i> and select color number.</p> <p>Specify with <i>9242 Brushed Metal</i>.</p>
<p>Wood Veneer Grain Direction</p> <ul style="list-style-type: none"> Length wise grain direction for rectangular and super-elliptical tops up to 96"L 	No cost	Specify with <i>lengthwise grain direction</i> .
<p>Technology Devices and Grommets</p> <ul style="list-style-type: none"> Power Grommet with Wire Manager PowerPod grommet Simple Power Module with Wire Manager Three power Two power/one USB Performance Power Module with Wire Manager Two power/one AAP One power/one USB/one AAP Three power/two USB 	<p>+\$ 301 each grommet</p> <p>+\$ 469 each module</p> <p>+\$ 588 each module</p> <p>+\$ 826 each module</p> <p>+\$ 945 each module</p> <p>+\$1063 each module</p>	<p>Specify with <i>PowerPod</i> and select count, location, and finish</p> <p>▶ See page 580 for count and location options.</p> <p>Specify with <i>three power, device count, device location</i> and select finish.</p> <p>▶ See page 580 for count and location options.</p> <p>Specify with <i>two power/one USB, device count, device location</i> and select finish.</p> <p>▶ See page 580 for count and location options.</p> <p>Specify with <i>two power/one AAP, device count, device location</i> and select finish.</p> <p>▶ See page 580 for count and location options.</p> <p>Specify with <i>two power/one USB/one AAP, device count, device location</i> and select finish.</p> <p>▶ See page 580 for count and location options.</p> <p>Specify with <i>three power/two USB, device count, device location</i> and select finish.</p> <p>▶ See page 580 for count and location options.</p>
<p>Power Infeed</p> <ul style="list-style-type: none"> Hardwire 15-amp plug 	<p>+\$ 77</p> <p>No cost</p>	<p>Specify with <i>hardwire infeed</i>.</p> <p>Specify with <i>plug infeed</i>.</p>
<p>Power Ganging</p> <ul style="list-style-type: none"> Ganged Individual 	<p>No cost</p> <p>No cost</p>	<p>Specify with <i>ganged power</i>.</p> <p>Specify with <i>individual power</i>.</p>

▶ Options, continued on next page

SW_1 Collaborative and Conference Tables Conference Tables

DESIGN SCOTT WILSON & MINIMAL

Tip: Cable management tray is only available when power is specified.

Tip: If the table has a cable tray, it will be painted 4141 Platinum Matte to coordinate with the base.

Veneer direction

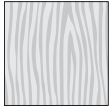

Tip: Your specification is not complete until you add the fifth letter to the style number to define top surface.

- L - Laminate top
- V - Wood veneer top
- C - Solid surface top
- G - Glass top

Tip: Glass tops are not secured to the substructure. Glass tops are placed on rubber pads that are adhered to the substructure. If the glass tables need to be moved, remove the glass top prior to moving the table.

Tip: 60" round table top is 59 1/2"D when solid surface is selected.

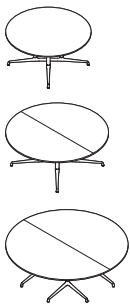

► Options, continued from previous page

Options		U.S. Price	Required to Specify
Cable Management Tray	Rectangular Tables		
	• 84"L rectangular table	+\$268	Specify with cable management tray.
	• 96"L rectangular table	+\$327	Specify with cable management tray.
	• 120"L rectangular table	+\$470	Specify with cable management tray.
	• 144"L rectangular table	+\$529	Specify with cable management tray.
	Super-Elliptical Tables		
	• 72"L super-elliptical table	+\$244	Specify with cable management tray.
	• 84"L super-elliptical table	+\$268	Specify with cable management tray.
	• 96"L super-elliptical table	+\$327	Specify with cable management tray.
	• 120"L super-elliptical table	+\$470	Specify with cable management tray.
	• 144"L super-elliptical table	+\$529	Specify with cable management tray.
	• 168"L super-elliptical table	+\$660	Specify with cable management tray.
	• 192"L super-elliptical table	+\$749	Specify with cable management tray.
	• 216"L super-elliptical table	+\$868	Specify with cable management tray.
• 240"L super-elliptical table	+\$975	Specify with cable management tray.	

Related Products		
• Accessories	► Page 605	
• PowerPod	► Page 604	
• Occasional tables	► Page 702	
• Lounge seating	► See Coalesse Seating Specification Guide.	
• Collaboration seating	► See Coalesse Seating Specification Guide.	
• Guest seating	► See Coalesse Seating Specification Guide.	

Specification Information

Dimensions			Style	U.S. Base Prices							
L	W	H	Number	Laminate		Veneer		Wedge Veneer Layup		Solid Surface	Glass
				Grade 1	Grade 2 and 3	Grade 1	Grade 2	Grade 1	Grade 2		

Large Round Tables

One-Piece Top

60" diameter	28 1/2"	COW_RND60	\$4685	\$4847	\$ 6568	\$ 7145	\$11,050	\$11,590	\$ 9841	\$11,732
--------------	---------	------------------	--------	--------	---------	---------	----------	----------	---------	----------

Two-Piece Top

72" diameter	28 1/2"	COW_RND72	\$6003	\$6207	\$ 8636	\$ 9392	\$14,527	\$15,238	\$12,609	\$15,008
--------------	---------	------------------	--------	--------	---------	---------	----------	----------	----------	----------

84" diameter	28 1/2"	COW_RND84	\$7481	\$7738	\$10,905	\$11,866	\$18,351	\$19,272	\$17,944	\$20,567
--------------	---------	------------------	--------	--------	----------	----------	----------	----------	----------	----------

96" diameter	28 1/2"	COW_RND96	\$9371	\$9694	\$13,808	\$15,022	\$23,235	\$24,367	\$19,673	\$23,422
--------------	---------	------------------	--------	--------	----------	----------	----------	----------	----------	----------

► Specification Information, continued on next page



For Canadian Pricing
 Multiply U.S. Price by the Canadian price factor.
 ► See page 1 for details.

SW_1 Collaborative and Conference Tables Conference Tables *continued*

DESIGN SCOTT WILSON & MINIMAL

► Specification Information, continued from previous page

Tip: Your specification is not complete until you add the fifth letter to the style number to define top surface.

- L** - Laminate top
- V** - Wood veneer top
- C** - Solid surface top
- G** - Glass top

Tip: Glass tops are not secured to the substructure. Glass tops are placed on rubber pads that are adhered to the substructure. If the glass tables need to be moved, remove the glass top prior to moving the table.

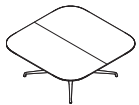

Tip: 60" and 72" round and square table base consists of four single legs. The 84" and 96" round and square table base consists of four v-legs.

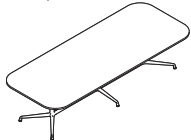

Tip: 96"L solid surface and glass tables require a center in-line leg as standard. The 96"L laminate and veneer tables do not require a center in-line leg for support. Refer to base matrix, page 582.

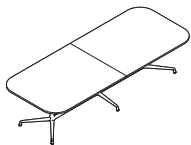

Tip: 144"L and longer are two-piece tops, all three piece tops are noted.

Tip: 144"L solid surface and glass tables require a center in-line leg as standard. The 144"L laminate and veneer tables do not require a center in-line leg for support. Refer to base matrix, page 582.

Specification Information

Dimensions			Style Number	U.S. Base Prices					
L	W	H		Laminate		Veneer	Solid Surface	Glass	
				Grade 1	Grade 2 and 3	Grade 1	Grade 2		

Large Square Tables

One-Piece Top									
60"	60"	28½"	COW_SQ60	\$4822	\$4987	\$ 6750	\$ 7344	\$10,114	\$12,280
Two-Piece Top									
72"	72"	28½"	COW_SQ72	\$6140	\$6354	\$ 8815	\$ 9590	\$12,883	\$15,553
84"	84"	28½"	COW_SQ84	\$7616	\$7877	\$11,090	\$12,063	\$18,220	\$21,111
96"	96"	28½"	COW_SQ96	\$9505	\$9832	\$13,989	\$15,215	\$19,947	\$23,968

Rectangular Tables

One-Piece Top									
84"	42"	28½"	COW_RC4284	\$4367	\$4544	\$ 6030	\$ 6689	\$10,192	\$11,992
96"	48"	28½"	COW_RC4896	\$5000	\$5225	\$ 6659	\$ 7538	\$10,731	\$12,891
120"	48"	28½"	COW_RC48120	\$6083	\$6330	\$ 9720	\$10,688	\$17,113	\$21,072
Two-Piece Top									
120"	48"	28½"	COW_RC48122	\$6624	\$6892	\$10,263	\$11,316	\$17,649	\$21,614
144"	48"	28½"	COW_RC48144	\$7162	\$7498	\$12,243	\$13,563	\$18,909	\$22,875

► Specification Information, continued on next page

SW_1 Collaborative and Conference Tables Conference Tables

DESIGN SCOTT WILSON & MINIMAL

► Specification Information, continued from previous page

Tip: Your specification is not complete until you add the fifth letter to the style number to define top surface.

- L** - Laminate top
- V** - Wood veneer top
- C** - Solid surface top
- G** - Glass top

Tip: Glass tops are not secured to the substructure. Glass tops are placed on rubber pads that are adhered to the substructure. If the glass tables need to be moved, remove the glass top prior to moving the table.

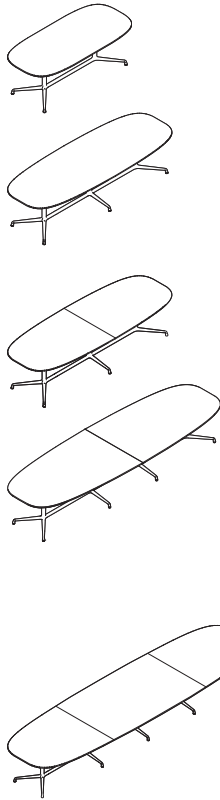

Specification Information

Dimensions			Style Number	U.S. Base Prices				Solid Surface	Glass
L	W	H		Laminate		Veneer			
				Grade 1	Grade 2 and 3	Grade 1	Grade 2		

Super Elliptical Tables

One-Piece Top

84"	40"	28½"	COW_SEC84	\$ 4458	\$ 4635	\$ 6118	\$ 6777	\$10,457	\$12,261
96"	40"	28½"	COW_SEC96	\$ 5090	\$ 5283	\$ 6750	\$ 7540	\$11,001	\$13,162
120"	44"	28½"	COW_SEC120	\$ 6261	\$ 6529	\$ 9902	\$10,955	\$17,474	\$21,433

Two-Piece Top

120"	44"	28½"	COW_SEC122	\$ 6804	\$ 7072	\$10,444	\$11,497	\$18,011	\$21,972
144"	48"	28½"	COW_SEC144	\$ 7341	\$ 7677	\$12,425	\$13,745	\$19,271	\$23,236
168"	52"	28½"	COW_SEC168	\$ 8424	\$ 8850	\$15,316	\$17,321	N.A.	N.A.
192"	56"	28½"	COW_SEC192	\$ 9596	\$10,107	\$18,739	\$21,026	N.A.	N.A.
216"	60"	28½"	COW_SEC216	\$10,857	\$11,474	\$20,723	\$23,310	N.A.	N.A.
240"	60"	28½"	COW_SEC240	\$12,210	\$12,936	\$22,704	\$25,560	N.A.	N.A.

Three-Piece Top

216"	60"	28½"	COW_SEC213	\$11,396	\$12,013	\$21,258	\$23,845	N.A.	N.A.
240"	60"	28½"	COW_SEC243	\$12,750	\$13,476	\$23,243	\$26,099	N.A.	N.A.

SW_1 Collaborative and Conference Tables

For Canadian Pricing
 Multiply U.S. Price by the Canadian price factor.
 ► See page 1 for details.

SW_1 Collaborative and Conference Tables Round, Square, and Super-Square Tables

DESIGN SCOTT WILSON & MINIMAL



Tip: Your specification is not complete until you add the fifth letter to the style number to define top surface.

- L - Laminate top
- V - Wood veneer top
- C - Solid surface top
- G - Glass top

Tip: Glass tops are not secured to the substructure. Glass tops are placed on rubber pads that are adhered to the substructure. If the glass tables need to be moved, remove the glass top prior to moving the table.

Standard Includes	Required to Specify
-------------------	---------------------

► Need help? Product details, page 576

- 1/2" thick top surface:
 - Laminate (grade 1) with 3 mm edge band, if selected
 - Wood veneer (grade 1) with matching 3 mm edge band, if selected
 - Solid surface, if selected: white only
 - Glass, if selected
- 1/4" thick bottom substructure: black or milk
- Base, column, and cone: 8040 Polished Matte Aluminum
- Glides
- Ships ready-to-assemble

- 1 Style number with appropriate top series letter indicated in the space provided. (For example: COW_RND30 becomes COWLRND30 for a laminate top surface):
 - L - Laminate top
 - V - Wood veneer top
 - C - Solid surface top
 - G - Glass top
- 2 Laminate, wood, or glass color number for top, if selected
- 3 Plastic color for edge band of laminate top, if selected
- 4 Bottom substructure:
 - 6000 Black
 - 6052 Milk
- 5 Options, if selected (see below)
 - See *Coalesse Surface Materials Reference Guide*.

Options	U.S. Price	Required to Specify
---------	------------	---------------------

Surface Materials	Options	U.S. Price	Required to Specify
	Laminate		
	• Grade 2 laminate	Prices at right	Specify with <i>grade 2 laminate</i> and select color number.
	• Grade 3 laminate	Prices at right	Specify with <i>grade 3 laminate</i> and select color number.
	Wood		
	• Grade 2 wood veneer	Prices at right	Specify with <i>grade 2 wood veneer</i> and select color number.
	• Grade 1 wedge layup veneer	Prices at right	Specify with <i>grade 1 wedge veneer layup</i> and select color number.
	• Grade 2 wedge layup veneer	Prices at right	Specify with <i>grade 2 wedge veneer layup</i> and select color number.

Tip: If grommet with wire manager is selected, the finish is not selectable, it will be the same as the substructure finish choice.

Technology Devices and Grommets	Options	U.S. Price	Required to Specify
	Power Grommet with Wire Manager		
	• PowerPod grommet	+\$301 each grommet	Specify with <i>PowerPod</i> and select count, location, and finish. ► See page 580 for count and location options.
	Simple Power Module with Wire Manager		
	• Three power	+\$469 each module	Specify with <i>three power, device count, device location</i> and select finish. ► See page 580 for count and location options.
	• Two power/one USB	+\$588 each module	Specify with <i>two power, device count, device location</i> and select finish. ► See page 580 for count and location options.

Related Products	Options	U.S. Price	Required to Specify
	<ul style="list-style-type: none"> • Accessories • PowerPod • Occasional tables • Lounge seating • Collaboration seating • Guest seating 		<ul style="list-style-type: none"> ► Page 605 ► Page 604 ► Page 702 ► See <i>Coalesse Seating Specification Guide</i>. ► See <i>Coalesse Seating Specification Guide</i>. ► See <i>Coalesse Seating Specification Guide</i>.

Veneer direction



For Canadian Pricing
Multiply U.S. Price by the Canadian price factor.
► See page 1 for details.

SW_1 Collaborative and Conference Tables Round, Square, and Super-Square Tables

DESIGN SCOTT WILSON & MINIMAL

Tip: Your specification is not complete until you add the fifth letter to the style number to define top surface.

- L** - Laminate top
- V** - Wood veneer top
- C** - Solid surface top
- G** - Glass top

Tip: Glass tops are not secured to the substructure. Glass tops are placed on rubber pads that are adhered to the substructure. If the glass tables need to be moved, remove the glass top prior to moving the table.



Specification Information

Dimensions			Style Number	U.S. Base Prices							
L	W	H		Laminate		Veneer		Wedge Veneer Layup		Solid Surface	Glass
				Grade 1	Grade 2 and 3	Grade 1	Grade 2	Grade 1	Grade 2		

Round Tables

30" diameter	28½"	COW_RND30	\$2748	\$2794	\$3813	\$3987	N.A.	N.A.	\$4048	\$4856
36" diameter	28½"	COW_RND36	\$2836	\$2897	\$3934	\$4196	\$6041	\$6305	\$4228	\$5306
42" diameter	28½"	COW_RND42	\$2929	\$3016	\$4062	\$4414	\$6787	\$7140	\$4406	\$5756
48" diameter	28½"	COW_RND48	\$3109	\$3222	\$4317	\$4713	\$7303	\$7701	\$4588	\$6209



Square Tables

30"	30"	28½"	COW_SQ30	\$2836	\$2882	\$3934	\$4108	N.A.	N.A.	\$4228	\$5306
36"	36"	28½"	COW_SQ36	\$2929	\$2990	\$4062	\$4324	N.A.	N.A.	\$4406	\$5756
42"	42"	28½"	COW_SQ42	\$3109	\$3196	\$4317	\$4669	N.A.	N.A.	\$4588	\$6209



Super-Square Tables

45½"	45½"	28½"	COW_SSQ45	\$3242	\$3355	\$4495	\$4891	\$7481	\$7850	\$4856	\$6659
------	------	------	------------------	--------	--------	--------	--------	--------	--------	--------	--------

SW_1 Collaborative and Conference Tables



For Canadian Pricing
 Multiply U.S. Price by the Canadian price factor.
 ▶ See page 1 for details.

SW_1 Collaborative and Conference Tables Work Tables

DESIGN SCOTT WILSON & MINIMAL

Standard Includes	Required to Specify
<p>► Need help? Product details, page 576</p> <ul style="list-style-type: none"> • ½" thick top surface: <ul style="list-style-type: none"> - Laminate (grade 1) with 3 mm edge band, if selected - Wood veneer (grade 1) with matching 3 mm edge band, if selected - Solid surface, if selected: white only - Glass, if selected • 1¼" thick bottom substructure: black or milk • Base, column, and cone: 8040 Polished Matte Aluminum • Glides • Ships ready-to-assemble 	<ol style="list-style-type: none"> 1 Style number with appropriate top series letter indicated in the space provided. (For example: COW_RT3060 becomes COWLRT3060 for a laminate top surface): <ul style="list-style-type: none"> L - Laminate top V - Wood veneer top C - Solid surface top G - Glass top 2 Laminate, wood, or glass color number for top, if selected 3 Plastic color for edge band of laminate top, if selected 4 Bottom substructure: <ul style="list-style-type: none"> 6000 Black 6052 Milk 5 Options, if selected (see below) <p>► See <i>Coalesse Surface Materials Reference Guide</i>.</p>

	Options	U.S. Price	Required to Specify
Surface Materials	Laminate		
	• Grade 2 laminate	Prices at right	Specify with <i>grade 2 laminate</i> and select color number.
	• Grade 3 laminate	Prices at right	Specify with <i>grade 3 laminate</i> and select color number.
	Wood		
	• Grade 2 wood veneer	Prices at right	Specify with <i>grade 2 wood veneer</i> and select color number.
	Performance Power Module		
	• Brushed metal finish	+\$ 85	Specify with <i>9242 Brushed Metal</i> .
Wood Veneer Grain Direction	• Lengthwise grain direction for tops up to 96"L	No cost	Specify with <i>lengthwise grain direction</i> .
Technology Devices and Grommets	Power Grommet with Wire Manager		
	• PowerPod grommet	+\$ 301 each grommet	Specify with <i>PowerPod grommet</i> and select count, location, and finish. ► See page 580 for count and location options.
	Simple Power Module with Wire Manager		
	• Three power	+\$ 469 each module	Specify with <i>three power, device count, device location</i> and select finish. ► See page 580 for count and location options.
	• Two power/one USB	+\$ 588 each module	Specify with <i>two power/one USB, device count, device location</i> and select finish. ► See page 580 for count and location options.
	Performance Power Module with Wire Manager		
	• Two power/one AAP	+\$ 826 each module	Specify with <i>two power/one AAP, device count, device location</i> and select finish. ► See page 580 for count and location options.
	• One power/one USB/one AAP	+\$ 945 each module	Specify with <i>two power/one USB/one AAP, device count, device location</i> and select finish. ► See page 580 for count and location options.
	• Three power/two USB	+\$1063 each module	Specify with <i>three power/two USB, device count, device location</i> and select finish. ► See page 580 for count and location options.
	Power Infeed	Performance and Power Module	
	• Hardwire	+\$ 77	Specify with <i>hardwire infeed</i> .
	• 15-amp plug	No cost	Specify with <i>plug infeed</i> .
Power Ganging	Performance and Simple Power Module		
	• Ganged	No cost	Specify with <i>ganged power</i> .
	• Individual	No cost	Specify with <i>individual power</i> .

► Options, continued on next page

Tip: Performance power available on select tables.
► See *Base Matrix* on page 582 for details.

Tip: If the table has a cable tray, it will be painted 4141 Platinum Matte to coordinate with the base.

Tip: Multiple power units of the same type can be specified with independent power configurations.

Tip: Power ganging is only available when two or more simple or performance power modules are specified.

Tip: When power ganging is specified, only one vertical wire manager is supplied.



For Canadian Pricing
Multiply U.S. Price by the Canadian price factor.
► See page 1 for details.

SW_1 Collaborative and Conference Tables Work Tables

DESIGN SCOTT WILSON & MINIMAL

Tip: Cable management tray is only available when power is specified.

► Options, continued from previous page

Options		U.S. Price	Required to Specify
Cable Management Tray	Rectangular Tables		
	• 69"L rectangular table	+\$208	Specify with cable management tray.
	• 72"L rectangular table	+\$244	Specify with cable management tray.
	Super-Elliptical Tables		
	• 72"L super-elliptical table	+\$244	Specify with cable management tray.
Related Products	<ul style="list-style-type: none"> • Accessories • PowerPod • Occasional tables • Lounge seating • Collaboration seating • Guest seating 		<ul style="list-style-type: none"> ► Page 605 ► Page 604 ► Page 702 ► See <i>Coalesse Seating Specification Guide</i>. ► See <i>Coalesse Seating Specification Guide</i>. ► See <i>Coalesse Seating Specification Guide</i>.

Tip: The wire manager finish is not selectable, it will be the same as the substructure finish choice.

Tip: Standard grain direction runs the width of the table (front-to-back).

Tip: Your specification is not complete until you add the fifth letter to the style number to define top surface.

- L** - Laminate top
- V** - Wood veneer top
- C** - Solid surface top
- G** - Glass top

Tip: Glass tops are not secured to the substructure. Glass tops are placed on rubber pads that are adhered to the substructure. If the glass tables need to be moved, remove the glass top prior to moving the table.

Specification Information

Dimensions			Style Number	U.S. Base Prices				Solid Surface	Glass
L	W	H		Laminate		Veneer			
				Grade 1	Grade 2 and 3	Grade 1	Grade 2		

SW_1 Collaborative and Conference Tables

Rectangular Tables									
60"	30"	28½"	Style Number	Laminate Grade 1	Laminate Grade 2 and 3	Veneer Grade 1	Veneer Grade 2	Solid Surface	Glass
			COW_RT3060	\$2836	\$2923	\$4495	\$4847	\$8838	\$10,281
			COW_RT3072	\$3023	\$3128	\$4676	\$5089	\$9197	\$10,637
	36"	28½"	COW_RT3660	\$3023	\$3128	\$4676	\$5089	\$9197	\$10,637
	36"	28½"	COW_RT3672	\$3199	\$3322	\$4856	\$5335	\$9560	\$11,001
Super-Elliptical Tables									
60"	40"	28½"	Style Number	Laminate Grade 1	Laminate Grade 2 and 3	Veneer Grade 1	Veneer Grade 2	Solid Surface	Glass
			COW_SE4060	\$3109	\$3232	\$4765	\$5244	\$9738	\$11,181
			COW_SE4072	\$3468	\$3608	\$5125	\$5661	\$9921	\$11,722



For Canadian Pricing
 Multiply U.S. Price by the Canadian price factor.
 ► See page 1 for details.

SW_1 Collaborative and Conference Tables PowerPod

DESIGN SCOTT WILSON & MINIMAL

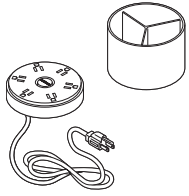

Tip: PowerPod must be plugged directly into the building power supply.

	Standard Includes	Required to Specify
--	-------------------	---------------------

► Need help?
Product details,
page 578

- PowerPod with 6' cord and three prong plug: brushed aluminum bottom cradle and milk face
- Accessory tray: milk
- Six 15-amp power outlets
- Illuminated on/off button
- Surge suppressor

Style number

Specification Information			
Dimensions	Style	U.S.	
Diameter	H	Number	Price
6 ³ / ₄ "	6"	COPP01	\$257



For Canadian Pricing
Multiply U.S. Price by the
Canadian price factor.
► See page 1 for details.

SW_1 Collaborative and Conference Tables Accessories

DESIGN SCOTT WILSON & MINIMAL

Standard Includes	Required to Specify
<p>► Need help? Product details, page 578</p> <ul style="list-style-type: none"> Vertical wire managers: milk or black plastic Horizontal wire manager, 6-pack: velcro and attachment hardware Manages small amounts of cords and wires Mesh cable cover, if selected: black 	<ol style="list-style-type: none"> Style number for vertical wire manager, if selected 6000 Black 6052 Milk Style number for horizontal wire manager, if selected Style number for mesh cable cover, if selected <p>► See <i>Coalesse Surface Materials Reference Guide</i>.</p>

Related Products
<ul style="list-style-type: none"> Occasional tables ► Page 702

Specification Information

Dimensions			Style	U.S.
L	W	H	Number	Price

Vertical Wire Manager For Use with Low Conference Tables

N.A.	N.A.	26"	COWVWM26	\$181
------	------	-----	----------	-------

Vertical Wire Manager For Use with Standard Height Tables

N.A.	N.A.	28½"	COWVWM28	\$181
------	------	------	----------	-------

Horizontal Wire Manager Clips (Package of 6)

½"	8"	½"	COWHWM	\$74
----	----	----	--------	------

Mesh Cable Cover

72"	1"	N.A.	VLYCDM	\$47
-----	----	------	--------	------



Tip: Horizontal wire manager clips attach under the work surface with screws.



Tip: Mesh cable cover can be cut to desired length.

Tip: For further details on this product, please reference the Conference and Collaborative Tables Specification Guide.



For Canadian Pricing
Multiply U.S. Price by the Canadian price factor.
► See page 1 for details.

Train Collaborative and Conference Tables

Understanding	608
Specifying	
Rectangular Tables	630
90° Corner Tops	636
Accessories	637

Train Collaborative and Conference Tables

Train tables are ideal for rapidly changing learning environments. Train tables have tops that flip. Tables nest for compact storage and can be rolled while nested.

Top is 1" thick particle board with laminate surface.

Base is cast aluminum with powder coat color.

Casters are 3" diameter locking dual wheels with urethane threads that allow the tables to move on hard or carpeted floors. Glides are also available.

Offset leg design allows tables to nest.

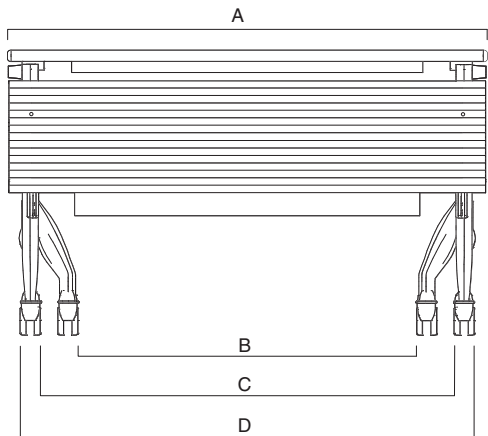
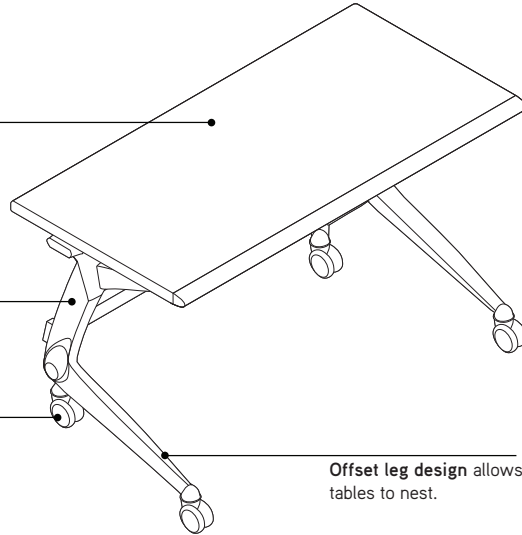

Dimensions

Table Length (A)	Width Between Inside Legs (B)	Inside Width Between Outside Legs (C)	Outside Width Between Outside Legs (D)
48"L	33 ⁷ / ₈ "	41 ¹ / ₄ "	45 ¹ / ₂ "
60"L	45 ⁷ / ₈ "	53 ¹ / ₄ "	57 ¹ / ₂ "
72"L	57 ⁷ / ₈ "	65 ¹ / ₄ "	69 ¹ / ₂ "

Seating Capacity Guidelines
 ▶ See page 618.

Product Details

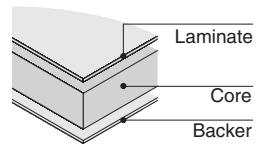

Solid core tops with 1" nominal edge thickness have a particle board core (45 lb cu ft density) with High-Pressure Laminate and a backer applied to the opposite side for a balanced construction. High-Pressure Laminate and backer are bonded to the core with a PVA adhesive.

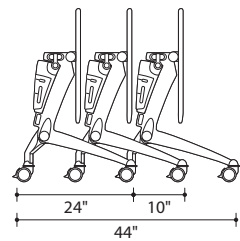
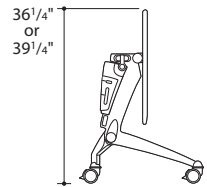
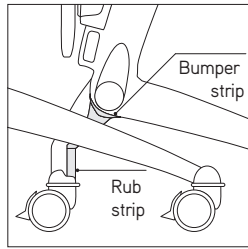

Table with top flipped is 24"W. Each additional table adds approximately 10". Three nested tables occupy about 44" of space and by angling can be moved through a standard 36"W doorway. Optional raceway or modesty panels do not affect nesting or space requirements.



Tables when flipped have overall heights of 36¹/₄" for 24"W tables and 39¹/₄" for 30"W tables.

Train Collaborative and Conference Tables



Bumpers and rub strips on legs prevent tables from damaging each other when nested.

Base is cast aluminum with powder coat color. Offset leg design allows tables to nest.

Table height is standard at 28½"H.

Glides are available as an alternative to casters if high mobility is not required. Glides are cast aluminum with a textured black powder coat. Adjustability range is ½"H. Replacing casters with glides does not alter the table height.

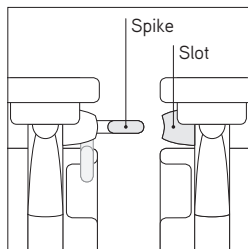

Coupling device is built into every Train table to enable tables to gang together end-to-end without tools or separate parts.

Top is 1"-thick particle board with laminate.

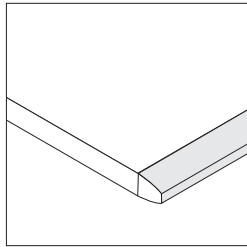
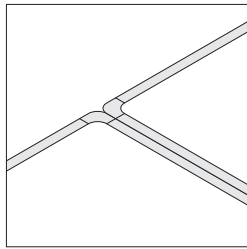

Signature edge profile is standard on Train. This special edge profile is not available on other table products and is only available in 6000 Black.

Table bases are available with powder coat colors. Refer to the individual product specifying pages for availability. Powder coat colors are shown in the *Coalesse Surface Materials Reference Guide*.

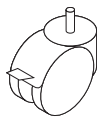

Casters are available as a factory-installed option on 3" dual locking castor Train tables.

Tip: Casters cannot be adjusted to level tables.

Edges are black vinyl. Soft rolled edge on user's side, black vinyl coupler edge on remaining sides, and black injection molded plastic corners. User edge is a soft, sloped profile that is comfortable for resting your arms. All other edges are flat and compress slightly when tables are ganged to produce a perfect seal. Corners are injection-molded plastic.

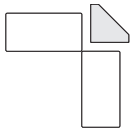

Corner tops can link perpendicular Train tables and expand the useable area in many configurations. Corner tops can also be specified with raceways to match adjacent tables.

Tip: Tables specified with raceway have the option of a 4-circuit corner raceway, to connect to a powered raceway, if desired. Tables specified with no raceway have the option of the 2-circuit jumper to connect the modular table power kit, if desired.

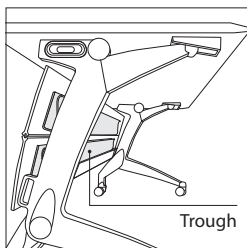

Modesty panel is available to enclose space beneath table and to provide two 2" x 3" wire management troughs. Panel is extruded aluminum with powder coat color to match the table legs. Trough is plastic extrusion. Modesty panel attaches to stretcher and swings open for access.

Tip: Desktop devices are located on the outside of the modesty panel and do not cover the underside wires.

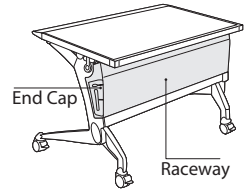

Raceway is a combination modesty panel, wire manager, and power/data distribution channel. Panel is extruded aluminum with powder coat color to match the table legs. Access to the space inside the raceway is possible from both sides. Two separate cable routing spaces are available.

The high-capacity lower space accommodates power and home run data cables. The upper space is used for appliance and patch cords. Removable end caps on raceways snap out to allow unobstructed cable routing.

Tip: The raceway is only compatible with the 4-circuit electrical system.

Custom shapes and sizes Special table sizes and shapes are possible. To confirm practicality and obtain a quotation, contact Customer Service at 1.800.627.6770.

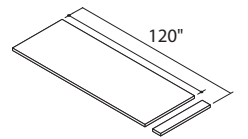

Cut-down tops, which are standard table tops with smaller dimensions, are available. Use the product number of the next larger size and specify the exact dimensions you want. Some restrictions apply, including minimum quantities. This option is not available for folding tables. Additional lead times may be required. Contact Customer Service at 1.800.627.6770.

Tip: Upcharge for a cut-down top is applied one time only per size/style number.

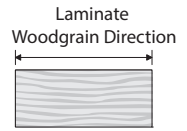

Tip: Fee is at list and contract discounts apply.



Woodgrain laminates are always oriented with the grain direction running parallel with the length of the table top. You cannot specify woodgrain laminates with end- or side-matched grain directions.

Train Collaborative and Conference Tables *continued*

Edge Alternatives

Edge Alternatives	Table Top Shape	
	Rectangular	Connecting
1" Tops		
	<ul style="list-style-type: none"> • 1" Train • Sloped profile 	<ul style="list-style-type: none"> • Available with injection-molded corners only • Available with injection-molded corners only

Train Collaborative and Conference Tables

4-Circuit Power, Data, and Wiring for Raceway

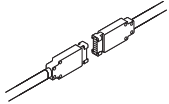

The 4-circuit modular electrical system can be specified with raceways on tables, or you can create a hardwired electrical network on site. Modular electrical units include harnesses with modular connectors to allow them to be snapped together or reconfigured and power blocks to accommodate power receptacles added on site.

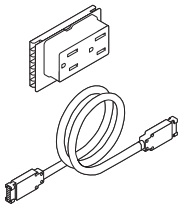

Duplex receptacles and power infeeds are ordered separately.

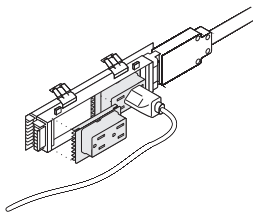

Duplex receptacles snap into power blocks on site. They are coded to indicate which circuit and type of ground they will engage. Tools are not required for installation. Tables that are 48" L can accommodate up to two receptacles. Tables that are 60" L or 72" L can accommodate up to four receptacles.

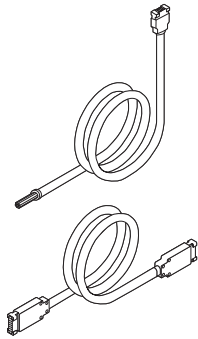

Power infeeds bring electrical power from the building to any table within a run of tables that are coupled together. Modular connections with the furniture is made at valance panel located at either end of the raceway on the knee-wall side, next to the table leg. Two alternative power infeeds can be used.

Each circuit allows up to a maximum of eight duplex receptacles.

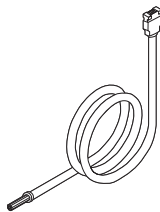

Four-circuit, hardwire power infeed connects to the building with a hardwired connection. Harness connects to the table with a modular connector. Infeed carries four 20-amp circuits. Connection must be made by a qualified electrician in accordance with local codes. A version of this infeed that is approved for use in New York City is also available.

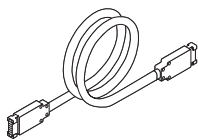

Four circuit, modular power infeed connects to the building with a modular connection at both ends. Wall box with modular connection point is hardwired to the building by a qualified electrician in accordance with local codes. Infeed carries four 20-amp circuits.

Train table electrical power components are available in various wiring schematics to accommodate a wide range of branch circuit configurations and power needs. The eight-wire system is available in three alternatives—four-circuit 3+1, four-circuit 2+2, and three-circuit separate neutrals.

All components in an electrical system must use the same wiring schematic. Components are color coded and keyed to make it impossible to connect mismatched parts. ▶ See *Wiring Schematics*, page 612

All Coalesse electrical components are approved by Underwriters Laboratory (UL) and by the Canadian Standards Association (CSA).

All Coalesse electrical systems are designed in compliance with the National Electrical Code (NEC) and Canadian Electrical Code (CEC) to function as a multi-wire branch circuit. Installations should be made in accordance with the NEC or CEC provisions for multi-wire branch circuits.

Local electrical codes vary. Consult a qualified electrical contractor or engineer for the proper installation of all electrical equipment.

Chicago and some other locations require installation to be hardwired.

Wire management modesty panel includes two integral wire management troughs made of 2" x 3" extruded black plastic. Each track accommodates approximately 18 Cat 5 UTP cables or four power cords. The troughs are spaced apart to provide an opportunity to separate power and voice/data networks. Modesty panel is hinged in its center to allow access to the cable routing space from the aisle side of the table.

Gap between the underside of table top and the top of modesty panel provides a 1" H space to allow cables to be routed from the worksurface to the cable management troughs. Grommets can also be specified in the table top to route cables.

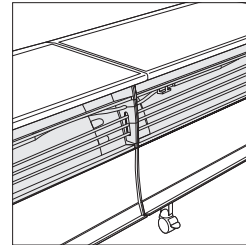

Raceway includes a 3" x 6" interior cavity that can accommodate approximately 40 four-pair UTP cables. Wire guide in this space is a steel bracket with numerous holes suitable for wire ties or clips to support tidy wire management. Raceway end caps have flexible vinyl openings to allow lay-in cable routing. Cables can enter or leave the raceway through openings in the valance panel.

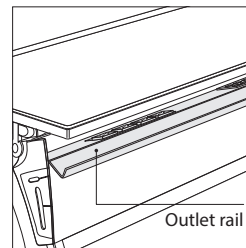

Outlet rail in the upper portion of the raceway has an opening to accommodate standard NEMA-style, single-gang, modular furniture voice/data faceplates.

The Train raceway can accommodate most industry standard 4-port network switches and patch cords (customer supplied) for easiest reconfiguration of network wired environments. For more static environments, the Train raceway can accommodate up to 40 twisted pair network cables (customer supplied).

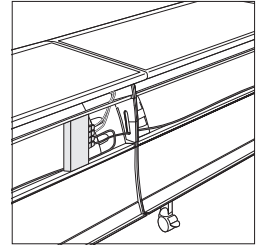

Modular infeeds to connect to wall-mounted boxes or monuments are also available to connect voice/data access points in the building. ▶ Page 644

Train Collaborative and Conference Tables *continued*

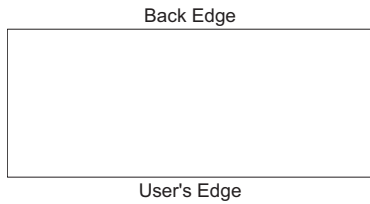

Four-circuit, 3+1 also known as 3+D (color-coded black). The fourth circuit is isolated and has its own neutral.

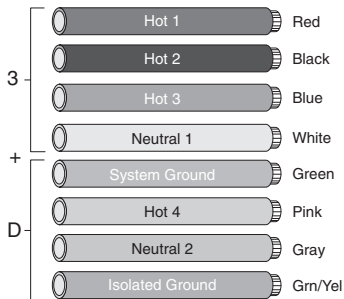

Circuit Panel 1

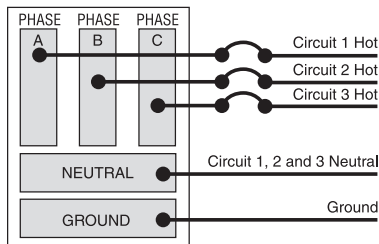

Circuit Panel 2

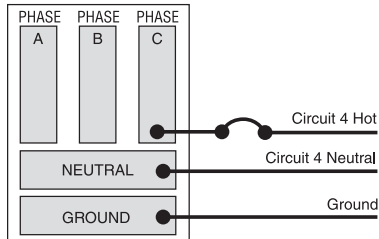

In the four-circuit, 3+1 schematic, circuits 1, 2, and 3 are distributed from the first circuit panel and are supported with one shared neutral and one shared ground. Circuit 4 is distributed from a second circuit panel and is supported with a separate neutral and ground.

Single 3-Phase Circuit Panel

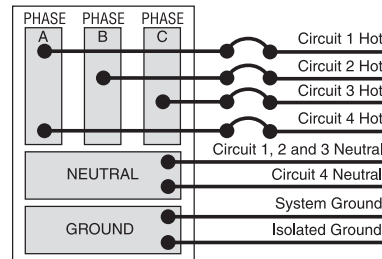

On a single 3-phase circuit panel, all four circuits are distributed as shown.

Four-circuit, 2+2 (product number suffix "Y", color-coded brown).

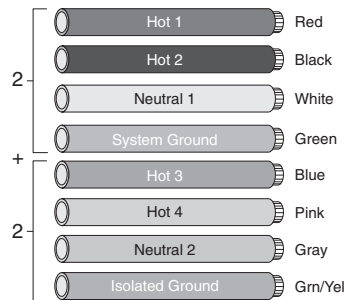

Circuit Panel 1

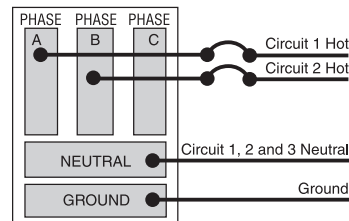

Circuit Panel 2

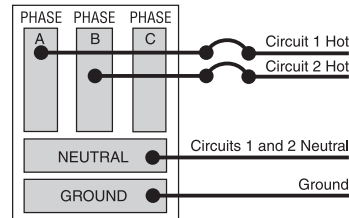

In the four-circuit, 2+2 schematic, circuits 1 and 2 are distributed from two different phases from the first circuit panel and are supported with one shared neutral and one shared ground. Circuits 3 and 4 are distributed from a second circuit panel and supported by their own shared neutral and ground.

Single 3-Phase Circuit Panel

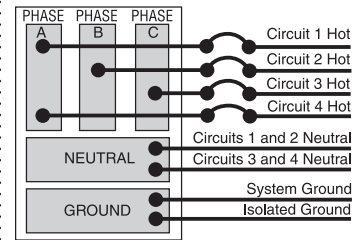

On a single 3-phase circuit panel, all four circuits are distributed as shown.

Split-Phase Circuit Panel

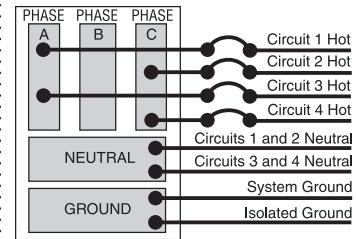

On a split-phase circuit panel, all four circuits are distributed as shown.

Three-circuit separate neutrals (model number suffix "Z" to model number, color-coded rust). Three circuits are each provided with their own neutral wire.



Train Collaborative and Conference Tables

Circuit Panel 1

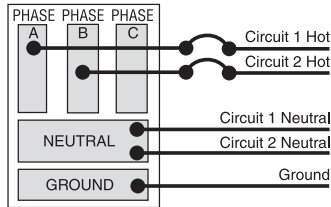

Circuit Panel 2

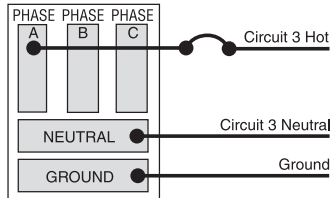

In the three-circuit, separate neutral schematic, circuits 1 and 2 are distributed from two different phases from the first circuit panel. Each circuit is supported with its own neutral and a common ground. Circuit 3 is distributed from the second circuit panel and is supported by its own neutral and ground.

Single 3-Phase Circuit Panel

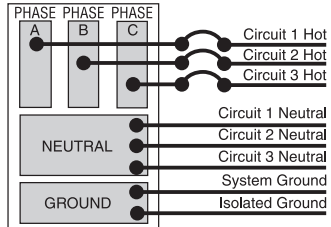

On a single 3-phase circuit panel, all four circuits are distributed as shown.

Split-Phase Circuit Panel

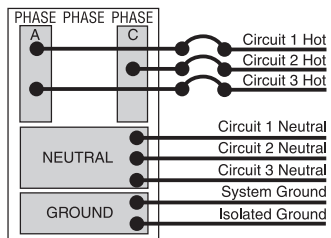

On a split-phase circuit panel, all four circuits are distributed as shown.

Power, Data, and Wiring for 2-Circuit Modular Table Power Kits

Axil Z

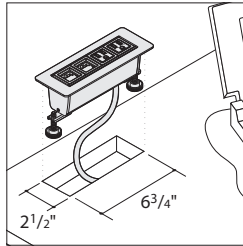
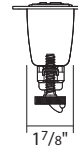
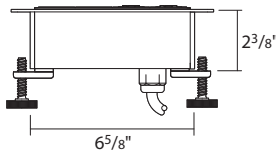

Axil Z is an 8" x 3" desktop module that mounts at the top surface of the table and can be configured in several choices of power/data/USB:

- 2 power/2 data
- 2 power/1 data/1 USB
- 2 power/2 USB
- 3 power/1 data
- 3 power/1 USB
- 4 power

The customer-supplied RJ-type voice/data communication outlets, when specified, come with an array of faceplates to accommodate a range of voice/data communication outlets.

► See *Axil Z and Ellora Telecommunications Reference Chart*, page 626).

Axil Z is available in gloss white or gloss black. Axil Z is UL listed. Axil Z can be used with table top thicknesses of 3/4"–1 1/2" by adjusting the thumb screws that secure the desktop module to the table.

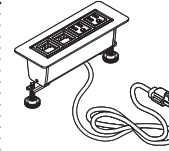

Axil Z cord has a six-foot power cord and standard 15-amp plug for configurations with three or less simplex power outlets. The configuration of four simplex power outlets includes a non-standard 15-amp plug with a circuit breaker.



Axil Z hardware has six feet of flexible steel conduit for permanently hardwiring to the building power supply by a licensed electrician. This is to be used with tables with glides only, no casters. This version is best suited for municipalities where code requires hardwire connections for this type of desktop device or for installations where the furniture will not be reconfigured or moved.

Train Collaborative and Conference Tables *continued*

Ellora

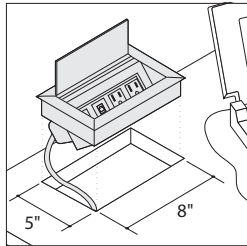
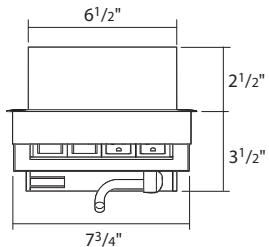
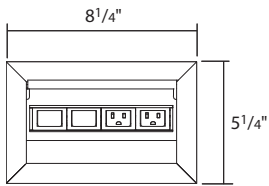

Ellora is an 8 1/4" x 5 1/4" desktop module that mounts at the top surface of the table and can be configured in several choices of power/data/USB:

- 2 power/2 data
- 2 power/1 data/1 USB
- 2 power/2 USB
- 3 power/1 data
- 3 power/1 USB
- 4 power

The customer-supplied RJ-type voice/data communication outlets, when specified, come with an array of faceplates to accommodate a range of voice/data communication outlets.

► See *Axil Z and Ellora Telecommunications Reference Chart*, page 626).

Ellora is available in anodized aluminum and is standard with a lift-up access door. Ellora is UL listed. Ellora can be used with table top thicknesses of 3/4"–1 1/2" by attaching the clips that secure the desktop module to the table.

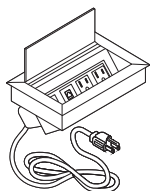

Ellora cord has a six-foot power cord and standard 15-amp plug for configurations with three or less simplex power outlets. The configuration of four simplex power outlets includes a non-standard 15-amp plug with a circuit breaker.

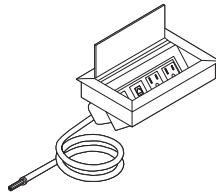

Ellora hardwire has six feet of flexible steel conduit for permanently hardwiring to the building power supply by a licensed electrician. This is to be used with tables with glides only, no casters. This version is best suited for municipalities where code requires hardwire connections for this type of desktop device or for installations where the furniture will not be reconfigured or moved.

In order to meet Chicago code approvals, the desktop module must be metal, therefore, only Axil Z, Ellora, and Interact would be approved.

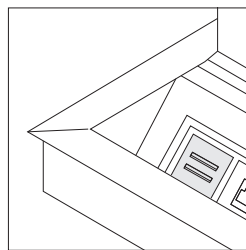

For Axil Z and Ellora, the USB for charging option is configured in the spot of one data port and is always configured on the end(s). It contains two USB ports for charging.

Modular furniture faceplates to accept voice/data outlets are available directly from many suppliers. Coalesse does not supply these components. For information about compatibility, contact the manufacturers: Amp 1.800.522.6752. Ask for Flexmode modular furniture faceplates and outlets. Krone 1.800.775.5766. Ask for Convergence modular furniture faceplates and outlets. Panduit 1.800.777.3300. Ask for Mini-Com modular furniture faceplates and outlets.

Factory installed cutouts are available as standard option for Train tables (see location guide for placement). For the top to have a factory installed cutout on Train, you must specify the option, where applicable, otherwise the table will be shipped without a cutout.

Field installed cutouts are ordered separately, not as an option, therefore, the table top will not have a cutout and must be cut in the field per the required locations.

► See *Standard Location for Grommets, Spheres, Interport, Mini-Port, Interact, Axil Z, and Ellora*, page 618.

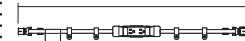
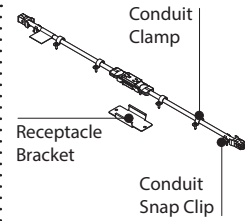

Single Duplex Receptacle

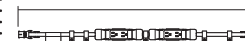

Double Duplex Receptacle

When several Train tables without raceways need to be daisy-chained, i.e., one table connected to the other providing power to the entire series, the 2-circuit modular table power kits are mounted to the underside of the Train tables without raceways. It is an option to select either one duplex receptacle or two duplex receptacles, depending on the table to connect power from one table to the next.

► See *Modular Power Kit Lengths*, page 622.

The installation of the modular table power system must be followed in accordance with all assembly directions. Improper usage could result in risk of fire or electric shock. Only connect to products labeled "Modular Table Power System". For use in indoor, dry locations only.

The modular table power system is a directional system in that it runs in one direction. Installation can be set-up to run left-to-right, or right-to-left, depending on the location of the base power infeed. This is ideal where modularity and reconfigurability are required with the number of connections to the building power supply being minimized.

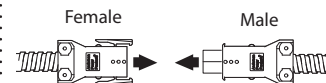

The directional modular power kit consists of one "male" modular connector and one "female" modular connector allowing the only way to connect and the power system. The modular connectors snap together, and easily disengage by squeezing the spring clips on the female end. The modular connectors are designed for easy end-user reconfigurations.

Train Collaborative and Conference Tables

Male Modular Connector

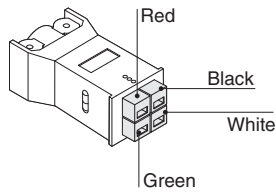

Female Modular Connector

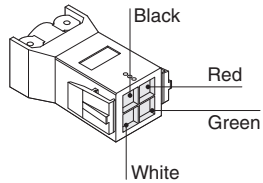

The modular connectors are color-coded for intuitive match-up when connecting the modular table power system. Match like colors only, i.e., green to green, red to red, black to black, and white to white.

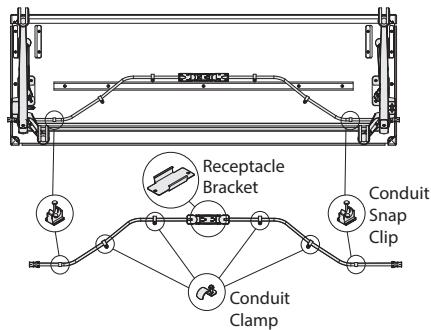

The 2-circuit modular table power kits are easily installed into pre-drilled holes in the Train table and are placed end-to-end with the duplex receptacle(s) in the middle. The modular power kit connectors are easily accessible and always in the same location. The optional power kit is available with either a one or two duplex receptacles and comes with all the necessary hardware, i.e., conduit clamps, receptacle bracket(s), and conduit plastic snap clips. Just specify the modular table power kit to match the length of your table.

Tip: The 2-circuit modular table power kit can only be specified on Train tables without raceways.

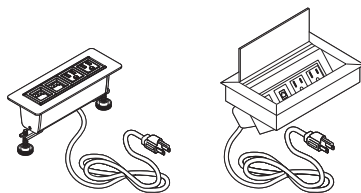

Axil Z

Ellora

Only corded desktop modules can be used with the modular table power kits. The hardwire Axil Z or Ellora desktop module does not work with modular table power kits.

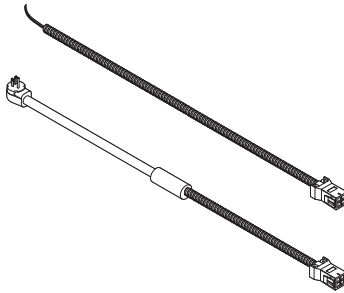

Modular table power kits require either a 20-amp plug infeed or hardwire infeed to power the tables. A 20-amp plug infeed with a modular female connector can only be used with Circuit-1 receptacles, whereas, the hardwire infeed with a modular female connector can be used with either or both, Circuit-1 and Circuit-2 receptacles.

The 20-amp plug infeed, COBP1FMP20, is used when reconfigurability is needed and does not require an electrician. When the installation is permanent or local electrical codes are restrictive, a hardwire base power infeed, COBP1FMH, is available. This requires the tables to be specified with glides, not casters. This infeed must be installed by a licensed electrician in compliance with all local and national codes.

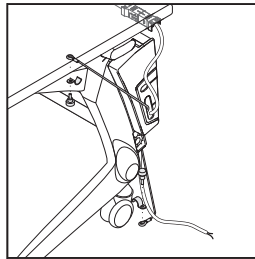

A tether/strain relief bracket comes standard with all base power infeeds. The first table in a series of tables connected with modular power, must be anchored in place with the tether. The tether anchors the table to the building, preventing disengagement of the electrical connections. The tether length between the connection to the table and the building must always be shorter than the hardwire infeed length between the modular connection and the building. Consult the assembly directions for proper installation.

Train Collaborative and Conference Tables *continued*

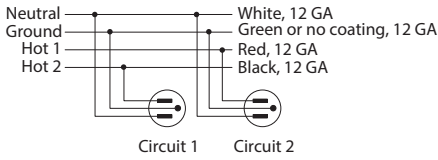

The modular table power kit is a 20-amp, 4-wire, 2-circuit system. Each circuit allows up to 13 duplex receptacles. The 20-amp plug infeed only allows up to 13 Circuit-1 duplex receptacles, and the hardwire infeed allows up to 26 Circuit-1 and -2 duplex receptacles, no more than 13 per circuit.

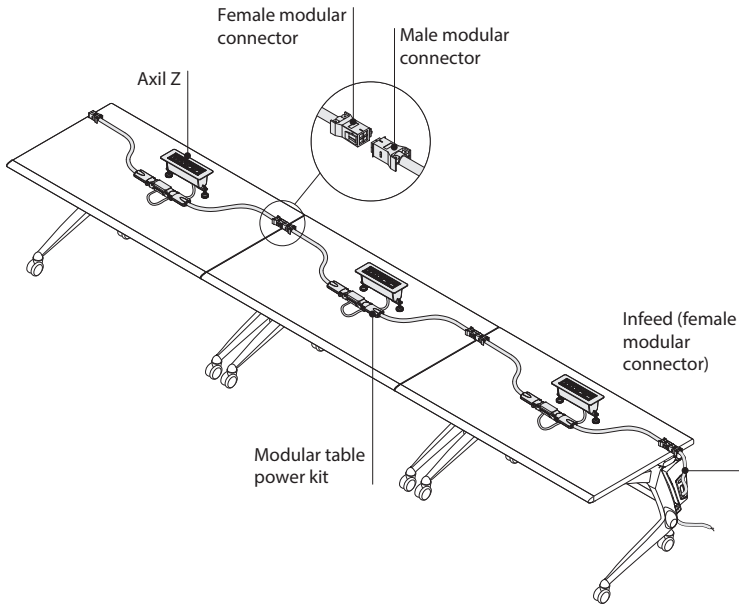

The duplex receptacle(s) in the table power kit and every two simplex receptacles from the desktop module count against the 13 duplex receptacles allowed for each circuit. The above example has a total of nine duplex receptacles being utilized.

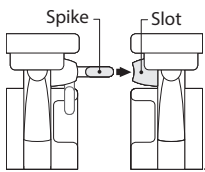

A coupling device is built into every Train Table to enable tables to gang together end-to-end without tools or separate parts. All Train tables that have modular table power specified, requires the tables to be connected with the coupling device provided.

Table-Table: must be held together with table connection hardware, not by electrical components.

Table-Power In-Feed: table must be anchored in place.

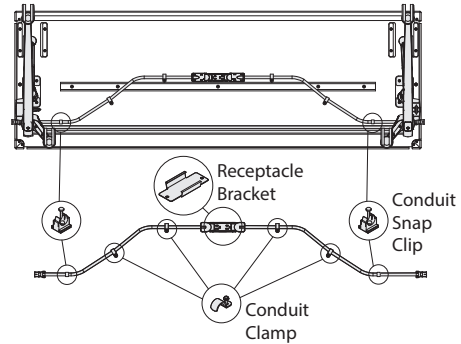

1. Identify the conduit path along the center channel. Utilize predrilled holes in the surface for all components. *Note: Conduit on 24"W Tables will "jump" the center spine (as shown). Conduit on 30"W tables will be located to the rear of the center spine.*
2. Fasten receptacle bracket and snap-clips, then loosely fasten conduit clamps. Install power in the desired direction and tighten clamps.

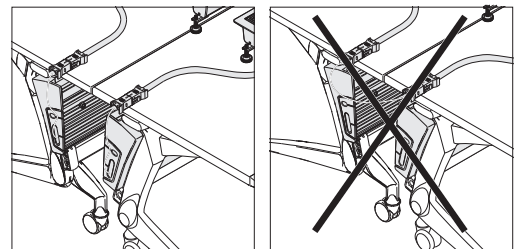

In back-to-back applications, where modesty panels are used, the modesty panel will prevent the modular power kits from connecting. Therefore, another infeed will be required for the adjacent row of tables.

Train Collaborative and Conference Tables

Specifying desktop power with modular table power kits.

Tip: Grommets can be mixed with desktop modules on a single table.

1. Determine the type of desktop module required and its configuration.

Choose among grommets and desktop modules, such as, Axil Z, or Ellora, and pick the one that fits the configuration requirements needed.

2. Determine how many desktop modules or grommets you need and where they will be located on each table.

Understand the number of people sitting at the table with the requirements between power, data, and USB along with where the desktop modules are located, one in the center and two in left and right position for individual or shared use.

▶ See *Standard Grommet/Axil Z/Ellora Locations for Train Rectangle Tables*, page 620.

3. Table length determines your modular table power length required.

If modular connections are required, then a modular table power kit is required. Choose between one duplex receptacle or two duplex receptacles, depending on the plug-in needs.

▶ See *Modular Power Kit Lengths*, page 622.

4. Determine how to connect to the building supply, code requirements, and user needs.

The most important consideration is adequate electrical power supplied to a number of desktop modules fed by a single base power infeed. If reconfiguration is desired and smaller configurations are required, then a single circuit 20-amp plug infeed is the best option. If larger configurations are required and the tables are not being reconfigured, then a hardwire infeed is the best option. Each circuit allows up to 13 duplex receptacles to be connected which includes desktop modules. Every two desktop simplex outlets count as one duplex receptacle. A two-power desktop module counts as one duplex receptacle, a three-power desktop module counts as one duplex receptacle and a four-power desktop module counts as two duplex receptacles.

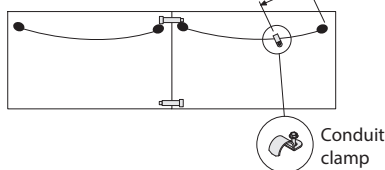
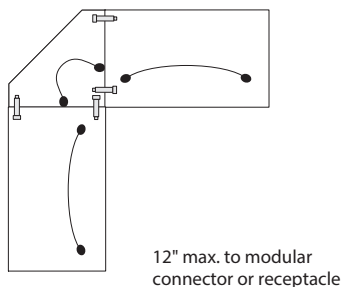

Straight and Corner layouts for Train.

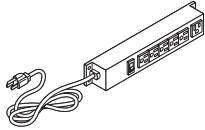

Power strip is available to provide additional power outlets beneath tables that must accommodate many technological components. Power strip includes six 15-amp outlets with surge protection, on-off switch, and 15' cord with three-prong plug. Power strip is black. UL and CSA listed and tested to UL standard 1449 at 400V.

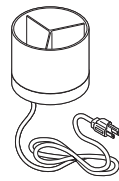

PowerPod is a design conscious, portable power source and accessory tray all in one. It can be used on any table top for easy access to power.

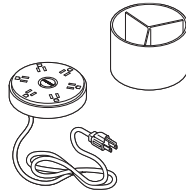

PowerPod includes six 15-amp outlets with an energy saving illuminated on/off switch. It comes with a 6' cord with three prong plug. The top tray is milk and the power source is silver with a milk face. It is UL and CSA listed.

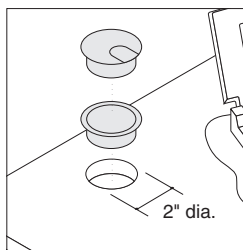

Grommets are available in the tops of Train tables to allow cords and cables to be routed through the top and into the modesty panel or raceway. Grommet is 2"-diameter, black plastic insert with snap-out cap.

Surface Materials

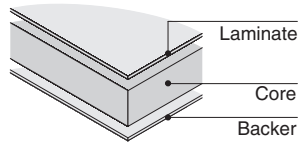

Laminates are available in two standard grades. Additional laminates from any manufacturer may also be practical—see Other laminates in the following column.

Grade 1 laminates include:

- Coalesse standard High-Pressure Laminates
- ▶ See *Coalesse Surface Materials Reference Guide*.
- Steelcase standard High-Pressure Laminates (code 290A)
- ▶ See *Steelcase Surface Materials Reference Manual*.
- Any standard-grade Wilsonart High-Pressure Laminate in solid color, woodgrain, or pattern finish (code 290A)

Grade 2 laminates (code 290B) include any standard-grade, solid color, woodgrain, or patterned High-Pressure Laminate from Nevamar (includes Matrix), Formica, or Pionite. Grade 2 laminates may have extended lead times. For details, contact Customer Service at 1.800.627.6770.

Other laminates that are not included in the Grade 1 or Grade 2 offerings may also be available, such as Abet Laminati and Laminart. To determine availability and pricing, contact Customer Service at 1.800.627.6770, with the laminate manufacturer's name and the name and number of the laminate you want.

Laminate swatches are reproduced in the *Coalesse Surface Materials Reference Guide*.

Swatch cards and actual samples of Coalesse standard laminates are available from your Coalesse Customer Service representative. For samples of High-Pressure Laminates from other manufacturers, contact them directly:

Wilsonart	1.800.433.3222
Nevamar	1.800.638.4380
Formica	1.800.FORMICA
Pionite	1.800.285.5161

Tip: Laminate manufacturers change their offerings frequently. Always check availability before ordering.

Tip: Signature edgeband is available in 6000 Black only.

Train Collaborative and Conference Tables continued

Standard Grommet/Axil Z/Ellora Locations for Train Rectangle Tables

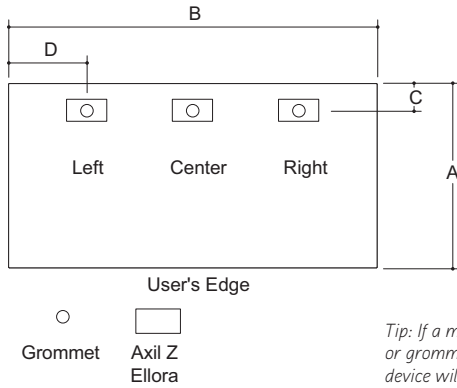

Tip: If a modesty panel is ordered with a desktop device or grommet, the cords or the bottom of the desktop device will be on the outside of the modesty panel.

Table	A	B	C	D
► Train				
Train : Grommets				
24"x 48"	24"	48"	6"	6"
60"	24"	60"	6"	6"
72"	24"	72"	6"	6"
30"x 48"	30"	48"	9"	6"
60"	30"	60"	9"	6"
72"	30"	72"	9"	6"
Train: Axil Z				
24"x 48"	24"	48"	3½"	N.A.
60"	24"	60"	3½"	15"*
72"	24"	72"	3½"	18"*
30"x 48"	30"	48"	3½"	N.A.
60"	30"	60"	3½"	15"*
72"	30"	72"	3½"	18"*
Train: Ellora				
24"x 48"	24"	48"	5"	N.A.
60"	24"	60"	5"	N.A.
72"	24"	72"	5"	N.A.
30"x 48"	30"	48"	5"	N.A.
60"	30"	60"	5"	15"*
72"	30"	72"	5"	18"*

* = Only available when a raceway is not specified

Seating Capacity Guidelines

Depth	Width	Approximate Capacity
Rectangular Tops		
48"	24"	1
60"	24"	2
72"	24"	3
48"	30"	2
60"	30"	4
72"	30"	4

Care & Maintenance

Laminate should be cleaned with soap and water. For stubborn stains, use a non-abrasive household cleaner.

Powder coat finishes on table bases should be cleaned with a liquid detergent and water. Remove stubborn stains with liquid cleanser, such as Formula 409.

Polished aluminum finishes on table bases should be cleaned with a commercial powder, liquid, or paste metal cleaner and polish. Follow the manufacturer's directions.

Tables should be inspected and maintained regularly by tightening screws and bolts, inspecting casters and glides for damage, and inspecting all moving parts for damage and wear.

Train Collaborative and Conference Tables

Train Collaborative and Conference Tables Power/Voice/Data Availability Matrix

	Grommet ▶Page 645	Sphere	Power Module	Mini-Port	Interport	Axil Z ▶Page 640	Ellora ▶Page 641
Train	●■ plastic	+■	+■	+■	+■	●	●

Tip: Some tables may not be able to accommodate a particular device or location. See product pages for complete details.

- = Hole factory cut in standard location (specify left, right, center)
- + = Hole factory cut in custom locations. Requires engineering review; additional leadtime may be required.
Tip: Send us a drawing indicating desired location(s). An additional charge may apply if the standard table design requires modification. Requires the grommet or electrical device to be ordered as a separate item from the table.
- = Available for field installation.
To specify, order the grommet or electrical device to be ordered as a separate item from the table.
Requires field cutout for grommet or electrical device. Requires engineering review for location.
See page referenced above for specification information.

Train Collaborative and Conference Tables Power/Voice/Data Availability Matrix

Interact	PowerPod ▶Page 646	Power Strip ▶Page 739
+■ requires a special bracket	■ sits on table top (no grommet)	■ sits on table top or attach underneath

Train Collaborative and Conference Tables Modular Power Kit Lengths for Train

Modular Power Kit Lengths																
48"W Tables				60"W Tables				72"W Tables				84"W Tables				
Single Receptacle Circuit 1		Single Receptacle Circuit 2		Double Receptacle Circuit 1		Double Receptacle Circuit 1 And Circuit 2		Single Receptacle Circuit 1		Single Receptacle Circuit 2		Double Receptacle Circuit 1		Double Receptacle Circuit 1 And Circuit 2		
Train Tables with Glides	54"	54"	N.A.	N.A.	66"	66"	66"	66"	78"	78"	78"	78"	N.A.	N.A.	N.A.	N.A.
Train Tables with Casters	54"	N.A.	N.A.	N.A.	66"	N.A.	66"	N.A.	78"	N.A.	78"	N.A.	N.A.	N.A.	N.A.	N.A.

Train Collaborative and Conference Tables

Modular Power Kit Lengths for Train

Train Collaborative and Conference Tables Desktop Devices

Table Type and Dimension	Axil Z Left	Axil Z Right	Axil Z Center	Axil Z Left and Right	Ellora Left	Ellora Right	Ellora Center	Ellora Left and Right	Sphere Left	Sphere Right	Sphere Center	Sphere Left and Right	Sphere Left and Center	Sphere Right and Center	Sphere Left, Right, and Center
Train Rectangle															
24x48	N.A.	N.A.	■	N.A.	N.A.	N.A.	■	N.A.	N.A.	N.A.	N.A.	N.A.	N.A.	N.A.	N.A.
30x48	N.A.	N.A.	■	N.A.	N.A.	N.A.	■	N.A.	N.A.	N.A.	N.A.	N.A.	N.A.	N.A.	N.A.
24x60	■	■	■	■	N.A.	N.A.	■	N.A.	N.A.	N.A.	N.A.	N.A.	N.A.	N.A.	N.A.
30x60	■	■	■	■	■	■	■	■	N.A.	N.A.	N.A.	N.A.	N.A.	N.A.	N.A.
24x72	■	■	■	■	N.A.	N.A.	■	N.A.	N.A.	N.A.	N.A.	N.A.	N.A.	N.A.	N.A.
30x72	■	■	■	■	■	■	■	■	N.A.	N.A.	N.A.	N.A.	N.A.	N.A.	N.A.

Note: Cannot have device, grommet or sphere in same location on table top, where applicable. Cannot have differing devices on same table top, but can have grommet and/or sphere with a desktop device as long as the location is differing.

■ = Available for field installation into factory-cut opening.

Train Collaborative and Conference Tables Desktop Devices

Grommet Left
Grommet Right
Grommet Center
Grommet Left and Right
Grommet Left and Center
Grommet Right and Center
Grommet Left, Right, and Center

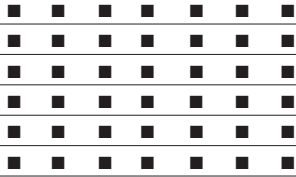

Train Collaborative and Conference Tables Axil Z and Ellora Telecommunication Reference Chart

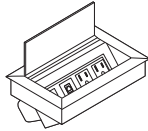
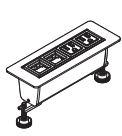

Type	Byrne Electrical	Allen Tel	Commscope/ Uniprise	Commscope/ Systemax	Hubbell	Krone/ADC
Category 5e						
110	BE406372-2	AT55SH-xx	UNJ500-xx	MPS100E-xxx	HXJ5Exx	6467-5-181-xx
USOC		None	None	M1AH-xxx	HXJUxx	6467-5-198-xx
Shielded		AT65SH-xx	FTP-5E	None	None	None
Tool-less		AT55-xx	None	None	None	None
Coupler		AT55C-xx	None	None	SFC5Exx	None
Pre-assembled	BE01445 ⁽¹⁾ BE01929 ⁽²⁾					
Category 6						
110		AT66-xx	UNJ600-xx	MGS400-xxx	HXJ6xx	6830-1-830-xx
Shielded		None	FTP-J6	None	None	None
Tool-less		None	None	None	None	None
Coupler		None	None	None	None	None
Pre-assembled	BE01445-6-72 ⁽³⁾ BE01445-6-120 ⁽⁴⁾					
Secure		None	None	None	None	None
Category 6A						
110		None	UNJ600-xx	MGS500-xx	HXJ6Axx	6830-1-835-xx
Shielded		None	FTP-J6A	MFP520	None	None
MD4 S-Video						
110 Terminal		AT32VD-xx	M81SVHs-110-xxx	None	SFSV110xx	6645-1-134-xx
Coupler		None	M81-SVHS-SVHS-xxx	None	SFSVxx	None
Solder		None	None	None	None	None
F-Coax Twist On		AT32F-xx	None	M81C	SFFxx SFFGxx SIFxx	6645-1-157-xx

► Axil Z and Ellora Telecommunications reference chart, continued on next page

Note: Information may be considered reliable as of 6/26/13. Manufacturers may add, delete, or change products without notice. Proper fit of any Telecommunications connector should always be tested before use.

(1) w/ 8-Pin, Amp RJ45 Cat 5e, Pre-terminated w/ 9' cable
 (2) w/8-Pin, Panduit RJ45 Cat 5e, Pre-terminated w/ 9' cable
 (3) w/ 8-Pin, Siemon RJ45 Cat 6, Pre-terminated w/ 6' cable
 (4) w/ 8-Pin, Siemon RJ45 Cat 6, Pre-terminated w/ 10' cable

Train Collaborative and Conference Tables Axil Z and Ellora Telecommunication Reference Chart

L-Com	Leviton	Ortronics	Panduit	Siemon	Tyco Electronics	Tyco Electronics/ AMP
MJS110C5E-xx RJ110CB-xx	5G108-Rxx	OR-TJ5E00-xx OR-63750001	NK5E88Mxx NKP5E88Mxx CJK5E88TGxx CJ5E88TGxx	MX5-Kxx	406372-x 1499905-x 368988-x 1499683-x	1375191-x 1375190-x 1116515-x
None	None	None	None	None	None	None
None	5S180-SH5	OR-TJS5E00	CJSK5E88TGxx CJS5E88TGxx	MX5-KS	1479717-x	1375189-1 1116515-1
None	None	None	None	MX-K-C5-(xx)	None	1116604-x 1339189-x 1339015-x
TDG1026KC5 TDG1026KS-C5E	None	None	CC5E88xx	None	None	None
TDG1026KS MJS110C6-xx	61110-Bxx	OR-TJ600-xx	NK688Mxx CJK688TGxx CJ688TGxx CJD688TPxx	MX6-Kxx	1499631-x 1499682-x 1479794-x	1375055-x 1375187-x
None	6S180-SH6	OR-TJS600	CJSK688TGxx CJS688TGxx	None	None	1375188-x 1479795-x
MJSTLC6-xx	None	None	None	None	None	None
TDG1026KC6 TDG1026KSC6	None	None	CC688xx	None	None	1479289-2 1479290-1
None	None	None	None	None	None	1479794-x 1478795-x
None	None	OR-TJ610	CJD6X88TGxx CJ6X88TGxx	10GMX-KS 10GMX-Kxx	None	None
None	None	None	CJS6X88TGxx CJK6X88TGxx	None	1711160-x 1711342-x 1711295-x 1711592-x	1375188-1 1479553-1
None	40734-Sxx	OR-63700025	NKSPMxx CJSVxx	MX-F-VHxx	1375149-x	None
None	None	OR-60900074	CMSVCxxx	None	None	None
None	None	None	None	None	None	None
MJSCPF-xx	41084-Fxx 40831-Bxx	OR-63700006-xx OR-KSFCN	CMFSRxx NKFxx MFxx	CCT-FA-xx	None	1499855-x

Train Collaborative and Conference Tables Axil Z and Ellora Telecommunication Reference Chart *continued*

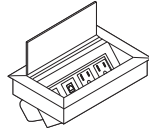
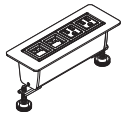

► Axil Z and Ellora Telecommunications reference chart, continued from previous page

Type	Byrne Electrical	Allen Tel	Commscope/Uniprise	Commscope/Systemax	Hubbell	Krone/ADC
MD4 S-Video, continued						
BNC		AT32BB-xx	None	M81 BNC-B	SFBxx	6645-1-159-xx
RCA						
110 Terminal		AT32RCA-110-xx	M81-RCA-PT-YL	None	SFRC110xx	6645-1-133-xx
Coupler		None	None	None	SFRCxxRxx	None
Solder		AT32RCA	None	None	SFRCxx	None
Compression		None	None	None	None	None
3 mm Sjack		None	M81-S35MM-S35MM	None	None	None
3.5 mm Sjack						
Solder		None	None	None	SF35FFxx	None
Pre-assembled	BE02494-C-120 w/ 20" MF Cable					
USB						
Coupler A-A		None	None	None	SFUSBAAxx	None
Coupler A-B		None	None	None	SFUSBABxx	None
Solder		None	None	None	None	None
-A Pre-assembled	BE02155-C w/ 4ft Cable					
-B Pre-assembled	BE02156-C w/ 4ft Cable					
Integral Cord		None	None	None	None	None
3 Pin XLR						
Solder		None	None	None	XLR10	None
Screw	BE02493-72(5) BE02493-120(6)	None	None	None	IM15ST10x	None
SVGA HD15 to 110		None	None	None	None	None
6 Pin DIN (KeyBd/Mouse)		None	None	None	SF6PK	None
HDMI						
Coupler	BE1018192					
MF 90°	BEFR-HH-FM270					

Note: Information may be considered reliable as of 6/26/13. Manufacturers may add, delete, or change products without notice. Proper fit of any Telecommunications connector should always be tested before use.

⁽⁵⁾ Preassembled w/15 Pin SVGA Male Connector and 72" cable

⁽⁶⁾ Preassembled w/15 Pin SVGA Male Connector and 120" cable

Train Collaborative and Conference Tables Axil Z and Ellora Telecommunication Reference Chart

L-Com	Leviton	Ortronics	Panduit	Siemon	Tyco Electronics	Tyco Electronics/ AMP
MJSCPBNC-xx	40832-Bxx	OR-63700023 OR-KSBNC	NKSPMxx	None	None	None
None	40735-Rxx	OR-63700047	CJRxxx NKRPmxxx	None	None	147923x-x
MJSCPRCA-xx	40830-Bxx	None	NKRTMxxx CMRPxxx	CT-RA-xx	1375362-x	1375361,2,3-x 1933192,3,4-x
None	None	None	NKRSMxxx	MX-F-RC-xx	1375365-x	1375364,5,6-x
None	40782-Rxx	None	None	None	None	None
None	40837-Bxx	None	NK35MSCxx CM35MSCB	None	None	1933582-x
None	None	None	NK35MSSxx CM35MSSxx	None	None	1479086-x
None	None	None	None	None	None	1933655-x
ECF504B-UAB	None	None	None	None	None	1933661-x
ECJ504B-UA	None	None	None	None	None	None
ECF504-5M	None	None	None	None	None	None
None	None	None	None	None	None	None
DGBH15FT	None	None	CMD15HDxxx	None	None	None
None	None	None	None	None	None	1479288-x
None	None	OR-63700025	None	None	None	None

Train Collaborative
and Conference Tables

Train Collaborative and Conference Tables Rectangular Tables

DESIGN VECTA DESIGN TEAM AND IDEO

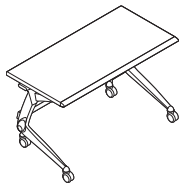

Tip: Shipped knocked down.

Standard Includes	Required to Specify
<p>► Need help? Product details, page 608</p> <ul style="list-style-type: none"> • Top: 1" particle board core with High-Pressure Laminate • Edge: black soft rolled front edge with black vinyl with black 3 mm sides and back • Base: cast aluminum legs and steel stretcher bar with single powder coat color • Coupling device to allow adjacent tables to be connected end-to-end • 3" diameter, locking, dual-wheel casters: black plastic 	<ol style="list-style-type: none"> 1 Style number 2 Powder coat color number for base 3 Laminate color number for top 4 Options, if selected (see below) <p>► See <i>Coalesse Surface Materials Reference Guide</i>.</p>

Options	U.S. Price	Required to Specify
<p>Surface Materials</p> <p>Top</p> <ul style="list-style-type: none"> • Grade 2 laminate • Grade 3 laminate 	<p>Prices at right</p> <p>Prices at right</p>	<p>Specify with <i>grade 2 laminate</i> and select color number.</p> <p>Specify with <i>grade 3 laminate</i> and select color number.</p>
<p>Modesty panel</p> <p>► Page 609</p> <p>Flip-down modesty panel</p> <ul style="list-style-type: none"> • 48"W • 60"W • 72"W 	<p>+\$ 858</p> <p>+\$ 899</p> <p>+\$ 942</p>	<p>Specify with <i>48"W modesty panel</i>.</p> <p>Specify with <i>60"W modesty panel</i>.</p> <p>Specify with <i>72"W modesty panel</i>.</p>
<p>Raceways with 4-circuit electrical</p> <p>► Page 610</p> <ul style="list-style-type: none"> • 48"L Table • 60"L Table • 72"L Table 	<p>+\$1806</p> <p>+\$1948</p> <p>+\$2034</p>	<p>Specify with <i>48"L electrical raceway, and the type of electrical system: 3+1 electrical, system, 2+2 electrical system, or three-circuit, separate neutrals electrical system</i>.</p> <p>Specify with <i>60"L electrical raceway, and the type of electrical system: 3+1 electrical, system, 2+2 electrical system, or three-circuit, separate neutrals electrical system</i>.</p> <p>Specify with <i>72"L electrical raceway, and the type of electrical system: 3+1 electrical, system, 2+2 electrical system, or three-circuit, separate neutrals electrical system</i>.</p>
<p>Raceways without 4-circuit electrical system</p> <p>► Page 610</p> <ul style="list-style-type: none"> • 48"L Table • 60"L Table • 72"L Table 	<p>+\$1276</p> <p>+\$1376</p> <p>+\$1440</p>	<p>Specify with <i>48"L raceway, and no electrical system</i>.</p> <p>Specify with <i>60"L raceway, and no electrical system</i>.</p> <p>Specify with <i>72"L raceway, and no electrical system</i>.</p>

<p>Axil Z</p> <p>► Page 613</p> <p>One 6' cord (48"L and center only)</p> <ul style="list-style-type: none"> • Two power/two data • Two power/one data/one USB • Two power/two USB • Three power/one data • Three power/one USB • Four power 	<p>+\$ 365</p> <p>+\$ 525</p> <p>+\$ 687</p> <p>+\$ 376</p> <p>+\$ 534</p> <p>+\$ 475</p>	<p>Specify with <i>one center Axil Z cord with two power/two data and select color number</i>.</p> <p>Specify with <i>one center Axil Z cord with two power/one data/one USB and select color number</i>.</p> <p>Specify with <i>one center Axil Z cord with two power/two USB and select color number</i>.</p> <p>Specify with <i>one center Axil Z cord with three power/one data and select color number</i>.</p> <p>Specify with <i>one center Axil Z cord with three power/one USB and select color number</i>.</p> <p>Specify with <i>one center Axil Z cord with four power and select color number</i>.</p>
--	---	---

► Options, continued on next page

Tip: All electrical system components (raceways, receptacles, base power infeeds, etc.) must be the same wiring schematic.

Tip: Raceway has access doors on both aisle and kneewell sides.

Tip: Modular connector occupies one receptacle location in raceway.

Tip: Raceway is only compatible with the 4-circuit electrical system.

Tip: For Axil Z and Ellora, the USB for charging is configured in the spot of one data port and is always configured on the end(s).

Tip: For each USB port specified, there are two USBs per port.

Tip: The hardware Axil Z, or hardware Ellora desktop module does not work with modular table power kits.

Tip: If a modesty panel is ordered with a desktop device or grammet, the cords or the bottom of the desktop device will be on the outside of the modesty panel.



For Canadian Pricing
 Multiply U.S. Price by the Canadian price factor.
 ► See page 1 for details.

Train Collaborative and Conference Tables Rectangular Tables

DESIGN VECTA DESIGN TEAM AND IDEO

►Options, continued from previous page

Tip: If one Axil Z desktop unit is specified other than center location, it can only be used on tables specified without raceway. If raceway is specified, then center location is only available location.

Options	U.S. Price	Required to Specify
Axil Z, continued ►Page 613		
One 6' hardwire (48"L and center only)		
• Two power/two data	+\$365	Specify with one center Axil Z hardwire with two power/two data and select color number.
• Two power/one data/one USB	+\$525	Specify with one center Axil Z hardwire with two power/one data/one USB and select color number.
• Two power/two USB	+\$687	Specify with one center Axil Z hardwire with two power/two USB and select color number.
• Three power/one data	+\$376	Specify with one center Axil Z hardwire with three power/one data and select color number.
• Three power/one USB	+\$534	Specify with one center Axil Z hardwire with three power/one USB and select color number.
• Four power	+\$475	Specify with one center Axil Z hardwire with four power and select color number.
One 6' cord (60"L and 72"L only)		
• Two power/two data	+\$365	Specify with one Axil Z cord with two power/two data, select left, right, or center location and select color number.
• Two power/one data/one USB	+\$525	Specify with one Axil Z cord with two power/one data/one USB, select left, right, or center location and select color number.
• Two power/two USB	+\$687	Specify with one Axil Z cord with two power/two USB, select left, right, or center location and select color number.
• Three power/one data	+\$376	Specify with one Axil Z cord with three power/one data, select left, right, or center location and select color number.
• Three power/one USB	+\$534	Specify with one Axil Z cord with three power/one USB, select left, right, or center location and select color number.
• Four power	+\$475	Specify with one Axil Z cord with four power, select left, right, or center location and select color number.
One 6' hardwire (60"L and 72"L only)		
• Two power/two data	+\$365	Specify with one Axil Z hardwire with two power/two data, select left, right, or center location and select color number.
• Two power/one data/one USB	+\$525	Specify with one Axil Z hardwire with two power/one data/one USB, select left, right, or center location and select color number.
• Two power/two USB	+\$687	Specify with one Axil Z hardwire with two power/two USB, select left, right, or center location and select color number.
• Three power/one data	+\$376	Specify with one Axil Z hardwire with three power/one data, select left, right, or center location and select color number.
• Three power/one USB	+\$534	Specify with one Axil Z hardwire with three power/one USB, select left, right, or center location and select color number.
• Four power	+\$475	Specify with one Axil Z hardwire with four power, select left, right, or center location and select color number.

►Options, continued on next page

Train Collaborative and Conference Tables



For Canadian Pricing
Multiply U.S. Price by the Canadian price factor.
►See page 1 for details.

Train Collaborative and Conference Tables Rectangular Tables *continued*

DESIGN VECTA DESIGN TEAM AND IDEO

►Options, continued from previous page

Tip: If two Axil Z desktop units are specified, they can only be used on tables specified without raceway. If raceway is specified, then center location is only available location.

	Options	U.S. Price	Required to Specify
Axil Z, continued ►Page 613	Two 6' cords (60"L and 72"L only)		
	• Two power/two data	+\$ 730	Specify with two (left and right) Axil Z cords with two power/two data and select color number.
	• Two power/one data/one USB	+\$1050	Specify with two (left and right) Axil Z cords with two power/one data/one USB and select color number.
	• Two power/two USB	+\$1374	Specify with two (left and right) Axil Z cords with two power/two USB and select color number.
	• Three power/one data	+\$ 752	Specify with two (left and right) Axil Z cords with three power/one data and select color number.
	• Three power/one USB	+\$1068	Specify with two (left and right) Axil Z cords with three power/one USB and select color number.
	• Four power	+\$ 950	Specify with two (left and right) Axil Z cords with four power and select color number.
	Two 6' hardwires (60"L and 72"L only)		
	• Two power/two data	+\$ 730	Specify with two (left and right) Axil Z hardwires with two power/two data and select color number.
	• Two power/one data/one USB	+\$1050	Specify with two (left and right) Axil Z hardwires with two power/one data/one USB and select color number.
	• Two power/two USB	+\$1374	Specify with two (left and right) Axil Z hardwires with two power/two USB and select color number.
	• Three power/one data	+\$ 752	Specify with two (left and right) Axil Z hardwires with three power/one data and select color number.
	• Three power/one USB	+\$1068	Specify with two (left and right) Axil Z hardwires with three power/one USB and select color number.
	• Four power	+\$ 950	Specify with two (left and right) Axil Z hardwires with four power and select color number.
Ellora ►Page 614	One 6' cord (center only)		
	• Two power/two data	+\$ 550	Specify with one center Ellora cord with two power/two data.
	• Two power/one data/one USB	+\$ 714	Specify with one center Ellora cord with two power/one data/one USB.
	• Two power/two USB	+\$ 873	Specify with one center Ellora cord with two power/two USB.
	• Three power/one data	+\$ 561	Specify with one center Ellora cord with three power/one data.
	• Three power/one USB	+\$ 719	Specify with one center Ellora cord with three power/one USB.
	• Four power	+\$ 663	Specify with one center Ellora cord with four power.
	One 6' hardwire (center only)		
	• Two power/two data	+\$ 550	Specify with one center Ellora cord with two power/two data.
	• Two power/one data/one USB	+\$ 714	Specify with one center Ellora cord with two power/one data/one USB.
	• Two power/two USB	+\$ 873	Specify with one center Ellora cord with two power/two USB.
	• Three power/one data	+\$ 561	Specify with one center Ellora cord with three power/one data.
	• Three power/one USB	+\$ 719	Specify with one center Ellora cord with three power/one USB.
	• Four power	+\$ 663	Specify with one center Ellora cord with four power.

►Options, continued on next page



For Canadian Pricing
Multiply U.S. Price by the Canadian price factor.
► See page 1 for details.

Train Collaborative and Conference Tables Rectangular Tables

DESIGN VECTA DESIGN TEAM AND IDEO

►Options, continued from previous page

Tip: If two Ellora desktop units are specified, they can only be used on tables specified without raceway. If raceway is specified, then center location is only available location.

	Options	U.S. Price	Required to Specify
Ellora continued ►Page 614	Two 6' cords (30"W x 60"L and 30"W x 72"L only)		
	• Two power/two data	+\$1100	Specify with two left and right Ellora cords with two power/two data.
	• Two power/one data/one USB	+\$1428	Specify with two left and right Ellora cords with two power/one data/one USB.
	• Two power/two USB	+\$1746	Specify with two left and right Ellora cords with two power/two USB.
	• Three power/one data	+\$1122	Specify with two left and right Ellora cords with three power/one data.
	• Three power/one USB	+\$1438	Specify with two left and right Ellora cords with three power/one USB.
	• Four power	+\$1326	Specify with two left and right Ellora cords with four power.

	Two 6' hardwires (30"W x 60"L and 30"W x 72"L only)		
	• Two power/two data	+\$1100	Specify with two left and right Ellora cords with two power/two data.
	• Two power/one data/one USB	+\$1428	Specify with two left and right Ellora cords with two power/one data/one USB.
	• Two power/two USB	+\$1746	Specify with two left and right Ellora cords with two power/two USB.
	• Three power/one data	+\$1122	Specify with two left and right Ellora cords with three power/one data.
	• Three power/one USB	+\$1438	Specify with two left and right Ellora cords with three power/one USB.
	• Four power	+\$1326	Specify with two left and right Ellora cords with four power.

Tip: Modular table power kits require either a 20-amp plug infeed or hardwire infeed to power the tables. A 20-amp plug infeed can only be used with Circuit 1 receptacles, and the hardwire infeed can be used with either or both, Circuit 1 and Circuit 2 receptacles. Both infeeds have a color coded female modular connector that must plug into the matching color coded male infeed connector on the modular power kits.

2-Circuit Modular Table Power Kits ►Page 622	One circuit 1 duplex receptacle		
	• For 48"L tables - modular power kit with one center duplex receptacle, circuit 1	+\$ 356	Specify with 48"L modular power kit with circuit 1 duplex receptacle.
	• For 60"L tables - modular power kit with one center duplex receptacle, circuit 1	+\$ 382	Specify with 60"L modular power kit with circuit 1 duplex receptacle.
	• For 72"L tables - modular power kit with one center duplex receptacle, circuit 1	+\$ 402	Specify with 72"L modular power kit with circuit 1 duplex receptacle.

Tip: The modular table power kit does not work with the raceways, with electrical or without electrical system, it can be used with or without a modesty panel.

	One circuit 2 duplex receptacle (to be used with hardwire infeed only)		
	• For 48"L tables - modular power kit with one center duplex receptacle, circuit 2	+\$ 356	Specify with 48"L modular power kit with circuit 2 duplex receptacle.
	• For 60"L tables - modular power kit with one center duplex receptacle, circuit 2	+\$ 382	Specify with 60"L modular power kit with circuit 2 duplex receptacle.
	• For 72"L tables - modular power kit with one center duplex receptacle, circuit 2	+\$ 402	Specify with 72"L modular power kit with circuit 2 duplex receptacle.

Tip: The modular table power kit is a 2-circuit system and is not compatible with the 4-circuit electrical in the raceway. The connectors are also not compatible.

►Options, continued on next page



For Canadian Pricing
Multiply U.S. Price by the Canadian price factor.
► See page 1 for details.

Train Collaborative and Conference Tables Rectangular Tables *continued*

DESIGN VECTA DESIGN TEAM AND IDEO

►Options, continued from previous page

Tip: For a factory installed cutout in the tabletop, specify Axil Z, or Ellora as an option. If a Axil Z, or Ellora is not specified as an option, the table top will require a field installed cutout.

Tip: For Axil Z, Ellora, and grommet locations, see Standard Grommet/Axil Z/Ellora Locations for Train Rectangle Tables.
►Page 618.

Tip: When three grommets are specified, grommets will be located left, right, and center.

	Options	U.S. Price	Required to Specify
2-Circuit Modular Table Power Kits, continued ►Page 622	Two circuit 1 duplex receptacles (60"L and 72"L tables only)		
	• For 60"L tables - modular power kit with two center duplex receptacles, circuit 1	+\$491	Specify with 60"L modular power kit with circuit 1 duplex receptacles.
	• For 72"L tables - modular power kit with two center duplex receptacles, circuit 1	+\$518	Specify with 72"L modular power kit with circuit 1 duplex receptacles.
	One circuit 1 and one circuit 2 duplex receptacles (60"L and 72"L tables only) (To be used with hardwire infeed only)		
	• For 60"L tables - modular power kit with two center duplex receptacles, one circuit 1 and one circuit 2	+\$491	Specify with 60"L modular power kit with one circuit 1 and one circuit 2 duplex receptacles.
	• For 72"L tables - modular power kit with two center duplex receptacles, one circuit 1 and one circuit 2	+\$518	Specify with 72"L modular power kit with one circuit 1 and one circuit 2 duplex receptacles.
Grommets ►Page 617	• One grommet: black plastic	+\$111	Specify with grommet and select left, right, or center location.
	• Two grommets: black plastic	+\$222	Specify with two grommets and select location of left/center, right/center, or right/left.
	• Three grommets: black plastic	+\$333	Specify with three grommets.
Glides	• Glides: aluminum with black textured powder coat	+\$264	Delete suffix C from the style number.
Related Products	• Power strip		►Page 739



For Canadian Pricing
Multiply U.S. Price by the Canadian price factor.
► See page 1 for details.

Train Collaborative and Conference Tables Rectangular Tables

DESIGN VECTA DESIGN TEAM AND IDEO

Specification Information

Dimensions			Style	Finish	U.S. Base Price
L	W	H	Number		



Train Vinyl Edge:

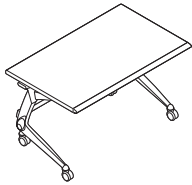
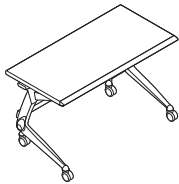

24"W Rectangular Tables

48"	24"	28½"	TN4824C	Grade 1 Laminate	\$2986
				Grade 2 and 3 Laminate	\$3058
60"	24"	28½"	TN6024C	Grade 1 Laminate	\$3235
				Grade 2 and 3 Laminate	\$3317
72"	24"	28½"	TN7224C	Grade 1 Laminate	\$3311
				Grade 2 and 3 Laminate	\$3409

30"W Rectangular Tables

48"	30"	28½"	TN4830C	Grade 1 Laminate	\$3128
				Grade 2 and 3 Laminate	\$3211
60"	30"	28½"	TN6030C	Grade 1 Laminate	\$3291
				Grade 2 and 3 Laminate	\$3397
72"	30"	28½"	TN7230C	Grade 1 Laminate	\$3412
				Grade 2 and 3 Laminate	\$3542



For Canadian Pricing
Multiply U.S. Price by the
Canadian price factor.
▶ See page 1 for details.

Train Collaborative and Conference Tables 90° Corner Tops

DESIGN VECTA DESIGN TEAM AND IDEO



Tip: Shipped knocked down.

Tip: All electrical system components (raceways, receptacles, base power infeeds, etc.) must be the same wiring schematic: 3+1, 2+2, or three-circuit, separate neutrals.

Tip: When using modular table power kits and connecting tops, a jumper kit must be specified for the corner, in order to maintain the power connection from table to table.

Tip: The modular table power jumper kit is a 2-circuit system and is not compatible with the 4-circuit electrical in the raceway. The connectors are also not compatible.

Standard Includes	Required to Specify
<ul style="list-style-type: none"> ▶ Need help? Product details, page 609 • Top: 1" particle board core with High-Pressure Laminate • Edge: black soft rolled front edge with black vinyl • Connecting hardware 	<ul style="list-style-type: none"> 1 Style number 2 Laminate color number for top 3 Options, if selected (see below) ▶ See <i>Coalesse Surface Materials Reference Guide</i>.

Options	U.S. Price	Required to Specify
Surface Materials <ul style="list-style-type: none"> • Top • Grade 2 laminate • Grade 3 laminate 	<ul style="list-style-type: none"> Prices below Prices below 	<ul style="list-style-type: none"> Specify with <i>Grade 2 laminate</i> and select color number. Specify with <i>Grade 3 laminate</i> and select color number.
Corner raceways (for 4-circuit electrical system connection only) <ul style="list-style-type: none"> • Corner raceway with four-circuit, 3+1 electrical system • Corner raceway with four-circuit, 2+2 electrical system • Corner raceway with three-circuit, separate neutrals electrical system • Corner raceway with no electrical system harness or power blocks 	<ul style="list-style-type: none"> +\$622 +\$622 +\$622 +\$622 	<ul style="list-style-type: none"> Specify with <i>3+1 corner raceway</i>. Specify with <i>2+2 corner raceway</i>. Specify with <i>separate neutrals corner raceway</i>. Specify <i>corner raceway with no electrical</i>.
Jumper (for 2-circuit modular table power kit connection only) <ul style="list-style-type: none"> • Jumper kit with one male and one female modular connector 	<ul style="list-style-type: none"> +\$104 	<ul style="list-style-type: none"> Specify with <i>jumper kit</i>.

Specification Information			
Dimension	Style Number	Finish	U.S. Base Price
W			<p>Train Vinyl Edge:</p>

90° Corner Tops			
24"	TN90D24	Grade 1 Laminate	\$962
		Grade 2 and 3 Laminate	\$998
30"	TN90D30	Grade 1 Laminate	\$1051
		Grade 2 and 3 Laminate	\$1111

For Canadian Pricing
 Multiply U.S. Price by the Canadian price factor.
 ▶ See page 1 for details.

Train Collaborative and Conference Tables Accessories

DESIGN VECTA DESIGN TEAM AND IDEO

Glides



Standard Includes		Required to Specify
<ul style="list-style-type: none"> ▶ Need help? Product details, page 609 	<ul style="list-style-type: none"> • Set of four glides for field retrofit: textured black powder coat 	Style number
Specification Information		
Style Number	U.S. Price	
TNGL	\$273	

Four-Circuit Receptacles

Tip: For alternative wiring configurations, see Options.

Tip: All electrical system components (raceways, receptacles, base power infeeds, etc.) must be the same wiring schematic: 3+1, 2+2, or three-circuit, separate neutrals.

Tip: Four-circuit receptacles are only compatible with raceway with electrical.

Standard Includes		Required to Specify	
<ul style="list-style-type: none"> ▶ Need help? Product details, page 610 	<ul style="list-style-type: none"> • Duplex receptacle: black plastic only • Four circuit, 3+1 wiring configuration 	1 Style number	2 Options, if selected (see below)
Options		U.S. Price	Required to Specify
Four-circuit, 2+2 wiring configuration ▶ Page 612	<ul style="list-style-type: none"> • Four-circuit, 2+2 wiring configuration 	No cost	Add suffix Y to the style number.
Three-circuit, separate neutrals wiring configuration ▶ Page 613	<ul style="list-style-type: none"> • Three-circuit, separate neutrals wiring configuration 	No cost	Add suffix Z to the style number.

Specification Information		
Style Number	U.S. Price	
Circuit 1		
321891	\$40	
Circuit 2		
321892	\$40	
Circuit 3		
321893	\$40	
Circuit 4, Isolated		
321894	\$40	



For Canadian Pricing
 Multiply U.S. Price by the Canadian price factor.
 ▶ See page 1 for details.

Train Collaborative and Conference Tables Accessories *continued*

DESIGN VECTA DESIGN TEAM AND IDEO

Axil Z, Cord

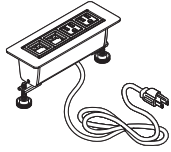

Tip: The Axil Z desktop module will ship with instructions and a hole cutout template for field installation, if needed.

Tip: For a factory installed cutout in the table top, specify Mini-Port as an option for Train. If you do not specify Mini-Port as an option, where applicable, the table top will require a field installed cutout. See Standard Grommet/Axil Z/ Ellora Locations for Train Rectangle Tables, page 618. For any other tables, other than Train, that require a Mini-Port desktop module, a special engineering quote is mandatory if you require a factory installed cutout in a location other than standard, send us a drawing with measurements indicating the exact location(s) required in the table top.

Tip: USB for charging is configured in the spot of one data port and is always configured on the end(s).

Tip: For each USB port specified, there are two USBs per port.

Standard Includes	Required to Specify
-------------------	---------------------

- | | | |
|---|--|---|
| <p>► Need help? Product details, page 613</p> | <ul style="list-style-type: none"> • Desktop module, anodized aluminum with painted steel face-plate mounts flat just above worksurface: <ul style="list-style-type: none"> - 4140 Arctic White Gloss - 4144 Black Gloss • 6' power cord with 15-amp plug • Requires 6¾" x 2" cutout • Utilizes water-proof simplex (outlets) • UL listed • Voice Data adaptor kit to accept couplers and jacks when needed (refer to telecommunications reference chart) | <ol style="list-style-type: none"> 1 Style number 2 Desktop module configuration (see Required Selections below) 3 Paint color number for desktop module |
|---|--|---|

Required Sections	U.S. Price	Required to Specify
-------------------	------------	---------------------

Required Sections	U.S. Price	Required to Specify
Power/Data/USB Configuration		
• Two power/two data	No cost	Specify with two power/two data and select color number.
• Two power/one data/one USB	+\$148	Specify with two power/one data/one USB and select color number.
• Two power/two USB	+\$301	Specify with two power/two USB and select color number.
• Three power/one data	+\$ 5	Specify with three power/one data and select color number.
• Three power/one USB	+\$158	Specify with three power/one USB and select color number.
• Four power	+\$102	Specify with four power and select color number.

Specification Information					
---------------------------	--	--	--	--	--

Dimensions			Style Number	U.S. Base Price
D	W	H		
3"	8"	2¾"	CODPA4	\$301



For Canadian Pricing
 Multiply U.S. Price by the Canadian price factor.
 ► See page 1 for details.

Train Collaborative and Conference Tables Accessories

DESIGN VECTA DESIGN TEAM AND IDEO

Axil Z, Hardwire

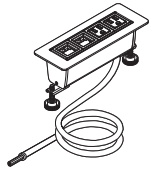

Tip: The Axil Z desktop module will ship with instructions and a hole cutout template for field installation, if needed.

Tip: For a factory installed cutout in the table top, specify Mini-Port as an option for Train. If you do not specify Mini-Port as an option, where applicable, the table top will require a field installed cutout. See Standard Grommet/Axil Z/ Ellora Locations for Train Rectangle Tables, page 618. For any other tables, other than Train, that require a Mini-Port desktop module, a special engineering quote is mandatory if you require a factory installed cutout in a location other than standard, send us a drawing with measurements indicating the exact location(s) required in the table top.

Tip: USB for charging is configured in the spot of one data port and is always configured on the end(s).

Tip: For each USB port specified, there are two USBs per port.

Tip: The hardwire Axil Z desktop module does not work with modular table power kits.

Tip: If a hardwire Axil Z desktop module is desired, then it should only be specified on tables with glides.

Standard Includes	Required to Specify
<p>► Need help? Product details, page 613</p> <ul style="list-style-type: none"> • Desktop module, anodized aluminum with painted steel face-plate mounts flat just above worksurface: <ul style="list-style-type: none"> - 4140 Arctic White Gloss - 4144 Black Gloss • 6' flexible steel hardwire conduit • Requires 6¾" x 2" cutout • Utilizes water-proof simplex (outlets) • UL listed • Voice/data adaptor kit to accept couplers and jacks when needed (refer to telecommunications reference chart) 	<ol style="list-style-type: none"> 1 Style number 2 Desktop module configuration (see Required Selections below) 3 Paint color number for desktop module

Required Sections	U.S. Price	Required to Specify
Power/Data/USB Configuration		
• Two power/two data	No cost	Specify with two power/two data and select color number.
• Two power/one data/one USB	+\$148	Specify with two power/one data/one USB and select color number.
• Two power/two USB	+\$301	Specify with two power/two USB and select color number.
• Three power/one data	+\$ 5	Specify with three power/one data and select color number.
• Three power/one USB	+\$158	Specify with three power/one USB and select color number.
• Four power	+\$102	Specify with four power and select color number.

Specification Information				
Dimensions			Style Number	U.S. Base Price
D	W	H		
3"	8"	2¾"	CODHA4	\$301

Train Collaborative and Conference Tables

For Canadian Pricing
 Multiply U.S. Price by the Canadian price factor.
 ► See page 1 for details.

Train Collaborative and Conference Tables Accessories *continued*

DESIGN VECTA DESIGN TEAM AND IDEO

Ellora, Cord

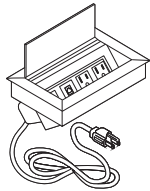

Tip: The Ellora desktop module will ship with instructions and a hole cutout template for field installation, if needed.

Tip: For a factory installed cutout in the table top, specify Ellora as an option for Train. If you do not specify Ellora as an option, where applicable, the table top will require a field installed cutout. See Standard Grommet/Axil Z/ Ellora Locations for Train Rectangle Tables, page 618. For any other tables, other than Train, that require an Ellora desktop module, a special engineering quote is mandatory. If you require a factory installed cutout in a location other than standard, send us a drawing with measurements indicating the exact location(s) required in the table top.

Tip: USB for charging is configured in the spot of one data port and is always configured on the end(s).

Tip: For each USB port specified, there are two USBs per port.

Standard Includes	Required to Specify
<p>► Need help? Product details, page 614</p> <ul style="list-style-type: none"> • Desktop module with lid, mounts flat just above worksurface: anodized aluminum, silver with black face plate • 6' power cord with 15-amp plug • Requires 8" x 5" cutout • Utilizes water-proof simplex (outlets) • UL listed • Voice/data adaptor kit to accept couplers and jacks when needed (refer to telecommunications reference chart) 	<ol style="list-style-type: none"> 1 Style number 2 Desktop module configuration (see Required Selections below)

Required Sections	U.S. Price	Required to Specify
<p>Power/Data/USB Configuration</p> <ul style="list-style-type: none"> • Two power/two data • Two power/one data/one USB • Two power/two USB • Three power/one data • Three power/one USB • Four power 	<p>No cost +\$148 +\$301 +\$ 5 +\$158 +\$102</p>	<p>Specify with two power/two data. Specify with two power/one data/one USB. Specify with two power/two USB. Specify with three power/one data. Specify with three power/one USB. Specify with four power.</p>

Specification Information					
Dimensions			Style Number	U.S. Base Price	
D	W	H			
5¼"	8"	3½"	CODPE4	\$474	



For Canadian Pricing
Multiply U.S. Price by the Canadian price factor.
► See page 1 for details.

Train Collaborative and Conference Tables Accessories

DESIGN VECTA DESIGN TEAM AND IDEO

Ellora, Hardware

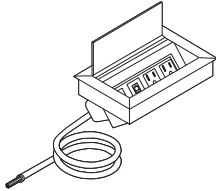

Tip: The Ellora desktop module will ship with instructions and a hole cutout template for field installation, if needed.

Tip: For a factory installed cutout in the table top, specify Mini-Port as an option for Train. If you do not specify Mini-Port as an option, where applicable, the table top will require a field installed cutout. See Standard Grommet/Axil Z/Ellora Locations for Train Rectangle Tables, page 618. For any other tables, other than Train, that require a Mini-Port desktop module, a special engineering quote is mandatory if you require a factory installed cutout in a location other than standard, send us a drawing with measurements indicating the exact location(s) required in the table top.

Tip: USB for charging is configured in the spot of one data port and is always configured on the end(s).

Tip: For each USB port specified, there are two USBs per port.

Tip: The hardware Ellora desktop module does not work with modular table power kits.

Tip: If a hardware Ellora desktop module is desired, then it should only be specified on tables with glides.

Standard Includes	Required to Specify
-------------------	---------------------

- | | | |
|--|---|--|
| <ul style="list-style-type: none"> ▶ Need help? Product details, page 614 | <ul style="list-style-type: none"> • Desktop module with lid, mounts flat just above worksurface: anodized aluminum, silver with black face plate • 6' flexible steel hardware conduit • Requires 8" x 5" cutout • Utilizes water-proof simplex (outlets) • UL listed • Voice/data adaptor kit to accept couplers and jacks when needed (refer to telecommunications reference chart) | <ol style="list-style-type: none"> 1 Style number 2 Desktop module configuration (see Required Selections below) |
|--|---|--|

Required Sections	U.S. Price	Required to Specify
-------------------	------------	---------------------

- | | | | |
|-------------------------------------|--|---|---|
| Power/Data/USB Configuration | <ul style="list-style-type: none"> • Two power/two data • Two power/one data/one USB • Two power/two USB • Three power/one data • Three power/one USB • Four power | <p>No cost</p> <p>+\$148</p> <p>+\$301</p> <p>+\$ 5</p> <p>+\$158</p> <p>+\$102</p> | <p>Specify with two power/two data.</p> <p>Specify with two power/one data/one USB.</p> <p>Specify with two power/two USB.</p> <p>Specify with three power/one data.</p> <p>Specify with three power/one USB.</p> <p>Specify with four power.</p> |
|-------------------------------------|--|---|---|

Specification Information					
Dimensions			Style Number	U.S. Base Price	
D	W	H			

5¼"	8¼"	3½"	CODHE4	\$474
-----	-----	-----	--------	-------

Train Collaborative and Conference Tables



For Canadian Pricing
 Multiply U.S. Price by the Canadian price factor.
 ▶ See page 1 for details.

Train Collaborative and Conference Tables Accessories *continued*

DESIGN VECTA DESIGN TEAM AND IDEO

Four-Circuit, Hardwire Base Power Infeed

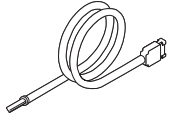

Tip: For alternative wiring configurations, see Options.

Tip: All electrical system components (raceways, receptacles, base power infeeds, etc.) must be the same wiring schematic: 3+1, 2+2, or three-circuit, separate neutrals.

Tip: Four-circuit hardwire base power infeed is only compatible with raceway with electrical.

Standard Includes		Required to Specify
▶ Need help? Product details, page 611	• Four-circuit power infeed with eight-wire pig tail for hardwire connection on one end and modular connector on the other end, 6'L: black	1 Style number 2 Options, if selected (see below)

Options	U.S. Price	Required to Specify
Four-circuit, 2+2 wiring configuration ▶ Page 612	No cost	Add suffix Y to the style number.
Three-circuit, separate neutrals wiring configuration ▶ Page 613	No cost	Add suffix Z to the style number.

Specification Information	
Style Number	U.S. Price
TNBPIHW	\$513
Approved for Use in New York City	
TNBPINY	\$513



For Canadian Pricing
Multiply U.S. Price by the Canadian price factor.
▶ See page 1 for details.

Train Collaborative and Conference Tables Accessories

DESIGN VECTA DESIGN TEAM AND IDEO

Four-Circuit Modular Base Power Infeeds

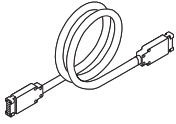

Tip: Modular base power infeed requires four-circuit wall jack, 321899.

► See below

Tip: For alternative wiring configurations, see Options.

Tip: All electrical system components (raceways, receptacles, base power infeeds, etc.) must be the same wiring schematic: 3+1, 2+2, or three-circuit, separate neutrals.

Tip: Four-circuit modular base power infeed is only compatible with raceway with electrical.

Standard Includes		Required to Specify
► Need help? Product details, page 611	<ul style="list-style-type: none"> Four-circuit power infeed with modular connectors on both ends, 6'L: black 	1 Style number 2 Options, if selected (see below)

Options	U.S. Price	Required to Specify
Four-circuit, 2+2 wiring configuration ► Page 613	No cost	Add suffix Y to the style number.

Three-circuit, separate neutrals wiring configuration ► Page 613	No cost	Add suffix Z to the style number.
--	---------	--

Specification Information

Style Number	U.S. Price
TNBPIMD	\$513

Four-Circuit Wall Jack/Faceplate

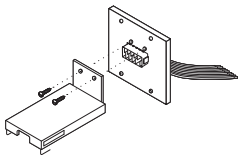

Tip: Wall jack requires 4¹¹/₁₆" square wall junction box, not included.

Tip: Wall jack requires modular base power infeed.

► See above

Tip: Four-circuit wall jack is only compatible with raceway with electrical.

Standard Includes		Required to Specify
► Need help? Product details, page 611	<ul style="list-style-type: none"> Wall jack with four-circuit modular connector: black Strain relief bracket 	1 Style number 2 Options, if selected (see below)

Options	U.S. Price	Required to Specify
Four-circuit, 2+2 wiring configuration ► Page 613	No cost	Add suffix Y to the style number.

Three-circuit, separate neutrals wiring configuration ► Page 613	No cost	Add suffix Z to the style number.
--	---------	--

Specification Information

Style Number	U.S. Price
321899	\$109



For Canadian Pricing
 Multiply U.S. Price by the Canadian price factor.
 ► See page 1 for details.

Train Collaborative and Conference Tables Accessories *continued*

DESIGN VECTA DESIGN TEAM AND IDEO

Single-Circuit 20-Amp Plug Base Power Infeed

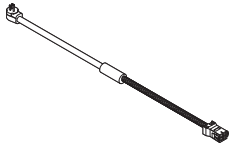

Tip: The hardwire desktop modules do not work with modular table power kits, therefore, do not require any type of infeeds.

Tip: The plug infeed can only be used with circuit 1 modular table power kits.

Tip: Single circuit 20-amp base power infeed is only compatible with modular table power kits.

Tip: The female modular connector of the infeed can only connect to the male infeed of the modular table power kit.

Tip: Plug infeed can be used on tables with glides or casters.

	Standard Includes	Required to Specify
▶ Need help? Product details, page 615	<ul style="list-style-type: none"> Single circuit (circuit 1) power infeed with 20-Amp plug on one end and female modular connector on the other end: 24" of thick rubber on plug end with coupler attaching 48" of conduit with modular connector UL recognized 	Style number

Specification Information

Dimensions Length	Style Number	U.S. Price
72"	COBPIFMP20	\$338

Two-Circuit Hardwire Base Power Infeed



Tip: The hardwire desktop modules do not work with modular table power kits, therefore, do not require any type of infeeds.

Tip: The hardwire infeed can only be used on tables with glides.

Tip: Two-circuit hardwire base power infeed is only compatible with modular table power kits.

Tip: The female modular connector of the infeed can only connect to the male infeed of the modular table power kit.

	Standard Includes	Required to Specify
▶ Need help? Product details, page 615	<ul style="list-style-type: none"> 2 circuit power infeed with 4-wire pigtail for hardwire connection on one end and female modular connector on the other end: flexible steel conduit UL listed 	Style number

Specification Information

Dimensions Length	Style Number	U.S. Price
72"	COBPIFMH	\$362

Train Collaborative and Conference Tables Accessories

DESIGN VECTA DESIGN TEAM AND IDEO

PowerPod

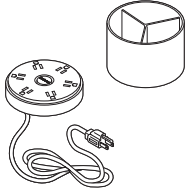

Tip: PowerPod must be plugged directly into the building power supply.

Standard Includes	Required to Specify
<ul style="list-style-type: none"> ▶ Need help? Product details, page 617 • PowerPod with 6' and three prong plug: silver bottom cradle and milk face • Accessory tray: milk • Six 15-amp power outlets • Illuminated on/off button • Surge suppressor 	Style number

Specification Information			
Dimensions		Style	U.S.
Dia	H	Number	Price
6"	6"	COPP01	\$257

Grommets for Standard Locations

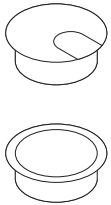

Tip: The grommet will be shipped with the table so it can be installed on site in the factory-cut opening.

Tip: Custom locations are possible. Custom locations require an engineering review to confirm practicality. Please send a drawing to your Customer Service representative to show the locations you want, confirm practicality, and obtain a quotation.

Tip: Please send a drawing of your arrangement along with your order to ensure that grommets are properly installed.

Tip: Additional tables may be able to accommodate grommets. Ask your Customer Service representative at 1.800.627.6770 to help you determine practicality.

Standard Includes	Required to Specify
<ul style="list-style-type: none"> ▶ Need help? Product details, page 617 • 2" diameter opening with snap out covers allow power cords and voice/data cables to pass through the worksurface: black plastic • Factory-installed in standard locations 	Style number

Specification Information	
Style Number	U.S. Price
793215	\$105

Train Collaborative and Conference Tables

Café Tables

* These product lines are collections and will be found in multiple locations in this specification guide and/or *Coalesse Seating Specification Guide*.
▶ See *Collections*, page 5.

Ballet Café Tables*	648
Bix Collaborative and Conference Tables*	649
Bob Collaborative and Conference Tables*	650
Enea Café Tables*	652
Mho Power Module for Enea Twin Base Tables	656
Enea Lottus Café Tables*	657
Montara650 Café Tables*	660

Ballet Café Tables Round Café Tables

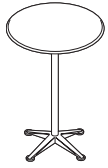

Tip: Shipped knocked down.

Tip: For installation of a grommet or sphere, submit a drawing indicating the desired location for a factory installed cutout. Field installation is also available. Both require the grommet or sphere to be ordered as a separate item.

Standard Includes		Required to Specify	
<p>► Need help? Product details, page 34</p>	<ul style="list-style-type: none"> • Top: 3/4" particle board core with High-Pressure Laminate • Edge: black ribbed vinyl T-mold • Base: 2" diameter steel column and 4-prong cast aluminum feet with single powder coat • 19" cast aluminum technology spider • Adjustable leveling glides: non-marring, black plastic 	<ul style="list-style-type: none"> 1 Style number 2 Powder coat color number for base 3 Laminate color number for top 4 Options, if selected (see below) <p>► See <i>Coalesse Surface Materials Reference Guide</i>.</p>	
Options		U.S. Price	Required to Specify
Surface Materials	Top		
	<ul style="list-style-type: none"> • Grade 2 laminate • Grade 3 laminate 	<p>Prices below</p> <p>Prices below</p>	<p>Specify with <i>grade 2 laminate</i> and select color number.</p> <p>Specify with <i>grade 3 laminate</i> and select color number.</p>
Related Products	<ul style="list-style-type: none"> • Collaborative and conference tables 		► Pages 39–48

Specification Information			
Dimensions	Style Number	Finish	U.S. Price
Dia H			<p>Ballet Ribbed Vinyl T-Mold Edge:</p>
30" 41½"	933421T	Grade 1 Laminate	\$1429
		Grade 2 and 3 Laminate	\$1480
36" 41½"	934422T	Grade 1 Laminate	\$1627
		Grade 2 and 3 Laminate	\$1693



For Canadian Pricing
 Multiply U.S. Price by the Canadian price factor.
 ► See page 1 for details.

Bix Collaborative and Conference Tables 27"H Work-Booth Tables

DESIGN METRO DESIGN GROUP

Standard Includes		Required to Specify
<p>► Need help? Product details, see <i>Coalesse Seating Specification Guide</i>.</p> <ul style="list-style-type: none"> • Top: <ul style="list-style-type: none"> - Laminate top (Grade 1 laminates) with matching plastic edge - Laminate top (Grade 1 Steelcase) with contrasting plastic edge - Wood veneer top with matching flat wood edge • Base: textured paints only • Grommet, if selected: black plastic only 	<ol style="list-style-type: none"> 1 Style number 2 Laminate or wood veneer color number for top 3 Plastic edge color number for top with Grade 1 Steelcase or Grade 2/3 laminate, if selected 4 Textured paint color number for base 5 Options, if selected (see below) <p>► See <i>Coalesse Surface Materials Reference Guide</i>.</p>	

Options	U.S. Price	Required to Specify
<p>Cable Management</p> <ul style="list-style-type: none"> • PDV module: black plastic 	+\$562 each	Specify with PDV module.

Tip: One or two power, data, and voice modules are available on rectangular occasional tables.

<p>Related Products</p> <ul style="list-style-type: none"> • Lounge chair • Sectional seating • Occasional tables 	<p>► See <i>Coalesse Seating Specification Guide</i>. ► See <i>Coalesse Seating Specification Guide</i>. ► Page 672</p>
---	---

Specification Information

Dimensions				Style Number	U.S. Base Prices			
D	W	H	Diameter		Lam 1	Lam 2 and 3	Wood Veneer 1	Wood Veneer 2

Round Work-Booth Tables

N.A.	N.A.	27"	20"	BTW20003	\$1636	\$1718	\$1801	\$1881
N.A.	N.A.	27"	28"	BTW28003	\$1704	\$1789	\$1884	\$2056

Round Work-Booth Table with Grommet

N.A.	N.A.	27"	28"	BTW28003U	\$1810	\$1898	\$1990	\$2162
------	------	-----	-----	-----------	--------	--------	--------	--------

Rectangular Work-Booth Tables

36"	48"	27"	N.A.	BTW36483	\$3113	\$3271	\$3459	\$3788
36"	72"	27"	N.A.	BTW36723	\$3445	\$3618	\$3791	\$4285

Rectangular Work-Booth Tables with Grommets

36"	48"	27"	N.A.	BTW36483U	\$3331	\$3497	\$3677	\$4006
36"	72"	27"	N.A.	BTW36723U	\$3660	\$3845	\$4006	\$4500

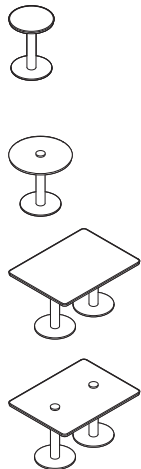

Edge Profiles

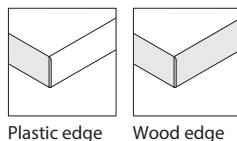

For Canadian Pricing
 Multiply U.S. Price by the Canadian price factor.
 ► See page 1 for details.

Bob Collaborative and Conference Tables Conference Dining Tables

DESIGN PEARSON LLOYD

Tip: Shipped assembled.

Tip: Glass tops are 1/2" thick. 1/32" chamfers are applied to top and bottom edges.

Standard Includes	Required to Specify
<ul style="list-style-type: none"> • Base: 8040 Aluminum Matte Polished or Grade 1 paint • Top: clear green glass • Glides 	<ol style="list-style-type: none"> 1 Style number 2 Color number for top 3 Plastic color for edge band of laminate top, if selected 4 Metal or paint color for base 5 Options, if selected (see below) <p>▶ See <i>Coalesse Surface Materials Reference Guide</i>.</p>

Options	U.S. Price	Required to Specify
Surface Materials Base <ul style="list-style-type: none"> • Aluminum matte polished • Grade 1 paint • Grade 3 paint 	No cost No cost +\$145	Specify with <i>aluminum matte polished</i> . Specify paint color number. Specify paint color number.
Glides <ul style="list-style-type: none"> • Felted glides 	+\$ 22	Specify with <i>felted glides</i> .
Related Products <ul style="list-style-type: none"> • Occasional tables • Lounge seating • Guest seating 		▶ Page 676 ▶ See <i>Coalesse Seating Specification Guide</i> . ▶ See <i>Coalesse Seating Specification Guide</i> .

Specification Information

Dimensions Height	Style Number	Top Surface	U.S. Base Prices	Dimensions Height	Style Number	Top Surface	U.S. Base Prices
24" Diameter Round Conference Dining Tables				30" Diameter Round Conference Dining Tables			
29"	105-T1	Clear Green Glass	\$2396	29"	105-T2	Clear Green Glass	\$2722
29"		Acid Etched 6511	\$2798	29"		Acid Etched 6511	\$3268
29"		Absolute Clear Glass	\$2811	29"		Absolute Clear Glass	\$3398
29"		Back-Painted Glass	\$3330	29"		Back-Painted Glass	\$4216
29"		Grade 1 Laminate	\$1799	29"		Grade 1 Laminate	\$1857
29"		Grade 2 and 3 Laminate	\$1829	29"		Grade 2 and 3 Laminate	\$1889
29"		Grade 1 Wood Veneer	\$2389	29"		Grade 1 Wood Veneer	\$2689
29"		Grade 2 Wood Veneer	\$2493	29"		Grade 2 Wood Veneer	\$2809
29"		Solid Surface	\$2925	29"		Solid Surface	\$3299

▶ Specification Information, continued on next page

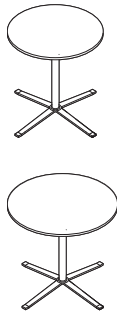

 **For Canadian Pricing**
 Multiply U.S. Price by the Canadian price factor.
 ▶ See page 1 for details.

Bob Collaborative and Conference Tables Conference Dining Tables

DESIGN PEARSON LLOYD

► Specification Information, continued from previous page

Specification Information

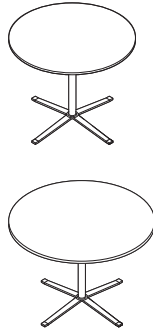

Dimensions Height	Style Number	Top Surface	U.S. Base Prices
36" Diameter Round Conference Dining Table			
29"	105-T3	Clear Green Glass	\$3237
29"		Acid Etched 6511	\$4003
29"		Absolute Clear Glass	\$4207
29"		Back-Painted Glass	\$5594
29"		Grade 1 Laminate	\$1989
29"		Grade 2 and 3 Laminate	\$2031
29"		Grade 1 Wood Veneer	\$3232
29"		Grade 2 Wood Veneer	\$3438
29"		Solid Surface	\$4214

Dimensions Height	Style Number	Top Surface	U.S. Base Prices
42" Diameter Round Conference Dining Table			
29"	105-T4	Clear Green Glass	\$3573
29"		Acid Etched 6511	\$4606
29"		Absolute Clear Glass	\$4878
29"		Back-Painted Glass	\$6370
29"		Grade 1 Laminate	\$2099
29"		Grade 2 and 3 Laminate	\$2154
29"		Grade 1 Wood Veneer	\$3551
29"		Grade 2 Wood Veneer	\$3847
29"		Solid Surface	\$4440

 **For Canadian Pricing**
 Multiply U.S. Price by the
 Canadian price factor.
 ► See page 1 for details.

Enea Café Tables Single Base X4/24

DESIGN JOSEP LLUSCA

Tip: Shipped knocked down.

Tip: Disc bases are 24" diameter for 30", 36", and 42" diameter tables. Disc bases are 31 1/2" diameter for 54" and 60" diameter tables.

Tip: White laminate tops may exhibit slightly visible black specks inherent to the top manufacturing process.

Standard Includes

- Laminate top: 3/4" thick with T-mold edge band
- Wood veneer top: 3/4" thick with maple edge and maple veneer
- Base/frame: steel tubing and base: paint
- Glides: non-skid

Required to Specify

- 1 Style number
 - 2 Laminate or wood veneer top color number
 - 3 Plastic color for edge band of laminate top, if selected:
6D10 Silver Metallic
6D11 Black
6D12 White
 - 4 Base/frame finish:
4016 White Gloss
4017 Black Gloss
4018 Silver Metallic
- ▶ See *Coalesse Surface Materials Reference Guide*.

Related Products

- Occasional tables
- ▶ Page 688
- Guest seating
- ▶ See *Coalesse Seating Specification Guide*.
- Stools
- ▶ See *Coalesse Seating Specification Guide*.

Specification Information

Dimensions		Style Number	U.S. Prices	
Diameter	H		Top Surface:	
			Laminate	Wood Veneer

Café/Conference Height Tables X4/24

30"	30"	H35-T3030L	\$1705	N.A.
30"	30"	H35-T3030W	N.A.	\$2653
36"	30"	H35-T3630L	\$1792	N.A.
36"	30"	H35-T3630W	N.A.	\$2952
42"	30"	H35-T4230L	\$2063	N.A.
42"	30"	H35-T4230W	N.A.	\$3189
54"	30"	H35-T5430L	\$3279	N.A.
54"	30"	H35-T5430W	N.A.	\$5168
60"	30"	H35-T6030L	\$3283	N.A.
60"	30"	H35-T6030W	N.A.	\$5602

▶ Specification Information, continued on next page

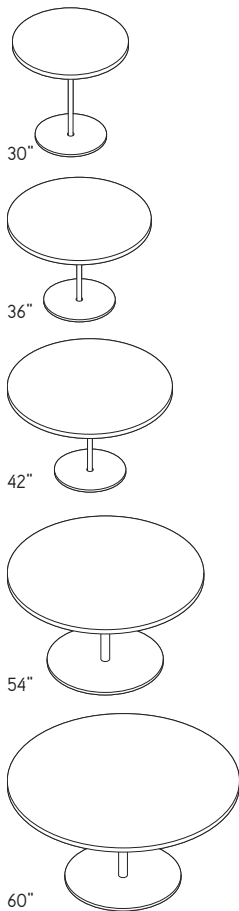

X

4/24 = Last order entry
April 14, 2024

Enea Café Tables Single Base

DESIGN JOSEP LLUSCA

► Specification Information, continued from previous page

Specification Information

Dimensions		Style Number	U.S. Prices	
Diameter	H		Top Surface: Laminate	Wood

Café/Counter-Height Tables X4/24

24"	36"	H35-T2436L	\$1645	N.A.
24"	36"	H35-T2436W	N.A.	\$2675
30"	36"	H35-T3036L	\$1799	N.A.
30"	36"	H35-T3036W	N.A.	\$2993
36"	36"	H35-T3636L	\$1864	N.A.
36"	36"	H35-T3636W	N.A.	\$3260
42"	36"	H35-T4236L	\$2148	N.A.
42"	36"	H35-T4236W	N.A.	\$4351

Café/Bar-Height Tables X4/24

24"	42"	H35-T2442L	\$1693	N.A.
24"	42"	H35-T2442W	N.A.	\$2745
30"	42"	H35-T3042L	\$1814	N.A.
30"	42"	H35-T3042W	N.A.	\$3073
36"	42"	H35-T3642L	\$1875	N.A.
36"	42"	H35-T3642W	N.A.	\$3338

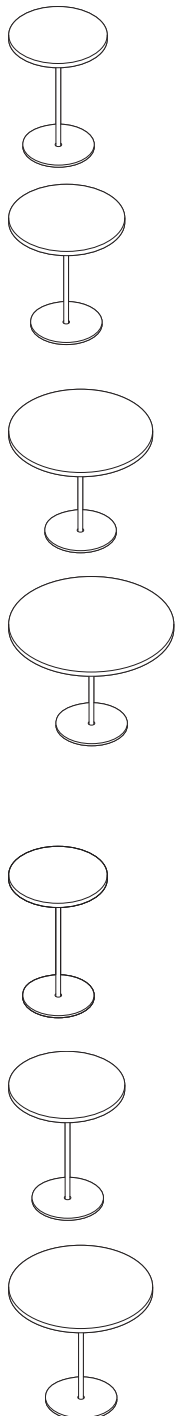

Café Tables

X4/24 = Last order entry
April 14, 2024

Enea Café Tables Twin Base X4/24

DESIGN JOSEP LLUSCA

Tip: Shipped knocked down.

Tip: Due to weight of steel bases, please lift or move tables by bases only (do not lift by tops) with at least two people.

Tip: White laminate tops may exhibit slightly visible black specks inherent to the top manufacturing process.

Standard Includes	Required to Specify
-------------------	---------------------

- Base/frame: steel tubing and base: paint
- Glides: non-skid
- Disc bases are 24" diameter
- Laminate top: 3/4" thick with T-mold edge band
- Wood veneer top: 3/4" thick with maple edge and maple veneer

- 1 Style number
 - 2 Base/frame finish:
4016 White Gloss
4017 Black Gloss
4018 Silver Metallic
 - 3 Plastic color for edge band of laminate top, if selected:
6D10 Silver Metallic
6D11 Black
6D12 White
 - 4 Laminate or wood veneer top color number
 - 5 Options, if selected (see below)
- ▶ See *Coalesse Surface Materials Reference Guide*.

Options	U.S. Price	Required to Specify
---------	------------	---------------------

Interport Power/Data Module	<ul style="list-style-type: none"> • Mho power/data module (available in 8047 Silver Anodized Aluminum) 	+\$504 Specify with Mho power/data module.
------------------------------------	--	---

Related Products	<ul style="list-style-type: none"> • Occasional tables • Guest seating • Stools 	<ul style="list-style-type: none"> ▶ Page 688 ▶ See <i>Coalesse Seating Specification Guide</i>. ▶ See <i>Coalesse Seating Specification Guide</i>.
-------------------------	--	--

Specification Information

Dimensions			Style Number	U.S. Base Prices	
D	W	H		Top Surface: Laminate	Wood Veneer

Conference/Racetrack Tables X4/24

30"	72"	30"	H35-T307230KL	\$4260	N.A.
30"	72"	30"	H35-T307230KW	N.A.	\$6218

Counter/Racetrack Tables X4/24

30"	72"	36"	H35-T307236KL	\$4445	N.A.
30"	72"	36"	H35-T307236KW	N.A.	\$6378

Café/Racetrack Tables X4/24

30"	72"	42"	H35-T307242KL	\$4708	N.A.
30"	72"	42"	H35-T307242KW	N.A.	\$6596

▶ Specification Information, continued on next page

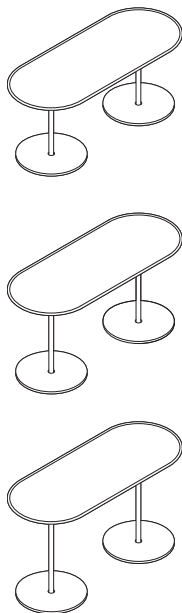

For Canadian Pricing
Multiply U.S. Price by the Canadian price factor.
▶ See page 1 for details.

X4/24 = Last order entry
April 14, 2024

Enea Café Tables Twin Base

DESIGN JOSEP LLUSCA

► Specification Information, continued from previous page

Specification Information

Dimensions			Style Number	U.S. Base Prices	
D	W	H		Top Surface:	
				Laminate	Wood

Rectangular Tables ✕4/24

30"	72"	30"	H35-T307230GL	\$4228	N.A.
30"	72"	30"	H35-T307230GW	N.A.	\$5972

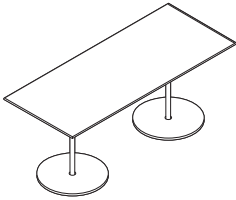

30"	72"	36"	H35-T307236GL	\$4437	N.A.
30"	72"	36"	H35-T307236GW	N.A.	\$6173

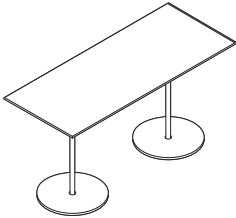

30"	72"	42"	H35-T307242GL	\$4902	N.A.
30"	72"	42"	H35-T307242GW	N.A.	\$6388

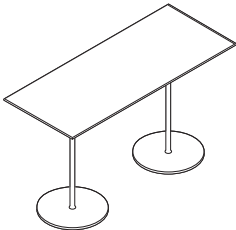

Oval Tables ✕4/24

30"	72"	30"	H35-T307230VL	\$4220	N.A.
30"	72"	30"	H35-T307230VW	N.A.	\$6149



30"	72"	36"	H35-T307236VL	\$4253	N.A.
30"	72"	36"	H35-T307236VW	N.A.	\$6339



30"	72"	42"	H35-T307242VL	\$4646	N.A.
30"	72"	42"	H35-T307242VW	N.A.	\$6507



✕4/24 = Last order entry
April 14, 2024

Mho Power Module for Enea Twin Base Tables

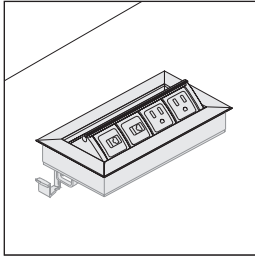
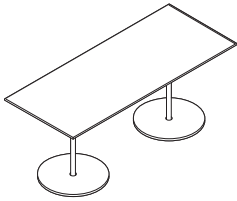

Available Models: Options: Available on wood, laminate and finesse covered tops only. Available in centered position only. Mho not available on Coalesse and CoalesseSpaces.models. Check grid for model availability.

Table	Model	Centered	Off Center
Enea	H35-T307230GL	Yes	No
	H35-T307230GW	Yes	No
	H35-T307236GL	Yes	No
	H35-T307236GW	Yes	No
	H35-T307242GL	Yes	No
	H35-T307242GW	Yes	No
	H35-T307230VL	Yes	No
	H35-T307230VW	Yes	No
	H35-T307236VL	Yes	No
	H35-T307236VW	Yes	No
	H35-T307242VL	Yes	No
	H35-T307242VW	Yes	No
	H35-T307230KL	Yes	No
	H35-T307230KW	Yes	No
	H35-T307236KL	Yes	No
	H35-T307236KW	Yes	No
	H35-T307242KL	Yes	No
	H35-T307242KW	Yes	No

Color:
Anodized Aluminum

Enea Lottus Café Tables

Café Conference Height Tables

DESIGN LIEVORE ALTHERR MOLINA

Standard Includes	Required to Specify
<ul style="list-style-type: none"> • Top: laminate or wood veneer with 1/2" thick phenolic core • Base and frame: painted steel tubing • Glides: non-skid 	<ol style="list-style-type: none"> 1 Style number 2 Laminate or wood veneer color number for top 3 Paint color number for base/frame 4 Options, if selected (see below) <p>▶ See <i>Coalesse Surface Materials Reference Guide</i>.</p>

Options	U.S. Price	Required to Specify
Surface Materials Base, single <ul style="list-style-type: none"> • Grade 1 paint • Grade 3 paint 	No cost +\$145	Specify paint color number. Specify paint color number.
Base, double <ul style="list-style-type: none"> • Grade 1 paint • Grade 3 paint 	No cost +\$290	Specify paint color number. Specify paint color number.
Related Products <ul style="list-style-type: none"> • Occasional tables • Guest seating • Stools 		<p>▶ Page 690</p> <p>▶ See <i>Coalesse Seating Specification Guide</i>.</p> <p>▶ See <i>Coalesse Seating Specification Guide</i>.</p>

Specification Information

Dimensions			Style Number	U.S. Base Prices			
D	W	H		Top Surface:			
				Laminate Grade 1	Laminate Grades 2 and 3	Wood Veneer 1	Wood Veneer 2

Single-Base Tables

30"	30"	30"	COEL3030	\$1988	\$2214	\$2214	\$2386
36"	36"	30"	COEL3036	\$2293	\$2560	\$2560	\$2774
42"	42"	30"	COEL3042	\$2771	\$3026	\$3026	\$3265

Double-Base Table

30"	72"	30"	COEL303072	\$4473	\$5033	\$5033	\$5437
-----	-----	-----	------------	--------	--------	--------	--------

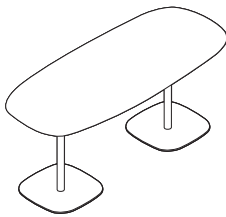

 **For Canadian Pricing**
 Multiply U.S. Price by the Canadian price factor.
 ▶ See page 1 for details.

Enea Lottus Café Tables

Café Counter-Height Tables

DESIGN LIEVORE ALTHERR MOLINA

Standard Includes	Required to Specify
<ul style="list-style-type: none"> • Top: laminate or wood veneer with 1/2" thick phenolic core • Base and frame: painted steel tubing • Glides: non-skid 	<ol style="list-style-type: none"> 1 Style number 2 Laminate or wood veneer color number for top 3 Paint color number for base/frame 4 Options, if selected (see below) <p>▶ See <i>Coalesse Surface Materials Reference Guide</i>.</p>

Options	U.S. Price	Required to Specify
Surface Materials Base, single <ul style="list-style-type: none"> • Grade 1 paint • Grade 3 paint 	No cost +\$145	Specify paint color number. Specify paint color number.
Base, double <ul style="list-style-type: none"> • Grade 1 paint • Grade 3 paint 	No cost +\$290	Specify paint color number. Specify paint color number.
Related Products <ul style="list-style-type: none"> • Occasional tables • Guest seating • Stools 		<p>▶ Page 690</p> <p>▶ See <i>Coalesse Seating Specification Guide</i>.</p> <p>▶ See <i>Coalesse Seating Specification Guide</i>.</p>

Specification Information							
Dimensions			Style Number	U.S. Prices			
D	W	H		Top Surface:			
				Laminate Grade 1	Laminate Grades 2 and 3	Wood Veneer 1	Wood Veneer 2

Single-Base Tables

24"	24"	36"	COEL3624	\$1648	\$1788	\$1788	\$1930
30"	30"	36"	COEL3630	\$2039	\$2270	\$2270	\$2447
36"	36"	36"	COEL3636	\$2351	\$2618	\$2618	\$2836
42"	42"	36"	COEL3642	\$2823	\$3078	\$3078	\$3321

Double-Base Table

30"	72"	36"	COEL363072	\$4573	\$5133	\$5133	\$5542
-----	-----	-----	------------	--------	--------	--------	--------

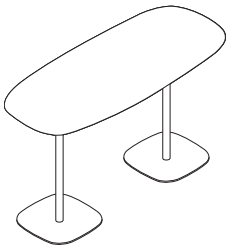
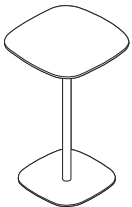

For Canadian Pricing
 Multiply U.S. Price by the Canadian price factor.
 ▶ See page 1 for details.

Enea Lottus Café Tables

Café Bar-Height Tables

DESIGN LIEVORE ALTHERR MOLINA

Standard Includes	Required to Specify
<ul style="list-style-type: none"> • Top: laminate or wood veneer with 1/2" thick phenolic core • Base and frame: painted steel tubing • Glides: non-skid 	<ol style="list-style-type: none"> 1 Style number 2 Laminate or wood veneer color number for top 3 Paint color number for base/frame 4 Options, if selected (see below) <p>▶ See <i>Coalesse Surface Materials Reference Guide</i>.</p>

Options	U.S. Price	Required to Specify
Surface Materials Base, single <ul style="list-style-type: none"> • Grade 1 paint • Grade 3 paint 	No cost +\$145	Specify paint color number. Specify paint color number.
Base, double <ul style="list-style-type: none"> • Grade 1 paint • Grade 3 paint 	No cost +\$290	Specify paint color number. Specify paint color number.
Related Products <ul style="list-style-type: none"> • Occasional tables • Guest seating • Stools 		<p>▶ Page 690</p> <p>▶ See <i>Coalesse Seating Specification Guide</i>.</p> <p>▶ See <i>Coalesse Seating Specification Guide</i>.</p>

Specification Information

Dimensions			Style Number	U.S. Base Prices			
D	W	H		Top Surface:			
				Laminate Grade 1	Laminate Grades 2 and 3	Wood Veneer 1	Wood Veneer 2

Single-Base Tables

24"	24"	42"	COEL4224	\$1693	\$1838	\$1838	\$1986
30"	30"	42"	COEL4230	\$2090	\$2316	\$2316	\$2495
36"	36"	42"	COEL4236	\$2394	\$2661	\$2661	\$2881
42"	42"	42"	COEL4242	\$2967	\$3222	\$3222	\$3476

Double-Base Table

30"	72"	42"	COEL423072	\$4671	\$5231	\$5231	\$5648
-----	-----	-----	------------	--------	--------	--------	--------

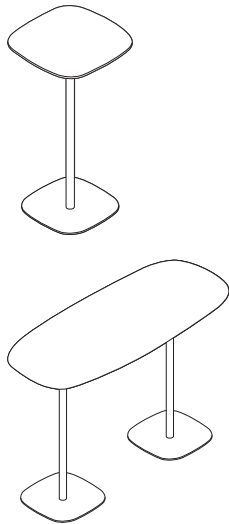

 **For Canadian Pricing**
 Multiply U.S. Price by the Canadian price factor.
 ▶ See page 1 for details.

Montara650 Café Tables

DESIGN COALESSE DESIGN GROUP

Montara650 is a comprehensive collection that offers a simple, refined design that can be customized to support a range of applications, postures, and aesthetics.

Tip: This product line is a collection and will be found in multiple locations, either in this specification guide and/or another specification guide.

► See Collections, page 5

Top is available in laminate with a 3 mm plastic edge or wood veneer with matching 3 mm edge.

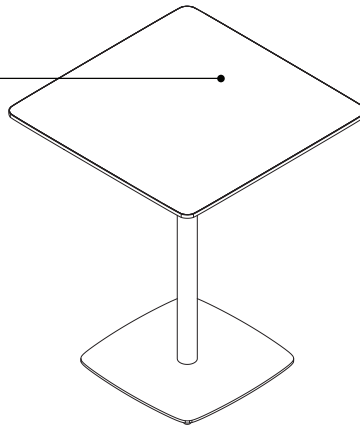

Round power module and PowerPod grommet are options on most table sizes.

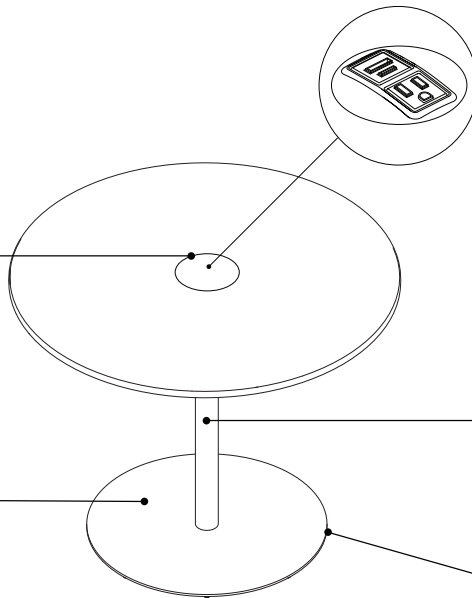

Base is available in powder coat paint.

Cord management is routed through the column and exits at the base. Clearance is 1/2".

Glides are non-adjustable.

Product Details



Round



Square



Rectangular

Base shape matches top shape. Round tops have round bases. Square and rectangular tops have square bases.

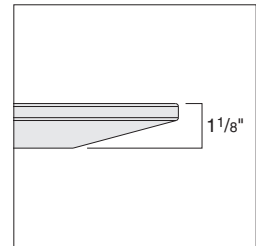

Tables are standard with a knife edge profile that has the appearance of a 1/2" thick top, which tapers to an overall top thickness of 1 1/8".

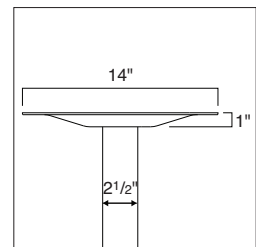

Understructure without power

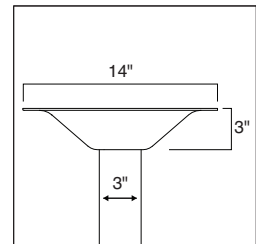

Understructure with power

Tops with a laminate surface have 3 mm plastic edge and finish selection. Wood veneer tops have a matching 3 mm edge.

Montara650 Café Tables

DESIGN COALESSE DESIGN GROUP

Surface Materials

Top

- Laminate
- Veneer

Base

- Paint

Power module

- Paint

Table heights include occasional, work, and café. Café style tables are offered in counter and bar heights.

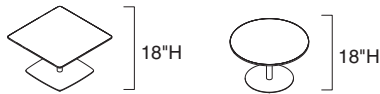

Occasional Height

► Specifying, page 696

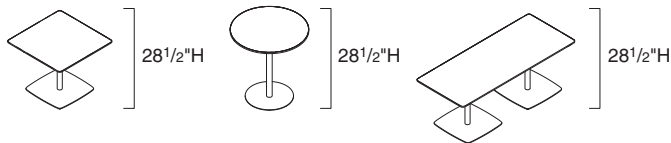

Café at Work Height

► Specifying, page 662

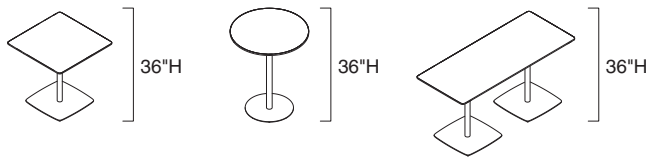

Café at Counter Height

► Specifying, page 664

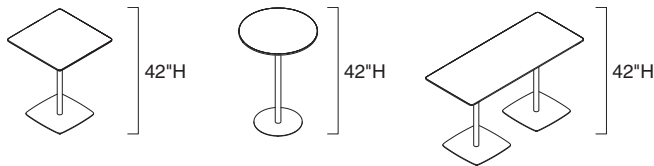

Café at Bar Height

► Specifying, page 664

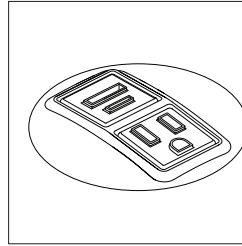

Power module and PowerPod grommet are options for the following tables:

- 30" and larger occasional tables
- 36" and larger work and café height tables
- Large rectangular tops have the option of one or two grommets, located on table end(s).

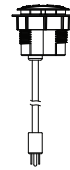

The module is available centered over the post. It comes with a 96" L power cord with 15-amp plug.

Round power module is available in:

- 4013 Silver/Black
- 4180 Graphite Matte
- 4242 Milk Smooth
- 4710 Low Gloss Black

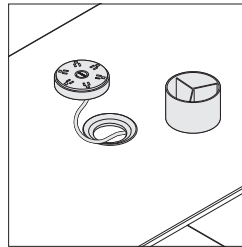

The grommet allows for pass through of cords and cables at the desktop. The grommet is open to allow for the PowerPod to be housed over or stored on the table. The grommet inside dimension is 3 1/2" and outside dimension is 5 1/16".

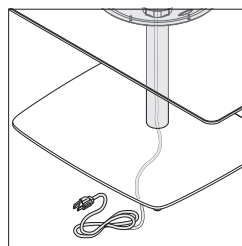

Cords can be routed from the grommet in the desktop through the column and out the base.

Tip: If table is over a floor core, the floor core must be recessed or flush to the floor and must be centered over the column.

Montara650 Café Tables Work-Height Tables

DESIGN COALESSE DESIGN GROUP

Standard Includes	Required to Specify
<ul style="list-style-type: none"> ► Need help? Product details, page 660 • Table top: <ul style="list-style-type: none"> - Grade 1 laminate with 3 mm flat plastic edge - Wood veneer with matching flat edge • Base: Grade 1 paint • Glides • Ships ready to assemble 	<ol style="list-style-type: none"> 1 Style number 2 Table top diameter for round table 3 Table top width for square or rectangular table 4 Table top depth for square or rectangular table 5 Laminate or wood veneer color number for table top 6 Plastic edge color number for laminate table top, if selected 7 Paint color number for base 8 Options, if selected (see below) <p>► See <i>Coalesse Surface Materials Reference Guide</i>.</p>

Options	U.S. Price	Required to Specify
Surface Materials <ul style="list-style-type: none"> • Table top <ul style="list-style-type: none"> • Grade 2 laminate • Grade 3 laminate • Grade 2 wood veneer 	<ul style="list-style-type: none"> Prices below and at right Prices below and at right Prices below and at right 	<ul style="list-style-type: none"> Specify with <i>grade 2 laminate</i> and select color number. Specify with <i>grade 3 laminate</i> and select color number. Specify with <i>grade 2 wood veneer</i> and select color number.
Base <ul style="list-style-type: none"> • Grade 3 paint on tables with single base • Grade 3 paint on tables with double base (30"D x 72"W) 	<ul style="list-style-type: none"> +\$145 +\$290 	<ul style="list-style-type: none"> Specify paint color number. Specify paint color number.
Power/USB Configuration and Grommets <ul style="list-style-type: none"> • Power module for 24"-42" diameter round and 24"W-42"W square tables (center only) <ul style="list-style-type: none"> • Two TR simplex receptacles • One TR simplex receptacle and one USB A charging port • One TR simplex receptacle, one USB A charging port, and one USB C charging port 	<ul style="list-style-type: none"> +\$375 +\$521 +\$521 	<ul style="list-style-type: none"> Specify with <i>power module with two power</i> and select finish. Specify with <i>power module with one power, one USB A</i> and select finish. Specify with <i>power module with one power, one USB A, one USB C</i> and select finish.
Power module for 30"D x 72"W rectangular tables <ul style="list-style-type: none"> • Two TR simplex receptacles • One TR simplex receptacle and one USB A charging port • One TR simplex receptacle, one USB A charging port, and one USB C charging port 	<ul style="list-style-type: none"> +\$375 each power module +\$521 each power module +\$521 each power module 	<ul style="list-style-type: none"> Specify with <i>power module with two power</i> and select finish. Specify with <i>power module with one power, one USB A</i> and select finish. Specify with <i>power module with one power, one USB A, one USB C</i> and select finish.
PowerPod grommet <ul style="list-style-type: none"> • PowerPod grommet for 24"-60" diameter round and 24"W-42"W square tables (center only) • PowerPod grommet for 30"D x 72"W rectangular tables 	<ul style="list-style-type: none"> +\$ 73 +\$ 73 each grommet 	<ul style="list-style-type: none"> Specify with <i>PowerPod grommet</i> and select finish. Specify with <i>one or two PowerPod grommets</i> and select finish.
Related Products <ul style="list-style-type: none"> • PowerPod • Occasional tables • Guest seating • Lounge seating • Stools 		<ul style="list-style-type: none"> ► Page 739 ► Page 696 ► See <i>Coalesse Seating Specification Guide</i>. ► See <i>Coalesse Seating Specification Guide</i>. ► See <i>Coalesse Seating Specification Guide</i>.

Tip: Grade 3 paints, including Lux Coatings, Steelcase accent paints, and PerfectMatch, are not available on 54" or 60" round tables.

Tip: PowerPod grommet is available in 6000 Black or 6052 Milk.

Tip: Column routes cables and wires when optional power or grommet are selected, and exits through the base.

Tip: Round power module is available in 4013 Silver/Black, 4180 Graphite Matte, 4242 Milk Smooth, or 4710 Low Gloss Black.

Tip: Round power modules are not available on 54" and 60" diameter tables. PowerPod is available.



For Canadian Pricing
 Multiply U.S. Price by the Canadian price factor.
 ► See page 1 for details.

Montara650 Café Tables Work-Height Tables

DESIGN COALESSE DESIGN GROUP

Specification Information

Style Number	Dimensions			U.S. Base Prices			
	D	W	H	Laminate		Wood Veneer	
				Grade 1	Grade 2 and 3	Grade 1	Grade 2



28½"H Round Café Tables

Style Number	Dimensions	H	Laminate Grade 1	Laminate Grade 2 and 3	Wood Veneer Grade 1	Wood Veneer Grade 2
COSFWTRD	24" diameter	28½"	\$1534	\$1560	\$2561	\$2854
	30" diameter	28½"	\$1642	\$1683	\$2669	\$2962
	36" diameter	28½"	\$1749	\$1809	\$2776	\$3069
	42" diameter	28½"	\$1998	\$2080	\$3170	\$3463
	54" diameter	28½"	\$3068	\$3203	\$4533	\$4826
	60" diameter	28½"	\$3212	\$3378	\$4970	\$5262

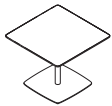

28½"H Square Café Tables

Style Number	D	W	H	Laminate Grade 1	Laminate Grade 2 and 3	Wood Veneer Grade 1	Wood Veneer Grade 2
COSFWTSQ	24"	24"	28½"	\$1534	\$1560	\$2561	\$2854
	30"	30"	28½"	\$1642	\$1683	\$2669	\$2962
	36"	36"	28½"	\$1749	\$1809	\$2776	\$3069
	42"	42"	28½"	\$1998	\$2080	\$3170	\$3463

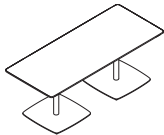

28½"H Rectangular Café Tables

Style Number	D	W	H	Laminate Grade 1	Laminate Grade 2 and 3	Wood Veneer Grade 1	Wood Veneer Grade 2
COSFWTSQ	24"	30"	28½"	\$1606	\$1639	\$2633	\$2926
	30"	72"	28½"	\$3852	\$3953	\$5757	\$6051

Tip: A 30"D x 72"W table has a double base.

Tip: One or two PowerPod grommets can be specified in 30"D x 72"W rectangular table.

Tip: One or two round power modules can be specified in 30"D x 72"W rectangular table.



For Canadian Pricing
 Multiply U.S. Price by the Canadian price factor.
 ▶ See page 1 for details.

Montara650 Café Tables Café-Height Tables

DESIGN COALESSE DESIGN GROUP



	Standard Includes	Required to Specify
<p>► Need help? Product details, page 660</p>	<ul style="list-style-type: none"> Table top: <ul style="list-style-type: none"> Grade 1 laminate with 3 mm flat plastic edge Wood veneer with matching flat edge Base: Grade 1 paint Glides Ships ready to assemble 	<ol style="list-style-type: none"> Style number Application (see below under Required Selections) Table top diameter for round table Table top width for square or rectangular table Table top depth for square or rectangular table Laminate or wood veneer color number for table top Plastic edge color number for laminate top, if selected Paint color number for base Options, if selected (see below) <p>► See <i>Coalesse Surface Materials Reference Guide</i>.</p>

	Required Sections	U.S. Price	Required to Specify
Application	<ul style="list-style-type: none"> 36"H counter height table 42"H bar height table 	No cost +\$ 36	Specify with counter height. Specify with bar height.

	Options	U.S. Price	Required to Specify
Surface Materials	Table top		
	<ul style="list-style-type: none"> Grade 2 laminate 	Prices at right	Specify with grade 2 laminate and select color number.
	<ul style="list-style-type: none"> Grade 3 laminate 	Prices at right	Specify with grade 3 laminate and select color number.
	<ul style="list-style-type: none"> Grade 2 wood veneer 	Prices at right	Specify with grade 2 wood veneer and select color number.
	Base		
	<ul style="list-style-type: none"> Grade 3 paint on tables with single base 	+\$145	Specify paint color number.
	<ul style="list-style-type: none"> Grade 3 paint on tables with double base (30"D x 72"W) 	+\$290	Specify paint color number.

Power/USB Configuration and Grommets	Power module for 24"-42" diameter round and 24"W-42"W square tables (center only)		
	<ul style="list-style-type: none"> Two TR simplex receptacles 	+\$375	Specify with power module with two power and select finish.
	<ul style="list-style-type: none"> One TR simplex receptacle and one USB A charging port 	+\$521	Specify with power module with one power, one USB A and select finish.
	<ul style="list-style-type: none"> One TR simplex receptacle, one USB A charging port, and one USB C charging port 	+\$521	Specify with power module with one power, one USB A, one USB C and select finish.
	Power module for 30"D x 72"W rectangular tables		
	<ul style="list-style-type: none"> Two TR simplex receptacles 	+\$375 each power module	Specify with power module with two power and select finish.
	<ul style="list-style-type: none"> One TR simplex receptacle and one USB A charging port 	+\$521 each power module	Specify with power module with one power, one USB A and select finish.
	<ul style="list-style-type: none"> One TR simplex receptacle, one USB A charging port, and one USB C charging port 	+\$521 each power module	Specify with power module with one power, one USB A, one USB C and select finish.
	PowerPod grommet		
	<ul style="list-style-type: none"> PowerPod grommet for 24"-42" diameter round and 24"W-42"W square tables (center only) 	+\$ 73	Specify with PowerPod grommet and select finish.
	<ul style="list-style-type: none"> PowerPod grommet for 30"D x 72"W rectangular tables 	+\$ 73 each grommet	Specify with one or two PowerPod grommets and select finish.

Related Products	<ul style="list-style-type: none"> PowerPod Collaborative and conference tables Guest seating Stools 	<ul style="list-style-type: none"> ► Page 739 ► Page 696 ► See <i>Coalesse Seating Specification Guide</i>. ► See <i>Coalesse Seating Specification Guide</i>.
------------------	--	--

Tip: PowerPod grommet is available in 6000 Black or 6052 Milk.

Tip: Column routes cables and wires when optional power or grommet are selected, and exits through the base.

Tip: Round power module is available in 4013 Silver/Black, 4180 Graphite Matte, 4242 Milk Smooth, or 4710 Low Gloss Black.



For Canadian Pricing
Multiply U.S. Price by the Canadian price factor.
► See page 1 for details.

Montara650 Café Tables Café-Height Tables

DESIGN COALESSE DESIGN GROUP

Specification Information

Style Number	Dimensions			U.S. Base Prices			
	D	W	H	Laminate		Wood Veneer	
				Grade 1	Grade 2 and 3	Grade 1	Grade 2

36"H Round Café Tables

COSFZCTRD	24" diameter		36"	\$1640	\$1666	\$2667	\$2960
	30" diameter		36"	\$1748	\$1789	\$2775	\$3068
	36" diameter		36"	\$1855	\$1915	\$2882	\$3175
	42" diameter		36"	\$2069	\$2151	\$3241	\$3534

36"H Square Café Tables

COSFZCTSQ	24"	24"	36"	\$1640	\$1666	\$2667	\$2960
	30"	30"	36"	\$1748	\$1789	\$1789	\$3068
	36"	36"	36"	\$1855	\$1915	\$2882	\$3175
	42"	42"	36"	\$2069	\$2151	\$3241	\$3534

36"H Rectangular Café Tables

COSFZCTSQ	24"	30"	36"	\$1712	\$1745	\$2739	\$3032
	30"	72"	36"	\$3958	\$4059	\$5863	\$6157

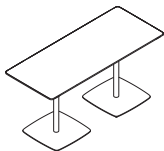
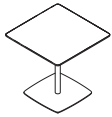

Tip: A 30"D x 72"W table has a double base.

Tip: One or two PowerPod grommets can be specified in 30"D x 72"W rectangular café table.

Tip: One or two round power modules can be specified in 30"D x 72"W rectangular café table.



For Canadian Pricing
 Multiply U.S. Price by the Canadian price factor.
 ▶ See page 1 for details.

Occasional Tables

* These product lines are collections and will be found in multiple locations in this specification guide and/or *Coalesce Seating Specification Guide*.

► See *Collections*, page 5.

Await Occasional Tables*	668
Bix Occasional Tables*	670
Bob Occasional Tables*	674
CG_1 Occasional Tables	678
Circa Lounge System*	684
Diekman Occasional Tables	685
Enea Occasional Tables*	687
Enea Lottus Occasional Tables*	689
Free Stand Occasional Table	691
Lagunitas Occasional Tables*	693
Lagunitas Personal Table*	694
Millbrae Occasional Tables*	695
Montara650 Occasional Tables*	696
Passerelle Occasional Tables*	697
Sebastopol Occasional Tables	698
SW_1 Occasional Tables*	702
Switch Occasional Tables*	706
Trees Occasional Tables	707

Await Occasional Tables

DESIGN E00S

Await occasional tables are cantilevered side tables offered in two heights. These tables offer a temporary home for laptops and coffee cups.

Tip: This product line is part of a collection and will be found in multiple locations in this specification guide and/or Coalesse Seating Specification Guide.

► See *Collections*, page 5

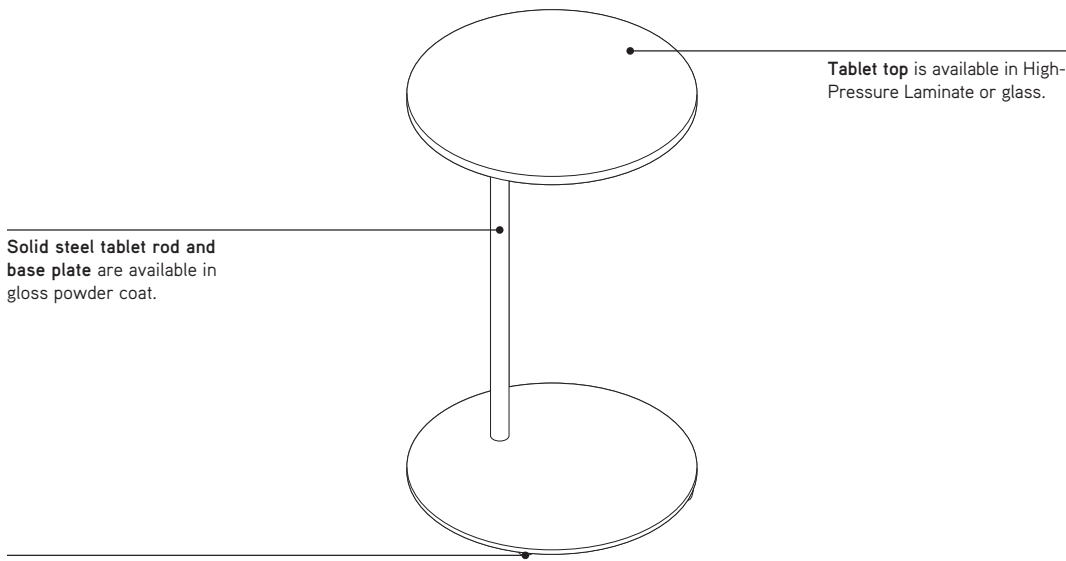
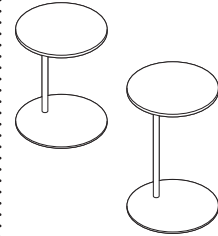

Table top is available in High-Pressure Laminate or glass.

Solid steel tablet rod and base plate are available in gloss powder coat.

Polyethylene glides are standard to ease movement and protect the flooring from damage.

Product Details



Freestanding round tables are 15³/₄" diameter on both 19" and 25" heights. Freestanding tables are standard with a gloss, powder coat frame. High-Pressure Laminate top option features a matching 3 mm edge band and glass top option is 1/2" thick with radiused edges.

Surface Materials

► See *Coalesse Surface Materials Reference Guide* for further information.

- Table top**
- Laminate
 - Glass

- Frame**
- Gloss powder coat

Await Occasional Tables

DESIGN E00S

Standard Includes		Required to Specify
<ul style="list-style-type: none"> ▶ Need help? Product details, page 668 	<ul style="list-style-type: none"> • Freestanding table frame: 4142 Platinum Gloss • Top: High-Pressure Laminate top with matching 3 mm edge band • Glass top: <ul style="list-style-type: none"> - 1/2" thick - Radiused edges 	<ul style="list-style-type: none"> 1 Style number 2 Laminate top and tablets, if selected: <ul style="list-style-type: none"> 2730 Arctic White 2746 Black 290N North Sea 3 Glass color number for top, if selected ▶ See <i>Coalesse Surface Materials Reference Guide</i> .

Related Products	
<ul style="list-style-type: none"> • Lounge seating • Connector benches and tables 	<ul style="list-style-type: none"> ▶ See <i>Coalesse Seating Specification Guide</i>. ▶ See <i>Coalesse Seating Specification Guide</i>.

Specification Information					
Style Number	U.S. Prices				
	Top Surface:				
	Laminate	Absolute Clear Glass	Absolute Clear Glass	Acid Etched 6511	Back-Painted Glass

Round, Low, Freestanding Table					
46-T1	\$1595	\$1903	\$1938	\$1938	\$2192

Round, High, Freestanding Table					
46-T2	\$2081	\$2389	\$2424	\$2424	\$2678

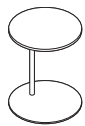

Overall: 15 3/4" Dia. 19"H



Overall: 15 3/4" Dia. 25"H



For Canadian Pricing
 Multiply U.S. Price by the Canadian price factor.
 ▶ See page 1 for details.

Bix Occasional Tables

DESIGN METRO DESIGN GROUP

Bix creates "loungue-based" worksettings that host teams and technology in comfort. A refined system of seating and tables that includes convenient connections to power, voice, and data - the essential elements to support conversation and collaborative work.

Tip: This product line is part of a collection and will be found in multiple locations in this specification guide and/or Coalesse Seating Specification Guide.

► See *Collections*, page 5

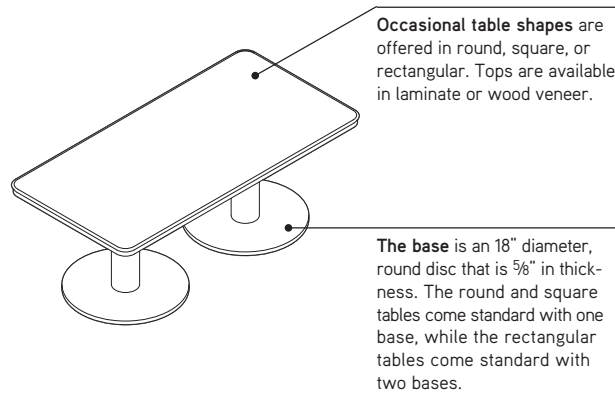
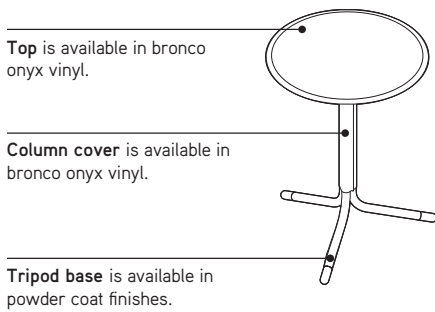

Bix Occasional Tables

DESIGN METRO DESIGN GROUP

Product Details



Side table offers a freestanding, mobile tablet surface. The tripod base allows it to be positioned close to a seating unit. The top is available in vinyl.

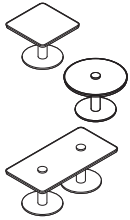

Occasional tables are freestanding 18"H tables that can be used with a variety of lounge applications. They are available with a round, square, or rectangular top. The tops are available with or without a grommet and an optional power, voice, and data module.

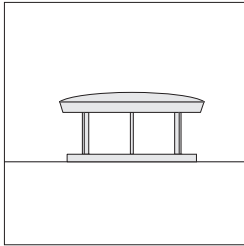
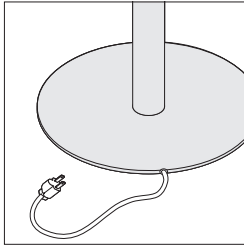

Occasional tables are available with a factory-installed grommet located over each column and base to allow cords and cables to pass through the top. A power, voice, and data module can be inserted in each grommet location.

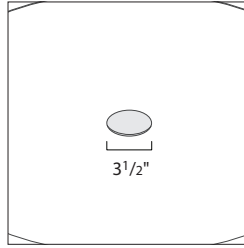

The worksurface cutout for the grommet and PVD is 3 1/2" in diameter.

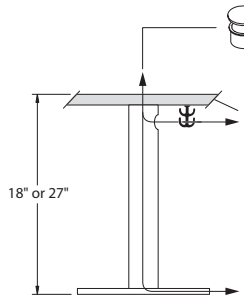

Column and base of occasional tables are used to route and conceal cords. The cords pass through the worksurface down through the column and out through a mouse hole in the base plate. Bases may be installed with the mouse hole facing in any of four directions, depending upon where cords need to exit for access to power/data/voice in the wall or floor. Cords should be routed through the concealed channels and out the mouse hole during the installation of the table base.

Hole at the top of each column allows cords to be routed between tables directly below the worksurfaces. Wire management clips are included for routing purposes.

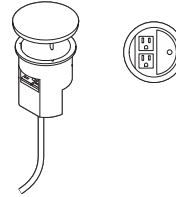

Power, voice, and data module can be installed in the grommet locations to bring power and communication to the worksurface. Each module is equipped with two 110 volt electrical outlets and one snap-in voice/data module insert consisting of dual CAT 5 RJ45 universal T568A/B jacks. It is UL listed and CSA certified. It has a 6' power cord. For additional data/voice outlet options, please contact Metro Customer Service at 1.800.627.6770.

Hardwired applications require on-site modifications by a licensed electrician following all local electrical code requirements.

Tip: The base will accommodate a 3/8" diameter flex-conduit.

Surface Materials

Side table surface and base cover

- Bronco onyx vinyl

Side table base

- Paint (vinyl)

Occasional table surface

- Laminate
- Wood veneer

Occasional table base

- Paint (textured only)

Grommet

- Black plastic only

Bix Occasional Tables Side Table—Vinyl Version

DESIGN METRO DESIGN GROUP



Standard Includes Required to Specify

- | | | |
|--|--|---|
| <ul style="list-style-type: none"> ▶ Need help? Product details, page 670 | <ul style="list-style-type: none"> • Base: paint • Table surface and base cover: bronco onyx vinyl | <ul style="list-style-type: none"> 1 Style number 2 Paint color number for base ▶ See <i>Coalesse Surface Materials Reference Guide</i>. |
|--|--|---|

Related Products

- | | |
|---|--|
| <ul style="list-style-type: none"> • Collaborative and conference tables • Lounge seating | <ul style="list-style-type: none"> ▶ Page 649 ▶ See <i>Coalesse Seating Specification Guide</i>. |
|---|--|

Specification Information

Dimensions		Style	U.S.
Diameter	H	Number	Price
16"	23"	BTS1700	\$795



For Canadian Pricing
 Multiply U.S. Price by the
 Canadian price factor.
 ▶ See page 1 for details.

Bix Occasional Tables 18"H Tables

DESIGN METRO DESIGN GROUP

Standard Includes Required to Specify

► Need help?
Product details,
page 670

- Top:
 - Laminate top (grade 1 laminates) with matching plastic edge
 - Laminate top (grade 1 Steelcase) with contrasting plastic edge
 - Wood veneer top with matching flat wood edge
- Base: textured paints only
- Grommet, if selected: black plastic only

- 1 Style number
 - 2 Laminate or wood veneer color number for top
 - 3 Plastic edge color number for top with grade 1 Steelcase or grade 2/3 laminate, if selected
 - 4 Textured paint color number for base
 - 5 Options, if selected (see below)
- See *Coalesse Surface Materials Reference Guide*.

Tip: One or two power, data, and voice modules are available on rectangular occasional tables.

Options U.S. Price Required to Specify

Cable Management

- PDV module: black plastic

+\$562 each

Specify with PDV module.

Related Products

- Collaborative and conference tables
- Lounge seating

► Page 649
► See *Coalesse Seating Specification Guide*.

Specification Information

Dimensions				Style Number	U.S. Base Prices			
D	W	H	Diameter		Lam 1	Lam 2 and 3	Wood Veneer 1	Wood Veneer 2

Round Occasional Tables

N.A.	N.A.	18"	20"	BTC20001	\$1595	\$1675	\$1760	\$1840
N.A.	N.A.	18"	28"	BTC28001	\$1661	\$1744	\$1841	\$2013

Round Occasional Table with Grommet

N.A.	N.A.	18"	28"	BTC28001U	\$1768	\$1855	\$1948	\$2120
------	------	-----	-----	-----------	--------	--------	--------	--------

Square Occasional Table

24"	24"	18"	N.A.	BTC24241	\$1636	\$1718	\$1810	\$1920
-----	-----	-----	------	----------	--------	--------	--------	--------

Rectangular Table

24"	48"	18"	N.A.	BTC24481	\$2649	\$2783	\$2923	\$3142
24"	72"	18"	N.A.	BTC24721	\$2715	\$2851	\$3019	\$3342

Rectangular Occasional Tables with Grommets

24"	48"	18"	N.A.	BTC24481U	\$2865	\$3006	\$3139	\$3358
-----	-----	-----	------	-----------	--------	--------	--------	--------

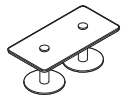
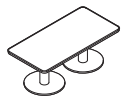

Edge Profiles

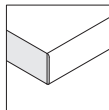

Plastic edge

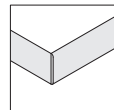

Wood edge



For Canadian Pricing
Multiply U.S. Price by the Canadian price factor.
► See page 1 for details.

Bob Occasional Tables

DESIGN PEARSON LLOYD

The Bob occasional table features a base design and support column that matches the lounge and guest chair.
Tip: This product line is part of a collection and will be found in multiple locations in this specification guide and/or Coalesse Seating Specification Guide.
▶ See *Collections*, page 5

Bob collection also features lounge and guest chairs.
▶ See *Coalesse Seating Specification Guide*.

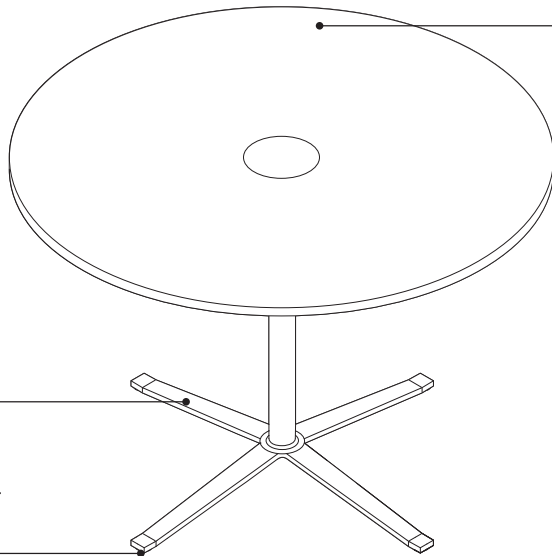

Top is 1/2" thick glass with beveled top and bottom edges.

Tops are also available in laminate and veneer with 3 mm edge, and solid surface. Tops are 1" thick.

Four-leg base features a single steel column with an aluminum base, available in painted or polished finishes.

Glides are a durable plastic to facilitate movement of the table. Felt glides are available for use on non-carpeted floors.

Product Details



Occasional tables are available in four sizes: 24", 30", 36", and 42" diameters. All sizes are 15 3/4"H. Table tops are 1/2" thick glass. Tops are also available in 1" thick laminate, veneer, or solid surface.

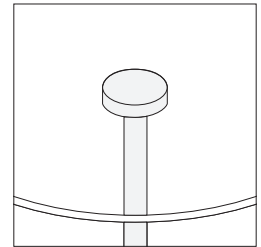

Center metal disc adheres to the glass top. The disc is supported on the column.

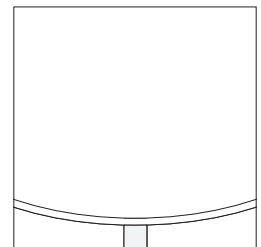

Laminate, veneer, and solid surface tops are attached to a plate on the column that cannot be seen through the top.

Bob Occasional Tables

DESIGN PEARSON LLOYD

Surface Materials

► See *Coalesse Surface Materials Reference Guide* for further information.

Top

- Glass
- Laminate
- Veneer
- Solid surface

Base

- Painted aluminum
- Aluminum matte polished

Bob Occasional Tables

DESIGN PEARSON LLOYD

Tip: Glass tops are 1/2" thick, except for the absolute clear frosted glass, which is 1/16" thick. 1/32" chamfers are applied to top and bottom edges.

Standard Includes		Required to Specify	
<ul style="list-style-type: none"> ▶ Need help? Product details, page 674 	<ul style="list-style-type: none"> • Base: 8040 Aluminum Matte Polished or Grade 1 paint • Top: clear green glass • Glides 	<ol style="list-style-type: none"> 1 Style number 2 Color number for top 3 Plastic color for edge band of laminate top, if selected 4 Metal or paint color for base 5 Options, if selected (see below) 	<ul style="list-style-type: none"> ▶ See <i>Coalesse Surface Materials Reference Guide</i>.

Options		U.S. Price	Required to Specify
Surface Materials	Base <ul style="list-style-type: none"> • Aluminum matte polished • Grade 1 paint • Grade 3 paint 	No cost No cost +\$145	Specify aluminum matte polished. Specify paint color number. Specify paint color number.
Glides	<ul style="list-style-type: none"> • Felted glides 	+\$ 22	Specify with felted glides.
Related Products	<ul style="list-style-type: none"> • Collaborative and conference tables • Lounge seating • Guest seating 		<ul style="list-style-type: none"> ▶ Page 650 ▶ See <i>Coalesse Seating Specification Guide</i>. ▶ See <i>Coalesse Seating Specification Guide</i>.

Specification Information

Dimensions Height	Style Number	Top Surface	U.S. Base Prices	Dimensions Height	Style Number	Top Surface	U.S. Base Prices
24" Diameter Round Occasional Table				30" Diameter Round Occasional Table			
15 ³ / ₄ "	100-T1	Clear Green Glass	\$2246	15 ³ / ₄ "	100-T2	Clear Green Glass	\$2577
15 ³ / ₄ "		Acid Etched 6511	\$2658	15 ³ / ₄ "		Acid Etched 6511	\$3136
15 ³ / ₄ "		Absolute Clear Glass	\$2673	15 ³ / ₄ "		Absolute Clear Glass	\$3263
15 ³ / ₄ "		Back-Painted Glass	\$3163	15 ³ / ₄ "		Back-Painted Glass	\$4088
15 ³ / ₄ "		Grade 1 Laminate	\$1487	15 ³ / ₄ "		Grade 1 Laminate	\$1549
15 ³ / ₄ "		Grade 2 and 3 Laminate	\$1518	15 ³ / ₄ "		Grade 2 and 3 Laminate	\$1580
15 ³ / ₄ "		Grade 1 Wood Veneer	\$2078	15 ³ / ₄ "		Grade 1 Wood Veneer	\$2380
15 ³ / ₄ "		Grade 2 Wood Veneer	\$2183	15 ³ / ₄ "		Grade 2 Wood Veneer	\$2501
15 ³ / ₄ "		Solid Surface	\$2613	15 ³ / ₄ "		Solid Surface	\$2992

▶ Specification Information, continued on next page

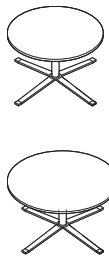

 **For Canadian Pricing**
Multiply U.S. Price by the Canadian price factor.
▶ See page 1 for details.

Bob Occasional Tables

DESIGN PEARSON LLOYD

► Specification Information, continued from previous page

Specification Information



Dimensions Height	Style Number	Top Surface	U.S. Base Prices
36" Diameter Round Occasional Table			
15 ³ / ₄ "	100-T3	Clear Green Glass	\$3137
15 ³ / ₄ "		Acid Etched 6511	\$3903
15 ³ / ₄ "		Absolute Clear Glass	\$4107
15 ³ / ₄ "		Back-Painted Glass	\$5551
15 ³ / ₄ "		Grade 1 Laminate	\$1681
15 ³ / ₄ "		Grade 2 and 3 Laminate	\$1723
15 ³ / ₄ "		Grade 1 Wood Veneer	\$2922
15 ³ / ₄ "		Grade 2 Wood Veneer	\$3132
15 ³ / ₄ "		Solid Surface	\$3909

Dimensions Height	Style Number	Top Surface	U.S. Base Prices
42" Diameter Round Occasional Table			
15 ³ / ₄ "	100-T4	Clear Green Glass	\$3473
15 ³ / ₄ "		Acid Etched 6511	\$4516
15 ³ / ₄ "		Absolute Clear Glass	\$4788
15 ³ / ₄ "		Back-Painted Glass	\$6328
15 ³ / ₄ "		Grade 1 Laminate	\$1793
15 ³ / ₄ "		Grade 2 and 3 Laminate	\$1849
15 ³ / ₄ "		Grade 1 Wood Veneer	\$3246
15 ³ / ₄ "		Grade 2 Wood Veneer	\$3539
15 ³ / ₄ "		Solid Surface	\$4135



For Canadian Pricing
 Multiply U.S. Price by the
 Canadian price factor.
 ► See page 1 for details.

CG_1 Occasional Tables

DESIGN CORY GROSSER

The CG_1 occasional table is an iconic, modern table that fits anywhere.

Frame is constructed with oak, walnut, or painted aluminum and features four tapered legs, reinforced with concealed steel bracing.

Glides are non-adjustable and are a part of the insert of solid wood or solid surface. Felt glides for use on non-carpeted surfaces are shipped as standard.

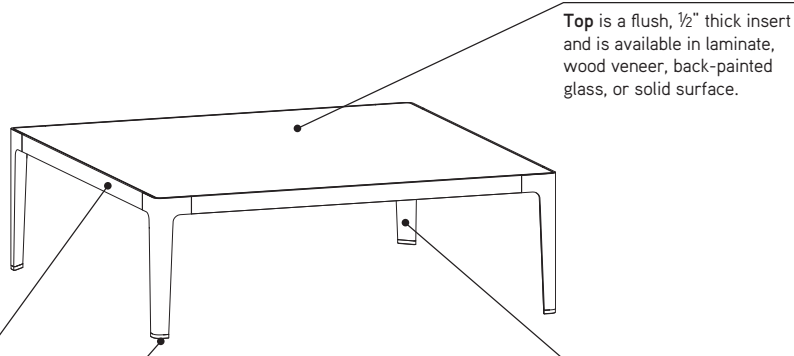

Top is a flush, 1/2" thick insert and is available in laminate, wood veneer, back-painted glass, or solid surface.

Inside leg inserts are available in multiple colors and solid woods with wood or metal frames, creating a unique aesthetic.

Product Details

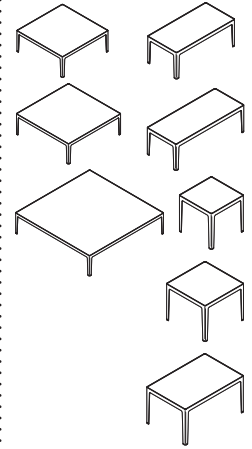

Tables are available in two heights: 14"H and 19"H. 14"H tables are available in the following widths: 36"D x 36"W, 42"D x 42"W, 60"D x 60"W, 18"D x 36"W, and 18"D x 42"W. 19"H tables are available as 20"D x 20"W, 24"D x 24"W, and 24"D x 36"W.

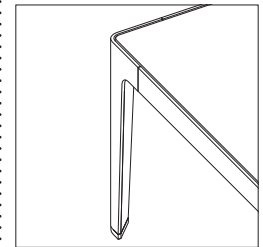

Tapered legs consist of an inner and outer piece. The inner piece is comprised of a contrasting solid surface material or solid wood, which wraps around the bottom to provide a glide. The outer piece is part of the frame that is offered in painted aluminum or wood veneer.

CG_1 Occasional Tables

DESIGN CORY GROSSER

Surface Materials

► See *Coalesse Surface Materials Reference Guide* for further information.

Wood frame

- Oak
- Walnut

Frame/Leg

- Painted aluminum

Top

- Wood veneer
- Glass
- Laminate
- Solid surface

Inside leg insert

- Solid surface
- Oak
- Walnut

Tip: Wood is available on metal tables only.

CG_1 Occasional Tables Metal

DESIGN CORY GROSSER

Standard Includes		Required to Specify
<p>► Need help? Product details, page 678</p> <ul style="list-style-type: none"> • Frame/legs: painted aluminum • Tops <ul style="list-style-type: none"> - Laminate: 1/2" thick top - Wood: veneer, 1/2" thick top - Solid surface: 1/2" thick top: glacier white only - Back-painted glass: 1/2" thick top • Leg inserts: <ul style="list-style-type: none"> - Solid surface, 1/4" thick - Solid wood, 1/4" thick • Glides: non-adjustable, ships with felt option 		<ol style="list-style-type: none"> 1 Style number 2 Metal color number for frame/leg <ul style="list-style-type: none"> 4141 Platinum Matte 4180 Graphite Matte 4193 Midnight Brown Matte 4242 Milk Matte 4710 Low Gloss Black 3 Color or finish number for top selection 4 Leg insert finish in solid surface or solid oak or walnut 5 Options, if selected (see below) <p>► See <i>Coalesse Surface Materials Reference Guide</i>.</p>

Tip: CG_1 solid wood frames and inserts are available in oak and walnut only. Wood veneer tops are available in all standard Coalesse finishes.

Options	U.S. Price	Required to Specify
<p>Surface Materials</p> <p>Legs</p> <ul style="list-style-type: none"> • Grade 1 paint • Grade 3 paint 	No cost +\$145	Specify paint color number. Specify paint color number.

Specification Information						
Dimensions D W H	Style Number	U.S. Base Prices				
		Top Surface:				
		Laminate	Veneer Grade 1	Veneer Grade 2	White Solid Surface	Back- Painted Glass

Low Square Tables

36"	36"	14"	COCGM3636L	\$2666	\$3143	\$3490	\$3989	\$4287
-----	-----	-----	------------	--------	--------	--------	--------	--------

42"	42"	14"	COCGM4242L	\$3023	\$3565	\$3964	\$4558	\$4873
-----	-----	-----	------------	--------	--------	--------	--------	--------

60"	60"	14"	COCGM6060L	\$3997	\$4926	\$5264	N.A.	N.A.
-----	-----	-----	------------	--------	--------	--------	------	------

Low Rectangular Tables

18"	36"	14"	COCGM1836L	\$2275	\$2708	\$3031	\$3473	\$3743
-----	-----	-----	------------	--------	--------	--------	--------	--------

18"	42"	14"	COCGM1842L	\$2398	\$2855	\$3186	\$3696	\$3951
-----	-----	-----	------------	--------	--------	--------	--------	--------

► Specification Information, continued on next page

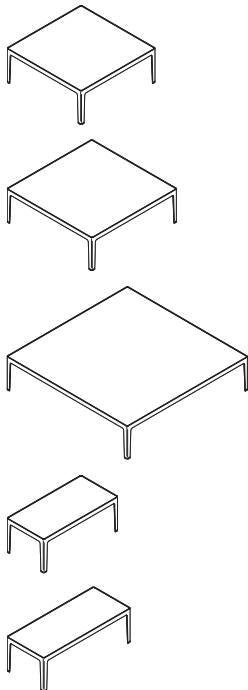

For Canadian Pricing
Multiply U.S. Price by the Canadian price factor.
► See page 1 for details.

CG_1 Occasional Tables Metal

DESIGN CORY GROSSER

► Specification Information, continued from previous page

Specification Information

Dimensions			Style Number	U.S. Base Prices				
D	W	H		Top Surface:				
				Laminate	Veneer Grade 1	Veneer Grade 2	White Solid Surface	Back-Painted Glass

High Square Tables

20"	20"	19"	COCGM2020H	\$2131	\$2536	\$2840	\$3296	\$3567
-----	-----	-----	------------	--------	--------	--------	--------	--------

24"	24"	19"	COCGM2424H	\$2327	\$2768	\$3102	\$3584	\$3833
-----	-----	-----	------------	--------	--------	--------	--------	--------

High Rectangular Table

24"	36"	19"	COCGM2436H	\$2470	\$2944	\$3290	\$3849	\$4068
-----	-----	-----	------------	--------	--------	--------	--------	--------

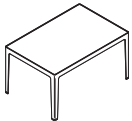
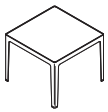

For Canadian Pricing
 Multiply U.S. Price by the
 Canadian price factor.
 ► See page 1 for details.

CG_1 Occasional Tables Wood

DESIGN CORY GROSSER

Standard Includes		Required to Specify
<p>► Need help? Product details, page 678</p> <ul style="list-style-type: none"> • Frame/legs: solid oak • Tops <ul style="list-style-type: none"> - Laminate: 1/2" thick top - Wood: veneer, 1/2" thick top - Solid surface: 1/2" thick top: glacier white only - Back-painted glass: 1/2" thick top • Leg inserts: solid surface, 1/4" thick • Glides: non-adjustable, ships with felt option 	<ol style="list-style-type: none"> 1 Style number 2 Wood color number for frame/legs 3 Color or finish number for top selection 4 Leg insert finish: <ul style="list-style-type: none"> 2801 Glacier White 2010 Black 2011 Midnight Brown 2012 Blue 2013 Red 5 Options, if selected (see below) <p>► See <i>Coalesse Surface Materials Reference Guide</i>.</p>	

Tip: CG_1 solid wood frames and inserts are available in oak and walnut only. Wood veneer tops are available in all standard Coalesse finishes.

Options	U.S. Price	Required to Specify
<p>Surface Materials</p> <ul style="list-style-type: none"> • Frame/legs • Walnut 	+ \$254	Specify with <i>frame/leg</i> in <i>walnut</i> and select finish number.

Specification Information						
Dimensions D W H	Style Number	U.S. Base Prices				
		Top Surface:				
		Laminate	Veneer Grade 1	Veneer Grade 2	White Solid Surface	Back- Painted Glass

Low Square Tables

36"	36"	14"	COCGW3636L	\$2935	\$3494	\$3760	\$4457	\$4625
-----	-----	-----	------------	--------	--------	--------	--------	--------

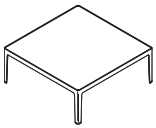

42"	42"	14"	COCGW4242L	\$3128	\$3721	\$4004	\$4802	\$4988
-----	-----	-----	------------	--------	--------	--------	--------	--------

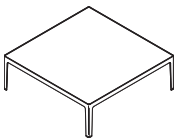

Low Rectangular Tables

18"	36"	14"	COCGW1836L	\$2579	\$3068	\$3305	\$3948	\$4068
-----	-----	-----	------------	--------	--------	--------	--------	--------

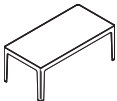

18"	42"	14"	COCGW1842L	\$2842	\$3384	\$3643	\$4364	\$4532
-----	-----	-----	------------	--------	--------	--------	--------	--------

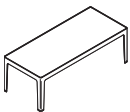

► Specification Information, continued on next page



For Canadian Pricing
Multiply U.S. Price by the Canadian price factor.
► See page 1 for details.

CG_1 Occasional Tables Wood

DESIGN CORY GROSSER

► Specification Information, continued from previous page

Specification Information

Dimensions			Style Number	U.S. Base Prices				
D	W	H		Top Surface:				
				Laminate	Veneer Grade 1	Veneer Grade 2	White Solid Surface	Back-Painted Glass

High Square Tables

20"	20"	19"	COCGW2020H	\$2312	\$2750	\$2965	\$3377	\$3615
-----	-----	-----	------------	--------	--------	--------	--------	--------

24"	24"	19"	COCGW2424H	\$2492	\$2969	\$3192	\$3632	\$3887
-----	-----	-----	------------	--------	--------	--------	--------	--------

High Rectangular Table

24"	36"	19"	COCGW2436H	\$2754	\$3276	\$3530	\$4195	\$4519
-----	-----	-----	------------	--------	--------	--------	--------	--------

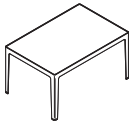
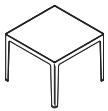

For Canadian Pricing
 Multiply U.S. Price by the Canadian price factor.
 ► See page 1 for details.

Circa Lounge System Freestanding Round Table

DESIGN ALISON SPEAR, AIA

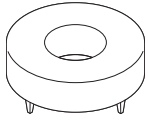

Tip: Stain-to-Match is offered on wood legs.

Tip: All legs measure 6½" in height.

Tip: The round plate that houses the power/data module is powder coated to complement the power/data module finish. For the black anodized aluminum module, the round plate will be painted in 4710 Low Gloss Black. For the silver anodized aluminum module, the round plate will be painted 4799 Platinum.

Overall: 42" dia. 15¾"H

Tip: Tapered wood and metal legs have a thin, blade aesthetic.

Standard Includes		Required to Specify
<ul style="list-style-type: none"> ▶ Need help? Product details, See <i>Coalesse Seating Specification Guide</i> 	<ul style="list-style-type: none"> • Table: laminate • Legs: <ul style="list-style-type: none"> - Tapered leg, if selected: solid maple or walnut - Cylinder leg, if selected: solid oak 	<ol style="list-style-type: none"> 1 Style number 2 Laminate color number for table 3 Wood leg type 4 Wood color number for legs 5 Options, if selected (see below) ▶ See <i>Coalesse Surface Materials Reference Guide</i> .

	Options	U.S. Price	Required to Specify
Surface Materials	Table <ul style="list-style-type: none"> • Wood veneer 	Price below	Specify with wood veneer and select wood color number. ▶ See <i>Coalesse Surface Materials Reference Guide</i> .
	<ul style="list-style-type: none"> • Sunburst wood veneer 	Price below	Specify with sunburst wood veneer and select wood color number. ▶ See <i>Coalesse Surface Materials Reference Guide</i> .
Metal Legs	Tapered legs <ul style="list-style-type: none"> • Grade 1 paint 	+\$204 per leg	Specify with tapered metal legs and select paint color number. ▶ See <i>Coalesse Surface Materials Reference Guide</i> .
	Modern legs <ul style="list-style-type: none"> • Grade 1 paint 	+\$204 per leg	Specify with modern metal legs and select paint color number. ▶ See <i>Coalesse Surface Materials Reference Guide</i> .
Glass Insert	<ul style="list-style-type: none"> • Green tinted glass insert ¾" thick with white enamel bottom square edge detail 	+\$399	Specify with glass insert.
Power/Data Module	<ul style="list-style-type: none"> • Two power/two data ports black anodized aluminum or silver anodized aluminum 	+\$592	Specify finish color number.
Related Products	<ul style="list-style-type: none"> • Lounge seating 		▶ See <i>Coalesse Seating Specification Guide</i> .

Specification Information	
Style Number	U.S. Base Prices
	Laminate Wood Veneer Sunburst Wood Veneer

Round Table, Freestanding, Four Legs			
45-T42RD	\$4172	\$5563	\$5994

 **For Canadian Pricing**
Multiply U.S. Price by the Canadian price factor.
▶ See page 1 for details.

Diekman Occasional Tables

DESIGN NORMAN DIEKMAN

Diekman offers an assortment of accent tables to be used alone or as a base for glass tops. Abstract art was Norman Diekman's inspiration for this collection.

Glass top models consist of two Diekman wood bases and 1/2" thick elliptical or rectangular glass top.

Bases are hard maple veneer.

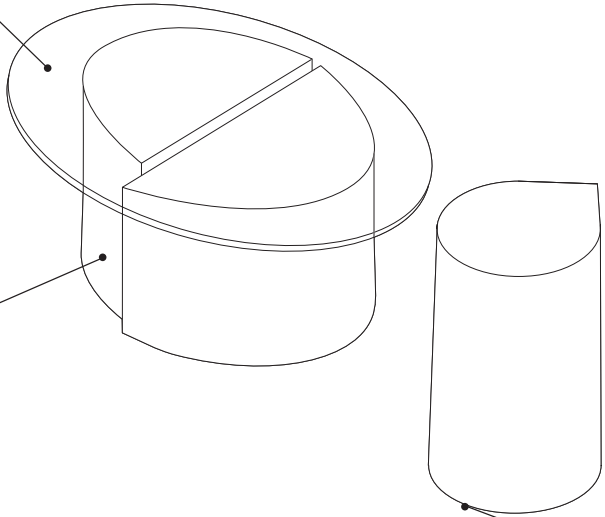

Glides are polyethylene and non-adjustable to protect floors.

Product Details

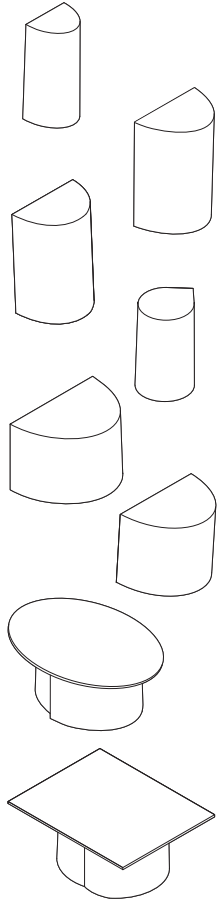

Tables are offered in multiple "half-cylinder" organic shapes which resemble tree trunks, in hard maple veneer. Glass top models consist of two wood bases with radiused edges. Clear, plastic buttons separate the glass from the table base.

Surface Materials

► See *Coalesse Surface Materials Reference Guide* for further information.

- Base**
- Maple veneer

- Glass top**
- Clear

Diekman Occasional Tables

DESIGN NORMAN DIEKMAN

Standard Includes	Required to Specify
<ul style="list-style-type: none"> ▶ Need help? Product details, page 685 • Frame/top: hard maple veneer • Glass top models: <ul style="list-style-type: none"> - 47-T17ELG and 47-T17RG1 models consist of two Diekman wood bases (47-T2617D and 47T2217E) with elliptical or rectangular glass tops - 1/2" thick clear glass top with radiused corners • Glides: polyethylene, non-adjustable 	<ul style="list-style-type: none"> 1 Style number 2 Top color number 3 Frame finish ▶ See <i>Coalesse Surface Materials Reference Guide</i>.

Specification Information

Dimensions			Style Number	U.S. Prices	
D	W	H		Top Surface:	
				Glass	Wood Veneer

Wood Tables

9 1/4"	13"	26"	47-T1326C	N.A.	\$2327
10"	16"	23"	47-T1623A	N.A.	\$2216
10"	16"	23"	47-T1623B	N.A.	\$2216
13 1/2"	15 3/4"	23"	47-T23EL	N.A.	\$2257
16"	25 3/4"	17"	47-T2617D	N.A.	\$2500
14 1/2"	22 1/4"	17"	47-T2217E	N.A.	\$2457

Wood Base, Elliptical Top Table

32"	40"	17 3/4"	47-T17ELG	\$5646	N.A.
-----	-----	---------	-----------	--------	------

Wood Base, Rectangle Top Table X4/24

32"	40"	17 3/4"	47-T17RG1	\$5672	N.A.
-----	-----	---------	-----------	--------	------

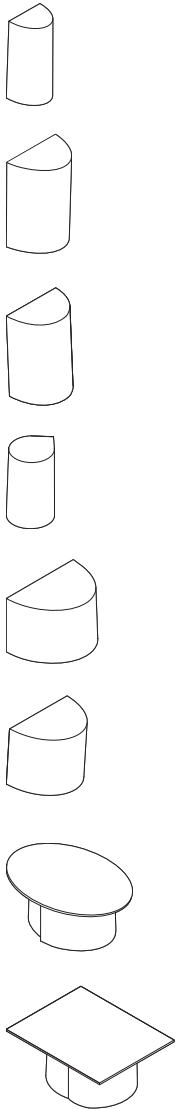

X4/24 = Last order entry
April 14, 2024

Enea Occasional Tables

DESIGN JOSEF LLUSCA

The Enea occasional table is simply designed and fits comfortably in any space.
Tip: This product line is part of a collection and will be found in multiple locations in this specification guide and/or Coalesse Seating Specification Guide.
▶ See *Collections*, page 5

Table tops are available in two sizes in 3/4" thick laminate or maple veneer.

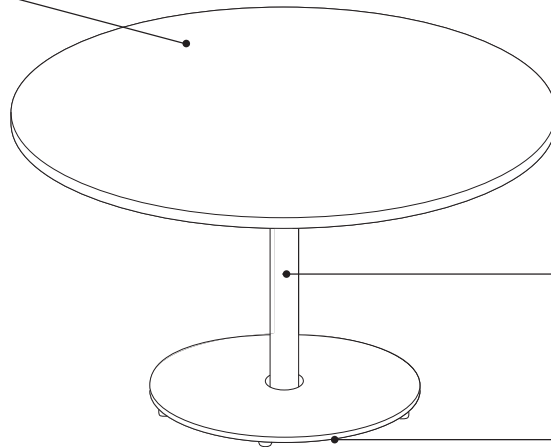

Base and column are constructed of steel tube and plate and are available in powder coat finishes.

Glides are non-skid.

The Enea collection also features visually compatible guest seating and stools.
▶ See *Coalesse Seating Specification Guide*.

Product Details

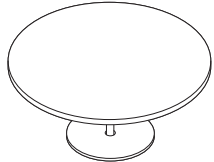
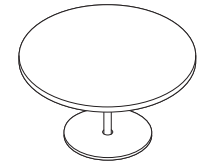

Occasional tables are 18"H and are available in 36" and 42" diameter tops. Tops are 3/4" thick with 3/4" core. Edgeband is T-mold for laminate and maple for veneer. Disc base is 24" in diameter available in powder coat finishes.

Surface Materials

▶ See *Coalesse Surface Materials Reference Guide* for further information.

Base and column

- Powder coat paint

Top

- Laminate
- Maple veneer

Edge band

- Plastic T-mold on laminate tops
- Maple on veneer tops

Enea Occasional Tables ✕4/24

DESIGN JOSEP LLUSCA

Tip: Shipped knocked down.

Tip: Disc bases are 24" diameter for 36" and 42" diameter tables.

Tip: White laminate tops may exhibit slightly visible black specks inherent to the top manufacturing process.

Standard Includes Required to Specify

► Need help? Product details, page 687

- Laminate top: 3/4" thick with T-mold edge band
- Wood top: 3/4" thick with maple edge and maple veneer
- Base/frame: steel tubing and base: paint
- Glides: non-skid

- 1 Style number
 - 2 Laminate or wood top color number
 - 3 Plastic color for edge band of laminate top, if selected:
6D10 Silver Metallic
6D11 Black
6D12 White
 - 4 Base/frame finish:
4016 White Gloss
4017 Black Gloss
4018 Silver Metallic
- See *Coalesse Surface Materials Reference Guide*.

Related Products

- Café tables
- Guest seating
- Stools

- Pages 652–654
- See *Coalesse Seating Specification Guide*.
- See *Coalesse Seating Specification Guide*.

Specification Information

Dimensions		Style Number	U.S. Prices	
Diameter	H		Top Surface:	
			Laminate	Wood Veneer

Occasional Tables ✕4/24

36"	18"	H35-T3618L	\$1448	N.A.
36"	18"	H35-T3618W	N.A.	\$2003
42"	18"	H35-T4218L	\$1741	N.A.
42"	18"	H35-T4218W	N.A.	\$2862

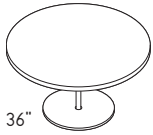

36"

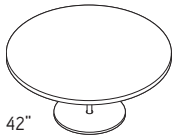

42"



For Canadian Pricing
Multiply U.S. Price by the Canadian price factor.
► See page 1 for details.

✕4/24 = Last order entry
April 14, 2024

Enea Lottus Occasional Tables

DESIGN LIEVORE ALTHERR MOLINA

The Enea Lottus collection is suitable for many applications including meeting spaces, cafeterias, and more. It brings a simple and clean design aesthetic to live/work settings. *Tip: This product line is part of a collection and will be found in multiple locations in this specification guide and/or Coalesse Seating Specification Guide.*

► See *Collections*, page 5

Table tops are available in three sizes in 1/2" thick laminate or wood veneer.

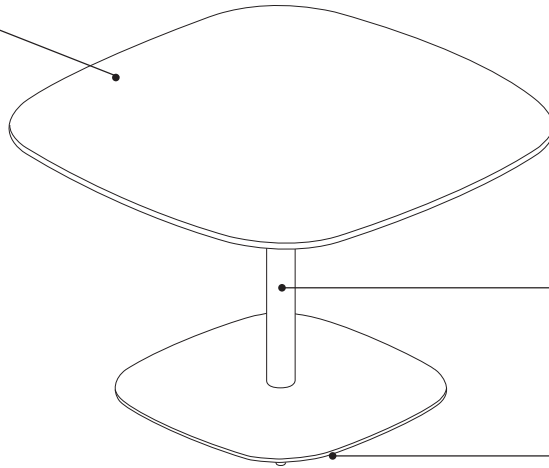

Base and column is constructed of steel and is available in powder coat finishes.

Glides are non-skid.

The Enea collection also features visually compatible guest seating and stools. ► See *Coalesse Seating Specification Guide*.

Product Details

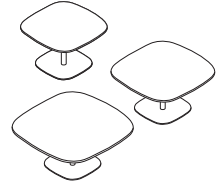

Occasional tables are 18"H and are available in three top sizes: 30", 36", and 42" diameter with 1/2" thick phenolic core and beveled bottom edge. Column is 2 5/16" diameter steel tubing. Disc base is 1/4" thick plate.

Surface Materials

► See *Coalesse Surface Materials Reference Guide* for further information.

Base and column

- Paint

Top

- Laminate
- Wood veneer

Enea Lottus Occasional Tables

DESIGN LIEVORE ALTHERR MOLINA

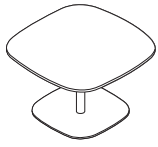

Standard Includes		Required to Specify
<ul style="list-style-type: none"> ▶ Need help? Product details, page 689 	<ul style="list-style-type: none"> • Top: laminate or wood veneer with 1/2" thick phenolic core • Base and frame: painted steel tubing • Glides: non-skid 	<ol style="list-style-type: none"> 1 Style number 2 Laminate or wood veneer color number for top 3 Paint color number for base/frame 4 Options, if selected (see below) <p>▶ See <i>Coalesse Surface Materials Reference Guide</i>.</p>

Options	U.S. Price	Required to Specify
Surface Materials <ul style="list-style-type: none"> • Grade 1 paint • Grade 3 paint 	No cost +\$145	Specify paint color number. Specify paint color number.
Related Products <ul style="list-style-type: none"> • Café tables • Guest seating • Stools 		<p>▶ Pages 657–659</p> <p>▶ See <i>Coalesse Seating Specification Guide</i>.</p> <p>▶ See <i>Coalesse Seating Specification Guide</i>.</p>

Specification Information								
Dimensions			Style Number	U.S. Base Prices				
D	W	H		Top Surface:				
				Grade 1 Laminate	Grade 2 and 3 Laminate	Wood Veneer 1	Wood Veneer 2	
30"	30"	18"	COEL1830	\$1903	\$2129	\$2129	\$2296	
36"	36"	18"	COEL1836	\$2213	\$2480	\$2480	\$2688	
42"	42"	18"	COEL1842	\$2694	\$2943	\$2943	\$3179	



For Canadian Pricing
 Multiply U.S. Price by the Canadian price factor.
 ▶ See page 1 for details.

Free Stand Occasional Table

DESIGN STEPHEN COPELAND

Free Stand is foldable, height-adjustable, and lightweight. The generous work-surface rotates to fit the style of the user. A built-in handle makes it easy to carry.

Worksurface height adjusts from 20"–27" using spring-loaded triggers.

Worksurface rotates 360° with soft detent stops at the parallel positions.

Base is cast aluminum with four glides.

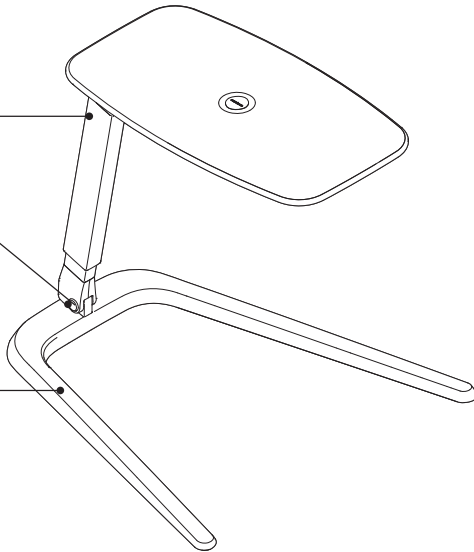

Product Details

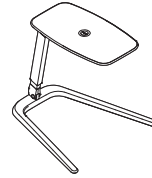

Worksurface is ABS plastic and painted with a soft touch paint which provides a soft, rubber-like texture. Column is made up of telescoping aluminum extrusions with a built-in handle, allowing ease of mobility. The u-shape of the base allows for maximum user foot space and easy maneuverability around chair bases.

Lightweight design allows for ease of portability; weighs 11 pounds.

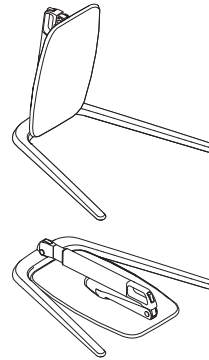

Worksurface is height adjustable to 22 possible height increments. No tools are required to fold/unfold unit or make height adjustments through the use of spring loaded triggers. Folds to 5" high for easy storage.

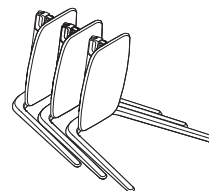

Nesting capabilities minimize required storage space. Each nested unit extends 5¼" beyond the previous unit.

Surface Materials

► See *Coalesse Surface Materials Reference Guide* for further information.

Tablet top

- Black, soft-touch

Column and base

- Black paint only

Free Stand Occasional Table

DESIGN STEPHEN COPELAND

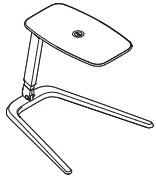

Tip: Worksurface height adjusts from 20"–27" and rotates 360°.

Tip: Free stand is 5" tall when folded/collapsed and weighs 11 lb.

Tip: Free stand can nest. In nested position each additional unit extends 5 1/4" beyond the previous unit.

Standard Includes		Required to Specify
<ul style="list-style-type: none"> ▶ Need help? Product details, page 691 	<ul style="list-style-type: none"> • Height-adjustable, soft-touch: 4433 Black • Foldable/collapsible column: 4144 Black Gloss paint • Base: 4144 Black Gloss paint 	Style number

Specification Information			
Dimensions		Style Number	U.S. Price
D	W		
22 1/4"	21 1/4"	COCFS	\$910



For Canadian Pricing
 Multiply U.S. Price by the Canadian price factor.
 ▶ See page 1 for details.

Lagunitas Occasional Tables

DESIGN TOAN NGUYEN

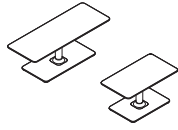

Standard Includes		Required to Specify
<ul style="list-style-type: none"> ▶ Need help? Product details, page 470 	<ul style="list-style-type: none"> Table top: <ul style="list-style-type: none"> – Grade 1 laminate with 3 mm flat plastic edge – Grade 1 wood veneer with matching flat wood edge Base with column: grade 1 paint Six non-adjustable glides Ships ready to assemble 	<ol style="list-style-type: none"> Style number Table top width Laminate or wood veneer color number for table top Plastic edge color number for laminate table top, if selected Paint color number for base with column Options, if selected (see below) <p>▶ See <i>Coalesse Surface Materials Reference Guide</i>.</p>

	Options	U.S. Price	Required to Specify
Surface Materials	Table top		
	<ul style="list-style-type: none"> Grade 2 laminate 	Prices below	Specify with <i>grade 2 laminate</i> and select color number.
	<ul style="list-style-type: none"> Grade 3 laminate 	Prices below	Specify with <i>grade 3 laminate</i> and select color number.
	<ul style="list-style-type: none"> Grade 2 wood veneer 	Prices below	Specify with <i>grade 2 wood veneer</i> and select color number.
	Base		
	<ul style="list-style-type: none"> Grade 3 paint 	+\$145	Specify paint color number.
Power/USB Configuration and Grommets	Power module	+\$380	Specify with <i>power module</i> .
	<ul style="list-style-type: none"> Two TR simplex receptacles 	No cost	Specify with <i>two power</i> .
	<ul style="list-style-type: none"> One TR simplex receptacle and 2 USB A charging ports 	+\$149	Specify with <i>one power, two USB A</i> .
	<ul style="list-style-type: none"> One TR simplex receptacle, one USB A charging port, and one USB C charging port 	+\$149	Specify with <i>one power, one USB A, one USB C</i> .
	3" metal grommet		
	<ul style="list-style-type: none"> One metal grommet in anodized silver finish (center only) 	+\$116	Specify with <i>3" metal grommet</i> .
	PowerPod grommet		
	<ul style="list-style-type: none"> One PowerPod grommet in 6052 Milk or 6000 Black plastic finish (center only) 	+\$ 76	Specify with <i>PowerPod grommet</i> and select color number.
Related Products	<ul style="list-style-type: none"> Collaborative and conference tables Lounge seating 		<p>▶ Page 474</p> <p>▶ See <i>Coalesse Seating Specification Guide</i>.</p>

Tip: Column routes cables and wires when optional power or grommet are selected and exits through the base.

Tip: Devices and grommets are center location only to allow for routing of cords through the column and exits through the base.

Tip: Round power module is available in 4013 Silver/Black, 4180 Graphite Matte, 4242 Milk Smooth, or 4710 Low Gloss Black.

Tip: Power module configuration upcharges are in addition to the power module upcharge.

Specification Information

Style Number	Dimensions			U.S. Base Prices			
	D	W	H	Flat Vinyl Edge on Laminate Top		Flat Wood Edge on Wood Veneer Top	
				Grade 1	Grade 2 and 3	Grade 1	Grade 2
COLAGTO	18"	32"	16"	\$2201	\$2297	\$4182	\$4438
	18"	48"	16"	\$2590	\$2728	\$5221	\$5568



For Canadian Pricing
 Multiply U.S. Price by the Canadian price factor.
 ▶ See page 1 for details.

Lagunitas Personal Table

DESIGN TOAN NGUYEN

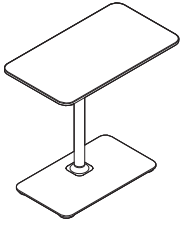

Standard Includes		Required to Specify
<ul style="list-style-type: none"> ► Need help? Product details, page 470 	<ul style="list-style-type: none"> • Table top: grade 1 laminate with 3 mm flat plastic edge • Table base with column: grade 1 paint • Four non-adjustable glides • Ships ready to assemble 	<ol style="list-style-type: none"> 1 Style number 2 Laminate color number for table top 3 Plastic edge color number for laminate table top, if selected 4 Paint color number base with column 5 Options, if selected (see below) <ul style="list-style-type: none"> ► See <i>Coalesse Surface Materials Reference Guide</i>.

	Options	U.S. Price	Required to Specify
Surface Materials	Personal table top		
	• Grade 2 laminate	Prices below	Specify with <i>grade 2 laminate</i> and select color number.
	• Grade 3 laminate	Prices below	Specify with <i>grade 3 laminate</i> and select color number.
	• Fusion fabric wrapped	Prices below	Specify with <i>Fusion fabric</i> and select color number.
	Personal table base		
	• Grade 3 paint	+\$145	Specify paint color number.

Related Products	<ul style="list-style-type: none"> • Collaborative and conference tables • Lounge seating 	<ul style="list-style-type: none"> ► Page 474 ► See <i>Coalesse Seating Specification Guide</i>.
-------------------------	---	--

Specification Information						
Style Number	Dimensions			U.S. Base Prices		
	D	W	H	Laminate: Grade 1	Grade 2 and 3	Fusion: Fabric
COLAGTP	13"	24"	25"	\$910	\$957	\$1292



For Canadian Pricing
 Multiply U.S. Price by the Canadian price factor.
 ► See page 1 for details.

Millbrae Occasional Tables

DESIGN COALESSE DESIGN GROUP

Standard Includes		Required to Specify
<ul style="list-style-type: none"> ▶ Need help? Product details, see <i>Coalesse Seating Specification Guide</i> 	<ul style="list-style-type: none"> • Base: painted steel with 1/2" x 1 3/4" legs • Glass top: 3/4" thick glass • Glides 	<ul style="list-style-type: none"> 1 Style number 2 Glass color number for top 3 Paint color number for base 4 Options, if selected (see below) ▶ See <i>Coalesse Surface Materials Reference Guide</i>.

Options	U.S. Price	Required to Specify
Surface Materials Base <ul style="list-style-type: none"> • Grade 1 paint • Grade 3 paint • Plated metal for side table, 30" x 30" and 36" x 36" square tables, and 20" x 54" and 30" x 60" rectangular tables • Plated metal for 48" x 48" square table 	<ul style="list-style-type: none"> No cost +\$111 +\$865 +\$996 	<ul style="list-style-type: none"> Specify paint color number. Specify paint color number. Specify with 4862 Stainless Steel. Specify with 4862 Stainless Steel.
Related Products <ul style="list-style-type: none"> • Lounge seating 		▶ See <i>Coalesse Seating Specification Guide</i> .

Specification Information

Dimensions D W H	Style Number	U.S. Base Prices			
		Top Surface:			
		Clear	Acid Etched	Absolute Clear	Back-Painted Glass
		Green	6511		

Square Tables

30"	30"	15"	COMOTL3030	\$3015	\$3192	\$3260	\$3403
36"	36"	15"	COMOTL3636	\$3583	\$3828	\$3929	\$4142
48"	48"	15"	COMOTL4848	\$4900	\$5305	\$5517	\$5880

Rectangular Tables

20"	54"	15"	COMOTL2054	\$3957	\$4171	\$4256	\$4424
30"	60"	15"	COMOTL3060	\$4332	\$4661	\$4821	\$5102

Side Table

20"	20"	20"	COMOTL2020	\$2448	\$2544	\$2556	\$2625
-----	-----	-----	------------	--------	--------	--------	--------

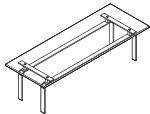
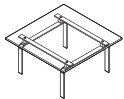

For Canadian Pricing
 Multiply U.S. Price by the Canadian price factor.
 ▶ See page 1 for details.

Montara650 Occasional Tables Occasional-Height Tables

DESIGN COALESSE DESIGN GROUP

	Standard Includes	Required to Specify
<p>► Need help? Product details, page 660</p>	<ul style="list-style-type: none"> Table top: <ul style="list-style-type: none"> Grade 1 laminate with 3 mm flat plastic edge Wood veneer with matching flat edge Base: grade 1 paint Glides Ships ready to assemble 	<ol style="list-style-type: none"> Style number Table top diameter for round table Table top depth and width for square table Laminate or wood veneer color number for table top Plastic edge color number for laminate table top, if selected Paint color number for base Options, if selected (see below) <p>► See <i>Coalesse Surface Materials Reference Guide</i>.</p>

	Options	U.S. Price	Required to Specify
Surface Materials	Table Top		
	<ul style="list-style-type: none"> Grade 2 laminate 	Prices below	Specify with <i>grade 2 laminate</i> and select color number.
	<ul style="list-style-type: none"> Grade 3 laminate 	Prices below	Specify with <i>grade 3 laminate</i> and select color number.
	<ul style="list-style-type: none"> Grade 2 wood veneer 	Prices below	Specify with <i>grade 2 wood veneer</i> and select color number.
	Base		
	<ul style="list-style-type: none"> Grade 3 paint 	+\$145	Specify paint color number.
Power/USB Configuration and Grommets	Power module		
	<ul style="list-style-type: none"> Two TR simplex receptacles 	+\$375	Specify with <i>power module with two power</i> and select finish.
	<ul style="list-style-type: none"> One TR simplex receptacle and one USB A charging port 	+\$521	Specify with <i>power module with one power, one USB A</i> and select finish.
	<ul style="list-style-type: none"> One TR simplex receptacle, one USB A charging port, and one USB C charging port 	+\$521	Specify with <i>power module with one power, one USB A, one USB C</i> and select finish.
	PowerPod grommet		
	<ul style="list-style-type: none"> PowerPod grommet (center only) 	+\$ 73	Specify with <i>PowerPod grommet</i> and select finish.

Tip: PowerPod grommet is available in 6000 Black or 6052 Milk.

Tip: Round power module is available in 4013 Silver/Black, 4180 Graphite Matte, 4242 Milk Smooth, or 4710 Low Gloss Black.

Related Products	<ul style="list-style-type: none"> PowerPod Café tables Guest seating Lounge seating Stools 	<ul style="list-style-type: none"> ► Page 739 ► Pages 662–664 ► See <i>Coalesse Seating Specification Guide</i>. ► See <i>Coalesse Seating Specification Guide</i>. ► See <i>Coalesse Seating Specification Guide</i>.
-------------------------	--	---

Specification Information

Style Number	Dimensions			U.S. Base Prices			
	D	W	H	Laminate		Wood Veneer	
				Grade 1	Grade 2 and 3	Grade 1	Grade 2

Round Occasional Tables

COSFZOTRD	30" diameter	18"	\$1429	\$1470	\$2456	\$2749
	36" diameter	18"	\$1537	\$1597	\$2564	\$2857
	42" diameter	18"	\$1715	\$1797	\$2887	\$3180

Square Occasional Tables

COSFZOTSQ	30"	30"	18"	\$1429	\$1470	\$2456	\$2749
	36"	36"	18"	\$1537	\$1597	\$2564	\$2857
	42"	42"	18"	\$1715	\$1797	\$2887	\$3180

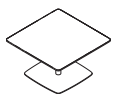

For Canadian Pricing
Multiply U.S. Price by the Canadian price factor.
► See page 1 for details.

Passerelle Occasional Tables

DESIGN STUDIO B

Tip: Bases are not sold separately.

Standard Includes	Required to Specify
<ul style="list-style-type: none"> ▶ Need help? Product details, see <i>Coalesse Seating Specification Guide</i> • Frame: Solid maple with mortise and tenon joinery for structural integrity • Glides: Polyethylene • Wood top: 1" thick, selected maple veneer • Ships ready-to-assemble 	<ul style="list-style-type: none"> 1 Style number 2 Top and frame finish 3 Options, if selected (see below) ▶ See <i>Coalesse Surface Materials Reference Guide</i>.

Tip: Interport is not available on 44-T164830.

Tip: Interport is for center location only.

Options	U.S. Price	Required to Specify
Surface Materials <ul style="list-style-type: none"> • Top <ul style="list-style-type: none"> • Contrasting wood top 	+\$308	Specify with <i>contrasting wood top</i> .
Interport Power/Data Module <ul style="list-style-type: none"> • Interport power/data module 	+\$531	Specify with <i>Interport</i> and select finish color number.
Related Products <ul style="list-style-type: none"> • Lounge seating 		▶ See <i>Coalesse Seating Specification Guide</i> .

Specification Information

Dimensions			Style Number	U.S. Base Price Top Surface: Wood Veneer
D	W	H		
24"	24"	17"	44-T242417	\$1539
24"	24"	21"	44-T242421	\$1674
16"	48"	30"	44-T164830	\$2302

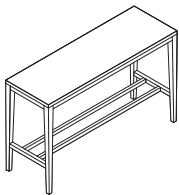
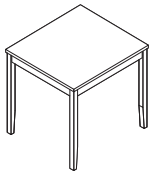
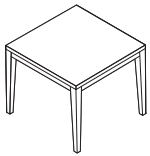

For Canadian Pricing
 Multiply U.S. Price by the Canadian price factor.
 ▶ See page 1 for details.

Sebastopol Occasional Tables Thought Starters

DESIGN EMILIA BORGTHORSDDOTTIR

Sebastopol is a unique collection of tables with endless configuration possibilities. It comprises of 2 shapes, each shape being offered in a 16" high and 22" high version. The following are just a few thought starters.

To create these table configurations use the following pieces labeled either A or B in any combination of the two heights, or use them on their own as a stand alone piece.

Shape A:
COEB2723 L or H

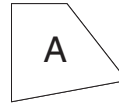

Shape B:
COEB4118 L or H

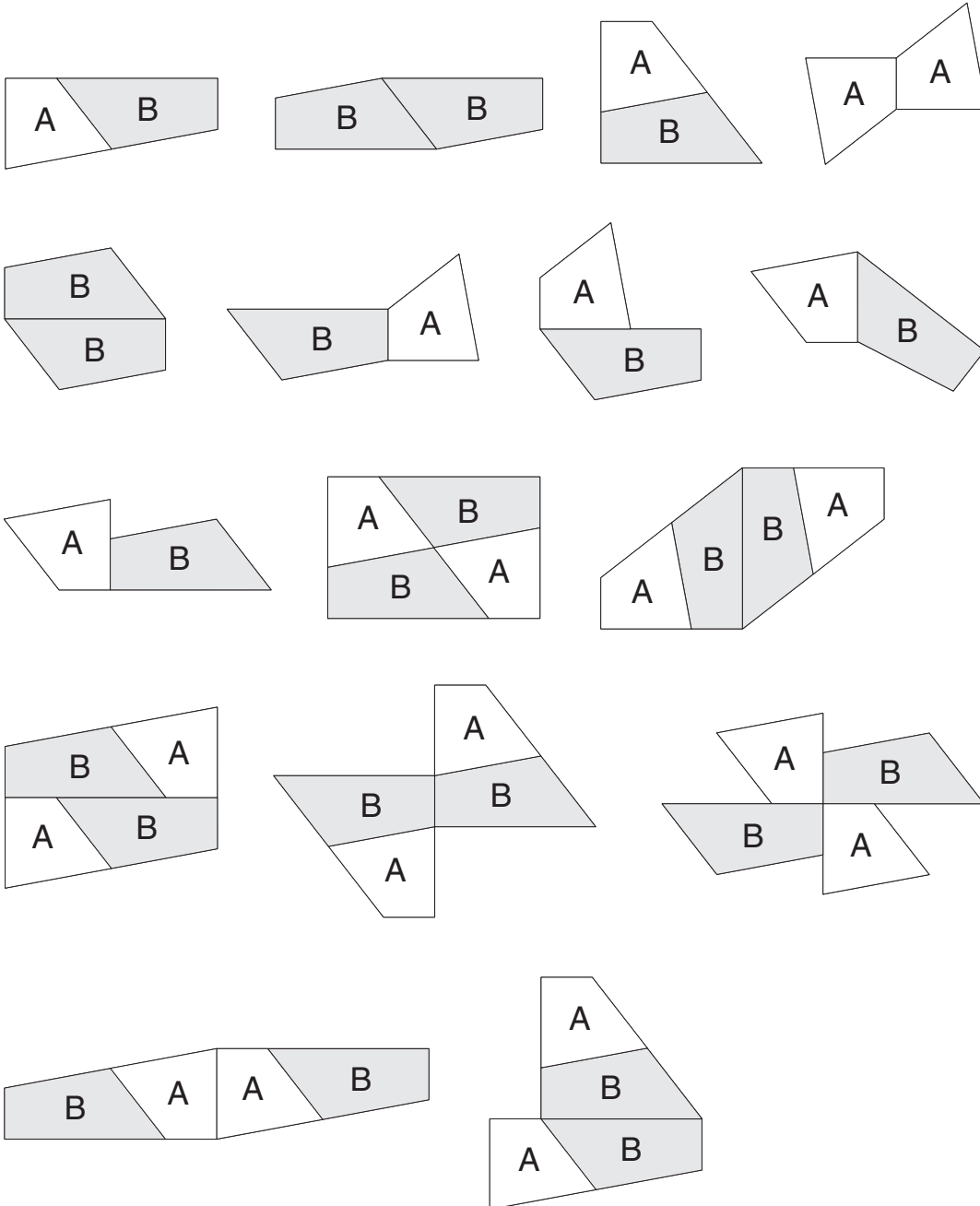
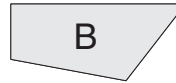

Sebastopol Occasional Tables

DESIGN EMILIA BORGTHORSDDOTTIR

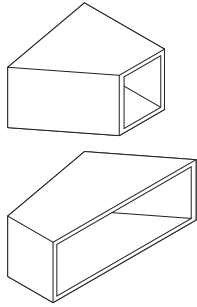

Tip: Optional grommet to accept PowerPod can be specified in milk white or black plastic.

Tip: If a grommet is specified with a PowerPod and the table is over a floor core, the floor core outlet cannot be flush to the floor, because the plug end will not allow the PowerPod to sit in the grommet. If the floor core is flush to the floor and the grommet and PowerPod are required, the table either cannot be set over the floor core, or a special plinth base will be required. Consult your specials representative for additional information on the plinth base.

Standard Includes		Required to Specify
<ul style="list-style-type: none"> ▶ Need help? Product details, page 698 	<ul style="list-style-type: none"> • Exterior surface: veneer grade 1, oak, or walnut • Interior surface: glossy laminate • Glides: concealed adjustable glide with non-marking nylon pad 	<ol style="list-style-type: none"> 1 Style number 2 Exterior surface wood finish number 3 Interior surface glossy laminate: <ul style="list-style-type: none"> 2001 Smoky White 2002 Studio Gray 2003 Wrought Iron 2004 Black Pearl 2005 Liberty Red 4 Options, if selected (see below) <p>▶ See <i>Coalesse Surface Materials Reference Guide</i>.</p>

Options	U.S. Price	Required to Specify
Grommet <ul style="list-style-type: none"> • Grommet to accept PowerPod 	+\$171	Specify <i>with grommet</i> and select finish color number either in milk white or black plastic.

Specification Information					
Dimensions			Style Number	U.S. Base Prices	
D	W	H		Top Surface:	
				Wood	Wood
				Veneer	Veneer
				Grade 1	Grade 2

16" High Tables

23"	27"	16"	COEB2723L	\$1888	\$2035
18"	41"	16"	COEB4118L	\$2235	\$2409

22" High Tables

23"	27"	22"	COEB2723H	\$2060	\$2222
18"	41"	22"	COEB4118H	\$2406	\$2595



For Canadian Pricing
 Multiply U.S. Price by the Canadian price factor.
 ▶ See page 1 for details.

Sebastopol Occasional Tables PowerPod

DESIGN EMILIA BORGTHORSDDOTTIR

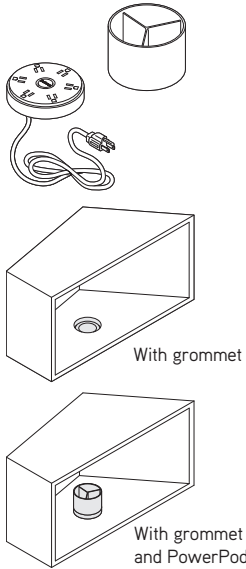

Standard Includes	Required to Specify
-------------------	---------------------

- PowerPod with 6' and three prong plug; silver bottom cradle and milk face
- Accessory tray: milk
- Six 15-amp power outlets
- Illuminated on/off button
- Surge suppressor

Style number

Specification Information			
---------------------------	--	--	--

Dimensions	Style	U.S.	
Dia	Number	Price	
6"	6"	COPP01	\$257

Tip: Leveling glides can be adjusted so that the bottom surface of the table can be anywhere from 5/8" to 1" off of the floor.

Tip: The PowerPod cord will exit out the bottom of the table.

Tip: If a grommet is specified with a PowerPod and the table is over a floor core, the floor core outlet cannot be flush to the floor, because the plug end will not allow the PowerPod to sit in the grommet. If the floor core is flush to the floor and the grommet and PowerPod are required, the table either cannot be set over the floor core, or a special plinth base will be required. Consult your special representative for additional information on the plinth base.

Tip: PowerPod must be plugged directly into the building power supply.



For Canadian Pricing
 Multiply U.S. Price by the Canadian price factor.
 ▶ See page 1 for details.

Coalesse

Sebastopol Occasional Tables PowerPod

DESIGN EMILIA BORGTHORSDDOTTIR

SW_1 Occasional Tables

DESIGN SCOTT WILSON & MINIMAL



Standard Includes	Required to Specify
<p>► Need help? Product details, page 576</p> <ul style="list-style-type: none"> • 1/2" thick top surface: <ul style="list-style-type: none"> - Laminate (grade 1) with 3 mm edge band, if selected - Wood veneer (grade 1) with matching 3 mm edge band, if selected - Solid surface, if selected: white only - Glass, if selected • 1/4" thick bottom substructure: black or milk • Base, column, and cone: 8040 Aluminum Matte Polished • Glides • Ships ready-to assemble 	<ol style="list-style-type: none"> 1 Style number with appropriate top series letter indicated in the space provided. (For example: COWO_RND30 becomes COWOLRND30 for a laminate top surface): <ul style="list-style-type: none"> L - Laminate top V - Wood veneer top C - Solid surface top G - Glass top 2 Laminate, wood, or glass color number for top, if selected 3 Plastic color for edge band of laminate top, if selected 4 Bottom substructure: <ul style="list-style-type: none"> 6000 Black 6052 Milk 5 Options, if selected (see below) <p>► See <i>Coalesse Surface Materials Reference Guide</i>.</p>

	Options	U.S. Price	Required to Specify
Surface Materials	Laminate		
	• Grade 2 laminate	Prices at right	Specify with <i>grade 2 laminate</i> and select color number.
	• Grade 3 laminate	Prices at right	Specify with <i>grade 3 laminate</i> and select color number.
	Wood		
	• Grade 2 wood veneer	Prices at right	Specify with <i>grade 2 wood veneer</i> and select color number.
	• Grade 1 wedge layup veneer	Prices at right	Specify with <i>grade 1 wedge layup veneer</i> and select color number.
	• Grade 2 wedge layup veneer	Prices at right	Specify with <i>grade 2 wedge layup veneer</i> and select color number.

Tip: If grommet is selected, the finish is not selectable, it will be the same as the substructure finish choice.

Tip: There is no vertical wire manager with grommet or power module selection.

Technology Devices and Grommets	Options	U.S. Price	Required to Specify
	Power Grommet with Wire Manager		
	• PowerPod grommet	+\$301 each grommet	Specify with <i>PowerPod grommet</i> and select count, location, and finish. ► See page 580 for count and location options.
	Simple Power Module with Wire Manager		
	• Three power	+\$469 each module	Specify with <i>three power, device count, device location</i> and select finish. ► See page 580 for count and location options.
	• Two power/one USB	+\$588 each module	Specify with <i>two power/one USB, device count, device location</i> and select finish. ► See page 580 for count and location options.

Related Products	Options	U.S. Price	Required to Specify
	<ul style="list-style-type: none"> • PowerPod • Collaborative and conference tables • Lounge seating • Guest seating 		<ul style="list-style-type: none"> ► Page 739 ► Page 474 ► See <i>Coalesse Seating Specification Guide</i>. ► See <i>Coalesse Seating Specification Guide</i>.

Veneer direction

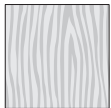

For Canadian Pricing
Multiply U.S. Price by the Canadian price factor.
► See page 1 for details.

SW_1 Occasional Tables

DESIGN SCOTT WILSON & MINIMAL

Tip: Your specification is not complete until you add the fifth letter to the style number to define top surface.

- L** - Laminate top
- V** - Wood veneer top
- C** - Solid surface top
- G** - Glass top



Tip: Glass tops are not secured to the substructure. Glass tops are placed on rubber pads that are adhered to the substructure. If the glass tables need to be moved, remove the glass top prior to moving the table.

Tip: 60" round table top is 59 1/2"D when solid surface is selected.

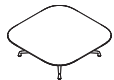

Specification Information

Dimensions			Style Number	U.S. Base Prices							
L	W	H		Laminate		Veneer		Wedge Veneer Layup		Solid Surface	Glass
				Grade 1	Grade 2 and 3	Grade 1	Grade 2	Grade 1	Grade 2		

Round Tables

30" diameter	15"		COWO_RND30	\$2659	\$2705	\$3722	\$3896	N.A.	N.A.	\$ 3958	\$ 4765
36" diameter	15"		COWO_RND36	\$2748	\$2809	\$3846	\$4108	\$ 5953	\$ 6217	\$ 4135	\$ 5218
42" diameter	15"		COWO_RND42	\$2836	\$2923	\$3973	\$4325	\$ 6698	\$ 7051	\$ 4317	\$ 5667
48" diameter	15"		COWO_RND48	\$3023	\$3136	\$4228	\$4624	\$ 7214	\$ 7612	\$ 4495	\$ 6118

Large-Round Tables

60" diameter	15"		COWO_RND60	\$4594	\$4756	\$6474	\$7051	\$10,956	\$11,496	\$ 9752	\$11,644
--------------	-----	--	-------------------	--------	--------	--------	--------	----------	----------	---------	----------

Square Tables

30"	30"	15"	COWO_SQ30	\$2748	\$2794	\$3846	\$4020	N.A.	N.A.	\$ 4135	\$ 5218
36"	36"	15"	COWO_SQ36	\$2836	\$2897	\$3973	\$4235	N.A.	N.A.	\$ 4317	\$ 5667
42"	42"	15"	COWO_SQ42	\$3023	\$3110	\$4228	\$4580	N.A.	N.A.	\$ 4495	\$ 6118

Large-Square Tables

60"	60"	15"	COWO_SQ60	\$4732	\$4897	\$6659	\$7253	N.A.	N.A.	\$10,025	\$12,187
-----	-----	-----	------------------	--------	--------	--------	--------	------	------	----------	----------

Super-Square Tables

45 1/2"	45 1/2"	15"	COWO_SSQ45	\$3154	\$3267	\$4406	\$4802	\$ 7392	\$ 7761	\$ 4765	\$ 6569
---------	---------	-----	-------------------	--------	--------	--------	--------	---------	---------	---------	---------



For Canadian Pricing
 Multiply U.S. Price by the Canadian price factor.
 ▶ See page 1 for details.

SW_1 Occasional Tables PowerPod

DESIGN SCOTT WILSON & MINIMAL

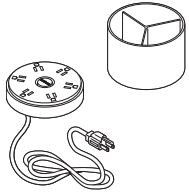

Tip: PowerPod must be plugged directly into the building power supply.

Standard Includes	Required to Specify
<ul style="list-style-type: none"> ▶ Need help? Product details, page 578 • PowerPod with 6' cord and three prong plug: brushed aluminum bottom cradle and milk face • Accessory tray: milk • Six 15-amp power outlets • Illuminated on/off button • Surge suppressor 	<p>Style number</p>

Specification Information

Dimensions	Style	U.S.
Diameter H	Number	Price
6 ³ / ₄ " 6"	COPP01	\$257



For Canadian Pricing
 Multiply U.S. Price by the Canadian price factor.
 ▶ See page 1 for details.

SW_1 Occasional Tables Accessories

DESIGN SCOTT WILSON & MINIMAL

Standard Includes	Required to Specify
<ul style="list-style-type: none"> ▶ Need help? Product details, page 578 • Horizontal wire manager, 6-pack: velcro and attachment hardware • Manages small amounts of cords and wires • Mesh cable cover, if selected: black 	<ul style="list-style-type: none"> Style number

Related Products
<ul style="list-style-type: none"> • SW_1 tables ▶ Pages 592 and 596

Specification Information

Dimensions			Style	U.S.
L	W	H	Number	Price

Horizontal Wire Manager Clips (Package of 6)

1/2"	8"	1/2"	COWHWM	\$74
------	----	------	--------	------



Tip: Horizontal wire manager clips attach under the work surface with screws.

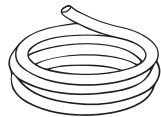

Tip: Mesh cable cover is 6' feet long and can be cut to desired length.

Tip: For further details on this product, please reference the Conference and Collaborative Tables Specification Guide.

Mesh Cable Cover

72"	1"	N.A.	VLYCDM	\$47
-----	----	------	--------	------



For Canadian Pricing
 Multiply U.S. Price by the Canadian price factor.
 ▶ See page 1 for details.

Switch Occasional Tables

DESIGN E00S

Standard Includes	Required to Specify
<ul style="list-style-type: none"> • Base: satin silver plated tubing • Matte chrome finish • Glass top: 5/8" thick, green tinted, tempered glass tops have radiused corners • Adjustable glides 	Style number

Related Products
<ul style="list-style-type: none"> • Lounge seating • Guest seating • Stools

▶ See *Coalesse Seating Specification Guide*.
▶ See *Coalesse Seating Specification Guide*.
▶ See *Coalesse Seating Specification Guide*.

Specification Information

Dimensions			Style	U.S. Price
D	W	H	Number	Top Surface: Glass

Square Table

24 ³ / ₈ "	24 ³ / ₈ "	15"	39-2424	\$2703
----------------------------------	----------------------------------	-----	---------	--------

Rectangle Table

24 ³ / ₈ "	43 ¹ / ₄ "	15"	39-2442	\$3331
----------------------------------	----------------------------------	-----	---------	--------

Square Table

36"	36"	15"	39-3636	\$3586
-----	-----	-----	---------	--------

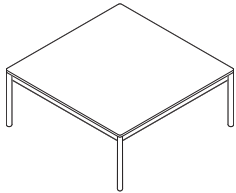
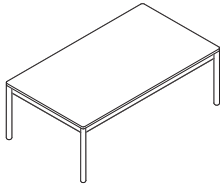
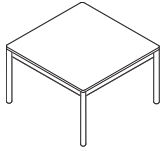

For Canadian Pricing
Multiply U.S. Price by the
Canadian price factor.
▶ See page 1 for details.

Trees Occasional Tables

DESIGN NORMAN DIEKMAN

Tip: Tops come in the same wood and finish but with smooth surface.

Standard Includes	Required to Specify
<ul style="list-style-type: none"> Embossed wood is created under high pressure to add dimensionality and texture on all sides of the table - Interior frame is constructed from a combination of engineered lumber and hardwood veneers - Embossed hardwood veneer is applied to all vertical and slanted surfaces - Embossed wood in Natural EWNT 	1 Style number 2 Options, if selected (see below)

Options	U.S. Price	Required to Specify
Surface Materials <ul style="list-style-type: none"> Bevel high embossed wood (Model 70-C-TPM) available in medium brown EWMB Bevel medium embossed wood (Model 70-D-TPM) available in medium brown EWMB 	+\$105 +\$105	Specify <i>with medium brown</i> . Specify <i>with medium brown</i> .

Specification Information

Dimensions			Style	U.S.
D	W	H	Number	Base Price

Bevel High-Embossed Wood Table

15½"	14"	23"	70-C-TPM	\$3671
------	-----	-----	----------	--------

Bevel Medium-Embossed Wood Table

15½"	14"	19¾"	70-D-TPM	\$3577
------	-----	------	----------	--------

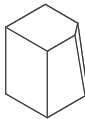
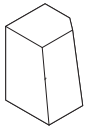

 **For Canadian Pricing**
 Multiply U.S. Price by the Canadian price factor.
 ▶ See page 1 for details.

Storage



Statement of Line

710



Credenzas and Cabinets

713

Statement of Line

Storage

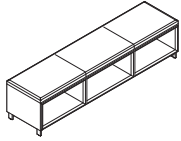

Open

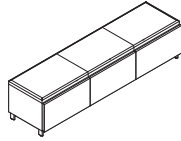

Closed

Understanding
▶ Page 714
Specifying
▶ Page 718

Exponents Benches

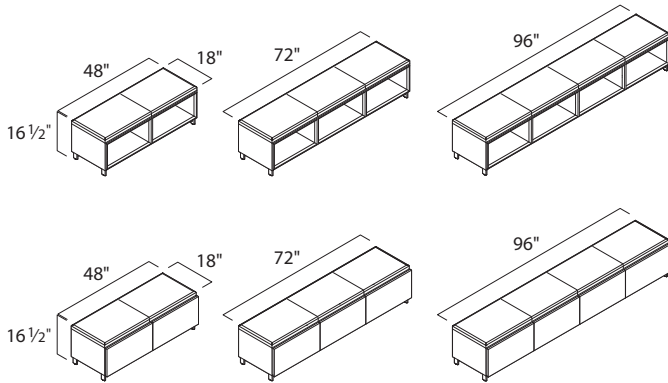

In-line



End-of-Run

Understanding
▶ Page 722
Specifying
▶ Page 725

Exponents Bench Bridges

Statement of Line

Storage, continued

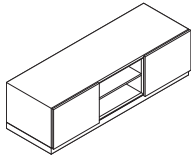

Partial - Open

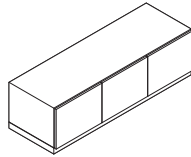

Closed

Understanding
▶ Page 726
Specifying
▶ Pages 730-734

Exponents Credenzas

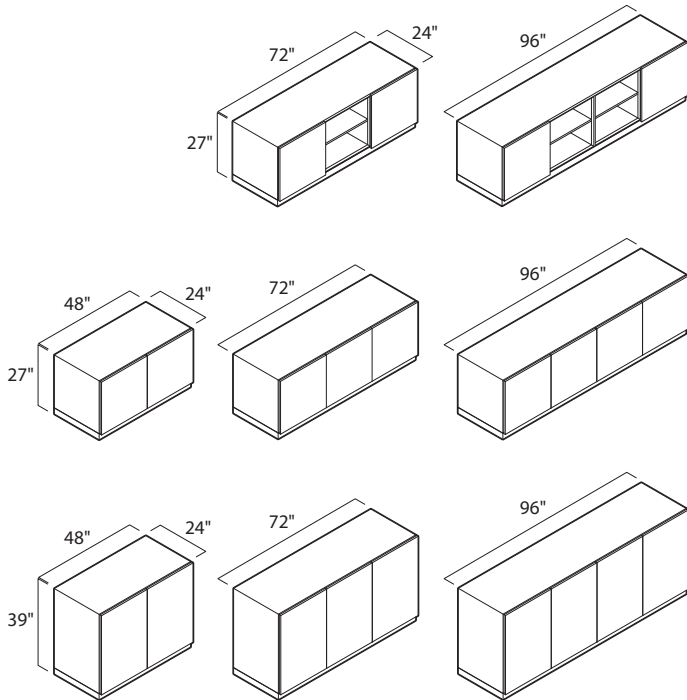

Credenzas and Cabinets

* These product lines are collections and will be found in multiple locations in this specification guide and/or *Coalesse Seating Specification Guide*.
▶ See *Collections*, page 5

Exponents Benches*	714
Exponents Bench Bridges*	722
Exponents Credenzas*	726

Exponents Benches

The Exponents collection offers holistic solutions for collaboration in conference rooms, enclaves, and open space settings. It is a flexible platform for addressing functional and aesthetic requirements in a single, comprehensive offering. Benches allow for additional perimeter "overflow" seating and storage for conference room settings which maximizes the use of the real estate. Benches can also be used in open plan settings for short term collaborative settings.

Tip: This product line is a collection and will be found in more than one location in this specification guide.

► See Collections, page 5

Top cushion is standard on all benches. The seat cushion is available in fabric and leather upholstery.

Metal leg bases are standard with adjustable glides. The legs are painted and are available in black matte, platinum matte or paint.

Back panel is standard unfinished. An optional finished back panel is available.

Doors open downward 90° utilizing self opening hinges with a soft close catch. Optional door locks are also available.

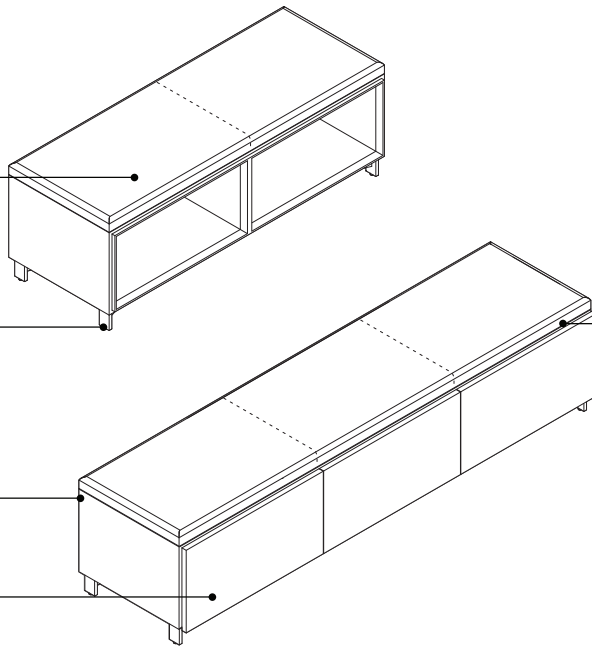

Accent ribbon detail is on the perimeter of the bench front openings and is offered in paint.

Exponents Benches

Product Details

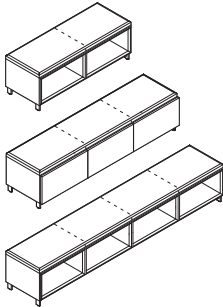

The bench is available in three widths, two depths, and one height: 48"W, 72"W, or 96"W x 18"D (no doors) or 18³/₄"D (with doors) x 16¹/₂"H.

The benches are standard in wood veneer. The door fronts, if selected, can be specified in a different finish from the case.

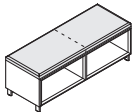

All benches are standard only with a top cushion which is approximately 1¹/₈" thick.

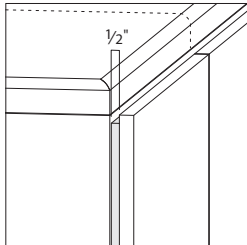

The doors are opened from the top. The 1/2" gap created by the accent ribbon detail allows for a clean, uninterrupted aesthetic.

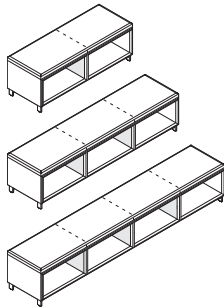

The benches always have an inner 3/4" divider. The 48"W bench has one divider creating two separate compartments, the 72"W bench has two dividers creating three compartments and the 96"W bench has three dividers creating four separate compartments.

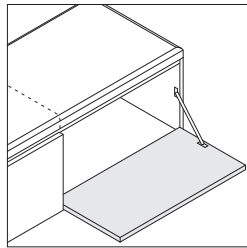

Doors are standard with 90° fold down self close hinges with soft close feature.

The interior dimension of each compartment is 16"D x 22³/₄"W (17¹/₄" with accent ribbon) x 10¹/₂"H. When the door is in the open position the height clearance is 10"H. The hinges impede on the width and depth of the bench, 14¹/₂"D x 20"W.

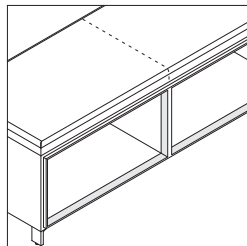

1/4"W accent ribbon detail runs along the inside fronts of the bench in painted aluminum.

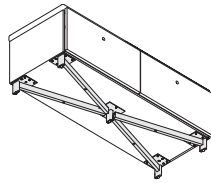

Bottom base on benches are standard with five legs, four outer, and one middle leg. The base is available in two powder coat paint finishes, black matte or platinum matte.

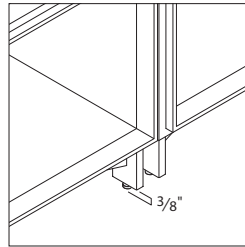

Glides are available for each bench base leg. The glide adjustment is 3/8".

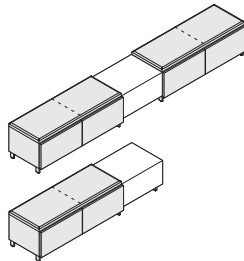

Benches can be placed next to another bench or can be ganged to bench bridges by the use of two ganging plates at the bottom on each end, which is standard with the bench bridges.

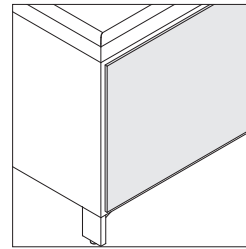

The back is standard unfinished in black backer. For applications where the back will not be against a wall, specify the optional finished back option. The back has an integrated reveal that is the finish of the case when the optional back finish is specified.

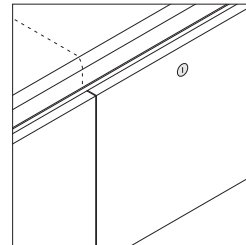

Optional locks are available for the benches with doors. Each door has its own lock. Locks are available in ember chrome or polished chrome finish.

Specials are possible. To confirm practicality and obtain a quotation, contact Customer Service at 1.800.627.6770.

Surface Materials

Case sides:

- Wood veneer

Door fronts:

- Wood veneer

Accent ribbon:

- Black matte paint
- Platinum matte paint

Back panel:

- Black backer (standard)
- Wood veneer (option)

3" metal base:

- Black matte paint
- Platinum matte paint

Cushion:

- Fabric
- Leather

Optional lock(s)

- 9201 Polished Chrome
- 9250 Ember Chrome

Wood is a natural material, slight variations occur in veneer texture, color, grain configuration, and stain acceptance. Coalesse stains are all applied with an exacting regard for consistency and are well within traditional tolerances for wood products. Due to natural variations in wood, finished products may vary from samples in color, texture, and grain.

Tip: You should know that finishes may vary slightly in tone or character from each other or from the samples Coalesse produces. No guarantee can be made for an exact match.

Coalesse strives to produce a consistently high quality product and some natural variation in color is to be expected. The variation is especially apparent on natural woods which have no stain applied, for example 3525 Natural Maple. This color variation is normal and reflects the unique and natural properties of wood. This should not be considered a defect.

Stain swatches are reproduced in the Surface Materials Color Palettes.

► See *Coalesse Surface Materials Reference Guide* for a list.

Exponents Benches *continued*

Swatch cards and actual samples of standard wood veneers are available from your Coalesse Customer Service representative.

Stain-to-Match is available on this product and allows the matching of any wood finish with a one-time charge per finish.

► See *Coalesse Surface Materials Reference Guide* for details.

Care & Maintenance

Veneers should be cleaned regularly with mild soap and water and dried with a soft cloth. To polish veneers, use silicone-free household polishers. Use sparingly.

Tip: Never use ammonia-based cleaners or wax on wood surfaces.

Painted finishes should be cleaned with a liquid detergent and water. Remove stubborn stains with liquid cleaner, such as Windex.

All products should be inspected and maintained regularly by inspecting glides for damage and inspecting all moving parts, i.e., suspensions, for damage and wear.

Coalesse

Exponents Benches

Exponents Benches

DESIGN COALESSE DESIGN GROUP

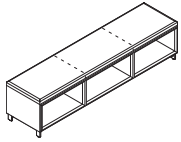

► Need help?
Product details,
page 714

Standard Includes

- Case: wood veneer
- Door fronts with pull down self opening door with soft close catch, if selected: wood veneer
- Accent ribbon: paint
- Metal base: paint
- Case ships assembled, seat and base require installation

Required to Specify

- 1 Style number
 - 2 Wood color number for case:
V145 Milk
 - 3 Paint color number for metal base:
4135 Black Matte
4141 Platinum Matte
 - 4 Wood color number for door fronts,
if selected
 - 5 Paint color number for accent ribbon:
4135 Black Matte
4141 Platinum Matte
 - 6 Seat cushion finish number:
– Fabric
– Leather
 - 7 Options, if selected (see below)
- See *Coalesse Surface Materials Reference Guide*.

Tip: Specification is not complete until a fabric selection is specified.

Required Sections

U.S. Price

Required to Specify

Upholstery for 48" W and 72" W benches

- Fabric price group 6 +\$ 72
- Fabric price group 7 +\$ 107
- Fabric price group 8 +\$ 140
- Fabric price group 9 +\$ 216
- Fabric price group 10 +\$ 267
- Fabric price group 11 +\$ 308
- Fabric price group 12 +\$ 335
- Fabric price group 13 +\$ 458
- Fabric price group 14 +\$ 626
- COM +\$ 105
- COL +\$ 420
- Leather price group C for 48" W only +\$ 870
- Leather price group E for 48" W only +\$ 962
- Leather price group C for 72" W only +\$1001
- Leather price group E for 72" W only +\$1107

Specify *with upholstery* and select fabric color number.
Specify *with upholstery* and select fabric color number.
Specify *with upholstery* and select fabric color number.
Specify *with upholstery* and select fabric color number.
Specify *with upholstery* and select fabric color number.
Specify *with upholstery* and select fabric color number.
Specify *with upholstery* and select fabric color number.
Specify *with upholstery* and select fabric color number.
Specify *with upholstery* and select fabric color number.
Specify *with upholstery* and select fabric color number.
Specify *with upholstery* and select leather color number.
Specify *with upholstery* and select leather color number.
Specify *with upholstery* and select leather color number.
Specify *with upholstery* and select leather color number.
Specify *with upholstery* and select leather color number.

Upholstery for 96" W benches

- Fabric price group 6 +\$ 101
- Fabric price group 7 +\$ 155
- Fabric price group 8 +\$ 199
- Fabric price group 9 +\$ 307
- Fabric price group 10 +\$ 388
- Fabric price group 11 +\$ 440

Specify *with upholstery* and select fabric color number.
Specify *with upholstery* and select fabric color number.
Specify *with upholstery* and select fabric color number.
Specify *with upholstery* and select fabric color number.
Specify *with upholstery* and select fabric color number.
Specify *with upholstery* and select fabric color number.

► Required Selections, continued on next page



For Canadian Pricing
Multiply U.S. Price by the
Canadian price factor.
► See page 1 for details.

Exponents Benches

DESIGN COALESSE DESIGN GROUP

► Required Selections, continued from previous page

Tip: Specification is not complete until a fabric selection is specified.

Required Sections	U.S. Price	Required to Specify
Upholstery for 96"W benches, continued		
• Fabric price group 12	+\$ 482	Specify with <i>upholstery</i> and select fabric color number.
• Fabric price group 13	+\$ 655	Specify with <i>upholstery</i> and select fabric color number.
• Fabric price group 14	+\$ 898	Specify with <i>upholstery</i> and select fabric color number.
• COM	+\$ 145	Specify with <i>upholstery</i> and select fabric color number.
• COL	+\$ 420	Specify with <i>upholstery</i> and select leather color number.
• Leather price group C for 96"W only	+\$1317	Specify with <i>upholstery</i> and select leather color number.
• Leather price group E for 96"W only	+\$1456	Specify with <i>upholstery</i> and select leather color number.

	Options	U.S. Price	Required to Specify
Surface Materials	Acrylic backer for seat cushion		
	• Backer for 48"W and 72"W benches	+\$ 26	Specify with <i>acrylic backer</i> .
	• Backer for 96"W benches	+\$ 33	Specify with <i>acrylic backer</i> .
	Case and door fronts		
	• Grade 2 wood veneer	Prices at right	Specify with <i>Grade 2 wood veneer</i> and select color number.
	Finished back panel for veneer bench		
	• 48"W credenza	+\$ 258	Specify with <i>finished back panel</i> .
	• 72"W credenza	+\$ 355	Specify with <i>finished back panel</i> .
	• 96"W credenza	+\$ 436	Specify with <i>finished back panel</i> .
Lock and Keying	Locks		
	• 48"W bench	+\$ 342	Specify with <i>9201 Polished Chrome locks</i> or with <i>9250 Ember Chrome locks</i> .
	• 72"W bench	+\$ 513	Specify with <i>9201 Polished Chrome locks</i> or with <i>9250 Ember Chrome locks</i> .
	• 96"W bench	+\$ 684	Specify with <i>9201 Polished Chrome locks</i> or with <i>9250 Ember Chrome locks</i> .
	Keying		
	• Factory- and field-installed keying units		► Page 754
Related Products	• In-line bridge and end-of-run bridge		► Page 725
	• Lectern		► Page 742

Tip: When finished back panel is specified, the finish will match the case finish.

► Specification Information, on next page

 **For Canadian Pricing**
 Multiply U.S. Price by the Canadian price factor.
 ► See page 1 for details.

Exponents Benches *continued*

DESIGN COALESSE DESIGN GROUP

► Options, on previous page

Specification Information

Dimensions			Style Number	U.S. Base Prices	
D	W	H		Grade 1 Veneer	Grade 2 Veneer

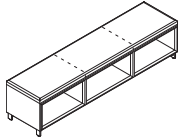

Open Benches

48"W

18"	48"	16½"	COCZBOC184815	\$4008	\$4141
COM/yds = 1¾, COL/sq ft = 33					

72"W

18"	72"	16½"	COCZBOC187215	\$4775	\$4931
COM/yds = 1¾, COL/sq ft = 33					

96"W

18"	96"	16½"	COCZBOC189615	\$5516	\$5691
COM/yds = 2½, COL/sq ft = 50					

Specification Information

Dimensions			Style Number	Case	U.S. Base Prices	
D	W	H			Door Fronts Grade 1 Veneer	Grade 2 Veneer

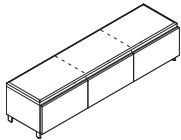

Benches with Doors

48"W

18¾"	48"	16½"	COCZBDC184815	Grade 1 Veneer	\$5576	\$5641
				Grade 2 Veneer	\$5709	\$5774
COM/yds = 1¾, COL/sq ft = 33						

72"W

18¾"	72"	16½"	COCZBDC187215	Grade 1 Veneer	\$6893	\$6976
				Grade 2 Veneer	\$7049	\$7132
COM/yds = 1¾, COL/sq ft = 33						

96"W

18¾"	96"	16½"	COCZBDC189615	Grade 1 Veneer	\$8084	\$8179
				Grade 2 Veneer	\$8259	\$8354
COM/yds = 2½, COL/sq ft = 50						



For Canadian Pricing
 Multiply U.S. Price by the
 Canadian price factor.
 ► See page 1 for details.

Coalesse

Exponents Benches

DESIGN COALESSE DESIGN GROUP

Exponents Bench Bridges

The Exponents collection offers holistic solutions for collaboration in conference rooms, enclaves, and open space settings. It is a flexible platform for addressing functional and aesthetic requirements in a single, comprehensive offering. Bench bridges work with the benches allowing for technology needs to be accessed within the setting.

Tip: This product line is a collection and will be found in more than one location in this specification guide.

► See *Collections*, page 5

End-of-run bench bridge is non-handed. An optional three power module is available.

End panels are always finished to match all other sides of the case.

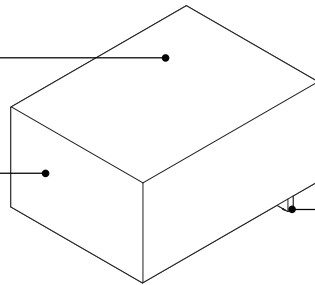

Metal leg base is standard with adjustable glides for the end-of-run bench bridge. The legs are painted and are available in black matte, platinum matte or paint.

In-line bench bridge is non-handed. An optional three power module is available.

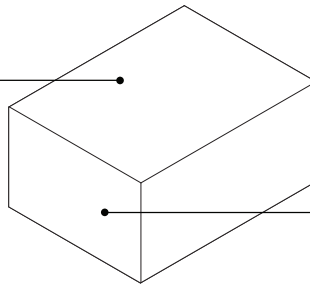

End panels are unfinished with a black backer, as these will always be hidden when connected to the benches.

Exponents Bench Bridges

Product Details

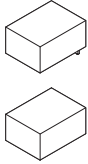

The bench bridge is available in two types:

- In-line bridge, 18"D x 24"W x 15"H
- End-of-run bridge, 18"D x 24"W x 15"H

The bench bridges are standard in wood veneer.

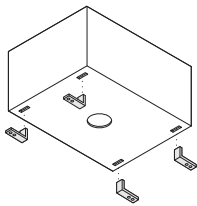

The in-line bridge has four attachment brackets to attach to the benches on each side.

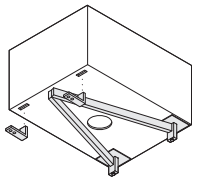

The end-of-run bridge has a bottom base and comes with two attachment brackets to attach to the bench.

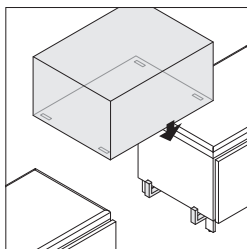

Bench bridges must be ganged to a bench unit only. The attachment brackets are 1/4"W x 1/4" thick.

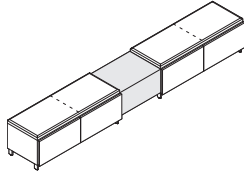

The in-line bridge must be attached to two benches, one on each side. The in-line bridge comes standard with four attachment brackets, and two ganging plates at the bottom of each end. The brackets attach in the slots at the bottom of the bridge and mounted with screws in the bench.

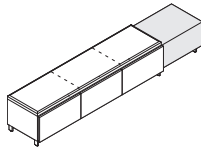

The end-of-run bridge must be attached to one bench at the end of a run. The end-of-run bridge comes standard with two attachment brackets and legs. The brackets attach in the slots at the bottom of the bridge and mounted with screws in the bench.

Specials are possible. To confirm practicality and obtain a quotation, contact Customer Service at 1.800.627.6770.

Wiring and Cabling

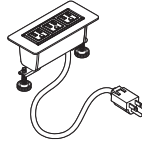

The optional power module is standard with three waterproof simplex outlets. It is standard with a six foot cord. The power module is aluminum with black gloss paint. The power module is UL listed.

The cutout on all bench bridges is 2"D x 5 1/4"W.

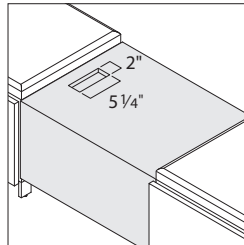

In-line Bridge

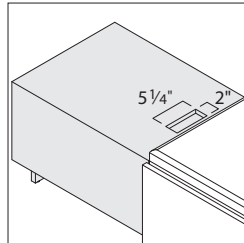

End-of-Run Bridge

Power module is standard on the end of the in-line and end-of-run bridge.

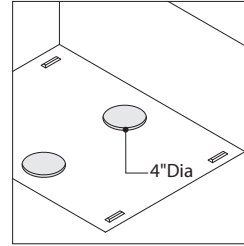

In-line Bridge

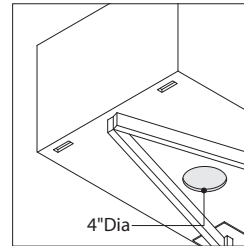

End-of-Run Bridge

To install, remove and route the power module cord, there is a 4" round cutout at the bottom of the corner bridge and there is one 4" cutout at the bottom of the in-line and end-of-run bridges.

Surface Materials

Top, front, and back of in-line bridge cases:

- Wood veneer

Top, front, sides and back of end-of-run bridge cases:

- Wood veneer

In-line bridge sides:

- Black backer

End-of-run bridge base:

- Black matte paint
- Platinum matte paint

Optional power:

- Black gloss

Wood is a natural material, slight variations occur in veneer texture, color, grain configuration and stain acceptance. Coalesse stains are all applied with an exacting regard for consistency and are well within traditional tolerances for wood products. Due to natural variations in wood, finished products may vary from samples in color, texture, and grain.

Tip: You should know that finishes may vary slightly in tone or character from each other or from the samples Coalesse produces. No guarantee can be made for an exact match.

Coalesse strives to produce a consistently high quality product and some natural variation in color is to be expected. The variation is especially apparent on natural woods which have no stain applied, for example 3525 Natural Maple. This color variation is normal and reflects the unique and natural properties of wood. This should not be considered a defect.

Exponents Bench Bridges *continued*

Stain swatches are reproduced in the Surface Materials Color Palettes.

► See *Coalesse Surface Materials Reference Guide* for a list.

Swatch cards and actual samples of standard wood veneers are available from your Customer Service representative.

Stain-to-Match is available on this product and allows the matching of any wood finish with a one-time charge per finish.

► See *Coalesse Surface Materials Reference Guide* for details.

Care & Maintenance

Veneers should be cleaned regularly with mild soap and water and dried with a soft cloth. To polish veneers, use silicone-free household polishers. Use sparingly.

Tip: Never use ammonia-based cleaners or wax on wood surfaces.

Painted finishes should be cleaned with a liquid detergent and water. Remove stubborn stains with liquid cleaner, such as Windex.

All products should be inspected and maintained regularly by inspecting glides for damage and inspecting all moving parts, i.e., suspensions, for damage and wear.

Exponents Bench Bridges

DESIGN COALESSE DESIGN GROUP

Standard Includes		Required to Specify
<ul style="list-style-type: none"> ▶ Need help? Product details, page 722 	<ul style="list-style-type: none"> • Case: wood veneer • In-line bridge: unfinished sides, black backer • Metal base, end-of-run bridge only: paint • Brackets with connecting hardware: black matte paint only • Case ships assembled, base requires installation 	<ol style="list-style-type: none"> 1 Style number 2 Wood color number for case: V145 Milk 3 Paint color number for end-of-run base, if selected: 4135 Black Matte 4141 Platinum Matte 4 Options, if selected (see below) <p>▶ See <i>Coalesse Surface Materials Reference Guide</i>.</p>

Tip: The power device finish is non-specifiable. For all finish specifications, the power device will be black gloss.

Options	U.S. Price	Required to Specify
Surface Materials Case <ul style="list-style-type: none"> • Grade 2 wood veneer 	Prices below	Specify with <i>Grade 2 wood veneer</i> and select color number.
Power <ul style="list-style-type: none"> • 3 power receptacles 	+\$435	Specify with <i>power</i> .
Related Products <ul style="list-style-type: none"> • Benches • Lectern 		▶ Page 718 ▶ Page 742

Specification Information

Dimensions			Style Number	U.S. Base Prices	
D	W	H		Grade 1 Veneer	Grade 2 Veneer

In-Line Bridge

18"	24"	15"	COCZBI182415	\$2339	\$2431
-----	-----	-----	--------------	--------	--------

End-of-Run Bridge

18"	24"	15"	COCZBE182415	\$2744	\$2847
-----	-----	-----	--------------	--------	--------



 **For Canadian Pricing**
 Multiply U.S. Price by the Canadian price factor.
 ▶ See page 1 for details.

Exponents Credenzas

The Exponents collection offers holistic solutions for collaboration in conference rooms, enclaves, and open space settings. It is a flexible platform for addressing functional and aesthetic requirements in a single, comprehensive offering. Credenzas allow for conference storage for varying types of items. Cable routing allows for easy and hidden connections.

Tip: This product line is a collection and will be found in more than one location in this specification guide.

► See Collections, page 5

The top matches the case finish. An optional accent top can be specified in differing material from the case; glass. Optional grommets are also available.

Credenzas come standard with black backer. Optional matching finished back panel is available.

Plinth base is standard on all credenzas and matches the case finish selection. An optional metal leg base is available in black matte or platinum matte paint. All bases are available with adjustable glides.

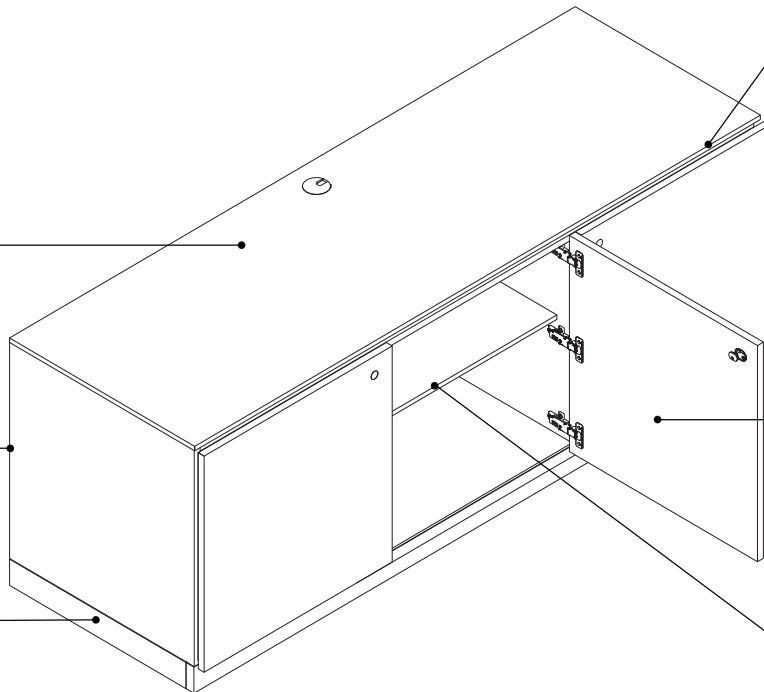

Accent ribbon detail is on the perimeter of the credenza front openings and is offered in paint.

Doors open 110° utilizing soft-close hinges. Optional door locks are also available.

Adjustable shelves are standard on the 27"H and 39"H credenzas. Additional shelves are also available. An optional pull-out shelf is available for the 27"H partial open credenza in the mid-section(s) only.

Exponents Credenzas

Product Details

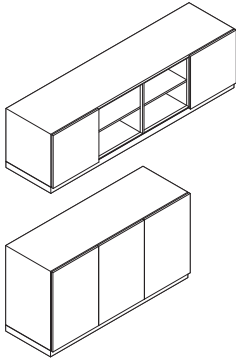

Credenzas are available in three widths, two depths, and two heights: 48"W, 72"W, or 96"W 24"D (no doors) or 24³/₄"D (with doors or partial doors) 27"H or 39"H

The credenzas are standard in wood veneer. The door fronts, if selected, can be specified in a different finish from the case.

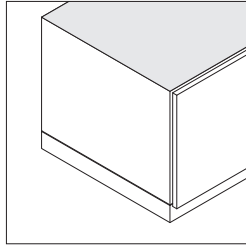

Standard Top

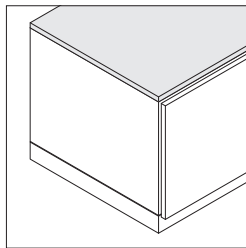

Accent Top

All credenzas are standard with a top that matches the case finish. An optional accent top can be specified in differing materials from the case. The accent top is available in the following:

- Glass (flare coated only)

The accent top adds 1/2" to the overall height.

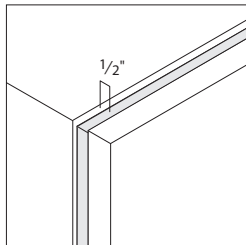

The doors are opened from the top. The 1/2" gap created by the ribbon detail allows for a clean, uninterrupted aesthetic.

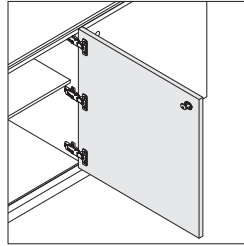

Doors are standard with 110° soft close hinges.

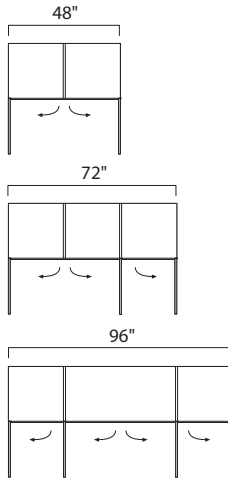

TOP VIEW

For 48"W credenzas, the left door is hinged left and the right door is hinged right. For 72"W credenzas, the left door is hinged left, the middle door is hinged right, and the right door is hinged right. For 96"W credenzas, the left two doors are hinged left and the right two doors are hinged right.

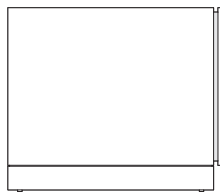

1/4"W accent ribbon detail runs along the inside fronts of the credenzas and comes in painted aluminum.

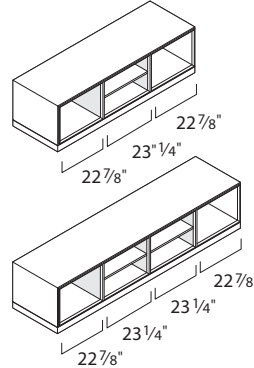

The credenzas have an inner 3/4" divider. The 72"W credenza has two dividers creating three compartments and the 96"W credenza has three dividers creating four separate compartments.

The interior width dimension of each compartment:

- 72"W (each compartment)**
 - 22¹/₂"W (two end compartments)
 - 24"W (middle compartment)
- Hinges impede the width by 1".
- 96"W (each compartment)**
 - 22¹/₂"W (two end compartments)
 - 23³/₈"W (middle two compartments)
- Hinges impede the width by 1".

The interior depth dimension of each compartment:

- 48"W, 72"W, and 96"W (each compartment)**
 - 22"D (23¹/₄" with accent ribbon)
- Hinges impede the depth without accent ribbon by 1¹/₂".

The interior height dimension of each compartment:

- 27"H (each compartment)**
 - 22¹/₂"H
- 39"H (each compartment)**
 - 34¹/₂"H

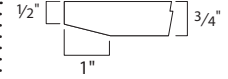

The adjustable shelves are 3/4" thick. The shelves adjust on 1/4" increments.

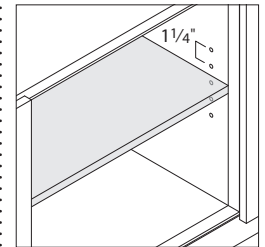

The adjustable shelves come in four dimensions, depending on the compartment and are standard with cable management routing in the corners of the shelf.

- 48"W (each compartment)**
 - 22³/₄"W
- 72"W (each compartment)**
 - 22³/₈"W (two end compartments)
 - 23⁷/₈"W (middle compartments)
- 96"W (each compartment)**
 - 22³/₈"W (two end compartments)
 - 23⁷/₁₆"W (middle two compartments)

For the 39"H credenza, there are two sets of five holes. The top hole is 9" down from the underside of the top to the center of the hole and the bottom hole is 9" up from the bottom fixed shelf to the center of the hole. The gap in between the two sets of holes is 6¹/₂".

For the 27"H credenza, there are five holes. The top hole is 8³/₄" down from the underside of the top to the center of the hole and the bottom hole is 8³/₄" up from the bottom fixed shelf to the center of the hole.

Exponents Credenzas *continued*

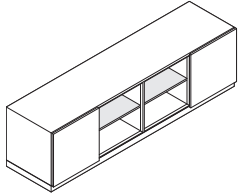

For credenza compartments without doors, the adjustable shelf will be the same color as the case finish. All adjustable shelves behind doors will match the finish of the case.

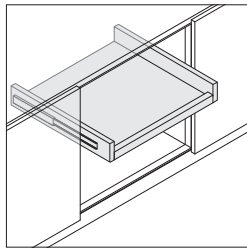

Optional pull-out shelf, for open middle compartments only, allows for easy access to devices. The pull-out shelf uses ball-bearing suspensions for a smooth operation. The pull-out shelf extends out 14³/₄". The pull-out shelf is specifiable in wood veneer. The interior dimension of the pull-out shelf is 17¹/₂"D x 21¹/₂"W x 2¹/₂"H. The exterior dimension is 18"D x 22¹/₂"W x 3"H.

Tip: When a pull-out shelf is specified, it does not take the place of the standard adjustable shelf. It is an additional item.

For the 39"H credenzas, no optional pull-out shelves are available.

For the 27"H credenzas, one optional pull-out shelf can be specified per open middle compartment. The pull-out shelves are only specifiable in the 72"W credenza, open middle compartment and the 96"W credenza, two open middle compartments.

The pull-out shelf will be the same finish as the case finish.

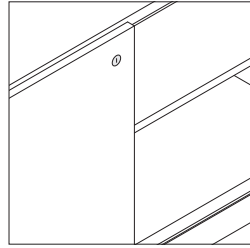

Optional locks are available for the credenzas with doors. Each door has its own lock. Locks are available in ember chrome or polished chrome finish.

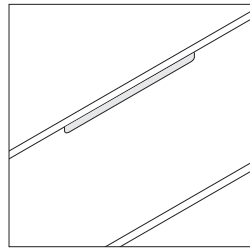

The back is standard unfinished in black backer and has a 1"D x 23"W cutout at the top middle for wire management.

For applications where the back will not be against a wall, specify the optional finished back panel.

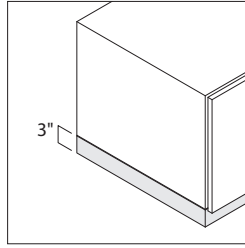

The base on all credenzas are standard as a 3" plinth base. The plinth base matches the case finish. The base is flush on the sides and front for open fronts.

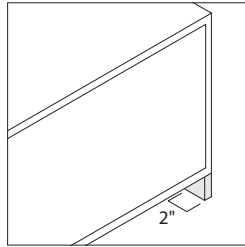

The back of the plinth base is inset 2" for access to the bottom cutouts.

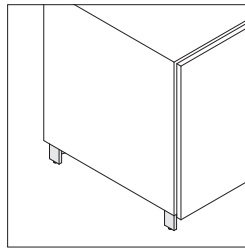

An optional metal base is available on all credenzas. The metal base always has one leg in each corner (four total). One additional middle leg is used for the 48"W, two additional middle legs are used for the 72"W, and three additional middle legs are used for the 96"W. The base is available in two powder coat paint finishes, black matte and platinum matte.

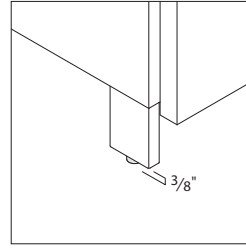

Plastic glides are available for each credenza base type, plinth, and metal leg. The glides are 3/8" diameter. The glide adjustment is 3/8".

Specials are possible. To confirm practicality and obtain a quotation, contact Customer Service at 1.800.627.6770.

Wiring and Cabling

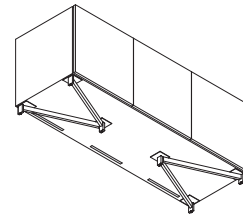

The bottom of the credenzas is standard with wire management cutouts, 1"D x 12"W. Each compartment has its own cutout.

- 48"W credenzas have two cutouts.
- 72"W credenzas have three cutouts.
- 96"W credenzas have four cutouts.

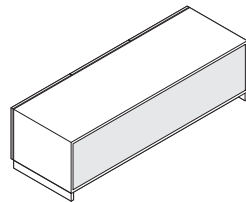

For applications where the back will not be against a wall, specify the optional finished back panel.

For applications to be used with the wire management cutout, specify the unfinished back. The cutout is not available with finished back in order to keep a clean aesthetic.

Wire management cutouts are standard in the back of the 3/4" compartment dividers to route wires from one compartment to the next.

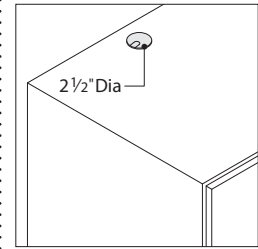
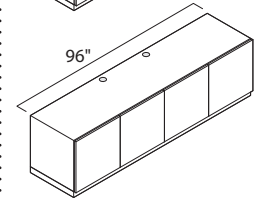
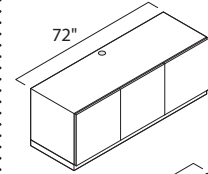
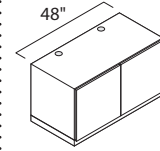

An optional grommet is available for all credenzas. The grommet is 2¹/₂" in diameter and is available in multiple locations with or without an accent top. Grommets are available in black matte or platinum matte paint.

Exponents Credenzas

Surface Materials

Case sides, top, and interior shelves

- Wood veneer

Door fronts

- Wood veneer

Accent ribbon

- Black matte paint
- Platinum matte paint

Back panel

- Black backer (standard)
- Wood veneer (option)

Base

- Plinth
 - Wood veneer
 - 3" metal
 - Black matte paint
 - Platinum matte paint

Optional accent top

- Glass - flare coated only

Optional grommets

- Black matte paint
- Platinum matte paint

Shelves (adjustable or optional pull-out)

- Wood veneer

Optional lock(s)

- 9201 Polished Chrome
- 9250 Ember Chrome

Wood is a natural material; slight variations occur in veneer texture, color, grain configuration, and stain acceptance. Coalesse stains are all applied with an exacting regard for consistency and are well within traditional tolerances for wood products. Due to natural variations in wood, finished products may vary from samples in color, texture and grain.

Tip: You should know that finishes may vary slightly in tone or character from each other or from the samples Coalesse produces. No guarantee can be made for an exact match.

Coalesse strives to produce a consistently high quality product and some natural variation in color is to be expected. This variation is especially apparent on natural woods which have no stain applied, for example 3525 Natural Maple. This color variation is normal and reflects the unique and natural properties of wood. This should not be considered a defect.

Stain swatches are reproduced in the Surface Materials Color Palettes.

► See *Coalesse Surface Materials Reference Guide* for a list.

Swatch cards and actual samples of standard wood veneers are available from your Customer Service representative.

Stain-to-Match is available on this product and allows the matching of any wood finish with a one-time charge per finish.

► See *Coalesse Surface Materials Reference Guide* for details.

Care & Maintenance

Veneers should be cleaned regularly with mild soap and water and dried with a soft cloth. To polish veneers, use silicone-free household polishers. Use sparingly.

Tip: Never use ammonia-based cleaners or wax on wood surfaces.

Painted finishes should be cleaned with a liquid detergent and water. Remove stubborn stains with liquid cleaner, such as Windex.

All products should be inspected and maintained regularly by inspecting glides for damage and inspecting all moving parts, i.e., suspensions, for damage and wear.

Exponents Credenzas 27"H

DESIGN COALESSE DESIGN GROUP

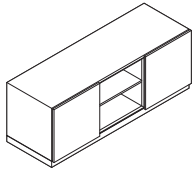

► Need help?
Product details,
page 726

Standard Includes

- Case: wood veneer
- Door fronts with 110° soft close hinges, if selected: wood veneer
- Accent ribbon: paint
- Plinth base: matches case finish
- One adjustable shelf per opening, behind doors: matches case
- One adjustable shelf per opening, without doors, if partial open credenza selected: wood veneer
- Ships assembled

Required to Specify

- 1 Style number
 - 2 Wood color number for case
 - 3 Wood color number for door fronts, if selected
 - 4 Wood color number for adjustable shelf without doors, if selected
 - 5 Paint color number for accent ribbon
4135 Black Matte
4141 Platinum Matte
 - 6 Options, if selected (see below)
- See *Coalesse Surface Materials Reference Guide*.

Tip: When finished back panel is specified, the finish will match the case finish.

Tip: The adjustable and pull-out shelf finishes behind doors are not specifiable. When selected, finish will match case.

Tip: Finish is only specifiable on adjustable shelves located in open section on partial open credenzas.

Tip: Pull-out shelf is available for the middle open section(s) only. For a 72"W credenza, the pull-out shelf is available in the middle open section only. For a 96"W credenza, the pull-out shelf is available in the middle two open sections only.

Tip: The pull-out shelf does not replace the adjustable shelf.

Options	U.S. Price	Required to Specify
Surface Materials	Case and door fronts	
	• Grade 2 wood veneer	Prices at right Specify with <i>grade 2 wood veneer</i> and select color number.
	Finished back panel for veneer credenza	
	• 48"W credenza	+\$ 355 Specify with <i>finished back panel</i> .
	• 72"W credenza	+\$ 445 Specify with <i>finished back panel</i> .
	• 96"W credenza	+\$ 516 Specify with <i>finished back panel</i> .
	Adjustable shelf in open section on partial open credenzas	
	• One adjustable shelf	
	– With grade 2 wood veneer	+\$ 10 Specify <i>grade 2 wood veneer</i> and select color number.
	• Two adjustable shelves	
	– With grade 2 wood veneer	+\$ 20 Specify <i>grade 2 wood veneer</i> and select color number.
Metal Legs	• Black matte or platinum matte	
	– 48"W credenza	+\$ 419 Specify with <i>metal legs</i> and select paint color number.
	– 72"W credenza	+\$ 509 Specify with <i>metal legs</i> and select paint color number.
	– 96"W credenza	+\$ 604 Specify with <i>metal legs</i> and select paint color number.
Pull-out Shelf for 72"W and 96"W Credenzas only	72"W (center/middle location only)	
	• With grade 1 wood veneer	+\$1265 Specify with <i>one pull-out shelf</i> .
	• With grade 2 wood veneer	+\$1307 Specify with <i>one pull-out shelf</i> .
	96"W (two center/middle locations only)	
	Left center location only	
	• With grade 1 wood veneer	+\$1265 Specify with <i>one pull-out shelf, left center location</i> .
	• With grade 2 wood veneer	+\$1307 Specify with <i>one pull-out shelf, left center location</i> .
	Right center location only	
	• With grade 1 wood veneer	+\$1265 Specify with <i>one pull-out shelf, right center location</i> .
	• With grade 2 wood veneer	+\$1307 Specify with <i>one pull-out shelf, right center location</i> .
	Left and right center locations	
	• With grade 1 wood veneer	+\$2522 Specify with <i>two pull-out shelves, left center and right center location</i> .
	• With grade 2 wood veneer	+\$2622 Specify with <i>two pull-out shelves, left center and right center location</i> .

► Options, continued on next page



For Canadian Pricing
Multiply U.S. Price by the Canadian price factor.
► See page 1 for details.

Exponents Credenzas 27"H

DESIGN COALESSE DESIGN GROUP

► Options, continued from previous page

Options		U.S. Price		Required to Specify	
Accent Top	Glass				
	• 48"W credenza	+\$	2217	Specify with <i>glass accent top</i> and select color number.	
	• 72"W credenza	+\$	2790	Specify with <i>glass accent top</i> and select color number.	
	• 96"W credenza	+\$	3659	Specify with <i>glass accent top</i> and select color number.	
Grommets: black matte or platinum matte		No Accent Top	Glass Accent Top		
	48"W credenza				
	• Grommet, left	+\$	84	+\$171	Specify with <i>grommet left</i> and select color number.
	• Grommet, right	+\$	84	+\$171	Specify with <i>grommet right</i> and select color number.
	72"W credenza				
	• Grommet, center	+\$	84	+\$171	Specify with <i>grommet center</i> and select color number.
	96"W credenza				
	• Grommet, left center or right center	+\$	84	+\$171	Specify with <i>grommet left center</i> and select color number.
	Lock and Keying	Lock			
	• 2 doors	+\$	342		Specify with <i>9201 Polished Chrome locks</i> or with <i>9250 Ember Chrome locks</i> .
• 3 doors	+\$	513		Specify with <i>9201 Polished Chrome locks</i> or with <i>9250 Ember Chrome locks</i> .	
• 4 doors	+\$	684		Specify with <i>9201 Polished Chrome locks</i> or with <i>9250 Ember Chrome locks</i> .	
	Keying				
	• Factory- and field-installed keying units			► Page 754	
Related Products	• Benches			► Page 718	
	• Lectern			► Page 742	
	• Mobile display boards			► Page 750	

Tip: Grommets can be specified on credenzas with and without accent tops.

► Specification Information, on next page

For Canadian Pricing
 Multiply U.S. Price by the
 Canadian price factor.
 ► See page 1 for details.

Exponents Credenzas 27"H *continued*

DESIGN COALESSE DESIGN GROUP

► Options, on previous page

Specification Information

Dimensions			Style Number	Case	U.S. Base Prices	
D	W	H			Door Fronts Grade 1 Veneer	Grade 2 Veneer

Partial Open Credenzas

72"W

24 ³ / ₄ "	72"	27"	COCZD0257227	Grade 1 Veneer	\$ 9171	\$ 9243
				Grade 2 Veneer	\$ 9425	\$ 9497

96"W

24 ³ / ₄ "	96"	27"	COCZD0259627	Grade 1 Veneer	\$ 10,361	\$ 10,433
				Grade 2 Veneer	\$ 10,650	\$ 10,722

Credenzas with Doors

48"W

24 ³ / ₄ "	48"	27"	COCZD254827	Grade 1 Veneer	\$ 8163	\$ 8235
				Grade 2 Veneer	\$ 8386	\$ 8458

72"W

24 ³ / ₄ "	72"	27"	COCZD257227	Grade 1 Veneer	\$ 9951	\$ 10,044
				Grade 2 Veneer	\$ 10,215	\$ 10,308

96"W

24 ³ / ₄ "	96"	27"	COCZD259627	Grade 1 Veneer	\$ 11,740	\$ 11,858
				Grade 2 Veneer	\$ 12,036	\$ 12,154

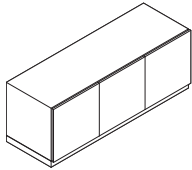
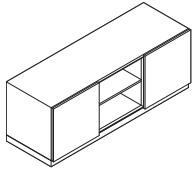

For Canadian Pricing
 Multiply U.S. Price by the
 Canadian price factor.
 ► See page 1 for details.

Coalesse

Exponents Credenzas 27"H

DESIGN COALESSE DESIGN GROUP

Exponents Credenzas 39"H

DESIGN COALESSE DESIGN GROUP

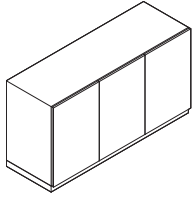

► Need help?
Product details,
page 726

Standard Includes

- Case: wood veneer
- Door fronts with 110° soft close hinges, if selected: wood veneer
- Accent ribbon: paint
- Plinth base: matches case finish
- Two adjustable shelves per opening, behind doors: matches case
- Ships assembled

Required to Specify

- 1 Style number
 - 2 Wood color number for case
 - 3 Wood color number for door fronts, if selected
 - 4 Paint color number for accent ribbon:
4135 Black Matte
4141 Platinum Matte
 - 5 Options, if selected (see below)
- See *Coalesse Surface Materials Reference Guide*.

Tip: The adjustable and pull-out shelf finishes are not specifiable. When selected, finish will match case.

Tip: When finished back panel is specified, the finish will match the case finish.

Tip: Metal legs and glass tops require assembly.

Tip: Grommets can be specified on credenzas with and without accent tops.

	Options	U.S. Price	Required to Specify	
Surface Materials	Case and door fronts			
	• Grade 2 wood veneer	Prices at right	Specify with <i>Grade 2 wood veneer</i> and select color number.	
	Finished back panel for veneer credenza			
	• 48"W credenza	+\$ 445	Specify with <i>finished back panel</i> .	
	• 72"W credenza	+\$ 516	Specify with <i>finished back panel</i> .	
	• 96"W credenza	+\$ 614	Specify with <i>finished back panel</i> .	
Metal Legs	• Black matte or platinum matte			
	- 48"W credenza	+\$ 419	Specify with <i>metal legs</i> and select paint color number.	
	- 72"W credenza	+\$ 509	Specify with <i>metal legs</i> and select paint color number.	
	- 96"W credenza	+\$ 604	Specify with <i>metal legs</i> and select paint color number.	
Accent Top	Glass			
	• 48"W credenza	+\$2217	Specify with <i>glass accent top</i> and select color number.	
	• 72"W credenza	+\$2790	Specify with <i>glass accent top</i> and select color number.	
	• 96"W credenza	+\$3659	Specify with <i>glass accent top</i> and select color number.	
Grommets: black matte or platinum matte		No Accent Top	Glass Accent Top	
	48"W credenza			
	• Grommet, left	+\$ 84	+\$171	Specify with <i>grommet left</i> and select color number.
	• Grommet, right	+\$ 84	+\$171	Specify with <i>grommet right</i> and select color number.
	72"W credenza			
	• Grommet, center	+\$ 84	+\$171	Specify with <i>grommet center</i> and select color number.
96"W credenza				
	• Grommet, left center or right center	+\$ 84	+\$171	Specify with <i>grommet left center</i> and select color number.

► Options, continued on next page



For Canadian Pricing
Multiply U.S. Price by the Canadian price factor.
► See page 1 for details.

Exponents Credenzas 39"H

DESIGN COALESSE DESIGN GROUP

► Options, continued from previous page

	Options	U.S. Price	Required to Specify
Lock and Keying	Lock		
	• 2 doors	+\$342	Specify with 9201 Polished Chrome locks or with 9250 Ember Chrome locks.
	• 3 doors	+\$513	Specify with 9201 Polished Chrome locks or with 9250 Ember Chrome locks.
	• 4 doors	+\$684	Specify with 9201 Polished Chrome locks or with 9250 Ember Chrome locks.
	Keying		
	• Factory- and field-installed keying units		► Page 754
Lock and Keying	• Benches		► Page 718
	• Lectern		► Page 742
	• Mobile display boards		► Page 750

Specification Information

Dimensions			Style	Case	U.S. Base Prices	
D	W	H	Number		Door Fronts	
					Grade 1	Grade 2
					Veneer	Veneer

Credenzas with Doors

48"W

24 ³ / ₄ "	48"	39"	COCZUD254839	Grade 1 Veneer	\$ 9180	\$ 9257
				Grade 2 Veneer	\$ 9415	\$ 9492

72"W

24 ³ / ₄ "	72"	39"	COCZUD257239	Grade 1 Veneer	\$11,290	\$11,394
				Grade 2 Veneer	\$11,565	\$11,669

96"W

24 ³ / ₄ "	96"	39"	COCZUD259639	Grade 1 Veneer	\$13,402	\$13,535
				Grade 2 Veneer	\$13,711	\$13,844

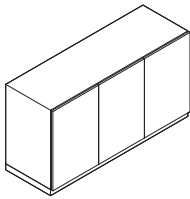

For Canadian Pricing
 Multiply U.S. Price by the
 Canadian price factor.
 ► See page 1 for details.

Accessories

* These product lines are collections and will be found in multiple locations in this specification guide and/or *Coalesse Seating Specification Guide*.

► See *Collections*, page 5

Statement of Line **738**

Utilities

PowerPod **739**

Power Strip **739**

Whiteboards and Podiums

Exponents Lectern* **740**

Exponents Mobile Display Boards* **744**

Statement of Line

Accessories

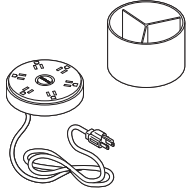

Understanding
▶ Page 578
Specifying
▶ Page 739

PowerPod

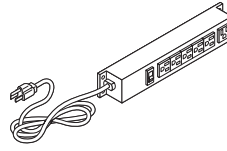

Understanding
▶ Page 617
Specifying
▶ Page 739

Power Strip

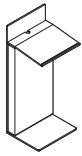

Understanding
▶ Page 740
Specifying
▶ Page 742

Exponents Lectern

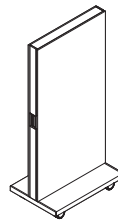

Understanding
▶ Page 744
Specifying
▶ Page 750

Exponents Mobile Whiteboard Display

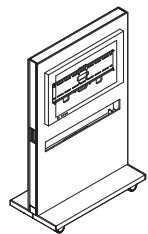

Understanding
▶ Page 744
Specifying
▶ Page 751

Exponents Mobile Mediaboard Display



Understanding
▶ Page 744
Specifying
▶ Page 751

Exponents Mediaboard Shelf

Utilities

DESIGN SCOTT WILSON & MINIMAL

PowerPod

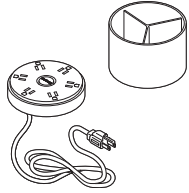

Tip: PowerPod must be plugged directly into the building power supply.

	Standard Includes	Required to Specify
▶ Need help? Product details, page 578	<ul style="list-style-type: none"> • PowerPod with 6' cord and three prong plug: brushed aluminum bottom cradle and milk face • Accessory tray: milk • Six 15-amp power outlets • Illuminated on/off button • Surge suppressor 	Style number

Specification Information			
Dimensions	Style	U.S.	
Diameter	H	Number	Price
6 ³ / ₄ "	6"	COPP01	\$257

Accessories

Power Strip

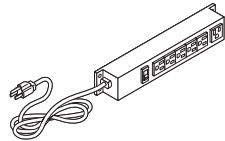

	Standard Includes	Required to Specify
▶ Need help? Product details, page 617	<ul style="list-style-type: none"> • Power strip with 15' cord and three-prong plug: black • Six power outlets • On-off switch • Surge suppressor 	Style number

Specification Information				
Dimensions	Style	U.S.		
L	D	W	Number	Price
16"	3/4"	2 1/4"	793330	\$395

 **For Canadian Pricing**
 Multiply U.S. Price by the Canadian price factor.
 ▶ See page 1 for details.

Exponents Lectern

The Exponents collection offers holistic solutions for collaboration in conference rooms, enclaves, and open space settings. It is a flexible platform for addressing functional and aesthetic requirements in a single, comprehensive offering. The lectern provides a place for formal presentations.

Tip: This product line is a collection and will be found in more than one location in this specification guide.

► See Collections, page 5

Back panel is removable for easy wire management access. The back panel can be specified in a different material than the rest of the lectern.

Accent detail is on the sides of the lectern in a coordinating veneer or laminate.

Lectern comes standard with four nylon glides.

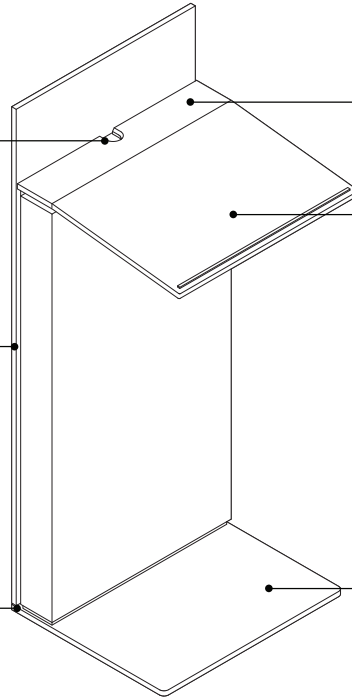

Top flip lid allows for access to power, voice, and data and/or storage of power and data cords.

The lectern top shelf is angled for presentations as well as laptop usage. It is standard with an aluminum pencil/paper stop, which matches the finish of the base. The lectern top shelf has a maximum recommended load of 45 pounds.

Metal base is painted in either black matte or platinum matte.

Exponents Lectern

Product Details

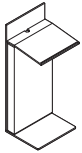

The lectern is available in one dimensional configuration: 18³/₄"D x 23¹/₂"W x 48"H.

The lectern is standard in wood veneer.

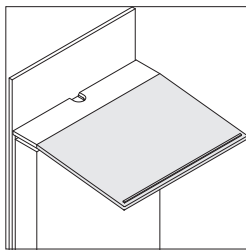

Lectern top shelf is 14¹/₄"D x 23¹/₂"W x 1/2" thick and 42¹/₈" high. The angle of the shelf is 8¹/₂". It has an integrated aluminum pencil/paper stop for holding documents, which is painted to match the finish of the base, platinum matte or black matte.

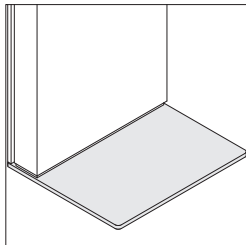

Metal base is 17"D x 23¹/₂"W x 3/8" thick and is painted, platinum matte or black matte. Four nylon glides are standard for easy movement when required. The glides are 1/4" thick and 3" in diameter.

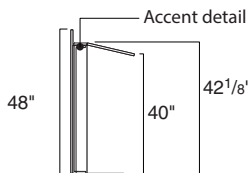

Accent detail runs along the sides of the lectern. Available in a coordinating veneer or laminate. The accent detail is 1/2"W.

Wiring and Cabling

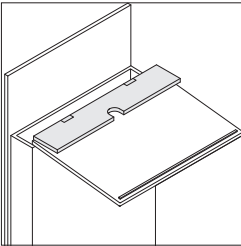

The top flip lid has a cutout for easy opening and cable routing. The lid opens towards the top shelf and comes standard with two 160° hinges to access power, voice and data or storing cords and cables.

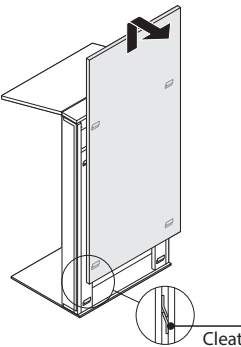

The back panel is removable by lifting up and out. The panel has four small aluminum cleats for easy removal and installation when access to wire management is required. The back panel can be specified in a different finish than the case. *Tip: The back panel must be removed to install the PVD device.*

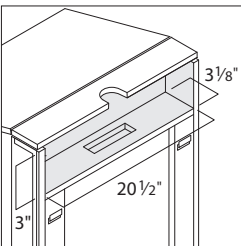

The section where the PVD is installed is 3¹/₈"D x 20¹/₂"W x 3"H which can store access wires, such as laptop power blocks, VGA cords, etc.

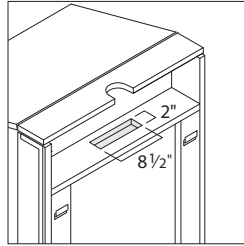

The cutout is standard on all lecterns and is 2"D x 8¹/₂"W.



Data Architectural Adapter Plate has two CAT 6 RJ45 barrel (pass-through) outlets.

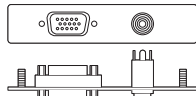

Video/Audio Architectural Adapter Plate has one VGA outlet (HD15 female to female gender changer) and one audio outlet (3¹/₂ mm stereo mini jack to solder tabs).

The optional PVD is standard with two water-proof simplex outlets, two data (Extron AAP) and one VGA with audio (Extron AAP). It is standard with a six foot cord. The PVD is aluminum and is available in black gloss paint only. The PVD is UL listed. For information on other style AAPs and to find an Extron Electronics dealer, call Extron at 800.633.9876 or online at www.extron.com.

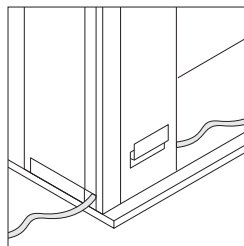

The cords can exit or enter from either side of the lectern at the bottom. The hole is 3/8"W x 1/2"H.

Surface Materials

Case sides, front, and top shelves

- Wood veneer

Accent ribbon

- Black laminate
- Satin stainless laminate
- Wood veneer

Base

- Black matte paint
- Platinum matte paint

Back panel

- Wood veneer

Pencil stop (matches base)

- Black matte paint
- Platinum matte paint

Optional PVD

- Black gloss only

Wood is a natural material, slight variations occur in veneer texture, color, grain configuration and stain acceptance. Coalesse stains are all applied with an exacting regard for consistency and are well within traditional tolerances for wood products. Due to natural variations in wood, finished products may vary from samples in color, texture and grain.

Tip: You should know that finishes may vary slightly in tone or character from each other or from the samples Coalesse produces. No guarantee can be made for exact match.

Coalesse strives to produce a consistently high quality product and some natural variation in color is to be expected. The variation is especially apparent on natural woods which have no stain applied, for example 3525 Natural Maple. This color variation is normal and reflects the unique and natural properties of wood. This should not be considered a defect.

Stain swatches are reproduced in the Surface Materials Color Palettes.

▶ See *Coalesse Surface Materials Reference Guide* for a list.

Swatch cards and actual samples of standard wood veneers are available from your Customer Service representative.

Stain-to-Match is available on this product and allows the matching of any wood finish with a one-time charge per finish.

▶ See *Coalesse Surface Materials Reference Guide* for details.

Care & Maintenance

Veneers should be cleaned regularly with mild soap and water and dried with a soft cloth. To polish veneers, use silicone-free household polishers. Use sparingly.

Tip: Never use ammonia-based cleaners or wax on wood surfaces.

Painted finishes should be cleaned with a liquid detergent and water. Remove stubborn stains with liquid cleaner, such as Windex.

All products should be inspected and maintained regularly by inspecting casters and glides for damage and inspecting all moving parts, i.e., suspensions, for damage and wear.

Exponents Lectern

DESIGN COALESSE DESIGN GROUP

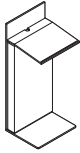

	Standard Includes	Required to Specify
<p>► Need help? Product details, page 740</p>	<ul style="list-style-type: none"> • Case: wood veneer • Removable back panel for easy access to wire management: wood veneer • Metal base: paint • Accent ribbon: paint • Integrated 160° hinged cover for power and data or storage • Wire management entry and exit points at bottom • Glides: nylon non-marring • Ships assembled 	<ol style="list-style-type: none"> 1 Style number 2 Wood color number for case 3 Wood color number for back panel 4 Paint color number for base: 4135 Black Matte 4141 Platinum Matte 5 Paint color number for accent ribbon: 4135 Black Matte 4141 Platinum Matte 6 Options, if selected (see below) <p>► See <i>Coalesse Surface Materials Reference Guide</i>.</p>

Tip: When specifying a wood veneer finish on the case and the ribbon, it is recommended the ribbon finish matches the case selection.

	Options	U.S. Price	Required to Specify
Surface Materials	Case and back panel <ul style="list-style-type: none"> • Grade 2 wood veneer 	Prices below	Specify with <i>grade 2 wood veneer</i> and select color number.
	Accent ribbon <ul style="list-style-type: none"> • Grade 2 wood veneer 	+\$ 93	Specify with <i>grade 2 wood veneer</i> and select color number.
Power and Data	<ul style="list-style-type: none"> • 2 power receptacles, 2 data, and 1 VGA with audio: black gloss only 	+\$608	Specify with <i>PVD</i> .
Related Products	<ul style="list-style-type: none"> • Benches and bench bridges • Credenzas • Lectern • Mobile display boards 		<ul style="list-style-type: none"> ► Pages 718 and 725 ► Pages 730–734 ► Page 742 ► Page 750

Specification Information						
Dimensions			Style Number	Case	U.S. Base Prices	
D	W	H			Grade 1 Veneer	Grade 2 Veneer
18¾"	23½"	48"	COCL42	Grade 1 Veneer	\$5678	\$5855
				Grade 2 Veneer	\$5729	\$5906

Tip: The height of the lectern includes the back panel. The top shelf measures 42½" high.



For Canadian Pricing
 Multiply U.S. Price by the Canadian price factor.
 ► See page 1 for details.

Coalesse

Exponents Lectern

DESIGN COALESSE DESIGN GROUP

Exponents Mobile Display Boards

The Exponents mobile display design allows seamless adaptability to any setting without compromising the integrity of the space. The mobile display boards, functionally and aesthetically, go beyond almost all industrial mobile displays.

Tip: This product line is a collection and will be found in more than one location in this specification guide.

► See Collections, page 5

Back panel is a removable markerboard surface that is standard in e³ CeramicSteel with milk gloss painted aluminum extrusion.

Outer frame trim, located on both sides, is standard in painted MDF and optional in wood veneer to complement any environment.

Handle, located on each side for easy movement, doubles as storage for dry erase markers and eraser. The handles are painted to match the base and inner frame.

Inner frame is painted to match the handle and base.

Grommet for plug is standard on one side in black plastic. It is standard on the mediaboard mobile display unit. It allows the cord to exit the display which powers the entire display.

Bumper on each end is plastic that complements the base paint.

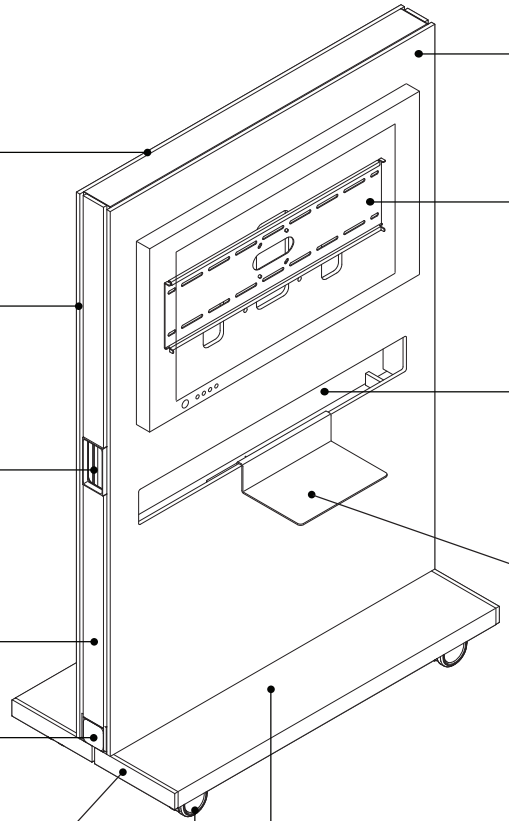

Front panel is a fixed markerboard surface that is standard in e³ CeramicSteel with milk gloss painted aluminum extrusion.

Monitor mount is standard on the mediaboard mobile display unit.

Well opening on mediaboard houses the power and display module.

A shelf can be ordered as an option for items like laptops or miscellaneous items that are used with the mediaboard mobile display unit.

Base is steel and is painted to match the handle and inner frame.

Two 4" swivel locking casters and two 4" fixed casters are standard. White casters default to the milk paint specification and black casters default to the black paint specification.

Exponents Mobile Display Boards

Product Details

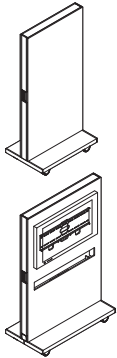

The mobile display products are available in two types, mobile whiteboard display and mobile mediaboard display with whiteboard.

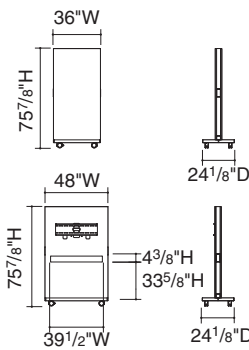

The mobile whiteboard display is offered in two widths, 36\"/>

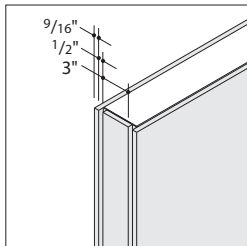

The front and back panel display thickness is 9/16\"/>

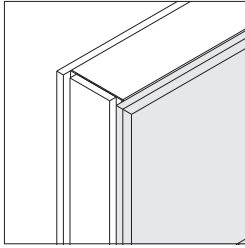

The front panel and back panel are standard in e³ CeramicSteel with a milk gloss painted aluminum extrusion. The e³ CeramicSteel is magnetic.

The e³ environmental CeramicSteel Difference Steelcase Premium White Boards incorporate the e³ environmental CeramicSteel surface, which is the first and only ecologically intelligent whiteboard surface to receive a MBDC Cradle to Cradle Gold certification. Cradle to Cradle certification evaluates products for environmentally safe and healthy materials; energy and water use during production, the ability to recycle and reuse materials, and social responsibility. Steelcase has created its fourth generation of CeramicSteel writing surfaces, e³, which delivers the properties of its best selling writing surface, P³ CeramicSteel, and complies with the Cradle to Cradle certification criteria. Steelcase will continue to follow standards set forth by MBDC Cradle to Cradle certification to reaffirm our commitment to sustainability. For over five decades, millions of boards have been produced around the world using P³ CeramicSteel. Steelcase used this cross section of consumers to gather the information that helped determine what the next generation of writing surfaces should provide. Our internationally renowned R&D team worked with experts in the field of ceramics and technology to create e³ environmental CeramicSteel surface – the new industry standard for superior quality.

The e³ environmental CeramicSteel Advantage

The ceramic finish consists of a specially formulated glass substance applied by machine. The e³ environmental CeramicSteel surface is fused to steel at a temperature of approximately 1500 degrees Fahrenheit for markerboards. It registers at a minimum of five (5) on the revised Mohs hardness scale.

Benefits of e³

- Ultra-smooth writing surface
- Improved erasability
- Greater color contrast
- Significantly less surface/ light distortion
- Optimum eye comfort
- Enhanced visibility
- Reduced chalk pressure, greater adherence
- Increased chalk/surface contrast
- Accepts magnets

Environmental Features

- Enamel fused to cold-rolled enameling-grade steel
- In all coatings, the total amount of heavy metals cadmium, mercury, hexavalent chromium, and lead is less than 0.1%
- All coatings are free of arsenic and antimony
- No Volatile Organic Compounds (VOCs)
- Steel core is made from minimum 30% post-consumer and post-industrial waste
- e³ environmental ceramic-steel surface is 99% recyclable

e³ environmental CeramicSteel

is produced by a controlled, continuous coil-coating process. The surface consists of a steel core of .013\"/>

Characteristic	e ³ environmental CeramicSteel Markerboard
Writeability	Can be written on with any dry-erase, semi-permanent, water-soluble, permanent marker, pen, or crayon without damaging the surface.
Visibility	Contrast/waviness for markerboards (light and dark effects) shall be no greater than 15 when tested with BYK - Gardner Wave Scan 5+ measurement device showing visual acuity (contrast sensitivity) to the human eye at distances greater than 3 meters (10' - 0"). Resolution (visual acuity) shall be based on 3 lines per degree and be visibly maintained beyond the current standard of 3 meters.
Erasability	Dry-erase marker ink can be wiped off easily with a dry cloth or standard eraser. Crayon, semi-permanent, and permanent marker pen inks can be removed with a solvent based cleaner.
Cleanability (Washability)	All residues that remain after normal erasing can be removed by following the care and cleaning instructions on page 749.
Wearability	Vitrified glass-hard ceramic surface fused to light-gauge enameling grade steel at approximately +1500°F. High resistance to impact damage, abrasion, scratching, and color fading. The e ³ environmental CeramicSteel surface registers a 6.5 on the revised Mohs hardness scale.
Magnet Capability	The e ³ environmental CeramicSteel surfaces are ideal for all magnets and magnetic impregnated materials and will not be scratched or damaged from the contact.
Flame Resistance	The e ³ surface is 100% non-combustible.

Exponents Mobile Display Boards *continued*

Material Description

e³ environmental CeramicSteel Low-Gloss Markerboard

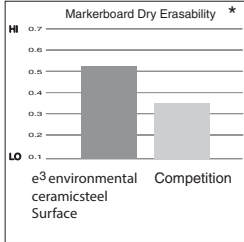

*All markerboard erasability tests were conducted using High-Gloss e³ environmental CeramicSteel surfaces.

The ultra-smooth finish enables dry markers to glide easily across the e³ environmental CeramicSteel surface with minimal friction. The surface smoothness allows more dry-erase ink to be removed, improving erasability and eliminating "ghost writing".

Writeability
Provides the same writing characteristics as high-gloss.

Erasability
Low-gloss surfaces will not erase as thoroughly as high-gloss surfaces. When this occurs, a water-dampened cloth will be required to erase the surface.

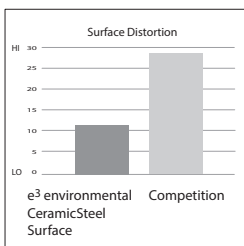

Surface distortion (orange peel) has been reduced significantly in direct comparison with the competition's surface.

Cleanability
After normal erasing of low-gloss surfaces, solvents may be used to remove harder-to-erase dry marker inks and residue from other pens. Always clear water rinse after using any cleaning agent on the surface.

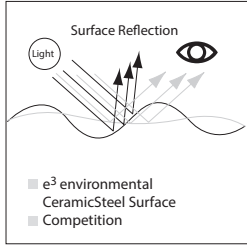

The e³ environmental CeramicSteel surface maximizes the performance of reflected light and reduces surface glare, resulting in improved visibility under a wide range of lighting conditions.

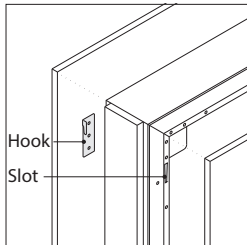

The back panel is removable to access the wiring and cabling of the mediaboard display for initial setup. There are slots in the inner frame, which is available in two powder coat paint finishes to match the base and handle, that engage with the hooks from the back panel. Lift to disengage the hooks from the slots in the frame. Two people are recommended to remove and install the back panel.

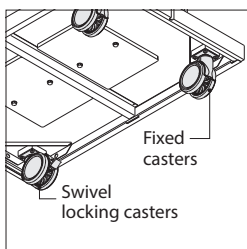

Two 4" swivel locking casters and two 4" fixed casters allow the mobile displays to move easily. White casters default to the milk paint specification and black casters default to the black paint specification.

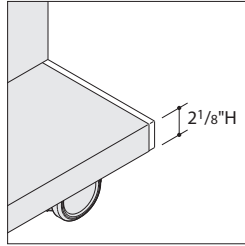

The 2 1/8" H base is metal with plastic bumpers on each end. It is available in two powder coat paint finishes and matches the handle and inner frame paint finish.

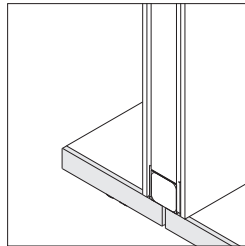

The bumper on each end is plastic that complements the base powder coat paint.

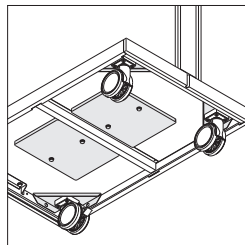

The base is reinforced at the corners and includes counterweights.

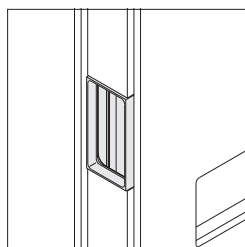

The handles are located on each side for easy movement. The handles double as storage for dry erase markers and eraser. The handles are available in two powder coat paint finishes to match the base and inner frame. The opening of the handle is 5 3/4" H x 2 3/4" W. The interior dimension is 1 1/2" D x 10" H x 3 1/2" W.

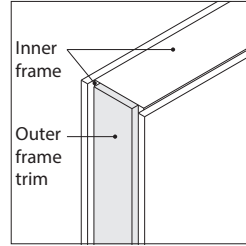

Outer frame trim, located on both sides, is standard in painted MDF and optional in wood veneer to complement any environment.

Inner frame is available in two powder coat paint finishes to match the base and handle.

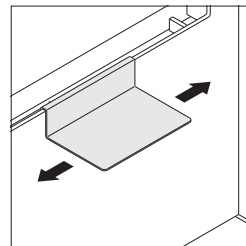

A shelf can be ordered for items like laptops or miscellaneous items that are used with the mediaboard unit. It is available in two powder coat paint finishes. The storage space on the shelf is 9 13/16" D x 15" W. The shelf thickness is 3/16" and can be placed anywhere along the opening of the well. Rubber bumpers are placed on the lip of the shelf to keep it in place and prevent damage to the panel and edge band.

Specials are possible. To confirm practicality and obtain a quotation, contact Customer Service at 1.800.627.6770.

Power, Data, Wiring, and Cabling

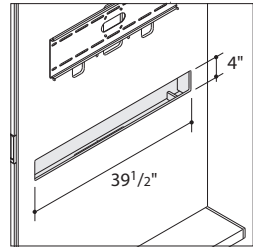

Mediaboard well cutout at the front is 4" H x 39 1/2" W. The inside dimensions of the well are 4" D x 8 1/2" H x 41 1/4" W.

Mediaboard well houses the power and display module and is centered in the bottom.

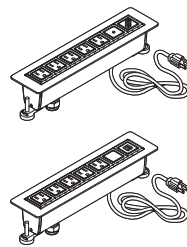

Mobile mediaboard display is standard with a power and display module that is offered in two choices; five white waterproof simplex power outlets, one VGA jack, and one audio jack with monitor connector cables or five white waterproof simplex power outlets, one HDMI jack, and one blank cover with monitor connector cable. The faceplate is in black gloss paint. The power and display module is centered in the bottom of the well.

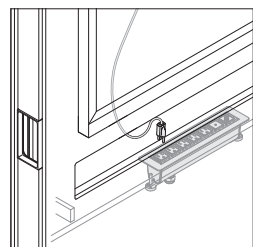

The monitor for the mobile mediaboard display will be routed to plug into the power module in the well. The remaining simplex outlets are used to power up to four mobile devices, including laptops and iPads.

Exponents Mobile Display Boards

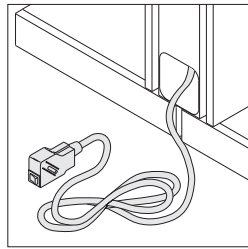

The corded plug on the power and display module is a 15-amp plug with a circuit breaker on the end. The cord has approximately nine feet of extension from the grommet exit point.

The grommet for the plug to exit in order to power up the mediaboard unit is standard on one side and is available in black plastic.

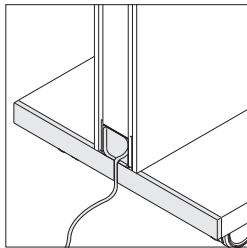

The grommet and the base plastic bumper has a groove to tuck the cord when the outlet is in the floor underneath the unit or when multiple units are placed next to each other in creating space division.

Tip: The mobile display units do not have a leveling mechanism, coupled with the floors not being even, in most cases it does not allow for a tight fit when put in a row to create space division. Recommendation is to leave a purposeful gap between the units.

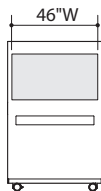
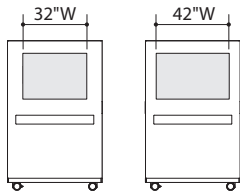

No larger than 46" monitors should be used on the mobile mediaboard displays. Monitors more than 55 pounds should also not be used.

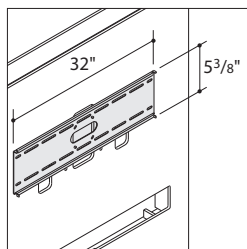

Monitor mount bracket is standard on the mobile mediaboard display unit. It is installed in the field.

Tip: Monitors must be purchased separately.

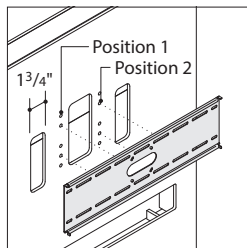

In order to install the monitor mount bracket, the back panel must be removed. Use the provided bolts and install to the desired mounting hole position on any mobile mediaboard unit. The front panel also has cutouts to route the wires from the monitor for a clean aesthetic.

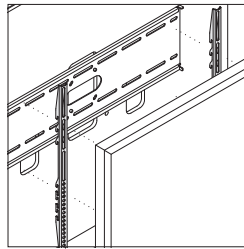

Monitor brackets that are assembled to the monitor have three height settings with 3" of adjustment range at 1 1/2" increments.

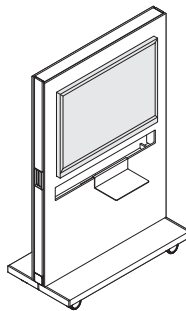

While media:scape can host many types of displays, media:scape has been optimized to support commercial grade LED backlit monitors. For other display feature requirements, please refer to the media:scape section in the *Steelcase Meeting Spaces Specification Guide*.

When using a 40" or 42" monitor that is not recommended by Steelcase, utilize the included hardware kit for mounting which provides all necessary cables and hardware to be used. Monitors should be multi-sync, with a horizontal frequency range of 31-80 kHz, a vertical frequency of 55-80 kHz, and detachable C13/C14 cords.

Questions? Please contact us at 888-783-3522 or send us an email at LineOne@steelcase.com.

Surface Materials

Inner frame, handle, and base (same finish):

- Black matte paint
- Milk gloss paint

Outer frame trim:

- Painted MDF
- Wood veneer

Front and back panel:

- e³ CeramicSteel (magnetic) with milk gloss painted aluminum extrusion

Shelf (mediaboards only):

- Black matte paint
- Milk gloss paint

Casters (non-specifiable):

- White plastic (default when milk paint is specified)
- Black plastic (default when black paint is specified)

Base bumpers

(non-specifiable):

- Complementing plastic to base paint

Mediaboard grommet only

(non-specifiable):

- Black plastic

Power/display module on mediaboards only

(non-specifiable):

- Black gloss only with white waterproof receptacles (inside trough)

Wood is a natural material, slight variations occur in veneer texture, color, grain configuration and stain acceptance. Coalesse stains are all applied with an exacting regard for consistency and are well within traditional tolerances for wood products. Due to natural variations in wood, finished products may vary from samples in color, texture and grain.

Tip: You should know that finishes may vary slightly in tone or character from each other or from the samples Coalesse produces. No guarantee can be made for exact match.

Coalesse strives to produce a consistently high quality product and some natural variation in color is to be expected. The variation is especially apparent on natural woods which have no stain applied, for example 3525 Natural Maple. This color variation is normal and reflects the unique and natural properties of wood. This should not be considered a defect.

Stain swatches are reproduced in the Surface Materials Color Palettes.

► See *Coalesse Surface Materials Reference Guide* for a list.

Swatch cards and actual samples of standard wood veneers are available from your Customer Service representative.

Stain-to-Match is available on this product and allows the matching of any wood finish with a one-time charge per finish.

► See *Coalesse Surface Materials Reference Guide* for details.

The painted medium density fiberboard (MDF) is utilizing molding grade MDF, therefore, the 45 lb density is consistent throughout the entire thickness of the board. This allows for a smooth edge when painted. Three coats of water reducible finish is applied to the board in milk or black. The painted MDF has durability and care properties like a wood veneer, thus, must be treated as such.

All paints are powder coated. Refer to the individual product specifying pages for availability. Powder coat finishes are shown in the *Coalesse Surface Materials Reference Guide*.

Exponents Mobile Display Boards *continued*

Care & Maintenance

Veneers and painted MDF should be cleaned regularly with mild soap and water and dried with a soft cloth. To polish veneers, use silicone-free household polishers. Use sparingly.

Tip: Never use ammonia-based cleaners or wax on wood or painted MDF surfaces.

Painted finishes should be cleaned with a liquid detergent and water. Remove stubborn stains with liquid cleaner, such as Formula 409.

All products should be inspected and maintained regularly by inspecting casters and glides for damage and inspecting all moving parts, i.e., suspensions, for damage and wear.

Cleaning Wood Surfaces
Keep a supply of soft, clean, absorbent cloths handy for wiping up spills and regular dusting.

To dust, wipe with a slightly damp, soft cloth, using another soft cloth to dry. Always wipe the surface in the direction of the woodgrain. Use a quality cleaner or flax soap formulated especially for use on wood surfaces. Do not use oils or ammonia. Dilute the cleaner as directed by the manufacturer. Dampen but do not saturate a soft cloth with the diluted cleaning solution. Wipe the surface in the direction of the woodgrain to remove dirt and fingerprints. Wipe the surface clean with a soft, dry cloth.

Cleaning CeramicSteel Markerboard Surface

- Cleaning/daily care and maintenance applies to both a³ CeramicSteel and e³ CeramicSteel.
- Wipe board with a clean cloth moistened by a liquid markerboard cleaner or a solution of 50% water and 50% isopropyl alcohol.
- Rinse with clear water.
- Wipe dry with a clean cloth. If your board is used daily, the cleaning should be performed at least 2-3 times a week.

More thorough cleaning may be required if writing is left on the board for more than two days.

Markers

Use any high-quality dry erase marker.

CAUTION! The use of Low Odor markers may cause ghosting to occur. If Low Odor markers have been used, the surface can be completely cleaned by following the cleaning instructions above. Remember to discard eraser if used with Low Odor markers.

Removing Permanent Marker

Option 1:

- Write over the top of the permanent marker ink with a dry-erase marker
- Simply erase

Option 2:

- Moisten a clean, dry cloth with isopropyl alcohol
- Wipe the board in a circular motion to loosen marker residue
- Rinse with clear water
- Dry the board with a clean cloth
- Repeat these steps as necessary

Installer's Instructions for Initial Cleaning at Time of Installation

NOTE: These initial cleaning instructions are shipped with every board.

- For initial cleaning, wipe your board with a clean cloth moistened by a mild, alcohol-based cleaner.
- Rinse with clear water. This step is simple, but very important.
- Wipe dry with a clean cloth.

Mobile Display Board Application

Easily transport the media:scape experience anywhere the mobile mediaboard takes you.

- Optimized for small teams of two to four to collaborate without interruption.
- Plug into a standard three prong outlet to bring power to the monitor and the five power outlets inside the mediaboard well.

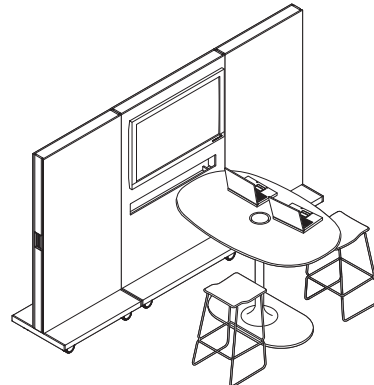

Open plan environment with space division

Exponents Mobile Display Boards



Learning environment with space division

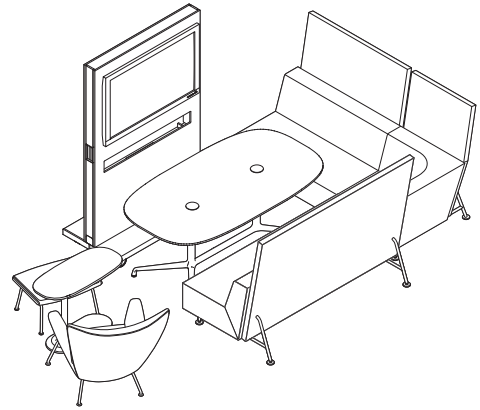

Social environment

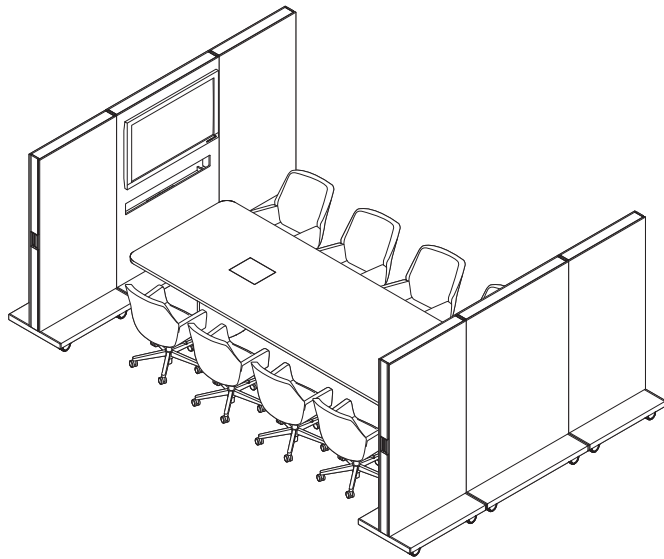

Conference/Collaboration environment

Exponents Mobile Whiteboard Display

DESIGN COALESSE DESIGN GROUP

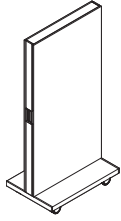

Tip: The e³ CeramicSteel markerboard surface is magnetic.

Tip: See CeramicSteel Care and Maintenance for additional information.

► Page 749

Standard Includes

- Need help? Product details, page 744
- One removable and one fixed whiteboard panel: 7655 e³ CeramicSteel markerboard surface with 4145 Milk Gloss painted aluminum trim
- Base, handle, and inner frame: paint
- Base bumper: plastic to complement paint on base
- Outer frame trim: painted MDF
- Two directional and two locking swivel 4" casters: 6009 Arctic; White plastic for 4145 Milk Gloss paint selection or 6000 Black plastic for 4137 Black Matte paint selection
- Ships assembled

Required to Specify

- 1 Style number
- 2 Paint color number for base, handle, and inner frame:
 - 4135 Black Matte
 - 4145 Milk Gloss
- 3 Painted MDF color number for trim panels:
 - V145 Milk
 - V197 Black
- 4 Options, if selected (see below)
 - See *Coalesse Surface Materials Reference Guide*.

Options

Surface Materials	Wood trim panels	U.S. Price	Required to Specify
	• Grade 1 wood veneer	+\$202	Specify with grade 1 wood veneer trim panels and select color number.
	• Grade 2 wood veneer	+\$214	Specify with grade 2 wood veneer trim panels and select color number.

Related Products	• Mobile mediaboard display	► Page 751
-------------------------	-----------------------------	------------

Related	• Benches and bench bridges • Credenzas • Lectern	► Pages 718 and 725 ► Pages 730–734 ► Page 742
----------------	---	--

Specification Information

Dimensions			Style Number	U.S. Base Price
D	W	H		
24 ¹ / ₈ "	36"	75 ⁷ / ₈ "	COCWBN	\$4897
24 ¹ / ₈ "	48"	75 ⁷ / ₈ "	COCBW	\$5944



For Canadian Pricing
Multiply U.S. Price by the Canadian price factor.
► See page 1 for details.

Exponents Mobile Mediaboard Display

DESIGN COALESSE DESIGN GROUP

Tip: The e³ CeramicSteel markerboard surface is magnetic.

Tip: See CeramicSteel Care and Maintenance for additional information.
▶ Page 749

Standard Includes	Required to Specify
<p>▶ Need help? Product details, page 744</p> <ul style="list-style-type: none"> One removable back panel and one front fixed whiteboard panel: 7655 e³ CeramicSteel markerboard surface with 4145 Milk Gloss painted aluminum trim Base, handle, and inner frame: paint Base bumper: plastic to complement paint on base Outer frame trim: painted MDF Mediaboard well for power and display module: black Power and display module: five white waterproof simplex power outlets, one VGA jack, and one audio jack with cable connection to monitor, faceplate is black gloss paint Monitor mount bracket kit: black paint Wire management grommet for plug: black plastic Two directional and two locking swivel 4" casters: 6009 Arctic White plastic for 4145 Milk Gloss paint selection or 6000 Black plastic for 4137 Black Matte paint selection Shelf: paint Ships assembled except for monitor mount 	<ol style="list-style-type: none"> Style number Paint color number for base, handle, and inner frame: <ul style="list-style-type: none"> 4135 Black Matte 4145 Milk Gloss Painted MDF color number for trim panels: <ul style="list-style-type: none"> V145 Milk V197 Black Paint color number for shelf, if selected: <ul style="list-style-type: none"> 4135 Black Matte 4145 Milk Gloss Options, if selected (see below) <ul style="list-style-type: none"> ▶ See <i>Coalesse Surface Materials Reference Guide</i>.

	Options	U.S. Price	Required to Specify
Surface Materials	<p>Wood trim panels</p> <ul style="list-style-type: none"> Grade 1 wood veneer Grade 2 wood veneer 	<p>+\$202</p> <p>+\$214</p>	<p>Specify with <i>grade 1 wood veneer trim panels</i> and select color number.</p> <p>Specify with <i>grade 2 wood veneer trim panels</i> and select color number.</p>
Power and Data	<ul style="list-style-type: none"> Five power outlets, one HDMI, and one blank 	No cost	Specify with <i>five power and HDMI</i> .
Related Products	<ul style="list-style-type: none"> Mobile whiteboard display Benches and bench bridges Credenzas Lectern 		<ul style="list-style-type: none"> ▶ Page 750 ▶ Pages 718 and 725 ▶ Pages 730-734 ▶ Page 742

Specification Information

Dimensions			Style	U.S.
D	W	H	Number	Base Price

Mobile Mediaboard Display				
24 ¹ / ₈ "	48"	75 ⁷ / ₈ "	COCMBW	\$7996

Shelf				
9 ¹³ / ₁₆ "	15"	4 ³ / ₁₆ "	COCMBSHLF	\$ 319

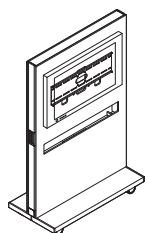

 **For Canadian Pricing**
Multiply U.S. Price by the Canadian price factor.
▶ See page 1 for details.

Resources

Lock and Keying—Exponents	754
Style Number Index	756

Lock and Keying Exponents

All Exponents locking products are standard with factory-installed, keyed-random locks. Consecutive, specific, and random keying are available as field-installed options. *Exceptions: Individual locking drawers are only available with field-installed locks. Overfiles are only available with factory-installed locks.*

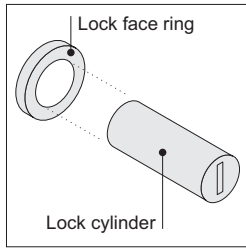

Locks consist of a factory- or field-installed lock cylinder and a factory-installed lock face ring.

Two types of locks are available for Exponents—the standard keying system (FR series) and the master keying system (XF series). All the locks in the XF series can be opened with a single master key.

Factory-Installed Keying

Factory-installed locks are always key random (standard) or master key random (option). Key random means that the locks will be assigned arbitrarily at the factory with key numbers ranging from FR305 to FR454 (Master keying numbers: XF1001 to XF1150). All locks within a unit will be keyed alike.

Tip: Random keying can mean that different furniture units will have the same key number. If you must have all locks keyed differently, you should specify field-installed, key specific or key consecutive lock cylinders.
▶ See example at right

Key Random

- FR305
- FR421
- FR305

or

- XF1011
 - XF1042
 - XF1011
- } XF Master Key

Required to Specify

Master key random	+\$36	Specify with master key random.
-------------------	-------	---------------------------------

Field-Installed Keying

Field-installed locks are only available on products that include factory-installed lock mechanisms.

Specify "plug" when specifying furniture, and the product will ship without the lock cylinder.

Tip: Lock tools are reusable. You do not need to order additional lock tools with every furniture order.

Lock cylinders will be shipped separately so that you can install the locks when you are ready.

Front-removable lock cylinders must be specified separately. You must also order a special lock tool to install or remove lock cylinders in the field.

Three keying choices are available for field installation—random (standard), specific, and consecutive. All three are also available with master keying, which means that all locks can be opened with a single master key.

Key random means that the locks will be assigned arbitrarily at the factory with key numbers ranging from FR305 to FR454 (Master keying numbers: XF1001 to XF1150). *Tip: Random keying can mean that different furniture units will have the same key number. If you must have all locks keyed differently, you should specify key specific or key consecutive lock cylinders.*

Key specific means that you can specify any key number from FR305 to FR454 (Master keying numbers: XF1001 to XF1150). This option can be used to key all the furniture units in a workstation or department the same. *Tip: Designate the quantity per key number in your specification.*
▶ See below.

Key consecutive means that you can specify lock numbers in a consecutive order to ensure that no two locks have the same key number until the key sequence repeats. You must select a beginning key number from FR305 to FR454 (Master keying numbers: XF1001 to XF1150).

Example of a typical lock cylinder specification is shown below:

10	LOCK9201FR FR320
5	LOCK9201FR FR350
15	LOCK9201XF XF1100
30 Total	
1	877102003SR standard lock tool
1	877102002SR master lock tool

Key Random

- FR305
- FR421
- FR305

or

- XF1011
 - XF1042
 - XF1011
- } XF Master Key

Key Specific

- FR350
- FR350
- FR350

or

- XF1020
 - XF1020
 - XF1020
- } XF Master Key

Key Consecutive

- FR350
- FR351
- FR352

or

- XF1020
 - XF1021
 - XF1022
- } XF Master Key

Lock and Keying Exponents

Field-Installed Lock Cylinders

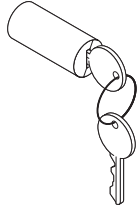

Tip: Lock price is included in price of furniture with locks.

Tip: For replacement lock cylinders, refer to Service Parts.

Tip: You can change lock cylinders in the field by using the appropriate lock tool.

Standard Includes	Required to Specify
<ul style="list-style-type: none"> Lock cylinder (for use on Exponents products): 9201 Polished Chrome or 9250 Ember Chrome Two keys 	1 Style number 2 Options, if selected (see below)

Options	U.S. Price	Required to Specify
Key specific	No cost	Select key number from FR305–FR454.
Key consecutive	No cost	Specify <i>key consecutive</i> and must select beginning key number from FR305–FR454.
Master key random	+\$36 each	Specify master key random.
Master key specific	+\$36 each	Specify key number from XF1001–XF1150.
Master key consecutive	+\$36 each	Specify <i>master key consecutive</i> and must select beginning key number from XF1001–XF1150.

Specification Information

Color	Style Number	U.S. Base Price
-------	--------------	-----------------

FR Series (Standard Keying System)—Lock Cylinder

Polished Chrome	LOCK9201FR	No cost
Ember Chrome	LOCK9250FR	No cost

Standard Lock Tool

877102003SR	\$36
-------------	------

XF Series (Master Keying System)—Lock Cylinder

Polished Chrome	LOCK9201XF	No additional cost. Price included in price of furniture with master-keyed locks.
Ember Chrome	LOCK9250XF	No additional cost. Price included in price of furniture with master-keyed locks.

Master Lock Tool

877102002SR	\$36
-------------	------

 **For Canadian Pricing**
 Multiply U.S. Price by the Canadian price factor.
 ▶ See page 1 for details.

Style Number Index

Style Number	Page	Description
100-T1	676	Bob Round Occasional Table
100-T2	676	Bob Round Occasional Table
100-T3	677	Bob Round Occasional Table
100-T4	677	Bob Round Occasional Table
105-T1	650	Bob Round Conference Dining Table
105-T2	650	Bob Round Conference Dining Table
105-T3	651	Bob Round Conference Dining Table
105-T4	651	Bob Round Conference Dining Table
321891	637	Train Receptacle, Circuit 1
321892	637	Train Receptacle, Circuit 2
321893	637	Train Receptacle, Circuit 3
321894	637	Train Receptacle, Circuit 4
321899	643	Wall Jack/Faceplate
39-2424	706	Switch Square
39-2442	706	Switch Rectangle
39-3636	706	Switch Square
44-T164830	697	Passerelle Occasional Table
44-T242417	697	Passerelle Occasional Table
44-T242421	697	Passerelle Occasional Table
45-T42RD	684	Circa Freestanding Table
46-T1	669	Await Freestanding Table
46-T2	669	Await Freestanding Table
47-T1326C	686	Diekman Wood Table
47-T1623A	686	Diekman Wood Table
47-T1623B	686	Diekman Wood Table
47-T17ELG	686	Diekman Wood Table
47-T17RG1	686	Diekman Wood Table
47-T2217E	686	Diekman
47-T23EL	686	Diekman
47-T2617D	686	Diekman
70-C-TPM	707	Tree Bevel High-Embossed Wood
70-D-TPM	707	Tree Bevel Medium-Embossed Wood
793215	50, 645	Grommet
793330	739	Power Strip
793332	49	Ballet Vertical Wire Mgr
793333	52	Ballet Mobile Strg Cart
793335	49	Bar Ganger Package
793369	331	Floor Monument Kit
809000	48	Ballet Connecting Top
814412	45	Ballet Folding X-Base
814462	45	Ballet Folding X-Base
815413	45	Ballet Folding X-Base
815463	45	Ballet Folding X-Base
816414	45	Ballet Folding X-Base
816464	45	Ballet Folding X-Base
823411	45	Ballet Folding X-Base
823461	45	Ballet Folding X-Base
824412	45	Ballet Folding X-Base
824462	45	Ballet Folding X-Base
825413	45	Ballet Folding X-Base
825463	45	Ballet Folding X-Base
826414	45	Ballet Folding X-Base
826464	45	Ballet Folding X-Base
834402	47	Ballet Non-Folding X-Base
834452	47	Ballet Non-Folding X-Base

Style Number	Page	Description
835403	47	Ballet Non-Folding X-Base
835453	47	Ballet Non-Folding X-Base
836404	47	Ballet Non-Folding X-Base
836454	47	Ballet Non-Folding X-Base
849000	48	Ballet Connecting Top
853411	44	Ballet Folding X-Base
853461	44	Ballet Folding X-Base
854412	44	Ballet Folding X-Base
854462	44	Ballet Folding X-Base
855413	44	Ballet Folding X-Base
855463	44	Ballet Folding X-Base
856414	44	Ballet Folding X-Base
856464	44	Ballet Folding X-Base
873401	46	Ballet Non-Folding X-Base
873451	46	Ballet Non-Folding X-Base
874402	46	Ballet Non-Folding X-Base
874452	46	Ballet Non-Folding X-Base
875403	46	Ballet Non-Folding X-Base
875453	46	Ballet Non-Folding X-Base
876404	46	Ballet Non-Folding X-Base
876454	46	Ballet Non-Folding X-Base
877102002SR	755	Master Lock Tool
877102003SR	755	Standard Lock Tool
883401	47	Ballet Non-Folding X-Base
883451	47	Ballet Non-Folding X-Base
884402	47	Ballet Non-Folding X-Base
884452	47	Ballet Non-Folding X-Base
885403	47	Ballet Non-Folding X-Base
885453	47	Ballet Non-Folding X-Base
886404	47	Ballet Non-Folding X-Base
886454	47	Ballet Non-Folding X-Base
909000	48	Ballet Connecting Top
915405	39	Ballet Arc
915415	39	Ballet Arc
916406	39	Ballet Arc
916416	39	Ballet Arc
919423C	40	Ballet Non-Folding Side
920424C	40	Ballet Non-Folding Side
926421	42	Ballet Sqr Pedestal Base
927422	42	Ballet Pedestal
933421	41	Ballet Rnd Pedestal Base
933421T	648	Ballet Round Café
934421	41	Ballet Rnd Pedestal Base
934422T	648	Ballet Round Café
BTC20001	673	Bix Occasional Table
BTC24241	673	Bix Occasional Table
BTC24481	673	Bix Occasional Table
BTC24481U	673	Bix Occasional Table
BTC24721	673	Bix Occasional Table
BTC28001	673	Bix Occasional Table
BTC28001U	673	Bix Occasional Table
BTS1700	672	Bix Side Table
BTW20003	649	Bix Work-Booth Table
BTW28003	649	Bix Work-Booth Table
BTW28003U	649	Bix Work-Booth Table

Style Number Index

Style Number	Page	Description	Style Number	Page	Description
BTW36483	649	Bix Work-Booth Table	COEL303072	657	Enea Lottus Rectangular Table
BTW36483U	649	Bix Work-Booth Table	COEL3036	657	Enea Lottus Conference Table
BTW36723	649	Bix Work-Booth Table	COEL3042	657	Enea Lottus Conference Table
BTW36723U	649	Bix Work-Booth Table	COEL3624	658	Enea Lottus Café Counter-Height Table
COBP1FMH	644	Two-Circuit Hdwr Base Pwr Infeed	COEL3630	658	Enea Lottus Café Counter-Height Table
COBP1FMP20	644	Single-Circuit 20-Amp Plug Base Pwr Infeed	COEL363072	658	Enea Lottus Rectangular Table
COCFS	692	Free Stand Occasional Table	COEL3636	658	Enea Lottus Café Counter-Height Table
COCGM1836L	680	CG_1 Metal Low Rectangular Table	COEL3642	658	Enea Lottus Café Counter-Height Table
COCGM1842L	680	CG_1 Metal Low Rectangular Table	COEL4224	659	Enea Lottus Café Bar-Height Table
COCGM2020H	681	CG_1 Metal High Square Table	COEL4230	659	Enea Lottus Café Bar-Height Table
COCGM2424H	681	CG_1 Metal High Square Table	COEL423072	659	Enea Lottus Rectangular Table
COCGM2436H	681	CG_1 Metal High Rectangular Table	COEL4236	659	Enea Lottus Café Bar-Height Table
COCGM3636L	680	CG_1 Metal Low Square Table	COEL4242	659	Enea Lottus Café Bar-Height Table
COCGM4242L	680	CG_1 Metal Low Square Table	COET2DA	309-314	D-Shape Alu Base Table-Working Height
COCGM6060L	680	CG_1 Metal Low Square Table	COET2DL	325-326	D-Shape Laminate Base Table
COCGW1836L	682	CG_1 Low Rectangular Table	COET2DSTA	317-322	D-Shape Alu Base Table-Standing Height
COCGW1842L	682	CG_1 Low Rectangular Table	COET2DV	329-330	D-Shape Veneer Base Table
COCGW2020H	683	CG_1 High Square Table	COET2FCTA	141-155	Faceted Alu Base Table-Working Height
COCGW2424H	683	CG_1 High Square Table	COET2FCTL	165-175	Faceted Laminate Base Table
COCGW2436H	683	CG_1 High Rectangular Table	COET2FCTSTA	157-162	Faceted Alu Base Table-Standing Height
COCGW3636L	682	CG_1 Low Square Table	COET2FCTV	177-187	Faceted Veneer Base Table
COCGW4242L	682	CG_1 Low Square Table	COET2RACEA	91-106	Racetrack Alu Base Table-Working Height
COCL42	742	Exponents Lectern	COET2RACEL	117-127	Racetrack Laminate Base Table
COCMBSHLF	751	Exponents Shelf	COET2RACESTA	109-114	Racetrack Alu Base Table-Standing Height
COCMBW	751	Mobile Mediaboard Display	COET2RACEV	129-139	Racetrack Veneer Base Table
COCWBN	750	Mobile Whiteboard Display	COET2RECA	189-204	Rectangular Alu Base Table-Working Height
COCWBW	750	Mobile Whiteboard Display	COET2RECL	215-225	Rectangular Laminate Base Table
COCZBDC184815	720	Exponents Bench with Doors	COET2RECSTA	207-212	Rectangular Alu Base Table-Standing Height
COCZBDC187215	720	Exponents Bench with Doors	COET2RECV	227-237	Rectangular Veneer Base Table
COCZBDC189615	720	Exponents Bench with Doors	COET2RNDL	87	Round Laminate Base Table
COCZBE182415	725	Exponents End-of-Run Bench Bridge	COET2RNDV	89	Round Veneer Base Table
COCZBI182415	725	Exponents In-Line Bench Bridge	COET2SFTA	239-252	Soft Radiused Alu Base Table-Working Height
COCZBOC184815	720	Exponents Open Bench	COET2SFTL	263-272	Soft Radiused Laminate Base Table
COCZBOC187215	720	Exponents Open Bench	COET2SFTSTA	255-260	Soft Radiused Alu Base Table-Standing Height
COCZBOC189615	720	Exponents Open Bench	COET2SFTV	275-284	Soft Radiused Veneer Base Table
COCZD254827	732	Exponents Credenza 27"H	COET2TRAPA	287-291	Trapezoid Alu Base Table-Working Height
COCZD257227	732	Exponents Credenza 27"H	COET2TRAPL	297-300	Trapezoid Laminate Base Table
COCZD259627	732	Exponents Credenza 27"H	COET2TRAPSTA	293-294	Trapezoid Alu Base Table-Standing Height
COCZDO257227	732	Exponents Credenza 27"H	COET2TRAPV	303-306	Trapezoid Veneer Base Table
COCZDO259627	732	Exponents Credenza 27"H	COFOFBT	514, 518, 521	Potrero415 Boat Table, Metal Legs
COCZUD254839	735	Exponents Credenza 39"H	COFOFBTST	514, 518	Potrero415 Boat Standing Height Table, Metal Legs
COCZUD257239	735	Exponents Credenza 39"H	COFOFBTSTW	536, 540	Potrero415 Boat Standing Height Table, Wood Legs
COCZUD259639	735	Exponents Credenza 39"H	COFOFBTW	536, 540, 543	Potrero415 Boat Table, Wood Legs
CODHA4	639	Axil Z, Hardwire	COFOFCABL	545	Cable Manager Column, Work-Height
CODHE4	641	Ellora, Hardwire	COFOFCABLM	544, 573	Potrero415 Mesh Cable Manager
CODPA4	638	Axil Z, Hardwire	COFOFCABLMST	544, 573	Potrero415 Mesh Cable Manager
CODPE4	640	Ellora, Hardwire	COFOFCABLST	545	Cable Manager Column, Standing-Height
COEB2723H	699	Sebastopol 22" High Table	COFOFLCMCW	573	Potrero415 Light Wood Leg Cable Manager
COEB2723L	699	Sebastopol 16" High Table	COFOFLCMCWST	573	Potrero415 Light Wood Leg Cable Manager
COEB4118H	699	Sebastopol 22" High Table	COFOFLRD	559	Potrero415 Light Round Table
COEB4118L	699	Sebastopol 16" High Table	COFOFLRDST	559	Potrero415 Light Round Table
COEL1830	690	Enea Lottus Occasional Table	COFOFLRDSTW	567	Potrero415 Light Round Table, Wood Legs
COEL1836	690	Enea Lottus Occasional Table	COFOFLRDW	567	Potrero415 Light Round Table, Wood Legs
COEL1842	690	Enea Lottus Occasional Table	COFOFLREC	563	Potrero415 Light Rectangular Table
COEL3030	657	Enea Lottus Conference Table	COFOFLRECST	564	Potrero415 Light Rectangular Table

Style Number Index *continued*

Style Number	Page	Description
COFOFLRECSTW	572	Potrero415 Light Rectangular Table, Wood Legs
COFOFLRECW	571	Potrero415 Light Rectangular Table, Wood Legs
COFOFLSQ	559	Potrero415 Light Square Table
COFOFLSQST	559	Potrero415 Light Square Table
COFOFLSQSTW	567	Potrero415 Light Square Table, Wood Legs
COFOFLSQW	567	Potrero415 Light Square Table, Wood Legs
COFOFRD	501	Potrero415 Round Table, Metal Legs
COFOFRDST	501	Potrero415 Round Standing Hgt Table, Metal Legs
COFOFRDSTW	523	Potrero415 Round Standing Hgt Table, Wood Legs
COFOFRDW	523	Potrero415 Round Table, Wood Legs
COFOFREC	504, 508, 511	Potrero415 Rect. Table, Metal Legs
COFOFRECST	504, 509	Potrero415 Rect. Standing Hgt Table, Metal Legs
COFOFRECSTW	526, 531	Potrero415 Rect. Standing Hgt Table, Wood Legs
COFOFRECW	526, 530, 533	Potrero415 Rect. Table, Wood Legs
COFOFSQ	501	Potrero415 Square Table, Metal Legs
COFOFSQST	501	Potrero415 Square Standing Hgt Table, Metal Legs
COFOFSQSTW	523	Potrero415 Square Standing Hgt Table, Wood Legs
COFOFSQW	523	Potrero415 Square Table, Wood Legs
COLAGTO	693	Lagunitas Occasional Table
COLAGTP	694	Lagunitas Personal Table
COLAGTRECT	474	Lagunitas Work Table
COLAGTW	475	Work Tables
COMOTL2020	695	Millbrae Side Table
COMOTL2054	695	Millbrae Rectangular Table
COMOTL3030	695	Millbrae Square Table
COMOTL3060	695	Millbrae Rectangular Table
COMOTL3636	695	Millbrae Square Table
COMOTL4848	695	Millbrae Square Table
COMT5RDG	482	Round MoreThanFive Table
COMT5RDL	482	Round MoreThanFive Table
COMT5RECG	484	Rectangle MoreThanFive Table
COMT5RECL	483	Rectangle MoreThanFive Table
COMT5SQG	482	Square MoreThanFive Table
COMT5SQL	482	Square MoreThanFive Table
COPP01	604, 645, 700, 704, 739	PowerPod
COSFZCTRD	665	Montara650 Café-Height Table
COSFZCTSQ	665	Montara650 Café-Height Table
COSFZOTRD	696	Montara650 Occasional Table
COSFZOTSQ	696	Montara650 Occasional Table
COSFZWTRD	663	Montara650 Work-Height Table
COSFZWTSQ	663	Montara650 Work-Height Table
COW_RC4284	598	SW_1 Rectangular Conference Table
COW_RC48120	598	SW_1 Rectangular Conference Table
COW_RC48122	598	SW_1 Rectangular Conference Table
COW_RC48144	598	SW_1 Rectangular Conference Table
COW_RC4896	598	SW_1 Rectangular Conference Table
COW_RND30	601	SW_1 Round Table
COW_RND36	601	SW_1 Round Table
COW_RND42	601	SW_1 Round Table
COW_RND48	601	SW_1 Round Table
COW_RND60	597	SW_1 Conference Table
COW_RND72	597	SW_1 Conference Table
COW_RND84	597	SW_1 Conference Table
COW_RND96	597	SW_1 Conference Table

Style Number	Page	Description
COW_RT3060	603	SW_1 Rectangular Work Table
COW_RT3072	603	SW_1 Rectangular Work Table
COW_RT3660	603	SW_1 Rectangular Work Table
COW_RT3672	603	SW_1 Rectangular Work Table
COW_SE4060	603	SW_1 Super-Elliptical Work Table
COW_SE4072	603	SW_1 Super-Elliptical Work Table
COW_SEC120	599	SW_1 Super Elliptical Conference Table
COW_SEC122	599	SW_1 Super Elliptical Conference Table
COW_SEC144	599	SW_1 Super Elliptical Conference Table
COW_SEC168	599	SW_1 Super Elliptical Conference Table
COW_SEC192	599	SW_1 Super Elliptical Conference Table
COW_SEC213	599	SW_1 Super Elliptical Conference Table
COW_SEC216	599	SW_1 Super Elliptical Conference Table
COW_SEC240	599	SW_1 Super Elliptical Conference Table
COW_SEC243	599	SW_1 Super Elliptical Conference Table
COW_SEC84	599	SW_1 Super Elliptical Conference Table
COW_SEC96	599	SW_1 Super Elliptical Conference Table
COW_SQ30	601	SW_1 Square Table
COW_SQ36	601	SW_1 Square Table
COW_SQ42	601	SW_1 Square Table
COW_SQ60	598	SW_1 Conference Table
COW_SQ72	598	SW_1 Conference Table
COW_SQ84	598	SW_1 Conference Table
COW_SQ96	598	SW_1 Conference Table
COW_SSQ45	601	SW_1 Super-Square Table
COWHWM	605, 705	SW_1 Horizontal Wire Manager Clips
COWO_RND30	703	SW_1 Round Occasional Table
COWO_RND36	703	SW_1 Round Occasional Table
COWO_RND42	703	SW_1 Round Occasional Table
COWO_RND48	703	SW_1 Round Occasional Table
COWO_RND60	703	SW_1 Occasional Table
COWO_SQ30	703	SW_1 Square Occasional Table
COWO_SQ36	703	SW_1 Square Occasional Table
COWO_SQ42	703	SW_1 Square Occasional Table
COWO_SQ60	703	SW_1 Occasional Table
COWO_SSQ45	703	SW_1 Super-Square Occasional Table
COWVWM26	605	SW_1 Vertical Wire Manager
COWVWM28	605	SW_1 Vertical Wire Manager
COWX_Q42	594	SW_1 Square Low Coll Conf Tbl
COWX_R4120	595	SW_1 Rectangular Low Coll Conf Tbl
COWX_R4284	595	SW_1 Rectangular Low Coll Conf Tbl
COWX_RND60	594	SW_1 Low Collaborative Conference Table
COWX_RND72	594	SW_1 Low Collaborative Conference Table
COWX_RND84	594	SW_1 Low Collaborative Conference Table
COWX_RND96	594	SW_1 Low Collaborative Conference Table
COWX_SE4072	595	SW_1 Super Elliptical Low Coll Conf Tbl
COWX_SE4084	595	SW_1 Super Elliptical Low Coll Conf Tbl
COWX_SE4096	595	SW_1 Super Elliptical Low Coll Conf Tbl
COWX_SE4120	595	SW_1 Super Elliptical Low Coll Conf Tbl
COWX_SE4122	595	SW_1 Super Elliptical Low Coll Conf Tbl
COWX_SQ60	594	SW_1 Low Collaborative Conference Table
COWX_SQ72	594	SW_1 Low Collaborative Conference Table
COWX_SQ84	594	SW_1 Low Collaborative Conference Table
COWX_SQ96	594	SW_1 Low Collaborative Conference Table
CSP	51	Communications Sphere

Style Number Index

Style Number	Page	Description	Style Number	Page	Description
H35-T2436L	653	Enea Table Single Base	HS1048R12	362	Host Rectangular
H35-T2436W	653	Enea Table Single Base	HS1048R13	363	Host Rectangular
H35-T2442L	653	Enea Table Single Base	HS1048R20	363	Host Rectangular
H35-T2442W	653	Enea Table Single Base	HS1048R21	363	Host Rectangular
H35-T3030L	652	Enea Table Single Base	HS1048R22	363	Host Rectangular
H35-T3030W	652	Enea Table Single Base	HS1048S10	391	Host Soft Radiused
H35-T3036L	653	Enea Table Single Base	HS1048S11	391	Host Soft Radiused
H35-T3036W	653	Enea Table Single Base	HS1048S12	391	Host Soft Radiused
H35-T3042L	653	Enea Table Single Base	HS1048S13	391	Host Soft Radiused
H35-T3042W	653	Enea Table Single Base	HS1048S20	392	Host Soft Radiused
H35-T307230GL	655	Enea Table Twin Base	HS1048S21	392	Host Soft Radiused
H35-T307230GW	655	Enea Table Twin Base	HS1048S22	392	Host Soft Radiused
H35-T307230KL	654	Enea Table Twin Base	HS1060B10	448	Host Boat
H35-T307230KW	654	Enea Table Twin Base	HS1060B11	448	Host Boat
H35-T307230VL	655	Enea Table Twin Base	HS1060B12	448	Host Boat
H35-T307230VW	655	Enea Table Twin Base	HS1060B13	448	Host Boat
H35-T307236GL	655	Enea Table Twin Base	HS1060B20	449	Host Boat
H35-T307236GW	655	Enea Table Twin Base	HS1060B21	449	Host Boat
H35-T307236KL	654	Enea Table Twin Base	HS1060B22	449	Host Boat
H35-T307236KW	654	Enea Table Twin Base	HS1060C10	421	Host Racetrack
H35-T307236VL	655	Enea Table Twin Base	HS1060C11	421	Host Racetrack
H35-T307236VW	655	Enea Table Twin Base	HS1060C12	421	Host Racetrack
H35-T307242GL	655	Enea Table Twin Base	HS1060C13	421	Host Racetrack
H35-T307242GW	655	Enea Table Twin Base	HS1060C20	422	Host Racetrack
H35-T307242KL	654	Enea Table Twin Base	HS1060C21	422	Host Racetrack
H35-T307242KW	654	Enea Table Twin Base	HS1060C22	422	Host Racetrack
H35-T307242VL	655	Enea Table Twin Base	HS1060R10	363	Host Rectangular
H35-T307242VW	655	Enea Table Twin Base	HS1060R11	363	Host Rectangular
H35-T3618L	688	Enea Table Single Base	HS1060R12	364	Host Rectangular
H35-T3618W	688	Enea Table Single Base	HS1060R13	364	Host Rectangular
H35-T3630L	652	Enea Table Single Base	HS1060R20	364	Host Rectangular
H35-T3630W	652	Enea Table Single Base	HS1060R21	364	Host Rectangular
H35-T3636L	653	Enea Table Single Base	HS1060R22	364	Host Rectangular
H35-T3636W	653	Enea Table Single Base	HS1060S10	392	Host Soft Radiused
H35-T3642L	653	Enea Table Single Base	HS1060S11	392	Host Soft Radiused
H35-T3642W	653	Enea Table Single Base	HS1060S12	392	Host Soft Radiused
H35-T4218L	688	Enea Table Single Base	HS1060S13	393	Host Soft Radiused
H35-T4218W	688	Enea Table Single Base	HS1060S20	393	Host Soft Radiused
H35-T4230L	652	Enea Table Single Base	HS1060S21	393	Host Soft Radiused
H35-T4230W	652	Enea Table Single Base	HS1060S22	393	Host Soft Radiused
H35-T4236L	653	Enea Table Single Base	HS1060T10	465	Host Trapezoid Table
H35-T4236W	653	Enea Table Single Base	HS1060T11	465	Host Trapezoid Table
H35-T5430L	652	Enea Table Single Base	HS1060T12	465	Host Trapezoid Table
H35-T5430W	652	Enea Table Single Base	HS1060T13	465	Host Trapezoid Table
H35-T6030L	652	Enea Table Single Base	HS1060T20	466	Host Trapezoid Table
H35-T6030W	652	Enea Table Single Base	HS1060T21	466	Host Trapezoid Table
HS1048C10	419	Host Racetrack	HS1060T22	466	Host Trapezoid Table
HS1048C11	419	Host Racetrack	HS1248C20	423	Host Racetrack
HS1048C12	419	Host Racetrack	HS1248C21	423	Host Racetrack
HS1048C13	419	Host Racetrack	HS1248C22	423	Host Racetrack
HS1048C20	420	Host Racetrack	HS1248R20	365	Host Rectangular
HS1048C21	420	Host Racetrack	HS1248R21	365	Host Rectangular
HS1048C22	420	Host Racetrack	HS1248R22	365	Host Rectangular
HS1048R10	362	Host Rectangular	HS1248S20	394	Host Soft Radiused
HS1048R11	362	Host Rectangular	HS1248S21	394	Host Soft Radiused

Style Number Index *continued*

Style Number	Page	Description
HS1248S22	394	Host Soft Radiused
HS1260B20	449	Host Boat
HS1260B21	449	Host Boat
HS1260B22	449	Host Boat
HS1260C20	424	Host Racetrack
HS1260C21	424	Host Racetrack
HS1260C22	424	Host Racetrack
HS1260R20	366	Host Rectangular
HS1260R21	366	Host Rectangular
HS1260R22	366	Host Rectangular
HS1260S20	395	Host Soft Radiused
HS1260S21	395	Host Soft Radiused
HS1260S22	395	Host Soft Radiused
HS1260T20	467	Host Trapezoid Table
HS1260T21	467	Host Trapezoid Table
HS1260T22	467	Host Trapezoid Table
HS1448C20	430	Host Racetrack
HS1448C21	430	Host Racetrack
HS1448C22	430	Host Racetrack
HS1448C24	430	Host Racetrack
HS1448C30	431	Host Racetrack
HS1448C31	431	Host Racetrack
HS1448C32	431	Host Racetrack
HS1448C34	431	Host Racetrack
HS1448R20	372	Host Rectangular
HS1448R21	372	Host Rectangular
HS1448R22	372	Host Rectangular
HS1448R24	372	Host Rectangular
HS1448R30	373	Host Rectangular
HS1448R31	373	Host Rectangular
HS1448R32	373	Host Rectangular
HS1448R34	373	Host Rectangular
HS1448S20	399	Host Soft Radiused
HS1448S21	399	Host Soft Radiused
HS1448S22	399	Host Soft Radiused
HS1448S24	399	Host Soft Radiused
HS1448S30	400	Host Soft Radiused
HS1448S31	400	Host Soft Radiused
HS1448S32	400	Host Soft Radiused
HS1448S34	400	Host Soft Radiused
HS1460B20	453	Host Boat
HS1460B21	453	Host Boat
HS1460B22	453	Host Boat
HS1460B24	453	Host Boat
HS1460B30	454	Host Boat
HS1460B31	454	Host Boat
HS1460B32	454	Host Boat
HS1460B34	454	Host Boat
HS1460C20	432	Host Racetrack
HS1460C21	432	Host Racetrack
HS1460C22	432	Host Racetrack
HS1460C24	432	Host Racetrack
HS1460C30	433	Host Racetrack
HS1460C31	433	Host Racetrack
HS1460C32	433	Host Racetrack

Style Number	Page	Description
HS1460C34	433	Host Racetrack
HS1460R20	374	Host Rectangular
HS1460R21	374	Host Rectangular
HS1460R22	374	Host Rectangular
HS1460R24	374	Host Rectangular
HS1460R30	375	Host Rectangular
HS1460R31	375	Host Rectangular
HS1460R32	375	Host Rectangular
HS1460R34	375	Host Rectangular
HS1460S20	401	Host Soft Radiused
HS1460S21	401	Host Soft Radiused
HS1460S22	401	Host Soft Radiused
HS1460S24	401	Host Soft Radiused
HS1460S30	402	Host Soft Radiused
HS1460S31	402	Host Soft Radiused
HS1460S32	402	Host Soft Radiused
HS1460S34	402	Host Soft Radiused
HS1648C20	434	Host Racetrack
HS1648C21	434	Host Racetrack
HS1648C22	434	Host Racetrack
HS1648C24	434	Host Racetrack
HS1648C30	435	Host Racetrack
HS1648C31	435	Host Racetrack
HS1648C32	435	Host Racetrack
HS1648C34	435	Host Racetrack
HS1648R20	376	Host Rectangular
HS1648R21	376	Host Rectangular
HS1648R22	376	Host Rectangular
HS1648R24	376	Host Rectangular
HS1648R30	377	Host Rectangular
HS1648R31	377	Host Rectangular
HS1648R32	377	Host Rectangular
HS1648R34	377	Host Rectangular
HS1648S20	403	Host Soft Radiused
HS1648S21	403	Host Soft Radiused
HS1648S22	403	Host Soft Radiused
HS1648S24	403	Host Soft Radiused
HS1648S30	404	Host Soft Radiused
HS1648S31	404	Host Soft Radiused
HS1648S32	404	Host Soft Radiused
HS1648S34	404	Host Soft Radiused
HS1660B20	455	Host Boat
HS1660B21	455	Host Boat
HS1660B22	455	Host Boat
HS1660B24	455	Host Boat
HS1660B30	456	Host Boat
HS1660B31	456	Host Boat
HS1660B32	456	Host Boat
HS1660B34	456	Host Boat
HS1660C20	436	Host Racetrack
HS1660C21	436	Host Racetrack
HS1660C22	436	Host Racetrack
HS1660C24	436	Host Racetrack
HS1660C30	437	Host Racetrack
HS1660C31	437	Host Racetrack

Style Number Index

Style Number	Page	Description	Style Number	Page	Description
HS1660C32	437	Host Racetrack	HS1860B32	458	Host Boat
HS1660C34	437	Host Racetrack	HS1860B34	458	Host Boat
HS1660R20	378	Host Rectangular	HS1860B36	458	Host Boat
HS1660R21	378	Host Rectangular	HS1860C20	440	Host Racetrack
HS1660R22	378	Host Rectangular	HS1860C21	440	Host Racetrack
HS1660R24	378	Host Rectangular	HS1860C22	440	Host Racetrack
HS1660R30	379	Host Rectangular	HS1860C24	440	Host Racetrack
HS1660R31	379	Host Rectangular	HS1860C26	440	Host Racetrack
HS1660R32	379	Host Rectangular	HS1860C30	441	Host Racetrack
HS1660R34	379	Host Rectangular	HS1860C31	441	Host Racetrack
HS1660S20	405	Host Soft Radiused	HS1860C32	441	Host Racetrack
HS1660S21	405	Host Soft Radiused	HS1860C34	441	Host Racetrack
HS1660S22	405	Host Soft Radiused	HS1860C36	441	Host Racetrack
HS1660S24	405	Host Soft Radiused	HS1860R20	382	Host Rectangular
HS1660S30	406	Host Soft Radiused	HS1860R21	382	Host Rectangular
HS1660S31	406	Host Soft Radiused	HS1860R22	382	Host Rectangular
HS1660S32	406	Host Soft Radiused	HS1860R24	382	Host Rectangular
HS1660S34	406	Host Soft Radiused	HS1860R26	382	Host Rectangular
HS1848C20	438	Host Racetrack	HS1860R30	383	Host Rectangular
HS1848C21	438	Host Racetrack	HS1860R31	383	Host Rectangular
HS1848C22	438	Host Racetrack	HS1860R32	383	Host Rectangular
HS1848C24	438	Host Racetrack	HS1860R34	383	Host Rectangular
HS1848C26	438	Host Racetrack	HS1860R36	383	Host Rectangular
HS1848C30	439	Host Racetrack	HS1860S20	409	Host Soft Radiused
HS1848C31	439	Host Racetrack	HS1860S21	409	Host Soft Radiused
HS1848C32	439	Host Racetrack	HS1860S22	409	Host Soft Radiused
HS1848C34	439	Host Racetrack	HS1860S24	409	Host Soft Radiused
HS1848C36	439	Host Racetrack	HS1860S26	409	Host Soft Radiused
HS1848R20	380	Host Rectangular	HS1860S30	410	Host Soft Radiused
HS1848R21	380	Host Rectangular	HS1860S31	410	Host Soft Radiused
HS1848R22	380	Host Rectangular	HS1860S32	410	Host Soft Radiused
HS1848R24	380	Host Rectangular	HS1860S34	410	Host Soft Radiused
HS1848R26	380	Host Rectangular	HS1860S36	410	Host Soft Radiused
HS1848R30	381	Host Rectangular	HS2048C20	442	Host Racetrack
HS1848R31	381	Host Rectangular	HS2048C21	442	Host Racetrack
HS1848R32	381	Host Rectangular	HS2048C22	442	Host Racetrack
HS1848R34	381	Host Rectangular	HS2048C24	442	Host Racetrack
HS1848R36	381	Host Rectangular	HS2048C26	442	Host Racetrack
HS1848S20	407	Host Soft Radiused	HS2048C30	443	Host Racetrack
HS1848S21	407	Host Soft Radiused	HS2048C31	443	Host Racetrack
HS1848S22	407	Host Soft Radiused	HS2048C32	443	Host Racetrack
HS1848S24	407	Host Soft Radiused	HS2048C34	443	Host Racetrack
HS1848S26	407	Host Soft Radiused	HS2048C36	443	Host Racetrack
HS1848S30	408	Host Soft Radiused	HS2048R20	384	Host Rectangular
HS1848S31	408	Host Soft Radiused	HS2048R21	384	Host Rectangular
HS1848S32	408	Host Soft Radiused	HS2048R22	384	Host Rectangular
HS1848S34	408	Host Soft Radiused	HS2048R24	384	Host Rectangular
HS1848S36	408	Host Soft Radiused	HS2048R26	384	Host Rectangular
HS1860B20	457	Host Boat	HS2048R30	385	Host Rectangular
HS1860B21	457	Host Boat	HS2048R31	385	Host Rectangular
HS1860B22	457	Host Boat	HS2048R32	385	Host Rectangular
HS1860B24	457	Host Boat	HS2048R34	385	Host Rectangular
HS1860B26	457	Host Boat	HS2048R36	385	Host Rectangular
HS1860B30	458	Host Boat	HS2048S20	411	Host Soft Radiused
HS1860B31	458	Host Boat	HS2048S21	411	Host Soft Radiused

Style Number Index *continued*

Style Number	Page	Description
HS2048S22	411	Host Soft Radiused
HS2048S24	411	Host Soft Radiused
HS2048S26	411	Host Soft Radiused
HS2048S30	412	Host Soft Radiused
HS2048S31	412	Host Soft Radiused
HS2048S32	412	Host Soft Radiused
HS2048S34	412	Host Soft Radiused
HS2048S36	412	Host Soft Radiused
HS2060B20	459	Host Boat
HS2060B21	459	Host Boat
HS2060B22	459	Host Boat
HS2060B24	459	Host Boat
HS2060B26	459	Host Boat
HS2060B30	460	Host Boat
HS2060B31	460	Host Boat
HS2060B32	460	Host Boat
HS2060B34	460	Host Boat
HS2060B36	460	Host Boat
HS2060C20	444	Host Racetrack
HS2060C21	444	Host Racetrack
HS2060C22	444	Host Racetrack
HS2060C24	444	Host Racetrack
HS2060C26	444	Host Racetrack
HS2060C30	445	Host Racetrack
HS2060C31	445	Host Racetrack
HS2060C32	445	Host Racetrack
HS2060C34	445	Host Racetrack
HS2060C36	445	Host Racetrack
HS2060R20	386	Host Rectangular
HS2060R21	386	Host Rectangular
HS2060R22	386	Host Rectangular
HS2060R24	386	Host Rectangular
HS2060R26	386	Host Rectangular
HS2060R30	387	Host Rectangular
HS2060R31	387	Host Rectangular
HS2060R32	387	Host Rectangular
HS2060R34	387	Host Rectangular
HS2060R36	387	Host Rectangular
HS2060S20	413	Host Soft Radiused
HS2060S21	413	Host Soft Radiused
HS2060S22	413	Host Soft Radiused
HS2060S24	413	Host Soft Radiused
HS2060S26	413	Host Soft Radiused
HS2060S30	414	Host Soft Radiused
HS2060S31	414	Host Soft Radiused
HS2060S32	414	Host Soft Radiused
HS2060S34	414	Host Soft Radiused
HS2060S36	414	Host Soft Radiused
HS4800D10	357	Host Round
HS4800D11	357	Host Round
HS4WXFRM	468	Host Corridor Power Kit, Modular
HS6000D10	357	Host Round
HS6000D11	358	Host Round
HS9648C10	418	Host Racetrack
HS9648C11	418	Host Racetrack

Style Number	Page	Description
HS9648C12	418	Host Racetrack
HS9648R10	362	Host Rectangular
HS9648R11	362	Host Rectangular
HS9648R12	362	Host Rectangular
HS9648S10	390	Host Soft Radiused
HS9648S11	390	Host Soft Radiused
HS9648S12	390	Host Soft Radiused
HS9654B10	448	Host Boat
HS9654B11	448	Host Boat
HS9654B12	448	Host Boat
HS9660T10	464	Host Trapezoid Table
HS9660T11	464	Host Trapezoid Table
HS9660T12	464	Host Trapezoid Table
HSFCONPT	468	Host Floor Kit: Connectrac
HSFSLHF	468	Host Corridor Shelf
LOCK9201FR	755	Lock Cylinder
LOCK9201XF	755	Lock Cylinder
LOCK9250FR	755	Lock Cylinder
LOCK9250XF	755	Lock Cylinder
PCS	51	Power/Comm Sphere
PSP	51	Power Sphere
RJ11	52	Coupler
RJ45	52	Coupler
TN4824C	635	Train 24"W Rectangular
TN4830C	635	Train 30"W Rectangular
TN6024C	635	Train 24"W Rectangular
TN6030C	635	Train 30"W Rectangular
TN7224C	635	Train 24"W Rectangular
TN7230C	635	Train 30"W Rectangular
TN90D24	636	Train Corner Top
TN90D30	636	Train Corner Top
TNBPIHW	642	Train Power Infeed
TNBPIMD	643	Train Power Infeed
TNBPINY	642	Train Power Infeed
TNGL	637	Train Glides
VLYCDM	605, 705	Verlay Cord Management Cover

Style Number Index

Trademark List

- ® The following are registered trademarks for products of Steelcase Inc. or one of its related corporate entities: 4 o'clock, 900 Series, à la carte, Airtouch, Ally, Amia, Answer, Archipelago, Avenir, Ballet, Bix, Brayton International, Cachet, Canopy, Canto, Chancellor, Coalesse, Confidante, Context, Convene, CopyCam, Criterion, Crushed Can, Currency, dash, Designtex, Details, Detour, Drive, Elective Elements, Ellipse, Ember Chrome, Emerge, E-Table 2, FYI, Garland, Gentry, Ginkgo Biloba, Groupwork, Ideo, Jacket, Jenny, Jersey, Kart, Kick, LaCosta, Leap, LessThanFive, Let's B, LiveBack, Max-Stacker, media:scape, Metro, Migrations, Mitra, Montage, Nurture, Oriana, Parade, Pathways, PCT, Permiso, Player, Portal, Power Pincher, Progeny, Protégé, R2, Rally, Relevant, Reply, Rizzi Arc, Sensor, Series 9000, Siento, Sieste, Sine, Softcare, Springboard, Steelcase, Steelcase Design Partnership, Stella, Stow Davis, Swathmore, Sylvi, TeamWork, Technique, Texpress, Think, Thunder, Topo, Train, turnstone, Underline, Unison, Vecta, Viridian, Walden, Werndl, and X-Stack.
- ® The following registered trademarks are under license from AWI Licensing Company, Dover, DE: SoundScapes, DuraBrite, BioBlock, and Armstrong.
- ® The following registered trademarks are under license from Byrne Electrical, Rockford, MI: Interport, Mini-Port, Axil Z, and Ellora.
- ® The following is a registered trademark of DuPont, Wilmington, DE: Corian.
- ® The following is a registered trademark of Genlyte Thomas Company, Louisville, KY: Lightlior.
- ® The following is a registered trademark of Hilti Corporation, FL-9494 Schaan, Principality of Liechtenstein: Hilti.
- ® The following is a registered trademark of Leviton Manufacturing Company, Little Neck, NY: Decora.
- ® The following is a registered trademark of Mechanical Plastics Corp, Elmsford, NY: Toggler.
- ® The following is a registered trademark of Microsoft Corporation, Redmond, WA: Microsoft.
- ® The following are registered trademarks of Orangebox Ltd., Cardiff, UK: Orangebox.
- ® The following is a registered trademark of Panduit Corporation, Lockport, IL: Panduit.
- ® The following is a registered trademark of Trav (Press), Cuneo, Italy: Assisa.
- ® The following is a registered trademark of Virtual Ink, Boston, MA: mimioActive.
- ® The following registered trademarks are under license from Wilkhahn Furniture Products: Avera, Senzo, Versal, and Wilkhahn FS.
- ® The following are registered trademarks of Polyvision Corp: Flow, Motif, Polyvision, Sans, and Serif.
- ® The following is a registered trademark of Wilsonart International, Temple, TX: Chemsurf.
- ® The following is a registered trademark of Wiremold, West Hartford, CT: Wiremold.
- ® The following is a registered trademark of EMU Group S.P.A., Perugia, Italy: EMU.
- ® The following is a registered trademark of Security People, Inc.: Digilock.
- ® The following are registered trademarks of Natural Capital Partners Europe Limited: CarbonNeutral and the CarbonNeutral Certified logo.
- ™ The following are trademarks for products of Steelcase Inc. or one of its related corporate entities: Access, Active/Passive Shelf, Agree, Ainsley, Akira, Alcove, Alerion, Alight, Amaris, American Elect, American Tradition, ap40, Arbor, Arriva, Asana, Ascot, Aspekt, Astor, Await, Bassline, B-Free, Bira, Bivi, Bixby, Bottomline, Brody, Brook, Buoy, Burton, c:scape, Calla, Calm, Camber, Campfire, Capa, Cappuccino, Cesar, Chester, Chord, Circa, Clarendon, Classic Rectangular, Clipper, cobl, Collaboration, Community, Company, Convey, Cortex, Coupe, Crea, Crew, Cura, Cypress, Davenport, Dearborn, Deck, Déjà, Denizen, Denska, Derby, DeskWizard, Divisio, Donovan, Dune, Duo, Echo, Edge, Elbrook, Elsa, Empath, Empress, Enea, ño, EnSync, Enviro, Escapade, Everwall, Exchange, Exponents, Field, Flat Top, FlexFrame, Flip Top, Flute, Folio, FrameOne, FreeFlow, Frontier, Galilei, Gesture, Ginger, Ginkgo, Go Wall, Grip, Groove, Hatchback, Hawthorne, Hitch, Host Collection, Hosu, Huddleboard, i2i, Impact, Indy, InfoLink, IOS, I-Solve, Jack, Jarrah, Jetty, Juice, Kami, Kast, Kathryn, Lagunitas, Lark, L'Attitude, LearnLab, Leela, Lincoln, Linden, LiveSeat, Loria, Lyric, Malibu, Malibu Too, Mansfield, Marathon, Marien152, Martini, Mason, Masque, Migration, Millbrae, Mineral, Mingle, Mystic, Mystic Metal, Mystic Wood, Montara650, Montreal, MoreThanFive, Move, Nadia, Neighbor, nesso, Nickel, Nikko, Nod, Node, Norfolk, Ocular, Ology, Ontrak, Oom, Opus, Orchid, Outlook Collection, Ovation, Paloma, Paperflo, Parliament, Pasio, Passerelle, Patriarch, Payback, Peek, Pile File, Pisa, Pool, Potrero415, PUCK, QiVi, Quba, Radia, Rave, Reed, Regard, Relay, Reunion, Ripple, Riser, Roam, Rocco, Rocky, RoomWizard, Runner, Satellite, Sawyer, ScapeSeries, Senti, Sentinel, Senza, Sequoia, Session, ShareLink, Shield, Shortcut, Sidewalk, SILQ, Skylar, Slumber, Smoke, Snug, Soft Leaf, Sonata, Sorrel, SOTO, Southside, Stationkits, Steelcase Karman, Steelcase Series, Stiletto, Surprise!, Surround, Switch, Symphony, Sync, TagWizard, Tava, TeamStudio, TeamTheater, Tenaro, Tenor, Terrazzo, Theorem, Thread, Topaz, Touchdown, Tour, Tower Too, Trees, Trillium, Trolly, tX2, U-Free, Umami, Underscore, Uno, V.I.A., Verb, Verge, Verlay, Victor2, Visalia, Waldorf, Woodruff, Workspring, WorkValet, and X-tenz.
- ™ The following is a trademark of Microsoft Corporation, Redmond, WA: Windows.
- ™ The following is a trademark of Rodman Industries, Inc., Oconomowoc, WI: ResinCore1.
- ™ The following is a trademark of Ultrafabrics, LLC, Elmsford, NY: Ultraleather.
- ™ The following trademarks are under license from Wilkhahn Furniture products: Cana, Linus, Logon, Picto, Range, Stitz, Thema, Timetable, and Tubis.
- ™ The following is a trademark of Cradle to Cradle Products Innovation Institute, Oakland, CA: Cradle to Cradle Certified.
- ™ The following trademarks are under license from Walter Knoll: Andoo, Bob, Lazlo, Lox, Ribbon, and Together.
- ™ The following trademarks are under license from PP Møbler: Bar and Flag Halyard.
- ™ The following trademarks are under license from Carl Hansen: Elbow, Paddle, Shell, Wing, and Wishbone.
- ™ The following trademarks are under license from Cambridge Sound Management, LLC, Cambridge, MA: QtPro Soundmasking, Qt Quiet Technology, and Sonet Qt.
- ™ The following is a trademark of Electri-Cable Assemblies, Shelton, CT: Interact.
- ™ The following is a trademark of Clestra Hauserman: IRYS.
- ™ The following is a trademark of Wiesner-Hager Möbel GmbH: Nooi.
- ™ The following are trademarks of Polyvision: Accord, a³, e³, Boundri, and Nota.
- ™ The following is a trademark of Bostock Company, Inc: SnapCab.
- ™ The following is a trademark of Williams-Sonoma, Inc: West Elm.
- ™ The following is a trademark of Elena Marquina Testor: nanimarquina.
- ™ The following is a trademark of Forbo International SA: Forbo.
- ™ The following are trademarks of Orangebox Ltd., Cardiff, UK: Air³, Aspect, Avi, Away from the Desk, Border, Campers & Dens, Coppice, Cubb, Kim, On the QT, Ramsey, Skoner, Sully, Track-B, and Vale.
- ™® The following are trademarks or registered trademarks of AMQ Solutions, LLC: AMQ, AMQ logo, KINEX, ILINE, ACTIV, AMOBI, CONCUR, 3F, REVI, S-SERIES, JAKU, SIYA, ZILO, BODI, FL-X, TIZU, EMBANK, TEKTIS, and BIXBY.
- ™® The following are trademarks or registered trademarks of Viccarbe Habitat, S.L.: Holy Day, Last Minute, Wrapp, Foro, Kelly, Noha, Viable, Solar, Sistema, Savina, Designed In The Sun, Cambio, Aleta, Viccarbe (logo), Viccarbe.

Trademarks used here in are the property of Steelcase Inc. or of their respective owners.