Coalesse Seating Specification Guide

Availability

Electronic price list updated with release 200.J (U.S.) and 156.J (Canada), dated December 18, 2023.

All specifications subject to change without notice. Reference the electronic catalog/Hedberg for current pricing.

Transitional products in this specification guide are **maintained for existing customers only** and are likely to be phased out over time. These products are indicated with a **T**. Products that are scheduled to be culled are indicated with an **X**, followed by the last order entry date.

► For a list of all trademarks, refer to the last page of this specification guide. © 2023 Steelcase Inc.

General Information

Ordering and Warranty	2
Sustainability	4
Collections	5

Statement of Line

6

Lounge Seating

27

Collaboration Seating

265

Guest Seating

293

Stools

337

Resources

381



For Canadian Pricing

Canadian factor can be found at steelcase.com/CADpricing.

Calculate in the following order to avoid rounding errors:

- Multiply the base price and each option by the Canadian factor.
- Round each to the nearest dollar.
- Add base and options for total list price.

Ordering and Warranty

How to Order

Coalesse furniture is available through authorized dealers and retailers. Select products are available for order from our web site. The authorized dealer can help you with everything from surface material selection and order placement, to specialized services, such as space planning and design, delivery and installation. Best of all, they are part of your local community, providing expert advice with a thorough understanding of local needs. For more information and a listing of dealers and retailers, visit www.coalesse.com or call 1.800.627.6770.

Coalesse reserves the right to limit distribution of any or all models.

MAIN TELEPHONE
866.645.6952

CUSTOMER SERVICE
1.800.627.6770

Credit, Prices, and Terms

Credit may be established upon acceptance of satisfactory references. For payment terms, contact Coalesse's Credit Department. Coalesse may cancel or change credit terms at its discretion and may request advance payment at any time.

The order confirmation will be deemed by the customer and by Coalesse, as the final expression of agreement and will be deemed the exclusive statement of terms. The order confirmation supersedes all prior writings and may not be modified or rescinded, except by a revised Coalesse order confirmation signed by the customer. No changes are binding on Coalesse until delivery of the order confirmation. Any storage charges and applicable sales taxes are in addition to the prices shown for merchandise. Inside delivery, uncartoning and installation are customer's responsibility unless separately quoted. All list pricing shown includes freight prepaid to one destination for delivery in the 48 contiguous United States. Hawaii and Alaska are not included. We reserve the right to increase prices without notice due to increases in labor and material costs. If timely payment is not made, customer is liable for reasonable collection costs, including attorney's fees.

Shipping and Storage

Coalesse reserves the right to select carrier and packaging method. Partial shipments may be delivered. Coalesse is not liable for delays or delivery failure due to strikes, lockouts, labor, or transportation difficulties, failure or delay of supply sources, accidents, fire, acts of God, or any other cause of like or unlike nature beyond Coalesse's control. Coalesse may transfer merchandise to storage if not accepted when shipment scheduled. Transfer and storage charges will be the customer's expense. Coalesse's invoice is payable upon transfer. If transfer is made prior to confirmed shipping date, storage expenses will be borne by customer.

Shipping charges MAY be calculated per order. Lead times vary by product. Coalesse reserves the right to select carrier. Partial shipments may be delivered. Coalesse will make every effort to provide current and accurate lead time information, however, Coalesse is not liable for delays or delivery failure due to strikes, lockouts, labor, or transportation difficulties, failure or delay of supply sources, accidents, fire, acts of God, or any other cause of like or unlike nature beyond Coalesse's control.

Freight is included on domestically manufactured products within the 48 contiguous states of the United States.

Claims

Merchandise shipped from Coalesse is thoroughly inspected and properly packed before leaving the factory. Responsibility of its safe delivery is assumed by the carrier at the time of shipment. Customer must match the freight delivered with the bill of lading. Customer must examine packaging material upon delivery and note any damage on the carrier bill of lading. If there is damage to the packaging material, inspect the furniture immediately. If concealed damage is found, contact the carrier within 10 days of delivery date. Save all packaging materials until after inspection.

Freight damage and claims must be reported by the purchaser to the carrier. Coalesse is not responsible for freight claims. Claims for loss or damage must not be deducted from our invoice, nor payment withheld awaiting adjustment of such claims. Do not return any merchandise to Coalesse without a Return Authorization number. By following these procedures carefully, Coalesse guarantees our full support of your claims to protect you against loss or damages. All claims against Coalesse for errors or shortages must be made by customer in writing within fifteen (15) days after delivery. Failure to make claims within fifteen (15) days constitutes acceptance of merchandise and waives claims. Cutting of textiles deems acceptance of yardage and waives all defects, errors, and shortages. Coalesse is not liable for subsequent damages.

Special/Custom Products

Coalesse prides itself on being responsive to our customer's needs. Contact our Customer Service team at 1.800.627.6770 to discuss a special opportunity. Due to product modifications and engineering time, special orders may not be cancelled. Charges will apply.

FOR MORE INFORMATION (on ordering our products) Please contact Coalesse Customer Service at: 1.800.627.6770.

Ordering and Warranty

Order Cancellations/ Changes

All order change/cancellation requests must be submitted using the Coalesse order change/cancellation request form. Late changes could jeopardize the committed delivery of an order.

Coalesse Rapid10 programs no change or cancellations allowed.

Coalesse Products:

- No charges will be assessed for change or cancellation 14 or more calendar days prior to the manufacturing completion date (excludes holidays and/or large quantity project size orders). For import products, charges may apply.

- No manufacturing changes are allowed 0-13 calendar days prior to the manufacturing completion date. Simple changes including shipping address changes are subject to approval but will be accommodated when possible.

- No cancellations or product changes will be accepted for quick ship or special/custom product orders including special laminates. A cancellation fee will be applicable for any custom product and/or change may jeopardize lead time.

- If COM/COL has been received at time of change or cancellation, it is the dealer's responsibility to advise disposition or return of materials. Coalesse will not store materials after 30 days.

Additional Charges

- Changes or cancellations that involve any of the following may be subject to a charge earlier and/or greater than shown above: Special engineering product, CSM, pre-ordered components, materials with extended lead times (e.g., veneers, special paint, etc.) or large quantities of standard materials.

- Use our Order Change/Cancellation Request Form for all order changes. It is Coalesse responsibility to accurately process change order requests. It is the dealer's responsibility to verify that we have accurately interpreted your change requests by checking the acknowledgment after the change has been made. If you do not use the web-based change order form process and an error occurs during our translation which cannot be corrected prior to ship, all costs will be shared on a 50/50 basis. Changing ship dates or adding product to your order is subject to the availability of manufacturing capacity.

- Cartoning changes and shipping address changes are subject to approval and to a change charge. Please consult your Customer Service for specific information pertaining to your order.

Reserved Fabric Policy

Prior to order receipt, reserving textiles (COM/COL, Maharam, Designtex, and select Luna Select Surfaces) is the responsibility of the dealer. Coalesse cannot reserve textiles based on projected orders. Coalesse cannot guarantee Maharam or Designtex fabric availability. If dealer reserves Maharam or Designtex textiles, Coalesse will require the reserve number and zip code for locating purposes when ordering.

Schedule Enhancements

Coalesse will entertain schedule enhancements on a case-by-case basis; however, please understand that we must receive complete information such as installation date, opening date in order to make informed scheduling decisions.

No order move-ups or move-outs are allowed on any order that falls within the 15-working day period of its manufacturing completion date. If it is within the 15-working day period, Coalesse will invoice at shipment but may offer storage options at a charge for manufactured product.

Rapid10

The Coalesse Rapid10 program provides a broad selection of our most popular seating, outdoor furniture, and tables with expedited manufacturing. To view and specify products that are included in the Coalesse Rapid10 program, please refer to the *Quick Ship Guide*. The comprehensive Coalesse offering in this program can easily provide a range of solutions for any setting. Coalesse Rapid10 is designed for clients whose needs require fast delivery of products. All products are made-to-order and ship in 10 business days and typically deliver within 15 business days.

Warranty

For warranty information, please go to <http://www.coalesse.com/warranty/>.

Sustainability

Sustainability

At Steelcase, we believe business can be a force for good. We create long-lasting products that are better for people and better for the planet. Our products and operations use life cycle thinking to meet our commitment to reducing climate change. This commitment is reinforced by practices such as designing to minimize global warming and other life cycle impacts, ensuring material health, and enabling end-of-use strategies.

To learn more at a corporate level, visit: <https://www.steelcase.com/discover/steelcase/esg-overview/environmental/>

Product Environmental Profiles, which provide key environmental attributes such as recycled content, embodied carbon and recyclability, as well as product certifications can be found by searching for Steelcase at *Origin.build*.

Collections

Await Collection

- Occasional Tables ▶ See *Coalesse Tables, Storage, and Accessories Specification Guide*
- Lounge Seating ▶ See *Coalesse Seating Specification Guide*

Bix Collection

- Collaborative and Conference Tables ▶ See *Coalesse Tables, Storage, and Accessories Specification Guide*
- Occasional Tables ▶ See *Coalesse Tables, Storage, and Accessories Specification Guide*
- Lounge Seating ▶ See *Coalesse Seating Specification Guide*

Bob Collection

- Collaborative and Conference Tables ▶ See *Coalesse Tables, Storage, and Accessories Specification Guide*
- Occasional Tables ▶ See *Coalesse Tables, Storage, and Accessories Specification Guide*
- Lounge Seating ▶ See *Coalesse Seating Specification Guide*
- Guest Seating ▶ See *Coalesse Seating Specification Guide*

Circa Collection

- Occasional Tables ▶ See *Coalesse Seating Specification Guide*
- Lounge Seating ▶ See *Coalesse Seating Specification Guide*

Enea Collection

- Café Tables ▶ See *Coalesse Tables, Storage, and Accessories Specification Guide*
- Occasional Tables ▶ See *Coalesse Tables, Storage, and Accessories Specification Guide*
- Guest Seating ▶ See *Coalesse Seating Specification Guide*
- Stools ▶ See *Coalesse Seating Specification Guide*

Enea Lottus Collection

- Café Tables ▶ See *Coalesse Tables, Storage, and Accessories Specification Guide*
- Occasional Tables ▶ See *Coalesse Tables, Storage, and Accessories Specification Guide*
- Guest Seating ▶ See *Coalesse Seating Specification Guide*
- Stools ▶ See *Coalesse Seating Specification Guide*

Exponents Collection

- Storage ▶ See *Coalesse Tables, Storage, and Accessories Specification Guide*
- Accessories**
 - Lectern
 - Mobile Display Boards

Host Collection

- Collaborative and Conference Tables ▶ See *Coalesse Tables, Storage, and Accessories Specification Guide*
- Storage ▶ See *Coalesse Tables, Storage, and Accessories Specification Guide*

Lagunitas Collection

- Collaborative and Conference Tables ▶ See *Coalesse Tables, Storage, and Accessories Specification Guide*
- Occasional Tables ▶ See *Coalesse Tables, Storage, and Accessories Specification Guide*
- Lounge Seating ▶ See *Coalesse Seating Specification Guide*

Massaud Collection

- Lounge Seating ▶ See *Coalesse Seating Specification Guide*
- Collaboration Seating ▶ See *Coalesse Seating Specification Guide*

Millbrae Collection

- Occasional Tables ▶ See *Coalesse Tables, Storage, and Accessories Specification Guide*
- Lounge Seating ▶ See *Coalesse Seating Specification Guide*

Montara650 Collection

- Café Tables ▶ See *Coalesse Tables, Storage, and Accessories Specification Guide*
- Occasional Tables ▶ See *Coalesse Tables, Storage, and Accessories Specification Guide*
- Guest Seating ▶ See *Coalesse Seating Specification Guide*
- Lounge Seating ▶ See *Coalesse Seating Specification Guide*
- Stools ▶ See *Coalesse Seating Specification Guide*

Passerelle Collection

- Occasional Tables ▶ See *Coalesse Tables, Storage, and Accessories Specification Guide*
- Lounge Seating ▶ See *Coalesse Seating Specification Guide*

Sidewalk Collection

- Lounge Seating ▶ See *Coalesse Seating Specification Guide*
- Collaboration Seating ▶ See *Coalesse Seating Specification Guide*

Switch Collection

- Occasional Tables ▶ See *Coalesse Tables, Storage, and Accessories Specification Guide*
- Lounge Seating ▶ See *Coalesse Seating Specification Guide*
- Guest Seating ▶ See *Coalesse Seating Specification Guide*
- Stools ▶ See *Coalesse Seating Specification Guide*

SW_1 Collection

- Collaborative and Conference Tables ▶ See *Coalesse Tables, Storage, and Accessories Specification Guide*
- Occasional Tables ▶ See *Coalesse Tables, Storage, and Accessories Specification Guide*
- Lounge Seating ▶ See *Coalesse Seating Specification Guide*
- Collaboration Seating ▶ See *Coalesse Seating Specification Guide*

Statement of Line

Lounge Seating

Await Lounge System

Understanding
▶ Page 28
Specifying
▶ Page 30

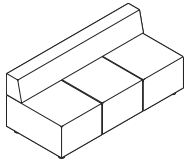

3-Seat Lounge

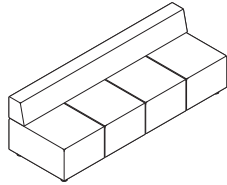

4-Seat Lounge

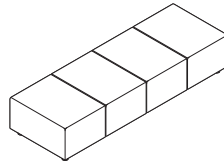

4-Seat Bench



Mobile Ottoman

Await Lounge System Connector Benches and Tables

Understanding
▶ Page 28
Specifying
▶ Pages 32 and 33

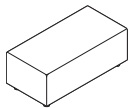

1-Section Connector Bench

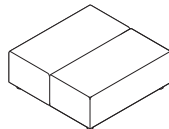

2-Section Connector Bench

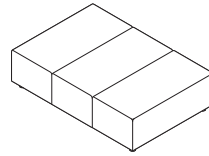

3-Section Connector Bench

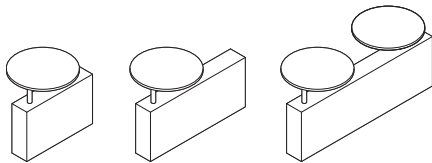

Connector Tables

Bix Lounge System Lounge Chairs

Understanding
▶ Page 36
Specifying
▶ Page 43

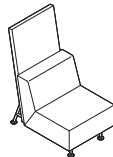

Bix Lounge System Sled Lounge Chairs

Understanding
▶ Page 36
Specifying
▶ Page 44

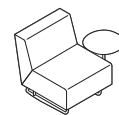
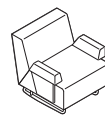
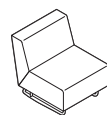

Statement of Line

Lounge Seating, continued

Bix Lounge System Sectional Seating

- Understanding
- ▶ Page 36
- Specifying
- ▶ Page 46

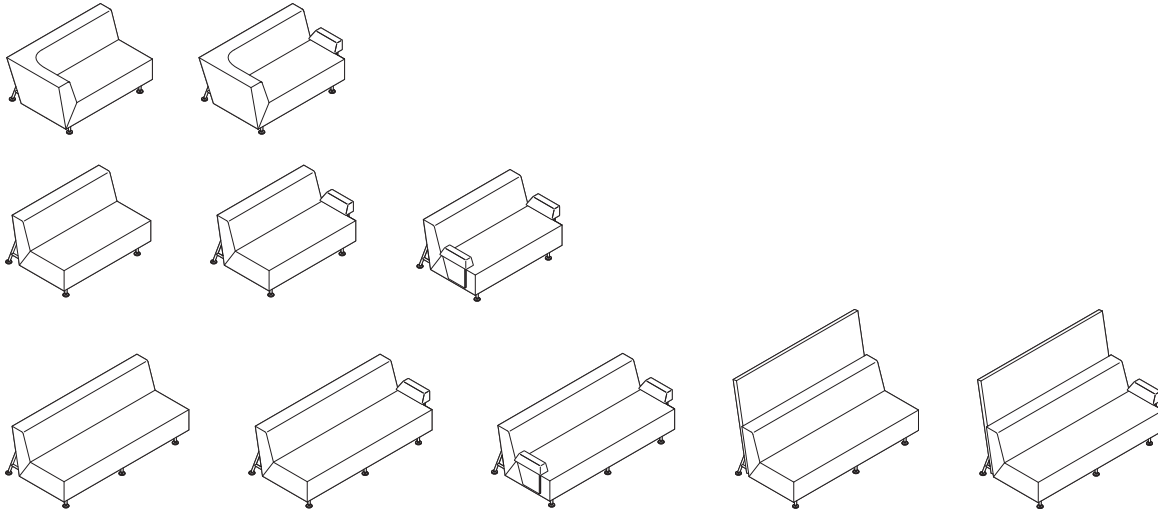

Bix Lounge System Benches

- Understanding
- ▶ Page 36
- Specifying
- ▶ Page 50

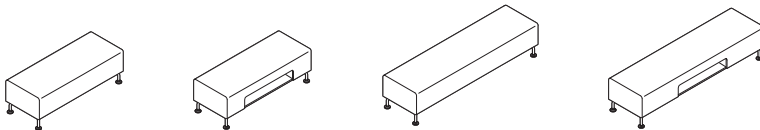

Bob Lounge Chairs

- Understanding
- ▶ Page 54
- Specifying
- ▶ Page 56



Lounge Chair

Lounge Chair with Headrest

Ottoman

Statement of Line *continued*

Lounge Seating, continued

Circa Lounge System

Understanding
▶ Page 60
Specifying
▶ Page 66

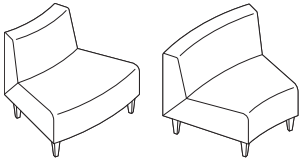

30° Outside/Inside Facing Wedge
1-Seat Lounge

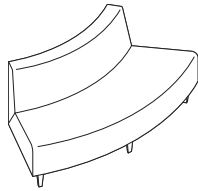

60° Wedge 2-Seat Lounge

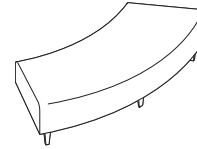
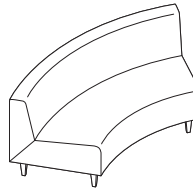

Wedge Bench

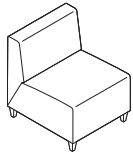
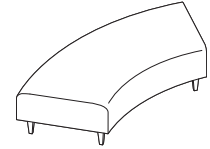

Straight 1-Seat
Lounge

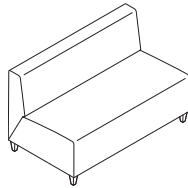

Straight 2-Seat
Lounge

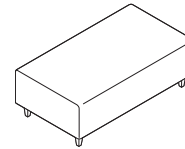

Straight Bench

Circa Lounge System Upholstered Modular Arm Rests and Ottoman

Understanding
▶ Page 60
Specifying
▶ Page 70



Straight Armrest
Intermediate without
Legs



Straight Armrest
End-of-Run with Two Legs



15° Inside Armrest
Intermediate without Legs



15° Inside Armrest
End-of-Run with Two Legs



15° Outside Armrest
Intermediate without Legs



15° Outside Armrest
End-of-Run with Two Legs

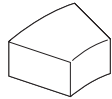

30° Inside Armrest
Intermediate without Legs

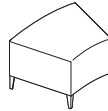

30° Inside Armrest
End-of-Run with Two Legs

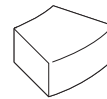

30° Outside Armrest
Intermediate without Legs

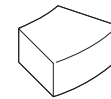

30° Outside Armrest
End-of-Run with Two Legs

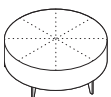



Round Ottoman

Statement of Line

Lounge Seating, continued

Circa Lounge System Ganging and Occasional Tables

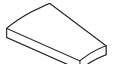
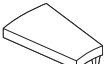
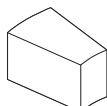
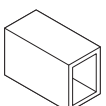
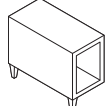
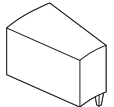
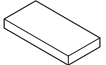
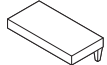
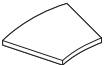
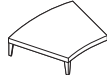
Understanding
 ▶ Page 60
 Specifying
 ▶ Page 72

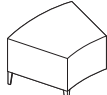
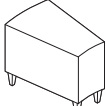
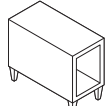
				
15° Low Wedge Table, Ganging	15° Low Wedge Table, End-of-Run, Two Legs	15° High Wedge Table, Ganging	Straight High Table, Ganging	Straight High Table, End-of-Run, Two Legs
				
15° High Wedge Table, End-of-Run, Two Legs	Straight Low Table, Ganging	Straight Low Table, End-of-Run, Two Legs	30° Low Wedge Table, Ganging	30° Low Wedge Table, End-of-Run, Two Legs
				
30° End-of-Run with One Leg	30° High Wedge Table, Ganging	30° High Wedge Table, End-of-Run, Two Legs	High Wedge	High Straight

Circa Lounge System Freestanding Round Table

Understanding
 ▶ Page 60
 Specifying
 ▶ Page 75

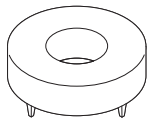

Round

Coupe Lounge Seating

Understanding
 ▶ Page 78
 Specifying
 ▶ Page 79

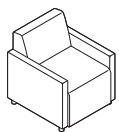

Lounge Chair

Statement of Line *continued*

Lounge Seating, continued

Coupe Grande/Mobile Lounge Seating

Understanding
▶ Page 78
Specifying
▶ Page 80

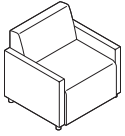

Grande Lounge Chair

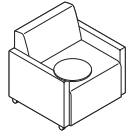

Grande Mobile Lounge Chair

Davos Lounge Seating

Understanding
▶ Page 81
Specifying
▶ Page 82

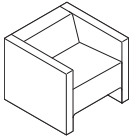

Lounge Chair

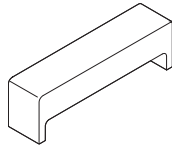

Large Bench

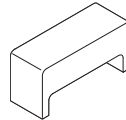

Medium Bench



Small Bench

Hosu Lounge Seating

Understanding
▶ Page 84
Specifying
▶ Page 86

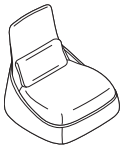

Lounge Chair with Lumbar Pillow

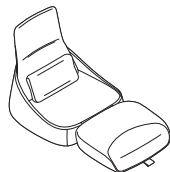

Lounge Chair with Ottoman and Lumbar Pillow

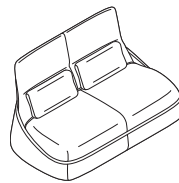

2-Seat Lounge with Two Lumbar Pillows

Joel Lounge Chair

Understanding
▶ Page 89
Specifying
▶ Page 90



Statement of Line

Lounge Seating, continued

Lagunitas Lounge System

Understanding
▶ Page 92
Specifying
▶ Pages 112–141

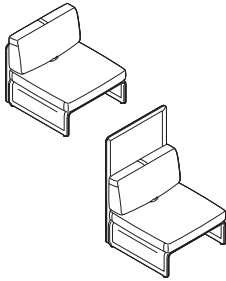

1-Seat Lounges

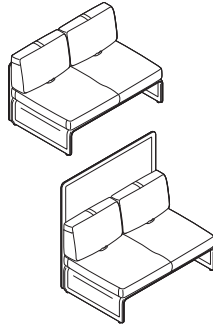

2-Seat Lounges

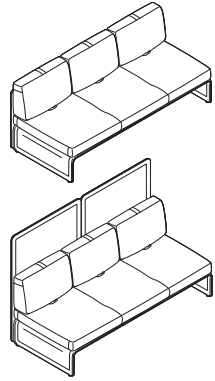

3-Seat Lounges

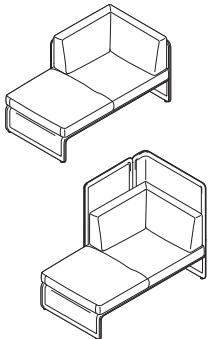

2-Seat Chaises

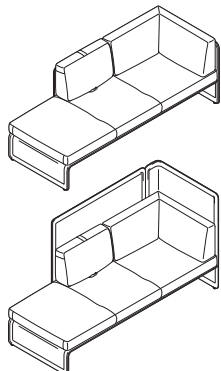

3-Seat Chaises

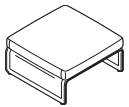

1-Seat Bench

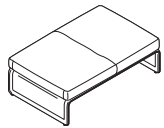

2-Seat Bench

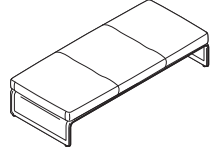

3-Seat Bench

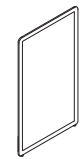

Lounge Booth
Connector Screen

Statement of Line *continued*

Lounge Seating, continued

Lagunitas Focus Nook

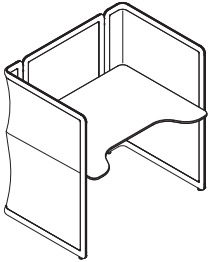

Understanding
▶ Page 142
Specifying
▶ Page 144

LessThanFive Lounge

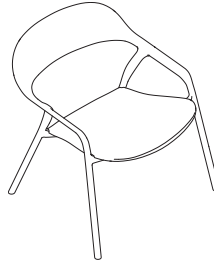

Understanding
▶ Page 146
Specifying
▶ Page 147

Marien152 Lounge Seating

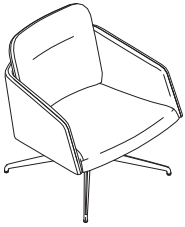

Metal Base Lounge

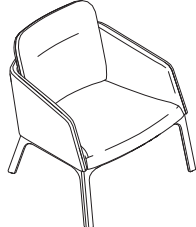

Wood Base Lounge

Understanding
▶ Page 148
Specifying
▶ Page 150

Massaud Lounge Seating



Lounge



Work Lounge



Ottoman

Understanding
▶ Page 154
Specifying
▶ Page 156

Millbrae Lifestyle Lounge Seating

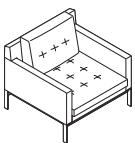

Lounge

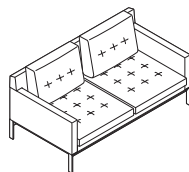

2-Seat Lounge

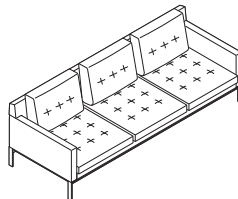

3-Seat Lounge



Round Arm Bolster



Square Arm Bolster

Understanding
▶ Page 160
Specifying
▶ Page 164

Statement of Line

Lounge Seating, continued

Millbrae Contract Lounge Seating

Understanding
▶ Page 162
Specifying
▶ Page 164

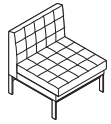

Lounge
without Arms



Lounge
with Arms



Lounge
with Left Arm Facing

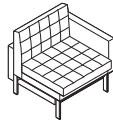

Lounge
with Right Arm Facing

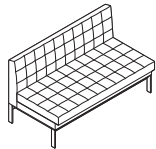

2-Seat Lounge
without Arms

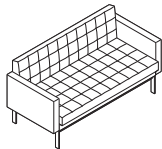

2-Seat Lounge with
Arms

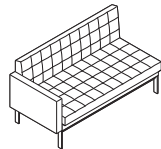

2-Seat Lounge
with Left Arm Facing

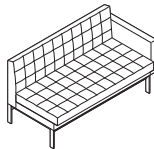

2-Seat Lounge
with Right Arm Facing

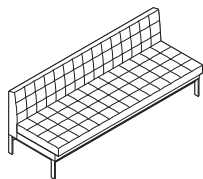

3-Seat Lounge
without Arms

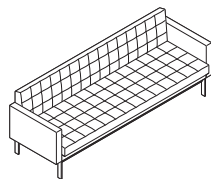

3-Seat Lounge
with Arms

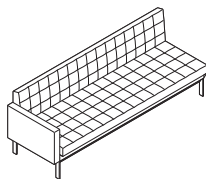

3-Seat Lounge
with Left Arm Facing

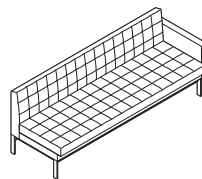

3-Seat Lounge
with Right Arm Facing

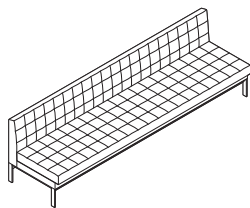

4-Seat Lounge
without Arms

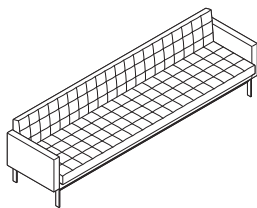

4-Seat Lounge
with Arms

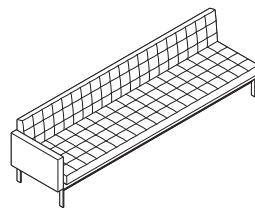

4-Seat Lounge
with Left Arm Facing

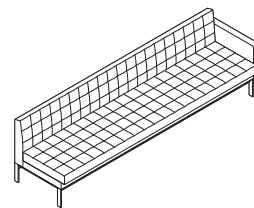

4-Seat Lounge
with Right Arm Facing

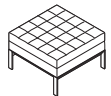

1-Seat
Bench

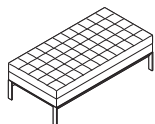

2-Seat Bench

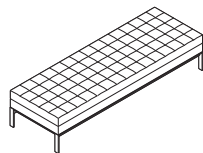

3-Seat Bench

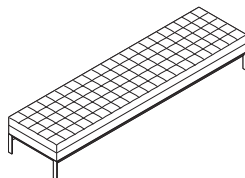

4-Seat Bench

Statement of Line *continued*

Lounge Seating, continued

Montara650 Lounge Chair

Understanding
▶ Page 172
Specifying
▶ Page 174



Wood Shell with Upholstered Seat,
Wood Shell with $\frac{3}{4}$ Upholstery,
and Fully Upholstered

Montara650 Rocker

Understanding
▶ Page 176
Specifying
▶ Page 178



Wood Shell with Upholstered Seat,
Wood Shell with $\frac{3}{4}$ Upholstery,
and Fully Upholstered

Passerelle Lounge Seating

Understanding
▶ Page 182
Specifying
▶ Pages 184–186

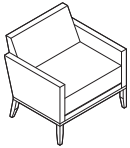

Lounge Chair

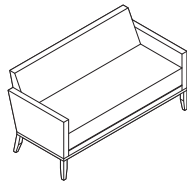

2-Seat Lounge

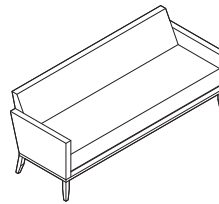

3-Seat Lounge



Arm Bolster

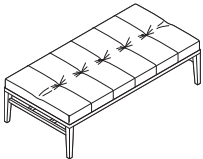

Benches

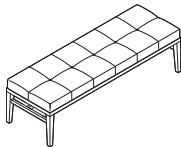

Ripple Benches

Understanding
▶ Page 188
Specifying
▶ Page 190

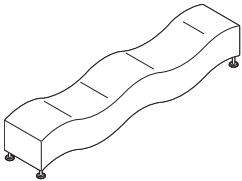

Upholstered
Wave Seat

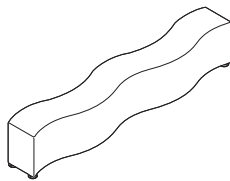

Upholstered
Flat Seat

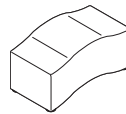

Little Ripple
Wave Seat

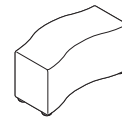

Little Ripple
Flat Seat

Statement of Line

Lounge Seating, continued

Sidewalk Lounge Seating

Understanding
▶ Page 194
Specifying
▶ Page 196

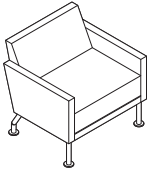

Low-Back Lounge Chair

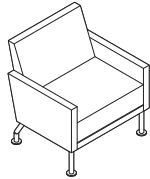

High-Back Lounge Chair

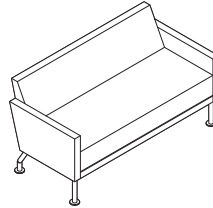

2-Seat Lounge

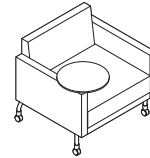

Mobile Low-Back Lounge Chair with Tablet

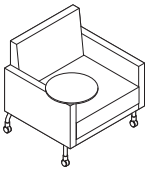

Mobile High-Back Lounge Chair with Tablet



Arm Bolster

Sidewalk Collaborative Lounge Seating

Understanding
▶ Page 200
Specifying
▶ Page 202

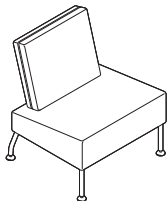

Lounge Chair

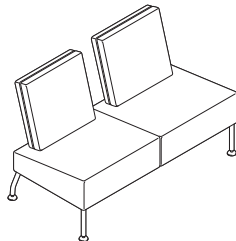

2-Seat Lounge

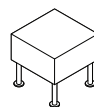

Ottoman

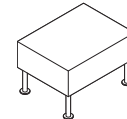
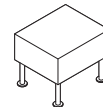

Sidewalk Lounge Seating Ottoman/Benches

Understanding
▶ Page 200
Specifying
▶ Page 204

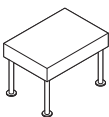

Bench

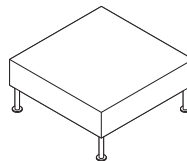
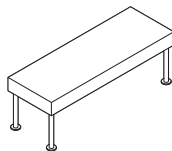
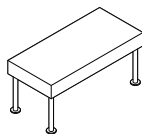

Ottoman

Statement of Line *continued*

Lounge Seating, continued

Sistema Lounge System, Leg Base

Understanding
▶ Pages 206–208
Specifying
▶ Pages 212-218

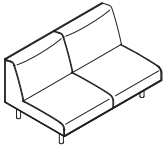

2-Seat Lounge

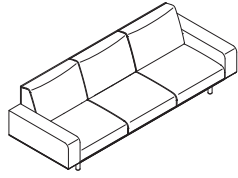

3-Seat Lounge



End Legs



Connector Frame With Legs

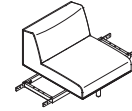

1-Seat Connector Lounge



Power Module

Tip: Legs are not included with 2- and 3-seat lounges and must be ordered separately.

Sistema Lounge System, Fully Upholstered Base

Understanding
▶ Page 210
Specifying
▶ Page 220

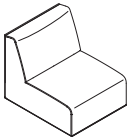

Lounge Chair, Armless

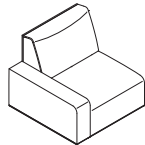

Lounge Chair, Right Arm

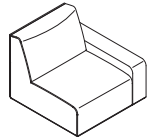

Lounge Chair, Left Arm

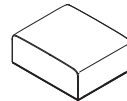

Backless Bench Lounge

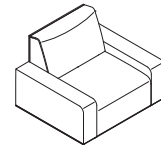

Lounge Chair, With Arms

Sistema Lounge System Accessories

Understanding
▶ Page 211
Specifying
▶ Pages 224-227



Round Ottoman

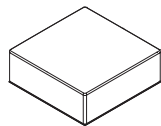

Square Ottoman



Arm Bolster, Moveable



Moveable Table



Square Pillow



Lumbar Pillow

Statement of Line

Lounge Seating, continued

SW_1 Lounge Seating

- Understanding
- Page 230
- Specifying
- Page 232



Low-Back Collaborative Lounge Chair



High-Back Collaborative Lounge Chair



Ottoman

Switch Lounge Seating

- Understanding
- Page 236
- Specifying
- Page 238



Lounge Chair

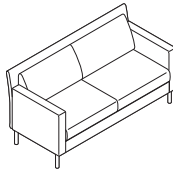

2-Seat Lounge

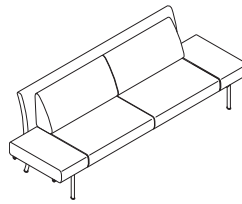

2-Seat Lounge with Extensions

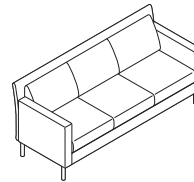

3-Seat Lounge



Arm Bolster

Thoughtful Lounge Seating

- Understanding
- Page 242
- Specifying
- Page 244

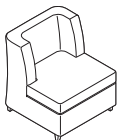

Lounge Chair

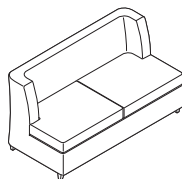

Small Lounge

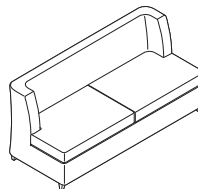

Medium Lounge

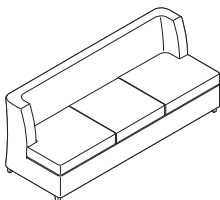

Long Lounge

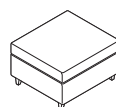

Ottoman

Lounge Seating, continued

Together Benches

Understanding
 ▶ Page 248
 Specifying
 ▶ Page 250

70½"D 96¼"W 31"H

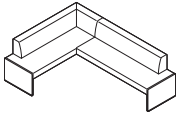

Left Corner with Back 8" Offset

97¼"D 96¼"W 31"H

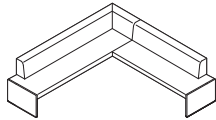

70½"D 96¼"W 31"H

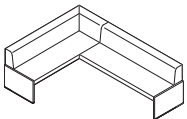

Right Corner with Back 8" Offset

97¼"D 96¼"W 31"H

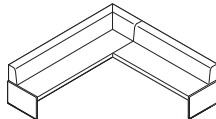

70½"D 96¼"W 31"H

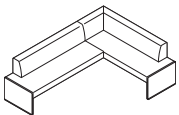

Right Corner with Back 1.5" Offset

97¼"D 96¼"W 31"H

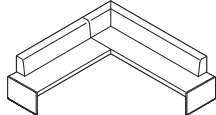

70½"D 96¼"W 31"H

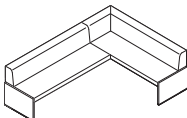

Straight with 8" Offset Back

97¼"D 96¼"W 31"H

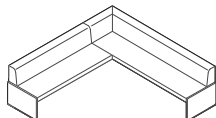

26¾"D 71"W 31"H

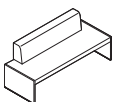

Straight without Back

26¾"D 97¾"W 31"H

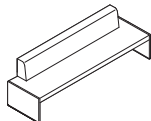

70½"D 123"W 31"H

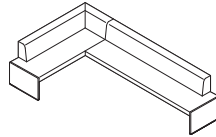

70½"D 123"W 31"H

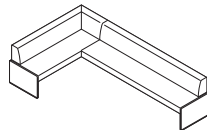

70½"D 123"W 31"H

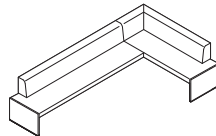

70½"D 123"W 31"H

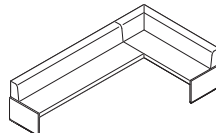

26¾"D 71"W 31"H

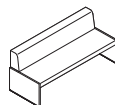

Straight with 8" Offset Back

97¼"D 123"W 31"H

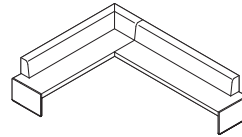

97¼"D 123"W 31"H

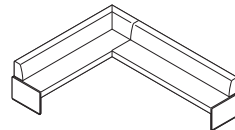

97¼"D 123"W 31"H

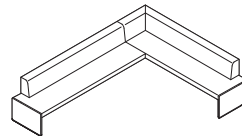

97¼"D 123"W 31"H

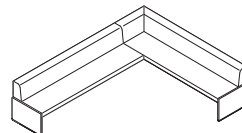

26¾"D 97¾"W 31"H

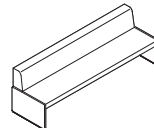

26¾"D 71"W 18½"H

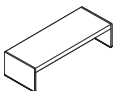

Straight with 8" Offset Back

26¾"D 97¾"W 18½"H

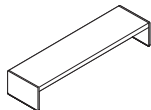

Statement of Line

Lounge Seating, continued

Visalia Lounge Seating

- Understanding
- ▶ Page 258
- Specifying
- ▶ Page 260

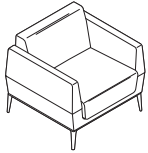

Lounge Chair

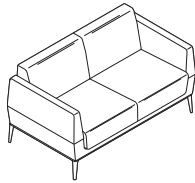

2-Seat Lounge

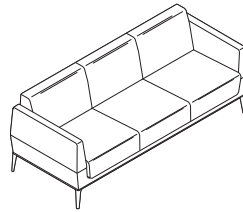

3-Seat Lounge

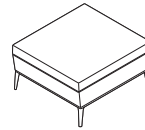

Ottoman

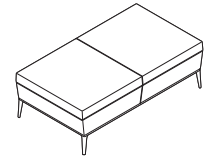

Bench

Collaboration Seating

Bindu Conference Seating

- Understanding
- ▶ Page 266
- Specifying
- ▶ Page 268



Mid-Back Conference Chair



High-Back Conference Chair

Chord Conference Seating

- Understanding
- ▶ Page 270
- Specifying
- ▶ Page 272



Conference Narrow



Mid-Back



High-Back Narrow

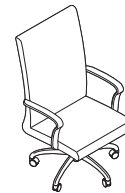

High-Back/Large Scale

Statement of Line *continued*

Collaboration Seating, continued

Marien152 Conference Seating

Understanding
▶ Page 274
Specifying
▶ Page 276



4-Star Conference Chair



5-Star Conference Chair

Lox Seating

Understanding
▶ Page 279
Specifying
▶ Page 280



4-Star Base Chair with Upholstered Seat



4-Star Base Chair with Upholstered Seat and Back



5-Star Base Chair with Upholstered Seat



5-Star Base Chair with Upholstered Seat and Back

Massaud Conference Seating

Understanding
▶ Page 282
Specifying
▶ Page 284

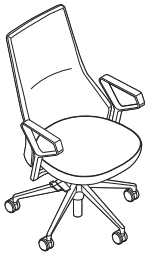

Mid-Back Conference Chair with Loop Arm



Mid-Back Duvet Conference Chair with Loop Arm



Low-Back Conference Chair with Integrated Arm



Low-Back Duvet Conference Chair with Integrated Arm



Mid-Back Conference Chair with Integrated Arm

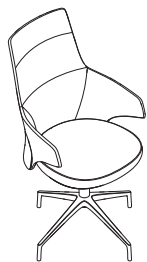

Mid-Back Duvet Conference Chair with Integrated Arm

Statement of Line

Collaboration Seating, continued

SW_1 Conference Seating

- ▶ Understanding Page 289
- ▶ Specifying Page 290



Conference Chair with 4-Star Base



Conference Chair with 5-Star Base

Guest Seating

Bindu Chairs



Low-Back Chair



Mid-Back Chair

- ▶ Understanding Page 294
- ▶ Specifying Page 295

Bob Chair



Guest Chair

- ▶ Understanding Page 296
- ▶ Specifying Page 297

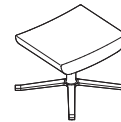

Ottoman

Capa Chair



- ▶ Understanding Page 299
- ▶ Specifying Page 300

Statement of Line *continued*

Guest Seating, continued

Enea Stacker Chairs

Understanding
 ▶ Page 301
 Specifying
 ▶ Pages 302-304



Wood Seat and Back with Arms



Metal Stacker with Upholstered Seat and Back with Arms



Metal Stacker with Upholstered Seat and Wood Back with Arms

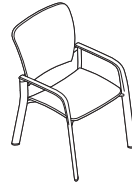

Metal Stacker with Polypropylene Seat and Back with Arms



Wood Seat and Back Without Arms



Upholstered Seat and Back Without Arms



Upholstered Seat and Wood Back Without Arms

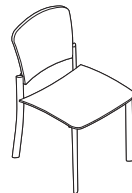

Polypropylene Seat and Back Without Arms

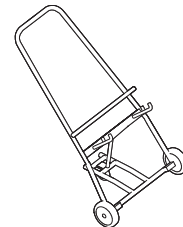

Dolly

Enea Lottus Chairs

Understanding
 ▶ Page 306
 Specifying
 ▶ Pages 308-311



Armless Chair



Cantilever Arm Chair



Aluminum Loop Arm Chair

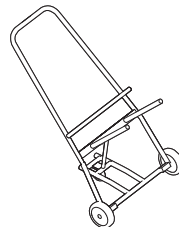

Dolly

Enea Altzo943 Chairs

Understanding
 ▶ Page 312
 Specifying
 ▶ Pages 313



Armless Chair



Armless Chair with Upholstered Cushion Insert

Kathryn Chairs

Understanding
 ▶ Page 314
 Specifying
 ▶ Page 316

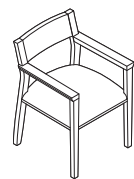

Open Wood Back

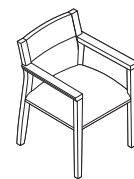

Upholstered Wood Back Panel

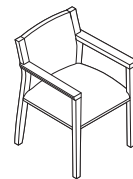

Fully Upholstered Back

Statement of Line

Guest Seating, continued

LessThanFive Chairs



Understanding
▶ Page 318
Specifying
▶ Page 319

Marien152 Guest Seating

Understanding
▶ Page 320
Specifying
▶ Pages 322-323



Wood Base Chair



Metal Base Chair

Montara650 Chairs

Understanding
▶ Page 326
Specifying
▶ Page 328



Wood Shell, Wood Shell with Upholstered Seat, Wood Shell with ³/₄ Upholstery, and Fully Upholstered

Switch Chairs

Understanding
▶ Page 331
Specifying
▶ Page 332

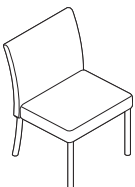

Armless Chair

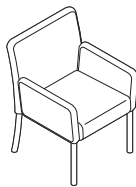

Arm Chair

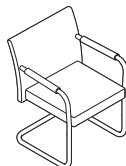

Low-Back Sled Base Chair

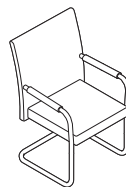

High-Back Sled Base Chair

Wrapp Chairs

Understanding
▶ Page 334
Specifying
▶ Page 335

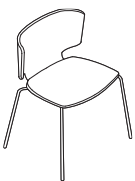

4-Leg Chair

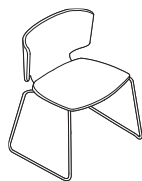

Sled-Base Chair

Statement of Line *continued*

Stools

Enea Bar Stools

Understanding
▶ Page 338
Specifying
▶ Pages 340–342

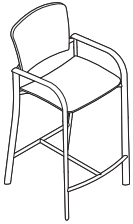

Bar-Height Stool with Wood Seat and Back with Arms

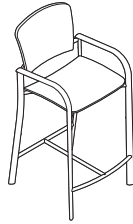

Bar-Height Stool with Upholstered Seat and Back with Arms

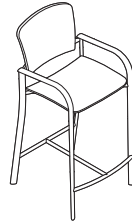

Bar-Height Stool with Upholstered Seat and Wood Back with Arms

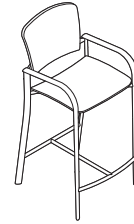

Bar-Height Stool with Polypropylene Seat and Back with Arms

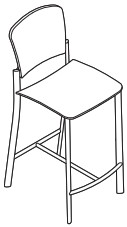

Bar-Height Stool with Wood Seat and Back without Arms

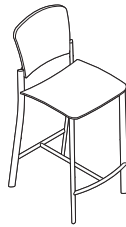

Bar-Height Stool with Upholstered Seat and Back without Arms

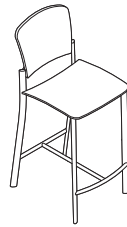

Bar-Height Stool with Upholstered Seat and Wood Back without Arms

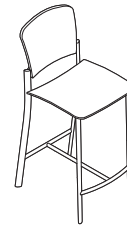

Bar-Height Stool with Polypropylene Seat and Back without Arms

Enea Café Post Stools

Understanding
▶ Page 344
Specifying
▶ Pages 346–348



Café Counter-Height Stool



Café Bar-Height Stool



Low Stool Upholstered Seat



Café Counter-Height Stool Upholstered Seat



Café Bar-Height Stool Upholstered Seat



Low Stool



Café Counter-Height Stool



Café Bar-Height Stool

Statement of Line

Stools, continued

Enea Café Wood Stools

Understanding
▶ Page 350
Specifying
▶ Page 352



Café Wood Counter-Height Stool Upholstered Seat



Café Wood Bar-Height Stool Upholstered Seat



Café Wood Counter-Height Stool



Café Wood Bar-Height Stool

Enea Lottus Stools

Understanding
▶ Pages 354 and 358
Specifying
▶ Pages 356 and 360

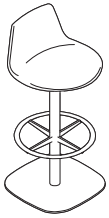

Counter-Height Post Base Stool

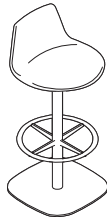

Bar-Height Post Base Stool



Counter-Height Sled Base Stool



Bar-Height Sled Base Stool

Enea Altzo943 Stools

Understanding
▶ Page 362
Specifying
▶ Page 363



Counter-Height Stool



Bar-Height Stool



Counter-Height Stool with Upholstered Cushion Insert



Bar-Height Stool with Upholstered Cushion Insert

LessThanFive Stool

Understanding
▶ Page 364
Specifying
▶ Page 365

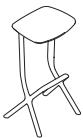

Lox Stools

Understanding
▶ Page 366
Specifying
▶ Page 367



Counter-Height Stool



Bar-Height Stool

Statement of Line *continued*

Stools, continued

Marien152 Stools

Understanding
▶ Page 368
Specifying
▶ Page 370

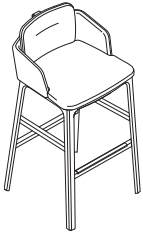

Metal Base Bar Stool

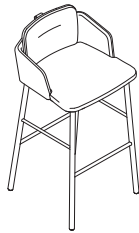

Wood Base Bar Stool



Metal Base Counter Stool



Wood Base Counter Stool

Montara650 Stools

Understanding
▶ Page 375
Specifying
▶ Page 376



Counter-Height or
Bar-Height Stool: Wood
Shell, Wood Shell with
Upholstered Seat, and
Fully Upholstered

Switch Stools

Understanding
▶ Page 378
Specifying
▶ Page 379

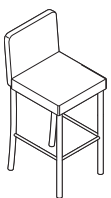

Counter-Height Stools

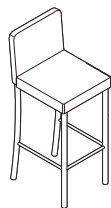

Bar-Height Stools

Lounge Seating

*These product lines are collections and will be found in multiple locations in this specification guide and/or *Coalesse Tables, Storage, and Accessories Specification Guide*.

▶ See *Collections*, page 5

Await Lounge System*	28
Bix Lounge System*	36
Bob Lounge Chairs*	54
Circa Lounge System*	60
Coupe/Coupe Grande/Mobile Lounge Seating	78
Davos Lounge Seating	81
Hosu Lounge Seating	84
Joel Lounge Chair	89
Lagunitas Lounge System*	92
Lagunitas Focus Nook	142
LessThanFive Lounge	146
Marien152 Lounge Seating*	148
Massaud Lounge Seating*	154
Millbrae Lifestyle/Contract Lounge Seating*	160
Montara650 Lounge Chair*	172
Montara650 Rocker*	176
Passerelle Lounge Seating*	182
Ripple Benches	188
Sidewalk Lounge Seating	194
Sidewalk Collaborative Lounge Seating	200
Sistema Lounge System	206
SW_1 Lounge Seating*	230
Switch Lounge Seating*	236
Thoughtful Lounge Seating	242
Together Benches	248
Visalia Lounge Seating	258

Await Lounge System

DESIGN E00S

The Await lounge system

is the perfect solution for a variety of settings. Its staggered ganging capabilities offer versatility and functionality in transforming spaces.

Tip: This product line is a collection and will be found in multiple locations in this specification guide and/or Coalesse Tables, Storage, and Accessories Specification Guide.

► See *Collections*, page 5.

Upholstery features a topstitch detail.

Legs are black, high-density polyurethane resin with non-adjustable glides. Floor mount legs available.

Freestanding tables and connector tables feature a High-Pressure Laminate top with a 3 mm edge band. ½" thick glass top with radiused edges is also available.

Seat features multiple densities of polyurethane foam and spring packs for added comfort.

Casters are standard on ottoman and are non-locking.

Connector tables attach to seating units with ¼" ganging plates. Power/data modules are also available.

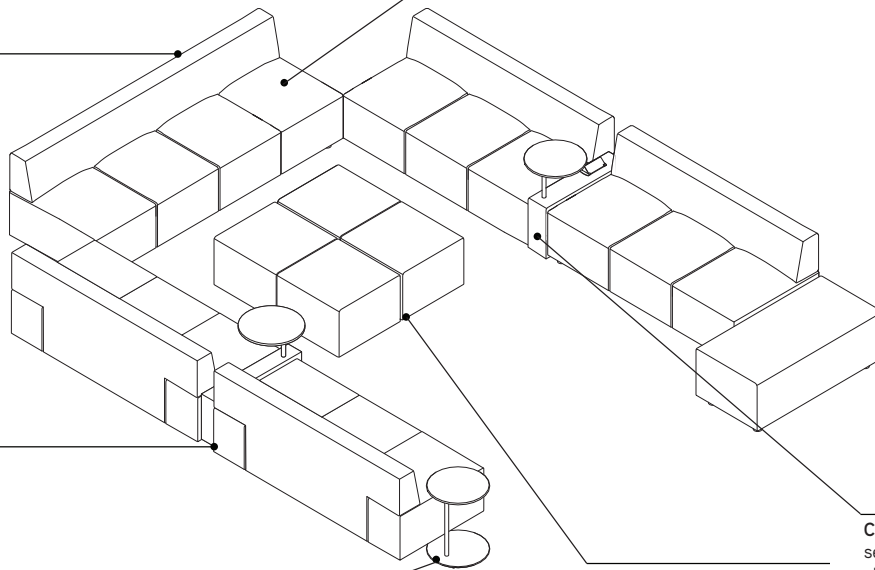

Await Lounge System

DESIGN EOOS

Product Details

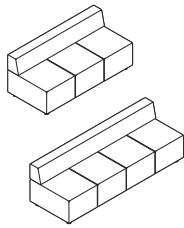

Lounge is available in 3- or 4-seat.

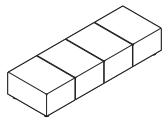

4-seater bench provides a backless seating option.

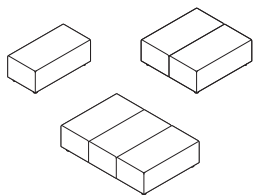

Connector benches are available in 1-, 2-, and 3-sections and feature a fixed seat with top and double needle stitching on seams. Ganging kit is available.

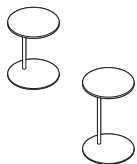

Freestanding tables are 15³/₄" diameter, and available in two heights: 19"H and 25"H. Standard with silver frame.
▶ See *Coalesse Tables, Storage, and Accessories Specification Guide*.

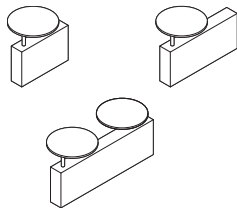

Connector tables are 4¹/₂"W and comes in three diameters: 20"D, 28"D, and 42"D; and in two heights: 15³/₄"H and 25³/₈"H. The tablet is 15³/₄" diameter and 1/4" thick. Bottom connecting ganging plate is standard. Power/data module is available. Panels are available in black, white, or gray.
Tip: Connector tables are not made for ganging to Await mobile ottoman.

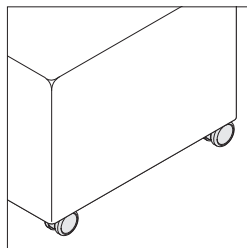

Ottoman standard with non-locking casters.

Surface Materials

▶ See *Coalesse Surface Materials Reference Guide* for further information.

Upholstery

- Fabric
- Leather

Table/Tablet Top

- Laminate
- Glass

Program and Services

Customer's Own Material/Leather (COM/COL) Program is available.

▶ See *Coalesse Surface Materials Reference Guide* for additional information.

Await Lounge System

DESIGN E00S

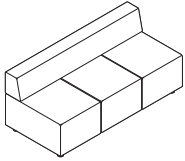

Tip: Recommended leathers are Elmosoft Grade C and Elmorustical Grade E.

Tip: Special color match, consult Customer Service.

Tip: For Customer's Own Material or Leather, see necessary requirements, important processing instructions, and ordering information
 ▶ See Coalesse Surface Materials Reference Guide.

Tip: Contrasting option available only on lounges.

Tip: Please include sketch for ganging.

Tip: Fabrics and leathers will appear loose with comfort wrinkles when upholstered.

Standard Includes	Required to Specify
-------------------	---------------------

<p>▶ Need help? Product details, page 28</p> <ul style="list-style-type: none"> • Frame: unibody construction with finger-jointed plywood • Multiple densities of polyurethane foam and polyester foam and polyester fiber • Lounge: <ul style="list-style-type: none"> - Seat and back: fabric or leather - Legs: black high-density polyurethane resin - Glides: non-adjustable • Ottoman: <ul style="list-style-type: none"> - Seat: fabric or leather - Casters: non-locking 	<ol style="list-style-type: none"> 1 Style number 2 Number of fabrics if contrasting fabric style number is selected 3 Fabric or leather color number for upholstery on seat and back 4 Options, if selected (see below) <p>▶ See <i>Coalesse Surface Materials Reference Guide</i>.</p>
---	--

Options	U.S. Price	Required to Specify
---------	------------	---------------------

<p>Surface Materials</p> <ul style="list-style-type: none"> • Contrasting fabric <hr/> <p>Acrylic backer</p> <ul style="list-style-type: none"> • 3-seat lounge • 4-seat lounge • 4-seat bench • Ottoman 	<p>+\$182 per fabric</p> <hr/> <p>+\$ 84 +\$105 +\$ 74 +\$ 24</p>	<p>Add suffix K to the style number and select fabric color number.</p> <hr/> <p>Specify with acrylic backer. Specify with acrylic backer. Specify with acrylic backer. Specify with acrylic backer.</p> <p>▶ See <i>Coalesse Surface Materials Reference Guide</i>.</p>
<p>Floor Mount Legs</p> <ul style="list-style-type: none"> • Floor mount legs 	<p>+\$191 per unit</p>	<p>Specify with floor mount legs.</p>

<p>Related Products</p> <ul style="list-style-type: none"> • Connector benches and tables • Occasional tables 	<p>▶ Pages 32 and 33 ▶ See <i>Coalesse Tables, Storage, and Accessories Specification Guide</i>.</p>
--	---



For Canadian Pricing
 Multiply U.S. Price by the Canadian price factor.
 ▶ See page 1 for details.

Await Lounge System

DESIGN EOOS

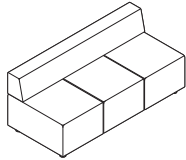

Overall: 30"D 66"W 27"H
 Inside: 22"D 66"W 27"H
 Seat: 16½"H
 Arm: 10½"H

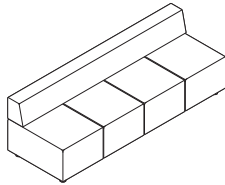

Overall: 30"D 88"W 27"H
 Inside: 22"D 88"W 27"H
 Seat: 16½"H
 Arm: 10½"H

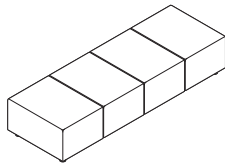

Overall: 30"D 88"W 16½"H
 Seat: 16½"H



Overall: 22"D 22"W 16½"H

Specification Information

Style Number	U.S. Base Prices													
	Fabric Grades:											Leather Grades:		
	COM	6	7	8	9	10	11	12	13	14	COL	C	E	

3-Seat Lounge

460-3	\$ 5178	\$ 5246	\$ 5305	\$ 5400	\$ 5691	\$ 5882	\$ 6103	\$ 6253	\$ 6522	\$ 6900	\$ 5393	\$ 9216	\$ 9907
-------	---------	---------	---------	---------	---------	---------	---------	---------	---------	---------	---------	---------	---------

COM/yds = 5¾, COL/sq ft = 147

4-Seat Lounge

460-4	\$ 6316	\$ 6465	\$ 6534	\$ 6656	\$ 7025	\$ 7264	\$ 7539	\$ 7731	\$ 8073	\$ 8549	\$ 6531	\$ 11,380	\$ 12,241
-------	---------	---------	---------	---------	---------	---------	---------	---------	---------	---------	---------	-----------	-----------

COM/yds = 7¼, COL/sq ft = 185

4-Seat Bench

460-4B	\$ 4682	\$ 4739	\$ 4796	\$ 4885	\$ 5166	\$ 5346	\$ 5556	\$ 5703	\$ 5960	\$ 6320	\$ 4897	\$ 8556	\$ 9209
--------	---------	---------	---------	---------	---------	---------	---------	---------	---------	---------	---------	---------	---------

COM/yds = 5½, COL/sq ft = 100

Mobile Ottoman

460-H	\$ 1156	\$ 1156	\$ 1172	\$ 1196	\$ 1274	\$ 1321	\$ 1380	\$ 1420	\$ 1488	\$ 1586	\$ 1519	\$ 2468	\$ 2640
-------	---------	---------	---------	---------	---------	---------	---------	---------	---------	---------	---------	---------	---------

COM/yds = 1½, COL/sq ft = 33

Lounge Seating

 **For Canadian Pricing**
 Multiply U.S. Price by the
 Canadian price factor.
 ▶ See page 1 for details.

Await Lounge System Connector Benches

DESIGN E00S

Tip: Recommended leathers are Elmosoft Grade C and Elmorustical Grade E.

Tip: Special color match, consult Customer Service.

Tip: For Customer's Own Material or Leather, see necessary requirements, important processing instructions, and ordering information
 ▶ See *Coalesse Surface Materials Reference Guide*.

Tip: Please include sketch for ganging.

Tip: Fabrics and leathers will appear loose with comfort wrinkles when upholstered.

Standard Includes		Required to Specify	
▶ Need help? Product details, page 29	<ul style="list-style-type: none"> Bench: fabric or leather Frame: unibody construction with finger-jointed plywood Multiple densities of polyurethane foam Fixed seat Top and double needle stitching on seams Legs: black high-density polyurethane resin Glides 	1 Style number	2 Fabric or leather color number for upholstery on bench
		3 Options, if selected (see below)	▶ See <i>Coalesse Surface Materials Reference Guide</i> .

Options	U.S. Price	Required to Specify	
Surface Materials	Acrylic backer		
• 1-section connector bench	+\$ 33	Specify with acrylic backer.	
• 2-section connector bench	+\$ 50	Specify with acrylic backer.	
• 3-section connector bench	+\$ 76	Specify with acrylic backer.	
		▶ See <i>Coalesse Surface Materials Reference Guide</i> .	
Floor Mount Legs	• Field-installed Floor mount legs	+\$191 per unit	Specify with floor mount legs.
Related Products	• Occasional tables		▶ See <i>Coalesse Tables, Storage, and Accessories Specification Guide</i> .
	• Lounge seating		▶ Page 30

Specification Information

Style Number	U.S. Base Prices												Leather Grades:			
	Fabric Grades:												COL	C	E	
	COM	6	7	8	9	10	11	12	13	14						

1-Section Connector Bench

461-1B	\$2136	\$2136	\$2159	\$2196	\$2310	\$2384	\$2471	\$2531	\$2639	\$2785	\$2462	\$3921	\$4180
COM/yds = 2¼, COL/sq ft = 53													

2-Section Connector Bench

461-2B	\$3286	\$3286	\$3322	\$3382	\$3574	\$3696	\$3840	\$3937	\$4115	\$4361	\$3531	\$6002	\$6447
COM/yds = 3¾, COL/sq ft = 83													

3-Section Connector Bench

461-3B	\$4527	\$4584	\$4641	\$4730	\$5011	\$5191	\$5401	\$5548	\$5805	\$6165	\$4742	\$8231	\$8854
COM/yds = 5, COL/sq ft = 110													

Ganging Kit

460-GANGPKG	\$ 73
-------------	-------

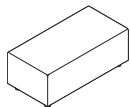

Overall: 44"D 22"W 16½"H

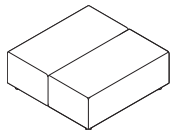

Overall: 44"D 44"W 16½"H

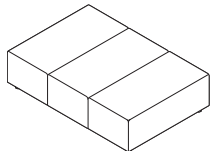

Overall: 44"D 66"W 16½"H



For Canadian Pricing
 Multiply U.S. Price by the Canadian price factor.
 ▶ See page 1 for details.

Await Lounge System Connector Tables

DESIGN EOOS

Tip: Await connector tables are not recommended to be used in end-of-run applications.

Tip: Await connector tables are not made for ganging to Await mobile ottoman.

Standard Includes Required to Specify

► Need help?
Product details, page 29

- Connector table frame: panels are black, white, or gray
- Top: High-Pressure Laminate top with matching 3 mm edge band
- Glass top (tablet):
 - 1/2" thick
 - Radiused edges
- Ganging plate: 1/4" thick ganging plates attach to the bottom of units to the seating unit plates

- 1 Style number
 - 2 Laminate top and tablets, if selected:
 - 2746 Black
 - 2730 Arctic White
 - 290N North Sea
 - 3 Glass color number for top, if selected
- See *Coalesse Surface Materials Reference Guide*.

Related Products

- Occasional tables
- Lounge seating

► See *Coalesse Tables, Storage, and Accessories Specification Guide*.
► Page 30

Specification Information

Style Number	U.S. Prices			Glass Tablet:			
	Laminate Top: No Tablet	Tablet	Power/Data	Acid Etched 6511 Glass Tablet	Acid Etched 6511 Tablet and Power/Data	Back-Painted Glass Tablet	Back-Painted Tablet and Power/Data
460-SE22	\$ 983	\$2257	N.A.	\$2368	N.A.	\$ 2610	N.A.
460-SE22PD	N.A.	N.A.	\$2680	N.A.	\$2869	N.A.	\$ 3112
460-SE30	\$1125	\$2399	N.A.	\$ 2518	N.A.	\$2752	N.A.
460-SE30PD	N.A.	N.A.	\$2832	N.A.	\$ 3021	N.A.	\$3264
460-SE44	\$1381	\$3929	N.A.	\$4042	N.A.	\$ 4519	N.A.
460-SE44PD	N.A.	N.A.	\$4347	N.A.	\$4622	N.A.	\$ 5106

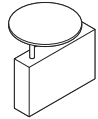

Overall: 20"D 4 1/2"W 15 3/4"H
With Tablet: 15 3/4" Dia. and 25 3/8"H

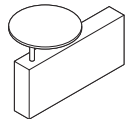

Overall: 28"D 4 1/2"W 15 3/4"H
With Tablet: 15 3/4" Dia. and 25 3/8"H

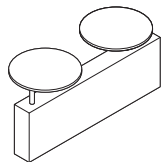

Overall: 42"D 4 1/2"W 25 3/8"H
With Tablets: 15 3/4" Dia. and 25 3/8"H



For Canadian Pricing
Multiply U.S. Price by the Canadian price factor.
► See page 1 for details.

Await Lounge System Ganging Diagrams by Model (Underside View)

DESIGN E00S

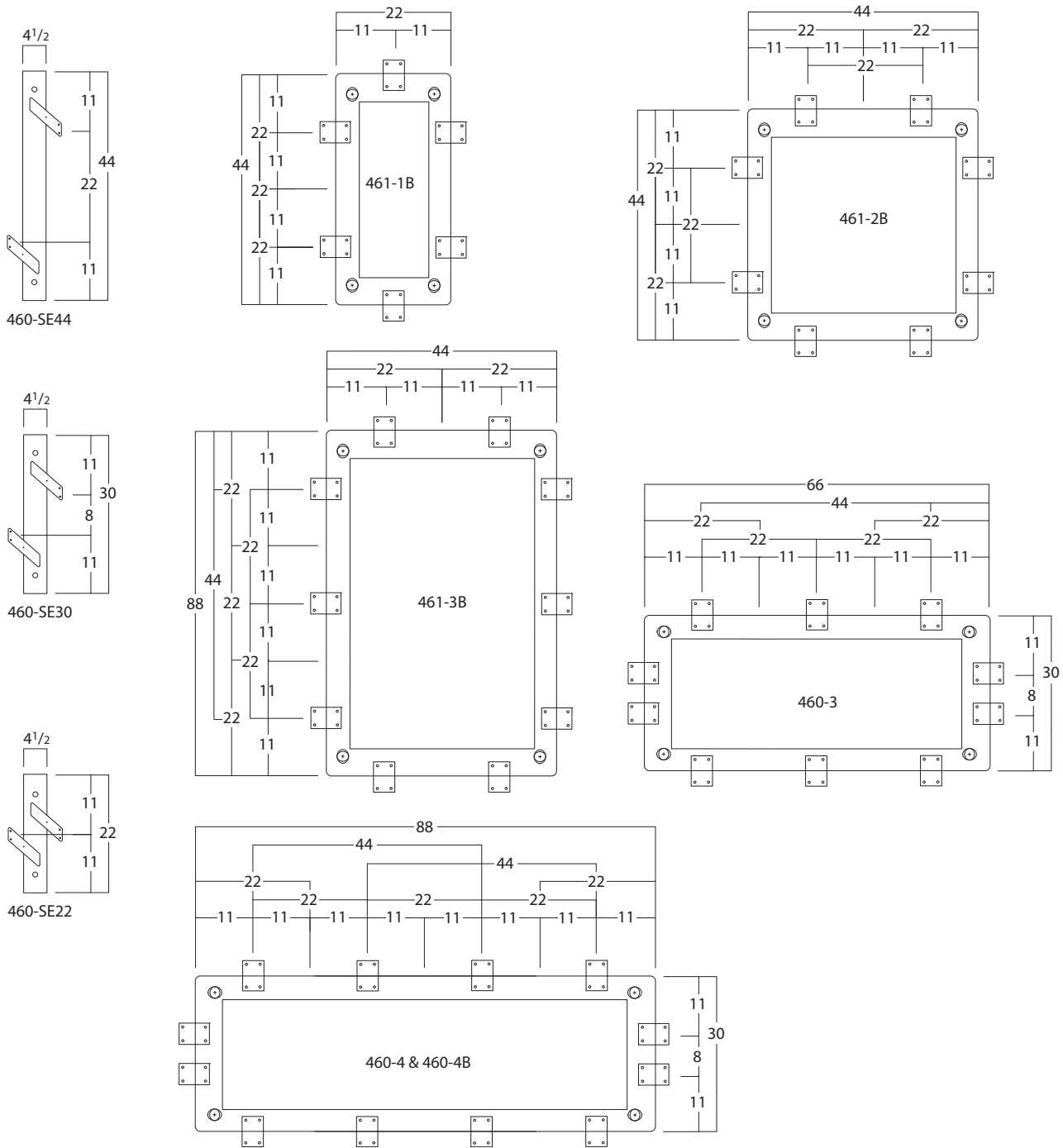

Await Lounge System Multi-Fabric Diagram

DESIGN E00S

TO: _____

FROM: _____

DATE: _____

FAX....888.413.5161

A Seat (upholstery selections default for entire unit if B is not selected): _____

B Back: _____

See specifying for contrasting fabric upcharge. List price based on highest fabric grade usage.

Specify Model below:

460-3K

460-4K

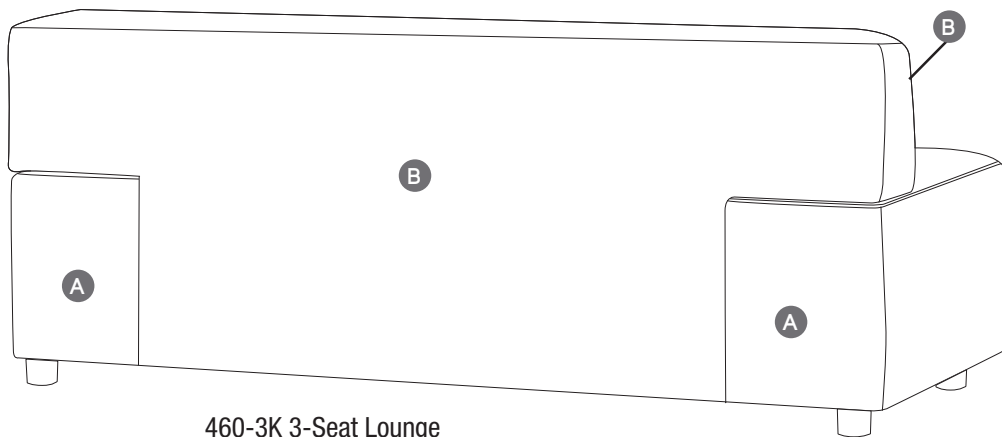
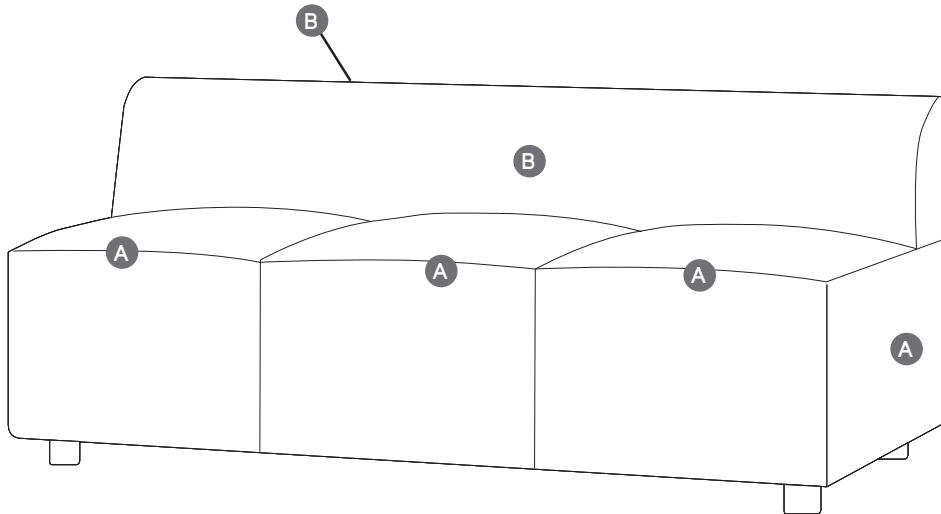

460-3K 3-Seat Lounge

Bix Lounge System

DESIGN METRO DESIGN GROUP

Bix offers a system of seating and tables that can create a variety of lounge-based applications that address group or individual work needs. Each application provides convenient connections to power, voice, and data.

Collaborative meeting space created with Bix furniture offers a sense of enclosure without walls for collaborating and provides social and physical comfort.

Tip: This product line is part of a collection and will be found in multiple locations in this specification guide and/or Coalesse Tables, Storage, and Accessories Specification Guide.

► See Collections, page 5.

Back screen is available on select units to provide privacy and divide space. It is upholstered.

Seat is upholstered.

Arms are available on select seating units. They are upholstered.

Back is upholstered.

Sled base on a lounge chair is finished with paint. The back of the sled base does not extend past the chair back.

Side table offers a freestanding mobile tablet surface. It is available in vinyl.

Face lock, keyed randomly, is standard on storage drawers to secure the items stored in it.

Bolster is upholstered.

Storage drawer is available on select models to store equipment.

Legs and base are constructed with steel tubing and steel plates for structural integrity. They are finished with paint. They are either inset under the seating unit (sled base) or slant off the back of a unit (legs).

Tablet provides a surface for user's notes, laptop computer, or wireless mouse.

Leveling glides adjust for installations on uneven floors. Adjustability range is 3/4".

Actual Dimensions

► See page 39

Bix Lounge System

DESIGN METRO DESIGN GROUP

Product Details

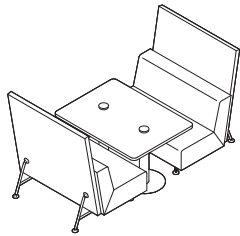

Individual work-booth area provides an alternative to a confined workstation. It offers a semi-private setting for temporary tasks that require projects to be spread out. It is created by grouping two straight sectionals or lounge chairs with a 27"H work-booth table.

Tip: Extended corner sectionals or straight sections with arms should not be used in a work-booth application because access to the seating area is obstructed.

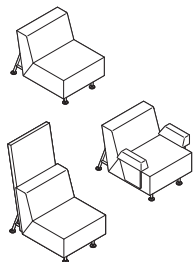

Lounge chairs are available with or without upholstered back screens. Models with upholstered arms are also available.

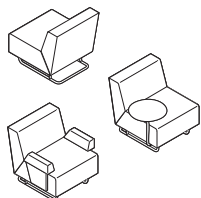

Sled lounge chairs feature a compact base that is designed for small spaces or to be used flush against the wall. They are available with or without upholstered arms or a tablet arm.

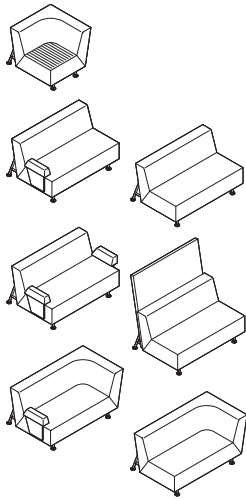

Sectional seating is offered in corner, extended corner, and straight units to provide a variety of configurations. Some styles are offered with or without back screens and with or without arms. All sections include an integrated ganging device. Corner sectional units are handed. Handedness is determined by the location of the back screen or back support legs.

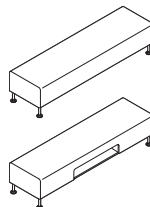

Bench provides a backless seating option. It can also be used as an alternative soft occasional table. An open storage space that is accessible from either side is available for storing magazine and media equipment.

18" seat height is an available option on all lounge, sectional seating, and bench. This option should not be used in conjunction with work booth tables. It allows a higher sit for health-care applications.

Multiple fabrics can be specified on lounge and sectional seating units for an additional fee per specified fabric.

- Seat cushion and sides of seat cushion - no additional fee
 - Back cushion and sides of back cushion - additional fee
 - Back screen (if selected) - no additional fee
 - Armrest (if selected) - no additional fee
- ▶ See *Bix Multi-Fabric Diagram and Yardage Request Form*, pages 49 and 53.
- Tip: Fabric for the seat and back is specified separate from the back screen, if selected. For a monochromatic look, specify the same fabric for both the seat and back and back screen.*

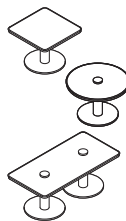

Occasional tables are freestanding 18"H tables that can be used a variety of lounge applications. They are available with a round, square, or rectangular top. The tops are available with or without a grommet and an optional power, voice, and data module.

▶ See occasional tables section in *Coalesse Tables, Storage, and Accessories Specification Guide*.

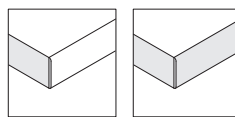

Edge detail is available in either plastic or wood edge.

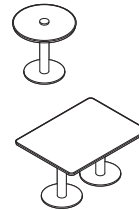

Work-booth tables are freestanding 27"H tables that are used with sectional seating to create a work-booth configuration. They are available with either a round or rectangular top. The tops are available with or without a grommet and an optional power, voice, and data module. Base features a low profile for foot clearance.

▶ See *Coalesse Tables, Storage, and Accessories Specification Guide*.



Side table offers a freestanding, mobile tablet surface. The tripod base allows it to be positioned close to a seating unit. The top is available in vinyl.

▶ See *Coalesse Tables, Storage, and Accessories Specification Guide*.

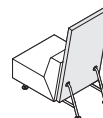

Back screen is available on lounge and sectional seating. It is fully upholstered with a zipper detail. However, it is not removable. Back screens must be ordered with the chair. It cannot be retrofitted to an existing backless lounge chair or seating sections.

Connections

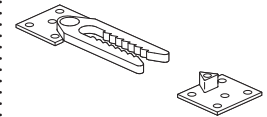

Integrated ganging device, included, connects sectional seating units together in the field. It is not intended for user reconfiguration.

Wiring & Cabling

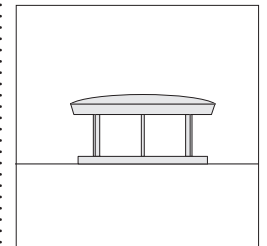
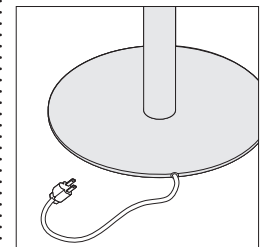

Occasional and work-booth tables are available with a factory-installed grommet located over each column and base to allow cords and cables to pass through the top. A power, voice, and data module can be inserted in each grommet location.

▶ See *Coalesse Tables, Storage, and Accessories Specification Guide*.

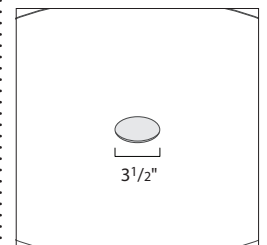

The work surface cutout for the grommet and PVD is 3 1/2" in diameter.

Bix Lounge System *continued*

DESIGN METRO DESIGN GROUP

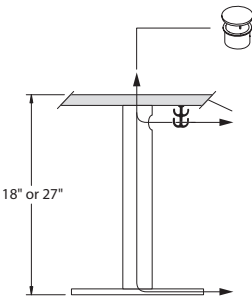

Column and base of occasional and work-booth tables are used to route and conceal cords. The cords pass through the worksurface down through the column and out through a mouse hole in the base plate. Bases may be installed with the mouse hole facing in any of four directions, depending upon where cords need to exit for access to power/data/voice in the wall or floor. Cords should be routed through the concealed channels and out the mouse hole during the installation of the table base.

Hole at the top of each column allows cords to be routed between tables directly below the worksurfaces. Wire management clips are included for routing purposes.

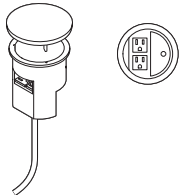

Power, voice, and data module can be installed in the grommet locations to bring power and communication to the worksurface. Each module is equipped with two 110 volt electrical outlets and one snap-in voice/data module insert consisting of dual CAT 5 RJ45 universal T568A/B jacks. It is UL listed and CSA certified. It has a 6' power cord. For additional data/voice outlet options, please contact Metro Customer Service at 1.800.627.6770.

Hardwired applications require on-site modifications by a licensed electrician following all local electrical code requirements.

Tip: The base will accommodate a 3/8" diameter flex-conduit.

Surface Materials

Seat and back

- Fabric

Arms

- Fabric

Bolster

- Fabric

Legs

- Paint

Sled base

- Paint

Glides

- Paint and nylon bottom

Back screen

- Fabric

Tablet surface

- Bronco onyx vinyl

Tablet support

- Paint

Open storage interior

- Paint

Storage drawer front

- Laminate (standard)
- Wood veneer (option)
- Custom wood veneer finish (option)

Integrated storage drawer pull

- Paint

Occasional, and work-booth table surface

- Laminate with matching 3 mm plastic edge
- Wood veneer with matching wood edge
- Custom wood veneer finish (option)

Occasional and work-booth table base

- Paint (textured only)

Grommet

- Black plastic only

Side table surface and base cover

- Bronco onyx vinyl

Side table base

- Paint (vinyl)

Note: Refer to the Coalesse Surface Materials Reference Guide for additional surface materials information.

Programs & Services

Customer's Own Material/Leather (COM/COL) Program is available.

► See *Coalesse Surface Materials Reference Guide* for additional information.
Note: Due to unusual upholstery conditions inherent in the design of Bix, not all seating fabrics may be specified. Refer to <http://fabric.coalesse.com/> for a list of pre-approved Designtex fabrics on Bix. Pre-approval is required for all COM fabric. Also, due to the geometric shapes and flat planes of the Bix design, seat fabric tautness will vary depending upon the amount of stretch in the fabric. Leather naturally stretches with use.

Designers

Metro Design Group | San Francisco

Bix Lounge System

DESIGN METRO DESIGN GROUP

Actual Dimensions

	Overall Depth	Width	Height	Seat Depth	Width	Seat Height From Floor	Back Height From Seat	Arm Height
Lounge	38½"	26" or 30"	29" or 31"	19½"	26"	16" or 18"	13½"	22"
Sled lounge	30½"	26", 30", or 36½"	29"	19½"	26"	16"	13½"	22"
Sled lounge tablet arm	17" Dia.	N.A.	N.A.	N.A.	N.A.	N.A.	N.A.	N.A.
Extended corner sectional	38½"	54" or 56"	29" or 31" 49½" or 51½"	19½"	48" or 72"	16" or 18"	13½"	22½"
Straight sectional, no arms	38½"	48" or 72"	29" or 31" 49½" or 51½"	19½"	48" or 72"	16" or 18"	13½"	N.A.
Straight sectional, one arm	38½"	50" or 74"	29" or 31" 49½" or 51½"	19½"	48" or 72"	16" or 18"	13½"	22½"
Straight sectional, two arms	38½"	52" or 76"	29" or 31"	19½"	48" or 72"	16" or 18"	13½"	22½"
Back screen	1¾"	23½", 45½", 51½", or 69"	49" or 51"	N.A.	N.A.	N.A.	N.A.	N.A.
Bench	19½"	48" or 72"	16" or 18"	N.A.	N.A.	16" or 18"	N.A.	N.A.
Round occasional tables	20" or 28" Dia.	N.A.	18"	N.A.	N.A.	N.A.	N.A.	N.A.
Square occasional tables	24"	24"	18"	N.A.	N.A.	N.A.	N.A.	N.A.
Rectangular occasional tables	24"	48" or 72"	18"	N.A.	N.A.	N.A.	N.A.	N.A.
Occasional table base	18" Dia.	N.A.	N.A.	N.A.	N.A.	N.A.	N.A.	N.A.
Occasional table column	4" Dia.	N.A.	N.A.	N.A.	N.A.	N.A.	N.A.	N.A.
Round work-booth tables	20" or 28" Dia.	N.A.	27"	N.A.	N.A.	N.A.	N.A.	N.A.
Rectangular work-booth tables	36"	48" or 72"	27"	N.A.	N.A.	N.A.	N.A.	N.A.
Side table	16" Dia.	N.A.	23"	N.A.	N.A.	N.A.	N.A.	N.A.

Bix Lounge System How To Plan

DESIGN METRO DESIGN GROUP

Configuration guidelines – work-booths with 27" high tables

Two straight sections are grouped with 27" high tables to create work-booth applications. Lounge chairs may also be specified with 27" high tables to create a two-person work-booth. Facing seats edges should be spaced 24"–27" apart from one another to accommodate leg clearance and maintain the correct user relationship to the worksurface. The table base is centered within the 24"–27" space.

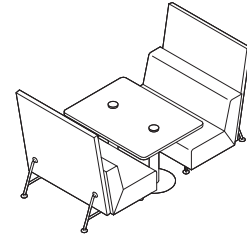

Configuration Examples

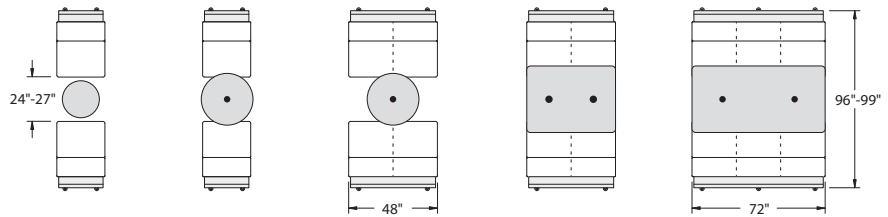

Configuration guidelines – work settings with 18" high tables

A variety of configurations may be created by combining sectional seating and 18" high tables. The Bix system is built upon a 12"/24" dimension module for planning. Seats are 24" wide. Rectangular tables are 24" deep. Tables are spaced 12" from seat edges. A 24" opening should be maintained for large 360° group enclaves.

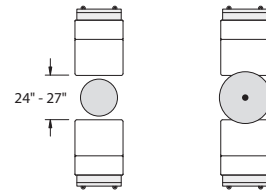

Configuration Examples

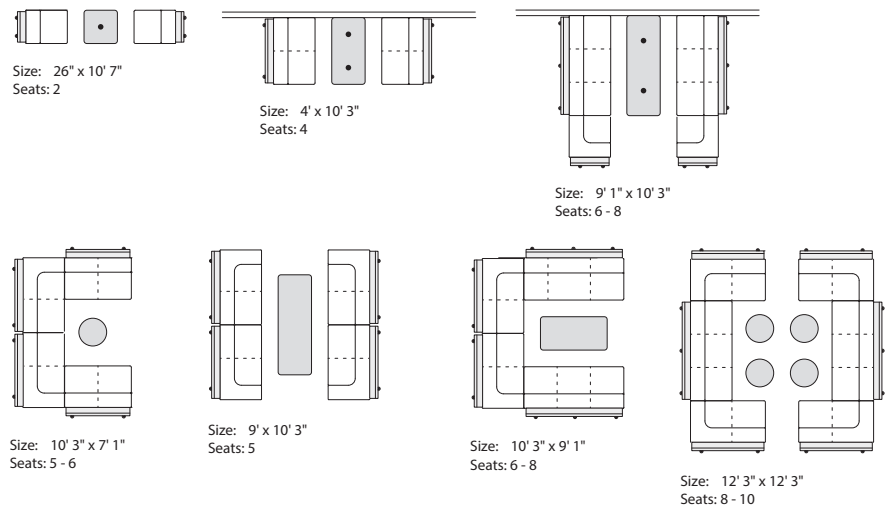

Bix Lounge System How To Plan

DESIGN METRO DESIGN GROUP

Configuration guidelines – DON'TS

- Individual lounge chairs are independent elements not designed as a module within the seating system. The lounge chair seat is wider than the 24" system module and lounge chairs do not include ganging hardware.
- Do not create a U-shaped configuration with a 27" high rectangular table. Access to the closed end is difficult and the table edge is too far from reach for the user.
- Do not use 54" wide extended corner sections or straight sections with arms to create a work-booth configuration with 27" high tables. Access is obstructed.

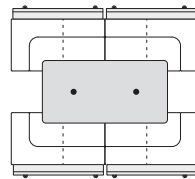
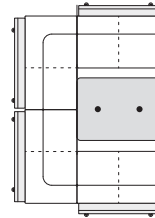
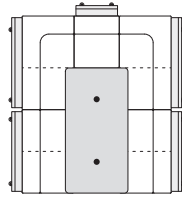
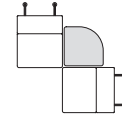
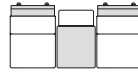
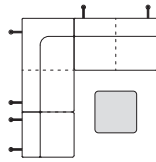

Bix Lounge System How To Plan *continued*

DESIGN METRO DESIGN GROUP

Orientation & fabric direction

Corner units are handed from a facing position. Location of back-screens should be considered for each configuration. In order to create a consistent pattern across seats in the configuration, seat fabric direction is determined by its relationship to the back-screen or back support legs. Seat and back

fabric on 54"W extended corner and straight sections is always railroaded.

Examples below assume a striped patterned fabric:

54"W Extended Corner and Straight Sections

Tip: Seat and back fabric is always railroaded

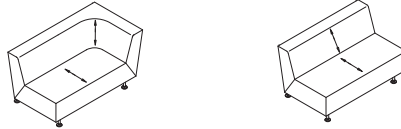

Configuration Examples

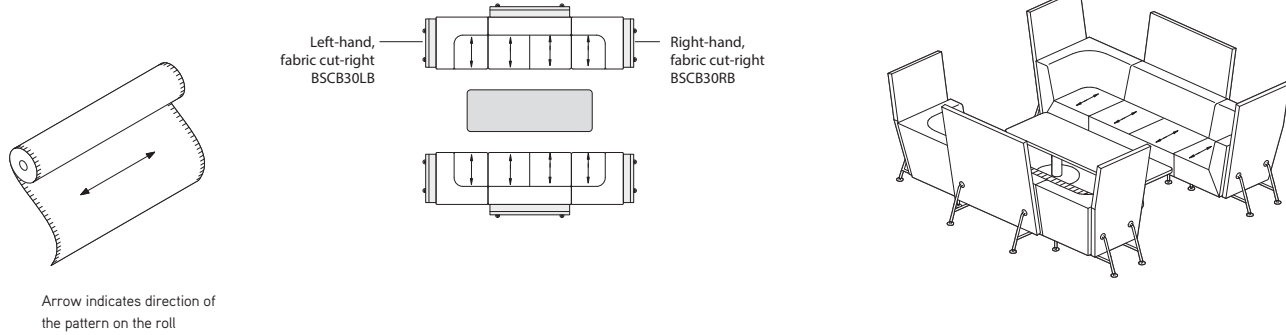

Bix Lounge System Lounge Chairs

DESIGN METRO DESIGN GROUP

Tip: Fabric for the seat and back is specified separate from the back screen, if selected. For a monochromatic look, specify the same fabric for both the seat and back and back screen.

Tip: Fabrics and leathers will appear loose with comfort wrinkles when upholstered.

Tip: When specifying fabric in different price grades, the highest price grade prevails.

Tip: The COM yards and COL square footage listed on this page reflect the requirements for a single fabric that are based on non-directional 54"W material applied railroaded. For multi-fabric COM requirements, please refer to Multi-Fabric Yardage.
 ▶ Page 52

Standard Includes		Required to Specify
▶ Need help? Product details, page 36	<ul style="list-style-type: none"> • Seat, back, and arms, if selected: fabric or leather • Legs: paint • Adjustable glides: paint to match legs • Back screen, if selected: fabric 	<ol style="list-style-type: none"> 1 Style number 2 Number of fabrics if contrasting fabric style number is selected 3 Fabric or leather color number for seat, back, and arms, if selected 4 Paint color number for legs and glides 5 Fabric color number for back screen, if selected 6 Options, if selected (see below) ▶ See <i>Coalesse Surface Materials Reference Guide</i> .

Options	U.S. Price	Required to Specify
Surface Materials	<ul style="list-style-type: none"> • Contrasting fabric 	+\$182 per fabric
	Acrylic backer	
	• Lounge chair	+\$ 52
	• Lounge chair with arms	+\$ 74
	• Lounge chair with back screen	+\$ 86
Seat Height	• 18" seat height	+\$351
Related Products	<ul style="list-style-type: none"> • Sectional seating • Bench • Occasional tables • Collaborative and conference tables • Side table 	▶ Page 46 ▶ Page 50 ▶ See <i>Coalesse Tables, Storage, and Accessories Specification Guide</i> . ▶ See <i>Coalesse Tables, Storage, and Accessories Specification Guide</i> . ▶ See <i>Coalesse Tables, Storage, and Accessories Specification Guide</i> .

Specification Information													
Style Number	U.S. Base Prices											Leather Grades:	
	Fabric Grades:											COL	C
	COM	6	7	8	9	10	11	12	13	14			

Lounge Chair													
BL26XX	\$2632	\$2632	\$2658	\$2707	\$2845	\$2936	\$3040	\$3113	\$3245	\$3425	\$2868	\$4237	\$4482
COM/yds = 2¾, COL/sq ft = 55													

Lounge Chair with Arms													
BL26AA	\$3685	\$3685	\$3721	\$3781	\$3973	\$4095	\$4239	\$4336	\$4514	\$4760	\$4013	\$5517	\$5816
COM/yds = 3¾, COL/sq ft = 73													

Lounge Chair with Back Screen													
BLB26XX	\$3796	\$3803	\$3848	\$3922	\$4153	\$4298	\$4470	\$4590	\$4799	\$5094	\$4112	\$6160	\$6559
Chair: COM/yds = 2¾, COL/sq ft = 55													
Screen: COM/yds = 1¾													

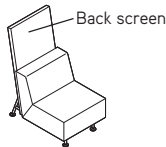
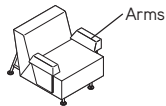
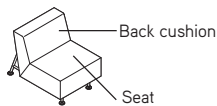

For Canadian Pricing
 Multiply U.S. Price by the Canadian price factor.
 ▶ See page 1 for details.

Bix Lounge System Sled Lounge Chairs

DESIGN METRO DESIGN GROUP

Tip: The COM yards and COL square footage listed on this page reflect the requirements for a single fabric that are based on non-directional 54"W material applied railroaded. For multi-fabric COM requirements, please refer to Multi-Fabric Yardage.
▶ Page 52

Tip: When specifying fabric in different price grades, the highest price grade prevails.

Standard Includes		Required to Specify
▶ Need help? Product details, page 36	<ul style="list-style-type: none"> • Seat, back, and arms, if selected: fabric or leather • Base and tablet support, if selected: paint • Glides • Tablet surface: bronco onyx vinyl 	<ol style="list-style-type: none"> 1 Style number 2 Number of fabrics if contrasting fabric style number is selected 3 Fabric or leather color number for seat, back, and arms, if selected 4 Paint color number for base and tablet, if selected 5 Options, if selected (see below) ▶ See <i>Coalesse Surface Materials Reference Guide</i> .

Options	U.S. Price	Required to Specify
Surface Materials	<ul style="list-style-type: none"> • Contrasting fabric +\$182 per fabric 	Add suffix K to the style number and select fabric color number.
	Acrylic backer <ul style="list-style-type: none"> • Lounge chair and lounge chair with tablet arm +\$ 52 • Lounge chair with arms +\$ 74 	Specify with acrylic backer. Specify with acrylic backer. ▶ See <i>Coalesse Surface Materials Reference Guide</i> .
Related Products	<ul style="list-style-type: none"> • Bench • Occasional tables • Side table • Collaborative and conference tables 	▶ Page 50 ▶ See <i>Coalesse Tables, Storage, and Accessories Specification Guide</i> . ▶ See <i>Coalesse Tables, Storage, and Accessories Specification Guide</i> . ▶ See <i>Coalesse Tables, Storage, and Accessories Specification Guide</i> .

Specification Information

Style Number	U.S. Base Prices												Leather Grades:			
	Fabric Grades:												COL	C	E	
	COM	6	7	8	9	10	11	12	13	14						

Sled Lounge Chair

BLD26XX	\$2352	\$2352	\$2378	\$2427	\$2565	\$2656	\$2760	\$2833	\$2965	\$3145	\$2485	\$3957	\$4202
COM/yds = 2¾, COL/sq ft = 55													

Sled Lounge Chair with Arms

BLD26AA	\$3404	\$3404	\$3440	\$3500	\$3692	\$3814	\$3958	\$4055	\$4233	\$4479	\$3570	\$5236	\$5535
COM/yds = 3¾, COL/sq ft = 73													

Sled Lounge Chair with Left-Hand Facing Tablet Arm

BLD26TX	\$2840	\$2840	\$2866	\$ 2915	\$3053	\$ 3144	\$3248	\$3321	\$3453	\$3633	\$ 3017	\$4445	\$4690
COM/yds = 2¾, COL/sq ft = 55													

Sled Lounge Chair with Right-Hand Facing Tablet Arm

BLD26XT	\$2840	\$2840	\$2866	\$ 2915	\$3053	\$ 3144	\$3248	\$3321	\$3453	\$3633	\$ 3017	\$4445	\$4690
COM/yds = 2¾, COL/sq ft = 55													

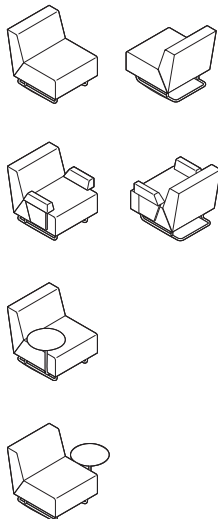

 **For Canadian Pricing**
Multiply U.S. Price by the Canadian price factor.
▶ See page 1 for details.

Coalesse

Bix Lounge System Sled Lounge Chairs

DESIGN METRO DESIGN GROUP

Bix Lounge System Sectional Seating

DESIGN METRO DESIGN GROUP

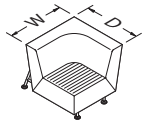

Tip: Fabric for the seat and back is specified separate from the back screen, if selected. For a monochromatic look, specify the same fabric for both the seat and back, and back screen.

Tip: The COM yards and COL square footage listed on these pages reflect the requirements for a single fabric that are based on non-directional 54"W material applied railroaded. For multi-fabric COM requirements, please refer to Multi-Fabric Yardage. ▶ Page 52

Tip: When specifying fabric in different price groups, the highest price group prevails.

Tip: Fabrics and leathers will appear loose with comfort wrinkles when upholstered.

Tip: Extended corner sections are standard with a railroaded seat and back fabric direction. ▶ Page 53

Tip: Fabrics and leathers will appear loose with comfort wrinkles when upholstered.

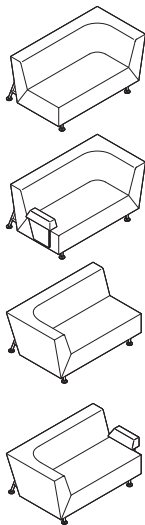

Standard Includes	Required to Specify
-------------------	---------------------

- | | | |
|---|---|--|
| <ul style="list-style-type: none"> ▶ Need help? Product details, page 36 | <ul style="list-style-type: none"> • Seat, back, and arms, if selected: fabric or leather • Legs: paint • Adjustable glides: paint to match legs • Back screen, if selected: fabric | <ol style="list-style-type: none"> 1 Style number 2 Number of fabrics if contrasting fabric style number is selected 3 Fabric or leather color number for seat, back, and arms, if selected 4 Paint color number for legs and glides 5 Fabric color number for back screen, if selected 6 Options, if selected (see below) <p>▶ See <i>Coalesse Surface Materials Reference Guide</i>.</p> |
|---|---|--|

Options	U.S. Price	Required to Specify
---------	------------	---------------------

Surface Materials <ul style="list-style-type: none"> • Contrasting fabric 	+\$182 per fabric	Add suffix K to the style number and select fabric color number.
Acrylic backer <ul style="list-style-type: none"> • 48"W sections • 48"W sections with back screen • 54"W sections • 72"W sections • 72"W sections with back screen 	+\$ 84 +\$129 +\$129 +\$112 +\$195	Specify with acrylic backer. Specify with acrylic backer. Specify with acrylic backer. Specify with acrylic backer. Specify with acrylic backer. ▶ See <i>Coalesse Surface Materials Reference Guide</i> .
Seat Height <ul style="list-style-type: none"> • 18" seat height 	+\$351	Specify with 18" seat height.
Related Products <ul style="list-style-type: none"> • Bench • Occasional tables • Collaborative and conference tables • Side table 		▶ Page 50 ▶ See <i>Coalesse Tables, Storage, and Accessories Specification Guide</i> . ▶ See <i>Coalesse Tables, Storage, and Accessories Specification Guide</i> . ▶ See <i>Coalesse Tables, Storage, and Accessories Specification Guide</i> .

Specification Information

Style Number	U.S. Base Prices												Leather Grades:			
	Fabric Grades:												COL	C	E	
	COM	6	7	8	9	10	11	12	13	14						

54"W Extended Corner Section–Left Section

BSE54LX	\$5176	\$5310	\$5379	\$5496	\$5854	\$6084	\$6348	\$6532	\$6862	\$7322	\$5675	\$7826	\$8272
COM/yds = 7, COL/sq ft = 140													

54"W Extended Corner Section–Left Section with Arm

BSE54LA	\$5676	\$5835	\$5909	\$6036	\$6418	\$6662	\$6950	\$7148	\$7499	\$7991	\$6239	\$8609	\$9107
COM/yds = 7½, COL/sq ft = 149													

54"W Extended Corner Section–Right Section

BSE54RX	\$5176	\$5310	\$5379	\$5496	\$5854	\$6084	\$6348	\$6532	\$6862	\$7322	\$5675	\$7826	\$8272
COM/yds = 7, COL/sq ft = 140													

54"W Extended Corner Section–Right Section with Arm

BSE54RA	\$5676	\$5835	\$5909	\$6036	\$6418	\$6662	\$6950	\$7148	\$7499	\$7991	\$6239	\$8609	\$9107
COM/yds = 7½, COL/sq ft = 149													

▶ Specification Information, continued on next page

Bix Lounge System Sectional Seating

DESIGN METRO DESIGN GROUP

Tip: Straight sections are standard with a railroaded seat and back fabric direction.
 ▶ Page 53

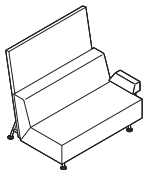
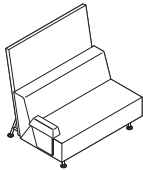
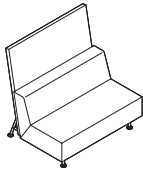
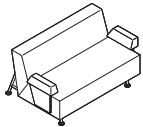
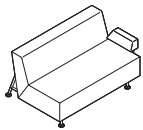
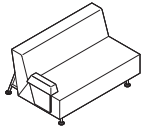
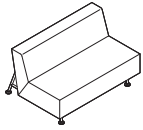

▶ Specification Information, continued from previous page

Specification Information

Style Number	U.S. Base Prices														Leather Grades:		
	Fabric Grades:														COL	C	E
	COM	6	7	8	9	10	11	12	13	14							

48"W Straight Section

BSS48XX	\$3897	\$3904	\$3949	\$4023	\$4254	\$4399	\$4571	\$4691	\$4900	\$5195	\$4221	\$6121	\$ 6496
----------------	--------	--------	--------	--------	--------	--------	--------	--------	--------	--------	--------	--------	---------

COM/yds = 4½, COL/sq ft = 90

48"W Straight Section with Left Arm

BSS48AX	\$4396	\$4426	\$4476	\$4560	\$4815	\$4977	\$5171	\$5304	\$5537	\$5866	\$4789	\$6760	\$ 7159
----------------	--------	--------	--------	--------	--------	--------	--------	--------	--------	--------	--------	--------	---------

COM/yds = 5, COL/sq ft = 99

48"W Straight Section with Right Arm

BSS48XA	\$4396	\$4426	\$4476	\$4560	\$4815	\$4977	\$5171	\$5304	\$5537	\$5866	\$4789	\$6760	\$ 7159
----------------	--------	--------	--------	--------	--------	--------	--------	--------	--------	--------	--------	--------	---------

COM/yds = 5, COL/sq ft = 99

48"W Straight Section with Two Arms

BSS48AA	\$4897	\$4954	\$5011	\$5100	\$5381	\$5561	\$5771	\$5918	\$6175	\$6535	\$5354	\$7547	\$ 7993
----------------	--------	--------	--------	--------	--------	--------	--------	--------	--------	--------	--------	--------	---------

COM/yds = 5½, COL/sq ft = 108

48"W Straight Section with Back Screen

BSSB48XX	\$5259	\$5418	\$5492	\$5619	\$6001	\$6245	\$6533	\$6731	\$7082	\$7574	\$5769	\$9178	\$ 9852
-----------------	--------	--------	--------	--------	--------	--------	--------	--------	--------	--------	--------	--------	---------

Chair: COM/yds = 4½, COL/sq ft = 90
 Screen: COM/yds = 3

48"W Straight Section with Back Screen and Left Arm

BSSB48AX	\$5756	\$5940	\$6019	\$6153	\$6561	\$6825	\$7130	\$7339	\$7718	\$8240	\$6330	\$9817	\$10,513
-----------------	--------	--------	--------	--------	--------	--------	--------	--------	--------	--------	--------	--------	----------

Chair: COM/yds = 5, COL/sq ft = 99
 Screen: COM/yds = 3

48"W Straight Section with Back Screen and Right Arm

BSSB48XA	\$5756	\$5940	\$6019	\$6153	\$6561	\$6825	\$7130	\$7339	\$7718	\$8240	\$6330	\$9817	\$10,513
-----------------	--------	--------	--------	--------	--------	--------	--------	--------	--------	--------	--------	--------	----------

Chair: COM/yds = 5, COL/sq ft = 99
 Screen: COM/yds = 3

▶ Specification Information, continued on next page

Lounge Seating

 **For Canadian Pricing**
 Multiply U.S. Price by the
 Canadian price factor.
 ▶ See page 1 for details.

Bix Lounge System Sectional Seating *continued*

DESIGN METRO DESIGN GROUP

Tip: Straight sections are standard with a railroaded seat and back fabric direction.

▶ Page 53

Tip: Fabrics and leathers will appear loose with comfort wrinkles when upholstered.

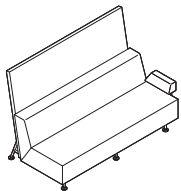
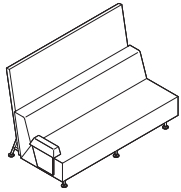
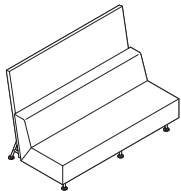
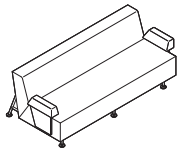
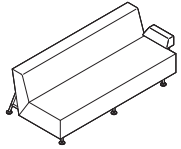
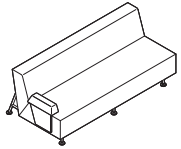
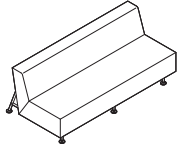

▶ Specification Information, continued from previous page

Specification Information

Style Number	U.S. Base Prices														Leather Grades:		
	Fabric Grades:														COL	C	E
	COM	6	7	8	9	10	11	12	13	14							

72"W Straight Section

BSS72XX	\$5441	\$5552	\$5613	\$5722	\$6054	\$6268	\$6514	\$6685	\$6993	\$7419	\$5972	\$8374	\$8872
----------------	--------	--------	--------	--------	--------	--------	--------	--------	--------	--------	--------	--------	--------

COM/yds = 6½, COL/sq ft = 130

72"W Straight Section with Left Arm

BSS72AX	\$5938	\$6072	\$6141	\$6258	\$6616	\$6846	\$7110	\$7294	\$7624	\$8084	\$6540	\$9151	\$9701
----------------	--------	--------	--------	--------	--------	--------	--------	--------	--------	--------	--------	--------	--------

COM/yds = 7, COL/sq ft = 139

72"W Straight Section with Right Arm

BSS72XA	\$5938	\$6072	\$6141	\$6258	\$6616	\$6846	\$7110	\$7294	\$7624	\$8084	\$6540	\$9151	\$9701
----------------	--------	--------	--------	--------	--------	--------	--------	--------	--------	--------	--------	--------	--------

COM/yds = 7, COL/sq ft = 139

72"W Straight Section with Two Arms

BSS72AA	\$6437	\$6596	\$6670	\$6797	\$7179	\$7423	\$7711	\$7909	\$8260	\$8752	\$7101	\$9933	\$10,529
----------------	--------	--------	--------	--------	--------	--------	--------	--------	--------	--------	--------	--------	----------

COM/yds = 7½, COL/sq ft = 148

72"W Straight Section with Back Screen

BSSB72XX	\$7256	\$7596	\$7704	\$7888	\$8449	\$8810	\$9228	\$9519	\$10,035	\$10,757	\$8028	\$12,726	\$13,673
-----------------	--------	--------	--------	--------	--------	--------	--------	--------	----------	----------	--------	----------	----------

Chair: COM/yds = 6½, COL/sq ft = 130

Screen: COM/yds = 4½

72"W Straight Section with Back Screen and Left Arm

BSSB72AX	\$7751	\$8116	\$8229	\$8423	\$9008	\$9384	\$9820	\$10,127	\$10,667	\$11,419	\$8590	\$13,506	\$14,500
-----------------	--------	--------	--------	--------	--------	--------	--------	----------	----------	----------	--------	----------	----------

Chair: COM/yds = 7, COL/sq ft = 139

Screen: COM/yds = 4½

72"W Straight Section with Back Screen and Right Arm

BSSB72XA	\$7751	\$8116	\$8229	\$8423	\$9008	\$9384	\$9820	\$10,127	\$10,667	\$11,419	\$8590	\$13,506	\$14,500
-----------------	--------	--------	--------	--------	--------	--------	--------	----------	----------	----------	--------	----------	----------

Chair: COM/yds = 7, COL/sq ft = 139

Screen: COM/yds = 4½

Bix Lounge System Multi-Fabric Diagram

DESIGN METRO DESIGN GROUP

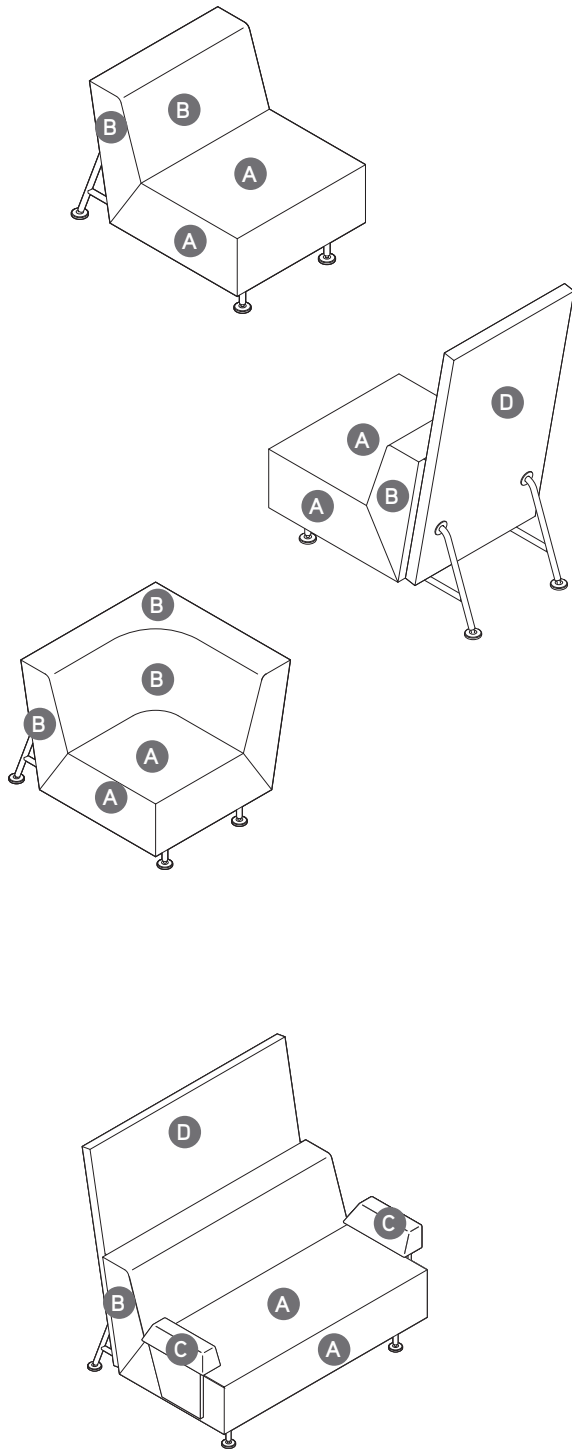

TO: _____

FROM: _____

DATE: _____

FAX...888.413.5161

A Seat (upholstery selections default for entire unit if B is not selected): _____

B Back: _____

C Arms (if applicable): _____

D Backscreen (if applicable): _____

**Back screen defined separately when ordered.*

See specifying for contrasting fabric upcharge. List price based on highest fabric grade usage.

Bix Lounge System Benches

DESIGN METRO DESIGN GROUP

Tip: Fabrics and leathers will appear loose with comfort wrinkles when upholstered.

Tip: The COM yards and COL square footage listed on this page reflect the requirements for a single fabric that are based on non-directional 54"W material applied railroaded.

Standard Includes Required to Specify

► Need help? Product details, page 36

- Seat: fabric or leather
- Legs and open storage interior, if selected: paint
- Adjustable glides: paint to match legs

- 1 Style number
 - 2 Fabric or leather color number for seat
 - 3 Paint color number for legs, glides, and open storage interior, if selected
 - 4 Options, if selected (see below)
- See *Coalesse Surface Materials Reference Guide*.

Options U.S. Price Required to Specify

Options	U.S. Price	Required to Specify
Surface Materials	Acrylic backer	
	• 48"W benches	Specify with acrylic backer.
	• 72"W benches	Specify with acrylic backer.
		► See <i>Coalesse Surface Materials Reference Guide</i> .
Seat Height	• 18" seat height	Specify with 18" seat height.
Related Products	<ul style="list-style-type: none"> • Lounge chairs • Sectional seating • Side table 	<ul style="list-style-type: none"> ► Page 43 ► Page 46 ► See <i>Coalesse Tables, Storage, and Accessories Specification Guide</i>. ► See <i>Coalesse Tables, Storage, and Accessories Specification Guide</i>. ► See <i>Coalesse Tables, Storage, and Accessories Specification Guide</i>.
	<ul style="list-style-type: none"> • Collaborative and conference tables • Occasional tables 	

Specification Information

Style Number	U.S. Base Prices												Leather Grades:			
	Fabric Grades:												COL	C	E	
	COM	6	7	8	9	10	11	12	13	14						

48"W Bench

BB48	\$2358	\$2358	\$2381	\$2418	\$2532	\$2606	\$2693	\$2753	\$2861	\$3007	\$2602	\$3847	\$4073
-------------	--------	--------	--------	--------	--------	--------	--------	--------	--------	--------	--------	--------	--------

COM/yds = 2¼, COL/sq ft = 41

72"W Bench

BB72	\$2854	\$2854	\$2885	\$2934	\$3085	\$3185	\$3297	\$3379	\$3521	\$3716	\$3123	\$4727	\$5026
-------------	--------	--------	--------	--------	--------	--------	--------	--------	--------	--------	--------	--------	--------

COM/yds = 3, COL/sq ft = 54

48"W Bench with Open Storage

BBS48	\$2723	\$2723	\$2746	\$2783	\$2897	\$2971	\$3058	\$3118	\$3226	\$3372	\$3016	\$4212	\$4438
--------------	--------	--------	--------	--------	--------	--------	--------	--------	--------	--------	--------	--------	--------

COM/yds = 2¼, COL/sq ft = 41

72"W Bench with Open Storage

BBS72	\$3217	\$3217	\$3248	\$3297	\$3448	\$3548	\$3660	\$3742	\$3884	\$4079	\$3535	\$5090	\$5389
--------------	--------	--------	--------	--------	--------	--------	--------	--------	--------	--------	--------	--------	--------

COM/yds = 3, COL/sq ft = 54

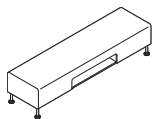
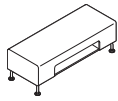
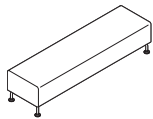
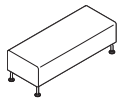

For Canadian Pricing
 Multiply U.S. Price by the Canadian price factor.
 ► See page 1 for details.

Coalesse

Bix Lounge System Benches

DESIGN METRO DESIGN GROUP

Bix Lounge System Multi-Fabric Yardage

DESIGN METRO DESIGN GROUP

Multi-Fabric Yardage

Description	Style Number	COM YDS*			
		Seat	Back	Arm(s)	Back Screen
Lounge chair	BL26XX	1¾	1¾	N.A.	N.A.
Lounge chair with arms	BL26AA	1¾	1¾	1	N.A.
Lounge chair with back screen	BLB26XX	1¾	1¾	N.A.	1¾
Sled lounge chair	BLD26XX	1¾	1¾	N.A.	N.A.
Sled lounge chair with arms	BLD26AA	1¾	1¾	1	N.A.
Sled lounge chair with left-hand tablet arm	BLD26TX	1¾	1¾	N.A.	N.A.
Sled lounge chair with right-hand tablet arm	BLD26XT	1¾	1¾	N.A.	N.A.
30"W corner section-left section with seat fabric cut-right	BSC30LB	2	2½	N.A.	N.A.
30"W corner section-right section with seat fabric cut-right	BSC30RB	2	2½	N.A.	N.A.
54"W extended corner section-left section	BSE54LX	2½	3	N.A.	N.A.
54"W extended corner section-left section with arm	BSE54LA	2½	3	½	N.A.
54"W extended corner section-right section	BSE54RX	2½	3	N.A.	N.A.
54"W extended corner section-right section with arm	BSE54RA	2½	3	½	N.A.
54"W extended corner section-left section with back screen	BSEB54LX	2½	3	N.A.	4
54"W extended corner section-left section with back screen and arm	BSEB54LA	2½	3	½	4
54"W extended corner section-right section with back screen	BSEB54RX	2½	3	N.A.	4
54"W extended corner section-right section with back screen and arm	BSEB54RA	2½	3	½	4
48"W straight section	BSS48XX	2½	2½	N.A.	N.A.
48"W straight section with left arm	BSS48AX	2½	2½	½	N.A.
48"W straight section with right arm	BSS48XA	2½	2½	½	N.A.
48"W straight section with two arms	BSS48AA	2½	2½	1	N.A.
48"W straight section with back screen	BSSB48XX	2½	2½	N.A.	3
48"W straight section with back screen and left arm	BSSB48AX	2½	2½	½	3
48"W straight section with back screen and right arm	BSSB48XA	2½	2½	½	3
72"W straight section	BSS72XX	4½	4½	N.A.	N.A.
72"W straight section with left arm	BSS72AX	4½	4½	½	N.A.
72"W straight section with right arm	BSS72XA	4½	4½	½	N.A.
72"W straight section with two arms	BSS72AA	4½	4½	1	N.A.
72"W straight section with back screen	BSSB72XX	4½	4½	N.A.	4½
72"W straight section with back screen and left arm	BSSB72AX	4½	4½	½	4½
72"W straight section with back screen and right arm	BSSB72XA	4½	4½	½	4½

*Fabric yardage is based on non-directional/solid fabrics. Use conversion chart on the following page for repeat/printed fabric yardage.

Bix Lounge System Multi-Fabric Yardage

DESIGN METRO DESIGN GROUP

Non-standard fabric requirements

Yardage requirements shown are based on non-directional 54"W material applied railroaded. Coalesse will apply fabric railroaded unless instructed otherwise on the dealer's purchase order. The following conversion chart should be used to determine yardage requirements when COM has a repeat of 2" or more. Please contact Coalesse Customer Service for a yardage quotation if the fabric is less than 54" wide, has a repeat of more than 24", or if the fabric must be cut-right.

CONVERSION CHART

PRODUCT	REPEAT		
	2" - 8"	9" - 14"	15" - 24"
Bix	15%	30%	75%

Yardage quotations will also be provided for order of 10 or more pieces.

Pattern matching on Bix

Due to Coalesse's high standards for pattern matching, we reserve the right to apply the following upcharges for extra labor incurred by a pattern or material that poses such challenges.

Customers will be informed if an upcharge will be applied to their order during the approval process. Should Coalesse receive an order without prior approval, it will be held as pending until the customer accepts such charges. The upcharge will be applied per item where applicable.

Cutting direction guidelines

Cutting direction is based on the fabric width and the way the fabric is cut from the roll and applied to Coalesse products. There are two cutting directions: railroaded or cut-right.

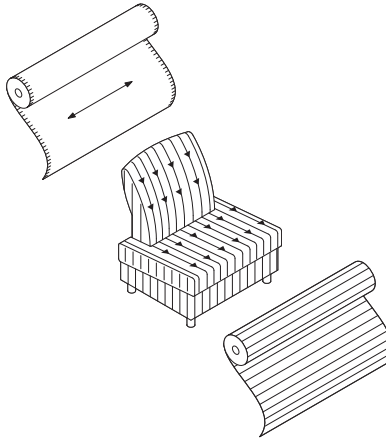

Horizontal or railroaded (across roll, warp horizontal) means fabric is cut across the roll; selvages are on the top and bottom.

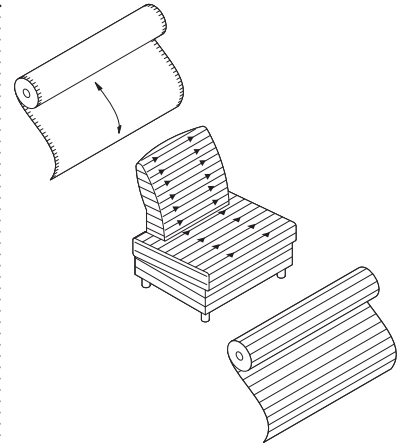

Vertical or cut-right (down roll, warp vertical) means fabric is cut in the same direction it is woven; selvages are on the left and right sides.

Coalesse reserves the right to railroad or apply fabric according to weave unless instructions specify otherwise. Fabrics are railroaded when possible to avoid seams in large upholstered areas and/or single cushion units. If a fabric is questionable, a cutting of adequate size showing full repeat (if any) should be sent to Coalesse for a fabric requirement quotation.

Bob Lounge Chairs by Walter Knoll

DESIGN PEARSON LLOYD

Bob lounge chair is well-suited to any professional space with its flared arms, aluminum base (painted or polished), and a coordinating ottoman.

Tip: This product line is part of a collection and will be found in multiple locations in this specification guide and/or Coalesse Tables, Storage, and Accessories Specification Guide.

► See *Collections*, page 5.

Adjustable headrest has a 2³/₄" range; also available without headrest.

Glides are a non-marring, black polymer. Optional soft felt glides can be used on non-carpeted surfaces.

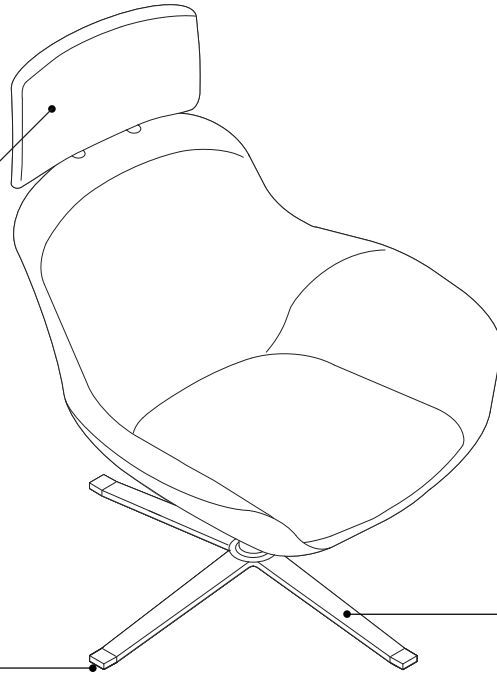

4-leg base comes standard with a swivel mechanism. An optional return swivel mechanism is available.

Product Details



Bob Lounge is available without adjustable headrest.

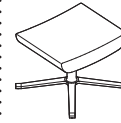

Ottoman is available in matching upholstery.

Surface Materials

► See *Coalesse Surface Materials Reference Guide* for further information.

Upholstery (contrasting fabric available on lounge chairs)

- Fabric
- Leather

Base

- Aluminum matte polished
- Painted aluminum (available on swivel base only)

Program and Services

Customer's Own Material/Leather (COM/COL) Program is available.

► See *Coalesse Surface Materials Reference Guide* for additional information.

Coalesse

Bob Lounge Chairs by Walter Knoll

DESIGN PEARSON LLOYD

Bob Lounge Chairs by Walter Knoll

DESIGN PEARSON LLOYD

Tip: For Customer's Own Material or Leather, see necessary requirements, important processing instructions, and ordering information
 ▶ See *Coalesse Surface Materials Reference Guide*.

Tip: Fabrics and leathers will appear loose with comfort wrinkles when upholstered.

Standard Includes		Required to Specify
▶ Need help? Product details, page 54	<ul style="list-style-type: none"> • Base: 8040 Aluminum Matte Polished or Grade 1 paint • Swivel base for lounge chairs, if selected • Upholstery for chair: fabric or leather • Glides 	1 Style number 2 Number of fabrics, if contrasting fabric style number is selected 3 Fabric or leather color number for upholstery 4 Options, if selected (see below) ▶ See <i>Coalesse Surface Materials Reference Guide</i> .

	Options	U.S. Price	Required to Specify
Surface Materials	<ul style="list-style-type: none"> • Contrasting fabric 	+\$182 per fabric	Add suffix K to the style number and select fabric color number.
	Acrylic backer <ul style="list-style-type: none"> • Lounge chair • Lounge chair with headrest • Ottoman 	+\$ 47 +\$ 50 +\$ 12	Specify with <i>acrylic backer</i> . Specify with <i>acrylic backer</i> . Specify with <i>acrylic backer</i> . ▶ See <i>Coalesse Surface Materials Reference Guide</i> .
Base	Lounge chair with standard swivel mechanism <ul style="list-style-type: none"> • Aluminum matte polished • Grade 1 paint • Grade 3 paint 	No cost No cost +\$105	Specify with <i>standard swivel</i> and select aluminum matte polished. Specify with <i>standard swivel</i> and select paint color number. Specify with <i>standard swivel</i> and select paint color number.
	Lounge chair with return swivel mechanism <ul style="list-style-type: none"> • Aluminum matte polished 	+\$353	Specify with <i>return swivel</i> and select aluminum matte polished.
Glides	<ul style="list-style-type: none"> • Felted glides 	+\$ 22	Specify with <i>felted glides</i> .
Related Products	<ul style="list-style-type: none"> • Guest seating • Occasional tables • Collaborative and conference tables 		▶ Page 297 ▶ See <i>Coalesse Tables, Storage, and Accessories Specification Guide</i> . ▶ See <i>Coalesse Tables, Storage, and Accessories Specification Guide</i> .

Specification Information

Style Number	U.S. Base Prices														Leather Grades:		
	Fabric Grades:														COL	C	E
	COM	6	7	8	9	10	11	12	13	14							

Lounge Chair																	
216	\$3363	\$3363	\$3394	\$3443	\$3594	\$3694	\$3806	\$3888	\$4030	\$4225	\$3634	\$5497	\$5836				
COM/yds = 3, COL/sq ft = 72																	

Lounge Chair with Headrest																	
221	\$3985	\$3985	\$4019	\$4079	\$4256	\$4370	\$4504	\$4596	\$4763	\$4989	\$4229	\$6412	\$6807				
COM/yds = 3½, COL/sq ft = 77																	

▶ Specification Information, continued on next page



Overall: 34¼"D 35"W 31¾"H
 Inside: 21¾"D 20"W 17¼"H
 Seat: 17"H
 Arm: 21¾"H



Overall: 34¼"D 35"W 41¼"H
 Inside: 21¾"D 20"W 27½"H
 Seat: 17"H
 Arm: 21¾"H

Bob Lounge Chairs by Walter Knoll

DESIGN PEARSON LLOYD

► Specification Information, continued from previous page

Specification Information

Style Number	U.S. Base Prices											Leather Grades:		
	Fabric Grades:											COL	C	E
	COM	6	7	8	9	10	11	12	13	14				

Ottoman

221-H	\$1237	\$1228	\$1238	\$1255	\$1307	\$1338	\$1376	\$1404	\$1452	\$1517	\$1602	\$2171	\$2282
-------	--------	--------	--------	--------	--------	--------	--------	--------	--------	--------	--------	--------	--------

COM/yds = 1, COL/sq ft = 22



Overall: 18½"D 19¾"W 15¼"H



For Canadian Pricing
 Multiply U.S. Price by the
 Canadian price factor.
 ► See page 1 for details.

Bob Lounge Chairs Multi-Fabric Diagram

DESIGN PEARSON LLOYD

TO: _____

FROM: _____

DATE: _____

FAX...888.413.5161

A Seat (upholstery selections default for entire unit if B is not selected): _____

B Back and Arms: _____
Headrest available for 221 model only.

Specify Model below:

216K

221K

221-HK

See specifying for contrasting fabric upcharge. List price based on highest fabric grade usage.

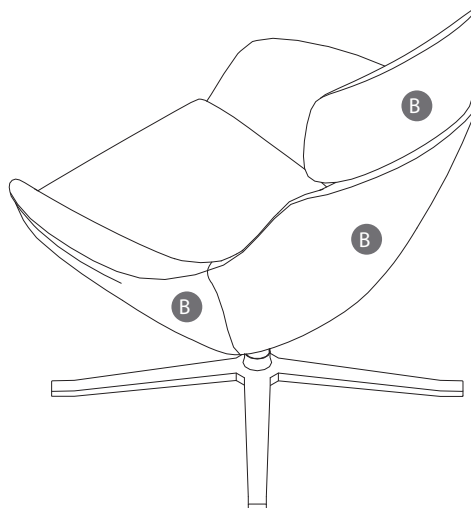
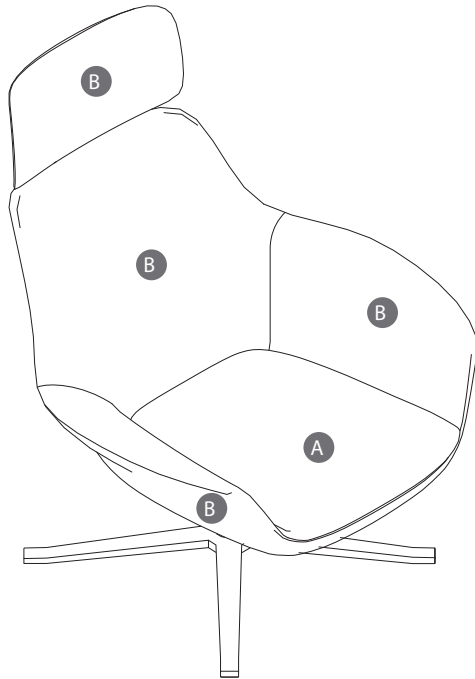

Coalesse

Bob Lounge Chairs Multi-Fabric Diagram

DESIGN PEARSON LLOYD

Circa Lounge System

DESIGN ALISON SPEAR, AIA

Circa lounge system offers a dramatic, creative palette for configuring signature spaces with a wide array of large and small application expressions, from straight to curvilinear modular lounges and ganging or freestanding tables.

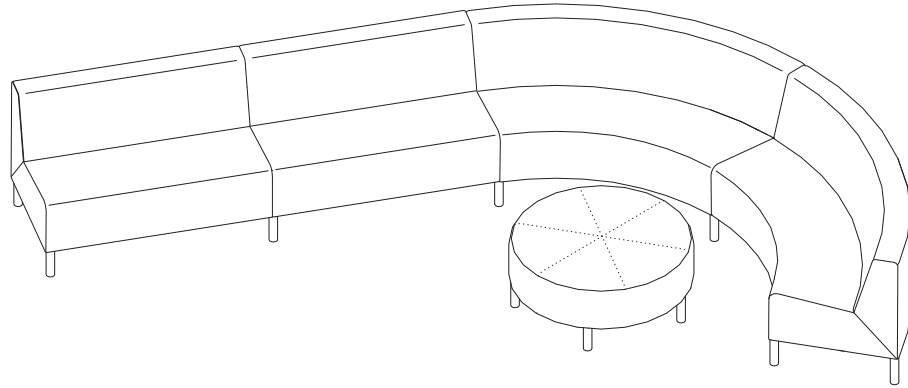

Intermediate tables are available in laminate (with self-edge) or veneer. Tables come with ganging brackets to attach to seating units. Shared application is an option.

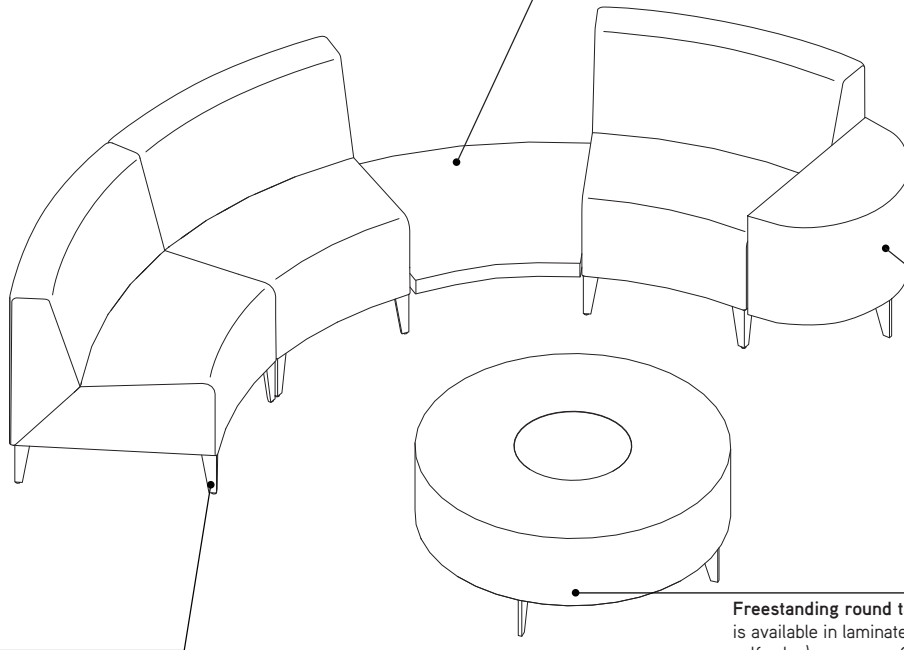

End-of-run tables are available in laminate (with self-edge) or veneer. Tables come with ganging brackets to attach to seating unit.

Freestanding round table is available in laminate (with self-edge) or veneer. Optional center inserts are available: green tinted glass or power/data module (available in black anodized aluminum or silver anodized aluminum).

Tapered legs are available in solid wood or metal. Solid wood legs are maple or walnut. Metal legs are offered in optional powder coat paint finishes. Tapered legs on lounge pieces support freestanding applications, allowing units to be easily rearranged.

Ganging kit is available to connect units together and maintain alignment.

Circa Lounge System

DESIGN ALISON SPEAR, AIA

Product Details

Cylinder legs are solid oak. Legs can be specified to be shared between adjacent lounge units, minimizing leg locations and ganging units together, as shown. Legs can also be specified freestanding, supporting individual units that can be easily rearranged.

Modern metal legs are available in powder coat paints. Legs can be specified to be shared between adjacent lounge units, minimizing leg locations and ganging units together, as shown. Legs can also be specified freestanding, supporting individual units that can be easily rearranged.

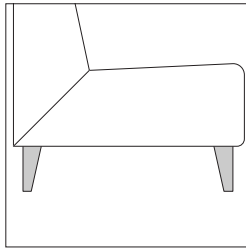

Tapered legs are available in solid maple or walnut, as well as optional metal in powder coat paints. Tapered legs on lounge units support freestanding applications, allowing units to be easily rearranged.

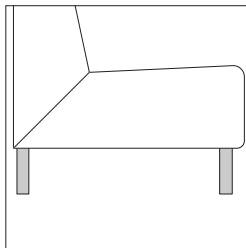

Cylinder legs are solid oak and are optional. Legs can be specified to be shared between adjacent lounge units or freestanding application, allowing units to be easily rearranged.

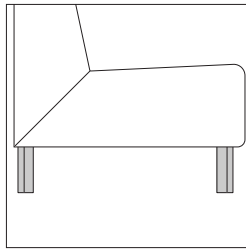

Modern metal legs are optional and are available in powder coat paints. Legs can be specified to be shared between adjacent lounge units or freestanding application, allowing units to be easily rearranged.

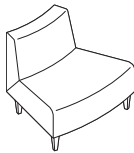

30° wedge seat is available outside facing or inside facing.

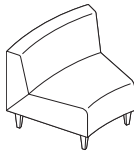

60° wedge seat is available outside facing or inside facing.

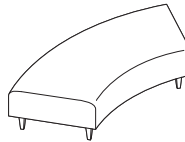
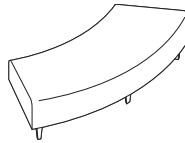
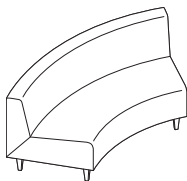
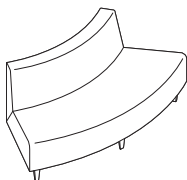

60° wedge bench is available and can be used in outside or inside facing applications.

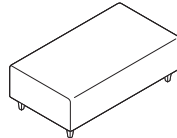
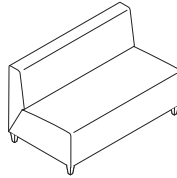
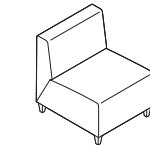

Straight seating available as 1-seat lounge, 2-seat lounge, or bench.

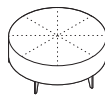

Round ottoman has five legs and is upholstered. Measures 42" diameter and 17"H. Tapered legs have a thin blade aesthetic and are available in solid maple and walnut, as well as optional metal in powder coat paints. Cylinder wood leg and modern metal leg are also available.

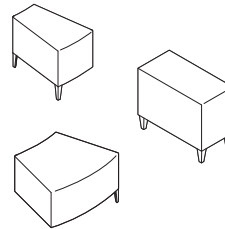

Straight, inside, or outside (15° or 30°) armrests can be specified without legs (intermediate) and ganged to adjacent lounge units. Or in end-of-run position, on left or right side.

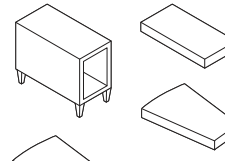

High and low ganging tables are available in three sizes: straight, 15° wedge, or 30° wedge. Tables can be specified without legs (intermediate) and ganged to adjacent lounge units or in end-of-run position, on left or right side.

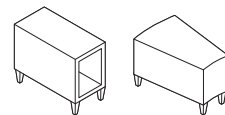
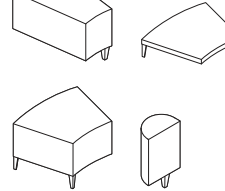

High and low freestanding tables are available straight, 15° wedge, or 30° wedge.

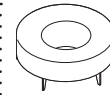
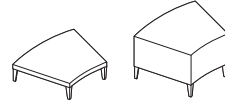

Freestanding round table is available in one size, 42" diameter, 15¾"H. Power/data module option available in black anodized aluminum or silver anodized aluminum. The round plate that houses the power module is powder coated to complement the module. Glass insert is available as an option.

Surface Materials

► See *Coalesse Surface Materials Reference Guide* for further information.

Upholstery (contrasting fabric available)

- Fabric
- Leather

Table tops

- Laminate with self edge (option)
- Veneer
 - Maple veneer (quarter cut, high and low sheen)
 - Walnut veneer (quarter cut, high and low sheen)
 - Oak veneer (rift cut, high and low sheen)

Tapered legs

- Solid maple (quarter cut, high and low sheen)
- Solid walnut (quarter cut, high and low sheen)
- Painted steel

Tip: Grade 3 paints are not available on tables.

Cylinder wood legs

- Solid oak (rift cut, high and low sheen)

Modern metal legs

- Painted steel

Tip: Grade 3 paints are not available on tables.

Program and Services

Customer's Own Material/Leather (COM/COL) Program is available.

► See *Coalesse Surface Materials Reference Guide* for additional information.

Circa Lounge System Thought Starters and Applications

DESIGN ALISON SPEAR, AIA

Modern Metal Legs, Shared Application

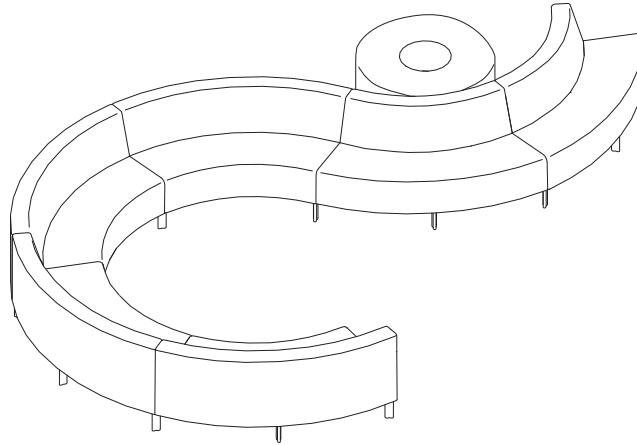

Quantity	Style Number	Description	Options
1	451-7460FI	60° Inside Wedge 2-Seat Lounge	5 Leg
3	451-7460FI	60° Inside Wedge 2-Seat Lounge	3 Leg (Shared)
2	451-7460FO	60° Outside Wedge 2-Seat Lounge	3 Leg (Shared)
1	45-T42RD	Freestanding Round Table	

Circa Lounge System Thought Starters and Applications

DESIGN ALISON SPEAR, AIA

Cylinder Wood Legs, Shared Application

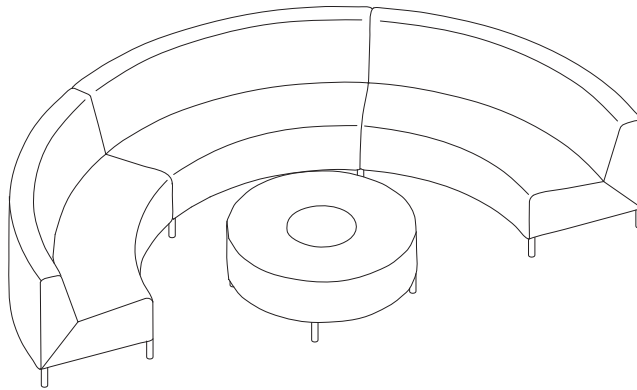

Quantity	Style Number	Description	Options
1	451-7460FI	60° Inside Wedge 2-Seat Lounge	5 Leg
2	451-7460FI	60° Inside Wedge 2-Seat Lounge	3 Leg (Shared)
1	45-T42RD	Freestanding Round Table	

Circa Lounge System Thought Starters and Applications *continued*

DESIGN ALISON SPEAR, AIA

Tapered Metal Legs, Non-Shared Application

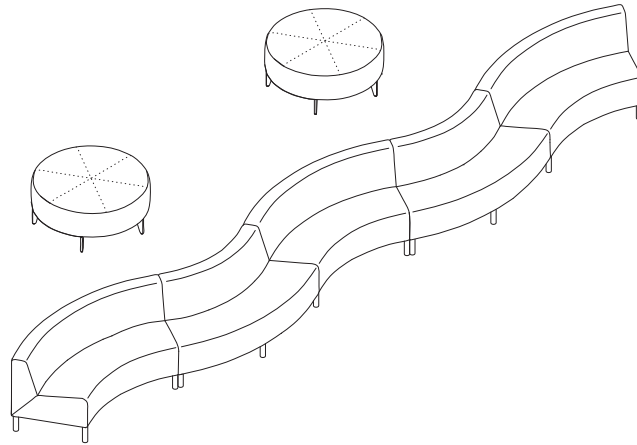

Quantity	Style Number	Description
3	451-7460FI	60° Inside Wedge 2-Seat Lounge
2	451-7460FO	60° Outside Wedge 2-Seat Lounge
1	451-B42RD	Freestanding Round Ottoman

Circa Lounge System Thought Starters and Applications

DESIGN ALISON SPEAR, AIA

Cylinder Wood Legs, Shared Application

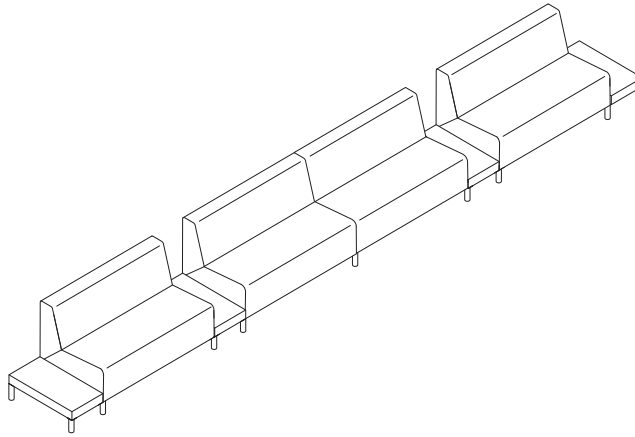

Quantity	Style Number	Description	Options
3	451-5000	Straight 2-Seat Lounge	4 Leg
1	451-5000	Straight 2-Seat Lounge	2 Leg (Shared)
2	45-T1300LG	Straight Low Table, Ganging	
1	45-T1300LER	Straight Low Table, End-of-Run	

Circa Lounge System Upholstered Individual Lounge Units

DESIGN ALISON SPEAR, AIA

Tip: Fabrics and leathers will appear loose with comfort wrinkles when upholstered.

Tip: For contrasting fabric, pricing is based on highest grade textile specified.

Tip: Stain-to-Match is offered on wood legs.

Tip: For Customer's Own Material or Leather, see necessary requirements, important processing instructions, and ordering information
 ▶ See *Coalesse Surface Materials Reference Guide*.

Tip: Benches are flat and 1-seat and 2-seat lounges are angled; therefore, seat angles will not be aligned when placed next to each other. A table is recommended between the units to minimize the difference.

Tip: All legs measure 6½" in height.

Tip: The 60° inside and outside wedge lounges and benches have five legs (if not sharing legs). If metal legs are selected, the upcharge is per leg.

	Standard Includes	Required to Specify
▶ Need help? Product details, page 60	<ul style="list-style-type: none"> • Frame: unibody construction of hardwood plywood utilizing box joinery • Upholstery: multiple densities of polyurethane foam fixed seat and back with top stitch on seams • Legs: <ul style="list-style-type: none"> - Tapered leg, if selected: solid maple or walnut - Cylinder leg, if selected: solid oak 	<ol style="list-style-type: none"> 1 Style number 2 Number of fabrics if contrasting fabric style number is selected 3 Fabric or leather color number for upholstery on seat and back 4 Wood leg type 5 Wood color number for legs 6 Options, if selected (see below) ▶ See <i>Coalesse Surface Materials Reference Guide</i> .

	Options	U.S. Price	Required to Specify
Surface Materials	<ul style="list-style-type: none"> • Contrasting fabric 	+\$182 per fabric	Add suffix K to the style number and select fabric color number.
	Acrylic backer		
	• 30° outside facing wedge 1-seat lounge	+\$ 49	Specify with acrylic backer.
	• 30° inside facing wedge seat 1-seat lounge	+\$ 50	Specify with acrylic backer.
	• 60° outside and inside wedge 2-seat lounge	+\$ 88	Specify with acrylic backer.
	• 60° benches	+\$ 60	Specify with acrylic backer.
	• Straight 1-seat lounge	+\$ 33	Specify with acrylic backer.
	• Straight 2-seat lounge	+\$ 74	Specify with acrylic backer.
	• Straight bench	+\$ 47	Specify with acrylic backer.
			▶ See <i>Coalesse Surface Materials Reference Guide</i> .
Shared Leg Application	<ul style="list-style-type: none"> • Cylinder wood legs • Modern metal legs 	-\$270 -\$270	Specify with cylinder wood legs. Specify with modern metal legs.
Metal Legs	Tapered legs		
	• Grade 1 paint	+\$204 per leg	Specify with tapered metal legs and select paint color number. ▶ See <i>Coalesse Surface Materials Reference Guide</i> .
	• Grade 3 paint	+\$232 per leg	Specify with tapered metal legs and select paint color number. ▶ See <i>Coalesse Surface Materials Reference Guide</i> .
	Modern legs		
	• Grade 1 paint	+\$204 per leg	Specify with modern metal legs and select paint color number. ▶ See <i>Coalesse Surface Materials Reference Guide</i> .
	• Grade 3 paint	+\$232 per leg	Specify with modern metal legs and select paint color number. ▶ See <i>Coalesse Surface Materials Reference Guide</i> .
Related Products	• Modular tables		▶ Page 72

Specification Information

Style Number	U.S. Base Prices												Leather Grades:		
	Fabric Grades:												COL	C	E
COM	6	7	8	9	10	11	12	13	14						

30° Outside Facing Wedge 1-Seat Lounge

451-3730FO	\$2079	\$2079	\$2113	\$2167	\$2334	\$2437	\$2561	\$2649	\$2803	\$3016	\$2402	\$4726	\$5153
------------	--------	--------	--------	--------	--------	--------	--------	--------	--------	--------	--------	--------	--------

COM/yds = 3¼, COL/sq ft = 72

▶ Specification Information, continued on next page

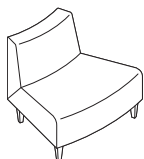

Overall: 28"D 36¾"W 29½"H
 Inside: 20"D 36¾"W 12¼"H
 Seat: 17¼"H
 Angle Degree: 30°

Circa Lounge System Upholstered Individual Lounge Units

DESIGN ALISON SPEAR, AIA

► Specification Information, continued from previous page

Specification Information

Style Number	U.S. Base Prices														Leather Grades:		
	Fabric Grades:														COL	C	E
	COM	6	7	8	9	10	11	12	13	14							

30° Inside Facing Wedge 1-Seat Lounge

451-3730FI	\$2079	\$2079	\$2113	\$2167	\$2334	\$2437	\$2561	\$2649	\$2803	\$3016	\$2402	\$4726	\$5153
------------	--------	--------	--------	--------	--------	--------	--------	--------	--------	--------	--------	--------	--------

COM/yds = 3¼, COL/sq ft = 72

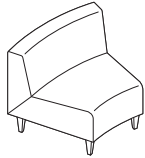

Overall: 28"D 38"W 29½"H
 Inside: 20"D 36¾"W 12¼"H
 Seat: 17¼"H
 Angle Degree: 30°

60° Outside Wedge 2-Seat Lounge

451-7460FO	\$3306	\$3417	\$3478	\$3587	\$3919	\$4133	\$4379	\$4550	\$4858	\$5284	\$3556	\$8288	\$9136
------------	--------	--------	--------	--------	--------	--------	--------	--------	--------	--------	--------	--------	--------

COM/yds = 4½, COL/sq ft = 99

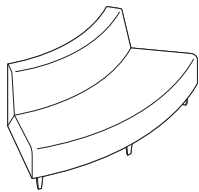

Overall: 28"D 71"W 29½"H
 Inside: 20"D 71"W 12¼"H
 Seat: 17¼"H
 Angle Degree: 60°

60° Inside Wedge 2-Seat Lounge

451-7460FI	\$3306	\$3417	\$3478	\$3587	\$3919	\$4133	\$4379	\$4550	\$4858	\$5284	\$3556	\$8288	\$9136
------------	--------	--------	--------	--------	--------	--------	--------	--------	--------	--------	--------	--------	--------

COM/yds = 4¾, COL/sq ft = 105

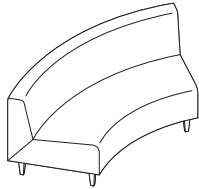

Overall: 28"D 71"W 29½"H
 Inside: 20"D 71"W 12¼"H
 Seat: 17¼"H
 Angle Degree: 60°

60° Outside Wedge Bench

451-B7460FO	\$2621	\$2621	\$2652	\$2701	\$2852	\$2952	\$3064	\$3146	\$3288	\$3483	\$2949	\$5091	\$5491
-------------	--------	--------	--------	--------	--------	--------	--------	--------	--------	--------	--------	--------	--------

COM/yds = 3, COL/sq ft = 66

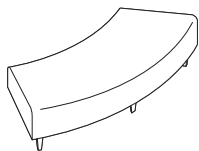

Overall: 28"D 71"W 17¼"H
 Seat: 17¼"H
 Angle Degree: 60°

60° Inside Wedge Bench

451-B7460FI	\$2621	\$2621	\$2652	\$2701	\$2852	\$2952	\$3064	\$3146	\$3288	\$3483	\$2949	\$5091	\$5491
-------------	--------	--------	--------	--------	--------	--------	--------	--------	--------	--------	--------	--------	--------

COM/yds = 3, COL/sq ft = 66

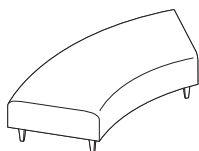

Overall: 28"D 71"W 17¼"H
 Seat: 17¼"H
 Angle Degree: 60°

► Specification Information, continued on next page



For Canadian Pricing
 Multiply U.S. Price by the
 Canadian price factor.
 ► See page 1 for details.

Circa Lounge System Upholstered Individual Lounge Units *continued*

DESIGN ALISON SPEAR, AIA

► Specification Information, continued from previous page

Specification Information

Style Number	U.S. Base Prices										Leather Grades:		
	Fabric Grades:										COL	C	E
	COM	6	7	8	9	10	11	12	13	14			

Straight 1-Seat Lounge

451-2500	\$1869	\$1869	\$1892	\$1935	\$2062	\$2143	\$2236	\$2305	\$2422	\$2584	\$2221	\$3988	\$4315
----------	--------	--------	--------	--------	--------	--------	--------	--------	--------	--------	--------	--------	--------

COM/yds = 2½, COL/sq ft = 55

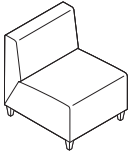

Overall: 28"D 25"W 29½"H
 Inside: 20"D 25"W 12¼"H
 Seat: 17¼"H
 Angle Degree: 0°

Straight 2-Seat Lounge

451-5000	\$2682	\$2712	\$2762	\$2846	\$3101	\$3263	\$3457	\$3590	\$3823	\$4152	\$2939	\$6556	\$7209
----------	--------	--------	--------	--------	--------	--------	--------	--------	--------	--------	--------	--------	--------

COM/yds = 4, COL/sq ft = 83

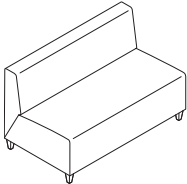

Overall: 28"D 50"W 29½"H
 Inside: 20"D 50"W 12¼"H
 Seat: 17¼"H
 Angle Degree: 0°

Straight Bench

451-B5000	\$2387	\$2387	\$2418	\$2467	\$2618	\$2718	\$2830	\$2912	\$3054	\$3249	\$2708	\$4864	\$5244
-----------	--------	--------	--------	--------	--------	--------	--------	--------	--------	--------	--------	--------	--------

COM/yds = 3, COL/sq ft = 66

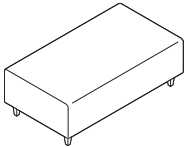

Overall: 28"D 50"W 17¼"H
 Seat: 17¼"H
 Angle Degree: 0°

Tip: Please submit sketch for modular application. One kit is required per two chairs.

Ganging Kit

451-GANGPKG	\$ 56	N.A.	N.A.	N.A.	N.A.	N.A.	N.A.	N.A.	N.A.	N.A.	N.A.	N.A.	N.A.
-------------	-------	------	------	------	------	------	------	------	------	------	------	------	------



For Canadian Pricing
 Multiply U.S. Price by the Canadian price factor.
 ► See page 1 for details.

Coalesse

Circa Lounge System Upholstered Individual Lounge Units

DESIGN ALISON SPEAR, AIA

Circa Lounge System Upholstered Modular Arm Rests—Straight, 15°, 30°, and Ottoman

DESIGN ALISON SPEAR, AIA

Tip: Fabrics and leathers will appear loose with comfort wrinkles when upholstered.

Tip: Cylinder wood and modern metal legs cannot be in shared position with armrests. The legs will always be on the lounge side.

Tip: Stain-to-Match is offered on wood legs.

Tip: For Customer's Own Material or Leather, see necessary requirements, important processing instructions, and ordering information
 ▶ See *Coalesse Surface Materials Reference Guide*.

Tip: All legs measure 6½" in height.

Tip: The round ottoman has five legs. If metal legs are selected, the upcharge is per leg.

Standard Includes		Required to Specify
▶ Need help? Product details, page 60	<ul style="list-style-type: none"> • Frame: hardwood panels • Upholstery: multiple densities of polyurethane • Top stitch on seams • Legs: <ul style="list-style-type: none"> - Tapered leg, if selected: solid maple or walnut - Cylinder leg, if selected: solid oak 	1 Style number 2 Fabric or leather color number for arm rests 3 Wood leg type 4 Wood color number for legs 5 Options, if selected (see below) ▶ See <i>Coalesse Surface Materials Reference Guide</i> .

Options	U.S. Price	Required to Specify
Surface Materials	<ul style="list-style-type: none"> • Contrasting fabric on ottoman +\$182 	Add suffix K to the style number and select fabric color number.
	Acrylic backer	
	<ul style="list-style-type: none"> • Straight armrests and 15° armrests +\$ 28 • 30° armrests and ottoman +\$ 49 	Specify with acrylic backer. ▶ See <i>Coalesse Surface Materials Reference Guide</i> . Specify with acrylic backer. ▶ See <i>Coalesse Surface Materials Reference Guide</i> .
Metal Legs	Tapered legs	
	<ul style="list-style-type: none"> • Grade 1 paint +\$204 per leg • Grade 3 paint +\$232 per leg 	Specify with tapered metal legs and select paint color number. ▶ See <i>Coalesse Surface Materials Reference Guide</i> . Specify with tapered metal legs and select paint color number. ▶ See <i>Coalesse Surface Materials Reference Guide</i> .
	Modern legs	
	<ul style="list-style-type: none"> • Grade 1 paint +\$204 per leg • Grade 3 paint +\$232 per leg 	Specify with modern metal legs and select paint color number. ▶ See <i>Coalesse Surface Materials Reference Guide</i> . Specify with modern metal legs and select paint color number. ▶ See <i>Coalesse Surface Materials Reference Guide</i> .

Related Products	• Modular tables	▶ Page 72
-------------------------	------------------	-----------

Specification Information

Style Number	U.S. Base Prices												Leather Grades:			
	Fabric Grades:												COL	C	E	
	COM	6	7	8	9	10	11	12	13	14						

Straight Armrest—Intermediate without Legs

451-A1800G	\$1152	\$1152	\$1175	\$1212	\$1326	\$1400	\$1487	\$1547	\$1655	\$1801	\$1463	\$2842	\$3095
COM/yds = 2¼, COL/sq ft = 50													

Straight Armrest—End-of-Run with Two Legs

451-A1800ER	\$1334	\$1334	\$1357	\$1394	\$1508	\$1582	\$1669	\$1729	\$1837	\$1983	\$1645	\$3024	\$3277
COM/yds = 2¼, COL/sq ft = 50													

▶ Specification Information, continued on next page



Overall: 28"D 18½"W 17"H



Overall: 28"D 18½"W 23½"H

Tip: Specify left or right facing.



For Canadian Pricing
 Multiply U.S. Price by the Canadian price factor.
 ▶ See page 1 for details.

Circa Lounge System Upholstered Modular Arm Rests—Straight, 15°, 30°, and Ottoman

DESIGN ALISON SPEAR, AIA

► Specification Information, continued from previous page

Specification Information

Style Number	U.S. Base Prices												Leather Grades:		
	Fabric Grades:												COL	C	E
	COM	6	7	8	9	10	11	12	13	14					



Overall: 28¾"D 18½"W 17"H



Overall: 28¾"D 18½"W 23½"H
Tip: Specify left or right facing.

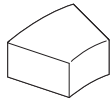

Overall: 29½"D 36¾"W 17"H

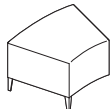

Overall: 29½"D 36¾"W 23½"H
Tip: Specify left or right facing.



Overall: 28¾"D 18½"W 17"H



Overall: 28¾"D 18½"W 23½"H
Tip: Specify left or right facing.

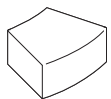

Overall: 29½"D 36¾"W 17"H

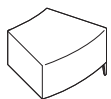

Overall: 29½"D 36¾"W 23½"H
Tip: Specify left or right facing.

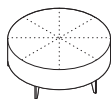

Overall: 42"Dia. 17"H

Tip: Please submit sketch for modular application. One kit is required per two chairs.

15° Inside Armrest-Intermediate without Legs

451-A1815FIG	\$1142	\$1142	\$1162	\$1193	\$1295	\$1362	\$1439	\$1491	\$1584	\$1715	\$1463	\$2681	\$2902
--------------	--------	--------	--------	--------	--------	--------	--------	--------	--------	--------	--------	--------	--------

COM/yds = 2, COL/sq ft = 44

15° Inside Armrest-End-of-Run with Two Legs

451-A1815FIER	\$1402	\$1402	\$1422	\$1453	\$1555	\$1622	\$1699	\$1751	\$1844	\$1975	\$1723	\$2941	\$3162
---------------	--------	--------	--------	--------	--------	--------	--------	--------	--------	--------	--------	--------	--------

COM/yds = 2, COL/sq ft = 44

30° Inside Arm Rest-Intermediate without Legs

451-A3730FIG	\$1629	\$1629	\$1660	\$1709	\$1860	\$1960	\$2072	\$2154	\$2296	\$2491	\$1900	\$3763	\$4102
--------------	--------	--------	--------	--------	--------	--------	--------	--------	--------	--------	--------	--------	--------

COM/yds = 3, COL/sq ft = 66

30° Inside Arm Rest-End-of-Run with Two Legs

451-A3730FIER	\$1827	\$1827	\$1858	\$1907	\$2058	\$2158	\$2270	\$2352	\$2494	\$2689	\$2098	\$3961	\$4300
---------------	--------	--------	--------	--------	--------	--------	--------	--------	--------	--------	--------	--------	--------

COM/yds = 3, COL/sq ft = 66

15° Outside Armrest-Intermediate without Legs

451-A1815FOG	\$1142	\$1142	\$1162	\$1193	\$1295	\$1362	\$1439	\$1491	\$1584	\$1715	\$1463	\$2681	\$2902
--------------	--------	--------	--------	--------	--------	--------	--------	--------	--------	--------	--------	--------	--------

COM/yds = 2, COL/sq ft = 44

15° Outside Armrest-End-of-Run with Two Legs

451-A1815FOER	\$1402	\$1402	\$1422	\$1453	\$1555	\$1622	\$1699	\$1751	\$1844	\$1975	\$1723	\$2941	\$3162
---------------	--------	--------	--------	--------	--------	--------	--------	--------	--------	--------	--------	--------	--------

COM/yds = 2, COL/sq ft = 44

30° Outside Arm Rest-Intermediate without Legs

451-A3730FOG	\$1629	\$1629	\$1660	\$1709	\$1860	\$1960	\$2072	\$2154	\$2296	\$2491	\$1900	\$3763	\$4102
--------------	--------	--------	--------	--------	--------	--------	--------	--------	--------	--------	--------	--------	--------

COM/yds = 3, COL/sq ft = 66

30° Outside Arm Rest-End-of-Run with Two Legs

451-A3730FOER	\$1827	\$1827	\$1858	\$1907	\$2058	\$2158	\$2270	\$2352	\$2494	\$2689	\$2098	\$3961	\$4300
---------------	--------	--------	--------	--------	--------	--------	--------	--------	--------	--------	--------	--------	--------

COM/yds = 3, COL/sq ft = 66

Round Ottoman with Five Legs

451-B42RD	\$2489	\$2489	\$2523	\$2577	\$2744	\$2847	\$2971	\$3059	\$3213	\$3426	\$2749	\$4779	\$5139
-----------	--------	--------	--------	--------	--------	--------	--------	--------	--------	--------	--------	--------	--------

COM/yds = 3¼, COL/sq ft = 72

Ganging Kit

451-GANGPKG	\$ 56	N.A.	N.A.	N.A.	N.A.	N.A.	N.A.	N.A.	N.A.	N.A.	N.A.	N.A.	N.A.
-------------	-------	------	------	------	------	------	------	------	------	------	------	------	------

Circa Lounge System Modular Tables

DESIGN ALISON SPEAR, AIA

Tip: Stain-to-Match is offered on wood legs.

Tip: All legs measure 6½" in height.

Standard Includes		Required to Specify
<ul style="list-style-type: none"> ▶ Need help? Product details, page 60 	<ul style="list-style-type: none"> • Table: hardwood veneer • Legs: <ul style="list-style-type: none"> - Tapered leg, if selected: solid maple or walnut - Cylinder leg, if selected: solid oak • Brackets and hardware, if ganging or end-of-run tables selected 	<ol style="list-style-type: none"> 1 Style number 2 Wood veneer color number for table 3 Wood leg type 4 Wood color number for legs 5 Options, if selected (see below) ▶ See <i>Coalesse Surface Materials Reference Guide</i> .

Surface Materials	Options	U.S. Price	Required to Specify
	Table <ul style="list-style-type: none"> • Laminate with self edge 	Prices below	Specify with <i>laminated</i> and select laminate color number. ▶ See <i>Coalesse Surface Materials Reference Guide</i> .
	Metal Legs <ul style="list-style-type: none"> • Tapered legs <ul style="list-style-type: none"> • Grade 1 paint • Modern legs <ul style="list-style-type: none"> • Grade 1 paint 	+\$204 per leg +\$204 per leg	Specify with <i>tapered metal legs</i> and select paint color number. ▶ See <i>Coalesse Surface Materials Reference Guide</i> . Specify with <i>modern metal legs</i> and select paint color number. ▶ See <i>Coalesse Surface Materials Reference Guide</i> .
Related Products	<ul style="list-style-type: none"> • Lounge seating 		▶ Pages 66-70

Specification Information

Style Number	U.S. Base Prices	
	Laminate	Wood Veneer

15° Low Wedge Table, Ganging

45-T1815LG	\$1757	\$2023
------------	--------	--------

15° Low Wedge Table, End-of-Run, Two Legs

45-T1815LER	\$1882	\$2296
-------------	--------	--------

15° High Wedge Table, Ganging

45-T1815HG	\$2229	\$2793
------------	--------	--------

15° High Wedge Table, End- of-Run, Two Legs

45-T1815HER	\$2351	\$3053
-------------	--------	--------

▶ Specification Information, continued on next page

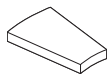

Overall: 28" D 18½" W 8½" H
Angle Degree: 15°

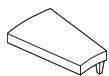

Overall: 28" D 18½" W 8½" H
Angle Degree: 15°

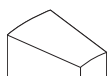

Overall: 28" D 18½" W 22½" H
Angle Degree: 15°

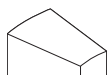

Overall: 28" D 18½" W 22½" H
Angle Degree: 15°



For Canadian Pricing
Multiply U.S. Price by the Canadian price factor.
▶ See page 1 for details.

Circa Lounge System Modular Tables

DESIGN ALISON SPEAR, AIA

► Specification Information, continued from previous page

Specification Information

Style Number	U.S. Base Prices	
	Laminate	Wood Veneer

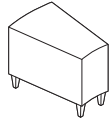

Overall: 28"D 18½"W 22½"H
Angle Degree: 15°

15° High Wedge Table, Freestanding, Four Legs

45-T1815H	\$2473	\$3331
-----------	--------	--------

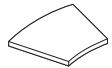

Overall: 29"D 36½"W 2"H
(8½" from floor once assembled)

30° Low Wedge Table, Ganging

45-T3730LG	\$2203	\$2478
------------	--------	--------

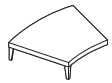

Overall: 29"D 36½"W 8½"H

30° Low Wedge Table, End-of-Run, Two Legs

45-T3730LER	\$2328	\$2772
-------------	--------	--------

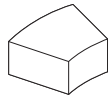

Overall: 29"D 36½"W 16"H

30° High Wedge Table, Ganging

45-T3730HG	\$3093	\$3531
------------	--------	--------

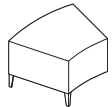

Overall: 29"D 36½"W 22½"H

30° High Wedge Table, End-of-Run, Two Legs

45-T3730HER	\$3217	\$3818
-------------	--------	--------

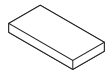

Overall: 27½"D 13½"W 8½"H
Angle Degree: 0°

Straight Low Table, Ganging

45-T1300LG	\$1755	\$1977
------------	--------	--------

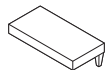

Overall: 27½"D 13½"W 8½"H
Angle Degree: 0°

Straight Low Table, End-of-Run, Two Legs

45-T1300LER	\$1882	\$2296
-------------	--------	--------

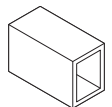

Overall: 27½"D 13½"W 22½"H
Angle Degree: 0°

Straight High Table, Ganging

45-T1300HG	\$2580	\$3166
------------	--------	--------

► Specification Information, continued on next page



For Canadian Pricing
Multiply U.S. Price by the
Canadian price factor.
► See page 1 for details.

Circa Lounge System Modular Tables *continued*

DESIGN ALISON SPEAR, AIA

► Specification Information, continued from previous page

Specification Information

Style Number	U.S. Base Prices	
	Laminate	Wood Veneer

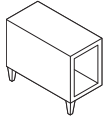

Overall: 27½"D 13½"W 22½"H
Angle Degree: 0°

Straight High Table, End-of-Run, Two Legs

45-T1300HER	\$2923	\$3707
-------------	--------	--------

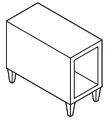

Overall: 27½"D 13½"W 22½"H
Angle Degree: 0°

Straight High Table, Freestanding, Four Legs

45-T1300H	\$3045	\$3928
-----------	--------	--------



Overall: 13¾"D 27½"W 22¼"H
(8½" from floor once assembled)
Tip: Model 45-T28HER has only a single width tapered leg, no corner.

30° End-of-Run, One Leg

45-T28HER	\$2425	\$2992
-----------	--------	--------

Options for Creating 90° Applications:

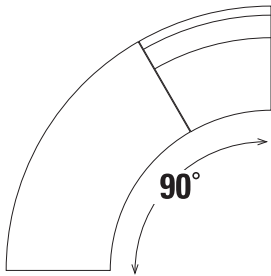

- (1) 30° Outside or Inside Facing Wedge Seat
- (1) 60° Wedge Bench

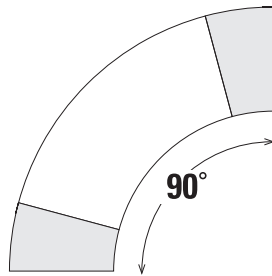

- (2) 15° Wedge Tables
- (1) 60° Wedge Bench

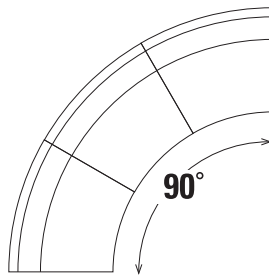

- (3) 30° Outside or Inside Facing Wedge Seats

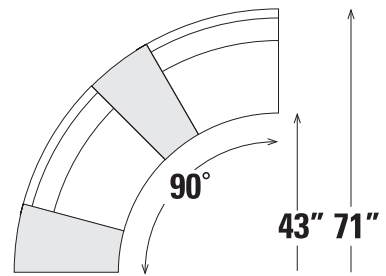

- (2) 30° Outside or Inside Facing Wedge Seats
- (2) 15° Wedge Tables



For Canadian Pricing
Multiply U.S. Price by the Canadian price factor.
► See page 1 for details.

Circa Lounge System Freestanding Round Table

DESIGN ALISON SPEAR, AIA

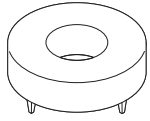

Tip: Stain-to-Match is offered on wood legs.

Tip: All legs measure 6½" in height.

Tip: The round plate that houses the power/data module is powder coated to complement the power/data module finish. For the black anodized aluminum module, the round plate will be painted in 4710 Low Gloss Black. For the silver anodized aluminum module, the round plate will be painted 4799 Platinum.

Overall: 42" dia. 15¾"H

Tip: Tapered wood and metal legs have a thin, blade aesthetic.

Standard Includes	Required to Specify
<ul style="list-style-type: none"> ▶ Need help? Product details, page 60 • Table: laminate • Legs: <ul style="list-style-type: none"> - Tapered leg, if selected: solid maple or walnut - Cylinder leg, if selected: solid oak 	<ol style="list-style-type: none"> 1 Style number 2 Laminate color number for table 3 Wood leg type 4 Wood color number for legs 5 Options, if selected (see below) <p>▶ See <i>Coalesse Surface Materials Reference Guide</i>.</p>

	Options	U.S. Price	Required to Specify
Surface Materials	Table		
	<ul style="list-style-type: none"> • Wood veneer 	Price below	Specify with wood veneer and select wood color number. ▶ See <i>Coalesse Surface Materials Reference Guide</i> .
	<ul style="list-style-type: none"> • Sunburst wood veneer 	Price below	Specify with sunburst wood veneer and select wood color number. ▶ See <i>Coalesse Surface Materials Reference Guide</i> .
Metal Legs	Tapered legs		
	<ul style="list-style-type: none"> • Grade 1 paint 	+\$204 per leg	Specify with tapered metal legs and select paint color number. ▶ See <i>Coalesse Surface Materials Reference Guide</i> .
	Modern legs		
	<ul style="list-style-type: none"> • Grade 1 paint 	+\$204 per leg	Specify with modern metal legs and select paint color number. ▶ See <i>Coalesse Surface Materials Reference Guide</i> .
Glass Insert	<ul style="list-style-type: none"> • Green tinted glass insert ¾" thick with white enamel bottom square edge detail 	+\$399	Specify with glass insert.
Power/Data Module	<ul style="list-style-type: none"> • Two power/two data ports black anodized aluminum or silver anodized aluminum 	+\$592	Specify finish color number.
Related Products	<ul style="list-style-type: none"> • Lounge seating 		▶ Pages 66-70

Specification Information			
Style Number	U.S. Base Prices		
	Laminate	Wood Veneer	Sunburst Wood Veneer
Round Table, Freestanding, Four Legs			
45-T42RD	\$4172	\$5563	\$5994

 **For Canadian Pricing**
Multiply U.S. Price by the Canadian price factor.
▶ See page 1 for details.

Circa Lounge System Multi-Fabric Diagram

DESIGN ALISON SPEAR, AIA

Applies to all Circa models including: Straight 1-Seat Lounge, Wedge, and Straight 2-Seat Lounge

TO: _____

FROM: _____

DATE: _____

FAX....888.413.5161

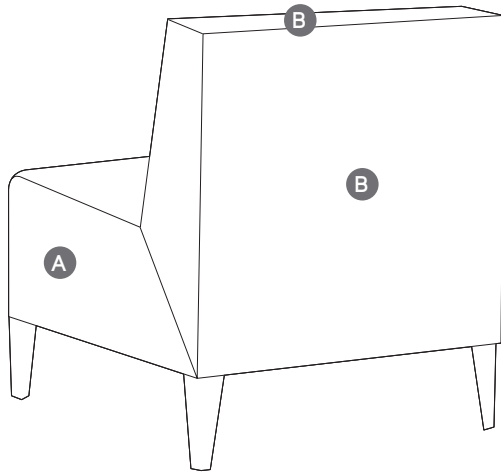
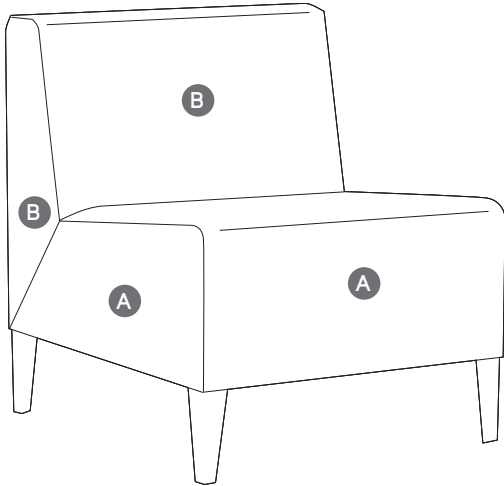

A Upholstery Selection (default for entire unit if B is not selected):

B Back: _____

Specify model below:

451-7460FOK Outside Facing

451-7460FIK Inside Facing

451-5000K

451-2500K

451-3730FOK Outside Facing

451-3730FIK Inside Facing

See specifying for contrasting fabric upcharge. List price based on highest fabric grade usage.

Coalesse

Circa Lounge System Multi-Fabric Diagram

DESIGN ALISON SPEAR, AIA

Coupe/Coupe Grande/Mobile Lounge Seating

DESIGN DENNIE PIMENTAL / JOHN DUFFY

Coupe offers versatile lounge seating that is adaptable to multiple environments and spatial needs.

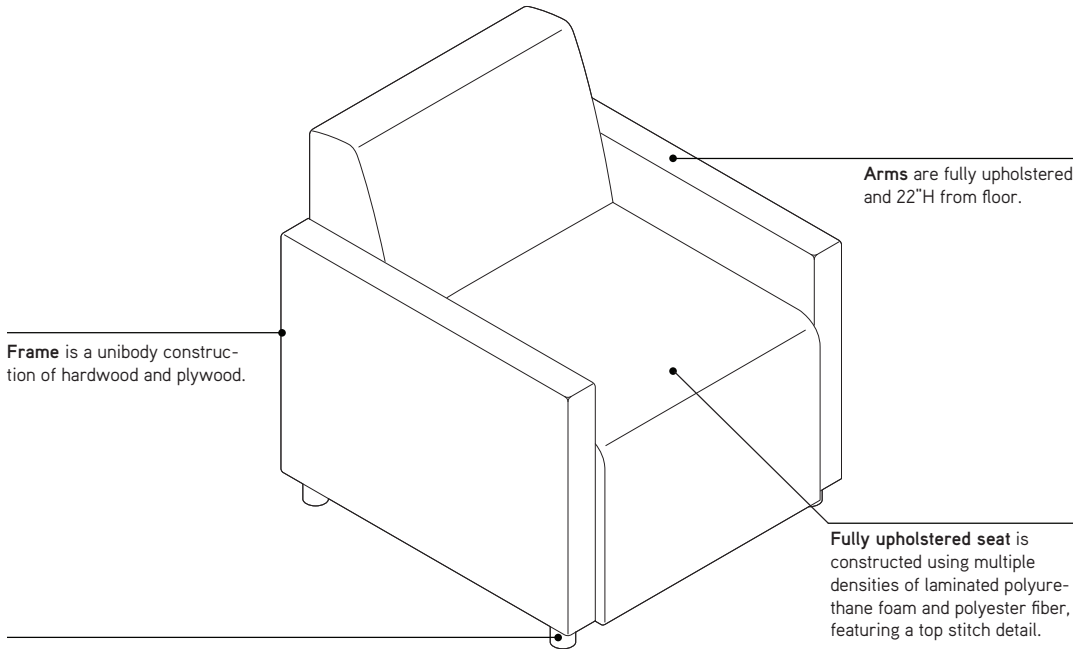

4-leg base includes non-marring, non-adjustable glides. Standard solid beech wood legs, also available in brushed aluminum, powder coat, or clear acrylic as options.

Product Details

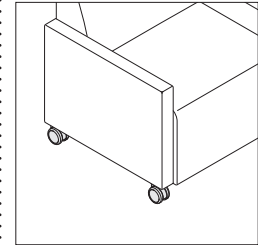
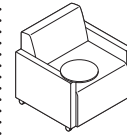

Coupe Grande's mobile chair is available with swivel hard casters with locking and non-locking wheels, or soft casters for use on hard floors. Optional tablet arm available in laminate 13¹/₂" diameter.

Surface Materials

► See *Coalesse Surface Materials Reference Guide* for further information.

Upholstery

- Fabric
- Leather

Legs

- Solid wood
- Brushed aluminum
- Paint
- Clear acrylic

Tablet on mobile chair

- Laminate

Program and Services

Customer's Own Material/Leather (COM/COL) Program is available.

► See *Coalesse Surface Materials Reference Guide* for additional information.

Coupe Lounge Seating

DESIGN DENNIE PIMENTAL / JOHN DUFFY

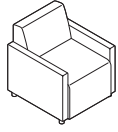

Overall: 28"D 26½"W 30"H
 Inside: 20"D 22"W 13"H
 Seat: 17"H
 Arm: 22"H

Tip: Fabrics and leathers will appear loose with comfort wrinkles when upholstered.

Tip: Recommended leathers are Elmosoft Grade C and Elmorustical Grade E.

Tip: Special color match, consult Customer Service.

Tip: For Customer's Own Material or Leather, see necessary requirements, important processing instructions, and ordering information
 ▶ See *Coalesse Surface Materials Reference Guide*.

Standard Includes	Required to Specify
▶ Need help? Product details, page 78 • Frame: unibody construction of hardwood plywood utilizing box joinery • Legs: solid beech • Glides: non-adjustable • Upholstery: multiple densities of laminated polyurethane foam and polyester fiber on seat and back with top stitch sewing detail	1 Style number 2 Wood color number for legs 3 Fabric or leather color number for upholstery on seat and back 4 Options, if selected (see below) ▶ See <i>Coalesse Surface Materials Reference Guide</i> .

Options	U.S. Price	Required to Specify
Surface Materials • Acrylic backer • Lounge chair	+\$ 60	Specify with acrylic backer. ▶ See <i>Coalesse Surface Materials Reference Guide</i> .
Legs • Brushed aluminum • Powder coat • Acrylic: clear	+\$253 +\$203 +\$356	Specify with brushed aluminum legs. Specify with powder coat legs and select color: 4138 Graphite Gloss 4140 Arctic White Gloss 4142 Platinum Gloss 4144 Black Gloss 4148 Midnight Brown Gloss Specify with acrylic legs.
Casters • Ottoman casters	+\$220	Specify with casters.

Specification Information														
Style Number	U.S. Base Prices											Leather Grades:		
	Fabric Grades:											COL	C	E
COM	6	7	8	9	10	11	12	13	14					

Lounge Chair													
470	\$2306	\$2306	\$2345	\$2420	\$2632	\$2773	\$2933	\$3048	\$3246	\$3525	\$2550	\$5434	\$5962
COM/yds = 4¼, COL/sq ft = 94													

Lounge Seating

 **For Canadian Pricing**
 Multiply U.S. Price by the Canadian price factor.
 ▶ See page 1 for details.

Coupe Grande/Mobile Lounge Seating

DESIGN DENNIE PIMENTAL / JOHN DUFFY

Tip: Fabrics and leathers will appear loose with comfort wrinkles when upholstered.

Tip: Recommended leathers are Elmosoft Grade C and Elmorustical Grade E.

Tip: Special color match, consult Customer Service.

Tip: For Customer's Own Material or Leather, see necessary requirements, important processing instructions, and ordering information
 ▶ See *Coalesse Surface Materials Reference Guide*.

Standard Includes	Required to Specify
▶ Need help? Product details, page 78 • Frame: unibody construction of hardwood plywood utilizing box joinery • Legs: solid beech • Glides: non-adjustable • Upholstery: multiple densities of laminated polyurethane foam and polyester fiber on seat and back with top stitch sewing detail • On 476M model: – Casters: swivel hard – Locking and non-locking wheels • Tablet: – Laminate – 13½" diameter	1 Style number 2 Wood color number for legs 3 Fabric or leather color number for seat and back 4 Laminate color number for 476M tablet, if selected 5 Options, if selected (see below) ▶ See <i>Coalesse Surface Materials Reference Guide</i> .

Options	U.S. Price	Required to Specify
Surface Materials • Acrylic backer • Lounge chair	+\$ 74	Specify with acrylic backer. ▶ See <i>Coalesse Surface Materials Reference Guide</i> .
Casters on 476M only • Soft casters	No cost	Specify with soft casters.
Legs • Brushed aluminum • Powder coat • Acrylic: clear	+\$253 +\$203 +\$356	Specify with brushed aluminum legs. Specify with powder coat legs and select color: 4138 Graphite Gloss 4140 Arctic White Gloss 4142 Platinum Gloss 4144 Black Gloss 4148 Midnight Brown Gloss Specify with acrylic legs.
Tablet 476M only • Omit tablet	-\$242	Specify with remove tablet.

Specification Information													
Style Number	U.S. Base Prices												
	Fabric Grades:												
	COM	6	7	8	9	10	11	12	13	14	Leather Grades:		
											COL	C	E

Grande Lounge Chair

476	\$2667	\$2697	\$2747	\$2831	\$3086	\$3248	\$3442	\$3575	\$3808	\$4137	\$2895	\$6318	\$6928
-----	--------	--------	--------	--------	--------	--------	--------	--------	--------	--------	--------	--------	--------

COM/yds = 5, COL/sq ft = 110

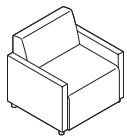

Overall: 28"D 31"W 30"H
 Inside: 20"D 25"W 13"H
 Seat: 17"H
 Arm: 22"H

Mobile Lounge Chair

476M	\$3425	\$3455	\$3505	\$3589	\$3844	\$4006	\$4200	\$4333	\$4566	\$4895	\$3653	\$7061	\$7681
------	--------	--------	--------	--------	--------	--------	--------	--------	--------	--------	--------	--------	--------

COM/yds = 5, COL/sq ft = 110

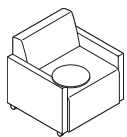

Overall: 28"D 31"W 30"H
 Inside: 20"D 25"W 13"H
 Seat: 17"H
 Arm: 22"H

Davos Lounge Seating by Viccarbe

DESIGN JEFFREY BERNETT

Elegantly contemporary, Davos is a natural for social spaces. Configure the lounge with benches in a lobby, lounge, or living room setting.

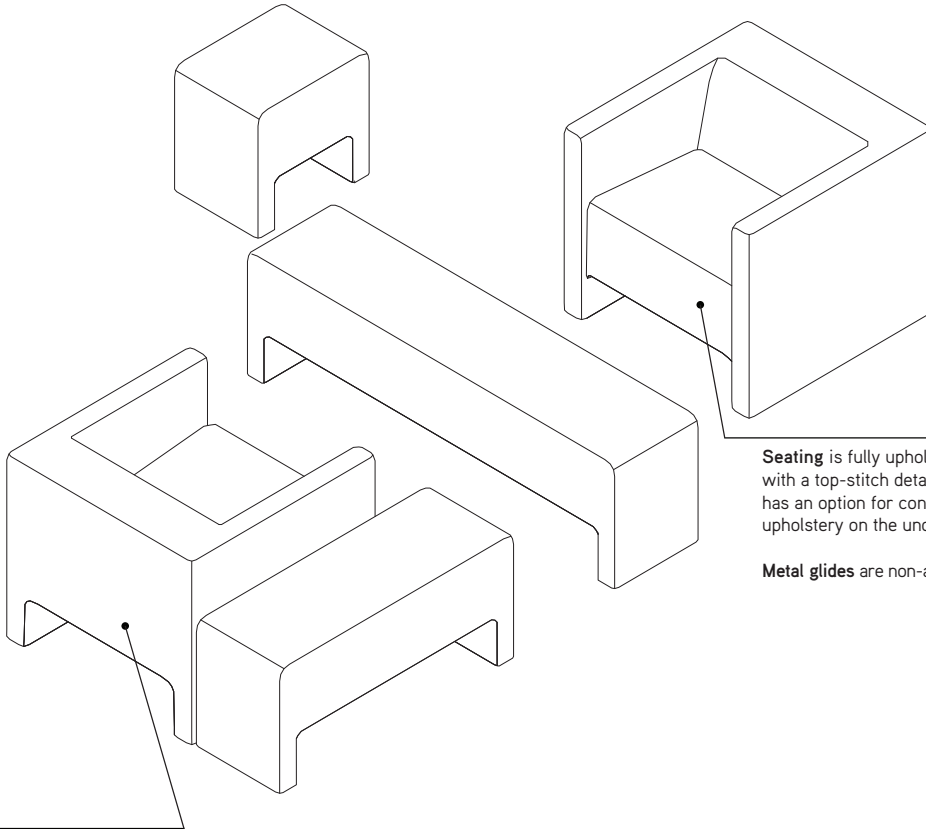

Frame is constructed of hardwood.

Seating is fully upholstered with a top-stitch detail and has an option for contrasting upholstery on the underside.

Metal glides are non-adjustable.

Product Details

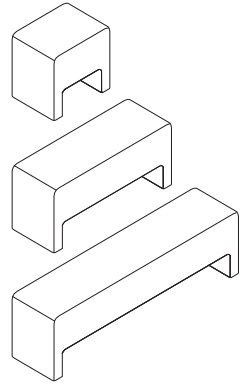

Benches are available in three sizes: the small bench measures 18"W, the medium bench measures 38"W, and the large bench measures 59½"W. All benches are fully upholstered with the option for contrasting upholstery on the underside.

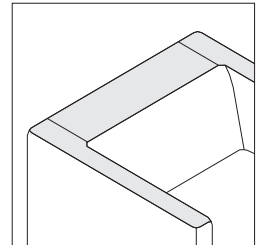

Top-stitch detail is featured on the back cushion and arm of chair.

Surface Materials

► See *Coalesse Surface Materials Reference Guide* for further information.

Upholstery (contrasting fabric available)

- Fabric
- Leather

Program and Services

Customer's Own Material/Leather (COM/COL) Program is available.

► See *Coalesse Surface Materials Reference Guide* for additional information.

Davos Lounge Seating by Viccarbe

DESIGN JEFFREY BERNETT

Tip: For Customer's Own Material or Leather, see necessary requirements, important processing instructions, and ordering information
 ▶ See *Coalesse Surface Materials Reference Guide*.

Tip: Fabrics and leathers will appear loose with comfort wrinkles when upholstered.
 ▶ See page 83 for *Multi-Fabric Diagram*.

Tip: K suffix must be specified for leather underside.

Tip: Models with fabric underside include black denim section to allow for proper air flow. If this aesthetic is not desired, select contrasting option with leather underside.

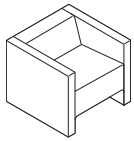

Overall: 30"D 30"W 25½"H
 Seat: 19"D 24"W 16½"H

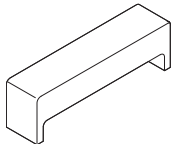

Overall: 13¼"D 59½"W 17½"H

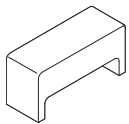

Overall: 13¼"D 38"W 17½"H



Overall: 13¼"D 18½"W 17½"H

 **For Canadian Pricing**
 Multiply U.S. Price by the Canadian price factor.
 ▶ See page 1 for details.

Standard Includes		Required to Specify
-------------------	--	---------------------

▶ Need help? Product details, page 81	<ul style="list-style-type: none"> Upholstery for chair or bench: fabric or leather Glides: non-adjustable metal 	1 Style number 2 Number of fabrics if contrasting fabric style number is selected 3 Fabric or leather color number for upholstery 4 Options, if selected (see below) ▶ See <i>Coalesse Surface Materials Reference Guide</i> .
---------------------------------------	--	--

Options	U.S. Price	Required to Specify
---------	------------	---------------------

Surface Materials <ul style="list-style-type: none"> Contrasting fabric 	+\$182 per fabric	Add suffix K to the style number and select fabric color number.
Acrylic backer <ul style="list-style-type: none"> Lounge chair Large bench Medium bench Small bench 	+\$ 84 +\$ 50 +\$ 39 +\$ 24	Specify with <i>acrylic backer</i> . Specify with <i>acrylic backer</i> . Specify with <i>acrylic backer</i> . Specify with <i>acrylic backer</i> . ▶ See <i>Coalesse Surface Materials Reference Guide</i> .

Specification Information

Style Number	U.S. Base Prices												Leather Grades:			
	Fabric Grades:												COL	C	E	
	COM	6	7	8	9	10	11	12	13	14						

Lounge Chair

CODAV	\$3176	\$3206	\$3256	\$3340	\$3595	\$3757	\$3951	\$4084	\$4317	\$4646	\$3360	\$5934	\$6373
-------	--------	--------	--------	--------	--------	--------	--------	--------	--------	--------	--------	--------	--------

COM/yds = 5, COL/sq ft = 110

Large Bench

CODAV60	\$2610	\$2610	\$2644	\$2698	\$2865	\$2968	\$3092	\$3180	\$3334	\$3547	\$2854	\$4344	\$4588
---------	--------	--------	--------	--------	--------	--------	--------	--------	--------	--------	--------	--------	--------

COM/yds = 3¼, COL/sq ft = 71½

Medium Bench

CODAV38	\$1876	\$1876	\$1899	\$1942	\$2069	\$2150	\$2243	\$2312	\$2429	\$2591	\$2155	\$3488	\$3707
---------	--------	--------	--------	--------	--------	--------	--------	--------	--------	--------	--------	--------	--------

COM/yds = 2½, COL/sq ft = 55

Small Bench

CODAV16	\$1204	\$1204	\$1219	\$1248	\$1337	\$1394	\$1461	\$1508	\$1592	\$1705	\$1521	\$2545	\$2738
---------	--------	--------	--------	--------	--------	--------	--------	--------	--------	--------	--------	--------	--------

COM/yds = 1¾, COL/sq ft = 39

Davos Lounge Seating Multi-Fabric Diagram

DESIGN JEFFREY BERNETT

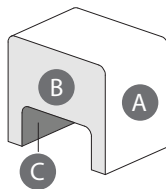
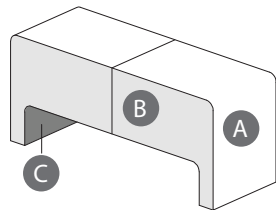
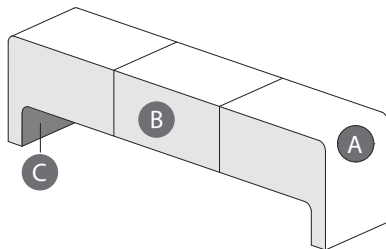
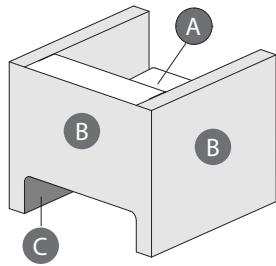
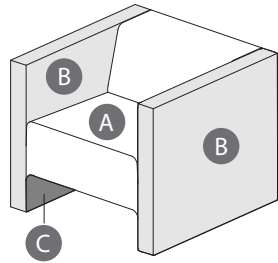

TO: _____

FROM: _____

DATE: _____

FAX...888.413.5161

Davos Lounge Chair

- A** Seat (upholstery selections default for entire unit if B is not selected): _____
- B** Arms and Back: _____
- C** Underside: _____

Davos Large Bench

- A** Seat (upholstery selections default for entire unit if B is not selected): _____
- B** Side: _____
- C** Underside: _____

Davos Medium Bench

- A** Seat (upholstery selections default for entire unit if B is not selected): _____
- B** Side: _____
- C** Underside: _____

Davos Small Bench

- A** Seat (upholstery selections default for entire unit if B is not selected): _____
- B** Side: _____
- C** Underside: _____

See specifying for contrasting fabric upcharge. List price based on highest grade textile specified.

***Highest grade pricing will not apply to C and E leathers when applied to the underside.*

Hosu Lounge Seating

DESIGN PATRICIA URQUIOLA

Hosu lounge seating offers a comforting, personal space to relax and get things done.

Fully upholstered with contoured backrest cushion and frame which allows back to flex to support user's back shape.

Attached lumbar pillow is 3" thick in coordinating upholstery.

Pockets on side and rear for additional storage are standard.

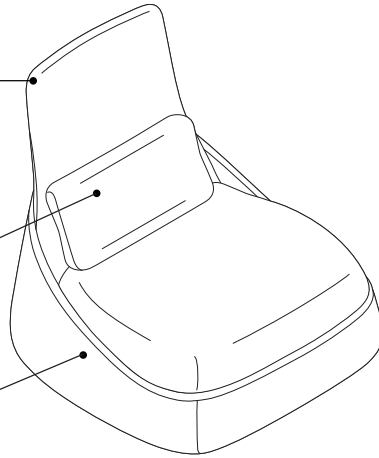

Glides are non-adjustable.

Product Details

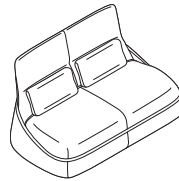
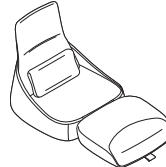

Lounge seating is available as a fixed single seat lounge or with a convertible chaise foldout. A fixed 2-seat lounge is also available.

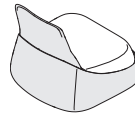

Storage pockets are located where the seat, backrest, and base wrap come together. Large pockets in the rear are ideal for holding magazines, and smaller pockets on the sides are sized appropriately for handheld devices. Cable pass-through holes are in the rear of the seat.

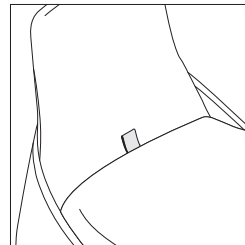

Convertible lounge converts to an extended low lounge with chaise ottoman using a webbed pull tab. The pull tab is available in red, blue, or black. The footbed surface is fusion fabric or leather.

Surface Materials

► See *Coalesse Surface Materials Reference Guide* for further information.

Seat, back, footrest, and pillow

- Fabric
- Leather

Wrap

- Plastic

Pull tab

- Nylon

Programs and Services

Customer's Own Material/Leather (COM/COL) Program is available.

► See *Coalesse Surface Materials Reference Guide* for additional information.

Coalesse

Hosu Lounge Seating

DESIGN PATRICIA URQUIOLA

Hosu Lounge Seating

DESIGN PATRICIA URQUIOLA

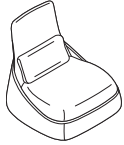

Tip: Fabrics and leathers will appear loose with comfort wrinkles when upholstered.

Tip: Vinyls will produce more wrinkles than other textiles.

Tip: Recommended leathers are Elmosoft Grade C and Elmorustical Grade E.

Tip: Frame design allows back to flex to support occupants back shape.

Tip: Due to the design and construction techniques of Hosu lounge seating only certain textiles can be successfully applied, therefore all COM fabrics must be submitted to Coalesse for approval prior to order acceptance.

Tip: Hexa fabrics (fabric group 10) were specifically designed by Patricia Urquiola for Hosu lounge seating.

► See *Coalesse Surface Materials Reference Guide* for complete listing of Hexa fabrics.

Standard Includes	Required to Specify
<p>► Need help? Product details, page 84</p> <ul style="list-style-type: none"> • Frame: plywood tab construction • Multiple densities of polyurethane foam and polyester fiber • Seat and back: fabric or leather • Wrap: made from ABS plastic • Footrest on fabric chair, if selected: Fusion fabric or leather • Footrest on leather chair, if selected: Fusion fabric or leather to match seat and back • Glides: non-adjustable • Pull tab on ottoman, if selected: Nylon strap • Grommet for wire pass-through on models COURQLO and COURQLOK, if selected • Pillow: fabric or leather 	<ol style="list-style-type: none"> 1 Style number 2 Number of fabrics if contrasting fabric style number is selected 3 Fabric or leather color number for upholstery on seat, back, and pillow 4 Fusion color number for footrest, if selected: <ul style="list-style-type: none"> CL60 Caviar CL62 Graphite CL80 Terracotta CL81 Copper CL82 Sage CL83 Blue Ink CL84 Blue Steel 5 Color number for pull tab with ottoman, if selected: <ul style="list-style-type: none"> CL40 Red CL41 Blue CL42 Black 6 Options, if selected (see below) <p>► See <i>Coalesse Surface Materials Reference Guide</i>.</p>

Surface Materials	Options	U.S. Price	Required to Specify
	Pillow for lounge chair and lounge chair with ottoman		
	<ul style="list-style-type: none"> • Fabric groups 6-10 • Fabric group 11 • Fabric group 12 • Fabric group 13 • Fabric group 14 • Fabric group C • Fabric group E • Customer's Own Material (COM) 	<ul style="list-style-type: none"> No cost +\$ 217 +\$ 245 +\$ 299 +\$ 368 +\$ 518 +\$ 623 +\$ 60 	<ul style="list-style-type: none"> Specify fabric color number. Specify fabric color number. Specify fabric color number. Specify fabric color number. Specify fabric color number. Specify fabric color number. Specify fabric color number. <p>► See <i>Coalesse Surface Materials Reference Guide</i>.</p> <p>► See <i>Coalesse Surface Materials Reference Guide</i>.</p>
	<ul style="list-style-type: none"> • Customer's Own Leather (COL) 	<ul style="list-style-type: none"> +\$ 409 	
	Pillows for 2-seat lounge		
	<ul style="list-style-type: none"> • Fabric groups 6-10 • Fabric group 11 • Fabric group 12 • Fabric group 13 • Fabric group 14 • Fabric group C • Fabric group E • Customer's Own Material (COM) 	<ul style="list-style-type: none"> No cost +\$ 379 +\$ 429 +\$ 519 +\$ 644 +\$ 918 +\$1109 +\$ 60 	<ul style="list-style-type: none"> Specify fabric color number. Specify fabric color number. Specify fabric color number. Specify fabric color number. Specify fabric color number. Specify fabric color number. Specify fabric color number. <p>► See <i>Coalesse Surface Materials Reference Guide</i>.</p> <p>► See <i>Coalesse Surface Materials Reference Guide</i>.</p>
	<ul style="list-style-type: none"> • Customer's Own Leather (COL) 	<ul style="list-style-type: none"> +\$ 409 	
	<ul style="list-style-type: none"> • Contrasting fabric 	<ul style="list-style-type: none"> +\$ 182 per fabric 	<ul style="list-style-type: none"> Add suffix K to the style number and select fabric color number.
	Acrylic backer		
	<ul style="list-style-type: none"> • Lounge chair • Lounge chair with ottoman • 2-seat lounge 	<ul style="list-style-type: none"> +\$ 60 +\$ 84 +\$ 112 	<ul style="list-style-type: none"> Specify with acrylic backer. Specify with acrylic backer. Specify with acrylic backer. <p>► See <i>Coalesse Surface Materials Reference Guide</i>.</p>



For Canadian Pricing
 Multiply U.S. Price by the Canadian price factor.
 ► See page 1 for details.

Hosu Lounge Seating

DESIGN PATRICIA URQUIOLA

Specification Information

Style Number	U.S. Base Prices												
	Fabric Grades:												
	COM	6	7	8	9	10	11	12	13	14	COL	C	E

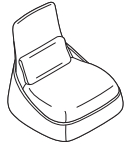

Overall: 35³/₈"D 34³/₈"W 35"H
 Inside: 24"D 31"W 14"H
 Pillow: 3"D 20¹/₈"W 10¹/₈"H
 Seat height: 14"H

Lounge Chair with Lumbar Pillow

COURQL	\$3262	\$3310	\$3357	\$3445	\$3713	\$3883	\$4087	\$4224	\$4471	\$4816	\$3446	\$5420	\$5669
--------	--------	--------	--------	--------	--------	--------	--------	--------	--------	--------	--------	--------	--------

Lounge chair: COM/yds = 4¹/₄, COL/sq ft = 94
 Pillow: COM/yds = 1, COL/sq ft = 22

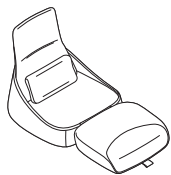

Overall: 35³/₈"D 34³/₈"W 35"H
 Overall extended: 57"L
 Inside: 24"D 31"W 14"H
 Inside extended: 48"L
 Pillow: 3"D 20¹/₈"W 10¹/₈"H
 Ottoman: 24"D 31"W 8¹/₂"H
 Seat height: 14"H
 Seat height extended: 9"H

Lounge Chair With Ottoman and Lumbar Pillow

COURQLO	\$3869	\$3990	\$4057	\$4167	\$4513	\$4731	\$4992	\$5170	\$5489	\$5930	\$4053	\$6836	\$7171
---------	--------	--------	--------	--------	--------	--------	--------	--------	--------	--------	--------	--------	--------

Lounge chair: COM/yds = 5³/₄, COL/sq ft = 126
 Pillow: COM/yds = 1, COL/sq ft = 22

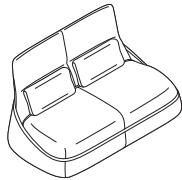

Overall: 35³/₈"D 64¹/₈"W 35"H
 Inside: 24"D 57¹/₈"W 14"H
 Pillows: 3"D 24"W 10¹/₈"H
 Seat height: 14"H

2-Seat Lounge with Two Lumbar Pillows

COURQS	\$5083	\$5294	\$5377	\$5521	\$5948	\$6230	\$6555	\$6780	\$7182	\$7738	\$5267	\$8480	\$8862
--------	--------	--------	--------	--------	--------	--------	--------	--------	--------	--------	--------	--------	--------

Lounge: COM/yds = 6³/₄, COL/sq ft = 143
 Pillows: COM/yds = 1³/₄, COL/sq ft = 39



For Canadian Pricing
 Multiply U.S. Price by the
 Canadian price factor.
 ▶ See page 1 for details.

Hosu Lounge Seating Multi-Fabric Diagram

DESIGN PATRICIA URQUIOLA

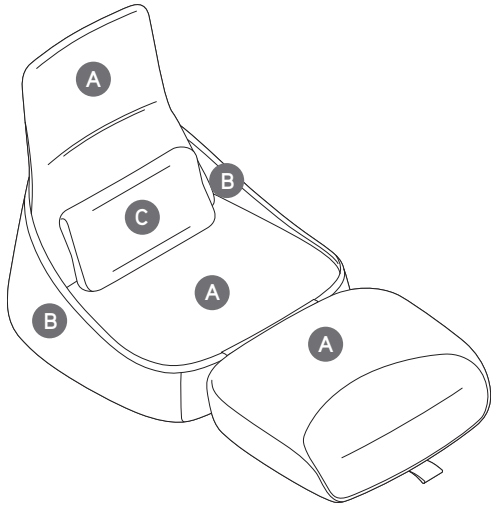

TO: _____

FROM: _____

DATE: _____

FAX....888.413.5161

A Seat & back: _____

B Wrap: _____

C Pillow: _____

Contrasting upcharge for each contrasting textile pricing based on highest grade textile specified. See specifying for contrasting upcharge.

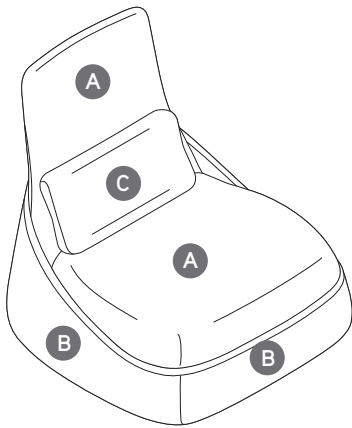

Specify Model below:

COURQLK Lounge Chair with Lumbar Pillow

COURQLOK Lounge Chair with Ottoman and Lumbar Pillow

COURQSK 2-Seat Lounge with Two Lumbar Pillows

Footrest is standard in Fusion caviar if fabric is specified. If leather is specified, leather on footrest will match.

Joel Lounge Chair by Walter Knoll

DESIGN EOOS

The Joel lounge chair is a new take on the classic club chair - refined, modern, and comfortable.

Arms are integral to backrest with no seams for added comfort.

Swivel-return base with auto-return mechanism returns chair to front-facing alignment.

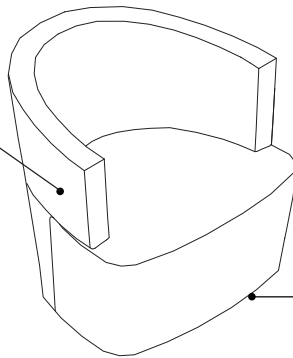

Frame is a two-piece construction. The seat is plywood and the back is steel for increased durability.

Disc base is 5/16" thick, with a chrome plated steel cover with plastic glides.

Product Details

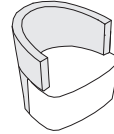

Integral arms provide added comfort for a range of postures.

Surface Materials

► See *Coalesse Surface Materials Reference Guide* for further information.

Upholstery (contrasting fabric available)

- Fabric
- Leather

Base

- Polished trivalent chrome

Programs and Services

Customer's Own Material/Leather (COM/COL) Program is available.

► See *Coalesse Surface Materials Reference Guide* for additional information.

Joel Lounge Chair by Walter Knoll

DESIGN E00S

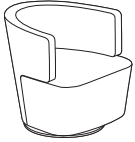

Overall: 29"D 30¼"W 27½"H
Seat: 16¼"H
Arm: 26¼"H
Inside: 21½"D x 16½"-23"W x 11"H

Tip: Fabrics and leathers will appear loose with comfort wrinkles when upholstered.

Tip: For Customer's Own Material or Leather, see necessary requirements, important processing instructions, and ordering information
 ▶ See *Coalesse Surface Materials Reference Guide*.

Standard Includes		Required to Specify
▶ Need help? Product details, page 89	<ul style="list-style-type: none"> • Base frame: steel with molded rigid foam • Seat frame: plywood with molded foam • Base: chrome plated steel • Auto swivel return mechanism 	1 Style number 2 Number of fabrics if contrasting fabric style number is selected 3 Fabric or leather color number for upholstery 4 Options, if selected (see below) ▶ See <i>Coalesse Surface Materials Reference Guide</i> .

Options	U.S. Price	Required to Specify
Surface Materials	<ul style="list-style-type: none"> • Contrasting fabric +\$182 per fabric 	Add suffix K to the style number and select fabric color number.
<ul style="list-style-type: none"> • Acrylic backer • Backer 	+\$ 50	Specify with acrylic backer. ▶ See <i>Coalesse Surface Materials Reference Guide</i> .

Specification Information															
Style Number	U.S. Base Prices												Leather Grades:		
	Fabric Grades:												COL	C	E
	COM	6	7	8	9	10	11	12	13	14					
COWK100	\$2886	\$2886	\$2920	\$2980	\$3157	\$3271	\$3405	\$3497	\$3664	\$3890	\$3114	\$5336	\$5594		

COM/yds = 3½, COL/sq ft = 77



For Canadian Pricing
 Multiply U.S. Price by the Canadian price factor.
 ▶ See page 1 for details.

Joel Lounge Chair Multi-Fabric Diagram

DESIGN E00S

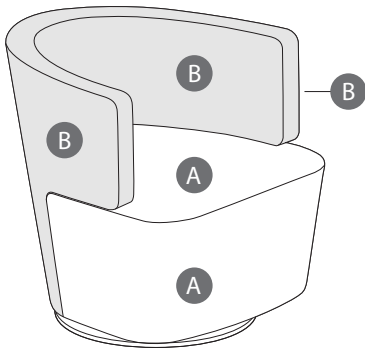

TO: _____

FROM: _____

DATE: _____

FAX...888.413.5161

A Seat (upholstery selections default for entire unit if B is not selected): _____

B Back: _____

Contrasting upcharge for each contrasting textile pricing based on highest grade textile specified. See specifying for contrasting upcharge.

Lagunitas Lounge System

DESIGN TOAN NGUYEN

The Lagunitas lounge system

offers a wide range of highly customizable settings, bringing a new level of versatility to all the ways we work. Lagunitas adapts to changing work styles and shifting postures. Lagunitas utilizes a full range of design expressions with benches, lounge pieces, and tables. Fabric and knit, combined with high and low panels, allow for a full range of aesthetic and functional possibilities. Benches complement the range of lounge pieces. Work, occasional, and personal tables are curated to work specifically with Lagunitas lounges and benches. Integrated power options for the lounges, benches, and tables are available. Lagunitas supports existing and emerging work activities in an endless number of social, collaborative, and personal settings.

Tip: This product line is part of a collection and will be found in multiple locations in this specification guide and/or Coalesse Tables, Storage, and Accessories Specification Guide.

► See *Collections*, page 5.

Lounges and benches are offered in 1-, 2-, and 3-seat models. The chaise is offered in 2- and 3-seat models. The corresponding table offering works with the seating dimensions for complete systematic compatibility.

Screens are available in two heights for lounges and chaises. Low-back screens are 26³/₄"H and high-back screens are 50"H. Overall height of low-back units is 32³/₈".

Screens are available in knit or fabric.

Articulating back is standard on lounges and chaises which allow user to change from a lounge position to a task position within the same unit. An integrated pull at the top and bottom intuitively identifies the back and aids in the function of the back.

Lounge units can be connected together to create permanent connections for L- and U-configurations. The alignment connector bracket package includes two brackets to connect the seat decks and one screen alignment clip to keep the screens aligned.

Tables are offered in three types; work, occasional, and personal tables. 26"H table dimensions are curated to work with the lounge pieces for optimal compatibility. 28¹/₂"H work tables are compatible with standard height seating. ► See *Coalesse Tables, Storage, and Accessories Specification Guide*.

Table bases and columns are standard in powder coat paint.

All corners are standard with a stationary corner cushion for all 2- and 3-seat lounges and chaises. Arm cushions are optional on units with left- and right-hand screens to allow for articulating backs on all back cushions.

Welt cord is standard on fabric screens and will match the outside screen fabric selection if contrasting is selected.

Seat deck is available in knit or fabric and must be same material as the screen.

Lounges and chaises are standard with two glides per screen section or seat deck. Each glide can adjust 1/2" for uneven floors.

Work and occasional table tops are standard in High-Pressure Laminate with a 3 mm plastic edge or wood veneer with a 3 mm matching edge profile.

Table glides are non-adjustable and are clear plastic.

Personal table tops are standard in High-Pressure Laminate with 3 mm plastic edge or Fusion fabric.

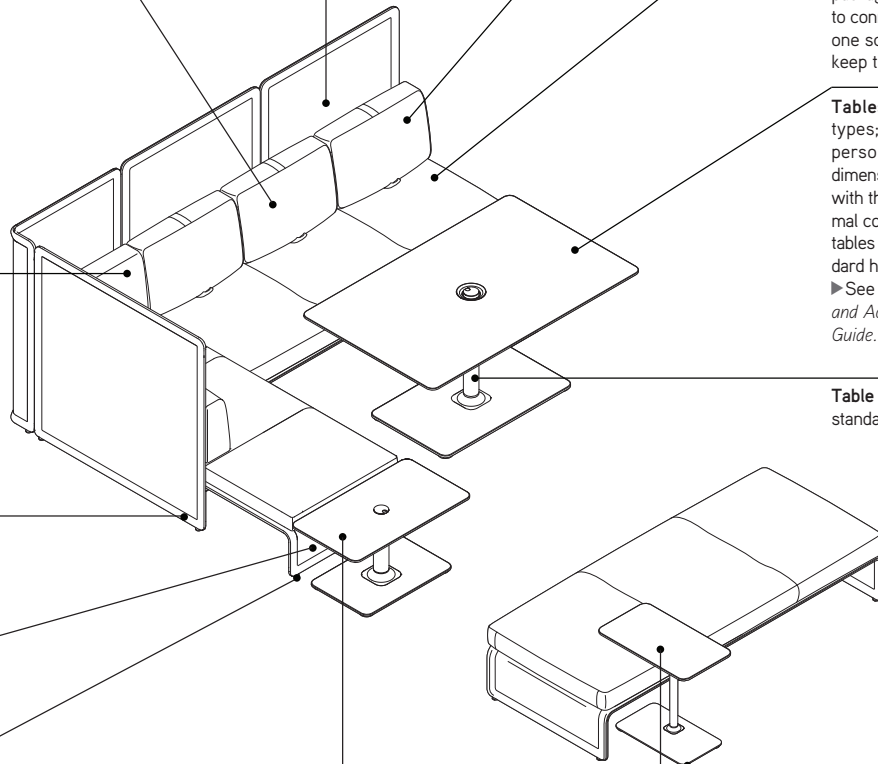

Lagunitas Lounge System

DESIGN TOAN NGUYEN

Product Details

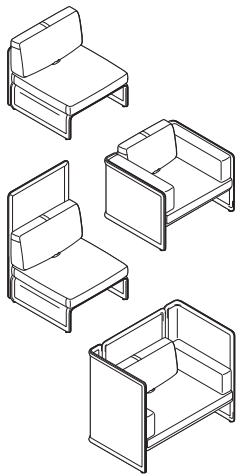

1-seat lounges are available in low- and high-back screens. Screens can be back only or back and left- and right-hand screens. 1-seat lounges are standard with upholstered fabric or knit screen(s), fabric or knit seat deck, fabric or leather seat cushion, and articulating back cushions. Fabric or leather end arm cushions are available.

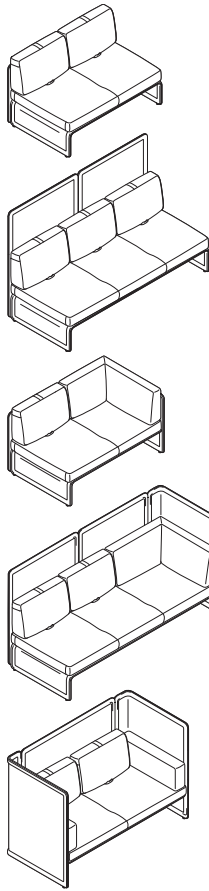

2- and 3-seat lounges are available in low- and high-back screens. Screens can be back only or back with left- or right-hand screens, or back and left- and right-hand screens. 2- and 3-seat lounges are standard with upholstered fabric or knit screen(s), fabric or knit seat deck, fabric or leather seat cushions, fabric or leather articulating back(s) and or corner cushion(s). Fabric or leather end arm cushions are available. *Tip: Handedness is noted by seated position.*

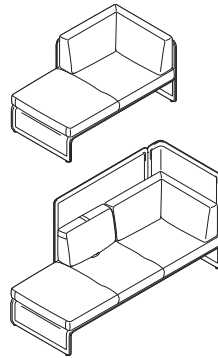

2- and 3-seat chaises are available in low- and high-back screens. Screens are back and left- or right-handed. 2- and 3-seat chaises are standard with upholstered fabric or knit screens, fabric or knit seat deck, fabric or leather seat and corner cushion. *Tip: Handedness is determined while in the seated position.*

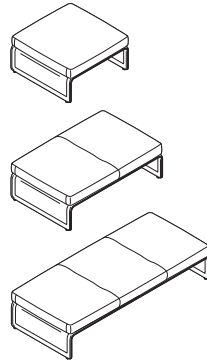

Benches are available in 1-, 2-, or 3-seat models. Benches are standard with an upholstered knit or fabric seat deck and a fabric or leather seat cushion.

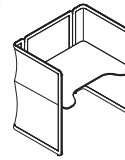

Lagunitas focus nook is available with 50"H high-back screens and is offered in two types of materials, knit and fabric. The worksurface is 28½"H and is compatible with standard height seating. Worksurface is available in laminate with matching or complementing 3 mm flat edge band profile; or wood veneer with matching 3 mm flat wood edge band. Optional lighting grommet and power are specifiable on the left or right side of the worksurface. ▶ See page 142.

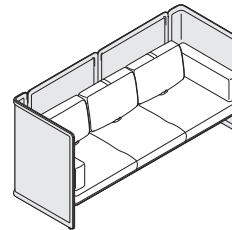

Screens are offered in two types of materials, knit and fabric. The knit panels allow for some transparency and light to pass through the panels. The fabric panels can be either monolithic (non-contrasting) or can be specified in differing finishes (contrasting) for the inside and outside of the screen. *Tip: If a contrasting screen is specified, the fabric must be chosen from the same fabric family.*

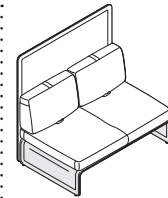

Seat deck is offered in two types of materials, knit and fabric. The seat deck material must match the screen material. If knit is specified on the screen, the seat deck will be applied automatically to the screen choice. If fabric is specified, seat deck must match either the inside or outside screen finish if contrasting is selected. When non-contrasting fabric screen is selected, seat deck will match screen fabric.

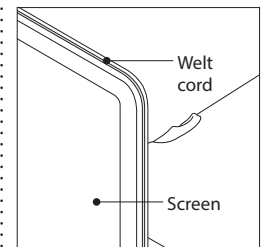

A welt cord is standard on all fabric specified screens and seat decks. The welt cord finish is non-specifiable and is the same fabric finish as the outside screen specification when contrasting screens are specified. For non-contrasting screens the welt cord matches the screen specification. The knit screen and seat deck does not require a welt cord.

Lagunitas Lounge System *continued*

DESIGN TOAN NGUYEN

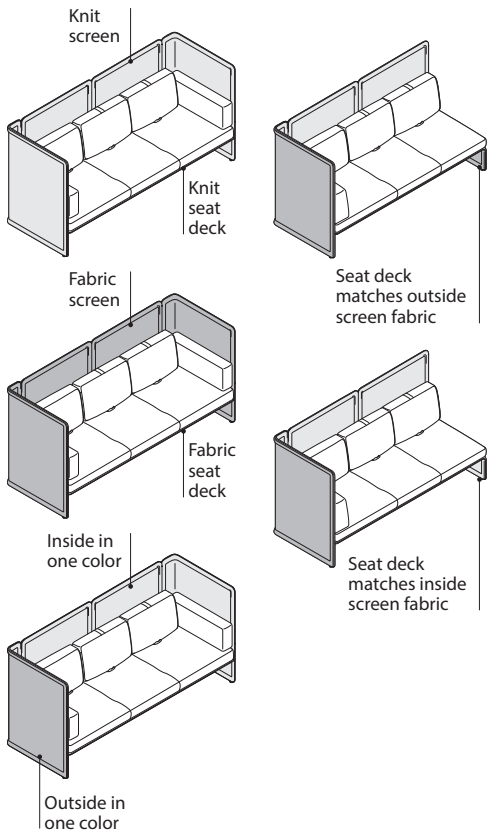

Screens and seat deck can be specified in:

- Knit
- Fabric (one fabric choice)
- Contrasting fabric (must be from fabric family)
 - Inside screen
 - Outside screen
 - Seat deck must match either the inside or outside fabric choice

Tip: Leather and vinyl are not approved for the screen(s) and seat deck. Consult the fabric database for fabric approvals.

Tip: It is important to understand the seat deck implication for contrasting fabric selection when two or more pieces are attached or adjacent to each other. The seat deck for contrasting fabric specification is either the outside screen (top example) or inside screen (bottom example).

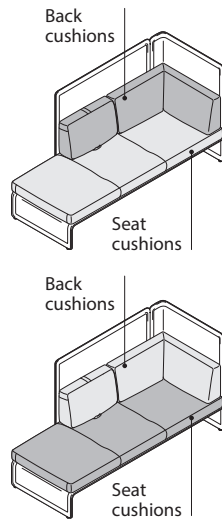

Seat back and seat cushions can be specified in:

- Fabric or leather (one fabric choice)
- Contrasting fabric or leather
 - Seat backs
 - Seat cushion
 - Top and bottom pulls on articulating back cushion(s)

The seat back, seat cushion, as well as, top and bottom pulls on the articulating back can be specified in fabric or leather. It can be specified as non-contrasting, one finish; or contrasting, finish for back cushions(s) and finish for seat cushion. Specification of back cushion is for all back cushions for that style number. Specification of seat cushion is for all seat cushions for the style number.

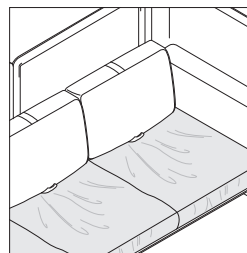

Comfort wrinkles are intended to occur over the time to increase the comfort of Lagunitas. Very little maintenance is required to reduce the definition: smooth the cushion fabric with a spreading/wiping motion.

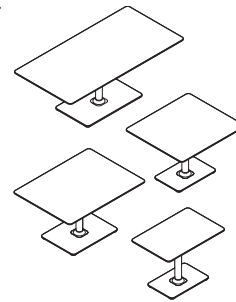

Work tables are available in six differing sizes, ranging from 30"W to 72"W that coordinate with the lounge dimensions to create a variety of social, collaborative, and personal applications. The work tables are available in two heights: 26"H and 28½"H. The work tables are comprised of a single column rectangular base in powder coat paint and a rectangular table top in laminate with matching or complementing 3 mm flat edge band profile or wood veneer with matching 3 mm flat wood edge band.

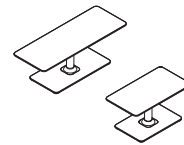

Occasional tables are available in two sizes, 32"W and 48"W, that coordinate with the lounge, chaise, and bench dimensions. The occasional tables are comprised of a single column with rectangular base available in powder coat paint and a rectangular table top in laminate with matching or complementing 3 mm flat edge band profile or wood veneer with matching 3 mm flat wood edge band.



Personal table is available in one size. It can easily be moved to your desired location for short term laptop work or simply used to set your coffee. The personal table is comprised of a single column with rectangular base available in powder coat paint and a rectangular table top in laminate with matching or complementing 3 mm flat edge band profile or a Fusion fabric-wrapped surface.

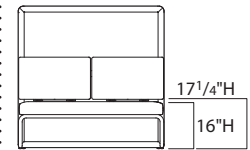

16" seat height is standard on all seating and benches. The 16"H seat height integrates specifically with the heights of all Lagunitas tables. There is an additional 1¼" crown of the seat cushion, which makes it 17¼" to work with the 26" work table height.

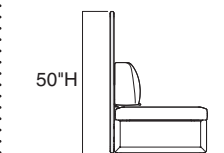
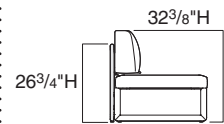

Two screen heights are available, 26¾"H for the low-back screen and 50"H for the high-back screen. Seat back cushions extend above the low-back screen, therefore, the overall height of low-back units is 32¾"H. Low-back screens are designed to provide an open environment. High-back screens are designed to provide privacy.

Lagunitas Lounge System

DESIGN TOAN NGUYEN

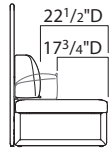

Seat depth accommodates two depths due to the articulated back design. In the lounge position, the seat depth is 22¹/₂"D and in the task position, the seat depth is 17³/₄"D.

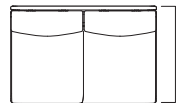

Lounge



Bench

The overall seat depth on benches is 32⁵/₈"D. The overall depth for lounge seating is 34"D.

1-seat lounge, left- and right-hand screens

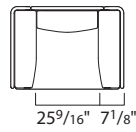

2-seat lounge, left-hand screen

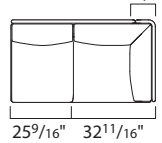

3-seat lounge

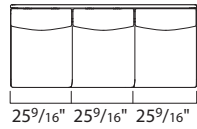

3-seat lounge, right-hand screen

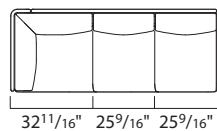

3-seat lounge, left- and right-hand screens

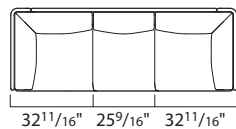

3-seat chaise, right-hand configuration

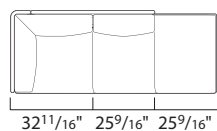

3-seat bench

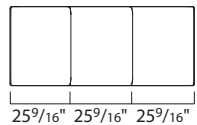

Two seat widths are available, 25⁹/₁₆"W and 32¹¹/₁₆"W. When specifying corner or end cushions, the 32¹¹/₁₆"W module is used. The corner cushion and end cushion account for 7¹/₈" of the 32¹¹/₁₆" width, equating to the same seating space as the 25⁹/₁₆"W module.

Exception: 1-seat lounge with three screens has an overall width of 46⁷/₈" allowing for a seating space of 32¹¹/₁₆"W.

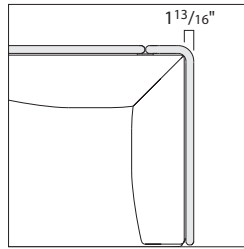

An additional 1¹³/₁₆" thickness for each end screen or corner is added to the seating width to obtain the overall width of the product.

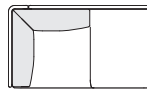

Corner cushions are standard when specifying two or three screens with closed end(s). Corner cushions are fixed and do not articulate.

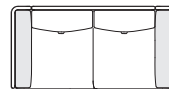

Two end cushions with two articulating backs

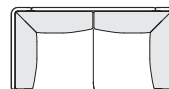

Two corner cushions

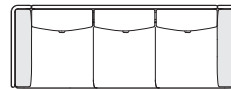

Two end cushions with three articulating backs

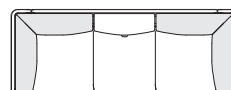

Two corner cushions with middle articulating back

Two corner cushions or two end cushions are available on all 2- and 3-seat lounges when back, left- and right-hand screens are specified. If articulating backs are specified, end cushions are required.



Lounge position



Task position

The articulating back is standard on all lounges and 3-seat chaises (2-seat chaises are only available with a corner cushion). The articulating back allows the user to easily change postures from a lounge position, when the back cushion is fully upright, to a task position, when the seat back is articulated down. Simply use the integrated pulls, one at the top and one at the bottom, to position the seat back to the desired position. The articulating mechanism is completely hidden behind the back cushion, and attaches the cushion to the seat frame.

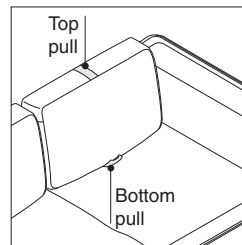

Pulls at top and bottom of all articulating backs aid the user to change from a lounge position to a task position and back to the lounge position.

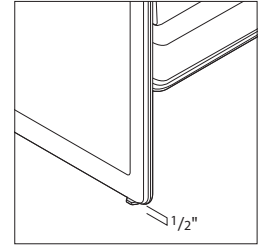

Glides adjust 1/2" for uneven floors. There are two glides per screen and/or seat deck. Glides have a metal rounded foot.

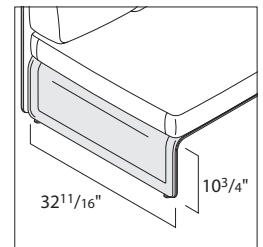

Space is available under the seat deck of all Lagunitas seating to provide a place to temporarily store personal items. The clearance height, without power module(s), is 10³/₄" and the depth is 32¹¹/₁₆".

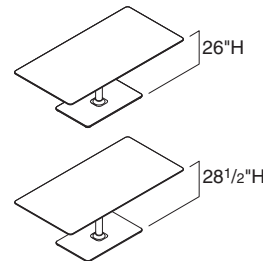

Work tables are available in two heights: 26"H tables are optimized to work with the lounge seat height, while 28¹/₂"H tables work with standard height seating.

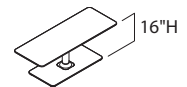

Occasional tables are available in one optimized height, 16"H, to work with the lounge seat height.

Lagunitas Lounge System *continued*

DESIGN TOAN NGUYEN

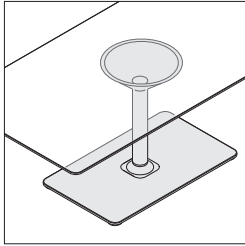

All work and occasional tables have a rectangular metal base with a centered column. The 3" column includes a cone at the top that attaches to the work surface. There are five rectangular base dimensions:

- 16"D x 23⁵/₈"W x ³/₈"H for 18"D x 32"W, 24"D x 30"W, and 24"D x 36"W work tables;
- 16"D x 31⁵/₈"W x ³/₈"H for 18"D x 48"W occasional table;
- 21"D x 28¹/₂"W x ³/₈"H for 36"D x 40"W and 36"D x 48"W work tables;
- 21"D x 35"W x ³/₈"H for 36"D x 57"W x work table; and
- 21"D x 35"W x ¹/₂"H for 36"D x 72"W x work table

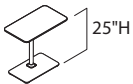

The personal table is available in one height, 25"H, to work with the lounge seat height.

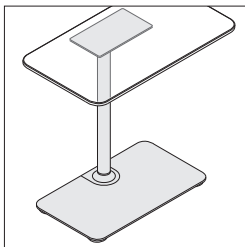

The personal table has a rectangular metal base with the column centered at the back of the base. The 1¹/₄" column includes a flat plate at the top that attaches to the underside of the top. The base plate dimension is 10³/₄"D x 15³/₄"W x ³/₈"H.

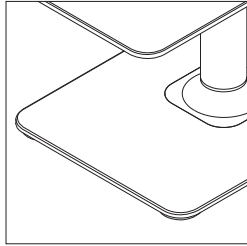

Non-adjustable 3" diameter plastic glides are standard on all tables. Glides are ³/₈" thick for the 36"D x 72"W table; ¹/₂" thick for all other work and occasional tables; and ¹/₄" thick for the personal table. For all work and occasional tables the glide height is needed to route cords.

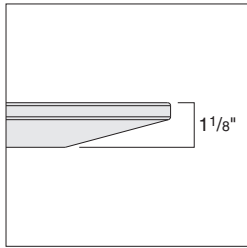

Tables are standard with a knife edge profile, that has the appearance of a ¹/₂" thick top that tapers to an overall top thickness of 1¹/₈".

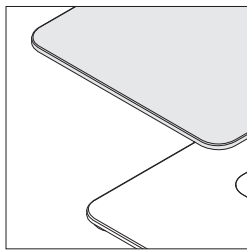

High-Pressure Laminate tables are standard with a matching or complementing 3 mm flat edge band. Wood veneer tables are standard with a matching wood 3 mm flat edge band. The underside of the table top is finished in black.

Specials are possible with Lagunitas. To confirm practicality and obtain a quotation, contact Customer Service at 1.800.627.6770.

Connections

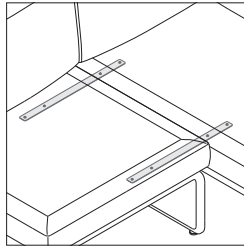

Alignment connector bracket package includes two seat attachment brackets and one screen alignment clip. The alignment connector bracket package is used when permanent connection is needed for L-, U-, and straight configurations of two or more pieces. The screen alignment clip is not needed for any bench connections, only the two seat attachment brackets would be utilized. The alignment connector bracket package should not be used if reconfigurations of the furniture pieces are required.

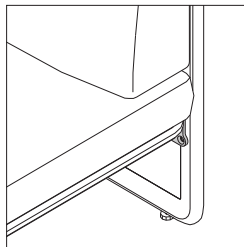

Attachment brackets for screen connection to seat deck must be specified in either platinum matte or low gloss black. Along with the brackets, the entire frame underneath will be painted to match the bracket finish specified.

Brackets can be specified in:

- 4710 Low Gloss Black paint (for dark color fabrics)
- 4141 Platinum Matte paint (for light color fabrics)

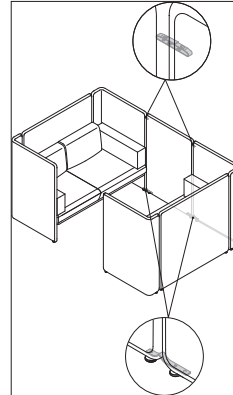

Lounge booth connector screen comes with two bottom brackets and two screen ganging alignment clips. The bottom brackets can be specified in either 4710 Low Gloss Black Paint or 4141 Platinum Matte Paint. The paint should match the bracket specification of the lounge.

Power, Data, Wiring & Cabling

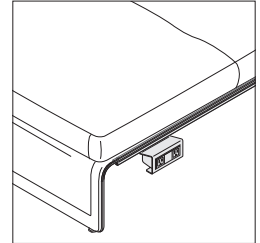

Optional power can be specified on all seating components (lounge, chaise, and bench):

- The power module consists of two power outlets.
- The USB power module consists of one USB port and one power outlet. There is one USB per port with two amps.

Power modules can be positioned anywhere along the attachment rail underneath the front lounge seat.

Power modules are available in black. One optional power module is available on 1-seat lounges. One or two optional power modules are available on 2- and 3-seat lounges.

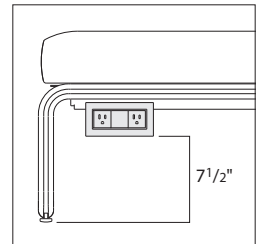

The power and USB power module options are located 7¹/₂" from the floor.

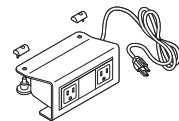

The power module has a 72"L cord and contains wire manager clips to route the cord underneath the seat deck when desired.

Lagunitas Lounge System

DESIGN TOAN NGUYEN

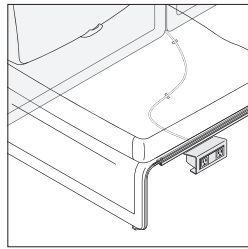

The power module cord is routed to the back utilizing clips attached to the underside of the lounge. The cord is then routed between the gap where the two screens meet when wall plug in access is needed.

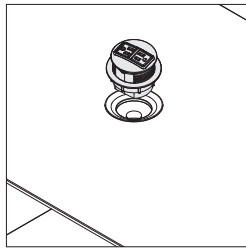

Round power modules are available on the focus nook, and all work and occasional tables. On the focus nook worksurface, the power module is specifiable on the back right or left side. On the tables, the power module is located in the center of the table top over the cone/column. The 3" power module features tamper resistant power simplexes, an 8'L power cord with 15-amp plug, and is available in four colors.

The round power modules are available in three configurations:

- Two TR simplex receptacles
- One TR simplex receptacle and two USB A charging ports
- One TR simplex receptacle, one USB A charging port, and one USB C charging port

Tip: USB receptacles conveniently charge a range of electronic devices. Some devices may not be compatible.

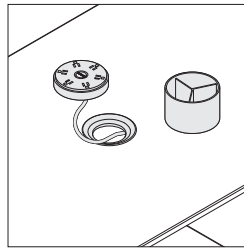

The grommet allows for pass through of cords and cables at the desktop. The grommet is open to allow for the PowerPod to be housed over or stored on the table. The grommet inside dimension is 3 1/2" and outside dimension is 5 1/16".

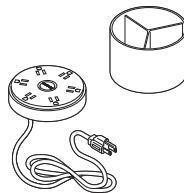

PowerPod includes six 15 amp outlets with an energy saving illuminated on/off switch. It comes with a 6' cord with three prong plug. The top tray is milk and the power source is silver with a milk face. It is UL and CSA listed.

Tip: PowerPod is sold separately.

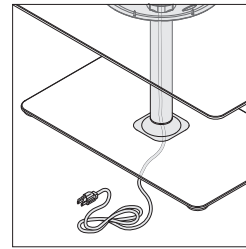

Work and occasional tables route cables and cords from the desktop through the column out through the base. Cords can be concealed in the cone.

Tip: A powerstrip cannot fit inside the cone.

Tip: If a desktop device is desired, other than the standard PowerPod or power module, consult Specials engineering for capability.

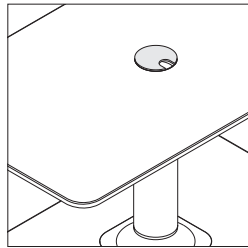

A metal grommet is an option on all work and occasional tables. The 3" grommet is flush-mounted and located in the center of the table top over the cone and column. The metal grommet is available in anodized silver only.

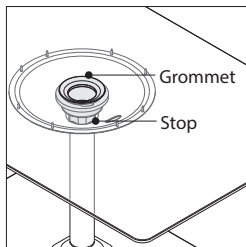

PowerPod grommet and stop is an option on all work and occasional tables. The grommet is located in the center of the table top over the cone/column. The stop attaches to the column to help hold and route cords and cables through the column. The grommet and stop cap are available in black or milk.

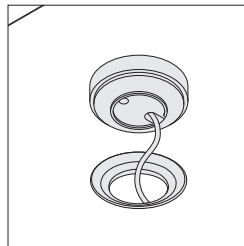

The contour of the PowerPod bottom cradle is designed to work in conjunction with the grommet for a snug fit or can be used independently without a grommet.

Lagunitas Lounge System *continued*

DESIGN TOAN NGUYEN

Surface Materials

Screen(s) and seat deck:

- Knit
- Fabric (contrasting and non-contrasting - contrasting must be same fabric family)

Seat and back cushion(s), contrasting and non-contrasting:

- Fabric
- Leather

Lounge attachment brackets and frame:

- Paint

Lounge glides:

- Non-specifiable plated metal

Lounge power and USB power modules (options):

- Black powder paint with black receptacles

Work and occasional table top surface:

- Laminated with matching or complementing 3 mm plastic edge band
- Wood veneer with matching 3 mm wood edge
- Custom wood finish (option)

Table base (cone or plate, column, and bottom plate):

- Paint

Table glides:

- Non-specifiable clear plastic

Metal grommet (option):

- Non-specifiable (anodized silver)

PowerPod grommet and stop cover (option):

- 6000 Black plastic
- 6052 Milk plastic

Table power modules:

- 4013 Silver/Black (silver powder paint with black receptacles)
- 4180 Graphite Matte
- 4242 Milk Matte
- 4710 Low Gloss Black

Personal table top surface:

- Laminate with matching or complementing 3 mm plastic edge band
- Fusion fabric

Tip: Refer to the Coalesse Surface Materials Reference Guide for additional surface materials information.

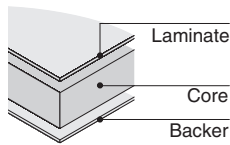

Laminates are available in two standard grades. Additional laminates from any manufacturer may also be practical—see *Other laminates* below.

Grade 1 laminates include:

- Coalesse standard laminates
▶ See *Coalesse Surface Materials Reference Guide*.
- Steelcase standard laminates (code 290A)
▶ See *Steelcase Surface Materials Reference Manual*.
- Any standard-grade Wilsonart laminate in solid color, woodgrain, or pattern finish (code 290A)

Grade 2 laminates

(code 290B) include any standard-grade, solid color, woodgrain, or patterned laminate from Nevamar (includes Matrix), Formica, or Pionite. Grade 2 laminates may have extended lead times. For details, contact Customer Service at 1.800.627.6770.

Other laminates that are not included in the Grade 1 or Grade 2 offerings may also be available, such as Abet Laminati and Laminart. To determine availability and pricing, contact Customer Service at 1.800.627.6770, with the laminate manufacturer's name and the name and number of the laminate you want.

Laminate swatches are reproduced in the Surface Materials Color Palettes.

▶ See *Coalesse Surface Materials Reference Guide* for a list.

Swatch cards and actual samples of Coalesse standard laminates are available from your Coalesse Customer Service representative. For samples of laminates from other manufacturers, contact them directly:

Wilsonart
1.800.433.3222
Nevamar
1.800.638.4380
Formica
1.800.FORMICA
Pionite
1.800.285.5161

Tip: Laminate manufacturers change their offerings frequently. Always check availability before ordering.

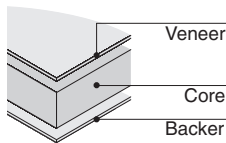

Wood veneer table tops are fabricated with Architectural Grade AA hand-selected hardwood veneer, plain sliced, book matched, and bonded to the core with a backing sheet for balance. Coalesse's primary wood finish, Clarity, is a water-borne UV topcoat, which protects the environment while providing exceptional durability and resistance to water and chemical stains. Due to natural variations in wood, finished products may vary from samples in color, texture, and grain.

Wood is a natural material; slight variations occur in veneer texture, color, grain configuration, and stain acceptance. Coalesse stains are all applied with an exacting regard for consistency and are well within traditional tolerances for wood products.

Tip: You should know that finished tops may vary slightly in tone or character from each other or from the samples Coalesse produces. No guarantee can be made of an absolutely exact match.

Wood veneer swatches are reproduced in the Surface Materials Color Palettes.

▶ See *Coalesse Surface Materials Reference Guide* for a list.

Swatch cards and actual samples of Coalesse standard wood veneers are available from your Coalesse Customer Service representative.

Additional wood veneer species are available. To confirm availability and to determine pricing, contact Customer Service at 1.800.627.6770.

Stains applied to Coalesse wood veneer table tops are standard with the same stain color applied to both the top and the solid hardwood edge profile. Coalesse strives to produce a consistently high quality product and some natural variation in color is to be expected. This is especially apparent on natural woods which have no stain applied, for example 3525 Natural Maple. This color variation is normal and reflects the unique and natural properties of wood. This should not be considered a defect.

Stain swatches are reproduced in the Surface Materials Color Palettes.

▶ See *Coalesse Surface Materials Reference Guide* for a list.

Swatch cards and actual samples of standard wood veneers are available from your Customer Service representative.

Stain-to-Match is available on this product and allows the matching of any wood finish with a one-time charge per finish.

▶ See *Coalesse Surface Materials Reference Guide* for details.

Programs & Services

Customer's Own Material/Leather (COM/COL) Program is available.

▶ See *Coalesse Surface Materials Reference Guide* for additional information.

Lagunitas Lounge System Thought Starters and Applications

DESIGN TOAN NGUYEN

Lagunitas offers a wide range of highly customizable settings with varying degrees of privacy and multimodal support that become a desired third place to collaborate, socialize, or focus on personal work as individuals spend less time at traditional workstations and require different postures for working.

Note: This product line is a collection and will be found in multiple locations in this specification guide and/or Coalesse Tables, Storage, and Accessories Specification Guide.

► See page 5.

Individual Carrels

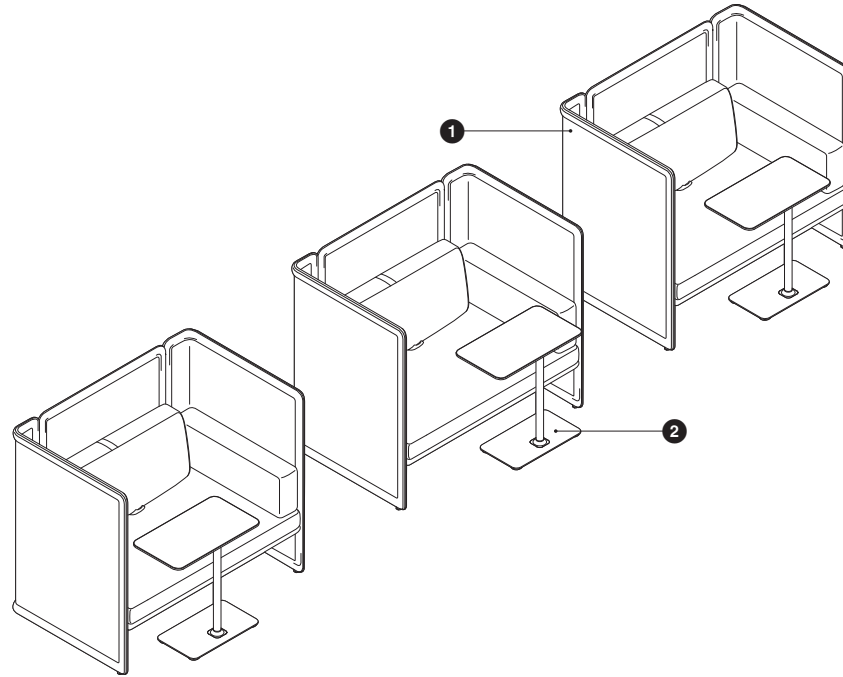

	Quantity	Style Number	Description	Components
1	3	COLAGLH13	1-Seat Lounge with High-Back Screen and Two Side Screens; One Articulating Back	Screen and Seat Deck Seat Back
2	3	COLAGTP	Personal Table	Table

Lagunitas Lounge System Thought Starters and Applications *continued*

DESIGN TOAN NGUYEN

Note: This product line is a collection and will be found in multiple locations in this specification guide and/or Coalesse Tables, Storage, and Accessories Specification Guide.
 ▶ See page 5.

Private Meeting

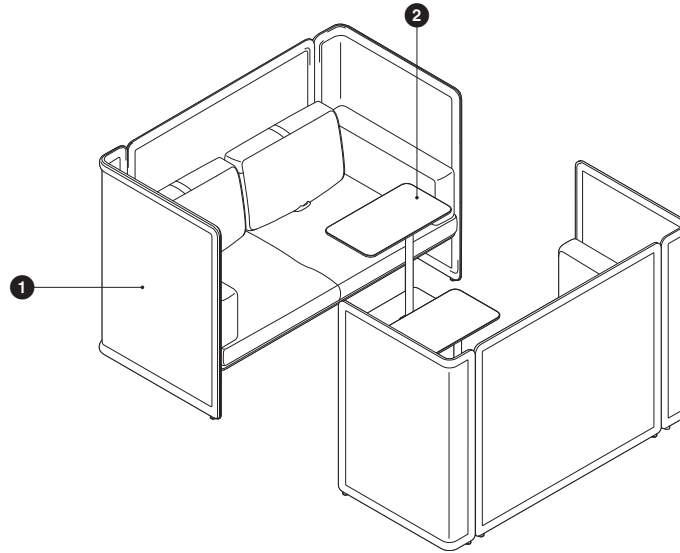

Quantity	Style Number	Description	Components	
1	2	COLAGLH23	2-Seat Lounge with High-Back Screen and Two Side Screens; Two Articulating Backs	
				Screen and Seat Deck
				Seat
			Back	
2	COLAGTP	Personal Table	Table	

Lagunitas Lounge System Thought Starters and Applications

DESIGN TOAN NGUYEN

Note: This product line is a collection and will be found in multiple locations in this specification guide and/or Coalesse Tables, Storage, and Accessories Specification Guide.
 ▶ See page 5.

Island

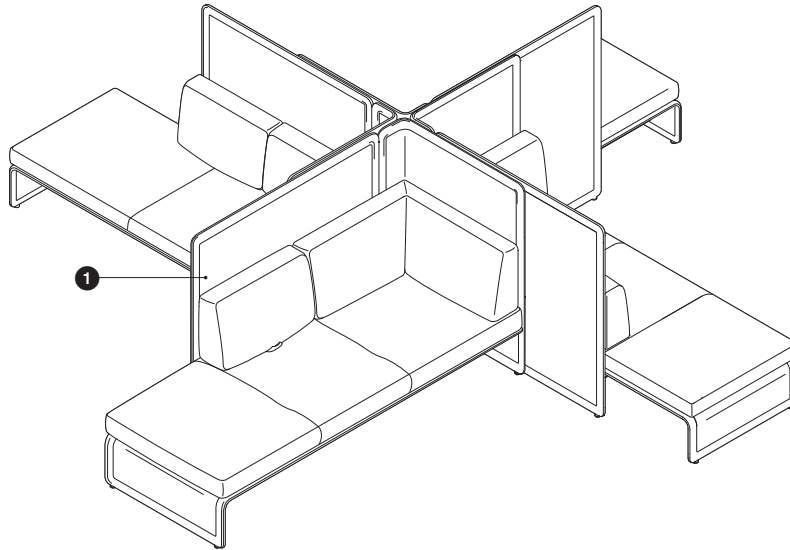

Lounge Seating

Quantity	Style Number	Description	Components
1	4	COLAGCH3 3-Seat Chaise with High-Back Screen and One Side Screen; One Articulating Back (Left-hand configuration)	Screen and Seat Deck
			Seat
			Back

Lagunitas Lounge System Thought Starters and Applications *continued*

DESIGN TOAN NGUYEN

Note: This product line is a collection and will be found in multiple locations in this specification guide and/or Coalesse Tables, Storage, and Accessories Specification Guide.
 ▶ See page 5.

Small Social

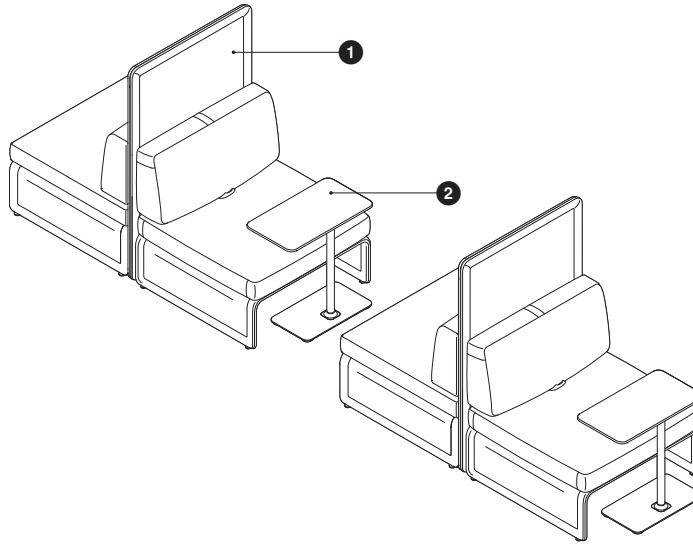

Quantity	Style Number	Description	Components	
1	4	COLAGLH11	1-Seat Lounge with High-Back Screen; One Articulating Back	
				Screen and Seat Deck
				Seat
			Back	
2	COLAGTP	Personal Table	Table	

Lagunitas Lounge System Thought Starters and Applications

DESIGN TOAN NGUYEN

Note: This product line is a collection and will be found in multiple locations in this specification guide and/or Coalesse Tables, Storage, and Accessories Specification Guide.
 ▶ See page 5.

Booth Setting

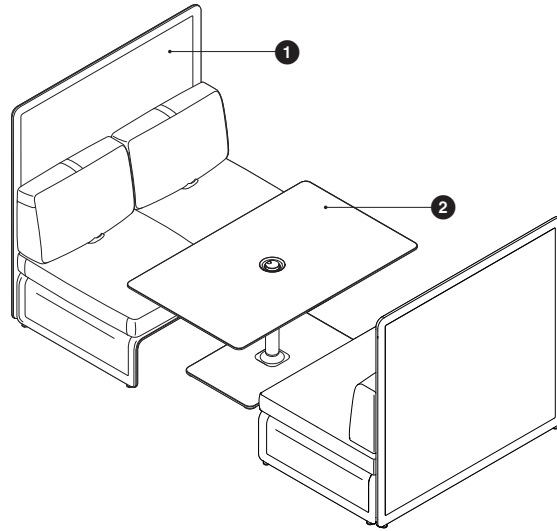

	Quantity	Style Number	Description	Components
1	2	COLAGLH21	2-Seat Lounge with High-Back Screen; Two Articulating Backs	Screen and Seat Deck
				Seat
				Back
2	1	COLAGTRECT	Work Table	Table

Lagunitas Lounge System Thought Starters and Applications *continued*

DESIGN TOAN NGUYEN

Note: This product line is a collection and will be found in multiple locations in this specification guide and/or Coalesse Tables, Storage, and Accessories Specification Guide.
 ▶ See page 5.

Crossover

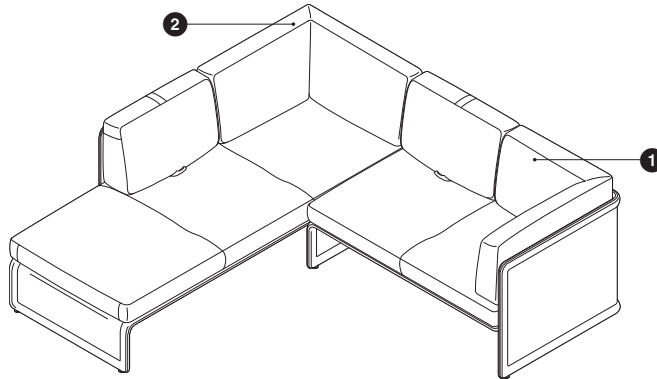

Quantity	Style Number	Description	Components
1	COLAGLL22	2-Seat Lounge with Low-Back Screen and One Side Screen; One Articulating Back and One Corner Cushion	Screen and Seat Deck
			Seat
			Back
1	COLAGCL3	3-Seat Chaise with Low-Back Screen and One Side Screen; One Articulating Back and One Corner Cushion (Left-hand configuration)	Screen and Seat Deck
			Seat
			Back

Lagunitas Lounge System Thought Starters and Applications

DESIGN TOAN NGUYEN

Note: This product line is a collection and will be found in multiple locations in this specification guide and/or Coalesse Tables, Storage, and Accessories Specification Guide.
 ▶ See page 5.

L-Configuration

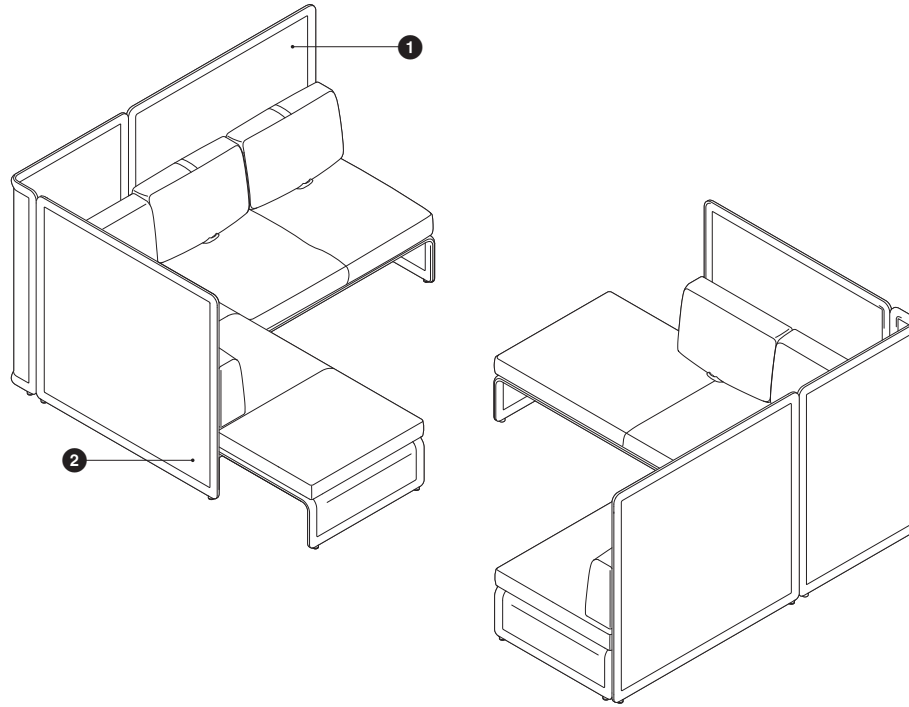

	Quantity	Style Number	Description	Components
1	2	COLAGLH22	2-Seat Lounge with High-Back Screen; Two Articulating Backs	Screen and Seat Deck
				Seat
				Back
2	2	COLAGCH3	3-Seat Chaise with High-Back Screen and One Side Screen; One Articulating Back and One Corner Cushion (Left-hand configuration)	Screen and Seat Deck
				Seat
				Back

Lagunitas Lounge System Thought Starters and Applications *continued*

DESIGN TOAN NGUYEN

Note: This product line is a collection and will be found in multiple locations in this specification guide and/or Coalesse Tables, Storage, and Accessories Specification Guide.
 ▶ See page 5.

Benching

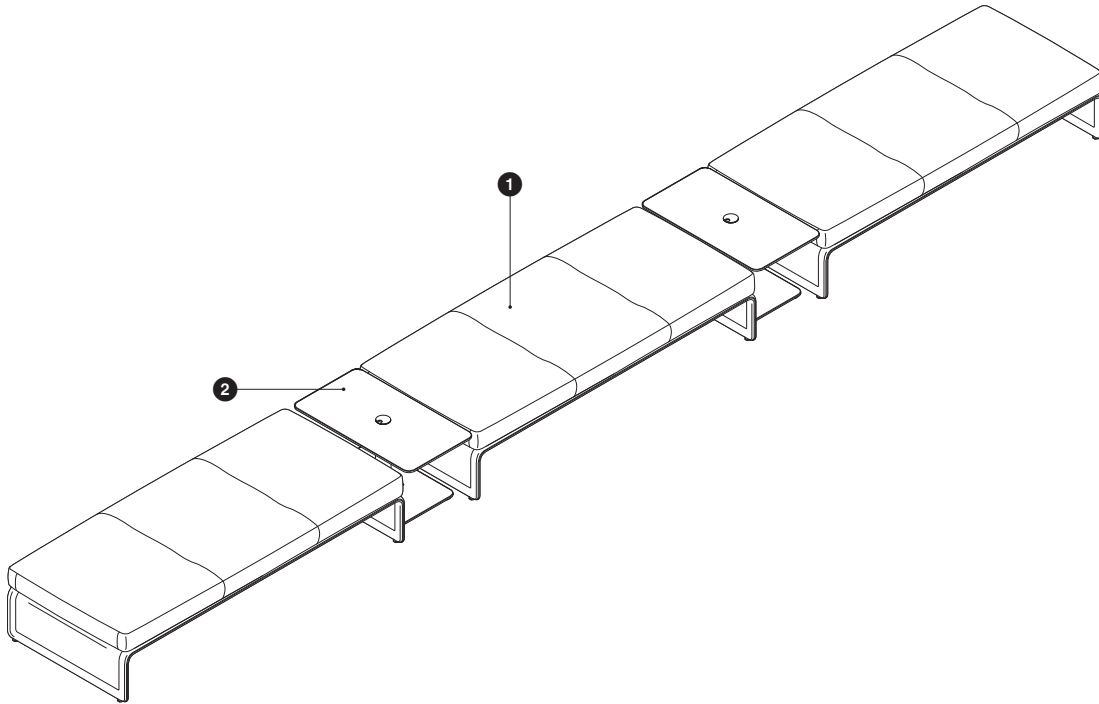

	Quantity	Style Number	Description	Components
1	3	COLAGB3	3-Seat Bench	Seat Deck Seat
2	2	COLAGTO	Occasional Table	Table

Lagunitas Lounge System Thought Starters and Applications

DESIGN TOAN NGUYEN

Note: This product line is a collection and will be found in multiple locations in this specification guide and/or Coalesse Tables, Storage, and Accessories Specification Guide.
 ▶ See page 5.

Benching, continued

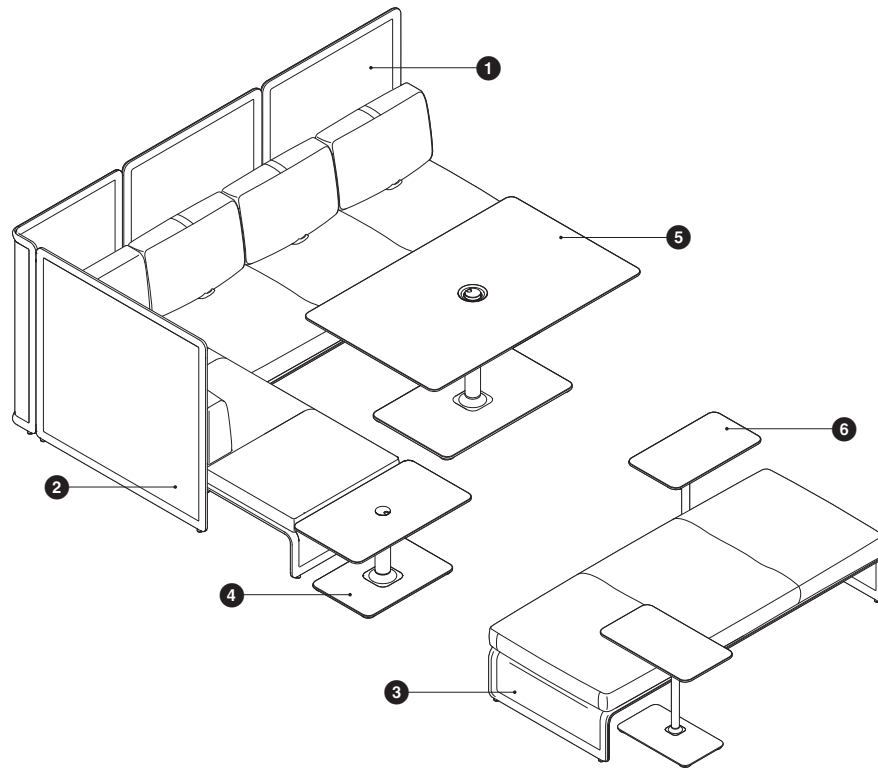

	Quantity	Style Number	Description	Components
1	1	COLAGLH31	3-Seat Lounge with High-Back Screen; Three Articulating Backs	Screen and Seat Deck Seat Back
2	1	COLAGCH3	3-Seat Chaise with High-Back Screen and One Side Screen; One Articulating Back and One Corner Cushion (Left-hand configuration)	Screen and Seat Deck Seat Back
3	1	COLAGB3	3-Seat Bench	Seat Deck Seat
4	1	COLAGTO	32"W Occasional Table	Occasional Table
5	1	COLAGTRECT	57"W Work Table	Work Table
6	2	COLAGTP	Personal Table	Personal Table

Lagunitas Lounge System Thought Starters and Applications *continued*

DESIGN TOAN NGUYEN

Note: This product line is a collection and will be found in multiple locations in this specification guide and/or Coalesse Tables, Storage, and Accessories Specification Guide.
 ▶ See page 5.

Lagunitas Enclosed Booth Setting

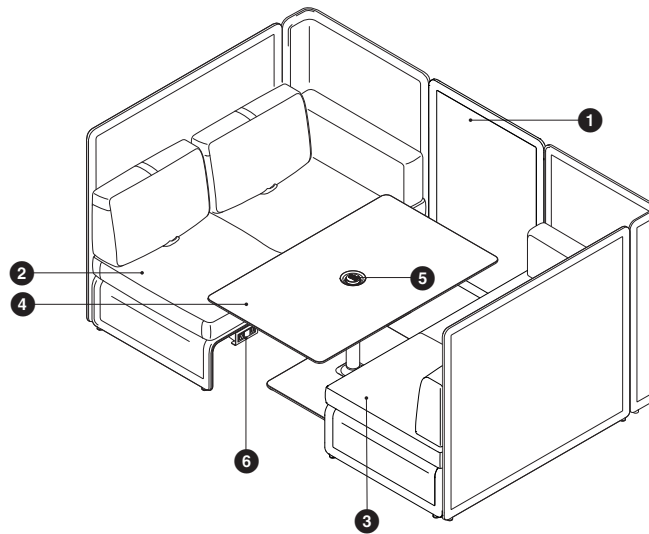

Quantity	Style Number	Description	Components
1	COLAGLBS	Lounge Booth Connector Screen	Screen
2	COLAGLH22	2-Seat Lounge with High-Back Screen and One Side Screen; Two Articulating Backs (Left Screen)	Seat and Seat Deck
			Seat
			Back
3	COLAGLH22	2-Seat Lounge with High-Back Screen and One Side Screen; Two Articulating Backs (Right Screen)	Seat and Seat Deck
4	COLAGTRECT	Work Table 57"W	Table
5	Option	USB Table Power Module	USB Power (option)
6	Option	USB Lounge Power Module	USB Power (option)

Lagunitas Lounge System Thought Starters and Applications

DESIGN TOAN NGUYEN

Note: This product line is a collection and will be found in multiple locations in this specification guide and/or Coalesse Tables, Storage, and Accessories Specification Guide.
 ▶ See page 5.

Lagunitas Private Meeting Booth

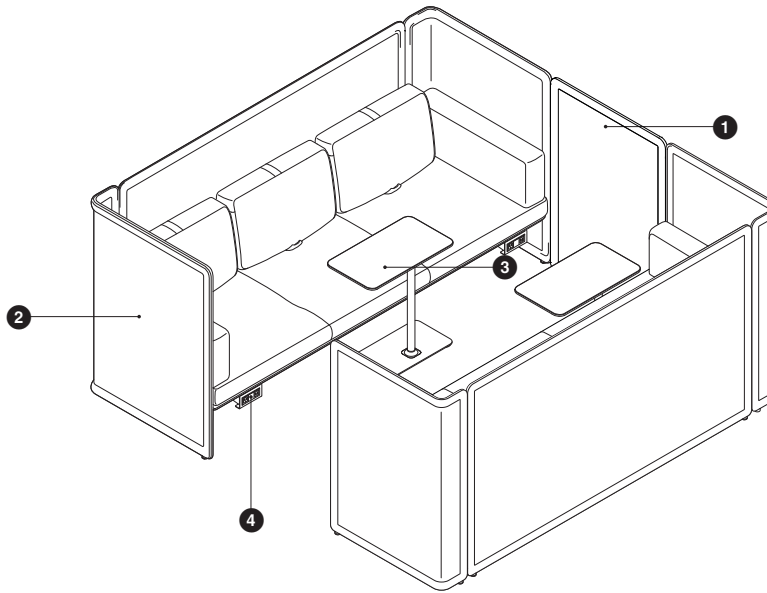

Lounge Seating

	Quantity	Style Number	Description	Components
1	1	COLAGLBS	Lounge Booth Connector Screen	Screen
2	2	COLAGLH33	3-Seat Lounge with High-Back Screen and Two Side Screens; Three Articulating Backs	Seat and Seat Deck
				Seat
				Back
3	2	COLAGTP	Personal Table	Table
4	4	Option	USB Lounge Power Module	USB Power (option)

Lagunitas Lounge System Thought Starters and Applications *continued*

DESIGN TOAN NGUYEN

Note: This product line is a collection and will be found in multiple locations in this specification guide and/or Coalesse Tables, Storage, and Accessories Specification Guide.
 ▶ See page 5.

Lagunitas Enclosed Rejuvenation Booth Setting

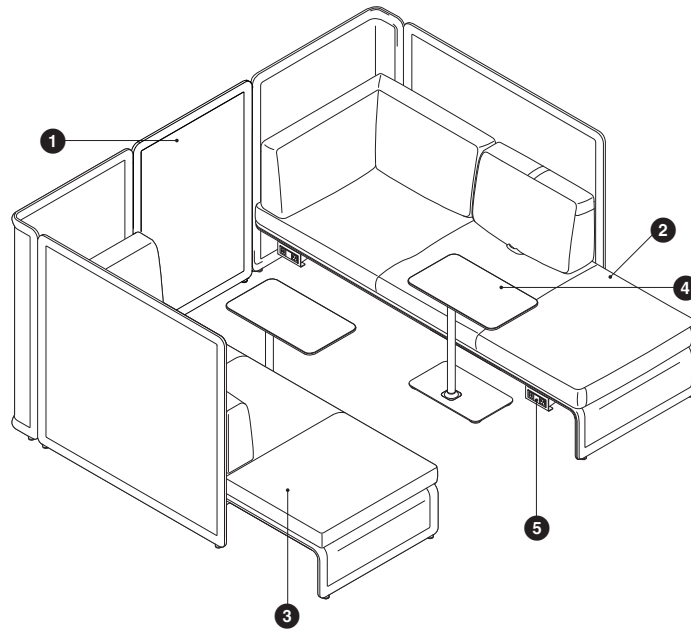

	Quantity	Style Number	Description	Components
1	1	COLAGLBS	Lounge Booth Connector Screen	Screen
2	1	COLAGCH3	3-Seat Chaise with High-Back Screen and One Side Screen; One Articulating Back and One Corner Cushion (Left Screen)	Seat and Seat Deck Seat Back
3	1	COLAGCH3	3-Seat Chaise with High-Back Screen and One Side Screen; One Articulating Back and One Corner Cushion (Right Screen)	Seat and Seat Deck
4	2	COLAGTP	Personal Table	Table
5	4	Option	USB Lounge Power Module	USB Power (option)

Lagunitas Lounge System Multi-Fabric Diagram

DESIGN TOAN NGUYEN

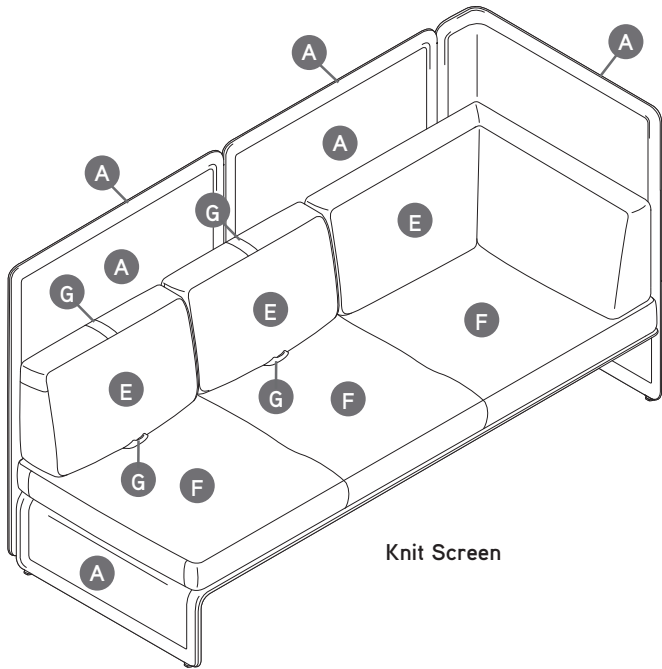

Knit Screen

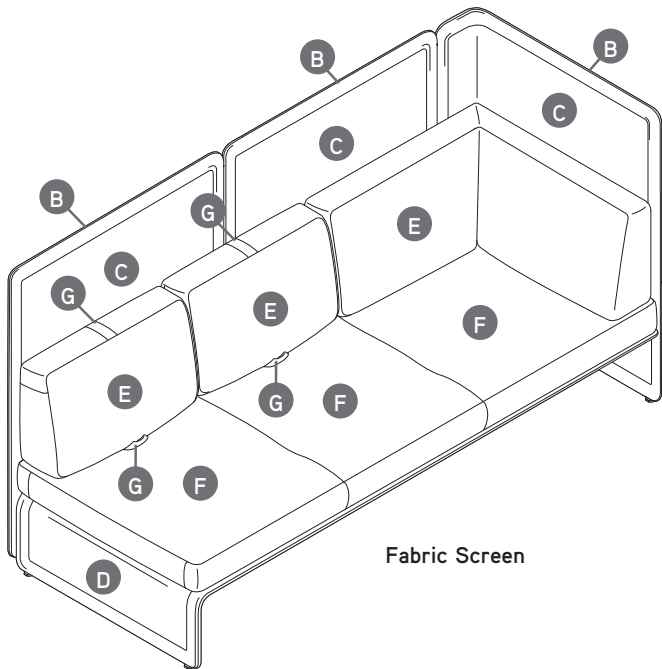

Fabric Screen

Tip: When selecting contrasting fabric screens, fabrics must be from same fabric family.

TO: _____

FROM: _____

DATE: _____

FAX...888.413.5161

A Knit screen, if selected (seat deck will match knit screen):

B Outside fabric screen, if contrasting fabric screen is selected:

C Inside fabric screen, if contrasting fabric screen is selected:

D Seat deck (must select to match outside or inside screen):

E Back/Corner cushion:

F Seat cushion:

G Top and bottom articulating back cushion pulls:

See specifying for contrasting fabric upcharge specified on screen and cushion.

See specifying for contrasting fabric upcharge on articulating back cushions pulls.

Lagunitas Lounge System 1-Seat Lounges

DESIGN TOAN NGUYEN

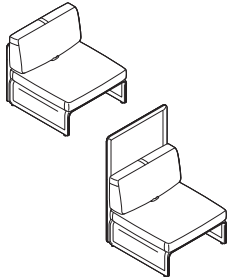

► Need help?
Product details,
page 92

Standard Includes	Required to Specify
<ul style="list-style-type: none"> • Screen: grade 1 knit • Seat deck: grade 1 knit to match screen • Non-contrasting seat cushion, articulating back cushion and pulls, back corner cushion, and end arm cushions: fabric or leather • Bracket: paint • Six adjustable glides • Ships assembled 	<ol style="list-style-type: none"> 1 Style number 2 Knit color number for screen 3 Fabric or leather color number for non-contrasting seat cushion, articulating back cushion and pulls, and end arm cushions, if selected 4 Paint color number for bracket: 4141 Platinum Matte 4710 Low Gloss Black 5 Options, if selected (see below) <p>► See <i>Coalesse Surface Materials Reference Guide</i>.</p>

Options	U.S. Price	Required to Specify
Surface Materials Fabric screen <ul style="list-style-type: none"> • 1-seat lounge with low-back screen +\$268 • 1-seat lounge with low-back screen and two side screens +\$497 • 1-seat lounge with high-back screen +\$307 • 1-seat lounge with high-back screen and two side screens +\$611 <hr/> <ul style="list-style-type: none"> • Contrasting fabric for screen +\$182 • Contrasting fabric for cushion +\$182 <hr/> <ul style="list-style-type: none"> • Contrasting fabric for top and bottom articulating back pulls +\$182 <hr/> <ul style="list-style-type: none"> • Fabric upcharges Prices at right 		<ul style="list-style-type: none"> Specify with <i>screen type fabric</i>. Specify with <i>screen type fabric</i>. <hr/> <ul style="list-style-type: none"> Specify with <i>screen type fabric</i>. Specify with <i>screen type fabric</i>. <hr/> <ul style="list-style-type: none"> Specify with <i>contrasting fabric</i> and select fabric or leather color number. Specify with <i>contrasting fabric</i> and select fabric or leather color number. <hr/> <ul style="list-style-type: none"> Specify with <i>contrasting fabric</i> and select fabric or leather color number.
Knit screen <ul style="list-style-type: none"> • Grade 1 knit screen No cost • Grade 2 knit screen <ul style="list-style-type: none"> – 1-seat lounge with low-back screen +\$268 – 1-seat lounge with low-back screen and two side screens +\$576 – 1-seat lounge with high-back screen +\$306 – 1-seat lounge with high-back screen and two side screens +\$692 		<ul style="list-style-type: none"> Specify with <i>screen type knit</i> and select knit color number. Specify with <i>screen type knit</i> and select knit color number. Specify with <i>screen type knit</i> and select knit color number. Specify with <i>screen type knit</i> and select knit color number.
Acrylic backer <ul style="list-style-type: none"> • 1-seat lounge with low-back screen +\$ 49 • 1-seat lounge with low-back screen and two side screens +\$102 • 1-seat lounge with high-back screen +\$ 81 • 1-seat lounge with high-back screen and two side screens +\$133 		<ul style="list-style-type: none"> Specify with <i>acrylic backer</i>. Specify with <i>acrylic backer</i>. Specify with <i>acrylic backer</i>. Specify with <i>acrylic backer</i>. <p>► See <i>Coalesse Surface Materials Reference Guide</i>.</p>
<ul style="list-style-type: none"> • COM +\$225 		<ul style="list-style-type: none"> Specify with <i>COM</i> and select fabric color number. <p>► See <i>Coalesse Surface Materials Reference Guide</i>.</p>
<ul style="list-style-type: none"> • COL +\$410 		<ul style="list-style-type: none"> Specify with <i>COL</i> and select leather color number. <p>► See <i>Coalesse Surface Materials Reference Guide</i>.</p>

► Options, continued on next page

Tip: If contrasting screen is selected, it is required to specify whether seat deck finish will match inner screen or outer screen.

Tip: Contrasting fabric for articulating back pulls upcharge is applied one time per style number.

Tip: When contrasting fabric for articulating back pulls is selected, only one contrasting fabric can be specified and will apply to all pulls.

Tip: For Customer's Own Material or Leather, see necessary requirements, important processing instructions and ordering information.

► See *Coalesse Surface Materials Reference Guide*.

Tip: For any portion of the product that requires a COM, the additional upcharge is a one time charge per product.

Tip: For any portion of the product that requires a COL, the additional upcharge is a one time charge per product.

Lagunitas Lounge System 1-Seat Lounges

DESIGN TOAN NGUYEN

Tip: For each USB port specified, there is one USB per port.

► Options, continued from previous page

	Options	U.S. Price	Required to Specify
Power/USB Configuration	• One power module: two power in 4710 Low Gloss Black paint	+\$456	Specify with one power module, with two power.
	• One power module: one USB/ one power in 4710 Low Gloss Black paint	+\$605	Specify with one power module, with one power/one USB.
Related Products	<ul style="list-style-type: none"> • Bench • Chaise • Collaborative and conference tables • Occasional tables • Personal table • Lounge booth connector screen and alignment connector 		<ul style="list-style-type: none"> ► Page 138 ► Pages 130-134 ► See <i>Coalesse Tables, Storage, and Accessories Specification Guide</i>. ► See <i>Coalesse Tables, Storage, and Accessories Specification Guide</i>. ► See <i>Coalesse Tables, Storage, and Accessories Specification Guide</i>. ► Pages 140-141

► Specification Information, on next page



For Canadian Pricing
 Multiply U.S. Price by the Canadian price factor.
 ► See page 1 for details.

Lagunitas Lounge System 1-Seat Lounges *continued*

DESIGN TOAN NGUYEN

► Options, on previous page

Specification Information

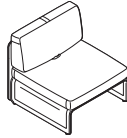

One articulating back
Overall: 32¾"W x 34"D x 32¾"H
Inside (Lounge): 32¾"W x 22½"D
Inside (Task): 32¾"W x 17¾"D
Seat: 16"H

Style Number U.S. Base Price

1-Seat Lounge with Low-Back Screen

COLAGLL11 \$2892

Fabric Upcharges

	Fabric Grades:								Leather Grades:		
	6	7	8	9	10	11	12	13	14	C	E
Articulating Back Pulls (if top and bottom contrasting pulls are selected)	+\$ 27	+\$ 33	+\$ 45	+\$ 74	+\$ 92	+\$112	+\$129	+\$ 154	+\$ 193	+\$ 277	+\$ 325
Seat Cushion	+\$126	+\$150	+\$190	+\$315	+\$396	+\$488	+\$556	+\$ 669	+\$ 832	+\$1200	+\$1410
Back Cushion	+\$126	+\$150	+\$190	+\$315	+\$396	+\$488	+\$556	+\$ 669	+\$ 832	+\$1200	+\$1410
Inside Screen	+\$153	+\$185	+\$234	+\$385	+\$485	+\$596	+\$682	+\$ 824	+\$1019	N.A.	N.A.
Outside Screen	+\$221	+\$266	+\$341	+\$561	+\$704	+\$867	+\$982	+\$1187	+\$1469	N.A.	N.A.

Tip: Articulating back pull fabric upcharges only apply when contrasting pulls are selected.

One Articulating Back: Seat Deck: 2.6 yards, Inside Screen: 1.4 yards, Outside Screen: 1.6 yards, Seat Cushion: 1.94 yards, 48.4 sq ft, Back Cushion: 1.56 yards, 48.4 sq ft, Contrasting Pulls on Articulating Back Cushion: 0.44 yards, 1.1 sq ft

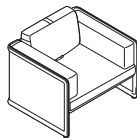

One articulating back and end arm cushions
Overall: 49¼"W x 34"D x 32¾"H
Seat: 16"H

Style Number U.S. Base Price

1-Seat Lounge with Low-Back Screen and Two Side Screens

COLAGLL13 \$4567

Fabric Upcharges

	Fabric Grades:								Leather Grades:		
	6	7	8	9	10	11	12	13	14	C	E
Articulating Back Pulls (if top and bottom contrasting pulls are selected)	+\$ 27	+\$ 33	+\$ 45	+\$ 74	+\$ 92	+\$ 112	+\$ 129	+\$ 154	+\$ 193	+\$ 277	+\$ 325
Seat Cushion	+\$146	+\$179	+\$227	+\$ 374	+\$ 470	+\$ 578	+\$ 655	+\$ 792	+\$ 980	+\$ 1418	+\$1666
Back Cushion	+\$314	+\$375	+\$480	+\$ 789	+\$ 989	+\$1221	+\$1386	+\$1674	+\$2078	+\$2999	+\$3524
Inside Screen	+\$305	+\$362	+\$463	+\$ 766	+\$ 964	+\$1189	+\$1348	+\$1628	+\$2019	N.A.	N.A.
Outside Screen	+\$404	+\$483	+\$615	+\$1014	+\$1270	+\$1567	+\$1778	+\$2146	+\$2656	N.A.	N.A.

Tip: Articulating back pull fabric upcharges only apply when contrasting pulls are selected.

One Articulating Back and End Arm Cushions: Arm: 0, Seat Deck: 1.8 yards, Inside Screen: 4.4 yards, Outside Screen: 5.1 yards, Seat Cushion: 1.58 yards, 57.2 sq ft, Back Cushion: 4.34 yards, 121 sq ft, Contrasting Pulls on Articulating Back Cushion: 0.44 yards, 1.1 sq ft

► Specification Information, continued on next page



For Canadian Pricing
 Multiply U.S. Price by the Canadian price factor.
 ► See page 1 for details.

Lagunitas Lounge System 1-Seat Lounges

DESIGN TOAN NGUYEN

► Specification Information, continued from previous page

Specification Information

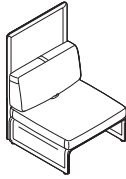

One articulating back
Overall: 32¾"W x 34"D x 50"H
Inside (Lounge): 32¾"W x 22½"D
Inside (Task): 32¾"W x 17¾"D
Seat: 16"H

Style Number U.S. Base Price

1-Seat Lounge with High-Back Screen

COLAGLH11 \$3348

Fabric Upcharges

	Fabric Grades:										Leather Grades:	
	6	7	8	9	10	11	12	13	14	C	E	
Articulating Back Pulls (if top and bottom contrasting pulls are selected)	+\$ 27	+\$ 33	+\$ 45	+\$ 74	+\$ 92	+\$112	+\$129	+\$ 154	+\$ 193	+\$ 277	+\$ 325	
Seat Cushion	+\$126	+\$150	+\$190	+\$315	+\$396	+\$488	+\$556	+\$ 669	+\$ 832	+\$1200	+\$1410	
Back Cushion	+\$126	+\$150	+\$190	+\$315	+\$396	+\$488	+\$556	+\$ 669	+\$ 832	+\$1200	+\$1410	
Inside Screen	+\$153	+\$185	+\$234	+\$385	+\$485	+\$598	+\$682	+\$ 824	+\$1019	N.A.	N.A.	
Outside Screen	+\$221	+\$266	+\$341	+\$561	+\$704	+\$868	+\$982	+\$1187	+\$1469	N.A.	N.A.	

Tip: Articulating back pulls fabric upcharges only apply when contrasting pulls are selected.

One Articulating Back: Seat Deck: 2.6 yards, Inside Screen: 1.4 yards, Outside Screen: 1.6 yards, Seat Cushion: 1.94 yards, 48.4 sq ft, Back Cushion: 1.56 yards, 48.4 sq ft, Contrasting Pulls on Articulating Back Cushion: 0.44 yards, 1.1 sq ft

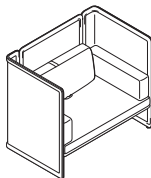

One articulating back and end arm cushions
Overall: 49¼"W x 34"D x 50"H
Seat: 16"H

Style Number U.S. Base Price

1-Seat Lounge with High-Back Screen and Two Side Screens

COLAGLH13 \$6092

Fabric Upcharges

	Fabric Grades:										Leather Grades:	
	6	7	8	9	10	11	12	13	14	C	E	
Articulating Back Pulls (if top and bottom contrasting pulls are selected)	+\$ 27	+\$ 33	+\$ 45	+\$ 74	+\$ 92	+\$ 112	+\$ 129	+\$ 154	+\$ 193	+\$ 277	+\$ 325	
Seat Cushion	+\$146	+\$179	+\$227	+\$ 374	+\$ 470	+\$ 578	+\$ 655	+\$ 792	+\$ 980	+\$1418	+\$1666	
Back Cushion	+\$314	+\$375	+\$480	+\$ 789	+\$ 989	+\$1221	+\$1386	+\$1674	+\$2078	+\$2999	+\$3524	
Inside Screen	+\$305	+\$362	+\$463	+\$ 766	+\$ 964	+\$1189	+\$1348	+\$1628	+\$2019	N.A.	N.A.	
Outside Screen	+\$404	+\$483	+\$615	+\$1014	+\$1270	+\$1567	+\$1778	+\$2146	+\$2656	N.A.	N.A.	

Tip: Articulating back pulls fabric upcharges only apply when contrasting pulls are selected.

One Articulating Back and End Arm Cushions: Arm: 0, Seat Deck: 1.8 yards, Inside Screen: 4.4 yards, Outside Screen: 5.1 yards, Seat Cushion: 1.58 yards, 57.2 sq ft, Back Cushion: 4.34 yards, 121 sq ft, Contrasting Pulls on Articulating Back Cushion: 0.44 yards, 1.1 sq ft

 **For Canadian Pricing**
 Multiply U.S. Price by the Canadian price factor.
 ► See page 1 for details.

Lagunitas Lounge System 2-Seat Lounges

DESIGN TOAN NGUYEN

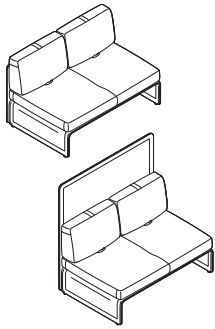

	Standard Includes	Required to Specify
<p>► Need help? Product details, page 92</p>	<ul style="list-style-type: none"> • Screen: grade 1 knit • Seat deck: grade 1 knit to match screen • Non-contrasting seat cushion, articulating back cushion and pulls, back corner cushion, and end arm cushions: fabric or leather • Bracket: paint • Six adjustable glides • Ships assembled 	<ol style="list-style-type: none"> 1 Style number 2 Handedness (see below under Required Selections) 3 Knit color number for screen 4 Fabric or leather color number for non-contrasting seat cushion, articulating back cushion and pulls, back corner cushion, and end arm cushions, if selected 5 Paint color number for bracket: 4141 Platinum Matte 4710 Low Gloss Black 6 Options, if selected (see below) <p>► See <i>Coalesse Surface Materials Reference Guide</i>.</p>

	Required Sections	U.S. Price	Required to Specify
Handedness	<ul style="list-style-type: none"> • Left-hand, 2-seat lounges only (seated position) • Right-hand, 2-seat lounges only (seated position) 	No cost	Specify with <i>left-hand configuration</i> .
		No cost	Specify with <i>right-hand configuration</i> .

	Options	U.S. Price	Required to Specify
Surface Materials	<p>Fabric screen</p> <ul style="list-style-type: none"> • 2-seat lounge with low-back screen +\$229 • 2-seat lounge with low-back screen and one side screen +\$344 • 2-seat lounge with low-back screen and two side screens +\$456 • 2-seat lounge with high-back screen +\$268 • 2-seat lounge with high-back screen and one side screen +\$421 • 2-seat lounge with high-back screen and two side screens +\$572 <hr/> <ul style="list-style-type: none"> • Contrasting fabric for screen +\$182 • Contrasting fabric for cushion +\$182 • Contrasting fabric for top and bottom articulating back pulls +\$182 <hr/> <p>Fabric upcharges</p> <p>Prices at right</p> <hr/> <p>Knit screen</p> <ul style="list-style-type: none"> • Grade 1 knit screen No cost • Grade 2 knit screen <ul style="list-style-type: none"> – 2-seat lounge with low-back screen +\$346 – 2-seat lounge with low-back screen and one side screen +\$538 – 2-seat lounge with low-back screen and two side screens +\$729 – 2-seat lounge with high-back screen +\$385 – 2-seat lounge with high-back screen and one side screen +\$617 – 2-seat lounge with high-back screen and two side screens +\$845 		<p>Specify with <i>screen type fabric</i>. Specify with <i>screen type fabric</i>.</p> <p>Specify with <i>screen type fabric</i>.</p> <p>Specify with <i>screen type fabric</i>. Specify with <i>screen type fabric</i>.</p> <p>Specify with <i>screen type fabric</i>.</p> <hr/> <p>Specify with <i>contrasting fabric</i> and select fabric or leather color number. Specify with <i>contrasting fabric</i> and select fabric or leather color number. Specify with <i>contrasting fabric</i> and select fabric or leather color number.</p> <hr/> <p>Specify fabric color number.</p> <hr/> <p>Specify with <i>screen type knit</i> and select knit color number.</p> <p>Specify with <i>screen type knit</i> and select knit color number. Specify with <i>screen type knit</i> and select knit color number. Specify with <i>screen type knit</i> and select knit color number. Specify with <i>screen type knit</i> and select knit color number. Specify with <i>screen type knit</i> and select knit color number. Specify with <i>screen type knit</i> and select knit color number. Specify with <i>screen type knit</i> and select knit color number.</p>

► Options, continued on next page

Tip: If contrasting screen is selected, it is required to specify whether seat deck finish will match inner screen or outer screen.

Tip: Contrasting fabric for articulating back pulls upcharge is applied one time per style number.

Tip: When contrasting fabric for articulating back pulls is selected, only one contrasting fabric can be specified and will apply to all pulls.



For Canadian Pricing
Multiply U.S. Price by the Canadian price factor.
► See page 1 for details.

Lagunitas Lounge System 2-Seat Lounges

DESIGN TOAN NGUYEN

► Options, continued from previous page

	Options	U.S. Price	Required to Specify
Surface Materials, continued	Acrylic backer		
	• 2-seat lounge with low-back screen	+\$ 78	Specify with acrylic backer.
	• 2-seat lounge with low-back screen and one side screen	+\$ 121	Specify with acrylic backer.
	• 2-seat lounge with low-back screen and two side screens	+\$ 164	Specify with acrylic backer.
	• 2-seat lounge with high-back screen	+\$ 121	Specify with acrylic backer.
	• 2-seat lounge with low-back screen and one side screen	+\$ 183	Specify with acrylic backer.
	• 2-seat lounge with high-back screen and two side screens	+\$ 244	Specify with acrylic backer. ► See Coalesse Surface Materials Reference Guide.
	• COM	+\$ 225	Specify with COM and select fabric color number. ► See Coalesse Surface Materials Reference Guide.
	• COL	+\$ 410	Specify with COL and select leather color number. ► See Coalesse Surface Materials Reference Guide.
	Power/USB Configuration	• One power module: two power in 4710 Low Gloss Black paint	+\$ 456
• One power module: one USB/one power in 4710 Low Gloss Black paint		+\$ 605	Specify with one power module, with one power/one USB.
• Two power modules: two power each in 4710 Low Gloss Black paint		+\$ 912	Specify with two power modules, with two power.
• Two power modules: one USB/one power each in 4710 Low Gloss Black paint		+\$1210	Specify with two power modules, with one power/one USB.
Related Products	• Bench		► Page 138
	• Chaise		► Pages 130–134
	• Collaborative and conference tables		► See Coalesse Tables, Storage, and Accessories Specification Guide.
	• Occasional tables		► See Coalesse Tables, Storage, and Accessories Specification Guide.
	• Personal table		► See Coalesse Tables, Storage, and Accessories Specification Guide.
	• Lounge booth connector screen and alignment connector		► Pages 140–141

► Specification Information, on next page

Tip: For Customer's Own Material or Leather, see necessary requirements, important processing instructions and ordering information.
► See Coalesse Surface Materials Reference Guide.

Tip: For any portion of the product that requires a COM, the additional upcharge is a one time charge per product.

Tip: For any portion of the product that requires a COL, the additional upcharge is a one time charge per product.

Tip: For each USB port specified, there is one USB per port.



For Canadian Pricing
Multiply U.S. Price by the Canadian price factor.
► See page 1 for details.

Lagunitas Lounge System 2-Seat Lounges *continued*

DESIGN TOAN NGUYEN

► Options, on previous page

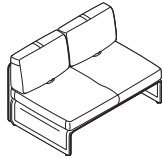
Specification Information



Two articulating backs
Overall: 51¼"W x 34"D x 32¾"H
Inside (Lounge): 51¼"W x 22½"D
Inside (Task): 51¼"W x 17¾"D
Seat: 16"H

Style Number U.S. Base Price

2-Seat Lounge with Low-Back Screen

COLAGLL21 \$4343

Fabric Upcharges

	Fabric Grades:								Leather Grades:		
	6	7	8	9	10	11	12	13	14	C	E
Articulating Back Pulls (if top and bottom contrasting pulls are selected)	+\$ 27	+\$ 33	+\$ 45	+\$ 74	+\$ 92	+\$ 112	+\$ 129	+\$ 154	+\$ 193	+\$ 277	+\$ 325
Seat Cushion	+\$ 146	+\$ 179	+\$ 227	+\$ 374	+\$ 470	+\$ 578	+\$ 655	+\$ 792	+\$ 980	+\$ 1418	+\$ 1666
Back Cushion	+\$ 211	+\$ 252	+\$ 320	+\$ 534	+\$ 667	+\$ 824	+\$ 933	+\$ 1127	+\$ 1396	+\$ 2017	+\$ 2371
Inside Screen	+\$ 231	+\$ 274	+\$ 348	+\$ 574	+\$ 720	+\$ 892	+\$ 1004	+\$ 1218	+\$ 1510	N.A.	N.A.
Outside Screen	+\$ 292	+\$ 349	+\$ 441	+\$ 730	+\$ 918	+\$ 1136	+\$ 1286	+\$ 1553	+\$ 1924	N.A.	N.A.

Tip: Articulating back pull fabric upcharges only apply when contrasting pulls are selected.

Two Articulating Backs: Seat Deck: 3.4 yards, Inside Screen: 2 yards, Outside Screen: 2.2 yards, Seat Cushion: 2.36 yards, 57.2 sq ft, Back Cushion: 2.44 yards, 81.4 sq ft, Contrasting Pulls on Articulating Back Cushions: 0.44 yards, 2.2 sq ft

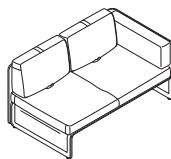

Two articulating backs
Overall: 59¾"W x 34"D x 32¾"H
Seat: 16"H

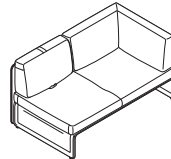

One articulating back and one corner cushion
Overall: 59¾"W x 34"D x 32¾"H
Seat: 16"H

Style Number U.S. Base Price

2-Seat Lounge with Low-Back Screen and One Side Screen

COLAGLL22 \$5180

Fabric Upcharges

	Fabric Grades:								Leather Grades:		
	6	7	8	9	10	11	12	13	14	C	E
Articulating Back Pulls (if top and bottom contrasting pulls are selected)	+\$ 27	+\$ 33	+\$ 45	+\$ 74	+\$ 92	+\$ 112	+\$ 129	+\$ 154	+\$ 193	+\$ 277	+\$ 325
Seat Cushion	+\$ 146	+\$ 179	+\$ 227	+\$ 374	+\$ 470	+\$ 578	+\$ 655	+\$ 792	+\$ 980	+\$ 1418	+\$ 1666
Back Cushion	+\$ 266	+\$ 320	+\$ 407	+\$ 675	+\$ 845	+\$ 1045	+\$ 1185	+\$ 1429	+\$ 1775	+\$ 2564	+\$ 3011
Inside Screen	+\$ 280	+\$ 338	+\$ 428	+\$ 709	+\$ 894	+\$ 1102	+\$ 1248	+\$ 1506	+\$ 1867	N.A.	N.A.
Outside Screen	+\$ 366	+\$ 434	+\$ 552	+\$ 910	+\$ 1143	+\$ 1414	+\$ 1600	+\$ 1934	+\$ 2397	N.A.	N.A.

Tip: Articulating back pull fabric upcharges only apply when contrasting pulls are selected.

Two Articulating Backs: Arm: 0, Seat Deck: 2.7 yards, Inside Screen: 3.5 yards, Outside Screen: 3.9 yards, Seat Cushion: 2.31 yards, 57.2 sq ft, Back Cushion: 3.83 yards, 103.4 sq ft, Contrasting Pulls on Articulating Back Cushions: 0.44 yards, 2.2 sq ft

One Articulating Back and One Corner Cushion: Arm: 0, Seat Deck: 2.7 yards, Inside Screen: 3.5 yards, Outside Screen: 3.9 yards, Seat Cushion: 2.31 yards, 57.2 sq ft, Back Cushion: 3.83 yards, 103.4 sq ft, Contrasting Pulls on Articulating Back Cushion: 0.44 yards, 1.1 sq ft



For Canadian Pricing
 Multiply U.S. Price by the Canadian price factor.

► See page 1 for details.

► Specification Information, continued on next page

Lagunitas Lounge System 2-Seat Lounges

DESIGN TOAN NGUYEN

► Specification Information, continued from previous page

Specification Information

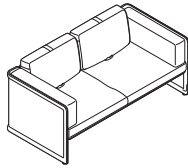

Two articulating backs
Overall: 67¾"W x 34"D x 32¾"H
Seat: 16"H

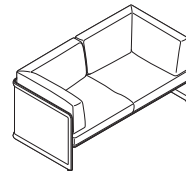

Two corner cushions
Overall: 67¾"W x 34"D x 32¾"H
Seat: 16"H

Style Number U.S. Base Price

2-Seat Lounge with Low-Back Screen and Two Side Screens

COLAGLL23 \$6017

Fabric Upcharges

	Fabric Grades:										Leather Grades:	
	6	7	8	9	10	11	12	13	14	C	E	
Articulating Back Pulls (if top and bottom contrasting pulls are selected)	+\$ 27	+\$ 33	+\$ 45	+\$ 74	+\$ 92	+\$ 112	+\$ 129	+\$ 154	+\$ 193	+\$ 277	+\$ 325	
Seat Cushion	+\$165	+\$198	+\$252	+\$ 417	+\$ 521	+\$ 645	+\$ 729	+\$ 881	+\$1090	+\$1579	+\$1857	
Back Cushion	+\$395	+\$472	+\$597	+\$ 989	+\$1244	+\$1537	+\$1740	+\$2100	+\$2602	+\$3762	+\$4421	
Inside Screen	+\$353	+\$421	+\$535	+\$ 880	+\$1106	+\$1366	+\$1549	+\$1872	+\$2321	N.A.	N.A.	
Outside Screen	+\$455	+\$543	+\$691	+\$1141	+\$1433	+\$1769	+\$2005	+\$2421	+\$3000	N.A.	N.A.	

Tip: Articulating back pull fabric upcharges only apply when contrasting pulls are selected.

Two Articulating Backs: Arm: 0, Seat Deck: 1.6 yards, Inside Screen: 4.9 yards, Outside Screen: 5.6 yards, Seat Cushion: 2.22 yards, 63.8 sq ft, Back Cushion: 5.22 yards, 151.8 sq ft, Contrasting Pulls on Articulating Back Cushions: 0.44 yards, 2.2 sq ft

Two Corner Cushions: Arm: 0, Seat Deck: 1.6 yards, Inside Screen: 4.9 yards, Outside Screen: 5.6 yards, Seat Cushion: 2.22 yards, 63.8 sq ft, Back Cushion: 5.22 yards, 151.8 sq ft

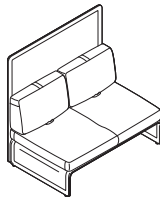

Two articulating backs
Overall: 51¼"W x 34"D x 50"H
Inside (Lounge): 51¼"W x 22½"D
Inside (Task): 51¼"W x 17¾"D
Seat: 16"H

Style Number U.S. Base Price

2-Seat Lounge with High-Back Screen

COLAGLH21 \$5254

Fabric Upcharges

	Fabric Grades:										Leather Grades:	
	6	7	8	9	10	11	12	13	14	C	E	
Articulating Back Pulls (if top and bottom contrasting pulls are selected)	+\$ 27	+\$ 33	+\$ 45	+\$ 74	+\$ 92	+\$ 112	+\$ 129	+\$ 154	+\$ 193	+\$ 277	+\$ 325	
Seat Cushion	+\$ 146	+\$179	+\$227	+\$374	+\$470	+\$578	+\$ 655	+\$ 792	+\$ 980	+\$1418	+\$1666	
Back Cushion	+\$ 211	+\$252	+\$320	+\$534	+\$667	+\$824	+\$ 933	+\$1127	+\$1396	+\$2017	+\$2371	
Inside Screen	+\$ 231	+\$274	+\$348	+\$574	+\$720	+\$892	+\$1004	+\$1218	+\$1510	N.A.	N.A.	
Outside Screen	+\$ 292	+\$349	+\$441	+\$730	+\$918	+\$1136	+\$1286	+\$1553	+\$1924	N.A.	N.A.	

Tip: Articulating back pull fabric upcharges only apply when contrasting pulls are selected.

Two Articulating Backs: Seat Deck: 3.4 yards, Inside Screen: 2 yards, Outside Screen: 2.2 yards, Seat Cushion: 2.36 yards, 57.2 sq ft, Back Cushion: 2.44 yards, 81.4 sq ft, Contrasting Pulls on Articulating Back Cushions: 0.44 yards, 2.2 sq ft

► Specification Information, continued on next page

 **For Canadian Pricing**
 Multiply U.S. Price by the Canadian price factor.
 ► See page 1 for details.

Lagunitas Lounge System 2-Seat Lounges *continued*

DESIGN TOAN NGUYEN

► Specification Information, continued from previous page

Specification Information

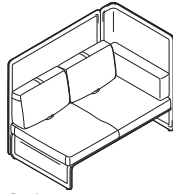

Two articulating backs
Overall: 59³/₈"W x 34"D x 50"H
Seat: 16"H

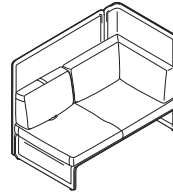

One articulating back and one corner cushion
Overall: 59³/₈"W x 34"D x 50"H
Seat: 16"H

Style Number U.S. Base Price

2-Seat Lounge with High-Back Screen and One Side Screen

COLAGLH22 \$6626

Fabric Upcharges

	Fabric Grades:										Leather Grades:	
	6	7	8	9	10	11	12	13	14	C	E	
Articulating Back Pulls (if top and bottom contrasting pulls are selected)	+\$ 27	+\$ 33	+\$ 45	+\$ 74	+\$ 92	+\$ 112	+\$ 129	+\$ 154	+\$ 193	+\$ 277	+\$ 325	
Seat Cushion	+\$ 146	+\$179	+\$227	+\$374	+\$ 470	+\$ 578	+\$ 655	+\$ 792	+\$ 980	+\$1418	+\$1666	
Back Cushion	+\$ 266	+\$320	+\$407	+\$675	+\$ 845	+\$1045	+\$1185	+\$1429	+\$1775	+\$2564	+\$3011	
Inside Screen	+\$ 280	+\$338	+\$428	+\$709	+\$ 894	+\$1102	+\$1248	+\$1506	+\$1867	N.A.	N.A.	
Outside Screen	+\$ 366	+\$434	+\$552	+\$910	+\$1143	+\$1414	+\$1600	+\$1934	+\$2397	N.A.	N.A.	

Tip: Articulating back pull fabric upcharges only apply when contrasting pulls are selected.

Two Articulating Backs: Arm: 0, Seat Deck: 2.7 yards, Inside Screen: 3.5 yards, Outside Screen: 3.9 yards, Seat Cushion: 2.31 yards, 57.2 sq ft, Back Cushion: 3.83 yards, 103.4 sq ft, Contrasting Pulls on Articulating Back Cushions: 0.44 yards, 2.2 sq ft

One Articulating Back and One Corner Cushion: Arm: 0, Seat Deck: 2.7 yards, Inside Screen: 3.5 yards, Outside Screen: 3.9 yards, Seat Cushion: 2.31 yards, 57.2 sq ft, Back Cushion: 3.83 yards, 103.4 sq ft, Contrasting Pulls on Articulating Back Cushion: 0.44 yards, 1.1 sq ft

► Specification Information, continued on next page



For Canadian Pricing
 Multiply U.S. Price by the Canadian price factor.
 ► See page 1 for details.

Lagunitas Lounge System 2-Seat Lounges

DESIGN TOAN NGUYEN

► Specification Information, continued from previous page

Specification Information

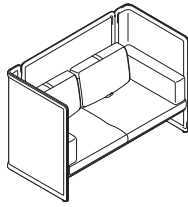

Two articulating backs
Overall: 67¾"W x 34"D x 50"H
Seat: 16"H

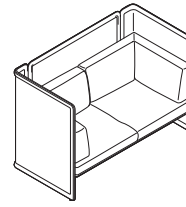

Two corner cushions
Overall: 67¾"W x 34"D x 50"H
Seat: 16"H

Style Number U.S. Base Price

2-Seat Lounge with High-Back Screen and Two Side Screens

COLAGLH23 \$7996

Fabric Upcharges

	Fabric Grades:										Leather Grades:	
	6	7	8	9	10	11	12	13	14	C	E	
Articulating Back Pulls (if top and bottom contrasting pulls are selected)	+\$ 27	+\$ 33	+\$ 45	+\$ 74	+\$ 92	+\$ 112	+\$ 129	+\$ 154	+\$ 193	+\$ 277	+\$ 325	
Seat Cushion	+\$165	+\$198	+\$252	+\$417	+\$ 521	+\$ 645	+\$ 729	+\$ 881	+\$1090	+\$1579	+\$1857	
Back Cushion	+\$395	+\$472	+\$597	+\$989	+\$1244	+\$1537	+\$1740	+\$2100	+\$2602	+\$3762	+\$4421	
Inside Screen	+\$353	+\$421	+\$535	+\$880	+\$1106	+\$1366	+\$1549	+\$1872	+\$2321	N.A.	N.A.	
Outside Screen	+\$455	+\$543	+\$691	+\$1141	+\$1433	+\$1769	+\$2005	+\$2421	+\$3000	N.A.	N.A.	

Two Articulating Backs: Arm: 0, Seat Deck: 1.6 yards, Inside Screen: 4.9 yards, Outside Screen: 5.6 yards, Seat Cushion: 2.22 yards, 63.8 sq ft, Back Cushion: 5.22 yards, 151.8 sq ft, Contrasting Pulls on Articulating Back Cushions: 0.44 yards, 2.2 sq ft

Two Corner Cushions: Arm: 0, Seat Deck: 1.6 yards, Inside Screen: 4.9 yards, Outside Screen: 5.6 yards, Seat Cushion: 2.22 yards, 63.8 sq ft, Back Cushion: 5.22 yards, 151.8 sq ft

Tip: Articulating back pull fabric upcharges only apply when contrasting pulls are selected.

Lounge Seating

 **For Canadian Pricing**
Multiply U.S. Price by the Canadian price factor.
► See page 1 for details.

Lagunitas Lounge System 3-Seat Lounges

DESIGN TOAN NGUYEN

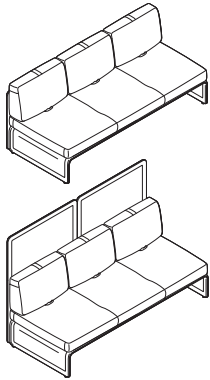

► Need help?
Product details,
page 92

Standard Includes

- Screen: grade 1 knit
- Seat deck: grade 1 knit to match screen
- Non-contrasting seat cushion, articulating back cushion and pulls, back corner cushion, and end arm cushions: fabric or leather
- Bracket: paint
- Eight adjustable glides
- Ships assembled

Required to Specify

- 1 Style number
 - 2 Handedness (see below under Required Selections)
 - 3 Knit color number for screen
 - 4 Fabric or leather color number for non-contrasting seat cushion, articulating back cushion and pulls, back corner cushion, and end arm cushions, if selected
 - 5 Paint color number for bracket:
4141 Platinum Matte
4710 Low Gloss Black
 - 6 Options, if selected (see below)
- See *Coalesse Surface Materials Reference Guide*.

Required Sections

Handedness

- Left-hand, 3-seat lounges only (seated position)
- Right-hand, 3-seat lounges only (seated position)

U.S. Price

No cost
No cost

Required to Specify

Specify *left-hand configuration*.
Specify *right-hand configuration*.

Options

Surface Materials

Fabric screen

- 3-seat lounge with low-back screen +\$344
- 3-seat lounge with low-back screen and one side screen +\$456
- 3-seat lounge with low-back screen and two side screens +\$572
- 3-seat lounge with high-back screen +\$384
- 3-seat lounge with high-back screen and one side screen +\$497
- 3-seat lounge with high-back screen and two side screens +\$651

U.S. Price

+\$182
+\$182
+\$182
Prices at right

Required to Specify

Specify with screen type fabric.
Specify with screen type fabric.
Specify with screen type fabric.
Specify with screen type fabric.
Specify with screen type fabric.
Specify with screen type fabric.
Specify with *contrasting fabric* and select fabric or leather color number.
Specify with *contrasting fabric* and select fabric or leather color number.
Specify with *contrasting fabric* and select fabric or leather color number.

Knit screen

- Grade 1 knit screen No cost
- Grade 2 knit screen
 - 3-seat lounge with low-back screen +\$423
 - 3-seat lounge with low-back screen and one side screen +\$653
 - 3-seat lounge with low-back screen and two side screens +\$881
 - 3-seat lounge with high-back screen +\$458
 - 3-seat lounge with high-back screen and one side screen +\$728
 - 3-seat lounge with high-back screen and two side screens +\$997

Specify with screen type knit and select knit color number.
Specify with screen type knit and select knit color number.
Specify with screen type knit and select knit color number.
Specify with screen type knit and select knit color number.
Specify with screen type knit and select knit color number.
Specify with screen type knit and select knit color number.

Tip: If contrasting screen is selected, it is required to specify whether seat deck finish will match inner screen or outer screen.

Tip: Contrasting fabric for articulating back pulls upcharge is applied one time per style number.

Tip: When contrasting fabric for articulating back pulls is selected, only one contrasting fabric can be specified and will apply to all pulls.



For Canadian Pricing
Multiply U.S. Price by the Canadian price factor.
► See page 1 for details.

► Options, continued on next page

Lagunitas Lounge System 3-Seat Lounges

DESIGN TOAN NGUYEN

► Options, continued from previous page

	Options	U.S. Price	Required to Specify
Surface Materials, continued	Acrylic backer		
	• 3-seat lounge with low-back screen	+\$ 107	Specify with acrylic backer.
	• 3-seat lounge with low-back screen and one side screen	+\$ 160	Specify with acrylic backer.
	• 3-seat lounge with low-back screen and two side screens	+\$ 217	Specify with acrylic backer.
	• 3-seat lounge with high-back screen	+\$ 183	Specify with acrylic backer.
	• 3-seat lounge with high-back screen and one side screen	+\$ 235	Specify with acrylic backer.
	• 3-seat lounge with high-back screen and two side screens	+\$ 293	Specify with acrylic backer. ► See Coalesse Surface Materials Reference Guide.
	• COM	+\$ 225	Specify with COM and select fabric color number. ► See Coalesse Surface Materials Reference Guide.
	• COL	+\$ 410	Specify with COL and select leather color number. ► See Coalesse Surface Materials Reference Guide
	Power/USB Configuration	• One power module: two power in 4710 Low Gloss Black paint	+\$ 456
• One power module: one USB/one power in 4710 Low Gloss Black paint		+\$ 605	Specify with one power module, with one power/one USB.
• Two power modules: two power each in 4710 Low Gloss Black paint		+\$ 912	Specify with two power modules, with two power.
• Two power modules: one USB/one power each in 4710 Low Gloss Black paint		+\$1210	Specify with two power modules, with one power/one USB.
Related Products	• Bench		► Page 138
	• Chaise		► Pages 130–134
	• Collaborative and conference tables		► See Coalesse Tables, Storage, and Accessories Specification Guide.
	• Occasional tables		► See Coalesse Tables, Storage, and Accessories Specification Guide.
	• Personal table		► See Coalesse Tables, Storage, and Accessories Specification Guide.
	• Lounge booth connector screen and alignment connector		► Pages 140–141

► Specification Information, on next page

Tip: For Customer's Own Material or Leather, see necessary requirements, important processing instructions and ordering information.
► See Coalesse Surface Materials Reference Guide.

Tip: For any portion of the product that requires a COM, the additional upcharge is a one time charge per product.

Tip: For any portion of the product that requires a COL, the additional upcharge is a one time charge per product.

Tip: For each USB port specified, there is one USB per port.



For Canadian Pricing
Multiply U.S. Price by the Canadian price factor.
► See page 1 for details.

Lagunitas Lounge System 3-Seat Lounges *continued*

DESIGN TOAN NGUYEN

► Options, on previous page

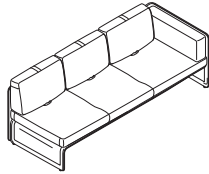
Specification Information



Three articulating backs
Overall: 76¾"W x 34"D x 32¾"H
Inside (Lounge): 76¾"W x 22½"D
Inside (Task): 76¾"W x 17¾"D
Seat: 16"H

Style Number	U.S. Base Price
--------------	-----------------

3-Seat Lounge with Low-Back Screen

COLAGLL31	\$5943
-----------	--------

Fabric Upcharges

	Fabric Grades:								Leather Grades:		
	6	7	8	9	10	11	12	13	14	C	E
Articulating Back Pulls (if top and bottom contrasting pulls are selected)	+\$ 27	+\$ 33	+\$ 45	+\$ 74	+\$ 92	+\$ 112	+\$ 129	+\$ 154	+\$ 193	+\$ 277	+\$ 325
Seat Cushion	+\$205	+\$245	+\$ 312	+\$516	+\$ 647	+\$ 800	+\$ 908	+\$1098	+\$1358	+\$1963	+\$2309
Back Cushion	+\$314	+\$375	+\$480	+\$789	+\$ 989	+\$1221	+\$1386	+\$1674	+\$2078	+\$2999	+\$3524
Inside Screen	+\$302	+\$360	+\$457	+\$753	+\$ 944	+\$1167	+\$1322	+\$1599	+\$1982	N.A.	N.A.
Outside Screen	+\$378	+\$453	+\$578	+\$955	+\$1195	+\$1482	+\$1675	+\$2024	+\$2510	N.A.	N.A.

Tip: Articulating back pull fabric upcharges only apply when contrasting pulls are selected.

Three Articulating Backs: Seat Deck: 3.6 yards, Inside Screen: 3.2 yards, Outside Screen: 3.7 yards, Seat Cushion: 2.83 yards, 79.2 sq ft, Back Cushion: 3.66 yards, 121 sq ft, Contrasting Pulls on Articulating Back Cushions: 0.44 yards, 3.3 sq ft

► Specification Information, continued on next page



For Canadian Pricing
 Multiply U.S. Price by the Canadian price factor.
 ► See page 1 for details.

Lagunitas Lounge System 3-Seat Lounges

DESIGN TOAN NGUYEN

► Specification Information, continued from previous page

Specification Information

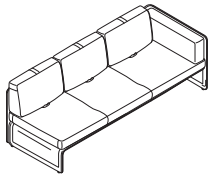

Three articulating backs
Overall: 76¾"W x 34"D x 32¾"H
Seat: 16"H

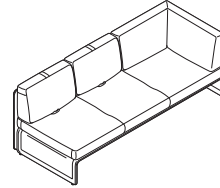

Two articulating backs and one corner cushion
Overall: 85"W x 34"D x 32¾"H
Seat: 16"H

Style Number **U.S. Base Price**

3-Seat Lounge with Low-Back Screen and One Side Screen

COLAGLL32 \$6777

Fabric Upcharges

	Fabric Grades:										Leather Grades:	
	6	7	8	9	10	11	12	13	14	C	E	
Articulating Back Pulls (if top and bottom contrasting pulls are selected)	+\$ 27	+\$ 33	+\$ 45	+\$ 74	+\$ 92	+\$ 112	+\$ 129	+\$ 154	+\$ 193	+\$ 277	+\$ 325	
Seat Cushion	+\$196	+\$233	+\$293	+\$ 487	+\$ 615	+\$ 758	+\$ 857	+\$1036	+\$1283	+\$1854	+\$2179	
Back Cushion	+\$372	+\$443	+\$564	+\$ 933	+\$1172	+\$1446	+\$1639	+\$1979	+\$2455	+\$3544	+\$4166	
Inside Screen	+\$362	+\$434	+\$557	+\$ 919	+\$1151	+\$1424	+\$1614	+\$1947	+\$2414	N.A.	N.A.	
Outside Screen	+\$467	+\$560	+\$709	+\$1178	+\$1478	+\$1824	+\$2066	+\$2498	+\$3095	N.A.	N.A.	

Tip: Articulating back pull fabric upcharges only apply when contrasting pulls are selected.

Three Articulating Backs: Arm: 0, Seat Deck: 2.3 yards, Inside Screen: 4.6 yards, Outside Screen: 5.4 yards, Seat Cushion: 2.9 yards, 74.8 sq ft, Back Cushion: 4.72 yards, 143 sq ft, Contrasting Pulls on Articulating Back Cushions: 0.44 yards, 3.3 sq ft

Two Articulating Backs and One Corner Cushion: Arm: 0, Seat Deck: 2.3 yards, Inside Screen: 4.6 yards, Outside Screen: 5.4 yards, Seat Cushion: 2.9 yards, 74.8 sq ft, Back Cushion: 4.72 yards, 143 sq ft, Contrasting Pulls on Articulating Back Cushions: 0.44 yards, 2.2 sq ft

► Specification Information, continued on next page

Lounge Seating



For Canadian Pricing
 Multiply U.S. Price by the
 Canadian price factor.
 ► See page 1 for details.

Lagunitas Lounge System 3-Seat Lounges *continued*

DESIGN TOAN NGUYEN

► Specification Information, continued from previous page

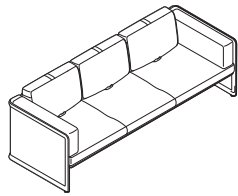
Specification Information



Three articulating backs
Overall: 93¼"W x 34"D x 32¾"H
Seat: 16"H

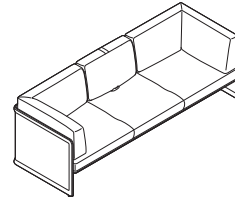

One articulating back and two corner cushions
Overall: 93¼"W x 34"D x 32¾"H
Seat: 16"H

Style Number U.S. Base Price

3-Seat Lounge with Low-Back Screen and Two Side Screens

COLAGLL33 \$7616

Fabric Upcharges

	Fabric Grades:									Leather Grades:	
	6	7	8	9	10	11	12	13	14	C	E
Articulating Back Pulls (if top and bottom contrasting pulls are selected)	+\$ 27	+\$ 33	+\$ 45	+\$ 74	+\$ 92	+\$ 112	+\$ 129	+\$ 154	+\$ 193	+\$ 277	+\$ 325
Seat Cushion	+\$205	+\$245	+\$312	+\$ 516	+\$ 647	+\$ 800	+\$ 908	+\$1098	+\$1358	+\$1963	+\$2309
Back Cushion	+\$495	+\$593	+\$754	+\$1249	+\$1565	+\$1936	+\$2193	+\$2645	+\$3283	+\$4742	+\$5574
Inside Screen	+\$427	+\$509	+\$647	+\$1069	+\$1341	+\$1656	+\$1877	+\$2266	+\$2809	N.A.	N.A.
Outside Screen	+\$548	+\$649	+\$829	+\$1368	+\$1721	+\$2124	+\$2407	+\$2909	+\$3606	N.A.	N.A.

Tip: Articulating back pull fabric upcharges only apply when contrasting pulls are selected.

Three Articulating Backs: Arm: 0, Seat Deck: 2 yards, Inside Screen: 6.1 yards, Outside Screen: 7.1 yards, Seat Cushion: 2.92 yards, 79.2 sq ft, Back Cushion: 6.44 yards, 191.4 sq ft, Contrasting Pulls on Articulating Back Cushions: 0.44 yards, 3.3 sq ft

One Articulating Back and Two Corner Cushions: Arm: 0, Seat Deck: 2 yards, Inside Screen: 6.1 yards, Outside Screen: 7.1 yards, Seat Cushion: 2.92 yards, 79.2 sq ft, Back Cushion: 6.44 yards, 191.4 sq ft, Contrasting Pulls on Articulating Back Cushion: 0.44 yards, 1.1 sq ft

► Specification Information, continued on next page



For Canadian Pricing
 Multiply U.S. Price by the Canadian price factor.
 ► See page 1 for details.

Lagunitas Lounge System 3-Seat Lounges

DESIGN TOAN NGUYEN

► Specification Information, continued from previous page

Specification Information

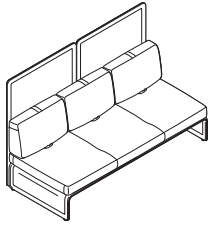

Three articulating backs
Overall: 76⁷/₈"W x 34"D x 50"H
Inside (Lounge): 76⁷/₈"W x 22¹/₂"D
Inside (Task): 76⁷/₈"W x 17³/₄"D
Seat: 16"H

Style Number U.S. Base Price

3-Seat Lounge with High-Back Screen

COLAGLH31 \$7160

Fabric Upcharges

	Fabric Grades:										Leather Grades:	
	6	7	8	9	10	11	12	13	14	C	E	
Articulating Back Pulls (if top and bottom contrasting pulls are selected)	+\$ 27	+\$ 33	+\$ 45	+\$ 74	+\$ 92	+\$ 112	+\$ 129	+\$ 154	+\$ 193	+\$ 277	+\$ 325	
Seat Cushion	+\$205	+\$245	+\$312	+\$516	+\$ 647	+\$ 800	+\$ 908	+\$1098	+\$1358	+\$1963	+\$2309	
Back Cushion	+\$314	+\$375	+\$480	+\$789	+\$ 989	+\$1221	+\$1386	+\$1674	+\$2078	+\$2999	+\$3524	
Inside Screen	+\$302	+\$360	+\$457	+\$753	+\$ 944	+\$1167	+\$1322	+\$1599	+\$1982	N.A.	N.A.	
Outside Screen	+\$378	+\$453	+\$578	+\$955	+\$1195	+\$1482	+\$1675	+\$2024	+\$2510	N.A.	N.A.	

Three Articulating Backs: Seat Deck: 3.6 yards, Inside Screen: 3.2 yards, Outside Screen: 3.7 yards, Seat Cushion: 2.83 yards, 79.2 sq ft, Back Cushion: 3.66 yards, 121 sq ft, Contrasting Pulls on Articulating Back Cushions: 0.44 yards, 3.3 sq ft

► Specification Information, continued on next page

Tip: Articulating back pull fabric upcharges only apply when contrasting pulls are selected.

Lounge Seating



For Canadian Pricing
 Multiply U.S. Price by the Canadian price factor.
 ► See page 1 for details.

Lagunitas Lounge System 3-Seat Lounges *continued*

DESIGN TOAN NGUYEN

► Specification Information, continued from previous page

Specification Information

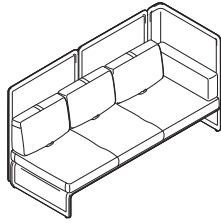

Three articulating backs
Overall: 85"W x 34½"D x 50"H
Seat: 16"H

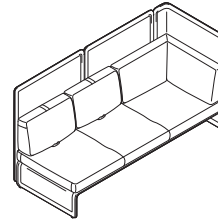

Two articulating backs with one corner cushion
Overall: 85"W x 34½"D x 50"H
Seat: 16"H

Style Number U.S. Base Price

3-Seat Lounge with High-Back Screen and One Side Screen

COLAGLH32 \$8528

Fabric Upcharges

	Fabric Grades:										Leather Grades:	
	6	7	8	9	10	11	12	13	14	C	E	
Articulating Back Pulls (if top and bottom contrasting pulls are selected)	+\$ 27	+\$ 33	+\$ 45	+\$ 74	+\$ 92	+\$ 112	+\$ 129	+\$ 154	+\$ 193	+\$ 277	+\$ 325	
Seat Cushion	+\$196	+\$233	+\$293	+\$487	+\$ 615	+\$ 758	+\$ 857	+\$1036	+\$1283	+\$1854	+\$2179	
Back Cushion	+\$372	+\$443	+\$564	+\$933	+\$1172	+\$1446	+\$1639	+\$1979	+\$2455	+\$3544	+\$4166	
Inside Screen	+\$362	+\$434	+\$557	+\$919	+\$1151	+\$1424	+\$1614	+\$1947	+\$2414	N.A.	N.A.	
Outside Screen	+\$467	+\$560	+\$709	+\$1178	+\$1478	+\$1824	+\$2066	+\$2498	+\$3095	N.A.	N.A.	

Tip: Articulating back pull fabric upcharges only apply when contrasting pulls are selected.

Three Articulating Backs: Arm: 0, Seat Deck: 2.3 yards, Inside Screen: 4.6 yards, Outside Screen: 5.4 yards, Seat Cushion: 2.9 yards, 74.8 sq ft, Back Cushion: 4.72 yards, 143 sq ft, Contrasting Pulls on Articulating Back Cushions: 0.44 yards, 3.3 sq ft

Two Articulating Backs with One Corner Cushion: Arm: 0, Seat Deck: 2.3 yards, Inside Screen: 4.6 yards, Outside Screen: 5.4 yards, Seat Cushion: 2.9 yards, 74.8 sq ft, Back Cushion: 4.72 yards, 143 sq ft, Contrasting Pulls on Articulating Back Cushions: 0.44 yards, 2.2 sq ft

► Specification Information, continued on next page



For Canadian Pricing
Multiply U.S. Price by the Canadian price factor.
► See page 1 for details.

Lagunitas Lounge System 3-Seat Lounges

DESIGN TOAN NGUYEN

► Specification Information, continued from previous page

Specification Information

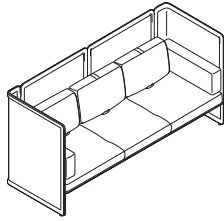

Three articulating backs
Overall: 93³/₈"W x 34"D x 50"H
Seat: 16"H

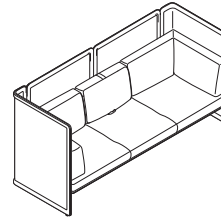

One articulating back and two corner cushions
Overall: 93³/₈"W x 34"D x 50"H
Seat: 16"H

Style Number U.S. Base Price

3-Seat Lounge with High-Back Screen and Two Side Screens

COLAGLH33 \$9898

Fabric Upcharges

	Fabric Grades:										Leather Grades:	
	6	7	8	9	10	11	12	13	14	C	E	
Articulating Back Pulls (if top and bottom contrasting pulls are selected)	+\$ 27	+\$ 33	+\$ 45	+\$ 74	+\$ 92	+\$ 112	+\$ 129	+\$ 154	+\$ 193	+\$ 277	+\$ 325	
Seat Cushion	+\$ 205	+\$245	+\$312	+\$ 516	+\$ 647	+\$ 800	+\$ 908	+\$1098	+\$1358	+\$1963	+\$2309	
Back Cushion	+\$ 495	+\$593	+\$754	+\$1249	+\$1565	+\$1936	+\$2193	+\$2645	+\$3283	+\$4742	+\$5574	
Inside Screen	+\$ 427	+\$509	+\$647	+\$1069	+\$1341	+\$1656	+\$1877	+\$2266	+\$2809	N.A.	N.A.	
Outside Screen	+\$ 548	+\$649	+\$829	+\$1368	+\$1721	+\$2124	+\$2407	+\$2908	+\$3606	N.A.	N.A.	

Tip: Articulating back pull fabric upcharges only apply when contrasting pulls are selected.

Three Articulating Backs: Arm: 0, Seat Deck: 2 yards, Inside Screen: 6.1 yards, Outside Screen: 7.1 yards, Seat Cushion: 2.92 yards, 79.2 sq ft, Back Cushion: 6.44 yards, 191.4 sq ft, Contrasting Pulls on Articulating Back Cushions: 0.44 yards, 3.3 sq ft

One Articulating Back and Two Corner Cushions: Arm: 0, Seat Deck: 2 yards, Inside Screen: 6.1 yards Outside Screen: 7.1 yards, Seat Cushion: 2.92 yards, 79.2 sq ft, Back Cushion: 6.44 yards, 191.4 sq ft, Contrasting Pulls on Articulating Back Cushion: 0.44 yards, 1.1 sq ft

Lounge Seating

 **For Canadian Pricing**
Multiply U.S. Price by the Canadian price factor.
► See page 1 for details.

Lagunitas Lounge System 2-Seat Chaises

DESIGN TOAN NGUYEN

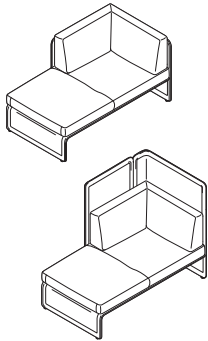

Tip: Handedness is determined while in the seated position. Illustration above shows left-hand chaise.

Tip: If contrasting screen is selected, it is required to specify whether seat deck finish will match inner screen or outer screen.

Tip: Contrasting fabric for articulating back pulls upcharge is applied one time per style number.

Tip: When contrasting fabric for articulating back pulls is selected, only one contrasting fabric can be specified and will apply to all pulls.

Standard Includes		Required to Specify
<ul style="list-style-type: none"> ▶ Need help? Product details, page 92 • Screen: grade 1 knit • Seat deck: grade 1 knit to match screen • Non-contrasting seat cushion, articulating back cushion and pulls, back corner cushion, and end arm cushion, if selected: fabric or leather • Bracket: paint • Six adjustable glides • Ships assembled 		<ol style="list-style-type: none"> 1 Style number 2 Handedness (see below under Required Selections) 3 Knit color number for screen 4 Fabric or leather color number for non-contrasting seat cushion, articulating back cushion and pulls, back corner cushion, and end arm cushion, if selected 5 Paint color number for bracket: 4141 Platinum Matte 4710 Low Gloss Black 6 Options, if selected (see below) <p>▶ See <i>Coalesse Surface Materials Reference Guide</i>.</p>

	Required Sections	U.S. Price	Required to Specify
Handedness	<ul style="list-style-type: none"> • Left-hand, 2-seat chaises only (seated position) • Right-hand, 2-seat chaises only (seated position) 	No cost	Specify with <i>left-hand configuration</i> .
		No cost	Specify with <i>right-hand configuration</i> .

	Options	U.S. Price	Required to Specify
Surface Materials	Fabric screen		
	• 2-seat chaise with one low-back screen and one right- or one left-hand screen	+\$344	Specify with <i>screen type fabric</i> .
	• 2-seat chaise with one high-back screen and one right- or one left-hand screen	+\$421	Specify with <i>screen type fabric</i> .
	• Contrasting fabric for screen	+\$182	Specify with <i>contrasting fabric</i> and select fabric or leather color number.
	• Contrasting fabric for cushion	+\$182	Specify with <i>contrasting fabric</i> and select fabric or leather color number.
	• Contrasting fabric for top and bottom articulating back pulls	+\$182	Specify with <i>contrasting fabric</i> and select fabric or leather color number.
	• Fabric upcharges	Prices at right	Specify fabric color number.
	Knit screen		
	• Grade 1 knit screen	No cost	Specify with <i>screen type knit</i> and select knit color number.
	• Grade 2 knit screen		
– 2-seat chaise with one low-back screen and one right- or one left-hand screen	+\$535	Specify with <i>screen type knit</i> and select knit color number.	
– 2-seat chaise with one high-back screen and one right- or one left-hand screen	+\$617	Specify with <i>screen type knit</i> and select knit color number.	
Acrylic backer			
• 2-seat chaise with one low-back screen and one right- or one left-hand screen	+\$102	Specify with <i>acrylic backer</i> .	
• 2-seat chaise with one high-back screen and one right- or one left-hand screen	+\$153	Specify with <i>acrylic backer</i> .	

▶ Options, continued on next page

▶ See *Coalesse Surface Materials Reference Guide*.



For Canadian Pricing
 Multiply U.S. Price by the Canadian price factor.
 ▶ See page 1 for details.

Lagunitas Lounge System 2-Seat Chaises

DESIGN TOAN NGUYEN

Tip: For Customer's Own Material or Leather, see necessary requirements, important processing instructions and ordering information.

► See Coalesse Surface Materials Reference Guide.

Tip: For any portion of the product that requires a COM, the additional upcharge is a one time charge per product.

Tip: For any portion of the product that requires a COL, the additional upcharge is a one time charge per product.

Tip: For each USB port specified, there is one USB per port.

► Options, continued from previous page

	Options	U.S. Price	Required to Specify
Surface Materials, continued	• COM	+\$ 225	Specify with COM and select fabric color number
	• COL	+\$ 410	Specify with COL and select leather color number. ► See Coalesse Surface Materials Reference Guide
Power/USB Configuration	• One power module: two power in 4710 Low Gloss Black paint	+\$ 456	Specify with one power module, with two power.
	• One power module: one USB/one power in 4710 Low Gloss Black paint	+\$ 605	Specify with one power module, with one power/one USB.
	• Two power modules: two power each in 4710 Low Gloss Black paint	+\$ 912	Specify with two power modules, with two power.
	• Two power modules: one USB/one power each in 4710 Low Gloss Black paint	+\$1210	Specify with two power modules, with one power/one USB.
Related Products	<ul style="list-style-type: none"> • Lounge • Bench • Collaborative and conference tables • Occasional tables • Personal table • Lounge booth connector screen and alignment connector 		<ul style="list-style-type: none"> ► Pages 112–122 ► Page 138 ► See Coalesse Tables, Storage, and Accessories Specification Guide. ► See Coalesse Tables, Storage, and Accessories Specification Guide. ► See Coalesse Tables, Storage, and Accessories Specification Guide. ► Pages 140–141

► Specification Information, on next page



For Canadian Pricing
Multiply U.S. Price by the Canadian price factor.
► See page 1 for details.

Lagunitas Lounge System 2-Seat Chaises *continued*

DESIGN TOAN NGUYEN

► Options, on previous page

Specification Information

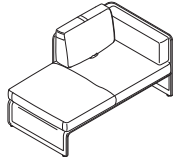

One articulating back
Overall: 59³/₈"W x 34"D x 32³/₈"H
Seat: 16"H

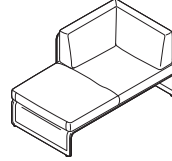

One corner cushion
Overall: 59³/₈"W x 34"D x 32³/₈"H
Seat: 16"H

Style Number	U.S. Base Price
--------------	-----------------

2-Seat Chaise with Low-Back Screen and One Side Screen

COLAGCL2	\$4384
----------	--------

Fabric Upcharges

	Fabric Grades:								Leather Grades:		
	6	7	8	9	10	11	12	13	14	C	E
Articulating Back Pulls (if top and bottom contrasting pulls are selected)	+\$ 27	+\$ 33	+\$ 45	+\$ 74	+\$ 92	+\$ 112	+\$ 129	+\$ 154	+\$ 193	+\$ 277	+\$ 325
Seat Cushion	+\$171	+\$204	+\$257	+\$428	+\$538	+\$ 665	+\$ 753	+\$ 909	+\$ 1127	+\$1625	+\$1911
Back Cushion	+\$165	+\$198	+\$252	+\$417	+\$521	+\$ 645	+\$ 729	+\$ 881	+\$1090	+\$1579	+\$1857
Inside Screen	+\$237	+\$279	+\$358	+\$588	+\$739	+\$ 915	+\$1036	+\$1250	+\$1550	N.A.	N.A.
Outside Screen	+\$316	+\$377	+\$480	+\$792	+\$993	+\$1224	+\$1388	+\$1676	+\$2080	N.A.	N.A.

One Articulating Back: Arm: 0, Seat Deck: 2.7 yards, Inside Screen: 2.7 yards, Outside Screen: 3.2 yards, Seat Cushion: 2.64 yards, 66 sq ft, Back Cushion: 2.61 yards, 63.8 sq ft, Contrasting Pulls on Articulating Back Cushion: 0.44 yards, 1.1 sq ft

One Corner Cushion: Arm: 0, Seat Deck: 2.7 yards, Inside Screen: 2.7 yards, Outside Screen: 3.2 yards, Seat Cushion: 2.64 yards, 66 sq ft, Back Cushion: 2.61 yards, 63.8 sq ft

► Specification Information, on next page

Tip: Handedness is determined while in the seated position. Illustration above shows left-hand chaise.

Tip: Articulating back pull fabric upcharges only apply when contrasting pulls are selected.



For Canadian Pricing
Multiply U.S. Price by the Canadian price factor.
► See page 1 for details.

Lagunitas Lounge System 2-Seat Chaises

DESIGN TOAN NGUYEN

► Specification Information, continued from previous page

Specification Information

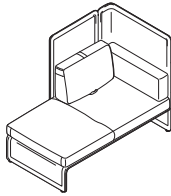

One articulating back
Overall: 59³/₈"W x 34"D x 50"H
Seat: 16"H

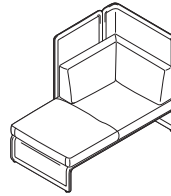

One corner cushion
Overall: 59³/₈"W x 34"D x 50"H
Seat: 16"H

Style Number U.S. Base Price

2-Seat Chaise with High-Back Screen and One Side Screen

COLAGCH2 \$5381

Fabric Upcharges

	Fabric Grades:										Leather Grades:	
	6	7	8	9	10	11	12	13	14	C	E	
Articulating Back Pulls (if top and bottom contrasting pulls are selected)	+\$ 27	+\$ 33	+\$ 45	+\$ 74	+\$ 92	+\$ 112	+\$ 129	+\$ 154	+\$ 193	+\$ 277	+\$ 325	
Seat Cushion	+\$171	+\$204	+\$257	+\$428	+\$ 538	+\$ 665	+\$ 753	+\$ 909	+\$1127	+\$1625	+\$1911	
Back Cushion	+\$165	+\$198	+\$252	+\$417	+\$ 521	+\$ 645	+\$ 729	+\$ 881	+\$1090	+\$1579	+\$1857	
Inside Screen	+\$238	+\$281	+\$360	+\$594	+\$ 748	+\$ 923	+\$1045	+\$1263	+\$1565	N.A.	N.A.	
Outside Screen	+\$319	+\$379	+\$483	+\$798	+\$1000	+\$1236	+\$1398	+\$1691	+\$2096	N.A.	N.A.	

One Articulating Back: Arm: 0, Seat Deck: 2.7 yards, Inside Screen: 2.7 yards, Outside Screen: 3.2 yards, Seat Cushion: 2.64 yards, 66 sq ft, Back Cushion: 2.61 yards, 63.8 sq ft, Contrasting Pulls on Articulating Back Cushion: 0.44 yards, 1.1 sq ft

One Corner Cushion: Arm: 0, Seat Deck: 2.7 yards, Inside Screen: 2.7 yards, Outside Screen: 3.2 yards, Seat Cushion: 2.64 yards, 66 sq ft, Back Cushion: 2.61 yards, 63.8 sq ft

Tip: Handedness is determined while in the seated position. Illustration above shows left-hand chaise.

Tip: Articulating back pull fabric upcharges only apply when contrasting pulls are selected.



For Canadian Pricing
Multiply U.S. Price by the Canadian price factor.
► See page 1 for details.

Lagunitas Lounge System 3-Seat Chaises

DESIGN TOAN NGUYEN

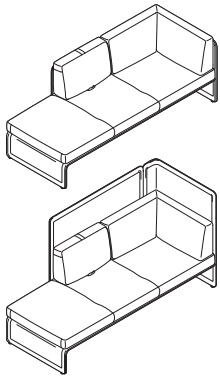

Tip: Handedness is determined while in the seated position. Illustration above shows left-hand chaise.

Tip: If contrasting screen is selected, it is required to specify whether seat deck finish will match inner screen or outer screen.

Tip: Contrasting fabric for articulating back pulls upcharge is applied one time per style number.

Tip: When contrasting fabric for articulating back pulls is selected, only one contrasting fabric can be specified and will apply to all pulls.

Standard Includes		Required to Specify
<p>► Need help? Product details, page 92</p> <ul style="list-style-type: none"> • Screen: grade 1 knit • Seat deck: grade 1 knit to match screen • Non-contrasting seat cushion, articulating back cushion and pulls, back corner cushion, and end arm cushions, if selected: fabric or leather • Bracket: paint • Six adjustable glides • Ships assembled 		<ol style="list-style-type: none"> 1 Style number 2 Handedness (see below under Required Selections) 3 Knit color number for screen 4 Fabric or leather color number for non-contrasting seat cushion, articulating back cushion and pulls, back corner cushion, and end arm cushion, if selected 5 Paint color number for bracket: 4141 Platinum Matte 4710 Low Gloss Black 6 Options, if selected (see below) <p>► See <i>Coalesse Surface Materials Reference Guide</i>.</p>

Required Sections	U.S. Price	Required to Specify
Handedness <ul style="list-style-type: none"> • Left-hand, 3-seat chaises only (seated position) • Right-hand, 3-seat chaises only (seated position) 	No cost	Specify with <i>left-hand configuration</i> .
	No cost	Specify with <i>right-hand configuration</i> .

Options	U.S. Price	Required to Specify
Surface Materials <ul style="list-style-type: none"> • Fabric screen • 3-seat chaise with one low-back screen and one right- or one left-hand screen • 3-seat chaise with one high-back screen and one right- or one left-hand screen 	+\$456 +\$497	Specify with <i>screen type fabric</i> .
<ul style="list-style-type: none"> • Contrasting fabric for screen • Contrasting fabric for cushion 	+\$182 +\$182	Specify with <i>contrasting fabric</i> and select fabric or leather color number.
<ul style="list-style-type: none"> • Contrasting fabric for top and bottom articulating back pulls 	+\$182	Specify with <i>contrasting fabric</i> and select fabric or leather color number.
<ul style="list-style-type: none"> • Fabric upcharges 	Prices at right	Specify fabric color number.
<ul style="list-style-type: none"> • Knit screen • Grade 1 knit screen • Grade 2 knit screen <ul style="list-style-type: none"> – 3-seat chaise with one low-back screen and one right- or one left-hand screen – 3-seat chaise with one high-back screen and one right- or one left-hand screen 	No cost +\$646 +\$724	Specify with <i>screen type knit</i> and select knit color number.
<ul style="list-style-type: none"> • Acrylic backer • 3-seat chaise with one low-back screen and one right- or one left-hand screen • 3-seat chaise with one high-back screen and one right- or one left-hand screen 	+\$133 +\$214	Specify with <i>acrylic backer</i> .

► See *Coalesse Surface Materials Reference Guide*.

► Options, continued on next page

 **For Canadian Pricing**
Multiply U.S. Price by the Canadian price factor.
► See page 1 for details.

Lagunitas Lounge System 3-Seat Chaises

DESIGN TOAN NGUYEN

Tip: For Customer's Own Material or Leather, see necessary requirements, important processing instructions and ordering information.
 ▶ See Coalesse Surface Materials Reference Guide.

Tip: For any portion of the product that requires a COM, the additional upcharge is a one time charge per product.

Tip: For any portion of the product that requires a COL, the additional upcharge is a one time charge per product.

Tip: For each USB port specified, there is one USB per port.

▶ Options, continued from previous page

	Options	U.S. Price	Required to Specify
Surface Materials, continued	• COM	+\$225	Specify with COM and select fabric color number. ▶ See Coalesse Surface Materials Reference Guide.
	• COL	+\$410	Specify with COL and select leather color number. ▶ See Coalesse Surface Materials Reference Guide.
Power/USB Configuration	• One power module: two power in 4710 Low Gloss Black paint	+\$456	Specify with one power module, with two power.
	• One power module: one USB/one power in 4710 Low Gloss Black paint	+\$605	Specify with one power module, with one power/one USB.
	• Two power modules: two power each in 4710 Low Gloss Black paint	+\$912	Specify with two power modules, with two power.
	• Two power modules: one USB/one power each in 4710 Low Gloss Black paint	+\$1210	Specify with two power modules, with one power/one USB.
Related Products	<ul style="list-style-type: none"> • Lounge • Bench • Collaborative and conference tables 		<ul style="list-style-type: none"> ▶ Pages 112–122 ▶ Page 138 ▶ See Coalesse Tables, Storage, and Accessories Specification Guide.
	<ul style="list-style-type: none"> • Occasional tables • Personal table • Lounge booth connector screen and alignment connector 		<ul style="list-style-type: none"> ▶ See Coalesse Tables, Storage, and Accessories Specification Guide. ▶ See Coalesse Tables, Storage, and Accessories Specification Guide. ▶ Page Pages 140–141

▶ Specification Information, on next page



For Canadian Pricing
 Multiply U.S. Price by the Canadian price factor.
 ▶ See page 1 for details.

Lagunitas Lounge System 3-Seat Chaises *continued*

DESIGN TOAN NGUYEN

► Options, on previous page

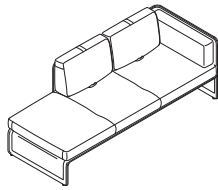
Specification Information



Two articulating backs
Overall: 85"W x 34"D x 32³/₈"H
Seat: 16"H

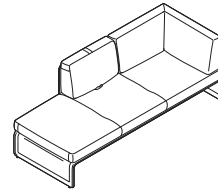

One articulating back and one corner cushion
Overall: 85"W x 34"D x 32³/₈"H
Seat: 16"H

Style Number U.S. Base Price

3-Seat Chaise with Low-Back Screen and One Side Screen

COLAGCL3 \$5768

Fabric Upcharges

	Fabric Grades:										Leather Grades:	
	6	7	8	9	10	11	12	13	14	C	E	
Articulating Back Pulls (if top and bottom contrasting pulls are selected)	+\$ 27	+\$ 33	+\$ 45	+\$ 74	+\$ 92	+\$ 112	+\$ 129	+\$ 154	+\$ 193	+\$ 277	+\$ 325	
Seat Cushion	+\$234	+\$279	+\$355	+\$586	+\$ 735	+\$ 908	+\$1027	+\$1244	+\$1540	+\$2223	+\$2615	
Back Cushion	+\$266	+\$320	+\$407	+\$675	+\$ 845	+\$1045	+\$1185	+\$1429	+\$1775	+\$2564	+\$3011	
Inside Screen	+\$300	+\$358	+\$455	+\$752	+\$ 944	+\$1166	+\$1322	+\$1598	+\$1981	N.A.	N.A.	
Outside Screen	+\$380	+\$455	+\$577	+\$953	+\$1197	+\$1478	+\$1675	+\$2024	+\$2506	N.A.	N.A.	

Two Articulating Backs: Arm: 0, Seat Deck: 3.7 yards, Inside Screen: 3.5 yards, Outside Screen: 3.9 yards, Seat Cushion: 3.31 yards, 90.2 sq ft, Back Cushion: 3.83 yards, 103.4 sq ft, Contrasting Pulls on Articulating Back Cushions: 0.44 yards, 2.2 sq ft

One Articulating Back and One Corner Cushion: Arm: 0, Seat Deck: 3.7 yards, Inside Screen: 3.5 yards, Outside Screen: 3.9 yards, Seat Cushion: 3.31 yards, 90.2 sq ft, Back Cushion: 3.83 yards, 103.4 sq ft, Contrasting Pulls on Articulating Back Cushion: 0.44 yards, 1.1 sq ft

► Specification Information, on next page

Tip: Handedness is determined while in the seated position. Illustration above shows left-hand chaise.

Tip: Articulating back pull fabric upcharges only apply when contrasting pulls are selected.



For Canadian Pricing
Multiply U.S. Price by the Canadian price factor.
► See page 1 for details.

Lagunitas Lounge System 3-Seat Chaises

DESIGN TOAN NGUYEN

► Specification Information, continued from previous page

Specification Information

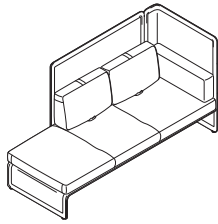

Two articulating backs
Overall: 85"W x 34"D x 50"H
Seat: 16"H

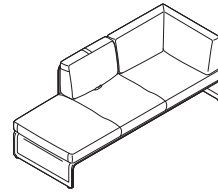

One articulating back and one corner cushion
Overall: 85"W x 34"D x 50"H
Seat: 16"H

Style Number **U.S. Base Price**

3-Seat Chaise with High-Back Screen and One Side Screen

COLAGCH3 \$6767

Fabric Upcharges

	Fabric Grades:										Leather Grades:	
	6	7	8	9	10	11	12	13	14	C	E	
Articulating Back Pulls (if top and bottom contrasting pulls are selected)	+\$ 27	+\$ 33	+\$ 45	+\$ 74	+\$ 92	+\$ 112	+\$ 129	+\$ 154	+\$ 193	+\$ 277	+\$ 325	
Seat Cushion	+\$234	+\$279	+\$355	+\$586	+\$ 735	+\$ 908	+\$1027	+\$1244	+\$1540	+\$2223	+\$2615	
Back Cushion	+\$266	+\$320	+\$407	+\$675	+\$ 845	+\$1045	+\$1185	+\$1429	+\$1775	+\$2564	+\$3011	
Inside Screen	+\$300	+\$358	+\$455	+\$752	+\$ 944	+\$1166	+\$1322	+\$1598	+\$1981	N.A.	N.A.	
Outside Screen	+\$380	+\$455	+\$577	+\$953	+\$1197	+\$1478	+\$1675	+\$2024	+\$2506	N.A.	N.A.	

Two Articulating Backs: Arm: 0, Seat Deck: 3.7 yards, Inside Screen: 3.5 yards, Outside Screen: 3.9 yards, Seat Cushion: 3.31 yards, 90.2 sq ft, Back Cushion: 3.83 yards, 103.4 sq ft, Contrasting Pulls on Articulating Back Cushions: 0.44 yards, 2.2 sq ft

One Articulating Back and One Corner Cushion: Arm: 0, Seat Deck: 3.7 yards, Inside Screen: 3.5 yards, Outside Screen: 3.9 yards, Seat Cushion: 3.31 yards, 90.2 sq ft, Back Cushion: 3.83 yards, 103.4 sq ft, Contrasting Pulls on Articulating Back Cushion: 0.44 yards, 1.1 sq ft

Tip: Handedness is determined while in the seated position. Illustration above shows left-hand chaise.

Tip: Articulating back pull fabric upcharges only apply when contrasting pulls are selected.

Lounge Seating

 **For Canadian Pricing**
Multiply U.S. Price by the Canadian price factor.
► See page 1 for details.

Lagunitas Lounge System Benches

DESIGN TOAN NGUYEN

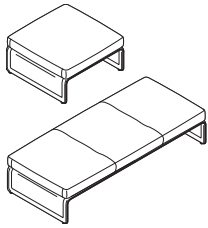

Standard Includes		Required to Specify
<ul style="list-style-type: none"> ▶ Need help? Product details, page 92 	<ul style="list-style-type: none"> • Seat deck: grade 1 knit • Seat cushion: fabric or leather • Four adjustable glides • Ships assembled 	<ol style="list-style-type: none"> 1 Style number 2 Knit color number for seat deck 3 Fabric or leather color number for seat cushion 4 Options, if selected (see below) <p>▶ See <i>Coalesse Surface Materials Reference Guide</i>.</p>

Options	U.S. Price	Required to Specify
Surface Materials <ul style="list-style-type: none"> • Acrylic backer <ul style="list-style-type: none"> • 1-seat bench cushion +\$ 24 • 2-seat bench cushion +\$ 32 • 3-seat bench cushion +\$ 44 • Fabric seat deck Prices at right 		Specify with acrylic backer. Specify with acrylic backer. Specify with acrylic backer. ▶ See <i>Coalesse Surface Materials Reference Guide</i> .
<ul style="list-style-type: none"> • Knit seat deck <ul style="list-style-type: none"> • Grade 1 knit seat deck No cost • Grade 2 knit seat deck <ul style="list-style-type: none"> – 1-seat bench +\$ 114 – 2-seat bench +\$ 154 – 3-seat bench +\$ 193 • COM +\$ 225 • COL +\$ 409 		Specify with fabric seat deck and select fabric color number. Specify with screen type knit and select fabric color number. Specify with screen type knit and select fabric color number. Specify with screen type knit and select fabric color number. Specify with screen type knit and select fabric color number. Specify with COM and select fabric color number. ▶ See <i>Coalesse Surface Materials Reference Guide</i> . Specify with COL and select leather color number. ▶ See <i>Coalesse Surface Materials Reference Guide</i> .

Power/USB Configuration <ul style="list-style-type: none"> • 1-seat benches <ul style="list-style-type: none"> • One power module: two power in 4710 Low Gloss Black paint +\$ 456 • One power module: one USB/one power in 4710 Low Gloss Black paint +\$ 605 • 2- and 3-seat benches <ul style="list-style-type: none"> • Two power modules: two power each in 4710 Low Gloss Black paint +\$ 912 • Two power modules: one USB/one power each in 4710 Low Gloss Black paint +\$1210 		Specify with one power module, with two power. Specify with one power module, with one power/one USB. Specify with two power modules, with two power. Specify with two power modules, with one power/one USB.
---	--	--

Related Products <ul style="list-style-type: none"> • Lounge • Chaise • Collaborative and conference tables • Occasional tables • Personal table 	<ul style="list-style-type: none"> ▶ Pages 112–122 ▶ Pages 130–134 ▶ See <i>Coalesse Tables, Storage, and Accessories Specification Guide</i>. ▶ See <i>Coalesse Tables, Storage, and Accessories Specification Guide</i>. ▶ See <i>Coalesse Tables, Storage, and Accessories Specification Guide</i>.
---	---

Tip: For Customer's Own Material or Leather, see necessary requirements, important processing instructions and ordering information.
 ▶ See *Coalesse Surface Materials Reference Guide*.

Tip: For any portion of the product that requires a COM, the additional upcharge is a one time charge per product.

Tip: For any portion of the product that requires a COL, the additional upcharge is a one time charge per product.

Tip: For each USB port specified, there is one USB per port.



For Canadian Pricing
 Multiply U.S. Price by the Canadian price factor.
 ▶ See page 1 for details.

Lagunitas Lounge System Benches

DESIGN TOAN NGUYEN

Specification Information

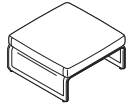

Overall: 32¾"W x 32¾"D x 16"H
Seat Deck: 2.8 yards
Seat Cushion: 2.6 yards, 57.2 sq ft

Style Number U.S. Base Price

1-Seat Bench

COLAGB1 \$1551

Fabric Upcharges

	Fabric Grades:								Leather Grades:		
	6	7	8	9	10	11	12	13	14	C	E
Seat Deck	+\$ 378	+\$419	+\$495	+\$714	+\$856	+\$1022	+\$1136	+\$1341	+\$1628	N.A.	N.A.
Seat Cushion	+\$ 146	+\$179	+\$227	+\$374	+\$470	+\$ 578	+\$655	+\$792	+\$980	+\$1418	+\$1666

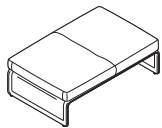

Overall: 51¼"W x 32¾"D x 16"H
Seat Deck: 3.1 yards
Seat Cushion: 3.2 yards, 70.4 sq ft

2-Seat Bench

COLAGB2 \$2176

Fabric Upcharges

	Fabric Grades:								Leather Grades:		
	6	7	8	9	10	11	12	13	14	C	E
Seat Deck	+\$ 393	+\$440	+\$516	+\$754	+\$912	+\$1089	+\$1211	+\$1433	+\$1739	N.A.	N.A.
Seat Cushion	+\$ 183	+\$220	+\$279	+\$458	+\$576	+\$ 714	+\$804	+\$974	+\$1209	+\$1745	+\$2049

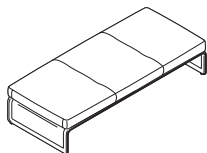

Overall: 76⅞"W x 32¾"D x 16"H
Seat Deck: 3.5 yards
Seat Cushion: 4 yards, 88 sq ft

3-Seat Bench

COLAGB3 \$2796

Fabric Upcharges

	Fabric Grades:								Leather Grades:		
	6	7	8	9	10	11	12	13	14	C	E
Seat Deck	+\$ 417	+\$468	+\$556	+\$817	+\$982	+\$1179	+\$1314	+\$1555	+\$1890	N.A.	N.A.
Seat Cushion	+\$ 231	+\$275	+\$348	+\$574	+\$720	+\$ 894	+\$1008	+\$1216	+\$1509	+\$2182	+\$2566

Lagunitas Lounge System Accessories

DESIGN TOAN NGUYEN

Lounge Booth Connector Screen



Screen: 38½"W x 50"H

Tip: Lounge booth connector screen joins two high screen lounges, enclosing one side of booth.

Standard Includes	Required to Specify
<ul style="list-style-type: none"> ▶ Need help? Product details, page 92 • Screen: grade 1 knit • Two bottom brackets: 4710 Low Gloss Black or 4141 Platinum Matte paint • Two screen ganging alignment clips 	<ul style="list-style-type: none"> 1 Style number 2 Knit color number for screen 3 Paint color number for bracket 4 Options, if selected (see below) ▶ See <i>Coalesse Surface Materials Reference Guide</i>.

Surface Materials	Options	U.S. Price	Required to Specify
	Knit screen		
	• Grade 1 knit	No cost	Specify with <i>screen type knit</i> and select knit color number.
	• Grade 2 knit	+\$129	Specify with <i>screen type knit</i> and select knit color number.
	• Fabric screen	+\$307	Specify with <i>screen type fabric</i> .
	• Contrasting fabric	+\$182	Specify with <i>contrasting fabric</i> and select fabric color number.
	• Fabric upcharges	Prices below	Specify fabric color number.
	• COM	+\$225	Specify with <i>COM</i> and select fabric color number. ▶ See <i>Coalesse Surface Materials Reference Guide</i> .

Related Products	<ul style="list-style-type: none"> • Lounge • Chaise 	<ul style="list-style-type: none"> ▶ Pages 112-122 ▶ Pages 130-134
-------------------------	--	--

Specification Information

Style Number	U.S. Base Price
COLAGLBS	\$1057

	Fabric Upcharges									
	Fabric Grades:									
	6	7	8	9	10	11	12	13	14	
Inside Screen	+\$ 153	+\$185	+\$234	+\$385	+\$485	+\$598	+\$682	+\$ 824	+\$1019	
Outside Screen	+\$ 221	+\$266	+\$341	+\$561	+\$704	+\$868	+\$982	+\$1187	+\$1469	

Booth Connector Screen: Inside Screen: 1.4 yards, Outside Screen: 2.6 yards



For Canadian Pricing
Multiply U.S. Price by the Canadian price factor.
▶ See page 1 for details.

Lagunitas Lounge System Accessories

DESIGN TOAN NGUYEN

Alignment Connector

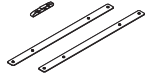

Standard Includes	Required to Specify
<ul style="list-style-type: none"> ▶ Need help? Product details, page 92 • Screen and seat deck connector package: pin, bracket, and hardware • Ships ready to assemble 	<ul style="list-style-type: none"> Style number

Related Products	
<ul style="list-style-type: none"> • Lounge • Chaise 	<ul style="list-style-type: none"> ▶ Pages 112-122 ▶ Pages 130-134

Specification Information	
Style Number	U.S. Price
COLAGCI	\$61

Lounge Seating

 **For Canadian Pricing**
 Multiply U.S. Price by the Canadian price factor.
 ▶ See page 1 for details.

Lagunitas Focus Nook

Lagunitas focus nook is a cozy, touch-down destination that offers users a traditional work posture and responds to the demand for privacy and focus throughout the open workspace. The Lagunitas focus nook is infused with the same Lagunitas design aesthetic and surface materials. It is available in a breadth of materials and finishes, inviting expression while optimizing space.

50"H screens are offered in two material types: knit and fabric.

Knit screens allow for some transparency and light to pass through the panels. Available in 17 colors.

Adjustable leveling glides have a range of 1/2" to accommodate uneven floors.

Fabric screens are available with non-contrasting or contrasting (inside and outside of the screen) fabric.

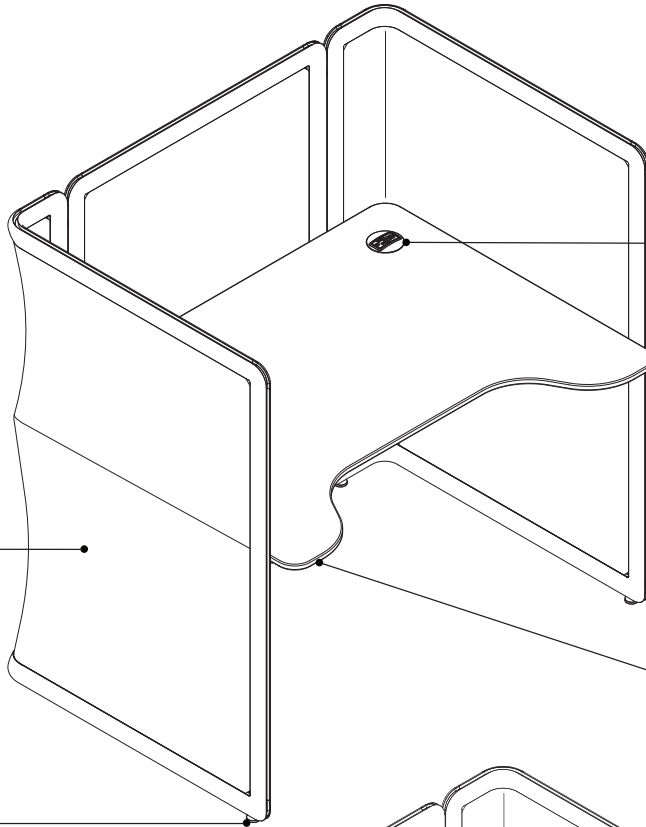

Power modules are available for easy access to power.

Cable management tray keeps below surface cords hidden.

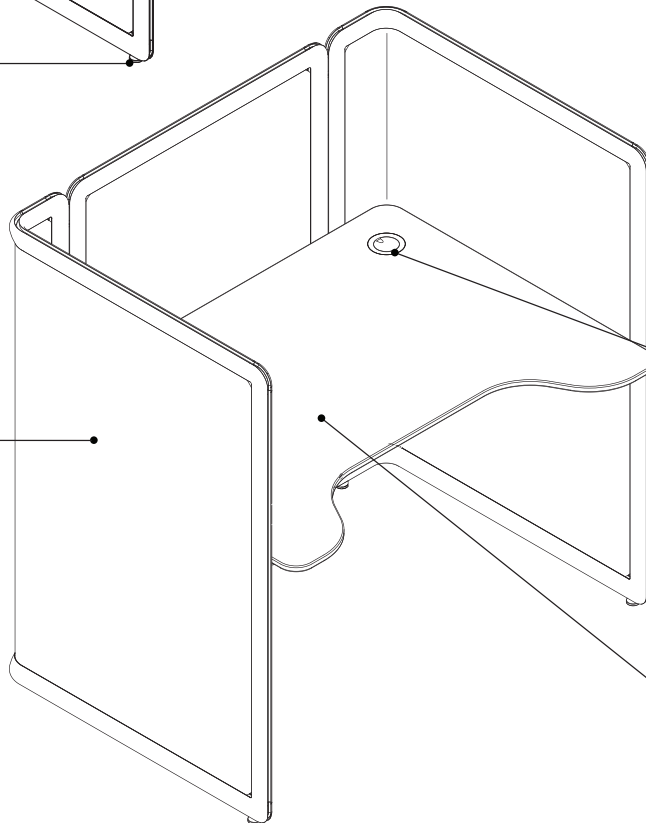

Light grommet is available to route on-surface light to the below-surface power source.

Worksurface is 28 1/2"H and is available in laminate and wood veneer in a wide variety of finishes.

Lagunitas Focus Nook

Product Details

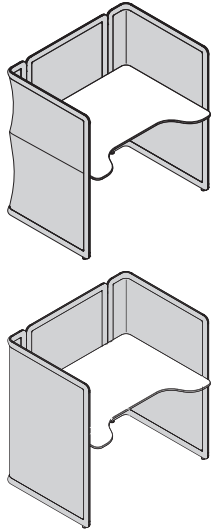

Screens are offered in two types of materials: knit and fabric. The knit panels allow for some transparency and light to pass through. The fabric panels can either be monolithic (non-contrasting) or specified in differing finishes (contrasting) for the inside and outside of the screen.

Tip: If a contrasting screen is specified, the fabric must be chosen from the same fabric family.

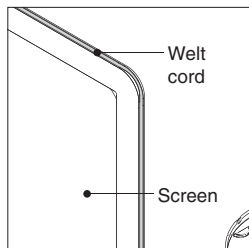

A welt cord is standard on all fabric specified screens. The welt cord finish is non-specifiable and is the same fabric finish as the outside screen when contrasting screens are specified. For non-contrasting screens, the welt cord matches the screen specification. The knit screen does not require a welt cord.

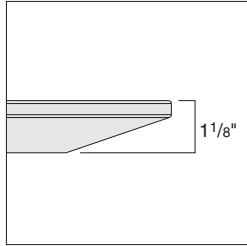

Laminate or wood veneer worksurface is standard with a knife edge profile that has the appearance of a 5/8" thick top, which tapers to an overall top thickness of 1 1/8".

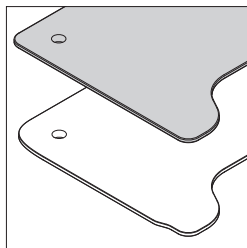

High-Pressure Laminate worksurface is standard with a matching or complementing 3 mm flat edge band. Wood veneer tables are standard with a matching wood 3 mm flat edge band. The underside of the table top is finished in black.

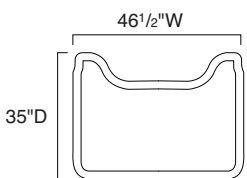

Knit Screen Surface

Knit screen worksurface measures 35"D x 46 1/2"W.

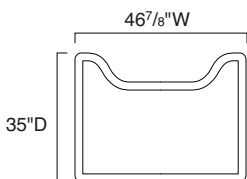

Fabric Screen Surface

Fabric screen worksurface measures 35"D x 46 7/8"W.

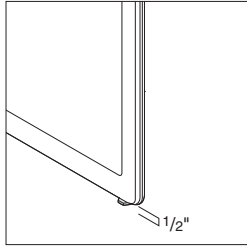

Glides adjust 1/2" for uneven floors. There are two glides per screen. Glides have a metal rounded foot.

Power, Data, Wiring & Cabling

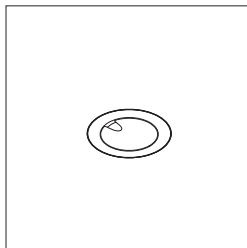

2" light grommet is available to accommodate an on-surface light by routing the on-surface light plug to the below-surface power source. Grommet is specifiable on the left or right side of worksurface and is available in three color options.

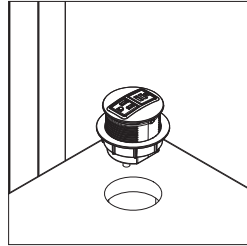

Round power modules are specifiable on the back right or back left side of the worksurface. The 3" power module features tamper resistant power simplexes, an 8'L power cord with 15-amp plug. Plug includes a built-in circuit breaker measuring 2 1/4"D x 1 1/2"W x 1 1/2"H. Round power module is available in four color options, and three configurations:

- Two TR simplex receptacles
- One TR simplex receptacle and two USB A charging ports
- One TR simplex receptacle, one USB A charging port, and one USB C charging port

Tip: USB receptacles conveniently charge a range of electronic devices. Some devices may not be compatible.

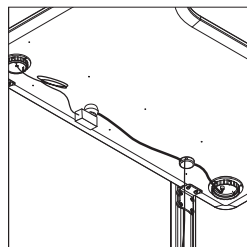

Power package is available when light grommet is specified. Power package includes power module with a below worksurface convenience outlet to power the available on-surface light and retain a single power cord out. Specifiable on the back right or back left side of the worksurface.

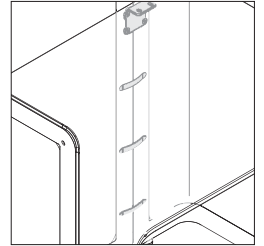

Magnetic wire management brackets are black and come standard with the power module and power package to neatly manage the cord to the floor.

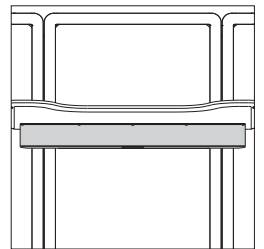

Cable management tray neatly conceals below surface cords to the underside of the worksurface.

Surface Materials

Screens:

- Knit
- Fabric

Screen attachment brackets:

- 4710 Low Gloss Black

Worksurface:

- Laminate with matching or complementing 3 mm plastic edge band
- Wood veneer with matching 3 mm wood edge

Glides:

- Non-specifiable plated metal

Power module and power package (options):

- 4013 Silver/Black
- 4180 Graphite Matte
- 4242 Milk Matte
- 4710 Low Gloss Black

Light grommet (option):

- 6000 Black
- 6052 Milk
- 6D03 Graphite

Cable management tray (option):

- 4710 Low Gloss Black paint

► See *Coalesse Surface Materials Reference Guide* for more information.

Lagunitas Focus Nook

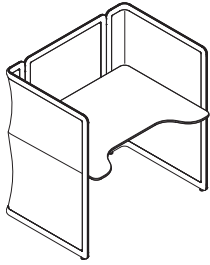

Tip: If a contrasting screen is specified, the fabric must be chosen from the same fabric family.

Tip: Grommets and power devices are specifiable on either the right or left side.

Tip: Power package must be specified when power and lighting grommet is specified.

Tip: Power simplex receptacles are tamper resistant.

Tip: When power module or power package in 4242 Milk Matte is specified, the 8' infeed cord will be white. When any other finish is specified, the infeed cord will be black.

Tip: Power/USB configuration upcharges are in addition to the power module or power package upcharge.



For Canadian Pricing
Multiply U.S. Price by the Canadian price factor.
▶ See page 1 for details.

Standard Includes		Required to Specify	
▶ Need help? Product details, page 142	<ul style="list-style-type: none"> Screen: grade 1 knit Worksurface: <ul style="list-style-type: none"> – Grade 1 laminate with 3 mm flat plastic edge Brackets: 4710 Black Low Gloss Black paint Six adjustable glides Ships ready to assemble 	<ol style="list-style-type: none"> Style number Knit color number for screen Laminate color number for table top Plastic edge color number for laminate top, if selected Options, if selected (see below) 	▶ See <i>Coalesse Surface Materials Reference Guide</i> .
Options		U.S. Price	Required to Specify
Surface Materials	Fabric screen		
	<ul style="list-style-type: none"> Fabric screen Contrasting fabric for screen 	<ul style="list-style-type: none"> +\$611 +\$182 	Specify with screen type fabric. Specify with contrasting fabric and select fabric color number. Specify fabric color number.
	<ul style="list-style-type: none"> Fabric upcharges 	Prices at right	
	Knit screen		
	<ul style="list-style-type: none"> Grade 1 knit screen Grade 2 knit screen 	<ul style="list-style-type: none"> No cost +\$692 	Specify with screen type knit and select knit color number. Specify with screen type knit and select knit color number.
	<ul style="list-style-type: none"> COM 	+\$225	Specify with COM and select fabric color number. ▶ See <i>Coalesse Surface Materials Reference Guide</i> .
	Worksurface		
	<ul style="list-style-type: none"> Grade 2 laminate Grade 3 laminate Grade 1 wood veneer Grade 2 wood veneer 	<ul style="list-style-type: none"> Prices at right Prices at right Prices at right Prices at right 	Specify with Grade 2 laminate and select laminate color number. Specify with Grade 3 laminate and select laminate color number. Specify with Grade 1 wood veneer and select wood color number. Specify with Grade 2 wood veneer and select wood color number.
2" Light Grommet	<ul style="list-style-type: none"> 2" light grommet 	+\$ 33	Specify with 2" grommet and select color number.
Power/USB Configuration	Power options (with three magnetic wire management brackets)		
	<ul style="list-style-type: none"> Power module Power package (contains power module and below surface convenience plug for on-surface light) 	<ul style="list-style-type: none"> +\$380 +\$593 	Specify with power module and select color number. Specify with power package and select color number.
	Power/USB configurations		
	<ul style="list-style-type: none"> Two TR simplex receptacles One TR simplex receptacle and two USB A charging ports One TR simplex receptacle, one USB A charging port, and one USB C charging port 	<ul style="list-style-type: none"> No cost +\$149 +\$149 	Specify with two power. Specify with one power, two USB A. Specify with one power, one USB A, one USB C.
Cable Management Tray	<ul style="list-style-type: none"> Cable management tray 	+\$181	Specify with tray and select color number.
Related Products	<ul style="list-style-type: none"> Lagunitas lounge seating Lagunitas work and occasional tables 		▶ Pages 112-122 ▶ See <i>Coalesse Tables, Storage and Accessories</i> .

Lagunitas Focus Nook

Specification Information

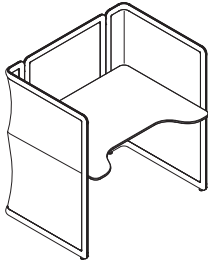

Knit Screen

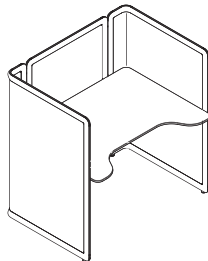

Fabric Screen

Style Number	Dimensions			U.S. Base Prices			
	W	D	H	Flat Vinyl Edge on Laminate Top		Flat Wood Edge on Wood Veneer Top	
				Grade 1	Grade 2 and 3	Grade 1	Grade 2
COLAGFN	49 1/4"	37"	50"	\$3841	\$4031	\$5304	\$5635

Fabric Upcharges

	Fabric Grades:								
	6	7	8	9	10	11	12	13	14
Inside Screen	+\$305	+\$362	+\$463	+\$ 766	+\$ 964	+\$1189	+\$1348	+\$1628	+\$2019
Outside Screen	+\$404	+\$483	+\$615	+\$1014	+\$1270	+\$1567	+\$1778	+\$2146	+\$2656

Inside screen: 4.4 yds, Outside screen: 5.1 yds

 **For Canadian Pricing**
 Multiply U.S. Price by the Canadian price factor.
 ▶ See page 1 for details.

LessThanFive Lounge

DESIGN MICHAEL YOUNG

The **LessThanFive lounge** is handcrafted from carbon fiber, making it exceptionally light and strong.

Lightweight, weighing less than five pounds.

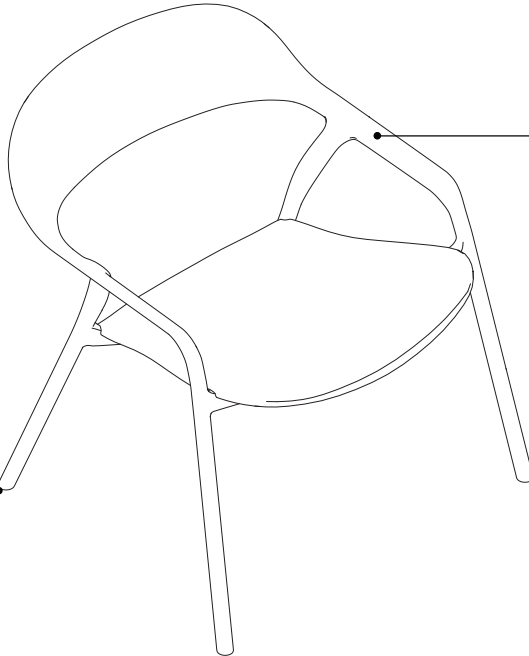

Glides are soft felt.

Frame is constructed entirely of carbon fiber, and comes in several standard finishes. Customization options are also available.

Product Details

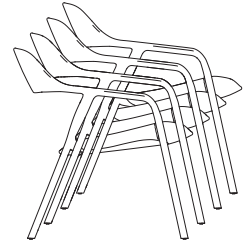

Stackable up to four high.

Surface Materials

► See *Coalesse Surface Materials Reference Guide* for further information.

Frame
• Paint

Tip: Consult the Coalesse concierge team for customization options.

LessThanFive Lounge

DESIGN MICHAEL YOUNG

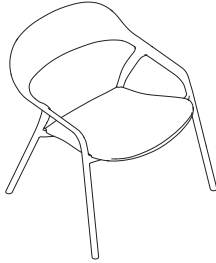

Overall: 26"D 27½"W 27½"H
Seat Height: 15¾"H

Standard Includes		Required to Specify
<ul style="list-style-type: none"> ▶ Need help? Product details, page 146 	<ul style="list-style-type: none"> • Frame: constructed of carbon fiber • Finish: smooth paint • Soft felt glides 	<ul style="list-style-type: none"> 1 Style number 2 Paint color number for frame 3 Options, if selected (see below) ▶ See <i>Coalesse Surface Materials Reference Guide</i>.

Options	U.S. Price	Required to Specify
Surface Materials <ul style="list-style-type: none"> • 4233 Carbon Weave 	+\$267	Specify with 4233 Carbon Weave.

Specification Information		
Style Number	Quantity	U.S. Base Price

LessThanFive Lounge

COLT5L	1	\$2175
--------	---	--------

 **For Canadian Pricing**
Multiply U.S. Price by the Canadian price factor.
▶ See page 1 for details.

Marien152 Lounge Seating

DESIGN COALESSE DESIGN GROUP AND ARIK LEVY

Marien152 is a richly tailored seating experience that's inspired by the home and designed for the workday. Design personalization is built into the collection through a wide range of upholstery, color, base, and materiality choices. Thoughtful proportions and a signature cushioned back create a comfortable lounge chair that can support work. Available with a wood or metal base.

Leather may be specified with a contrasting back cushion only.

Black glides are available in hard and soft options.

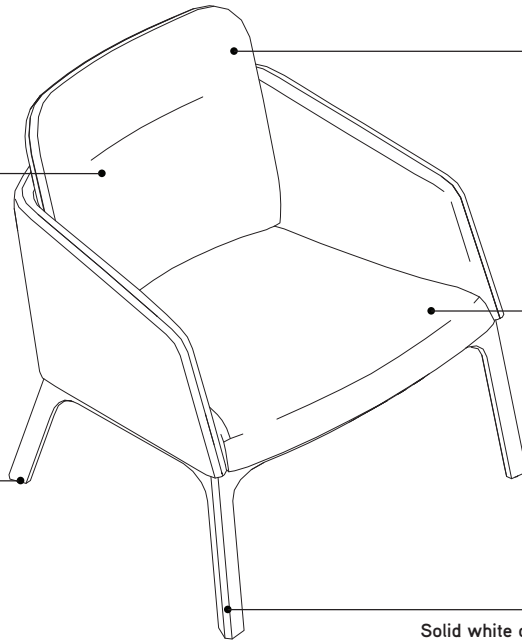

Back cushion gives the appearance of a soft, loose pillow. Intentionally relaxed upholstery on the back cushion adds to the welcoming appeal.

Contrasting fabric is available on seat, surround, and back cushion.

Solid white oak frame has a chamfered edge profile.

360° swivel base provides full range of motion.

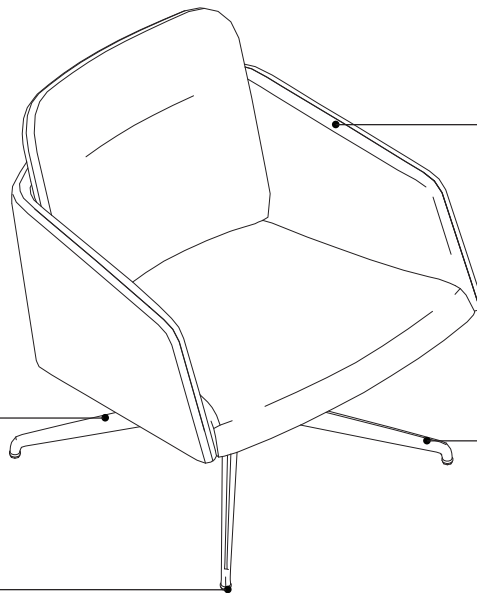

Gently sloping arms are subtle yet supportive.

Base is standard in powder coat paint and polished aluminum.

Black glides are available in hard and soft options.

Marien152 Lounge Seating

DESIGN COALESSE DESIGN GROUP AND ARIK LEVY

Product Details

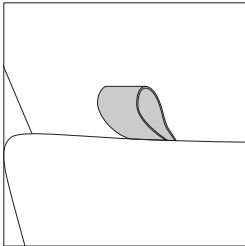

Standard leather pull, located behind the back cushion, allows users to easily move the chair. Leather in the color coal only. Option to specify without pull if desired.

Surface Materials

Upholstery

- Fabric
- Leather

Metal base

- Paint
- Polished chrome

Wood base

- Solid white oak wood frame

Programs & Services

Customer's Own Material/Leather (COM/COL) Program is available.

► See *Coalesse Surface Materials Reference Guide* for additional information.

Marien152 Seating Metal Base Lounge

DESIGN COALESSE DESIGN GROUP AND ARIK LEVY

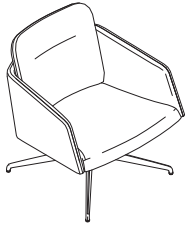

Standard Includes	Required to Specify
<ul style="list-style-type: none"> ▶ Need help? Product details, page 148 • Seat, back cushion, and surround: upholstery • Leather strap: coal • Base: 8046 Polished Aluminum or grade 1 paint • 360° swivel • Black hard glides 	<ol style="list-style-type: none"> 1 Style number 2 Contrasting fabric (see below under Required Selections) 3 Fabric or leather color number for upholstery on seat, surround, and back cushion 4 Metal or paint color number for base 5 Options, if selected (see below) <p>▶ See <i>Coalesse Surface Materials Reference Guide</i>.</p>

Required Selections	U.S. Price	Required to Specify
Contrasting Fabric <ul style="list-style-type: none"> • Non contrasting fabric • Contrasting back cushion fabric • Contrasting surround fabric • Contrasting seat fabric • Contrasting all fabrics 	<ul style="list-style-type: none"> No cost +\$182 +\$182 +\$182 +\$182 	<ul style="list-style-type: none"> Specify with <i>non contrasting</i>. Specify with <i>contrasting back cushion</i>. Specify with <i>contrasting surround</i>. Specify with <i>contrasting seat</i>. Specify with <i>contrasting all fabrics</i>.

Options	U.S. Price	Required to Specify
Surface Materials <ul style="list-style-type: none"> • Base • Polished aluminium • Grade 1 paint • Grade 3 paint 	<ul style="list-style-type: none"> No cost No cost +\$102 	<ul style="list-style-type: none"> Specify with <i>aluminium matte polished</i>. Specify paint color number. Specify paint color number.
<ul style="list-style-type: none"> • Acrylic backer • Backer 	<ul style="list-style-type: none"> +\$ 46 	<ul style="list-style-type: none"> Specify with <i>acrylic backer</i>.
Glide Type <ul style="list-style-type: none"> • Hard glides • Soft glides 	<ul style="list-style-type: none"> No cost No cost 	<ul style="list-style-type: none"> Specify with <i>hard glides</i>. Specify with <i>soft glides</i>.
Pull <ul style="list-style-type: none"> • With leather pull • Without leather pull 	<ul style="list-style-type: none"> No cost No cost 	<ul style="list-style-type: none"> Specify with <i>pull</i>. Specify <i>without pull</i>.
Related Products <ul style="list-style-type: none"> • Conference seating • Guest seating • Stools 		<ul style="list-style-type: none"> ▶ Page 276 ▶ Page 322 ▶ Pages 370–372

Specification Information

Style Number		U.S. Base Prices											Leather Grades		
		Fabric Grades:											COL	C	E
		COM	6	7	8	9	10	11	12	13	14				
COMARLCMB	Seat	\$1775	\$1768	\$1782	\$1796	\$1834	\$1862	\$1895	\$1939	\$1983	\$2063	\$1827	\$ 2221	\$2316	
	Surround	+\$ 53	+\$ 73	+\$ 95	+\$117	+\$175	+\$220	+\$274	+\$340	+\$413	+\$537	+\$105	+\$1296	+\$1543	
	Back cushion	+\$ 53	+\$ 36	+\$ 48	+\$ 59	+\$ 90	+\$113	+\$140	+\$173	+\$210	+\$275	+\$105	+\$532	+\$ 645	

COM/yds: Seat = .97, Surround = 1.53, Cushion = .78, COL/sq ft: Seat = 15, Surround = 39, Cushion = 16

Overall: 28½"D x 29"W x 30½"H
 Inside: 20½"D x 21"W
 Seat: 16½"H
 Arm: 23"H



For Canadian Pricing
 Multiply U.S. Price by the Canadian price factor.
 ▶ See page 1 for details.

Marien152 Seating Wood Base Lounge

DESIGN COALESSE DESIGN GROUP AND ARIK LEVY

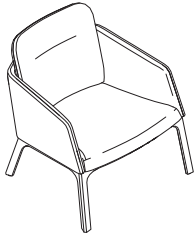

Standard Includes		Required to Specify
<ul style="list-style-type: none"> ▶ Need help? Product details, page 148 	<ul style="list-style-type: none"> • Seat, back cushion, and surround: upholstery • Leather strap: coal • Base: grade 1 oak wood • Black hard glides 	<ol style="list-style-type: none"> 1 Style number 2 Contrasting fabric (see below under Required Selections) 3 Fabric or leather color number for upholstery on seat, surround, and back cushion 4 Wood color number for base 5 Options, if selected (see below) <p>▶ See <i>Coalesse Surface Materials Reference Guide</i>.</p>

Required Selections	U.S. Price	Required to Specify
Contrasting Fabric <ul style="list-style-type: none"> • Non contrasting fabric • Contrasting back cushion fabric • Contrasting surround fabric • Contrasting seat fabric • Contrasting all fabrics 	<p>No cost</p> <p>+\$182</p> <p>+\$182</p> <p>+\$182</p> <p>+\$182</p>	<p>Specify <i>with non contrasting</i>.</p> <p>Specify <i>with contrasting back cushion</i>.</p> <p>Specify <i>with contrasting surround</i>.</p> <p>Specify <i>with contrasting seat</i>.</p> <p>Specify <i>with contrasting all fabrics</i>.</p>

Options	U.S. Price	Required to Specify
Surface Materials <ul style="list-style-type: none"> • Wood base <ul style="list-style-type: none"> • Grade 1 wood • Grade 2 wood • Acrylic backer <ul style="list-style-type: none"> • Backer 	<p>No cost</p> <p>+\$ 83</p> <p>+\$ 46</p>	<p>Specify wood color number.</p> <p>Specify wood color number.</p> <p>Specify <i>with acrylic backer</i>.</p>
Glide Type <ul style="list-style-type: none"> • Hard glides • Soft glides 	<p>No cost</p> <p>No cost</p>	<p>Specify <i>with hard glides</i>.</p> <p>Specify <i>with soft glides</i>.</p>
Pull <ul style="list-style-type: none"> • With leather pull • Without leather pull 	<p>No cost</p> <p>No cost</p>	<p>Specify <i>with pull</i>.</p> <p>Specify <i>without pull</i>.</p>
Related Products <ul style="list-style-type: none"> • Conference seating • Guest seating • Stools 		<p>▶ Page 276</p> <p>▶ Page 322</p> <p>▶ Pages 370–372</p>

Specification Information														
Style Number		U.S. Base Prices												
		Fabric Grades:											Leather Grades	
		COM	6	7	8	9	10	11	12	13	14	COL	C	E
COMARLCWB	Seat	\$2303	\$2296	\$2310	\$2324	\$2662	\$2390	\$2423	\$2467	\$2511	\$2591	\$2355	\$ 2749	\$2844
	Surround	+\$ 53	+\$ 73	+\$ 95	+\$ 117	+\$ 175	+\$ 220	+\$274	+\$ 340	+\$413	+\$537	+\$ 105	+\$1296	+\$1543
	Back cushion	+\$ 53	+\$ 36	+\$ 48	+\$ 59	+\$ 90	+\$ 113	+\$140	+\$ 173	+\$210	+\$275	+\$ 105	+\$ 532	+\$645

COM/yds: Seat = .97, Surround = 1.53, Cushion = .78, COL/sq ft: Seat = 15, Surround = 39, Cushion = 16

Overall: 28½"D x 29"W x 30½"H
 Inside: 20½"D x 21"W
 Seat: 16½"H
 Arm: 23"H

 **For Canadian Pricing**
 Multiply U.S. Price by the Canadian price factor.
 ▶ See page 1 for details.

Marien152 Lounge Seating Multi-Fabric Diagram

DESIGN COALESSE DESIGN GROUP AND ARIK LEVY

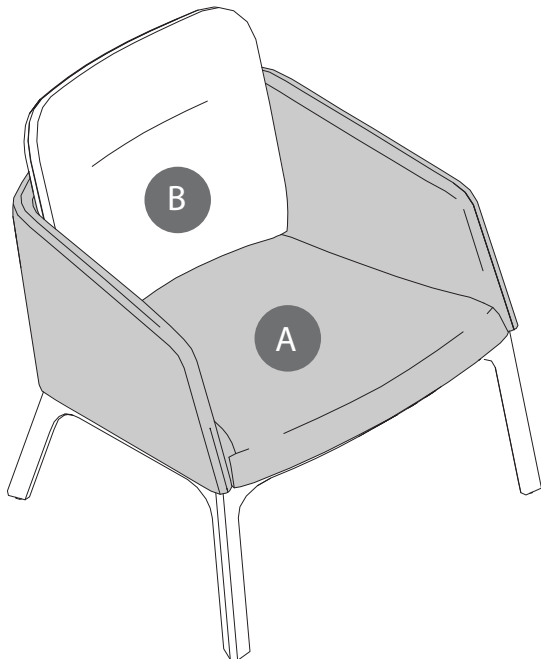
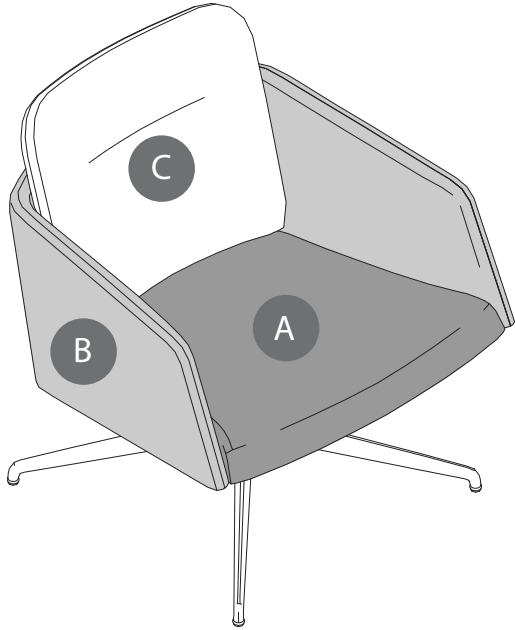

TO: _____

FROM: _____

DATE: _____

FAX...888.413.5161

FABRIC

A Seat: _____

B Surround: _____

C Back: _____

LEATHER

A Seat + Surround: _____

B Back Cushion: _____

Specify Model below:

COMARLCMB Metal Base Chair

COMARLCWB Wood Base Chair

*See specifying for contrasting fabric upcharge.
List price based on highest fabric grade usage.*

Coalesse

Marien152 Lounge Seating Multi-Fabric Diagram

DESIGN COALESSE DESIGN GROUP AND ARIK LEVY

Massaud Lounge Seating

DESIGN JEAN-MARIE MASSAUD

Massaud lounge seating is designed for relaxed postures and connecting with technology at the office or at home. *Tip: This product line is a collection and will be found in multiple locations in this specification guide.*
▶ See Collections, page 5.

Inner seat back features a duvet stitching technique accented with comfort wrinkles.

Swivel-return base with auto-return mechanism returns chair to front-facing alignment.

Plastic glides are $\frac{11}{32}$ " thick to allow cords to pass safely underneath without causing damage to the floor.

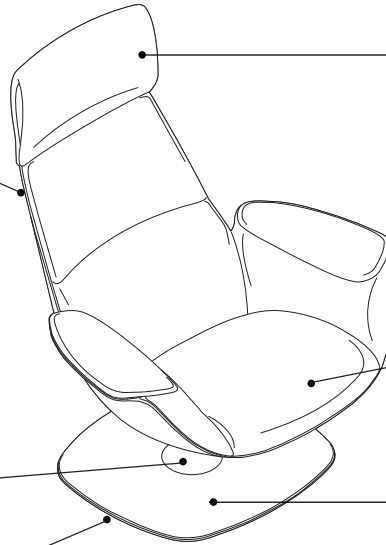

Backrest features an articulating headrest with removable pillow.

Wire management through seat cushion.

Flat base is $\frac{3}{8}$ " thick and allows users to rotate 95° left or right to prevent cords from wrapping around base of a fully rotating seat.

Massaud Lounge Seating

DESIGN JEAN-MARIE MASSAUD

Product Details



Lounge seating includes the standard lounge chair and a work lounge chair with swiveling tablet.



Tablet on work lounge offers 180 square inches of surface area with a depth adjustment of 2³/₄" to accommodate a wide range of users.



Matching ottoman is 20¹/₂"D x 26"W x 14"H, and features 10⁵/₈" rectangular storage space. It is standard with one space divider and bottom insert in 3224 Charcoal. Lid features pull-tab opening with dampened, dual, four-bar hinge mechanism. Left and right storage pockets are standard with felt glides or integral molded feet.

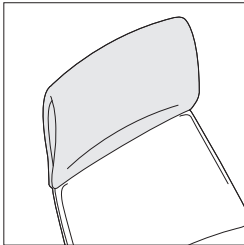

Backrest features an articulating headrest which contains a removable, teardrop-shaped pillow to allow for optimal user comfort. Headrest pillow resides inside an upholstered pocket, permanently attached to the backrest.

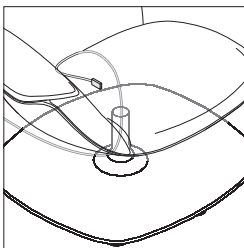

Wire management is concealed with seat hinges that open to reveal a passage to the floor. Base support features a hollow passageway of 3/4" diameter to allow clearance for cords.

Surface Materials

► See *Coalesse Surface Materials Reference Guide* for further information.

Upholstery (contrasting fabric available)

- Fabric
- Leather

Tablet

- Fusion fabric

Base

- Paint

Programs and Services

Customer's Own Material/Leather (COM/COL) Program is available.

► See *Coalesse Surface Materials Reference Guide* for additional information.

Massaud Lounge Seating

DESIGN JEAN-MARIE MASSAUD

Tip: Upholstery intent is loose to provide visual and inviting comfort.

Tip: Headrest is articulated to adjust forward and back 2¾" to accommodate support needs. Headrest contains removeable pillow to allow reorientation and differing heights.

Tip: Base swivels with automatic return to center position.

Tip: Fusion fabric is available on the outer back and tablet only. It is not recommended for any other surface.

Standard Includes		Required to Specify
<ul style="list-style-type: none"> ▶ Need help? Product details, page 154 	<ul style="list-style-type: none"> • Base: Grade 1 paint • Seat and inner back, and outer back: fabric or leather • Arm caps: fabric or leather • Work lounge tablet, if selected: Fusion fabric only • Removable pillow: fabric or leather to match inner back • Ottoman, if selected: fabric or leather • Pull tab on ottoman, if selected: paint 	<ol style="list-style-type: none"> 1 Style number 2 Paint color number for base 3 Fabric or leather color number for inner and outer back, and arm caps 4 Fusion color number for work lounge tablet, if selected: <ul style="list-style-type: none"> CL60 Caviar CL62 Graphite CL64 Steam CL80 Terracotta CL81 Copper CL82 Sage CL83 Blue Ink CL84 Blue Steel 5 Fabric or leather color number for ottoman, if selected 6 Paint color number for pull tab on ottoman, if selected 7 Options, if selected (see below) <p>▶ See <i>Coalesse Surface Materials Reference Guide</i>.</p>

Options	U.S. Price	Required to Specify
Surface Materials <ul style="list-style-type: none"> • Contrasting arm cap +\$182 • Contrasting inner back +\$182 • Contrasting outer back +\$182 • Contrasting all target surfaces +\$365 		Specify with <i>contrasting arm cap</i> . Specify with <i>contrasting inner back</i> . Specify with <i>contrasting outer back</i> . Specify with <i>contrasting all</i> . ▶ See <i>Coalesse Surface Materials Reference Guide</i> .
Base <ul style="list-style-type: none"> • Grade 3 paint +\$111 		Specify paint color number.
Acrylic backer <ul style="list-style-type: none"> • Lounge and work lounge +\$ 63 • Ottoman +\$ 32 		Specify with <i>acrylic backer</i> . Specify with <i>acrylic backer</i> .
Related Products <ul style="list-style-type: none"> • Collaboration seating 		▶ Page 284

Tip: Grade 3 paints are not available on Massaud ottoman pull tab.

Specification Information													
Style Number	U.S. Base Prices											Leather Grades:	
	Fabric Grades:											COL	C
	COM	6	7	8	9	10	11	12	13	14			

Lounge Chair														
COMCLG	Inner back and seat	\$5154	\$5156	\$5180	\$5216	\$5330	\$5404	\$5491	\$5551	\$5659	\$5805	\$5247	\$ 6145	\$6337
	Outer back	+\$112	+\$117	+\$138	+\$174	+\$289	+\$362	+\$449	+\$509	+\$618	+\$763	+\$206	+\$1104	+\$1296

COM/yds: Inner back and seat = 2.5, Outer back = 2.6, Arm caps = .5
 COL/sq ft: Inner back and seat = 55, Outer back = 55, Arm caps = 20

▶ Specification Information, continued on next page



Overall: 33"D 36½"W 41⅓"H
Seat Height: 15½"H

For Canadian Pricing
 Multiply U.S. Price by the Canadian price factor.
 ▶ See page 1 for details.

Massaud Lounge Seating

DESIGN JEAN-MARIE MASSAUD

► Specification Information, continued from previous page

Specification Information

Style Number	U.S. Base Prices											Leather Grades:		
	Fabric Grades:											COL	C	E
	COM	6	7	8	9	10	11	12	13	14				

Work Lounge Chair

COMCWL	Inner back and seat	\$6170	\$6175	\$6196	\$6237	\$6357	\$6437	\$6531	\$6593	\$6704	\$6860	\$6256	\$7214	\$7419
	Outer back	+\$119	+\$124	+\$146	+\$187	+\$307	+\$386	+\$481	+\$543	+\$654	+\$812	+\$206	+\$1165	+\$1369

COM/yds: Inner back and seat = 2.5, Outer back = 2.6, Arm caps = .5
 COL/sq ft: Inner back and seat = 55, Outer back = 55, Arm caps = 20



Overall: 33"D 41½"W 41½"H
Seat Height: 15½"H
Top of Cushion to Bottom of Tablet: 6½"H

Tip: Pivoting tablet is fixed at a height of 17½".



Overall: 20½"D 26"W 14"H
Tip: Ottoman is standard with one space divider and bottom insert. Divider and bottom insert are available in 3224 Charcoal only.

Tip: Ottoman is standard with Coalesse imprinted on pull and a left- and right-hand storage pocket.

Tip: Ottoman is not available in contrasting fabrics.

Ottoman

COMCOT	\$2401	\$2484	\$2513	\$2562	\$2702	\$2796	\$2903	\$2978	\$3113	\$3295	\$2750	\$3720	\$3961
--------	--------	--------	--------	--------	--------	--------	--------	--------	--------	--------	--------	--------	--------

COM/yds = 3, COL/sq ft = 55

Lounge Seating



For Canadian Pricing
 Multiply U.S. Price by the Canadian price factor.
 ► See page 1 for details.

Massaud Lounge Seating Multi-Fabric Diagram

DESIGN JEAN-MARIE MASSAUD

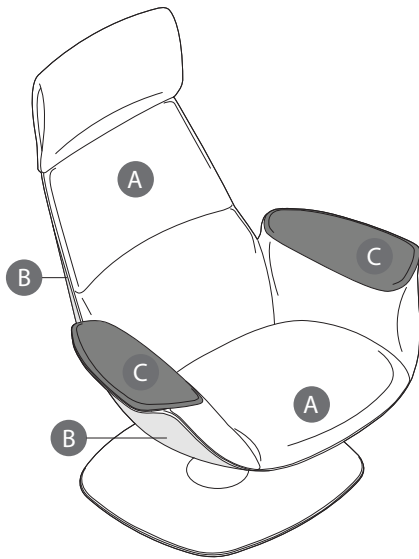

TO: _____

FROM: _____

DATE: _____

FAX...888.413.5161

A Inner Back and Seat: _____

B Outer Back: _____

C Arm Cap: _____

Specify Model below:

COMCLG Lounge Chair

COMCWL Work Lounge Chair

*Tip: Ottoman is not available in contrasting fabrics.
See specifying for contrasting fabric upcharge.
List price based on highest fabric grade usage.*

Coalesse

Massaud Lounge Seating

Multi-Fabric Diagram

DESIGN JEAN-MARIE MASSAUD

Millbrae Lifestyle Lounge Seating

DESIGN COALESSE DESIGN GROUP

Millbrae Lifestyle lounge seating is designed for relaxed postures in a social office setting, creating a social feel in the workplace.

Tip: This product line is a collection and will be found in multiple locations in this specification guide and/or Coalesse Tables, Storage, and Accessories Specification Guide.

► See *Collections*, page 5.

Lounge seating is available in 1-, 2-, or 3-seat lounge with two enclosed arms.

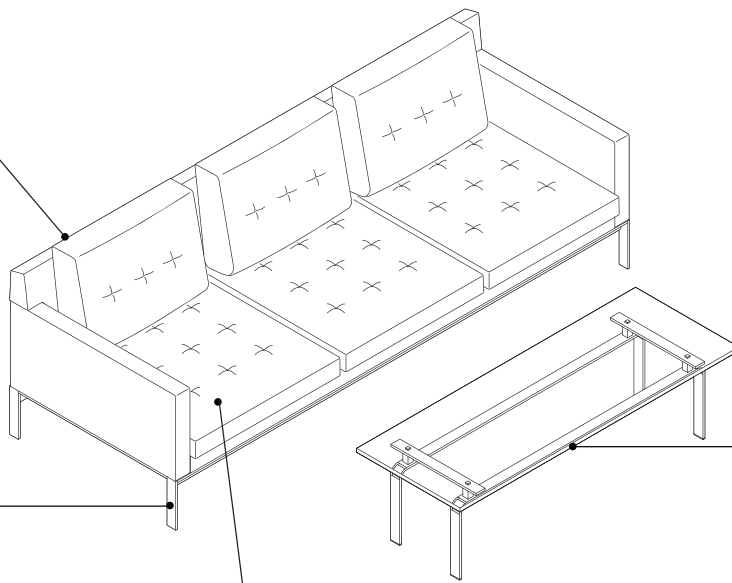

Four leg base is steel with durable plastic glides.

Seat cushions are attached. Back cushions are loose with attachment straps.

Occasional tables are available in three styles: square tables, rectangle tables, and side tables. All are standard with a 3/4" glass top and four-leg steel base.
► See *Coalesse Tables, Storage, and Accessories Specification Guide*.

Millbrae Lifestyle Lounge Seating

DESIGN COALESSE DESIGN GROUP

Product Details

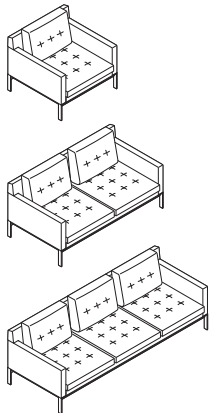

Lounge seating is available in 1-, 2-, and 3-seat lounge with tufted pattern accents and separate back pillows. Attachment straps are an available option. All styles have four steel legs, 1/2" x 1 3/4" with fixed plastic glides.

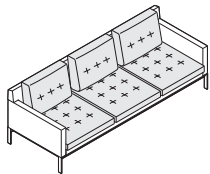

Upholstery detail features tufted pattern accents with double needle top stitch and is available in a wide range of fabrics and leathers.



Arm bolsters are available round or square in coordinating upholstery, and are 18 1/2"D x 7"W x 7"H.

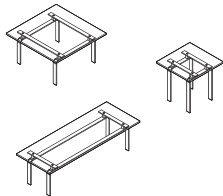

Occasional tables are available in three styles: square, rectangle, and side tables. Square tables are available in three sizes: 30"D x 30"W x 15"H, 36"D x 36"W x 15"H, or 48"D x 48"W x 15"H. Rectangle tables are available in two sizes: 20"D x 54"W x 15"H or 30"D x 60"W x 15"H. Side tables are 20"D x 20"W x 20"H. ▶ See *Coalesse Tables, Storage, and Accessories Specification Guide*.

Surface Materials

▶ See *Coalesse Surface Materials Reference Guide* for further information.

Upholstery

- Fabric
- Leather

Base

- Paint
- 4862 Stainless Steel (option)

Table tops

- Glass

Programs & Services

Customer's Own Material/Leather (COM/COL) Program is available.

▶ See *Coalesse Surface Materials Reference Guide* for additional information.

Millbrae Contract Lounge Seating

DESIGN COALESSE DESIGN GROUP

Millbrae Contract lounge seating enhances the social feel of today's progressive workplaces and is inspired by mid-century designs.

Tip: This product line is a collection and will be found in multiple locations in this specification guide and/or Coalesse Tables, Storage, and Accessories Specification Guide.

► See *Collections*, page 5.

Lounge chairs are available in arm, armless, or single-arm styles with fixed glides.

Benches are available in 1-, 2-, 3-, or 4-seat models with fixed glides.

Ganging kit is available for Contract lounges and benches to be ganged.

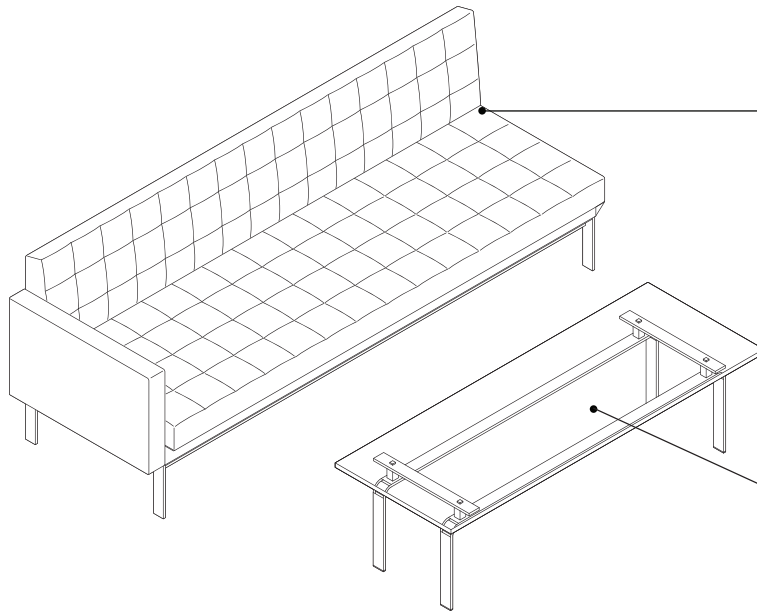

Lounges are available in 1-, 2-, 3-, or 4-seat options. All lounges offer arm, armless, and single-arm options with fixed glides.

Occasional tables are available in three styles: square tables, rectangle tables, and side tables. All are standard with $\frac{3}{4}$ " glass top and four-leg steel base.

► See *Coalesse Tables, Storage, and Accessories Specification Guide*.

Millbrae Contract Lounge Seating

DESIGN COALESSE DESIGN GROUP

Product Details

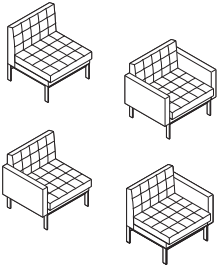

Lounge chairs are available with arms, armless, or a single-arm. Armless chairs are 30"D x 26"W x 31"H. Each arm adds 3" to the width. Steel legs are 1/2" x 1 3/4" with fixed glides.

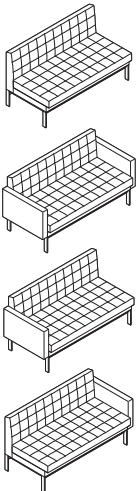

2-seat lounges are available with arms, armless, or a single-arm. Armless lounges are 30"D x 52"W x 31"H. Each arm adds 6" to the width. Steel legs are 1/2" x 1 3/4" with fixed glides.

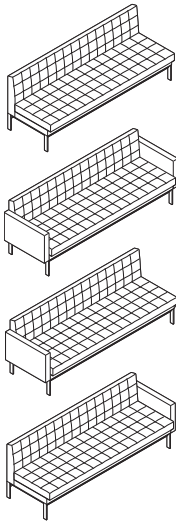

3-seat lounges are available with arms, armless, or a single-arm. Armless lounges are 30"D x 78"W x 31"H. Each arm adds 6" to the width. Steel legs are 1/2" x 1 3/4" with fixed glides.

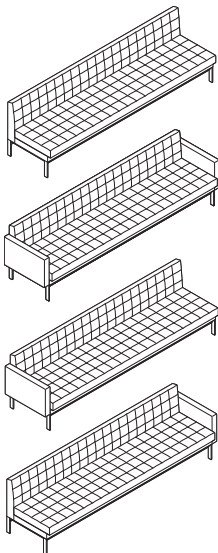

4-seat lounges are available with arms, armless, or a single-arm; armless lounges are 30"D x 104"W x 31"H, each arm adds 3" to the width. Steel legs are 1/2" x 1 3/4" with fixed glides.

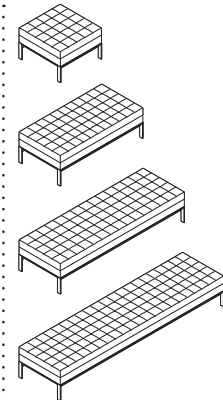

Benches are available in 1-, 2-, 3-, or 4-seat. All are 16 1/2"H with four steel legs (1/2" x 1 3/4") with fixed glides. Front and side ganging brackets available.

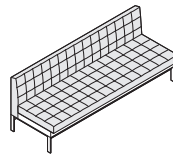

Upholstery features a quilted pattern accent with a double needle top-stitch and is available in a wide range of fabrics and leathers.



Arm bolsters are available round or square in coordinating upholstery, and are 18 1/2"D x 7"W x 7"H.



Ganging kit for Contract lounges and benches is available for front and side ganging using 3/16" thick steel plates.

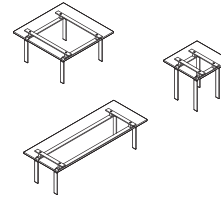

Occasional tables are available in three styles: square, rectangle, and side tables. Square tables are available in three sizes: 30"D x 30"W x 15"H, 36"D x 36"W x 15"H, or 48"D x 48"W x 15"H. Rectangle tables are available in two sizes: 20"D x 54"W x 15"H or 30"D x 60"W x 15"H. Side tables are 20"D x 20"W x 20"H. ▶ See *Coalesse Tables, Storage, and Accessories Specification Guide*.

Surface Materials

▶ See *Coalesse Surface Materials Reference Guide* for further information.

Upholstery

- Fabric
- Leather

Base

- Paint
- 4862 Stainless Steel (option)

Table tops

- Glass

Programs and Services

Customer's Own Material/Leather (COM/COL) Program is available.

▶ See *Coalesse Surface Materials Reference Guide* for additional information.

Millbrae Lifestyle/Contract Lounge Seating

DESIGN COALESSE DESIGN GROUP

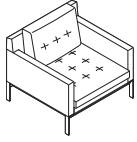

Tip: Fabrics and leathers will appear loose with comfort wrinkles when upholstered.

Tip: For Customer's Own Material or Leather, see necessary requirements, important processing instructions, and ordering information
 ▶ See Coalesse Surface Materials Reference Guide.

Tip: Attachment straps are standard on back cushions of Lifestyle lounge seating.



For Canadian Pricing
 Multiply U.S. Price by the Canadian price factor.
 ▶ See page 1 for details.

Standard Includes		Required to Specify		
▶ Need help? Product details, page 160	<ul style="list-style-type: none"> • Frame: constructed with finger jointed plywood • Multiple densities of polyurethane foams and polyester fiber on seat and back: fabric or leather • The lifestyle collection has tufted pattern accents and separate back cushions with double needle top stitch: fabric or leather • The contract collection has quilted pattern accents with double needle top stitch: fabric or leather • Steel base: Grade 1 paint 	<ol style="list-style-type: none"> 1 Style number 2 Fabric or leather color number for seat, back, and arms 3 Paint color number for base 4 Options, if selected (see below) 	▶ See Coalesse Surface Materials Reference Guide.	
Options		U.S. Price	Required to Specify	
Surface Materials	<ul style="list-style-type: none"> • Contrasting fabric 	+\$ 182 per fabric	Add suffix K to the style number and select fabric color number.	
	Acrylic backer Lifestyle chairs			
	<ul style="list-style-type: none"> • Lounge chair • 2-seat lounge • 3-seat lounge 	<ul style="list-style-type: none"> +\$ 86 +\$ 144 +\$ 197 	<ul style="list-style-type: none"> Specify with acrylic backer. Specify with acrylic backer. Specify with acrylic backer. 	
	Acrylic backer Contract chairs			
	<ul style="list-style-type: none"> • Lounge chair armless • Lounge chair with arms • Lounge chair left or right arm facing • 2-seat lounge armless • 2-seat lounge with arms • 2-seat lounge left or right arm facing • 3-seat lounge armless • 3-seat lounge with arms • 3-seat lounge left or right arm facing • 4-seat lounge armless • 4-seat lounge with arms • 4-seat lounge left or right arm facing • 1-seat bench • 2-seat bench • 3-seat bench • 4-seat bench 	<ul style="list-style-type: none"> +\$ 33 +\$ 55 +\$ 49 +\$ 55 +\$ 77 +\$ 70 +\$ 77 +\$ 98 +\$ 86 +\$ 98 +\$ 119 +\$ 106 +\$ 24 +\$ 33 +\$ 49 +\$ 55 	<ul style="list-style-type: none"> Specify with acrylic backer. Specify with acrylic backer. Specify with acrylic backer. Specify with acrylic backer. Specify with acrylic backer. Specify with acrylic backer. Specify with acrylic backer. Specify with acrylic backer. Specify with acrylic backer. Specify with acrylic backer. Specify with acrylic backer. Specify with acrylic backer. Specify with acrylic backer. Specify with acrylic backer. Specify with acrylic backer. Specify with acrylic backer. Specify with acrylic backer. 	
	Bolsters			
	<ul style="list-style-type: none"> • Square or round bolster pillows 	+\$ 10	<ul style="list-style-type: none"> Specify with acrylic backer. 	
	Base			
	<ul style="list-style-type: none"> • Grade 3 paint 	+\$ 145	Specify paint color number.	
	Plated metal base			
	<ul style="list-style-type: none"> • Lounge chair • 2-seat lounge • 3-seat lounge • 4-seat lounge • 1-seat bench • 2-seat bench • 3-seat bench • 4-seat bench 	<ul style="list-style-type: none"> +\$1172 +\$1328 +\$1954 +\$2118 +\$1172 +\$1328 +\$1954 +\$2118 	<ul style="list-style-type: none"> Specify with 4862 Stainless Steel base. Specify with 4862 Stainless Steel base. Specify with 4862 Stainless Steel base. Specify with 4862 Stainless Steel base. Specify with 4862 Stainless Steel base. Specify with 4862 Stainless Steel base. Specify with 4862 Stainless Steel base. Specify with 4862 Stainless Steel base. 	
	Bolster/Pillow Attachment Rings	<ul style="list-style-type: none"> • Attachment rings for bolster/pillow attach to lounge attachment straps 	<ul style="list-style-type: none"> +\$ 98 	Specify with attachment rings.
	Lounge Attachment Straps	<ul style="list-style-type: none"> • Attachment straps for lounge attach to bolster/pillow attachment rings 	No cost	Specify with attachment straps for left and right sides.
	Related Products	<ul style="list-style-type: none"> • Occasional tables 		▶ See Coalesse Tables, Storage, and Accessories Specification Guide.

Millbrae Lifestyle/Contract Lounge Seating

DESIGN COALESSE DESIGN GROUP

Specification Information

Style Number	U.S. Base Prices														Leather Grades:		
	Fabric Grades:														COL	C	E
	COM	6	7	8	9	10	11	12	13	14							

Lifestyle Lounge Seating

Lounge Chair

COMSL1	\$3745	\$3793	\$3840	\$3928	\$4196	\$4366	\$4570	\$4707	\$4954	\$5299	\$3929	\$ 6484	\$ 6798
--------	--------	--------	--------	--------	--------	--------	--------	--------	--------	--------	--------	---------	---------

COM/yds = 5¼, COL/sq ft = 115

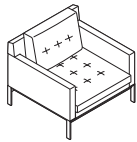

Overall: 35"D 35"W 28¾"H
Overall inside: 29"D 29"W 17"H
Inside to pillow: 22"D 29"W 17"H

2-Seat Lounge

COMSL2	\$5551	\$5751	\$5830	\$5968	\$6388	\$6657	\$6973	\$7192	\$7582	\$8122	\$5735	\$ 9992	\$10,487
--------	--------	--------	--------	--------	--------	--------	--------	--------	--------	--------	--------	---------	----------

COM/yds = 8¼, COL/sq ft = 181

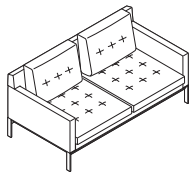

Overall: 35"D 64"W 28¾"H
Overall inside: 29"D 58"W 17"H
Inside to pillow: 22"D 58"W 17"H

3-Seat Lounge

COMSL3	\$6882	\$7198	\$7299	\$7477	\$8011	\$8354	\$8755	\$9033	\$9526	\$10,210	\$7066	\$12,611	\$13,241
--------	--------	--------	--------	--------	--------	--------	--------	--------	--------	----------	--------	----------	----------

COM/yds = 10½, COL/sq ft = 231

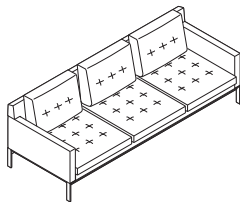

Overall: 35"D 92½"W 28¾"H
Overall inside: 29"D 87"W 17"H
Inside to pillow: 22"D 87"W 17"H

Contract Lounge Chairs

Without Arms

COMFL1	\$3155	\$3155	\$3181	\$3230	\$3368	\$3459	\$3563	\$3636	\$3768	\$3948	\$3424	\$ 4434	\$ 4582
--------	--------	--------	--------	--------	--------	--------	--------	--------	--------	--------	--------	---------	---------

COM/yds = 2¾, COL/sq ft = 60



Overall: 30"D 26"W 31"H
Inside seat height: 22"D 17"H

With Arms

COMFLA1	\$3596	\$3596	\$3634	\$3703	\$3907	\$4037	\$4189	\$4297	\$4480	\$4747	\$3800	\$ 5659	\$ 5900
---------	--------	--------	--------	--------	--------	--------	--------	--------	--------	--------	--------	---------	---------

COM/yds = 4, COL/sq ft = 88

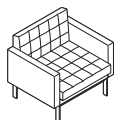

Overall: 30"D 32"W 31"H
Inside: 22"D 26½"W 17"H

With Left Arm Facing

COMFLLA1	\$3369	\$3369	\$3403	\$3457	\$3624	\$3727	\$3851	\$3939	\$4093	\$4306	\$3613	\$ 5059	\$ 5254
----------	--------	--------	--------	--------	--------	--------	--------	--------	--------	--------	--------	---------	---------

COM/yds = 3¼, COL/sq ft = 72



Overall: 30"D 29"W 31"H
Inside: 22"D 26½"W 17"H

With Right Arm Facing

COMFLRA1	\$3369	\$3369	\$3403	\$3457	\$3624	\$3727	\$3851	\$3939	\$4093	\$4306	\$3613	\$ 5059	\$ 5254
----------	--------	--------	--------	--------	--------	--------	--------	--------	--------	--------	--------	---------	---------

COM/yds = 3¼, COL/sq ft = 72

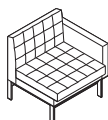

Overall: 30"D 29"W 31"H
Inside: 22"D 26½"W 17"H

► Specification Information, continued on next page

Millbrae Lifestyle/Contract Lounge Seating *continued*

DESIGN COALESSE DESIGN GROUP

► Specification Information, continued from previous page

Specification Information

Style Number	U.S. Base Prices														Leather Grades:		
	Fabric Grades:														COL	C	E
	COM	6	7	8	9	10	11	12	13	14							

Contract 2-Seat Lounges

Without Arms

COMFL2	\$5032	\$5039	\$5084	\$5158	\$5389	\$5534	\$5706	\$5826	\$6035	\$6330	\$5216	\$7075	\$7316
--------	--------	--------	--------	--------	--------	--------	--------	--------	--------	--------	--------	--------	--------

COM/yds = 4½, COL/sq ft = 99

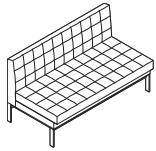

Overall: 30"D 52"W 31"H
Inside seat height: 22"D 17"H

With Arms

COMFLA2	\$5406	\$5474	\$5533	\$5628	\$5919	\$6110	\$6331	\$6481	\$6750	\$7128	\$5590	\$8301	\$8631
---------	--------	--------	--------	--------	--------	--------	--------	--------	--------	--------	--------	--------	--------

COM/yds = 5¾, COL/sq ft = 126

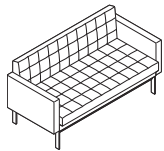

Overall: 30"D 58"W 31"H
Inside: 22"D 52½"W 17"H

With Left Arm Facing

COMFLLA2	\$5218	\$5248	\$5298	\$5382	\$5637	\$5799	\$5993	\$6126	\$6359	\$6688	\$5402	\$7675	\$7957
----------	--------	--------	--------	--------	--------	--------	--------	--------	--------	--------	--------	--------	--------

COM/yds = 5, COL/sq ft = 110

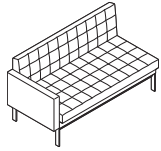

Overall: 30"D 55"W 31"H
Inside: 22"D 52¾"W 17"H

With Right Arm Facing

COMFLRA2	\$5218	\$5248	\$5298	\$5382	\$5637	\$5799	\$5993	\$6126	\$6359	\$6688	\$5402	\$7675	\$7957
----------	--------	--------	--------	--------	--------	--------	--------	--------	--------	--------	--------	--------	--------

COM/yds = 5, COL/sq ft = 110

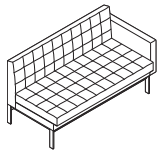

Overall: 30"D 55"W 31"H
Inside: 22"D 52¾"W 17"H

► Specification Information, continued on next page



For Canadian Pricing
Multiply U.S. Price by the
Canadian price factor.
► See page 1 for details.

Millbrae Lifestyle/Contract Lounge Seating

DESIGN COALESSE DESIGN GROUP

► Specification Information, continued from previous page

Specification Information

Style Number	U.S. Base Prices													
	Fabric Grades:													
	COM	6	7	8	9	10	11	12	13	14	Leather Grades:			
											COL	C	E	

Contract 3-Seat Lounges

Without Arms

COMFL3	\$6251	\$6333	\$6393	\$6493	\$6800	\$6995	\$7224	\$7383	\$7666	\$8058	\$6435	\$ 9146	\$ 9476
---------------	--------	--------	--------	--------	--------	--------	--------	--------	--------	--------	--------	---------	---------

COM/yds = 6, COL/sq ft = 132

With Arms

COMFLA3	\$6630	\$6789	\$6863	\$6990	\$7372	\$7616	\$7904	\$8102	\$8453	\$8945	\$6814	\$10,376	\$10,796
----------------	--------	--------	--------	--------	--------	--------	--------	--------	--------	--------	--------	----------	----------

COM/yds = 7½, COL/sq ft = 159

With Left Arm Facing

COMFLLA3	\$6441	\$6562	\$6629	\$6739	\$7085	\$7303	\$7564	\$7742	\$8061	\$8502	\$6625	\$ 9774	\$10,149
-----------------	--------	--------	--------	--------	--------	--------	--------	--------	--------	--------	--------	---------	----------

COM/yds = 6¾, COL/sq ft = 148

With Right Arm Facing

COMFLRA3	\$6441	\$6562	\$6629	\$6739	\$7085	\$7303	\$7564	\$7742	\$8061	\$8502	\$6625	\$ 9774	\$10,149
-----------------	--------	--------	--------	--------	--------	--------	--------	--------	--------	--------	--------	---------	----------

COM/yds = 6¾, COL/sq ft = 148

► Specification Information, continued on next page

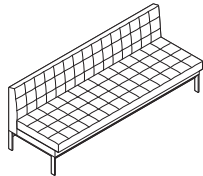

Overall: 30"D 78"W 31"H
Inside seat height: 22"D 17"H

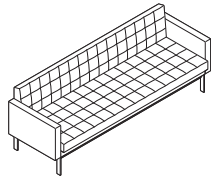

Overall: 30"D 84"W 31"H
Inside: 22"D 78½"W 17"H

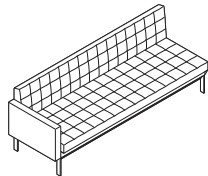

Overall: 30"D 81"W 31"H
Inside: 22"D 78¾"W 17"H

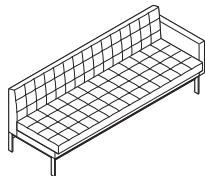

Overall: 30"D 81"W 31"H
Inside: 22"D 78¾"W 17"H



For Canadian Pricing
Multiply U.S. Price by the
Canadian price factor.
► See page 1 for details.

Millbrae Lifestyle/Contract Lounge Seating *continued*

DESIGN COALESSE DESIGN GROUP

► Specification Information, continued from previous page

Specification Information

Style Number	U.S. Base Prices											Leather Grades:		
	Fabric Grades:											COL	C	E
	COM	6	7	8	9	10	11	12	13	14				

Contract 4-Seat Lounges

Without Arms

COMFL4	\$6630	\$6803	\$6882	\$7007	\$7402	\$7659	\$7953	\$8157	\$8522	\$9031	\$6814	\$10,376	\$10,796
--------	--------	--------	--------	--------	--------	--------	--------	--------	--------	--------	--------	----------	----------

COM/yds = 7¾, COL/sq ft = 170

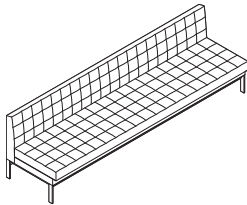

Overall: 30"D 104"W 31"H
Inside seat height: 22"D 17"H

With Arms

COMFLA4	\$7006	\$7230	\$7317	\$7463	\$7908	\$8196	\$8529	\$8760	\$9171	\$9745	\$7190	\$11,605	\$12,111
---------	--------	--------	--------	--------	--------	--------	--------	--------	--------	--------	--------	----------	----------

COM/yds = 8¾, COL/sq ft = 192

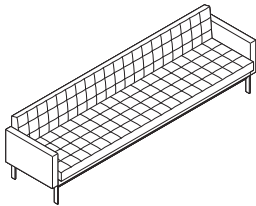

Overall: 30"D 110"W 31"H
Inside: 22"D 104½"W 17"H

With Left Arm Facing

COMFLLA4	\$6818	\$7018	\$7097	\$7235	\$7655	\$7924	\$8240	\$8459	\$8849	\$9389	\$7002	\$10,975	\$11,439
----------	--------	--------	--------	--------	--------	--------	--------	--------	--------	--------	--------	----------	----------

COM/yds = 8¼, COL/sq ft = 181

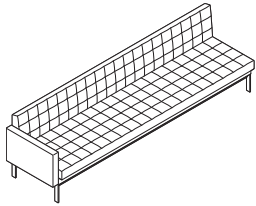

Overall: 30"D 107"W 31"H
Inside: 22"D 104¾"W 17"H

With Right Arm Facing

COMFLRA4	\$6818	\$7018	\$7097	\$7235	\$7655	\$7924	\$8240	\$8459	\$8849	\$9389	\$7002	\$10,975	\$11,439
----------	--------	--------	--------	--------	--------	--------	--------	--------	--------	--------	--------	----------	----------

COM/yds = 8¼, COL/sq ft = 181

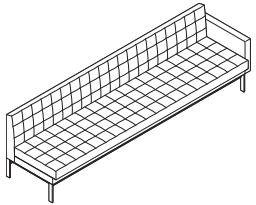

Overall: 30"D 107"W 31"H
Inside: 22"D 104¾"W 17"H

► Specification Information, continued on next page



For Canadian Pricing
Multiply U.S. Price by the Canadian price factor.
► See page 1 for details.

Millbrae Lifestyle/Contract Lounge Seating

DESIGN COALESSE DESIGN GROUP

► Specification Information, continued from previous page

Specification Information

Style Number	U.S. Base Prices														Leather Grades:		
	Fabric Grades:														COL	C	E
	COM	6	7	8	9	10	11	12	13	14							

Contract Lounge Benches

1-Seat Bench

COMFLB1	\$2540	\$2540	\$2555	\$2584	\$2673	\$2730	\$2797	\$2844	\$2928	\$3041	\$2857	\$3455	\$3560
---------	--------	--------	--------	--------	--------	--------	--------	--------	--------	--------	--------	--------	--------

COM/yds = 1³/₄, COL/sq ft = 39

2-Seat Bench

COMFLB2	\$3531	\$3531	\$3557	\$3606	\$3744	\$3835	\$3939	\$4012	\$4144	\$4324	\$3800	\$4810	\$4958
---------	--------	--------	--------	--------	--------	--------	--------	--------	--------	--------	--------	--------	--------

COM/yds = 2³/₄, COL/sq ft = 60

3-Seat Bench

COMFLB3	\$4122	\$4122	\$4156	\$4210	\$4377	\$4480	\$4604	\$4692	\$4846	\$5059	\$4366	\$5812	\$6007
---------	--------	--------	--------	--------	--------	--------	--------	--------	--------	--------	--------	--------	--------

COM/yds = 3³/₄, COL/sq ft = 72

4-Seat Bench

COMFLB4	\$4557	\$4564	\$4609	\$4683	\$4914	\$5059	\$5231	\$5351	\$5560	\$5855	\$4741	\$6600	\$6841
---------	--------	--------	--------	--------	--------	--------	--------	--------	--------	--------	--------	--------	--------

COM/yds = 4¹/₂, COL/sq ft = 93

Contract Lounge Round Arm Bolster

COMLPRND	\$ 458	\$ 437	\$ 445	\$ 457	\$ 495	\$ 518	\$ 548	\$ 566	\$ 603	\$ 652	\$ 807	\$ 835	\$ 882
----------	--------	--------	--------	--------	--------	--------	--------	--------	--------	--------	--------	--------	--------

COM/yds = ³/₄, COL/sq ft = 17

Contract Lounge Square Arm Bolster

COMLPSQR	\$ 458	\$ 449	\$ 459	\$ 476	\$ 528	\$ 559	\$ 597	\$ 625	\$ 673	\$ 738	\$ 807	\$ 964	\$1024
----------	--------	--------	--------	--------	--------	--------	--------	--------	--------	--------	--------	--------	--------

COM/yds = 1, COL/sq ft = 22

Contract Lounge Ganging Kit

COMF1	\$ 105	N.A.	N.A.	N.A.	N.A.	N.A.	N.A.	N.A.	N.A.	N.A.	N.A.	N.A.	N.A.
-------	--------	------	------	------	------	------	------	------	------	------	------	------	------

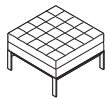

Overall: 26"D 26"W 16¹/₂"H

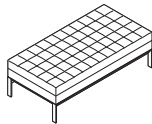

Overall: 26"D 52"W 16¹/₂"H

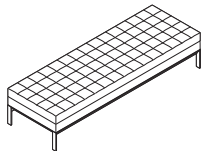

Overall: 26"D 78"W 16¹/₂"H

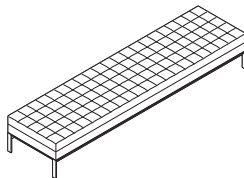

Overall: 26"D 104"W 16¹/₂"H



Overall: 18¹/₂"D 7"W 7"H



Overall: 18¹/₂"D 7"W 7"H

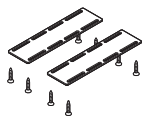

For Canadian Pricing
 Multiply U.S. Price by the
 Canadian price factor.
 ► See page 1 for details.

Millbrae Lifestyle/Contract Lounge Seating

Multi-Fabric Diagram

DESIGN COALESSE DESIGN

TO: _____

FROM: _____

DATE: _____

FAX....888.413.5161

A Seat, Back, and Arms: _____

B Back Cushion: _____

Lifestyle

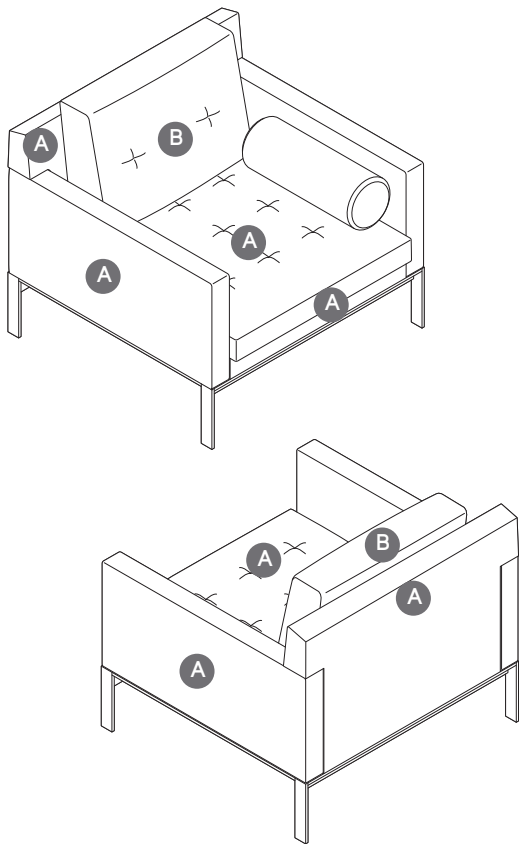

Tip: Arm bolsters must be specified separately.

Tip: Attachment straps are standard on back pillow of lifestyle chairs.

Contrasting upcharge for each contrasting textile pricing based on highest grade textile specified. See specifying for contrasting upcharge.

Millbrae Lifestyle/Contract Lounge Seating

Multi-Fabric Diagram

DESIGN COALESSE DESIGN

TO: _____

FROM: _____

DATE: _____

FAX...888.413.5161

Contract

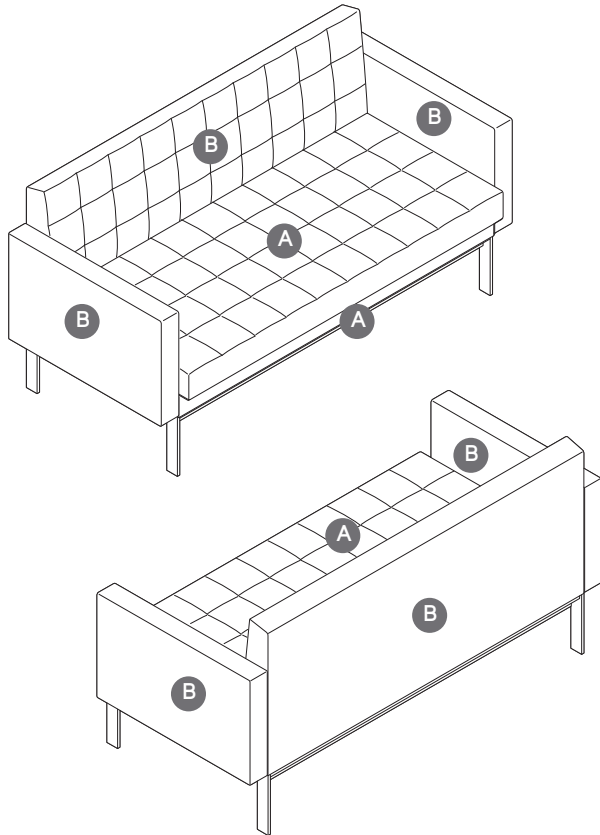

A Seat: _____

B Back and Arms: _____

Tip: Arm bolsters must be specified separately.

Contrasting upcharge for each contrasting textile pricing based on highest grade textile specified. See specifying for contrasting upcharge.

Montara650 Lounge Chair

DESIGN LIEVORE ALTHERR MOLINA

Montara650 lounge chair is infused with comfort and craft, with its refined upholstery and customizable details. This simple lounge solution brings warmth, materiality, and posture to in-between spaces.

Tip: This product line is a collection and will be found in multiple locations in this specification guide and/or Coalesse Tables, Storage, and Accessories Specification Guide.

► See *Collections*, page 5.

Shell is a durable, one-piece plywood with oak veneer and is offered fully upholstered, ³/₄ upholstered back, or upholstered seat.

Frame is standard in powder coat paint. Polished trivalent chrome is optional.

Glides are polyethylene for superior durability on carpeted and hard floors.

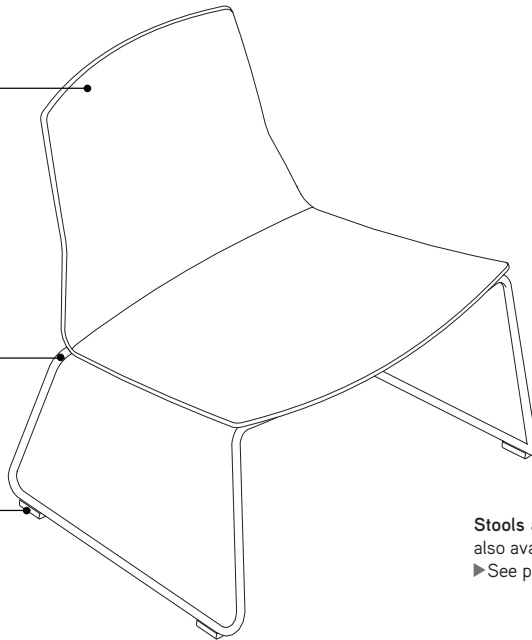

Stools and guest chairs are also available.
► See page 328 and 376

Product Details

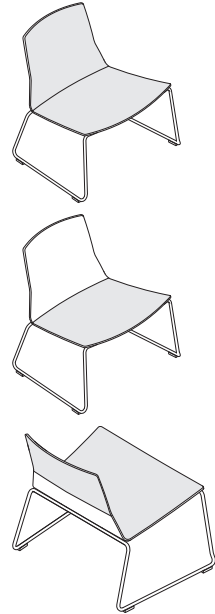

Upholstery choices include: fully upholstered, wood shell with upholstered seat, and wood shell with ³/₄ upholstered back.

Surface Materials

► See *Coalesse Surface Materials Reference Guide* for further information.

Wood shell

- Oak veneered plywood

Frame

- Paint
- Polished trivalent chrome

Upholstery

- Fabric
- Leather

Program and Services

Customer's Own Material/Leather (COM/COL) Program is available.

► See *Coalesse Surface Materials Reference Guide* for additional information.

Coalesse

Montara650 Lounge Chair

DESIGN LIEVORE ALTHERR MOLINA

Montara650 Lounge Chair

DESIGN LIEVORE ALTHERR MOLINA



Tip: Leathers will appear loose with comfort wrinkles when upholstered.

Tip: For Customer's Own Material or Leather, see necessary requirements, important processing instructions, and ordering information.
 ▶ See *Coalesse Surface Materials Reference Guide* and online fabric database at <http://fabric.coalesse.com>.

Standard Includes		Required to Specify
▶ Need help? Product details, page 172	<ul style="list-style-type: none"> • Seat and back upholstery, if selected • Shell: wood shell with 3/4 upholstery or wood shell with upholstered seat, if selected: wood veneer grade 1 • Sled base: Grade 1 paint • Glides 	<ol style="list-style-type: none"> 1 Style number 2 Upholstery version (see below under Required Selections) 3 Contrasting fabric on 3/4 upholstered or fully upholstered, if selected (see below under Required Selections) 4 Fabric and/or leather color number for seat and/or back, if selected 5 Wood finish on shell, if selected 6 Paint color number for base 7 Options, if selected (see below) ▶ See <i>Coalesse Surface Materials Reference Guide</i> .

Required Selections	U.S. Price	Required to Specify
Upholstery Version <ul style="list-style-type: none"> • Wood shell with 3/4 upholstery • Wood shell with upholstered seat • Fully upholstered 	Prices at right Prices at right Prices at right	Specify with 3/4 upholstered. Specify with upholstered seat and wood back. Specify with upholstered seat and back.
Contrasting Fabric on Fully Upholstered <ul style="list-style-type: none"> • Non contrasting fabric • Contrasting fabric 	No cost +\$182	Specify with non contrasting fabric. Specify with contrasting fabric. ▶ See <i>Multi Fabric Diagram</i> , page 180

Options	U.S. Price	Required to Specify
Surface Materials <p>Base</p> <ul style="list-style-type: none"> • Grade 3 paint • Polished trivalent chrome <p>Shell</p> <ul style="list-style-type: none"> • Grade 1 wood veneer • Grade 2 wood veneer <p>Acrylic backer</p> <ul style="list-style-type: none"> • Seat • Seat and back 	+\$105 +\$109 No cost +\$ 88 +\$ 9 +\$ 23	Specify paint color number. Specify with polished trivalent chrome. Specify with VP01 Oak Light, VP03 Black Oak, or VP05 White Oak. Specify with VP02 Smoked Oak or VP04 Grey Oak. Specify with acrylic backer. Specify with acrylic backer.
Related Products <ul style="list-style-type: none"> • Guest seating • Stools • Café tables • Occasional tables 		▶ Page 328 ▶ Page 376 ▶ See <i>Coalesse Tables, Storage, and Accessories Specification Guide</i> . ▶ See <i>Coalesse Tables, Storage, and Accessories Specification Guide</i> .



For Canadian Pricing
 Multiply U.S. Price by the Canadian price factor.
 ▶ See page 1 for details.

Montara650 Lounge Chair

DESIGN LIEVORE ALTHERR MOLINA



Overall: 25½"D x 29"W x 21¼"H
Seat: 16"

Overall: 25½"D x 29"W x 21¼"H
Seat: 16"

Overall: 25½"D x 29"W x 21¼"H
Seat: 16"

Specification Information

Style Number	U.S. Base Prices													
	Fabric Grades:													
	COM	6	7	8	9	10	11	12	13	14	Leather Grades:			
												COL	C	E

Wood Shell Lounge Chair with Upholstered Seat

COSFZLC	Seat	\$1279	\$1275	\$1283	\$1302	\$1356	\$1389	\$1430	\$1458	\$1507	\$1576	\$1578	\$1495	\$1552
---------	------	--------	--------	--------	--------	--------	--------	--------	--------	--------	--------	--------	--------	--------

COM/yds = 1, COL/sq ft = 9

Wood Shell Lounge Chair with ¾ Upholstered Back

COSFZLC	Seat	\$1417	\$1413	\$1421	\$1440	\$1494	\$1527	\$1568	\$1596	\$1645	\$1714	\$1716	\$1633	\$1690
	Back	+\$ 59	+\$ 41	+\$48	+\$ 61	+\$102	+\$129	+\$158	+\$180	+\$216	+\$266	+\$114	+\$547	+\$659

COM/yds = 1, COL/sq ft = 17

Fully Upholstered Lounge Chair

COSFZLC	Seat	\$1314	\$1310	\$1318	\$1337	\$1391	\$1424	\$1465	\$1493	\$1542	\$1611	\$1613	\$1530	\$1587
	Back	+\$ 59	+\$ 81	+\$ 97	+\$124	+\$204	+\$255	+\$315	+\$358	+\$432	+\$536	+\$114	+\$685	+\$826

COM/yds = 2½, COL/sq ft = 32



For Canadian Pricing
Multiply U.S. Price by the
Canadian price factor.
▶ See page 1 for details.

Montara650 Rocker

DESIGN LIEVORE ALTHERR MOLINA

Montara650 rocker is classically casual and is infused with comfort and craft. The rhythmic motion invites movement, supporting physical and emotion wellbeing at work.

Tip: This product line is a collection and will be found in multiple locations in this specification guide and/or Coalesse Tables, Storage, and Accessories Specification Guide.

► See Collections, page 5.

Shell is a durable, one-piece plywood with oak-veneer and is offered fully upholstered, ³/₄ upholstered back, or upholstered seat.

Frame is standard in powder coat paint. Polished trivalent chrome is optional.

Runners are solid oak with clear finish.

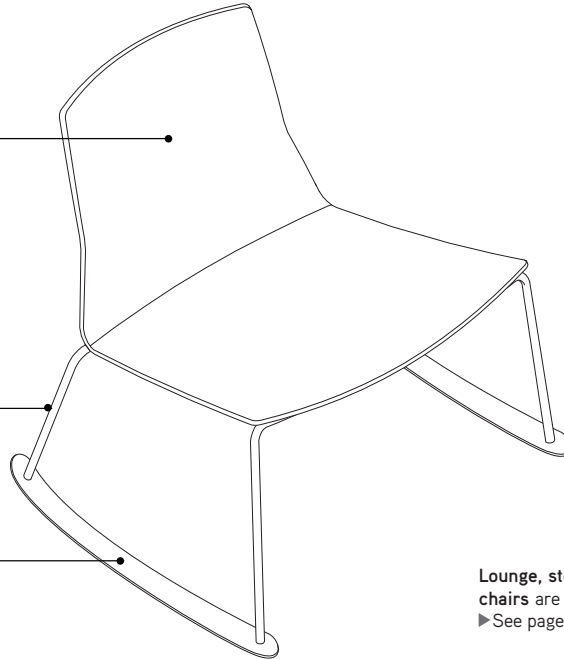

Lounge, stools, and guest chairs are also available.
► See pages 160, 328, and 376

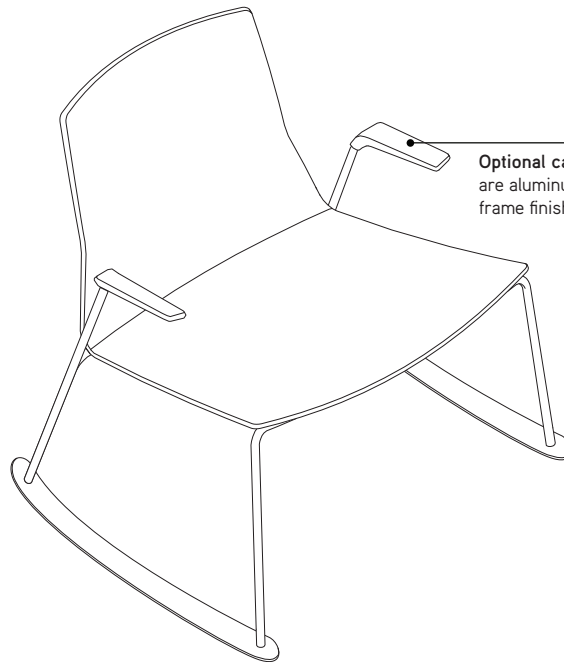

Optional cantilever arms are aluminum and will match frame finish.

Product Details

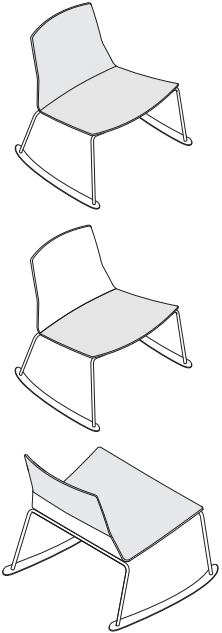

Upholstery choices include: fully upholstered, wood shell with upholstered seat, and wood shell with ³/₄ upholstered back.

Surface Materials

► See *Coalesse Surface Materials Reference Guide* for further information.

Wood shell

- Oak veneered plywood

Frame

- Paint
- Polished trivalent chrome

Upholstery

- Fabric
- Leather

Program and Services

Customer's Own Material/Leather (COM/COL) Program is available.

► See *Coalesse Surface Materials Reference Guide* for additional information.

Coalesse

Montara650 Rocker

DESIGN LIEVORE ALTHERR MOLINA

Montara650 Rocker

DESIGN LIEVORE ALTHERR MOLINA



Tip: Leathers will appear loose with comfort wrinkles when upholstered.

Tip: For Customer's Own Material or Leather, see necessary requirements, important processing instructions, and ordering information.
 ▶ See *Coalesse Surface Materials Reference Guide* and online fabric database at <http://fabric.coalesse.com>.



With arms

Standard Includes	Required to Specify
-------------------	---------------------

<ul style="list-style-type: none"> ▶ Need help? Product details, page 176 • Seat and back upholstery, if selected • Shell: wood shell with 3/4 upholstery or wood shell with upholstered seat, if selected: wood veneer grade 1 • Base: Grade 1 paint • Runners: solid oak in clear finish 	<ol style="list-style-type: none"> 1 Style number 2 Upholstery version (see below under Required Selections) 3 Contrasting fabric on 3/4 upholstered or fully upholstered, if selected (see below under Required Selections) 4 Fabric and/or leather color number for seat and/or back, if selected 5 Wood finish on shell, if selected 6 Paint color number for base 7 Options, if selected (see below) <p>▶ See <i>Coalesse Surface Materials Reference Guide</i>.</p>
---	---

Required Selections	U.S. Price	Required to Specify
---------------------	------------	---------------------

Upholstery Version <ul style="list-style-type: none"> • Wood shell with 3/4 upholstery • Wood shell with upholstered seat • Fully upholstered 	Prices at right Prices at right Prices at right	Specify with 3/4 upholstered. Specify with upholstered seat and wood back. Specify with upholstered seat and back.
Contrasting Fabric on 3/4 and Fully Upholstered <ul style="list-style-type: none"> • Non contrasting fabric • Contrasting fabric 	No cost +\$182	Specify with non contrasting fabric. Specify with contrasting fabric. ▶ See <i>Multi-Fabric Diagram</i> , page 180
Arm Type <ul style="list-style-type: none"> • Armless • With arms 	No cost +\$138	Specify with no arms. Specify with arms.

Options	U.S. Price	Required to Specify
---------	------------	---------------------

Surface Materials <ul style="list-style-type: none"> • Base, armless • Grade 3 paint • Polished trivalent chrome 	+\$105 +\$109	Specify paint color number. Specify with polished trivalent chrome.
<ul style="list-style-type: none"> • Base, with arms • Grade 3 paint • Polished trivalent chrome 	+\$105 +\$242	Specify paint color number. Specify with polished trivalent chrome.
<ul style="list-style-type: none"> • Wood shell • Grade 1 wood veneer • Grade 2 wood veneer 	No cost +\$ 88	Specify with VP01 Oak Light, VP03 Black Oak, or VP05 White Oak. Specify with VP02 Smoked Oak or VP04 Grey Oak.
<ul style="list-style-type: none"> • Acrylic backer • Seat • Seat and back 	+\$ 9 +\$ 23	Specify with acrylic backer. Specify with acrylic backer.

Related Products <ul style="list-style-type: none"> • Guest seating • Stools • Café tables • Occasional tables 	<ol style="list-style-type: none"> ▶ Page 328 ▶ Page 376 ▶ See <i>Coalesse Tables, Storage, and Accessories Specification Guide</i>. ▶ See <i>Coalesse Tables, Storage, and Accessories Specification Guide</i>.
---	--



For Canadian Pricing
 Multiply U.S. Price by the Canadian price factor.
 ▶ See page 1 for details.

Montara650 Rocker

DESIGN LIEVORE ALTHERR MOLINA



Overall: 29"D x 28½"W x 30"H
Seat: 16"

Overall: 29"D x 28½"W x 30"H
Seat: 16"

Overall: 29"D x 28½"W x 30"H
Seat: 16"

Specification Information

Style Number	U.S. Base Prices														
	Fabric Grades:													Leather Grades:	
	COM	6	7	8	9	10	11	12	13	14	COL	C	E		

Wood Shell Rocker with Upholstered Seat

COSFZRC	Seat	\$1955	\$1951	\$1959	\$1978	\$2032	\$2065	\$2106	\$2134	\$2183	\$2252	\$2254	\$2171	\$2228
---------	------	--------	--------	--------	--------	--------	--------	--------	--------	--------	--------	--------	--------	--------

COM/yds = 1, COL/sq ft = 9

Wood Shell Rocker with ¾ Upholstered Back

COSFZRC	Seat	\$2093	\$2089	\$2097	\$2116	\$2170	\$2203	\$2244	\$2272	\$2321	\$2390	\$2392	\$2309	\$2366
	Back	+\$ 59	+\$41	+\$ 48	+\$ 61	+\$102	+\$129	+\$158	+\$180	+\$216	+\$266	+\$114	+\$547	+\$659

COM/yds = 1, COL/sq ft = 17

Fully Upholstered Rocker

COSFZRC	Seat	\$1990	\$1986	\$1994	\$2013	\$2067	\$2100	\$2141	\$2169	\$2218	\$2287	\$2289	\$2206	\$2263
	Back	+\$ 59	+\$ 81	+\$ 97	+\$124	+\$204	+\$255	+\$315	+\$358	+\$432	+\$536	+\$114	+\$685	+\$826

COM/yds = 2½, COL/sq ft = 32



For Canadian Pricing
Multiply U.S. Price by the Canadian price factor.
► See page 1 for details.

Montara650 Lounge Chair and Rocker Multi-Fabric Diagram

DESIGN LIEVORE ALTHERR MOLINA

TO: _____

FROM: _____

DATE: _____

FAX...888.413.5161

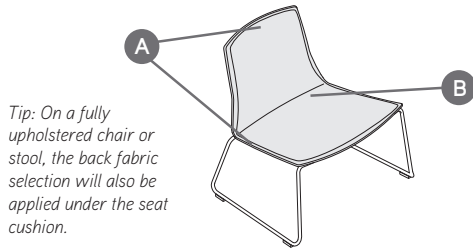

Fully Upholstered

A Back: _____

B Seat: _____

Contrasting upcharge for each contrasting textile pricing based on highest grade textile specified. See specifying for contrasting upcharge.

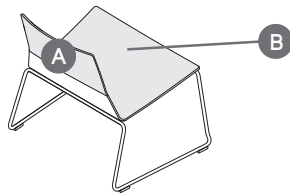

3/4 Upholstered

Specify Model below:

COSFZLC Montara650 Lounge Chair

COSFZRC Montara650 Rocker

Coalesse

Montara650 Lounge Chair and Rocker Multi-Fabric Diagram

DESIGN LIEVORE ALTHERR MOLINA

Passerelle Lounge Seating

DESIGN STUDIO B

Passerelle lounge seating is a rich tradition of fine craftsmanship. It is exemplified in a button-tufted, double needle stitch detail, while the defined edges of the internal frame allow for a tightly upholstered appearance.

Tip: This product line is a collection and will be found in multiple locations in this specification guide and/or Coalesse Tables, Storage, and Accessories Specification Guide.

► See *Collections*, page 5.

Benches with tufted button detail are available in three sizes.

Lounge seating is available in 1-, 2-, or 3-seat lounge. Arm bolsters are available with optional attachment straps.

4-leg base is standard in solid maple with non-adjustable glides.

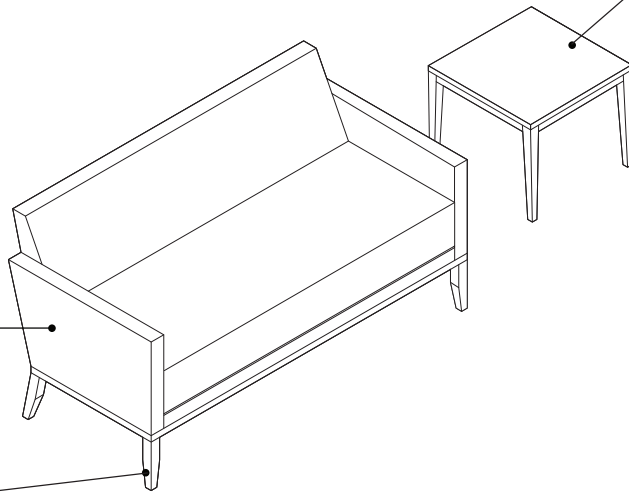

Occasional tables are available in three sizes. All have a veneer top and a solid maple frame. An optional interport power module is available.

► See *Coalesse Tables, Storage, and Accessories Specification Guide*.

Passerelle Lounge Seating

DESIGN STUDIO B

Product Details

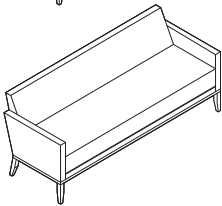
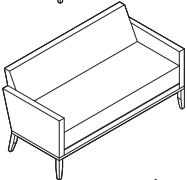
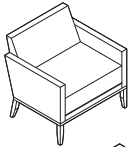

Lounge seating is available in 1-, 2-, and 3-seat with crisply tucked upholstery. 4-leg base is standard in solid maple, with 27 finishes available. Custom match wood finish option is also available on base.

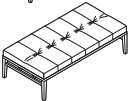
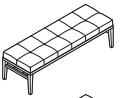

Benches are available in two sizes. The frame is constructed of solid maple. The upholstery is hand-tailored with a button-tufted, double needle stitched detail.



Arm bolster pillows are available with optional attachment rings.

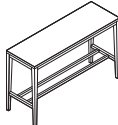
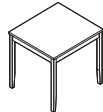
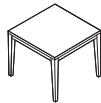

Occasional tables with solid hardwood frame are available with any Coalesse standard finish. Custom match wood finishes are also available. Veneer top is 1" thick with optional contrasting finish. ▶ See *Coalesse Tables, Storage, and Accessories Specification Guide*

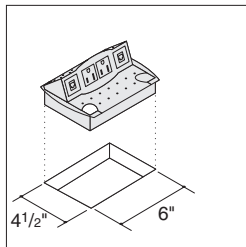

Interport power/data module is an available option for the 17"H table and the 21"H table, and is available for center location only.

Surface Materials

▶ See *Coalesse Surface Materials Reference Guide* for further information.

Upholstery

- Fabric
- Leather

Legs

- Maple solid wood

Programs and Services

Customer's Own Material/Leather (COM/COL) Program is available.

▶ See *Coalesse Surface Materials Reference Guide* for additional information.

Passerelle Lounge Seating

DESIGN STUDIO B

Tip: Fabrics and leathers will appear loose with comfort wrinkles when upholstered.

Tip: Recommended leathers are Elmosoft Grade C and Elmorustical Grade E.

Tip: Special color match, consult Customer Service.

Tip: For Customer's Own Material or Leather, see necessary requirements, important processing instructions, and ordering information
 ▶ See *Coalesse Surface Materials Reference Guide*.

Standard Includes	Required to Specify
▶ Need help? Product details, page 182	1 Style number 2 Number of fabrics if contrasting fabric style number is selected 3 Fabric or leather color number for upholstery on seat, back, and arms 4 Wood color number for legs 5 Options, if selected (see below) ▶ See <i>Coalesse Surface Materials Reference Guide</i> .

Options	U.S. Price	Required to Specify
Surface Materials <ul style="list-style-type: none"> Contrasting fabric 	+\$182 per fabric	Add suffix K to the style number and select fabric color number.
Acrylic backer <ul style="list-style-type: none"> Lounge chair 2-seat lounge 3-seat lounge Arm bolster 	+\$ 50 +\$ 70 +\$ 84 +\$ 10	Specify with acrylic backer. Specify with acrylic backer. Specify with acrylic backer. Specify with acrylic backer. ▶ See <i>Coalesse Surface Materials Reference Guide</i> .
Bolster/Pillow Attachment Rings <ul style="list-style-type: none"> Attachment rings on bolster pillow attach to lounge chair/lounge attachment straps 	+\$ 98	Specify with attachment rings.
Lounge Chair/Lounge Attachment Straps <ul style="list-style-type: none"> Attachment straps on lounge chair/lounge attach to bolster pillow attachment rings 	No cost	Specify with attachment straps for left and right sides.
Related Products <ul style="list-style-type: none"> Occasional tables 		▶ See <i>Coalesse Tables, Storage, and Accessories Specification Guide</i> .

Specification Information													
Style Number	U.S. Base Prices											Leather Grades:	
	Fabric Grades:											COL	C
COM	6	7	8	9	10	11	12	13	14				

Lounge Chair

440-WB	\$2465	\$2497	\$2555	\$2614	\$2721	\$2823	\$3086	\$3270	\$3323	\$3660	\$2749	\$5887	\$6422
--------	--------	--------	--------	--------	--------	--------	--------	--------	--------	--------	--------	--------	--------

COM/yds = 4, COL/sq ft = 88

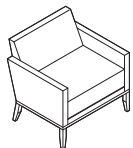

Overall: 27"D 30½"W 29"H
 Inside: 19"D 26"W 17"H
 Seat: 17½"H
 Arm: 23"H

2-Seat Lounge

440-2WB	\$4418	\$4537	\$4639	\$4706	\$4861	\$4983	\$5354	\$5621	\$5668	\$6280	\$4710	\$9072	\$9663
---------	--------	--------	--------	--------	--------	--------	--------	--------	--------	--------	--------	--------	--------

COM/yds = 5½, COL/sq ft = 121

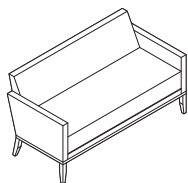

Overall: 27"D 56½"W 29"H
 Inside: 19"D 52"W 17"H
 Seat: 17½"H
 Arm: 23"H

▶ Specification Information, continued on next page



For Canadian Pricing
 Multiply U.S. Price by the Canadian price factor.
 ▶ See page 1 for details.

Passerelle Lounge Seating

DESIGN STUDIO B

► Specification Information, continued from previous page

Specification Information

Style Number	U.S. Base Prices											Leather Grades:		
	Fabric Grades:											COL	C	E
	COM	6	7	8	9	10	11	12	13	14				

3-Seat Lounge

440-3WB	\$4933	\$5129	\$5251	\$5333	\$5528	\$5678	\$6147	\$6442	\$6528	\$7223	\$5217	\$10,630	\$11,274
---------	--------	--------	--------	--------	--------	--------	--------	--------	--------	--------	--------	----------	----------

COM/yds = 6¾, COL/sq ft = 149

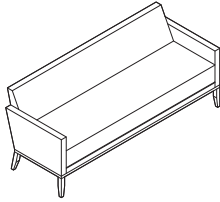

Overall: 27"D 72¾"W 29"H
 Inside: 19"D 68"W 17"H
 Seat: 17½"H
 Arm: 23"H



Overall: 17½"W 5¾"Dia

Arm Bolster

440-B	\$ 421	\$ 428	\$ 438	\$ 459	\$ 506	\$ 581	\$ 638	\$ 652	\$ 677	\$ 703	\$ 847	\$ 1286	\$ 1722
-------	--------	--------	--------	--------	--------	--------	--------	--------	--------	--------	--------	---------	---------

COM/yds = 1, COL/sq ft = 18

Lounge Seating

 **For Canadian Pricing**
 Multiply U.S. Price by the
 Canadian price factor.
 ► See page 1 for details.

Passerelle Lounge Seating Benches

DESIGN STUDIO B

Tip: Fabrics and leathers will appear loose with comfort wrinkles when upholstered.

Tip: For plain upholstery option or contrasting textiles, contact Customer Service.

Tip: Recommended leathers are Elmosoft Grade C and Elmorustical Grade E.

Tip: Special color match, consult Customer Service.

Tip: For Customer's Own Material or Leather, see necessary requirements, important processing instructions, and ordering information
 ▶ See *Coalesse Surface Materials Reference Guide*.

Standard Includes		Required to Specify
▶ Need help? Product details, page 183	<ul style="list-style-type: none"> • Frame: solid maple • Upholstery: multiple densities of polyurethane foam • Legs: solid maple with non-adjustable glides • Button detail: tufted and double needled 	1 Style number 2 Fabric or leather color number for upholstery on bench 3 Wood color number for legs 4 Options, if selected (see below) ▶ See <i>Coalesse Surface Materials Reference Guide</i> .

Options	U.S. Price	Required to Specify
Surface Materials Acrylic backer • 20"D x 60"W bench • 30"D x 60"W bench	+\$39 +\$55	Specify with acrylic backer. Specify with acrylic backer. ▶ See <i>Coalesse Surface Materials Reference Guide</i> .
Related Products • Occasional tables		▶ See <i>Coalesse Tables, Storage, and Accessories Specification Guide</i> .

Specification Information													
Style Number	U.S. Base Prices											Leather Grades:	
	Fabric Grades:											COL	C
	COM	6	7	8	9	10	11	12	13	14			

Bench													
440-B3060WB	\$3009	\$3026	\$3109	\$3154	\$3265	\$3347	\$3547	\$3718	\$3789	\$4195	\$3318	\$6476	\$7044
COM/yds = 4, COL/sq ft = 88													

440-B2060WB	\$2621	\$2633	\$2695	\$2718	\$2795	\$2873	\$2974	\$3112	\$3168	\$3526	\$2998	\$5158	\$5553
COM/yds = 2¾, COL/sq ft = 61													

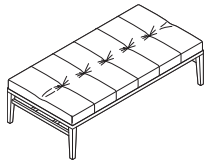

Overall: 30"D 60"W 17"H

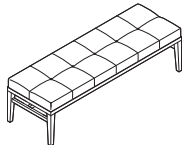

Overall: 20"D 60"W 17"H

 **For Canadian Pricing**
 Multiply U.S. Price by the Canadian price factor.
 ▶ See page 1 for details.

Passerelle Lounge Seating Multi-Fabric Diagram

DESIGN STUDIO B

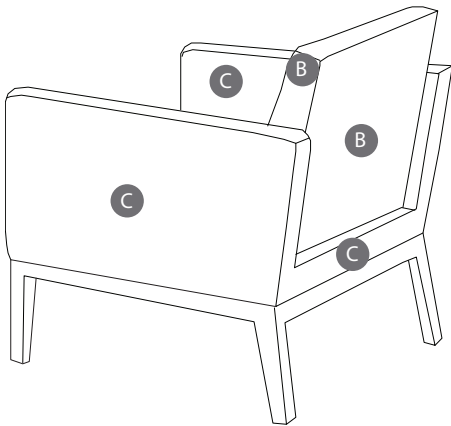
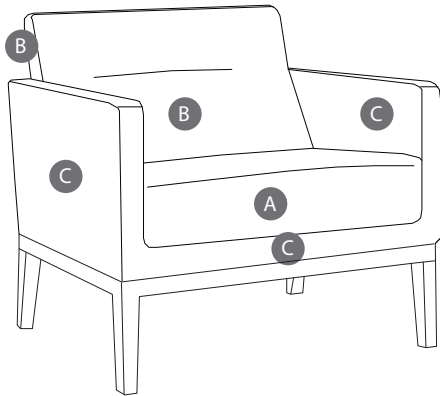

Model 440-WBK Shown Above

TO: _____

FROM: _____

DATE: _____

FAX...888.413.5161

A Upholstery Selection (default for entire unit if B is not selected):

B Back: _____

C Arms: _____

Total list price upcharge for contrasting fabrics: \$ _____

*See specifying for contrasting fabric upcharge.
List price based on highest fabric grade usage.*

Specify Model below:

440-WBK Passerelle Lounge Chair

440-2WBK Passerelle 2-Seat Lounge

440-3WBK Passerelle 3-Seat Lounge

Ripple Benches

DESIGN LAURINDA SPEAR, FAIA

Ripple benches are sculptured and fully upholstered in two orientations for flat or wave seating.

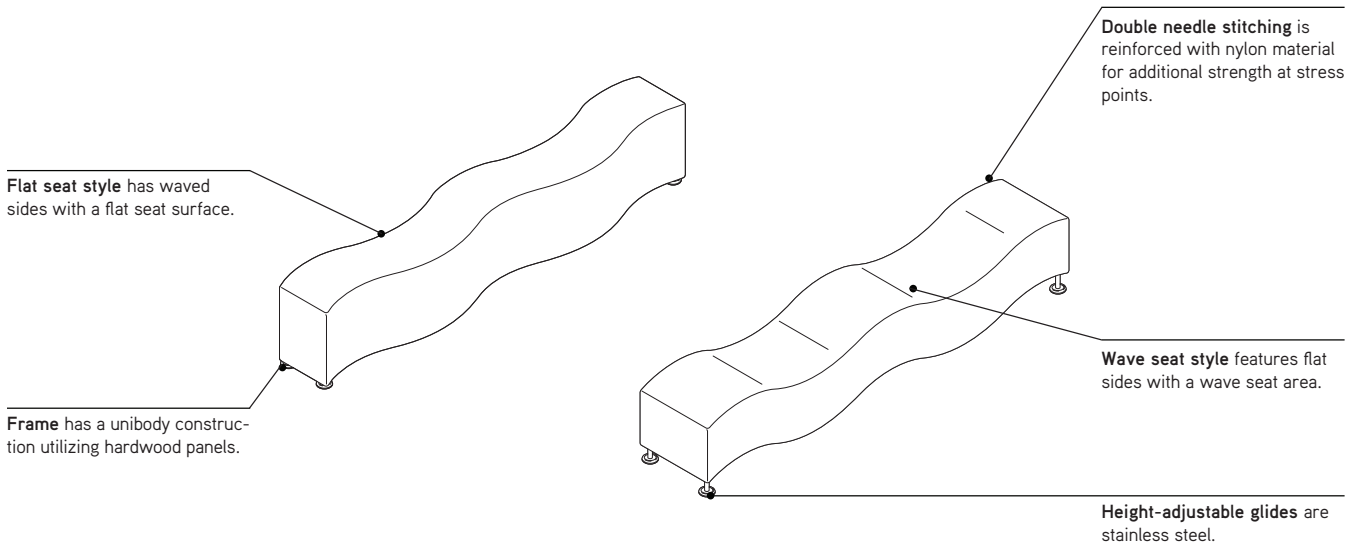

Ripple Benches

DESIGN LAURINDA SPEAR, FAIA

Product Details

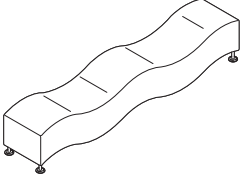
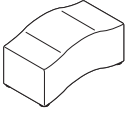

Wave seat is available in two sizes. The 1-seat is 35¾"W and the 3-seat is 96"W. Both are fully upholstered with a top stitch detail. The bottom of the seats are covered with cambric. Ganging device is available for end-to-end runs.

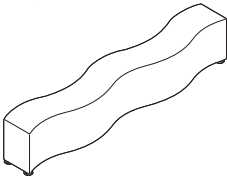
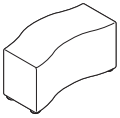

Flat seat is available in two sizes. The 1-seat is 35½"W and the 3-seat is 96"W. Both are fully upholstered with a top stitch detail. The bottom of the seats are covered with cambric. Ganging device is available for end-to-end runs.

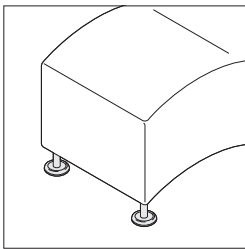

Height-adjustable glides are stainless steel.

Surface Materials

▶ See *Coalesse Surface Materials Reference Guide* for further information.

Upholstery (contrasting fabric available)

- Fabric
- Leather

Programs and Services

Customer's Own Material/Leather (COM/COL) Program is available.

▶ See *Coalesse Surface Materials Reference Guide* for additional information.

Ripple Benches

DESIGN LAURINDA SPEAR, FAIA

Tip: Fabrics and leathers will appear loose with comfort wrinkles when upholstered.

Tip: Pricing based on highest grade textile specified.

Tip: Due to the design and construction techniques of Ripple lounge, only certain textiles can be successfully applied, therefore COM fabrics must be submitted to Coalesse for approval prior to order acceptance. Solid patterns with no repeat are recommended.

Tip: Recommended leathers are Elmosoft Grade C and Elmorustical Grade E.

Tip: Special color match, consult Customer Service.

Tip: For Customer's Own Material or Leather, see necessary requirements, important processing instructions, and ordering information
 ► See Coalesse Surface Materials Reference Guide.

Tip: 35" is a single seat and 96" is a 3-seat lounge.

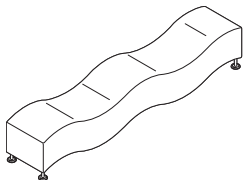

Overall: 19¼"D 97"W 19¼"H
 Dip: 14"H

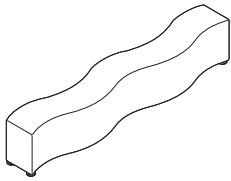

Overall: 19¼"D 97"W 19¼"H
 Seat Surface: 19"H

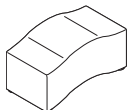

Overall: 19"D 35¾"W 19¼"H



For Canadian Pricing
 Multiply U.S. Price by the Canadian price factor.
 ► See page 1 for details.

Standard Includes		Required to Specify
► Need help? Product details, page 188	<ul style="list-style-type: none"> Frame: unibody construction with finger jointed plywood Upholstery: multiple densities of laminated polyurethane foam Glides: height adjustable with stainless steel finish leveling polyurethane glides Double needle stitch seams 	1 Style number 2 Number of fabrics if contrasting fabric style number is selected 3 Fabric or leather color number for upholstery on bench 4 Options, if selected (see below) ► See Coalesse Surface Materials Reference Guide.

Options	U.S. Price	Required to Specify
Surface Materials <ul style="list-style-type: none"> Contrasting fabric 	+\$182 per fabric	Add suffix K to the style number and select fabric color number.
Acrylic backer <ul style="list-style-type: none"> Wave and flat seats Little Ripple wave and flat seats 	+\$105 +\$ 47	Specify with acrylic backer. Specify with acrylic backer. ► See Coalesse Surface Materials Reference Guide.

Style Number	U.S. Base Prices														Leather Grades:		
	Fabric Grades:														COL	C	E
	COM	6	7	8	9	10	11	12	13	14							

Upholstered Wave Seat

490-B96VRT	\$3154	\$3313	\$3387	\$3514	\$3896	\$4140	\$4428	\$4626	\$4977	\$5469	\$3416	\$8144	\$8995
------------	--------	--------	--------	--------	--------	--------	--------	--------	--------	--------	--------	--------	--------

COM/yds = 7½, COL/sq ft = 143

Upholstered Flat Seat

490-B96HRZ	\$3154	\$3313	\$3387	\$3514	\$3896	\$4140	\$4428	\$4626	\$4977	\$5469	\$3416	\$8144	\$8995
------------	--------	--------	--------	--------	--------	--------	--------	--------	--------	--------	--------	--------	--------

COM/yds = 7½, COL/sq ft = 143

Little Ripple Wave Seat

490-B35VRT	\$1328	\$1328	\$1351	\$1388	\$1502	\$1576	\$1663	\$1723	\$1831	\$1977	\$1689	\$3273	\$3562
------------	--------	--------	--------	--------	--------	--------	--------	--------	--------	--------	--------	--------	--------

COM/yds = 2¼, COL/sq ft = 50

► Specification Information, continued on next page

Ripple Benches

DESIGN LAURINDA SPEAR, FAIA

► Specification Information, continued from previous page

Specification Information

Style Number	U.S. Base Prices											Leather Grades:		
	Fabric Grades:											COL	C	E
	COM	6	7	8	9	10	11	12	13	14				

Little Ripple Flat Seat

490-B35HRZ	\$1328	\$1328	\$1351	\$1388	\$1502	\$1576	\$1663	\$1723	\$1831	\$1977	\$1689	\$3273	\$3562
------------	--------	--------	--------	--------	--------	--------	--------	--------	--------	--------	--------	--------	--------

COM/yds = 2¼, COL/sq ft = 50

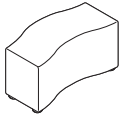

Overall: 19"D 35½"W 19"H



For Canadian Pricing
 Multiply U.S. Price by the
 Canadian price factor.
 ► See page 1 for details.

Ripple Benches Multi-Fabric Diagram

DESIGN LAURINDA SPEAR, FAIA

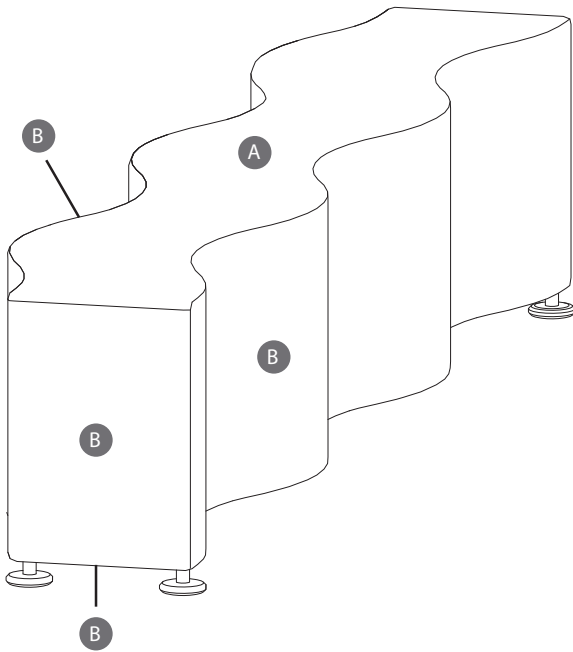

Model 490-B96HRZK Shown Above

TO: _____

FROM: _____

DATE: _____

FAX....888.413.5161

A Upholstery Selection (default for entire unit if B is not selected):

B Side, Bottom, and End: _____

Total list price upcharge for contrasting fabrics: \$ _____

*See specifying for contrasting fabric upcharge.
List price based on highest fabric grade usage.*

Specify Model below:

- 490-B96VRTK Ripple Upholstered Wave Seat
- 490-B96HRZK Ripple Upholstered Flat Seat
- 490-B35VRTK Ripple Little Ripple Wave Seat
- 490-B35HRZK Ripple Little Ripple Flat Seat

Coalesse

Ripple Benches Multi-Fabric Diagram

DESIGN LAURINDA SPEAR, FAIA

Sidewalk Lounge Seating

DESIGN STUDIO B

Sidewalk lounge seating is a crisp, lightly scaled, and portable collection for comfort and mobility, allowing a workspace to become a social space.

Upholstery is hand-tailored, featuring a horizontally tucked upholstery detail and double needle topstitched seams.

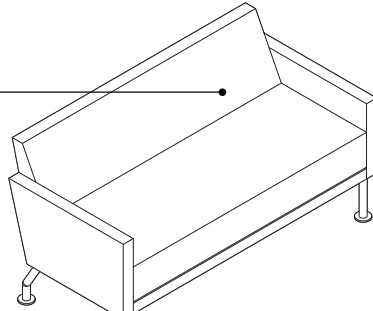

Frame is a unibody construction with finger jointed plywood.

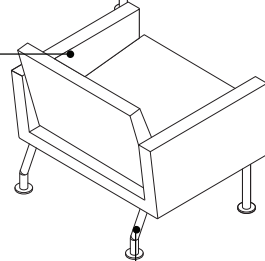

4-leg steel base is standard in powder coat paint with easy gliding "go" glides.

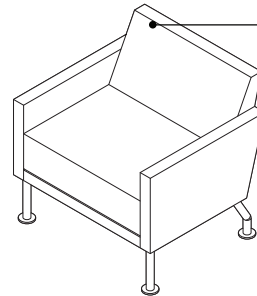

Lounge chairs are available in a low back (shown here), or a high back.

Sidewalk Lounge Seating

DESIGN STUDIO B

Product Details

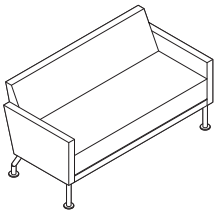
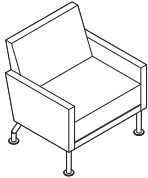
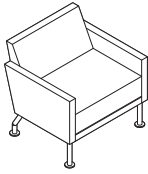

Lounge seating is available in three styles: low-back chair, high-back chair, and a 2-seat lounge. Seat height from floor is 17½"H.

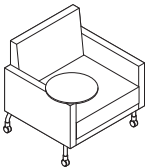
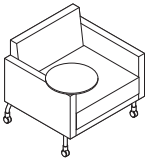

Mobile lounge seating is available in a low back or high back with casters and a pivoting table arm. Extra tablet pivoter and cupholder available.

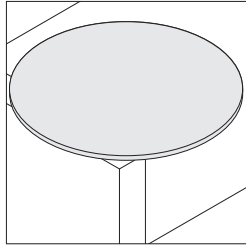

Tablet is 13½" and is standard in laminate. Extra tablet pivoter is available, allowing tablet to be moved side to side.

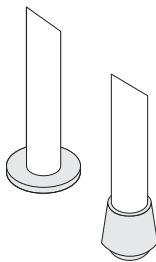

"Go" glides are standard. "No go" glides are optional.

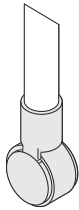

Casters on mobile model are dual-wheel, swivel, and non-locking. Locking casters are optional.



Arm bolster in coordinating fabric is available (5½"D x 17½"H).

Surface Materials

► See *Coalesse Surface Materials Reference Guide* for further information.

Upholstery

- Fabric
- Leather

Base

- Paint

Tablet

- Laminate

Programs and Services

Customer's Own Material/Leather (COM/COL) Program is available.

► See *Coalesse Surface Materials Reference Guide* for additional information.

Sidewalk Lounge Seating

DESIGN STUDIO B

Tip: Fabrics and leathers will appear loose with comfort wrinkles when upholstered.

Tip: Recommended leathers are Elmosoft Grade C and Elmorustical Grade E.

Tip: Special color match, consult Customer Service.

Tip: For multi-fabric diagram, refer to page 198.

Tip: Specify tablet from facing position.

Tip: Cup holder must be specified with tablet.

Tip: For Customer's Own Material or Leather, see necessary requirements, important processing instructions, and ordering information
 ▶ See *Coalesse Surface Materials Reference Guide*.

Tip: Extra pivoter allows tablet to be moved side to side.

Tip: Tablet can be installed on mobile models only.

	Standard Includes	Required to Specify
▶ Need help? Product details, page 194	<ul style="list-style-type: none"> • Frame: unibody construction with finger jointed plywood • Upholstery: multiple densities of polyurethane foam and polyester fiber on seat, back, and arms. • Lounge: <ul style="list-style-type: none"> - Legs: 4799 Platinum Metallic powder coat steel legs with "go" glides • Mobile: <ul style="list-style-type: none"> - 13½" diameter tablet: laminate - Legs: 4799 Platinum Metallic powder coat steel legs with casters - Casters: four non-locking 	<ol style="list-style-type: none"> 1 Style number 2 Number of fabrics if contrasting fabric style number is selected 3 Fabric or leather color number for upholstery on seat, back, and arms 4 Options, if selected (see below) ▶ See <i>Coalesse Surface Materials Reference Guide</i> .

	Options	U.S. Price	Required to Specify
Surface Materials	<ul style="list-style-type: none"> • Contrasting fabric <hr/> Acrylic backer <ul style="list-style-type: none"> • Lounge chair • Lounge 2-seat chair • Arm bolster 	+\$182 per fabric +\$ 55 +\$ 77 +\$ 10	Add suffix K to the style number and select fabric color number. Specify with <i>acrylic backer</i> . Specify with <i>acrylic backer</i> . Specify with <i>acrylic backer</i> . ▶ See <i>Coalesse Surface Materials Reference Guide</i> .
Cup Holder	<ul style="list-style-type: none"> • Cup holder 	+\$ 77	Specify with <i>cup holder</i> .
Tablet Side Storage	<ul style="list-style-type: none"> • Tablet side storage 	+\$114	Specify with <i>tablet side storage</i> and select left- or right-facing.
Extra Pivoter	<ul style="list-style-type: none"> • Extra pivoter 	+\$267	Specify with <i>extra pivoter</i> .
Omit Tablet	<ul style="list-style-type: none"> • Omit tablet 	-\$233	Specify with <i>omit tablet</i> .
Glides	Lounge <ul style="list-style-type: none"> • "No go" ½" polyethylene glide <hr/> Mobile <ul style="list-style-type: none"> • Go glides 	No cost	Specify with <i>"no go" glides</i> .
Casters	<ul style="list-style-type: none"> • Locking casters 	No cost	Specify with <i>locking casters</i> .
Related Products	<ul style="list-style-type: none"> • Ottoman/benches • Occasional tables 		▶ See page 204 ▶ See <i>Coalesse Tables, Storage, and Accessories Specification Guide</i> .

Specification Information													
Style Number	U.S. Base Prices												
	Fabric Grades:												
	COM	6	7	8	9	10	11	12	13	14	Leather Grades:		
											COL	C	E

Low-Back Lounge Chair

444	\$2356	\$2356	\$2394	\$2463	\$2667	\$2797	\$2949	\$3057	\$3240	\$3507	\$2646	\$5677	\$6177
-----	--------	--------	--------	--------	--------	--------	--------	--------	--------	--------	--------	--------	--------

COM/yds = 4, COL/sq ft = 88

▶ Specification Information, continued on next page

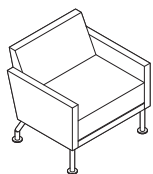

Overall: 27"D 30½"W 29"H
 Inside: 19"D 26"W 17"H
 Seat: 17½"H
 Arm: 23"H



For Canadian Pricing
 Multiply U.S. Price by the Canadian price factor.
 ▶ See page 1 for details.

Sidewalk Lounge Seating

DESIGN STUDIO B

► Specification Information, continued from previous page

Specification Information

Style Number	U.S. Base Prices													
	Fabric Grades:													
	COM	6	7	8	9	10	11	12	13	14	Leather Grades:			
											COL	C	E	

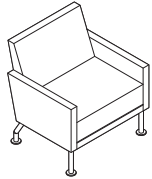

Overall: 27"D 30½"W 32"H
 Inside: 19"D 26"W 20"H
 Seat: 17½"H
 Arm: 23"H

High-Back Lounge Chair

446	\$2598	\$2605	\$2650	\$2724	\$2955	\$3100	\$3272	\$3392	\$3601	\$3896	\$2882	\$6122	\$6625
-----	--------	--------	--------	--------	--------	--------	--------	--------	--------	--------	--------	--------	--------

COM/yds = 4½, COL/sq ft = 99

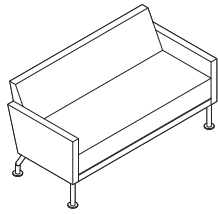

Overall: 27"D 56½"W 29"H
 Inside: 19"D 52"W 17"H
 Seat: 17½"H
 Arm: 23"H

2-Seat Lounge

444-2	\$3670	\$3727	\$3784	\$3873	\$4154	\$4334	\$4544	\$4691	\$4948	\$5308	\$3954	\$8152	\$8714
-------	--------	--------	--------	--------	--------	--------	--------	--------	--------	--------	--------	--------	--------

COM/yds = 5½, COL/sq ft = 121

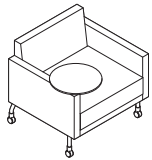

Overall: 27"D 30½"W 29"H
 Inside: 19"D 26"W 17"H
 Seat: 17½"H
 Arm: 22½"H

Low-Back, Mobile Lounge Chair with Tablet

444M	\$3201	\$3201	\$3239	\$3308	\$3512	\$3642	\$3794	\$3902	\$4085	\$4352	\$3483	\$6515	\$7075
------	--------	--------	--------	--------	--------	--------	--------	--------	--------	--------	--------	--------	--------

COM/yds = 4, COL/sq ft = 88

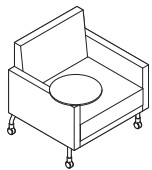

Overall: 27"D 30½"W 32"H
 Inside: 19"D 26"W 20"H
 Seat: 17½"H
 Arm: 22½"H

High-Back, Mobile Lounge Chair with Tablet

446M	\$3449	\$3456	\$3501	\$3575	\$3806	\$3951	\$4123	\$4243	\$4452	\$4747	\$3719	\$7140	\$7757
------	--------	--------	--------	--------	--------	--------	--------	--------	--------	--------	--------	--------	--------

COM/yds = 4½, COL/sq ft = 99



Overall: 17½"H 5¾" Dia

Arm Bolster

440-B	\$ 421	\$ 428	\$ 438	\$ 459	\$ 506	\$ 581	\$ 638	\$ 652	\$ 677	\$ 703	\$ 847	\$1286	\$1722
-------	--------	--------	--------	--------	--------	--------	--------	--------	--------	--------	--------	--------	--------

COM/yds = 1, COL/sq ft = 18



For Canadian Pricing
 Multiply U.S. Price by the
 Canadian price factor.
 ► See page 1 for details.

Sidewalk Lounge Seating Multi-Fabric Diagram

DESIGN STUDIO B

TO: _____

FROM: _____

DATE: _____

FAX....888.413.5161

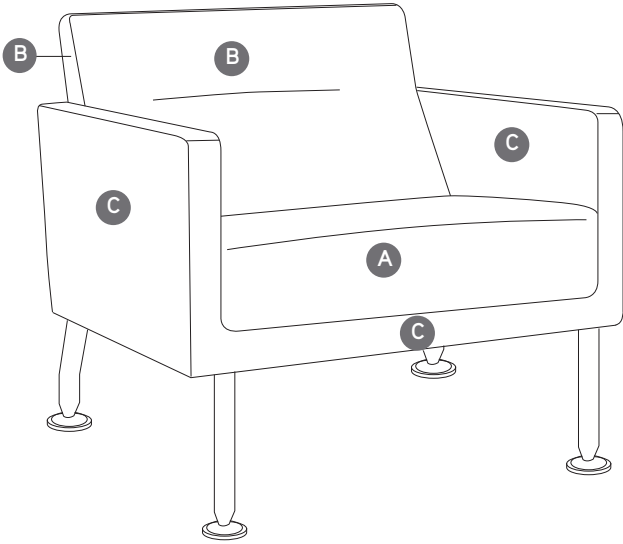

A Upholstery Selection (default for entire unit if B is not selected):

B Back: _____

C Arms: _____

Total list price upcharge for contrasting fabrics: \$ _____

*See specifying for contrasting fabric upcharge.
List price based on highest fabric grade usage.*

Specify Model below:

444K Sidewalk Low-Back Lounge Chair or Mobile Lounge Chair

446K Sidewalk High-Back Lounge Chair or Mobile Lounge Chair

444-2K Sidewalk 2-Seat Lounge

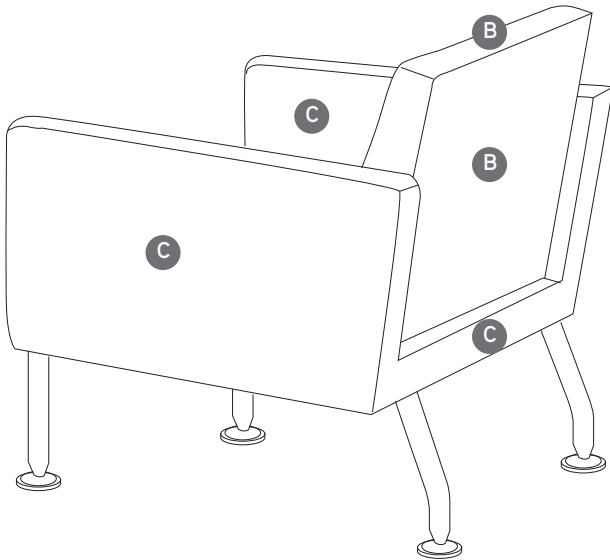

Coalesse

Sidewalk Lounge Seating Multi-Fabric Diagram

DESIGN STUDIO B

Sidewalk Lounge Seating Collaborative

DESIGN STUDIO B

Sidewalk collaborative lounge was designed with engagement, comfort, and mobility in mind. Armless chairs encourage collaboration and easy gliding "go" glides allow for ease of movement.

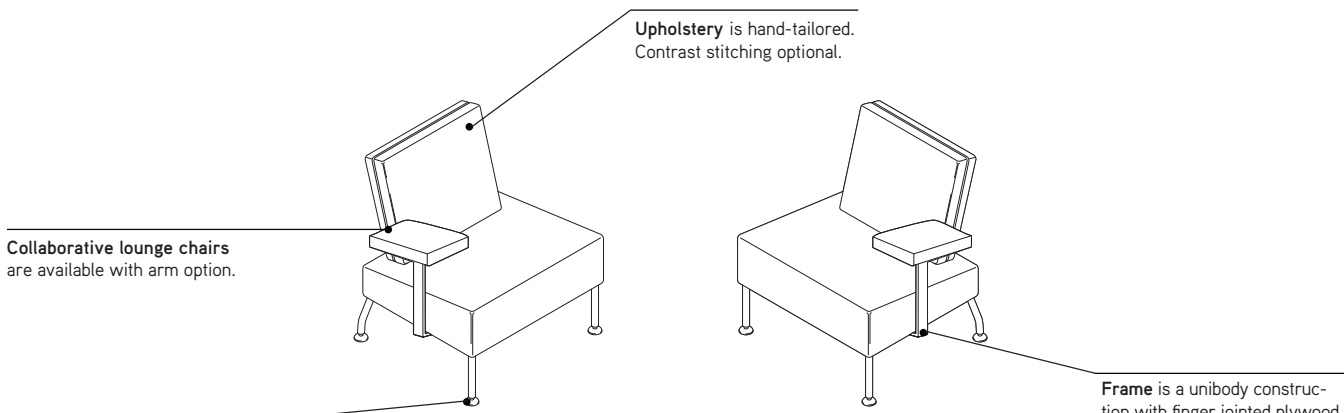

Upholstery is hand-tailored. Contrast stitching optional.

Collaborative lounge chairs are available with arm option.

4-leg steel base is standard in powder coat paint with easy gliding "go" glides.

Frame is a unibody construction with finger jointed plywood.

Sidewalk Lounge Seating Collaborative

DESIGN STUDIO B

Product Details

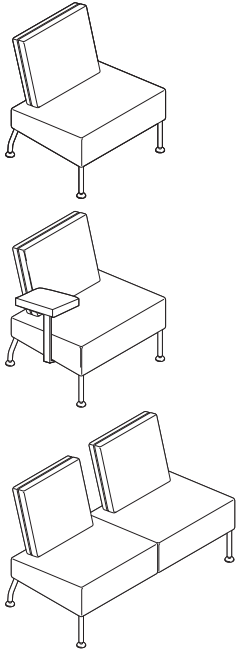

Collaborative lounge seating is available in three styles: an armless chair, chair with arm option, and a 2-seat lounge. Seat height from floor is 17"H. All styles feature double needle, topstitched seams; and easy gliding "go" glides.

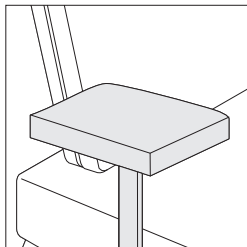

Arm option detail is available on collaborative lounge chair.

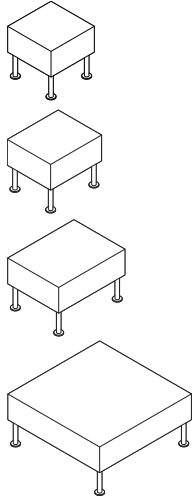

Ottomans are available in four sizes: 17"D x 17"W x 17"H, 17"D x 20"W x 17"H, 20"D x 26"W x 17"H, and 36"D x 36"W x 17"H. All ottomans are visually compatible with all other pieces in the Sidewalk collection.

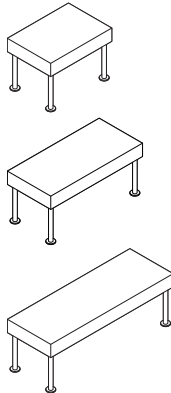

Benches are available in three sizes: 17"D x 24"W x 17"H, 17"D x 36"W x 17"H, and 17"D x 48"W x 17"H. All benches are visually compatible with all other pieces in the Sidewalk collection.

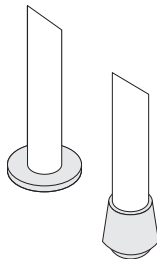

"Go" glides are standard. "No go" glides are optional.

Surface Materials

► See *Coalesse Surface Materials Reference Guide* for further information.

Upholstery

- Fabric
- Leather

Base

- Paint

Programs and Services

Customer's Own Material/Leather (COM/COL) Program is available.

► See *Coalesse Surface Materials Reference Guide* for additional information.

Sidewalk Lounge Seating Collaborative

DESIGN STUDIO B

Tip: Fabrics and leathers will appear loose with comfort wrinkles when upholstered.

Tip: Recommended leathers are Elmosoft Grade C and Elmorustical Grade E.

Tip: Special color match, consult Customer Service.

Tip: For Customer's Own Material or Leather, see necessary requirements, important processing instructions, and ordering information
 ▶ See *Coalesse Surface Materials Reference Guide*.

Tip: When specifying style 430 with arms, both arms must match.

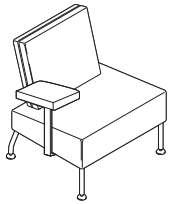

Tip: Overall width dimensions with arm options: 430: 35"W 430-2: 49"W. Overall inside width dimensions with arm options: 430: 19½"W 430-2: 49"W
 ▶ See *Sidewalk multi-fabric diagram on page 205*.

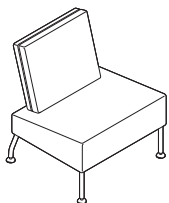

Overall: 27"D 27"W 30½"H
Inside: 17"D 27"W 18"H
Seat: 17"H
Arm: 21"H

Standard Includes		Required to Specify	
▶ Need help? Product details, page 200	<ul style="list-style-type: none"> Frame: unibody construction with finger jointed plywood Upholstery: multiple densities of polyurethane foam and polyester fiber on seat and back Legs: 4799 Platinum Metallic powder coat steel with "go" glides 	<ol style="list-style-type: none"> Style number Number of fabrics if contrasting fabric style number is selected Fabric or leather color number for upholstery on seat and back Options, if selected (see below) 	▶ See <i>Coalesse Surface Materials Reference Guide</i> .
Options		U.S. Price	Required to Specify
Surface Materials	<ul style="list-style-type: none"> Contrasting fabric 	+\$182 per fabric	Add suffix K to the style number and select fabric color number.
	Acrylic backer		
	<ul style="list-style-type: none"> Chair 2-seat lounge 17"D x 17"W and 17"D x 20"W ottomans 20"D x 26"W ottoman 	+\$ 33 +\$ 60 +\$ 20 +\$ 26	Specify with acrylic backer. Specify with acrylic backer. Specify with acrylic backer.
			▶ See <i>Coalesse Surface Materials Reference Guide</i> .
Attachment Straps	<ul style="list-style-type: none"> 430 model 430-2 model 	+\$101 +\$202	Specify with attachment straps. Specify with attachment straps.
Arms	<ul style="list-style-type: none"> Arms on 430 and 430-2 ¾ yard or 14 sq. ft. required for COM/COL 	+\$ 72 per arm	Specify with arms.
Glides	<ul style="list-style-type: none"> "No go" ½" polyethylene glides 	No cost	Specify with "no go" glides.
Related Products	<ul style="list-style-type: none"> Occasional tables 		▶ See <i>Coalesse Tables, Storage, and Accessories Specification Guide</i> .

Specification Information

Style Number	U.S. Base Prices										Leather Grades:		
	Fabric Grades:										COL	C	E
	COM	6	7	8	9	10	11	12	13	14			

Lounge Chair

430	\$2209	\$2209	\$2235	\$2284	\$2422	\$2513	\$2617	\$2690	\$2822	\$3002	\$2564	\$4417	\$4898
-----	--------	--------	--------	--------	--------	--------	--------	--------	--------	--------	--------	--------	--------

COM/yds = 2¾, COL/sq ft = 77

▶ Specification Information, continued on next page



For Canadian Pricing
 Multiply U.S. Price by the Canadian price factor.
 ▶ See page 1 for details.

Sidewalk Lounge Seating Collaborative

DESIGN STUDIO B

► Specification Information, continued from previous page

Specification Information

Style Number	U.S. Base Prices														Leather Grades:		
	Fabric Grades:														COL	C	E
	COM	6	7	8	9	10	11	12	13	14							

2-Seat Lounge

430-2	\$3285	\$3285	\$3324	\$3399	\$3611	\$3752	\$3912	\$4027	\$4225	\$4504	\$3574	\$6356	\$6897
-------	--------	--------	--------	--------	--------	--------	--------	--------	--------	--------	--------	--------	--------

COM/yds = 4¼, COL/sq ft = 115

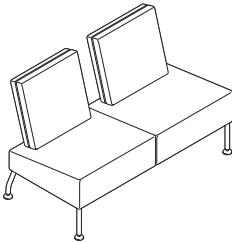

Overall: 27"D 49"W 30½"H
 Inside: 17"D 49"W 18"H
 Seat: 17"H
 Arm: 21"H

Ottoman

430-H1717	\$1345	\$1345	\$1361	\$1385	\$1463	\$1510	\$1569	\$1609	\$1677	\$1775	\$1777	\$2293	\$2666
-----------	--------	--------	--------	--------	--------	--------	--------	--------	--------	--------	--------	--------	--------

COM/yds = 1½, COL/sq ft = 22½

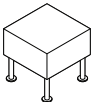

Overall: 17"D 17"W 17"H

430-H1720	\$1345	\$1345	\$1361	\$1385	\$1463	\$1510	\$1569	\$1609	\$1677	\$1775	\$1777	\$2293	\$2666
-----------	--------	--------	--------	--------	--------	--------	--------	--------	--------	--------	--------	--------	--------

COM/yds = 1½, COL/sq ft = 24

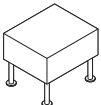

Overall: 17"D 20"W 17"H

430-H2026	\$1609	\$1609	\$1629	\$1660	\$1762	\$1829	\$1906	\$1958	\$2051	\$2182	\$1992	\$2820	\$3202
-----------	--------	--------	--------	--------	--------	--------	--------	--------	--------	--------	--------	--------	--------

COM/yds = 2, COL/sq ft = 36

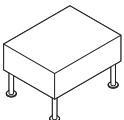

Overall: 20"D 26"W 17"H



For Canadian Pricing
 Multiply U.S. Price by the
 Canadian price factor.
 ► See page 1 for details.

Sidewalk Lounge Seating Ottoman/Benches

DESIGN STUDIO B

Tip: Fabrics and leathers will appear loose with comfort wrinkles when upholstered.

Tip: Recommended leathers are Elmosoft Grade C and Elmorustical Grade E.

Tip: Special color match, consult Customer Service.

Tip: For Customer's Own Material or Leather, see necessary requirements, important processing instructions, and ordering information
 ▶ See *Coalesse Surface Materials Reference Guide*.

Standard Includes		Required to Specify	
▶ Need help? Product details, page 200	<ul style="list-style-type: none"> Frame: unibody construction with finger jointed plywood. Upholstery: multiple densities of polyurethane foam and polyester fiber on ottoman/benches Legs: 4799 Platinum Metallic powder coat steel with "go" glides 	1 Style number 2 Fabric or leather color number for upholstery on ottoman/benches 3 Options, if selected (see below) ▶ See <i>Coalesse Surface Materials Reference Guide</i> .	
Options		U.S. Price	Required to Specify
Surface Material	Acrylic backer		
	• 17"D x 24"W bench	+\$20	Specify with acrylic backer.
	• 17"D x 36"W bench	+\$26	Specify with acrylic backer.
	• 17"D x 48"W bench	+\$33	Specify with acrylic backer.
	• Ottoman	+\$47	▶ See <i>Coalesse Surface Materials Reference</i>
<i>Guide.</i>			
Glides	• "No go" 1/2" polyethylene glides	No cost	Specify with "no go" glides.
Related Products	• Occasional tables		▶ See <i>Coalesse Tables, Storage, and Accessories Specification Guide</i> .

Specification Information

Style Number	U.S. Base Prices											Leather Grades:		
	Fabric Grades:											COL	C	E
	COM	6	7	8	9	10	11	12	13	14				

Benches

430-B1724	\$1458	\$1458	\$1474	\$1498	\$1576	\$1623	\$1682	\$1722	\$1790	\$1888	\$1888	\$2487	\$2842
------------------	--------	--------	--------	--------	--------	--------	--------	--------	--------	--------	--------	--------	--------

COM/yds = 1½, COL/sq ft = 27

430-B1736	\$1714	\$1714	\$1734	\$1765	\$1867	\$1934	\$2011	\$2063	\$2156	\$2287	\$2108	\$2937	\$3335
------------------	--------	--------	--------	--------	--------	--------	--------	--------	--------	--------	--------	--------	--------

COM/yds = 2, COL/sq ft = 36

430-B1748	\$1976	\$1976	\$1999	\$2042	\$2169	\$2250	\$2343	\$2412	\$2529	\$2691	\$2333	\$3388	\$3786
------------------	--------	--------	--------	--------	--------	--------	--------	--------	--------	--------	--------	--------	--------

COM/yds = 2½, COL/sq ft = 45

Ottoman

430-H3636	\$1998	\$1998	\$2024	\$2073	\$2211	\$2302	\$2406	\$2479	\$2611	\$2791	\$2345	\$4434	\$4879
------------------	--------	--------	--------	--------	--------	--------	--------	--------	--------	--------	--------	--------	--------

COM/yds = 2¾, COL/sq ft = 61

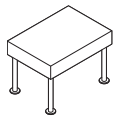

Overall: 17"D 24"W 17"H

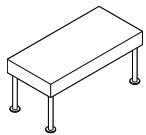

Overall: 17"D 36"W 17"H

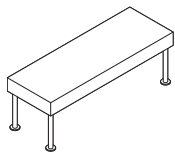

Overall: 17"D 48"W 17"H

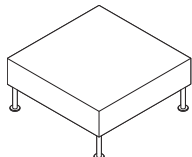

Overall: 36"D 36"W 17"H



For Canadian Pricing
 Multiply U.S. Price by the Canadian price factor.
 ▶ See page 1 for details.

Sidewalk Lounge Seating Collaborative Multi-Fabric Diagram

DESIGN STUDIO B

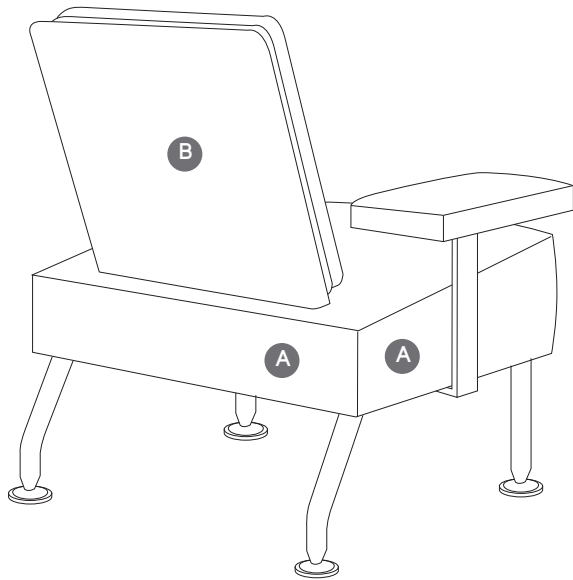
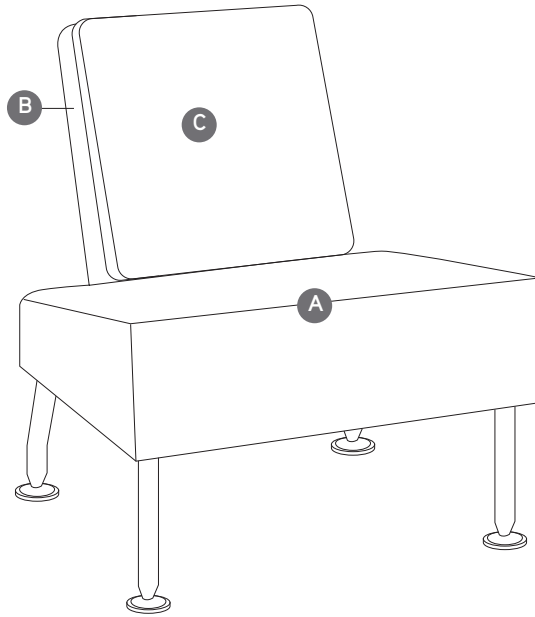

TO: _____

FROM: _____

DATE: _____

FAX....888.413.5161

A Upholstery Selection (default for entire unit if B is not selected):

B Back: _____

C Back Cushion: _____

Total list price upcharge for contrasting fabrics: \$ _____

*See specifying for contrasting fabric upcharge.
List price based on highest fabric grade usage.*

Sistema Lounge System General Overview

DESIGN LIEVORE ALTHERR MOLINA FOR VICCARBE

Sistema lounge system is an innovative modular system of fully customizable arms, backrest heights, base options, and accessories in the spirit of the modern sofa. With Sistema, build anything from a classic, high-back sofa to a sleek bench, a social sectional in any length, to a quiet niche for one or two.

Lounges with leg bases are available as 2- and 3-seat units that can be used on their own or together, for endless straight-run configurations. There is an ability to personalize with varying lounge, table, and leg choices.

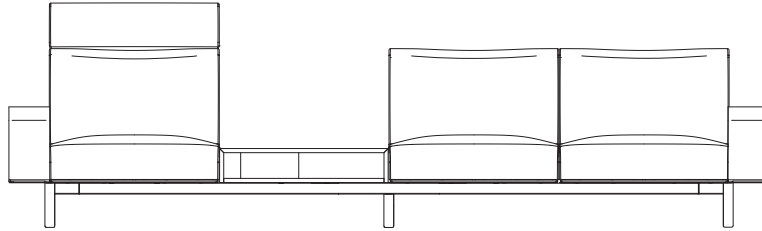

Individual modular lounge components with fully-upholstered base are available in a range of back height and arm choices. Integrated ganging device keeps units aligned.

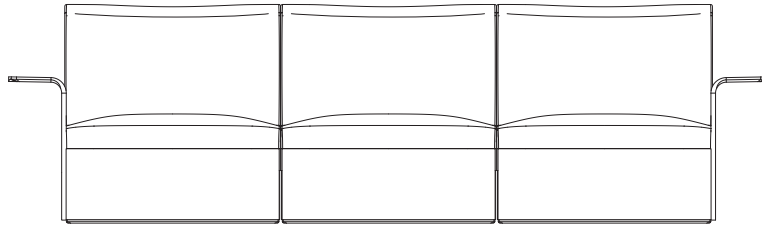

Coalesse

Sistema Lounge System General Overview

DESIGN LIEVORE ALTHERR MOLINA FOR VICCARBE

Sistema Lounge System Leg Base

DESIGN LIEVORE ALTHERR MOLINA FOR VICCARBE

Lounge choices include backless bench, low-, mid-, or high-back lounge components.

Arm bolster is user movable and can be positioned anywhere between lounge units. It provides arm support, boundary, or a landing place for mobile technology. Arm bolster is specified separately.

End legs are available in metal or wood choices. One set per each end is required. Legs are not included and must be ordered separately.

Modular design allows individual components to be easily repositioned or reconfigured on the frame by an installer.

Backless bench

Upholstered and plywood arm options are available. Arms can be specified at end locations only.

In-line box table includes cylinder cutout for storage. Cylinder can be specified in black or milk finishes. Slim table option is also available.

Connector legs gang 2- and 3-seat frames together. They are available in metal or wood options. Legs are not included and must be ordered separately.

Each position can be specified with varying lounge or table choices. Configuration shown: (2) 3-seat lounge frames with (1) connector leg and (2) end legs.

Power module is ordered separately and can be installed in the end positions on individual lounge units or centered between two units (as shown).

1-seat connector lounge, leg base is specified with a 5-seat configuration only. This unit connects (2) 2-seat frames together and positions the leg in a centered location. It can be specified with table or lounge and includes a connector frame and legs.

Each position can be specified with varying lounge or table choices. Configuration shown: (2) 2-seat lounge frames with 1-seat unit with legs and (2) end legs.

In-line slim table

Each position can be specified with varying lounge or table choices. Configuration shown: (2) 2-seat lounge frames with 1-seat unit with legs and (2) end legs.

Sistema Lounge System Leg Base

DESIGN LIEVORE ALTHERR MOLINA FOR VICCARBE

Product Details

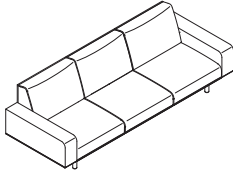
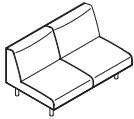

Modular design allows each component to be personalized with varying lounge and table choices. Create 2- and 3- seat lounges, or gang together to create endless straight configurations. Individual components are assembled to a welded steel frame. Lounge units ship installed to frame. Tables ship separately and are assembled in the field with four bolts. Lounge units ship facing same direction and can be easily flipped in the field to support yin-yang applications. Legs are ordered and shipped separately.

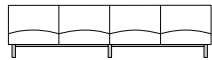

End Legs Connector Legs End Legs

Connector legs gang 2- and 3- seat frames together.

End legs are specified at the end positions of each configuration.

Legs are available in wood or metal finishes and are specified separately based on desired configuration.

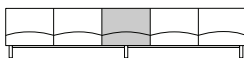

1-seat connector lounge, leg base is specified with a 5-seat configuration only. This unit connects two 2-seat lounge frames together and positions the leg in a centered location. It can be specified with table or lounge and includes a connector frame and legs.

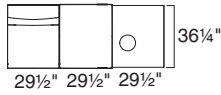

Overall depth and width of each lounge and in-line table component is the same due to its modular design, allowing units to be reconfigured. Overall depth is 36 1/4". Overall width of each unit is 29 1/2".

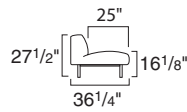

Low-back lounge

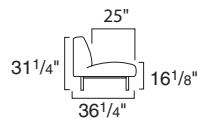

Mid-back lounge

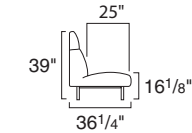

High-back lounge

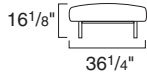

Backless bench

Three backrest height options unit are available (low, mid, or high back). A backless bench is also available. Seat depth on lounge chairs measures 25". Bench units have an overall depth of 36 1/4". Seat height is 16 1/8".

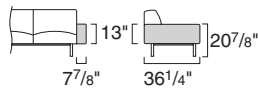

Upholstered Arm

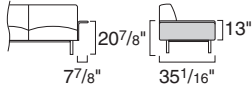

Wood Arm

Upholstered and wood arms are available. Arms can be specified in end positions only. Arms extend the overall width of the lounge unit by 7 7/8". Wood arms are one piece plywood with oak veneer.

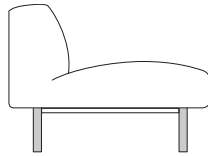

Cylinder legs, metal

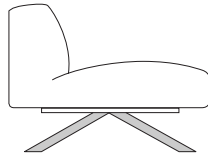

Scissor legs

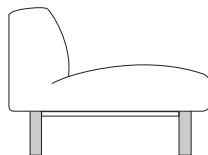

Cylinder legs, wood

End and connector legs are available in metal and wood choices; metal cylinder and scissor legs are available in painted finishes, and wood cylinder legs are solid oak. Cylinder legs offer 1/2" of adjustment. Legs are specified separately.

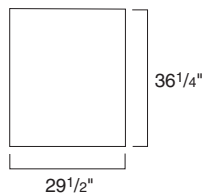

Slim table

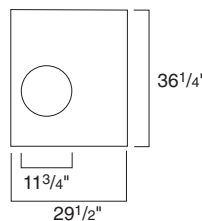

Box table

In-line slim and box tables are available. Tables are oak veneer with plywood core and exposed, stained edges. Box table has an 11 3/4" diameter cylinder cutout for storage. Cylinder is available in 6000 Black and 6052 Milk.

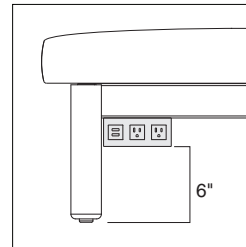

Power modules are ordered separately and installed in set positions under upholstered units only. USB C single 60W can charge tablets and laptops. Configurations available:

- (2) power, (1) USB A dual port
- (1) power, (1) USB C single 60W

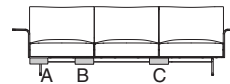

Power modules can be installed in set positions under upholstered units only.

- (A) Right position on individual lounge units.
- (B) Left position on individual lounge units.
- (C) Shared position between two lounge units facing the same direction.

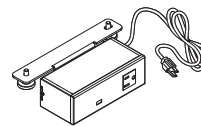
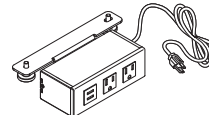

Power modules have a 72" L cord and contain wire manager clips to route cord under seat when desired.

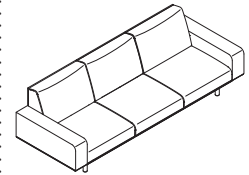

Each component is specified and can be ordered in contrasting fabrics, if desired.

Surface Materials

Seat and back on lounge

- Fabric
- Leather

Arms on lounge

- Upholstered in fabric or leather
- Oak veneered plywood

Legs

- Metal cylinder and painted steel legs
- Wood cylinder leg - solid oak
- Steel frame - painted in black

Slim and box tables

- Oak veneered plywood
- Box table cylinder cutout - 6000 Black - 6052 Milk

Arm bolster

- Upholstered in fabric or leather
- Metal fin is painted black

Sistema Lounge System Fully-Upholstered Base

DESIGN LIEVORE ALTHERR MOLINA FOR VICCARBE

Individual modular lounge components with fully upholstered base are specified separately and include integrated ganging device to keep units aligned.

Lounges are available with three backrest height options: low, mid, or high back. Backless bench lounge is also available.

Lounges can be specified armless (bench), right or left arm, or with arms. Narrow and wide upholstered arm or wood arm is available.

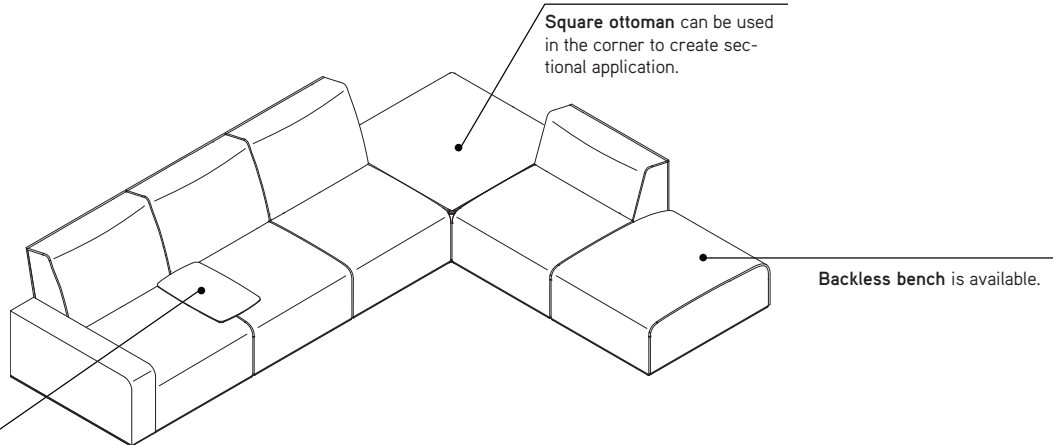

Moveable table is user movable and can be positioned anywhere between lounge components. Moveable table is ordered separately.

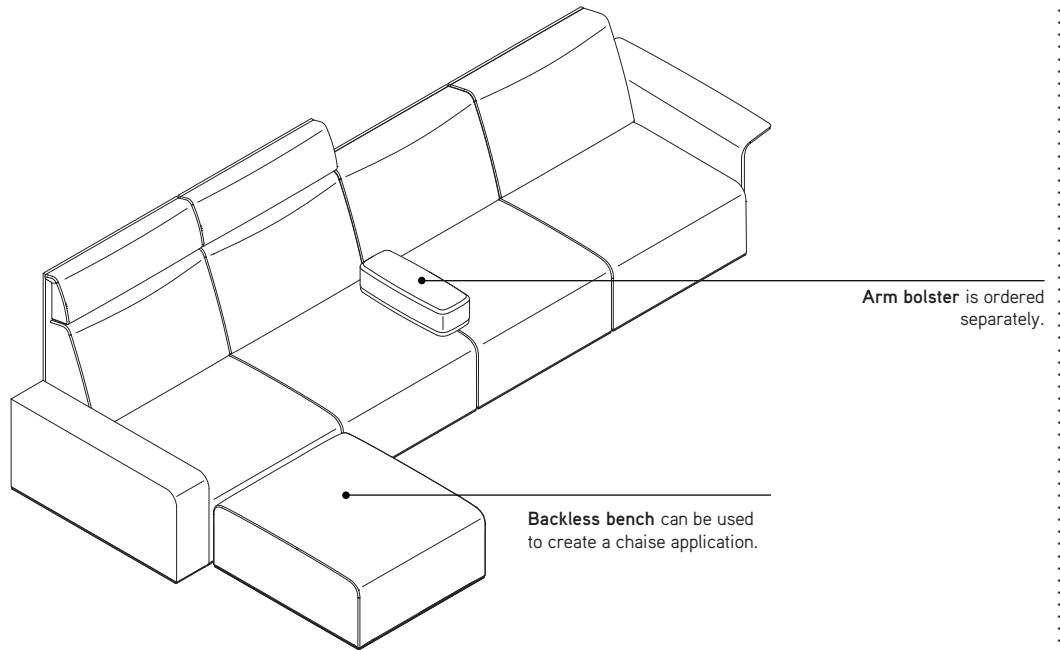

Sistema Lounge System Fully-Upholstered Base

DESIGN LIEVORE ALTHERR MOLINA FOR VICCARBE

Product Details

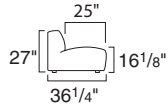
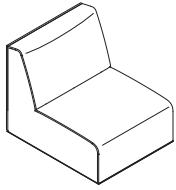

Low-back lounge

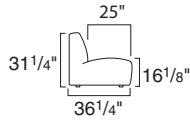
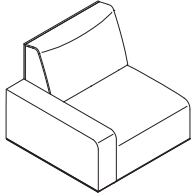

Mid-back lounge

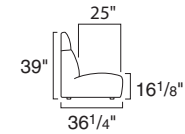
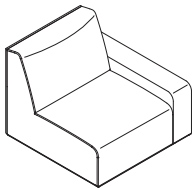

High-back lounge

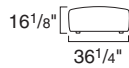
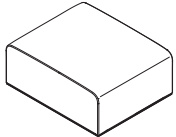

Backless bench

Three backrest height options are available: low, mid, or high back. A backless bench is also available. Seat depth on lounge chairs measures 25". Bench units have an overall depth of 36 1/4". Seat height is 16 1/8".

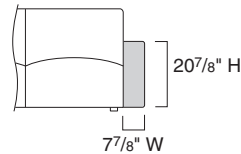
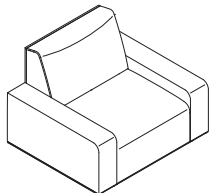

Upholstered narrow arm

Individual modular lounge components with fully upholstered base are specified separately and include integrated ganging device to keep units aligned. Three backrest height and three arm options are available. A backless bench is also available.

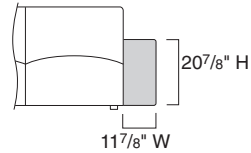

Upholstered wide arm

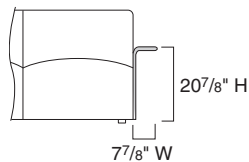

Wood Arm

Upholstered and wood arms are available. Arms can be specified on individual arm units on left or right side, or with two arms. Upholstered arms are available in narrow or wide options. Wood arms are one piece of plywood with oak veneer.

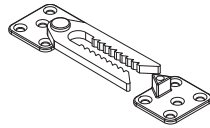

Integrated ganging device is included and keeps units aligned.

Lounges can be specified in contrasting upholstery, if desired.

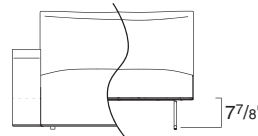

Additional seam will be included on arms when fabric is in horizontal/cross direction. The seam location aligns with the height of Sistema lounge with legs for visual connection.

Ottomans and Accessories

Accessories and ottomans can be used across the entire Sistema product line to add a decorative touch and function.

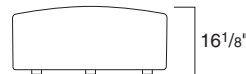

Round and square ottomans are available. Round ottoman is 36 1/4" in diameter. Square ottoman measures 36 1/4" x 36 1/4".



Moveable table is user movable and can be positioned anywhere between lounge units. Table measures 13"D x 20 1/2"L.

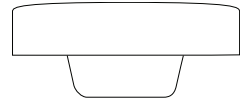

Arm bolster is user movable and can be positioned anywhere between lounge units. The upholstered unit provides arm support, boundary, or a landing place for mobile technology. Arm bolster measures 8 2/3"D x 20 1/2"L.



Pillows are a great way to elevate the design and comfort of any lounge setting. Square pillow measures 17 3/4"L x 17 3/4"H. The lumbar pillow is more firm to provide support and measures 20 2/3"L x 9 5/8"H.

Surface Materials

Seat and back on lounge

- Fabric
- Leather

Arms on lounge

- Upholstered in fabric or leather
- Oak veneered plywood

Moveable table

- Oak veneered plywood
- Wood fin matches table finish

Arm bolster

- Upholstered in fabric or leather
- Metal fin is painted black

Ottomans

- Upholstered in fabric or leather

Pillows

- Upholstered in fabric or leather

Sistema Lounge System 2- and 3-Seat Lounges, Leg Base

DESIGN LIEVORE ALTHERR MOLINA FOR VICCARBE

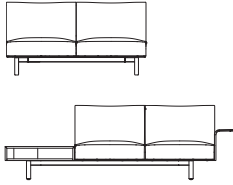

Tip: End legs are used with 2- and 3- seat lounge frames and are in the end location. One set per each end is required. Legs are not included and must be ordered separately.
 ▶Page 215.

Tip: Lounge units ship installed to frame. Tables require field installation with four bolts.

Tip: Each position can be personalized with modular lounge or table component and is required to be specified. Specification starts with the right position, which is from the user seated position.



For Canadian Pricing
 Multiply U.S. Price by the Canadian price factor.
 ▶ See page 1 for details.

Standard Includes	Required to Specify
▶ Need help? Product details, page 206	1 Style number 2 Position (see below under Required Selections) 3 Fabric or leather color number for seat and back, if selected 4 Wood color number for table, if selected 5 Finish color number for arms, if selected 6 Options, if selected (see below) ▶ See <i>Coalesse Surface Materials Reference Guide</i> .
<ul style="list-style-type: none"> • Lounge: constructed with finger-jointed plywood • Seat and back: <ul style="list-style-type: none"> - Fabric or leather - Multiple densities of polyurethane foam and polyester fiber, web seat suspension • Table, if selected: plywood core with oak wood veneer • Arms, if selected: upholstered or wood • Welded steel frame: black 	

Position	Required Selections	U.S. Price	Required to Specify
	2-seat lounge		
	• Bench		
	- Right position	Prices at right	Specify with <i>bench right position</i> and select fabric color number.
	- Left position	Prices at right	Specify with <i>bench left position</i> and select fabric color number.
	• Low-back lounge		
	- Right position	Prices at right	Specify with <i>low-back right position</i> and select fabric color number.
	- Left position	Prices at right	Specify with <i>low-back left position</i> and select fabric color number.
	• Mid-back lounge		
	- Right position	Prices at right	Specify with <i>mid-back right position</i> and select fabric color number.
	- Left position	Prices at right	Specify with <i>mid-back left position</i> and select fabric color number.
	• High-back lounge		
	- Right position	Prices at right	Specify with <i>high-back right position</i> and select fabric color number.
	- Left position	Prices at right	Specify with <i>high-back left position</i> and select fabric color number.
	• Table		
	- Right position	Prices at right	Specify with <i>table right position</i> and select wood color number.
	- Left position	Prices at right	Specify with <i>table left position</i> and select wood color number.
	3-seat lounge		
	• Bench		
	- Right position	Prices at right	Specify with <i>bench right position</i> and select fabric color number.
	- Center position	Prices at right	Specify with <i>bench center position</i> and select fabric color number.
	- Left position	Prices at right	Specify with <i>bench left position</i> and select fabric color number.
	• Low-back lounge		
	- Right position	Prices at right	Specify with <i>low-back right position</i> and select fabric color number.
	- Center position	Prices at right	Specify with <i>low-back center position</i> and select fabric color number.
	- Left position	Prices at right	Specify with <i>low-back left position</i> and select fabric color number.
	• Mid-back lounge		
	- Right position	Prices at right	Specify with <i>mid-back right position</i> and select fabric color number.
	- Center position	Prices at right	Specify with <i>mid-back center position</i> and select fabric color number.
	- Left position	Prices at right	Specify with <i>mid-back left position</i> and select fabric color number.
	• High-back lounge		
	- Right position	Prices at right	Specify with <i>high-back right position</i> and select fabric color number.
	- Center position	Prices at right	Specify with <i>high-back center position</i> and select fabric color number.
	- Left position	Prices at right	Specify with <i>high-back left position</i> and select fabric color number.

▶ Required Selections , continued on next page

Sistema Lounge System 2- and 3-Seat Lounges, Leg Base

DESIGN LIEVORE ALTHERR MOLINA FOR VICCARBE

Tip: When selecting COM or COL, pricing is per each position.

► Required Selections, continued from previous page

	Required Selections	U.S. Price	Required to Specify
Position, continued	• Table		
	– Right position	Prices at right	Specify with <i>table right position</i> and select wood color number.
	– Center position	Prices at right	Specify with <i>table center position</i> and select wood color number.
	– Left position	Prices at right	Specify with <i>table left position</i> and select wood color number.

	Options	U.S. Price	Required to Specify
Surface Materials	• Customer's Own Material (COM)—per position	+\$ 113	Specify with <i>COM</i> and select fabric color number.
	• Customer's Own Leather (COL)—per position	+\$ 182	Specify with <i>COL</i> and select fabric color number.

Acrylic backer—entire product			
	• 2-seat lounge	+\$ 81	Specify with <i>acrylic backer</i> .
	• 3-seat lounge	+\$ 125	Specify with <i>acrylic backer</i> .
	• Fabric upcharges	Prices at right	Specify fabric color number.

Arm Type	Arm—if selected, per arm		
	• Upholstery	+\$ 595	Specify with <i>upholstered arm</i> and select fabric color number.
	• Wood veneer Grade 1	+\$1249	Specify with <i>wood arm</i> and select wood veneer grade 1 color number.
	• Wood veneer Grade 2	+\$1372	Specify with <i>wood arm</i> and select wood veneer grade 2 color number.

Related Products	• End and connector legs		► Page 215
	• 1-seat connector lounge		► Page 216
	• Arm bolster		► Page 225
	• Moveable table		► Page 226
	• Ottomans		► Page 224
	• Pillows		► Page 227
	• Power module		► Page 218

► Specification Information on next page

 **For Canadian Pricing**
Multiply U.S. Price by the Canadian price factor.
► See page 1 for details.

Sistema Lounge System 2- and 3-Seat Lounges, Leg Base *continued*

DESIGN LIEVORE ALTHERR MOLINA FOR VICCARBE

► Options on previous page

Specification Information

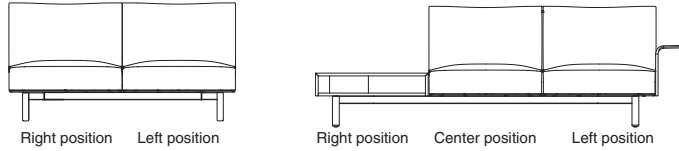

*Legs are not included and must be ordered separately.

Tip: Each position can be personalized with modular lounge or table component.

Tip: Start with 2- or 3-seat lounge frame and then specify each position.

Tip: For upholstered components with COM, use the base price and add COM upcharge for each position it applies.

Tip: Cylinder cutout on box table can be specified in 6000 Black or 6052 Milk.

Tip: End and connector legs must be specified separately.

Tip: Comfort wrinkles are intended to occur over time with upholstered fabrics and leathers.

Style Number	U.S. Base Price (Frame)	Options (Add \$ to Base Price)							
		Per position upcharges:							
		Bench	Low-Back Lounge	Mid-Back Lounge	High-Back Lounge	Slim Table Wood Veneer Grade 1	Slim Table Wood Veneer Grade 2	Box Table Wood Veneer Grade 1	Box Table Wood Veneer Grade 2

2-Seat Lounge Frame, Leg Base

COSISL2	\$412	+\$1142	+\$1562	+\$1632	+\$1806	+\$2095	+\$2259	+\$3491	+\$3766
---------	-------	---------	---------	---------	---------	---------	---------	---------	---------

3-Seat Lounge Frame, Leg Base

COSISL3	\$552	+\$1142	+\$1562	+\$1632	+\$1806	+\$2095	+\$2259	+\$3491	+\$3766
---------	-------	---------	---------	---------	---------	---------	---------	---------	---------

Fabric Upcharges

	Fabric Grades:										Leather Grades:	
	6	7	8	9	10	11	12	13	14	C	E	
Bench	+\$123	+\$144	+\$185	+\$306	+\$384	+\$475	+\$537	+\$647	+\$803	+\$1133	+\$1365	
Low-Back Lounge												
Seat	+\$ 84	+\$102	+\$129	+\$214	+\$266	+\$329	+\$374	+\$452	+\$560	+\$ 788	+\$ 948	
Back	+\$101	+\$119	+\$153	+\$252	+\$317	+\$389	+\$444	+\$536	+\$664	+\$ 935	+\$1128	
Mid-Back Lounge												
Seat	+\$ 84	+\$102	+\$129	+\$214	+\$266	+\$329	+\$374	+\$452	+\$560	+\$ 788	+\$ 948	
Back	+\$101	+\$119	+\$153	+\$252	+\$317	+\$389	+\$444	+\$536	+\$664	+\$ 935	+\$1128	
High-Back Lounge												
Seat	+\$ 84	+\$102	+\$129	+\$214	+\$266	+\$329	+\$374	+\$452	+\$560	+\$ 788	+\$ 948	
Back	+\$106	+\$126	+\$160	+\$265	+\$335	+\$412	+\$465	+\$564	+\$700	+\$ 982	+\$1186	
Upholstered Arm	+\$ 41	+\$ 49	+\$ 63	+\$106	+\$134	+\$165	+\$186	+\$225	+\$279	+\$ 393	+\$ 475	

COM: Seat: 2 yards/ 41 sq ft, Low back: 2½ yards/ 38 sq ft, Mid back: 2½ yards/ 42 sq ft, High back: 2½ yards/ 54 sq. ft, Bench: 2 yards/ 43 sq ft, Upholstered arm: 1¾ yards/ 39 sq ft

Tip: For upholstered arm fabric grade pricing, add upcharge to arm option.



For Canadian Pricing
Multiply U.S. Price by the Canadian price factor.
► See page 1 for details.

Sistema Lounge System End Legs and Connector Frame

DESIGN LIEVORE ALTHERR MOLINA FOR VICCARBE

Tip: End legs and connector frame are used with 2- and 3-seat lounge frames.

Standard Includes	Required to Specify
<ul style="list-style-type: none"> ▶ Need help? Product details, page 206 • Frame: black steel • Cylinder metal legs: Grade 1 paint • Ship ready-to-assemble and connect to 2- and 3-seat lounge frames 	<ul style="list-style-type: none"> 1 Style number 2 Paint color number for legs 3 Options, if selected (see below) ▶ See <i>Coalesse Surface Materials Reference Guide</i>.

Leg Type	Options	U.S. Price	Required to Specify
	Cylinder metal legs		
	• Grade 1 paint	No cost	Specify <i>with cylinder metal legs</i> and select paint color number.
	• Grade 3 paint	+\$ 55	Specify <i>with cylinder metal legs</i> and select paint color number.
	Scissor metal legs		
	• Grade 1 paint	+\$ 21	Specify <i>with scissor metal legs</i> and select paint color number.
	• Grade 3 paint	+\$ 75	Specify <i>with scissor metal legs</i> and select paint color number.
	Cylinder wood legs		
	• Wood veneer Grade 1	+\$140	Specify <i>with cylinder wood</i> and select wood veneer grade 1 color number.
	• Wood veneer Grade 2	+\$174	Specify <i>with cylinder wood</i> and select wood veneer grade 2 color number.
Related Products	• 2- and 3-seat lounge frames		▶ Page 212

Specification Information

Style Number	U.S. Base Price
--------------	-----------------

End Legs

COSISEL	\$279
---------	-------

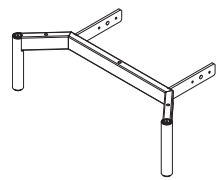

Tip: End legs are used with 2- and 3- seat lounge frames and are in the end location. One per each end is required.

Connector Frame with Legs

COSISGL	\$385
---------	-------

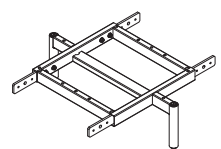

Tip: Connector frame is used to gang 2- and 3- seat lounge frames together. Legs are included.

For Canadian Pricing
 Multiply U.S. Price by the Canadian price factor.
 ▶ See page 1 for details.

Sistema Lounge System 1-Seat Connector Lounge, Leg Base

DESIGN LIEVORE ALTHERR MOLINA FOR VICCARBE

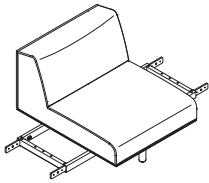

Tip: 1-seat connector lounge is used for a 5-seat lounge configuration only. It is the center unit and gangs two 2-seat frames together.

	Standard Includes	Required to Specify
<p>► Need help? Product details, page 208</p>	<ul style="list-style-type: none"> Lounge, center position: constructed with finger-jointed plywood Seat and back, if selected: <ul style="list-style-type: none"> Fabric or leather Multiple densities of polyurethane foam and polyester fiber, web seat suspension Table, if selected: plywood core with oak wood veneer Steel connector frame: black Cylinder metal legs: Grade 1 paint Ships ready-to-assemble 	<ol style="list-style-type: none"> Style number Position (see below under Required Selections) Fabric or leather color number for seat and back, if selected Wood color number for table, if selected Paint number for legs Options, if selected (see below) <p>► See <i>Coalesse Surface Materials Reference Guide</i>.</p>

	Required Selections	U.S. Price	Required to Specify
Position	<p>1-seat lounge</p> <ul style="list-style-type: none"> Bench <ul style="list-style-type: none"> Center position Low-back lounge <ul style="list-style-type: none"> Center position Mid-back lounge <ul style="list-style-type: none"> Center position High-back lounge <ul style="list-style-type: none"> Center position Table <ul style="list-style-type: none"> Center position 	<p>Prices at right</p> <p>Prices at right</p> <p>Prices at right</p> <p>Prices at right</p> <p>Prices at right</p>	<p>Specify with <i>bench center position</i> and select fabric color number.</p> <p>Specify with <i>low-back center position</i> and select fabric color number.</p> <p>Specify with <i>mid-back center position</i> and select fabric color number.</p> <p>Specify with <i>high-back center position</i> and select fabric color number.</p> <p>Specify with <i>table center position</i> and select fabric color number.</p>

	Options	U.S. Price	Required to Specify
Surface Materials	<ul style="list-style-type: none"> Customer's Own Material (COM) Customer's Own Leather (COL) 	<p>+\$113</p> <p>+\$182</p>	<p>Specify with <i>COM</i> and select fabric color number.</p> <p>Specify with <i>COL</i> and select fabric color number.</p>
	<ul style="list-style-type: none"> Acrylic backer—entire product 	<p>+\$ 44</p>	<p>Specify with <i>acrylic backer</i>.</p>
	<ul style="list-style-type: none"> Fabric upcharges 	<p>Prices at right</p>	<p>Specify fabric color number.</p>
Leg Type	<p>Cylinder metal legs</p> <ul style="list-style-type: none"> Grade 1 paint Grade 3 paint <p>Scissor metal legs</p> <ul style="list-style-type: none"> Grade 1 paint Grade 3 paint <p>Cylinder wood legs</p> <ul style="list-style-type: none"> Wood veneer Grade 1 Wood veneer Grade 2 	<p>No cost</p> <p>+\$ 56</p> <p>+\$ 21</p> <p>+\$ 75</p> <p>+\$140</p> <p>+\$173</p>	<p>Specify with <i>cylinder metal legs</i> and select paint color number.</p> <p>Specify with <i>cylinder metal legs</i> and select paint color number.</p> <p>Specify with <i>scissor metal legs</i> and select paint color number.</p> <p>Specify with <i>scissor metal legs</i> and select paint color number.</p> <p>Specify with <i>cylinder wood</i> and select wood veneer grade 1 color number.</p> <p>Specify with <i>cylinder wood</i> and select wood veneer grade 2 color number.</p>

Related Products	<ul style="list-style-type: none"> 2- and 3-seat lounge frames Power module 	<p>► Page 212</p> <p>► Page 218</p>
-------------------------	---	-------------------------------------



For Canadian Pricing
 Multiply U.S. Price by the Canadian price factor.
 ► See page 1 for details.

Sistema Lounge System 1-Seat Connector Lounge, Leg Base

DESIGN LIEVORE ALTHERR MOLINA FOR VICCARBE

Tip: Start with connector frame base price and then specify lounge or table and any options.

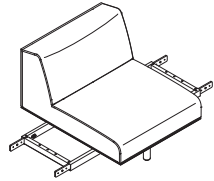

Tip: Cylinder cutout box table can be specified in 6052 Milk or 6000 Black.

Tip: For upholstered connectors with COM, use the base price and add COM upcharge.

Tip: Comfort wrinkles are intended to occur over time with upholstered fabrics and leathers.

Specification Information

Style Number	U.S. Base Price (Frame)	Options (Add \$ to Base Price)							
		Per position upcharges:							
		Bench	Low-Back Lounge	Mid-Back Lounge	High-Back Lounge	Slim Table Wood Veneer Grade 1	Slim Table Wood Veneer Grade 2	Box Table Wood Veneer Grade 1	Box Table Wood Veneer Grade 2

1-Seat Connector Lounge Frame, Leg Base

COSISL1	\$349	+\$1142	+\$1562	+\$1632	+\$1806	+\$2095	+\$2259	+\$3491	+\$3766
---------	-------	---------	---------	---------	---------	---------	---------	---------	---------

Fabric Upcharges

	Fabric Grades:								Leather Grades:		
	6	7	8	9	10	11	12	13	14	C	E
Bench	+\$123	+\$144	+\$185	+\$306	+\$384	+\$475	+\$537	+\$647	+\$803	+\$1133	+\$1365
Low-Back Lounge											
Seat	+\$ 84	+\$102	+\$129	+\$214	+\$266	+\$329	+\$374	+\$452	+\$560	+\$ 788	+\$ 948
Back	+\$101	+\$119	+\$153	+\$252	+\$317	+\$389	+\$444	+\$536	+\$664	+\$ 935	+\$1128
Mid-Back Lounge											
Seat	+\$ 84	+\$102	+\$129	+\$214	+\$266	+\$329	+\$374	+\$452	+\$560	+\$ 788	+\$ 948
Back	+\$101	+\$119	+\$153	+\$252	+\$317	+\$389	+\$444	+\$536	+\$664	+\$ 935	+\$1128
High-Back Lounge											
Seat	+\$ 84	+\$102	+\$129	+\$214	+\$266	+\$329	+\$374	+\$452	+\$560	+\$ 788	+\$ 948
Back	+\$106	+\$126	+\$160	+\$265	+\$335	+\$412	+\$465	+\$564	+\$700	+\$ 982	+\$1186

COM: Seat: 2 yards/ 41 sq ft, Low back: 2½ yards/ 38 sq ft, Mid back: 2½ yards/ 42 sq ft, High back: 2½ yards/ 54 sq. ft, Bench: 2 yards/ 43 sq ft.

 **For Canadian Pricing**
 Multiply U.S. Price by the Canadian price factor.
 ▶ See page 1 for details.

Sistema Lounge System Power Module for Lounge, Leg Base

DESIGN LIEVORE ALTHERR MOLINA FOR VICCARBE

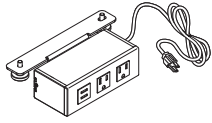

Tip: Cannot be installed under tables.

Tip: Can be installed in pre-defined locations on leg base lounges.

Tip: USB C single 60W delivers more power and capability to charge larger devices like laptops.

Standard Includes	Required to Specify
<ul style="list-style-type: none"> ▶ Need help? Product details, page 209 • Installation hardware and wire manager clips • Power cord: 72" L • Power configuration: two power, one USB A dual port 	<ul style="list-style-type: none"> 1 Style number 2 Options, if selected (see below) ▶ See <i>Coalesse Surface Materials Reference Guide</i>.

Options	U.S. Price	Required to Specify
Power Configuration <ul style="list-style-type: none"> • One power, one USB C single 60W 	+\$133	Specify with one power, one USB C.
Related Products <ul style="list-style-type: none"> • 2- and 3-seat lounge frames • 1-seat connector lounge 		<ul style="list-style-type: none"> ▶ Page 212 ▶ Page 216

Specification Information	
Style Number	U.S. Base Price
COSISPWR	\$598



For Canadian Pricing
 Multiply U.S. Price by the Canadian price factor.
 ▶ See page 1 for details.

Coalesse

Sistema Lounge System

Power Module for Lounge, Leg Base

DESIGN LIEVORE ALTHERR MOLINA FOR VICCARBE

Sistema Lounge System Fully-Upholstered Base

DESIGN LIEVORE ALTHERR MOLINA FOR VICCARBE

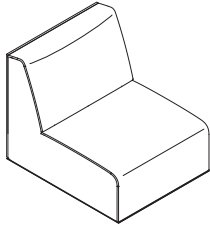

	Standard Includes	Required to Specify
<p>► Need help? Product details, page 210</p>	<ul style="list-style-type: none"> Lounge: constructed with finger-jointed plywood Seat and back: <ul style="list-style-type: none"> - Fabric or leather - Multiple densities of polyurethane foam and polyester fiber, web seat suspension Upholstered arm, if selected: fabric Glides: 1/2" of adjustment Integrated ganging device Ships assembled 	<ol style="list-style-type: none"> Style number Fabric or leather color number for seat and back Fabric or leather color number for arm, if selected Options, if selected (see below) <p>► See <i>Coalesse Surface Materials Reference Guide</i>.</p>

	Options	U.S. Price	Required to Specify
Surface Materials	• Customer's Own Material (COM)	+\$113	Specify <i>with COM</i> and select fabric color number.
	• Customer's Own Leather (COL)	+\$182	Specify <i>with COL</i> and select fabric color number.
	• Acrylic backer	+\$ 44	Specify <i>with acrylic backer</i> .
	• Fabric upcharges	Prices at right	Specify fabric color number.
	• Fabric upcharges	Prices at right	Specify fabric color number.
Lounge Back Height	• Low-back lounge height	No cost	Specify <i>with low-back lounge height</i> .
	• Mid-back lounge height	+\$ 72	Specify <i>with mid-back lounge height</i> .
	• High-back lounge height	+\$244	Specify <i>with high-back lounge height</i> .
Arm Type	Arm—if lounge chair with arm(s) selected, per arm		
	• Upholstered arm	No cost	Specify <i>with upholstered arm</i> and select fabric color number.
	• Wide, upholstered arm	+\$ 34	Specify <i>with wide upholstered arm</i> and select fabric color number.
	• Wood veneer Grade 1	+\$796	Specify <i>with wood arm</i> and select wood veneer grade 1 color number.
	• Wood veneer Grade 2	+\$919	Specify <i>with wood arm</i> and select wood veneer grade 2 color number.
Related Products	• Arm bolster		► Page 225
	• Moveable table		► Page 226
	• Ottomans		► Page 224
	• Pillows		► Page 227



For Canadian Pricing
Multiply U.S. Price by the Canadian price factor.
► See page 1 for details.

Sistema Lounge System Fully-Upholstered Base

DESIGN LIEVORE ALTHERR MOLINA FOR VICCARBE

Specification Information

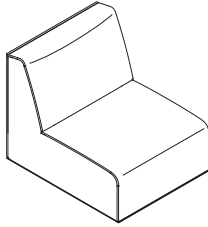

Overall: 29¹/₂"W x 36¹/₄"D
Low back: 27¹/₂"H
Mid back: 31¹/₄"H
High back: 39"H
Seat height: 16¹/₈"
Seat depth: 25"

Style Number **U.S. Base Price**

Lounge Chair, Armless

COSISLC \$1562

Fabric Upcharges

	Fabric Grades:										Leather Grades:	
	6	7	8	9	10	11	12	13	14	C	E	
Seat	+\$106	+\$126	+\$160	+\$265	+\$335	+\$412	+\$465	+\$564	+\$700	+\$ 982	+\$1186	
Low Back	+\$123	+\$144	+\$185	+\$306	+\$384	+\$475	+\$537	+\$647	+\$803	+\$1133	+\$1365	
Mid Back	+\$123	+\$144	+\$185	+\$306	+\$384	+\$475	+\$537	+\$647	+\$803	+\$1133	+\$1365	
High Back	+\$126	+\$152	+\$195	+\$318	+\$401	+\$494	+\$561	+\$677	+\$839	+\$1182	+\$1424	

Tip: Comfort wrinkles are intended to occur over time with upholstered fabrics and leathers.

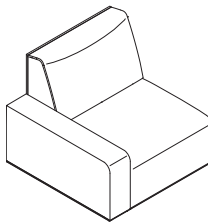

Overall: 37¹/₃"W x 36¹/₄"D
Low back: 27¹/₂"H
Mid back: 31¹/₄"H
High back: 39"H
Seat height: 16¹/₈"
Seat depth: 25"

Lounge Chair, Right Arm

COSISIR \$2157

Fabric Upcharges

	Fabric Grades:										Leather Grades:	
	6	7	8	9	10	11	12	13	14	C	E	
Seat	+\$106	+\$126	+\$160	+\$265	+\$335	+\$412	+\$465	+\$564	+\$700	+\$ 982	+\$1186	
Low Back	+\$123	+\$144	+\$185	+\$306	+\$384	+\$475	+\$537	+\$647	+\$803	+\$1133	+\$1365	
Mid Back	+\$123	+\$144	+\$185	+\$306	+\$384	+\$475	+\$537	+\$647	+\$803	+\$1133	+\$1365	
High Back	+\$126	+\$152	+\$195	+\$318	+\$401	+\$494	+\$561	+\$677	+\$839	+\$1182	+\$1424	
Upholstered Arm	+\$ 63	+\$ 76	+\$ 97	+\$160	+\$201	+\$247	+\$279	+\$339	+\$421	+\$ 590	+\$ 712	
Wide, Upholstered Arm	+\$ 97	+\$113	+\$144	+\$239	+\$302	+\$372	+\$421	+\$508	+\$627	+\$ 884	+\$1069	

Tip: Overall width on lounge chair with wide upholstered arm is 41¹/₃".

Tip: For upholstered or fabric grade pricing, add upcharge to arm option.

 **For Canadian Pricing**
 Multiply U.S. Price by the Canadian price factor.
 ▶ See page 1 for details.

▶ Specification Information, continued on next page

Sistema Lounge System Fully-Upholstered Base *continued*

DESIGN LIEVORE ALTHERR MOLINA FOR VICCARBE

► Specification Information, continued from previous page

Specification Information

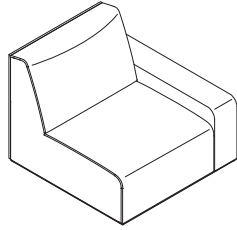

Overall: 37¹/₃"W x 36¹/₄"D
Low back: 27¹/₂"H
Mid back: 31¹/₄"H
High back: 39"H
Seat height: 16¹/₈"
Seat depth: 25"

Style Number	U.S. Base Price
--------------	-----------------

Lounge Chair, Left Arm

COSIS1L	\$2157
---------	--------

Tip: Comfort wrinkles are intended to occur over time with upholstered fabrics and leathers.

Fabric Upcharges

	Fabric Grades:										Leather Grades:	
	6	7	8	9	10	11	12	13	14	C	E	
Seat	+\$106	+\$126	+\$160	+\$265	+\$335	+\$412	+\$465	+\$564	+\$700	+\$982	+\$1186	
Low Back	+\$123	+\$144	+\$185	+\$306	+\$384	+\$475	+\$537	+\$647	+\$803	+\$1133	+\$1365	
Mid Back	+\$123	+\$144	+\$185	+\$306	+\$384	+\$475	+\$537	+\$647	+\$803	+\$1133	+\$1365	
High Back	+\$126	+\$152	+\$195	+\$318	+\$401	+\$494	+\$561	+\$677	+\$839	+\$1182	+\$1424	
Upholstered Arm	+\$ 63	+\$ 76	+\$ 97	+\$160	+\$201	+\$247	+\$279	+\$339	+\$421	+\$ 590	+\$ 712	
Wide, Upholstered Arm	+\$ 97	+\$113	+\$144	+\$239	+\$302	+\$372	+\$421	+\$508	+\$627	+\$ 884	+\$1069	

Tip: For upholstered arm fabric grade pricing, add upcharge to arm option.

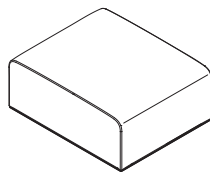

Overall: 29¹/₂"W x 36¹/₄"D x 16¹/₈"H

Backless Bench Lounge

COSISBN	\$1269
---------	--------

Fabric Upcharges

	Fabric Grades:										Leather Grades:	
	6	7	8	9	10	11	12	13	14	C	E	
Bench	+\$143	+\$171	+\$217	+\$359	+\$452	+\$558	+\$628	+\$761	+\$943	+\$1328	+\$1602	

► Specification Information, continued on next page



For Canadian Pricing
 Multiply U.S. Price by the
 Canadian price factor.
 ► See page 1 for details.

Sistema Lounge System Fully-Upholstered Base

DESIGN LIEVORE ALTHERR MOLINA FOR VICCARBE

► Specification Information, continued from previous page

Specification Information

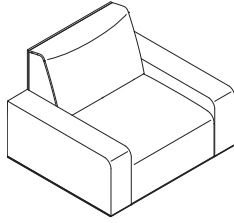

Overall: 45¹/₄"W x 36¹/₄"D

Low back: 27¹/₂"H

Mid back: 31¹/₄"H

High back: 39"H

Seat height: 16¹/₈"

Seat depth: 25"

Tip: Comfort wrinkles are intended to occur over time with upholstered fabrics and leathers.

Tip: Overall width on lounge chair with wide upholstered arm is 53¹/₄".

Tip: For upholstered arm fabric grade pricing, add upcharge to arm option.

Style Number	U.S. Base Price
--------------	-----------------

Lounge Chair, with Arms

COSIS2A	\$2752
---------	--------

Fabric Upcharges

	Fabric Grades:										Leather Grades:	
	6	7	8	9	10	11	12	13	14	C	E	
Seat	+\$106	+\$126	+\$160	+\$265	+\$335	+\$412	+\$465	+\$ 564	+\$ 700	+\$ 982	+\$1186	
Low Back	+\$123	+\$144	+\$185	+\$306	+\$384	+\$475	+\$537	+\$ 647	+\$ 803	+\$1133	+\$1365	
Mid Back	+\$123	+\$144	+\$185	+\$306	+\$384	+\$475	+\$537	+\$ 647	+\$ 803	+\$1133	+\$1365	
High Back	+\$126	+\$152	+\$195	+\$318	+\$401	+\$494	+\$561	+\$ 677	+\$ 839	+\$1182	+\$1424	
Upholstered Arm	+\$126	+\$152	+\$194	+\$320	+\$402	+\$494	+\$558	+\$ 678	+\$ 842	+\$1180	+\$1424	
Wide, Upholstered Arm	+\$194	+\$226	+\$288	+\$478	+\$604	+\$744	+\$842	+\$1016	+\$1254	+\$1768	+\$2138	

COM: Seat: 2 yards/ 44 sq ft, Low back: 2¹/₂ yards/ 45 sq ft, Mid back: 2¹/₂ yards/ 49 sq ft, High back: 2¹/₂ yards/ 54 sq ft, Bench: 2 yards/ 45 sq ft, Upholstered arm: 1³/₄ yards/ 39 sq ft, Wide upholstered arm: 2 yards/ 41 sq ft



For Canadian Pricing
 Multiply U.S. Price by the Canadian price factor.
 ► See page 1 for details.

Sistema Lounge System Ottomans and Accessories

DESIGN LIEVORE ALTHERR MOLINA FOR VICCARBE

Ottomans

Tip: Ottomans and accessories complement the entire Sistema lounge system.

Standard Includes	Required to Specify
<ul style="list-style-type: none"> ▶ Need help? Product details, page 210 • Ottoman frame: constructed with finger jointed plywood • Ottoman upholstery: multiple densities of polyurethane foam and polyester fiber with web seat suspension • Ottoman glide: 1/2" of adjustment • Integrated ganging device, if square ottoman selected • Ships assembled 	<ul style="list-style-type: none"> 1 Style number 2 Fabric or leather color number 3 Options, if selected (see below) ▶ See <i>Coalesse Surface Materials Reference Guide</i>.

Options	U.S. Price	Required to Specify
Surface Materials <ul style="list-style-type: none"> • Customer's Own Leather (COL) 	+\$181	Specify with COL and select fabric color number.
Acrylic backer <ul style="list-style-type: none"> • Round or square ottoman 	+\$ 44	Specify with acrylic backer.
Related Products <ul style="list-style-type: none"> • 2- and 3-seat lounge • 1-seat connector lounge • Lounge chairs 		<ul style="list-style-type: none"> ▶ Page 212 ▶ Page 216 ▶ Page 220

Specification Information

Style Number	U.S. Base Prices										Leather Grades:	
	Fabric Grades:										C	E
	COM	6	7	8	9	10	11	12	13	14		

Round Ottoman

COSISOR	\$1534	\$1564	\$1592	\$1638	\$1780	\$1873	\$1979	\$2049	\$2182	\$2364	\$2749	\$3023
COM: 2¼ yards/ 50 sq ft.												

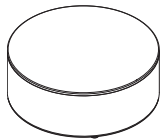

Overall: 36¼" Dia x 16½"H

Square Ottoman

COSISOS	\$1534	\$1585	\$1618	\$1670	\$1833	\$1938	\$2060	\$2145	\$2294	\$2503	\$2946	\$3262
COM: 3¼ yards/ 62 sq ft.												

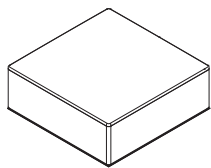

Overall: 36¼"W x 36¼"D x 16½"H

Tip: Integrated ganging device included on square ottoman to gang to lounge chair in corner application.

 **For Canadian Pricing**
 Multiply U.S. Price by the Canadian price factor.
 ▶ See page 1 for details.

Sistema Lounge System Ottomans and Accessories

DESIGN LIEVORE ALTHERR MOLINA FOR VICCARBE

Arm Bolster, Moveable



	Standard Includes	Required to Specify
▶ Need help? Product details, page 210	<ul style="list-style-type: none"> • Arm bolster: upholstered with painted black metal fin 	1 Style number 2 Fabric or leather color number 3 Options, if selected (see below) ▶ See <i>Coalesse Surface Materials Reference Guide</i> .

	Options	U.S. Price	Required to Specify
Surface Materials	• Customer's Own Leather (COL)	+\$181	Specify with COL and select fabric color number.
	• Acrylic backer	+\$ 10	Specify with acrylic backer.
Related Products	<ul style="list-style-type: none"> • 2- and 3-seat lounge • 1-seat connector lounge • Lounge chairs 		▶ Page 212 ▶ Page 216 ▶ Page 220

Specification Information

Style Number	U.S. Base Prices											Leather Grades:	
	Fabric Grades:											C	E
	COM	6	7	8	9	10	11	12	13	14			
COSISAB	\$708	\$676	\$692	\$718	\$799	\$849	\$911	\$953	\$1027	\$1130	\$1348	\$1503	

COM: 1½ yards/ 18 sq ft.

Lounge Seating

 **For Canadian Pricing**
 Multiply U.S. Price by the Canadian price factor.
 ▶ See page 1 for details.

Sistema Lounge System Ottomans and Accessories *continued*

DESIGN LIEVORE ALTHERR MOLINA FOR VICCARBE

Moveable Table



	Standard Includes	Required to Specify
► Need help? Product details, page 210	<ul style="list-style-type: none"> Moveable table: plywood core with oak wood veneer 	1 Style number 2 Wood color number for table 3 Options, if selected (see below) ► See <i>Coalesse Surface Materials Reference Guide</i> .

	Options	U.S. Price	Required to Specify
Surface Materials	<ul style="list-style-type: none"> Wood veneer Grade 1 	Prices below	Specify <i>with grade 1 wood veneer</i> and select color number.
	<ul style="list-style-type: none"> Wood veneer Grade 2 	Prices below	Specify <i>with grade 2 wood veneer</i> and select color number.
Related Products	<ul style="list-style-type: none"> 2- and 3-seat lounge 1-seat connector lounge Lounge chairs 		► Page 212 ► Page 216 ► Page 220

Specification Information		
Style Number	U.S. Base Prices	
	Veneer Grades:	
	1	2
COSISTBL	\$831	\$912

 **For Canadian Pricing**
 Multiply U.S. Price by the Canadian price factor.
 ► See page 1 for details.

Sistema Lounge System Ottomans and Accessories

DESIGN LIEVORE ALTHERR MOLINA FOR VICCARBE

Pillows

Standard Includes		Required to Specify
<ul style="list-style-type: none"> ▶ Need help? Product details, page 211 	<ul style="list-style-type: none"> • Pillow: upholstery 	<ul style="list-style-type: none"> 1 Style number 2 Fabric or leather color number 3 Options, if selected (see below) ▶ See <i>Coalesse Surface Materials Reference Guide</i>.

Options	U.S. Price	Required to Specify
Surface Materials <ul style="list-style-type: none"> • Customer's Own Leather (COL) 	+\$181	Specify with COL and select fabric color number.
<ul style="list-style-type: none"> • Acrylic backer 	+\$ 10	Specify with acrylic backer.
Related Products <ul style="list-style-type: none"> • 2- and 3-seat lounge • 1-seat connector lounge • Lounge chairs 		<ul style="list-style-type: none"> ▶ Page 212 ▶ Page 216 ▶ Page 220

Specification Information													
Style Number	U.S. Prices											Leather Grades:	
	Fabric Grades:											C	E
COM	6	7	8	9	10	11	12	13	14				



Overall: 17³/₄"L x 17³/₄"H

Square Pillow

Style Number	COM	6	7	8	9	10	11	12	13	14	C	E
COPILSQ	\$498	\$440	\$457	\$498	\$498	\$528	\$562	\$586	\$627	\$687	\$808	\$896

COM: 1 yard/ 18 sq ft.

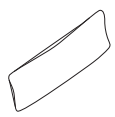

Overall: 20²/₃"L x 9⁵/₈"H

Lumbar Pillow

Style Number	COM	6	7	8	9	10	11	12	13	14	C	E
COPILLM	\$462	\$402	\$417	\$458	\$458	\$487	\$520	\$544	\$583	\$638	\$757	\$841

COM: 1 yard/ 18 sq ft.



For Canadian Pricing
 Multiply U.S. Price by the Canadian price factor.
 ▶ See page 1 for details.

Sistema Lounge System Multi-Fabric Diagram

DESIGN LIEVORE ALTHERR MOLINA FOR VICCARBE

TO: _____

FROM: _____

DATE: _____

FAX....888.413.5161

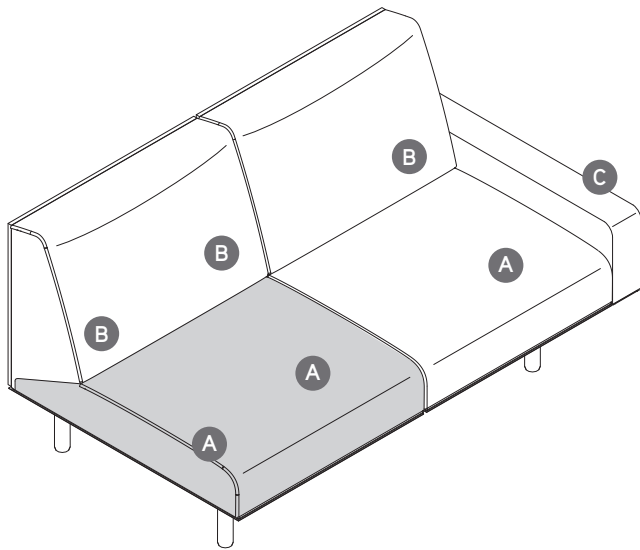

A Seat: _____

B Back: _____

C Arm: _____

Tip: Each individual component is specified and can be ordered in contrasting fabrics.

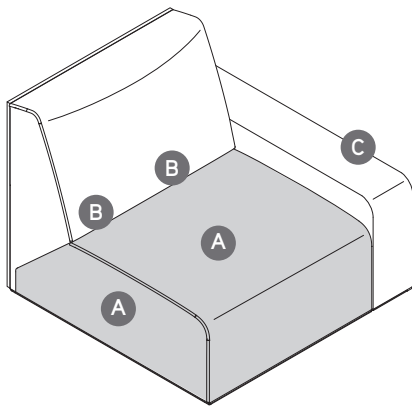

Coalesse

Sistema Lounge System Multi-Fabric Diagram

DESIGN LIEVORE ALTHERR MOLINA FOR VICCARBE

SW_1 Lounge Seating

DESIGN SCOTT WILSON & MINIMAL

Three inches lower than conventional seating and with a more relaxed posture, the SW_1 lounge chair is a conference/lounge hybrid that creates a more intimate and comfortable environment for collaboration.

Tip: This product line is part of a collection and will be found in multiple locations in this specification guide and/or Coalesse Tables, Storage, and Accessories Specification Guide.

► See *Collections*, page 5.

Seat back is available in two heights: a low back 36³/₄"H or a high back 41³/₄"H.

Swivel base has an automatic, return-to-center mechanism.

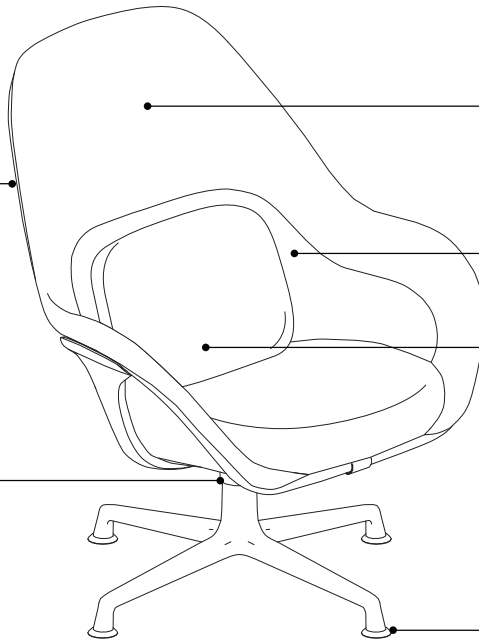

Backrest reclines at an angle of approximately 102° to the seat.

Knit back provides back support and breathability.

Lumbar pillow enhances comfort. It is available in coordinating or contrasting upholstery.

Glides are aluminum with a non-marring, plastic insert.

SW_1 collection features collaboration seating, collaborative and conference tables, and occasional tables.

► For collaboration seating, see page 290.

► For tables, see *Coalesse Tables, Storage, and Accessories Specification Guide*.

SW_1 Lounge Seating

DESIGN SCOTT WILSON & MINIMAL

Product Details



SW_1 lounge seating is available in a low back or high back; the low back overall height is 36³/₄"H, the high back overall height is 41³/₄"H.



Swiveling tablet arm option is available in left- and right-hand models. Tubular steel support arm allows tablet to freely swivel 110° for easy user ingress and egress.

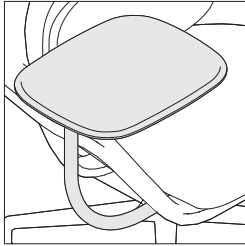

Tablet arm is 12⁵/₃₂" x 15" x 5/8" thick. Tablet surface is available in black or milk.



Lumbar pillow in coordinating or contrasting upholstery is available, 4¹/₄"D x 16¹/₂"W x 10¹/₂"H. Lumbar pillow is relocatable for optimal comfort.

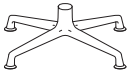

4-star base is aluminum matte polished with non-marring, easy gliding nylon feet.

Swivel return mechanism is standard. It has built in memory and will return to the fixed position when the user leaves the chair.

Surface Materials

► See *Coalesse Surface Materials Reference Guide* for further information.

Upholstery (contrasting fabric available)

- Knit
- Fabric
- Leather

Base

- Aluminum matte polished

Programs and Services

Customer's Own Material/Leather (COM/COL) Program is available.

► See *Coalesse Surface Materials Reference Guide* for further information.

SW_1 Lounge Seating

DESIGN SCOTT WILSON & MINIMAL



Tip: For Customer's Own Material or Leather, see necessary requirements, important processing instructions, and ordering information
 ▶ See *Coalesse Surface Materials Reference Guide*.

	Standard Includes	Required to Specify
▶ Need help? Product details, page 230	<ul style="list-style-type: none"> • Seat and upper back: fabric or leather • Lower back: knit • Base: 8040 Aluminum Matte Polished • Frame: steel tube • Glides: aluminum with non marring plastic insert • Swivel return mechanism • Ottoman, if selected: fabric or leather 	<ol style="list-style-type: none"> 1 Style number 2 Fabric or leather color number for seat, upper back, or ottoman, if selected 3 Knit color number for lower back 4 Options, if selected (see below) ▶ See <i>Coalesse Surface Materials Reference Guide</i> .

	Options	U.S. Price	Required to Specify
Surface Materials	<ul style="list-style-type: none"> • Contrasting fabric 	+\$ 182	Specify with <i>contrasting fabric</i> and select fabric color number.
	Acrylic backer		
	• Chairs	+\$ 46	Specify with <i>acrylic backer</i> .
	• Ottoman	+\$ 17	Specify with <i>acrylic backer</i> . ▶ See <i>Coalesse Surface Materials Reference Guide</i> .
	Lumbar pillow for lounge chairs		
	• Fabric group 6	+\$ 39	Specify fabric color number.
	• Fabric group 7	+\$ 47	Specify fabric color number.
	• Fabric group 8	+\$ 59	Specify fabric color number.
	• Fabric group 9	+\$ 97	Specify fabric color number.
	• Fabric group 10	+\$ 120	Specify fabric color number.
	• Fabric group 11	+\$ 150	Specify fabric color number.
	• Fabric group 12	+\$ 168	Specify fabric color number.
	• Fabric group 13	+\$ 205	Specify fabric color number.
	• Fabric group 14	+\$ 254	Specify fabric color number.
	• Leather group C	+\$ 376	Specify leather color number.
	• Leather group E	+\$ 385	Specify leather color number.
	• Customer's Own Material (COM)	+\$ 60	Specify fabric color number. ▶ See <i>Coalesse Surface Materials Reference Guide</i> .
	• Customer's Own Leather (COL)	+\$ 409	Specify leather color number. ▶ See <i>Coalesse Surface Materials Reference Guide</i> .
Lumbar Pillow	<ul style="list-style-type: none"> • No pillow • Pillow 	No cost +\$ 341	Specify with <i>no pillow</i> . Specify with <i>pillow</i> .
Swivel Mechanism	<ul style="list-style-type: none"> • Swivel-only mechanism (omit return feature) 	No cost	Specify with <i>swivel-only mechanism</i> .
Tablet	<ul style="list-style-type: none"> • No tablet • Right tablet (seated position) • Left tablet (seated position) 	No cost +\$1020 +\$1020	Specify with <i>no tablet</i> . Specify with <i>right tablet</i> and select 6000 Black or 6052 Milk finish. Specify with <i>left tablet</i> and select 6000 Black or 6052 Milk finish.
Related Products	<ul style="list-style-type: none"> • Collaborative and conference tables • Occasional tables • Collaboration seating 		▶ See <i>Coalesse Tables, Storage, and Accessories Specification Guide</i> . ▶ See <i>Coalesse Tables, Storage, and Accessories Specification Guide</i> . ▶ Page 290



Top of Cushion to Bottom of Tablet: 8 1/2"H

Tip: Paint on lounge tablet arm support will complement 8040 Aluminum Matte polished base.

Tip: Handedness is determined while in the seated position.



For Canadian Pricing
 Multiply U.S. Price by the Canadian price factor.
 ▶ See page 1 for details.

SW_1 Lounge Seating

DESIGN SCOTT WILSON & MINIMAL

Specification Information

Style Number	U.S. Base Prices											Leather Grades:		
	Fabric Grades:											COL	C	E
	COM	6	7	8	9	10	11	12	13	14				



Overall: 28 1/4"D 32 1/4"W 36 3/4"H
 Seat: 16"H
 Arm: 23"H

Low-Back Collaborative Lounge Chair

Style Number	Seat	COM	6	7	8	9	10	11	12	13	14	COL	C	E
COW613		\$3189	\$3189	\$3198	\$3214	\$3256	\$3287	\$3323	\$3346	\$3387	\$3447	\$3266	\$ 3612	\$3660
	Upper back	+\$108	+\$108	+\$130	+\$162	+\$273	+\$340	+\$421	+\$477	+\$574	+\$710	+\$ 287	+\$1090	+\$1211

COM/yds = 3, COL/sq ft = 60
 Pillow COM/yds = 1 1/4, COL/sq ft = 27 1/2



Overall: 30"D 32 1/4"W 41 3/4"H
 Seat: 16"H
 Arm: 23"H

High-Back Collaborative Lounge Chair

Style Number	Seat	COM	6	7	8	9	10	11	12	13	14	COL	C	E
COW713		\$3709	\$3709	\$3718	\$3734	\$3776	\$3807	\$3843	\$3866	\$3907	\$3967	\$3786	\$ 4132	\$4180
	Upper back	+\$108	+\$108	+\$130	+\$162	+\$273	+\$340	+\$421	+\$477	+\$574	+\$710	+\$ 287	+\$1090	+\$1211

COM/yds = 3, COL/sq ft = 60
 Pillow COM/yds = 1 1/4, COL/sq ft = 27 1/2



Overall: 20"D 23"W 14"H

Ottoman

Style Number	COM	6	7	8	9	10	11	12	13	14	COL	C	E
COW210	\$1654	\$1645	\$1655	\$1672	\$1724	\$1755	\$1793	\$1821	\$1869	\$1934	\$2003	\$ 2160	\$2220

COM/yds = 1, COL/sq ft = 22



For Canadian Pricing
 Multiply U.S. Price by the
 Canadian price factor.
 ▶ See page 1 for details.

SW_1 Lounge Seating Multi-Fabric Diagram

DESIGN STUDIO B

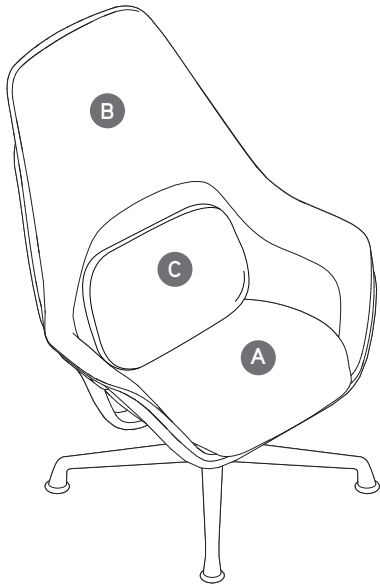

TO: _____

FROM: _____

DATE: _____

FAX....888.413.5161

A Seat: _____

B Upper Back: _____

C Lumbar Pillow: _____

Contrasting fabric charges will apply. List price based on highest grade textile specified.

See specifying for contrasting textile upcharge based on highest grade textile specified. Lumbar pillow, specified separately as an option, is not included in upcharge for contrasting.

Specify Model below:

COW613 Low-Back Collaborative Lounge Chair

COW713 High-Back Collaborative Lounge Chair

Coalesse

SW_1 Lounge Seating Multi-Fabric Diagram

DESIGN STUDIO B

Switch Lounge Seating

DESIGN E00S

Switch lounge seating combines comfort and elegant design, featuring double needle stitch detail and satin finish steel legs.

Tip: This product line is part of a collection and will be found in multiple locations in this specification guide and/or Coalesse Tables, Storage, and Accessories Specification Guide.

► See *Collections*, page 5.

Upholstery features multiple densities of polyurethane foam and polyester fiber on seat back and arms.

Arm bolster pillows are available with optional attachment straps.

Frame is solid hardwood and wood veneer.

Base features four tubular steel legs with adjustable glides.

Loose back and seat cushions are standard. Attachment straps are available.

Occasional tables are available in three sizes, with a $\frac{5}{8}$ " thick, green tinted, tempered glass top. Legs are visually compatible with seating with adjustable glides.

► See *Coalesse Tables, Storage, and Accessories Specification Guide*

Switch collection features guest seating and stools.

► Pages 332 and 379

Switch Lounge Seating

DESIGN E00S

Product Details

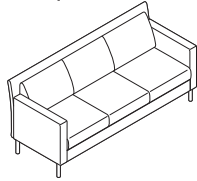
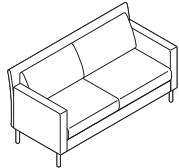
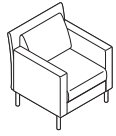

Standard lounge seating is available as a 1-, 2-, or 3-seat model.

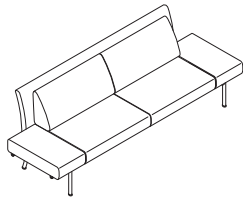

2-seat lounge with extensions allows users to fold the arms up and down, independent of each other, extending the overall width to 96"W.

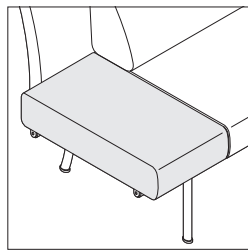

Extensions in the down position offer additional surface area for belongings.

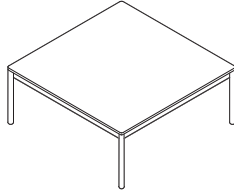
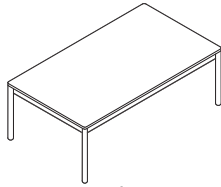
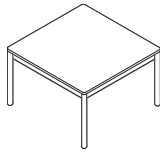

Occasional tables are available in three sizes: square 24³/₈"D x 24³/₈"W x 15"H, rectangle 24³/₈"D x 43¹/₄"W x 15"H, and square 36"D x 36"W x 15"H.



Arm bolster in coordinating fabric is available (17¹/₂"D x 5³/₄" diameter).

Surface Materials

► See *Coalesse Surface Materials Reference Guide* for further information.

Upholstery

- Fabric
- Leather

Base

- Matte chrome finish

Programs and Services

Customer's Own Material/Leather (COM/COL) Program is available.

► See *Coalesse Surface Materials Reference Guide* for further information.

Switch Lounge Seating

DESIGN E00S

Tip: Fabrics and leathers will appear loose with comfort wrinkles when upholstered.

Tip: Due to seat conversion arms are 4 1/2" W. Lowered arm has weight limit of 100 lb.

Tip: Recommended leathers are Elmosoft Grade C and Elmorustical Grade E.

► For multi-fabric diagram, see page 240.

Tip: Loose cushions standard.

Tip: Arm bolsters must be specified separately.

Tip: Special color match, consult Customer Service.

Tip: For Customer's Own Material or Leather, see necessary requirements, important processing instructions, and ordering information

► See *Coalesse Surface Materials Reference Guide*.

Tip: 391-4 2-seat with extensions, when extended: Both arms = 96"W overall One arm = 84"W overall Arms not extended = 71"W overall (closed).

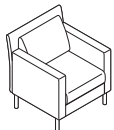

Overall: 29 1/2"D 28"W 32 1/2"H
Inside: 19"D 20"W 17"H
Seat: 18 1/2"H
Arm: 26"H

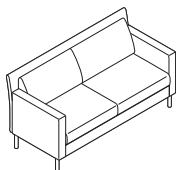

Overall: 24 1/2"D 62"W 33"H
Inside: 19"D 54 1/2"W 33"H
Seat: 18 1/2"H
Arm: 26 1/4"H



For Canadian Pricing
 Multiply U.S. Price by the Canadian price factor.

► See page 1 for details.

Standard Includes

- Need help? Product details, page 236
- Selected solid hardwood and wood veneer frame
- 2-seat lounge with extension: tubular steel frame with solid hardwood arms
 - Arms are 4 1/2" wide
- Upholstery: multiple densities of polyurethane foam and polyester fiber on seat back and arms
- Legs: matte chrome finish on steel
- Arm bolster, if selected: fabric or leather

Required to Specify

- 1 Style number
 - 2 Number of fabrics if contrasting fabric style number is selected
 - 3 Fabric or leather color number for upholstery on seat, back, and arms, or arm bolsters, if selected
 - 4 Options, if selected (see below)
- See *Coalesse Surface Materials Reference Guide*.

Options

Surface Materials	Options	U.S. Price	Required to Specify
	• Contrasting fabric	+\$182 per fabric	Add suffix K to the style number and select fabric color number.
	Acrylic backer		
	• Lounge chair	+\$ 60	Specify with acrylic backer.
	• 2-seat lounge	+\$112	Specify with acrylic backer.
	• 3-seat lounge	+\$119	Specify with acrylic backer.
	• 2-seat lounge with extensions	+\$134	Specify with acrylic backer.
	• Arm bolster	+\$ 10	Specify with acrylic backer.
			► See <i>Coalesse Surface Materials Reference Guide</i> .
	Attachment Straps		
	• 391	+\$195	Specify with attachment straps.
	• 391-2	+\$390	Specify with attachment straps.
	• 391-3	+\$585	Specify with attachment straps.
	• 391-4	+\$390	Specify with attachment straps.
	• Bolster	+\$101	Specify with attachment straps.
	Related Products		
	• Guest seating		► Page 332
	• Stools		► Page 379
	• Occasional tables		► See <i>Coalesse Tables, Storage, and Accessories Specification Guide</i> .

Specification Information

Style Number	U.S. Base Prices														Leather Grades:		
	Fabric Grades:														COL	C	E
	COM	6	7	8	9	10	11	12	13	14							

Lounge Chair

391	\$3608	\$3615	\$3660	\$3734	\$3965	\$4110	\$4282	\$4402	\$4611	\$4906	\$3866	\$ 7646	\$ 8656
-----	--------	--------	--------	--------	--------	--------	--------	--------	--------	--------	--------	---------	---------

COM/yds = 4 1/2, COL/sq ft = 99

2-Seat Lounge

391-2	\$5522	\$5681	\$5755	\$5882	\$6264	\$6508	\$6796	\$6994	\$7345	\$7837	\$5781	\$11,933	\$13,395
-------	--------	--------	--------	--------	--------	--------	--------	--------	--------	--------	--------	----------	----------

COM/yds = 7 1/2, COL/sq ft = 165

► Specification Information, continued on next page

Switch Lounge Seating

DESIGN E00S

► Specification Information, continued from previous page

Specification Information

Style Number	U.S. Base Prices										Leather Grades:		
	Fabric Grades:										COL	C	E
	COM	6	7	8	9	10	11	12	13	14			

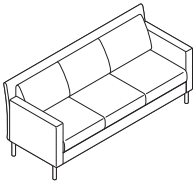

Overall: 30½"D 73"W 33"H
 Inside: 20"D 66"W 33"H
 Seat: 20"D 18¾"H
 Arm: 26¼"H

3-Seat Lounge

391-3	\$7251	\$7435	\$7514	\$7648	\$8056	\$8320	\$8625	\$8834	\$9213	\$ 9735	\$7510	\$15,746	\$17,585
-------	--------	--------	--------	--------	--------	--------	--------	--------	--------	---------	--------	----------	----------

COM/yds = 8, COL/sq ft = 176

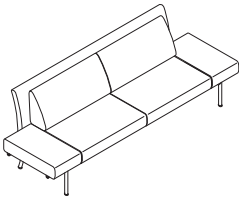

Lounge overall: 35"D 70½"W 33"H
 Overall extended: 35"D 95½"W 33"H
 Seat: 23"D 16¼"H
 Arm: 29"D 26½"W
 One arm up: 77"W

2-Seat Lounge with Extensions

391-4	\$7681	\$7919	\$8005	\$8157	\$8615	\$8911	\$9253	\$9492	\$9916	\$10,506	\$7940	\$17,375	\$19,429
-------	--------	--------	--------	--------	--------	--------	--------	--------	--------	----------	--------	----------	----------

COM/yds = 9, COL/sq ft = 198



Overall: 17½"D 5¾"Dia

Arm Bolster

391-B	\$ 361	\$ 352	\$ 362	\$ 379	\$ 431	\$ 462	\$ 500	\$ 528	\$ 576	\$ 641	\$ 790	\$ 1189	\$ 1582
-------	--------	--------	--------	--------	--------	--------	--------	--------	--------	--------	--------	---------	---------

COM/yds = 1, COL/sq ft = 18

Lounge Seating

 **For Canadian Pricing**
 Multiply U.S. Price by the
 Canadian price factor.
 ► See page 1 for details.

Switch Lounge Seating Multi-Fabric Diagram

DESIGN E00S

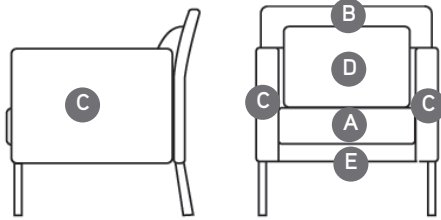

Model 391 Shown Above

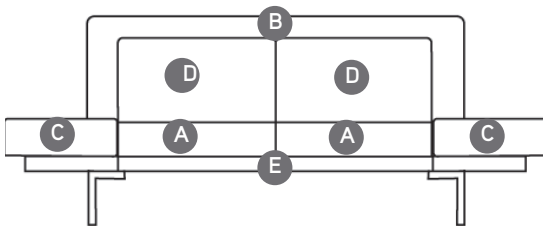

Model 391-4 Shown Above

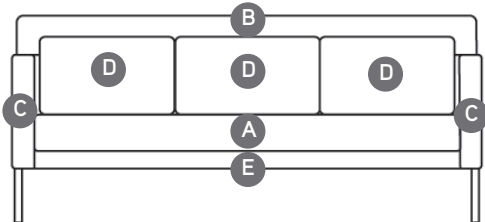

391-3 Shown Above

TO: _____

FROM: _____

DATE: _____

FAX....888.413.5161

A Seat (upholstery selections default for entire unit if B is not selected): _____

B Back: _____

C Arm: _____

D Back Cushion: _____

E Base Frame: _____

Due to soft nature of loose cushions, genuine leathers are recommended. All other textiles must be submitted for pre-approval.

Tip: Arm bolsters must be specified separately.

See specifying for contrasting fabric upcharge. List price based on highest fabric grade usage.

Specify Model below:

391K Switch Lounge Chair

391-2K Switch 2-Seat Lounge (not shown)

391-3K Switch 3-Seat Lounge

391-4K Switch 2-Seat Lounge with Extension

Coalesse

Switch Lounge Seating Multi-Fabric Diagram

DESIGN E00S

Thoughtful Lounge Seating

DESIGN PAMELA LIGHT, FIIDA SHIELDS

Thoughtful lounge seating features a slightly winged back for comfort, while double needle stitching and upholstery detail provides effortless style.

Frame is a unibody construction with finger jointed plywood.

Backrest embraces the user with a sweeping, concave design and side wings.

Base features four solid hardwood legs with subtle curve design; non-adjustable glides standard.

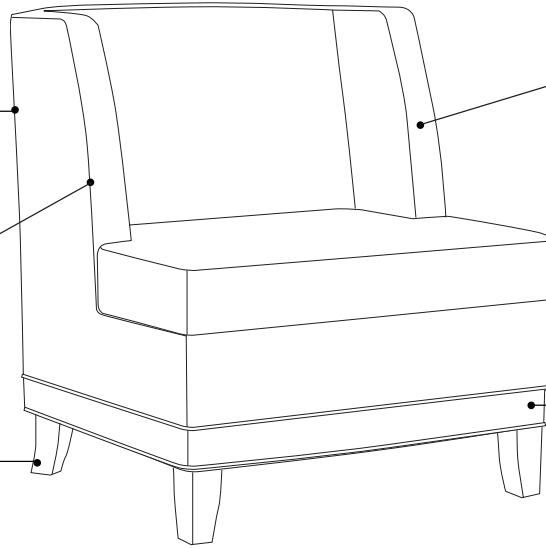

Upholstery features double needle stitching detail on the seams.

Contrast welting around base is available.

Matching ottoman is also available.

Thoughtful Lounge Seating

DESIGN PAMELA LIGHT, FIIDA SHIELDS

Product Details

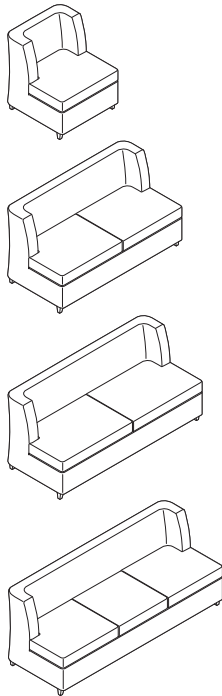

Lounge seating is available in four styles: lounge chair, small lounge, medium lounge, and long lounge; ranging in widths from 28³/₄"W to 80³/₄"W. All styles are fully upholstered with four solid hardwood maple or walnut legs. The base features a two-tiered welt design which wraps around the entire lounge chair/lounge.

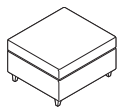

Matching ottoman carries the design signature of the lounge seating and features the same four legs and two-tiered base welting; 26¹/₄"D x 28¹/₂"W x 17³/₄"H.

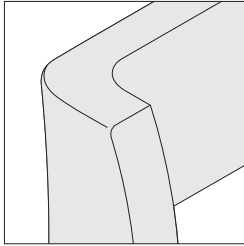

Side wings and sweeping concave design of the backrest provide the user with the feeling of being embraced.

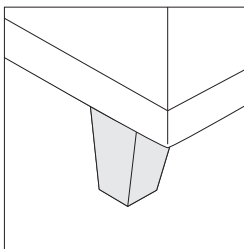

Base features four solid hardwood legs; non-adjustable glides are standard. Two-tiered welt design on base is available in contrasting welting to create a unique aesthetic.

Surface Materials

► See *Coalesse Surface Materials Reference Guide* for further information.

Upholstery

- Fabric
- Leather

Legs

- Solid maple wood
- Solid walnut wood

Programs and Services

Customer's Own Material/Leather (COM/COL) Program is available.

► See *Coalesse Surface Materials Reference Guide* for further information.

Thoughtful Lounge Seating

DESIGN PAMELA LIGHT, FIIDA SHIELDS

Tip: Fabrics and leathers will appear loose with comfort wrinkles when upholstered.

Tip: All polyurethane foam meets CAL-117 specifications.

Tip: Pricing based on highest grade textile specified.

Tip: Seats will always have some comfort wrinkles. The amount of wrinkles will vary depending on the fabric.

Tip: When contrasting fabric and non-contrasting welt are selected, the welt will match the base fabric.

Tip: Welting COM yardage required = 1/2 yards or 22 square feet.

Tip: Recommended leathers are Elmosoft Grade C and Elmorustical Grade E.

Tip: Special color match, consult Customer Service.

Tip: For Customer's Own Material or Leather, see necessary requirements, important processing instructions, and ordering information
 ▶ See *Coalesse Surface Materials Reference Guide*.

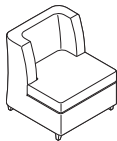

Overall: 29¾"D 28¾"W 32"H
Inside: 20"D 21½"W 14½"H
Seat: 17½"H

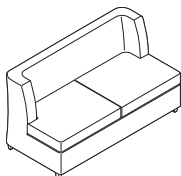

Overall: 30¼"D 60¾"W 32"H
Inside: 20¼"D 53½"W 14½"H
Seat: 17½"H

Standard Includes	Required to Specify
-------------------	---------------------

- | | | |
|--|---|---|
| ▶ Need help? Product details, page 242 | <ul style="list-style-type: none"> • Frame: unibody construction with finger jointed plywood • Legs: solid maple or walnut wood • Upholstery: multiple densities of polyurethane foam • Double needle stitch on seams | 1 Style number
2 Number of fabrics if contrasting fabric style number is selected
3 Fabric or leather color number for upholstery on seat and back
4 Wood species
5 Wood color number for legs
6 Options, if selected (see below)
▶ See <i>Coalesse Surface Materials Reference Guide</i> . |
|--|---|---|

Options	U.S. Price	Required to Specify
---------	------------	---------------------

Surface Materials	<ul style="list-style-type: none"> • Contrasting fabric +\$182 per fabric • Contrasting welt for welting around base of chair +\$284 	Add suffix K to the style number and select fabric color number. Specify <i>with contrasting welt</i> and select fabric color number.
	Acrylic backer <ul style="list-style-type: none"> • Lounge chair +\$ 77 • Small lounge +\$148 • Medium lounge +\$165 • Long lounge +\$182 • Ottoman +\$ 39 	Specify <i>with acrylic backer</i> . Specify <i>with acrylic backer</i> . Specify <i>with acrylic backer</i> . Specify <i>with acrylic backer</i> . Specify <i>with acrylic backer</i> . ▶ See <i>Coalesse Surface Materials Reference Guide</i> .

Specification Information													
Style Number	U.S. Base Prices											Leather Grades:	
	Fabric Grades:											COL C E	
COM	6	7	8	9	10	11	12	13	14				

Lounge Chair

385	\$3291	\$3366	\$3458	\$3512	\$3664	\$3792	\$4143	\$4382	\$4528	\$5050	\$3553	\$ 7765	\$ 8516
COM/yds = 5½, COL/sq ft = 121													

Small Lounge

385-60	\$6005	\$6324	\$6506	\$6647	\$6921	\$7149	\$7837	\$8283	\$8558	\$9541	\$6268	\$14,363	\$15,801
COM/yds = 10½, COL/sq ft = 231													

▶ Specification Information, continued on next page



For Canadian Pricing
 Multiply U.S. Price by the Canadian price factor.
 ▶ See page 1 for details.

Thoughtful Lounge Seating

DESIGN PAMELA LIGHT, FIIDA SHIELDS

► Specification Information, continued from previous page

Specification Information

Style Number	U.S. Base Prices														Leather Grades:		
	Fabric Grades:														COL	C	E
	COM	6	7	8	9	10	11	12	13	14							

Medium Lounge

385-70	\$7979	\$8373	\$8574	\$8716	\$9019	\$9268	\$10,012	\$10,526	\$10,816	\$12,200	\$8263	\$17,112	\$18,702
--------	--------	--------	--------	--------	--------	--------	----------	----------	----------	----------	--------	----------	----------

COM/yds = 11½, COL/sq ft = 253

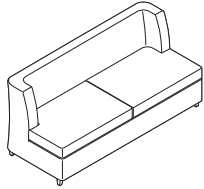

Overall: 30¾"D 70¾"W 32"H
 Inside: 20½"D 63½"W 14½"H
 Seat: 17½"H

Long Lounge

385-80	\$8387	\$8817	\$9060	\$9218	\$9560	\$9818	\$10,664	\$11,227	\$11,539	\$12,901	\$8657	\$18,509	\$20,258
--------	--------	--------	--------	--------	--------	--------	----------	----------	----------	----------	--------	----------	----------

COM/yds = 12¾, COL/sq ft = 281

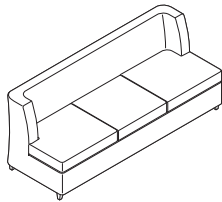

Overall: 31¼"D 80¾"W 32"H
 Inside: 20¾"D 73½"W 14½"H
 Seat: 17½"H

Ottoman

385-H	\$2416	\$2428	\$2474	\$2513	\$2582	\$2650	\$ 2832	\$ 2944	\$ 3006	\$ 3375	\$2774	\$ 4852	\$ 5224
-------	--------	--------	--------	--------	--------	--------	---------	---------	---------	---------	--------	---------	---------

COM/yds = 2¾, COL/sq ft = 61

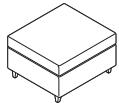

Overall: 26¼"D 28½"W 17¾"H

Lounge Seating



For Canadian Pricing
 Multiply U.S. Price by the
 Canadian price factor.
 ► See page 1 for details.

Thoughtful Lounge Seating Multi-Fabric Diagram

DESIGN PAMELA LIGHT, FIIDA SHIELDS

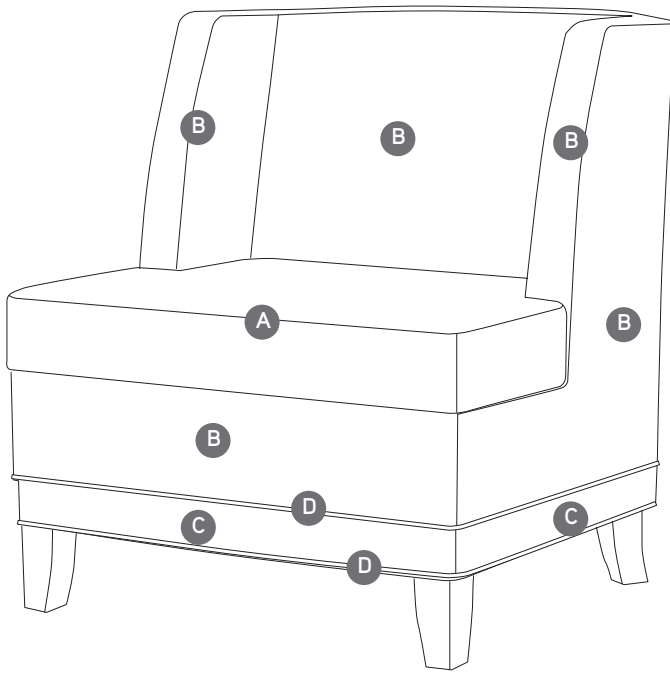

TO: _____

FROM: _____

DATE: _____

FAX....888.413.5161

A Seat (default for entire unit if B is not selected):

B Arms and Back: _____

C Base Frame: _____

D Welt: _____

Please indicate which model:

- 385K
- 385-60K
- 385-70K
- 385-80K

Total list price upcharge for contrasting fabrics: \$ _____

See specifying for contrasting fabric upcharge. List price based on highest fabric grade usage.

***Contrasting welt offered as a separate option.**

Tip: When contrasting fabric and non-contrasting welt are selected, the welt will match base frame.

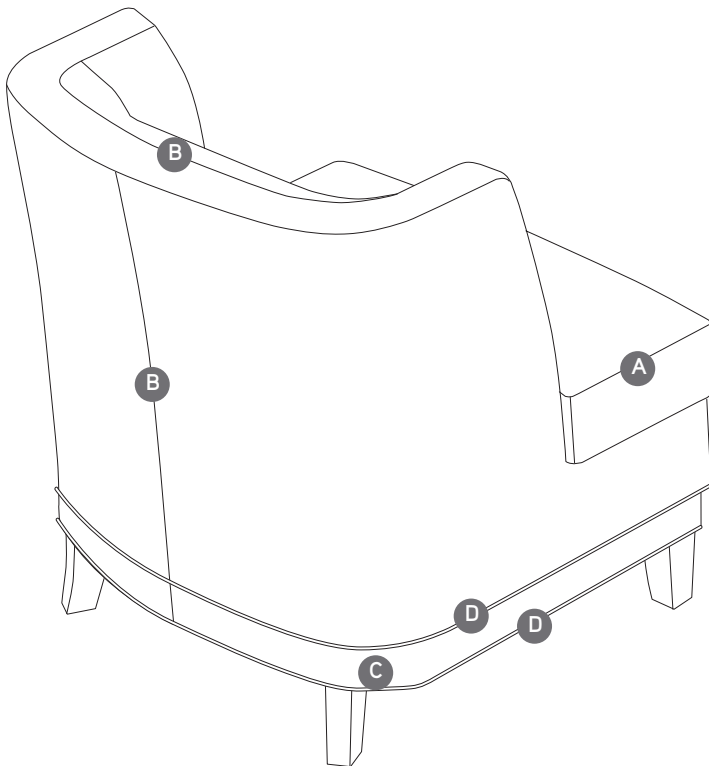

Coalesse

Thoughtful Lounge Seating Multi-Fabric Diagram

DESIGN PAMELA LIGHT, FIIDA SHIELDS

Together Benches by Walter Knoll

DESIGN E00S

Together elevates the upholstered bench to an impressive new height while reinventing the corner seat. Corner shapes define space and create rooms within rooms; straight benches offer open seating.

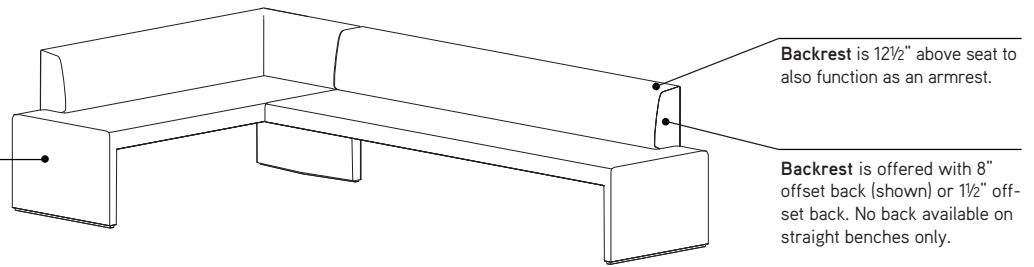

End and corner legs are fully upholstered panels featuring fixed glides.

Together features straight benches and corner benches, available in varying dimensions.

Backrest is 12½" above seat to also function as an armrest.

Backrest is offered with 8" offset back (shown) or 1½" offset back. No back available on straight benches only.

Together Benches by Walter Knoll

DESIGN EOOS

Product Details

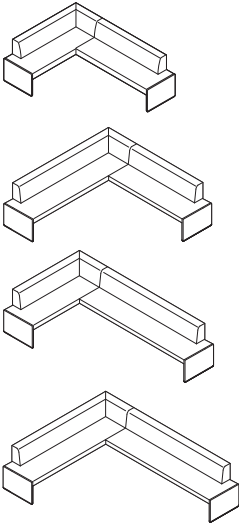

Left corner with back, 8" offset styles are 31"H and are available in four overall sizes: 70½"D x 96¼"W, 97¼"D x 96¼"W, 70½"D x 123"W, and 97¼"D x 123"W.

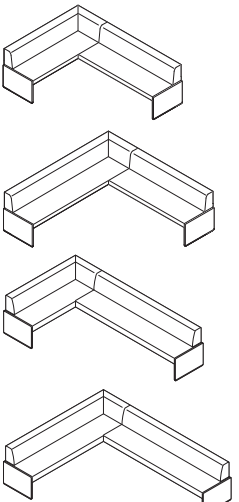

Left corner with back, 1½" offset styles are 31"H and are available in four overall sizes: 70½"D x 96¼"W, 97¼"D x 96¼"W, 70½"D x 123"W, and 97¼"D x 123"W.

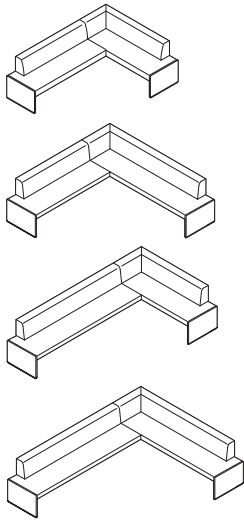

Right corner with back, 8" offset styles are 31"H and are available in four overall sizes: 70½"D x 96¼"W, 97¼"D x 96¼"W, 70½"D x 123"W, and 97¼"D x 123"W.

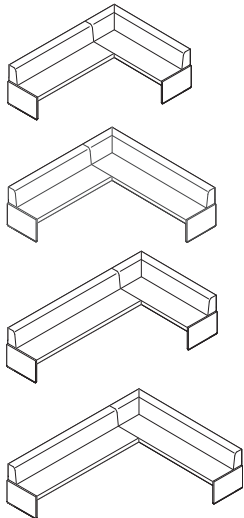

Right corner with back, 1½" offset styles are 31"H and are available in four overall sizes: 70½"D x 96¼"W, 97¼"D x 96¼"W, 70½"D x 123"W, and 97¼"D x 123"W.

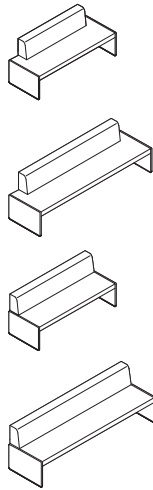

Straight with back styles are available with 8" offset or 1½" offset; all with 26¾"D and 31"H.

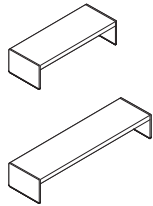

Straight without back styles are available with 26¾"D and 18½"H. Available in two sizes: 71"W and 97¾"W.

Surface Materials

► See *Coalesse Surface Materials Reference Guide* for further information.

Upholstery

- Fabric
- Leather

Programs and Services

Customer's Own Material/Leather (COM/COL) Program is available.

► See *Coalesse Surface Materials Reference Guide* for additional information.

Together Benches by Walter Knoll

DESIGN E00S

Tip: Fabrics and leathers will appear loose with comfort wrinkles when upholstered.

▶ See page 256 for multi-fabric diagram.

▶ See page 257 for offset diagram.

Tip: For Customer's Own Material or Leather, see necessary requirements, important processing instructions, and ordering information
▶ See *Coalesse Surface Materials Reference Guide*.

Standard Includes		Required to Specify	
▶ Need help? Product details, page 248	<ul style="list-style-type: none"> Upholstery for chair: fabric or leather Glides 	1 Style number	2 Number of fabrics if contrasting fabric style number is selected
		3 Fabric or leather color number for upholstery	4 Options, if selected (see below)
		▶ See <i>Coalesse Surface Materials Reference Guide</i> .	

Options	U.S. Price	Required to Specify	
Surface Materials		Add suffix K to the style number and select fabric color number.	
<ul style="list-style-type: none"> Contrasting fabric 	+\$182 per fabric		
Acrylic backer			
<ul style="list-style-type: none"> 71"W straight bench without back 	+\$ 53	Specify with acrylic backer.	
<ul style="list-style-type: none"> 97¾"W straight bench without back 	+\$ 60	Specify with acrylic backer.	
<ul style="list-style-type: none"> 26¾"D x 71"W benches 	+\$ 76	Specify with acrylic backer.	
<ul style="list-style-type: none"> 26¾"D x 97¾"W and 97⁷/₁₀"W benches 	+\$ 88	Specify with acrylic backer.	
<ul style="list-style-type: none"> 69¾"D x 96¼"W benches 	+\$144	Specify with acrylic backer.	
<ul style="list-style-type: none"> 96½"D x 96¼"W and 69¾"D x 123"W benches 	+\$165	Specify with acrylic backer.	
<ul style="list-style-type: none"> 96½"D x 123"W bench 	+\$182	Specify with acrylic backer.	
		▶ See <i>Coalesse Surface Materials Reference Guide</i> .	
Back Offset	<ul style="list-style-type: none"> Back offset 	No cost	Specify with back offset.

Specification Information

Style Number	U.S. Base Prices											Leather Grades:		
	Fabric Grades:											COL	C	E
	COM	6	7	8	9	10	11	12	13	14				

Left Corner with Back, 8" Offset

COT09669L8	\$12,005	\$12,278	\$12,375	\$12,541	\$13,037	\$13,354	\$13,727	\$13,985	\$14,446	\$15,083	\$12,189	\$18,168	\$19,235
-------------------	----------	----------	----------	----------	----------	----------	----------	----------	----------	----------	----------	----------	----------

COM/yds = 9¾, COL/sq ft = 215

COT09696L8	\$12,933	\$13,260	\$13,366	\$13,546	\$14,092	\$14,447	\$14,854	\$15,140	\$15,644	\$16,351	\$13,117	\$19,720	\$20,896
-------------------	----------	----------	----------	----------	----------	----------	----------	----------	----------	----------	----------	----------	----------

COM/yds = 10¾, COL/sq ft = 237

▶ Specification Information, continued on next page

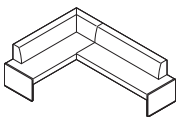

Overall: 70½"D 96¼"W 31"H
Seat: 19"D 18½"H

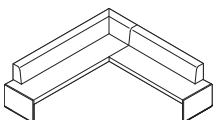

Overall: 97¼"D 96¼"W 31"H
Seat: 19"D 18½"H



For Canadian Pricing
Multiply U.S. Price by the Canadian price factor.
▶ See page 1 for details.

Together Benches by Walter Knoll

DESIGN EOOS

► See page 257 for offset diagram.

► Specification Information, continued from previous page

Specification Information

Style Number	U.S. Base Prices														Leather Grades:		
	Fabric Grades:														COL	C	E
	COM	6	7	8	9	10	11	12	13	14							

Left Corner with Back, 8" Offset, continued

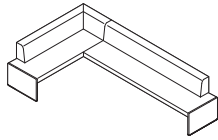

Overall: 70½"D 123"W 31"H
Seat: 19"D 18½"H

COTO12369L8	\$13,301	\$13,654	\$13,763	\$13,951	\$14,524	\$14,893	\$15,322	\$15,619	\$16,148	\$16,886	\$13,485	\$20,398	\$21,630			
--------------------	----------	----------	----------	----------	----------	----------	----------	----------	----------	----------	----------	----------	----------	--	--	--

COM/yds = 11¼, COL/sq ft = 248

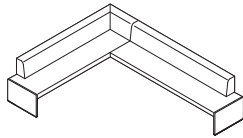

Overall: 97¼"D 123"W 31"H
Seat: 19"D 18½"H

COTO12396L8	\$13,969	\$14,386	\$14,509	\$14,717	\$15,355	\$15,763	\$16,241	\$16,571	\$17,161	\$17,980	\$14,153	\$21,684	\$23,030			
--------------------	----------	----------	----------	----------	----------	----------	----------	----------	----------	----------	----------	----------	----------	--	--	--

COM/yds = 12½, COL/sq ft = 270

Left Corner with Back, 1½" Offset

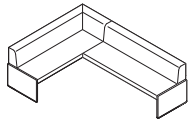

Overall: 70½"D 96¼"W 31"H
Seat: 19"D 18½"H

COTO9669L15	\$12,258	\$12,556	\$12,659	\$12,831	\$13,353	\$13,689	\$14,080	\$14,354	\$14,836	\$15,504	\$12,442	\$18,733	\$19,856			
--------------------	----------	----------	----------	----------	----------	----------	----------	----------	----------	----------	----------	----------	----------	--	--	--

COM/yds = 10¼, COL/sq ft = 226

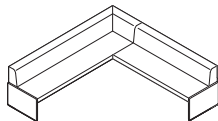

Overall: 97¼"D 96¼"W 31"H
Seat: 19"D 18½"H

COTO9669L15	\$13,188	\$13,541	\$13,650	\$13,838	\$14,411	\$14,780	\$15,209	\$15,506	\$16,035	\$16,773	\$13,372	\$20,285	\$21,517			
--------------------	----------	----------	----------	----------	----------	----------	----------	----------	----------	----------	----------	----------	----------	--	--	--

COM/yds = 11¼, COL/sq ft = 248

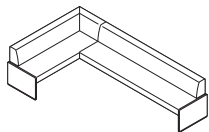

Overall: 70½"D 123"W 31"H
Seat: 19"D 18½"H

COTO12369L15	\$13,551	\$13,928	\$14,045	\$14,242	\$14,837	\$15,226	\$15,672	\$15,981	\$16,536	\$17,305	\$13,735	\$20,960	\$22,247			
---------------------	----------	----------	----------	----------	----------	----------	----------	----------	----------	----------	----------	----------	----------	--	--	--

COM/yds = 11¾, COL/sq ft = 259

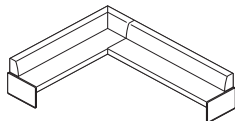

Overall: 97¼"D 123"W 31"H
Seat: 19"D 18½"H

COTO12396L15	\$14,222	\$14,651	\$14,777	\$14,991	\$15,639	\$16,056	\$16,543	\$16,880	\$17,480	\$18,314	\$14,406	\$22,248	\$23,648			
---------------------	----------	----------	----------	----------	----------	----------	----------	----------	----------	----------	----------	----------	----------	--	--	--

COM/yds = 12¾, COL/sq ft = 281

► Specification Information, continued on next page



For Canadian Pricing
Multiply U.S. Price by the Canadian price factor.

► See page 1 for details.

Together Benches by Walter Knoll *continued*

DESIGN EOOS

Tip: For Customer's Own Material or Leather, see necessary requirements, important processing instructions, and ordering information
 ▶ See Coalesse Surface Materials Reference Guide.

Tip: Fabrics and leathers will appear loose with comfort wrinkles when upholstered.

▶ See page 257 for offset diagram.

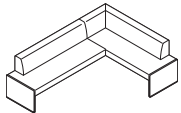

Overall: 70½"D 96¼"W 31"H
 Seat: 19"D 18½"H

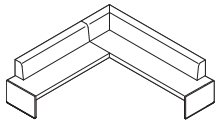

Overall: 97¼"D 96¼"W 31"H
 Seat: 19"D 18½"H

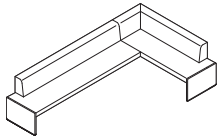

Overall: 70½"D 123"W 31"H
 Seat: 19"D 18½"H

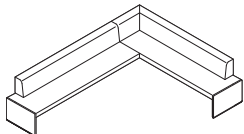

Overall: 97¼"D 123"W 31"H
 Seat: 19"D 18½"H

▶ Specification Information, continued from previous page

Specification Information

Style Number	U.S. Base Prices														Leather Grades:		
	Fabric Grades:														COL	C	E
	COM	6	7	8	9	10	11	12	13	14							

Right Corner with Back, 8" Offset

COTO9669R8	\$12,005	\$12,278	\$12,375	\$12,541	\$13,037	\$13,354	\$13,727	\$13,985	\$14,446	\$15,083	\$12,189	\$18,168	\$19,235
-------------------	----------	----------	----------	----------	----------	----------	----------	----------	----------	----------	----------	----------	----------

COM/yds = 9¾, COL/sq ft = 215

COTO9696R8	\$12,933	\$13,260	\$13,366	\$13,546	\$14,092	\$14,447	\$14,854	\$15,140	\$15,644	\$16,351	\$13,117	\$19,720	\$20,896
-------------------	----------	----------	----------	----------	----------	----------	----------	----------	----------	----------	----------	----------	----------

COM/yds = 10¾, COL/sq ft = 237

COTO12369R8	\$13,301	\$13,654	\$13,763	\$13,951	\$14,524	\$14,893	\$15,322	\$15,619	\$16,148	\$16,886	\$13,485	\$20,398	\$21,630
--------------------	----------	----------	----------	----------	----------	----------	----------	----------	----------	----------	----------	----------	----------

COM/yds = 11¼, COL/sq ft = 248

COTO12396R8	\$13,969	\$14,386	\$14,509	\$14,717	\$15,355	\$15,763	\$16,241	\$16,571	\$17,161	\$17,980	\$14,153	\$21,684	\$23,030
--------------------	----------	----------	----------	----------	----------	----------	----------	----------	----------	----------	----------	----------	----------

COM/yds = 12½, COL/sq ft = 270

▶ Specification Information, continued on next page



For Canadian Pricing
 Multiply U.S. Price by the Canadian price factor.
 ▶ See page 1 for details.

Together Benches by Walter Knoll

DESIGN EOOS

► See page 257 for offset diagram.

► Specification Information, continued from previous page

Specification Information

Style Number	U.S. Base Prices										Leather Grades:		
	Fabric Grades:										14	COL	C
	COM	6	7	8	9	10	11	12	13				

Right Corner with Back, 1 1/2" Offset

COTO9669R15 \$12,258 \$12,556 \$12,659 \$12,831 \$13,353 \$13,689 \$14,080 \$14,354 \$14,836 \$15,504 \$12,442 \$18,733 \$19,856

COM/yds = 10 1/4, COL/sq ft = 226

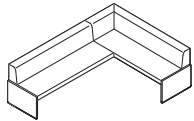

Overall: 70 1/2"D 96 1/4"W 31"H
Seat: 19"D 18 1/2"H

COTO9696R15 \$13,188 \$13,541 \$13,650 \$13,838 \$14,411 \$14,780 \$15,209 \$15,506 \$16,035 \$16,773 \$13,372 \$20,285 \$21,517

COM/yds = 11 1/4, COL/sq ft = 248

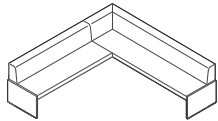

Overall: 97 1/4"D 96 1/4"W 31"H
Seat: 19"D 18 1/2"H

COTO12369R15 \$13,551 \$13,928 \$14,045 \$14,242 \$14,837 \$15,226 \$15,672 \$15,981 \$16,536 \$17,305 \$13,735 \$20,960 \$22,247

COM/yds = 11 3/4, COL/sq ft = 259

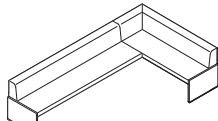

Overall: 70 1/2"D 123"W 31"H
Seat: 19"D 18 1/2"H

COTO12396R15 \$14,222 \$14,651 \$14,777 \$14,991 \$15,639 \$16,056 \$16,543 \$16,880 \$17,480 \$18,314 \$14,406 \$22,248 \$23,648

COM/yds = 12 3/4, COL/sq ft = 281

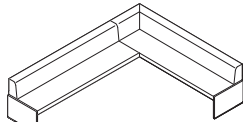

Overall: 97 1/4"D 123"W 31"H
Seat: 19"D 18 1/2"H

► Specification Information, continued on next page



For Canadian Pricing
Multiply U.S. Price by the Canadian price factor.
► See page 1 for details.

Together Benches by Walter Knoll *continued*

DESIGN EOOS

Tip: For Customer's Own Material or Leather, see necessary requirements, important processing instructions, and ordering information

► See Coalesse Surface Materials Reference Guide.

Tip: Fabrics and leathers will appear loose with comfort wrinkles when upholstered.

► See page 257 for offset diagram.

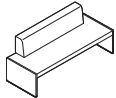

Overall: 26¾"D 71"W 31"H
Seat: 19"D 18½"H

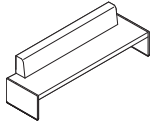

Overall: 26¾"D 97¾"W 31"H
Seat: 19"D 18½"H

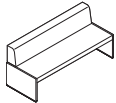

Overall: 26¾"D 71"W 31"H
Seat: 19"D 18½"H

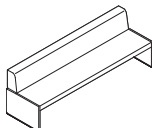

Overall: 26¾"D 97¾"W 31"H
Seat: 19"D 18½"H

► Specification Information, continued from previous page

Specification Information

Style Number	U.S. Base Prices											Leather Grades:		
	Fabric Grades:											COL	C	E
	COM	6	7	8	9	10	11	12	13	14				

Straight with Back, 8" Offset

COTO69WB8	\$5940	\$5958	\$6004	\$6085	\$6329	\$6485	\$6661	\$6790	\$7013	\$7325	\$6124	\$ 8998	\$9520
------------------	--------	--------	--------	--------	--------	--------	--------	--------	--------	--------	--------	---------	--------

COM/yds = 4¾, COL/sq ft = 105

COTO96WB8	\$6794	\$6889	\$6949	\$7055	\$7372	\$7578	\$7818	\$7984	\$8275	\$8685	\$6978	\$10,786	\$11,471
------------------	--------	--------	--------	--------	--------	--------	--------	--------	--------	--------	--------	----------	----------

COM/yds = 6¼, COL/sq ft = 138

Straight with Back, 1½" Offset

COTO69WB15	\$6189	\$6219	\$6269	\$6353	\$6608	\$6770	\$6964	\$7097	\$7330	\$7659	\$6373	\$ 9402	\$9952
-------------------	--------	--------	--------	--------	--------	--------	--------	--------	--------	--------	--------	---------	--------

COM/yds = 5, COL/sq ft = 110

COTO96WB15	\$7046	\$7157	\$7218	\$7327	\$7659	\$7873	\$8119	\$8290	\$8598	\$9024	\$7230	\$11,192	\$11,904
-------------------	--------	--------	--------	--------	--------	--------	--------	--------	--------	--------	--------	----------	----------

COM/yds = 6½, COL/sq ft = 143

► Specification Information, continued on next page



For Canadian Pricing
Multiply U.S. Price by the Canadian price factor.

► See page 1 for details.

Together Benches by Walter Knoll

DESIGN EOOS

► Specification Information, continued from previous page

Specification Information

Style Number	U.S. Base Prices											Leather Grades:		
	Fabric Grades:											COL	C	E
	COM	6	7	8	9	10	11	12	13	14				

Straight without Back

COT069	\$4275	\$4275	\$4313	\$4382	\$4586	\$4716	\$4868	\$4976	\$5159	\$5426	\$4479	\$6888	\$7328
---------------	--------	--------	--------	--------	--------	--------	--------	--------	--------	--------	--------	--------	--------

COM/yds = 4, COL/sq ft = 88

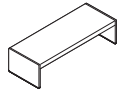

Overall: 26¾"D 71"W 18½"H
Seat: 18½"H

COT096	\$4876	\$4894	\$4940	\$5021	\$5265	\$5421	\$5597	\$5726	\$5949	\$6261	\$5060	\$7934	\$8456
---------------	--------	--------	--------	--------	--------	--------	--------	--------	--------	--------	--------	--------	--------

COM/yds = 4¾, COL/sq ft = 105

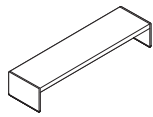

Overall: 26¾"D 97¾"W 18½"H
Seat: 18½"H

Lounge Seating



For Canadian Pricing
Multiply U.S. Price by the
Canadian price factor.
► See page 1 for details.

Together Benches Multi-Fabric Diagram

DESIGN E00S

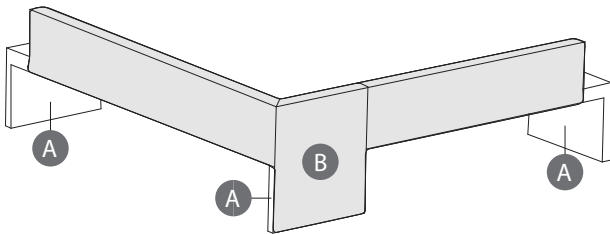
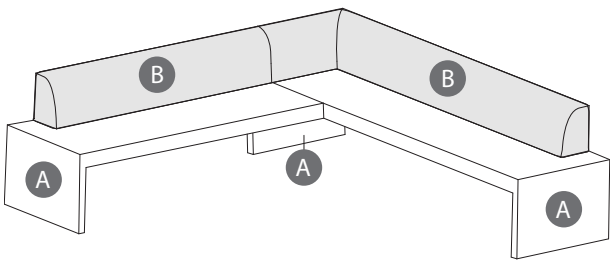
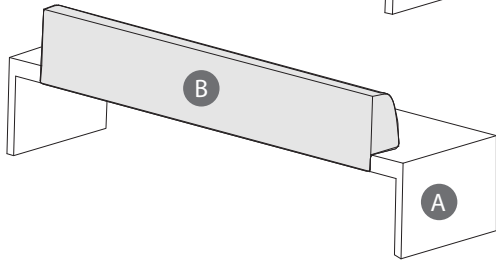
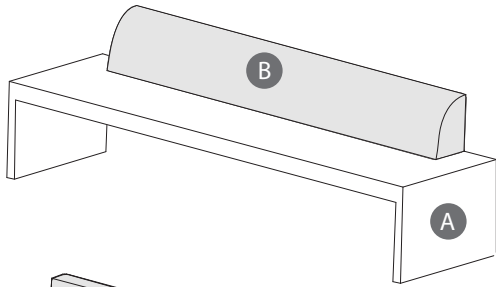

TO: _____

FROM: _____

DATE: _____

FAX...888.413.5161

Together Bench/Straight with Back

A Upholstery selections (default for entire unit if B is not selected): _____

B Back: _____

Together Bench/Corner with Back

A Upholstery selections (default for entire unit if B is not selected): _____

B Back: _____

See specifying for contrasting fabric upcharge. List price based on highest fabric grade usage.

Together Benches Offset Diagram

DESIGN E00S

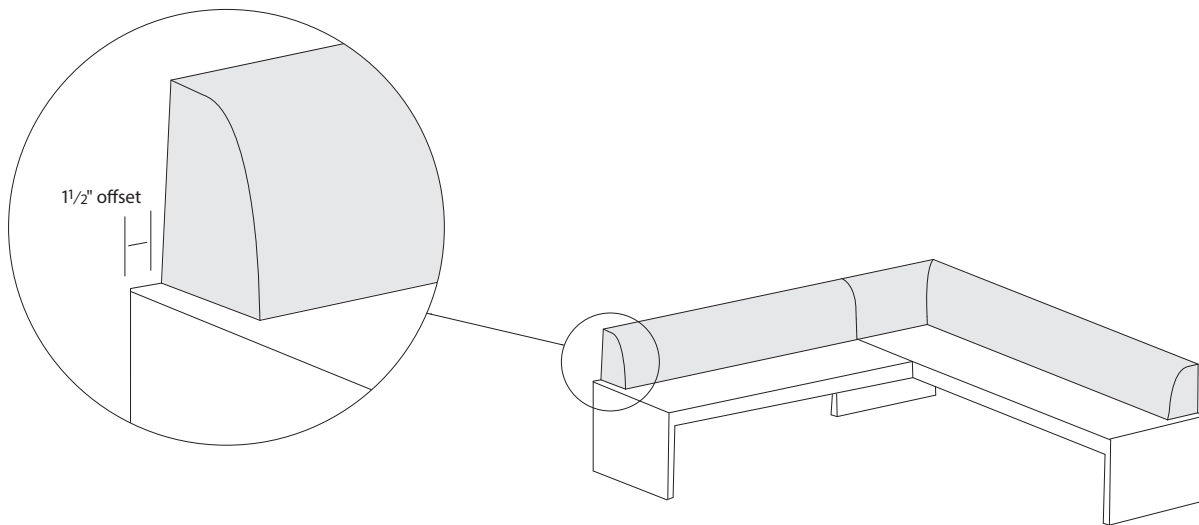
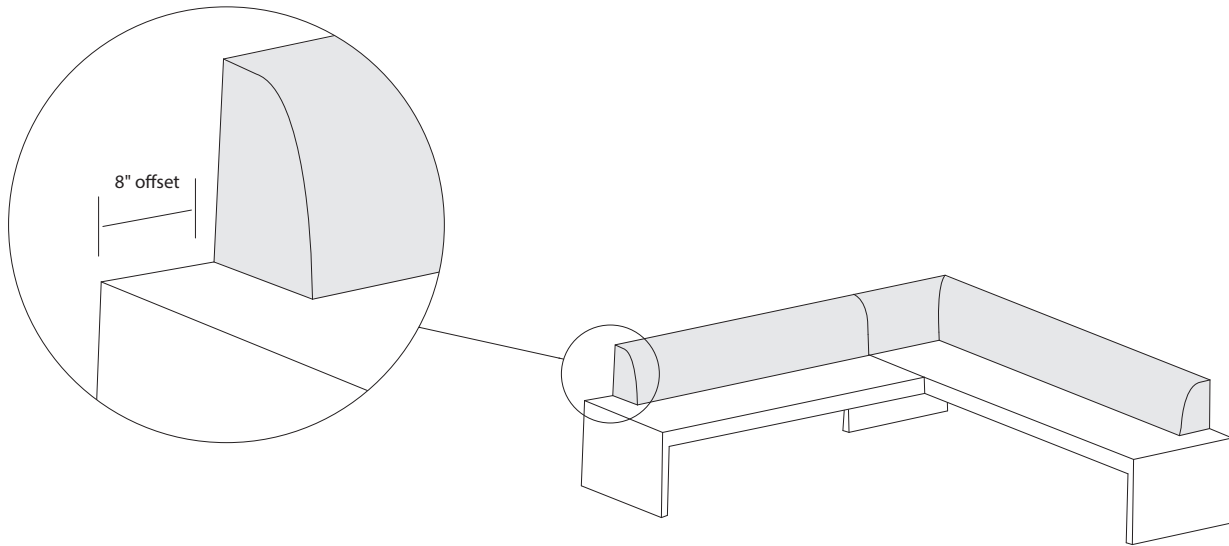

Visalia Lounge Seating

DESIGN COALESSE DESIGN GROUP

Visalia lounge seating is a range of soft seating efficiently scaled and designed to be grouped to promote collaboration. It can also be arranged for relaxed reflection in offices, lobbies, or hospitality environments.

Upholstery features top-stitched upper and lower facets that can be upholstered in one material or two, for an attractive contrasting effect.

Seat and back cushions are attached.

Frame is a unibody construction with finger jointed plywood.

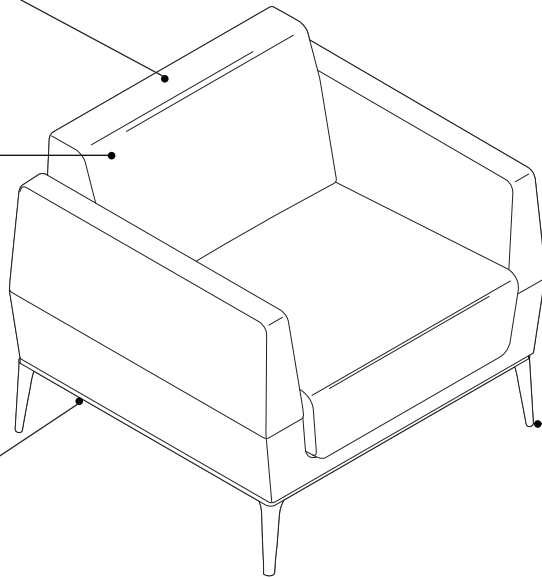

4-leg base in cast aluminum is standard in powder coat paint.

Visalia lounge seating features a lounge chair, 2-seat lounge, 3-seat lounge, ottoman, and bench.

Visalia Lounge Seating

DESIGN COALESSE DESIGN GROUP

Product Details

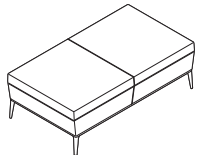
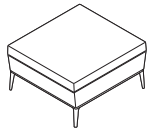
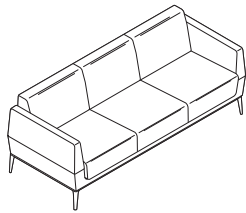
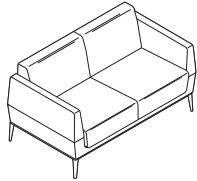
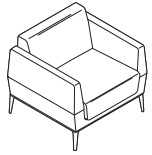

Lounge seating features five fully upholstered, complementary models: lounge chair, 2-seat lounge, 3-seat lounge, ottoman, and bench. All models feature a 4-leg, cast aluminum base with a powder coat painted finish. Upholstery is hand tailored. Double needle top stitching detail on upper and lower upholstery seams is available.

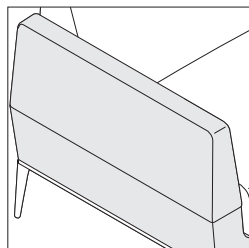

Faceted arm features a top-stitched detail on its upper and lower facets.

Surface Materials

► See *Coalesse Surface Materials Reference Guide* for further information.

Upholstery*

- Fabric
- Leather

*Available in one tone or two tone

Base

- Paint

Programs & Services

Customer's Own Material/Leather (COM/COL) Program is available.

► See *Coalesse Surface Materials Reference Guide* for further information.

Visalia Lounge Seating

DESIGN COALESSE DESIGN GROUP

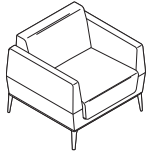

Tip: Fabrics and leathers will appear loose with comfort wrinkles when upholstered.

Tip: All cushions are attached.

Tip: Recommended leathers are Elmosoft Grade C and Elmorustical Grade E.

Tip: Special color match, consult Customer Service.

Tip: For Customer's Own Material or Leather, see necessary requirements, important processing instructions, and ordering information
 ▶ See Coalesse Surface Materials Reference Guide.

Standard Includes	Required to Specify
<ul style="list-style-type: none"> ▶ Need help? Product details, page 258 • Frame: unibody construction with finger jointed plywood • Cast aluminum base: Grade 1 paint • Upholstery: multiple densities of polyurethane foams and polyester fiber on seat and back • Upper and lower upholstery accents with double needle top stitch, if selected 	<ol style="list-style-type: none"> 1 Style number 2 Fabric or leather color number for seat, back, and arms 3 Upholstery accent color number, if selected 4 Paint color number for base: <ul style="list-style-type: none"> 4138 Graphite Gloss Black Matte 4141 Platinum Matte 4144 Black Gloss 4145 Milk Gloss 4148 Midnight Brown Gloss 4180 Graphite Matte 4193 Midnight Brown Matte 4238 Mocha Smooth 4239 Clay Smooth 4240 Chalk Smooth 4242 Milk Smooth 4710 Low Gloss Black 5 Options, if selected (see below) ▶ See Coalesse Surface Materials Reference Guide.

Required Selections	U.S. Price	Required to Specify
Upholstery accent	Prices to right	Select accent upholstery.

	Options	U.S. Price	Required to Specify
Surface Materials	Base		
	• Grade 3 paint	+\$145	Specify paint color number.
	Acrylic backer		
	• Lounge chair with single fabric	+\$ 53	Specify with acrylic backer.
	• Lounge chair with two fabrics	+\$ 60	Specify with acrylic backer.
	• 2-seat lounge with single fabric	+\$ 74	Specify with acrylic backer.
	• 2-seat lounge with two fabrics	+\$ 81	Specify with acrylic backer.
	• 3-seat lounge with single fabric	+\$ 84	Specify with acrylic backer.
	• 3-seat lounge with two fabrics	+\$ 95	Specify with acrylic backer.
	• Ottomans with single fabric	+\$ 26	Specify with acrylic backer.
	• Ottomans with two fabrics	+\$ 26	Specify with acrylic backer.
	• 2-seat benches with single fabric	+\$ 33	Specify with acrylic backer.
	• 2-seat benches with two fabrics	+\$ 33	Specify with acrylic backer.
			▶ See Coalesse Surface Materials Reference Guide.



For Canadian Pricing
 Multiply U.S. Price by the Canadian price factor.
 ▶ See page 1 for details.

Visalia Lounge Seating

DESIGN COALESSE DESIGN GROUP

Specification Information

Lounge Chair

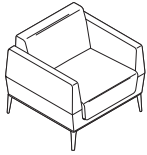

Overall: 29"D 31¾"W 28"H
 Seat height: 16¼"H
 Arm height to the floor: 23"H
 Inside: 19"D 23"W 16¼"H

2-Seat Lounge

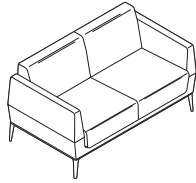

Overall: 29"D 53¾"W 28"H
 Seat height: 16¼"H
 Arm height to the floor: 23"H
 Inside: 19"D 45"W 16¼"H

3-Seat Lounge

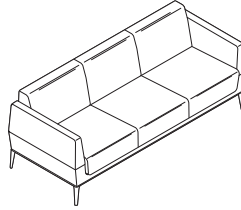

Overall: 29"D 73¾"W 28"H
 Seat height: 16¼"H
 Arm height to the floor: 23"H
 Inside: 19"D 65"W 16¼"H

Ottoman

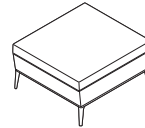

Overall: 29"D 30"W 16¼"H

Bench

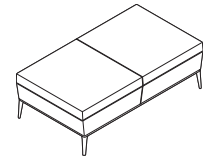

Overall: 29"D 52"W 16¼"H

Lounge Seating

Style Number	Upholstery	U.S. Base Prices										Leather Grades:		
		Fabric Grades:										COL	C	E
		COM	6	7	8	9	10	11	12	13	14			

Lounge Chair with Single Fabric

COJHL100		\$3223	\$3223	\$3259	\$3319	\$3511	\$3633	\$3777	\$3874	\$4052	\$4298	\$3437	\$4883	\$5078
	COM/yds = 3¾, COL/sq ft = 83													

Lounge Chair with Accent Upholstery

COJHLC100	Standard Upholstery	\$3314	\$3314	\$3345	\$3394	\$3545	\$3645	\$3757	\$3839	\$3981	\$4176	\$3472	\$4861	\$5042
	COM/yds = 3, COL/sq ft = 66													
	Accent Upholstery	+\$ 9	No cost	+\$ 10	+\$ 27	+\$ 79	+\$110	+\$148	+\$176	+\$224	+\$289	+\$358	+\$515	+\$575
	COM/yds = 1, COL/sq ft = 22													

2-Seat Lounge with Single Fabric

COJHL200		\$4946	\$4976	\$5026	\$5110	\$5365	\$5527	\$5721	\$5854	\$6087	\$6416	\$5130	\$7275	\$7544
	COM/yds = 5, COL/sq ft = 110													

2-Seat Lounge with Accent Upholstery

COJHLC200	Standard Upholstery	\$5090	\$5097	\$5142	\$5216	\$5447	\$5592	\$5764	\$5884	\$6093	\$6388	\$5274	\$7397	\$7670
	COM/yds = 4½, COL/sq ft = 99													
	Accent Upholstery	No cost	No cost	+\$ 14	+\$ 35	+\$ 97	+\$139	+\$187	+\$219	+\$279	+\$362	+\$346	+\$653	+\$727
	COM/yds = 1¼, COL/sq ft = 27													

3-Seat Lounge with Single Fabric

COJHL300		\$5655	\$5737	\$5797	\$5897	\$6204	\$6399	\$6628	\$6787	\$7070	\$7462	\$5839	\$8702	\$9050
	COM/yds = 6, COL/sq ft = 132													

3-Seat Lounge with Accent Upholstery

COJHLC300	Standard Upholstery	\$5828	\$5885	\$5942	\$6031	\$6312	\$6492	\$6702	\$6849	\$7106	\$7466	\$6012	\$8736	\$9068
	COM/yds = 5½, COL/sq ft = 121													
	Accent Upholstery	No cost	No cost	+\$ 15	+\$ 44	+\$133	+\$190	+\$257	+\$304	+\$388	+\$501	+\$317	+\$897	+\$998
	COM/yds = 1¾, COL/sq ft = 39													

► Specification Information, continued on next page

 **For Canadian Pricing**
 Multiply U.S. Price by the
 Canadian price factor.
 ► See page 1 for details.

Visalia Lounge Seating *continued*

DESIGN COALESSE DESIGN GROUP

► Specification Information, continued from previous page

Specification Information

Lounge Chair

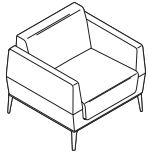

Overall: 29"D 31¾"W 28"H
 Seat height: 16¼"H
 Arm height to the floor: 23"H
 Inside: 19"D 23"W 16¼"H

2-Seat Lounge

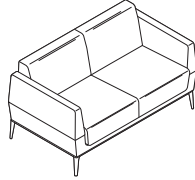

Overall: 29"D 53¾"W 28"H
 Seat height: 16¼"H
 Arm height to the floor: 23"H
 Inside: 19"D 45"W 16¼"H

3-Seat Lounge

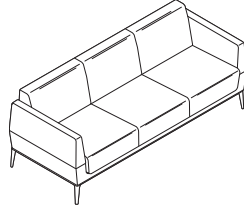

Overall: 29"D 73¾"W 28"H
 Seat height: 16¼"H
 Arm height to the floor: 23"H
 Inside: 19"D 65"W 16¼"H

Ottoman

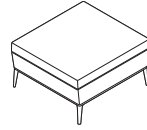

Overall: 29"D 30"W 16¼"H

Bench

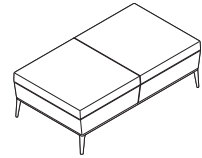

Overall: 29"D 52"W 16¼"H

Style
Number

Upholstery

U.S. Base Prices

Fabric Grades:
COM 6 7 8 9 10 11 12 13 14

Leather Grades:
COL C E

Ottoman with Single Fabric

COJHB100		\$1782	\$1782	\$1805	\$1842	\$1956	\$2030	\$2117	\$2177	\$2285	\$2431	\$2077	\$2802	\$2924
	COM/yds = 2, COL/sq ft = 44													

Ottoman with Accent Upholstery

COJHBC100	Standard Upholstery	\$1860	\$1851	\$1861	\$1878	\$1930	\$1961	\$1999	\$2027	\$2075	\$2140	\$2209	\$2366	\$2426
	COM/yds = 1, COL/sq ft = 22													
	Accent Upholstery	+\$ 9	No cost	+\$ 10	+\$ 27	+\$ 79	+\$110	+\$148	+\$176	+\$224	+\$289	+\$358	+\$515	+\$575
	COM/yds = 1, COL/sq ft = 22													

2-Seat Bench with Single Fabric

COJHB200		\$2607	\$2607	\$2643	\$2703	\$2895	\$3017	\$3161	\$3258	\$3436	\$3682	\$2821	\$3983	\$4152
	COM/yds = 3, COL/sq ft = 50													

2-Seat Bench with Accent Upholstery

COJHBC200	Standard Upholstery	\$2648	\$2648	\$2663	\$2692	\$2781	\$2838	\$2905	\$2952	\$3036	\$3149	\$2965	\$3549	\$3654
	COM/yds = 1¾, COL/sq ft = 39													
	Accent Upholstery	No cost	No cost	+\$ 14	+\$ 35	+\$ 97	+\$139	+\$187	+\$219	+\$279	+\$362	+\$346	+\$653	+\$727
	COM/yds = 1, COL/sq ft = 22													



For Canadian Pricing
 Multiply U.S. Price by the
 Canadian price factor.
 ► See page 1 for details.

Visalia Lounge Seating Multi-Fabric Diagram

DESIGN COALESSE DESIGN GROUP

Applies to Visalia models including: lounge chair, 2-seat lounge, 3-seat lounge, ottoman, and 2-seat bench.

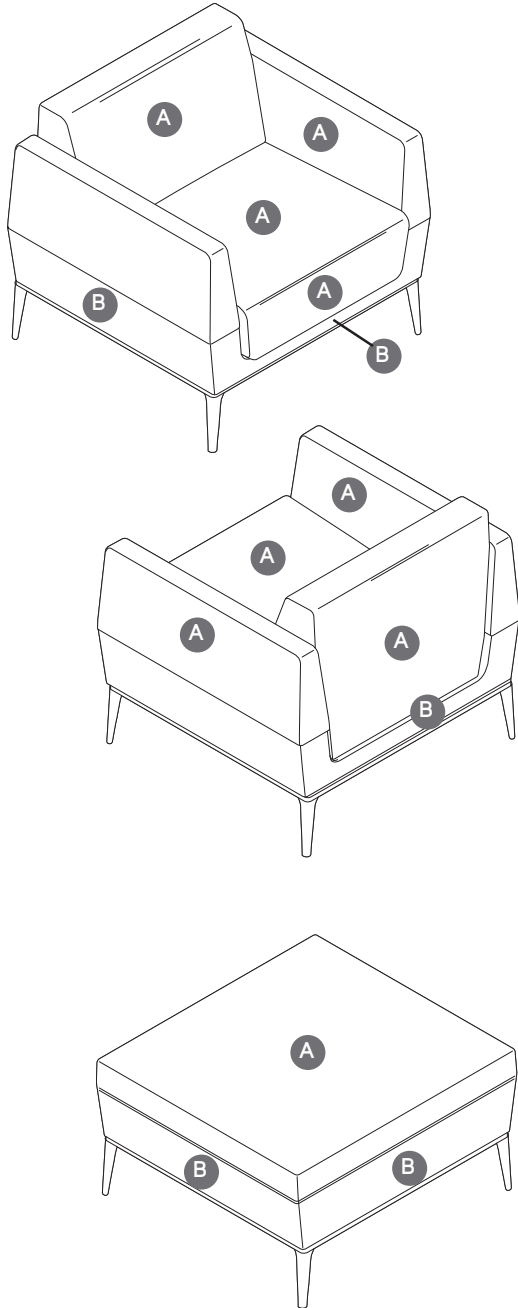

TO: _____

FROM: _____

DATE: _____

FAX....888.413.5161

A Upholstery Selection (default for entire unit if B is not selected): _____

B Accent: _____

Specify model below:

- COJHLC100 Lounge Chair
- COJHLC200 2-Seat Lounge
- COJHLC300 3-Seat Lounge
- COJHBC100 Ottoman
- COJHBC200 2-Seat Bench

Collaboration Seating

*These product lines are collections and will be found in multiple locations in this specification guide and/or *Coalesse Tables, Storage, and Accessories Specification Guide*.

▶ See *Collections*, page 5

Bindu Conference Seating	266
Chord Conference Seating	270
Marien152 Conference Seating	274
Lox Seating*	279
Massaud Conference Seating*	282
SW_1 Conference Seating*	289
Adjustment Feature Definitions	292

Bindu Conference Seating

DESIGN BRIAN KANE

Bindu conference seating combines the comfort and craft of an upholstered lounge with the performance needs of a work task chair.

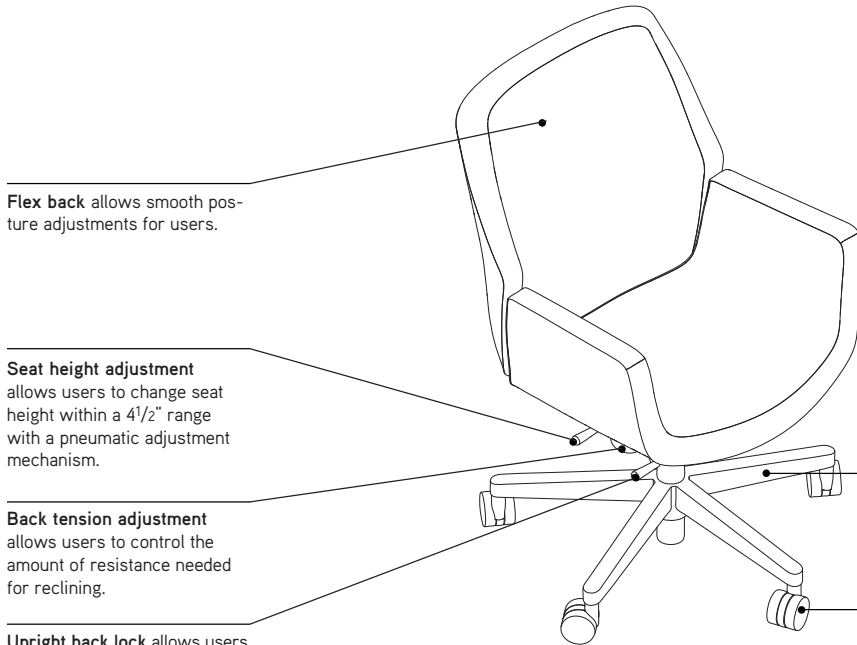

Flex back allows smooth posture adjustments for users.

Seat height adjustment allows users to change seat height within a 4 1/2" range with a pneumatic adjustment mechanism.

Back tension adjustment allows users to control the amount of resistance needed for reclining.

Upright back lock allows users to lock the backrest in a full, upright position. To unlock for free tilting, push handle back towards seat.

5-star base is black resin. A polished aluminum base is available as an option.

Casters are standard with hard, dual-wheels that roll smoothly on carpets. Optional soft casters are available for use on hard floors and chair mats.

Bindu Conference Seating

DESIGN BRIAN KANE

Product Details



Bindu conference seating is offered in mid back and high back.

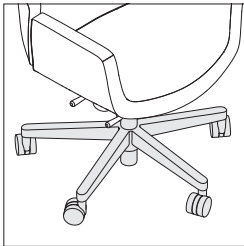

5-star base is available in black or optional polished aluminum.

Casters are standard with hard, dual-wheels that roll smoothly on carpets. Soft casters for use on hard floors are an available option.

Adjustment Features

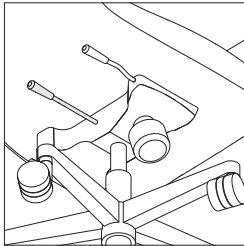

Seat height adjusts pneumatically. Lift lever to activate cylinder for desired height. To raise height, stand slightly while lifting lever; to lower, sit while lifting lever and weight pressure will lower seat height. Range of adjustability is 4¹/₂" with a maximum seat height of 20¹/₂".

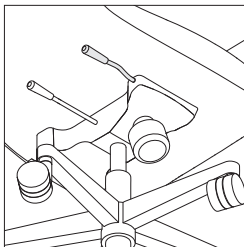

Upright back lock allows users to lock the backrest in a full, upright position. To unlock for free tilting, push handle back towards seat.

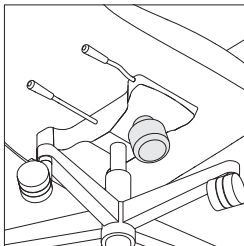

Back tension control knob turns clockwise to increase tension and counter-clockwise to decrease tension, allowing free tilt.

Surface Materials

► See *Coalesse Surface Materials Reference Guide* for further information.

Upholstery

- Fabric
- Leather

Base

- Black resin
- Polished aluminum

Programs & Services

Customer's Own Material/Leather (COM/COL) Program is available.

► See *Coalesse Surface Materials Reference Guide* for additional information.

Bindu Conference Seating

DESIGN BRIAN KANE

Tip: Fabrics and leathers will appear loose with comfort wrinkles when upholstered.

Tip: For Customer's Own Material or Leather, see necessary requirements, important processing instructions, and ordering information
 ▶ See *Coalesse Surface Materials Reference Guide*.

Tip: Craft in upholstery cautions the use of stripes and patterns on Bindu. Please use fabric database when specifying.

Tip: For fabric with a large pattern and a specific pattern location is desired, contact Customer Service.

Standard Includes		Required to Specify
▶ Need help? Product details, page 266	<ul style="list-style-type: none"> Bent plywood frame Chair: fabric Molded polypropylene foam Base (Desk and Conference): 6205 Black resin Dual wheel hard casters, desk and conference Back tilt lock 	1 Style number 2 Fabric or leather color number for upholstery 3 Options, if selected (see below) ▶ See <i>Coalesse Surface Materials Reference Guide</i> .

	Options	U.S. Price	Required to Specify
Surface Materials	Acrylic backer <ul style="list-style-type: none"> Mid-back chair High-back chair 	+\$ 47 +\$ 49	Specify with <i>acrylic backer</i> . Specify with <i>acrylic backer</i> . ▶ See <i>Coalesse Surface Materials Reference Guide</i> .
Base	<ul style="list-style-type: none"> 8046 Polished Aluminum 	+\$223	Specify with <i>8046 Polished Aluminum</i> .
Casters	<ul style="list-style-type: none"> Soft casters 	+\$ 35	Specify with <i>soft casters</i> .

Specification Information															
Style Number	U.S. Base Prices												Leather Grades:		
	Fabric Grades:												COL	C	E
	COM	6	7	8	9	10	11	12	13	14					

Mid-Back Conference Chair

CO300	\$2189	\$2189	\$2220	\$2269	\$2420	\$2520	\$2632	\$2714	\$2856	\$3051	\$2444	\$4232	\$4561
-------	--------	--------	--------	--------	--------	--------	--------	--------	--------	--------	--------	--------	--------

COM/yds = 3, COL/sq ft = 66



Overall: 25"D 25"W 35½"-40¼"H
 Inside: 18¾"D 18½"-19½"W 21"H
 Seat: 16"-20½"H
 Arm: 24¼"-29"H

High-Back Conference Chair

CO400	\$2555	\$2555	\$2589	\$2643	\$2810	\$2913	\$3037	\$3125	\$3279	\$3492	\$2799	\$4740	\$5098
-------	--------	--------	--------	--------	--------	--------	--------	--------	--------	--------	--------	--------	--------

COM/yds = 3.25, COL/sq ft = 72



Overall: 25"D 25"W 45½"-50¼"H
 Inside: 18¾"D 18½"-19½"W 31"H
 Seat: 16"-20½"H
 Arm: 24¼"-29"H



For Canadian Pricing
 Multiply U.S. Price by the Canadian price factor.
 ▶ See page 1 for details.

Coalesse

Bindu Conference Seating

DESIGN BRIAN KANE

Chord Conference Seating

DESIGN MICHAEL SHIELDS

Chord conference seating offers built-in, passive ergonomic curvature of the back, making this design well-suited for long-term conferencing.

Back and pillow top option wraps over the seat edge.

Conference chair upholstery features a double-needle stitching technique and an accent welt that flows across the back and down the arms.

Seat height adjustment allows users to change seat height within a 3" range with a pneumatic adjustment mechanism.

Casters are standard with black-hooded, hard, dual wheels that roll smoothly on carpets. Optional soft casters are available for use on hard floors and chair mats.

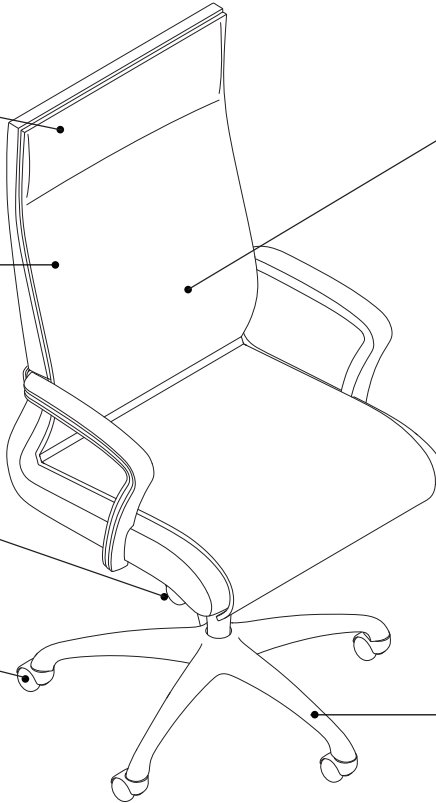

Fixed lumbar support.

Tilt tension adjustment allows users to control the amount of resistance needed for reclining.

Swivel-tilt mechanism swivels 360°. Seat and back stay in a fixed position (no recline).

5-star base is black resin. A polished aluminum base is available as an option.

Chord Conference Seating

DESIGN MICHAEL SHIELDS

Product Details

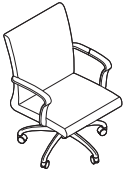

Chord conference seating is offered in mid back or high back.

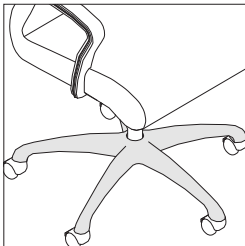

5-star base is standard in black resin or optional polished aluminum.

Casters are standard with hard, dual-wheels that roll smoothly on carpets. Soft casters for use on hard floors are an available option.

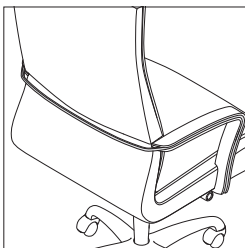

Accent welt flows across the back and down the arms (contrasting fabric option).

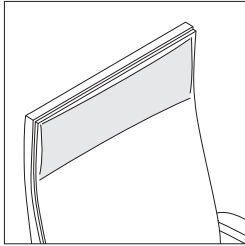

Pillowback versions are available on mid-back and high-back chairs for added comfort.

Adjustment Features

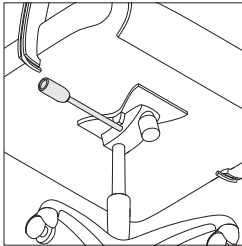

Seat height adjusts pneumatically. Lift lever to activate cylinder for desired height. To raise height, slightly stand while lifting lever; to lower, sit while lifting and weight pressure will lower seat height. Range of adjustability is 3" with a maximum seat height of 22".

Upright back lock allows users to lock the backrest in a full, upright position. To unlock for free tilting, push handle back towards seat.

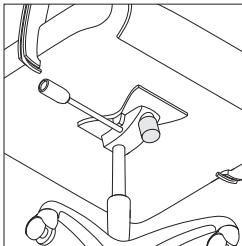

Tension control knob allows the user to increase tension (will require more force to tilt chair back), by turning the knob clockwise. For reduced tension and more responsive tilt adjustment, turn knob counter-clockwise.

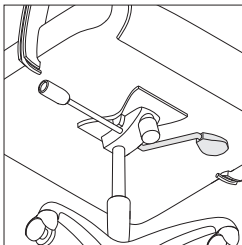

Knee tilt control (optional) minimizes the rise of the front of the chair when the chair is in a reclined position, allowing the user's feet to remain on the floor. Push handle up to lock and down to free tilting.

Surface Materials

► See *Coalesse Surface Materials Reference Guide* for further information.

Upholstery (contrasting fabric available)

- Fabric
- Leather

Arms

- Black
- Aluminum

Base

- Black resin
- Polished aluminum

Programs & Services

Customer's Own Material/Leather (COM/COL) Program is available.

► See *Coalesse Surface Materials Reference Guide* for additional information.

Chord Conference Seating

DESIGN MICHAEL SHIELDS

Tip: Fabrics and leathers will appear loose with comfort wrinkles when upholstered.

Tip: For Customer's Own Material or Leather, see necessary requirements, important processing instructions, and ordering information
 ▶ See *Coalesse Surface Materials Reference Guide*.

Tip: Arm is cast from 100% recycled material then hand buffed to a mirror finish. Arm caps are molded in black.

Tip: List price based on highest fabric grade usage.

Tip: Contrasting option available only on 798-P and 796-P.

Tip: Chord does not pass CAL 133 with urethane arms. To choose the CAL 133 option polished aluminum arms must be selected.



Overall: 23"D 24½"W 36"-39"H
Inside: 18"D 20½"W 18½"H
Seat: 18½"-21½"H
Arm: 25¾"-28¾"H



For Canadian Pricing
 Multiply U.S. Price by the Canadian price factor.
 ▶ See page 1 for details.

Standard Includes		Required to Specify
▶ Need help? Product details, page 270	<ul style="list-style-type: none"> • Frame: hardwood plywood assembled into unibody structures utilizing interlocking finger joinery • Cushioning: <ul style="list-style-type: none"> - back: multiple laminations of high-density polyurethane foam over an elastic sheet suspension system for lumbar support - seat: closed cell, contour molded urethane foam • Upholstery: <ul style="list-style-type: none"> - seams are double needle stitched with seam binding for extended durability - unique wrap around welt detail and is cut from the same fabric as specified on chair • Arms: resilient self-skinned urethane molded around carbon steel armature, black or aluminum arm with urethane cap, if selected • Chair controls: tilt-swivel with tilt tension, pneumatic height adjustment, and tilt lockout • Bases: five star black resin • Casters: black hooded dual wheel 	<ol style="list-style-type: none"> 1 Style number 2 Number of fabrics if contrasting fabric style number is selected 3 Fabric or leather color number for upholstery on seat and back 4 Options, if selected (see below) ▶ See <i>Coalesse Surface Materials Reference Guide</i> .

Options	U.S. Price	Required to Specify
Surface Materials		
Welt detail		
• Contrasting fabric welt	+\$ 94	Specify with <i>contrasting fabric welt</i> and select fabric color number.
• Contrasting leather welt	+\$136	Specify with <i>contrasting leather welt</i> and select fabric color number.
• Contrasting fabric	+\$182 per fabric	Add suffix K to the style number and select fabric color number.
Acrylic backer		
• Conference, mid-back, and high-back large chairs	+\$ 28	Specify with <i>acrylic backer</i> .
• High-back large chair	+\$ 33	Specify with <i>acrylic backer</i> .
• Mid-back with pillow chairs	+\$ 47	Specify with <i>acrylic backer</i> .
• High-back with pillow chairs	+\$ 49	▶ See <i>Coalesse Surface Materials Reference Guide</i> .
Base		
• Polished aluminum with black, hooded dual wheel casters	+\$ 96	Specify with <i>polished aluminum base</i> .
Casters		
• Soft wheel casters	+\$ 69	Specify with <i>soft casters</i> .
Control		
• Knee-tilt with pneumatic height adjustment and tilt lockout	+\$237	Specify with <i>knee-tilt</i> .

Style Number	U.S. Base Prices												Leather Grades:		
	Fabric Grades:												COL	C	E
	COM	6	7	8	9	10	11	12	13	14					

Conference Narrow/Narrow with Urethane Arms

795	\$1710	\$1707	\$1738	\$1767	\$1802	\$1845	\$1956	\$2041	\$2140	\$2331	\$2056	\$3125	\$3328
-----	--------	--------	--------	--------	--------	--------	--------	--------	--------	--------	--------	--------	--------

COM/yds = 2, COL/sq ft = 40

Conference Narrow/Narrow with Aluminum Arms

795AU	\$2275	\$2272	\$2303	\$2332	\$2367	\$2410	\$2521	\$2606	\$2705	\$2896	\$2621	\$3690	\$3893
-------	--------	--------	--------	--------	--------	--------	--------	--------	--------	--------	--------	--------	--------

▶ Specification Information, continued on next page

Chord Conference Seating

DESIGN MICHAEL SHIELDS

► Specification Information, continued from previous page

Specification Information

Style Number	U.S. Base Prices												Leather Grades:		
	Fabric Grades:												COL	C	E
	COM	6	7	8	9	10	11	12	13	14					



Overall: 23¾"D 26"W 37½"-40½"H
 Inside: 19"D 22"W 21½"H
 Seat: 19"-22"H
 Arm: 25¾"-28¾"H

Mid-Back with Urethane Arms

796	\$1914	\$1904	\$1936	\$1959	\$1996	\$2045	\$2160	\$2235	\$2344	\$2563	\$2260	\$3329	\$3523
-----	--------	--------	--------	--------	--------	--------	--------	--------	--------	--------	--------	--------	--------

COM/yds = 2, COL/sq ft = 40

Mid-Back with Aluminum Arms

796AU	\$2479	\$2469	\$2501	\$2524	\$2561	\$2610	\$2725	\$2800	\$2909	\$3128	\$2825	\$3894	\$4088
-------	--------	--------	--------	--------	--------	--------	--------	--------	--------	--------	--------	--------	--------



Overall: 23¾"D 26"W 37½"-40½"H
 Inside: 18½"D 22"W 19"H
 Seat: 19"-22"H
 Arm: 25¾"-28¾"H

Mid-Back/Pillow Upholstery with Urethane Arms

796-P	\$2364	\$2357	\$2394	\$2427	\$2505	\$2558	\$2740	\$2852	\$3006	\$3267	\$2658	\$4301	\$4601
-------	--------	--------	--------	--------	--------	--------	--------	--------	--------	--------	--------	--------	--------

COM/yds = 3, COL/sq ft = 60

Mid-Back/Pillow Upholstery with Aluminum Arms

796-PAU	\$2929	\$2992	\$2959	\$2992	\$3070	\$3123	\$3305	\$3417	\$3571	\$3832	\$3223	\$4866	\$5166
---------	--------	--------	--------	--------	--------	--------	--------	--------	--------	--------	--------	--------	--------

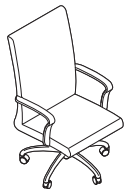

Overall: 23"D 24½"W 44½"-47½"H
 Inside: 18"D 20½"W 18½"H
 Seat: 18½"-21½"H
 Arm: 25¾"-28¾"H

High-Back Narrow/Narrow with Urethane Arms

797	\$2372	\$2369	\$2406	\$2429	\$2464	\$2503	\$2618	\$2703	\$2802	\$3092	\$2718	\$3552	\$3754
-----	--------	--------	--------	--------	--------	--------	--------	--------	--------	--------	--------	--------	--------

COM/yds = 2, COL/sq ft = 44

High-Back Narrow/Narrow with Aluminum Arms

797AU	\$2937	\$2934	\$2971	\$2994	\$3029	\$3068	\$3183	\$3268	\$3367	\$3657	\$3283	\$4117	\$4319
-------	--------	--------	--------	--------	--------	--------	--------	--------	--------	--------	--------	--------	--------

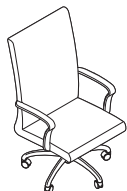

Overall: 23¾"D 26"W 46"-49"H
 Inside: 19"D 22"W 18½"H
 Seat: 18½"-21½"H
 Arm: 25¾"-28¾"H

High-Back/Large Scale with Urethane Arms

798	\$2402	\$2388	\$2419	\$2448	\$2483	\$2522	\$2637	\$2722	\$2821	\$3116	\$2747	\$3564	\$3765
-----	--------	--------	--------	--------	--------	--------	--------	--------	--------	--------	--------	--------	--------

COM/yds = 2¼, COL/sq ft = 44

High-Back/Large Scale with Aluminum Arms

798AU	\$2967	\$2953	\$2984	\$3013	\$3048	\$3087	\$3202	\$3287	\$3386	\$3681	\$3312	\$4129	\$4330
-------	--------	--------	--------	--------	--------	--------	--------	--------	--------	--------	--------	--------	--------



Overall: 23¾"D 26"W 46"-49"H
 Inside: 19"D 22"W 19"H
 Seat: 19"-22"H
 Arm: 26¾"H-28¾"H

High-Back/Large Scale with Pillow Upholstery with Urethane Arms

798-P	\$2571	\$2553	\$2594	\$2634	\$2712	\$2765	\$2934	\$3059	\$3213	\$3500	\$2865	\$4498	\$4797
-------	--------	--------	--------	--------	--------	--------	--------	--------	--------	--------	--------	--------	--------

COM/yds = 3, COL/sq ft = 66

High-Back/Large Scale with Pillow Upholstery with Aluminum Arms

798-PAU	\$3136	\$3118	\$3159	\$3199	\$3277	\$3330	\$3499	\$3624	\$3778	\$4065	\$3430	\$5063	\$5362
---------	--------	--------	--------	--------	--------	--------	--------	--------	--------	--------	--------	--------	--------

Marien152 Conference Seating

DESIGN COALESSE DESIGN GROUP AND ARIK LEVY

Marien152 is a richly tailored seating experience that's inspired by the home and designed for the workday. An innovative back cushion provides support with soft, residential style. Easy personalization is built into the collection through a wide range of color, form, and materiality choices.

Back cushion gives the appearance of a soft, loose pillow while built-in flex allows the cushion to move with the user. Intentionally relaxed upholstery on the back cushion adds to the welcoming appeal.

Contrasting fabric is available on seat, surround, and back cushion.

360° swivel base provides full range of motion.

Seat height adjustment allows users to change seat height within a 5" range with the assistance of a pneumatic gas cylinder.

Gently sloping arms are subtle yet supportive.

Black casters have hard, dual wheels that roll smoothly on carpet. Soft casters are designed to roll quietly and are available for use on hard floors and chair mats.

Base is standard in powder coat paint and polished aluminum.

Base is standard in powder coat paint and polished aluminum. It is a fixed height with 360° swivel only.

Black glides are available in hard and soft options.

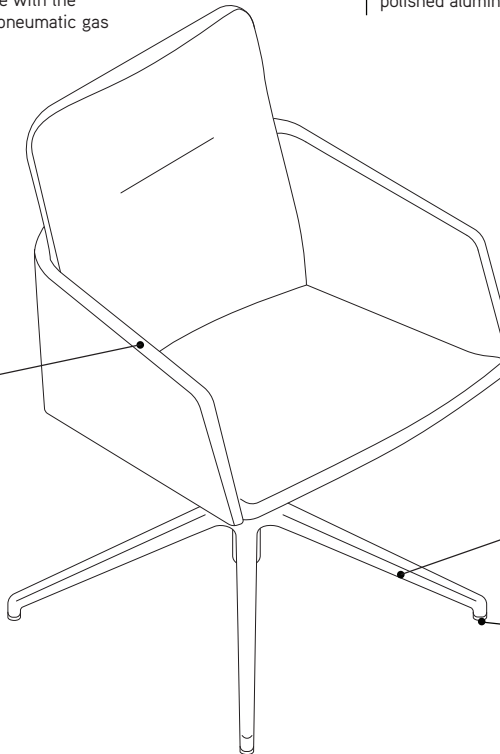
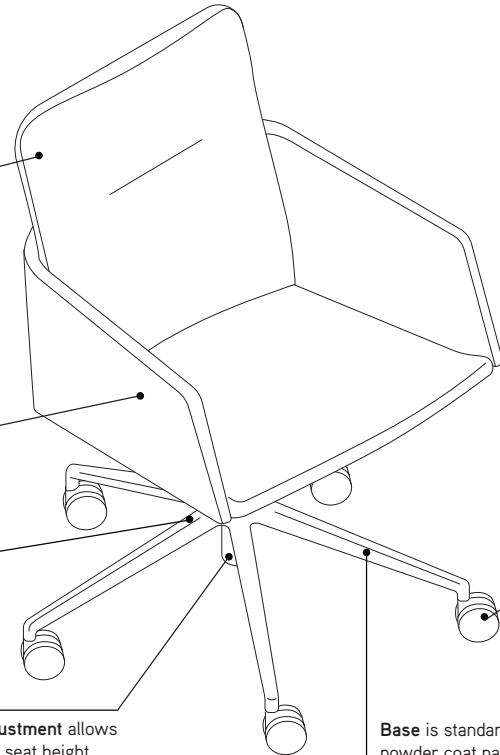

Marien152 Conference Seating

DESIGN COALESSE DESIGN GROUP AND ARIK LEVY

Product Details

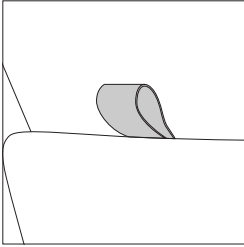

Standard leather pull, located behind the back cushion, allows users to easily move the chair. Leather in the color coal only. Option to specify without pull if desired.

Surface Materials

4-star and 5-star metal bases

- Painted
- Polished aluminum

Programs & Services

Customer's Own Material/Leather (COM/COL) Program is available.
▶ See *Coalesse Surface Materials Reference Guide* for additional information.

Marien152 Conference Seating

DESIGN COALESSE DESIGN GROUP AND ARIK LEVY

Standard Includes		Required to Specify
<ul style="list-style-type: none"> ▶ Need help? Product details, page 274 	<ul style="list-style-type: none"> • Seat, back, and surround: upholstery • Leather strap: coal • Base: 8046 Polished Aluminum or grade 1 paint • 4-star base: <ul style="list-style-type: none"> – Fixed height – 360° swivel – Black hard glides • 5-star base: <ul style="list-style-type: none"> – 5" pneumatic height adjustment, 360° swivel – Black dual wheel casters 	<ol style="list-style-type: none"> 1 Style number 2 Contrasting fabric (see below under Required Selections) 3 Fabric or leather color number for upholstery on seat, surround, and back 4 Metal or paint color number for base 5 Options, if selected (see below) <p>▶ See <i>Coalesse Surface Materials Reference Guide</i>.</p>

Required Selections	U.S. Price	Required to Specify
Contrasting Fabric	<ul style="list-style-type: none"> • Non contrasting fabric: No cost • Contrasting back fabric: +\$182 • Contrasting surround fabric: +\$182 • Contrasting seat fabric: +\$182 • Contrasting all fabrics: +\$182 	<p>Specify with <i>non contrasting</i>.</p> <p>Specify with <i>contrasting back</i>.</p> <p>Specify with <i>contrasting surround</i>.</p> <p>Specify with <i>contrasting seat</i>.</p> <p>Specify with <i>contrasting all fabrics</i>.</p>

Options	U.S. Price	Required to Specify
Surface Materials	<p>Base</p> <ul style="list-style-type: none"> • Polished aluminium: No cost • Grade 1 paint: No cost • Grade 3 paint: +\$102 <hr/> <ul style="list-style-type: none"> • Backer: +\$ 46 	<p>Specify with <i>aluminium matte polished</i>.</p> <p>Specify paint color number.</p> <p>Specify paint color number.</p> <hr/> <p>Specify with <i>acrylic backer</i>.</p>
Caster or Glide Type	<p>Chairs with 4-star base</p> <ul style="list-style-type: none"> • Hard glides: No cost • Soft glides: No cost <hr/> <p>Chairs with 5-star base</p> <ul style="list-style-type: none"> • Hard casters: No cost • Soft casters: +\$ 29 	<p>Specify with <i>hard glides</i>.</p> <p>Specify with <i>soft glides</i>.</p> <hr/> <p>Specify with <i>hard casters</i>.</p> <p>Specify with <i>soft casters</i>.</p>
Pull	<ul style="list-style-type: none"> • With leather pull: No cost • Without leather pull: No cost 	<p>Specify with <i>pull</i>.</p> <p>Specify <i>without pull</i>.</p>
Related Products	<ul style="list-style-type: none"> • Guest seating 	▶ Page 322

Specification Information

Style Number	U.S. Base Prices														Leather Grades		
	Fabric Grades:														COL	C	E
	COM	6	7	8	9	10	11	12	13	14							

4-Star Conference Chair

COMARCCH4	Seat	\$1610	\$1610	\$1618	\$1636	\$1685	\$1718	\$1755	\$1781	\$1826	\$1891	\$1668	\$ 2026	\$ 2124
	Surround	+\$ 56	+\$117	+\$137	+\$177	+\$291	+\$365	+\$452	+\$511	+\$617	+\$764	+\$109	+\$1076	+\$1297
	Back	+\$ 56	+\$ 37	+\$ 46	+\$ 57	+\$ 96	+\$119	+\$146	+\$166	+\$201	+\$249	+\$109	+\$ 351	+\$ 423

COM/yds: Seat = .78, Surround = 1.25, Cushion = .67, COL/sq ft: Seat = 9, Surround = 30, Cushion = 11

▶ Specification Information, continued on next page

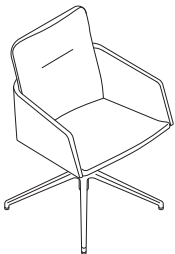

Overall: 24"D x 26"W x 31"H
 Inside: 16 1/2"D x 18"W
 Seat: 18"H



For Canadian Pricing
 Multiply U.S. Price by the Canadian price factor.
 ▶ See page 1 for details.

Marien152 Conference Seating

DESIGN COALESSE DESIGN GROUP AND ARIK LEVY

► Specification Information, continued from previous page

Specification Information

Style Number	U.S. Base Prices													
	Fabric Grades:											Leather Grades		
	COM	6	7	8	9	10	11	12	13	14	COL	C	E	

5-Star Conference Chair

COMARCCH5	Seat	\$1610	\$1610	\$1618	\$1636	\$1685	\$1718	\$1755	\$1781	\$1826	\$1891	\$1668	\$ 2026	\$ 2124
	Surround	+\$ 56	+\$117	+\$137	+\$177	+\$291	+\$365	+\$452	+\$511	+\$617	+\$764	+\$109	+\$1076	+\$1297
	Back	+\$ 56	+\$ 37	+\$ 46	+\$ 57	+\$ 96	+\$119	+\$146	+\$166	+\$201	+\$249	+\$109	+\$ 351	+\$ 423

COM/yds: Seat = .78, Surround = 1.25, Cushion = .67, COL/sq ft: Seat = 9, Surround = 30, Cushion = 11

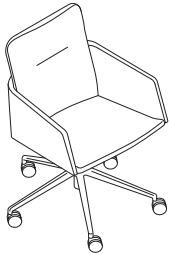

Overall: 24"D x 26"W x 31-36"H
 Inside: 16 1/2"D x 18"W
 Seat: 17"-22"H

 **For Canadian Pricing**
 Multiply U.S. Price by the
 Canadian price factor.
 ► See page 1 for details.

Marien152 Conference Seating Multi-Fabric Diagram

DESIGN COALESSE DESIGN GROUP AND ARIK LEVY

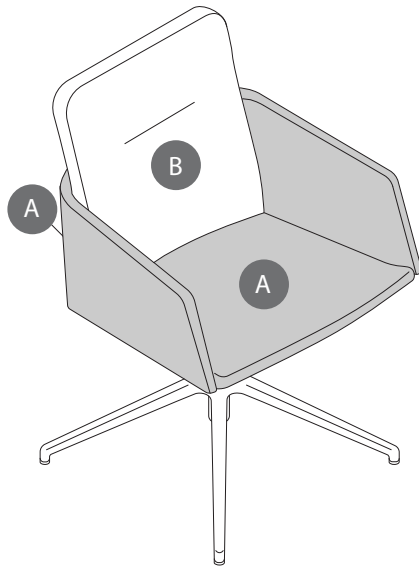
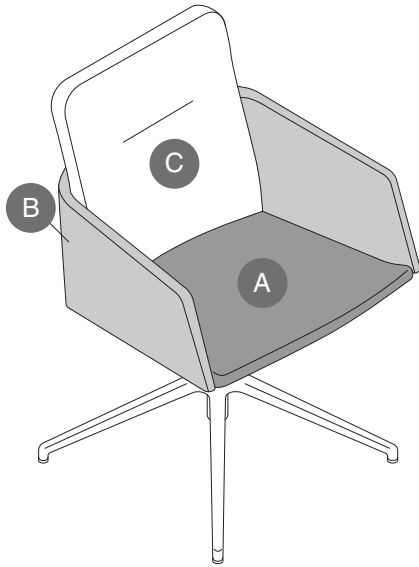

TO: _____

FROM: _____

DATE: _____

FAX...888.413.5161

FABRIC

A Seat: _____

B Surround: _____

C Back: _____

LEATHER

A Seat + Surround: _____

B Back: _____

Specify Model below:

COMARCCH4 4-Star Base Chair

COMARCCH5 5-Star Base Chair

*See specifying for contrasting fabric upcharge.
List price based on highest fabric grade usage.*

Lox Seating

DESIGN PEARSON LLOYD

Lox provides comfortable and sleek seating in social spaces for informal gatherings in cafés and lobbies, meeting rooms, and dining rooms as well as in dynamic, collaborative meeting spaces.

Seat back can be upholstered.

Shell is plastic, and is available in three color choices.

Seat is upholstered.

Swivel mechanism is standard.

4-star base is polished aluminum.

Glides are black plastic; felt glides are available for use on non-carpeted surfaces.

Seat back can be upholstered.

Shell is plastic, and is available in three color choices.

Seat is upholstered.

Swivel mechanism with spring is standard.

5-star base is polished aluminum.

Casters have hard, dual wheels that roll smoothly on carpets. Soft casters with roll control have been designed to roll quietly and are available for use on hard floors and chair mats.

Product Details

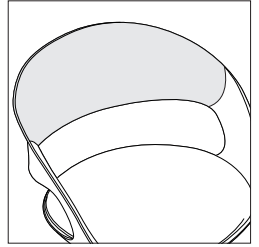

Textile patterns require seams on the inside back of chair. Limited solid textiles and leathers also require seams.

Surface Materials

► See *Coalesse Surface Materials Reference Guide* for further information.

Upholstery

- Fabric
- Leather

Shell

- Plastic

4- or 5-star base

- Polished aluminum

Program & Services

Customer's Own Material/Leather (COM/COL) Program is available.

► See *Coalesse Surface Materials Reference Guide* for additional information.

Lox Seating

DESIGN PEARSON LLOYD

Tip: For Customer's Own Material or Leather, see necessary requirements, important processing instructions, and ordering information
 ▶ See *Coalesse Surface Materials Reference Guide*.

Tip: Due to the design and construction techniques of the Lox chairs only certain textiles can be successfully applied, therefore all COM fabrics must be submitted to Coalesse for approval prior to order acceptance.

Tip: Textile patterns for chair with upholstered back will require seams on the inside back of the chair. Limited solid textiles or leathers may also require seams. For specific textile information, visit the fabric database at www.coalesse.com.

Standard Includes		Required to Specify
▶ Need help? Product details, page 279	<ul style="list-style-type: none"> • Shell: plastic • Base: 8046 Polished Aluminum • Seat: fixed upholstery with polyurethane foam base • Back: fixed upholstery with polyurethane foam base, if selected • 4-star base: <ul style="list-style-type: none"> – Swivel mechanism – Glides: plastic • 5-star base: <ul style="list-style-type: none"> – Swivel mechanism with spring – Dual-wheel, hard casters: black 	1 Style number 2 Plastic color number for shell: 6345 Black 6346 White 6349 Greige 3 Fabric or leather color number for upholstery 4 Options, if selected (see below) ▶ See <i>Coalesse Surface Materials Reference Guide</i> .

Options	U.S. Price	Required to Specify
Surface Materials	Acrylic backer	
	• Chair with upholstered seat	+\$ 7 Specify with acrylic backer.
	• Chair with upholstered seat and back	+\$12 Specify with acrylic backer. ▶ See <i>Coalesse Surface Materials Reference Guide</i> .
Felt Glides	• Glides (available on COLX400 and COLX410)	No cost Specify with felt glides.
Casters	• Soft wheel casters with roll control (available on COLX500 and COLX510)	+\$31 Specify with soft casters.

Related Products • Stools ▶ Page 367

Specification Information

Style Number	U.S. Base Prices														Leather Grades:		
	Fabric Grades:														COL	C	E
	COM	6	7	8	9	10	11	12	13	14							

4-Star Base Chair with Upholstered Seat

COLX400	\$1734	\$1712	\$1720	\$1733	\$1773	\$1797	\$1827	\$1845	\$1881	\$1932	\$2093	\$1860	\$2052
COM/yds = 3/4, COL/sq ft = 13													

4-Star Base Chair with Upholstered Seat and Back

COLX410	\$2070	\$2070	\$2084	\$2105	\$2171	\$2212	\$2262	\$2295	\$2354	\$2438	\$2426	\$2586	\$2647
COM/yds = 1/4, COL/sq ft = 22													

▶ Specification Information, continued on next page



Overall: 27"D 27"W 31"H
 Seat: 18"D 18"W 19"H



Overall: 27"D 27"W 31"H
 Seat: 18"D 18"W 19"H



For Canadian Pricing
 Multiply U.S. Price by the Canadian price factor.
 ▶ See page 1 for details.

Lox Seating

DESIGN PEARSON LLOYD

► Specification Information, continued from previous page

Specification Information

Style Number	U.S. Base Prices														Leather Grades:		
	Fabric Grades:														COL	C	E
	COM	6	7	8	9	10	11	12	13	14							

5-Star Base Chair with Upholstered Seat

COLX500	\$1926	\$1904	\$1912	\$1925	\$1965	\$1989	\$2019	\$2037	\$2073	\$2124	\$2285	\$2052	\$2244
---------	--------	--------	--------	--------	--------	--------	--------	--------	--------	--------	--------	--------	--------

COM/yds = 3/4, COL/sq ft = 13



Overall: 27"D 27"W 31"H
Seat: 18"D 18"W 19"H

5-Star Base Chair with Upholstered Seat and Back

COLX510	\$2255	\$2255	\$2269	\$2290	\$2356	\$2397	\$2447	\$2480	\$2539	\$2623	\$2611	\$2771	\$2832
---------	--------	--------	--------	--------	--------	--------	--------	--------	--------	--------	--------	--------	--------

COM/yds = 1 1/4, COL/sq ft = 22



Overall: 27"D 27"W 31"H
Seat: 18"D 18"W 19"H



For Canadian Pricing
Multiply U.S. Price by the
Canadian price factor.
► See page 1 for details.

Massaud Conference Seating

DESIGN COALESSE DESIGN GROUP AND JEAN-MARIE MASSAUD

Conference and duvet conference chairs feature different upholstery techniques expressed through the unique geometry on each chair's inner back.

Tip: These techniques apply to mid- and low-back chairs with both loop and integrated arms.

Tip: This product line is part of a collection and will be found in multiple locations in this specification guide.

Aluminum loop arm, available in painted or polished finishes, is contoured for comfort and is available on mid-back chairs only. Optional upholstered arm caps are available.

Casters have hard, dual-wheels that roll smoothly on carpets. Soft casters with roll control have been designed to roll quietly and are available for use on hard floors and chair mats.

Back tension adjustment offers two settings to allow the user to adjust the rate of increase or decrease in force as the user reclines. Turn lever forward to increase tension. Turn lever back to decrease.

Seat height adjustment allows users to change seat height within a 5" range with the assistance of a pneumatic gas cylinder.

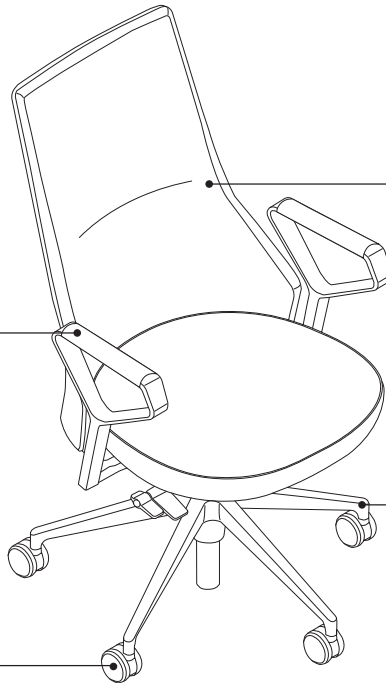

Conference chair upholstery features a horizontal, single needle stitching technique on the chair's inner back.

5-star base is standard on mid-back chair with loop arm.

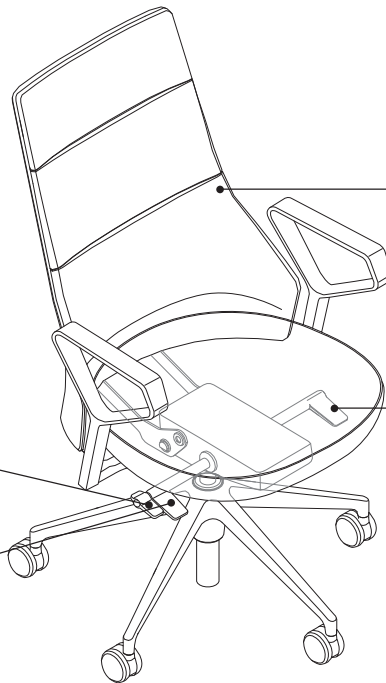

Duvet conference chair upholstery features a duvet stitching technique accented with comfort wrinkles on the chair's inner back.

Recline adjustment allows user to choose from three recline positions: full-tilt, mid-stop, and full upright positions.

Synchro-tilt mechanism is weight activated and automatically responds to recline resistance proportionate to the user's weight. The chair and back move in a 3:1 ratio.

Massaud Conference Seating

DESIGN COALESSE DESIGN GROUP AND JEAN-MARIE MASSAUD

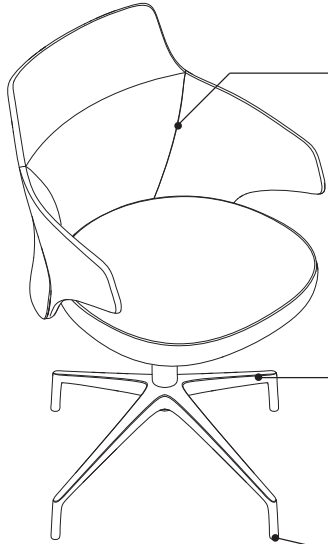

Inner back vertical seam is standard on chairs with integrated arms.

4-star base is standard on low and mid-back chairs with integrated arm. Aluminum base, available in painted or polished finishes, comes standard with glides. Seat is fixed height with a swivel only mechanism.

Non-adjustable glide is standard on low- and mid-back chairs. Easy slide glide is optional and features a wide surface, allowing a smooth slide on carpet and soft flooring.



Integrated arm follows the elegant curve and profile of the chair and is available on low and mid-back chairs.

5-star base is optional on chairs with integrated arm. Includes synchro-tilt mechanism with pneumatic height, tension, and recline adjustments.

Product Details

Tip: Upholstery details apply to mid- and low-back chairs with both loop and integrated arms.

Seamless Upholstery

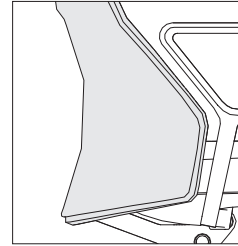

Outer back seams are not required on conference and duvet conference chairs with seamless upholstery selection.

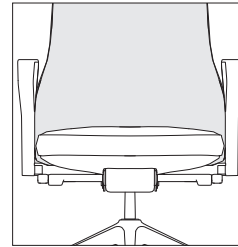

Inner back vertical seams are not required on conference chairs with seamless upholstery selection.

Seamed Upholstery

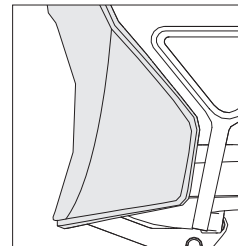

Outer back seams are required on conference and duvet conference chairs with seamed upholstery selection.

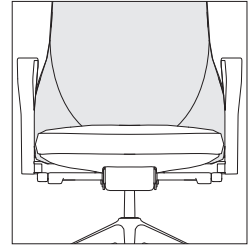

Inner back vertical seams are required on conference chairs with seamed upholstery selection.

Tip: Duvet conference chairs with loop arms always have horizontal inner back seams, but vertical seams are not required. Conference and duvet conference chairs with integrated arms always have vertical inner back seams.

Surface Materials

Seamless Upholstery:

- Coalesse Fusion (back only)
- Designtex Chromatic
- Designtex Heather
- Designtex Billiard Cloth
- Designtex Pigment
- Designtex Melrose
- Maharam Hallingdal
- Maharam Messenger
- Steelcase Cogent: Connect
- Steelcase Billiard Multi-Use by Designtex

Seamed Upholstery:

- Any upholstery not listed above will require seams.

Base and arms

- Aluminum matte polished
- Paint

Easy slide glides (option):

- Paint

Programs & Services

Customer's Own Material/Leather (COM/COL) Program is available.

► See *Coalesse Surface Materials Reference Guide* for additional information.

Massaud Conference Seating

DESIGN COALESSE DESIGN GROUP AND JEAN-MARIE MASSAUD



Tip: For duvet conference chairs, fabrics and leathers will appear loose with comfort wrinkles when upholstered.

Tip: For Customer's Own Material or Leather, see necessary requirements, important processing instructions, and ordering information.

► See *Coalesse Surface Materials Reference Guide* and online fabric database at <http://fabric.coalesse.com>

Tip: Pneumatic height adjustment allows user to change seat height, with the assistance of a pneumatic gas cylinder. Synchro-tilt mechanism has three recline positions and two tension positions.

Tip: Faux leathers and vinyls are not recommended on arm cap upholstery.

Tip: Loop arms can be adjusted out 1" on either side. Requires tools and must be done by a facility manager.

Tip: Easy slide glides are to be used on carpet and soft flooring.

Tip: Fusion fabric is available on the outer back only. It is not recommended for any other surface.

	Standard Includes	Required to Specify
► Need help? Product details, page 282	<ul style="list-style-type: none"> • Base: 8040 Aluminum Matte Polished or Grade 1 paint • Inner back and seat: <ul style="list-style-type: none"> - Conference chair, if selected: horizontal single needle stitching detail on inner back - Duvet conference chair, if selected: comfort wrinkles on inner back • Outer back and inner back: see upholstery understanding <ul style="list-style-type: none"> ► See page 283 for seaming placement based on upholstery selection • Pneumatic height adjustment and synchro-tilt mechanism • Arms: <ul style="list-style-type: none"> - Mid-back chair, if selected: 8040 Aluminum Matte or Grade 1 paint • Polished loop arms (without arm caps): <ul style="list-style-type: none"> - Low-back chair, if selected: fully upholstered integrated arms • Base: <ul style="list-style-type: none"> - Chairs with loop arms, if selected: 5-star base with black, dual wheel hard casters - Chairs with integrated arms, if selected: 4-star base with non-adjustable glides 	<ol style="list-style-type: none"> 1 Style number 2 Metal of paint color number for base and arms 3 Fabric or leather color number for upholstery on seat, inner, and outer back 4 Options, if selected (see below) <p>► See <i>Coalesse Surface Materials Reference Guide</i>.</p>

	Options	U.S. Price	Required to Specify
Surface Materials	<ul style="list-style-type: none"> • Contrasting inner back • Contrasting outer back • Contrasting seat • Contrasting all target surfaces 	<ul style="list-style-type: none"> +\$182 +\$182 +\$182 +\$364 	<p>Specify with <i>contrasting inner back</i>. Specify with <i>contrasting outer back</i>. Specify with <i>contrasting seat</i>. Specify with <i>contrasting all</i>.</p> <p>► See <i>Coalesse Surface Materials Reference Guide</i>.</p>
	Base and arms		
	<ul style="list-style-type: none"> • Aluminum matte polished • Grade 1 paint • Grade 3 paint 	<ul style="list-style-type: none"> No cost No cost +\$105 	<p>Specify with <i>aluminum matte polished</i>. Specify paint color number. Specify paint color number.</p>
Acrylic backer	<ul style="list-style-type: none"> • Conference chair • Duvet conference chair 	<ul style="list-style-type: none"> +\$ 46 +\$ 74 	<p>Specify with <i>acrylic backer</i>. Specify with <i>acrylic backer</i>.</p>
Base	Chairs with integrated arms		
	<ul style="list-style-type: none"> • 4-star base • 5-star base 	<ul style="list-style-type: none"> No cost +\$ 74 	<p>Specify with <i>4-star base</i>. Specify with <i>5-star base</i>.</p>
Arm Caps	Chairs with loop arms		
	<ul style="list-style-type: none"> • Faux leather and vinyl are excluded 	<ul style="list-style-type: none"> +\$293 	<p>Specify with <i>arm caps</i> and select finish.</p>
Caster or Glide Type	Chairs with 5-star base		
	<ul style="list-style-type: none"> • Hard casters • Soft casters 	<ul style="list-style-type: none"> No cost +\$ 29 	<p>Specify with <i>hard casters</i>. Specify with <i>soft casters</i>.</p>
	Chairs with 4-star base		
	<ul style="list-style-type: none"> • Easy slide glides 	<ul style="list-style-type: none"> No cost 	<p>Specify with <i>easy slide glides</i> and select 6167 Black or 6168 Natural finish.</p>
Related Products	<ul style="list-style-type: none"> • Lounge seating 		► Page 156



For Canadian Pricing
Multiply U.S. Price by the Canadian price factor.
► See page 1 for details.

Massaud Conference Seating

DESIGN COALESSE DESIGN GROUP AND JEAN-MARIE MASSAUD

Specification Information



With 5-star base
Overall: 23¾"W x 25"D x 38¼"-43½"H
Inside: 19¼"W x 18"D
Seat: 16¾"-21¾" H
Arm: 24½"-29¾"H

Style Number	U.S. Base Prices													
	Fabric Grades:											Leather Grades:		
	COM	6	7	8	9	10	11	12	13	14	COL	C	E	

Mid-Back Conference Chair with Loop Arm

COMCCHMBST	Seat	\$2385	\$2385	\$2401	\$2428	\$2510	\$2561	\$2623	\$2664	\$2471	\$2846	\$2471	\$2851	\$2966
	Inner back	+\$ 59	+\$ 41	+\$ 49	+\$ 62	+\$104	+\$130	+\$160	+\$181	+\$218	+\$273	+\$114	+\$416	+\$502
	Outer back	+\$ 59	+\$ 41	+\$ 49	+\$ 62	+\$104	+\$130	+\$160	+\$181	+\$218	+\$273	+\$114	+\$368	+\$447

COM/yds: Seat = 1.6, Inner Back = .75, Outer Back = .75, Optional Arm Caps = .25 COL/sq ft: Seat = 21, Inner Back = 15, Outer Back = 16, Optional Arm Caps = 2



With 5-star base
Overall: 23¾"W x 25"D x 38¼"-43½"H
Inside: 19¼"W x 18"D
Seat: 16¾"-21¾" H
Arm: 24½"-29¾"H

Mid-Back Duvet Conference Chair with Loop Arm

COMCCHMBDV	Seat	\$2385	\$2385	\$2401	\$2428	\$2510	\$2561	\$2623	\$2664	\$2741	\$2846	\$2471	\$2851	\$2966
	Inner back	+\$ 59	+\$ 41	+\$ 49	+\$ 62	+\$104	+\$130	+\$160	+\$181	+\$218	+\$273	+\$114	+\$416	+\$502
	Outer back	+\$ 59	+\$ 41	+\$ 49	+\$ 62	+\$104	+\$130	+\$160	+\$181	+\$218	+\$273	+\$114	+\$368	+\$447

COM/yds: Seat = 1.6, Inner Back = .90, Outer Back = .75, Optional Arm Caps = .90 COL/sq ft: Seat = 21, Inner Back = 15, Outer Back = 16, Optional Arm Caps = 2

► Specification Information, continued on next page



For Canadian Pricing
 Multiply U.S. Price by the Canadian price factor.
 ► See page 1 for details.

Massaud Conference Seating continued

DESIGN COALESSE DESIGN GROUP AND JEAN-MARIE MASSAUD

► Specification Information, continued from previous page

Specification Information



With 4-star base
Overall: 24¾"W x 22½"D x 34"H
Inside: 23¾"W x 18"D
Seat: 18"H
Arm: 26½"H



With 5-star base
Overall: 24¾"W x 23"D x 31½"-36¾"H
Inside: 23¾"W x 18"D
Seat: 16¾"-21¾"H
Arm: 24½"-29¾"H

Style Number	U.S. Base Prices										Leather Grades:		
	Fabric Grades:										COL	C	E
	COM	6	7	8	9	10	11	12	13	14			

Low-Back Conference Chair with Integrated Arm

COMCCHLBSTNT	Seat	\$1993	\$1993	\$2009	\$2036	\$2118	\$2169	\$2231	\$2272	\$2349	\$2454	\$2079	\$2459	\$2574
	Inner back	+\$ 59	+\$ 73	+\$ 83	+\$108	+\$180	+\$223	+\$277	+\$314	+\$379	+\$470	+\$114	+\$548	+\$663
	Outer back	+\$ 59	+\$ 41	+\$ 49	+\$ 62	+\$104	+\$130	+\$160	+\$181	+\$218	+\$273	+\$114	+\$368	+\$447

COM/yds: Seat = 1.5, Inner Back = 1.4, Outer back = .8 COL/sq ft: Seat = 23.75, Inner Back = 15, Outer Back = 16



With 4-star base
Overall: 24¾"W x 22½"D x 34"H
Inside: 23¾"W x 18"D
Seat: 18"H
Arm: 26½"H



With 5-star base
Overall: 24¾"W x 23"D x 31½"-36¾"H
Inside: 23¾"W x 18"D
Seat: 16¾"-21¾"H
Arm: 24½"-29¾"H

Low-Back Duvet Conference Chair with Integrated Arm

COMCCHLBDVNT	Seat	\$1993	\$1993	\$2009	\$2036	\$2118	\$2169	\$2231	\$2272	\$2349	\$2454	\$2079	\$2459	\$2574
	Inner back	+\$ 59	+\$ 73	+\$ 83	+\$108	+\$180	+\$223	+\$277	+\$314	+\$379	+\$470	+\$114	+\$548	+\$663
	Outer back	+\$ 59	+\$ 41	+\$ 49	+\$ 62	+\$104	+\$130	+\$160	+\$181	+\$218	+\$273	+\$114	+\$368	+\$447

COM/yds: Seat = 1.5, Inner Back = 1.4, Outer back = .8 COL/sq ft: Seat = 23.75, Inner Back = 15, Outer Back = 16

► Specification Information, continued on next page



For Canadian Pricing
 Multiply U.S. Price by the Canadian price factor.
 ► See page 1 for details.

Massaud Conference Seating

DESIGN COALESSE DESIGN GROUP AND JEAN-MARIE MASSAUD

► Specification Information, continued from previous page

Specification Information



With 4-star base
Overall: 24¾"W x 24½"D x 40¼"H
Inside: 19¼"W x 18"D
Seat: 18"H
Arm: 26½"H



With 5-star base
Overall: 24¾"W x 25"D x 38¼"-43½"H
Inside: 19¼"W x 18"D
Seat: 16¾"-21¾"H
Arm: 24½"-29¾"H

Style Number	U.S. Base Prices														Leather Grades:		
	Fabric Grades:														COL	C	E
	COM	6	7	8	9	10	11	12	13	14							

Mid-Back Conference Chair with Integrated Arm

COMCCHMBSTNT	Seat	\$2435	\$2435	\$2451	\$2478	\$2560	\$2611	\$2673	\$2714	\$2791	\$2896	\$2521	\$2901	\$3016
	Inner back	+\$ 59	+\$ 77	+\$ 93	+\$117	+\$193	+\$240	+\$300	+\$339	+\$408	+\$507	+\$114	+\$548	+\$663
	Outer back	+\$ 59	+\$ 41	+\$ 49	+\$ 62	+\$104	+\$130	+\$160	+\$181	+\$218	+\$273	+\$114	+\$368	+\$447

COM/yds: Seat = 1.5, Inner Back = 1.4, Outer back = .8 COL/sq ft: Seat = 23.75, Inner Back = 15, Outer Back = 16

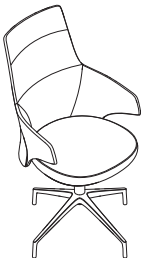

With 4-star base
Overall: 24¾"W x 24½"D x 40¼"H
Inside: 19¼"W x 18"D
Seat: 18"H
Arm: 26½"H



With 5-star base
Overall: 24¾"W x 25"D x 38¼"-43½"H
Inside: 19¼"W x 18"D
Seat: 16¾"-21¾"H
Arm: 24½"-29¾"H

Mid-Back Duvet Conference Chair with Integrated Arm

COMCCHMBDVNT	Seat	\$2435	\$2435	\$2451	\$2478	\$2560	\$2611	\$2673	\$2714	\$2791	\$2896	\$2521	\$2901	\$3016
	Inner back	+\$ 59	+\$ 77	+\$ 93	+\$117	+\$193	+\$240	+\$300	+\$339	+\$408	+\$507	+\$114	+\$548	+\$663
	Outer back	+\$ 59	+\$ 41	+\$ 49	+\$ 62	+\$104	+\$130	+\$160	+\$181	+\$218	+\$273	+\$114	+\$368	+\$447

COM/yds: Seat = 1.5, Inner Back = 1.4, Outer back = .8 COL/sq ft: Seat = 23.75, Inner Back = 15, Outer Back = 16

 **For Canadian Pricing**
 Multiply U.S. Price by the Canadian price factor.
 ► See page 1 for details.

Massaud Conference Seating Multi-Fabric Diagram

DESIGN COALESSE DESIGN GROUP AND JEAN-MARIE MASSAUD

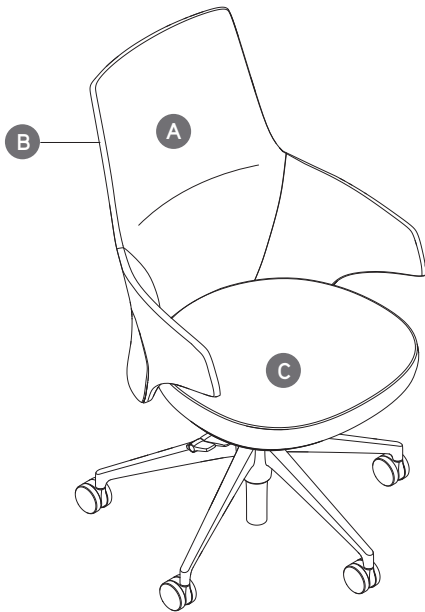
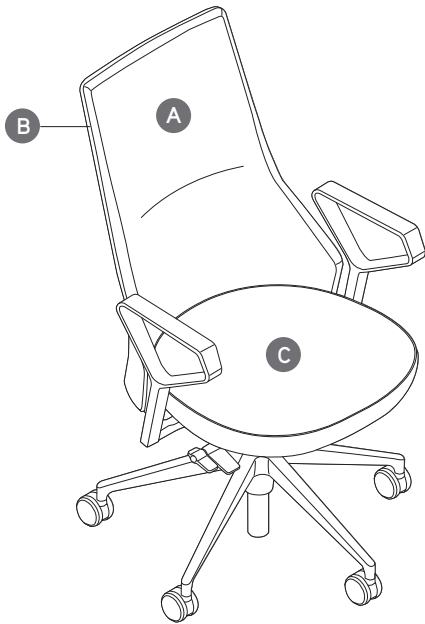

TO: _____

FROM: _____

DATE: _____

FAX...888.413.5161

A Inner Back: _____

B Outer Back: _____

C Seat: _____

Contrasting upcharge for each contrasting textile pricing based on highest grade textile specified. See specifying for contrasting upcharge.

Specify Model below:

COMCCHMBST Massaud Mid-Back Conference Chair with Loop Arm

COMCCHMBDV Massaud Mid-Back Duvet Conference Chair with Loop Arm

COMCCHLBTNT Massaud Low-Back Conference Chair with Integrated Arm

COMCCHLBDVNT Massaud Low-Back Duvet Conference Chair with Integrated Arm

COMCCHMBSTNT Massaud Mid-Back Conference Chair with Integrated Arm

COMCCHMBDVNT Massaud Mid-Back Duvet Conference Chair with Integrated Arm

Tip: On chairs with integrated arm, the inner back selection [A] also applies to the entire integrated arm (both front and back).

SW_1 Conference Seating

DESIGN SCOTT WILSON & MINIMAL

SW_1 conference seating offers a wide range of expressive possibilities with the use of knit mixed with fabric or leather upholstery. *Tip: This product line is part of a collection and will be found in multiple locations in this specification guide and/or Coalesse Tables, Storage, and Accessories Specification Guide.*

► See Collections, page 5.

Knit back provides back support and breathability.

5-star base is standard in aluminum matte polished.

Casters are standard with hard, dual-wheels in black that roll smoothly on carpets. Soft casters are available in black for use on hard floors and chair mats.

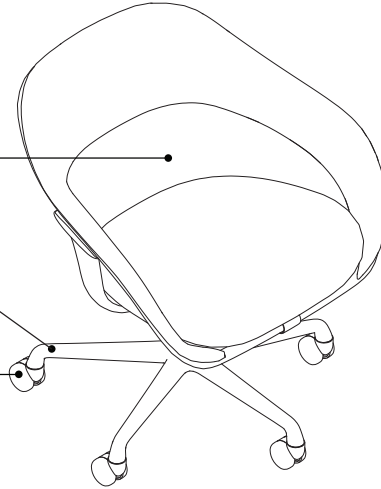

360° swivel base mechanism provides full range of motion.

Knit back provides back support and breathability.

Glides are standard in aluminum with non-marring plastic insert.

Swivel return mechanism has a built in memory and will return to the fixed position when the user leaves the chair.

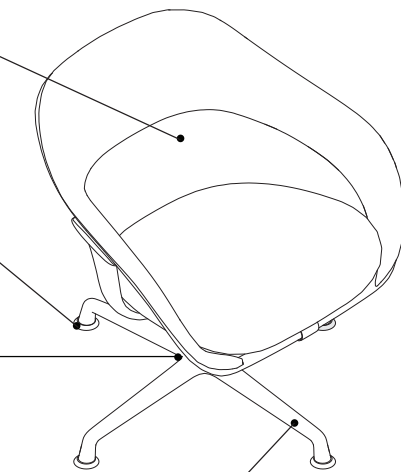

4-star base is standard in aluminum matte polished.

Product Details

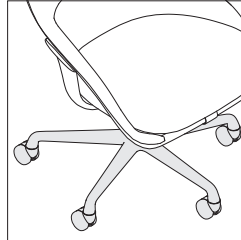

Conference chair with 5-star base is standard with black, dual-wheel casters. Aluminum matte polished casters are available as an option.

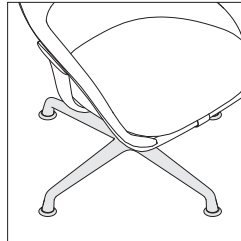

Conference chair with 4-star base is available for guest seating. Seat height is 18".

Adjustment Features

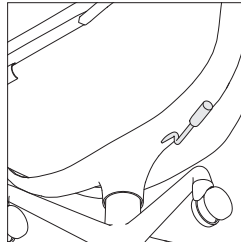

Seat height adjusts pneumatically. Lift lever to activate cylinder for desired height. To raise height, slightly stand while lifting lever; to lower, sit while lifting lever and weight pressure will adjust seat height. Range of adjustability is 3 1/2" with a maximum height of 19 3/4".

360° swivel mechanism is standard on 5-star base and provides user with a full range of motion.

Swivel return mechanism is standard on 4-star base. It has a built in memory and will return to the fixed position when the user leaves the chair.

Surface Materials

► See *Coalesse Surface Materials Reference Guide* for further information.

Upholstery (contrasting fabric available)

- Knit
- Fabric
- Leather

Base

- Aluminum matte polished

Casters on 5-star base

- Black plastic
- Aluminum matte polished

Glides on 4-star base

- Aluminum with non-marring plastic insert

Programs & Services

Customer's Own Material/Leather (COM/COL) Program is available.

► See *Coalesse Surface Materials Reference Guide* for additional information.

SW_1 Conference Seating

DESIGN SCOTT WILSON & MINIMAL

Tip: For Customer's Own Material or Leather, see necessary requirements, important processing instructions, and ordering information
 ▶ See *Coalesse Surface Materials Reference Guide*.

Standard Includes		Required to Specify
▶ Neep help? Product details. Page 289	<ul style="list-style-type: none"> • Seat and upper back: fabric or leather • Lower back: knit • Base: 8040 Aluminum Matte Polished • Frame: steel tube • Glides on conference chair with 4-star base, if selected: aluminum with non marring plastic insert • Casters on conference chair with 5-star base, if selected: dual wheel hard casters, black only • Swivel return mechanism on conference chair with 4-star base, if selected • Swivel mechanism on conference chair with 5-star base, if selected 	1 Style number 2 Upholstery color number for seat or upper back 3 Knit color number for lower back 4 Options, if selected (see below) ▶ See <i>Coalesse Surface Materials Reference Guide</i> .

Options	U.S. Price	Required to Specify
Surface Materials	<ul style="list-style-type: none"> • Contrasting fabric +\$182 	Specify with <i>contrasting fabric</i> and select fabric color number.
	<ul style="list-style-type: none"> • Acrylic backer • Backer +\$ 46 	Specify with <i>acrylic backer</i> . ▶ See <i>Coalesse Surface Materials Reference Guide</i> .
Mechanism	<ul style="list-style-type: none"> • Full swivel (omit swivel-return feature) No cost 	Specify with <i>swivel-only mechanism</i> .
Casters	<ul style="list-style-type: none"> • Black soft casters +\$ 37 • Hard black casters with polished aluminum body +\$102 • Soft black casters with polished aluminum body +\$140 	Specify with <i>soft casters</i> . Specify with <i>hard polished aluminum casters</i> . Specify with <i>soft polished aluminum casters</i> .
Related Products	<ul style="list-style-type: none"> • Collaborative and conference tables • Occasional tables • Lounge seating 	▶ See <i>Coalesse Tables, Storage, and Accessories Specification Guide</i> . ▶ See <i>Coalesse Tables, Storage, and Accessories Specification Guide</i> . ▶ Page 232

Specification Information

Style Number	U.S. Base Prices														Leather Grades:		
	Fabric Grades:														COL	C	E
	COM	6	7	8	9	10	11	12	13	14							

Conference Chair with 4-Star Base

Style Number	Seat	COM	6	7	8	9	10	11	12	13	14	COL	C	E
COW413	\$2837	\$2837	\$2846	\$2862	\$2904	\$2935	\$2971	\$2994	\$3035	\$3095	\$2914	\$3260	\$3308	
	Upper back	+\$108	+\$108	+\$130	+\$162	+\$273	+\$340	+\$421	+\$477	+\$574	+\$710	+\$287	+\$1090	+\$1211
COM/yds = 3, COL/sq ft = 60														

Conference Chair with 5-Star Base

Style Number	Seat	COM	6	7	8	9	10	11	12	13	14	COL	C	E
COW415	\$2837	\$2837	\$2846	\$2862	\$2904	\$2935	\$2971	\$2994	\$3035	\$3095	\$2914	\$3260	\$3308	
	Upper back	+\$108	+\$108	+\$130	+\$162	+\$273	+\$340	+\$421	+\$477	+\$574	+\$710	+\$287	+\$1090	+\$1211
COM/yds = 3, COL/sq ft = 60														



Overall: 25¼"D 28"W 31½"H
 Seat: 18"H
 Arm: 25¼"H



Overall: 25¼"D 28"W 29½"H-33"H
 Seat: 16¼"H-19¾"H
 Arm: 23½"H-27"H

 **For Canadian Pricing**
 Multiply U.S. Price by the Canadian price factor.
 ▶ See page 1 for details.

SW_1 Conference Seating Multi-Fabric Diagram

DESIGN SCOTT WILSON & MINIMAL

TO: _____

FROM: _____

DATE: _____

FAX...888.413.5161

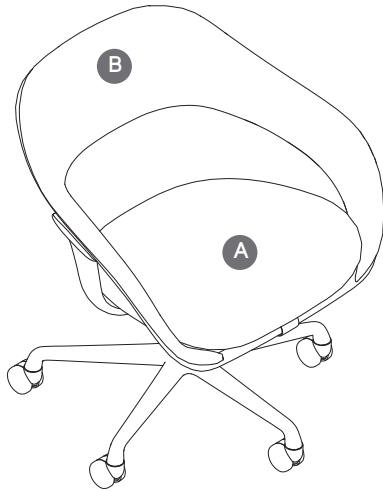

A Seat: _____

B Upper Back: _____

Contrasting fabric charges will apply. List price based on highest grade textile specified.

Contrasting upcharge for each contrasting textile pricing based on highest grade textile specified. See specifying for contrasting upcharge.

Specify Model below:

COW413 Conference Chair with 4-Star Base

COW415 Conference Chair with 5-Star Base

Adjustment Feature Definitions

Active mechanism (AM+) allows the seat and back angle to be adjusted independently of each other. The seat can be locked at various angles, and the back can free tilt with adjustable tension or lock in four positions.

Arms, height adjustable allow the user to independently move each arm up and down.

Arms, width-adjustable allows the arm rests to be adjusted in and out.

Arms, folding allows the user to independently fold each arm up or down for total freedom of leg movement and posture accommodation.

Back, height adjustable allows the user to raise or lower the chair back within a given range.

Back lock, forward allows the user to lock the backrest in a full upright position or release it to recline.

Back stop, selective allows the user to lock and unlock the backrest in any position within the tilt range.

Back tilt tension adjustment regulates the ease of tilt movement of the back only.

Back and seat tilt (Your Power mechanism) automatically responds to the weight and seating position of the user with an individual back resistance.

Base, free swivel allows chair to swivel 360°.

Base, memory-return swivel allows a chair to swivel 360°, but return to the forward-facing position when released.

Base, nesting four-prong has two front legs that are lower than the two rear legs, allowing chairs to nest for storage. A nylon tooth on the base engages a notch in the seat when folded. This engagement properly aligns the seat and base for nesting.

Folding seat allows the seat to flip up, while the chair automatically rises for nesting and storage.

Knee tilt control (low front rise) minimizes the rise of the front of the seat when the chair is in a reclined position, allowing the users' feet to remain on the floor. This feature reduces pressure under the thighs, allowing for continuous blood circulation.

Lumbar support, adjustable provides additional lower back comfort by allowing the user to move the lumbar support up or down, as well as increase or decrease the amount of support.

Passive mechanism (PM) allows the seat and back to move in synchronization without manual adjustment.

Pneumatic height allows the user to change the seat height assisted by a pneumatic gas cylinder.

Seat angle adjustment allows the user to change and lock the seat angle in various positions.

Seat depth, adjustable allows the user to slide the seat forward or back within a set range.

Seat tilt control allows the seat and back to rotate as a unit backward one position and forward two positions.

Seat, zero front rise allows the user to tilt back in the chair while feet remain on the floor because the seat front remains level.

Swivel-tilt mechanism control allows the chair to swivel 360° and the fixed seat and back to tilt in unison when the user leans back.

Synchro-tilt mechanism synchronizes the tilting movement of the seat and back in a set ratio.

Tilt tension adjustment allows the user to vary the amount of recline resistance. Your Power mechanism allows the back and seat tilt to adjust automatically to the weight and seating position of the user.

Your Preference control allows the user to adjust the back tilt by selecting one of four settings: weight activated, weight activated with 20% resistance boost, mid-stop recline, and upright back lock.

Guest Seating

*These product lines are collections and will be found in multiple locations in this specification guide and/or *Coalesce Tables, Storage, and Accessories Specification Guide*.

▶ See *Collections*, page 5

Bindu Chairs	294
Bob Chair*	296
Capa Chairs	299
Enea Stacker Chairs*	301
Enea Lottus Chairs*	306
Enea Altzo943 Chairs*	312
Kathryn Chairs	314
LessThanFive Chairs	318
Marien152 Guest Seating	320
Montara650 Chairs*	326
Switch Chairs*	331
Wrapp Chairs	334

Bindu Chairs

DESIGN BRIAN KANE

Bindu chair combines the comfort of an upholstered lounge with the performance needs of a work task chair.

Bindu chair offered in mid back and low back. Low-back chair is shown.

Flex back allows smooth posture adjustments for users.

Glides are black and non-marring.

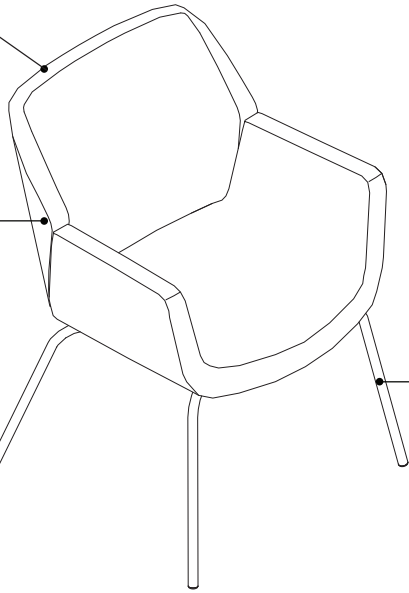

4-leg base is standard on guest chair.

Product Details

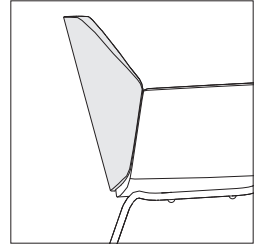

Flex back and unique arm detail allow for fluid posture adjustments.

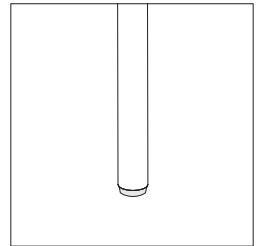

Glides are black and non-marring.

Surface Materials

► See *Coalesse Surface Materials Reference Guide* for further information.

Upholstery

- Fabric
- Leather

Base

- Black gloss
- Polished trivalent chrome

Program & Services

Customer's Own Material/Leather (COM/COL) Program is available.

► See *Coalesse Surface Materials Reference Guide* for additional information.

Bindu Chairs

DESIGN BRIAN KANE

Tip: Fabrics and leathers will appear loose with comfort wrinkles when upholstered.

Tip: Craft in upholstery cautions the use of stripes and patterns on Bindu. Please use fabric database when specifying.

Tip: For Customer's Own Material or Leather, see necessary requirements, important processing instructions, and ordering information
 ▶ See Coalesse Surface Materials Reference Guide.

Tip: For fabric with large pattern and specific pattern location is desired, contact Customer Service.

Standard Includes		Required to Specify
▶ Need help? Product details, page 294	<ul style="list-style-type: none"> Bent plywood frame Chair: fabric Molded polypropylene foam Frame: 4144 Black Gloss Glides: black, non-marring 	1 Style number 2 Fabric or leather color number for upholstery 3 Options, if selected (see below) ▶ See Coalesse Surface Materials Reference Guide.

Options	U.S. Price	Required to Specify
Surface Materials • Acrylic backer • Backer	+\$ 47	Specify with acrylic backer. ▶ See Coalesse Surface Materials Reference Guide.
Base • 9207 Polished Trivalent Chrome (available on CO200G & CO300G)	+\$223	Specify with 9207 Polished Trivalent Chrome.

Specification Information

Style Number	U.S. Base Prices											Leather Grades:		
	Fabric Grades:											COL	C	E
	COM	6	7	8	9	10	11	12	13	14				

Low-Back Chair

CO200G	\$1833	\$1833	\$1864	\$1913	\$2064	\$2164	\$2276	\$2358	\$2500	\$2695	\$2088	\$3876	\$4205
--------	--------	--------	--------	--------	--------	--------	--------	--------	--------	--------	--------	--------	--------

COM/yds = 3, COL/sq ft = 66



Overall: 25"D 24½"W 33¾"H
 Inside: 18¾"D 18½"-19½"W 15"H
 Seat: 17¾"H
 Arm: 26¼"H

Mid-Back Chair

CO300G	\$2102	\$2102	\$2133	\$2182	\$2333	\$2433	\$2545	\$2627	\$2769	\$2964	\$2357	\$4145	\$4474
--------	--------	--------	--------	--------	--------	--------	--------	--------	--------	--------	--------	--------	--------

COM/yds = 3, COL/sq ft = 66



Overall: 25"D 24½"W 37¾"H
 Inside: 18¾"D 18½"-19½"W 21"H
 Seat: 17¾"H
 Arm: 26¼"H



For Canadian Pricing
 Multiply U.S. Price by the Canadian price factor.
 ▶ See page 1 for details.

Bob Chair by Walter Knoll

DESIGN PEARSON LLOYD

Bob chair is well-crafted with careful detailing. It is equally suited to the office or boardroom.

Tip: This product line is a collection and will be found in multiple locations in this specification guide and/or Coalesse Tables, Storage, and Accessories Specification Guide.

► See *Collections*, page 5.

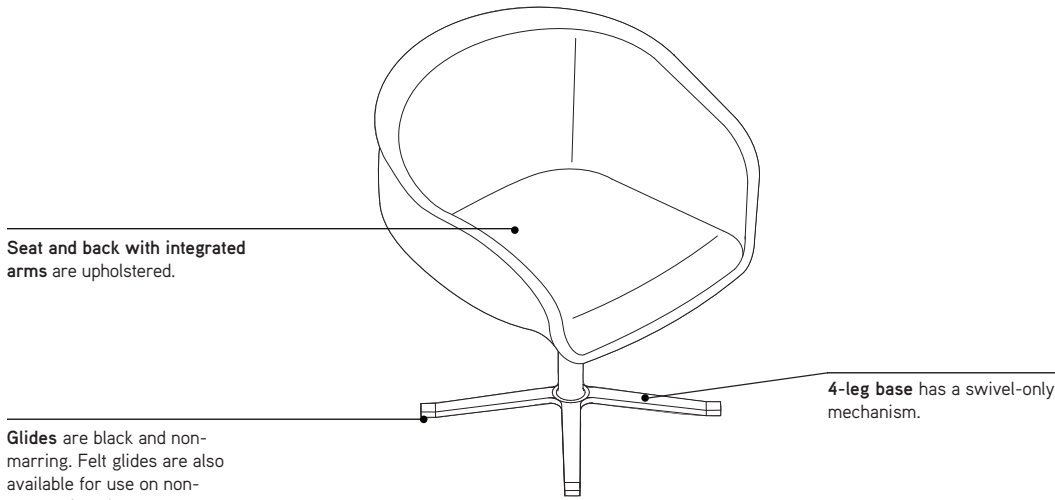

Seat and back with integrated arms are upholstered.

Glides are black and non-marring. Felt glides are also available for use on non-carpeted surfaces.

4-leg base has a swivel-only mechanism.

Product Details

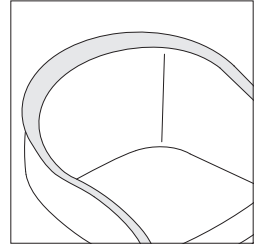

Fluted arm detail creates a pocket seat.

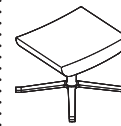

Ottoman in matching upholstery is available.

Surface Materials

► See *Coalesse Surface Materials Reference Guide* for further information.

Upholstery (contrasting fabric available)

- Fabric
- Leather

Base

- Aluminum matte polished
- Painted aluminum

Program & Services

Customer's Own Material/Leather (COM/COL) Program is available.

► See *Coalesse Surface Materials Reference Guide* for additional information.

Bob Chair by Walter Knoll

DESIGN PEARSON LLOYD

Tip: For Customer's Own Material or Leather, see necessary requirements, important processing instructions, and ordering information
 ▶ See *Coalesse Surface Materials Reference Guide*.

Tip: Fabrics and leathers will appear loose with comfort wrinkles when upholstered.

Standard Includes		Required to Specify	
▶ Need help? Product details, page 296	<ul style="list-style-type: none"> Swivel base: 8040 Aluminum Matte Polished or Grade 1 paint Upholstery for chair: fabric or leather Glides 	<ol style="list-style-type: none"> Style number Metal of paint color number for base and arms Fabric or leather color number for upholstery on seat, inner, and outer back Options, if selected (see below) 	▶ See <i>Coalesse Surface Materials Reference Guide</i> .
Options		U.S. Price	Required to Specify
Surface Materials	<ul style="list-style-type: none"> Contrasting fabric 	+\$182 per fabric	Add suffix K to the style number and select fabric color number.
	Base		
	<ul style="list-style-type: none"> Aluminum matte polished Grade 1 paint Grade 3 paint 	No cost No cost +\$105	Specify with <i>aluminum matte polished</i> . Specify paint color number. Specify paint color number.
	Acrylic backer		
	<ul style="list-style-type: none"> Backer for guest chair Backer for ottoman 	+\$ 33 +\$ 12	Specify with <i>acrylic backer</i> . Specify with <i>acrylic backer</i> . ▶ See <i>Coalesse Surface Materials Reference Guide</i> .
Glides	<ul style="list-style-type: none"> Felted glides 	+\$ 22	Specify with <i>felted glides</i> .
Related Products	<ul style="list-style-type: none"> Collaborative and conference tables Occasional tables Lounge seating 		▶ See <i>Coalesse Tables, Storage, and Accessories Specification Guide</i> . ▶ See <i>Coalesse Tables, Storage, and Accessories Specification Guide</i> . ▶ Page 56

Specification Information														
Style Number	U.S. Base Prices												Leather Grades:	
	Fabric Grades:												COL	C
	COM	6	7	8	9	10	11	12	13	14				

Guest Chair													
231	\$2753	\$2753	\$2773	\$2804	\$2906	\$2973	\$3050	\$3102	\$3195	\$3326	\$3074	\$4292	\$4515
COM/yds = 2, COL/sq ft = 44													

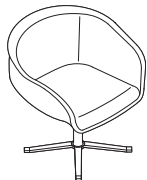

Overall: 25¼"D 27¼"W 29¾"H
 Inside: 18"D 18"W 12½"H
 Seat: 18½"H
 Arm: 26½"H

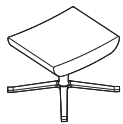

Overall: 18½"D 19¾"W 15¼"H

Ottoman													
221-H	\$1237	\$1228	\$1238	\$1255	\$1307	\$1338	\$1376	\$1404	\$1452	\$1517	\$1602	\$2171	\$2282
COM/yds = 1, COL/sq ft = 22													

 **For Canadian Pricing**
 Multiply U.S. Price by the Canadian price factor.
 ▶ See page 1 for details.

Bob Guest Seating Multi-Fabric Diagram

DESIGN PEARSON LLOYD

TO: _____

FROM: _____

DATE: _____

FAX...888.413.5161

A Seat (upholstery selections default for entire unit if B is not selected): _____

B Back and Arms: _____

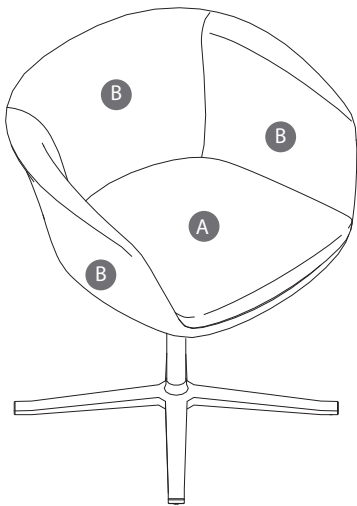

Specify Model below:

231K

221-HK

See specifying for contrasting fabric upcharge. List price based on highest fabric grade usage.

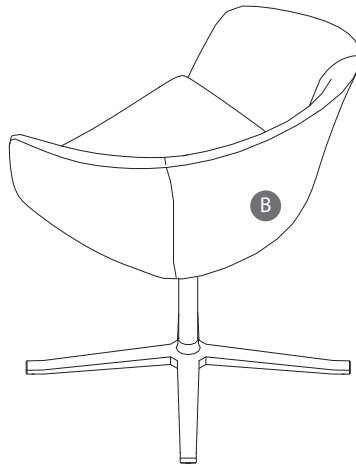

Capa Chairs

DESIGN E00S

Capa adds contemporary style with practical comfort. Capa has a unique shape, fully upholstered body, and double-needle topstitching.

Upholstery is molded around frame components.

Flex back design forms to match user's back shape.

Glides are black and non-marring.

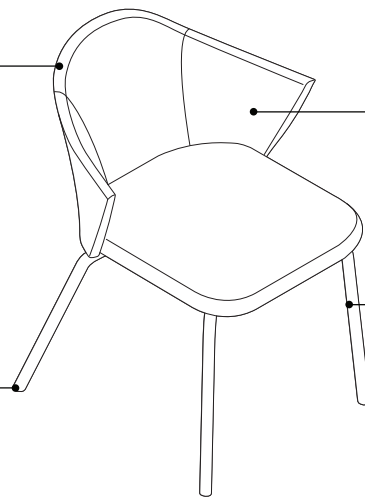

Side panels are recessed.

4-leg base allows for stacking up to five high with stacking dolly and three high on floor.

Product Details

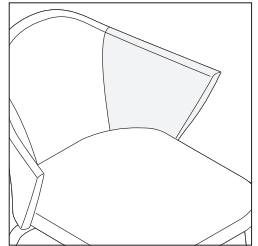

Recessed side panel creates arm rest without restricting user postures.

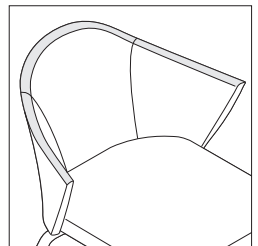

Topstitching design features a double-needle technique.

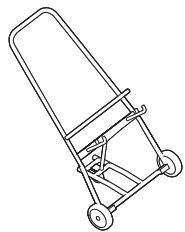

Stacking dolly is available to stack, move, and store up to five chairs. Dolly measures 34"D x 26"W x 34"H.

Surface Materials

► See *Coalesse Surface Materials Reference Guide* for further information.

Upholstery (contrasting fabric available)

- Fabric
- Leather

Legs

- Matte chrome
- Polished chrome

Program & Services

Customer's Own Material/Leather (COM/COL) Program is available.

► See *Coalesse Surface Materials Reference Guide* for additional information.

Capa Chairs

DESIGN EOOS



Overall: 24¾"D 23¾"W 31½"H
 Inside: 18"D 16½"W 15"H
 Seat: 18"H
 Arm: 28"H

Tip: Fabrics and leathers will appear loose with comfort wrinkles when upholstered.

Tip: Frame design allows back to flex to match occupant's back shape.

Tip: Due to the design and construction techniques of the Capa Chair only certain textiles can be successfully applied, therefore all COM fabrics must be submitted to Coalesse for approval prior to order acceptance.

Tip: Recommended leathers are Elmosoft Grade C and Elmorustical Grade E.

Tip: Special color match, consult Customer Service.

Tip: For Customer's Own Material or Leather, see necessary requirements, important processing instructions, and ordering information
 ▶ See Coalesse Surface Materials Reference Guide.

Tip: Chair stacks five high with stacking dolly and three high on floor.

Standard Includes	Required to Specify
▶ Need help? Product details, page 299 • Frame: hardwood plywood, steel tubing and bar stock • Arms: solid steel rod and bar stock • Upholstery: arms, back, and seat foam are molded around the frame components • Legs: matte chrome (M) or polished chrome (PC) leg finish	1 Style number 2 Number of fabrics if contrasting fabric style number is selected 3 Fabric or leather color number for upholstery 4 Options, if selected (see below) ▶ See Coalesse Surface Materials Reference Guide.

Options	U.S. Price	Required to Specify
Surface Materials • Contrasting fabric	+\$182 per fabric	Add suffix K to the style number and select fabric color number.
Acrylic backer • Backer	+\$ 26	Specify with acrylic backer. ▶ See Coalesse Surface Materials Reference Guide.

Specification Information													
Style Number	U.S. Base Prices											Leather Grades:	
	Fabric Grades:											COL	C
	COM	6	7	8	9	10	11	12	13	14			

Chairs

1810M	\$1700	\$1700	\$1720	\$1751	\$1853	\$1920	\$1997	\$2049	\$2142	\$2273	\$2094	\$3575	\$3845
1810PC	\$1742	\$1742	\$1762	\$1793	\$1895	\$1962	\$2039	\$2091	\$2184	\$2315	\$2136	\$3624	\$3887

COM/yds = 2, COL/sq ft = 44

Stacking Dolly

9014S	\$1150	N.A.	N.A.	N.A.	N.A.	N.A.	N.A.	N.A.	N.A.	N.A.	N.A.	N.A.	N.A.
-------	--------	------	------	------	------	------	------	------	------	------	------	------	------



For Canadian Pricing
 Multiply U.S. Price by the Canadian price factor.
 ▶ See page 1 for details.

Enea Stacker Chairs

DESIGN JOSEP LLUSCA

The Enea stacker has a higher back than most side chairs, providing a greater level of comfort and support. Chairs are available with or without arms.

Tip: This product line is a collection and will be found in multiple locations in this specification guide and/or Coalesse Tables, Storage, and Accessories Specification Guide.

► See Collections, page 5.

Back is 33¼"H.

Seat and back are available in polypropylene, wood veneer, or upholstery.

Glides are black polypropylene. Felt glides are optional for use on non-carpeted surfaces are available.

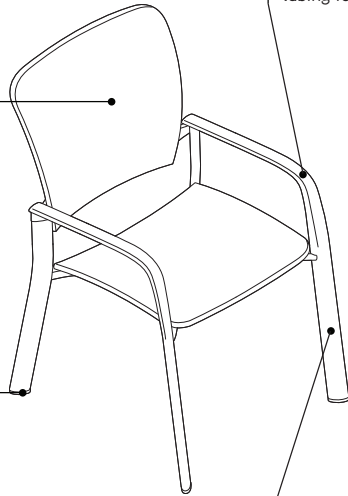

Frame is constructed of steel tubing for increased stability.

4-leg base allows for stacking. Stacking dolly available.

Product Details

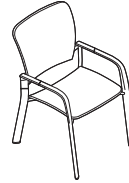
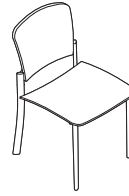

Chairs are available in armless and loop arm versions.

Tip: Ganging and tablet options are not available on armless chairs.



Tablet is available in black powder coat, on left or right side, and measures 11"D x 9"W.

Ganging device option is available to link chairs with arms for evenly spaced rows.

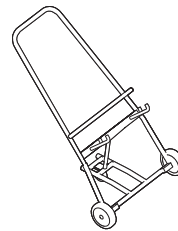

Stacking dolly is available to stack, move, and store chairs. Chairs stack nine high on the dolly. Chairs with tablet stack six high. Unloaded dolly measures 34"D x 26"W x 34"H.

Surface Materials

► See Coalesse Surface Materials Reference Guide for further information.

Seat and back

- Fabric
- Leather
- Wood veneer
- Polypropylene

Frame

- Paint

Enea Stacker Chairs With Arms

DESIGN JOSEP LLUSCA

Tip: Due to the design and construction techniques of the Enea Chair only certain textiles can be successfully applied, therefore all COM fabrics must be submitted to Coalesse for approval prior to order acceptance.

Tip: Fabrics and leathers will appear loose with comfort wrinkles when upholstered.

Tip: For Customer's Own Material or Leather, see necessary requirements, important processing instructions, and ordering information
 ▶ See Coalesse Surface Materials Reference Guide.

Tip: Contrasting fabric option available on model 3501 only.

Tip: CAL 133 for polypropylene is available as a special quote. Polypropylene color will change slightly when FR treatment is applied. Contact Customer Service for availability and pricing. Minimum quantity will apply.

Tip: Tablet is 11"D x 9"W.

Tip: Arm chairs stack nine high. Arm chair with tablet stacks six high.

Standard Includes

- ▶ Need help? Product details, page 301
- Frame: constructed of steel tubing
- Seat and back: molded nylon, wood, or upholstery (wood is laminated layers of hard maple veneer)

Required to Specify

- 1 Style number
 - 2 Fabric or leather color number for upholstery, if selected
 - 3 Plastic or wood finish color number for seat and back, if selected
 - 4 Base/frame finish:
 - 4016 White Gloss
 - 4017 Black Gloss
 - 4018 Silver Metallic
 - 5 Options, if selected (see below)
- ▶ See Coalesse Surface Materials Reference Guide.

Options

Options	U.S. Price	Required to Specify
Surface Materials		
• Contrasting fabric	+\$182 per fabric	Add suffix K to the style number and select fabric color number.
Acrylic backer		
• Chair with upholstered seat and back	+\$ 26	Specify with acrylic backer.
• Chair with upholstered seat and wood back	+\$ 10	Specify with acrylic backer. ▶ See Coalesse Surface Materials Reference Guide.
Ganging		
• Ganging	+\$ 98	Specify with ganging.
Tablet		
• Black powder coat	+\$512	Specify with tablet and specify side as facing.
Felt Glides		
• Glides	No cost	Specify with felt glides.
Related Products		
• Café tables		▶ See Coalesse Tables, Storage, and Accessories Specification Guide.
• Occasional tables		▶ See Coalesse Tables, Storage, and Accessories Specification Guide.
• Stools		▶ Pages 340–363

Specification Information

Style Number	U.S. Base Prices														Leather Grades:			Wood	Polypropylene
	Fabric Grades:														COL	C	E		
	COM	6	7	8	9	10	11	12	13	14									

Wood Seat and Back Stacker

3500	✕10/24	N.A.	N.A.	N.A.	N.A.	N.A.	N.A.	N.A.	N.A.	N.A.	N.A.	N.A.	N.A.	N.A.	N.A.	\$1421	N.A.
------	--------	------	------	------	------	------	------	------	------	------	------	------	------	------	------	--------	------

Upholstered Seat and Back

3501	\$1329	\$1329	\$1345	\$1369	\$1447	\$1494	\$1553	\$1593	\$1661	\$1759	\$1716	\$2026	\$2220	N.A.	N.A.
------	--------	--------	--------	--------	--------	--------	--------	--------	--------	--------	--------	--------	--------	------	------

COM/yds = 1, COL/sq ft = 22

▶ Specification Information, continued on next page



Overall: 22½"D 22½"W 33¼"H
 Inside: 18"D 18"W 15¼"H
 Seat: 18"H
 Arm: 26¾"H



Overall: 22½"D 22½"W 33¼"H
 Inside: 18"D 18"W 15¼"H
 Seat: 18"H
 Arm: 26¾"H

✕10/24 = Last order entry
 October 20, 2024

Enea Stacker Chairs With Arms

DESIGN JOSEP LLUSCA

► Specification Information, continued from previous page

Specification Information

Style Number	U.S. Base Prices														Leather Grades:			Wood	Polypropylene
	Fabric Grades:														COL	C	E		
	COM	6	7	8	9	10	11	12	13	14									

Upholstered Seat and Wood Back

3502	\$1425	\$1404	\$1412	\$1424	\$1462	\$1485	\$1515	\$1533	\$1570	\$1619	\$1829	\$1968	\$2077	N.A.	N.A.
------	--------	--------	--------	--------	--------	--------	--------	--------	--------	--------	--------	--------	--------	------	------

COM/yds = 3/4, COL/sq ft = 17



Overall: 22½"D 22½"W 33¼"H
 Inside: 18"D 18"W 15¼"H
 Seat: 18"H
 Arm: 26¾"H

Polypropylene Seat and Back

3503	N.A.	N.A.	N.A.	N.A.	N.A.	N.A.	N.A.	N.A.	N.A.	N.A.	N.A.	N.A.	N.A.	N.A.	N.A.	\$820
------	------	------	------	------	------	------	------	------	------	------	------	------	------	------	------	-------



Overall: 22½"D 22½"W 33¼"H
 Inside: 18"D 18"W 15¼"H
 Seat: 18"H
 Arm: 26¾"H

Stacking Dolly

9014S	\$1150	N.A.	N.A.	N.A.	N.A.	N.A.	N.A.	N.A.	N.A.	N.A.	N.A.	N.A.	N.A.	N.A.	N.A.	N.A.
-------	--------	------	------	------	------	------	------	------	------	------	------	------	------	------	------	------

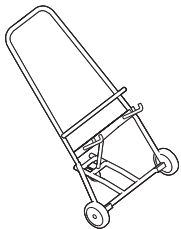

Overall: 34"D 26"W 34"H

 **For Canadian Pricing**
 Multiply U.S. Price by the
 Canadian price factor.
 ► See page 1 for details.

Enea Stacker Chairs Without Arms

DESIGN JOSEP LLUSCA

Tip: CAL 133 for polypropylene is available as a special quote. Polypropylene color will change slightly when FR treatment is applied. Contact Customer Service for availability and pricing. Minimum quantity will apply.

Tip: Due to the design and construction techniques of the Enea Chair only certain textiles can be successfully applied, therefore all COM fabrics must be submitted to Coalesse for approval prior to order acceptance.

Tip: Armless chairs stack nine high.

Tip: Fabrics and leathers will appear loose with comfort wrinkles when upholstered.

Tip: For Customer's Own Material or Leather, see necessary requirements, important processing instructions, and ordering information
 ▶ See Coalesse Surface Materials Reference Guide.

Tip: Contrasting fabric option available on model 3501S only.

Tip: No tablet or ganging available on armless models.



Overall: 22½"D 18"W 33¼"H
 Inside: 18"D 18"W 15¼"H
 Seat: 18"H



Overall: 22½"D 18"W 33¼"H
 Inside: 18"D 18"W 15¼"H
 Seat: 18"H

For Canadian Pricing
 Multiply U.S. Price by the Canadian price factor.
 ▶ See page 1 for details.

Standard Includes

- ▶ Need help? Product details, page 301
- Frame: steel tubing
- Seat and back: molded nylon, wood, or upholstery (wood is laminated layers of hard maple veneer)

Required to Specify

- 1 Style number
 - 2 Fabric or leather color number for upholstery, if selected
 - 3 Plastic or wood finish color number for seat and back, if selected
 - 4 Base/frame finish:
 - 4016 White Gloss
 - 4017 Black Gloss
 - 4018 Silver Metallic
 - 5 Options, if selected (see below)
- ▶ See Coalesse Surface Materials Reference Guide.

Options

Options	U.S. Price	Required to Specify
Surface Materials		
• Contrasting fabric	+\$182 per fabric	Add suffix K to the style number and select fabric color number.
Acrylic backer		
• Chair with upholstered seat and back	+\$ 26	Specify with acrylic backer.
• Chair with upholstered seat and wood back	+\$ 10	Specify with acrylic backer. ▶ See Coalesse Surface Materials Reference Guide.
Felt Glides		
• Glides	No cost	Specify with felt glides.
Related Products		
• Café tables		▶ See Coalesse Tables, Storage, and Accessories Specification Guide.
• Occasional tables		▶ See Coalesse Tables, Storage, and Accessories Specification Guide.
• Stools		▶ Pages 340–363

Specification Information

Style Number	U.S. Base Prices														Leather Grades:			Wood	Polypropylene
	Fabric Grades:														COL	C	E		
	COM	6	7	8	9	10	11	12	13	14									

Wood Seat and Back

3500S	✕10/24	N.A.	N.A.	N.A.	N.A.	N.A.	N.A.	N.A.	N.A.	N.A.	N.A.	N.A.	N.A.	N.A.	N.A.	N.A.	N.A.	\$1252	N.A.
-------	--------	------	------	------	------	------	------	------	------	------	------	------	------	------	------	------	------	--------	------

Upholstered Seat and Back

3501S	\$1157	\$1157	\$1171	\$1192	\$1254	\$1296	\$1344	\$1376	\$1436	\$1519	\$1547	\$1872	\$2055	N.A.	N.A.
-------	--------	--------	--------	--------	--------	--------	--------	--------	--------	--------	--------	--------	--------	------	------

COM/yds = 1, COL/sq ft = 22

▶ Specification Information, continued on next page

✕10/24 = Last order entry
 October 20, 2024

Enea Stacker Chairs Without Arms

DESIGN JOSEP LLUSCA

► Specification Information, continued from previous page

Specification Information

Style Number	U.S. Base Prices														Leather Grades:			Wood	Polypropylene
	Fabric Grades:														COL	C	E		
	COM	6	7	8	9	10	11	12	13	14									

Upholstered Seat and Wood Back

3502S	\$1256	\$1235	\$1243	\$1255	\$1293	\$1316	\$1346	\$1364	\$1401	\$1450	\$1671	\$1791	\$1908	N.A.	N.A.
-------	--------	--------	--------	--------	--------	--------	--------	--------	--------	--------	--------	--------	--------	------	------

COM/yds = 3/4, COL/sq ft = 17



Overall: 22½"D 18"W 33¼"H
Inside: 18"D 18"W 15¼"H
Seat: 18"H

Polypropylene Seat and Back

3503S	N.A.	N.A.	N.A.	N.A.	N.A.	N.A.	N.A.	N.A.	N.A.	N.A.	N.A.	N.A.	N.A.	N.A.	N.A.	\$765
-------	------	------	------	------	------	------	------	------	------	------	------	------	------	------	------	-------



Overall: 22½"D 18"W 33¼"H
Inside: 18"D 18"W 15¼"H
Seat: 18"H

Stacking Dolly

9014S	\$1150	N.A.	N.A.	N.A.	N.A.	N.A.	N.A.	N.A.	N.A.	N.A.	N.A.	N.A.	N.A.	N.A.	N.A.	N.A.
-------	--------	------	------	------	------	------	------	------	------	------	------	------	------	------	------	------

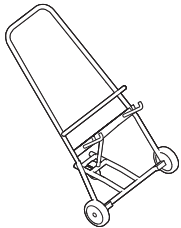

Overall: 34"D 26"W 34"H

 **For Canadian Pricing**
Multiply U.S. Price by the
Canadian price factor.
► See page 1 for details.

Enea Lottus Chairs

DESIGN LIEVORE ALTHERR MOLINA

Enea Lottus is sculpted for comfort with just the right amount of flex. Chairs are available in armless, loop arm, and cantilevered arm versions.

Tip: This product line is a collection and will be found in multiple locations in this specification guide and/or Coalesse Tables, Storage, and Accessories Specification Guide.

► See *Collections*, page 5.

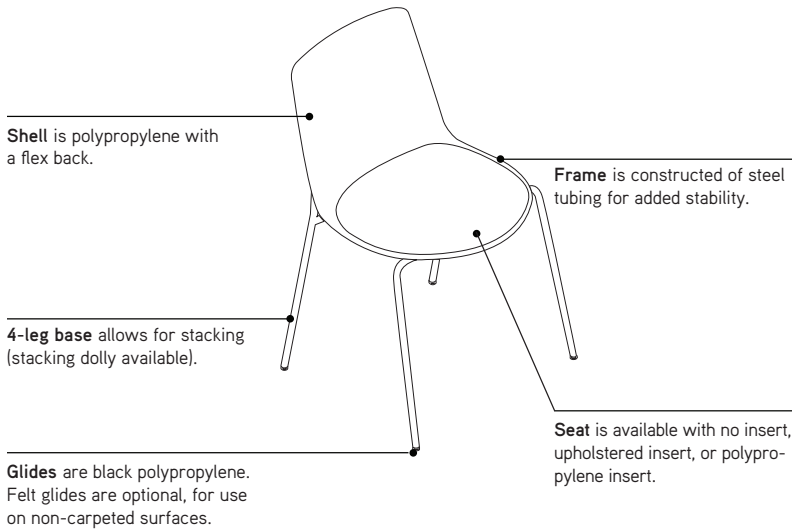

Product Details



Chairs are available in armless, cantilever arm, or loop arm versions.

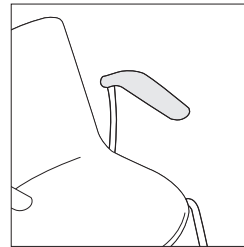

Cantilever arm comes standard with polypropylene arm cap.

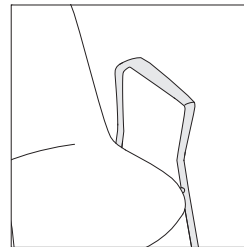

Aluminum loop arm chairs are available.

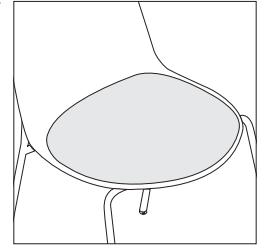

Upholstered and polypropylene insert seat detail is available.

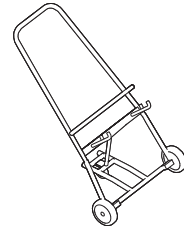

Stacking dolly is available to stack, move, and store chairs. Armless chairs are able to stack 10 high on dolly. Cantilever and loop arm chairs stack six high on dolly.

Surface Materials

► See *Coalesse Surface Materials Reference Guide* for further information.

Seat, back, and arm cap

- Polypropylene

Base and frame

- Paint

Upholstery (seat)

- Fabric
- Leather

Program & Services

Customer's Own Material/Leather (COM/COL) Program is available.

► See *Coalesse Surface Materials Reference Guide* for additional information.

Coalesse

Enea Lottus Chairs

DESIGN LIEVORE ALTHERR MOLINA

Enea Lottus Chairs Armless

DESIGN LIEVORE ALTHERR MOLINA

Tip: For Customer's Own Material or Leather, see necessary requirements, important processing instructions, and ordering information
 ▶ See *Coalesse Surface Materials Reference Guide*.

Tip: CAL133 for polypropylene and fire code seating are available as a special quote. Polypropylene color will change slightly when FR treatment is applied. Contact Customer Service for availability and pricing. Minimum quantity will apply.

Tip: Lottus chair with no insert stacks 10 high on floor. Lottus chair with polypropylene or upholstered insert stacks four high on floor. Lottus chair stacks six high with dolly.

Standard Includes

- ▶ Need help? Product details, page 306
- Base and frame constructed of painted steel tubing
- Seat and back: polypropylene
- Insert, if selected: polypropylene or upholstery

Required to Specify

- 1 Style number
 - 2 Plastic color number for seat and back
 - 3 Fabric or leather color number for upholstery insert, if selected
 - 4 Paint color number for base and frame
 - 5 Options, if selected (see below)
- ▶ See *Coalesse Surface Materials Reference Guide*.

Options

Options	U.S. Price	Required to Specify
Surface Materials		
Base		
• Grade 1 paint	No cost	Specify paint color number.
• Grade 3 paint	+\$105	Specify paint color number.
Acrylic backer		
• Backer for chair with upholstered insert	+\$ 7	Specify with acrylic backer. ▶ See <i>Coalesse Surface Materials Reference Guide</i> .
Felt Glides		
• Glides	No cost	Specify with felt glides.
Related Products		
• Café tables		▶ See <i>Coalesse Tables, Storage, and Accessories Specification Guide</i> .
• Occasional tables		▶ See <i>Coalesse Tables, Storage, and Accessories Specification Guide</i> .
• Stools		▶ Pages 356–360

Specification Information

Style Number	U.S. Base Prices												Leather Grades:			Polypropylene
	Fabric Grades:															
COM	6	7	8	9	10	11	12	13	14	COL	C	E				

Armless Chair with No Insert

COEL100	\$521	N.A.	N.A.	N.A.	N.A.	N.A.	N.A.	N.A.	N.A.	N.A.	N.A.	N.A.	N.A.	N.A.	N.A.
---------	-------	------	------	------	------	------	------	------	------	------	------	------	------	------	------



Overall: 20¾"D 20¾"W 30½"H
 Seat: 18"H

Armless Chair with Polypropylene Insert

COEL100INSERT	N.A.	N.A.	N.A.	N.A.	N.A.	N.A.	N.A.	N.A.	N.A.	N.A.	N.A.	N.A.	N.A.	N.A.	\$582
---------------	------	------	------	------	------	------	------	------	------	------	------	------	------	------	-------



Overall: 20¾"D 20¾"W 30½"H
 Seat: 18"H

Armless Chair with Upholstered Insert

COEL100UPH	\$778	\$757	\$765	\$777	\$815	\$838	\$868	\$886	\$923	\$972	\$1107	\$1125	\$1170	N.A.
------------	-------	-------	-------	-------	-------	-------	-------	-------	-------	-------	--------	--------	--------	------

COM/yds = ¾, COL/sq ft = 15

▶ Specification Information, continued on next page



Overall: 20¾"D 20¾"W 30½"H
 Seat: 18"H

Enea Lottus Chairs Armless

DESIGN LIEVORE ALTHERR MOLINA

► Specification Information, continued from previous page

Specification Information

Style Number	U.S. Price
--------------	------------

Stacking Dolly

COELDOLLY	\$1095
-----------	--------

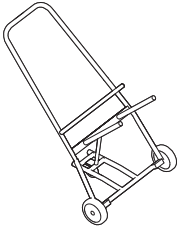

Overall: 27"D 25"W 46"H

Tip: Dolly can be used with any Enea Lottus chair.

Tip: Armless chairs, cantilever arm chairs, and loop arm chairs stack six high on dolly.



For Canadian Pricing
Multiply U.S. Price by the Canadian price factor.
► See page 1 for details.

Enea Lottus Chairs Cantilever Arm

DESIGN LIEVORE ALTHERR MOLINA

Tip: Cantilever arm can hook on table to provide storing option.

Tip: Cantilever arm stacks six high.

Tip: Can specify arm cap in any plastic color for Lottus.

Tip: For Customer's Own Material or Leather, see necessary requirements, important processing instructions, and ordering information
 ▶ See Coalesse Surface Materials Reference Guide.

Tip: CAL133 for polypropylene and fire code seating are available as a special quote. Polypropylene color will change slightly when FR treatment is applied. Contact Customer Service for availability and pricing. Minimum quantity will apply.

Standard Includes	Required to Specify
▶ Need help? Product details, page 306 <ul style="list-style-type: none"> • Base and frame constructed of painted steel tubing • Seat and back: polypropylene • Arm cap: polypropylene • Insert, if selected: polypropylene or upholstery 	1 Style number 2 Plastic color number for seat, back, and arm cap 3 Fabric or leather color number for upholstery insert, if selected 4 Paint color number for base and frame 5 Options, if selected (see below) ▶ See Coalesse Surface Materials Reference Guide.

Options	U.S. Price	Required to Specify
Surface Materials <ul style="list-style-type: none"> • Base • Grade 1 paint • Grade 3 paint 	No cost +\$105	Specify paint color number. Specify paint color number.
<ul style="list-style-type: none"> • Acrylic backer • Backer for chair with upholstered insert 	+\$ 7	Specify with acrylic backer. ▶ See Coalesse Surface Materials Reference Guide.
Felt Glides <ul style="list-style-type: none"> • Glides 	No cost	Specify with felt glides.
Related Products <ul style="list-style-type: none"> • Café tables • Occasional tables • Stools 		▶ See Coalesse Tables, Storage, and Accessories Specification Guide. ▶ See Coalesse Tables, Storage, and Accessories Specification Guide. ▶ Pages 356–360

Specification Information															
Style Number	U.S. Base Prices														
	Fabric Grades:													Leather Grades:	
	COM	6	7	8	9	10	11	12	13	14	COL	C	E		

Cantilever Arm Chair with No Insert

COEL200	\$642	N.A.	N.A.	N.A.	N.A.	N.A.	N.A.	N.A.	N.A.	N.A.	N.A.	N.A.	N.A.	N.A.
---------	-------	------	------	------	------	------	------	------	------	------	------	------	------	------



Overall: 20¾"D 23¾"W 30½"H
 Seat: 18"H
 Arm: 26"H

Cantilever Arm Chair with Polypropylene Insert

COEL200INSERT	N.A.	N.A.	N.A.	N.A.	N.A.	N.A.	N.A.	N.A.	N.A.	N.A.	N.A.	N.A.	N.A.	\$704
---------------	------	------	------	------	------	------	------	------	------	------	------	------	------	-------



Overall: 20¾"D 23¾"W 30½"H
 Seat: 18"H
 Arm: 26"H

Cantilever Arm Chair with Upholstered Insert

COEL200UPH	\$898	\$877	\$885	\$897	\$935	\$958	\$988	\$1006	\$1043	\$1092	\$1227	\$1245	\$1290	N.A.
------------	-------	-------	-------	-------	-------	-------	-------	--------	--------	--------	--------	--------	--------	------

COM/yds = ¾, COL/sq ft = 15



Overall: 20¾"D 23¾"W 30½"H
 Seat: 18"H
 Arm: 26"H

Enea Lottus Chairs Aluminum Loop Arm

DESIGN LIEVORE ALTHERR MOLINA

Tip: For Customer's Own Material or Leather, see necessary requirements, important processing instructions, and ordering information
 ▶ See *Coalesse Surface Materials Reference Guide*.

Tip: CAL133 for polypropylene and fire code seating are available as a special quote. Polypropylene color will change slightly when FR treatment is applied. Contact Customer Service for availability and pricing. Minimum quantity will apply.

Tip: Arm chair stacks six high.

Standard Includes		Required to Specify
▶ Need help? Product details, page 306	<ul style="list-style-type: none"> • Base and frame constructed of painted steel tubing • Seat and back: polypropylene • Arm: aluminum • Insert, if selected: polypropylene or upholstery 	1 Style number 2 Plastic color number for seat, back, and arm cap 3 Fabric or leather color number for upholstery insert, if selected 4 Paint color number for base and frame 5 Options, if selected (see below) ▶ See <i>Coalesse Surface Materials Reference Guide</i> .

Options	U.S. Price	Required to Specify
Surface Materials Base <ul style="list-style-type: none"> • Grade 1 paint • Grade 3 paint Acrylic backer <ul style="list-style-type: none"> • Backer for chair with upholstered insert 	No cost +\$105 +\$ 7 No cost	Specify paint color number. Specify paint color number. Specify with acrylic backer. ▶ See <i>Coalesse Surface Materials Reference Guide</i> . Specify with felt glides.
Felt Glides	<ul style="list-style-type: none"> • Glides 	Specify with felt glides.
Related Products	<ul style="list-style-type: none"> • Café tables • Occasional tables • Stools 	▶ See <i>Coalesse Tables, Storage, and Accessories Specification Guide</i> . ▶ See <i>Coalesse Tables, Storage, and Accessories Specification Guide</i> . ▶ Pages 356–360

Specification Information														
Style Number	U.S. Base Prices													
	Fabric Grades:													
	COM	6	7	8	9	10	11	12	13	14	Leather Grades:			Polypropylene
		COL	C	E										

Aluminum Loop Arm Chair with No Insert

COEL300	\$695	N.A.	N.A.	N.A.	N.A.	N.A.	N.A.	N.A.	N.A.	N.A.	N.A.	N.A.	N.A.	N.A.
---------	-------	------	------	------	------	------	------	------	------	------	------	------	------	------



Overall: 20¾"D 22"W 30½"H
 Seat: 18"H
 Arm: 26"H

Aluminum Loop Arm Chair with Polypropylene Insert

COEL300INSERT	N.A.	N.A.	N.A.	N.A.	N.A.	N.A.	N.A.	N.A.	N.A.	N.A.	N.A.	N.A.	N.A.	N.A.	\$752
---------------	------	------	------	------	------	------	------	------	------	------	------	------	------	------	-------



Overall: 20¾"D 22"W 30½"H
 Seat: 18"H
 Arm: 26"H

Aluminum Loop Arm Chair with Upholstered Insert

COEL300UPH	\$948	\$927	\$935	\$947	\$985	\$1008	\$1038	\$1056	\$1093	\$1142	\$1297	\$1295	\$1340	N.A.
------------	-------	-------	-------	-------	-------	--------	--------	--------	--------	--------	--------	--------	--------	------

COM/yds = ¾, COL/sq ft = 15



Enea Altzo943 Chairs

DESIGN: ESTUDI MANEL MOLINA DESIGN ORIGIN: SPAIN

Enea Altzo943 seating

collection brings residential warmth and soul to the workplace. Answering the demand for mixed materials, Altzo943 combines a precision-molded seat shell with solid oak legs. The special oval profile of the legs follows the pure curvature of the shell for a complete, harmonious design statement.

Tip: This product line is part of a collection and will be found in multiple locations in this specification guide.

► See *Collections*, page 5.

Seat and back are polypropylene with a slight flex and rounded edges for optimal comfort; available in 12 colors.

Wood legs are solid wood oak; available in six finishes.

Glides are polyethylene for superior durability on carpeted and hard floors.

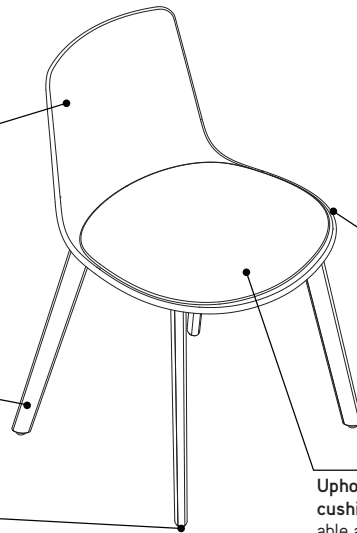

Casting under the seat is painted in textured finishes to match polypropylene seat shell.

Upholstered seat cushion insert is available and is ½" thick.

Product Details

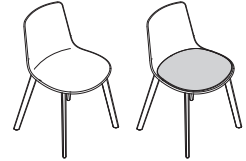

Upholstered seat cushion insert is available.

Surface Materials

► See *Coalesse Surface Materials Reference Guide* for further information.

Seat and back

- Polypropylene

Seat casting

- Paint

Legs

- Solid oak

Upholstery (seat)

- Fabric
- Leather

Program and Services

Customer's Own Material/Leather (COM/COL) Program is available.

► See *Coalesse Surface Materials Reference Guide* for additional information.

Enea Altzo943 Chairs

DESIGN: ESTUDI MANEL MOLINA DESIGN ORIGIN: SPAIN

Standard Includes		Required to Specify
<ul style="list-style-type: none"> ▶ Need help? Product details, page 312 	<ul style="list-style-type: none"> • Legs: solid oak • Seat and seat casting: <ul style="list-style-type: none"> – Polypropylene seat with matching textured paint on seat casting • Seat cushion insert, if selected: upholstery • Glides, non-adjustable 	<ol style="list-style-type: none"> 1 Style number 2 Plastic color number for polypropylene seat 3 Fabric or leather color number for upholstered seat cushion insert, if selected 4 Wood finish for legs: <ul style="list-style-type: none"> – V3AK Natural Oak – VP01 Light Oak – VP02 Smoke Oak – VP03 Black Oak – VP04 Grey Oak – VP05 White Oak 6 Options, if selected (see below) <p>▶ See <i>Coalesse Surface Materials Reference Guide</i>.</p>

Tip: For Customer's Own Material or Leather, see necessary requirements, important processing instructions, and ordering information.
▶ See *Coalesse Surface Materials Reference Guide*.

Options	U.S. Price	Required to Specify
Surface Materials <ul style="list-style-type: none"> • Legs <ul style="list-style-type: none"> • Grade 1 wood veneer • Grade 2 wood veneer 	<p>No cost</p> <p>+\$82</p>	<p>Specify with <i>V3AK Natural Oak, VP01 Oak Light, VP03 Black Oak, or VP05 White Oak</i>. Specify with <i>VP02 Smoked Oak or VP04 Grey Oak</i>.</p>
<ul style="list-style-type: none"> • Acrylic backer <ul style="list-style-type: none"> • Chair with upholstered seat cushion insert 	<p>+\$ 7</p>	<p>Specify with <i>acrylic backer</i>. ▶ See <i>Coalesse Surface Materials Reference Guide</i>.</p>
Related Products <ul style="list-style-type: none"> • Altzo943 stools • Lottus café tables • Lottus occasional tables 		<p>▶ Page 363</p> <p>▶ See <i>Coalesse Tables, Storage, and Accessories Specification Guide</i>.</p> <p>▶ See <i>Coalesse Tables, Storage, and Accessories Specification Guide</i>.</p>

Specification Information

Style Number	U.S. Base Prices												Leather Grades:			Polypropylene
	Fabric Grades:												COL	C	E	
COM	6	7	8	9	10	11	12	13	14							

Armless Chair without Seat Cushion

COALT100	N.A.	N.A.	N.A.	N.A.	N.A.	N.A.	N.A.	N.A.	N.A.	N.A.	N.A.	N.A.	N.A.	N.A.	N.A.	\$819
----------	------	------	------	------	------	------	------	------	------	------	------	------	------	------	------	-------



Overall: 20³/₄"D 22"W 30¹/₂"H
Seat: 18"H

Armless Chair with Upholstered Seat Cushion Insert

COALT100UPH	\$1002	\$982	\$991	\$1001	\$1037	\$1059	\$1088	\$1105	\$1140	\$1187	\$1317	\$1332	\$1373	N.A.
-------------	--------	-------	-------	--------	--------	--------	--------	--------	--------	--------	--------	--------	--------	------



Overall: 20³/₄"D 22"W 30¹/₂"H
Seat: 18"H



For Canadian Pricing
Multiply U.S. Price by the Canadian price factor.
▶ See page 1 for details.

Kathryn Chairs

DESIGN STUDIO B

The Kathryn chair is a classically constructed guest chair offered with an open wood back, an upholstered wood back panel, or a fully upholstered back.

Back contains passive ergonomic support and is steam bent. Available in open, panel, or fully upholstered.

Glides are non-adjustable.

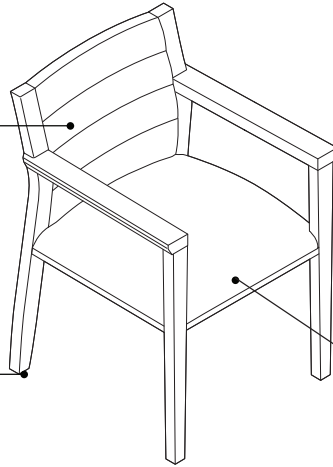

Frame is solid European beech hardwood.

Seat is upholstered and incorporates a welt detail.

Product Details

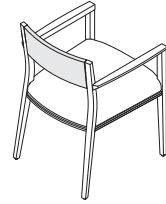

Open-back detail is available in all standard wood finishes with optional upholstered panel back.

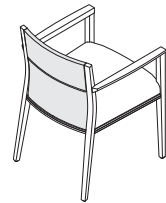

Back with fully upholstered detail is available.

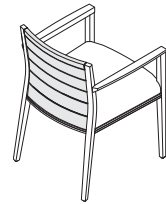

Ribbed detail on fully upholstered back is available.

Surface Materials

► See *Coalesse Surface Materials Reference Guide* for further information.

Upholstery

- Fabric
- Leather

Frame (and open back)

- Wood

Program & Services

Customer's Own Material/Leather (COM/COL) Program is available.

► See *Coalesse Surface Materials Reference Guide* for additional information.

Coalesse

Kathryn Chairs

DESIGN STUDIO B

Kathryn Chairs

DESIGN STUDIO B

Tip: Fabrics and leathers will appear loose with comfort wrinkles when upholstered.

Tip: Recommended leathers are Elmosoft Grade C and Elmorustical Grade E.

Tip: Special color match, consult Customer Service.

Tip: For Customer's Own Material or Leather, see necessary requirements, important processing instructions, and ordering information
 ▶ See *Coalesse Surface Materials Reference Guide*.

Standard Includes		Required to Specify
▶ Need help? Product details, page 314	<ul style="list-style-type: none"> • Frame: solid European beech hardwood • Mortise and tenon joinery • Upholstery: multiple densities of laminated polyurethane foam and polyester fiber • Glides: non-adjustable 	1 Style number 2 Number of fabrics if contrasting fabric style number is selected 3 Fabric or leather color number for upholstery 4 Wood color number for frame 5 Options, if selected (see below) ▶ See <i>Coalesse Surface Materials Reference Guide</i> .

Options	U.S. Price	Required to Specify
Surface Materials	<ul style="list-style-type: none"> • Contrasting fabric +\$182 per fabric • Contrasting welt +\$208 	Add suffix K to the style number and select fabric color number. Specify with <i>contrasting welt</i> and select fabric color number.
Acrylic backer	<ul style="list-style-type: none"> • Chair with open back +\$ 10 • Chair with upholstery +\$ 20 	Specify with <i>acrylic backer</i> . Specify with <i>acrylic backer</i> . ▶ See <i>Coalesse Surface Materials Reference Guide</i> .

Specification Information													
Style Number	U.S. Base Prices											Leather Grades:	
	Fabric Grades:											COL	C
	COM	6	7	8	9	10	11	12	13	14			

Wood with Open Back

2540-1	\$1465	\$1456	\$1471	\$1482	\$1502	\$1519	\$1577	\$1619	\$1670	\$1780	\$1845	\$2261	\$2359
--------	--------	--------	--------	--------	--------	--------	--------	--------	--------	--------	--------	--------	--------

COM/yds = 1, COL/sq ft = 18

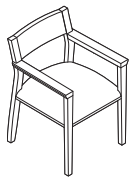

Overall: 22¾"D 22¾"W 32"H
 Inside: 19"D 18½"W 14"H
 Seat: 18"H
 Arm: 26"H

Wood/Upholstered with Panel Back

2542-1	\$1527	\$1531	\$1551	\$1568	\$1595	\$1626	\$1711	\$1806	\$1846	\$1937	\$1894	\$2553	\$2708
--------	--------	--------	--------	--------	--------	--------	--------	--------	--------	--------	--------	--------	--------

COM/yds = 1½, COL/sq ft = 27

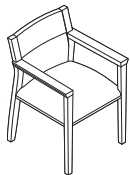

Overall: 22¾"D 22¾"W 32"H
 Inside: 19"D 18½"W 14"H
 Seat: 18"H
 Arm: 26"H

Fully Upholstered Back

2547-1	\$1721	\$1725	\$1752	\$1762	\$1789	\$1820	\$1905	\$1962	\$2052	\$2152	\$2088	\$2747	\$2902
--------	--------	--------	--------	--------	--------	--------	--------	--------	--------	--------	--------	--------	--------

COM/yds = 1½, COL/sq ft = 27

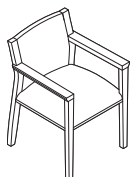

Overall: 22¾"D 22¾"W 32"H
 Inside: 19"D 18½"W 14"H
 Seat: 18"H
 Arm: 26"H

▶ Specification Information, continued on next page



For Canadian Pricing
 Multiply U.S. Price by the Canadian price factor.
 ▶ See page 1 for details.

Kathryn Chairs

DESIGN STUDIO B

► Specification Information, continued from previous page

Specification Information

Style Number	U.S. Base Prices											Leather Grades:		
	Fabric Grades:											COL	C	E
	COM	6	7	8	9	10	11	12	13	14				

Fully Upholstered Back with Ribbed Upholstery

2547-1RIBD	\$1774	\$1778	\$1805	\$1815	\$1842	\$1873	\$1958	\$2015	\$2105	\$2205	\$2141	\$2800	\$2955
------------	--------	--------	--------	--------	--------	--------	--------	--------	--------	--------	--------	--------	--------

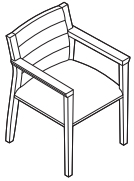

Overall: 22¾"D 22¾"W 32"H
 Inside: 19"D 18½"W 14"H
 Seat: 18"H
 Arm: 26"H



For Canadian Pricing
 Multiply U.S. Price by the
 Canadian price factor.
 ► See page 1 for details.

LessThanFive Chairs

DESIGN MICHAEL YOUNG

The **LessThanFive** chair is handcrafted from carbon fiber, making it exceptionally light and strong.

Lightweight, weighing less than five pounds.

Glides are soft felt.

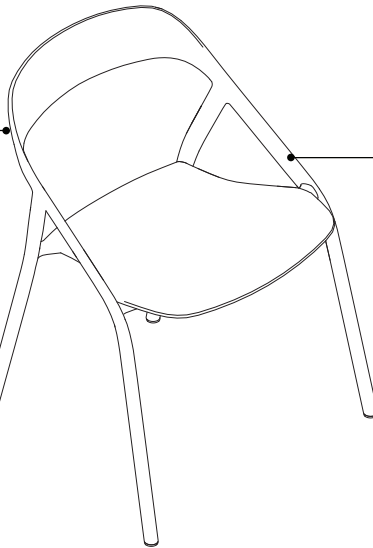

Frame is constructed entirely of carbon fiber, and comes in several standard finishes. Customization options are also available.

Product Details

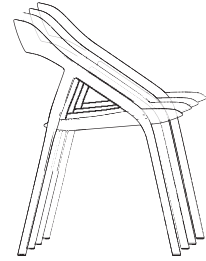

Stackable up to four high.

LessThanFive Essential Series is available in four neutral finishes, purchased in packs of two or four at a reduced price point. No customization is available for Essential styles.

Surface Materials

► See *Coalesse Surface Materials Reference Guide* for further information.

Frame
• Paint

Tip: Consult the Coalesse concierge team for customization options.

LessThanFive Chairs

DESIGN MICHAEL YOUNG



Overall: 20½"D 23½"W 30"H
 Inside Seat: 17½"D 19"W 18"H

Tip: Chair stacks four high.

Tip: LessThanFive essential styles have a defined finish palette. Please see Coalesse Surface Materials Reference Guide for available finishes.

Tip: LessThanFive essential series can only contain one color per pack.

Standard Includes		Required to Specify
▶ Need help? Product details, page 318	<ul style="list-style-type: none"> • Frame: constructed of carbon fiber • Finish: smooth paint • Soft felt glides 	1 Style number 2 Paint color number for frame 3 Options, if selected (see below) ▶ See <i>Coalesse Surface Materials Reference Guide</i> .

Options	U.S. Price	Required to Specify
Surface Materials • 4233 Carbon Weave	+\$296	Specify with 4233 Carbon Weave.

Specification Information		
Style Number	Quantity	U.S. Base Price
LessThanFive		
COLT5	1	\$2175

LessThanFive Essential Series		
Style Number	Quantity	U.S. Base Price
COLT5E	2	\$3479
COLT5EP	4	\$6523

 **For Canadian Pricing**
 Multiply U.S. Price by the Canadian price factor.
 ▶ See page 1 for details.

Marien152 Guest Seating

DESIGN COALESSE DESIGN GROUP AND ARIK LEVY

Marien152 is a richly tailored seating experience that's inspired by the home and designed for the workday. An innovative back cushion provides support with soft, residential style. Easy personalization is built into the collection through a wide range of color, form, and materiality choices.

Back cushion gives the appearance of a soft, loose pillow while built-in flex allows the cushion to move with the user. Intentionally relaxed upholstery on the back cushion adds to the welcoming appeal.

Contrasting fabric is available on seat, surround, and back cushion.

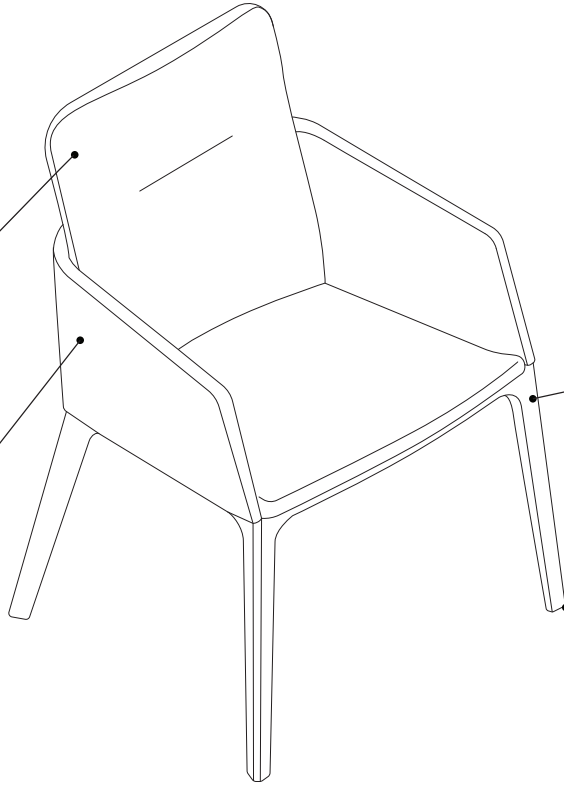

Solid white oak frame with chamfered edge profile.

Black glides are available in hard and soft options.

Gently sloping arms are subtle yet supportive.

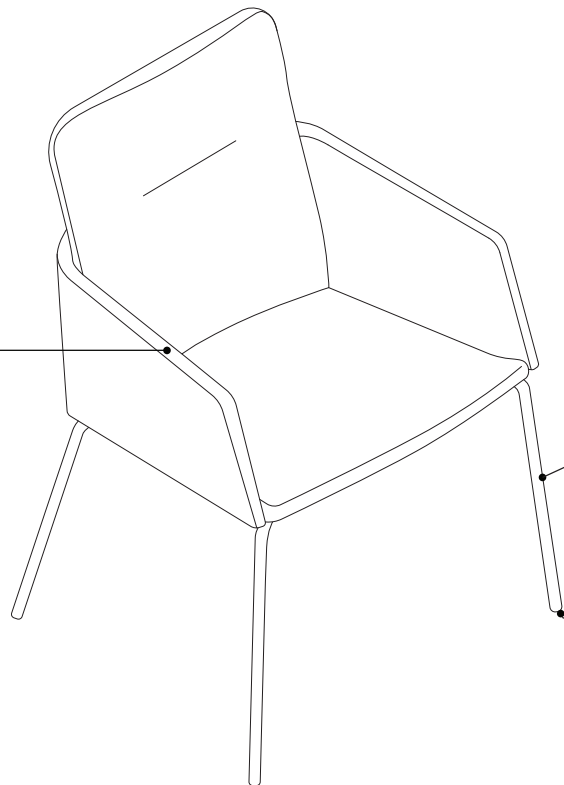

4-leg metal base is standard in powder coat paint. Trivalent chrome optional.

Black hard glides are standard.

Marien152 Guest Seating

DESIGN COALESSE DESIGN GROUP AND ARIK LEVY

Product Details

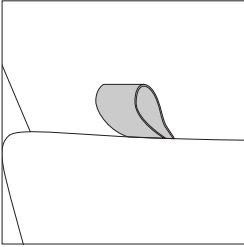

Standard leather pull, located behind the back cushion, allows users to easily move the chair. Leather in the color coal only. Option to specify without pull if desired.

Surface Materials

Upholstery

- Fabric
- Leather

4-leg metal base

- Painted
- Trivalent chrome

4-leg wood base

- Solid white oak wood frame

Programs & Services

Customer's Own

Material/Leather (COM/COL) Program is available.

► See *Coalesse Surface Materials Reference Guide* for additional information.

Marien152 Guest Seating Wood Base

DESIGN COALESSE DESIGN GROUP AND ARIK LEVY

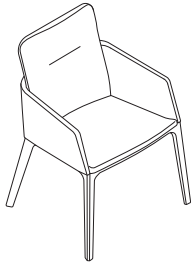

Overall: 23½"D x 25"W x 31½"H
 Inside: 16½"D x 18"W
 Seat: 18½"H

Standard Includes		Required to Specify
<ul style="list-style-type: none"> ▶ Need help? Product details, page 320 	<ul style="list-style-type: none"> • Seat, back, and surround: upholstery • Leather strap: coal • Base: grade 1 oak stain • Black hard glides 	<ol style="list-style-type: none"> 1 Style number 2 Contrasting fabric (see below under Required Selections) 3 Fabric or leather color number for upholstery on seat, surround, and back 4 Stain color number for base 5 Options, if selected (see below) <p>▶ See <i>Coalesse Surface Materials Reference Guide</i>.</p>

Required Selections	U.S. Price	Required to Specify
Contrasting Fabric <ul style="list-style-type: none"> • Non contrasting fabric • Contrasting back fabric • Contrasting surround fabric • Contrasting seat fabric • Contrasting all fabrics 	No cost +\$182 +\$182 +\$182 +\$182	Specify <i>with non contrasting</i> . Specify <i>with contrasting back</i> . Specify <i>with contrasting surround</i> . Specify <i>with contrasting seat</i> . Specify <i>with contrasting all fabrics</i> .

Options	U.S. Price	Required to Specify
Surface Materials <ul style="list-style-type: none"> • Wood Base <ul style="list-style-type: none"> • Grade 1 stain • Grade 3 stain • Backer 	No cost +\$ 83 +\$ 46	Specify wood stain number. Specify wood stain number. Specify <i>with acrylic backer</i> .
Caster or Glide Type <ul style="list-style-type: none"> • Hard glides • Soft glides 	No cost No cost	Specify <i>with hard glides</i> . Specify <i>with soft glides</i> .
Pull <ul style="list-style-type: none"> • With leather pull • Without leather pull 	No cost No cost	Specify <i>with pull</i> . Specify <i>without pull</i> .
Related Products <ul style="list-style-type: none"> • Conference seating 		▶ Page 276

Style Number		U.S. Base Prices											Leather Grades		
		Fabric Grades:													
		COM	6	7	8	9	10	11	12	13	14	COL	C	E	
COMARCHWB	Seat	\$2071	\$2071	\$2079	\$2097	\$2146	\$2179	\$2216	\$2242	\$2287	\$2352	\$2129	\$2487	\$2585	
	Surround	+\$ 56	+\$ 117	+\$ 137	+\$ 177	+\$291	+\$365	+\$452	+\$511	+\$617	+\$764	+\$109	+\$1076	+\$1297	
	Back	+\$ 56	+\$ 37	+\$ 46	+\$ 57	+\$ 96	+\$ 119	+\$146	+\$166	+\$201	+\$249	+\$109	+\$ 351	+\$ 423	

COM/yds: Seat = .78, Surround = 1.25, Cushion = .67, COL/sq ft: Seat = 9, Surround = 30, Cushion = 11



For Canadian Pricing
 Multiply U.S. Price by the Canadian price factor.
 ▶ See page 1 for details.

Marien152 Guest Seating Metal Base

DESIGN COALESSE DESIGN GROUP AND ARIK LEVY

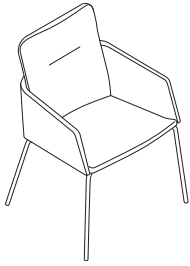

Overall: 24"D x 26"W x 31½"H
 Inside: 16½"D x 18"W
 Seat: 18"H

Standard Includes	Required to Specify
<ul style="list-style-type: none"> ▶ Need help? Product details, page 320 • Seat, back, and surround: upholstery • Leather strap: coal • Base: grade 1 paint • Black hard glides 	<ol style="list-style-type: none"> 1 Style number 2 Contrasting fabric (see below under Required Selections) 3 Fabric or leather color number for upholstery on seat, surround, and back 4 Paint color number for base 5 Options, if selected (see below) <p>▶ See <i>Coalesse Surface Materials Reference Guide</i>.</p>

Required Selections	U.S. Price	Required to Specify
Contrasting Fabric <ul style="list-style-type: none"> • Non contrasting fabric • Contrasting back fabric • Contrasting surround fabric • Contrasting seat fabric • Contrasting all fabrics 	No cost +\$182 +\$182 +\$182 +\$182	Specify <i>with non contrasting</i> . Specify <i>with contrasting back</i> . Specify <i>with contrasting surround</i> . Specify <i>with contrasting seat</i> . Specify <i>with contrasting all fabrics</i> .

Options	U.S. Price	Required to Specify
Surface Materials <ul style="list-style-type: none"> • Base <ul style="list-style-type: none"> • Grade 1 paint • Grade 3 paint • Trivalent chrome 	No cost +\$102 +\$105	Specify paint color number. Specify paint color number. Specify <i>with trivalent chrome</i> .
<ul style="list-style-type: none"> • Backer 	+\$ 46	Specify <i>with acrylic backer</i> .
Pull <ul style="list-style-type: none"> • With leather pull • Without leather pull 	No cost No cost	Specify <i>with pull</i> . Specify <i>without pull</i> .

Related Products • Conference seating ▶ Page 276

Specification Information

Style Number		U.S. Base Prices												
		Fabric Grades:										Leather Grades		
		COM	6	7	8	9	10	11	12	13	14	COL	C	E
COMARCHMB	Seat	\$1355	\$1355	\$1363	\$1381	\$1430	\$1463	\$1500	\$1526	\$1571	\$1636	\$1413	\$ 1771	\$ 1869
	Surround	+\$ 56	+\$117	+\$137	+\$177	+\$291	+\$365	+\$452	+\$511	+\$617	+\$764	+\$109	+\$1076	+\$1297
	Back	+\$ 56	+\$ 37	+\$ 46	+\$ 57	+\$ 96	+\$ 119	+\$146	+\$166	+\$201	+\$249	+\$109	+\$ 351	+\$ 423

COM/yds: Seat = .78, Surround = 1.25, Cushion = .67, COL/sq ft: Seat = 9, Surround = 30, Cushion = 11



For Canadian Pricing
 Multiply U.S. Price by the Canadian price factor.
 ▶ See page 1 for details.

Marien152 Guest Seating Multi-Fabric Diagram

DESIGN COALESSE DESIGN GROUP AND ARIK LEVY

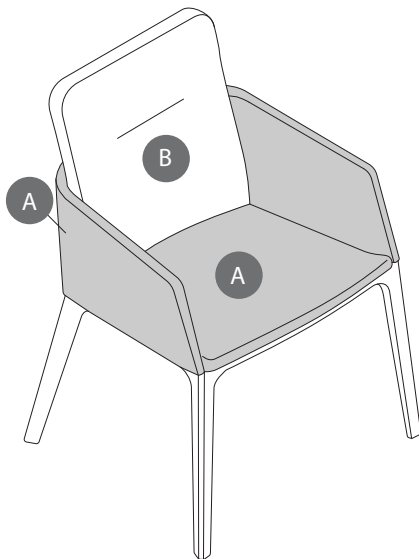
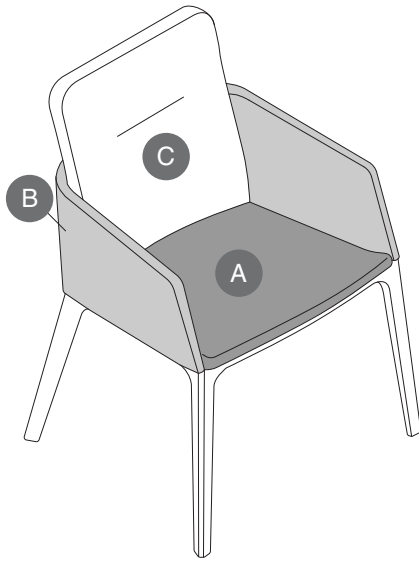

TO: _____

FROM: _____

DATE: _____

FAX...888.413.5161

FABRIC

A Seat: _____

B Surround: _____

C Back: _____

LEATHER

A Seat + Surround: _____

B Back: _____

Specify Model below:

COMARCHWB Wood Base Chair

COMARCHMB Metal Base Chair

*See specifying for contrasting fabric upcharge.
List price based on highest fabric grade usage.*

Coalesse

Marien152 Guest Seating Multi-Fabric Diagram

DESIGN COALESSE DESIGN GROUP AND ARIK LEVY

Montara650 Chairs

DESIGN LIEVORE ALTHERR MOLINA

Montara650 seating is infused with comfort and craft, with its refined upholstery and customizable details. The sculpted seating pairs with simple pedestal tables to provide an inspired social solution for today's mobile workforce.

Tip: This product line is a collection and will be found in multiple locations in this specification guide and/or Coalesse Tables, Storage, and Accessories Specification Guide.

► See Collections, page 5.

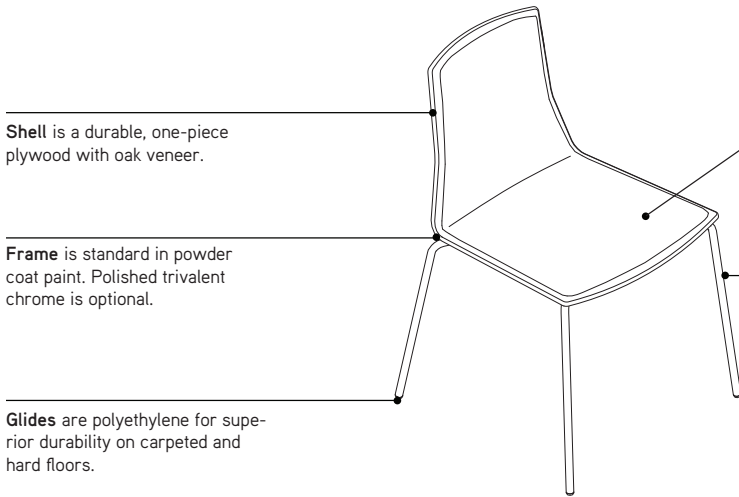

Shell is a durable, one-piece plywood with oak veneer.

Frame is standard in powder coat paint. Polished trivalent chrome is optional.

Glides are polyethylene for superior durability on carpeted and hard floors.

Upholstery choices include: wood shell, wood shell with upholstered seat, wood shell with ¾ upholstery, or fully upholstered.

4-leg base is standard. Available with loop arms or armless. Arms are aluminum and match the frame finish.

Stools are also available. ► See page 376

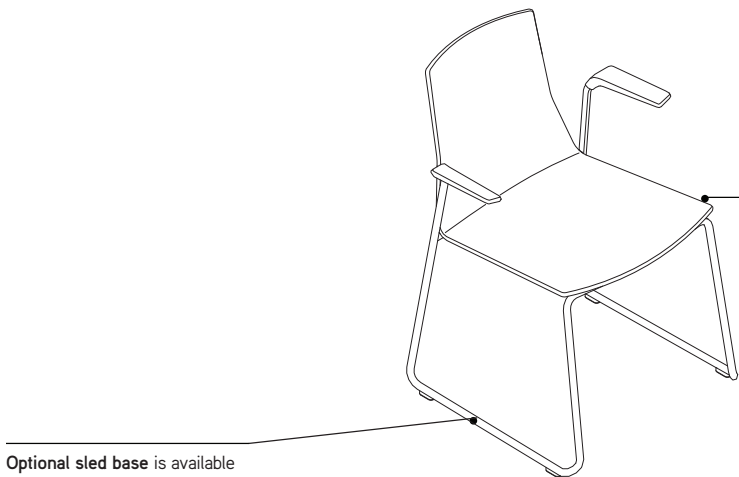

Optional sled base is available with cantilever arms or armless. Arms are aluminum and match the frame finish.

Chairs are stackable. The stack pad is standard and protects upholstery from damage. Chairs stack to six high.

Product Details

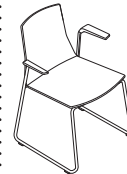
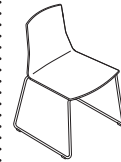
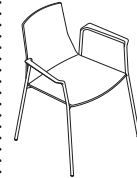
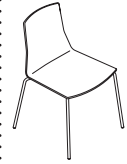

Chairs are available with a 4-leg base (armless or with loop arms) and with a sled base (armless or with cantilever arms).

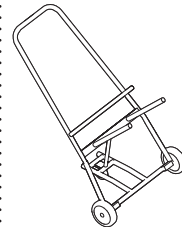

The Enea Iottus dolly can be used for storage or easy transport. Chairs stack to six high on the dolly.

Montara650 Chairs

DESIGN LIEVORE ALTHERR MOLINA

Surface Materials

► See *Coalesse Surface Materials Reference Guide* for further information.

Wood shell

- Oak veneered plywood

Frame

- Paint
- Polished trivalent chrome (optional)

Upholstery

- Fabric
- Leather

Program & Services

Customer's Own Material/Leather (COM/COL) Program is available.

► See *Coalesse Surface Materials Reference Guide* for additional information.

Montara650 Chairs

DESIGN LIEVORE ALTHERR MOLINA



Tip: Leathers will appear loose with comfort wrinkles when upholstered.

Tip: For Customer's Own Material or Leather, see necessary requirements, important processing instructions, and ordering information.
 ▶ See *Coalesse Surface Materials Reference Guide* and online fabric database at <http://fabric.coalesse.com>.

Standard Includes	Required to Specify
▶ Need help? Product details, page 326	<ol style="list-style-type: none"> 1 Style number 2 Upholstery version (see below under Required Selections) 3 Contrasting fabric on ¾ or fully upholstered, if selected (see below under Required Selections) 4 Fabric and/or leather color number for seat and/or back, if selected 5 Wood finish on shell, if selected 6 Base type (see below under Required Selections) 7 Paint color number for base 8 Options, if selected (see below) ▶ See <i>Coalesse Surface Materials Reference Guide</i> .
<ul style="list-style-type: none"> • Seat and back: upholstery, if selected • Shell: wood shell, wood shell with upholstered seat, or ¾ upholstery with wood shell, if selected: Grade 1 wood veneer • Base: Grade 1 paint • Glides 	

Required Selections	U.S. Price	Required to Specify
Upholstery Version <ul style="list-style-type: none"> • Wood shell • Wood shell with upholstered seat • Wood shell with ¾ upholstery • Fully upholstered 	Prices at right Prices at right Prices at right Prices at right	Specify with <i>wood seat and back</i> . Specify with <i>upholstered seat, wood back</i> . Specify with <i>¾ upholstered</i> . Specify with <i>upholstered seat and back</i> .
Contrasting Fabric on ¾ and Fully Upholstered <ul style="list-style-type: none"> • Non contrasting fabric • Contrasting fabric 	No cost +\$182	Specify with <i>non contrasting fabric</i> . Specify with <i>contrasting fabric</i> .
Base Type <ul style="list-style-type: none"> • 4-leg • Sled base • Sled base with cantilever arms • 4-leg base with loop arms 	No cost +\$ 72 +\$210 +\$167	Specify with <i>4-leg</i> . Specify with <i>sled base</i> . Specify with <i>sled cantilever arm</i> . Specify with <i>4-leg loop arm</i> .

Options	U.S. Price	Required to Specify
Surface Materials <ul style="list-style-type: none"> Base, armless <ul style="list-style-type: none"> • Grade 1 paint • Polished trivalent chrome • Grade 3 paint Base, with arms <ul style="list-style-type: none"> • Grade 1 paint • Grade 3 paint • Polished trivalent chrome Wood shell <ul style="list-style-type: none"> • Grade 1 wood veneer • Grade 2 wood veneer Acrylic backer <ul style="list-style-type: none"> • Seat • Seat and back 	No cost +\$ 74 +\$105 No cost +\$105 +\$243 No cost +\$ 88 +\$ 9 +\$ 23	Specify paint color number. Specify with <i>polished trivalent chrome</i> . Specify paint color number. Specify paint color number. Specify paint color number. Specify with <i>polished trivalent chrome</i> . Specify with <i>VP01 Oak Light, VP03 Black Oak, or VP05 White Oak</i> . Specify with <i>VP02 Smoked Oak or VP04 Grey Oak</i> . Specify with <i>acrylic backer</i> . Specify with <i>acrylic backer</i> .
Related Products <ul style="list-style-type: none"> • Café tables • Lounge seating • Stools 		▶ See <i>Coalesse Tables, Storage, and Accessories Specification Guide</i> . ▶ Page 174 ▶ Page 376



For Canadian Pricing
 Multiply U.S. Price by the Canadian price factor.
 ▶ See page 1 for details.

Montara650 Chairs

DESIGN LIEVORE ALTHERR MOLINA

Specification Information



4-leg, armless
Overall: 20½"W x 20½"D x 31"H
Seat: 17½"H



4-leg with loop arms
Overall: 24"W x 20½"D x 31"H
Seat: 17½"H
Arms: 25¼"H



Sled base, armless
Overall: 20½"W x 20½"D x 31"H
Seat: 17½"H



Sled base with cantilever arms
Overall: 22"W x 20½"D x 31"H
Seat: 17½"H
Arms: 25"H

Style
Number

U.S. Base Price

Wood Shell Chair

COSFZCH	Seat	\$ 749
---------	------	--------

Style
Number

U.S. Base Prices

Fabric Grades:											Leather Grades:		
	COM	6	7	8	9	10	11	12	13	14	COL	C	E

Wood Shell Chair with Upholstered Seat

COSFZCH	Seat	\$ 950	\$ 917	\$ 923	\$ 932	\$ 960	\$ 975	\$ 996	\$1010	\$1034	\$1071	\$1257	\$1119	\$1168
---------	------	--------	--------	--------	--------	--------	--------	--------	--------	--------	--------	--------	--------	--------

COM/yds = ¾, COL/sq ft: 8

Wood Shell Chair with ¾ Upholstery

COSFZCH	Seat	\$1094	\$1061	\$1067	\$1076	\$1104	\$1119	\$1140	\$1154	\$1178	\$1215	\$1401	\$1263	\$1312
	Back	+\$ 59	+\$ 26	+\$ 32	+\$ 41	+\$ 69	+\$84	+\$105	+\$119	+\$143	+\$180	+\$118	+\$228	+\$277

COM/yds = ¾, COL/sq ft: 16

Fully Upholstered Chair

COSFZCH	Seat	\$ 987	\$ 954	\$ 960	\$ 969	\$ 997	\$1012	\$1033	\$1047	\$1071	\$1108	\$1294	\$1156	\$1205
	Back	+\$ 59	+\$ 55	+\$ 63	+\$ 81	+\$135	+\$169	+\$211	+\$238	+\$287	+\$358	+\$118	+\$504	+\$605

COM/yds = 1¼, COL/sq ft: 19

Guest Seating



For Canadian Pricing
Multiply U.S. Price by the
Canadian price factor.
▶ See page 1 for details.

Montara650 Chair and Stool Multi-Fabric Diagram

DESIGN LIEVORE ALTHERR MOLINA

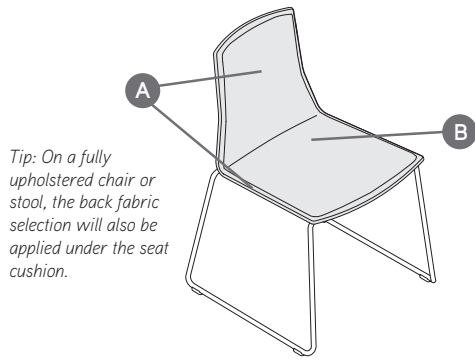

Tip: On a fully upholstered chair or stool, the back fabric selection will also be applied under the seat cushion.

Fully Upholstered

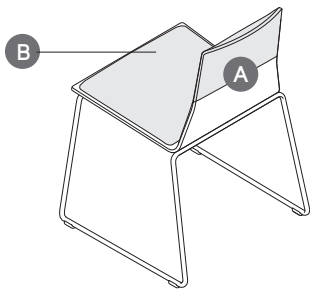

3/4 Upholstered

TO: _____

FROM: _____

DATE: _____

FAX...888.413.5161

A Back: _____

B Seat: _____

Contrasting upcharge for each contrasting textile pricing based on highest grade textile specified. See specifying for contrasting upcharge.

Specify Model below:

COSFZCH Montara650 Chair

COSFZST Montara650 Stool

Switch Chairs

DESIGN EOOS

Switch chairs bring modern and comfortable seating to the workplace.

Tip: This product line is a collection and will be found in multiple locations in this specification guide and/or Coalesse Tables, Storage, and Accessories Specification Guide.

► See *Collections*, page 5.

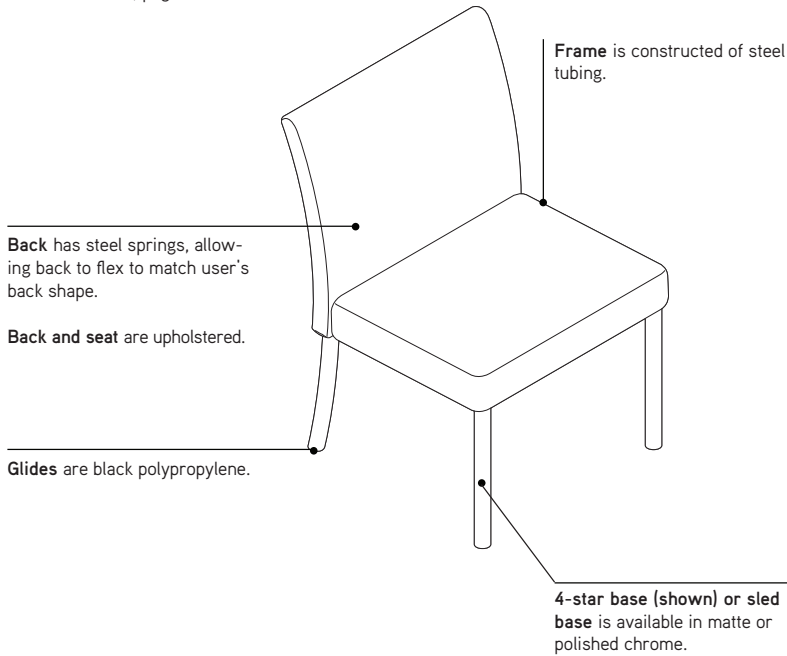

Product Details

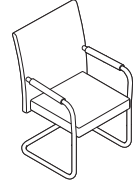
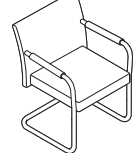
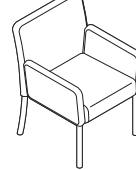
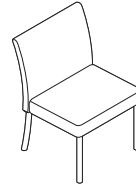

Switch is available with or without arms in a leg or sled base. Sled base version is offered in both a low-back and high-back model.

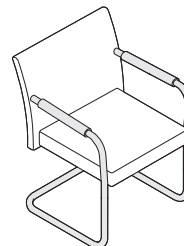

Sled base with arms and felt glides is designed for hard floors.

Tip: Movement on carpet is more difficult.

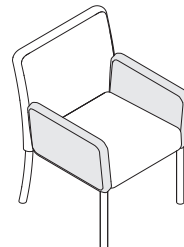

Upholstered arm detail is available on 4-leg base only.

Surface Materials

► See *Coalesse Surface Materials Reference Guide* for further information.

Upholstery (contrasting fabric available)

- Fabric
- Leather

Frame

- Matte chrome
- Polished chrome

Program & Services

Customer's Own Material/Leather (COM/COL) Program is available.

► See *Coalesse Surface Materials Reference Guide* for additional information.

Switch Chairs

DESIGN E00S

Tip: Fabrics and leathers will appear loose with comfort wrinkles when upholstered.

Tip: Recommended leathers are Elmosoft Grade C and Elmorustical Grade E.

Tip: Special color match, consult Customer Service.

Tip: For Customer's Own Material or Leather, see necessary requirements, important processing instructions, and ordering information
 ▶ See *Coalesse Surface Materials Reference Guide*.

Tip: Pricing based on highest grade textile specified.

Tip: Steel springs allow back to flex to match occupant's back shape.

Tip: Upholstered arm caps fit firmly on arms in coordinating textiles, COM yardage required 1/4 yards, COL square feet required 4 1/2 (1519 and 1529 only).

Tip: Glide on sled base chair has a felt pad made for hard floors. Movement on carpet is more difficult.

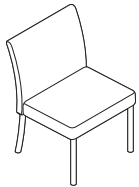

Overall: 22 1/2"D 21 1/2"W 33 1/2"H
Inside: 18 1/2"D 19 1/4"W 15 1/2"H
Seat: 18 1/2"H

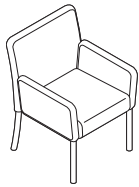

Overall: 22 1/2"D 25 3/4"W 33 1/2"H
Inside: 18 1/2"D 19"W 15 1/2"H
Seat: 18 1/2"H
Arm: 26 1/2"H

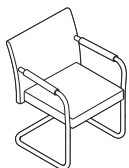

Overall: 23 1/2"D 23 3/4"W 34 1/4"H
Inside: 18"D 17 3/4"W 15 1/2"H
Seat: 18 1/2"H
Arm: 26 1/2"H

Standard Includes

▶ Need help? Product details, page 331

- Frame: Constructed of steel tubing and bar stock
- Arms: solid steel rod and bar stock
- Upholstery: Back and seat are molded foam and fiber
- Legs: matte chrome (M) or polished chrome (PC) leg finish

Required to Specify

- 1 Style number
 - 2 Number of fabrics if contrasting fabric style number is selected
 - 3 Fabric or leather color number for upholstery on seat
 - 4 Options, if selected (see below)
- ▶ See *Coalesse Surface Materials Reference Guide*.

Options

Surface Materials

- Contrasting fabric

U.S. Price
 +\$182 per fabric

Required to Specify

Add suffix K to the style number and select fabric color number.

Acrylic backer

- Armless chair and low-back sled base
- High-back sled base
- Arm chair

+ \$ 26
 + \$ 28
 + \$ 39

Specify with acrylic backer.

Specify with acrylic backer.
 Specify with acrylic backer.

▶ See *Coalesse Surface Materials Reference Guide*.

Related Products

- Lounge seating
- Stools
- Occasional tables

▶ Page 238
 ▶ Page 379

▶ See *Coalesse Tables, Storage, and Accessories Specification Guide*.

Specification Information

Style Number	U.S. Base Prices											Leather Grades:		
	Fabric Grades:											COL	C	E
	COM	6	7	8	9	10	11	12	13	14				

Armless Chairs

1500M	\$1806	\$1806	\$1822	\$1846	\$1924	\$1971	\$2030	\$2070	\$2138	\$2236	\$2208	\$3257	\$3448
1500PC	\$1870	\$1870	\$1886	\$1910	\$1988	\$2035	\$2094	\$2134	\$2202	\$2300	\$2272	\$3321	\$3513

COM/yds = 1 1/2, COL/sq ft = 27

Arm Chairs

1510M	\$2064	\$2064	\$2087	\$2130	\$2257	\$2338	\$2431	\$2500	\$2617	\$2779	\$2418	\$4212	\$4534
1510PC	\$2139	\$2139	\$2162	\$2205	\$2332	\$2413	\$2506	\$2575	\$2692	\$2854	\$2493	\$4269	\$4609

COM/yds = 2 1/2, COL/sq ft = 45

Low-Back Sled Base Chairs

1519M	\$2113	\$2113	\$2133	\$2164	\$2266	\$2333	\$2410	\$2462	\$2555	\$2686	\$2493	\$3903	\$4169
1519PC	\$2161	\$2161	\$2181	\$2212	\$2314	\$2381	\$2458	\$2510	\$2603	\$2734	\$2541	\$3954	\$4217

COM/yds = 2, COL/sq ft = 36

▶ Specification Information, continued on next page

Switch Chairs

DESIGN EOOS

► Specification Information, continued from previous page

Specification Information

Style Number	U.S. Base Prices											Leather Grades:		
	Fabric Grades:											COL	C	E
	COM	6	7	8	9	10	11	12	13	14				

High-Back Sled Base Chairs

1529M	\$2330	\$2330	\$2353	\$2390	\$2504	\$2578	\$2665	\$2725	\$2833	\$2979	\$2705	\$4310	\$4599
1529PC	\$2396	\$2396	\$2419	\$2456	\$2570	\$2644	\$2731	\$2791	\$2899	\$3045	\$2761	\$4367	\$4654

COM/yds = 2¼, COL/sq ft = 41

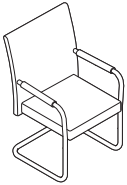

Overall: 23½"D 24"W 38½"H
 Inside: 17¾"D 17¾"W 15½"H
 Seat: 18½"H
 Arm: 26½"H



For Canadian Pricing
 Multiply U.S. Price by the
 Canadian price factor.
 ► See page 1 for details.

Wrap Chairs by Viccarbe

DESIGN MARK KRUSIN

Wrap chair combines a snug, winged back with a generous contoured seat, inclined slightly for comfort and support.

Back is fully upholstered with back stitch detail.

Seat is upholstered foam with slight incline for added comfort and support.

Glides are black polypropylene.

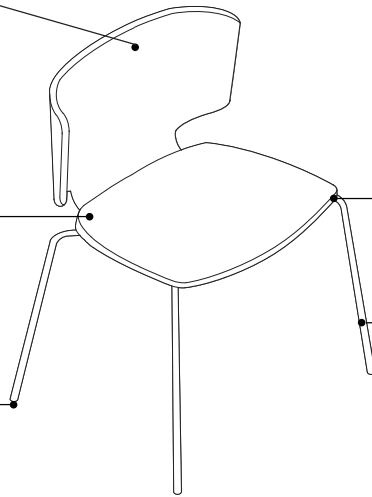

Frame is standard polished trivalent chrome.

4-leg base or sled base are available.

Product Details

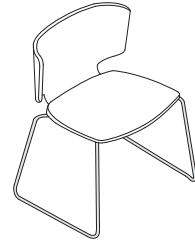

Sled base is available.

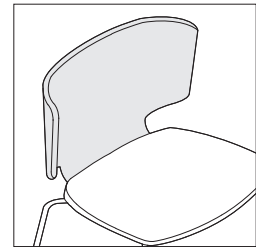

Back stitch detail is standard on all upholstery.

Surface Materials

► See *Coalesse Surface Materials Reference Guide* for further information.

Upholstery (contrasting fabric available)

- Fabric
- Leather

Frame

- Polished trivalent chrome

Program & Services

Customer's Own Material/Leather (COM/COL) Program is available.

► See *Coalesse Surface Materials Reference Guide* for additional information.

Wrapp Chairs by Viccarbe

DESIGN MARK KRUSIN

Tip: Fabrics and leathers will appear loose with comfort wrinkles when upholstered.

Tip: Stacking is not recommended as the frame will dent the foam on the seat on which it is being stacked.

Tip: For Customer's Own Material or Leather, see necessary requirements, important processing instructions, and ordering information
 ▶ See *Coalesse Surface Materials Reference Guide*.

Standard Includes	Required to Specify
▶ Need help? Product details, page 334	1 Style number 2 Number of fabrics if contrasting fabric style number is selected 3 Fabric or leather color number for upholstery 4 Options, if selected (see below) ▶ See <i>Coalesse Surface Materials Reference Guide</i> .

Options	U.S. Price	Required to Specify
Surface Materials <ul style="list-style-type: none"> Contrasting fabric 	+\$182 per fabric	Add suffix K to the style number and select fabric color number.
<ul style="list-style-type: none"> Acrylic backer Backer 	+\$ 20	Specify with acrylic backer. ▶ See <i>Coalesse Surface Materials Reference Guide</i> .

Specification Information													
Style Number	U.S. Base Prices											Leather Grades:	
	Fabric Grades:											COL	C
	COM	6	7	8	9	10	11	12	13	14			

4-Leg Chair

COWRP4LEG	\$1857	\$1857	\$1873	\$1897	\$1975	\$2022	\$2081	\$2121	\$2189	\$2287	\$2189	\$3044	\$3206
------------------	--------	--------	--------	--------	--------	--------	--------	--------	--------	--------	--------	--------	--------

COM/yds = 1½, COL/sq ft = 33



Overall: 21"D 25¼"W 29½"H
 Inside: 16"D 19½"W 17½"H
 Seat: 17½"H

Sled-Base Chair

COWRPSLD	\$1922	\$1922	\$1938	\$1962	\$2040	\$2087	\$2146	\$2186	\$2254	\$2352	\$2254	\$3109	\$3271
-----------------	--------	--------	--------	--------	--------	--------	--------	--------	--------	--------	--------	--------	--------

COM/yds = 1½, COL/sq ft = 33



Overall: 20¼"D 24½"W 28¾"H
 Inside: 16"D 19½"W 17½"H
 Seat: 17½"H



For Canadian Pricing
 Multiply U.S. Price by the Canadian price factor.
 ▶ See page 1 for details.

Stools

*These product lines are collections and will be found in multiple locations in this specification guide and/or *Coalesce Tables, Storage, and Accessories Specification Guide*.

▶ See *Collections*, page 5

Enea Bar Stools*	338
Enea Café Post Stools*	344
Enea Café Wood Stools*	350
Enea Lottus Post Stools*	354
Enea Lottus Sled Stools*	358
Enea Altzo943 Stools*	362
LessThanFive Stool	364
Lox Stools	366
Marien152 Stools*	368
Montara650 Stools*	375
Switch Stools*	378

Enea Bar Stools

DESIGN JOSEP LLUSCA

The Enea seating collection is comfortable and versatile, with a wide palette of colors and finish possibilities. Arm and armless bar-height stools feature clean back detailing for open plan layouts.

Tip: This product line is a collection and will be found in multiple locations in this specification guide and/or Coalesse Tables, Storage, and Accessories Specification Guide.

► See Collections, page 5.

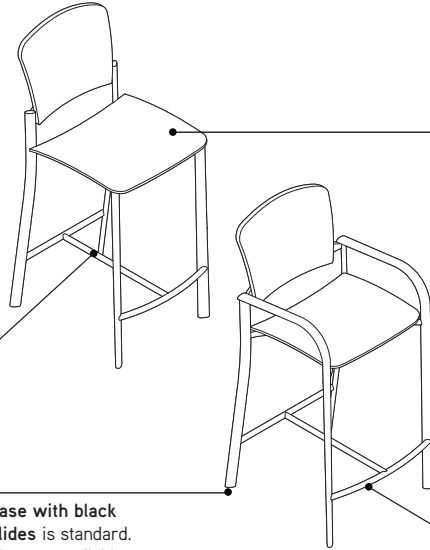

Frame is standard in powder coat paint.

4-leg base with black resin glides is standard. Felt glides are available as an option.

Seat and back are available in polypropylene, wood veneer, or upholstery. Contoured seat and backrest have rounded edges for comfort.

Footrest with leg stretcher is chrome plated.

Arm and armless stools are available; arms are cast aluminum.

Enea collection features bar and café stools, guest seating, café tables, and occasional tables.

► For guest seating, see page 301

► For tables, see *Coalesse Tables, Storage, and Accessories Specification Guide*.

Surface Materials

► See *Coalesse Surface Materials Reference Guide* for further information.

Seat and back

- Polypropylene
- Wood, maple veneered plywood
- Upholstery, fabric, or leather

Frame

- Paint

Programs & Services

Customer's Own Material/Leather (COM/COL) Program is available.

► See *Coalesse Surface Materials Reference Guide* for additional information.

Coalesse

Enea Bar Stools

DESIGN JOSEP LLUSCA

Enea Bar Stools Bar-Height with Arms

DESIGN JOSEP LLUSCA

Tip: CAL 133 for polypropylene is available as a special quote. Polypropylene color will change slightly when FR treatment is applied. Contact Customer Service for availability and pricing. Minimum quantity will apply.

Tip: Due to the design and construction techniques of the Enea Barstool only certain textiles can be successfully applied, therefore all COM fabrics must be submitted to Coalesse for approval prior to order acceptance.

Tip: Pricing based on highest grade textile specified.

Tip: Fabrics and leathers will appear loose with comfort wrinkles when upholstered.

Tip: Contrasting fabric option available on model 3511 only.

Tip: For Customer's Own Material or Leather, see necessary requirements, important processing instructions, and ordering information
 ▶ See Coalesse Surface Materials Reference Guide.

Standard Includes Required to Specify

<p>▶ Need help? Product details, page 338</p>	<ul style="list-style-type: none"> Constructed of steel tubing with cast aluminum arms Seat and back: polypropylene, wood, or upholstery (wood is laminated layers of hard maple veneer) Foot rest with leg stretchers: chrome-plated 	<ol style="list-style-type: none"> Style number Number of fabrics if contrasting fabric style number is selected Fabric or leather color number for upholstery, if selected Plastic or wood finish color number for seat and back, if selected Base/frame finish: <ul style="list-style-type: none"> - 4016 White Gloss - 4017 Black Gloss - 4018 Silver Metallic Options, if selected (see below) <p>▶ See Coalesse Surface Materials Reference Guide.</p>
---	--	---

Options U.S. Price Required to Specify

<p>Surface Materials</p> <ul style="list-style-type: none"> Contrasting fabric <hr/> <p>Acrylic backer</p> <ul style="list-style-type: none"> Chair with upholstered seat and back Chair with upholstered seat and wood back 	<p>+ \$182 per fabric</p> <hr/> <p>+ \$ 20</p> <p>+ \$ 7</p>	<p>Add suffix K to the style number and select fabric color number.</p> <hr/> <p>Specify with acrylic backer.</p> <p>Specify with acrylic backer.</p> <p>▶ See Coalesse Surface Materials Reference Guide.</p>
<p>Felt Glides</p> <ul style="list-style-type: none"> Glides 	<p>No cost</p>	<p>Specify with felt glides.</p>
<p>Related Products</p> <ul style="list-style-type: none"> Café tables Occasional tables Guest seating 		<p>▶ See Coalesse Tables, Storage, and Accessories Specification Guide.</p> <p>▶ See Coalesse Tables, Storage, and Accessories Specification Guide.</p> <p>▶ Pages 302-304</p>

Specification Information

Style Number	U.S. Base Prices														Leather Grades:			Wood	Poly-propylene
	Fabric Grades:														COL	C	E		
	COM	6	7	8	9	10	11	12	13	14									

Wood Seat and Back

3510	X10/24	N.A.	N.A.	N.A.	N.A.	N.A.	N.A.	N.A.	N.A.	N.A.	N.A.	N.A.	N.A.	N.A.	N.A.	N.A.	N.A.	\$1536	N.A.
------	--------	------	------	------	------	------	------	------	------	------	------	------	------	------	------	------	------	--------	------

▶ Specification Information, continued on next page

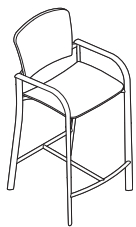

Overall: 24¾"D 22¼"W 45½"H
 Inside: 18½"D 17¾"W 15¼"H
 Seat: 30½"H
 Arm: 39¼"H

For Canadian Pricing
 Multiply U.S. Price by the Canadian price factor.
 ▶ See page 1 for details.

X10/24 = Last order entry
 October 20, 2024

Enea Bar Stools Bar-Height with Arms

DESIGN JOSEF LLUSCA

► Specification Information, continued from previous page

Specification Information

Style Number	U.S. Base Prices														Leather Grades:			Wood	Polypropylene
	Fabric Grades:														COL	C	E		
	COM	6	7	8	9	10	11	12	13	14									

Upholstered Seat and Back

3511	\$1446	\$1446	\$1462	\$1486	\$1564	\$1611	\$1670	\$1710	\$1778	\$1876	\$1853	\$2181	\$2379	N.A.	N.A.
------	--------	--------	--------	--------	--------	--------	--------	--------	--------	--------	--------	--------	--------	------	------

COM/yds = 1, COL/sq ft = 22

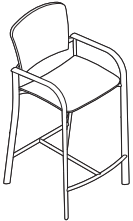

Overall: 24¾"D 22¼"W 45½"H
 Inside: 18½"D 17¾"W 15¼"H
 Seat: 30½"H
 Arm: 39¼"H

Upholstered Seat and Wood Back

3512	✕10/24	\$1552	\$1531	\$1539	\$1551	\$1589	\$1612	\$1642	\$1660	\$1697	\$1746	\$1971	\$2127	\$2244	N.A.	N.A.
------	--------	--------	--------	--------	--------	--------	--------	--------	--------	--------	--------	--------	--------	--------	------	------

COM/yds = ¾, COL/sq ft = 17

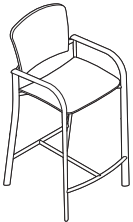

Overall: 24¾"D 22¼"W 45½"H
 Inside: 18½"D 17¾"W 15¼"H
 Seat: 30½"H
 Arm: 39¼"H

Polypropylene Seat and Back

3513	N.A.	N.A.	N.A.	N.A.	N.A.	N.A.	N.A.	N.A.	N.A.	N.A.	N.A.	N.A.	N.A.	N.A.	N.A.	\$1053
------	------	------	------	------	------	------	------	------	------	------	------	------	------	------	------	--------

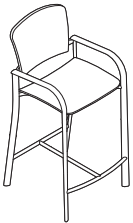

Overall: 24¾"D 22¼"W 45½"H
 Inside: 18½"D 17¾"W 15¼"H
 Seat: 30½"H
 Arm: 39¼"H



For Canadian Pricing
 Multiply U.S. Price by the Canadian price factor.
 ► See page 1 for details.

✕10/24 = Last order entry
 October 20, 2024

Enea Bar Stools Bar-Height without Arms

DESIGN JOSEP LLUSCA

Tip: CAL 133 for polypropylene is available as a special quote. Polypropylene color will change slightly when FR treatment is applied. Contact Customer Service for availability and pricing. Minimum quantity will apply.

Tip: Due to the design and construction techniques of the Enea Barstool only certain textiles can be successfully applied, therefore all COM fabrics must be submitted to Coalesse for approval prior to order acceptance.

Tip: Pricing based on highest grade textile specified.

Tip: Fabrics and leathers will appear loose with comfort wrinkles when upholstered.

Tip: For Customer's Own Material or Leather, see necessary requirements, important processing instructions, and ordering information
 ▶ See Coalesse Surface Materials Reference Guide.

Tip: Contrasting fabric option available on model 3511S only.

Standard Includes

- ▶ Need help? Product details, page 338
- Constructed of steel tubing with cast aluminum arms
- Seat and back: polypropylene, wood, or upholstery (wood is laminated layers of hard maple veneer)
- Foot rest with leg stretchers: chrome-plated

Required to Specify

- 1 Style number
 - 2 Number of fabrics if contrasting fabric style number is selected
 - 3 Fabric or leather color number for upholstery, if selected
 - 4 Plastic or wood finish color number for seat and back, if selected
 - 5 Base/frame finish:
 - 4016 White Gloss
 - 4017 Black Gloss
 - 4018 Silver Metallic
 - 6 Options, if selected (see below)
- ▶ See Coalesse Surface Materials Reference Guide.

Options

Options	U.S. Price	Required to Specify
Surface Materials		
• Contrasting fabric	+\$182 per fabric	Add suffix K to the style number and select fabric color number.
Acrylic backer		
• Chair with upholstered seat and back	+\$ 20	Specify with acrylic backer.
• Chair with upholstered seat and wood back	+\$ 7	Specify with acrylic backer. ▶ See Coalesse Surface Materials Reference Guide.
Felt Glides		
• Glides	No cost	Specify with felt glides.
Related Products		
• Café tables		▶ See Coalesse Tables, Storage, and Accessories Specification Guide.
• Occasional tables		▶ See Coalesse Tables, Storage, and Accessories Specification Guide.
• Guest seating		▶ Pages 302-304

Specification Information

Style Number	U.S. Base Prices														Leather Grades:			Wood	Poly-propylene
	Fabric Grades:															COL	C	E	
	COM	6	7	8	9	10	11	12	13	14									

Wood Seat and Back

3510S	✕10/24	N.A.	N.A.	N.A.	N.A.	N.A.	N.A.	N.A.	N.A.	N.A.	N.A.	N.A.	N.A.	N.A.	N.A.	N.A.	\$1492	N.A.
-------	--------	------	------	------	------	------	------	------	------	------	------	------	------	------	------	------	--------	------

Upholstered Seat and Back

3511S	\$1329	\$1329	\$1345	\$1369	\$1447	\$1494	\$1553	\$1593	\$1661	\$1759	\$1741	\$2073	\$2273	N.A.	N.A.
-------	--------	--------	--------	--------	--------	--------	--------	--------	--------	--------	--------	--------	--------	------	------

COM/yds = 1, COL/sq ft = 22

▶ Specification Information, continued on next page

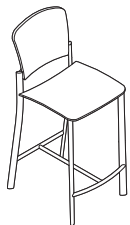

Overall: 25"D 18½"W 45¾"H
 Inside: 18½"D 17¾"W 15¼"H
 Seat: 30½"H

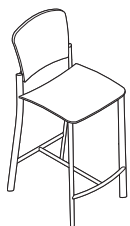

Overall: 25"D 18½"W 45¾"H
 Inside: 18½"D 17¾"W 15¼"H
 Seat: 30½"H

✕10/24 = Last order entry
 October 20, 2024

Enea Bar Stools Bar-Height without Arms

DESIGN JOSEP LLUSCA

► Specification Information, continued from previous page

Specification Information

Style Number	U.S. Base Prices														Leather Grades:			Wood	Poly-propylene
	Fabric Grades:														COL	C	E		
	COM	6	7	8	9	10	11	12	13	14									

Upholstered Seat and Wood Back

3512S **X10/24** \$1429 \$1408 \$1416 \$1428 \$1466 \$1489 \$1519 \$1537 \$1574 \$1623 \$1853 \$1995 \$2107 N.A. N.A.

COM/yds = ¾, COL/sq ft = 17

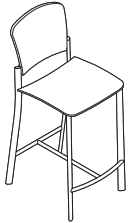

Overall: 25"D 18½"W 45¾"H
 Inside: 18½"D 17¾"W 15¼"H
 Seat: 30½"H

Polypropylene Seat and Back

3513S N.A. N.A. N.A. N.A. N.A. N.A. N.A. N.A. N.A. N.A. N.A. N.A. N.A. N.A. N.A. \$913

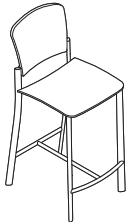

Overall: 25"D 18½"W 45¾"H
 Inside: 18½"D 17¾"W 15¼"H
 Seat: 30½"H

 **For Canadian Pricing**
 Multiply U.S. Price by the
 Canadian price factor.
 ► See page 1 for details.

X10/24 = Last order entry
 October 20, 2024

Enea Café Post Stools

DESIGN JOSEP LLUSCA

The Enea café post stool delivers simple and contemporary style. It has an optional back for added support and three heights to accommodate any café area and gathering space.

Tip: This product line is a collection and will be found in multiple locations in this specification guide and/or Coalesse Tables, Storage, and Accessories Specification Guide.

► See Collections, page 5.

Backless stools are available in three heights: counter height, bar height, and low stool.

Stools with backrest are available in two heights: counter height and bar height.

Backless stools feature a 14½" diameter base.

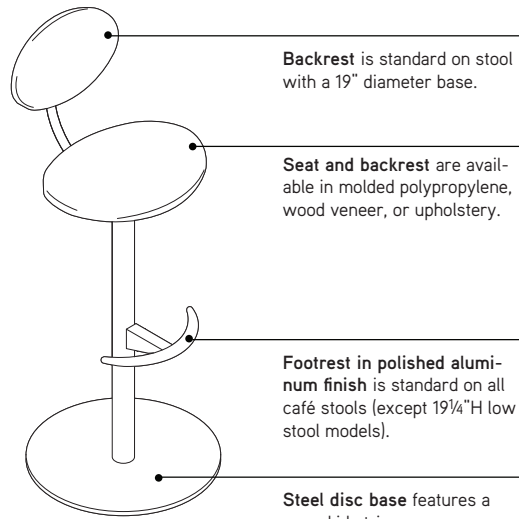
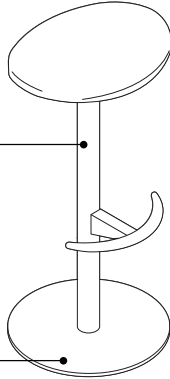

Backrest is standard on stool with a 19" diameter base.

Seat and backrest are available in molded polypropylene, wood veneer, or upholstery.

Footrest in polished aluminum finish is standard on all café stools (except 19¼"H low stool models).

Steel disc base features a non-skid strip.

Enea collection features bar and café stools, guest seating, café tables and occasional tables.
► For guest seating, see page 301.
► For tables, see *Coalesse Tables, Storage, and Accessories Specification Guide*.

Surface Materials

► See *Coalesse Surface Materials Reference Guide* for further information.

Seat and back

- Polypropylene
- Wood, maple veneered plywood
- Upholstery, fabric, or leather

Frame

- Paint

Programs & Services

Customer's Own Material/Leather (COM/COL) Program is available.
► See *Coalesse Surface Materials Reference Guide* for additional information.

Coalesse

Enea Café Post Stools

DESIGN JOSEP LLUSCA

Enea Café Post Stools Café with Back

DESIGN JOSEP LLUSCA

Tip: CAL 133 for polypropylene is available as a special quote. Polypropylene color will change slightly when FR treatment is applied. Contact Customer Service for availability and pricing. Minimum quantity will apply.

Tip: For Customer's Own Material or Leather, see necessary requirements, important processing instructions, and ordering information
 ▶ See *Coalesse Surface Materials Reference Guide*.

Standard Includes		Required to Specify
▶ Need help? Product details, page 344	<ul style="list-style-type: none"> • Base/frame: steel tubing and base with non-skid strip • Seat and back: molded polypropylene, wood, or upholstery (wood is laminated layers of hard maple veneer) • Footrest: polished aluminum • Upholstered seat/back: Laminations of multiple density polyurethane foam and polyester fiber 	<ol style="list-style-type: none"> 1 Style number 2 Number of fabrics if contrasting fabric style number is selected 3 Fabric or leather color number for upholstery, if selected 4 Plastic or wood finish color number for seat and back, if selected 5 Base/frame finish: <ul style="list-style-type: none"> - 4016 White Gloss - 4017 Black Gloss - 4018 Silver Metallic 6 Options, if selected (see below) ▶ See <i>Coalesse Surface Materials Reference Guide</i> .

Options	U.S. Price	Required to Specify
Surface Materials	<ul style="list-style-type: none"> • Contrasting fabric +\$182 per fabric 	Add suffix K to the style number and select fabric color number.
	<ul style="list-style-type: none"> • Acrylic backer 	Specify with acrylic backer.
	<ul style="list-style-type: none"> • Stool with upholstered seat and back +\$ 7 • Stool with upholstered seat and wood back +\$ 4 	Specify with acrylic backer. ▶ See <i>Coalesse Surface Materials Reference Guide</i> .
Related Products	<ul style="list-style-type: none"> • Café tables • Occasional tables • Guest seating 	▶ See <i>Coalesse Tables, Storage, and Accessories Specification Guide</i> . ▶ See <i>Coalesse Tables, Storage, and Accessories Specification Guide</i> . ▶ Pages 302–304

Specification Information

Style Number	U.S. Base Prices														Leather Grades:			Wood	Polypropylene
	Fabric Grades:														COL	C	E		
	COM	6	7	8	9	10	11	12	13	14									

Café Counter-Height Stools, 19" Base

Upholstered Seat and Back

H351-SB2719	X 10/24	\$1615	\$1594	\$1602	\$1614	\$1652	\$1675	\$1705	\$1723	\$1760	\$1809	\$1992	\$2325	\$2400	N.A.	N.A.
-------------	--------------------	--------	--------	--------	--------	--------	--------	--------	--------	--------	--------	--------	--------	--------	------	------

COM/yds = ¾, COL/sq ft = 13½

Upholstered Seat with Wood Back

H352-SB2719	\$1705	\$1672	\$1678	\$1690	\$1717	\$1732	\$1754	\$1770	\$1795	\$1831	\$2082	\$2308	\$2361	N.A.	N.A.
-------------	--------	--------	--------	--------	--------	--------	--------	--------	--------	--------	--------	--------	--------	------	------

COM/yds = 5/9, COL/sq ft = 10

Café Bar-Height Stools, 19" Base

Upholstered Seat and Back

H351-SB3119	X 10/24	\$1624	\$1603	\$1611	\$1623	\$1661	\$1684	\$1714	\$1732	\$1769	\$1818	\$2001	\$2334	\$2409	N.A.	N.A.
-------------	--------------------	--------	--------	--------	--------	--------	--------	--------	--------	--------	--------	--------	--------	--------	------	------

COM/yds = ¾, COL/sq ft = 13½

Upholstered Seat with Wood Back

H352-SB3119	X 10/24	\$1711	\$1678	\$1684	\$1696	\$1723	\$1738	\$1760	\$1776	\$1801	\$1837	\$2088	\$2314	\$2375	N.A.	N.A.
-------------	--------------------	--------	--------	--------	--------	--------	--------	--------	--------	--------	--------	--------	--------	--------	------	------

▶ Specification Information, continued on next page

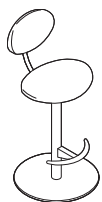

Overall: 19"D 19"W 38¼"H
 Inside: 14¼"D 17"W 12¾"H
 Seat: 25½"H

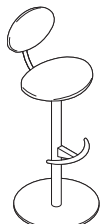

Overall: 19"D 19"W 42¼"H
 Inside: 14¼"D 17"W 12¾"H
 Seat: 29½"H

~~X~~10/24 = Last order entry
 October 20, 2024

Enea Café Post Stools Café with Back

DESIGN JOSEF LLUSCA

► Specification Information, continued from previous page

Specification Information

Style Number	U.S. Base Prices														Leather Grades:			Wood	Polypropylene
	Fabric Grades:														COL	C	E		
	COM	6	7	8	9	10	11	12	13	14									

Café Counter-Height Stools, 19" Base

Wood Seat and Back

H350-SB2719	✕10/24	N.A.	N.A.	N.A.	N.A.	N.A.	N.A.	N.A.	N.A.	N.A.	N.A.	N.A.	N.A.	N.A.	N.A.	N.A.	\$1739	N.A.
-------------	---------------	------	------	------	------	------	------	------	------	------	------	------	------	------	------	------	--------	------

Polypropylene Seat and Back

H353-SB2719	✕10/24	N.A.	N.A.	N.A.	N.A.	N.A.	N.A.	N.A.	N.A.	N.A.	N.A.	N.A.	N.A.	N.A.	N.A.	N.A.	\$1307	
-------------	---------------	------	------	------	------	------	------	------	------	------	------	------	------	------	------	------	--------	--

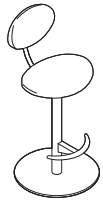

Overall: 19"D 19"W 38¼"H
 Inside: 14¼"D 17"W 12½"H
 Seat: 25½"H

Café Bar-Height Stools, 19" Base

Wood Seat and Back

H350-SB3119	✕10/24	N.A.	N.A.	N.A.	N.A.	N.A.	N.A.	N.A.	N.A.	N.A.	N.A.	N.A.	N.A.	N.A.	N.A.	N.A.	\$1754	N.A.
-------------	---------------	------	------	------	------	------	------	------	------	------	------	------	------	------	------	------	--------	------

Polypropylene Seat and Back

H353-SB3119	✕10/24	N.A.	N.A.	N.A.	N.A.	N.A.	N.A.	N.A.	N.A.	N.A.	N.A.	N.A.	N.A.	N.A.	N.A.	N.A.	\$1316	
-------------	---------------	------	------	------	------	------	------	------	------	------	------	------	------	------	------	------	--------	--

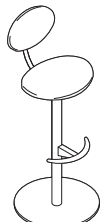

Overall: 19"D 19"W 42¼"H
 Inside: 14¼"D 17"W 12½"H
 Seat: 29½"H

Stools



For Canadian Pricing
 Multiply U.S. Price by the
 Canadian price factor.
 ► See page 1 for details.

✕10/24 = Last order entry
 October 20, 2024

Enea Café Post Stools X10/24

DESIGN JOSEP LLUSCA

Tip: CAL 133 for polypropylene is available as a special quote. Polypropylene color will change slightly when FR treatment is applied. Contact Customer Service for availability and pricing. Minimum quantity will apply.

Tip: Due to the design and construction techniques of the Enea Barstool only certain textiles can be successfully applied, therefore all COM fabrics must be submitted to Coalesse for approval prior to order acceptance.

Tip: Recommended leathers are Elmosoft Grade C and Elmorustical Grade E.

Tip: Special color match, consult Customer Service.

Tip: For Customer's Own Material or Leather, see necessary requirements, important processing instructions, and ordering information
 ▶ See *Coalesse Surface Materials Reference Guide*

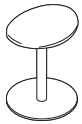

Overall: 14½"D 17"W 19¼"H
 Seat: 17½"H



Overall: 14½"D 17"W 27¼"H
 Seat: 25½"H

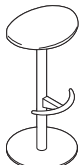

Overall: 14½"D 17"W 31¼"H
 Seat: 29½"H

For Canadian Pricing
 Multiply U.S. Price by the Canadian price factor.
 ▶ See page 1 for details.

Standard Includes	Required to Specify
▶ Need help? Product details, page 344	1 Style number 2 Plastic color number for seat and back 3 Fabric or leather color number for upholstery 4 Base/frame finish: - 4016 White Gloss - 4017 Black Gloss - 4018 Silver Metallic 5 Options, if selected (see below) ▶ See <i>Coalesse Surface Materials Reference Guide</i> .
<ul style="list-style-type: none"> Base/frame: steel tubing and base with non-skid strip Seat and back: molded polypropylene, wood, or upholstery (wood is laminated layers of hard maple veneer) Footrest: polished aluminum Base/frame finishes: paint Upholstered seat/back: Laminations of multiple density polyurethane foam and polyester fiber 	

Options	U.S. Price	Required to Specify
Surface Materials <ul style="list-style-type: none"> Acrylic backer Backer 	+\$4	Specify with acrylic backer. ▶ See <i>Coalesse Surface Materials Reference Guide</i> .
Related Products <ul style="list-style-type: none"> Café tables Occasional tables Guest seating 		▶ See <i>Coalesse Tables, Storage, and Accessories Specification Guide</i> . ▶ See <i>Coalesse Tables, Storage, and Accessories Specification Guide</i> . ▶ Pages 302-304

Specification Information													
Style Number	U.S. Base Prices												
	Fabric Grades:												
	COM	6	7	8	9	10	11	12	13	14	Leather Grades:		
											COL	C	E

Low Stool with Upholstered Seat													
H352-S19 X10/24	\$1260	\$1227	\$1233	\$1245	\$1272	\$1287	\$1309	\$1325	\$1350	\$1386	\$1473	\$1742	\$1800
COM/yds = 5/9, COL/sq ft = 10													

Café Counter-Height Stool with Upholstered Seat													
H352-S27 X10/24	\$1312	\$1279	\$1285	\$1297	\$1324	\$1339	\$1361	\$1377	\$1402	\$1438	\$1532	\$1800	\$1852
COM/yds = 5/9, COL/sq ft = 10													

Café Bar-Height Stool with Upholstered Seat													
H352-S31 X10/24	\$1370	\$1337	\$1343	\$1355	\$1382	\$1397	\$1419	\$1435	\$1460	\$1496	\$1583	\$1852	\$1910
COM/yds = 5/9, COL/sq ft = 10													

▶ Specification Information, continued on next page

X10/24 = Last order entry
 October 20, 2024

Enea Café Post Stools

DESIGN JOSEF LLUSCA

► Specification Information, continued from previous page

Specification Information

Style Number	U.S. Base Prices														Leather Grades:			Wood	Polypropylene
	Fabric Grades:														COL	C	E		
	COM	6	7	8	9	10	11	12	13	14									

Low Stools

Wood Seat

H350-S19	✕10/24	N.A.	N.A.	N.A.	N.A.	N.A.	N.A.	N.A.	N.A.	N.A.	N.A.	N.A.	N.A.	N.A.	N.A.	\$1145	N.A.
----------	--------	------	------	------	------	------	------	------	------	------	------	------	------	------	------	--------	------

Polypropylene Seat

H353-S19	✕10/24	N.A.	N.A.	N.A.	N.A.	N.A.	N.A.	N.A.	N.A.	N.A.	N.A.	N.A.	N.A.	N.A.	N.A.	\$	896
----------	--------	------	------	------	------	------	------	------	------	------	------	------	------	------	------	----	-----

Café Counter-Height Stools

Wood Seat

H350-S27	✕10/24	N.A.	N.A.	N.A.	N.A.	N.A.	N.A.	N.A.	N.A.	N.A.	N.A.	N.A.	N.A.	N.A.	\$1200	N.A.
----------	--------	------	------	------	------	------	------	------	------	------	------	------	------	------	--------	------

Polypropylene Seat

H353-S27	✕10/24	N.A.	N.A.	N.A.	N.A.	N.A.	N.A.	N.A.	N.A.	N.A.	N.A.	N.A.	N.A.	N.A.	\$	996
----------	--------	------	------	------	------	------	------	------	------	------	------	------	------	------	----	-----

Café Bar-Height Stools

Wood Seat

H350-S31	✕10/24	N.A.	N.A.	N.A.	N.A.	N.A.	N.A.	N.A.	N.A.	N.A.	N.A.	N.A.	N.A.	N.A.	\$1252	N.A.
----------	--------	------	------	------	------	------	------	------	------	------	------	------	------	------	--------	------

Polypropylene Seat

H353-S31	✕10/24	N.A.	N.A.	N.A.	N.A.	N.A.	N.A.	N.A.	N.A.	N.A.	N.A.	N.A.	N.A.	N.A.	\$	1088
----------	--------	------	------	------	------	------	------	------	------	------	------	------	------	------	----	------

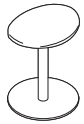

Overall: 14½"D 17"W 19¼"H
Seat: 17⅝"H



Overall: 14½"D 17"W 27¼"H
Seat: 25⅝"H

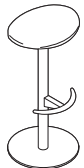

Overall: 14½"D 17"W 31¼"H
Seat: 29⅝"H



For Canadian Pricing
Multiply U.S. Price by the Canadian price factor.
► See page 1 for details.

✕10/24 = Last order entry
October 20, 2024

Enea Café Wood Stools

DESIGN JOSEP LLUSCA

The warm, modern design of the Enea café wood stool makes a statement with a residential design character. The Enea café wood stool is available in two heights (counter or bar) and has solid wood oak legs.

Tip: This product line is a collection and will be found in multiple locations in this specification guide and/or Coalesse Tables, Storage, and Accessories Specification Guide.

► See Collections, page 5.

Seat is available in molded polypropylene, wood, or upholstery.

Casting under the seat is offered in textured paints.

Wood legs are solid wood oak, with a natural finish.

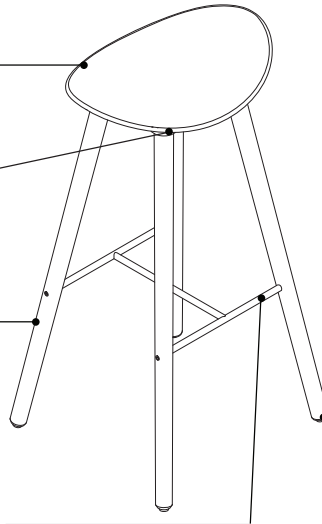

Footring in trivalent chrome is standard on all wood leg stools.

Glides are non-adjustable and available in black polyethylene, for superior durability on carpeted and hard floors.

Enea collection features bar and café stools, guest seating, café tables, and occasional tables.

► For guest seating, see page 301.

► For tables, see *Coalesse Tables, Storage, and Accessories Specification Guide*.

Surface Materials

► See *Coalesse Surface Materials Reference Guide* for further information.

Seat

- Polypropylene
- Rift-cut oak plywood
- Fabric or leather upholstery

Frame/legs

- Solid oak

Programs & Services

Customer's Own Material/Leather (COM/COL) Program is available.

► See *Coalesse Surface Materials Reference Guide* for additional information.

Coalesse

Enea Café Wood Stools

DESIGN JOSEP LLUSCA

Enea Café Wood Stools

DESIGN JOSEP LLUSCA

Tip: Recommended leathers are Elmosoft Grade C and Elmorustical Grade E.

Tip: Special color match, consult Customer Service.

Tip: For Customer's Own Material or Leather, see necessary requirements, important processing instructions, and ordering information
 ▶ See Coalesse Surface Materials Reference Guide.

Standard Includes	Required to Specify
▶ Need help? Product details, page 350 • Legs: solid oak with natural finish • Footring: 9201 Polished Trivalent Chrome • Seat and seat casting: – Polypropylene seat with matching textured paint on seat casting, if selected – V3AK Rift-Cut Oak veneer plywood seat with 4062 Anthracite Grey textured paint on seat casting, if selected – Upholstered seat with textured paint on seat casting, if selected • Glides, non-adjustable: black plastic	1 Style number 2 Plastic color number for polypropylene seat, if selected 3 Fabric or leather color number for upholstered seat, if selected 4 Paint color number for seat casting, if upholstered seat selected: 4062 Anthracite Grey 7207 Black 7241 Arctic White 5 Options, if selected (see below) ▶ See Coalesse Surface Materials Reference Guide.

Options	U.S. Price	Required to Specify
Surface Materials • Acrylic backer • Backer	+\$4	Specify with acrylic backer. ▶ See Coalesse Surface Materials Reference Guide.
Related Products • Café tables • Occasional tables • Guest seating		▶ See Coalesse Tables, Storage, and Accessories Specification Guide. ▶ See Coalesse Tables, Storage, and Accessories Specification Guide. ▶ Pages 302–304

Specification Information															
Style Number	U.S. Base Prices														
	Fabric Grades:														
	COM	6	7	8	9	10	11	12	13	14	Leather Grades:			Wood	Polypropylene
											COL	C	E		

Café Wood Counter-Height Stool with Upholstered Seat

COH352W27	\$1177	\$1144	\$1150	\$1162	\$1187	\$1202	\$1225	\$1238	\$1263	\$1299	\$1392	\$1653	\$1703	N.A.	N.A.
-----------	--------	--------	--------	--------	--------	--------	--------	--------	--------	--------	--------	--------	--------	------	------



Overall: 14½"D 16½"W 27½"H
 Seat: 25¾"H

Café Wood Bar-Height Stool with Upholstered Seat

COH352W31	\$1248	\$1215	\$1221	\$1233	\$1258	\$1273	\$1296	\$1309	\$1334	\$1370	\$1463	\$1724	\$1774	N.A.	N.A.
-----------	--------	--------	--------	--------	--------	--------	--------	--------	--------	--------	--------	--------	--------	------	------



Overall: 15¾"D 16½"W 31½"H
 Seat: 29¾"H

Café Wood Counter-Height Stools

Wood Seat															
COH350W27	N.A.	N.A.	N.A.	N.A.	N.A.	N.A.	N.A.	N.A.	N.A.	N.A.	N.A.	N.A.	N.A.	\$1088	N.A.
Polypropylene Seat															
COH353W27	N.A.	N.A.	N.A.	N.A.	N.A.	N.A.	N.A.	N.A.	N.A.	N.A.	N.A.	N.A.	N.A.	N.A.	\$903

▶ Specification Information, continued on next page

Enea Café Wood Stools

DESIGN JOSEP LLUSCA

► Specification Information, continued from previous page

Specification Information

Style Number	U.S. Base Prices														Leather Grades:			Wood	Polypropylene
	Fabric Grades:														COL	C	E		
	COM	6	7	8	9	10	11	12	13	14									

Café Wood Bar-Height Stools

Wood Seat

COH350W31	N.A.	N.A.	N.A.	N.A.	N.A.	N.A.	N.A.	N.A.	N.A.	N.A.	N.A.	N.A.	N.A.	N.A.	\$1159	N.A.
-----------	------	------	------	------	------	------	------	------	------	------	------	------	------	------	--------	------

Polypropylene Seat

COH353W31	N.A.	N.A.	N.A.	N.A.	N.A.	N.A.	N.A.	N.A.	N.A.	N.A.	N.A.	N.A.	N.A.	N.A.	N.A.	\$972
-----------	------	------	------	------	------	------	------	------	------	------	------	------	------	------	------	-------



Overall: 15¾"D 16½"W 31½"H
Seat: 29¾"H

Stools

 **For Canadian Pricing**
Multiply U.S. Price by the Canadian price factor.
► See page 1 for details.

Enea Lottus Post Stools Post Base

DESIGN LIEVORE ALTHERR MOLINA

Enea Lottus is a flexible, multi-height collection of seating and tables that integrates simply and cleanly with any space. Sculpted for comfort with just the right flex, the elegant shell of the Lottus stool can be used alone or customized with a colored insert or upholstered cushion.

Tip: This product line is a collection and will be found in multiple locations in this specification guide and/or Coalesse Tables, Storage, and Accessories Specification Guide.

► See Collections, page 5.

Post stool is available in counter height or bar height.

Seat and backrest is one-piece, injection-molded polypropylene construction with rounded edges for comfort.

Base and frame are constructed of steel. Standard in powder coat paint.

Post base allows seat to freely swivel 360°. Base is a steel plate with four plastic glides.

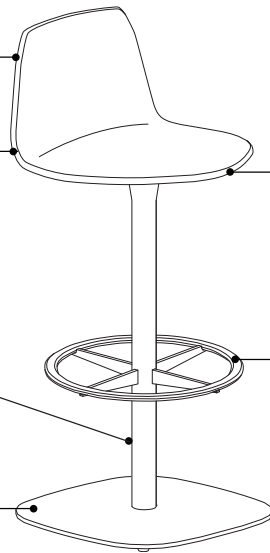

Seat insert is available in polypropylene or upholstered insert. Polypropylene insert is flush with seat and attached. Upholstered insert is 1/2" thick foam pad and attached.

Tubular steel foot ring is fixed at 9" from the floor.

Enea Lottus collection features post and sled base stools, guest seating, café tables, and occasional tables.
 ► For guest seating, see page 306.
 ► For tables, see *Coalesse Tables, Storage, and Accessories Specification Guide*.

Surface Materials

► See *Coalesse Surface Materials Reference Guide* for further information.

Shell

- Polypropylene

Shell insert (optional)

- Polypropylene
- Upholstery

Base and frame

- Paint

Footring

- Paint to match the base and frame
- Polished trivalent chrome (optional)

Programs & Services

Customer's Own Material/Leather (COM/COL) Program is available.

► See *Coalesse Surface Materials Reference Guide* for additional information.

Coalesse

Enea Lottus Post Stools

Post Base

DESIGN LIEVORE ALTHERR MOLINA

Enea Lottus Post Stools Post Base

DESIGN LIEVORE ALTHERR MOLINA

Tip: Post stool seat swivels.

Tip: For Customer's Own Material or Leather, see necessary requirements, important processing instructions, and ordering information

▶ See *Coalesse Surface Materials Reference Guide*.

Tip: CAL133 for polypropylene and fire code seating are available as a special quote. Polypropylene color will change slightly when FR treatment is applied. Contact Customer Service for availability and pricing. Minimum quantity will apply.

Standard Includes	Required to Specify
▶ Need help? Product details, page 354 <ul style="list-style-type: none"> • Base and frame constructed of painted steel tubing • Seat and back: polypropylene • Insert, if selected: polypropylene or upholstery • Foot ring: paint to match the base and frame 	1 Style number 2 Plastic color number for seat and back 3 Fabric or leather color number for upholstery insert, if selected 4 Paint color number for base and frame 5 Options, if selected (see below) ▶ See <i>Coalesse Surface Materials Reference Guide</i> .

Options	U.S. Price	Required to Specify
Surface Materials Base <ul style="list-style-type: none"> • Grade 1 paint • Grade 3 paint 	No cost +\$145	Specify paint color number. Specify paint color number.
Acrylic backer <ul style="list-style-type: none"> • Chair with upholstered insert 	+\$ 7	Specify with acrylic backer. ▶ See <i>Coalesse Surface Materials Reference Guide</i> .
<ul style="list-style-type: none"> • Polished trivalent chrome ring 	+\$ 93	Specify with trivalent chrome ring.
Related Products <ul style="list-style-type: none"> • Café tables • Occasional tables • Guest seating 		▶ See <i>Coalesse Tables, Storage, and Accessories Specification Guide</i> . ▶ See <i>Coalesse Tables, Storage, and Accessories Specification Guide</i> . ▶ Pages 308–311

Specification Information													
Style Number	U.S. Base Prices												
	Fabric Grades:												
COM	6	7	8	9	10	11	12	13	14	COL	Leather Grades:		Polypropylene
	C	E											

Post Base Counter-Height Stool with No Insert

COEL700	\$1473	N.A.	N.A.	N.A.	N.A.	N.A.	N.A.	N.A.	N.A.	N.A.	N.A.	N.A.	N.A.	N.A.
---------	--------	------	------	------	------	------	------	------	------	------	------	------	------	------

Post Base Counter-Height Stool with Polypropylene Insert

COEL700INSERT	N.A.	N.A.	N.A.	N.A.	N.A.	N.A.	N.A.	N.A.	N.A.	N.A.	N.A.	N.A.	N.A.	\$1514
---------------	------	------	------	------	------	------	------	------	------	------	------	------	------	--------

Post Base Counter-Height Stool with Upholstered Insert

COEL700UPH	\$1710	\$1689	\$1697	\$1709	\$1747	\$1770	\$1800	\$1818	\$1855	\$1904	\$2059	\$2057	\$2102	N.A.
------------	--------	--------	--------	--------	--------	--------	--------	--------	--------	--------	--------	--------	--------	------

COM/yds = 3/4, COL/sq ft = 15

▶ Specification Information, continued on next page

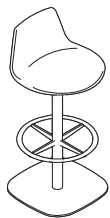

Overall: 19 3/4" D 19 3/4" W 34 1/2" H
Seat: 26 1/4" H

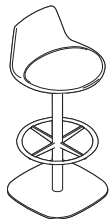

Overall: 19 3/4" D 19 3/4" W 34 1/2" H
Seat: 26 1/4" H

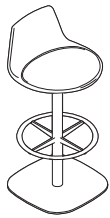

Overall: 19 3/4" D 19 3/4" W 34 1/2" H
Seat: 26 1/4" H

Enea Lottus Post Stools Post Base

DESIGN LIEVORE ALTHERR MOLINA

► Specification Information, continued from previous page

Specification Information

Style Number	U.S. Base Prices														Leather Grades:		Polypropylene
	Fabric Grades:														C	E	
	COM	6	7	8	9	10	11	12	13	14	COL						

Post Base Bar-Height Stool with No Insert

COEL600	\$1489	N.A.	N.A.	N.A.	N.A.	N.A.	N.A.	N.A.	N.A.	N.A.	N.A.	N.A.	N.A.	N.A.	N.A.	N.A.	N.A.
---------	--------	------	------	------	------	------	------	------	------	------	------	------	------	------	------	------	------

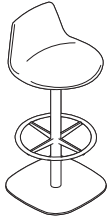

Overall: 19¾"D 19¾"W 38½"H
Seat: 30"H

Post Base Bar-Height Stool with Polypropylene Insert

COEL600INSERT	N.A.	N.A.	N.A.	N.A.	N.A.	N.A.	N.A.	N.A.	N.A.	N.A.	N.A.	N.A.	N.A.	N.A.	N.A.	N.A.	\$1531
---------------	------	------	------	------	------	------	------	------	------	------	------	------	------	------	------	------	--------

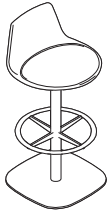

Overall: 19¾"D 19¾"W 38½"H
Seat: 30"H

Post Base Bar-Height Stool with Upholstered Insert

COEL600UPH	\$1728	\$1707	\$1715	\$1727	\$1765	\$1788	\$1818	\$1836	\$1873	\$1922	\$2077	\$2075	\$2120	N.A.			
------------	--------	--------	--------	--------	--------	--------	--------	--------	--------	--------	--------	--------	--------	------	--	--	--

COM/yds = ¾, COL/sq ft = 15

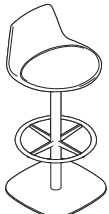

Overall: 19¾"D 19¾"W 38½"H
Seat: 30"H

Stools

 **For Canadian Pricing**
Multiply U.S. Price by the Canadian price factor.
► See page 1 for details.

Enea Lottus Sled Stools Sled Base

DESIGN LIEVORE ALTHERR MOLINA

Enea Lottus is a flexible, multi-height collection of seating and tables that integrates simply and cleanly with any space. Sculpted for comfort with just the right flex, the elegant shell of the Lottus stool can be used alone or customized with a colored insert or upholstered cushion.

Tip: This product line is a collection and will be found in multiple locations in this specification guide and/or Coalesse Tables, Storage, and Accessories Specification Guide.

▶ See Collections, page 5.

Sled stool is available in counter height or bar height.

Seat and backrest is one-piece, injection-molded polypropylene construction with rounded edges for optimal comfort.

Frame is constructed of steel tubing. Standard in powder coat paint.



Seat insert is available in polypropylene or upholstered insert. Polypropylene insert is flush with seat and attached. Upholstered insert is 1/2" thick foam pad and attached.

Sled base features a steel, tubular, integrated footrest, located 13" from the floor.

Enea Lottus collection features post and sled base stools, guest seating, café tables, and occasional tables.
▶ For guest seating, see page 306.
▶ For tables, see *Coalesse Tables, Storage, and Accessories Specification Guide*.

Surface Materials

▶ See *Coalesse Surface Materials Reference Guide* for further information.

Shell

- Polypropylene

Shell insert (optional)

- Polypropylene
- Upholstery

Base and frame

- Paint

Programs & Services

Customer's Own Material/Leather (COM/COL) Program is available.

▶ See *Coalesse Surface Materials Reference Guide* for additional information.

Coalesse

Enea Lottus Sled Stools

Sled Base

DESIGN LIEVORE ALTHERR MOLINA

Enea Lottus Sled Stools Sled Base

DESIGN LIEVORE ALTHERR MOLINA

Tip: For Customer's Own Material or Leather, see necessary requirements, important processing instructions, and ordering information
 ▶ See *Coalesse Surface Materials Reference Guide*.

Tip: CAL133 for polypropylene and fire code seating are available as a special quote. Polypropylene color will change slightly when FR treatment is applied. Contact Customer Service for availability and pricing. Minimum quantity will apply.

Tip: If base and frame are specified in a white, platinum, or champagne finish, glides will be white. For all other base and frame colors, glides will be black.

Standard Includes		Required to Specify
▶ Need help? Product details, page 358	<ul style="list-style-type: none"> • Base and frame constructed of painted steel tubing • Seat and back: polypropylene • Insert, if selected: polypropylene or upholstery 	1 Style number 2 Plastic color number for seat and back 3 Fabric or leather color number for upholstery insert, if selected 4 Paint color number for base and frame 5 Options, if selected (see below) ▶ See <i>Coalesse Surface Materials Reference Guide</i> .

Options	U.S. Price	Required to Specify
Surface Materials Base <ul style="list-style-type: none"> • Grade 1 paint • Grade 3 paint Acrylic backer <ul style="list-style-type: none"> • Backer for chair with upholstered insert 	No cost +\$105 +\$ 7	Specify paint color number. Specify paint color number. Specify with acrylic backer. ▶ See <i>Coalesse Surface Materials Reference Guide</i> .
Related Products <ul style="list-style-type: none"> • Café tables • Occasional tables • Guest seating 		▶ See <i>Coalesse Tables, Storage, and Accessories Specification Guide</i> . ▶ See <i>Coalesse Tables, Storage, and Accessories Specification Guide</i> . ▶ Pages 308–311

Specification Information

Style Number	U.S. Base Prices														Leather Grades:			Polypropylene
	Fabric Grades:																	
	COM	6	7	8	9	10	11	12	13	14	COL	C	E					

Sled Base Counter-Height Stool with No Insert

COEL500	\$ 763	N.A.	N.A.	N.A.	N.A.	N.A.	N.A.	N.A.	N.A.	N.A.	N.A.	N.A.	N.A.	N.A.	N.A.
---------	--------	------	------	------	------	------	------	------	------	------	------	------	------	------	------



Overall: 18"D 18 1/4"W 34 1/2"H
 Seat: 26 1/4"H

Sled Base Counter-Height Stool with Polypropylene Insert

COEL500INSERT	N.A.	N.A.	N.A.	N.A.	N.A.	N.A.	N.A.	N.A.	N.A.	N.A.	N.A.	N.A.	N.A.	N.A.	\$807
---------------	------	------	------	------	------	------	------	------	------	------	------	------	------	------	-------



Overall: 18"D 18 1/4"W 34 1/2"H
 Seat: 26 1/4"H

Sled Base Counter-Height Stool with Upholstered Insert

COEL500UPH	\$1001	\$980	\$988	\$1000	\$1038	\$1061	\$1091	\$1109	\$1146	\$1195	\$1350	\$1348	\$1393	N.A.
------------	--------	-------	-------	--------	--------	--------	--------	--------	--------	--------	--------	--------	--------	------

COM/yds = 3/4, COL/sq ft = 15

▶ Specification Information, continued on next page



Overall: 18"D 18 1/4"W 34 1/2"H
 Seat: 26 1/4"H

Enea Lottus Sled Stools Sled Base

DESIGN LIEVORE ALTHERR MOLINA

► Specification Information, continued from previous page

Specification Information

Style Number	U.S. Base Prices														Leather Grades:			Polypropylene
	Fabric Grades:														COL	C	E	
	COM	6	7	8	9	10	11	12	13	14								

Sled Base Bar-Height Stool with No Insert

COEL400	\$ 838	N.A.	N.A.	N.A.	N.A.	N.A.	N.A.	N.A.	N.A.	N.A.	N.A.	N.A.	N.A.	N.A.	N.A.	N.A.	N.A.	N.A.
---------	--------	------	------	------	------	------	------	------	------	------	------	------	------	------	------	------	------	------



Overall: 18"D 18¼"W 38½"H
Seat: 30"H

Sled Base Bar-Height Stool with Polypropylene Insert

COEL400INSERT	N.A.	N.A.	N.A.	N.A.	N.A.	N.A.	N.A.	N.A.	N.A.	N.A.	N.A.	N.A.	N.A.	N.A.	N.A.	N.A.	N.A.	\$883
---------------	------	------	------	------	------	------	------	------	------	------	------	------	------	------	------	------	------	-------



Overall: 18"D 18¼"W 38½"H
Seat: 30"H

Sled Base Bar-Height Stool with Upholstered Insert

COEL400UPH	\$1079	\$1058	\$1066	\$1078	\$1116	\$1139	\$1169	\$1187	\$1224	\$1273	\$1428	\$1426	\$1471	N.A.				
------------	--------	--------	--------	--------	--------	--------	--------	--------	--------	--------	--------	--------	--------	------	--	--	--	--

COM/yds = ¾, COL/sq ft = 15



Overall: 18"D 18¼"W 38½"H
Seat: 30"H

Stools



For Canadian Pricing
Multiply U.S. Price by the Canadian price factor.
► See page 1 for details.

Enea Altzo943 Stools

DESIGN: ESTUDI MANEL MOLINA DESIGN ORIGIN: SPAIN

Enea Altzo943 seating collection brings residential warmth and soul to the workplace. Answering the demand for mixed materials, Altzo943 combines a precision-molded seat shell with solid oak legs. The special oval profile of the legs follows the pure curvature of the shell for a complete, harmonious design statement.

Tip: This product line is part of a collection and will be found in multiple locations in this specification guide.

► See Collections, page 5.

Seat and back is polypropylene with a slight flex and rounded edges for optimal comfort; available in 12 colors.

Wood legs are solid wood oak; available in six finishes.

Glides are polyethylene for superior durability on carpeted and hard floors.

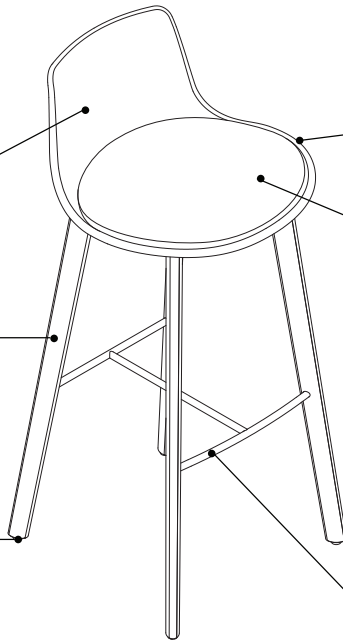

Casting under the seat is painted in textured finishes to match polypropylene seat shell.

Upholstered seat cushion insert is available and is ½" thick.

Footring in trivalent chrome comes standard.

Product Details



Altzo943 stools are available in two heights (to the seat): counter height (26"H) and bar height (30"H).

Upholstered seat cushion insert is available.

Surface Materials

► See *Coalesse Surface Materials Reference Guide* for further information.

Seat and back

- Polypropylene

Seat casting

- Paint

Legs

- Solid oak

Upholstery (seat)

- Fabric
- Leather

Program and Services

Customer's Own Material/Leather (COM/COL) Program is available.

► See *Coalesse Surface Materials Reference Guide* for additional information.

Enea Altzo943 Stools

DESIGN: ESTUDI MANEL MOLINA DESIGN ORIGIN: SPAIN

Standard Includes		Required to Specify
<ul style="list-style-type: none"> ▶ Need help? Product details, page 362 	<ul style="list-style-type: none"> • Legs: solid oak • Footring: 9201 Polished Trivalent Chrome • Seat and seat casting: <ul style="list-style-type: none"> - Polypropylene seat with matching textured paint on seat casting • Seat cushion insert, if selected: upholstery • Glides, non-adjustable 	<ol style="list-style-type: none"> 1 Style number 2 Plastic color number for polypropylene seat 3 Fabric or leather color number for upholstered seat cushion insert, if selected 4 Wood finish for legs: <ul style="list-style-type: none"> - V3AK Natural Oak - VP01 Light Oak - VP02 Smoke Oak - VP03 Black Oak - VP04 Grey Oak - VP05 White Oak 5 Options, if selected (see below) <p>▶ See <i>Coalesse Surface Materials Reference Guide</i>.</p>

Tip: For Customer's Own Material or Leather, see necessary requirements, important processing instructions, and ordering information.
▶ See *Coalesse Surface Materials Reference Guide*.

Options	U.S. Price	Required to Specify
Surface Materials Legs <ul style="list-style-type: none"> • Grade 1 wood veneer • Grade 2 wood veneer 	No cost +\$82	Specify with <i>V3AK Natural Oak, VP01 Oak Light, VP03 Black Oak, or VP05 White Oak</i> . Specify with <i>VP02 Smoked Oak or VP04 Grey Oak</i> .
Acrylic backer <ul style="list-style-type: none"> • Stool with upholstered seat cushion insert 	+ \$ 7	Specify with <i>acrylic backer</i> . ▶ See <i>Coalesse Surface Materials Reference Guide</i> .
Related Products <ul style="list-style-type: none"> • Altzo943 chairs • Lottus café tables • Lottus occasional tables 		▶ Page 313 ▶ See <i>Coalesse Tables, Storage, and Accessories Specification Guide</i> . ▶ See <i>Coalesse Tables, Storage, and Accessories Specification Guide</i> .

Specification Information

Style Number	U.S. Base Prices													Leather Grades:			Polypropylene
	Fabric Grades:																
	COM	6	7	8	9	10	11	12	13	14	COL	C	E				

Counter-Height Stool

Polypropylene Seat and Back															
COALT400	N.A.	N.A.	N.A.	N.A.	N.A.	N.A.	N.A.	N.A.	N.A.	N.A.	N.A.	N.A.	N.A.	N.A.	\$1068
Polypropylene Seat and Upholstered Seat Cushion Insert															
COALT400UPH	\$1251	\$1231	\$1240	\$1250	\$1286	\$1308	\$1337	\$1354	\$1389	\$1436	\$1566	\$1581	\$1622	N.A.	

Bar-Height Stool

Polypropylene Seat and Back															
COALT500	N.A.	N.A.	N.A.	N.A.	N.A.	N.A.	N.A.	N.A.	N.A.	N.A.	N.A.	N.A.	N.A.	N.A.	\$1131
Polypropylene Seat and Upholstered Seat Cushion Insert															
COALT500UPH	\$1314	\$1294	\$1303	\$1313	\$1349	\$1371	\$1400	\$1417	\$1452	\$1499	\$1629	\$1644	\$1685	N.A.	



Overall: 18"D
18¼"W 34½"H
Seat: 26¼"H



Overall: 18"D
18¼"W 38½"H
Seat: 30"H

LessThanFive Stool

DESIGN MICHAEL YOUNG

The **LessThanFive** stool is handcrafted from carbon fiber, making it exceptionally light and strong.

Lightweight, weighing less than five pounds.

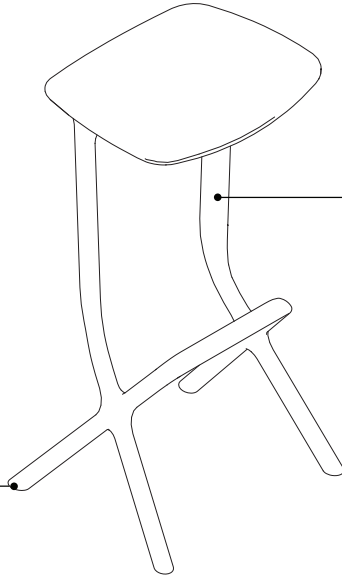

Glides are soft felt.

Frame is constructed entirely of carbon fiber, and comes in several standard finishes. Customization options are also available.

Surface Materials

► See *Coalesse Surface Materials Reference Guide* for further information.

Frame
• Paint

Tip: Consult the Coalesse concierge team for customization options.

LessThanFive Stool

DESIGN MICHAEL YOUNG



Overall: 13½"D 16"W 31"H

Standard Includes		Required to Specify
<ul style="list-style-type: none"> ▶ Need help? Product details, page 364 	<ul style="list-style-type: none"> • Frame: constructed of carbon fiber • Finish: smooth paint • Soft felt glides 	<ul style="list-style-type: none"> 1 Style number 2 Paint color number for frame 3 Options, if selected (see below) ▶ See <i>Coalesse Surface Materials Reference Guide</i>.

Options	U.S. Price	Required to Specify
Surface Materials <ul style="list-style-type: none"> • 4233 Carbon Weave 	+\$241	Specify with 4233 Carbon Weave.

Specification Information

Style Number	Quantity	U.S. Base Price
--------------	----------	-----------------

LessThanFive Stool

COLT5S	1	\$1967
--------	---	--------

 **For Canadian Pricing**
 Multiply U.S. Price by the Canadian price factor.
 ▶ See page 1 for details.

Lox Stools

DESIGN PEARSONLLOYD

Lox is designed to bring people together with minimal effort. The seat has a subtly concealed mechanism beneath it for height adjustment and can be finished with fabric or leather.

Lox stool is available in counter height or bar height.

Comfortably sculpted, contoured seat rotates 360° to provide user with full range of motion. Seat features slight tilt forward for optimal comfort.

Seat height adjustment allows users to change seat height within a 4" range from 26"H to 30"H.

Disc base is 15³/₄" in diameter with felt glides.

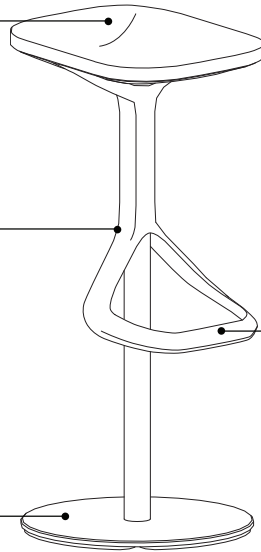

Ribbon-shape footrest is part of the shell and is available in plastic.

Lox seating features a stool and guest chair. ▶ For guest seating, see page 346

Surface Materials

▶ See *Coalesse Surface Materials Reference Guide* for further information.

Upholstery

- Fabric
- Leather

Frame

- Brushed chrome

Shell

- Plastic

Programs & Services

Customer's Own Material/Leather (COM/COL) Program is available. All COM fabrics must be submitted to Coalesse for approval prior to order acceptance.

▶ See *Coalesse Surface Materials Reference Guide* for additional information.

Lox Stools

DESIGN PEARSONLLOYD

Tip: Due to the design and construction techniques of the Lox stools only certain textiles can be successfully applied, therefore all COM fabrics must be submitted to Coalesse for approval prior to order acceptance.

Tip: For Customer's Own Material or Leather, see necessary requirements, important processing instructions, and ordering information
 ▶ See Coalesse Surface Materials Reference Guide.

Tip: In high-traffic applications, scuff marks on footrest may be visible in white gloss.



Overall: 17"D 17"W 28"-32"H
 Seat: 26"-30"H



Overall: 17"D 17"W 31"-34"H
 Seat: 29"-33"H

Standard Includes		Required to Specify
▶ Need help? Product details, page 366	<ul style="list-style-type: none"> • Shell and ribbon-shaped footrest: plastic • Base: 9251 Brushed Chrome • Seat: upholstered foam • Swivel mechanism • Height-adjustable button under seat • Felt glides 	1 Style number 2 Plastic color number for shell: 6347 Black Gloss 6348 White Gloss 3 Fabric or leather color number for upholstery 4 Options, if selected (see below) ▶ See Coalesse Surface Materials Reference Guide.

Options	U.S. Price	Required to Specify
Surface Materials • Acrylic backer • Backer	+ \$7	Specify with acrylic backer. ▶ See Coalesse Surface Materials Reference Guide.
Related Products • Chairs		▶ Page 280

Specification Information													
Style Number	U.S. Base Prices										Leather Grades:		
	Fabric Grades:										COL	C	E
	COM	6	7	8	9	10	11	12	13	14			

Counter-Height Stool

COLX200	\$1902	\$1881	\$1889	\$1901	\$1939	\$1962	\$1992	\$2010	\$2047	\$2096	\$2251	\$2179	\$2214
---------	--------	--------	--------	--------	--------	--------	--------	--------	--------	--------	--------	--------	--------

COM/yds = 3/4, COL/sq ft = 13

Bar-Height Stool

COLX210	\$1983	\$1962	\$1970	\$1982	\$2020	\$2043	\$2073	\$2091	\$2128	\$2177	\$2332	\$2260	\$2295
---------	--------	--------	--------	--------	--------	--------	--------	--------	--------	--------	--------	--------	--------

COM/yds = 3/4, COL/sq ft = 13

 **For Canadian Pricing**
 Multiply U.S. Price by the Canadian price factor.
 ▶ See page 1 for details.

Marien152 Stools Seating

DESIGN COALESSE DESIGN GROUP AND ARIK LEVY

Marien152 is a richly tailored seating experience that's inspired by the home and designed for the workday. Design personalization is built into the collection through a wide range of upholstery, color, base, and materiality choices. Thoughtful proportions and a signature cushioned back create a comfortable stool that can support work. Available in bar- or counter-height, and with a wood or metal base.

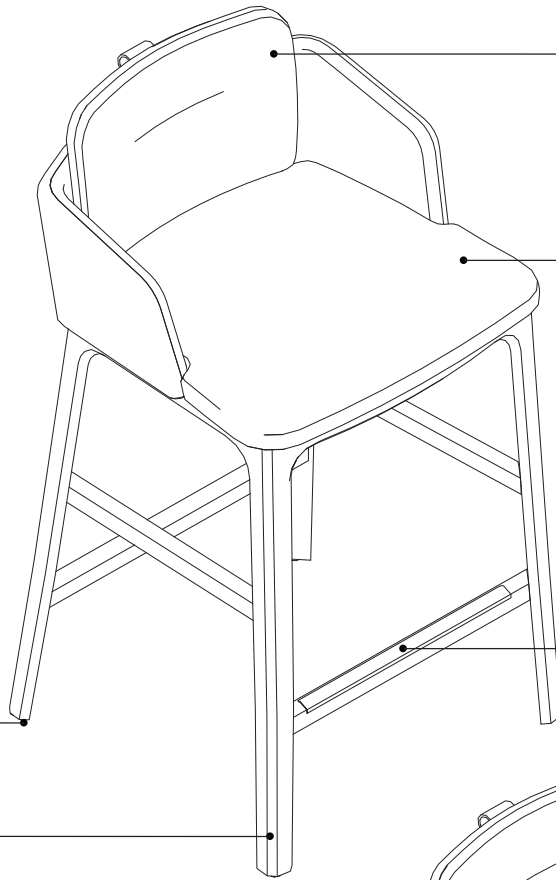

Back cushion gives the appearance of a soft, loose pillow. Intentionally relaxed upholstery on the back cushion adds to the welcoming appeal.

Contrasting fabric is available on seat, surround, and back cushion.

Footrest has protective metal top.

Black glides are available in hard and soft options.

Solid white oak frame has a chamfered edge profile.

Back cushion gives the appearance of a soft, loose pillow. Intentionally relaxed upholstery on the back cushion adds to the welcoming appeal.

Leather may be specified with a contrasting back cushion only.

Contrasting fabric is available on seat, surround, and back cushion.

Base is standard in powder coat paint and polished aluminum.

Black hard glides are standard.

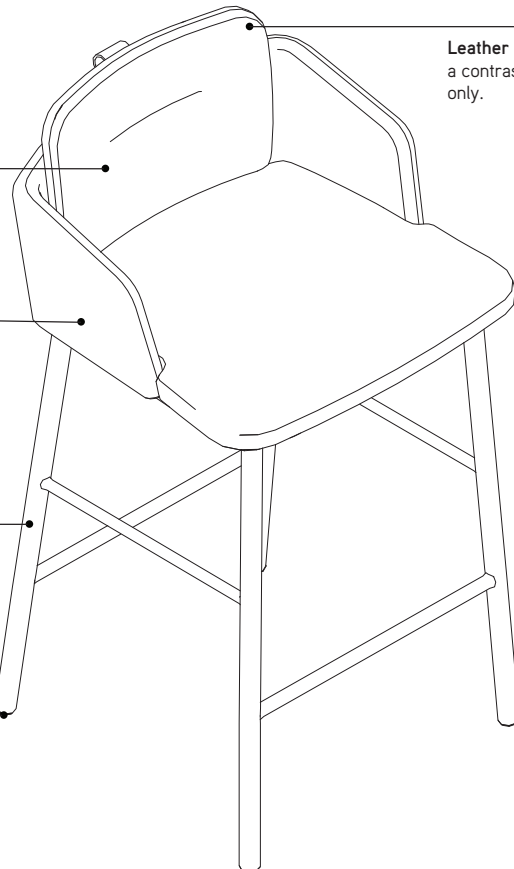

Marien152 Stools Seating

DESIGN COALESSE DESIGN GROUP AND ARIK LEVY

Product Details

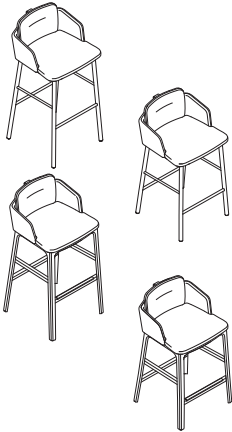

Marien152 stools are available in bar and counter heights.

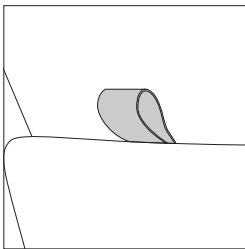

Standard leather pull, located behind the back cushion, allows users to easily move the chair. Leather in the color coal only. Option to specify without pull if desired.

Surface Materials

Upholstery

- Fabric
- Leather

Metal base

- Paint
- Polished chrome

Wood base

- Solid white oak wood frame

Programs & Services

Customer's Own Material/Leather (COM/COL) Program is available.

► See *Coalesse Surface Materials Reference Guide* for additional information.

Marien152 Seating Bar-Height Stool

DESIGN COALESSE DESIGN GROUP AND ARIK LEVY

Standard Includes		Required to Specify
<ul style="list-style-type: none"> ▶ Need help? Product details, page 368 	<ul style="list-style-type: none"> • Seat, back cushion, and surround: upholstery • Leather strap: coal • Base: grade 1 paint • Black hard glides 	<ol style="list-style-type: none"> 1 Style number 2 Contrasting fabric (see below under Required Selections) 3 Fabric or leather color number for upholstery on seat, surround, and back cushion 4 Paint color number for base 5 Options, if selected (see below) <p>▶ See <i>Coalesse Surface Materials Reference Guide</i>.</p>

Required Selections	U.S. Price	Required to Specify
Contrasting Fabric <ul style="list-style-type: none"> • Non contrasting fabric • Contrasting back cushion fabric • Contrasting surround fabric • Contrasting seat fabric • Contrasting all fabrics 	<ul style="list-style-type: none"> No cost +\$182 +\$182 +\$182 +\$182 	<ul style="list-style-type: none"> Specify with <i>non contrasting</i>. Specify with <i>contrasting back cushion</i>. Specify with <i>contrasting surround</i>. Specify with <i>contrasting seat</i>. Specify with <i>contrasting all fabrics</i>.

Options	U.S. Price	Required to Specify
Surface Materials <ul style="list-style-type: none"> • Metal base <ul style="list-style-type: none"> • Grade 1 paint • Grade 3 paint • Polished chrome • Wood base <ul style="list-style-type: none"> • Grade 1 wood • Grade 2 wood • Acrylic backer <ul style="list-style-type: none"> • Backer 	<ul style="list-style-type: none"> No cost +\$102 +\$105 No cost +\$ 83 +\$ 29 	<ul style="list-style-type: none"> Specify paint color number. Specify paint color number. Specify with <i>polished chrome</i>. Specify wood color number. Specify wood color number. Specify with <i>acrylic backer</i>.
Glide Type <ul style="list-style-type: none"> • Bar stool wood base <ul style="list-style-type: none"> • Hard glides • Soft glides 	<ul style="list-style-type: none"> No cost No cost 	<ul style="list-style-type: none"> Specify with <i>hard glides</i>. Specify with <i>soft glides</i>.
Pull <ul style="list-style-type: none"> • With leather pull • Without leather pull 	<ul style="list-style-type: none"> No cost No cost 	<ul style="list-style-type: none"> Specify with <i>pull</i>. Specify with <i>without pull</i>.
Related Products <ul style="list-style-type: none"> • Conference seating • Guest seating • Lounge seating 		<ul style="list-style-type: none"> ▶ Page 276 ▶ Page 322 ▶ Pages 150–151

Specification Information

Style Number	U.S. Base Prices													
	Fabric Grades:													
	COM	6	7	8	9	10	11	12	13	14	Leather Grades			
											COL	C	E	

Bar-Height Stool Metal Base

COMARBSMB	Seat	\$1457	\$1453	\$1469	\$1485	\$1525	\$1557	\$1593	\$1639	\$1690	\$1777	\$1509	\$1769	\$1840
	Surround	+\$ 53	+\$ 31	+\$ 40	+\$ 49	+\$ 75	+\$ 94	+\$116	+\$144	+\$175	+\$228	+\$105	+\$387	+\$476
	Back cushion	+\$ 53	+\$ 27	+\$ 36	+\$ 45	+\$ 65	+\$ 84	+\$104	+\$129	+\$157	+\$204	+\$105	+\$199	+\$238

COM/yds: Seat = 1.06, Surround = .64, Cushion = .58, COL/sq ft: Seat = 11, Surround = 12, Cushion = 6

▶ Specification Information, continued on next page

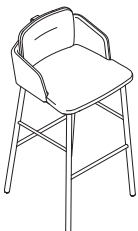

Overall: 19½"D x 19"W x 39"H
 Inside: 16"D x 15¾"W
 Seat: 30½"H
 Surround: 23"H



For Canadian Pricing
 Multiply U.S. Price by the Canadian price factor.
 ▶ See page 1 for details.

Marien152 Seating Bar-Height Stool

DESIGN COALESSE DESIGN GROUP AND ARIK LEVY

► Specification Information, continued from previous page

Specification Information

Style Number	U.S. Base Prices															
	Fabric Grades:													Leather Grades		
	COM	6	7	8	9	10	11	12	13	14	COL	C	E			

Bar-Height Stool Wood Base

COMARBSWB	Seat	\$2135	\$2131	\$2147	\$2163	\$2203	\$2235	\$2271	\$2317	\$2368	\$2455	\$2187	\$2447	\$2518
	Surround	+\$ 53	+\$ 31	+\$ 40	+\$ 49	+\$ 75	+\$ 94	+\$116	+\$144	+\$175	+\$228	+\$105	+\$387	+\$476
	Back cushion	+\$ 53	+\$ 27	+\$ 36	+\$ 45	+\$ 65	+\$ 84	+\$104	+\$129	+\$157	+\$204	+\$105	+\$199	+\$238

COM/yds: Seat = 1.06, Surround = .64, Cushion = .58, COL/sq ft: Seat = 11, Surround = 12, Cushion = 6

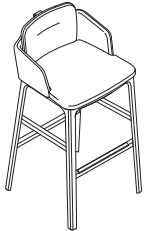

Overall: 19½"D x 19"W x 39"H
 Inside: 16"D x 15¾"W
 Seat: 30½"H
 Surround: 23"H

Stools

 **For Canadian Pricing**
 Multiply U.S. Price by the
 Canadian price factor.
 ► See page 1 for details.

Marien152 Seating Counter-Height Stool

DESIGN COALESSE DESIGN GROUP AND ARIK LEVY

Standard Includes		Required to Specify
<ul style="list-style-type: none"> ▶ Need help? Product details, page 368 	<ul style="list-style-type: none"> • Seat, back cushion, and surround: upholstery • Leather strap: coal • Base: grade 1 paint • Black hard glides 	<ol style="list-style-type: none"> 1 Style number 2 Contrasting fabric (see below under Required Selections) 3 Fabric or leather color number for upholstery on seat, surround, and back cushion 4 Paint color number for base 5 Options, if selected (see below) <ul style="list-style-type: none"> ▶ See <i>Coalesse Surface Materials Reference Guide</i>.

Required Selections	U.S. Price	Required to Specify
Contrasting Fabric <ul style="list-style-type: none"> • Non contrasting fabric • Contrasting back cushion fabric • Contrasting surround fabric • Contrasting seat fabric • Contrasting all fabrics 	<ul style="list-style-type: none"> No cost +\$182 +\$182 +\$182 +\$182 	<ul style="list-style-type: none"> Specify with <i>non contrasting</i>. Specify with <i>contrasting back cushion</i>. Specify with <i>contrasting surround</i>. Specify with <i>contrasting seat</i>. Specify with <i>contrasting all fabrics</i>.

Options	U.S. Price	Required to Specify
Surface Materials <ul style="list-style-type: none"> • Metal base <ul style="list-style-type: none"> • Grade 1 paint • Grade 3 paint • Polished chrome • Wood base <ul style="list-style-type: none"> • Grade 1 wood • Grade 2 wood • Acrylic backer <ul style="list-style-type: none"> • Backer 	<ul style="list-style-type: none"> No cost +\$102 +\$105 No cost +\$ 83 +\$ 29 	<ul style="list-style-type: none"> Specify paint color number. Specify paint color number. Specify with <i>polished chrome</i>. Specify wood color number. Specify wood color number. Specify with <i>acrylic backer</i>.
Glide Type <ul style="list-style-type: none"> • Counter-height stool wood base <ul style="list-style-type: none"> • Hard glides • Soft glides 	<ul style="list-style-type: none"> No cost No cost 	<ul style="list-style-type: none"> Specify with <i>hard glides</i>. Specify with <i>soft glides</i>.
Pull <ul style="list-style-type: none"> • With leather pull • Without leather pull 	<ul style="list-style-type: none"> No cost No cost 	<ul style="list-style-type: none"> Specify with <i>pull</i>. Specify with <i>without pull</i>.
Related Products <ul style="list-style-type: none"> • Conference seating • Guest seating • Lounge seating 		<ul style="list-style-type: none"> ▶ Page 276 ▶ Page 322 ▶ Pages 150–151

Specification Information

Style Number	U.S. Base Prices												
	Fabric Grades:										Leather Grades		
	COM	6	7	8	9	10	11	12	13	14	COL	C	E

Counter-Height Stool Metal Base

COMARCSMB	Seat	\$1457	\$1453	\$1469	\$1485	\$1525	\$1557	\$1593	\$1639	\$1690	\$1777	\$1509	\$1769	\$1840
	Surround	+\$ 53	+\$ 31	+\$ 40	+\$ 49	+\$ 75	+\$ 94	+\$116	+\$144	+\$175	+\$228	+\$105	+\$387	+\$476
	Back cushion	+\$ 53	+\$ 27	+\$ 36	+\$ 45	+\$ 65	+\$ 84	+\$104	+\$129	+\$157	+\$204	+\$105	+\$199	+\$238

COM/yds: Seat = 1.06, Surround = .64, Cushion = .58, COL/sq ft: Seat = 11, Surround = 12, Cushion = 6

▶ Specification Information, continued on next page



Overall: 19½"D x 19"W x 34½"H
 Inside: 16"D x 15¾"W
 Seat: 26½"H
 Surround: 30½"H



For Canadian Pricing
 Multiply U.S. Price by the Canadian price factor.
 ▶ See page 1 for details.

Marien152 Seating Counter-Height Stool

DESIGN COALESSE DESIGN GROUP AND ARIK LEVY

► Specification Information, continued from previous page

Specification Information

Style Number	U.S. Base Prices												
	Fabric Grades:											Leather Grades	
	COM	6	7	8	9	10	11	12	13	14	COL	C	E

Counter-Height Stool Wood Base

COMARCSWB	Seat	\$2135	\$2131	\$2147	\$2163	\$2203	\$2235	\$2271	\$2317	\$2368	\$2455	\$2187	\$2447	\$2518
	Surround	+\$ 53	+\$ 31	+\$ 40	+\$ 49	+\$ 75	+\$ 94	+\$116	+\$144	+\$175	+\$228	+\$105	+\$387	+\$476
	Back cushion	+\$ 53	+\$ 27	+\$ 36	+\$ 45	+\$ 65	+\$ 84	+\$104	+\$129	+\$157	+\$204	+\$105	+\$199	+\$238

COM/yds: Seat = 1.06, Surround = .64, Cushion = .58, COL/sq ft: Seat = 11, Surround = 12, Cushion = 6



Overall: 19½"D x 19"W x 34½"H
 Inside: 16"D x 15¾"W
 Seat: 26½"H
 Surround: 30½"H

 **For Canadian Pricing**
 Multiply U.S. Price by the
 Canadian price factor.
 ► See page 1 for details.

Marien152 Stools Seating Multi-Fabric Diagram

DESIGN COALESSE DESIGN GROUP AND ARIK LEVY

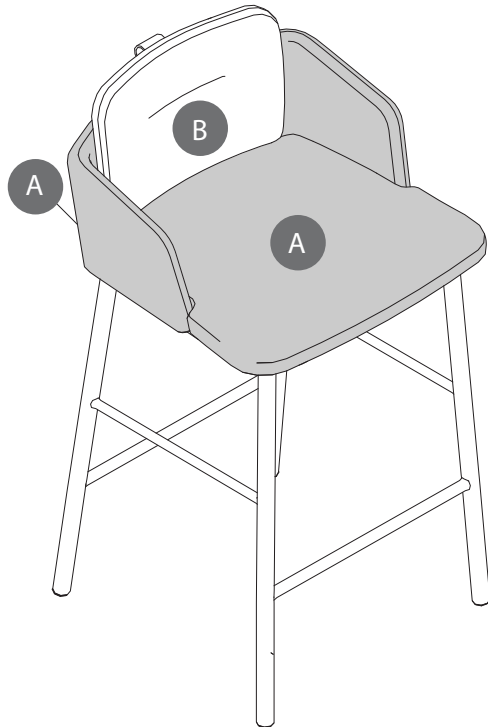
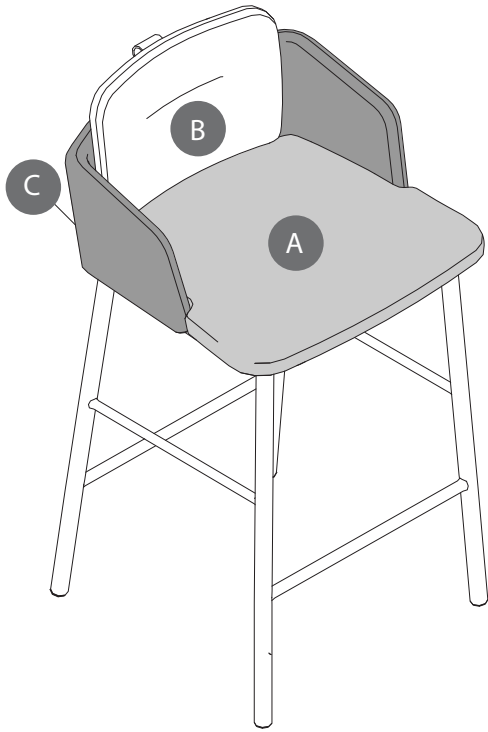

TO: _____

FROM: _____

DATE: _____

FAX...888.413.5161

FABRIC

A Seat: _____

B Surround: _____

C Back: _____

LEATHER

A Seat + Surround: _____

B Back: _____

Specify Model below:

COMARBSMB Bar-Stool Metal Base

COMARBSWB Bar-Stool Wood Base

COMARCSMB Counter-Height Stool Metal Base

COMARCSWB Counter-Height Stool Wood Base

See specifying for contrasting fabric upcharge.

List price based on highest fabric grade usage.

Montara650 Stools

DESIGN LIEVORE ALTHERR MOLINA

Montara650 is a comprehensive collection that offers a simple, refined design that can be customized to support a range of applications, postures, and aesthetics.

Tip: This product line is a collection and will be found in multiple locations in this specification guide and/or Coalesse Tables, Storage, and Accessories Specification Guide.

► See Collections, page 5.

Shell is a durable, one-piece plywood construction with oak veneer.

Sled base features an integral footrest and polyethylene glides.

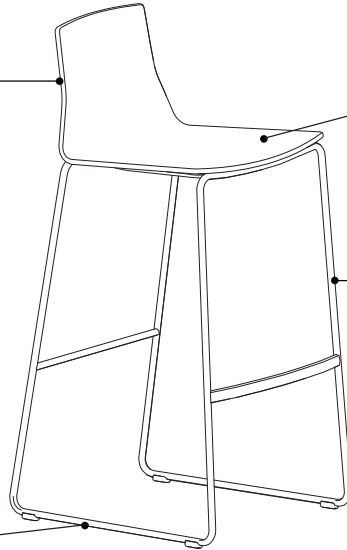

Upholstery choices include: wood shell, wood shell with upholstered seat, or fully upholstered.

Frame is standard in powder coat paint. Polished trivalent chrome is also available.

Montara650 collection features guest seating and pedestal tables.
► For guest seating, see page 326
► For tables, see *Coalesse Tables, Storage, and Accessories Specification Guide*.

Product Details



Montara650 stools are available in two heights (to the seat): counter height (26"H) and bar height (30"H).

Surface Materials

► See *Coalesse Surface Materials Reference Guide* for further information.

Upholstery

- Fabric
- Leather

Wood shell

- Oak veneered plywood

Frame

- Paint
- Trivalent chrome

Programs & Services

Customer's Own Material/Leather (COM/COL) Program is available.

► See *Coalesse Surface Materials Reference Guide* for additional information.

Montara650 Stools

DESIGN LIEVORE ALTHERR MOLINA

Tip: Leathers will appear loose with comfort wrinkles when upholstered.

Tip: For Customer's Own Material or Leather, see necessary requirements, important processing instructions, and ordering information.

▶ See *Coalesse Surface Materials Reference Guide* and online fabric database at <http://fabric.coalesse.com>.

Standard Includes	Required to Specify
<ul style="list-style-type: none"> ▶ Need help? Product details, page 375 • Seat and back upholstery, if selected • Shell: wood shell or wood shell with upholstered seat, if selected: wood veneer grade 1 • Sled base: Grade 1 paint • Glides 	<ol style="list-style-type: none"> 1 Style number 2 Application (see below under Required Selections) 3 Upholstery version (see below under Required Selections) 4 Contrasting fabric on fully upholstered, if selected (see below under Required Selections) 5 Fabric and/or leather color number for seat and/or back, if selected 6 Wood finish on shell, if selected 7 Paint color number for base 8 Options, if selected (see below) <p>▶ See <i>Coalesse Surface Materials Reference Guide</i>.</p>



Stool at counter height
Overall: 18 1/2"W 19 1/2"D 35 1/2"H
Seat: 26"H



Stool at bar height
Overall: 18 1/2"W 19 1/2"D 39 1/2"H
Seat: 30"H

Required Selections	U.S. Price	Required to Specify
Application <ul style="list-style-type: none"> • Counter height • Bar height 	No cost +\$ 72	Specify with counter height. Specify with bar height.
Upholstery Version <ul style="list-style-type: none"> • Wood shell • Wood shell with upholstered seat • Fully upholstered 	Price at right Price at right Price at right	Specify with wood seat and back. Specify with upholstered seat and wood back. Specify with upholstered seat and back.
Contrasting Fabric on Fully Upholstered <ul style="list-style-type: none"> • Non contrasting fabric • Contrasting fabric 	No cost +\$182	Specify with non contrasting fabric. Specify with contrasting fabric. ▶ See <i>Multi Fabric Diagram</i> , page 180

Options	U.S. Price	Required to Specify
Surface Materials <p>Base</p> <ul style="list-style-type: none"> • Grade 3 paint • Polished trivalent chrome base <p>Shell</p> <ul style="list-style-type: none"> • Grade 1 wood veneer • Grade 2 wood veneer <p>Acrylic backer</p> <ul style="list-style-type: none"> • Seat • Seat and back 	+\$105 +\$109 No cost +\$ 88 +\$ 9 +\$ 23	Specify paint color number. Specify with polished trivalent chrome. Specify with VP01 Oak Light, VP03 Black Oak, or VP05 White Oak. Specify with VP02 Smoked Oak or VP04 Grey Oak. Specify with acrylic backer. Specify with acrylic backer.

Related Products <ul style="list-style-type: none"> • Guest seating • Lounge seating • Café tables • Occasional tables 	<ul style="list-style-type: none"> ▶ Page 328 ▶ Page 174 ▶ See <i>Coalesse Tables, Storage, and Accessories Specification Guide</i>. ▶ See <i>Coalesse Tables, Storage, and Accessories Specification Guide</i>.
---	--



For Canadian Pricing
Multiply U.S. Price by the Canadian price factor.
▶ See page 1 for details.

Montara650 Stools

DESIGN LIEVORE ALTHERR MOLINA



Stool at counter height
 Overall: 18½"W x 19½"D x 35½"H
 Seat: 26"H

Specification Information

Style Number	U.S. Base Price
--------------	-----------------

Wood Shell Stool

COSFZST	\$1035
---------	--------

Specification Information

Style Number	U.S. Base Prices											Leather Grades:		
	Fabric Grades:											COL	C	E
	COM	6	7	8	9	10	11	12	13	14				

Wood Shell Stool with Upholstered Seat

COSFZST	Seat	\$1236	\$1203	\$1209	\$1218	\$1246	\$1261	\$1282	\$1296	\$1320	\$1357	\$1543	\$1457	\$1517
COM/yds = ¾, COL/sq ft = 7														

Fully Upholstered Stool

COSFZST	Seat	\$1273	\$1240	\$1246	\$1255	\$1283	\$1298	\$1319	\$1333	\$1357	\$1394	\$1580	\$1494	\$1554
	Back	+\$ 59	+\$ 55	+\$ 63	+\$ 81	+\$135	+\$169	+\$211	+\$238	+\$287	+\$358	+\$425	+\$ 504	+\$ 605
COM/yds = 1¼, COL/sq ft = 18														



For Canadian Pricing
 Multiply U.S. Price by the
 Canadian price factor.
 ▶ See page 1 for details.

Switch Stools

DESIGN E00S

Switch stool is upholstered and offered in two heights: counter and bar. Switch stool shares the clean lines and flared back of the Switch lounge and chair.

Tip: This product line is a collection and will be found in multiple locations in this specification guide and/or Coalesse Tables, Storage, and Accessories Specification Guide.

► See Collections, page 5.

Switch stool is available in counter height or bar height.

Seat and back cushions are constructed of molded foam with comfort pockets for optimal comfort.

Adjustable glides are standard to accommodate uneven floors.

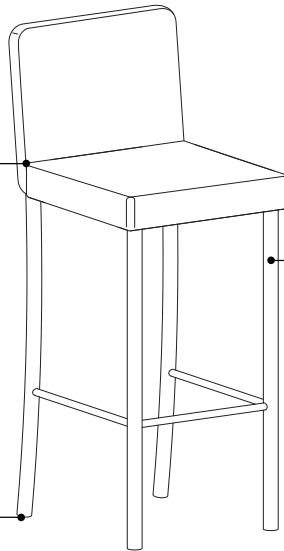

Legs feature four tubular steel legs with integrated steel footrests at the front and sides.

The Switch collection features chairs, stools, lounge seating, and occasional tables.
► For chairs, see page 331
► For lounge seating, see page 236
► For tables, see *Coalesse Tables, Storage, and Accessories Specification Guide*.

Surface Materials

► See *Coalesse Surface Materials Reference Guide* for further information.

Upholstery

- Fabric
- Leather

Legs

- Matte chrome
- Polished chrome

Programs & Services

Customer's Own Material/Leather (COM/COL) Program is available.

► See *Coalesse Surface Materials Reference Guide* for additional information.

Switch Stools

DESIGN E00S

Tip: Fabrics and leathers will appear loose with comfort wrinkles when upholstered.

Tip: Recommended leathers are Elmosoft Grade C and Elmorustical Grade E.

Tip: Special color match, consult Customer Service.

Tip: Pricing based on highest grade textile specified.

Tip: For Customer's Own Material or Leather, see necessary requirements, important processing instructions, and ordering information
 ▶ See *Coalesse Surface Materials Reference Guide*.

Standard Includes		Required to Specify	
▶ Need help? Product details, page 378	<ul style="list-style-type: none"> Frame: Constructed of steel tubing and bar stock Upholstery: back foam are molded around the frame components. Seat foam is molded with "comfort pockets" Legs: matte chrome (M) or polished chrome (PC) leg finish 	<ol style="list-style-type: none"> Style number Number of fabrics if contrasting fabric style number is selected Fabric or leather color number for upholstery Options, if selected (see below) ▶ See <i>Coalesse Surface Materials Reference Guide</i> .	
Options		U.S. Price	Required to Specify
Surface Materials	• Contrasting fabric	+\$182 per fabric	Add suffix K to the style number and select fabric color number.
	Acrylic backer • Backer	+\$ 12	Specify with acrylic backer. ▶ See <i>Coalesse Surface Materials Reference Guide</i> .
Related Products	<ul style="list-style-type: none"> Lounge seating Guest seating Occasional tables 		▶ Page 238 ▶ Page 332 ▶ See <i>Coalesse Tables, Storage, and Accessories Specification Guide</i> .

Specification Information

Style Number	U.S. Base Prices											Leather Grades:		
	Fabric Grades:											COL	C	E
	COM	6	7	8	9	10	11	12	13	14				

Counter-Height Stools

1404M	\$1847	\$1847	\$1861	\$1882	\$1944	\$1986	\$2034	\$2066	\$2126	\$2209	\$2268	\$3118	\$3284
1404PC	\$1882	\$1882	\$1896	\$1917	\$1979	\$2021	\$2069	\$2101	\$2161	\$2244	\$2303	\$3153	\$3328

COM/yds = 1¼, COL/sq ft = 23

Bar-Height Stools

1405M	\$1902	\$1902	\$1916	\$1937	\$1999	\$2041	\$2089	\$2121	\$2181	\$2264	\$2318	\$3173	\$3339
1405PC	\$1956	\$1956	\$1970	\$1991	\$2053	\$2095	\$2143	\$2175	\$2235	\$2318	\$2377	\$3227	\$3393

COM/yds = 1¼, COL/sq ft = 23

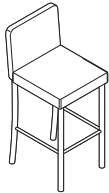

Overall: 19"D 16"W 38"H
 Inside: 15"D 15"W 11¾"H
 Seat: 27¾"H

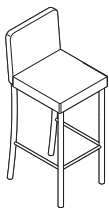

Overall: 19¾"D 16"W 41½"H
 Inside: 15"D 15"W 11¾"H
 Seat: 31¼"H

 **For Canadian Pricing**
 Multiply U.S. Price by the Canadian price factor.
 ▶ See page 1 for details.

Resources

Style Number Index

382

Style Number Index

Style Number	Page	Description	Style Number	Page	Description
1404M	379	Switch Counter-Height Stool	430-H2026	203	Sidewalk Collaborative Ottoman
1404PC	379	Switch Counter-Height Stool	430-H3636	204	Sidewalk Ottoman
1405M	379	Switch Bar-Height Stool	440-2WB	184	Passerelle Two-Seat Lounge
1405PC	379	Switch Bar-Height Stool	440-3WB	185	Passerelle Three-Seat Lounge
1500M	332	Switch Guest Armless Chair	440-B	185	Passerelle Arm Bolster
1500PC	332	Switch Guest Armless Chair	440-B2060WB	186	Passerelle Bench
1510M	332	Switch Guest Arm Chair	440-B3060WB	186	Passerelle Bench
1510PC	332	Switch Guest Arm Chair	440-WB	184	Passerelle Chair
1519M	332	Switch Guest Lowback Sledbase	444	196	Sidewalk Lowback Chair
1519PC	332	Switch Guest Lowback Sledbase	444-2	197	Sidewalk Two-Seat
1529M	333	Switch Guest Highback Sledbase	444M	197	Sidewalk Lowback Chair w/Tablet
1529PC	333	Switch Guest Highback Sledbase	446	197	Sidewalk Highback Chair
1810M	300	Capa Chair	446M	197	Sidewalk Mobile Highback Chair w/Tablet
1810PC	300	Capa Chair	45-T1300H	74	Circa Freestanding Table
216	56	Bob Lounge Swivel Chair	45-T1300HER	74	Circa Ganging Table
221	56	Bob Lounge Chair w/Headrest	45-T1300HG	73	Circa Ganging Table
221-H	57, 297	Bob Ottoman	45-T1300LER	73	Circa Ganging Table
231	297	Bob Guest Chair	45-T1300LG	73	Circa Ganging Table
2540-1	316	Kathryn Wood with Open Back	45-T1815H	73	Circa Freestanding Table
2542-1	316	Kathryn Wood/Uph with Panel Back	45-T1815HER	72	Circa Ganging Table
2547-1	316	Kathryn Fully Uphol Back	45-T1815HG	72	Circa Ganging Table
2547-1RIBD	317	Kathryn Fully Uphol Back w/Ribbed uph	45-T1815LER	72	Circa Ganging Table
3500	302	Enea Arm Chair	45-T1815LG	72	Circa Ganging Table
3500S	304	Enea Armless	45-T28HER	74	Circa Ganging Table
3501	302	Enea Arm Chair	45-T3730HER	73	Circa Ganging Table
3501S	304	Enea Armless	45-T3730HG	73	Circa Ganging Table
3502	303	Enea Arm Chair	45-T3730LER	73	Circa Ganging Table
3502S	305	Enea Armless	45-T3730LG	73	Circa Ganging Table
3503	303	Enea Arm Chair	45-T42RD	75	Circa Freestanding Table
3503S	305	Enea Armless	451-2500	68	Circa Straight Seat Chair
3510	340	Enea Bar-Height Stool w/Arms	451-3730FI	67	Circa 30° Inside Wedge Armless Seat
3510S	342	Enea Armless Bar-Height Stool	451-3730FO	66	Circa 30° Outside Wedge Seat
3511	341	Enea Bar-Height Stool w/Arms	451-5000	68	Circa Straight Loveseat
3511S	342	Enea Armless Bar-Height Stool	451-7460FI	67	Circa 60° Inside Wedge Loveseat
3512	341	Enea Bar-Height Stool w/Arms	451-7460FO	67	Circa 60° Outside Wedge Loveseat
3512S	343	Enea Armless Bar-Height Stool	451-A1800ER	70	Circa Straight Armrest
3513	341	Enea Bar-Height Stool w/Arms	451-A1800G	70	Circa Straight Armrest
3513S	343	Enea Armless Bar-Height Stool	451-A1815FIER	71	Circa 15° Inside Armrest
385	244	Thoughtful Lounge Chair	451-A1815FIG	71	Circa 15° Inside Armrest
385-60	244	Thoughtful Small Lounge	451-A1815FOER	71	Circa 15° Outside Armrest
385-70	245	Thoughtful Medium Lounge	451-A1815FOG	71	Circa 15° Outside Armrest
385-80	245	Thoughtful Long Lounge	451-A3730FIER	71	Circa 30° Inside Armrest
385-H	245	Thoughtfull Ottoman	451-A3730FIG	71	Circa 30° Inside Armrest
391	238	Switch Chair	451-A3730FOER	71	Circa 30° Outside Armrest
391-2	238	Switch Two-Seat	451-A3730FOG	71	Circa 30° Outside Armrest
391-3	239	Switch Three-Seat	451-B42RD	71	Circa Round Ottoman
391-4	239	Switch Two-Seat w/Extensions	451-B5000	68	Circa Straight Bench
391-B	239	Switch Arm Bolster	451-B7460FI	67	Circa 60° Inside Wedge Bench
430	202	Sidewalk Collaborative Chair	451-B7460FO	67	Circa 60° Outside Wedge Bench
430-2	203	Sidewalk Collaborative Two-Seat	451-GANGPKG	68, 71	Circa Ganging Kit
430-B1724	204	Sidewalk Bench	460-3	31	Await Modular Three-Seat Lounge
430-B1736	204	Sidewalk Bench	460-4	31	Await Modular Four-Seat Lounge
430-B1748	204	Sidewalk Bench	460-4B	31	Await Modular Four-Seat Bench
430-H1717	203	Sidewalk Collaborative Ottoman	460-GANGPKG	32	Ganging Kit
430-H1720	203	Sidewalk Collaborative Ottoman	460-H	31	Await Modular Ottoman

Style Number Index

Style Number	Page	Description	Style Number	Page	Description
460-SE22	33	Await Lounge Table	BSSB72XA	48	Bix Sectional Seating
460-SE22PD	33	Await Lounge Table	BSSB72XX	48	Bix Sectional Seating
460-SE30	33	Await Lounge Table	CO200G	295	Bindu-Low Back Guest/Side Chair
460-SE30PD	33	Await Lounge Table	CO300	268	Bindu-Mid Back Executive Chair
460-SE44	33	Await Lounge Table	CO300G	295	Bindu-Mid Back Guest/Side Chair
460-SE44PD	33	Await Lounge Table	CO400	268	Bindu Mid-Back High Back Executive Chair
461-1B	32	Await Connector Bench	COALT100	313	Enea Altzo943 Chair, Armless
461-2B	32	Await Connector Bench	COALT100UPH	313	Enea Altzo943 Chair, Armless, Upholstered
461-3B	32	Await Connector Bench	COALT400	363	Enea Altzo943 Stool, Counter Height
470	79	Coupe Lounge Chair	COALT400UPH	363	Enea Altzo943 Stool, Counter Height, Upholstered
476	80	Coupe Grande Chair	COALT500	363	Enea Altzo943 Stool, Bar Height
476M	80	Coupe Grande Chair	COALT500UPH	363	Enea Altzo943 Stool, Bar Height, Upholstered
490-B35HRZ	191	Ripple Bench	CODAV	82	Davos Chair
490-B35VRT	190	Little Ripple Wave Bench	CODAV16	82	Davos Small Bench
490-B96HRZ	190	Ripple Flat Seat Bench	CODAV38	82	Davos Medium Bench
490-B96VRT	190	Ripple Wave Bench	CODAV60	82	Davos Large Bench
795	272	Chord Conference Chair	COEL100	308	Enea Lottus Armless Chair
795AU	272	Chord Conference Chair	COEL100INSERT	308	Enea Lottus Armless Chair
796	273	Chord Midback Chair	COEL100UPH	308	Enea Lottus Armless Chair
796-P	273	Chord Midback Chair	COEL200	310	Enea Lottus Cantilever Arm Chair
796-PAU	273	Chord Midback Chair	COEL200INSERT	310	Enea Lottus Cantilever Arm Chair
796AU	273	Chord Midback Chair	COEL200UPH	310	Enea Lottus Cantilever Arm Chair
797	273	Chord High Back Chair	COEL300	311	Enea Lottus Aluminum Loop Arm Chair
797AU	273	Chord Midback Chair	COEL300INSERT	311	Enea Lottus Aluminum Loop Arm Chair
798	273	Chord High-Back Chair	COEL300UPH	311	Enea Lottus Aluminum Loop Arm Chair
798-P	273	Chord High-Back Chair	COEL400	361	Enea Lottus Sled-Base Stool
798-PAU	273	Chord Midback Chair	COEL400INSERT	361	Enea Lottus Sled-Base Stool
798AU	273	Chord Midback Chair	COEL400UPH	361	Enea Lottus Sled-Base Stool
9014S	300, 303, 305	Stacking Dolly	COEL500	360	Enea Lottus Sled-Base Stool
BB48	50	Bix Bench	COEL500INSERT	360	Enea Lottus Sled-Base Stool
BB72	50	Bix Bench	COEL500UPH	360	Enea Lottus Sled-Base Stool
BBS48	50	Bix Bench	COEL600	357	Enea Lottus Post-Base Stool
BBS72	50	Bix Bench	COEL600INSERT	357	Enea Lottus Post-Base Stool
BL26AA	43	Bix Lounge Chair with Arms	COEL600UPH	357	Enea Lottus Post-Base Stool
BL26XX	43	Bix Lounge Chair	COEL700	356	Enea Lottus Post-Base Stool
BLB26XX	43	Bix Lounge Chair with Screen	COEL700INSERT	356	Enea Lottus Post-Base Stool
BLD26AA	44	Bix Sled Lounge with Arms	COEL700UPH	356	Enea Lottus Post-Base Stool
BLD26TX	44	Bix Sled Lounge Tablet Arm	COELDOLLY	309	Enea Lottus Stacking Dolly
BLD26XT	44	Bix Sled Lounge Tablet Arm	COH350W27	352	Enea Wood Café Stool, Counter-Height
BLD26XX	44	Bix Sled Lounge	COH350W31	353	Enea Wood Café Stool, Bar-Height
BSE54LA	46	Bix Sectional Seating	COH352W27	352	Enea Wood Café Stool, Counter-Height Upholstered
BSE54RA	46	Bix Sectional Seating	COH352W31	352	Enea Wood Café Stool, Bar-Height Upholstered
BSE54RX	46	Bix Sectional Seating	COH353W27	352	Enea Wood Café Stool, Counter-Height
BSS48AA	47	Bix Sectional Seating	COH353W31	353	Enea Wood Café Stool, Bar-Height
BSS48AX	47	Bix Sectional Seating	COJHB100	262	Visalia Lounge
BSS48XA	47	Bix Sectional Seating	COJHB200	262	Visalia Lounge
BSS48XX	47	Bix Sectional Seating	COJHBC100	262	Visalia Lounge
BSS72AA	48	Bix Sectional Seating	COJHBC200	262	Visalia Lounge
BSS72AX	48	Bix Sectional Seating	COJHL100	261	Visalia Lounge
BSS72XA	48	Bix Sectional Seating	COJHL200	261	Visalia Lounge
BSS72XX	48	Bix Sectional seating	COJHL300	261	Visalia Lounge
BSSB48AX	47	Bix Sectional Seating	COJHLC100	261	Visalia Lounge
BSSB48XA	47	Bix Sectional Seating	COJHLC200	261	Visalia Lounge
BSSB48XX	47	Bix Sectional Seating	COJHLC300	261	Visalia Lounge
BSSB72AX	48	Bix Sectional Seating	COLAGB1	139	Lagunitas 1-Seat Bench

Style Number Index *continued*

Style Number	Page	Description	Style Number	Page	Description
COLAGB2	139	Lagunitas 2-Seat Bench	COMF1	169	Millbrae Ganging Kit
COLAGB3	139	Lagunitas 3-Seat Bench	COMFL1	165	Millbrae Lounge
COLAGCH2	133	Lagunitas 2-Seat Chaise	COMFL2	166	Millbrae Lounge
COLAGCH3	137	Lagunitas 3-Seat Chaise	COMFL3	167	Millbrae 3-Seat Lounge
COLAGCI	141	Alignment Connector	COMFL4	168	Millbrae 4-Seat Lounge
COLAGCL2	132	Lagunitas 2-Seat Chaise	COMFLA1	165	Millbrae Lounge
COLAGCL3	136	Lagunitas 3-Seat Chaise	COMFLA2	166	Millbrae 2-Seat Lounge
COLAGFN	145	Lagunitas Focus Nook	COMFLA3	167	Millbrae 3-Seat Lounge
COLAGLBS	140	Lounge Booth Screen	COMFLA4	168	Millbrae 4-Seat Lounge
COLAGLH11	115	Lagunitas 1-Seat Lnge w/ High-Bk Scrn	COMFLB1	169	Millbrae 1-Seat Bench
COLAGLH13	115	Lagunitas 1-Seat Lnge w/ HB Scrn, 2 Side Scrns	COMFLB2	169	Millbrae 2-Seat Bench
COLAGLH21	119	Lagunitas 2-Seat Lnge w/ High-Bk Scrn	COMFLB3	169	Millbrae 3-Seat Bench
COLAGLH22	120	Lagunitas 2-Seat Lnge w/ HB Scrn, 1 Side Scrn	COMFLB4	169	Millbrae 4-Seat Bench
COLAGLH23	121	Lagunitas 2-Seat Lnge w/ HB Scrn, 2 Side Scrns	COMFLLA1	165	Millbrae Lounge
COLAGLH31	127	Lagunitas 3-Seat Lnge w/ High-Bk Scrn	COMFLLA2	166	Millbrae 2-Seat Lounge
COLAGLH32	128	Lagunitas 3-Seat Lnge w/ HB Scrn, 1 Side Scrn	COMFLLA3	167	Millbrae 3-Seat Lounge
COLAGLH33	129	Lagunitas 3-Seat Lnge w/ HB Scrn, 2 Side Scrns	COMFLLA4	168	Millbrae 4-Seat Lounge
COLAGLL11	114	Lagunitas 1-Seat Lnge w/ Low-Bk Scrn	COMFLRA1	165	Millbrae Lounge
COLAGLL13	114	Lagunitas 1-Seat Lnge w/ LB Scrn, 2 Side Scrns	COMFLRA2	166	Millbrae 2-Seat Lounge
COLAGLL21	118	Lagunitas 2-Seat Lnge w/ Low-Bk Scrn	COMFLRA3	167	Millbrae 3-Seat Lounge
COLAGLL22	118	Lagunitas 2-Seat Lnge w/ LB Scrn, 1 Side Scrn	COMFLRA4	168	Millbrae 4-Seat Lounge
COLAGLL23	119	Lagunitas 2-Seat Lnge w/ LB Scrn, 2 Side Scrns	COMLPRND	169	Millbrae Round Arm Bolster
COLAGLL31	124	Lagunitas 3-Seat Lnge w/ Low-Bk Scrn	COMLPSQR	169	Millbrae Square Arm Bolster
COLAGLL32	125	Lagunitas 3-Seat Lnge w/ LB Scrn, 1 Side Scrn	COMSL1	165	Millbrae Lounge
COLAGLL33	126	Lagunitas 3-Seat Lnge w/ LB Scrn, 2 Side Scrns	COMSL2	165	Millbrae 2-Seat
COLT5	319	LessThanFive Chair	COMSL3	165	Millbrae 3-Seat
COLT5E	319	LessThanFive Essential Chairs	COPILLM	227	Sistema Lumbar Pillow
COLT5EP	319	LessThanFive Essential Chairs	COPILSQ	227	Sistema Square Pillow
COLT5L	147	LessThanFive Lounge	COSFZCH	329	Montara650 Chair
COLT5S	365	LessThanFive Stool	COSFZLC	175	Montara650 Lounge
COLX200	367	Lox Stool	COSFZRC	179	Montara650 Rocker
COLX210	367	Lox Stool	COSFZST	377	Montara650 Stools
COLX400	280	Lox Chair, Upholstered Seat	COSIS1L	222	Sistema Lounge Chair, Left Arm
COLX410	280	Lox Chair, Upholstered Seat and Back	COSIS1R	221	Sistema Lounge Chair, Right Arm
COLX500	281	Lox Chair, Upholstered Seat	COSIS2A	223	Sistema Lounge Chair with Arms
COLX510	281	Lox Chair, Upholstered Seat and Back	COSISAB	225	Sistema Arm Bolster
COMARBSMB	370	Marien152 Stool, Bar-Height	COSISBN	222	Sistema Backless Bench Lounge
COMARBSWB	371	Marien152 Stool, Bar-Height	COSISEL	215	Sistema End Legs
COMARCCH4	276	Marien152 Conference Seating	COSISGL	215	Sistema Connector Frame with Legs
COMARCCH5	277	Marien152 Conference Seating	COSISL1	217	Sistema 1-St Cnctr Frame, Leg Base
COMARCHMB	323	Marien152 Guest Seating, Metal Base	COSISL2	214	Sistema 2-St Lounge Frame, Leg Base
COMARCHWB	322	Marien152 Guest Seating, Wood Base	COSISL3	214	Sistema 3-St Lounge Frame, Leg Base
COMARCSMB	372	Marien152 Stool, Counter-Height	COSISLC	221	Sistema Lounge Chair, Armless
COMARCSWB	373	Marien152 Stool, Counter-Height	COSISOR	224	Sistema Round Ottoman
COMARLCMB	150	Marien152 Lounge, Metal Base	COSISOS	224	Sistema Square Ottoman
COMARLCWB	151	Marien152 Lounge, Wood Base	COSISPWR	218	Sistema Power Module
COMCCHLBDVNT	286	Massaud Low-Back Duvet Conference Chair	COSISTBL	226	Sistema Moveable Table
COMCCHLBSTNT	286	Massaud Low-Back Duvet Conference Chair	COTO12369L15	251	Together Bench
COMCCHMBDV	285	Massaud Mid-Back Duvet Conference Chair	COTO12369L8	251	Together Bench
COMCCHMBDVNT	287	Massaud Mid-Back Duvet Conference Chair	COTO12369R15	253	Together Bench
COMCCHMBST	285	Massaud Mid-Back Duvet Conference Chair	COTO12369R8	252	Together Bench
COMCCHMBSTNT	287	Massaud Mid-Back Duvet Conference Chair	COTO12396L15	251	Together Bench
COMCLG	156	Massaud Lounge Chair	COTO12396L8	251	Together Bench
COMCOT	157	Massaud Ottoman	COTO12396R15	253	Together Bench
COMCWL	157	Massaud Work Lounge Chair	COTO12396R8	252	Together Bench

Style Number Index

Style Number	Page	Description
COTO69	255	Together Bench
COTO69WB15	254	Together Bench
COTO69WB8	254	Together Bench
COTO96	255	Together Bench
COTO9669L15	251	Together Bench
COTO9669L8	250	Together Bench
COTO9669R15	253	Together Bench
COTO9669R8	252	Together Bench
COTO9696L15	251	Together Bench
COTO9696L8	250	Together Bench
COTO9696R15	253	Together Bench
COTO9696R8	252	Together Bench
COTO96WB15	254	Together Bench
COTO96WB8	254	Together Bench
COURQL	87	Hosu Lounge w/Attached Lumbar
COURQLO	87	Hosu Lounge w/Otto and Attached Lumbar
COURQS	87	Hosu 2-Seat Lounge
COW210	233	SW_1 Ottoman
COW413	290	SW_1 Conference Chair
COW415	290	SW_1 Conference Chair
COW613	233	SW_1 Low-Back Collaborative Lounge Chair
COW713	233	SW_1 High-Back Collaborative Lounge Chair
COWK100	90	Joel Lounge
COWRP4LEG	335	Wrapp Chair, 4 Leg
COWRPSLD	335	Wrapp Chair, Sled-Base
H350-S19	349	Enea Café Low Stool
H350-S27	349	Enea Café Counter-Height Stool
H350-S31	349	Enea Café Bar-Height Stool
H350-SB2719	347	Enea Café Stool with Back
H350-SB3119	347	Enea Café Stool with Back
H351-SB2719	346	Enea Café Stool with Back
H351-SB3119	346	Enea Café Stool with Back
H352-S19	348	Enea Café Low Stool
H352-S27	348	Enea Café Counter-Height Stool
H352-S31	348	Enea Café Bar-Height Stool
H352-SB2719	346	Enea Café Stool with Back
H352-SB3119	346	Enea Café Stool with Back
H353-S19	349	Enea Café Low Stool
H353-S27	349	Enea Café Counter-Height Stool
H353-S31	349	Enea Café Bar-Height Stool
H353-SB2719	347	Enea Café Stool with Back
H353-SB3119	347	Enea Café Stool with Back

Trademark List

- ® The following are registered trademarks for products of Steelcase Inc. or one of its related corporate entities: 4 o'clock, 900 Series, à la carte, Airtouch, Ally, Amia, Answer, Archipelago, Avenir, Ballet, Bix, Brayton International, Cachet, Canopy, Canto, Chancellor, Coalesse, Confidante, Context, Convene, CopyCam, Criterion, Crushed Can, Currency, dash, Designtex, Details, Detour, Drive, Elective Elements, Ellipse, Ember Chrome, Emerge, E-Table 2, FYI, Garland, Gentry, Ginkgo Biloba, Groupwork, Ideo, Jacket, Jenny, Jersey, Kart, Kick, LaCosta, Leap, LessThanFive, Let's B, LiveBack, Max-Stacker, media:scape, Metro, Migrations, Mitra, Montage, Nurture, Oriana, Parade, Pathways, PCT, Permiso, Player, Portal, Power Pincher, Progeny, Protégé, R2, Rally, Relevant, Reply, Rizzi Arc, Sensor, Series 9000, Siento, Sieste, Sine, Softcare, Springboard, Steelcase, Steelcase Design Partnership, Stella, Stow Davis, Swathmore, Sylvi, TeamWork, Technique, Texpress, Think, Thunder, Topo, Train, turnstone, Underline, Unison, Vecta, Viridian, Walden, Werndl, and X-Stack.
- ® The following registered trademarks are under license from AWI Licensing Company, Dover, DE: SoundScapes, DuraBrite, BioBlock, and Armstrong.
- ® The following registered trademarks are under license from Byrne Electrical, Rockford, MI: Interport, Mini-Port, Axil Z, and Ellora.
- ® The following is a registered trademark of DuPont, Wilmington, DE: Corian.
- ® The following is a registered trademark of Genlyte Thomas Company, Louisville, KY: Lightlior.
- ® The following is a registered trademark of Hilti Corporation, FL-9494 Schaan, Principality of Liechtenstein: Hilti.
- ® The following is a registered trademark of Leviton Manufacturing Company, Little Neck, NY: Decora.
- ® The following is a registered trademark of Mechanical Plastics Corp, Elmsford, NY: Toggler.
- ® The following is a registered trademark of Microsoft Corporation, Redmond, WA: Microsoft.
- ® The following are registered trademarks of Orangebox Ltd., Cardiff, UK: Orangebox.
- ® The following is a registered trademark of Panduit Corporation, Lockport, IL: Panduit.
- ® The following is a registered trademark of Trav (Press), Cuneo, Italy: Assisa.
- ® The following is a registered trademark of Virtual Ink, Boston, MA: mimioActive.
- ® The following registered trademarks are under license from Wilkhahn Furniture Products: Avera, Senzo, Versal, and Wilkhahn FS.
- ® The following are registered trademarks of Polyvision Corp: Flow, Motif, Polyvision, Sans, and Serif.
- ® The following is a registered trademark of Wilsonart International, Temple, TX: Chemsurf.
- ® The following is a registered trademark of Wiremold, West Hartford, CT: Wiremold.
- ® The following is a registered trademark of EMU Group S.P.A., Perugia, Italy: EMU.
- ® The following is a registered trademark of Security People, Inc.: Digilock.
- ® The following are registered trademarks of Natural Capital Partners Europe Limited: CarbonNeutral and the CarbonNeutral Certified logo.
- ™ The following are trademarks for products of Steelcase Inc. or one of its related corporate entities: Access, Active/Passive Shelf, Agree, Ainsley, Akira, Alcove, Alerion, Alight, Amaris, American Elect, American Tradition, ap40, Arbor, Arriva, Asana, Ascot, Aspekt, Astor, Await, Bassline, B-Free, Bira, Bivi, Bixby, Bottomline, Brody, Brook, Buoy, Burton, c:scape, Calla, Calm, Camber, Campfire, Capa, Cappuccino, Cesar, Chester, Chord, Circa, Clarendon, Classic Rectangular, Clipper, cobl, Collaboration, Community, Company, Convey, Cortex, Coupe, Crea, Crew, Cura, Cypress, Davenport, Dearborn, Deck, Déjà, Denizen, Denska, Derby, DeskWizard, Divisio, Donovan, Dune, Duo, Echo, Edge, Elbrook, Elsa, Empath, Empress, Enea, ēno, EnSync, Enviro, Escapade, Everwall, Exchange, Exponents, Field, Flat Top, FlexFrame, Flip Top, Flute, Folio, FrameOne, FreeFlow, Frontier, Galilei, Gesture, Ginger, Ginkgo, Go Wall, Grip, Groove, Hatchback, Hawthorne, Hitch, Host Collection, Hosu, Huddleboard, i2i, Impact, Indy, InfoLink, IOS, I-Solve, Jack, Jarrah, Jetty, Juice, Kami, Kast, Kathryn, Lagunitas, Lark, L'Attitude, LearnLab, Leela, Lincoln, Linden, LiveSeat, Loria, Lyric, Malibu, Malibu Too, Mansfield, Marathon, Marien152, Martini, Mason, Masque, Migration, Millbrae, Mineral, Mingle, Mystic, Mystic Metal, Mystic Wood, Montara650, Montreal, MoreThanFive, Move, Nadia, Neighbor, nesso, Nickel, Nikko, Nod, Node, Norfolk, Ocular, Ology, Ontrak, Oom, Opus, Orchid, Outlook Collection, Ovation, Paloma, Paperflo, Parliament, Pasio, Passerelle, Patriarch, Payback, Peek, Pile File, Pisa, Pool, Potrero415, PUCK, QiVi, Quba, Radia, Rave, Reed, Regard, Relay, Reunion, Ripple, Riser, Roam, Rocco, Rocky, RoomWizard, Runner, Satellite, Sawyer, ScapeSeries, Senti, Sentinel, Senza, Sequoia, Session, ShareLink, Shield, Shortcut, Sidewalk, SILQ, Skylar, Slumber, Smoke, Snug, Soft Leaf, Sonata, Sorrel, SOTO, Southside, Stationkits, Steelcase Karman, Steelcase Series, Stiletto, Surprise!, Surround, Switch, Symphony, Sync, TagWizard, Tava, TeamStudio, TeamTheater, Tenaro, Tenor, Terrazzo, Theorem, Thread, Topaz, Touchdown, Tour, Tower Too, Trees, Trillium, Trolly, tX2, U-Free, Umami, Underscore, Uno, V.I.A., Verb, Verge, Verlay, Victor2, Visalia, Waldorf, Woodruff, Workspring, WorkValet, and X-tenz.
- ™ The following is a trademark of Microsoft Corporation, Redmond, WA: Windows.
- ™ The following is a trademark of Rodman Industries, Inc., Oconomowoc, WI: ResinCore1.
- ™ The following is a trademark of Ultrafabrics, LLC, Elmsford, NY: Ultraleather.
- ™ The following trademarks are under license from Wilkhahn Furniture products: Cana, Linus, Logon, Picto, Range, Stitz, Thema, Timetable, and Tubis.
- ™ The following is a trademark of Cradle to Cradle Products Innovation Institute, Oakland, CA: Cradle to Cradle Certified.
- ™ The following trademarks are under license from Walter Knoll: Andoo, Bob, Lazlo, Lox, Ribbon, and Together.
- ™ The following trademarks are under license from PP Møbler: Bar and Flag Halyard.
- ™ The following trademarks are under license from Carl Hansen: Elbow, Paddle, Shell, Wing, and Wishbone.
- ™ The following trademarks are under license from Cambridge Sound Management, LLC, Cambridge, MA: QtPro Soundmasking, Qt Quiet Technology, and Sonet Qt.
- ™ The following is a trademark of Electri-Cable Assemblies, Shelton, CT: Interact.
- ™ The following is a trademark of Clestra Hauserman: IRYS.
- ™ The following is a trademark of Wiesner-Hager Möbel GmbH: Nooi.
- ™ The following are trademarks of Polyvision: Accord, a³, e³, Boundri, and Nota.
- ™ The following is a trademark of Bostock Company, Inc: SnapCab.
- ™ The following is a trademark of Williams-Sonoma, Inc: West Elm.
- ™ The following is a trademark of Elena Marquina Testor: nanimarquina.
- ™ The following is a trademark of Forbo International SA: Forbo.
- ™ The following are trademarks of Orangebox Ltd., Cardiff, UK: Air³, Aspect, Avi, Away from the Desk, Border, Campers & Dens, Coppice, Cubb, Kim, On the QT, Ramsey, Skoner, Sully, Track-B, and Vale.
- ™/® The following are trademarks or registered trademarks of AMQ Solutions, LLC: AMQ, AMQ logo, KINEX, ILINE, ACTIV, AMOBI, CONCUR, 3F, REVI, S-SERIES, JAKU, SIYA, ZILO, BODI, FL-X, TIZU, EMBANK, TEKTIS, and BIXBY.
- ™/® The following are trademarks or registered trademarks of Viccarbe Habitat, S.L.: Holy Day, Last Minute, Wrapp, Foro, Kelly, Noha, Viable, Solar, Sistema, Savina, Designed In The Sun, Cambio, Aleta, Viccarbe (logo), Viccarbe.

Trademarks used here in are the property of Steelcase Inc. or of their respective owners.