

---

# AMQ

## Specification Guide

### Availability

**Electronic price list updated** with release 200.J (U.S.) and 156.J (Canada), dated December 18, 2023.

All specifications subject to change without notice. Reference the electronic catalog/Hedberg for current pricing.

Trademarks contained herein are the property of AMQ Solutions, LLC or their respective owner.

<b>General</b>	<b>2</b>
<b>Furniture</b>	<b>19</b>
<b>Seating</b>	<b>417</b>
<b>Resources</b>	<b>513</b>
<b>Furniture Finishes</b>	<b>514</b>
<b>Seating Finishes</b>	<b>516</b>
<b>Style Number Index</b>	<b>518</b>

# Orders

## Orders

Please send P.O.s to [orders@amqsolutions.com](mailto:orders@amqsolutions.com).

## Cancellations

Orders may be cancelled within 48 hours of order placement in writing via email to [orders@amqsolutions.com](mailto:orders@amqsolutions.com). Please note that orders are not officially cancelled until a confirmation is sent via email from AMQ. Custom or made-to-order products are not eligible for cancellation.

## Returns and Exchanges

We do not accept returns or exchanges on products; sales are final once acknowledgments are sent. If a product is ordered by mistake or other issue arises, contact us at [orders@amqsolutions.com](mailto:orders@amqsolutions.com).

## Change Orders

Orders may be changed within 48 hours of order placement. The request must be made via email to [orders@amqsolutions.com](mailto:orders@amqsolutions.com). The change order is subject to approval and is not accepted until an AMQ acknowledgment is sent to the dealer. In the event that a change order is accepted, change fees may apply. Lead time starts on the day of approval of changes.

## Pricing/Order Entry Errors

Claims for pricing or order entry errors must be made no later than 48 hours from receipt of an AMQ acknowledgment. After the 48 hour grace period, customers will be responsible for orders as they are acknowledged.

Please send emails to [orders@amqsolutions.com](mailto:orders@amqsolutions.com) along with your order acknowledgment number, line number with error and detail of the error.

## Lead Times

Lead times vary by product - refer to our Lead Time table. Lead time begins the day after receipt of a clean P.O., including receipt of deposit if applicable. When your order is shipped, a tracking notification will be emailed to the contact specified on your purchase order.

## Order Fulfillment

We make every attempt to ship all of our orders complete. In the event of a partial or split shipment, you will be notified and an estimated date will be provided for the backordered items. We cannot guarantee which warehouse the product will ship from.

Customer has 10 calendar days after delivery at the specified location to file a claim with AMQ for missing items or AMQ errors not obvious at the time of delivery. If AMQ determines missing items or error was made by AMQ, AMQ's sole obligation is to replace the missing items or correct error and ship at AMQ's expense. AMQ does not cover labor or trip charges. Customer waives right to file a claim if filed after 10 calendar days of receipt of shipment.

# Warranties

Product warranties vary; refer to the Warranty sheet in Dealer Tools.

AMQ's obligation under this warranty is limited to replacing any product or part that it determines to be defective after inspection by its authorized representative, following receipt of written notice of the defect from the purchaser within the warranty period. This warranty shall apply to the original purchaser only, is non-transferable, and is not applicable outside the United States, Canada, and Mexico.

This warranty is based on normal installation and use of the product in an 8-hour shift. This warranty does not apply to:

- Damage in shipment caused by a carrier
- Defects caused by improper installation
- Products subject to improper use and conditions
- Customer modifications to the product
- Any product that has been modified, altered, tampered with or repaired by any person other than an authorized representative of AMQ
- Normal wear and tear

Labor charges and/or damage incurred in the installation, repair, or replacement of any products are excluded; AMQ will replace the product if the claim is approved.

## Product Design

The right is reserved by AMQ to make changes in design and material, as well as discontinuance of parts and units when such action is deemed to be an improvement in design, function and/or construction.

## Warranty Claims

Please email claims to [cc@amqsolutions.com](mailto:cc@amqsolutions.com).

Lead Time	Product	Order Size
10 Day <sup>1</sup>	3F	25 workstations
	Amobi	
	Seating	
	Activ	
	Kinex	
	Iline	
	Accessories	
	Storage	
	Concur	
	Intro Worktools	
	Majority of Tektis	
	Majority of Embank	
	West Elm Work Greenpoint	
20 Day	Select Styles of Embank • 3- and 4-High Laterals • Credenzas w/ Kneespace • D- and P-Shape Desks Tables • Dual Towers • Modesty Panel • Conference & Collaborative Tables	26-50 workstations
	Tektis Corner Worksurfaces	
	25 Day	
West Elm Work Brighton		

<sup>1</sup>The default lead time is 20 days when 10 days is not requested.

<sup>2</sup>Larger orders may extend past 25 days depending on inventory availability.

# Shipping

## Will Call

AMQ offers Will Call upon request; please contact [orders@amqsolutions.com](mailto:orders@amqsolutions.com) for details.

## Freight Terms

Freight is included in pricing for all \$1500+ Net Orders, and Seating- or Accessories-only Orders regardless of Net, shipped within the 48 contiguous United States. For orders under \$1500 Net, a \$100 surcharge is added.

All shipments within the 48 contiguous United States, except those designated ports of disembarkation, will be shipped FCA Factory, freight prepaid and allowed regardless of weight. AMQ may select the most appropriate mode of shipment from the manufacturing point of its choice. Special shipping methods and/or handling (including customer requested split shipments) will be subject to an additional charge. Any special freight requirements must be requested prior to order placement and are subject to approval by AMQ. Please contact AMQ Customer Care team for details.

## Freight – Canada/Hawaii/Alaska

For shipments to Canada, AMQ pricing only includes Transportation fees (dock to dock). Any other fees or costs associated with shipment, such as customs clearance and import duty/taxes shall be paid directly by the Customer. For shipments to Hawaii/Alaska, AMQ pricing does not include freight. Customer will be responsible for arranging and paying all shipping costs.

## Commitment Delivery Option

AMQ offers 10 day delivery on 97% of our portfolio, when requested. Delivery times are at the discretion of the carrier within reasonable transit time unless special arrangements have been agreed to in writing between the Customer and AMQ prior to shipment. There is an additional charge to guarantee delivery on a specific day. These charges will be quoted at Customer request.

## Redelivery and Re-consignment of Freight

The Customer will be charged for redelivery or re-consignment of all orders (regardless of shipping terms agreed to) if redelivery or re-consignment was caused by a Customer change after the goods have left AMQ's dock.

## Shipment Damage Claims

All shipments must be carefully inspected by Customer before acceptance. The Customer must record any damage or shortages noted at time of delivery on the Bill of Lading, and provide this information to AMQ immediately along with photos of any damage. AMQ will arrange inspection by the carrier. If Customer believes it has uncovered further damage after delivery they must take photos of the damage and immediately request inspection by the delivering carrier. Damaged freight must be kept at point of delivery in original packaging for inspection by carrier until further notice by AMQ. If carrier is designated by AMQ, then AMQ will seek recourse on behalf of the Customer. Freight Claims must be filed within 10 days of delivery date.

AMQ warrants to the original purchaser that the products it manufactures are free from defects in design, material and workmanship. Subject to the limitations below, AMQ warrants each product in this catalog to be free from material defects in materials and workmanship.

## Title

Title and risk of loss or damage shall pass from AMQ to Customer/Dealer upon delivery to the carrier, including Steelcase trucks.

## Submission of Claims

Please submit all order fulfillment, shipping, and warranty claims to [cc@amqsolutions.com](mailto:cc@amqsolutions.com).

## Order Processing

Please send purchase orders to [orders@amqsolutions.com](mailto:orders@amqsolutions.com).

- Lead times start from the next day after receipt of clean P.O.
- P.O.s with missing information/finishes or incorrect pricing will be placed on order processing hold and the lead time will not start until the revised P.O. is sent to Customer Care ([orders@amqsolutions.com](mailto:orders@amqsolutions.com)).
- Please provide .sif file and AMQ quote number along with P.O., if applicable.
- Orders will be acknowledged within 24-48 hours with an AMQ acknowledgment number.
- Claims for quote errors, pricing, order entry errors and/or incorrect finishes must be made within 48 hours of receipt of acknowledgment. After 48 hours, AMQ will not be responsible for errors.
- P.O.s must include your Joey Coin # in order to obtain Joey points. Register at [amqsolutions.com/joey](http://amqsolutions.com/joey) and within 5 business days you'll receive your Joey Coin #.

**Please be sure to check order acknowledgments to confirm accuracy of products, fabrics and finishes against your purchase order.**

## Payments & Deposits

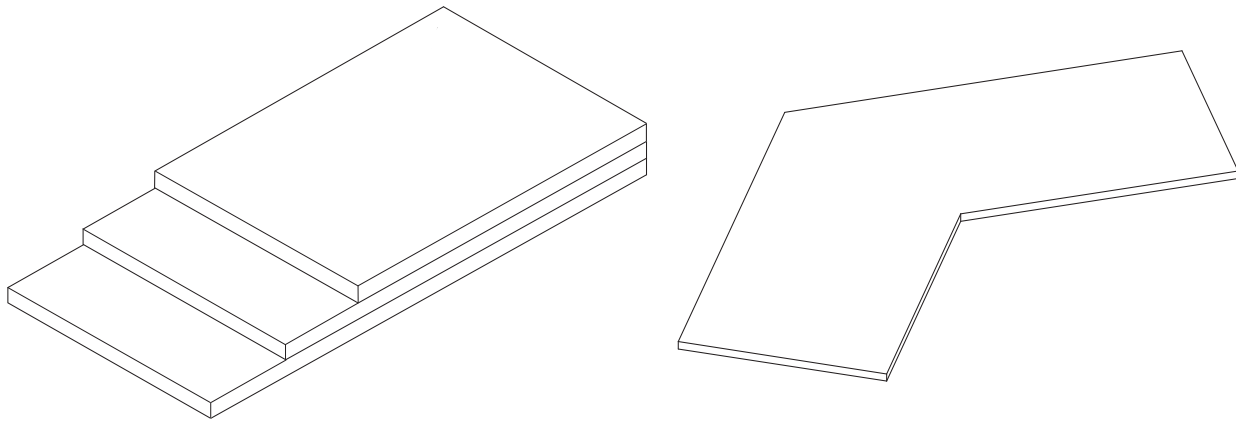
Terms of payment will be established based on the credit rating and credit information provided by and for specific customers. Orders are invoiced at the time of shipment or will call date. Standard payment terms are net 30 days.

	Orders Under 40,000 Net	Orders Over 40,000 Net
Deposit	No Deposit Required*	50% Deposit Due Upon Order
Balance Due	Net 30	Net 30

\*First order with new dealership requires 50% deposit.



# Worksurfaces



**AMQ worksurfaces are low pressure laminate (LPL).**

Available in linear, 90° and 120° degree shapes in thirteen colors: Acacia, Arctic White, Ash Wenge, Clay Noce, Clay Wenge, Clear Maple, Clear Oak, Clear Walnut, Graphite Walnut, Milk White, Natural Cherry, Seagull, and Virginia Walnut.

---

## Specifications

---

LPL (low pressure laminate)

---

1 inch/25mm thick

---

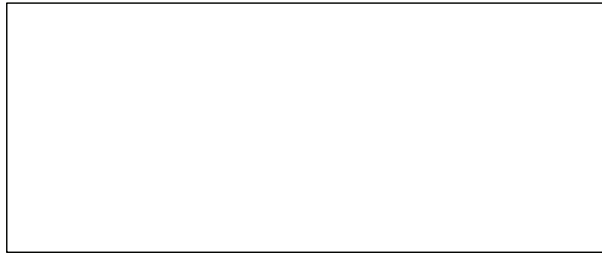
3mm PVC on four sides

---

Linear, 120, extended corner

---

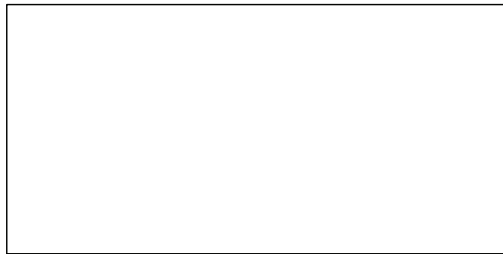
Our linear worksurfaces come in 48", 54", 60", 66" and 72" widths at 23", 24", 29", or 30" depths. Plus 46", 52", 58", 64" & 70" widths at 23", 24", 29", or 30" depths.



72" width



66" width



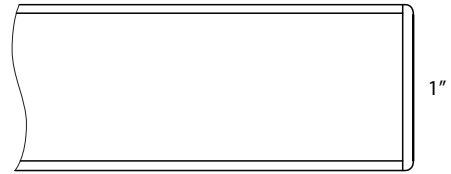
60" width



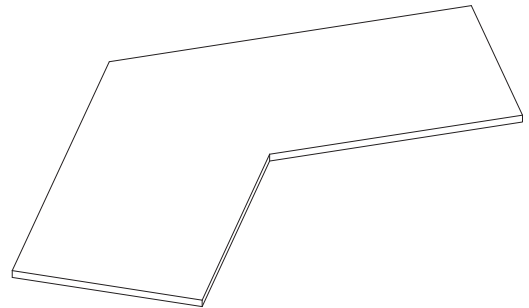
54" width



48" width



Worksurfaces are 1" thick with 3mm PVC on 4 sides.

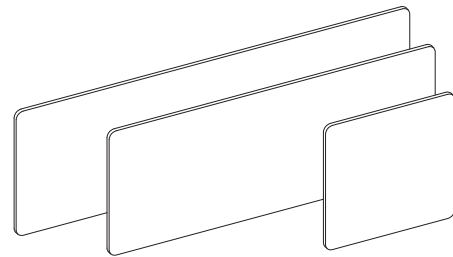
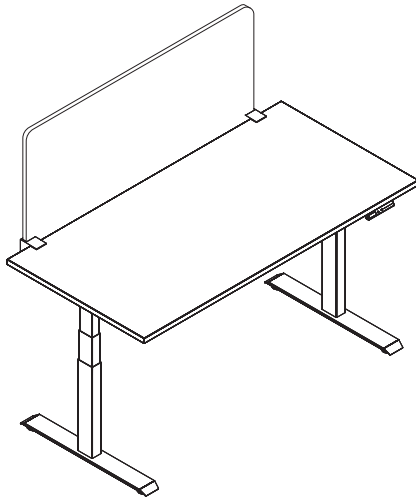


120° worksurfaces also available for ACTIV PRO 3 height adjustable base.

# Privacy Screens

We offer 3F privacy screens for your open plan environments.

3F Felt Screens offer 5 attachment options with varying functionalities



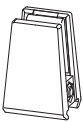
### 3F Screens

AMQ 3F felt screens are 18mm thick made from 100% Polyester.

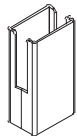
Oeko-Tex Standard 100

### Screen Clips and Brackets

AMQ screen clips vary by product line and configuration. All sold in pairs (separately from screens). Activ base clips work with worksurfaces between .7"-1.5" (18mm and 40mm) thickness.



Iline



Kinex double run



Top Mounted Bracket



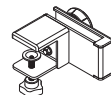
Top Mounted Bracket Clamp



Undermounted Sleeve Bracket



Fixed Privacy Modesty Bracket



Height Adjustable Bracket



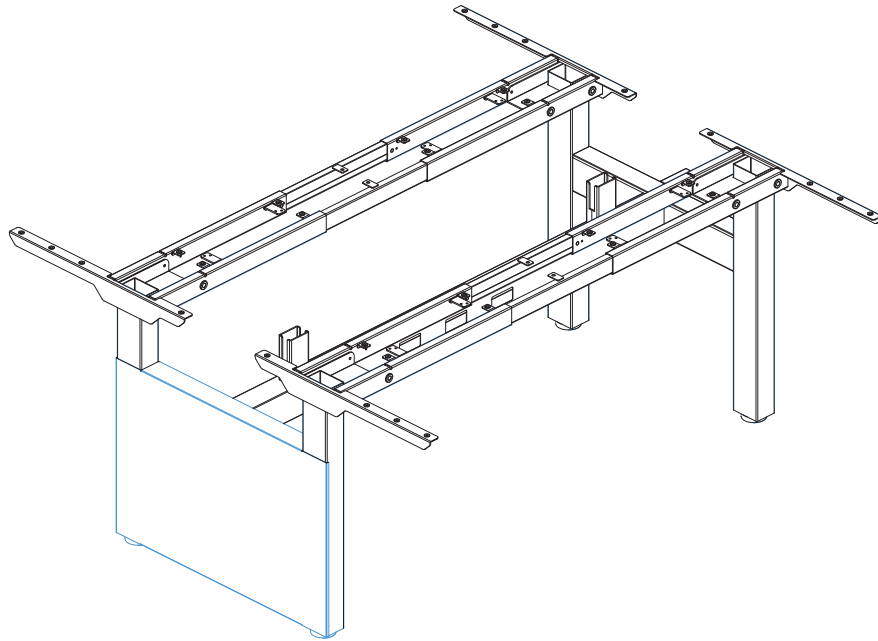
Screen Corner Connector

3F Screens





## Modesty & Insert Panels



---

**Kinex End Panel**

End Panel for 24" and 30" DR applications.  
Available in Platinum and White.

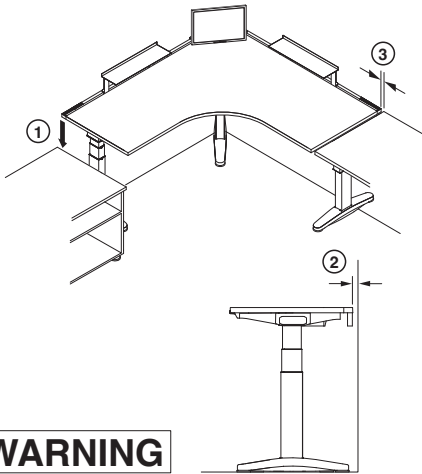
# Workstation Design Guidelines & Requirements

## Overview

Designed for movement with dynamic seating, adjustable work tools and height-adjustable desks are important for today's office workers.

To determine the best height-adjustable solution, consider these four criteria:

1. Adjustability needed: What is the height range requirement? (seated or sit-to-stand)
2. Worksurface size needed: What does the physical space look like? (worksurface configuration)
3. Equipment/tools used: What type of computer equipment and other work tools are being used on the worksurface? (Load capacity)
4. Use: What is the height adjustable desk being used for (individual or shared, touchdown space or full workstation, sit-to-stand or seated)?



### **WARNING**

Risk of Serious Injury. If not used as intended, moving work-surfaces can pinch or injure people, or damage property.

Always follow these Instructions:

1. Keep height-adjustment range free from obstructions above and below the worksurface.
2. Plan for a minimum 1" gap against a panel or wall.
3. Plan for a minimum 1" gap to adjacent furniture.

## Tips

### Obstructions

Moving worksurfaces can collide with other objects. Do not install overhead storage, stationary pedestals or components in the path of height-adjustable desks.

### Weight

The maximum allowable load (varies by height-adjustable desk) should be evenly distributed and must not be exceeded.

### Width

Specify a minimum 1" gap to adjacent furniture. This eliminates any pinch points between a height-adjustable desk and a fixed object.

### Depth

When placing a height-adjustable desk against a panel or wall specify the worksurface depth shorter to provide a minimum 1" gap. This eliminates pinch points and adds clearances for cable access.

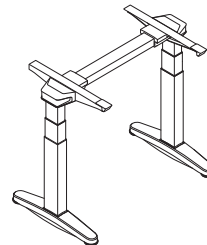
### Managing Technology

Design workstations with computer equipment in mind so that the height-adjustment range of the height-adjustable desk is not impeded because of cables. Consider the addition of a cable riser, cable basket, or cableway to help harness these wires and cables.

### Power

Plan easy and unobstructed access to electrical outlets for computer equipment and height-adjustable desks (when applicable).

AMQ Specification Guide



### **WARNING**

Risk of serious injury.

Bases-only warranty limitations and potential for injury: The use of worksurfaces that do not comply with the AMQ defined criteria and limitations could cause personal injury or property damage due to pinch points, instability, or other problems, and voids all AMQ Warranties, expressed or implied.

The use of worksurfaces that do not comply with AMQ criteria voids any AMQ claims of compliance with ANSI/BIFMA, UL, LEED, or other applicable requirements. The use of non-AMQ worksurfaces on AMQ height adjustable bases may not be accepted as compliant to municipal electrical codes or OSHA federal workplace standards, because this use does not create an NRTL (UL, ETL, etc.) listed product. AMQ is not responsible for the ultimate determinations of compliance for height-adjustable bases with non-AMQ worksurface, and assumes no liability for their compliance with standards when height adjustable bases are used without a AMQ worksurface as intended.

### Worksurface Criteria and Limitations

The use of non-AMQ worksurfaces is not recommended. Any use of a non-AMQ worksurface requires additional investigation by the customer regarding the appropriateness for use. It is the sole responsibility of the customer to determine the suitability and safety of the selected worksurface construction and attachment means. The following information is provided as a guideline, but does not address all potential issues. Customers should seek professional guidance as to the appropriateness of their chosen worksurface.

## Tips

- Height-adjustable bases include fasteners intended for use with AMQ worksurfaces. These fasteners may be suitable for worksurfaces meeting the following criteria: Medium-density or higher particleboard or berboard cores, with High- or Low-Pressure Laminates and backers.
- Thickness of 1" or greater.
- Fasteners located a minimum distance of 1" from any edge.

## Electrical — General

---

We use the USA-based company Byrne Electrical for all our power and data.

The Byrne 8-Trac System and Phase 3 are UL recognized as an Office Furnishing Accessory (UL 1286), and are UL Listed as a Manufactured Wiring System (UL 183) in full compliance with electrical specifications found in the National Electrical Code (NEC). It also complies with municipal standards such as New York, Los Angeles and San Francisco.

To learn more about Byrne, visit their website at [www.byrne-electrical.com](http://www.byrne-electrical.com)



# Electrical — 3 Circuit/5 Wire

The Byrne Phase 3 System is similar to 8-trac system except is a double sided 3-Circuit/5-Wire system. It Includes flexible mesh conduit jumpers (UL1286 only). Also offers multiple circuit configurations selected by the receptacles.

---

## Specifications

UL183 Listed and UL 1286 Recognized in full compliance with National Electric Code (NEC)

3-Phase System

Modular Receptacles

Flexible mesh conduit jumpers (UL1286 only)

Multiple Circuit configurations selected by receptacles

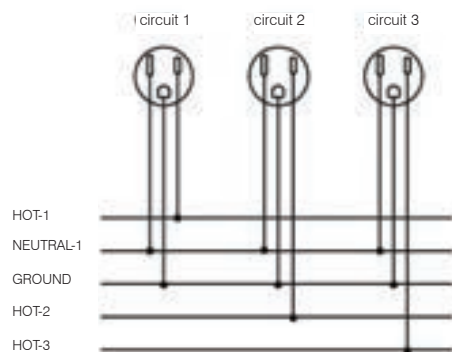
Double-sided system

---



---

## Wire Diagram for 3 Keying



# Electrical — 4 Circuit/8 Wire

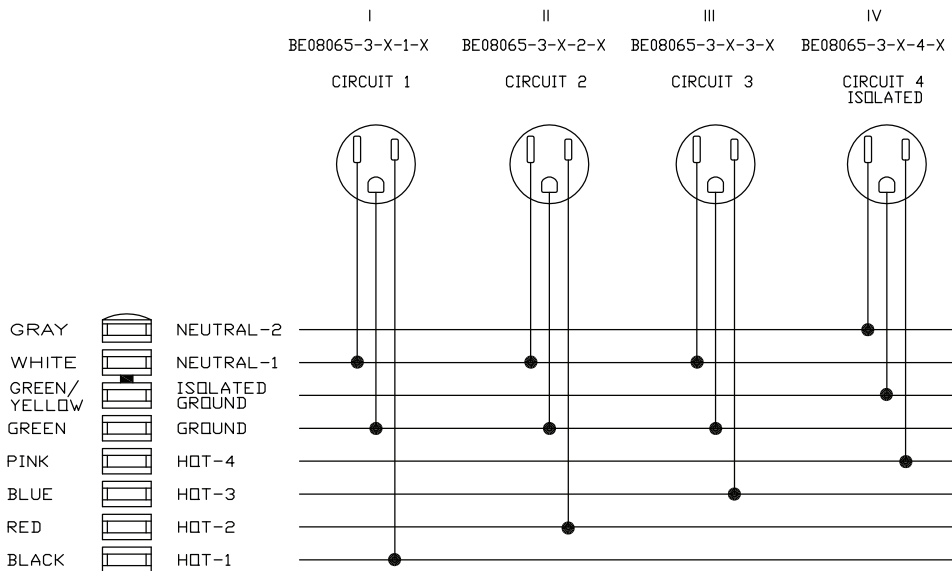
## BYRNE 8-TRAC SYSTEM

The Byrne 8-Trac System is rated for 15 amps allowing the use of 4 circuits with 4 line conductors, 2 neutrals and 2 grounds. Under NEC requirements, up to 13 duplex receptacles maybe used per circuit, with a total of 52 available receptacles if all circuits are used, per single power entry. The line conductors are 12 AWG, and share 12 AWG ground and a 10 AWG neutral. The fourth circuit is isolated and dedicated, and is serviced by its own line conductor, neutral and isolated ground. The Byrne System can be wired in both single and 3-phase configurations, 240/120V, 208/120V respectively. Additionally, a 3 hot, 3 general, 2 ground (3-3-2) wiring system is available.

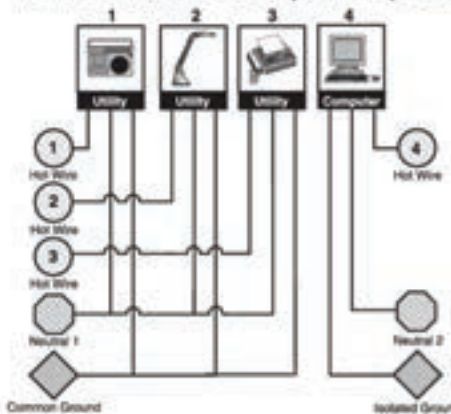
The System accommodates panel applications of 2" to 3½" thick harnesses available from 12" to 1800" in length.

Assemblies are 100% electrically tested to ensure the highest quality and reliability.

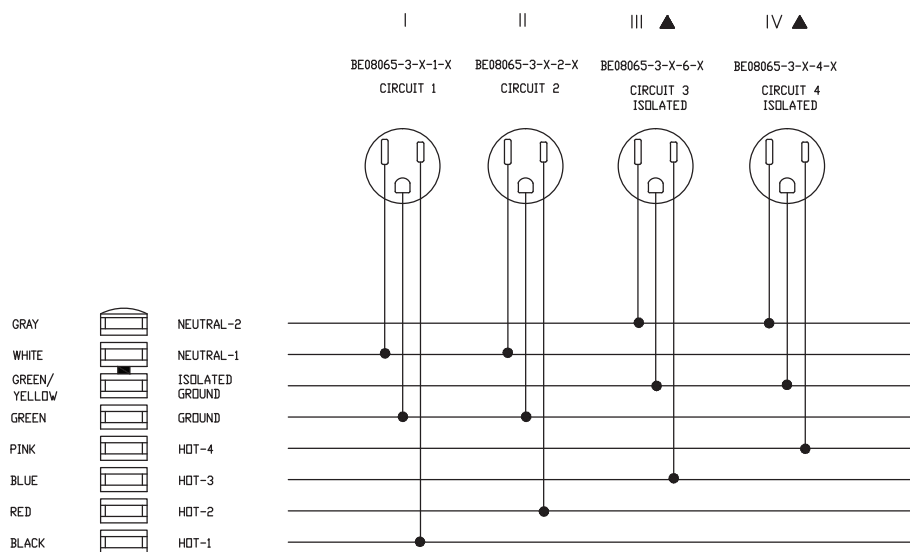
### 3+1



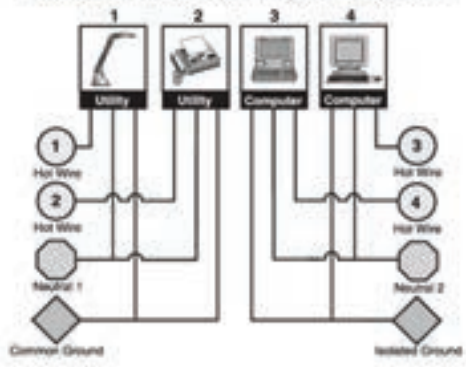
### Four-circuit, 3 + 1 Receptacle Option



2+2 special order



Four-circuit, 2 + 2 Receptacle Option



## General — Unique Electrical Codes

The primary electrical code used in the United States is the National Electrical Code (NEC) (NFPA70). While most states and cities use the NEC as is, some have created their own electrical code using the NEC as the basis for the requirements. There are 3 cities that have unique requirements that directly affect office furnishings installations:

New York, Chicago, and San Francisco. These unique requirements are detailed below.

---

### Chicago

Chicago has their own electrical code based on the NEC.

Chicago does not allow the use of any modular systems. All electrical must be hardwired by a licensed electrician.

The specific wording of the 2009 Chicago Electrical Code is as follows:

**18-27-605.2. General.** Wiring in and on office partitions shall conform to all applicable chapter provisions. Relocatable wired partitions are not considered portable and, as such, plug and jack connections are not acceptable. All wiring is to be contained in listed and labeled electrical raceways and outlet boxes.

(a) Use. Wired relocatable office partitions shall be installed and used only as provided for by this Article. The biggest ambiguity is what product types will require TR receptacle for code compliance applications. For example, the NEC TR code dwelling requirements specify "appliances" as exempt from the scope of TR receptacles. Relocatable Power Taps are often grouped into this category.

Hardwire accessories can be used in Chicago if they have a metallic enclosure. This includes Mho, Assemble, Axil, Glenbeigh, and Wonderbar product lines. These hardwire units can be provided as a Chicago version which includes 15" of conduit and a 4X4 junction box.



---

## New York City

- Allows the use of Office Furnishings Systems (as permitted by Article 605 of the NEC) but requires that licensed electricians install the electrical components into the furniture.
- Does not allow the use of any non-metallic liquid tight conduit.
- Metallic liquid tight conduit can only be 18" long.
- Flexible metal conduit used on infeeds can only be 6' long.
- Does not allow Manufactured Wiring Systems in furniture.

As of 2009, New York City allows the use of Relocatable Power Taps in office environments.

The New York Electric Code exception of Article 604 for Manufactured Wiring Systems includes Article 604(3) Such wiring may only be used for general lighting circuits above the hung ceiling line.

Until now, this statement was interpreted as lighting circuits must be above the ceiling, while other Manufactured Wiring Systems can be used below the ceiling line.

The new official interpretation requested by BIFMA indicates Manufactured Wiring Systems can only be used for lighting and must be above the ceiling. This applies to Byrne 8-Trac, Byrne 4-Trac and Byrne Phase 3 product lines. This interpretation has not been published on the official NYC Codes site even though more recent interpretations have been. BIFMA continues to work on a resolution to this issue.

---

## San Francisco

San Francisco uses the California Electrical Code which in turn uses the NEC. San Francisco has additional / revised requirements that are called out as an addendum to the code. San Francisco does not allow the use of non-metallic liquid tight conduit and only metallic liquid tight conduit is permitted.

### ARTICLE 356 – LIQUIDTIGHT FLEXIBLE NONMETALLIC CONDUIT: TYPE LFNC

- 356.10      Revise the first sentence of this section as follows:  
356.10      Uses Permitted.

LFNC shall be permitted to be used in exposed or concealed locations for systems not exceeding 50 volts for the following purposes:

356.12 Uses Not Permitted

356.12 Revise item 4 of this section as follows:

- (4) Where the operating voltage of the contained conductors is in excess of 50 volts, nominal, except as permitted in 600.32(A).



---

# AMQ Furniture

<b>KINEX</b>	<b>21</b>
<b>ILINE</b>	<b>35</b>
<b>POWER &amp; DATA</b>	<b>47</b>
<b>ACTIV PRO 2.0</b>	<b>53</b>
<b>ACTIV</b>	<b>65</b>
<b>CLUVO</b>	<b>79</b>
<b>AMOBİ</b>	<b>89</b>
<b>CONCUR</b>	<b>121</b>
<b>3F</b>	<b>129</b>
<b>REVI</b>	<b>149</b>
<b>S-SERIES</b>	<b>155</b>
<b>WORK TOOLS</b>	<b>159</b>
<b>TEKTIS</b>	<b>197</b>
<b>EMBANK</b>	<b>279</b>
<b>UPTAKE LOCKERS</b>	<b>379</b>
<b>WEST ELM FURNITURE</b>	<b>401</b>



---

# KINEX

## KINEX

Understanding

**22**

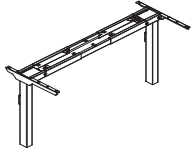
Specifying

**30**

KINEX

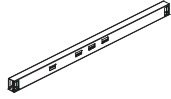
# Statement of Line

## Bases



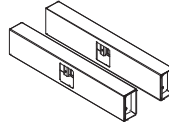
1 Stage/Fixed,  
2 Stage/dual motor,  
3 Stage/dual motor

## Beams



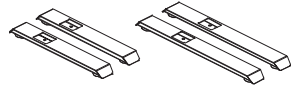
48", 54, 60", 66 and 72"  
*single and double run*

## Crossbeams



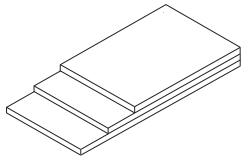
24" and 30"D

## Feet



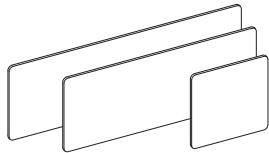
22" and 28" feet  
*single run applications only*

## Worksurfaces

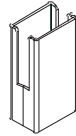


Linear

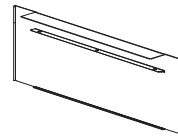
## Privacy Screens & Panels



3F Screens



Screen Mounting Clip

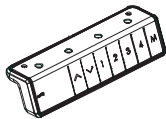


End Panel

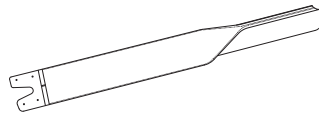
## Accessories



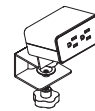
Standard Hand Set



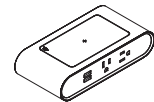
Pre-set Hand Set  
Upgrade



Soft Cable Management



Eco Power Box

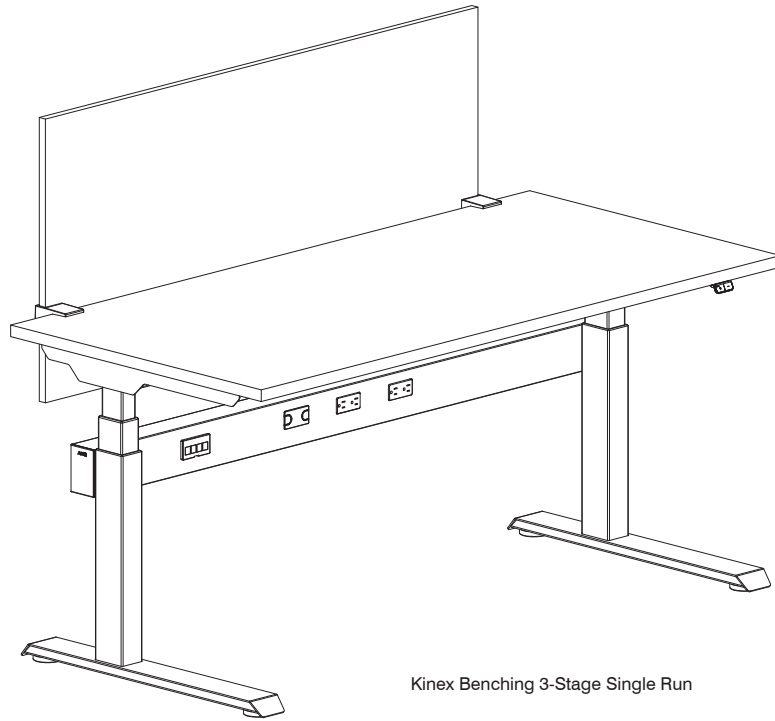


Boost Power Box

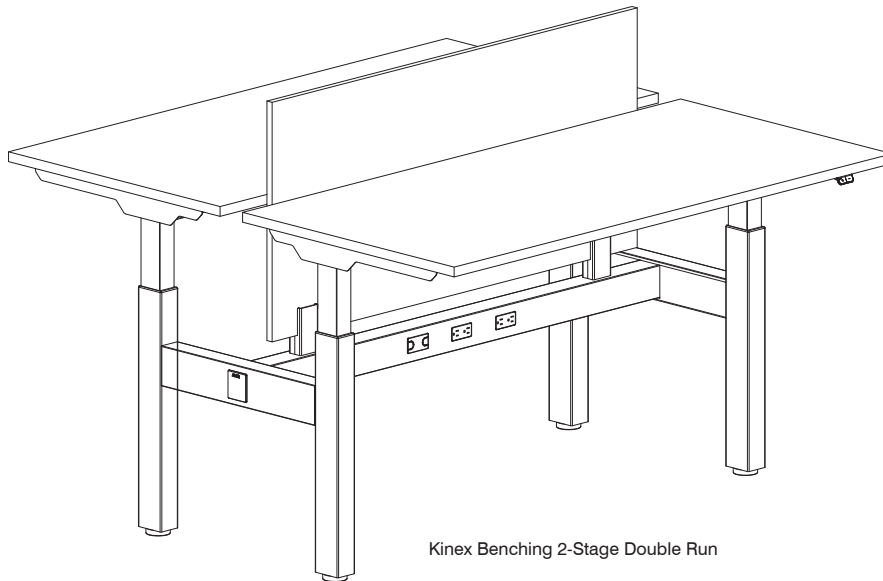


# Typical Configurations

A full gallery of typicals is available on our web site.  
Each typical includes CET file, specifications, rendering and 2D layout.

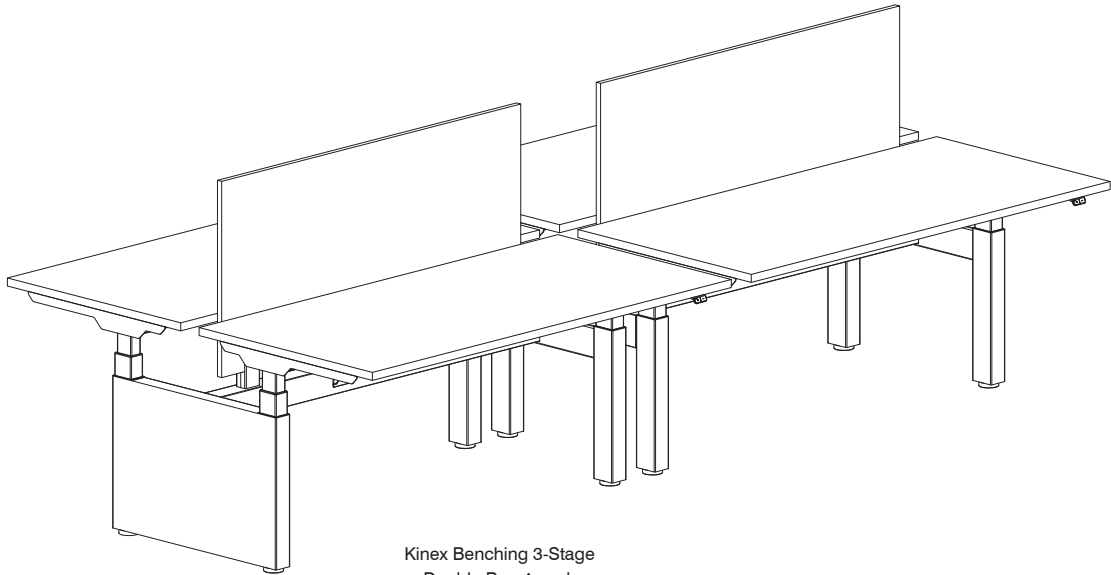


Kinex Benching 3-Stage Single Run

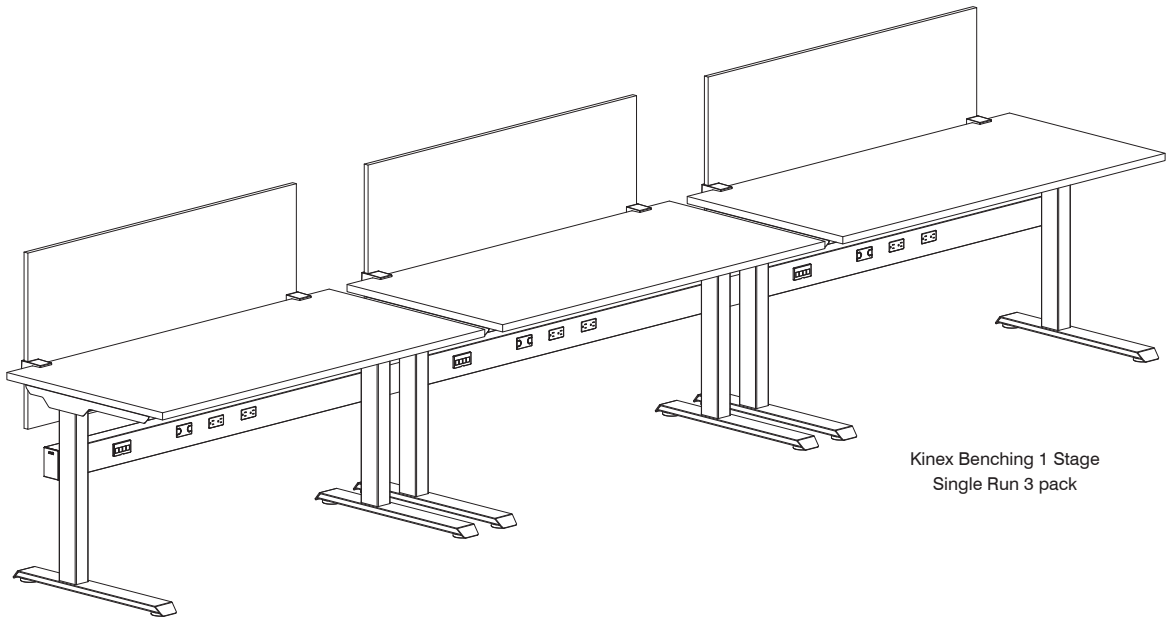


Kinex Benching 2-Stage Double Run





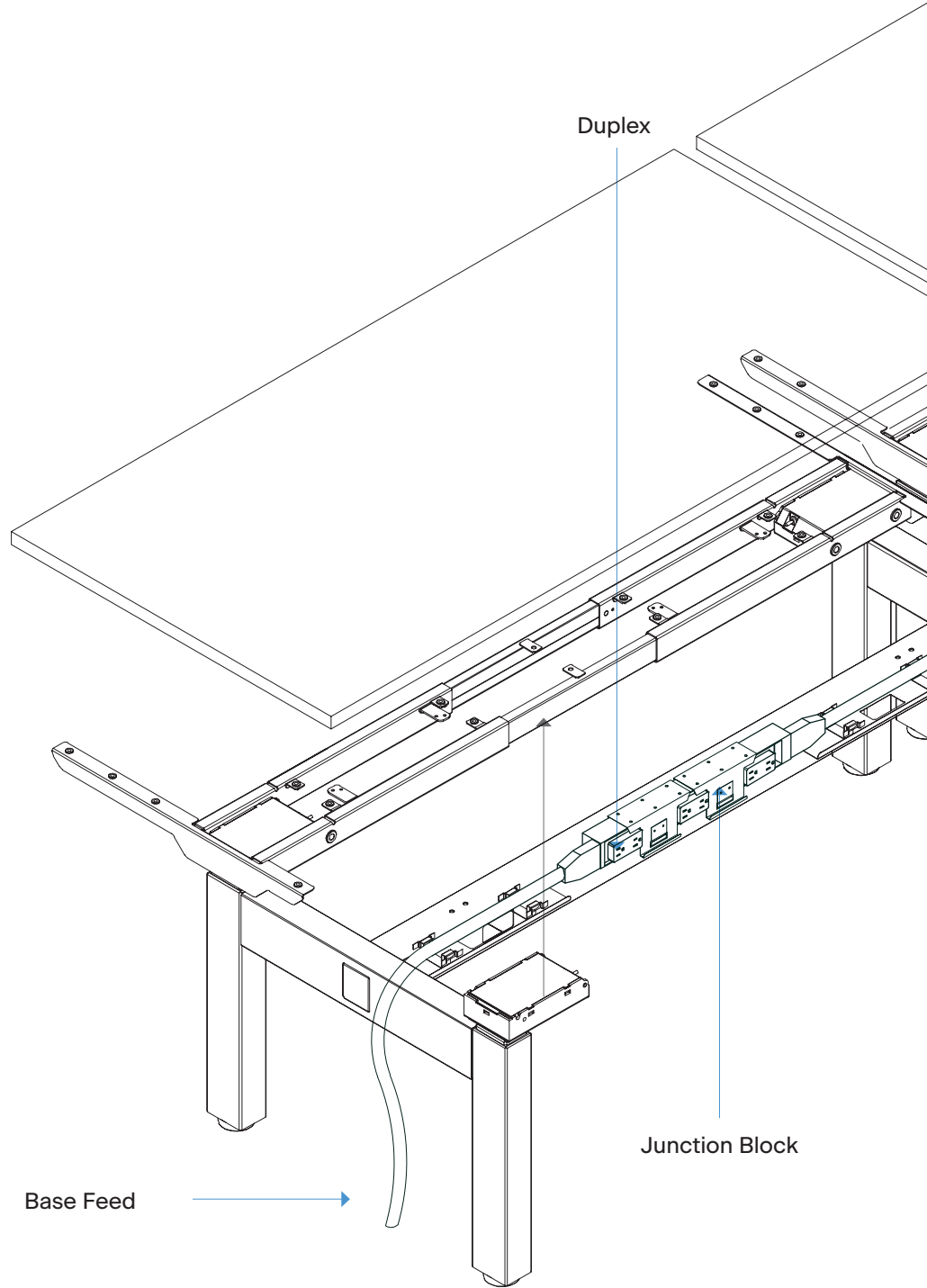
Kinex Benching 3-Stage  
Double Run 4 pack  
with end panel

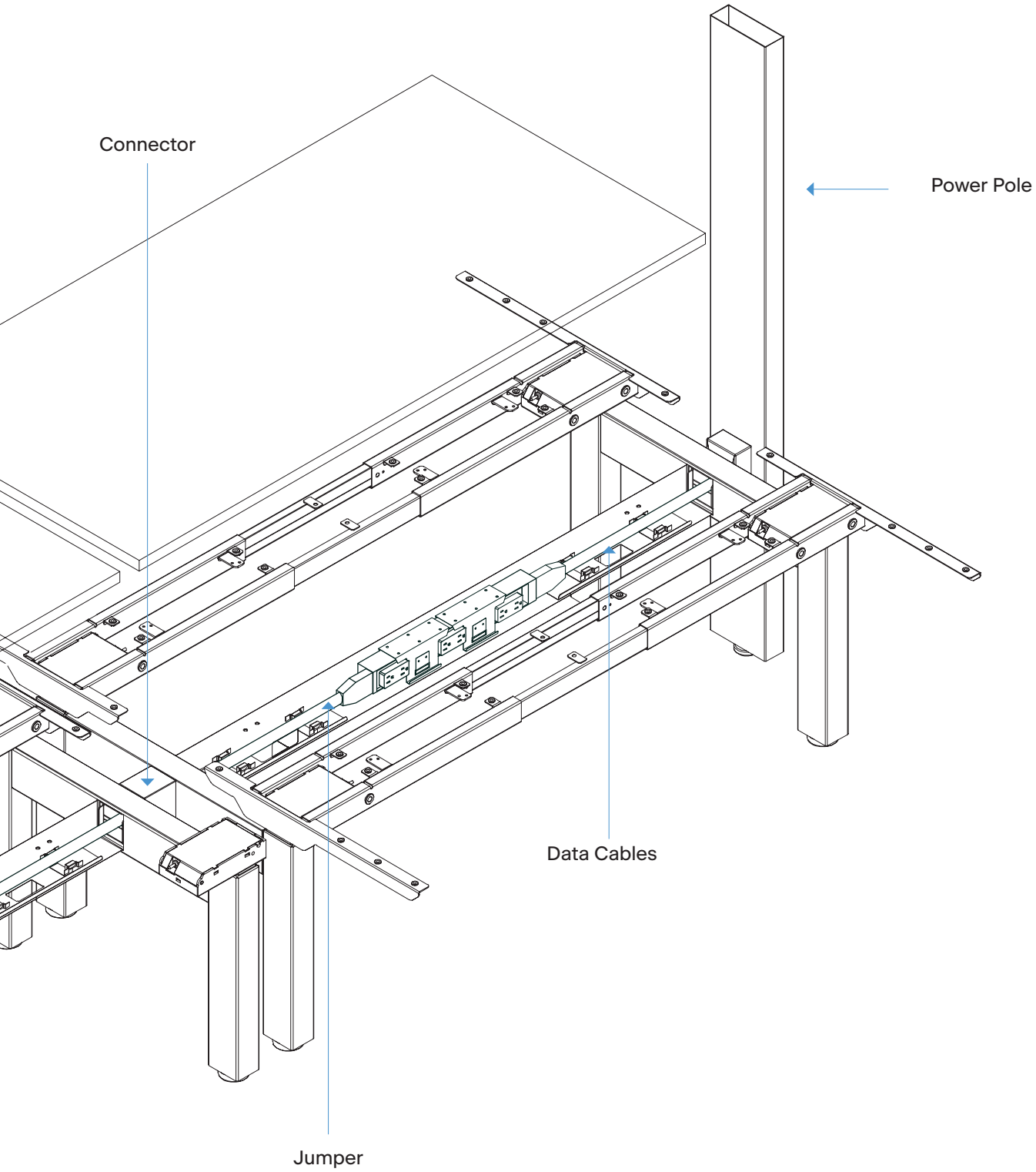


Kinex Benching 1 Stage  
Single Run 3 pack

# Electrical

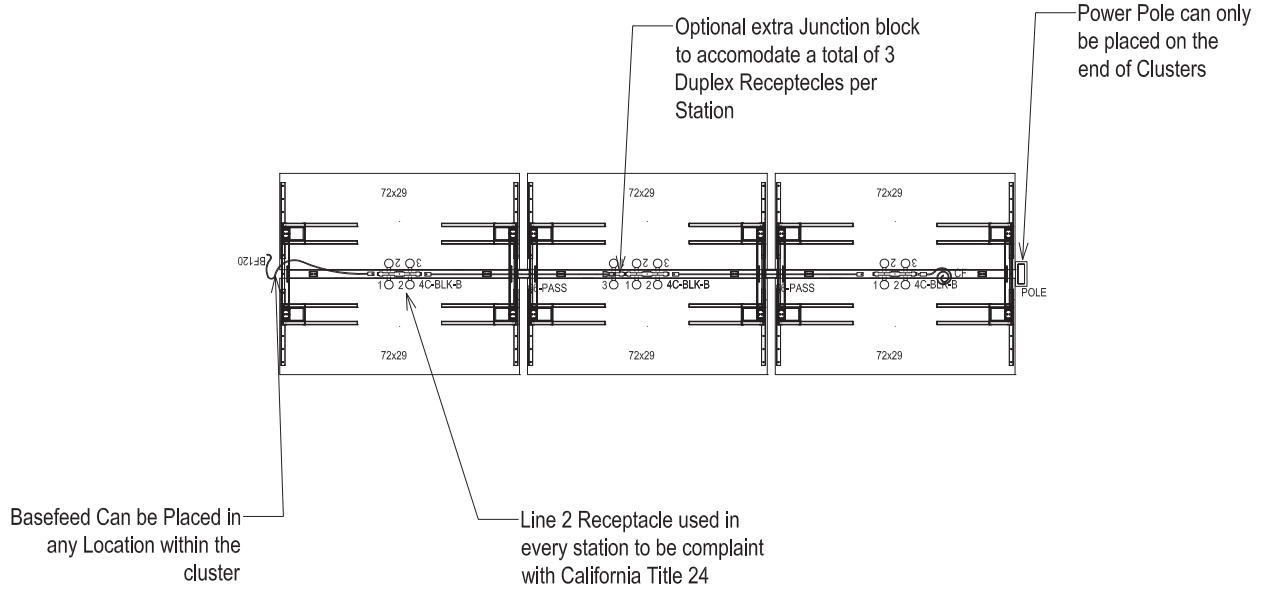
Kinex Benching uses Iline beam technology to distribute power, with either 3 circuit/5 wire or 4 circuit/8 wire electrical.



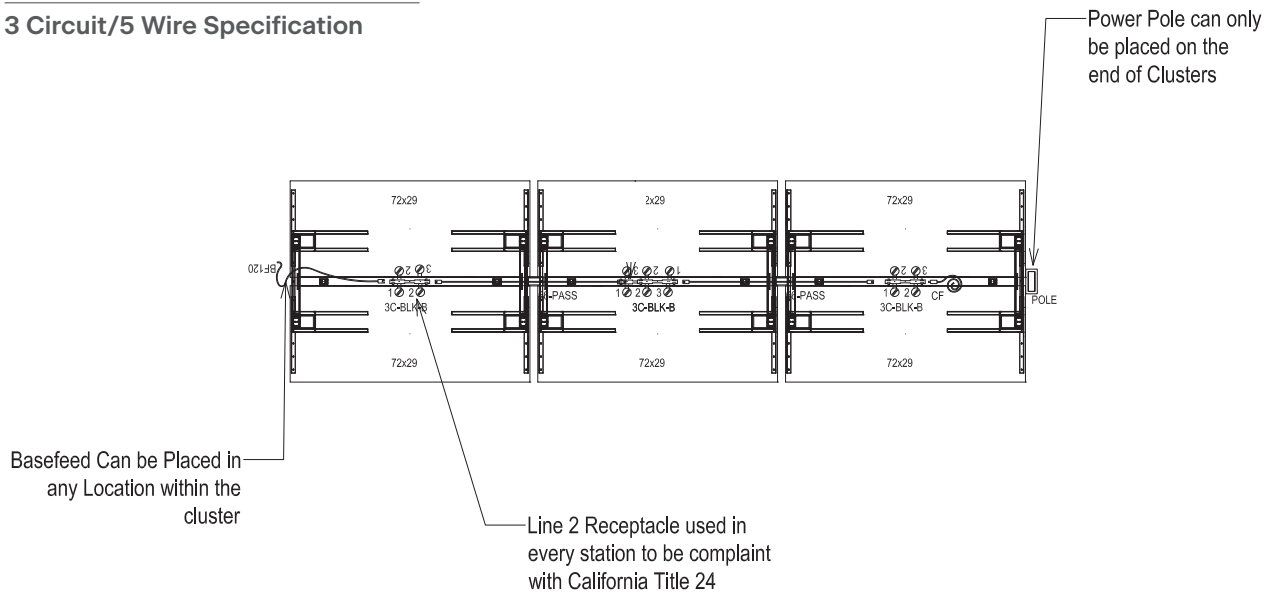


# Electrical

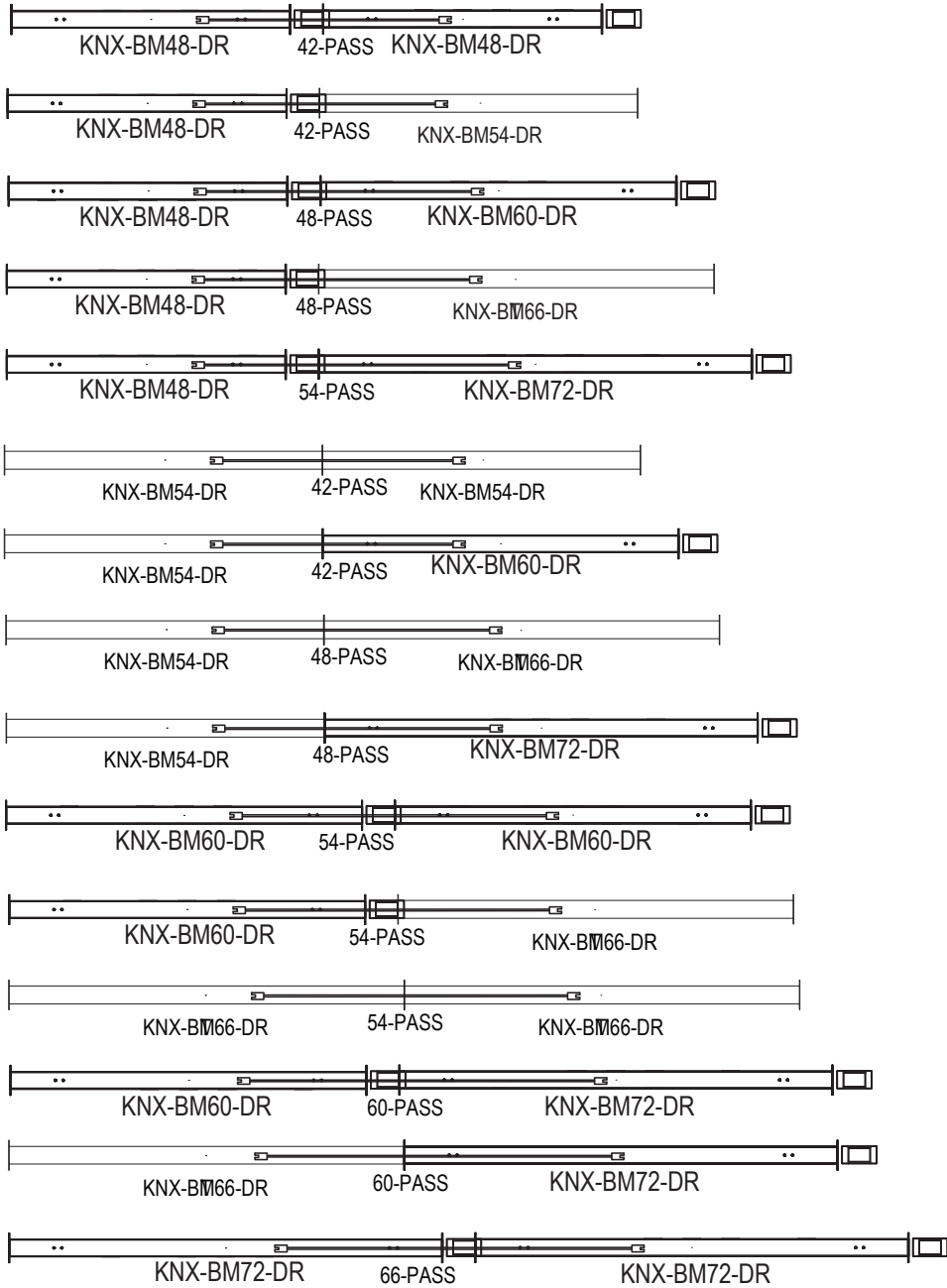
## 4 Circuit/8 Wire Specification



## 3 Circuit/5 Wire Specification



Jumpers — 4 Circuit/8 Wire and 3 Circuit/5 Wire





*Tip: Base supports a maximum distributed weight capacity of 265 pounds. When calculating lifting capacity, subtract the weight of the worksurface.*

*Tip: Actual depths are 23" and 29".*

*Tip: End panel(s) are not available on single-run application.*

*Tip: Fixed height does not have a hand set option or a power cord.*

### Standard Includes

- Fixed or adjustable base:
  - Black
  - Platinum
  - White
- Power beam for single and double run application: includes 2 data faceplates, 2 bottom caps, 6 plastic front covers, 2 plastic side covers, and 1 bridge connector
- Crossbeam for double run application: includes 2 double run plastic side covers
- Benching set of two feet for single run application
- Power cord: 9'
- Attachment hardware
- Laminate worksurface

### Options

Worksurface Finish	Laminate LPL Price Group 01	No cost
Base Finish	Paint	No cost
End Panel Finish	With One End Panel	24"D: +\$223 30"D: +\$247
	With Two End Panels	24"D: +\$446 30"D: +\$494
Hand Set	Standard	No cost
	4 Pre-Set	Single Run: +\$93 Double Run: +\$186

### ► Product Information continued on next page

► **Product Information continued from previous page**

**Specification Information**

Style Number	Dimensions Depth	Base Prices				
		Width				
		48"W	54"W	60"W	66"W	72"W

**KINEX Fixed Desk - Single Run**

<b>KINXBENCH</b>	24"	\$1311	\$1354	\$1392	\$1441	\$1484
	30"	\$1374	\$1417	\$1435	\$1497	\$1533

**KINEX 2 Stage Desk - Single Run**

<b>KINXBENCH</b>	24"	\$2232	\$2275	\$2313	\$2362	\$2405
	30"	\$2295	\$2338	\$2356	\$2418	\$2454

**KINEX 3 Stage Desk - Single Run**

<b>KINXBENCH</b>	24"	\$2368	\$2411	\$2449	\$2498	\$2541
	30"	\$2431	\$2474	\$2492	\$2554	\$2590

**KINEX Fixed Desk - Double Run**

<b>KINXBENCH</b>	24"	\$2412	\$2492	\$2562	\$2647	\$2728
	30"	\$2530	\$2610	\$2640	\$2751	\$2818

**KINEX 2 Stage Desk - Double Run**

<b>KINXBENCH</b>	24"	\$4254	\$4334	\$4404	\$4489	\$4570
	30"	\$4372	\$4452	\$4482	\$4593	\$4660

**KINEX 3 Stage Desk - Double Run**

<b>KINXBENCH</b>	24"	\$4526	\$4606	\$4676	\$4761	\$4842
	30"	\$4644	\$4724	\$4754	\$4865	\$4932



# KINEX

## KINEX



Tip: Base supports a maximum distributed weight capacity of 265 pounds. When calculating lifting capacity, subtract the weight of the worksurface.

Tip: Fixed height does not have a hand set option or a power cord.

### Standard Includes

- Fixed or adjustable base:
  - Black
  - Platinum
  - White
- Power beam for single and double run application: includes 2 data faceplates, 2 bottom caps, 6 plastic front covers, 2 plastic side covers, and 1 bridge connector
- Crossbeam for double run application: includes 2 double run plastic side covers
- Benching set of two feet for single run application
- Power cord: 9'
- Attachment hardware

### Options

Base Finish	Paint	No cost
Hand Set	Standard 4 Pre-Set	No cost Single Run: +\$93 Double Run: +\$186

### Specification Information

Style Number	Dimensions Depth	Base Prices Width				
		48"W	54"W	60"W	66"W	72"W
<b>KINEX Fixed Base - Single Run</b>						
<b>KINXBASE</b>	24"	\$1027	\$1033	\$1039	\$1052	\$1057
	30"	\$1040	\$1046	\$1052	\$1065	\$1070
<b>KINEX 2 Stage Base - Single Run</b>						
<b>KINXBASE</b>	24"	\$1948	\$1954	\$1960	\$1973	\$1978
	30"	\$1961	\$1967	\$1973	\$1986	\$1991
<b>KINEX 3 Stage Base - Single Run</b>						
<b>KINXBASE</b>	24"	\$2084	\$2090	\$2096	\$2109	\$2114
	30"	\$2097	\$2103	\$2109	\$2122	\$2127
<b>KINEX Fixed Base - Double Run</b>						
<b>KINXBASE</b>	24"	\$1844	\$1850	\$1856	\$1869	\$1874
	30"	\$1862	\$1868	\$1874	\$1887	\$1892
<b>KINEX 2 Stage Base - Double Run</b>						
<b>KINXBASE</b>	24"	\$3686	\$3692	\$3698	\$3711	\$3716
	30"	\$3704	\$3710	\$3716	\$3729	\$3734
<b>KINEX 3 Stage Base - Double Run</b>						
<b>KINXBASE</b>	24"	\$3958	\$3964	\$3970	\$3983	\$3988
	30"	\$3976	\$3982	\$3988	\$4001	\$4006





**Standard Includes**

- Laminate worksurface

**Options**

Worksurface Finish                      Laminate LPL Price Group 01                      No cost

**Specification Information**

Style Number	Dimensions Depth	Prices				
		Width				
		48"W	54"W	60"W	66"W	72"W

**KINEX Worksurface**

KINXWORKSURFACE	24"	\$284	\$321	\$353	\$389	\$427
	30"	\$334	\$371	\$383	\$432	\$463

KINEX



**Standard Includes**

- Painted end panel
- Attachment hardware

**Options**

Base Finish                      Paint                      No cost

**Specification Information**

Style Number	End Panel Depth	Prices
--------------	-----------------	--------

**KINEX End Panel**

KINXENDPANEL	24"	\$223
	30"	\$247

# KINEX

KINEX



Tip: Style number comes with two feet.

Tip: For single run application only.

### Standard Includes

- Set of two feet

### Options

Base Finish	Paint	No cost
-------------	-------	---------

### Specification Information

Style Number	Dimensions Depth	Prices
--------------	---------------------	--------

### KINEX Feet

<b>KINXFEEET</b>	24"	\$105
	30"	\$118

### AMQ Kinex Cross Beam

Style Number	List Price
<b>KINXCROSSBEAM</b>	<b>No cost</b>

### Options

Depth	24"	No cost
	30"	No cost
Base Finish	Paint	No cost

### AMQ Kinex Beam

Style Number	List Price
<b>KINXBEAM</b>	<b>No cost</b>

### Options

Width	48"	No cost
	54"	No cost
	60"	No cost
	66"	No cost
	72"	No cost
Base Finish	Paint	No cost
Run Type	Double Run	No cost
	Single Run	No cost

---

# ILINE

## ILINE

Understanding	36
Specifying	46

# Statement of Line

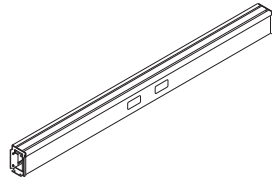
## Frames



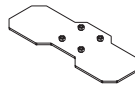
90°/180° Post  
(2-way, 3-way, 4-way)



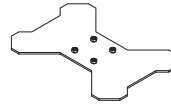
120° Post  
(3-way)



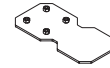
Beam



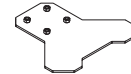
DR End Foot



DR Center Foot

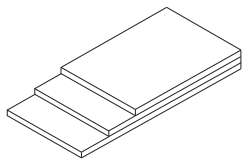


SR End Foot

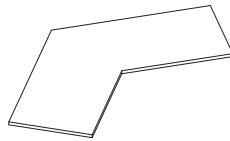


SR Center Foot

## Worksurfaces

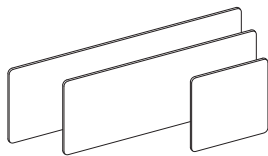


Linear



120°  
with ACTIV PRO 3

## Privacy Screens & Panels



3F Screens

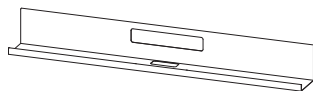


Screen Mounting Clip

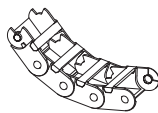


Kinex Screen Mounting Clip

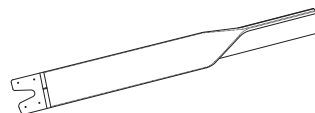
## Accessories



Iline Wire Tray



Cable Management Track

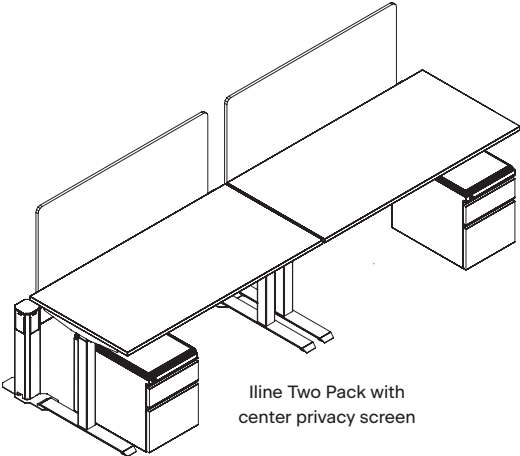


Soft Cable Management

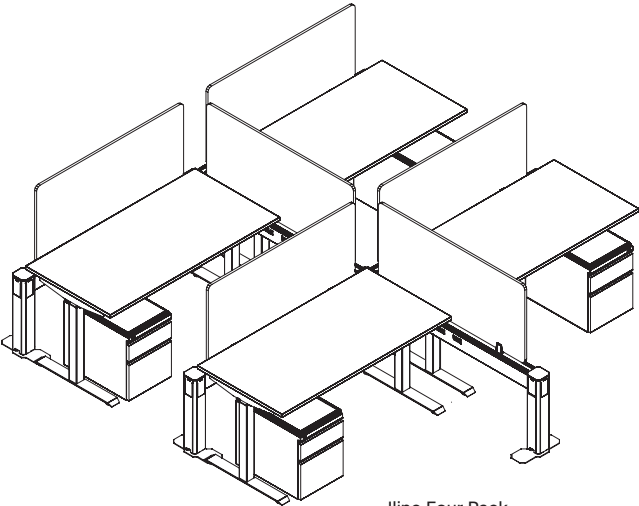


# Typical Configurations

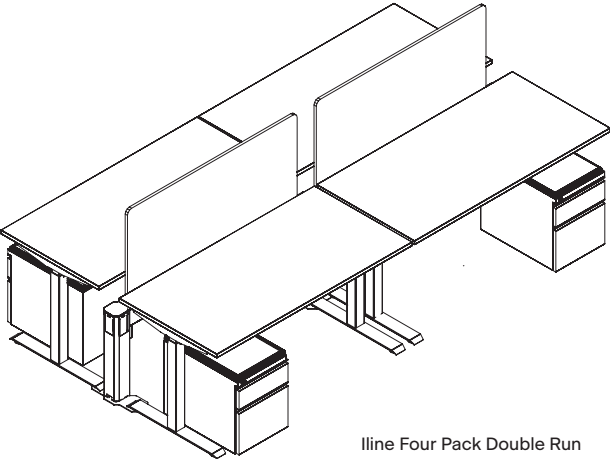
A full gallery of typicals is available on our web site.  
Each typical includes CET file, specifications, rendering and 2D layout.



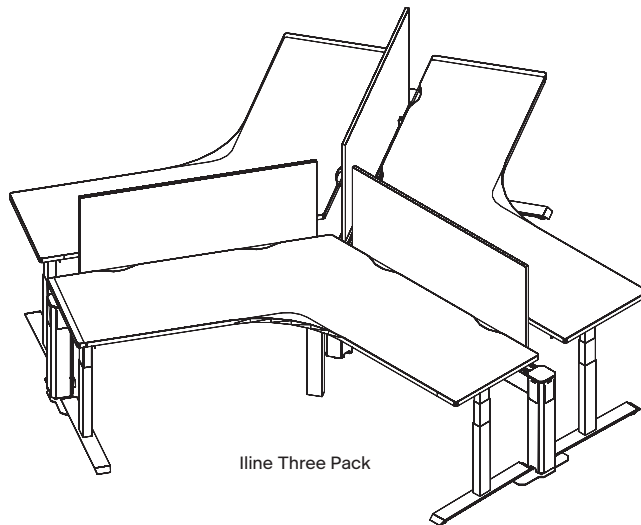
Iline Two Pack with center privacy screen



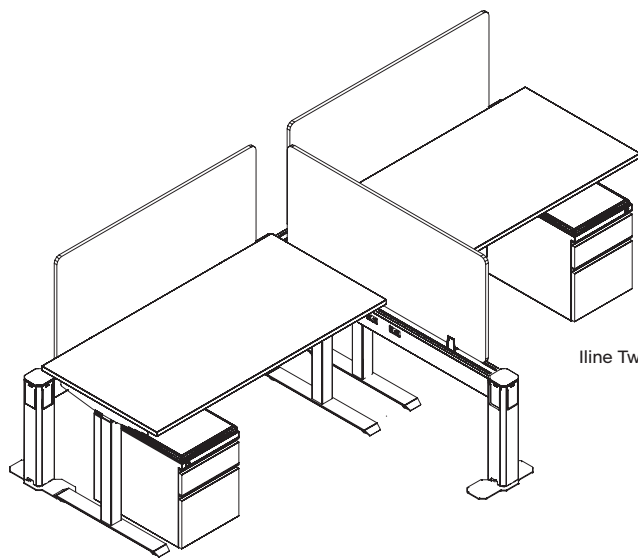
Iline Four Pack



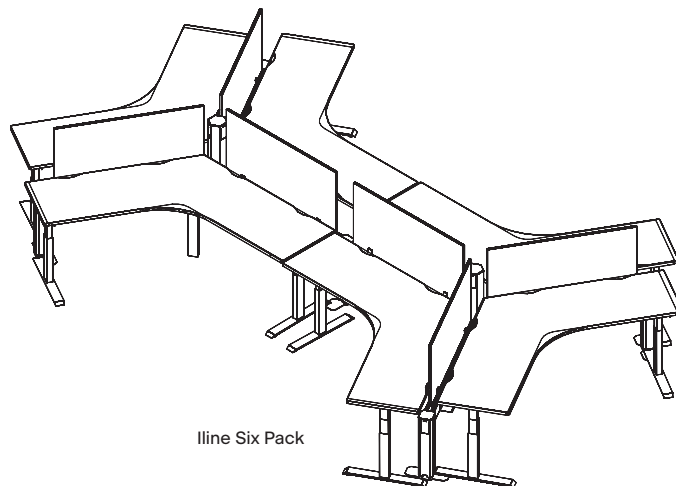
Iline Four Pack Double Run



iline Three Pack



iline Two Pack Single Run

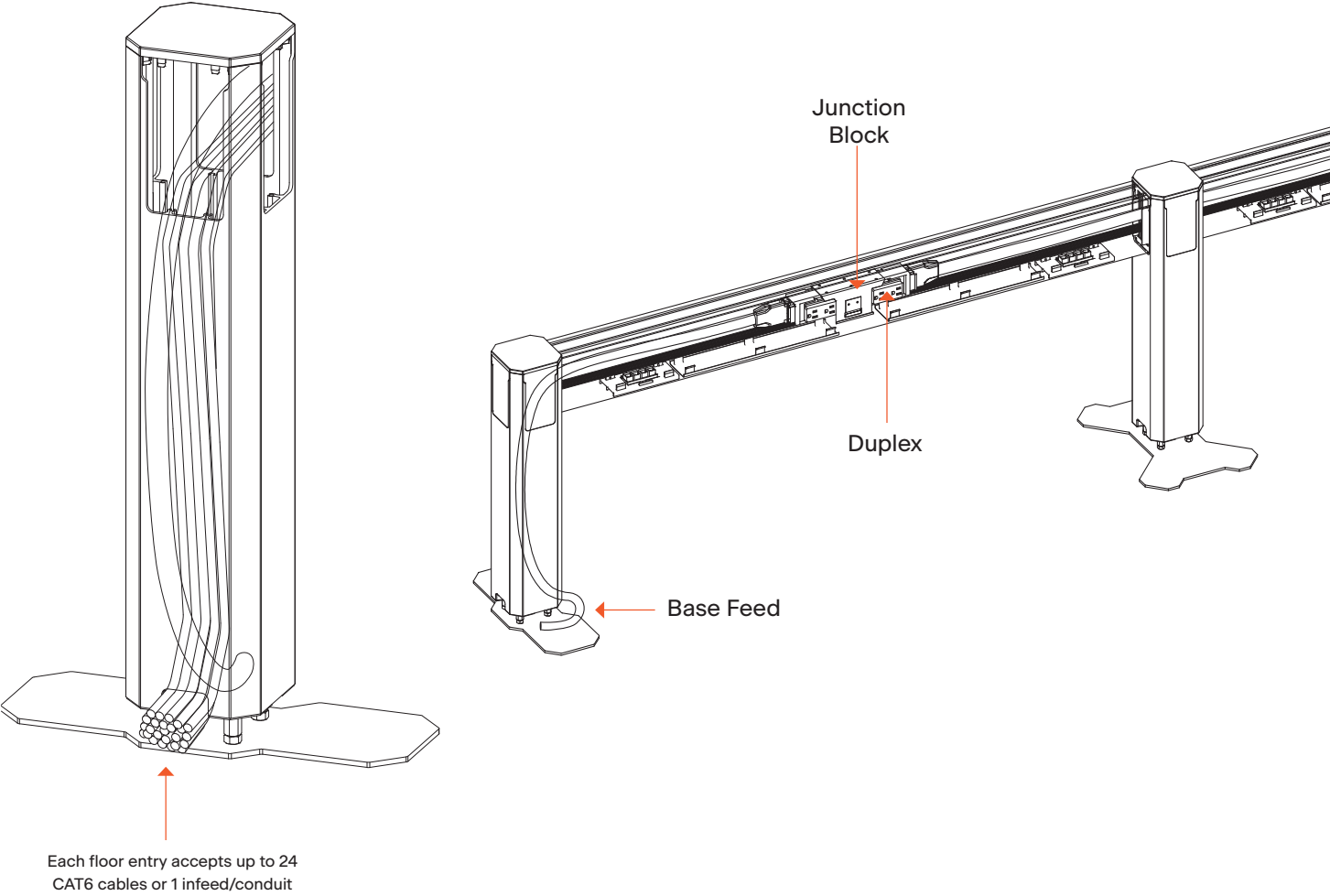


iline Six Pack

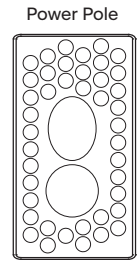
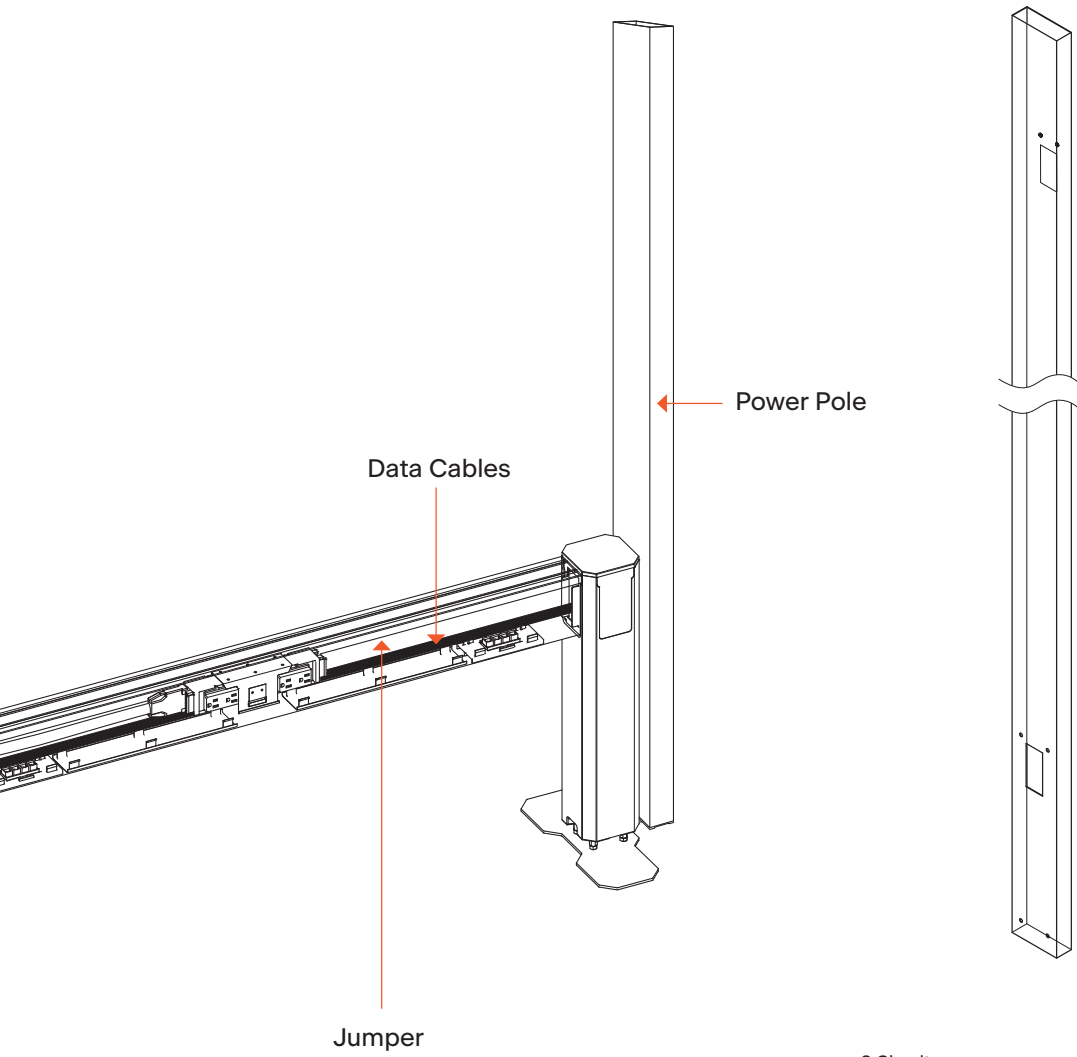
# Electrical

iLINE beam technology distributes electrical with either 3 circuit/5 wire or 4 circuit/8 wire.

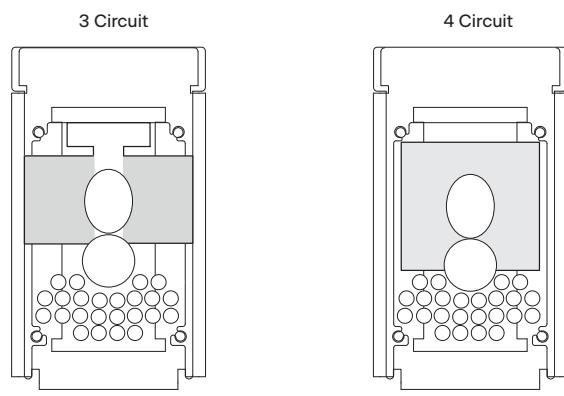
iLine power/data beam







Can accept  
42 CAT6 cables,  
1 conduit and  
1 infeed

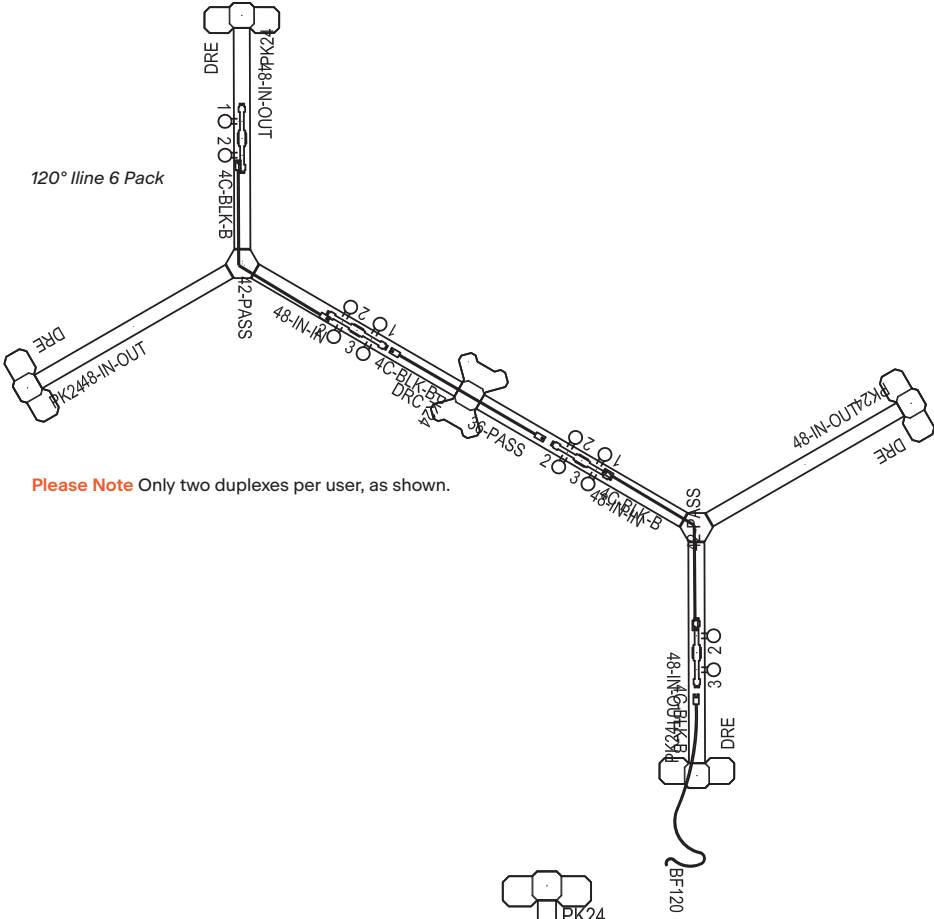


Accepts 24 CAT6 cables, 1 conduit and 1 infeed

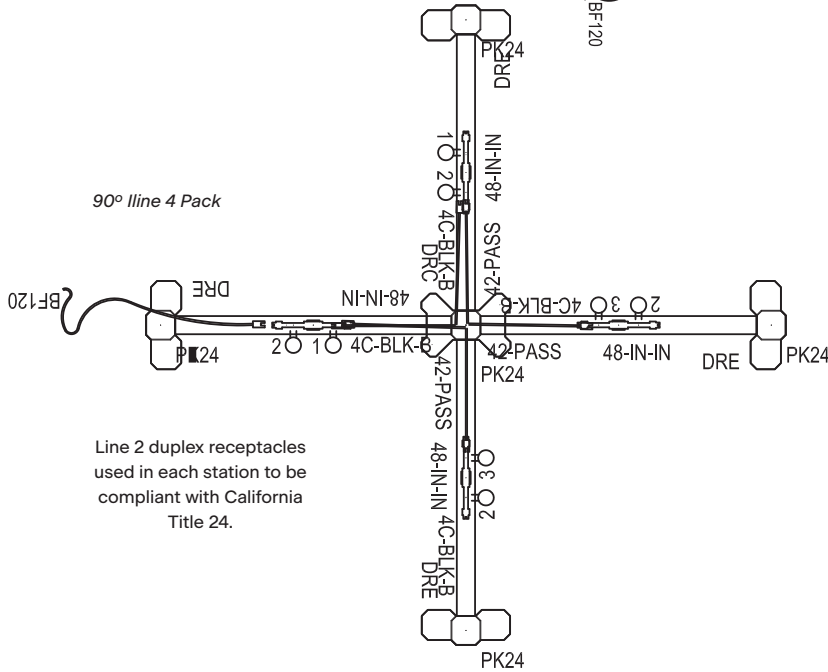
# Electrical

Examples of how to specify ILINE in 3 different configurations.

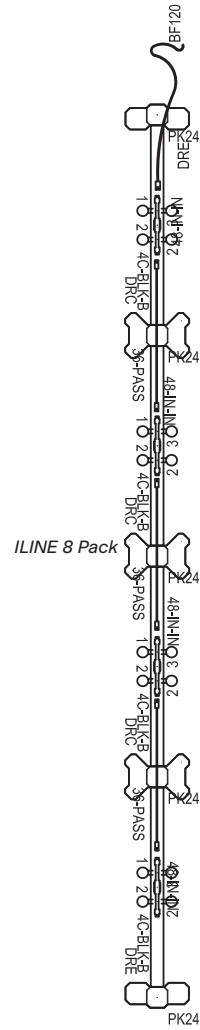
## 4 Circuit/8 Wire



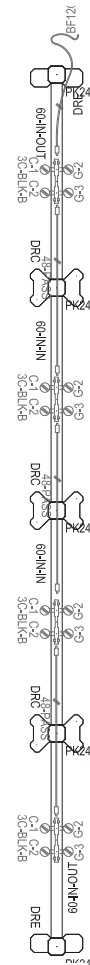
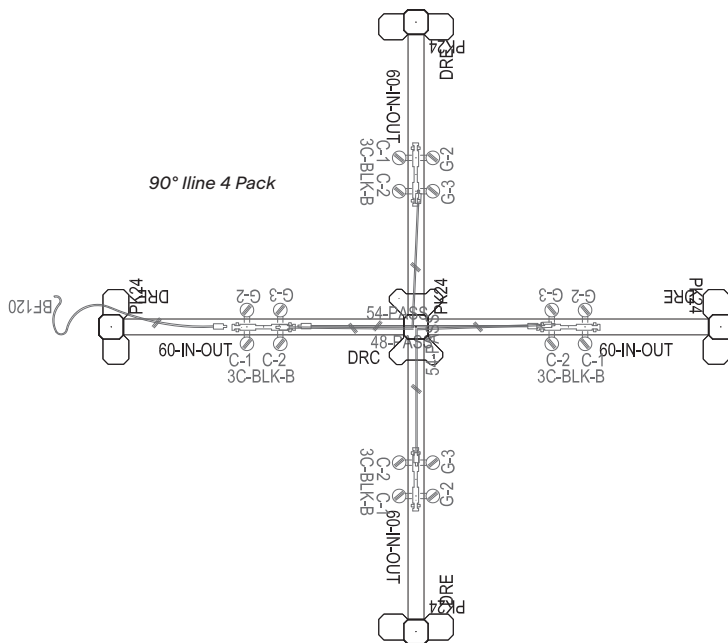
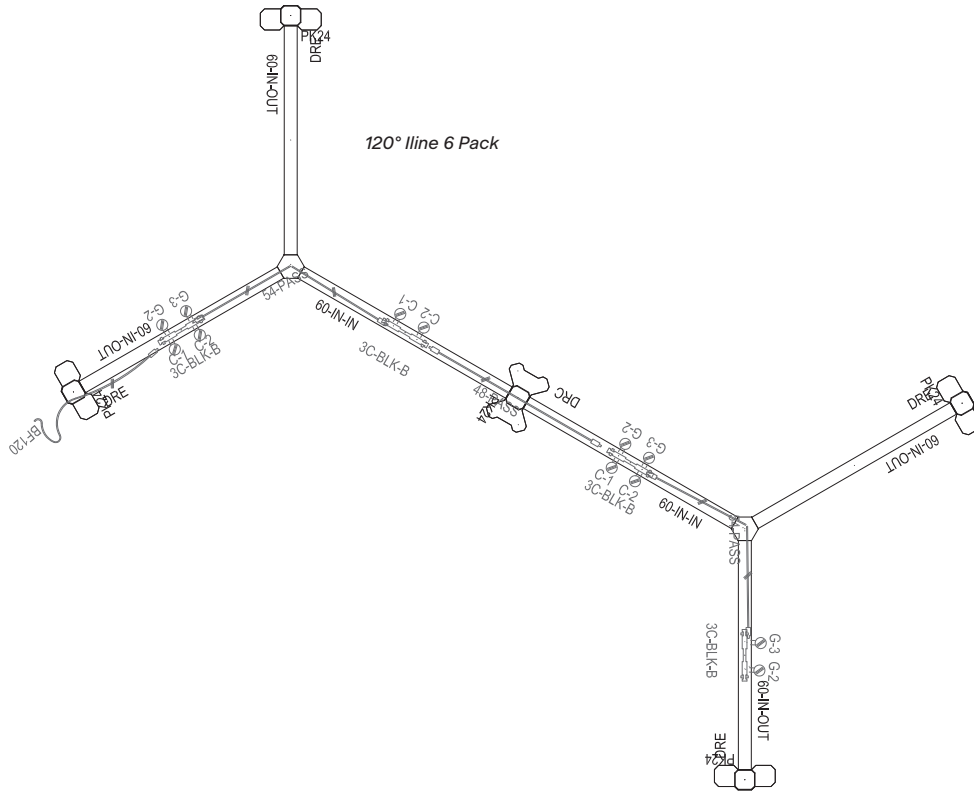
Please Note Only two duplexes per user, as shown.



Line 2 duplex receptacles used in each station to be compliant with California Title 24.



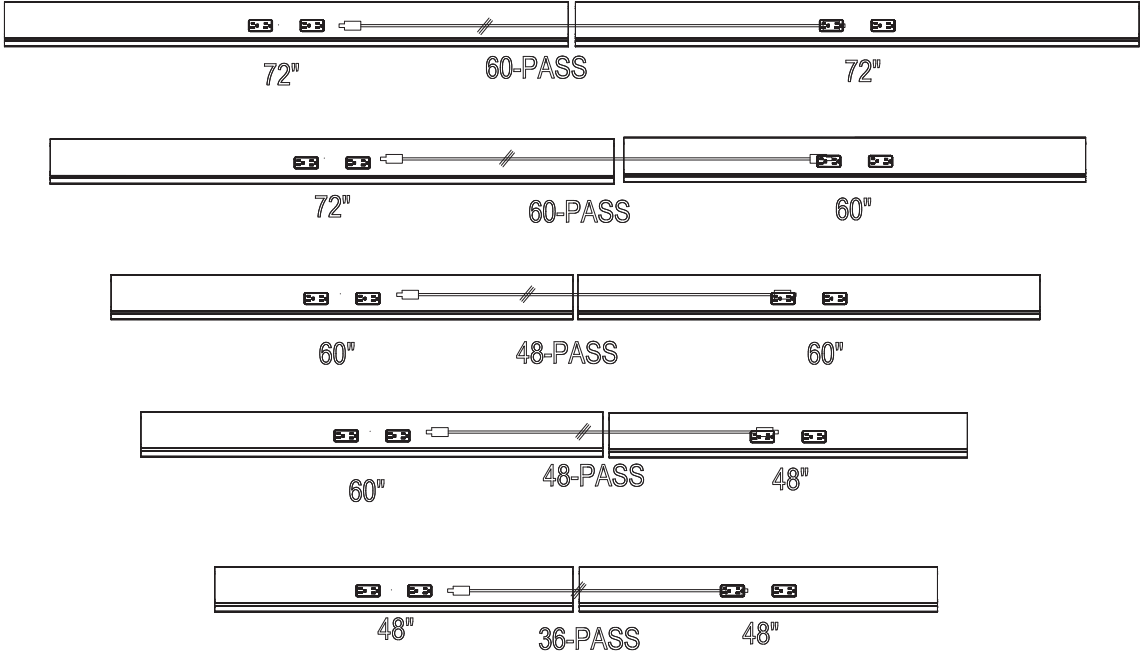
### 3 Circuit/5 Wire



Iline power/data beam

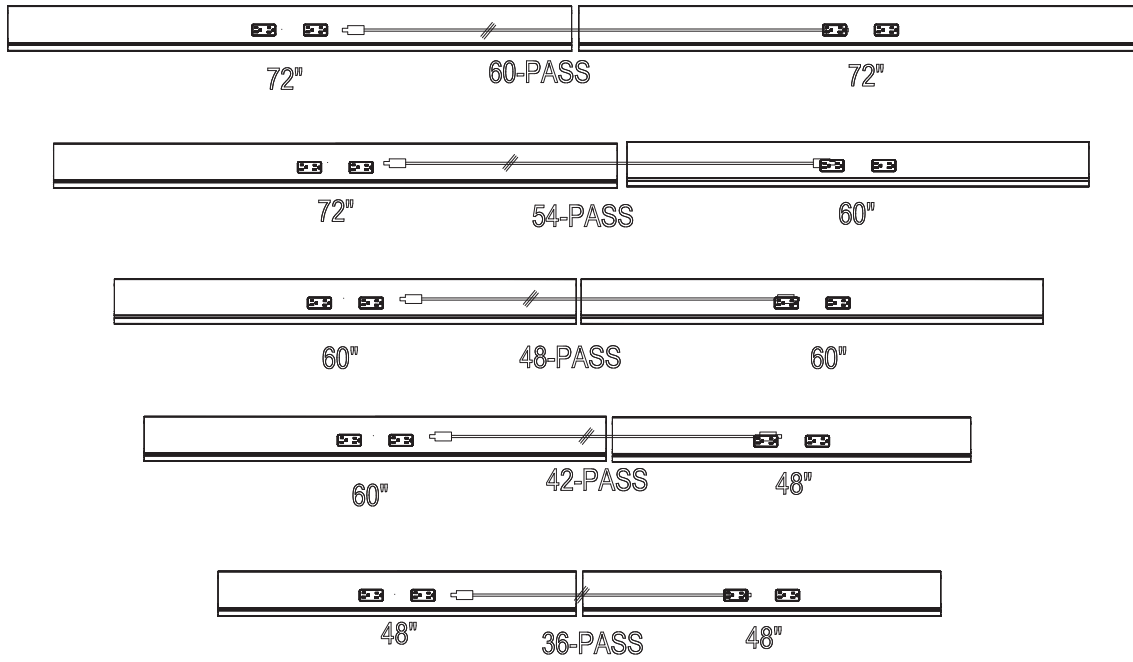
# Electrical

## Jumpers (4 Circuit/8 Wire)



iline power/data beam

Jumpers (3 Circuit/5 Wire)



# ILINE

## ILINE



### Standard Includes

- 2 beam plates, 2 bridge connectors, 2 receptacle covers, 2 data adapters with data faceplates and hardware

### Options

Frame Finish	Paint	No cost
--------------	-------	---------

### Specification Information

Style Number	Prices
	Width
	48"W 60"W 72"W

### ILINE Beam

<b>ILNEBEAM</b>	\$452	\$512	\$576
-----------------	-------	-------	-------



### Standard Includes

- Post top cap, post, hardware, and 3 plastic side covers
- Base plate, glides, and hardware

### Options

Frame Finish	Paint	No cost
--------------	-------	---------

### Specification Information

Style Number	Prices
	90/180 Degree 120 Degree

### ILINE Post Kit

<b>ILNEPOST</b>	\$339	\$353
-----------------	-------	-------



### Standard Includes

- Base plate and hardware

### Options

Frame Finish	Paint	No cost
--------------	-------	---------

### Specification Information

Style Number	Prices
	End Foot Center Foot

### ILINE Base Kit - Single Run

<b>ILNEBASE</b>	\$87	\$99
-----------------	------	------

### ILINE Base Kit - Double Run

<b>ILNEBASE</b>	\$105	\$124
-----------------	-------	-------

---

# Power & Data

Specifying

48

# Power & Data



### Standard Includes

- ILINE attachment bracket

### Options

Frame Finish	Paint	No cost
--------------	-------	---------

### Specification Information

Style Number      Price

## ILINE Power Pole

**ILNEPOWERPOLE** \$512



### Standard Includes

- Painted power pole
- Attachment hardware

### Options

Run Type	Double Run	No cost
	Single Run	No cost

### Specification Information

Style Number      Price

## KINEX Power Pole

**KINXPOWERPOLE** \$512



### Standard Includes

- Power entry

### Specification Information

Style Number      Prices  
                          Base Feed    Ceiling Power Pole    New York City Base Feed    San Francisco Base Feed

## Power Entry

### PWRENTRY

3-Circuit	\$254	\$303	\$339	\$334
4-Circuit	\$339	\$371	\$408	\$427

*Tip: Used on both ILINE and KINEX desks and bases.*





Tip: Used on both ILINE and KINEX desks and bases.

**Standard Includes**

- Power entry

**Specification Information**

Style Number      Price

**72" 3-Circuit Corded Power Entry Base Feed**

**X-E3-BF-CD72**    \$257

**72" 4-Circuit Corded Power Entry Base Feed**

**X-E4-BF-CD72**    \$210



**Standard Includes**

- Double sided double junction block
- 2 junction block brackets

**Specification Information**

Style Number                      Circuit      Prices

**KINEX Double Sided Double Junction Block**

**KINXDBLJUNCTIONBLK**    3-Circuit    \$143

4-Circuit    \$186



**Standard Includes**

- Double sided single junction block
- Junction block bracket

**Specification Information**

Style Number                      Price

**KINEX Double Sided Single Junction Block**

**KINXSGLJUNCTIONBLK**    \$173

# Power & Data



### Standard Includes

- Double sided junction block

### Specification Information

Style Number	Price
	3-Circuit 4-Circuit

### ILINE Double Sided Junction Block

<b>PWRJUNCTIONBLK</b>	\$143	\$186
-----------------------	-------	-------



### Standard Includes

- Power supply

### Options

Frame Finish	Paint	No cost
--------------	-------	---------

### Specification Information

Style Number	Price

### ILINE Chicago Power Box

<b>ILNECHIPWR</b>	\$329
-------------------	-------



### Standard Includes

- Power supply

### Options

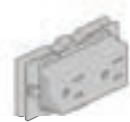
Base Finish	Paint	No cost
-------------	-------	---------

### Specification Information

Style Number	Price

### KINEX Chicago Power Box

<b>KINXCHIPWR</b>	\$329
-------------------	-------



**Standard Includes**

- Power supply

**Options**

Receptacle Finish	Plastic	No cost
Circuit	3-Circuit	No cost
	4-Circuit	No cost
Receptacle Option	Line 1	No cost
	Line 2	No cost
	Line 3	No cost
	Line 4	No cost

**Specification Information**

Style Number                      Price

**KINEX Power C Receptacle**

**PWRCRECEPTACLE**    \$37



**Standard Includes**

- Power supply

**Options**

Receptacle Finish	Plastic	No cost
Circuit	3-Circuit	No cost
	4-Circuit	No cost
Receptacle Option	Line 1	No cost
	Line 2	No cost
	Line 3	No cost
	Line 4	No cost

**Specification Information**

Style Number                      Price

**ILINE G-Power**

**PWRGRECEPTACLE**    \$37

Power & Data

# Power & Data



Tip: Used on both ILINE and KINEX desks and bases.

### Standard Includes

- Adjustable jumper

### Specification Information

Style Number	Circuit Type	Prices						
		36"W	42"W	48"W	54"W	60"W	66"W	72"W

### Adjustable Jumper Adapter

PWRJUMPER	Circuit	Price						
		36"W	42"W	48"W	54"W	60"W	66"W	72"W
	3-Circuit	\$105	\$111	\$118	\$124	\$129	\$136	\$148
	4-Circuit	\$154	\$161	\$179	\$186	\$198	\$204	\$223



Tip: Used on both ILINE and KINEX desks and bases.

### Standard Includes

- Power connector

### Specification Information

Style Number	Price
--------------	-------

### 3-Circuit Y Connector

<b>X-E3-YC</b>	\$37
----------------	------

---

# ACTIV PRO 2.0

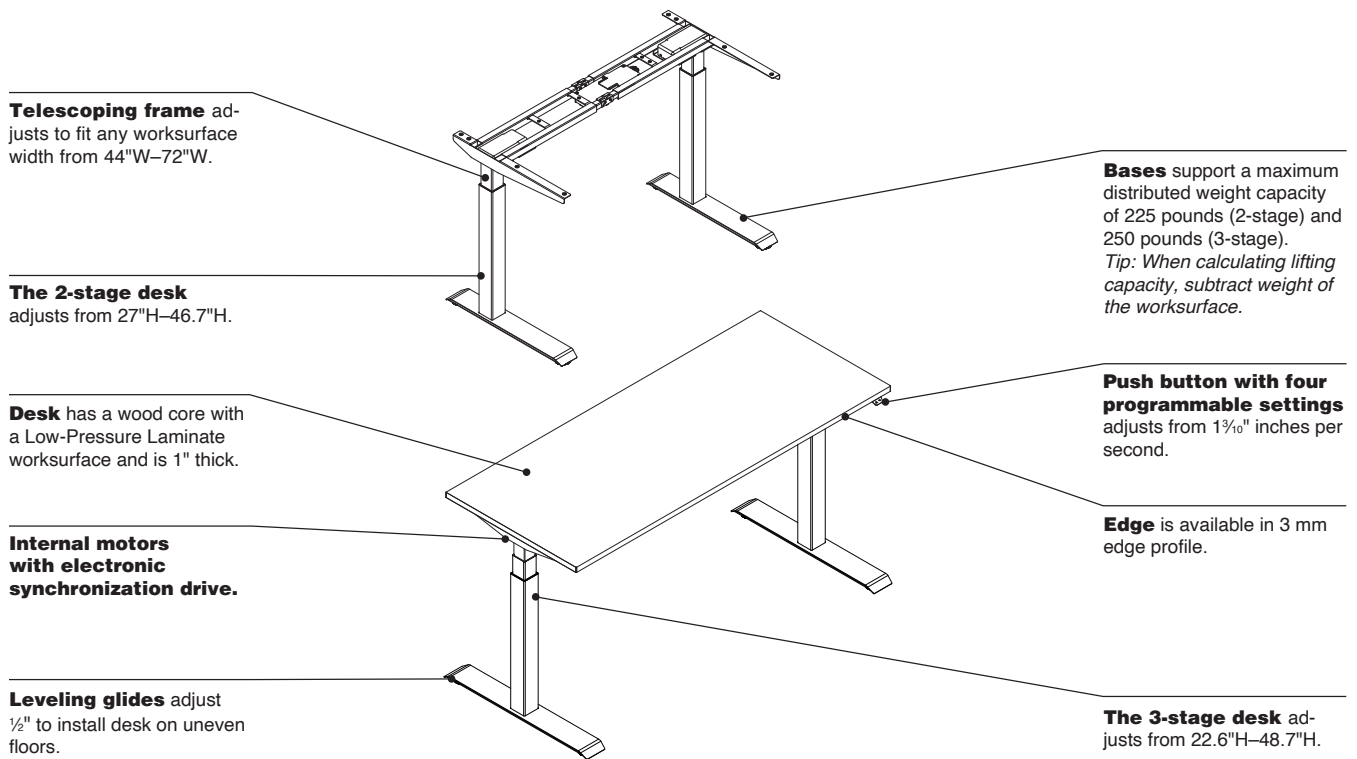
---

## ACTIV PRO 2.0

Understanding	54
Specifying	62

# ACTIV PRO 2.0 Height-Adjustable Desks and Bases

**ACTIV PRO 2.0** supports wellbeing at work by allowing users to move between seated and standing postures throughout the workday.  
► Specifying, page 62



**Telescoping frame** adjusts to fit any worksurface width from 44"W–72"W.

**The 2-stage desk** adjusts from 27"H–46.7"H.

**Desk** has a wood core with a Low-Pressure Laminate worksurface and is 1" thick.

**Internal motors with electronic synchronization drive.**

**Leveling glides** adjust  $\frac{1}{2}$ " to install desk on uneven floors.

**Bases** support a maximum distributed weight capacity of 225 pounds (2-stage) and 250 pounds (3-stage).  
*Tip: When calculating lifting capacity, subtract weight of the worksurface.*

**Push button with four programmable settings** adjusts from  $1\frac{3}{10}$ " inches per second.

**Edge** is available in 3 mm edge profile.

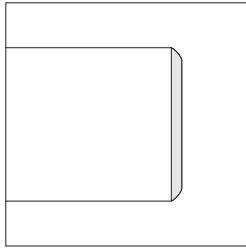
**The 3-stage desk** adjusts from 22.6"H–48.7"H.

**ACTIV PRO 2.0** offers both T- and C-leg configuration for the rectangle desk.

## Product Details

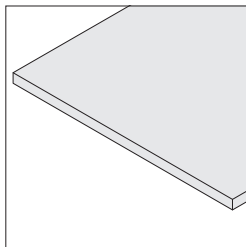
### Low-Pressure Laminate

**Front (user's) edge profile** is available in 3 mm edge profile.



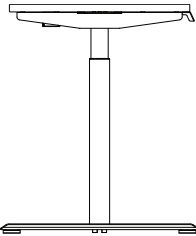
**PVC-free, 3 mm edge profiles with matching 1 mm side and back edges** are also PVC-free. ▶ See *Surface Materials* in this book for specific PVC-free availability, page 513.

**Edge profile finishes** always match laminate finishes.

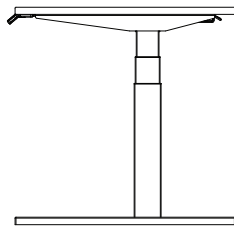


**Square corners** are standard and have 90° corners on all four sides.

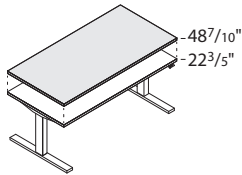
**Overhang** is available. The maximum overhang available as a standard option is 15"W.



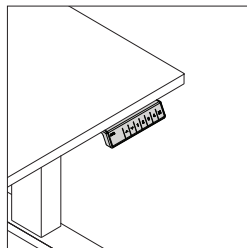
**T-leg configuration** is available on ACTIV PRO 2.0 in 23"/24" and 29"/30" depth worksurface options.



**C-leg configuration** is available on ACTIV PRO 2.0 in 23"/24" and 29"/30" depth worksurface options.



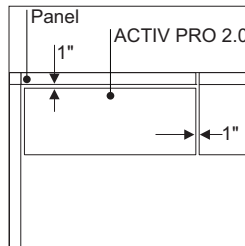
**ACTIV PRO 2.0** 3-stage desk adjusts from 22<sup>3</sup>/<sub>5</sub>"H–48<sup>7</sup>/<sub>10</sub>"H, while the 2-stage desk adjusts from 27"H–46<sup>7</sup>/<sub>10</sub>"H in any increment.



**4 pre-set programmable controller** allows users to set the seated and standing height positions or pre-set heights for multiple users. When activated, the digital display will show the height of desk.

**Obstruction sensing technology** is standard with all ACTIV PRO 2.0 desks. The worksurface will backtrack when it makes contact with an object.

**Casters** are available as an option on ACTIV PRO 2.0. The front two casters lock while the back two casters do not.



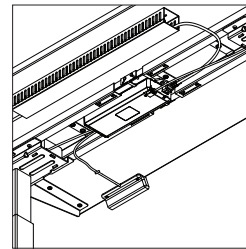
**Rectangle desk sizes** are listed in actual dimensions to allow for 1" gap to adjacent furniture eliminating any pinch points.

## Wiring and Cabling

**Electric motor with whisper quiet operation** adjusts at 1<sup>3</sup>/<sub>10</sub>" per second. Motor is 24V DC and includes a 9' power cord. Motor for 2-leg desk has a 0.2W standby power.

**ACTIV PRO 2.0 desks and bases** are listed by ETL. ▶ See page 58

**Power and data strips** are field-installed on worksurface. Specify appropriate attachment bracket depending on application. ▶ See page 159 for *Work Tools*.



**Cable management** includes a simple wire tray that screws to the worksurface to help manage desk cables.

## Surface Materials

### Low-Pressure Laminate Desk

24L0	Graphite Walnut
25L5	Virginia Walnut
25L8	Clear Walnut
26L1	Natural Cherry
2L09	Clear Maple
2L30	Arctic White
2L83	Seagull
2L84	Milk White
2LAW	Ash Wenge
2LCN	Clay Noce
2LCW	Clay Wenge
2LAK	Clear Oak
2LAT	Acacia

### 3 mm edge profile

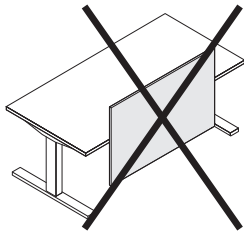
- Plastic

### Height-adjustable base

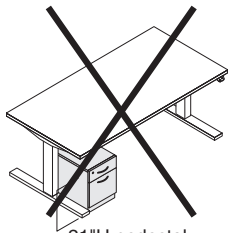
F1	Platinum
F2	White
F3	Black
F4	Merle

**Application Topics**

**Moving desks** can collide with other components. Do not install overhead storage, desk-height power, or desk accessories in the path of height-adjustable desks.



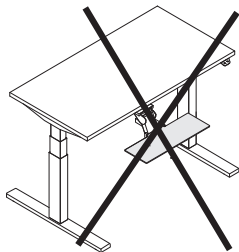
**Universal boundary screens** are not permitted on height-adjustable desks, as they do not pass minimum safety requirements which could result in the desk tipping over.



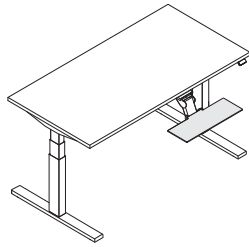
21"H pedestal

**On extended height desks**, any storage higher than 18<sup>3</sup>/<sub>4</sub>" will impede height range of desk. On basic height desks, any storage higher than 24" will impede the height range of the desk.

**All assemblies** meet or exceed ANSI/BIFMA standards.



**Keyboard assemblies** are not allowed on 23"D or smaller than 46"W height-adjustable desks. They do not meet minimum safety requirements.



**Steelcase keyboard assemblies** can be installed on 29"/30"D ACTIV PRO 2.0. Specify with an 11" track.

**WARNING**

Read base only warranty limitations.

**Installation**

**Height-adjustable base** requires attachment to the worksurface.

**Base** supports a maximum of distributed weight capacity of 225 pounds (2-stage) and 250 pounds (3-stage).



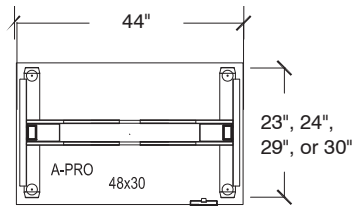


# ACTIV PRO 2.0 2-Stage

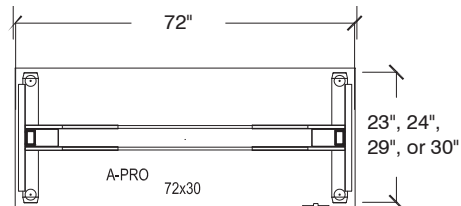


Activ sit-to-stand desk

## Worksurface Sizes



minimum



maximum

# ACTIV PRO 2.0 2-Stage Specifications

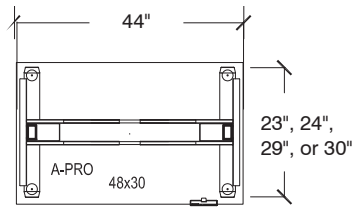
Handset	Push button with 4 programmable settings
Safety	Obstruction detection technology
Foot Length in Inches	23.5" foot for 23"D and 24"D tops. 28.5" foot for 29"D and 30"D tops.
Legs	2 stage, available with T or C Leg
Leg Diameter	2.75" x 2.75"
Height Range (excluding top)	26"–45.7"
Height Range (including top)	27"–46.7"
Frame Width Expansion	width extendable 44"–72" in 1mm increments
Worksurface Widths	46", 48", 52", 54", 58", 60", 64", 66", 70" and 72"
Worksurface Depths	23", 24", 29", and 30"
Max Lifting Capacity	225 lbs
Base Weight Without Top	66 lbs
Gauge of Steel	2mm for inner tube and 1.5mm for outer tube
Speed	33mm/s
Standby Consumption	.2W
ACTIV PRO 2.0e Consumption	Max 350W and Max 5A
Decibel Rating	50db $\leq$
Total Stroke	500 mm
Power Cord	9' cord length with standard NEMA 3 prong plug
Finishes	Platinum, White, Black and Merle
ANSI BIFMA	X5.5
Green Certification	SCS Gold
UL	UL962
Warranty	10 years plus approved labor

# ACTIV PRO 2.0 3-Stage

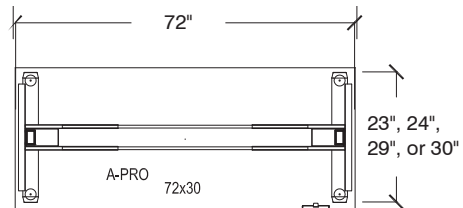


Activ sit-to-stand desk

## Worksurface Sizes



minimum



maximum

# ACTIV PRO 2.0 3-Stage Specifications

Handset	Push button with 4 programmable settings
Safety	Obstruction detection technology
Foot Length in Inches	23.5" foot for 23"D and 24"D tops. 28.5" foot for 29"D and 30"D tops.
Legs	3 stage, available with T or C Leg
Leg Diameter	2.75" x 2.75"
Height Range (excluding top)	21.6"–47.7"
Height Range (including top)	22.6"–48.7"
Frame Width Expansion	width extendable 44"–72" in 1mm increments
Worksurface Widths	46", 48", 52", 54", 58", 60", 64", 66", 70" and 72"
Worksurface Depths	23", 24", 29", and 30"
Max Lifting Capacity	250 lbs
Base Weight Without Top	72 lbs
Gauge of Steel	2mm
Speed	38mm/s
Standby Consumption	.2W
ACTIV PRO 2.0e Consumption	Max 350W and Max 5A
Decibel Rating	50db≤
Total Stroke	650 mm
Power Cord	9' cord length with standard NEMA 3 prong plug
Finishes	Platinum, White, Black and Merle
ANSI BIFMA	X5.5
Green Certification	SCS Gold
UL	UL962
Warranty	10 years plus approved labor

# ACTIV Pro 2.0



Tip: Illustration above shows desk with C-legs.

Tip: Only single and dual flat panel monitor arm applications are permitted for use with 2-leg height-adjustable desks.

Tip: 2 stage base supports a maximum distributed weight capacity of 225 pounds (250 for 3 stage). When calculating lifting capacity, subtract the weight of the worksurface.

### Standard Includes

- Electric height-adjustable base:
  - Black
  - Merle
  - Platinum
  - White
- Cable management tray
- Laminate worksurface
- Power cord: 9'
- 4-preset switch
- 1/2" glide adjustment
- Attachment hardware

### Options

Worksurface Finish	Laminate LPL Price Group 01	No cost
Base Finish	Paint	No cost
Leg Type	C-Leg	No cost
	T-Leg	No cost
Castors or Glides	Glides	No cost
	Castors, Black	+\$174

### Specification Information

Style Number	Dimensions Depth	Base Prices									
		Width									
		46"W	48"W	52"W	54"W	58"W	60"W	64"W	66"W	70"W	72"W
<b>ACTIV Pro 2.0 2 Stage Desk</b>											
<b>APS2</b>	23" or 24"	\$1191	\$1202	\$1227	\$1238	\$1263	\$1274	\$1299	\$1310	\$1335	\$1346
	29" or 30"	\$1230	\$1241	\$1266	\$1277	\$1302	\$1313	\$1338	\$1349	\$1374	\$1385
<b>ACTIV Pro 2.0 3 Stage Desk</b>											
<b>APS3</b>	23" or 24"	\$1315	\$1326	\$1351	\$1362	\$1387	\$1398	\$1423	\$1434	\$1459	\$1470
	29" or 30"	\$1354	\$1365	\$1390	\$1401	\$1426	\$1437	\$1462	\$1473	\$1498	\$1509



# ACTIV Pro 2.0



Tip: Illustration above shows desk with C-legs.

Tip: Only single and dual flat panel monitor arm applications are permitted for use with 2-leg height-adjustable desks.

Tip: 2 stage base supports a maximum distributed weight capacity of 225 pounds (250 for 3 stage). When calculating lifting capacity, subtract the weight of the worksurface.

## Standard Includes

- Electric height-adjustable base:
  - Black
  - Merle
  - Platinum
  - White
- Cable management tray
- 4-preset switch
- Power cord: 9'
- 1/2" glide adjustment
- Attachment hardware

## Options

Base Finish	Paint	No cost
Leg Type	C-Leg	No cost
	T-Leg	No cost
Castors or Glides	Glides	No cost
	Castors, Black	+\$174

## Specification Information

Style Number	Dimensions Depth	Base Prices
<b>ACTIV Pro 2.0 2 Stage Base</b>		
<b>APS2B</b>	23" or 24"	\$985
	29" or 30"	\$985
<b>ACTIV Pro 2.0 3 Stage Base</b>		
<b>APS3B</b>	23" or 24"	\$1114
	29" or 30"	\$1114



ACTIV Pro 2.0





---

# ACTIV

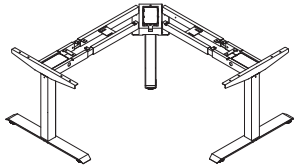


## ACTIV

Understanding	66
Specifying	72

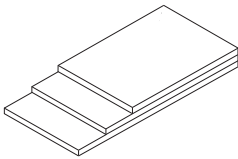
# Statement of Line

## Activ Sit-to-Stand Bases

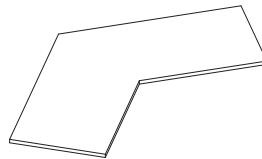


ACTIV PRO 3  
3 legs/triple motor  
90°/120° configurations

## Worksurfaces

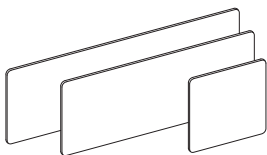


Linear



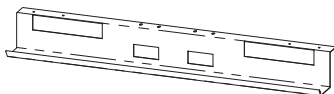
90°/120° (ACTIV PRO 3)

## Privacy Screens

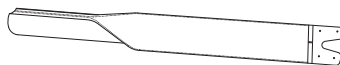


3F Screens

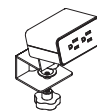
## Accessories



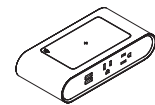
Wire Tray



Soft Cable Management



Eco Power Box



Boost Power Box

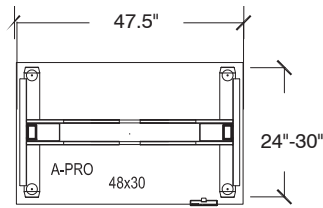


# ACTIV PRO/3 Stage

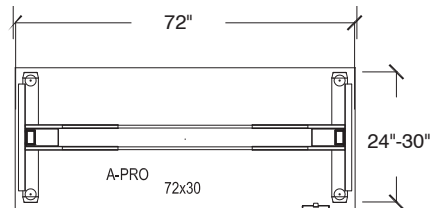


Activ sit-to-stand desk

## Worksurface Sizes



minimum



maximum

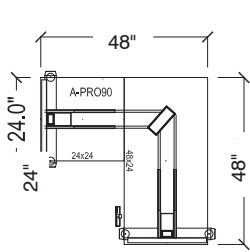
# ACTIV PRO/3 Stage Specifications

Handset	Push button with 4 programmable settings
Safety	Anti-collision
Foot Length in Inches	22" and 28" available for 24" and 30" deep worksurfaces
Legs	3 stage, available with T or C Leg
Leg Diameter	2.75" x 2.75"
Height Range (excluding top)	23.5" - 49"
Height Range (including top)	24.5" - 50"
Frame Width Expansion	width extendable 48"-72" in 1mm increments
Worksurface Widths	46", 48", 52", 54", 58", 60", 64", 66", 70" and 72"
Worksurface Depths	24" and 30"
Max Lifting Capacity	250 lbs
Base Weight Without Top	72 lbs
Gauge of Steel	2mm
Speed	38mm/s
Standby Consumption	.2W
Active Consumption	Max 400W and Max 5A
Decibel Rating	50db $\leq$
Total Stroke	650 mm
Power Cord	9' cord length with standard NEMA 3 prong plug
Finishes	Platinum, White, Black and Merle
ANSI BIFMA	X5.5
Green Certification	SCS Gold
UL	UL962
Warranty	10 years plus approved labor

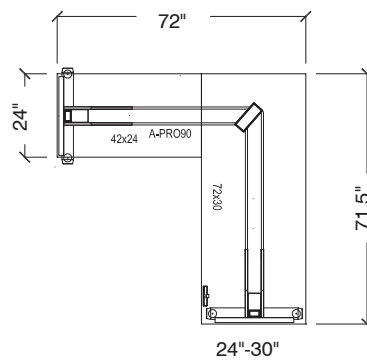
# ACTIV PRO 3



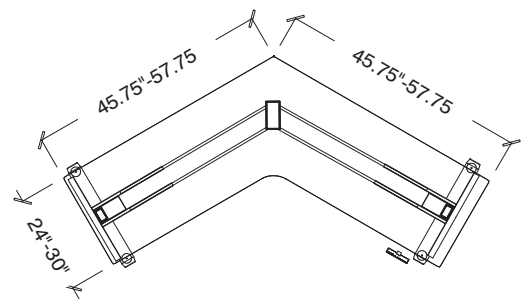
## Worksurface Sizes



90° — minimum



90° — maximum



120°

# ACTIV PRO 3 Specifications

Handset	Push button with 4 programmable settings
Safety	Anti-collision
Foot Length in Inches	22" and 28" available for 24" and 30" deep worksurfaces
Leg Stage	3 stage
Leg Diameter	2.75" x 2.75"
Height Range (excluding top)	23.5" - 49"
Frame Width Expansion	120°: 470mm / 90°: 500mm
Worksurface Widths	Linear: 48", 60", 72" (see page 105 for 90° and 120° sizes)
Worksurface Depths	24" and 30"
Max Lifting Capacity	300 lbs
Gauge of Steel	Inner/Middle tubes: 2mm / Outer tube 2mm
Base Weight Without Top	113 lbs
Speed	38mm/s
Standby Consumption	0.2W
Active Consumption	Max 500W and Max 13.5A
Decibel Rating	50db≤
Total Stroke	650 mm
Power Cord	9' cord length with standard NEMA 3 prong plug
Finishes	Platinum, White, Black and Merle
ANSI BIFMA	X5.5
Green Certification	SCS Gold
UL	UL962
Warranty	10 years plus approved labor

# ACTIV

## ACTIV Desks



**Tip: In transition while supplies last. Moving to Activ Pro 2.0.**

*Tip: Illustration above shows desk with C-legs.*

*Tip: Only single and dual flat panel monitor arm applications are permitted for use with 2-leg height-adjustable desks.*

*Tip: 3 stage base supports a maximum distributed weight capacity of 250 pounds. When calculating lifting capacity, subtract the weight of the worksurface.*

### Standard Includes

- Electric height-adjustable base:
  - Black
  - Merle
  - Platinum
  - White
- Laminate worksurface
- 4-preset switch
- Power cord: 9'
- 1/2" glide adjustment
- Attachment hardware

### Options

Worksurface Finish	Laminate LPL Price Group 01	No cost
Base Finish	Paint	No cost
Leg Type	C-Leg	No cost
	T-Leg	No cost
Castors or Glides	Glides	No cost
	Castors, Black	+\$174

### Specification Information

Style Number	Dimensions Depth	Base Prices Width										
		46"W	48"W	52"W	54"W	58"W	60"W	64"W	66"W	70"W	72"W	

#### ACTIV 3 Stage Desk

<b>ACTVDESKS3</b>	24"	\$1315	\$1327	\$1351	\$1354	\$1372	\$1385	\$1409	\$1420	\$1444	\$1457
	30"	\$1354	\$1367	\$1391	\$1403	\$1420	\$1414	\$1450	\$1463	\$1481	\$1487







**Tip: In transition while supplies last. Moving to Activ Pro 2.0.**

*Tip: Illustration above shows desk with C-legs.*

*Tip: Only single and dual flat panel monitor arm applications are permitted for use with 2-leg height-adjustable desks.*

*Tip: 3 stage base supports a maximum distributed weight capacity of 250 pounds. When calculating lifting capacity, subtract the weight of the worksurface.*

**Standard Includes**

- Electric height-adjustable base:
  - Black
  - Merle
  - Platinum
  - White
- 4-preset switch
- Power cord: 9'
- 1/2" glide adjustment
- Attachment hardware

**Options**

Base Finish	Paint	No cost
Leg Type	C-Leg	No cost
	T-Leg	No cost
Castors or Glides	Glides	No cost
	Castors, Black	+\$174

**Specification Information**



Style Number	Dimensions		Base Prices
	Depth		
<b>ACTIV 3 Stage Base</b>			
<b>ACTVBASES3</b>	24"		\$1114
	30"		\$1114



# ACTIV

## ACTIV Desks



Tip: Base supports a maximum distributed weight capacity of 300 pounds. When calculating lifting capacity, subtract the weight of the worksurface.

Tip: All return depths are 24". The depths indicated at the bottom of "return width" indicate desk depths that include an extra stretcher bar needed for certain configurations.

### Standard Includes

- Electric height-adjustable base:
  - Black
  - Merle
  - Platinum
  - White
- 4-preset switch
- Power cord: 9'
- 1/2" glide adjustment
- Attachment hardware
- Laminate worksurface
- Stretcher bar, if 72"W selected

### Options

Return Depth	24 in	No cost
Worksurface Finish	Laminate LPL Price Group 01	No cost
Base Finish	Paint	No cost
Leg Type	T-Leg	No cost

### Specification Information

Style Number	Dimensions Depth	Prices Width									
		48"W	52"W	54"W	58"W	60"W	64"W	66"W	70"W	72"W	

### ACTIV 90 Degree Desk

ACTVPRO90	24"	\$2160	\$2185	\$2196	\$2214	\$2227	\$2251	\$2262	\$2286	\$2398
	30"	\$2208	\$2232	\$2245	\$2262	\$2256	\$2292	\$2304	\$2328	\$2433

Return Width	24"	+\$193
	30"	+\$204
	36"	+\$211
	42"	+\$216
	42"W with 30"D	+\$315
	48"W with 24"D	+\$321



**Standard Includes**

- Electric height-adjustable base:
  - Black
  - Merle
  - Platinum
  - White
- 4-preset switch
- Power cord: 9'
- 1/2" glide adjustment
- Attachment hardware
- Laminate worksurface

**Options**

Worksurface Finish	Laminate LPL Price Group 01	No cost
Base Finish	Paint	No cost
Leg Type	T-Leg	No cost

**Specification Information**

Style Number	Depth	Prices
<b>ACTIV 120 Degree Desk</b>		
<b>ACTVPRO120</b>	24"	\$2749
	30"	\$3145



**Standard Includes**

- Electric height-adjustable base:
  - Black
  - Merle
  - Platinum
  - White
- 4-preset switch
- Power cord: 9'
- 1/2" glide adjustment
- Attachment hardware

**Options**

Depth	24"	No cost
	30"	No cost
Base Finish	Paint	No cost
Leg Type	T-Leg	No cost

**Specification Information**

Style Number	Price
<b>ACTIV 90 &amp; 120 Degree Base</b>	
<b>ACTVBASE90120</b>	\$1884



# ACTIV

## ACTIV Power and Accessories



### Standard Includes

- Castors: 2 locking, 2 non-locking

### Specification Information

Style Number	Price
--------------	-------

### ACTIV Castors - Set of 4

<b>ACTIV-CASTORS</b>	\$174
----------------------	-------



*Tip: Two stretcher bars are included in a box.*

*Tip: One box of two stretcher bars needed per 72"W worksurface side.*

### Standard Includes

- 72" stretcher bar for Activ-Pro3 1 box

### Specification Information

Style Number	Price
--------------	-------

### ACTIV 72" Stretcher Bar

<b>ACTVSTRETCHERBAR72</b>	\$99
---------------------------	------



### Standard Includes

- Short stretcher bar for desks or bases 46" or less

### Specification Information

Style Number	Price
--------------	-------

### ACTIV Short Stretcher Bar

<b>ACTVSHORTSTRETCH</b>	No cost
-------------------------	---------



*Tip: Style number comes with two feet.*

**Standard Includes**

- Set of two feet

**Options**

Depth	24"	No cost
	30"	No cost
Base Finish	Paint	No cost
Leg Type	C-Leg	No cost
	T-Leg	No cost

**Specification Information**

Style Number	Price
<b>ACTVFEET</b>	\$138



# ACTIV

## Worksurfaces



### Standard Includes

- Laminate worksurface

### Options

Worksurface Finish      Laminate LPL Price Group 01      No cost

### Specification Information

Style Number	Dimensions Depth	Prices									
		Width									
		46"W	48"W	52"W	54"W	58"W	60"W	64"W	66"W	70"W	72"W

### ACTIV Worksurface

ACTVWORKSURFACE	24"	\$265	\$276	\$301	\$312	\$330	\$343	\$367	\$378	\$402	\$415
	30"	\$312	\$324	\$348	\$361	\$378	\$372	\$408	\$420	\$444	\$450



### Standard Includes

- Laminate worksurface

### Options

Worksurface Finish      Laminate LPL Price Group 01      No cost

### Specification Information

Style Number	Dimensions Depth	Prices				
		Width				
		24"W	30"W	36"W	42"W	48"W

### ACTIV Return Worksurface

ACTVRETURNWKSF	24"	\$193	\$204	\$211	\$216	\$222
----------------	-----	-------	-------	-------	-------	-------



### Standard Includes

- Laminate worksurface

### Options

Worksurface Finish      Laminate LPL Price Group 01      No cost

### Specification Information

Style Number	Dimensions Depth	Prices

### ACTIV 120 Degree Worksurface

ACTVWORKSURF120	24"	\$865
	30"	\$1261

---

# CLUVO



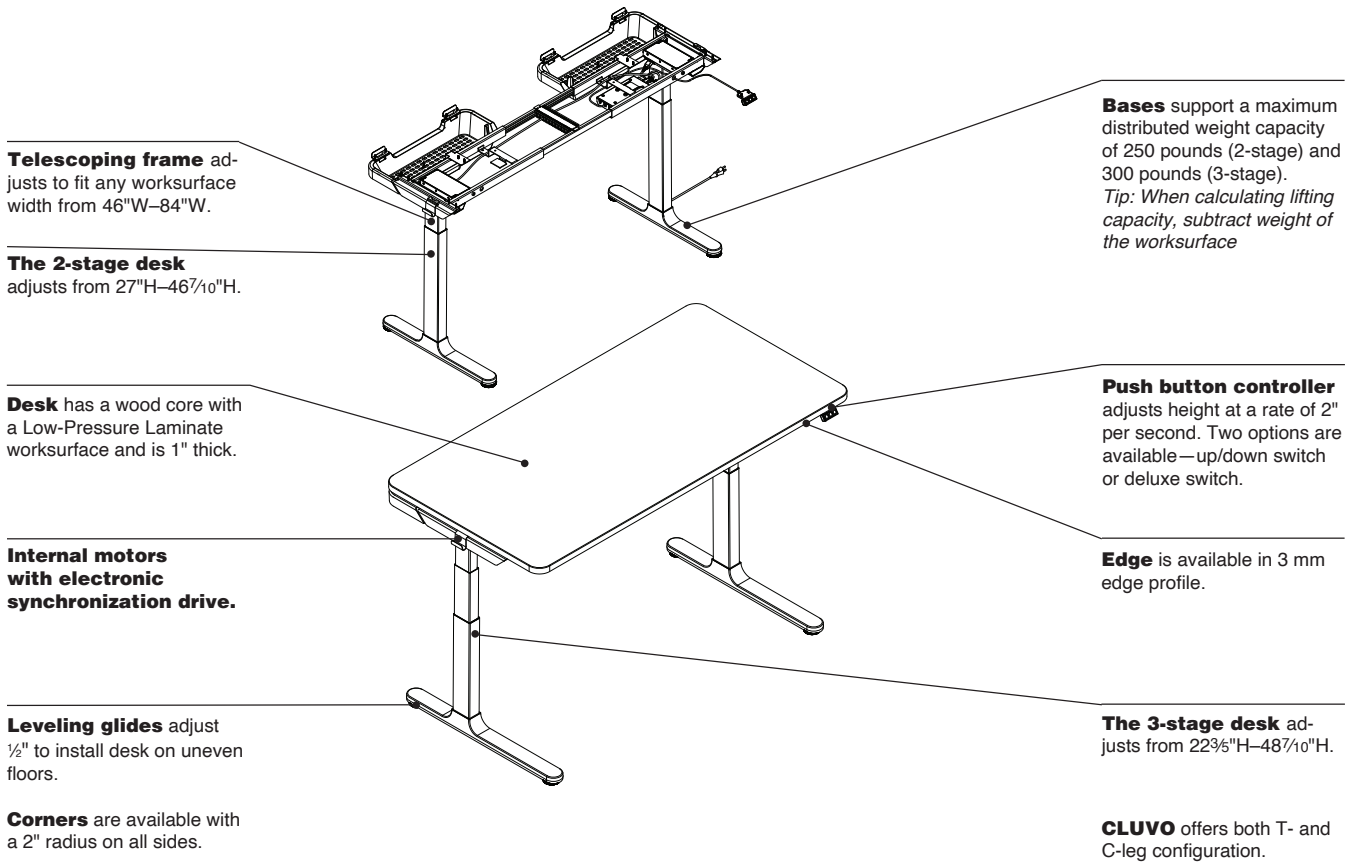
## CLUVO

Understanding	80
Specifying	86

# CLUVO Height-Adjustable Desks and Bases

**CLUVO** supports wellbeing at work by allowing users to move between seated and standing postures throughout the workday.

► Specifying, page 86

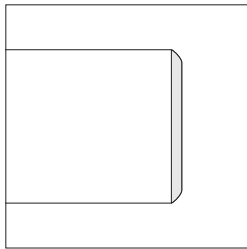




## Product Details

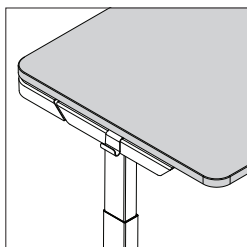
### Low-Pressure Laminate

**Front (user's) edge profile** is available in 3 mm edge profile.



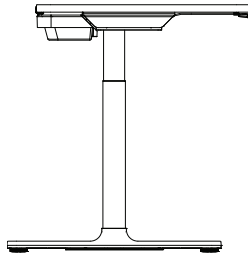
**PVC-free, 3 mm edge profiles with matching 1 mm side and back edges** are also PVC-free. ▶ See *Surface Materials* in this book for specific PVC-free availability, page 513.

**Edge profile finishes** always match laminate finishes.

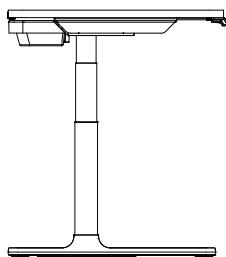


**Radius corners** are standard with a 2" radius on all four sides.

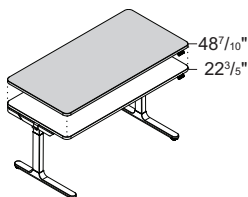
**Overhang** is available. The maximum overhang available as a standard option is 15"W.



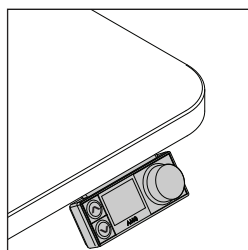
**T-leg configuration** is available on CLUVO in 29"/30" depth worksurface options.



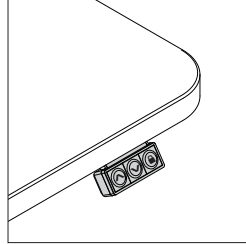
**C-leg configuration** is available on CLUVO in 24" and 29"/30" depths worksurface options.



**CLUVO 3-stage desk** adjusts from 22<sup>3</sup>/<sub>5</sub>"H–48<sup>7</sup>/<sub>10</sub>"H, while the 2-stage desk adjusts from 27"H–46<sup>7</sup>/<sub>10</sub>"H in any increment.



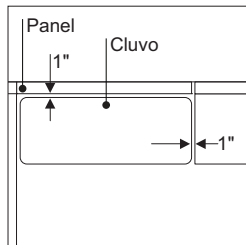
**Deluxe switch** includes the ability to personalize the LED display, allows users to set seated and standing heights, and set reminders to change postures.



**Up/down controller** is available as an option and easily adjusts height of desk, at a rate of 2" per second, by simply pushing the up and down arrows.

**Obstruction sensing technology** is standard with all CLUVO desks. The worksurface will backtrack when it makes contact with an object.

**Casters** are available as an option on CLUVO. The front two casters lock while the back two casters do not.



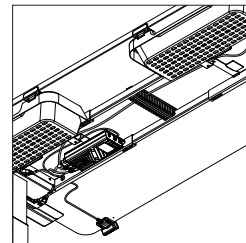
**Rectangle desk sizes** are listed in actual dimensions to allow for 1" gap to adjacent furniture eliminating any pinch points.

## Wiring and Cabling

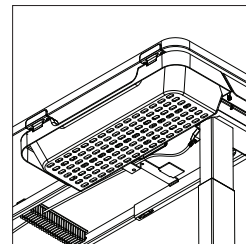
**Electric motor with whisper quiet operation** adjusts at 2" per second. Motor is 24V DC and includes a 9' power cord. Motor for 2-leg desk has a 0.2W standby power.

**CLUVO desks and bases** are listed by ETL. ▶ See page 84

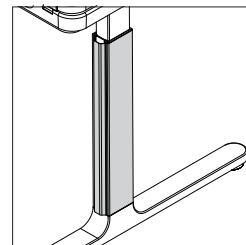
**Power and data strips** are field-installed on worksurface. Specify appropriate attachment bracket depending on application. ▶ See page 159 for *Work Tools*.



**Cable management** includes a simple organizer to manage desk cables.



**Cable baskets**, available as an option or ordered separately, support cable management below the worksurface.



**Leg sleeves**, available as an option, help route the power cords down to the floor and provide additional finish options.

**Controller** can be mounted on either the left- or right-hand side of the top and is field installed.

## Surface Materials

### Low-Pressure Laminate Desk

24L0	Graphite Walnut
25L5	Virginia Walnut
25L8	Clear Walnut
26L1	Natural Cherry
2L09	Clear Maple
2L30	Arctic White
2L83	Seagull
2L84	Milk White
2LAW	Ash Wenge
2LCN	Clay Noce
2LCW	Clay Wenge
2LAK	Clear Oak
2LAT	Acacia

**3 mm edge profile**

- Plastic

### Height-adjustable base

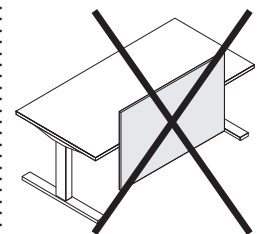
- F1 Platinum
- F2 White

### Feet and leg sleeves

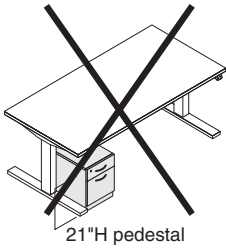
- F1 Platinum
- F2 White
- F4 Merle
- F9 Burnished Bronze
- F10 Brass

## Application Topics

**Moving desks** can collide with other components. Do not install overhead storage, desk-height power, or desk accessories in the path of height-adjustable desks.

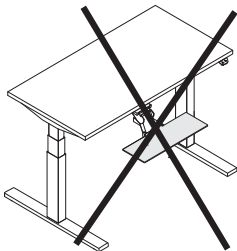


**Universal boundary screens** are not permitted on height-adjustable desks, as they do not pass minimum safety requirements which could result in the desk tipping over.

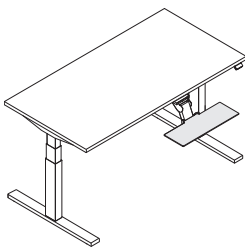


**On extended height desks**, any storage higher than 18<sup>3</sup>/<sub>10</sub>" will impede height range of desk. On basic height desks, any storage higher than 24" will impede the height range of the desk.

**All assemblies** meet or exceed ANSI/BIFMA standards.



**Keyboard assemblies** are not allowed on 23"D or smaller than 46"W height-adjustable desks. They do not meet minimum safety requirements.



**Steelcase keyboard assemblies** can be installed on 29"/30"D. Specify with an 11" track.



**WARNING**  
Read base only warranty limitations.

### Installation

**Height-adjustable base** requires attachment to the worksurface.

**Base** supports a maximum of distributed weight capacity of 250 pounds (2-stage) and 300 pounds (3-stage).



# CLUVO 2-Stage Specifications

Handset	Up/down switch with lock or deluxe switch with LED
Safety	Obstruction detection technology
Foot Length in Inches	24" foot for 24"D top 30" foot for 29"D and 30"D tops
Legs	2 stage, available with T or C Leg
Leg Diameter	1.9" x 3.15"
Height Range (excluding top)	26"–45.7"
Height Range (including top)	27"–46.7"
Frame Width Expansion	Width extendable 46"–84" in 1mm increments
Worksurface Widths	46", 48", 52", 54", 58", 60", 64", 66", 70", 72", 76", and 84"
Worksurface Depths	24", 29", and 30"
Max Lifting Capacity	250 lbs
Base Weight Without Top	66 lbs
Gauge of Steel	2mm for inner tube and 1.5mm for outer tube
Speed	2" per second
Standby Consumption	.2W
Consumption	Max 350W and Max 5A
Decibel Rating	50db $\leq$
Total Stroke	500 mm
Power Cord	9' cord length with standard NEMA 3 prong plug
Finishes	Platinum, White, Merle, Burnished Bronze, and Brass
ANSI BIFMA	X5.5
Green Certification	SCS Gold
UL	UL962
Warranty	10 years plus approved labor

# CLUVO 3-Stage Specifications

Handset	Up/down switch with lock or deluxe switch with LED
Safety	Obstruction detection technology
Foot Length in Inches	24" foot for 24"D top 30" foot for 29"D and 30"D tops
Legs	3 stage, available with T or C Leg
Leg Diameter	1.9" x 3.15"
Height Range (excluding top)	21.6"–47.7"
Height Range (including top)	22.6"–48.7"
Frame Width Expansion	Width extendable 46"–84" in 1mm increments
Worksurface Widths	46", 48", 52", 54", 58", 60", 64", 66", 70", 72", 76", and 84"
Worksurface Depths	24", 29", and 30"
Max Lifting Capacity	300 lbs
Base Weight Without Top	72 lbs
Gauge of Steel	2mm
Speed	2" per second
Standby Consumption	.2W
Consumption	Max 350W and Max 5A
Decibel Rating	50db≤
Total Stroke	650 mm
Power Cord	9' cord length with standard NEMA 3 prong plug
Finishes	Platinum, White, Black, Merle, Burnished Bronze, and Brass
ANSI BIFMA	X5.5
Green Certification	SCS Gold
UL	UL962
Warranty	10 years plus approved labor

# Cluvo



Tip: Illustration above shows desk with T-legs.

Tip: Only single and dual flat panel monitor arm applications are permitted for use with 2-leg height-adjustable desks.

Tip: 2 stage base supports a maximum distributed weight capacity of 250 pounds (300 for 3 stage). When calculating lifting capacity, subtract the weight of the worksurface.

## Standard Includes

- Electric height-adjustable base:
  - Platinum
  - White
- Foot: paint
- Power cord: 9'
- Laminate worksurface with radius corners
- Up/down switch
- 1/2" glide adjustment
- Attachment hardware

## Options

Worksurface Finish	Laminate LPL Price Group 01	No cost
Leg Type	C-Leg	No cost
	T-Leg	No cost
Hand Set	Up/down	No cost
	Deluxe	+\$95
Leg Sleeve Option	No Leg Sleeve	No cost
	With Leg Sleeve	+\$95
Leg Sleeve Finish	Paint	No cost
Wire Tray	No Cable Baskets	No cost
	With Cable Baskets	+\$150
Castors or Glides	Glides	No cost
	Castors, Black	+\$174

## Specification Information

Style Number	Dimensions Depth	Base Prices Width											
		46"W	48"W	52"W	54"W	58"W	60"W	64"W	66"W	70"W	72"W	76"W	84"W

### Cluvo Desk, 2 Stage

<b>CLS2</b>	24"	\$1519	\$1529	\$1554	\$1564	\$1589	\$1599	\$1624	\$1634	\$1659	\$1669	\$1694	\$1739
	29" or 30"	\$1554	\$1564	\$1589	\$1599	\$1624	\$1634	\$1659	\$1669	\$1694	\$1704	\$1729	\$1774

### Cluvo Desk, 3 Stage

<b>CLS3</b>	24"	\$1677	\$1687	\$1712	\$1722	\$1747	\$1757	\$1782	\$1792	\$1817	\$1827	\$1852	\$1897
	29" or 30"	\$1712	\$1722	\$1747	\$1757	\$1782	\$1792	\$1817	\$1827	\$1852	\$1862	\$1887	\$1932





Tip: Illustration above shows base with T-legs.

Tip: Only single and dual flat panel monitor arm applications are permitted for use with 2-leg height-adjustable bases.

Tip: 2 stage base supports a maximum distributed weight capacity of 250 pounds (300 for 3 stage).

**Standard Includes**

- Electric height-adjustable base:
  - Platinum
  - White
- Foot: paint
- Up/down switch
- 1/2" glide adjustment
- Power cord: 9'
- Attachment hardware

**Options**

Leg Type	C-Leg	No cost
	T-Leg	No cost
Hand Set	Up/down	No cost
	Deluxe	+\$95
Leg Sleeve Option	No Leg Sleeve	No cost
	With Leg Sleeve	+\$95
Leg Sleeve Finish	Paint	No cost
Wire Tray	No Cable Baskets	No cost
	With Cable Baskets	+\$150
Castors or Glides	Glides	No cost
	Castors, Black	+\$174

**Specification Information**

Style Number	Dimension Depth	Base Price
<b>Cluvo Base, 2 Stage</b>		
<b>CLS2B</b>	24"	\$1260
	29" or 30"	\$1260
<b>Cluvo Base, 3 Stage</b>		
<b>CLS3B</b>	24"	\$1418
	29" or 30"	\$1418



# Cluvo



### Standard Includes

- Set of two cable bases (F1 Platinum)
- Install hardware

### Specification Information

Style Number	Price
--------------	-------

### Cable Basket, Set of 2

<b>CLCBASKET</b>	\$150
------------------	-------

### Standard Includes

- Castors: two locking, two non-locking

### Specification Information

Style Number	Price
--------------	-------

### Set of 4 Casters

<b>CLCASTERS</b>	\$174
------------------	-------





---

# AMOBI

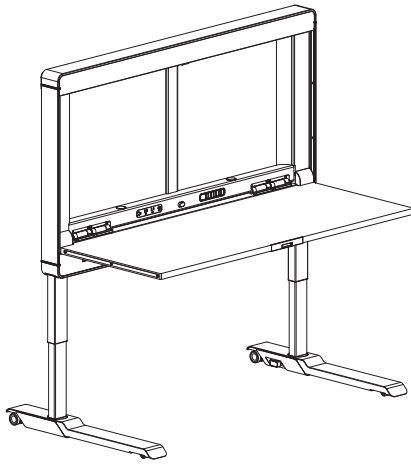
---

## AMOBI

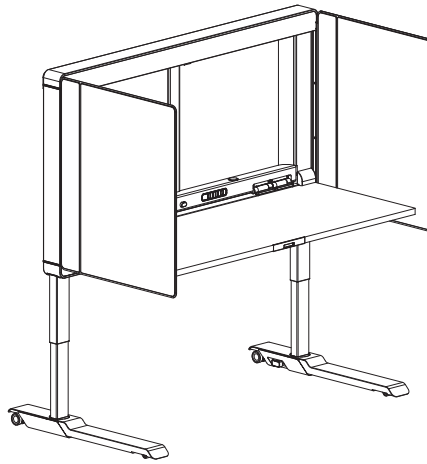
Understanding	90
Specifying	97

# Statement of Line

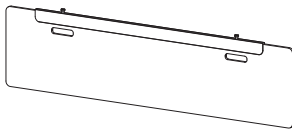
## Desk



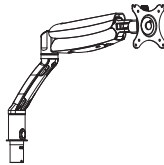
Amobi Desk/One



Amobi Desk/Focus



Modesty Panel



Monitor Arm



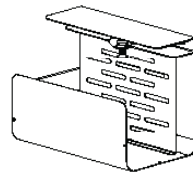
LED Light



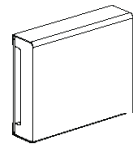
Privacy Screen Connector



Magnetic Accessory Clips



Undermount Cubby



Desktop Cable Organizer



Magnetic Utility Holder

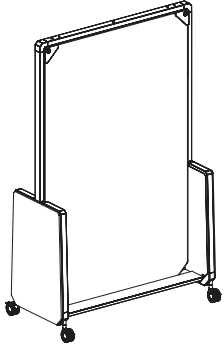


Magnetic Pencil Holder

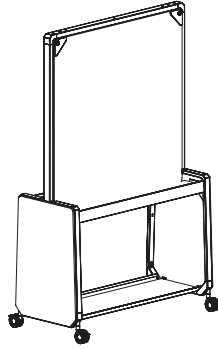


Magnetic File Holder

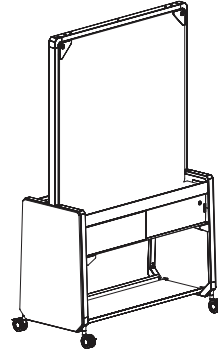
## Team



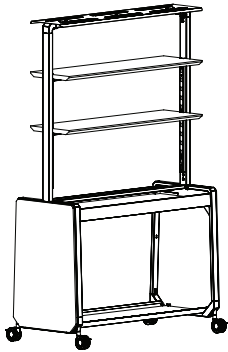
Amobi Team Wall



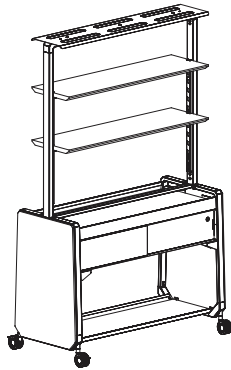
Amobi Team Half Wall



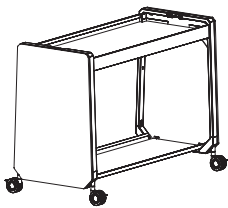
Amobi Team Half Wall with Storage



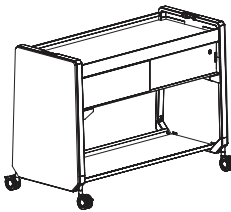
Amobi Team Display



Amobi Team Display with Storage



Amobi Team Cart



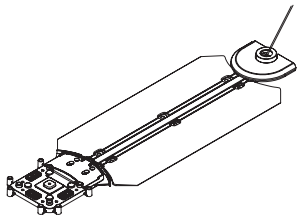
Amobi Team Cart with Storage



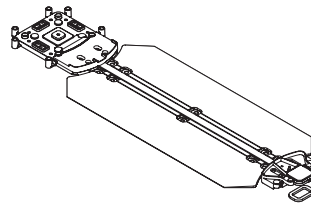
Storage Basket

# Statement of Line

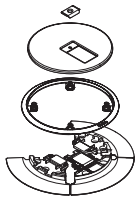
## Power Distribution – Structured, Spine-Based



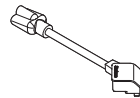
Thread Wall Infeed with Ramps - Dual Circuit



Thread Power Track with Ramps

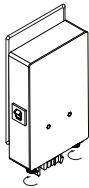


Thread Power Connector



Thread Low-Profile Adapter

# Power Distribution – Dynamic, Grid-Based



JumperBox



Infeed Jumper



Power Connector

# Amobi Desk Specifications



Product Overall Height Adjustment Range	39.9" - 78.8"
Worksurface Height Adjustment Range	9.9" - 48.8"
Front Handset	Push button with 2 programmable settings and LED Light Control
Rear Handset	Up/Down Push Button
Feature	Anti-Collision (Gyro Sensor)
Columns	3-Stage
Worksurface	High-Pressure Laminate with 2mm plastic edge
Worksurface Thickness	1"
Worksurface Width	54", 60"
Worksurface Depth	25"
Worksurface Maximum Capacity	176 lbs
Acoustic Panel	NRC Value .80
Magnetic Side Panels	NRC Value .45
Magnetic Side Panels Dimensions	33"H x 27"D
Whiteboard Surface	Painted Steel
Volts	120V AC
Input Amps	3A (Maximum 3.6A)
Watts	400W (Maximum)
Frequency	60Hz
Standby Consumption	0.2W
Active Consumption	0 - 280W (under 176 lbs maximum loading)
Overcurrent Protection	Yes
Output Receptacle	120V, 10A
USB-A Output	2.1A / 5V (10.5W)
USB-C Output	1.5A /12V (18W)
Speed	30mm/s
Total Stroke	38.9"
Decibel Rating	55db $\leq$
Desk Weight	54": 182 lbs, 60": 192 lbs
Compliance	BIMFA X5.5-2021
UL	UL962 Listed
Environmental	SCS IAQ Gold
Flammability	UL723, TB117

# Amobi Team Specifications



Frame Dimensions	44"W x 71.5"H x 20"D
Collaboration Board Dimensions - Full Size	42"W x 67"H
Collaboration Board Dimensions - Half Size	42"W x 42"H
Side Infill Dimensions	20"W x 28.75"H
Frame Weight	88 lbs
Lower Tray Dimensions	43.5"W x 1.5"H x 9"D
Lower Tray Weight Capacity	10 lbs
Full Size Whiteboard Weight	17 lbs
Half Size Whiteboard Weight	11 lbs
Whiteboard Type	PET G
Upper Tray Dimensions	44"W x 18.75"D x 2"H
Upper Tray Weight Capacity	16 lbs
Storage Dimensions	20"W x 15.75"D x 8"H
Storage Weight Capacity	41 lbs
Shelving Dimensions	42"W x 8"D x 1"H
Shelving Weight Capacity	14 lbs
Shelving Finishes	10 laminates
Laminate Material	LPL
Finishes	White, Platinum
Storage Locking Availability	Yes
Castors	4 locking
Storage Basket Dimensions	9.57"W x 12.88"D x 5.24"H
Certifications	SCS IAQ Gold

# Amobi Finishes

## Bases/Frames



F1 Platinum



F2 White



W3.1 True White



W3.2 Dove Grey

## Worksurface

## Edge Banding

## Magnetic Side Panels Verve Collection



FB2 Shadow



FB4 Pearl



FB5 Celestial



FB10 Seafoam

## Collaboration Boards / Modesty Panels / Infills / Inlays Verve Collection



FC1 Briquette



FC2 Shadow



FC3 Ash



FC4 Pearl



FC5 Celestial



FC6 Verde



FC7 Tuscan



FC8 Saffron



FC9 Sand



FC10 Seafoam



Whiteboard

## Amobi Team Shelves



W2.1 Milk White



W2.2 Maple



W2.3 Teak



W2.4 Walnut



W2.5 Arctic White



W2.6 Seagull



W2.7 Ash Wenge



W2.8 Clay Wenge



W2.9 Acacia



W2.10 Graphite Walnut

**Note** Please view material swatches before specifying. Printed colors may vary from actual fabric.  
View material specs and cleaning instructions on our web site at [www.amqsolutions.com](http://www.amqsolutions.com)





**Standard Includes**

- Electric height-adjustable sit-to-stand base:
  - White
  - Platinum
- Laminate foldable worksurface
- One cord out, integrated power
- Power cord: 9'
- LED handset with 2 memory presets and lighting control
- Built-in power box: 2 power, USB A+C
- Lockable casters
- Collaboration board

**Options**

Base Finish	Paint	No cost
Collaboration Board	Tackboard	No cost
	Whiteboard	+\$286
Tackboard Finish	Verve	No cost
Snap-in Monitor Arm	Single	+\$276
	Double	+\$552
Monitor Arm Finish	Paint	No cost
Lighting	Led	+\$451
Modesty Panel	W/ Modesty Panel	+\$265
Modesty Panel Finish	Verve	No cost
Magnetic Clips	Set of 5	+\$64

**Specification Information**

Style Number	Base Price
<b>AMOBI 54" Desk</b>	
<b>AD054</b>	\$4028

# AMOBI

## Desk



### Standard Includes

- Electric height-adjustable sit-to-stand base:
  - White
  - Platinum
- Laminate foldable worksurface
- One cord out, integrated power
- Power cord: 9'
- LED handset with 2 memory presets and lighting control
- Built-in power box: 2 power, USB A+C
- Lockable casters
- Collaboration board

### Options

Base Finish	Paint	No cost
Collaboration Board	Tackboard Whiteboard	No cost +\$286
Tackboard Finish	Verve	No cost
Snap-in Monitor Arm	Single Double	+\$276 +\$552
Monitor Arm Finish	Paint	No cost
Lighting	Led	+\$477
Modesty Panel	W/ Modesty Panel	+\$292
Modesty Panel Finish	Verve	No cost
Magnetic Clips	Set of 5	+\$64

### Specification Information

Style Number    Base Price

#### AMOBI 60" Desk

**ADO60**      \$4134



## Standard Includes

- Electric height-adjustable sit-to-stand base:
  - White
  - Platinum
- Laminate foldable worksurface
- One cord out, integrated power
- Power cord: 9'
- LED handset with 2 memory presets and lighting control
- Built-in power box: 2 power, USB A+C
- Lockable casters
- Collaboration board

## Options

Base Finish	Paint	No cost
Collaboration Board	Tackboard Whiteboard	No cost +\$286
Tackboard Finish	Verve	No cost
Privacy Screen Finish	Verve	No cost
Snap-in Monitor Arm	Single Double	+\$276 +\$552
Monitor Arm Finish	Paint	No cost
Lighting	Led	+\$451
Modesty Panel	W/ Modesty Panel	+\$265
Modesty Panel Finish	Verve	No cost
Magnetic Clips	Set of 5	+\$64
Privacy Screen Connector	Set of 2	+\$133

## Specification Information

Style Number    Base Price

### AMOBI 54" Focus

**ADF54**      \$4717

# AMOBI

## Desk



### Standard Includes

- Electric height-adjustable sit-to-stand base:
  - White
  - Platinum
- Laminate foldable worksurface
- One cord out, integrated power
- Power cord: 9'
- LED handset with 2 memory presets and lighting control
- Built-in power box: 2 power, USB A+C
- Lockable casters
- Collaboration board

### Options

Base Finish	Paint	No cost
Collaboration Board	Tackboard Whiteboard	No cost +\$286
Tackboard Finish	Verve	No cost
Privacy Screen Finish	Verve	No cost
Snap-in Monitor Arm	Single Double	+\$276 +\$552
Monitor Arm Finish	Paint	No cost
Lighting	Led	+\$477
Modesty Panel	W/ Modesty Panel	+\$292
Modesty Panel Finish	Verve	No cost
Magnetic Clips	Set of 5	+\$64
Privacy Screen Connector	Set of 2	+\$133

### Specification Information

Style Number    Base Price

#### AMOBI 60" Focus

**ADF60**            \$4823



**Standard Includes**

- Tackable collaboration board

**Options**

Tackboard Finish                      Verve    No cost

**Specification Information**

Style Number    Price

**AMOBI 54" Tackboard**

**ADTB54**            \$265

**AMOBI 60" Tackboard**

**ADTB60**            \$297



**Standard Includes**

- Magnetic whiteboard

**Specification Information**

Style Number    Price

**AMOBI 54" Whiteboard**

**ADWB54**            \$551

**AMOBI 60" Whiteboard**

**ADWB60**            \$583



**Standard Includes**

- Single monitor arm

**Options**

Monitor Arm Finish                      Paint    No cost

**Specification Information**

Style Number    Price

**AMOBI Monitor Arm**

**ADSMA**            \$276

# AMOBI

## Desk



### Standard Includes

- Dimmable LED task light

### Specification Information

Style Number Price

#### AMOBI 54" LED

**ADLED54** \$451

#### AMOBI 60" LED

**ADLED60** \$477



### Standard Includes

- Modesty panel: PET felt

### Options

Modesty Panel Finish	Verve	No cost
----------------------	-------	---------

### Specification Information

Style Number Price

#### AMOBI 54" Modesty Panel

**ADMP54** \$265

#### AMOBI 60" Modesty Panel

**ADMP60** \$292



### Standard Includes

- Set of five magnetic clips for cable management

### Specification Information

Style Number Price

#### AMOBI Clip

**ADCLIP** \$64


**Standard Includes**

- Set of two privacy screen connectors

**Specification Information**

Style Number Price

**AMOBI Privacy Screen Connector**
**ADPSC** \$133

**Standard Includes**

- Magnetic cable organizer for AMOBI desk

**Specification Information**

Style Number Price

**AMOBI Desktop Cable Organizer**
**ADDCBL** \$140

**Standard Includes**

- Magnetic hanging storage cubby for AMOBI desk

**Specification Information**

Style Number Price

**AMOBI Undermount Cubby**
**ADSCUB** \$275

**Standard Includes**

- Set of 5 magnetic utility holders

**Specification Information**

Style Number Price

**AMOBI Magnetic Utility Holder (Set of 5)**
**ADUCUP** \$250

# AMOBI

Desk



### Standard Includes

- Set of 5 magnetic pencil holders

### Specification Information

Style Number Price

#### AMOBI Magnetic Pencil Holder (Set of 5)

**ADUBSKT** \$300



### Standard Includes

- Set of 5 magnetic file holders

### Specification Information

Style Number Price

#### AMOBI Magnetic File Holder (Set of 5)

**ADFORG** \$350





**Standard Includes**

- Upper frame assembly
- Full-size collaboration PET felt board: 18 mm
- Quick release board buttons: finish to match frame
- Board levers: white only
- Lower frame cart assembly
- PET felt side infills: 9 mm
- PET felt inlays: 9 mm
- Lower open storage tray
- 4 locking castors

**Options**

Frame Finish	Paint	No cost
Collaboration Board	2 Sided Tackboard	No cost
	1 Side Tackbrd 1 Side Whitebrd	+\$350
	2 Sided Whiteboard	+\$700
Tackboard Side A Finish	Verve	No cost
Tackboard Side B Finish	Verve	No cost
Infill Finish	Verve	No cost
Inlay Finish	Verve	No cost

**Specification Information**

Style Number	Base Price
<b>AMOBI Team Wall</b>	
<b>ATWALL</b>	\$1855

# AMOBİ

## Team



### Standard Includes

- Upper frame assembly
- Half-size collaboration PET felt board: 18 mm
- Quick release board buttons: finish to match frame
- Board levers: white only
- Lower frame cart assembly
- PET felt side infills: 9 mm
- Upper open storage tray
- Lower open storage tray
- PET felt inlays: 9 mm
- 4 locking castors

### Options

Frame Finish	Paint	No cost
Collaboration Board	2 Sided Tackboard	No cost
	1 Side Tackbrd 1 Side Whitebrd	+\$223
	2 Sided Whiteboard	+\$445
Tackboard Side A Finish	Verve	No cost
Tackboard Side B Finish	Verve	No cost
Infill Finish	Verve	No cost
Inlay Finish	Verve	No cost

### Specification Information

Style Number    Base Price

## AMOBİ Team Half Wall

**ATHWL**      \$2067



**Standard Includes**

- Upper frame assembly
- Half-size collaboration PET felt board: 18 mm
- Quick release board buttons: finish to match frame
- Board levers: white only
- Lower frame cart assembly
- PET felt side infills: 9 mm
- Enclosed sliding storage tray: paint to match frame
- Upper open storage tray
- Lower open storage tray
- PET felt inlays: 9 mm
- 4 locking castors

**Options**

Frame Finish	Paint	No cost
Collaboration Board	2 Sided Tackboard	No cost
	1 Side Tackbrd 1 Side Whitebrd	+\$223
	2 Sided Whiteboard	+\$445
Tackboard Side A Finish	Verve	No cost
Tackboard Side B Finish	Verve	No cost
Infill Finish	Verve	No cost
Inlay Finish	Verve	No cost

**Specification Information**

Style Number	Base Price
--------------	------------

**AMOBI Team Half Wall with Storage**

<b>ATSTR</b>	\$2703
--------------	--------

# AMOBI

## Team



Tip: Max monitor size is 55 inches (140 cm). The max rated load weight is 44 lbs (20 kg).

Tip: Technology not included.

### Standard Includes

- Upper frame assembly
- Vesa mount assembly
- Half-size collaboration PET felt board: 9 mm
- Quick release board buttons: black
- Lower frame cart assembly
- PET felt side infills: 9 mm
- Enclosed sliding storage tray: paint to match frame
- Upper open storage tray
- Lower open storage tray
- PET felt inlays: 9 mm
- Four locking casters
- Two handle bars: paint to match frame

### Options

Frame Finish	Paint	No cost
Collaboration Board	2 Sided Tackboard	No cost
Tackboard Side A Finish	Verve	No cost
Tackboard Side B Finish	Verve	No cost
Infill Finish	Verve	No cost
Inlay Finish	Verve	No cost
Hood Option	No Hood With Hood	No cost +\$100

### Specification Information

Style Number    Base Price

## AMOBI Team Digital Display with Storage

**ATDIGITAL**    \$3600



**Standard Includes**

- Upper frame assembly
- Upper hood top: finish to match frame
- Two laminate display shelves
- Lower frame cart assembly
- PET felt side infills: 9 mm
- Upper open storage tray
- Lower open storage tray
- PET felt inlays: 9 mm
- 4 locking castors

**Options**

Frame Finish	Paint	No cost
Infill Finish	Verve	No cost
Shelf Finish	Laminate LPL Price Group 01	No cost
Inlay Finish	Verve	No cost

**Specification Information**

Style Number    Price

**AMOBI Team Display**

**ATDSP**            \$2279

# AMOBI

## Team



### Standard Includes

- Upper frame assembly
- Upper hood top: finish to match frame
- Two laminate display shelves
- Lower frame cart assembly
- PET felt side infills: 9 mm
- Enclosed sliding storage tray: paint to match frame
- Upper open storage tray
- Lower open storage tray
- PET felt inlays: 9 mm
- 4 locking castors

### Options

Frame Finish	Paint	No cost
Infill Finish	Verve	No cost
Shelf Finish	Laminate LPL Price Group 01	No cost
Inlay Finish	Verve	No cost

### Specification Information

Style Number Price

#### AMOBI Team Display with Storage

**ATDST** \$2915



### Standard Includes

- Lower frame cart assembly
- PET felt side infills: 9 mm
- Upper open storage tray
- Lower open storage tray
- PET felt inlays: 9 mm
- 4 locking castors

### Options

Frame Finish	Paint	No cost
Infill Finish	Verve	No cost
Inlay Finish	Verve	No cost

### Specification Information

Style Number Price

#### AMOBI Team Cart

**ATTC** \$1166



**Standard Includes**

- Lower frame cart assembly
- PET felt side infills: 9 mm
- Enclosed sliding storage tray: paint to match frame
- Upper open storage tray
- Lower open storage tray
- PET felt inlays: 9 mm
- 4 locking castors

**Options**

Frame Finish	Paint	No cost
Infill Finish	Verve	No cost
Inlay Finish	Verve	No cost

**Specification Information**

Style Number Price

**AMOBI Team Cart with Storage**

**ATSC** \$1802



**Standard Includes**

- PET felt tackboard panel

**Options**

Tackboard Finish	Verve	No cost
------------------	-------	---------

**Specification Information**

Style Number Price

**AMOBI Team Tackboards**

**Half Size**

**ATTBHS** \$286

**Full Size**

**ATTBFL** \$339

# AMOBI

## Team



### Standard Includes

- Laminate whiteboard panel

### Specification Information

Style Number	Price
--------------	-------

### AMOBI Team Whiteboards

#### Half Size

<b>ATWBHS</b>	\$509
---------------	-------

#### Full Size

<b>ATWBFL</b>	\$689
---------------	-------



### Standard Includes

- Set of two PET felt baskets

### Specification Information

Style Number	Price
--------------	-------

### AMOBI Team Storage Basket (Set of 2)

<b>ATBSK</b>	\$265
--------------	-------



### Standard Includes

- Set of two button assemblies

### Options

Frame Finish	Paint	No cost
--------------	-------	---------

### Specification Information

Style Number	Price
--------------	-------

### AMOBI Quick Release Assembly

<b>ATQUICKRELEASE</b>	\$382
-----------------------	-------





**Standard Includes**

- Sliding steel storage: paint
- Attachment hardware

**Options**

Frame Finish	Paint	No cost
--------------	-------	---------

**Specification Information**

Style Number	Price
--------------	-------

**AMOBI Storage Assembly**

**ATSTGASSEMBLY** \$636



**Standard Includes**

- Set of two laminate shelves
- Attachment hardware

**Options**

Shelf Finish	Laminate LPL Price Group 01	No cost
--------------	-----------------------------	---------

**Specification Information**

Style Number	Price
--------------	-------

**AMOBI Laminate Shelves**

**ATSHELF** \$382

# AMOBI

## Power



### Standard Includes

- Thread power track infeed

### Options

Trim Ring Finish	Plastic	No cost
------------------	---------	---------

### Specification Information

Style Number Price

## AMOBI 72" Thread Power Track Wall Infeed with Ramps, Dual Circuit

**THDIF72** \$750



### Standard Includes

- Thread power track infeed

### Options

Trim Ring Finish	Plastic	No cost
------------------	---------	---------

### Specification Information

Style Number Price

## AMOBI 96" Thread Power Track Wall Infeed with Ramps, Dual Circuit

**THDIF96** \$870



### Standard Includes

- Thread power track infeed

### Options

Trim Ring Finish	Plastic	No cost
------------------	---------	---------

### Specification Information

Style Number Price

## AMOBI 120" Thread Power Track Wall Infeed with Ramps, Dual Circuit

**THDIF120** \$996


**Standard Includes**

- Thread power track

**Specification Information**

Style Number Price

**AMOBI 60" Thread Power Track with Ramps**
**THDPT60** \$528

**Standard Includes**

- Thread power track infeed

**Specification Information**

Style Number Price

**AMOBI 72" Thread Power Track Wall Infeed with Ramps**
**THDPT72** \$581

**Standard Includes**

- Thread power track

**Specification Information**

Style Number Price

**AMOBI 84" Thread Power Track with Ramps**
**THDPT84** \$633

**Standard Includes**

- Thread power track infeed

**Specification Information**

Style Number Price

**AMOBI 96" Thread Power Track Wall Infeed with Ramps**
**THDPT96** \$682

# AMOBI

## Power



### Standard Includes

- Thread power track infeed

### Specification Information

Style Number Price

## AMOBI 120" Thread Power Track Wall Infeed with Ramps

**THDPT120** \$790



### Standard Includes

- Power connector

### Options

Trim Ring Finish	Plastic	No cost
Connector Cover Finish	Textured Paint	No cost

### Specification Information

Style Number Price

## AMOBI Thread Power Connector, Blank Low Profile

**THDBLK** \$278



### Standard Includes

- Power connector

### Options

Trim Ring Finish	Plastic	No cost
Connector Cover Finish	Textured Paint	No cost

### Specification Information

Style Number Price

## AMOBI Thread Power Connector, One Door Low Profile

**THD1DR** \$326



**Standard Includes**

- Power connector

**Options**

Trim Ring Finish	Plastic	No cost
Connector Cover Finish	Textured Paint	No cost

**Specification Information**

Style Number	Price
--------------	-------

**AMOBI Thread Power Connector, Two Door Low Profile**

<b>THD2DR</b>	\$371
---------------	-------



**Standard Includes**

- Power connector

**Options**

Trim Ring Finish	Plastic	No cost
------------------	---------	---------

**Specification Information**

Style Number	Price
--------------	-------

**AMOBI Thread Power Connector, NEMA Monument with Tamper Resistant Receptacles**

<b>THDNEMA</b>	\$438
----------------	-------



**Standard Includes**

- Plug adapter

**Specification Information**

Style Number	Price
--------------	-------

**AMOBI Low Profile Plug Adapter**

<b>THDADPTR</b>	\$87
-----------------	------

# AMOBI

## Power



*Tip: Illustration above does not show mounting plate which is included in the base price.*

### Standard Includes

- Wall converter

### Specification Information

Style Number Price

#### AMOBI Jumper Box Wall Converter and Mounting Plate

**JBWC** \$413



### Standard Includes

- Power infeed

### Specification Information

Style Number Price

#### AMOBI 72" Jumper Box Corded Infeed with Black Mesh

**JBIF72** \$191



### Standard Includes

- Power infeed

### Specification Information

Style Number Price

#### AMOBI 120" Jumper Box Corded Infeed with Black Mesh

**JBIF120** \$265



### Standard Includes

- Power connector

### Specification Information

Style Number Price

#### AMOBI Jumper Box Power Connector Kit for 54" Desk

**JBCNT54** \$519

**Standard Includes**

- Power connector

**Specification Information**

Style Number    Price

---

**AMOBI Jumper Box Power Connector Kit for 60" Desk**

---

**JBCNT60**    \$572





---

# CONCUR

## CONCUR

Understanding

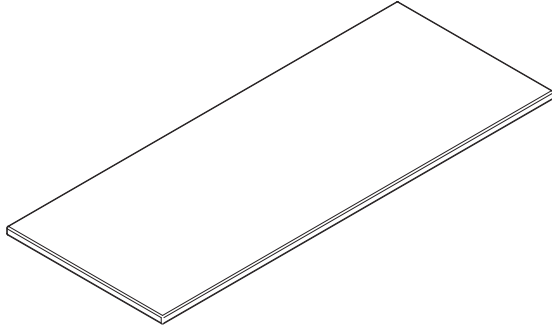
**122**

Specifying

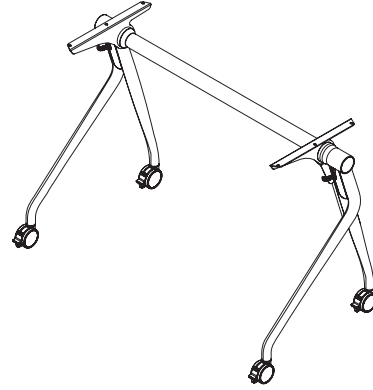
**124**

CONCUR

# Statement of Line



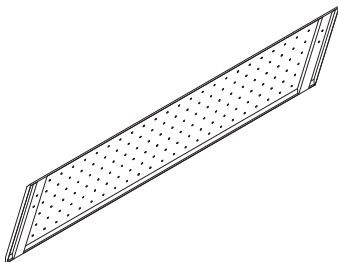
Worksurface



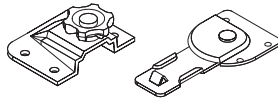
Frame Assembly

---

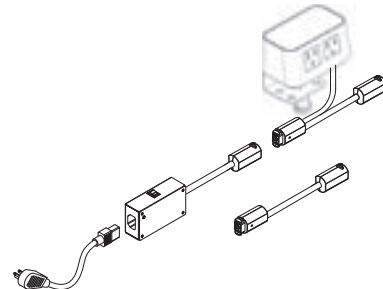
## Optional



Modesty Panel



Ganging Kit



Power

# Concur Specifications



Frame width	47.25", 59.05" and 70.85"
Width between front legs	44.5", 56.25" and 68.1"
Width between rear legs	40.75", 52.5" and 64.35"
Leg Depth	21"
Cantilever Depth	13.75"
Height (excluding top)	28.5"
Worksurface widths	48", 60" and 72"
Worksurface depths	24" and 30"
Worksurface thickness	1"
Modesty Panel	Steel
Modesty Panel Width	39.5", 51.25" and 63.1"
Modesty Panel Height	14"
Clearance between Modesty Panel and Floor	12"
Castors	Soft, Height Adjustable, Locking
Weight Capacity	200 lbs
Frame weight without top	27 lbs
Power in-feed length	72"
Power Box	2 electrical outlets with worksurface clamp
Certifications	BIFMAX5.5-2014
Electrical Compliance	ETL Listed, UL Recognized

# CONCUR

## CONCUR



### Standard Includes

- Table: 1" top, laminate
- Square edge: 3mm plastic edge band
- Steel legs with locking casters

### Options

Worksurface Finish	Laminate LPL Price Group 01	No cost
Frame Finish	Paint	No cost
Modesty Panel	W/ Modesty Panel	48"W: +\$255 60"W: +\$281 72"W: +\$306

### Specification Information

Style Number	Dimensions Depth	Base Prices		
		Width		
		48"W	60"W	72"W

### CONCUR Table

Style Number	48"W	60"W	72"W
<b>CNCRTABLE 24"</b>	\$1201	\$1309	\$1420
30"	\$1251	\$1339	\$1456



### Standard Includes

- Frame: steel leg with locking casters

### Options

Frame Finish	Paint	No cost
--------------	-------	---------

### Specification Information

Style Number	Dimensions	Prices		
		Width		
		48"W	60"W	72"W

### CONCUR Frame

Style Number	48"W	60"W	72"W
<b>CNCRFRAME</b>	\$917	\$956	\$993



*Tip: Bundle includes two TIZU nest chairs.*

*Tip: Black frame only available with chrome base and soft, black castors or glides.*

*Tip: White frame only available with white or platinum base and soft, 2-tone grey castors or glides.*

*Tip: Armless option not available with plastic back.*

**Standard Includes**

- Frame: steel leg with locking casters
- Set of two TIZU nest chairs

**Options**

Seat Cover Finish	Fabric Price Group 01	No cost
	Fabric Price Group 02	+\$36
	Fabric Price Group 03	+\$74
	Polyurethane - Price Group 4	+\$136
Packaging	Knocked down	No cost
	Fully Assembled	+\$186
Castors or Glides	Soft, 2-Tone Grey	No cost
	Soft, Black	No cost
	Glides, Black	+\$122

▶ **Product Information continued on next page**

► **Product Information continued from previous page**

## Specification Information

Style Number	Dimensions	Base Prices	
		Table Width	
		60"W	72"W

### **CONCUR Frame and 2 TIZU Nest Chairs Bundle**

#### **Bundle with Black Frame, Mesh Back, Armless, Chrome Base Chairs**

<b>CNCRTIZUBNDL</b>	\$2010	\$2045
---------------------	--------	--------

#### **Bundle with White Frame, Mesh Back, Armless, Platinum Base Chairs**

<b>CNCRTIZUBNDL</b>	\$2045	\$2080
---------------------	--------	--------

#### **Bundle with White Frame, Mesh Back, Armless, White Base Chairs**

<b>CNCRTIZUBNDL</b>	\$2070	\$2105
---------------------	--------	--------

#### **Bundle with Black Frame, Plastic Back, Fixed Arms, Chrome Base Chairs**

<b>CNCRTIZUBNDL</b>	\$2046	\$2082
---------------------	--------	--------

#### **Bundle with White Frame, Plastic Back, Fixed Arms, Platinum Base Chairs**

<b>CNCRTIZUBNDL</b>	\$2083	\$2118
---------------------	--------	--------

#### **Bundle with White Frame, Plastic Back, Fixed Arms, White Base Chairs**

<b>CNCRTIZUBNDL</b>	\$2108	\$2144
---------------------	--------	--------

#### **Bundle with Black Frame, Mesh Back, Fixed Arms, Chrome Base Chairs**

<b>CNCRTIZUBNDL</b>	\$2092	\$2127
---------------------	--------	--------

#### **Bundle with White Frame, Mesh Back, Fixed Arms, Platinum Base Chairs**

<b>CNCRTIZUBNDL</b>	\$2130	\$2160
---------------------	--------	--------

#### **Bundle with White Frame, Mesh Back, Fixed Arms, White Base Chairs**

<b>CNCRTIZUBNDL</b>	\$2157	\$2188
---------------------	--------	--------



**Standard Includes**

- Power infeed

**Specification Information**

Style Number      Price

**CONCUR Power Base In-Feed with Control Box and 72" Cord**

**CONCUR-EE-CB**    \$509



**Standard Includes**

- Power link

**Specification Information**

Style Number      Price

**CONCUR 60" Power Link for Concur Training Table**

**CONCUR-EE-CNT**    \$337



**Standard Includes**

- Power jumper

**Specification Information**

Style Number      Price

**CONCUR 24" Power Jumper for Concur Training Table**

**CONCUR-EE-JMP**    \$121



**Standard Includes**

- Ganging kit and hardware

**Specification Information**

Style Number      Price

**CONCUR Ganging Kit**

**CONCUR-GK**      \$46

# CONCUR

## CONCUR



### Standard Includes

- Laminate worksurface

### Options

Worksurface Finish                      Laminate LPL Price Group 01                      No cost

### Specification Information

Style Number	Dimensions Depth	Prices		
		Width		
		48"W	60"W	72"W

### CONCUR Worksurface

CNCRWORKSURFACE	24"	\$284	\$353	\$427
	30"	\$334	\$383	\$463



### Standard Includes

- Steel modesty panel with attachment hardware

### Specification Information

Style Number	Prices		
	Width		
	48"W	60"W	72"W

### CONCUR Modesty Panel

CNCRMODESTY	\$255	\$281	\$306
-------------	-------	-------	-------



---

# 3F

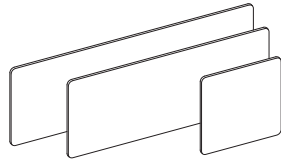


## 3F

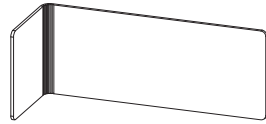
Understanding	<b>130</b>
Specifying	<b>137</b>

# Statement of Line

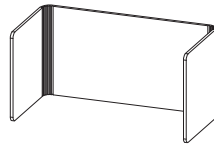
## 3F Screens



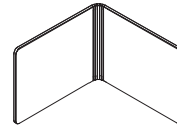
Linear



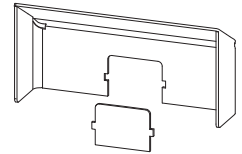
L-Shape



U-Shape

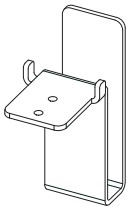


Half Desk

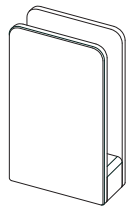


Hooded

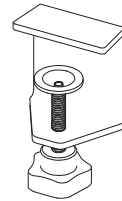
## Brackets



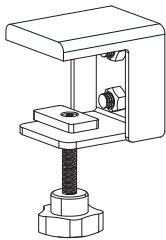
Sleeve Bracket



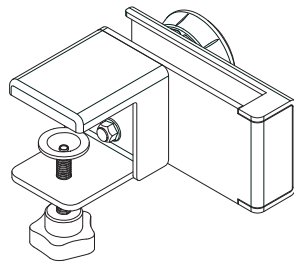
Top Mounted Bracket



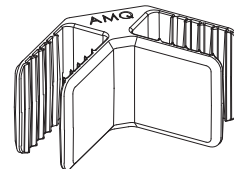
Top Mounted Bracket Clamp



Fixed Privacy Modesty Bracket



Height Adjustable Bracket



Screen Corner Connector

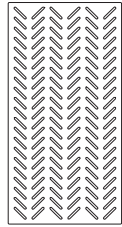
3F Hanging Panels



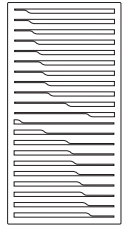
Solid



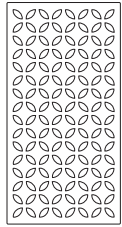
Skyline



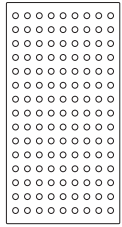
Array



Stairstep



Clover



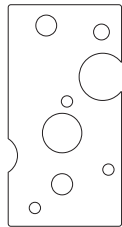
Polka



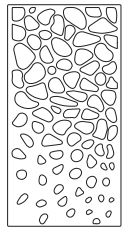
Palm



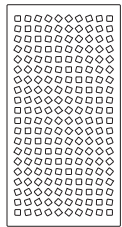
Botanica



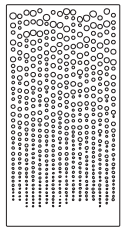
Bubbles



Pebbles



Cubes



Shimmer

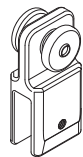
Panel Suspension Kits



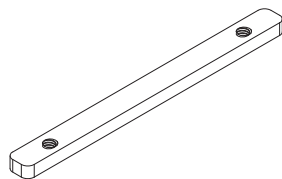
Ceiling Suspension Kit



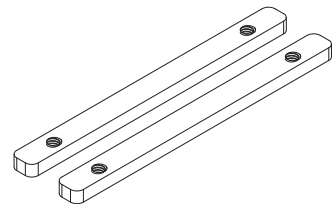
Rail Suspension Kit



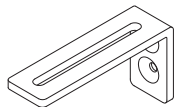
Rail Sliding Kit



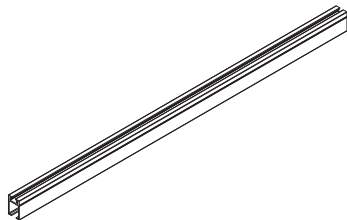
Single Rail Bridge Extension Kit



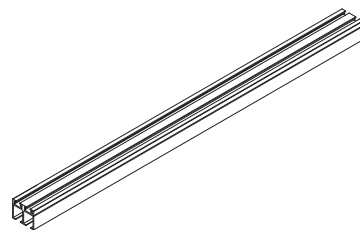
Double Rail Bridge Extension Kit



Rail Wall Mounting Kit



50" Single Rail



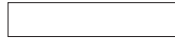
50" Double Rail

# Statement of Line

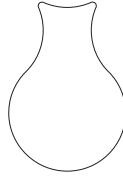
## 3F Wall Tiles



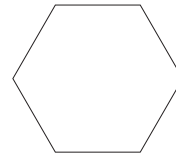
Trapezoid



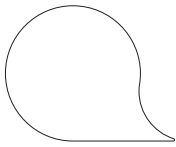
Stripe



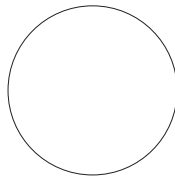
Drop



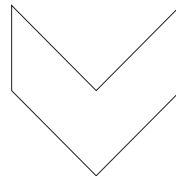
Hexagon



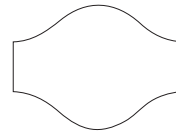
Balloon



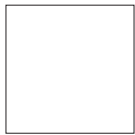
Circle



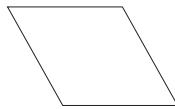
Chevron



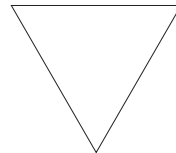
Belt



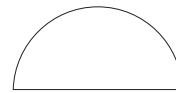
Square



Rhombus



Triangle



Dome

## 3F Screens Specifications



Standard Widths	23", 28", 30", 36", 44", 46", 50", 52", 56", 58", 62", 64", 68", 70"
Standard Heights	18", 23" and 28"
Thickness	.7" / 18mm
Applications	Linear, L-Shape, U-Shape and Half Desk
Mounting Options	3F Worksurface Brackets, ILINE Clips or KINEX Clips
Density	3kg/m <sup>2</sup>
Composition	100% Polyester (min. 50% recycled PET fiber)
Sound Absorption	NRC Value .85
Environmental	Oeko-Tex Standard 100 certified, VOC free
Recyclability	100% Recyclable
Bracket Compliance	BIFMA X5.6-2016



## 3F Hooded Screens Specifications

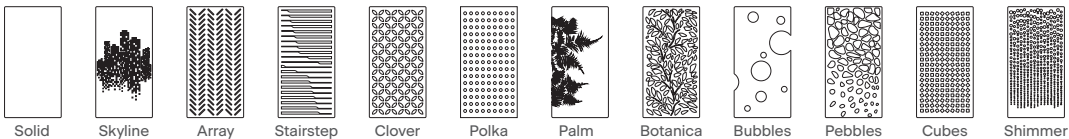
Standard Widths	48", 54", 60", 66", 72"
Standard Heights	30"
Roof Angle	30°
Mounting Options	3F Top Mounted Bracket/Clamp

# 3F Hanging Panels Specifications

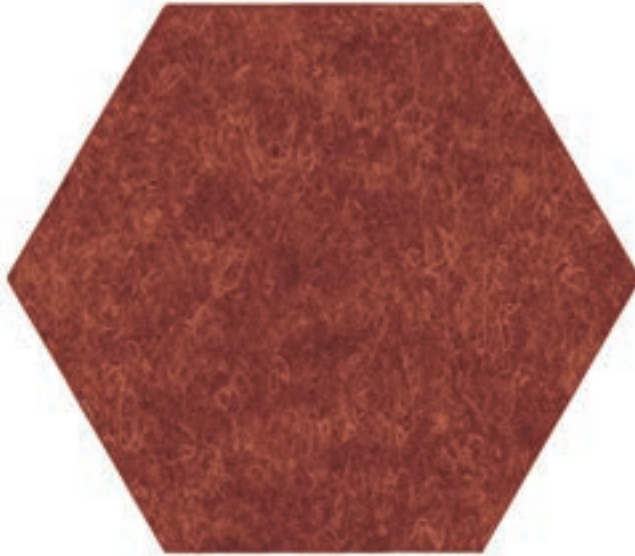
3F



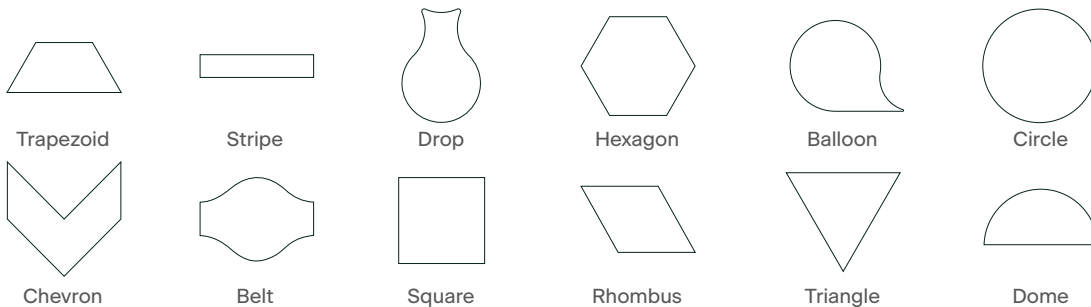
Standard Widths	28", 38", 48"
Standard Heights	94"
Thickness	9mm / .35"
Density	1.9kg/m2
Composition	100% Polyester (min. 50% recycled PET fiber)
Sound Absorption	NRC Value .60
Mounting Options	Ceiling Suspension, Rail Suspension, Sliding Track
Environmental	Oeko-Tex Standard 100 certified, VOC free
Recyclability	100% Recyclable
Flammability	ATSM E-84 Class A



# 3F Wall Tiles Specifications



Standard Widths	11.5"
Thickness	9mm / .35"
Density	1.9kg/m2
Composition	100% Polyester (min. 50% recycled PET fiber)
Sound Absorption	NRC Rating: 0.3
Mounting Options	Industrial Tape (approx. 1 roll per 60 tiles)
Environmental	Oeko-Tex Standard 100 certified, VOC free
Recyclability	100% Recyclable
Flammability	ATSM E-84 Class A



# Finishes

## Verve Collection

Specify at the end of product SKU



Briquette FC1



Shadow FC2



Ash FC3



Pearl FC4



Celestial FC5



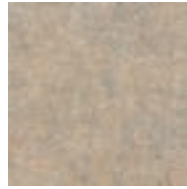
Verde FC6



Tuscan FC7



Saffron FC8



Sand FC9



Seafoam FC10





**Standard Includes**

• 94"L hanging panel: PET felt

**Options**

Pattern	Array	No cost
	Botanica	No cost
	Bubbles	No cost
	Clover	No cost
	Cubes	No cost
	Palm	No cost
	Pebbles	No cost
	Polka	No cost
	Shimmer	No cost
	Skyline	No cost
	Solid	No cost
	Stairstep	No cost
Panel Finish	Verve	No cost

**Specification Information**

Style Number	Prices		
	Width		
	28"W	38"W	48"W

**3F Hanging Panel**

<b>3FHPHANGINGPNL</b>	\$664	\$866	\$1067
-----------------------	-------	-------	--------



# 3F

## Wall Tile



### Standard Includes

- PET felt wall tile

### Options

Tile Finish	Verve	No cost
-------------	-------	---------

### Specification Information

Style Number	Prices											
	Balloon	Belt	Chevron	Circle	Dome	Drop	Hexagon	Rhombus	Square	Stripe	Trapezoid	Triangle
<b>3FWTTILE</b>	\$44	\$44	\$44	\$44	\$31	\$44	\$44	\$44	\$44	\$31	\$31	\$44



**Standard Includes**

- Desk screen: PET felt

**Options**

Screen Finish	Verve	No cost
---------------	-------	---------

Tip: Compatible with any bracket.

**Specification Information**

Style Number	Dimensions Height	Prices													
		Width													
		23"W	28"W	30"W	36"W	44"W	46"W	50"W	52"W	56"W	58"W	62"W	64"W	68"W	70"W

**3F Linear Screen**

<b>3FSNLINER</b>	18"	\$141	\$166	\$185	\$217	\$242	\$254	\$280	\$294	\$319	\$332	\$357	\$370	\$396	\$408
	23"	\$153	\$179	\$198	\$230	\$254	\$268	\$294	\$306	\$332	\$345	\$370	\$382	\$408	\$420
	28"	\$179	\$204	\$224	\$254	\$280	\$294	\$319	\$332	\$357	\$370	\$396	\$408	\$435	\$445



**Standard Includes**

- Desk screen: PET felt

**Options**

Screen Finish	Verve	No cost
---------------	-------	---------

**Specification Information**

Style Number	Dimensions Height	Prices				
		Width				
		46"W	52"W	58"W	64"W	70"W

**3F Full Desk L Screen**

<b>3FSNLSCREEN</b>	18"	\$415	\$452	\$496	\$536	\$574
	23"	\$440	\$485	\$522	\$561	\$606
	28"	\$478	\$522	\$561	\$599	\$644

Tip: Compatible with any bracket other than height adjustable bracket.

Tip: Full desk L screens have a 23" side depth.

# 3F

## Screens



*Tip: Half desk L screens are non-handed. Two half-desk L screens are required to wrap a full worksurface.*

*Tip: Half desk L screens have a 30" side depth. For worksurfaces <30" deep, half desk L screens can overhang the front of the worksurface to provide additional privacy.*

*Tip: Top mount is compatible with top mounted brackets.*

*Tip: Half desk L screens are designed to work with 48", 60", and 72" wide worksurfaces. Mounting a pair of screens on a different size worksurface will create a gap between screens.*

*Tip: Outer wrapped is compatible with sleeve brackets and fixed privacy modesty brackets.*

### Standard Includes

- Desk screen: PET felt

### Options

Mount Type	Outer Wrapped	No cost
	Top Mount	No cost

### Specification Information

Style Number	Dimensions Height	Prices		
		Width		
		24"W	30"W	36"W

### 3F Half Desk L Screen

3FSNHALFDESK	Height	24"W	30"W	36"W
	18"	\$325	\$396	\$452
	23"	\$350	\$420	\$478
	28"	\$389	\$459	\$516



*Tip: Top mount is compatible with top mounted brackets.*

*Tip: Outer wrapped is compatible with sleeve brackets and fixed privacy modesty brackets.*

*Tip: Depth dimensions may vary depending on bracket mount type.*

### Standard Includes

- Desk screen: PET felt

### Options

Mount Type	Outer Wrapped	No cost
	Top Mount	No cost

### Specification Information

Style Number	Dimensions Height	Prices				
		Width/Depth				
		46"W/20"D	48"W/20"D	52"W/20"D	54"W/20"D	58"W/18"D

### 3F U Screen

<b>3F3NUSCREEN</b>	18"	\$547	\$561	\$586	\$606	\$631
	23"	\$586	\$606	\$631	\$644	\$670
	28"	\$637	\$656	\$683	\$694	\$720

Style Number	Dimensions Height	Prices				
		Width/Depth				
		60"W/17"D	64"W/15"D	66"W/14"D	70"W/12"D	72"W/11"D

<b>3F3NUSCREEN</b>	18"	\$644	\$670	\$683	\$708	\$732
	23"	\$683	\$708	\$720	\$746	\$758
	28"	\$732	\$758	\$770	\$796	\$811



# 3F

## Screens



*Tip: Hooded screens only compatible with top mount bracket.*

*Tip: The removable monitor arm cut-out ships with the hooded screen and is designed to accommodate applications with or without monitor arms.*

*Tip: The cut-out can be removed to clamp monitor arms or can be plugged into the opening if monitor arms are not being used.*

### Standard Includes

- Desk screen: PET felt

### Options

Screen Finish	Verve	No cost
---------------	-------	---------

### Specification Information

Style Number	Prices				
	Width				
	48"W	54"W	60"W	66"W	72"W

### 3F Hooded Screen

<b>3F5NHOODED</b>	\$709	\$757	\$804	\$854	\$902
-------------------	-------	-------	-------	-------	-------



*Tip: When ordering a 3F rail, you must also order a rail suspension mount, a rail sliding mount, or a wall mount.*

**Standard Includes**

- Mounting rail beam: paint
- Attachment hardware

**Options**

Extension Kit	With Extension	Single Rail: +\$13 Double Rail: +\$26
Wall Mount	With Wall Mount	+\$33

**Specification Information**

Style Number	Prices	
	50" Single Rail	50" Double Rail

**3F Rail**

<b>3FHPRAILKIT</b>	\$161	\$228
--------------------	-------	-------

**Standard Includes**

- Suspension mount: set of two 5'L steel cables
- Sliding mount: sliding glider bracket
- Attachment hardware

**Specification Information**

Style Number	Prices	
	Rail Suspension Mount	Rail Sliding Mount

**3F Rail Mount Kit**

<b>3FHPMOUNTKIT</b>	\$54	\$140
---------------------	------	-------

**Standard Includes**

- Set of two 5'L steel cables
- Attachment hardware

**Specification Information**

Style Number	Price
--------------	-------

**3F Ceiling Kit**

<b>X-3F-SUSPENSION</b>	\$121
------------------------	-------

*Tip: Rails can be positioned adjacent to each other to build a multi-rail system.*

# 3F

## Screen Accessories



### Standard Includes

- Set of two desk screen brackets: paint

### Options

Bracket Finish	Paint	No cost
----------------	-------	---------

### Specification Information

Style Number	Price
--------------	-------

### 3F Corner Connector (2 per set)

<b>3FSNCORNERCNCT</b>	\$57
-----------------------	------



Tip: 1 1/2" clearance is needed from edge of worksurface to cantilever.

Tip: Compatible with 3/4" to 1 3/4" thick worksurfaces.

### Standard Includes

- Set of two desk screen brackets: paint

### Options

Bracket Finish	Paint	No cost
----------------	-------	---------

### Specification Information

Style Number	Price
--------------	-------

### 3F Sleeve Bracket (2 per set)

<b>3FNSLEEVEBKT</b>	\$71
---------------------	------



Tip: Compatible with 3/4" to 1 3/4" thick worksurfaces.

### Standard Includes

- Set of two desk screen brackets: paint

### Options

Bracket Finish	Paint	No cost
----------------	-------	---------

### Specification Information

Style Number	Price
--------------	-------

### 3F Top Mount Bracket (2 per set)

<b>3FSNTOPMOUNTBKT</b>	\$76
------------------------	------





**Standard Includes**

- Set of two desk screen brackets: paint

**Options**

Bracket Finish	Paint	No cost
----------------	-------	---------

**Specification Information**

Style Number	Price
--------------	-------

**3F Top Mount Bracket and Clamp Set (2 per set)**

<b>3FSNTOPMNTCLAMPBKT</b>	\$115
---------------------------	-------

*Tip: 1 1/2" clearance is needed from edge of work surface to cantilever.*

*Tip: Compatible with 3/4" to 1 3/4" thick work surfaces.*



**Standard Includes**

- Set of two desk screen brackets: paint

**Options**

Bracket Finish	Paint	No cost
----------------	-------	---------

**Specification Information**

Style Number	Price
--------------	-------

**3F Fixed Modesty Screen Bracket (2 per set)**

<b>3FSNFIXEDPRVCYBKT</b>	\$102
--------------------------	-------

*Tip: 1 1/2" clearance is needed from edge of work surface to cantilever.*

*Tip: Compatible with 3/4" to 1 3/4" thick work surfaces.*



# 3F

## Screen Accessories



Tip: 1 1/2" clearance is needed from edge of worksurface to cantilever.

Tip: Compatible with 3/4" to 1 3/4" thick worksurfaces.

### Standard Includes

- Set of two desk screen brackets: paint

### Options

Bracket Finish	Paint	No cost
----------------	-------	---------

### Specification Information

Style Number	Price
--------------	-------

### 3F Height Adjustable Bracket (2 per set)

<b>3FSNHEIGHTADJBKT</b>	\$141
-------------------------	-------

### Standard Includes

- Set of two desk screen brackets: paint

### Options

Bracket Finish	Paint	No cost
----------------	-------	---------

### Specification Information

Style Number	Price
--------------	-------

### 3F Kinex Screen Clip - Double Run (2 per set)

<b>3FSNKINEXCLIP</b>	\$157
----------------------	-------



Tip: One roll of tape is recommended per 30 wall tiles.

### Standard Includes

- Industrial strength double sided tape for 3F wall tiles

### Specification Information

Style Number	Price
--------------	-------

### 3F Tape Roll - 1"W, 54 ft.

<b>X-3F-TAPE</b>	\$111
------------------	-------

**AMQ 3F Screens ILINE Screen Mount Clip**

Style Number	List Price
<b>3FSNILINEMOUNT</b>	<b>\$149</b>

**Options**

Bracket Finish	Paint	No cost
----------------	-------	---------



---

# REVI



## REVI

Understanding	150
Specifying	152

# Revi Pedestal Specifications



Housing Dimensions	13"w x 23.5"d x 22.75"h
Drawers	Push-to-open (no pulls or handles)
Drawer Depth	20"
Drawer Width	12.5"
Single/Dual Drawer Height	6"
File Drawer Height	12.25"
Maximum Drawer Extension	15.75"
Bag Drop Height	14"
Bag Drop Extension Range	.25" - 6.5"
Personal Locker Door Rotation	95°
Magnetic Cushion Thickness	.85"
Castors	2 locking, 2 non-locking
Bag Drop Castors	2 non-locking
Seated Weight Capacity	220 lbs
Bag Drop Weight Capacity	45 lbs
Lock Availability	Dual Drawer, Drawer + File, Personal Locker
Certifications	ANSI/BIFMA X5.9-2019

# Revi Undermount Specifications



Housing Dimensions	10"W x 15"D x 18.5"H
Top Shelf Dimensions	10"W x 7.75"D x 2.5"H
Inside Clearance	10"W x 15"D x 15.5"H
Housing Finish Color	Platinum, White and Black
Personal Storage Bin Net Weight	15 lbs
Personal Storage Console Net Weight	18 lbs
Shelf Clearance below	6"
Shelf Clearance above	9"
Laptop Divider Clearance	3"W x 15"D x 15.5"H
Short Shelf Clearance	6.75"W x 15"D x 9"H
Bag Hook	1"W x 1"D x 2"H
File Pocket	1.25"W x 13"D x 5.5"H
Undermount Weight Capacity	80 lbs
Bag Hook Weight Capacity	15 lbs
File Pocket Weight Capacity	5 lbs
Door Rotation	135°
Certifications	ANSI/BIFMA X5.9-2019

# REVI

## REVI



Tip: Swing door is only available if locker storage is selected.

### Standard Includes

- Pedestal
- Steel top
- Push-to-open (no pulls or handles)
- Castors: 2 locking, 2 non-locking

### Options

Storage Finish	Paint	No cost
Swing Door Finish	Paint	No cost
Expandable Bag Drop	With Expandable Bag Drop	+\$228
Bag Drop Finish	Paint	No cost
Seat Cushion Option	With Magnetic Seat Cushion	+\$215
Seat Cushion Finish	Verve	No cost
Pencil Tray	With Pencil Tray	+\$21

### Specification Information

Style Number	Base Prices				
	Bookcase	Single Drawer	Locker	Dual Drawer	Drawer/File
<b>REVI Pedestal</b>					
<b>REVIPEDESTAL</b>	\$501	\$555	\$582	\$629	\$669



### Standard Includes

- Steel storage
- Hardware package

### Options

Storage Finish	Paint	No cost
Door Type	Left Hinged	+\$94
	Right Hinged	+\$94
Swing Door Finish	Paint	No cost
Shelf Option	With Shelf	+\$40
	Laptop Divider and Short Shelf	+\$107
Shelf Finish	Paint	No cost
Bag Hook	1 Bag Hook	+\$26
	2 Bag Hooks	+\$52
File Pocket	1 File Pocket	+\$47
	2 File Pockets	+\$94
	3 File Pockets	+\$141

### Specification Information

Style Number	Base Price
<b>REVI Undermount</b>	
<b>REVIUNDERMOUNT</b>	\$348





**Standard Includes**

- Fabric cushion

**Options**

Seat Cushion Finish                      Verve    No cost

**Specification Information**

Style Number                      Price

**REVI Cushion**

**REVICUSHION**    \$215



**Standard Includes**

- Plastic pencil tray

**Specification Information**

Style Number                      Price

**REVI Pencil Tray**

**REVI-PNCLTRY**    \$21



**Standard Includes**

- Metal shelf

**Options**

Shelf Finish                      Paint    No cost

**Specification Information**

Style Number                      Price

**REVI Undermount Shelf**

**REVISHELF**    \$40



# REVI

## REVI



### Standard Includes

- Laptop shelf and divider

### Options

Shelf Finish	Paint	No cost
--------------	-------	---------

### Specification Information

Style Number	Price
--------------	-------

## REVI Laptop Shelf

<b>REVILAPTOPSHELF</b>	\$40
------------------------	------



### Standard Includes

- Bag hook

### Specification Information

Style Number	Price
--------------	-------

## REVI Bag Hook

<b>REVI-BH</b>	\$26
----------------	------

*Tip: Revi bag hook also works on Amobi undermount cubby ADSCUB.*



### Standard Includes

- File pocket

### Specification Information

Style Number	Price
--------------	-------

## REVI File Pocket

<b>REVI-FP</b>	\$47
----------------	------

---

# S-SERIES

## S-SERIES

Understanding	156
Specifying	157

# S-Series Storage Specifications



- 
- Powder coated
  - 22 gauge steel
  - Pedestal has locking castors and 220 lb. seated capacity
  - Lateral and Book Shelf have 65 lb. storage weight capacity
  - Lateral and Book Shelf have glides, with 16mm Castors also available
  - Seat cushions for Slim Pedestal in 10 colors
-



**Standard Includes**

- Steel storage pedestal with casters
- Includes pencil tray, box drawer divider, file hanger, anti-tip counterweight, locking castors, full extension ball bearing glides, and removable lock core

**Options**

Width	12" 15"	Prices below Prices below
Storage Finish	Paint	No cost
Seat Cushion Finish	Verve	No cost

**Specification Information**

Style Number	Dimensions			Prices
	D	W	H	

**S-SERIES Pedestal**

<b>SSRSPEDESTAL</b>	23"	12"	19 7/10"	\$478
	23"	15"	21"	\$555

**S-SERIES Pedestal with Cushion**

<b>SSRSPEDESTAL</b>	23"	12"	19 7/10"	\$677
	23"	15"	21"	\$767



Tip: Illustration above shows lateral file with drawers.

**Standard Includes**

- Steel storage pedestal with casters

**Options**

Storage Finish	Paint	No cost
Castors or Glides	With Castors	+\$93

**Specification Information**

Style Number	Dimensions			Prices	
	D	W	H	Bookcase	Lateral File with Drawers

**S-SERIES Storage**

<b>SSRSSTORAGE</b>	18"	30"	21 1/4"	\$662	\$872
--------------------	-----	-----	---------	-------	-------

# S-SERIES

## S-SERIES



### Standard Includes

- Fabric cushion

### Options

Seat Cushion Finish	Verve	No cost
---------------------	-------	---------

### Specification Information

Style Number	Prices
	12"W 15"W

### S-SERIES Pedestal Cushion

<b>SSRSCUSHION</b>	\$199	\$212
--------------------	-------	-------

---

# WORK TOOLS

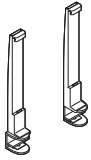
---

## WORK TOOLS

Understanding	160
Specifying	181

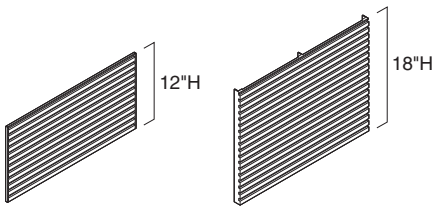
# Statement of Line

## Slatwall



Understanding  
 ▶ Page 172  
 Specifying  
 ▶ Page 187

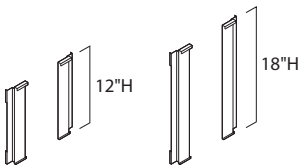
## Freestanding Slatwall Stanchions



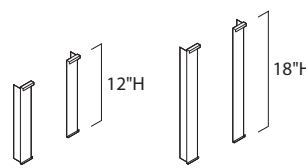
Understanding  
 ▶ Page 172  
 Specifying  
 ▶ Page 188

## Slatwall Tiles

	24"W	30"W	36"W	42"W	45"W	48"W	60"W
12"H	●	●	●	●	●	●	●
18"H	●	●	●	●	●	●	●



Understanding  
 ▶ Page 172  
 Specifying  
 ▶ Page 189



Understanding  
 ▶ Page 172  
 Specifying  
 ▶ Page 189

## Slatwall Panel-Mount Brackets

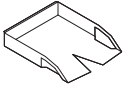
12 <sup>1</sup> / <sub>3</sub> "H	18"H
●	●

## Slatwall Wall-Mount Brackets

12 <sup>1</sup> / <sub>3</sub> "H	18"H
●	●

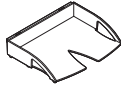


## Freestanding Worktools



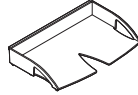
### 10" Portrait Letter Tray

Understanding  
 ▶ Page 174  
 Specifying  
 ▶ Page 190



### 12" Landscape Letter Tray

Understanding  
 ▶ Page 174  
 Specifying  
 ▶ Page 190



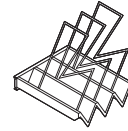
### 15" Landscape Legal Tray

Understanding  
 ▶ Page 174  
 Specifying  
 ▶ Page 190



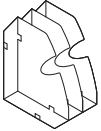
### Binder Holder

Understanding  
 ▶ Page 174  
 Specifying  
 ▶ Page 191



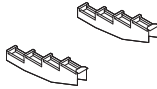
### PaperFlo Manager

Understanding  
 ▶ Page 174  
 Specifying  
 ▶ Page 191



### Universal Shelves

Understanding  
 ▶ Page 175  
 Specifying  
 ▶ Page 191



### Hanging Brackets

Understanding  
 ▶ Page 175  
 Specifying  
 ▶ Page 192



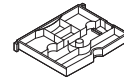
### Pen/Pencil Cup

Understanding  
 ▶ Page 175  
 Specifying  
 ▶ Page 192



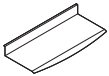
### Double Square Dish

Understanding  
 ▶ Page 176  
 Specifying  
 ▶ Page 192



### Office in a File

Understanding  
 ▶ Page 176  
 Specifying  
 ▶ Page 193



### Personal Shelf

Understanding  
 ▶ Page 176  
 Specifying  
 ▶ Page 193



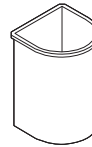
### Telephone Caddy

Understanding  
 ▶ Page 176  
 Specifying  
 ▶ Page 193



### Tackstrip

Understanding  
 ▶ Page 177  
 Specifying  
 ▶ Page 194



### Wastebasket

Understanding  
 ▶ Page 177  
 Specifying  
 ▶ Page 194



### Coat Hook

Understanding  
 ▶ Page 177  
 Specifying  
 ▶ Page 194

# Monitor Arms Specifications

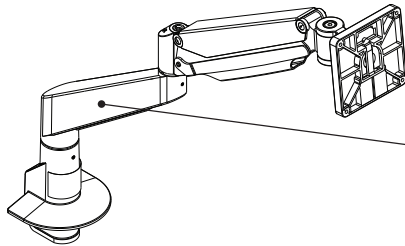
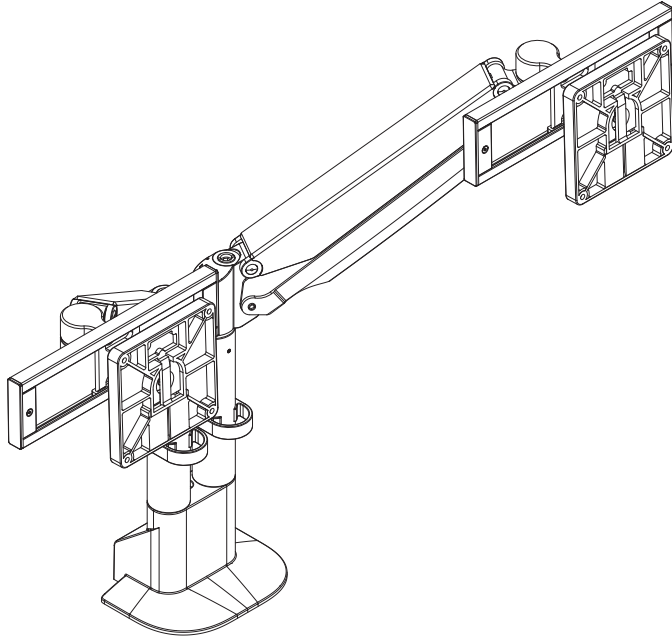


Monitor Support	Up to 30"
Monitor Weight	4.5 – 20 lbs
Monitor Tilt Range	-85° – 15°
Height Adjustment Range	12"
Arm Extension	20"
Arm Retraction	6"
VESA hole sizes	75×75mm / 100×100mm



# Intro Monitor Arms

**Intro display supports** are available in single and dual assembly with universal slider bar tilt heads.



**Intro monitor arm** supports one or two monitors. Quick release tilt head standard.

**Cable management** is included.

*Tip: Monitor arms utilize the VESA hole pattern to connect monitor to arm. Apple monitors do not connect without optional adapter plate. Plate must be acquired through Apple.*

## Product Details

**Intro monitor arms** are standard with 100 VESA plate and tilt head.

**Intro monitor arms** allow for monitor to rotate portrait to landscape orientation.

**Monitor arm assemblies** include mounting bracket options of C-clamp and through-mount.

**Intro single and dual arm brackets** can be C-clamped or through mounted.

**Brackets** are available in desk C-clamp and through-mount.

**All monitor arms** utilize the VESA hole pattern to connect monitor to arm. Apple monitors do not connect without optional adapter plate. Plate must be acquired through Apple.

# Monitor Arm Assemblies and Supports Dimensions

Monitor Arm Assemblies  
and Supports Dimensions

Features	Intro Single (AMQCFINTRO)	Intro Dual with Sliders (AMQCFINTRODLIDE)
<b>Display Supports</b>		
<b>Maximum Monitor Weight</b>	2.2–20 lb	2.2–20 lb per monitor
<b>Maximum Monitor Width</b> (measured left to right)	32"	27"
<b>Maximum Monitor Height</b>	18"	18"
<b>Functional Focal Length*</b>	23.7"	16"
<b>Vertical Adjustment Range</b>	13.2"	13"
<b>Tilt</b> Forward/backward	200°	180°
<b>Lower Arm Rotation</b>	200°	180°
<b>Upper Arm Rotation</b>	360°	360°
<b>Rotation</b> (portrait to landscape)	Yes	Yes
<b>VESA Plate</b>	100 mm	100 mm
<b>VESA Bracket Range</b> (side to side)	180°	180°
<b>Vertical Adjustment Pole Range</b>	N.A.	N.A.

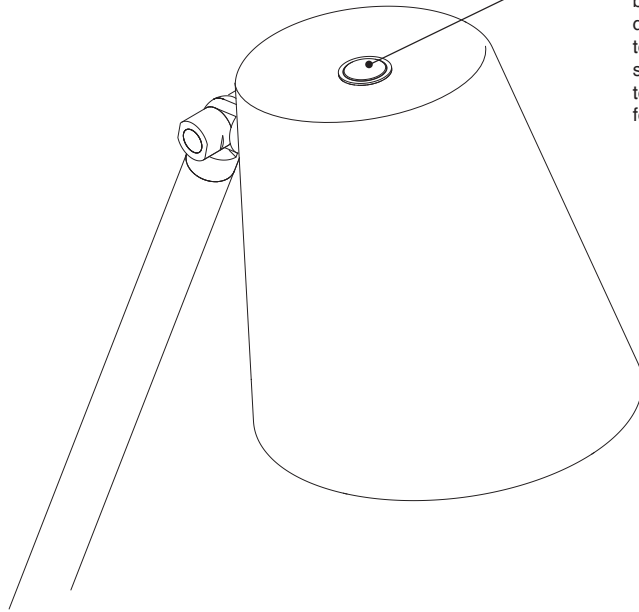
*Tip: Maximum monitor size may be impacted by thickness of monitor and location of VESA bracket mount. Dimensions are estimates.*

*\*Focal length decreases with larger monitor size.*

*Tip: All monitor arms utilize the VESA hole pattern to connect monitor to arm. Apple monitors do not connect without optional adapter plate. Plate must be acquired through Apple.*

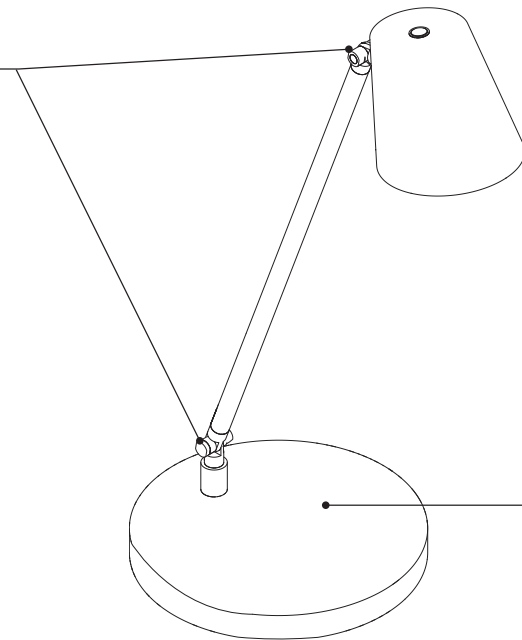
# LED Intro Task Lights

**LED intro task lights** provides ease of user adjustments to direct light where needed, plus a three-step dimming feature. LED light source for energy efficiency.



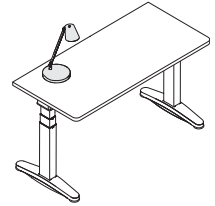
**Capacitive touch switch** is located on the back of the light source with dimming control. The first touch is 10% illumination, second touch is 50%, third touch is 100%, and the fourth touch turns off.

**Light source knuckle and base knuckle** provide articulation points for ease of adjustments to where the light is needed.

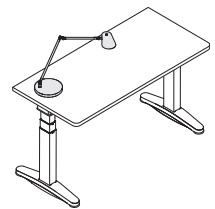


**Freestanding base** is ideal for placing on desk or table tops. Painted to match the entire light fixture and weighted to prevent tipping.

## Product Details



**LED intro single-arm lights** are for use with worksurfaces 58"W or smaller.



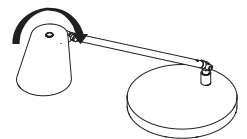
**LED intro double-arm lights** are for use with worksurfaces 60"W or larger.

**LED light performance** with 3000K color temperature and a 90 color rendering index rating.

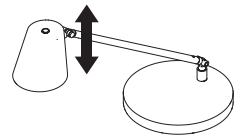
**Adjustability** at the light source and base directs light where needed.

### Examples

- Light head swivels 350° (side to side)



- Light head pivots up and down 180° (up/down)



**Capacitive touch on/off switch and dimming feature** comes standard with three levels: 10%, 50%, and 100%.

**Color temperature of LED** is 3000K.

**Color rendering index (CRI)** is 90.

**Connections**

 Freestanding base

**Wiring & Cabling**

**Light** comes standard with single touch on /10%–50%–100% / off.

**Power supply** uses a modular cord with standard two prong plug, cord length 75".

**Surface Materials**

**Paint**

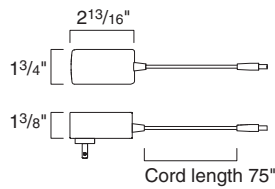
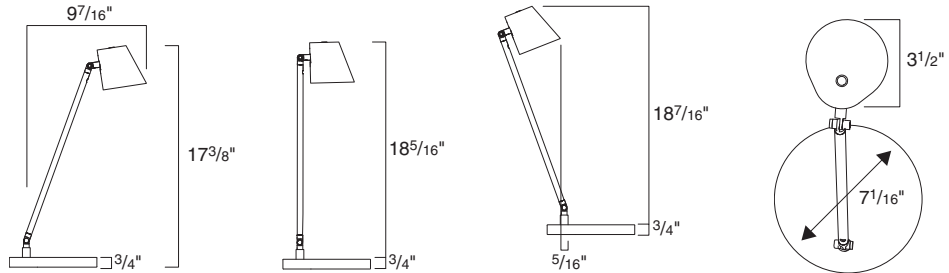
- 4135 Black Matte
- 4142 Platinum Gloss
- 4143 White Matte

**Application Topics**

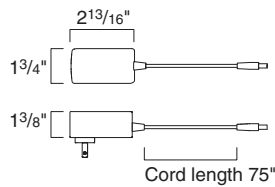
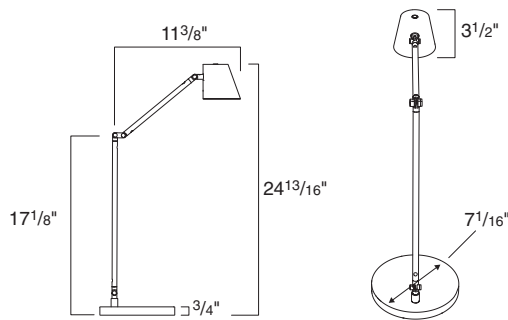
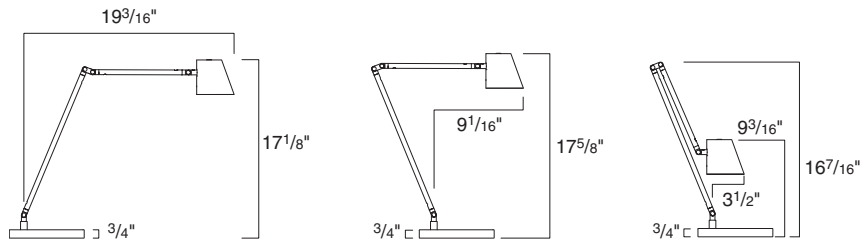
**Power cord** length is 75". Consider distance from light to power receptacle, and if surface or under the work-surface power receptacle may be needed.  
 ▶ Pages 169–170

**Actual Dimensions**

**Single Arm**



**Double Arm**

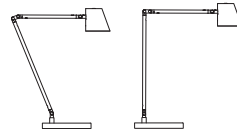


**Task lights** offer end users added control and adjustability to place the proper amount of task lighting to create a holistic work setting.

**LED Lights**

**LED Intro Task Light Single Arm**

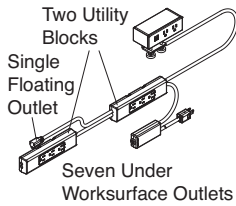
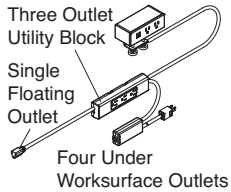
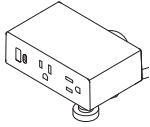
**LED Intro Task Light Double Arm**



Mounting Options	<ul style="list-style-type: none"> <li>Freestanding Base</li> </ul>	
	Specifying ▶ Page 184	Specifying ▶ Page 184
<b>Watts/Lumens/Efficacy</b>	7 Watts/400 Lumens/62 Efficacy	7 Watts/400 Lumens/62 Efficacy
<b>Color Rendering Index</b>	90	90
<b>Color Temperature</b>	3000K	3000K
<b>Horizontal Arm Range</b>	0"-9 <sup>2</sup> / <sub>5</sub> "	3"-19 <sup>1</sup> / <sub>4</sub> "
<b>Vertical Height Adjustment</b>	17 <sup>2</sup> / <sub>5</sub> "-18 <sup>9</sup> / <sub>20</sub> "	9 <sup>1</sup> / <sub>5</sub> "-24 <sup>4</sup> / <sub>5</sub> "
<b>Tilt/Swivel</b>	<ul style="list-style-type: none"> <li>Light head pivot – 180° up/down</li> <li>Swivel – 350°</li> </ul>	<ul style="list-style-type: none"> <li>Light head pivot – 180° up/down</li> <li>Swivel – 350°</li> </ul>
<b>Replacement Lamp/Bulb</b>	<ul style="list-style-type: none"> <li>Not available</li> </ul>	<ul style="list-style-type: none"> <li>Not available</li> </ul>
<b>Average Rated Lamp Life</b>	<ul style="list-style-type: none"> <li>50,000 hrs.</li> </ul>	<ul style="list-style-type: none"> <li>50,000 hrs.</li> </ul>
<b>Finish Options</b>	<ul style="list-style-type: none"> <li>Paint: Black Matte (4135), Platinum Gloss (4142), or White Matte (4143)</li> </ul>	<ul style="list-style-type: none"> <li>Paint: Black Matte (4135), Platinum Gloss (4142), or White Matte (4143)</li> </ul>
<b>Electronic Dimmer</b>	<ul style="list-style-type: none"> <li>Three-step: 10%–50%–100%</li> </ul>	<ul style="list-style-type: none"> <li>Three-step: 10%–50%–100%</li> </ul>
<b>Occupancy Sensor</b>	<ul style="list-style-type: none"> <li>Not available</li> </ul>	<ul style="list-style-type: none"> <li>Not available</li> </ul>
<b>Warranty</b>	<ul style="list-style-type: none"> <li>3 year warranty</li> </ul>	<ul style="list-style-type: none"> <li>3 year warranty</li> </ul>
<b>Power Supply Wattage</b>	<ul style="list-style-type: none"> <li>12 watts</li> </ul>	<ul style="list-style-type: none"> <li>12 watts</li> </ul>
<b>Power Supply Voltage</b>	<ul style="list-style-type: none"> <li>volts</li> </ul>	<ul style="list-style-type: none"> <li>24 volts</li> </ul>
<b>Cord length</b>	<ul style="list-style-type: none"> <li>75" (6<sup>1</sup>/<sub>4</sub>)</li> </ul>	<ul style="list-style-type: none"> <li>75" (6<sup>1</sup>/<sub>4</sub>)</li> </ul>
<b>Cord material</b>	<ul style="list-style-type: none"> <li>Black plastic only</li> </ul>	<ul style="list-style-type: none"> <li>Black plastic only</li> </ul>



## Powerstrip Intro



► Specifying, page 184

## Product Details

**Powerstrip intro** offers two power, one USB-A and one USB-C intelligent 20W with a C-clamp mount for the desktop.

### Desktop power configuration options and specifications include:

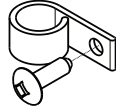
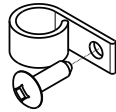
- Two power, one USB-A and one USB-C 20W
- Power outlet is 15A, 120V, 60Hz
- Tamper resistant power outlets

### Meets spill test criteria.

### Two power with 20 watt intelligent USB A+C (3 port):

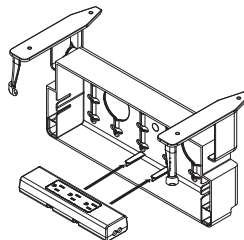
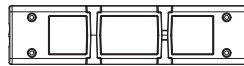
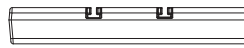
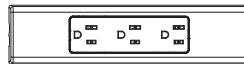
- If only USB-C in use: delivers what the device needs up to 20 watts
- If only USB-A in use, up to 10 watts
- If both USB A+C in use, USB-A delivers up to 10 watts and 10 watts to USB-C. If USB-A device needs less than 10W, the remainder up to 20 watts goes to the USB-C device
- USB-A watt/amp output (2 port) is 10W/2A per port with dedicated charging ports

**Under workspace optional utility power-blocks** do not ship with independent mounting hardware. They are designed to mount into the universal cable management kit without additional hardware.



**Cable management kit** comes standard with each powerstrip. Mounts under the worksurface to manage cords.

## Optional Under Workspace Utility Power



**The bottom of each utility powerstrip block** has slots. The slots allow the block to slide onto raised bars in the universal cable management trays. These help keep the powerstrip in place when the tray is opened or closed.

**Universal cable management tray**—small tray holds four outlets and large tray holds seven outlets under workspace utility power.

## Overcurrent protection via a circuit breaker

prevents one powerstrip intro assembly from drawing more than 15 amps of power.

**Overcurrent protection** is included as standard with powerstrip intro configurations with more than four outlets and is an option on configurations with less than four outlets. Check with your local authorities having jurisdiction to see if overcurrent protection is required for assemblies with less than four outlets.

**Powerstrip intro** includes a 6-foot standard smooth cord with a diameter of 3/8".

**Powerstrip intro** includes a standard straight 3-prong plug. An overcurrent protection (OCP) 90-degree plug is also an option. Check with your local authorities having jurisdiction to see if overcurrent protection is required.

**Overcurrent protection (OCP)** includes a circuit breaker rated for 15 amps.

**C-clamp** is designed to accommodate worksurfaces up to 1 1/2" thick.

Dual 10W USB-A  
20W USB A+C



**Powerstrip intro USB ports** are recommended for charging: cell phones, tablets, headphones, wearable fitness trackers, or other small electronic devices. Not recommended for devices needing higher output, more than 20-watts, like compact laptops. See Powerstrip Plus for higher output USB options.

## Surface Materials

### Housing

- 6009 Arctic White

*Tip: Arctic white housing will have white cord.*

## Actual Dimensions

**Depth** 37/16"

**Width** 41 1/16"

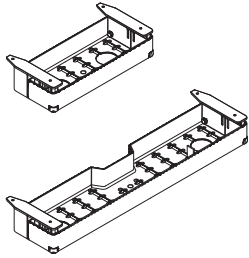
**Height** 1 5/8"

Underwriters Laboratory (UL) Listed. These products have been designed to meet U.S. and Canadian national electrical and energy codes and most local building codes. Local electrical codes vary, so consult with your local authority having jurisdiction as they have final say if the products as installed are compliant with local code.

### Certifications include:

- cULus

**Universal Cable Management Kit**



► Specifying, page 185

**Product Details**

**Universal cable management kit** provides easy management and access to cords, cables, and power blocks under a workstation.

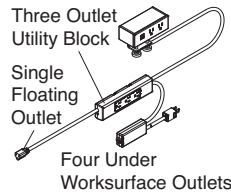
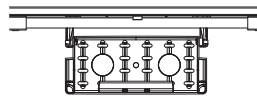
**Optional smart straps** allow for easy management of cables and cords in the cable management tray. Straps are 5<sup>3</sup>/<sub>4</sub>" long.

**Cable management tray** is designed to fit behind the stretcher bar and understructure of most height-adjustable tables.

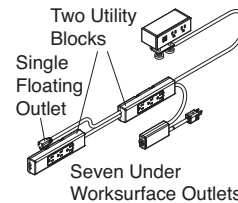
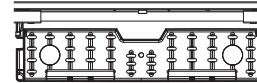
**Cable management tray** provides tool-free and hardware-free mounting of under worksurface utility power.

**Cable management tray** allows for a 4<sup>5</sup>/<sub>8</sub>" gap around all four sides between the tray and the worksurface when mounted to allow for cable egress.

**The small 15<sup>1</sup>/<sub>2</sub>" cable management tray** is designed to hold one, 4 outlet, utility powerstrip. The tray does not have the capacity to hold more than one utility powerstrip.



**The large 30" cable management tray** holds two utility powerstrips in the raised bars section. There is capacity to add three utility powerstrips, two in the raised bar area and one more in the tray, strapped down.



**Surface Materials**

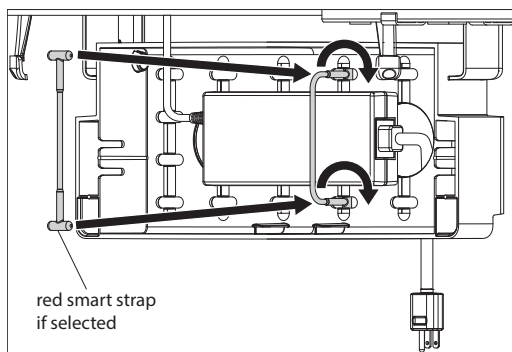
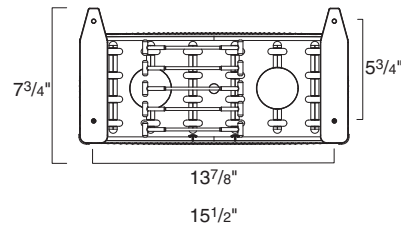
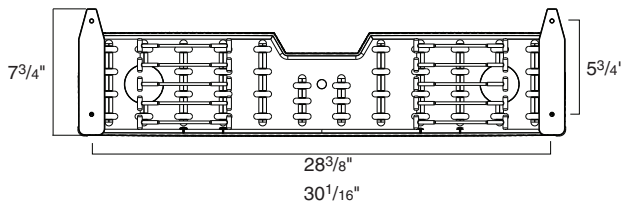
**Cable tray**  
• 6527 Merle

**Actual Dimensions**

**Depth** 6<sup>5</sup>/<sub>16</sub>"  
(7<sup>4</sup>/<sub>8</sub>" with bracket)

**Width** 15<sup>1</sup>/<sub>2</sub>", 30"

**Height** 2<sup>5</sup>/<sub>8</sub>"  
(3<sup>1</sup>/<sub>2</sub>" when installed)



## SOTO Tool Box



► Specifying, page 186

### Product Details

**SOTO tool box** accommodates pens, pencils, Post-it® notes, and other small office tools.

**SOTO tool box** is standard with a translucent removable dividing insert to keep items separate.

**SOTO tool box** will fit inside c:scape furniture drawers and on shelves.

### Surface Materials

**SOTO tool box**  
• 6009 Arctic White

### Actual Dimensions

**Depth** 3½"

**Width** 3¼"

**Height** 3½"

**Weight** 0.3 lb

## SOTO Utility Box



► Specifying, page 186

### Product Details

**SOTO utility box** is for use on 3" shelf, inside personal box, or on worksurface.

**SOTO utility box** will fit inside c:scape furniture drawers and on shelves.

### Surface Materials

**SOTO utility box**  
• 6009 Arctic White

### Actual Dimensions

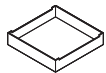
**Depth** 3⅞"

**Width** 9"

**Height** 1¼"

**Weight** 0.3 lb

## SOTO Personal Box



► Specifying, page 186

### Product Details

**SOTO personal box** provides user controlled area for small business or personal items.

**SOTO personal boxes** may be used freestanding or on 10" shelf.

**SOTO personal boxes** may be used individually or stacked horizontal. Boxes interlock when stacked horizontal.

**SOTO storage box set of three** fits neatly inside personal box.

**SOTO personal box** will fit inside c:scape furniture drawers and on shelves.

### Surface Materials

**SOTO personal box**  
• 6009 Arctic White

### Actual Dimensions

**Depth** 9"

**Width** 9"

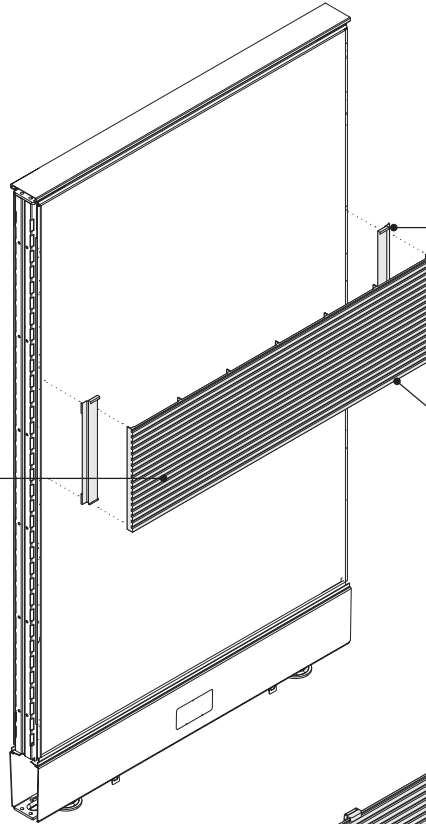
**Height** 2"

**Weight** 0.3 lb

# Slatwall

**Slatwall** allows for vertical stacking anywhere on the tile.

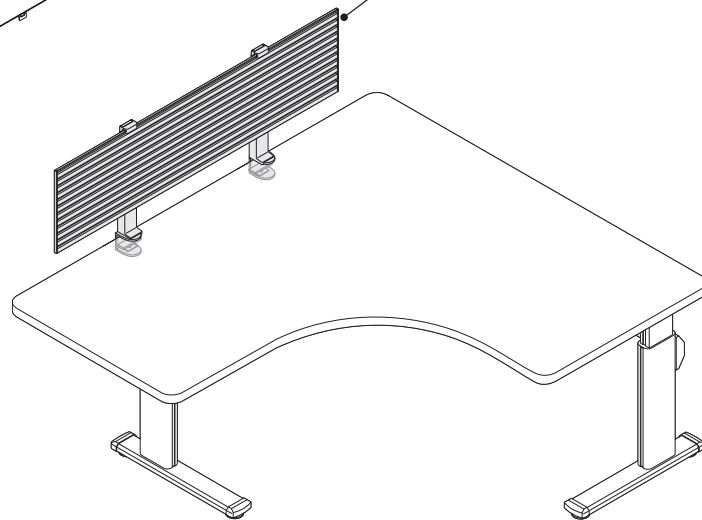
► Specifying, page 187



**Mounting brackets** are available to correspond with selected furniture system and are ordered separately.

**Slatwall tiles** are standard in 12" or 18" heights and seven different widths.

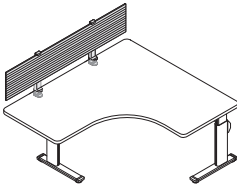
**Slatwall** can be panel-mounted or wall-mounted. 12" high Slatwall can be freestanding.



## Actual Dimensions

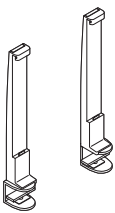
	Freestanding slatwall stanchions	Slatwall tiles	Slatwall brackets
Depth	3"	1/2"	N.A.
Width	3 1/2"	24", 30", 36", 42", 45", 48", or 60"	2"
Height	16"	12" or 18"	12 1/3" or 18"

**Product Details**

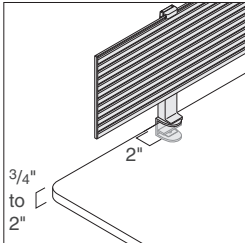


**Slatwall tiles** are available for straight mounting applications only.

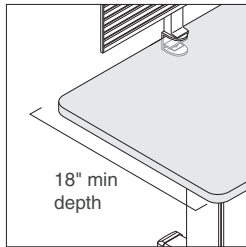
**Slatwall tiles** support a maximum of 60 lb.



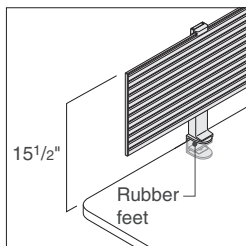
**Freestanding Slatwall stanchions** are for use with 12"H Slatwall tiles only. Stanchions and Slatwall tiles must be ordered separately.



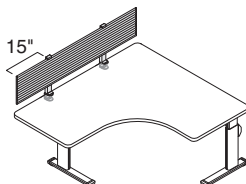
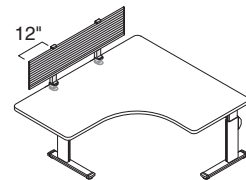
**Freestanding Slatwall stanchions** clamp to work surfaces  $\frac{3}{4}$ " to 2" thick and uses a 2" footprint on the work surface.



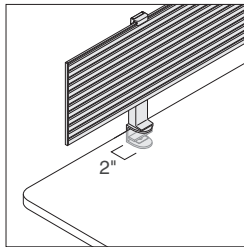
**Worksurface** must be a minimum depth of 18" and able to support a maximum weight of 60 lb when using freestanding Slatwall stanchions.



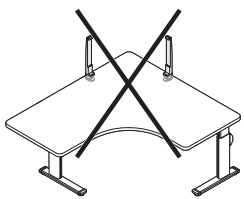
**In freestanding application**, top of Slatwall is 15 $\frac{1}{2}$ " above mounting surface and is a fixed height. Rubber feet under stanchions ensure a tight fit without marring work surface.



**Slatwall** can overhang freestanding stanchions by 12" for tiles 48"W or less and 15" for 60"W tiles.

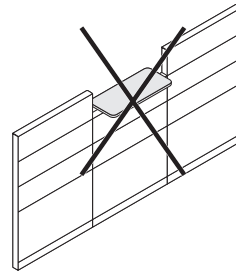


**When using freestanding Slatwall stanchions**, a 2" clearance is required below work surface to accommodate C-clamp.

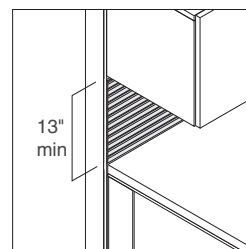


**Freestanding Slatwall stanchions** cannot work in a corner application.

**Freestanding Slatwall stanchions** are not for use with glass, bullnose, knife edge, or other non-standard work surface edges.



**Panel mount Slatwall brackets** cannot be used with transaction top work surfaces.



**Panel or wall-mount applications** require a minimum of 13" vertical space between work surface and overhead bins or shelves.

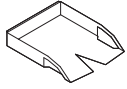
**Wall mount brackets** must be installed in a wall stud.

**Surface Materials**

**Slatwall tiles, stanchions, and brackets**  
• 4799 Platinum

# Freestanding Worktools

## Trays



► Specifying, page 190

### Product Details

**Trays** are available to accommodate letter, legal, and A4 filing.

**Trays** may be used with Slatwall or freestanding applications.

**Trays** are 2½"H and stackable.

**Tray** holds a maximum weight of 7 lb per tray.

**Trays** stack four high on 12"H Slatwall and six high on 18" Slatwall.

### Surface Materials

#### Tray

- 6009 Arctic White
- 6544 Frost

### Actual Dimensions

#### Letter tray

Depth 12½"

Width 10<sup>3</sup>/<sub>16</sub>"

Height 2½"

Weight 1.5 lb

#### Landscape letter tray

Depth 10"

Width 12½"

Height 2½"

Weight 1.5 lb

#### Landscape legal tray

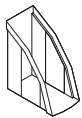
Depth 10"

Width 15½"

Height 2½"

Weight 1.75 lb

## Binder Holder



*Tip: Binder holder requires 9½" of clearance under overhead bins and shelves.*

► Specifying, page 191

### Product Details

**Binder holder** may be used with Slatwall, or freestanding applications.

**Binder holder** mounts in tall orientation for most materials or short orientation for large binders.

**Binder holder** holds a maximum weight of 10 lb and holds up to 4" of materials.

### Surface Materials

#### Binder holder

- 6009 Arctic White
- 6544 Frost

### Actual Dimensions

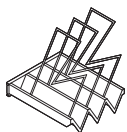
**Depth** 9½"

**Width** 4¾"

**Height** 11¾"

**Weight** 1.2 lb

## PaperFlo Manager



*Tip: PaperFlo Manager requires 11" of clearance under overhead bins and shelves.*

► Specifying, page 191

### Product Details

**PaperFlo Manager** may be used with Slatwall or freestanding applications.

**PaperFlo Manager** is standard with three sloped slots with non-handed wire dividers and sturdy base.

**Blank identification tags** are included.

**PaperFlo Manager** holds a maximum weight of 15 lb.

### Surface Materials

#### PaperFlo Manager

- 6009 Arctic White
- 6544 Frost

### Actual Dimensions

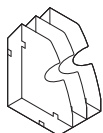
**Depth** 12"

**Width** 9¾"

**Height** 9¾"

**Weight** 2 lb

## Universal Shelves



► Specifying, page 191

### Product Details

**Universal shelves** are sloped for storing 2<sup>3</sup>/<sub>4</sub>" of materials.

**Universal shelves** may be positioned vertically for letter-size material or horizontally for legal-size material.

**Universal shelves** are available in either a single pack or three pack.

**Universal shelf** holds a maximum weight of 7 lb per shelf.

### Surface Materials

**Universal shelves**

- 6009 Arctic White
- 6544 Frost

### Actual Dimensions

**Depth** 9<sup>1</sup>/<sub>2</sub>"

**Width** 2<sup>3</sup>/<sub>4</sub>"

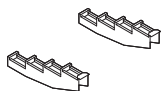
**Height** 12"

**Weight** 0.5 lb

### Slatwall Width      Maximum Number of Shelves

24"W	6
30"W	9
36"W	11
42"W	13
45"W	14
48"W	15
60"W	19

## Hanging Brackets



*Tip: Hanging brackets are recommended for use in pairs only. Brackets should not be shared with mounting multiple brackets side by side.*

► Specifying, page 192

### Product Details

**Hanging brackets** are solid and four stepped for displaying hanging files.

**Hanging brackets** require 6" clearance from top step of bracket to access files under bin and 9" clearance from the bottom step to allow files to hang freely.

### Surface Materials

**Hanging brackets**

- 6009 Arctic White
- 6544 Frost

### Actual Dimensions

**Depth** 9<sup>3</sup>/<sub>4</sub>"

**Width** 1<sup>1</sup>/<sub>2</sub>"

**Height** 1<sup>1</sup>/<sub>4</sub>"

**Weight** 1 lb

## Pen/Pencil Cup



► Specifying, page 192

### Product Details

**Pen/Pencil cup** is 2<sup>3</sup>/<sub>8</sub>" in diameter.

### Surface Materials

**Pen/Pencil cup**

- 6009 Arctic White
- 6544 Frost

### Actual Dimensions

**Depth** 4"

**Width** 3<sup>1</sup>/<sub>4</sub>"

**Height** 3<sup>5</sup>/<sub>8</sub>"

**Weight** 0.5 lb

**Double Square Dish**



► Specifying, page 192

**Product Details**

**Double square dish** may be used with Slatwall or freestanding applications.

**Surface Materials**

**Double square dish**

- 6009 Arctic White
- 6544 Frost

**Actual Dimensions**

**Small square**

Depth 27/8"  
Width 25/8"

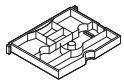
**Large square**

Depth 27/8"  
Width 55/8"

**Outside dimensions**

Depth 4"  
Width 93/4"  
Height 11/2"  
Weight 0.5 lb

**Office in a File**



► Specifying, page 193

**Product Details**

**Office in a File** may be used with Slatwall, hanging brackets, or freestanding applications.

**Office in a File** is portable and standard with seven compartments and translucent cover.

**Office in a File** is standard with built-in tape dispenser.

**Translucent cover** may be used as a writing surface.

**Surface Materials**

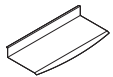
**Office in a File**

- 6009 Arctic White
- 6544 Frost

**Actual Dimensions**

**Depth** 95/8"  
**Width** 121/4"  
**Height** 13/8"  
**Weight** 1.5 lb

**Personal Shelf**



► Specifying, page 193

**Product Details**

**Personal shelf** is standard with raised front edge to prevent items from falling.

**Surface Materials**

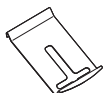
**Personal shelf**

- 7018 Pewter

**Actual Dimensions**

**Depth** 71/8"  
**Height** 131/2"  
**Weight** 3 lb

**Telephone Caddy**



*Tip: Telephone caddy is not compatible with Cisco phones.*

► Specifying, page 193

**Product Details**

**Telephone caddy** mounts off desktop at an optimal angle to view numbers and dialing.

**Telephone caddy** is standard with vertical channel for managing telephone cable.

**43/4" clearance** required to mount on Slatwall.

**Surface Materials**

**Telephone caddy**

- 7018 Pewter

**Actual Dimensions**

**Depth** 2"  
**Width** 8"  
**Height** 11"  
**Weight** 6 lb



### Tackstrip



► Specifying, page 194

#### Product Details

**Tackstrip** is a slim tack-able surface for posting reminders or photos.

**Tackstrip surface** is self-filling, reducing the sight of holes from frequent use.

#### Surface Materials

**Tackstrip**  
• 6000 Black

#### Actual Dimensions

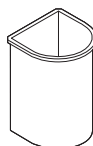
**Depth** 5/16"

**Width** 15"

**Height** 3 1/8"

**Weight** 0.5 lb

### Wastebasket



► Specifying, page 194

#### Product Details

**Wastebasket design** allows wastebasket to hug wall and provide greater foot room underneath worksurface.

**Wastebasket** is made of recycled materials.

**Capacity of wastebasket** is four gallons.

**Recycling labels** are available at no charge and must be ordered separately.

#### Surface Materials

**Wastebasket**  
• 6000 Black

#### Actual Dimensions

**Depth** 10"

**Width** 10"

**Height** 15"

**Weight** 5 lb

### Coat Hook



*Tip: Coat hook is not recommended for use at end of panel run configurations.*

► Specifying, page 194

#### Product Details

**Coat hook** is one piece, solid steel and for use with Tektis.

#### Surface Materials

**Coat hook**  
• 7018 Pewter

#### Actual Dimensions

**Depth** 7/8"

**Width** 2 1/2"

**Height** 2 1/4"

**Weight** 0.15 lb

# LED Linear Shelf Lights

**A properly diffused light source under the linear head** provides a softly blended light pattern that reduces eye strain.  
 ▶ Specifying, page 195

**Optional occupancy sensor** turns off after 30 minutes of no activity and will turn back on upon return.

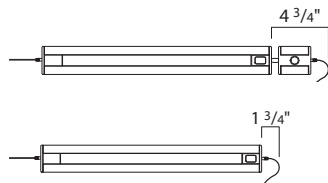
**Magnetic mounts and wood mount bracket hardware**, both come standard with both LED light and optional occupancy sensor.

**Single touch on/off pad plus touch and hold dimming** for easy individual user control.

**Continuous dimming** from 100% to 15% with last state memory.

**Light widths** available in 17", 31", and 44".

**Cord** exits from either end of the light. When needed, allow 1<sup>3</sup>/<sub>4</sub>" cord bend clearance. With optional occupancy sensor, allow additional 4<sup>3</sup>/<sub>4</sub>" clearance from the light fixture.



## Actual Dimensions

	Light	Occupancy Sensor
Depth	2"	2"
Width	17", 31", or 44"	2 <sup>9</sup> / <sub>10</sub> "
Height	1/2"	7/10"

**Product Details**

**LED linear stand alone and daisy chain starter lights** include the lamp, power supply, and both magnetic mounts, and wood bracket hardware with adhesive cord managers.

**LED linear daisy chain lights** include the lamp, daisy chain cords, and both magnetic mounts, and wood mount bracket hardware with adhesive cord managers.

**Optional occupancy sensor** is a separate component that connects to the light fixture and activates in 30 minutes when no movement is detected to conserve energy. It will also turn back on upon return.

**Average rated lamp life of LED linear shelf lights** is 50,000 hours.

**Color temperature of LEDs** is 3500K.

**Color rendering index of LEDs** is 92.

**Automatic turn off after 10 hours** (+/- 15 mins.); standard with both models.

**Connections**

**Lights** mount recessed or flush depending on design of overhead storage bin or shelf. Installation is done in the field.

**Magnet mounts** allow shelf lights to be installed without tools under most metal overhead storage bins or shelves.

**Wood mount brackets** allow shelf lights to be mounted to wood shelves.

**Specify** LED linear shelf light for use under 24" wide bins.

Light width	Number of LEDs in Standard Output	System Wattage Standard Output
17"	24	9.1
31"	48	17.6
44"	72	25.9

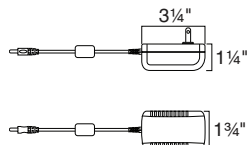
**Wiring & Cabling**

**Light** is standard with single touch on/off and touch control dimming.

**User adjustable touch and hold dimming pad** includes continuous dimming range of 100% to 15%.

**Power supply for 17" linear stand alone only** uses a straight plug with a 9' 18 watt 24 volt wall transformer.

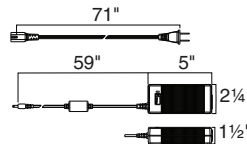
**LED Linear Shelf Light Power Supply Dimensions**



*Tip: Cord length is 9'.*

**Power supply for 31", 44", or 17" starter light;** 65 watt compact in-line brick straight plug. The cord is 11', 6' from power supply to power outlet and 5' from power supply to fixture.

**LED Linear Shelf Light Power Supply Dimensions**



*Tip: Applies to 31", 44", and daisy chained.*

*Tip: Daisy chain starter light comes with a 65 watt power supply to support up to a limited number of lights – refer to chart for daisy chaining fixture. Daisy chain secondary lights do not come with a power supply, but instead come with two daisy chain jumper cords, one 8" and one 30" set.*

▶ See page 180.

**Surface Materials**

- Housing**
- 4321 Arctic White
  - 0835 Black

- Cord**
- Black plastic only

**Photometric Data**

**17" W Standard Output Linear Shelf Light** *Measured from 18" above worksurface*

	Worksurface rear							Worksurface front		
12"	10	18	27	31	27	18	11			
6"	15	30	49	59	49	30	15			
CL	18	38	64	79	65	38	19			
8"	16	32	54	65	64	33	17			
12"	12	21	31	37	31	21	12			
	18"	12"	6"	CL	6"	12"	18"			

**31" W Standard Output Linear Shelf Light**

	Worksurface rear							Worksurface front		
12"	25	38	49	53	50	39	26			
6"	41	67	88	95	87	67	42			
CL	50	86	114	125	115	87	52			
8"	43	73	96	104	97	74	45			
12"	29	45	57	62	58	46	30			
	18"	12"	6"	CL	6"	12"	18"			

**44" W Standard Output Linear Shelf Light**

	Worksurface rear							Worksurface front		
12"	42	54	61	63	61	54	42			
6"	73	95	106	109	104	93	72			
CL	94	124	138	141	137	122	94			
8"	80	105	117	121	117	104	80			
12"	50	64	72	75	72	64	50			
	18"	12"	6"	CL	6"	12"	18"			

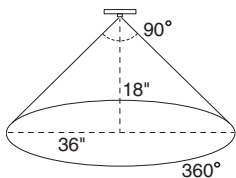
**Chart for Daisy Chaining Fixtures**

Standard Output Linear Shelf Light											
Light fixture widths	Maximum number of fixtures allowed with daisy chain starter light										
17"	6	4	3	2	2	1	1	-	-	-	-
31"	-	1	-	2	-	2	1	3	1	1	-
44"	-	-	1	-	-	-	1	-	1	-	2

- A 65 watt power supply is required for daisy chaining.
- Total system wattage of all fixtures together cannot meet or exceed 65 watts, see chart.
- Cannot daisy chain standard output and high output together.
- Cannot daisy chain 58" high output fixtures.
- Occupancy sensor must be positioned between the power supply and the first starter fixture.
- Only need one sensor when daisy chaining.

*Tip: Each column is the maximum number of fixtures that can be daisy chained together.*

**Occupancy Sensor**



- Turns off after 30 minutes of no activity and will turn back on upon return
- 360° lens view
- 90° outward detection angle
- 30" diameter coverage if mounted 15" above worksurface
- 36" diameter coverage if mounted 18" above worksurface
- Connects to fixture with one end-to-end connector. 8" or 30" jumper cords



**Standard Includes**

- Power box with 2 electrical outlets
- Edge mounting clamp
- 78" cord
- White

**Specification Information**

Style Number    Price

**ACTIV Eco Power Box**

**X-E-PB4**      \$179



**Standard Includes**

- Power box with 2 electrical outlets
- Micro-suction direct surface mount
- 108" cord
- 1 USB A and 1 USB C

**Options**

Finish	Paint	No cost
--------	-------	---------

**Specification Information**

Style Number    Price

**ACTIV Boost Power**

**BOOSTPOWER**    \$382



**Standard Includes**

- Felt cable manager with zipper and attachment hardware

**Specification Information**

Style Number    Price

**ACTIV Cable Management**

**X-FCMT**      \$147

# Work Tools



### Standard Includes

- Metal tray: paint

### Options

Frame Finish	Paint	No cost
Wire Tray	Wire Tray W/ Cable Management	+\$135

### Specification Information

Style Number	Base Price
--------------	------------

## ILINE Wire Tray

**ILNEWIRETRAY** \$129



### Standard Includes

- 36"W metal tray: paint
- Attachment hardware

### Options

Finish	Paint	No cost
--------	-------	---------

### Specification Information

Style Number	Price
--------------	-------

## ACTIV Wire Tray

**ACTVWIRETRAY** \$121



### Standard Includes

- Single monitor arm with VESA plate

### Options

Finish	Paint	No cost
--------	-------	---------

### Specification Information

Style Number	Price
--------------	-------

## Single Monitor Arm

**MONITORARM** \$286



Tip: AMQCFINTRO supports 2.2-20 lbs. per monitor.

Tip: Standard tilt head is standard with quick release.

Tip: Intro monitor arms come standard with C-clamp and through mount bracket types.

**Standard Includes**

- Monitor arm: paint
- Standard tilt head with 100x100 VESA plate

**Options**

Arm Finish	Paint Price Group 01	No cost
	Paint Price Group 02	No cost
Tilt Head Option	Intro Standard Tilt Head	No cost

**Specification Information**

Weight	Style Number	Price
--------	--------------	-------

**Intro Single**

7.6 lbs	<b>AMQCFINTRO</b>	\$399
---------	-------------------	-------



Tip: AMQCFINTRODSLIDE is not recommended for corner applications.

Tip: AMQCFINTRODSLIDE is standard with two Universal slider bar tilt heads.

Tip: AMQCFINTRODSLIDE supports 2.2-20 lbs. per monitor.

Tip: Intro monitor arms come standard with C-clamp and through mount bracket types.

**Standard Includes**

- Monitor arm: paint
- Standard tilt head with 100x100 VESA plate

**Options**

Arm Finish	Paint Price Group 01	No cost
	Paint Price Group 02	No cost

**Specification Information**

Weight	Style Number	Price
--------	--------------	-------

**Intro Dual Assembly with Universal Slider Bar Tilt Heads**

13.65 lbs	<b>AMQCFINTRODSLIDE</b>	\$769
-----------	-------------------------	-------

# Work Tools



*Tip: Power cord length is 75". Consider distance from light to power receptacle, and if surface or under the the worksurface power receptacle may be needed. Applies to both single-arm and double-arm lights.*

## Standard Includes

- Task light and freestanding base: paint price group 01
- 75" cord two-prong power supply
- LED light source
- Capacitive switch
- Three-step dimming
- 7W LED 3000K

## Options

Light Finish	Paint Price Group 01	No cost
--------------	----------------------	---------

## Specification Information

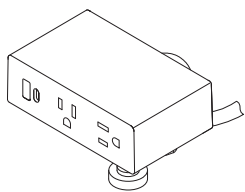
Dimensions			Style	Price
D	W	H	Number	

### LED Intro Single-Arm Task Light

7"	7"	18 3/10"	<b>AMQLSCTSKLIGHT1</b>	\$321
----	----	----------	------------------------	-------

### LED Intro Double-Arm Task Light

7"	7"	17 3/4"	<b>AMQLSCTSKLIGHT2</b>	\$459
----	----	---------	------------------------	-------



*Tip: C-clamp is designed to accommodate worksurfaces up to 1 1/2" thick.*

*Tip: Each USB port can provide up to 10 watts (2 amps).*

*Tip: Overcurrent protection includes a 15 amp circuit breaker.*

## Standard Includes

- Powerstrip intro: plastic
- Straight 3-prong plug
- C-clamp mount

## Options

Power Finish	Plastic - PG1	No cost
Power Mount	C-Clamp	No cost
Power Configuration	2pwr 1usba 1usbc 20w	No cost
Utility Power	1utility+1female Plug+tray Mnt	No cost
	2utility+1female Plug+tray Mnt	+\$145
Power Cord	6' Standard Cord	No cost
Power Plug Type	Standard NEMA 5-15 3-Prong	No cost
PVC	With PVC	No cost

## Specification Information

Dimensions			Style	Price
D	W	H	Number	

### Powerstrip Intro

3"	3"	3 1/8"	<b>AMQDSPINTRO</b>	\$519
----	----	--------	--------------------	-------

► **Product Information continued on next page**



► **Product Information continued from previous page**

*Tip: USB A+C 20W for charging cell phones, tablets, headphones, wearable fitness trackers, or other small electronic devices.*

*Tip: Optional under worksurface utility power blocks do not ship with independent mounting hardware. Designed to be used with the universal cable management kits.*



**Standard Includes**

- Cable management tray: 6527 Merle
- Attachment hardware

**Specification Information**

Dimensions			Style	Price
D	W	H	Number	
<b>Small Cable Management Kit</b>				
6 5/16"	15 1/2"	3 1/2"	<b>AMQDSTRAYSM</b>	\$110
<b>Large Cable Management Kit</b>				
6 5/16"	30"	3 1/2"	<b>AMQDSTRAYLG</b>	\$147

*Tip: The weight limit of the 15 1/2" tray is five pounds, while the weight limit of the 30" tray is 10 pounds.*

*Tip: Tray attachment hardware accommodates worksurfaces more than 3/4" in thickness. Screws may pop through thinner worksurfaces.*

*Tip: When installed, tray provides 4/5" of clearance on all sides to allow for cable egress between the underside of the worksurface and the top of the tray.*

# Work Tools



### Standard Includes

- 100 red rubber: smart straps
- 5 4/5" in length

### Specification Information

Style Number	Price
--------------	-------

## Smart Straps Bulk Pack - For Use with Universal Cable Management Kit

<b>AMQDSBULKSTRP</b>	\$147
----------------------	-------



*Tip: SOTO intro bundle contains a tool box, personal box, and personal hook.*

### Standard Includes

- SOTO tool box: 6009 Arctic White
- SOTO personal box: 6009 Arctic White
- SOTO personal hook: 6009 Arctic White

### Options

Tool Box Finish	Plastic - PG1	No cost
Personal Box Finish	Plastic - PG1	No cost
Personal Hook Finish	Plastic - PG1	No cost

### Specification Information

Style Number	Price
--------------	-------

## SOTO Intro Bundle

<b>AMQPCDB1</b>	\$124
-----------------	-------



*Tip: SOTO box bundle contains a tool box, utility box, and personal box.*

### Standard Includes

- SOTO tool box: 6009 Arctic White
- SOTO utility box: 6009 Arctic White
- SOTO personal box: 6009 Arctic White

### Options

Tool Box Finish	Plastic - PG1	No cost
Personal Box Finish	Plastic - PG1	No cost
Utility Box Finish	Plastic - PG1	No cost

### Specification Information

Style Number	Price
--------------	-------

## SOTO Box Bundle

<b>AMQPCDB3</b>	\$147
-----------------	-------



**Standard Includes**

- LED task lamp
- Power cord

**Options**

Color	Walnut	No cost
-------	--------	---------

**Specification Information**

Style Number	Price
--------------	-------

**Linear Wood LED Task Lamp**

<b>AMQWEM61</b>	\$374
-----------------	-------



**Standard Includes**

- Pair of Slatwall stanchions: 4799 Platinum
- Non-marring rubber feet

**Specification Information**

Dimensions	Weight	Style Number	Price
Depth	Width	Height	

**Freestanding Slatwall Stanchions**

3"	3 1/2"	16"	3.5 lb	<b>SWALLFS</b>	\$248
----	--------	-----	--------	----------------	-------

*Tip: Position top of Slatwall a fixed height of 15 1/2" above mounting surface.*

*Tip: Slatwall can overhang stanchions up to 12".*

*Tip: For use on worksurfaces 3/4" to 2" thick.*

*Tip: Worksurface/table must be able to support 60 lb.*

*Tip: Stanchion cannot be used in a corner application or on a glass surface.*

*Tip: Requires 18"D worksurface and uses 2" surface footprint.*

*Tip: Freestanding Slatwall stanchion is for use with 12"H tiles only.*



# Work Tools

*Tip: Total dimensions of worktools specified should not exceed slatwall dimensions.*

*Tip: Slatwall is not dedicated to the exact panel width; a 12" overhang is acceptable.*

*Tip: Two slatwall tiles cannot be used in a corner application.*

*Tip: Tiles require a minimum worksurface depth of 18" for stability.*

*Tip: A clearance of 2" is required under worksurface to accommodate C-clamp.*

*Tip: Tiles cannot be used on glass, bullnose, knife edge, or other non-standard worksurface edges.*

*Tip: Supports up to 140 lb.*

*Tip: Slatwall is 1/8" shorter than stated without end caps installed.*

## Standard Includes

- Slatwall tile: 4799 Platinum

## Specification Information



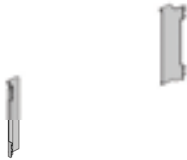
Dimensions			Weight	Style Number	Price
Depth	Width	Height			

### 12"H Slatwall Tiles

1/2"	24"	12"	4.5 lb	<b>SWALLTILE</b>	\$197
1/2"	30"	12"	5.7 lb	<b>SWALLTILE</b>	\$222
1/2"	36"	12"	6.8 lb	<b>SWALLTILE</b>	\$248
1/2"	42"	12"	8 lb	<b>SWALLTILE</b>	\$289
1/2"	45"	12"	8.5 lb	<b>SWALLTILE</b>	\$307
1/2"	48"	12"	9.1 lb	<b>SWALLTILE</b>	\$330
1/2"	60"	12"	11.4 lb	<b>SWALLTILE</b>	\$410

### 18"H Slatwall Tiles

1 1/8"	24"	18"	4.04 lb	<b>SWALLTILE</b>	\$416
1 1/8"	30"	18"	11.5 lb	<b>SWALLTILE</b>	\$477
1 1/8"	36"	18"	13.16 lb	<b>SWALLTILE</b>	\$534
1 1/8"	42"	18"	15.62 lb	<b>SWALLTILE</b>	\$587
1 1/8"	45"	18"	16.5 lb	<b>SWALLTILE</b>	\$646
1 1/8"	48"	18"	17.28 lb	<b>SWALLTILE</b>	\$706
1 1/8"	60"	18"	19 lb	<b>SWALLTILE</b>	\$764



*Tip: Brackets for use with 42”H panels cannot be used with transaction top worksurfaces.*

*Tip: SWALLPM42 positions the slatwall tile in the top position on the panel. Use this bracket with Tektis 42”H panels.*

**Standard Includes**

• Pair of slatwall brackets: 4799 Platinum

**Specification Information**

Dimensions	Weight	Style Number	Price
Width Height			

**12”H Panel-Mount Brackets**

**For Use with Tektis**

2”	12 1/3”	2 lb	<b>SWALLPM</b>	\$63
----	---------	------	----------------	------

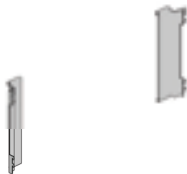
**For Use with Tektis 42”H Panels**

2”	12 1/3”	2 lb	<b>SWALLPM42</b>	\$122
----	---------	------	------------------	-------

**18”H Panel-Mount Brackets**

**For Use with Tektis**

2”	18”	3.5 lb	<b>SWALLPM</b>	\$178
----	-----	--------	----------------	-------



*Tip: Wall-mount brackets must be mounted to a wall stud.*

**Standard Includes**

• Pair of slatwall brackets: 4799 Platinum

**Specification Information**

Dimensions	Weight	Style Number	Price
Width Height			

**12”H Wall-Mount Brackets**

2”	12 1/3”	2 lb	<b>SWALLWM</b>	\$59
----	---------	------	----------------	------

**18”H Wall-Mount Brackets**

2”	18”	3.5 lb	<b>SWALLWM</b>	\$178
----	-----	--------	----------------	-------




# Work Tools

*Tip: Trays do not interlock when installed on slatwall.*

## Standard Includes

- Tray: 6009 Arctic White or 6544 Frost

## Specification Information

	Dimensions			Weight	Style Number	Price
	Depth	Width	Height			
	<b>Portrait Letter Tray</b>					
	12 1/2"	10 3/16"	2 1/2"	1.5 lb	<b>SWALLTRAY</b>	\$63
	<b>Landscape Letter Tray</b>					
	10"	12 1/2"	2 1/2"	1.5 lb	<b>SWALLTRAY</b>	\$63
	<b>Landscape Legal Tray</b>					
	10"	15 1/2"	2 1/2"	1.75 lb	<b>SWALLTRAY</b>	\$63



*Tip: Binder holder requires 9 1/2"H clearance under bins or shelves.*

**Standard Includes**

- Binder holder: 6009 Arctic White or 6544 Frost

**Specification Information**

Dimensions			Weight	Style Number	Price
Depth	Width	Height			

**Binder Holder**

9 1/8"	4 3/4"	11 3/8"	1.2 lb	<b>SWALLBH</b>	\$63
--------	--------	---------	--------	----------------	------



*Tip: PaperFlo manager requires 11" clearance under bins.*

**Standard Includes**

- PaperFlo manager: 6009 Arctic White or 6544 Frost

**Specification Information**

Dimensions			Weight	Style Number	Price
Depth	Width	Height			

**PaperFlo Manager**

12"	9 3/4"	9 3/4"	2 lb	<b>SWALLPF</b>	\$153
-----	--------	--------	------	----------------	-------



*Tip: Shelves do not interlock when installed on Slatwall.*

**Standard Includes**

- Shelf: 6009 Arctic White or 6544 Frost

**Specification Information**

Dimensions			Weight	Style Number	Price
Depth	Width	Height			

**Universal Shelves - Single Pack**

9 1/2"	2 3/4"	12"	0.5 lb	<b>SWALLUS</b>	\$37
--------	--------	-----	--------	----------------	------

**Universal Shelves - Three Pack**

9 1/2"	2 3/4"	12"	1.5 lb	<b>SWALLUS3</b>	\$110
--------	--------	-----	--------	-----------------	-------

# Work Tools



*Tip: Hanging brackets require 6" clearance from top step of bracket to access files under bin and a 9" clearance from the bottom step to the top of worksurface to allow files to hang freely.*

*Tip: Hanging brackets are recommended using in pairs only. Brackets should not be shared when mounting multiple brackets side by side.*

### Standard Includes

- Hanging brackets: 6009 Arctic White or 6544 Frost

### Specification Information

Dimensions			Weight	Style Number	Price
Depth	Width	Height			

### Hanging Brackets

9 3/4"	1 1/2"	1 1/4"	1 lb	<b>SWALLHB</b>	\$63
--------	--------	--------	------	----------------	------



### Standard Includes

- Pen/pencil cup: 6009 Arctic White or 6544 Frost

### Specification Information

Dimensions			Weight	Style Number	Price
Depth	Width	Height			

### Pen/Pencil Cup

4"	3 1/4"	3 5/8"	0.5 lb	<b>SWALLCUP</b>	\$63
----	--------	--------	--------	-----------------	------



### Standard Includes

- Hanging brackets: 6009 Arctic White or 6544 Frost
- Attachment bracket

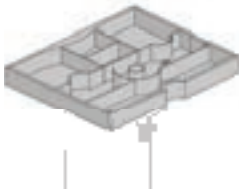
### Specification Information

Dimensions			Weight	Style Number	Price
Depth	Width	Height			

### Double Square Dish

4"	9 3/4"	1 1/2"	0.5 lb	<b>SWALLDISH</b>	\$63
----	--------	--------	--------	------------------	------





**Standard Includes**

- Storage file: 6009 Arctic White or 6544 Frost
- Built-in tape dispenser
- Translucent cover

**Specification Information**

Dimensions			Weight	Style Number	Price
Depth	Width	Height			

**Office in a File**

9 5/8"	12 1/4"	1 3/8"	1.5 lb	<b>SWALLOF</b>	\$63
--------	---------	--------	--------	----------------	------



**Standard Includes**

- Personal shelf: 7018 Pewter

**Specification Information**

Dimensions		Weight	Style Number	Price
Depth	Width			

**Personal Shelf**

7 1/8"	13 1/2"	3 lb	<b>SWALLPS</b>	\$70
--------	---------	------	----------------	------



**Standard Includes**

- Telephone caddy: 7018 Pewter

**Specification Information**

Dimensions			Weight	Style Number	Price
Depth	Width	Height			

**Telephone Caddy**

2"	8"	11"	6 lb	<b>SWALLTC</b>	\$154
----	----	-----	------	----------------	-------

*Tip: Telephone caddy is not compatible with Cisco phones.*

*Tip: 4 3/4" clearance required to install on Slatwall.*

# Work Tools



### Standard Includes

- Tackstrip: 6000 Black

### Specification Information

Dimensions			Weight	Style Number	Price
Depth	Width	Height			

### Tackstrip

5/16"	15"	3 1/8"	0.5 lb	<b>SWALLTACK</b>	\$73
-------	-----	--------	--------	------------------	------



### Standard Includes

- Wastebasket: 6000 Black

### Specification Information

Dimensions			Weight	Style Number	Price
Depth	Width	Height			

### Wastebasket

10"	10"	15"	5 lb	<b>SWALLWB</b>	\$70
-----	-----	-----	------	----------------	------



### Standard Includes

- Coat hook: 7018 Pewter

### Specification Information

Dimensions			Weight	Style Number	Price
Depth	Width	Height			

### Coat Hook

7/8"	2 1/2"	2 1/4"	0.15 lb	<b>SWALLHOOK</b>	\$28
------	--------	--------	---------	------------------	------

*Tip: Coat hook not recommended for use at end of panel run configurations.*

*Tip: Maximum weight for coat hook is 10 lb.*



*Tip: The power supply for the 17" stand alone only uses a straight plug with a 9' 18 watt 24 volt transformer. The power supply for the 31" or 44" starter light uses a 11' 65 watt compact in-line brick with straight plug.*

*Tip: Cord exists on ends of light fixture. Allow 1 3/4" cord bend radius. With optional occupancy sensor, add 4 3/4".*

**Standard Includes**

- Task light and mounting bracket: paint price group 01
- Standard output
- Power supply with cord: black
- Soft touch switch
- Magnetic and wood mounting brackets
- Continuous range dimmer
- Automatic turn off program
- Color temperature: 3500K

**Options**

Light Finish	Paint Price Group 01	No cost
	Paint Price Group 02	+\$16
Occupancy Sensor Option	No Occupancy Sensor	No cost
	With Occupancy Sensor	+\$162

**Specification Information**

Dimensions			Style Number	Base Price
Depth	Width	Height		

**LED Linear 17" Stand Alone Shelf Light**

2"	17"	7/10"	<b>UBLIGHT17</b>	\$333
----	-----	-------	------------------	-------

**LED Linear 31" Stand Alone or Daisy Chain Starter Shelf Light**

2"	31"	7/10"	<b>UBLIGHT31</b>	\$538
----	-----	-------	------------------	-------

**LED Linear 44" Stand Alone or Daisy Chain Starter Shelf Light**

2"	44"	7/10"	<b>UBLIGHT44</b>	\$714
----	-----	-------	------------------	-------





---

# TEKTIS

---

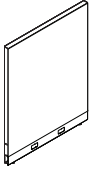
	
<b>Statement of Line</b>	<b>198</b>

	
<b>TEKTIS</b>	
Understanding	<b>206</b>
Specifying	<b>249</b>

	
<b>Surface Materials</b>	<b>277</b>
<b>Resources</b>	<b>375</b>

# Statement of Line

## Monolithic Panels

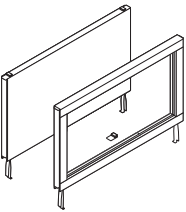


Understanding  
 ▶ Page 206  
 Specifying  
 ▶ Page 249

### Monolithic Panels

	24"W	30"W	36"W	42"W	48"W	60"W
42"H	●	●	●	●	●	●
48"H	●	●	●	●	●	●
54"H	●	●	●	●	●	●
66"H	●	●	●	●	●	●

## Panel Stackers



Understanding  
 ▶ Page 210  
 Specifying  
 ▶ Pages 250–251

### Panel Stackers

	24"W	30"W	36"W	42"W	48"W	60"W	72"W
12"H	●	●	●	●	●	●	●
18"H	●	●	●	●	●	●	●
24"H	●	●	●	●	●	●	●

## Panel Trim



Understanding  
 ▶ Page 212  
 Specifying  
 ▶ Page 252



Understanding  
 ▶ Page 212  
 Specifying  
 ▶ Page 253

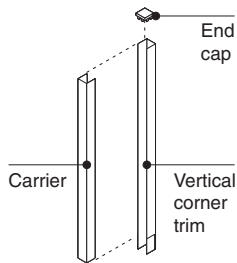
### Vertical End-of-Run Trim

	42"H	48"H	54"H	60"H	66"H	72"H	78"H
Standard	●	●	●	●	●	●	●

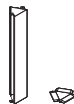
### Change-of-Height Trim

	6"H	12"H	18"H	24"H	36"H
Standard	●	●	●	●	●

## Panel Trim, continued



Understanding  
 ▶ Page 212  
 Specifying  
 ▶ Page 254



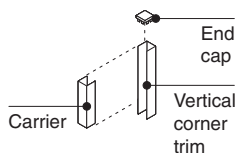
Understanding  
 ▶ Page 212  
 Specifying  
 ▶ Page 255

### Vertical Corner Trims

	42"H	48"H	54"H	66"H
Standard	●	●	●	●

### 120° Vertical Corner Trims

	42"H	48"H	54"H	66"H
Standard	●	●	●	●

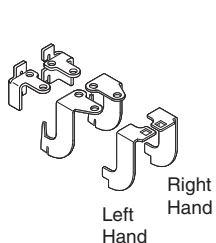


Understanding  
 ▶ Page 212  
 Specifying  
 ▶ Page 256

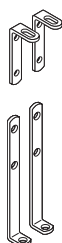
### Vertical Corner Change-of-Height Trims

	6"H	12"H	18"H	24"H
Standard	●	●	●	●

## Panel Connectors



**Change-of-Height In-Line and Corner Panel Connector Package**  
 Understanding  
 ▶ Page 214  
 Specifying  
 ▶ Page 257



**Wall Start Connector Package**  
 Understanding  
 ▶ Page 214  
 Specifying  
 ▶ Page 257

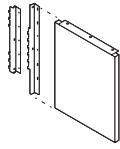


**120° Connectors**  
 Understanding  
 ▶ Page 214  
 Specifying  
 ▶ Page 257

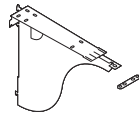
## Worksurface Legs and Supports



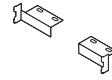
**Post Leg**  
Understanding  
▶ Page 242  
Specifying  
▶ Page 258



**On-Module End Panel**  
Understanding  
▶ Page 242  
Specifying  
▶ Page 258

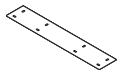


**Cantilever with Tie Plate**  
Understanding  
▶ Page 242  
Specifying  
▶ Page 258

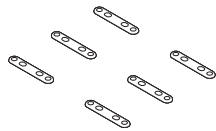


**Side Support Brackets to Connect Worksurface to Panel**  
Understanding  
▶ Page 242  
Specifying  
▶ Page 258

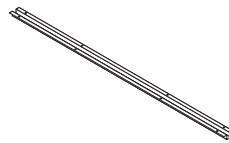
## TEKTIS and EMBANK Shared Accessories



**In-Line Support Plates**  
Understanding  
▶ Page 242  
Specifying  
▶ Page 374

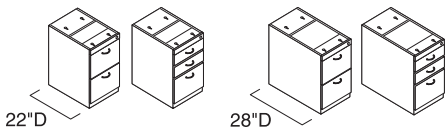


**Package of Six Tie Plates for Side-by-Side Worksurfaces**  
Understanding  
▶ Page 242  
Specifying  
▶ Page 374



**Reinforcing Channels**  
Understanding  
▶ Page 242  
Specifying  
▶ Page 374

## Fixed Pedestals



Understanding  
▶ Page 244  
Specifying  
▶ Page 259

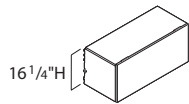
## Fixed Pedestals

15\"/>

27\"/>



## Bins

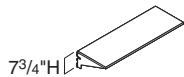


Understanding  
 ▶ Page 246  
 Specifying  
 ▶ Page 260

## Bins

	24"W	30"W	36"W	42"W	48"W	60"W	72"W
15 3/4"D	●	●	●	●	●	●	●

## Laminate Common Shelves



Understanding  
 ▶ Page 248  
 Specifying  
 ▶ Page 261

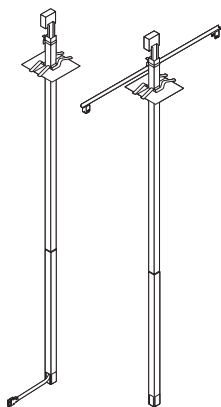
## Laminate Common Shelves

	24"W	30"W	36"W	42"W	48"W
15"D	●	●	●	●	●

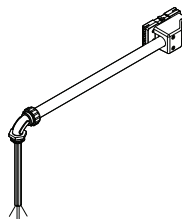
## Panel Wiring and Cabling



**Receptacles**  
 Understanding  
 ▶ Page 228  
 Specifying  
 ▶ Page 262



**2" x 2" Power and Cable Poles**  
 Understanding  
 ▶ Page 230  
 Specifying  
 ▶ Page 263

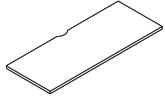


**Base Power-Ins**  
 Understanding  
 ▶ Page 232  
 Specifying  
 ▶ Page 265



**Grommet Package**  
 Understanding  
 ▶ Page 238  
 Specifying  
 ▶ Page 266

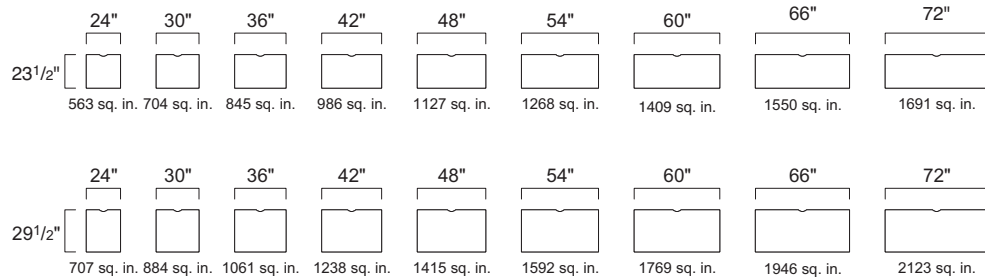
## Worksurfaces



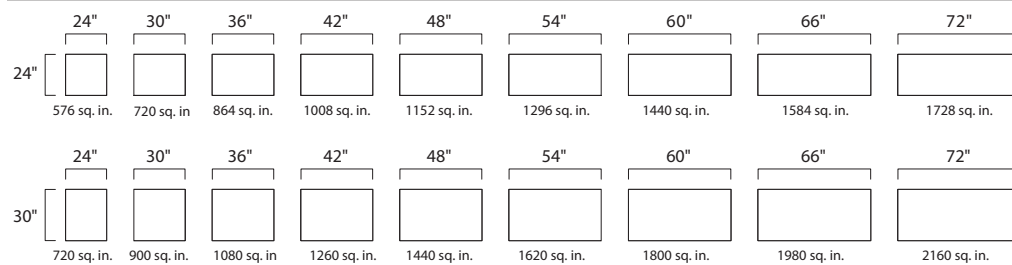
Understanding  
 ▶ Page 240  
 Specifying  
 ▶ Page 267

## Straight Worksurfaces

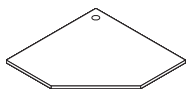
### With 1/2" Cord Drop



### With Full Depth

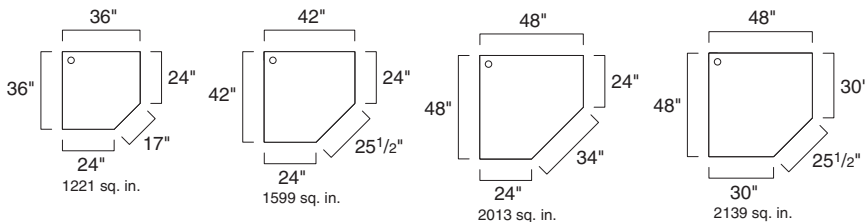


Understanding  
 ▶ Page 240  
 Specifying  
 ▶ Page 269

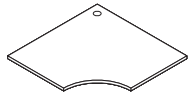


Understanding  
 ▶ Page 240  
 Specifying  
 ▶ Page 270

## Straight Corner Worksurfaces

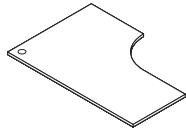
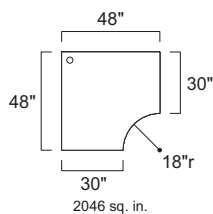
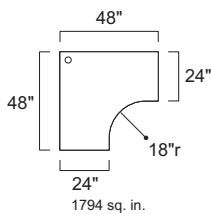
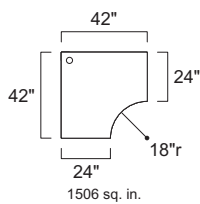
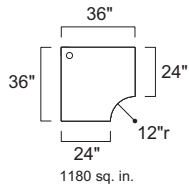


## Worksurfaces, continued



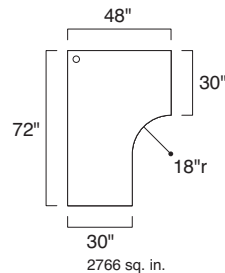
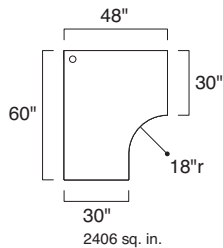
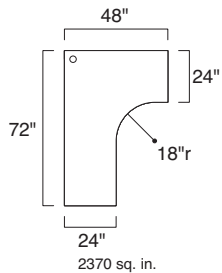
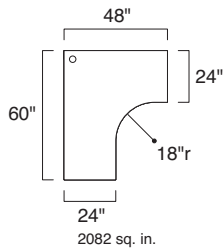
Understanding  
 ▶ Page 240  
 Specifying  
 ▶ Page 271

## Curved Corner Worksurfaces



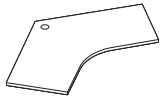
Understanding  
 ▶ Page 240  
 Specifying  
 ▶ Pages 272–273

## Extended Curved Corner Worksurfaces\*



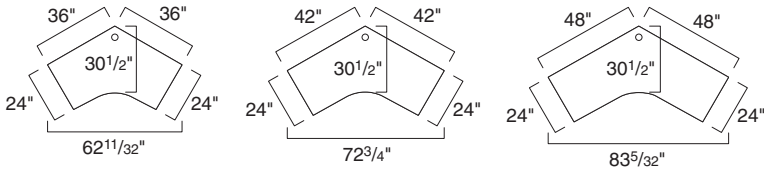
\* Left-hand is shown. Right-hand is also available.

**Worksurfaces, continued**

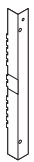


Understanding  
 ▶ Page 240  
 Specifying  
 ▶ Page 274

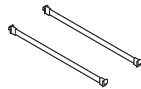
**120° Corner Worksurfaces**



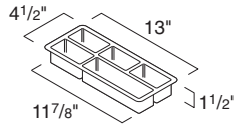
**Fixed Pedestals Accessories**



**Pedestal Filler**  
 Understanding  
 ▶ Page 244  
 Specifying  
 ▶ Page 275

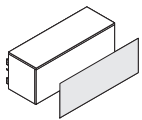


**Rails**  
 Understanding  
 ▶ Page 244  
 Specifying  
 ▶ Page 275



**Pencil Tray**  
 Understanding  
 ▶ Page 244  
 Specifying  
 ▶ Page 275

**Flexible Markerboard Surface**



Specifying  
 ▶ Page 276

**Flexible Markerboard Surface**

	30"W	36"W	42"W	48"W
16 1/4"H	●	●	●	●



# Monolithic Panels

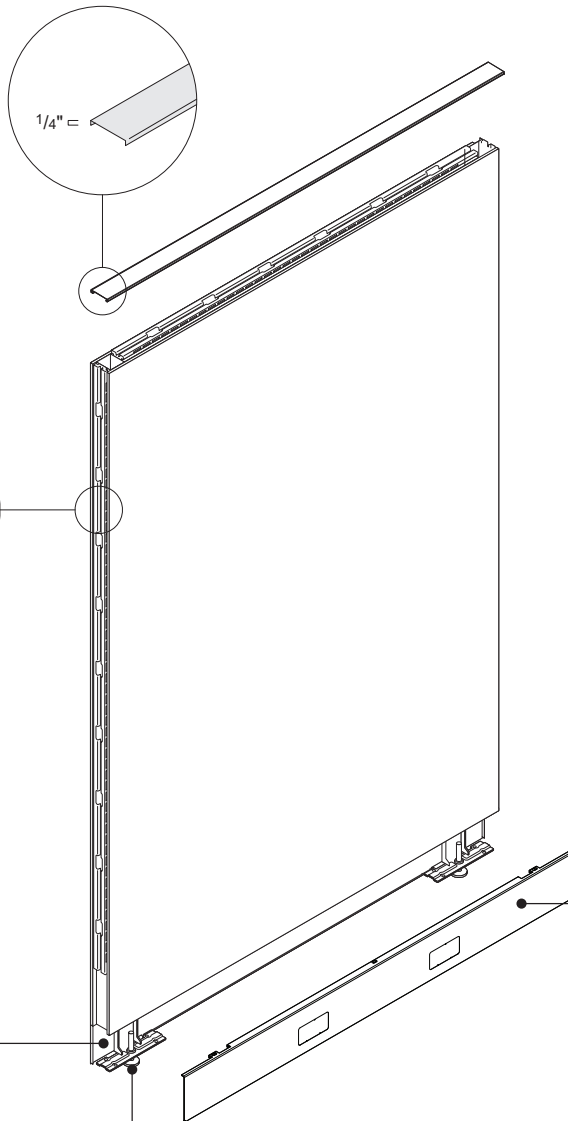
**Panels** are constructed with a rigid, tubular steel frame and are shipped fully assembled. Remember to order trim separately.

**Vertical slots in panel** accommodate hang-on components, overhead storage bins, shelves, worksurface supports, and connector brackets. Components can be mounted at 1" increments.

**Base cavity** accepts a factory-installed powerway  
 ▶ See *Powerways*, page 226.

**Removable base cover** has receptacle knockouts. Base covers have a receptacle opening on the left and right side of the base cover.  
*Exception: 24"W base covers have a receptacle opening in the center of the base trim.*

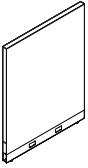
**Leveling glides** adjust 1½" to install panels on uneven floors.



## Actual Dimensions

<b>Height</b>	42", 48", 54", or 66"
<b>Width</b>	24", 30", 36", 42", 48", or 60"
<b>Thickness</b>	2"
<b>Base Raceway Height</b>	3 <sup>5</sup> / <sub>8</sub> "
<b>Glides</b>	1½" adjustment

**Product Details**



**Tackable acoustical** has a skin on each side, covered with horizontal surface fabric.

**Wiring & Cabling**

**Panel frames** have hollow interior to allow routing cables from top cap through to base raceway.

**Chicago electrical code** requires that all electrical connections be hardwired in the field. Order a non-powered panel and have the electrician obtain conduit and receptacles (Leviton 5325) to make the connections in the field.

**Surface Materials**

**Base cover, top cap, and border**

- Paint

**Panel surface**

- Fabric

*Tip: Fabric is applied horizontally on the screen. Fabric must be of the same fabric group and color on both sides.*

# Monolithic Panels and Stacker Options

**TEKTIS** allows a wide variety of panel arrangements to meet specific functional and aesthetic needs.

## Stacking Guidelines

**Stackers** are available in 12"H, 18"H, or 24"H in tackable acoustical or glass.

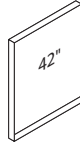
**Maximum height** is 78".

**Maximum number of tackable acoustical stackers** is three.

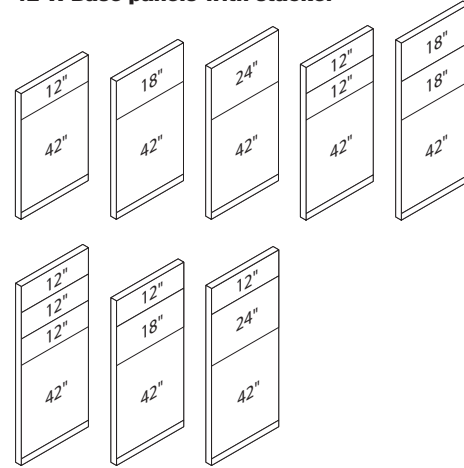
**Maximum number of glass stackers** is one.

**Any height base panel** can be used with stackers.

### 42"H Base panels



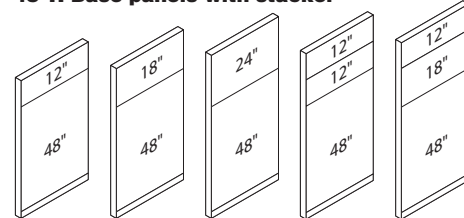
### 42"H Base panels with stacker



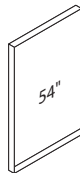
### 48"H Base panels



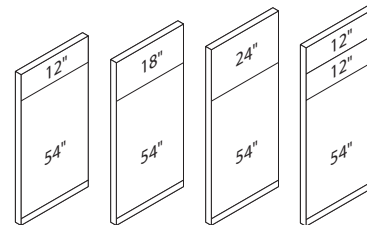
### 48"H Base panels with stacker



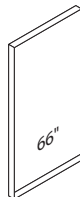
### 54"H Base panels



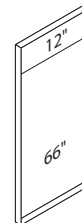
### 54"H Base panels with stacker



### 66"H Base panels



### 66"H Base panels with stacker



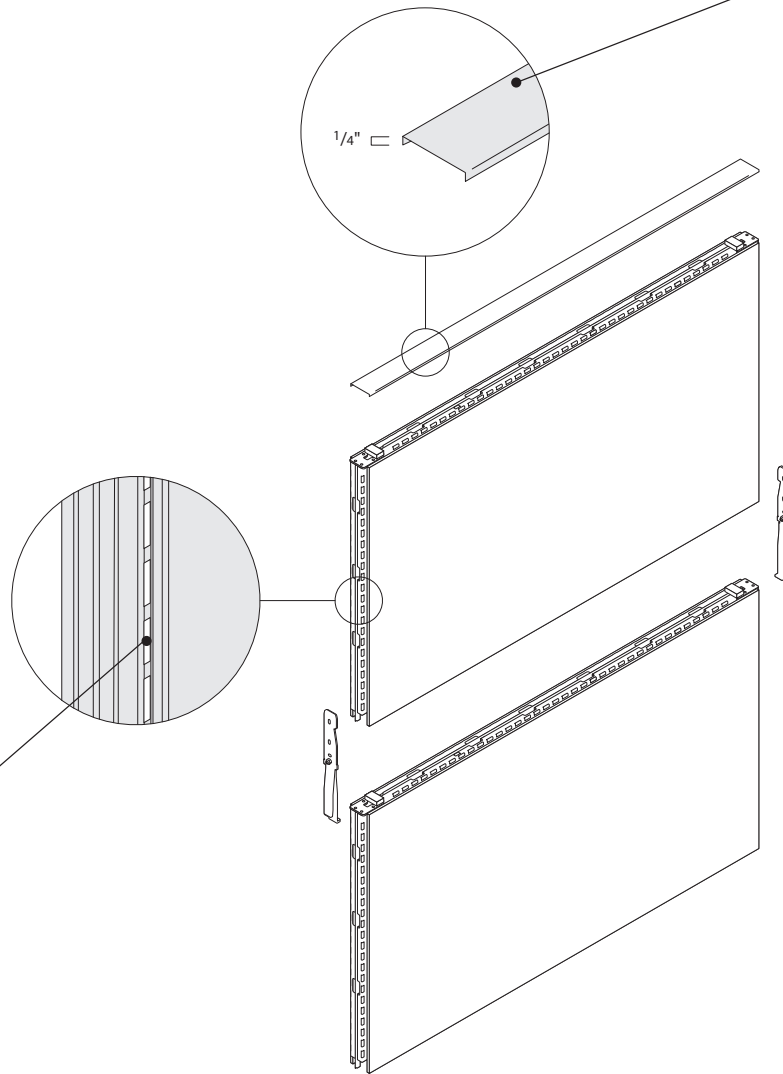




# Panel Stackers

**Stackers** are constructed with a rigid, tubular steel frame and are shipped fully assembled.

**Top cap and top cap aligner** from base panel are used to trim the top of stacker.



**Vertical slots in stackers**, identical to slots in base panel, accommodate overhead storage, laminate common shelves, and connector brackets.

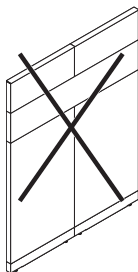
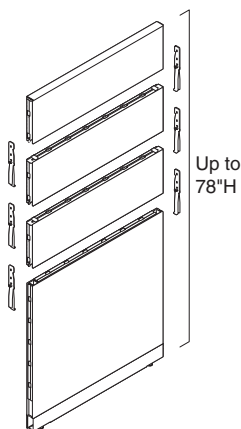
## Actual Dimensions

<b>Height</b>	12", 18", or 24"
<b>Width</b>	24", 30", 36", 42", 48", 60", or 72"
<b>Thickness</b>	2"

**Product Details**

**All existing base panels** accept stackers.

**Stackers** do not include vertical trim, must be specified separately.



**Two smaller stackers** cannot be attached to the top of a larger stacker or panel.

**Stackers** are available in two surface options.



**Tackable acoustical**—skin on each side, covered with horizontal surface fabric.

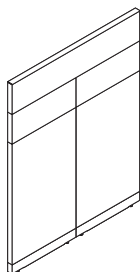


**Glass**—single pane of clear, tempered safety glass on panel centerline, surrounded by painted border.  
*Tip: Fabric and glass stackers cannot be combined on the same panel.*

**Base panels** can accept one, two, or three stackers, up to a total height of 78". Base panels can only accept one glass stacker. All stackers are load bearing, but load cannot be mounted above 66" height.  
▶ See page 208.

**Two fork connectors** are included with every stacker.

**Attaching stackers to panels** will not cause disruption to existing panel connections.



**Spanning stackers** are available in 48", 60", or 72" widths.

**Stacker** can span over an in-line connection between two base panels or two stackers. Width of stacker must equal total width of two base panels.

**Application Topics**

**Maximum height with base panel and stackers** cannot exceed 78".

**Maximum number of stackers** is three.

**Any base panel** can accept stackers.

**Bins and shelves** can hang from first or second, stacker, not above 66" in height.

**When** adding a stacker to existing panels with a power or cable pole connected at L-, T-, or X- corner, the universal panel connector can not be used. Contact [orders@amqsolutions.com](mailto:orders@amqsolutions.com) to order service parts for special connections.

**Panel stackers** cannot be used in a V- or Y-configuration.

**Surface Materials**

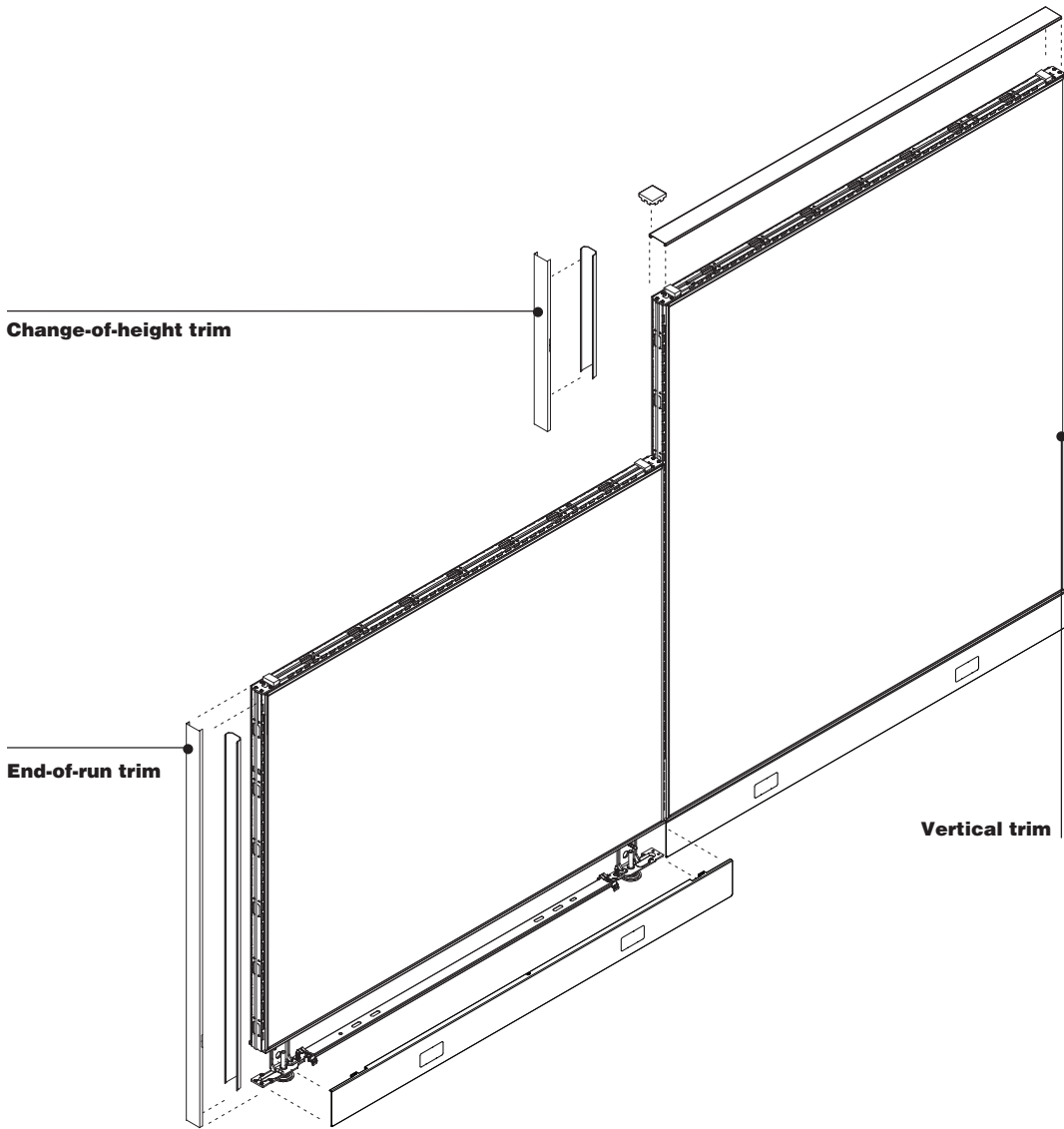
**Border**  
• Paint

**Panel surface**  
• Fabric  
• 6500 Clear Glass

*Tip: Fabric is applied horizontally on the screen. Fabric must be of the same fabric group and color on both sides.*

# Panel Trim

**Steel top caps** are standard in low height.

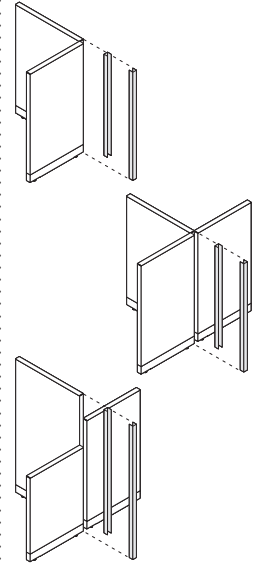


**Change-of-height trim**

**End-of-run trim**

**Vertical trim**

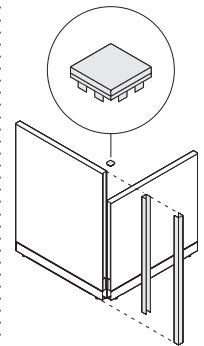
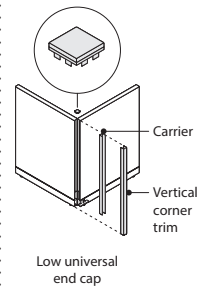
## Product Details



**Vertical corner trim** allows cables to be laid in before the cover is snapped into place and can be removed for cable access. Corner trim is required for L-, T-, and X-configurations.

**Always specify vertical corner trim** the same height as the tallest panel.

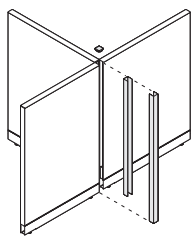
### L-configurations:



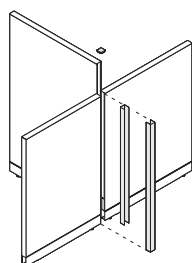
## Actual Dimensions

	Vertical Corner Trim	End-of-Run Trim	Change-of-Height Trim
Height	42", 48", 54", or 66"	42", 48", 54", 60", 66", 72", or 78"	6", 12", 18", 24", or 36"
Standard Thickness	1/4"	1/4"	1/4"

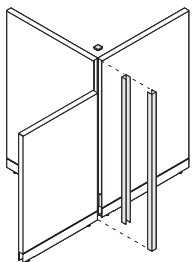
**T-configurations:**



Low universal end cap

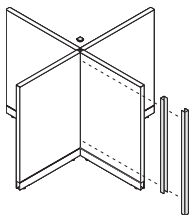


Low universal end cap



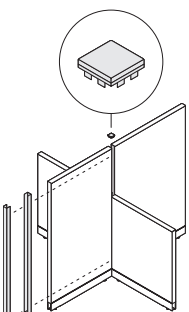
Low universal end cap

**X-configurations:**

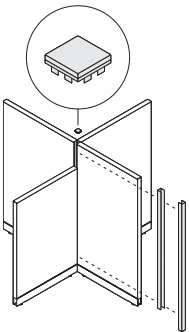


Low universal end cap

*Tip: In an X-configuration, carrier and vertical corner trim must be attached to one panel prior to installation of last panel.*



Low universal end cap

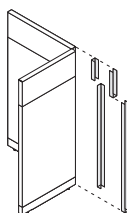
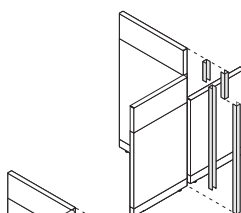
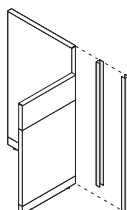


Low universal end cap

**End caps:**



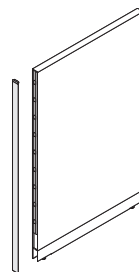
Low universal end cap



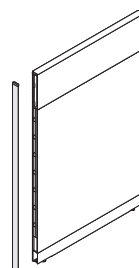
**Vertical corner trim and corner change-of-height trim** are required in combination for L-, T-, and X-configurations when stackers are used. All corner trims include a low trim end cap.

**Always specify vertical corner trim** the same height as the tallest base panel. Specify vertical corner change-of-height trim to cover the ends of stackers.

**Vertical end-of-run trim** covers the exposed end of panels and includes a low trim end cap.



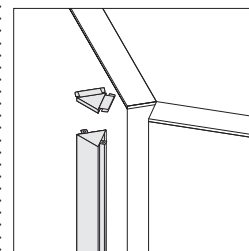
**Vertical end-of-run trim** must match height of base panel.



**Vertical end-of-run trim** must match combined height of base panel and stacker.



**Vertical in-line change-of-height trim** is available 6"H, 12"H, 18"H, 24"H, and 36"H. Trim covers the exposed section of the taller panel when panels of different heights are joined.



**120° vertical corner trim** is required for all 120° connections. The same 120° vertical corner trim is used for two- and three-way connections. Both two- and three-way end caps are included with each 120° vertical corner trim package.

▶ Page 243

**Application Topics**

**Always** specify vertical corner trim the same height as tallest panel.

**When specifying a base panel and a stacker,** specify corner trim to match base panel and change-of-height trim piece to cover the ends of stacker.

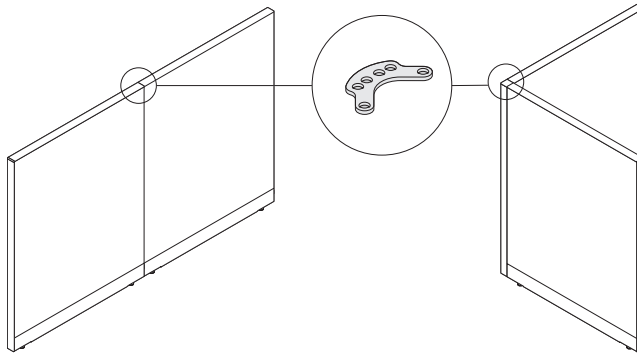
**When base panel and stacker** are specified in end-of-run trim must match total overall height.

**Surface Materials**

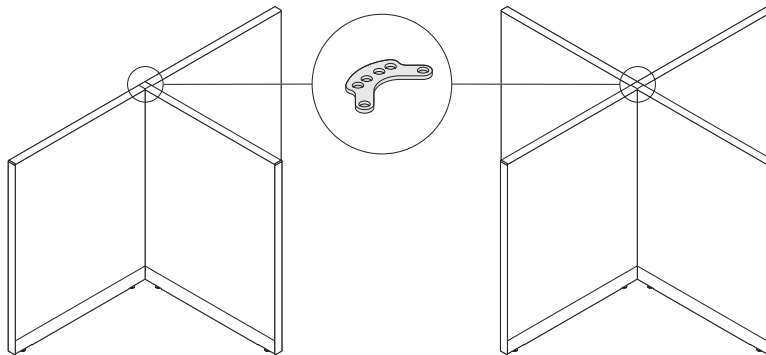
**Trim**  
• Paint

# Panel Connectors

**Universal connector package** joins panels of the same height in a straight line or in L-, T-, or X-configurations. The package, included with panels, contains two universal connectors—one for the top and one for the bottom connection.



**Same connector** is used at both the top and bottom of panel.



**Different slots** are used to create in-line, L-, T-, or X-conditions.



Left Hand  
Right Hand

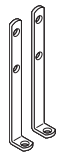
Change-of-Height Connector



Universal Connector

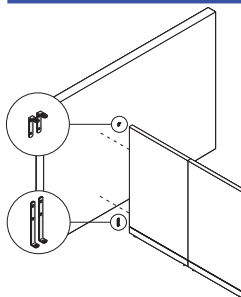


120° Connector



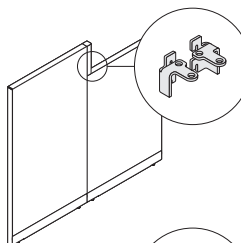
Wall Start

**Product Details**



**Wall start connector package** is used to anchor a panel run to a perpendicular wall. Mounting screws that connect the brackets to the panel are included in each package.

*Tip: Vertical end-of-run trim is not required at the end of panel that is attached to the wall.*



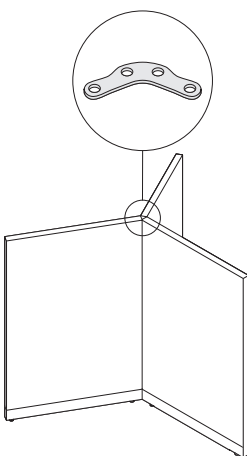
**Change-of-height in-line and corner panel connector package**

is used to join panels at varying heights in a straight line or at 90° angles. Package contains left and right connectors for both in-line and corner configurations.

*Tip: Change-of-height in-line and corner panel connectors cannot be used in 120° configurations.*

**Left and right in-line connectors** are required to connect panels in a straight line.

**One-handed corner connector** is required for connecting panels at 90°.



**To connect panels in a 120° application**, a 120° panel connector is required. A two-panel connection requires one 120° connector package. A three-panel connection requires three 120° connector packages.

*Tip: Change-of-height in-line and corner panel connectors cannot be used in 120° configurations.*

▶ Page 245

**120° connectors** are for the same height panels only.

**120° and 90° connections** can occur within the same workstation.

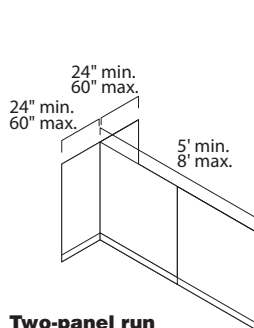
**Surface Materials**

**Universal and 120° connector**

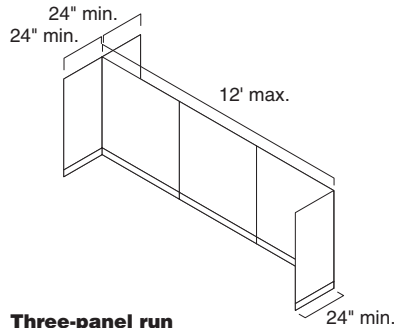
- 0835 Black

# Stability Guidelines

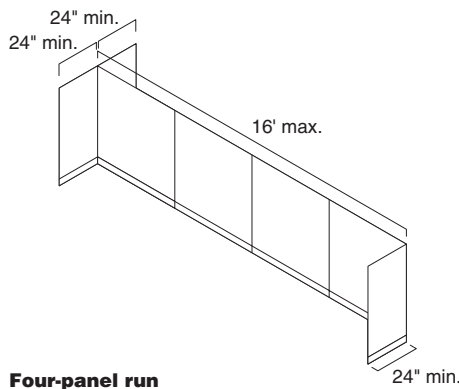
## Tackable Acoustical Panels without Components



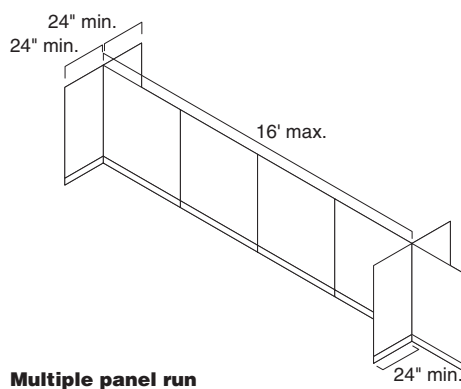
**Two-panel run**



**Three-panel run**



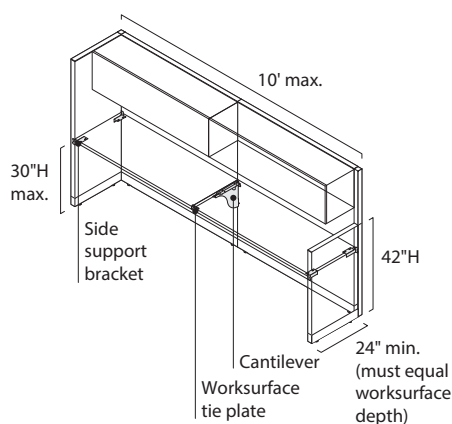
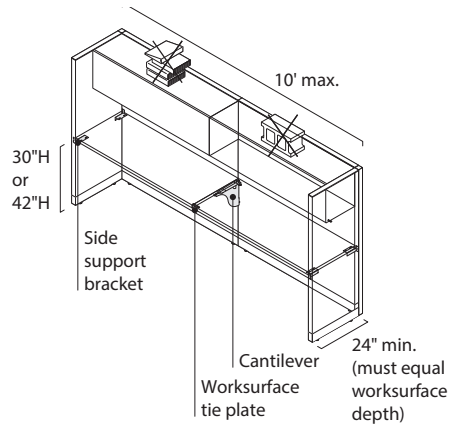
**Four-panel run**



**Multiple panel run**

## Tackable Acoustical Panels

### Two-Panel Run with Supported Components



**Optional worksurface supports:**

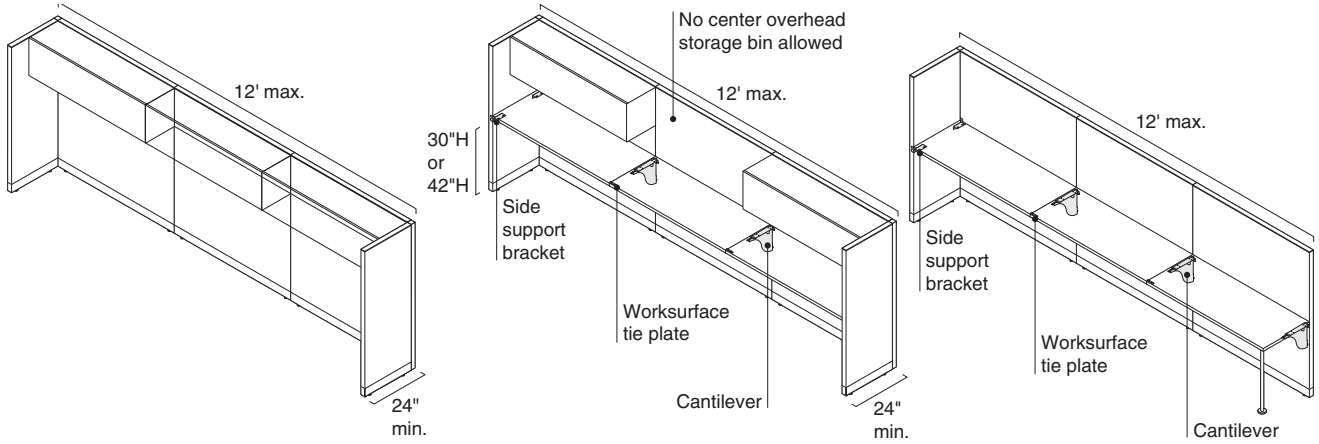
- Pedestal with filler
- Lateral file
- End panel

*Tip: Overhead storage bins cannot support any load on top.*



**Tackable Acoustical Panels, continued**

**Three-Panel Run with Supported Components**



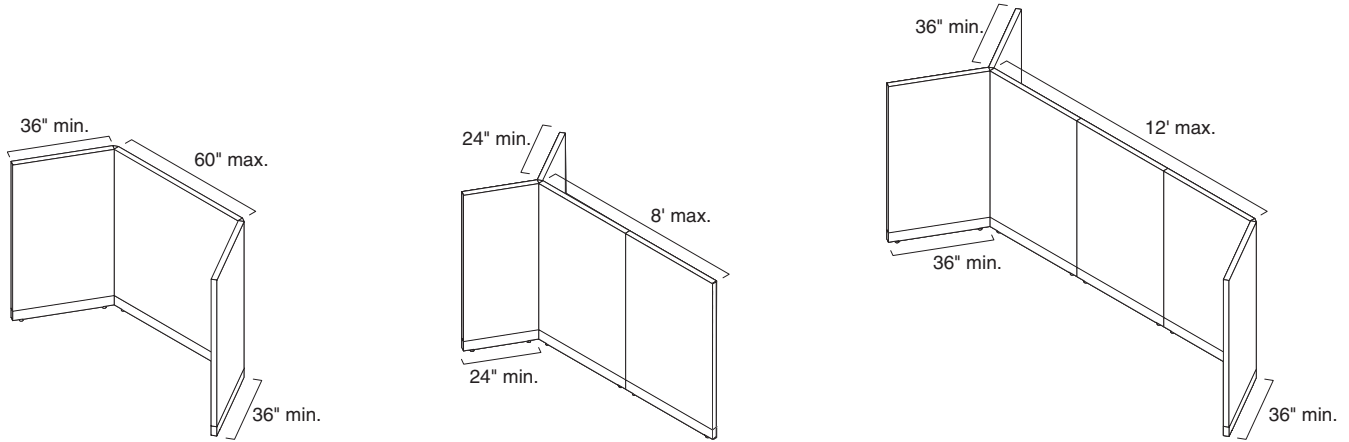
**Optional worksurface supports at 30"H:**

- Pedestal with filler
- End panel

*Tip: Overhead storage bins cannot support any load on top.*

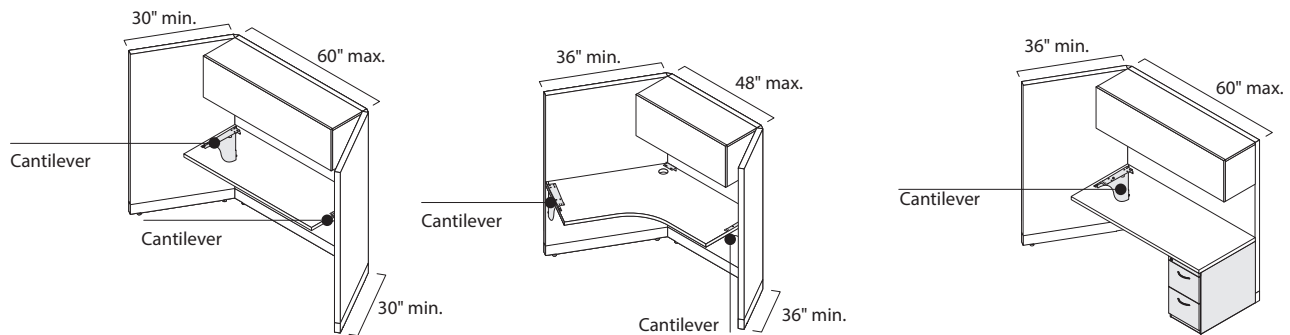
**Tackable Acoustical Panels without Components**

**120° Connection**



**Tackable Acoustical Panels with Supported Components**

**One Panel—120° Connection**



**Optional worksurface supports:**

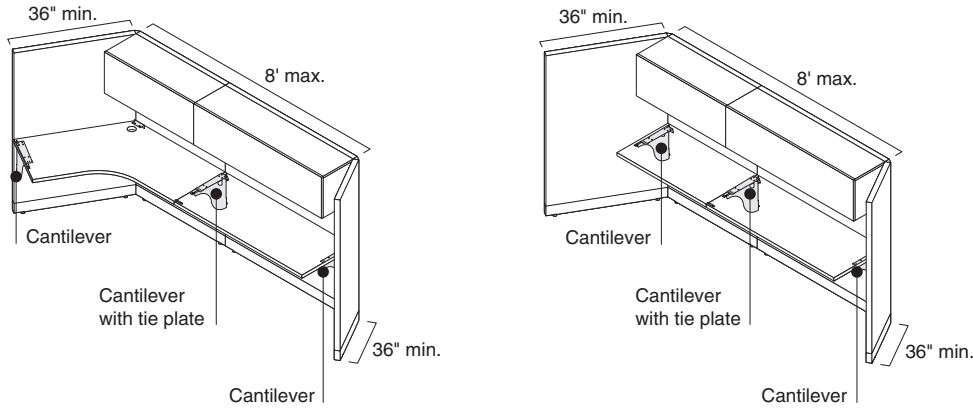
- Pedestal with filler
- 90° panel connection—panel width must match worksurface depth
- End panel

**Optional worksurface supports:**

- 90° panel connection—panel width must match worksurface depth

**Tackable Acoustical Panels with Supported Components, continued**

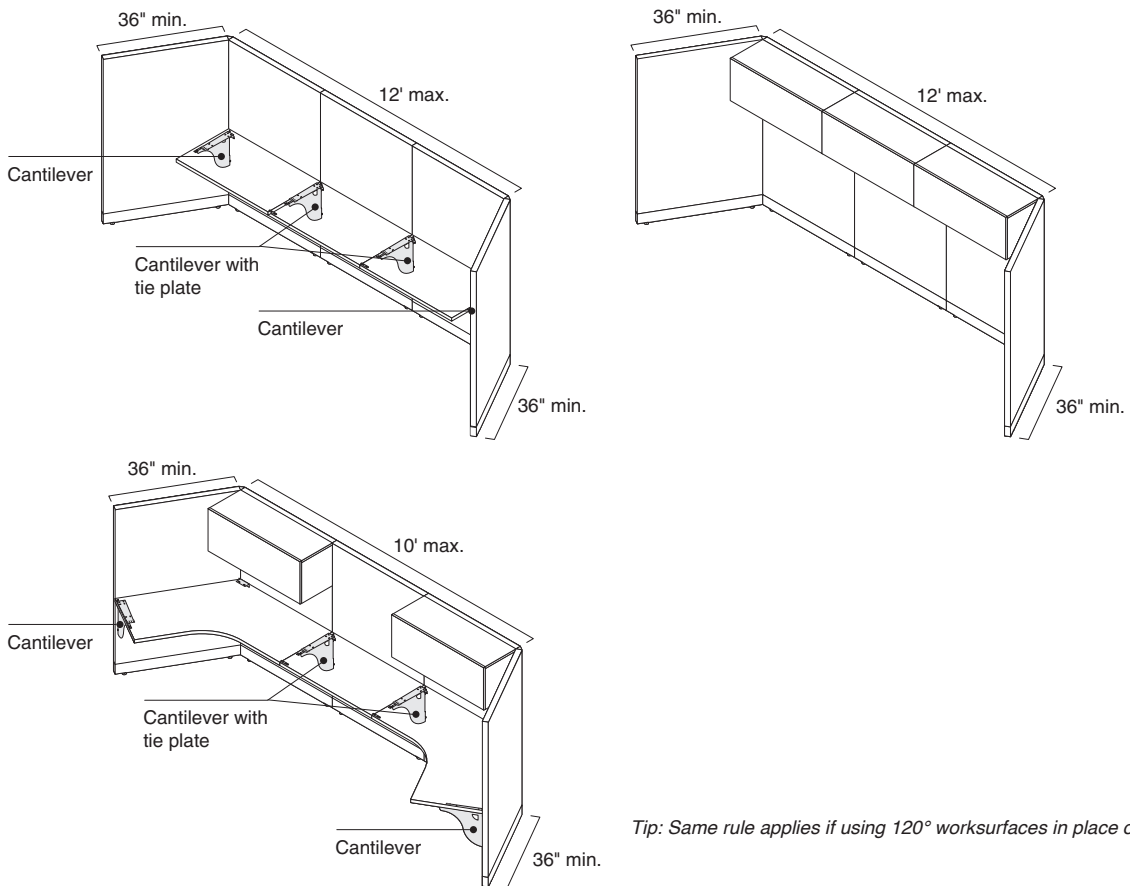
**Two-Panel Run—120° Connection**



**Optional worksurface supports:**

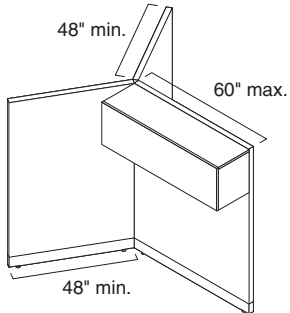
- Pedestal with filler
- 90° panel connection—panel width must match worksurface depth

**Three-Panel Run—120° Connection**

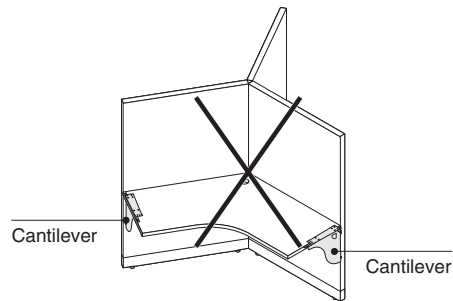
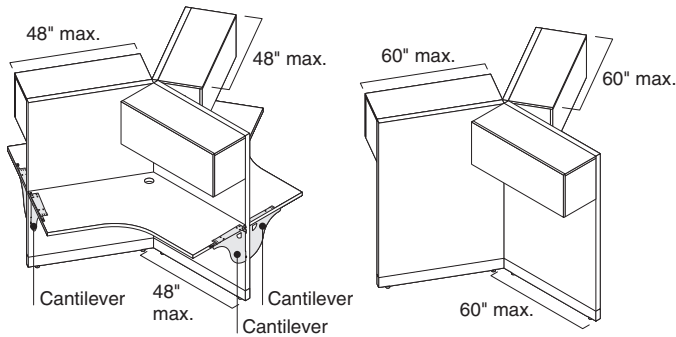


**Tackable Acoustical Panels—Three-Way 120° Connection**

**Three Panel 120° Connection with One Supported Component**



**Three Panel 120° Connection with 120° Worksurface and up to One Additional Component**



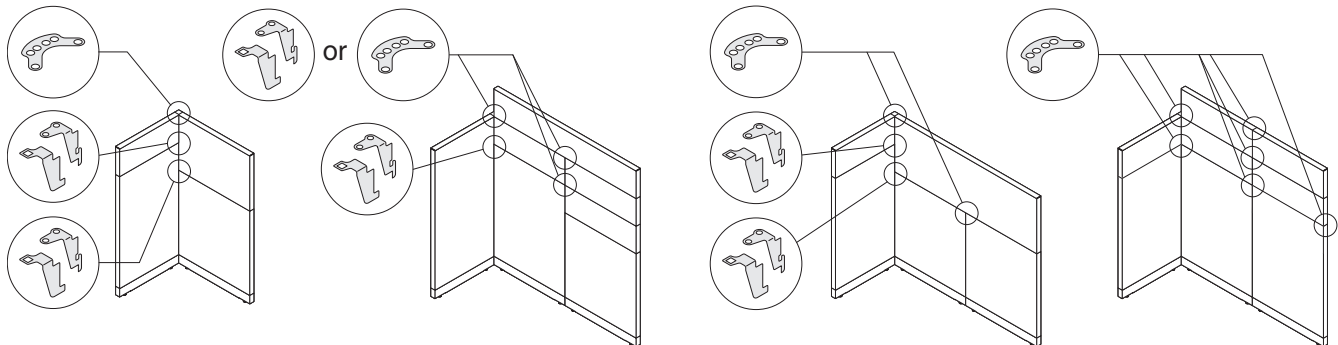
*Tip: Loads must be counterbalanced in this application.*

*Tip: Worksurface needs to be supported to floor or application needs to be counterbalanced.*

**Panels and Panel Stackers**

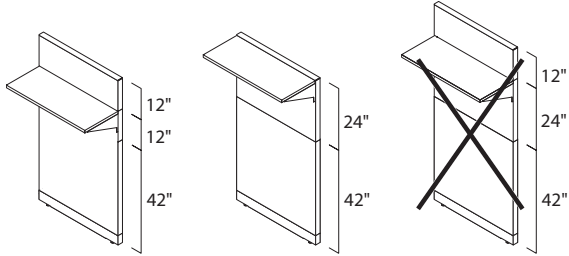
**Base panels** can accept one, two, or three stackers, up to a total height of 78". Base panels can accept only one glass stacker. See below for additional rules and exceptions.

**Universal or change-of-height connectors** must be used at top of base panel and each stacker wherever possible to increase stability.



### Panels and Panel Stackers, continued

All stackers are load bearing, but load cannot be mounted above 66" height.



# Circuit Specifications

Detailed Information for the Electrical Engineer

## Five wiring schematics

are available for TEKTIS—two 3-circuit systems and three 4-circuit systems.

## All the components in an electrical distribution network

must use the same wiring schematic. The components (power poles, base power-ins, and receptacles) snap together and are keyed to make it impossible to connect mismatched parts. Color-coded and labeled components make it easy for installers to identify which wiring schematic each component is dedicated to.

## Color coding

For power components manufactured before June 19, 2023:

- 3 circuits shared = Black
- 3 circuits separate = White
- 4 circuits 3+D = Black
- 4 circuit 3I+1 = Tan
- 4 circuit 2+2 = Grey

For power components manufactured on or after June 19, 2023:

- 3 circuits shared = Blue
- 3 circuits separate = Rust
- 4 circuits 3+D = Black
- 4 circuit 3I+1 = Black
- 4 circuit 2+2 = Brown

## Overview

### Three-circuit electrical components with shared neutrals

are standard with 5 wires to provide three circuits that share one oversized neutral and one ground.

### Three-circuit with separate neutrals

have 8 wires providing three circuits, each with its own separate neutral. The first two circuits share an isolated ground; the third uses the system ground.

### Four-circuit 3+D

are standard with 8 wires to provide four circuits. Three of these circuits share an oversized neutral and a system ground while the remaining circuit has its own neutral and isolated ground.

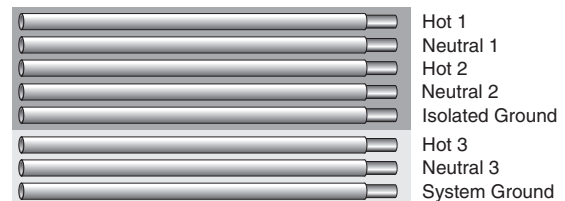
**Four-circuit, 3I+1** again have 8 wires but with three circuits that share an oversized neutral and isolated ground. The fourth circuit has its own neutral and is attached to the system ground. This electrical system is like the standard 3+D, but the grounds are switched, providing three isolated circuits and one general purpose circuit as compared to one isolated circuit and three general purpose circuits.

**Four-circuit 2+2** also have 8 wires but provide two circuits that share an oversized neutral and a system ground and an additional two circuits with a second oversized neutral and an isolated ground.

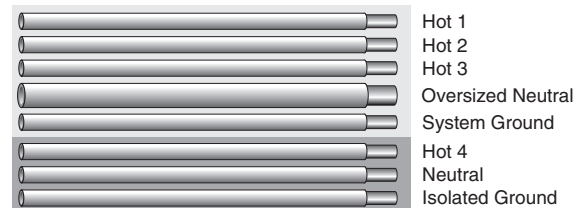
## 3 Circuit Shared Neutral, 5 Wires



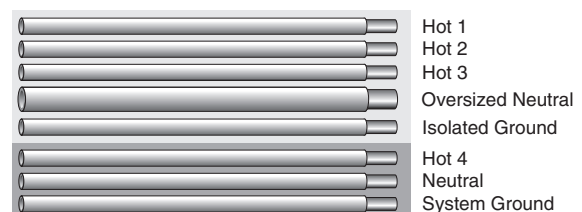
## 3 Circuit Separate Neutral, 8 Wires



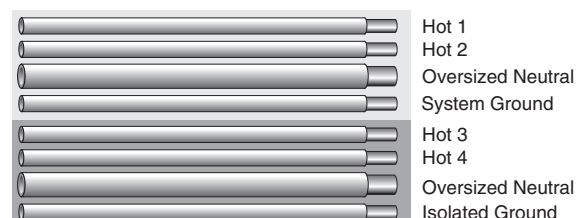
## 4 Circuit 3+D, 8 Wires



## 4 Circuit 3I+1, 8 Wires



## 4 Circuit 2+2, 8 Wires



# How to Calculate Power Needs

Use This to Determine How Many Power-Ins You'll Need

**When planning a power network,** you must calculate the amperage requirements of all your electrical components so you can provide sufficient electricity to power them.

**If your usage is not known in advance:** The National Electrical Code (NEC) allows a maximum of 13 receptacles on each 20-amp circuit. This provides up to 30 receptacles for each 3-circuit power-in.

**If your usage is known in advance:** Add up the amperage used by each piece of equipment in the workstation. Whenever you reach 60 amps (20 amps times 3 circuits) from items that are likely to be used at the same time, you have reached the limit for a single power-in. Specify another power-in and continue until all equipment is powered.

If the circuits will normally be subject to a continuous load (three or more hours of continuous use, such as lights or computers), the NEC requires that circuit capacity be "de-rated" by 20 percent. Therefore, treat circuits used for continuous loads as if they were rated at 16 amps instead of the regular 20 amps.

Try to anticipate future increases in power requirements and build some excess capacity into your plan.

▶ See table at right for typical and actual amperage usages for components.

To calculate amperage when the wattage of a device is known, divide watts by 120.

Some appliances, such as large copiers, coffee makers, or space heaters require most of the current available on a 20-amp circuit. It is recommended that such devices be supplied with their own receptacle/circuit, directly from the building. This leaves the capacity of the furniture circuits available for the more dynamic requirements of the office equipment.

Local electrical codes vary. Consult a qualified electrical contractor or engineer for the proper planning of electrical circuits in your locale.

## Approximate power consumption for common devices

Device	Wattage	Amperage	Voltage	Number of Devices Supported on Single 20 Amp Circuit*
Laptop	90	0.8	110	20
CPU/Desktop Computer	120	1.1	110	15
Monitor	60	0.5	110	29
Phone	5	0.0	110	352
High Power Tablet (e.g. Surface Pro)	40	0.4	110	44
Low Power Tablet (e.g. iPad Air)	15	0.1	110	117
Desktop Printer	40	0.4	110	44
42" LCD Screen	210	1.9	110	8
DVD Player	25	0.2	110	70
Projector	175	1.6	110	10
Desktop Lamp	19	0.2	110	93
Large Printer/Copier (high)	1900	17.3	110	1
Large Printer/Copier (low)	850	7.7	110	2
Paper Shredder	360	3.3	110	5
Desktop Fan	20	0.2	110	88
Standing Fan	180	1.6	110	10
Coffee Maker (high)	1200	10.9	110	1
Coffee Maker (low)	600	5.5	110	3
Microwave (high)	400	13.6	110	1
Microwave (low)	150	5.5	110	3
Refrigerator (high)	1500	3.6	110	4
Refrigerator (low)	200	1.4	110	12
Vacuum (high)	1500	13.6	110	1
Vacuum (low)	200	1.8	110	9
Space Heater (high)	1500	13.6	110	1
Space Heater (low)	750	6.8	110	2

*Tip: These calculations are estimations and are meant solely for informational purposes. It is important to conduct proper power planning for each installation to prevent overloading a circuit.*

# Special Requirements for Chicago

	Chicago Code	Specification:	Electrician will supply:
<b>Panel Requirements</b>	<b>Panel</b> must be hardwired in the field.	<ul style="list-style-type: none"><li>• <b>Order panels</b> with factory-installed power base covers with receptacle knockouts where you intend to install receptacles. <i>Tip: Chicago code doesn't require a special base cover with different receptacle locations.</i></li><li>• <b>Receptacles</b> in Chicago are supplied by electrician. Contact <a href="mailto:orders@amqsolutions.com">orders@amqsolutions.com</a> to order service parts for special connections. <i>Tip: Because receptacles in Chicago cannot be installed back-to-back, you may want to avoid powered panels that are 30"W or less. These panels only have one receptacle location on each side, so these panels can only accommodate one duplex-size receptacle.</i></li><li>• <b>Order corner fillers</b> for L-, T-, and X-configurations separately to conceal electrical conduits.</li></ul>	<ul style="list-style-type: none"><li>• Connection to building power supply</li><li>• Wires</li><li>• Fittings</li><li>• Duplex receptacle (Leviton 5325-Decora style)</li><li>• Electrical components</li></ul>
<b>Chicago code</b> requires hardwiring of all electrical components.	<b>Electrician hardwires</b> all receptacle boxes and conduits into panel bases in the field. <i>Tip: Panel depth prohibits use of standard device boxes for back-to-back receptacles in Chicago.</i>		



### Test and verify capacities for your individual situation.

We recommend that testing be conducted using your specific cable, as well as the furniture configuration you are considering. Cable capacities in this table are based on actual cable studies performed by an independent contractor following EIA/TIA codes and practices and can be taken as an accurate assessment of maximum practical capacity. Actual cable capacities may vary slightly depending on which manufacturer produced the cable and the specific field conditions.

**Cable capacities** are based on Category 6 and Category 6a cables at 55% fill capacity.

*Tip: Low top cap does not accept any cables.*

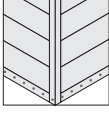
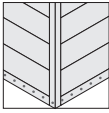
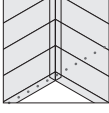
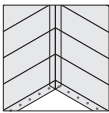
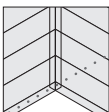
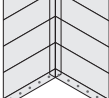
### Cables Tested

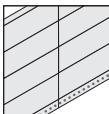
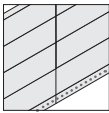
**A CommScope Systemax Gigaspeed 1071E Series Category 6 Cable**  
OD=0.23"

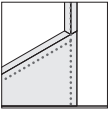
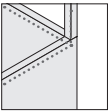
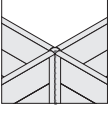
**B CommScope Systemax X10D 1091B Series Category 6A Cable**  
OD=0.285"

**Powerways reduce cable capacity.** An average of 10-15 cables will be reduced per powerway used. However, this number varies according to installation practices and the type of cables used.

**When laying cables vertically behind skins,** capacity is dependent on skin width.

	A	B
<b>L, T, X, V, and Y Horizontal Routing</b>		
 Lay-in cable routing (corner) at base of panel <b>with</b> power in L, T, or V configuration	9	5
 Lay-in cable routing (corner) at base of panel <b>without</b> power in L, T, or V configuration	32	21
 Lay-in cable routing (straight) at base of panel <b>with</b> power in X or Y configuration	9	5
 Lay-in cable routing (corner) at base of panel <b>with</b> power in X or Y configuration	9	5
 Lay-in cable routing (straight) at base of panel <b>without</b> power, or with powerway routed above in X or Y configuration	32	21
 Lay-in cable routing (corner) at base of panel <b>without</b> power, or with powerway routed above in X or Y configuration	32	21

	A	B
<b>Straight Horizontal Routing</b>		
 Lay-in cable routing at base of panel <b>with</b> power	8	5
 Lay-in cable routing at base of panel <b>without</b> power or with powerway routed above	32	21

	A	B
<b>Straight Vertical Routing</b>		
 Vertical cable routing inside power pole (used on an end, L or T configuration an end)	28 Hi	18 Hi
 Vertical cable routing inside power pole	28 Hi	18 Hi
 Through center of X	24	16

*Tip: Low top cap does not accept any cables.*

# Powerways

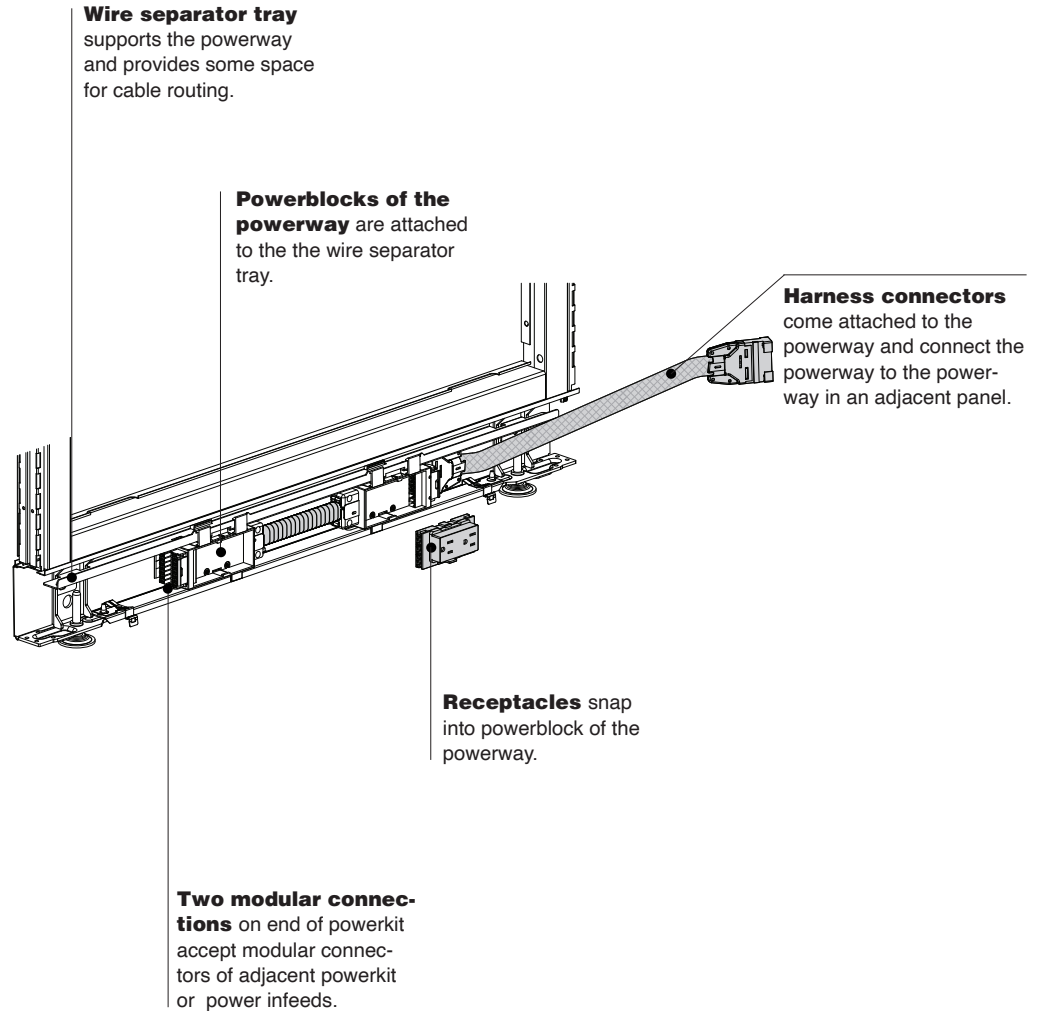
**Powerways** that are installed in the panel base cavity allow power to be distributed wherever panels go. They are concealed when properly installed.

**On June 19, 2023,** TEKTIS power components changed design. Power components manufactured before June 19, 2023 are not compatible with power components manufactured after June 19, 2023.  
▶ See *Power Components Transition Details* on page 234.

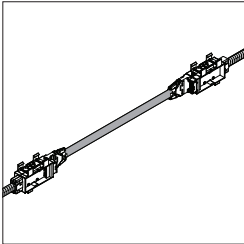
**All the components in an electrical distribution network** must use the same wiring schematic. Components are color coded and keyed to make it impossible to connect mismatched parts.

**Electrical systems** are designed in compliance with the National Electrical Code (NEC) and Canadian Electrical Code (CEC) to function as a multi-wire branch circuit. Installations should be made in accordance with the NEC or CEC provisions for multi-wire branch circuits.

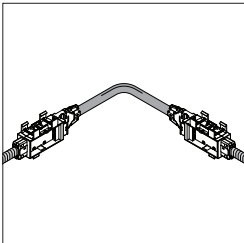
**Local electrical codes** vary. Consult a qualified electrical contractor or engineer for the proper installation of electrical equipment. Chicago, New York City, and Los Angeles have special requirements.



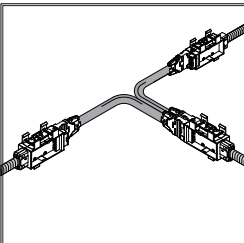
**Product Details**



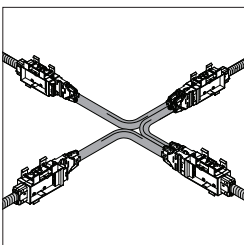
**Straight connection** is formed when a harness connector from one powerway attaches to the powerblock of the adjacent powerway.



**L-connection** is formed when a powerway connector harness turns to the left or right and connects to the powerblock of the adjacent panel.



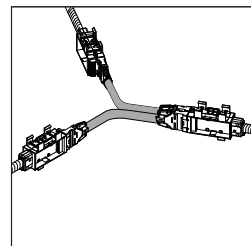
**T-connection** is formed by two powerway connector harnesses each turning in the same direction.



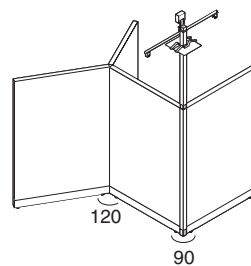
**X-connection** is formed by three powerway connector harnesses, each turning in the same direction.

The **powerway connector harness** comes attached to each powerway and can be removed in the field.

**Removing the powerway connector harness and adding it to the opposite end of the powerway powerblock** can be used to correct planning and installation oversights.



**Power** can be routed through the base of panels in a two- and three-panel, 120° connection.



(inside measurement)  
**2" x 2" power and cable poles** can bring building power and data from the ceiling to a 120° panel application at the end of a run or 90° connection only.

**Application Topics**

**Factory included powerway** for field installation replaces need to order separate powerways.

**Wiring and Cabling**

**Chicago, New York City, and Los Angeles** have special requirements.

**Chicago electrical code** requires that all electrical connections be hardwired in the field. Order a non-powered panel and have the electrician obtain conduit and receptacles (Leviton 5325) to make the connections in the field.

**Underwriters Laboratory (UL)** listed. These products have been designed to meet U.S. and Canadian national electrical and energy codes and most local building codes. Local electrical codes vary, so consult with your local authority having jurisdiction as they have final say if the products as installed are compliant with local code. Consult with a qualified electrician or electrical engineer for proper installation of all electrical equipment.

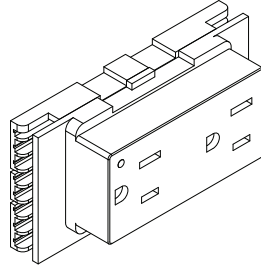
# Receptacle

**Receptacles** are ordered separately and installed in the field in the base cover knockout opening. Receptacles snap into the powerblock in the field. Receptacles are designed to link to a specific circuit.

**On June 19, 2023,** TEKTIS power components changed design. Power components manufactured before June 19, 2023 are not compatible with power components manufactured after June 19, 2023.

► See *Power Components Transition Details* on page 234.

**All receptacles** are duplex (two outlets) and are available in 15-amp.



## Product Details

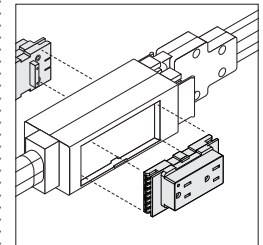
**Numbers** printed on the receptacles indicate the line number. Label on receptacle indicates which circuit the receptacle connects to, so the user can control which devices are on specific circuits.

**With the 3-circuit separate neutral system,** these designations are with letters A, B, or C as compared to 1, 2, 3, or 4 in the other systems.

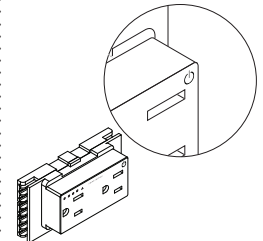
**All the components in an electrical distribution network** must use the same wiring schematic. Components are color coded and keyed to make it impossible to connect mismatched parts.

**Available** in 6000 Black plastic only.

**Receptacles** come in packages of six receptacles.



**Receptacles** snap into both faces of the powerblock in the field.



**Controlled receptacle** must be indicated when tying into the building management system. Duplex receptacles have an option for a factory permanent, pad stamp power icon symbol with the word controlled per compliance with the Energy Code.



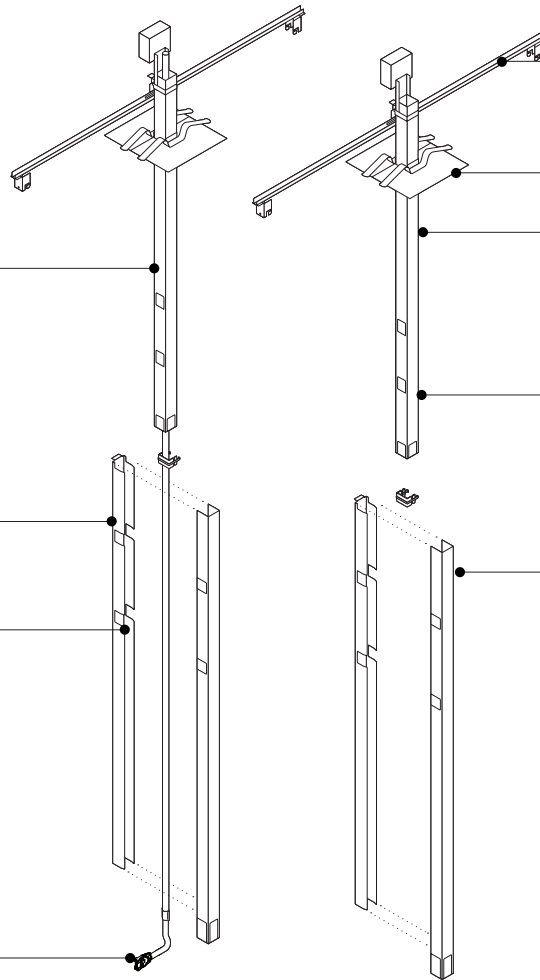
# 2" x 2" Power and Cable Pole

**Power poles** bring building power from the ceiling to the powerways in the base cavity of panels. They can also be used to run cables into the top cap or into the panel base cavity. All five wiring schematics are available.

**Trim** conceals powerway and cables routed to the base of the panel.

**Knockout**

**The power pole harness** attaches to either end of a powerway.



**Hanger bar** secures the top of the pole to the ceiling grid.

**Ceiling trim plate**

**Cable poles** provide a space to route cables from the ceiling to the high top cap or base cavity of a panel.

**Knockouts** allow data distribution in change-of-height conditions.

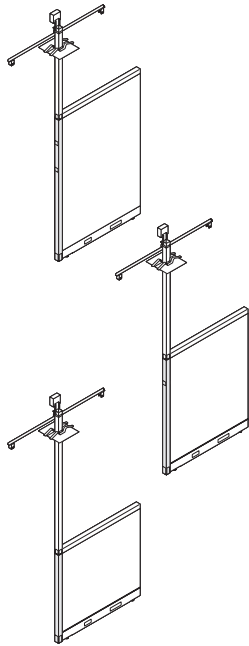
**Retainer** attaches to the end of a panel with screws that attach below the top cap. Panel remains undamaged so power and cable pole can be removed and relocated later.

**On June 19, 2023,** TEKTIS power components changed design. Power components manufactured before June 19, 2023 are not compatible with power components manufactured after June 19, 2023.  
▶ See *Power Components Transition Details* on page 234.

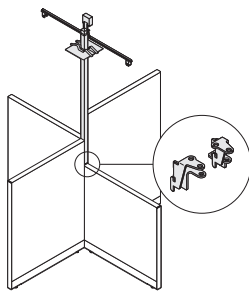
**All the components in an electrical distribution network** must use the same wiring schematics. Components are color coded and keyed to make it impossible to connect mismatched parts.

**Product Details**

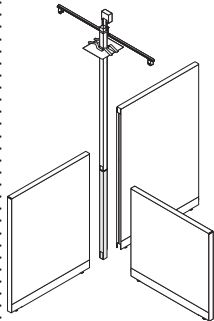
**Power and cable poles** accommodate ceiling heights up to 10'4"H.



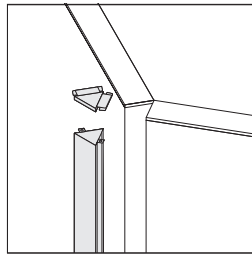
**Height of the pole** must correspond with the height of the panel it is attached to so that the pole will connect under the top cap. Adjacent panels can be lower. Ceiling heights up to 10'4" can be accommodated.



**Power and cable pole packages** ship with one left-hand and one right-hand corner change-of-height connector. A separate change-of-height package may be required in certain X configurations.



**In T configurations,** height of power and cable pole must correspond to the height of the center panel.



**120° vertical corner trim** is required for all 120° connections. The same 120° vertical corner trim is used for two- and three-way connections and is available with a low end cap only. Both two- and three-way end caps are included with each 120° vertical corner trim package.

▶ Page 243

**Surface Materials**

**Power pole**  
• Paint

**Ceiling trim plate**  
• 4790 Sodium paint

# Base Power-In

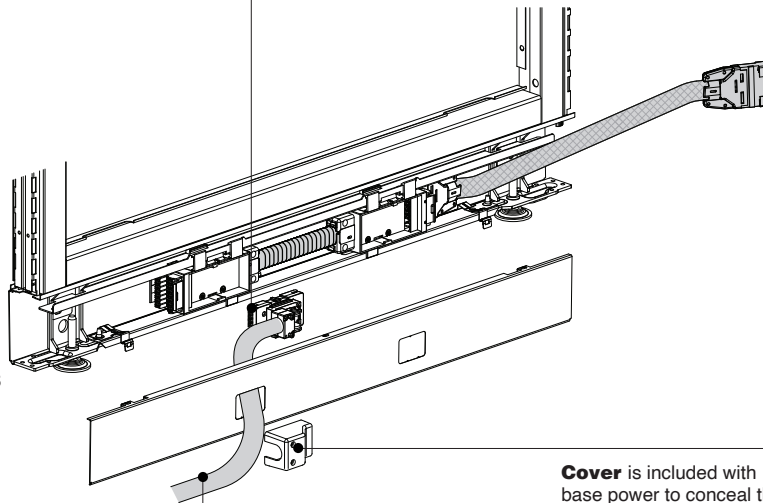
**Base power-ins** are field installed and connect the panel electrical system to the building power source.

**Power-ins** are UL listed and CSA certified. Local electrical codes vary, so consult with your local authority having jurisdiction as they have final say if the products as installed are compliant with local code.

**All the components in an electrical distribution network** must use the same wiring schematic. Components are color coded and keyed to make it impossible to connect mismatched parts. Building power source can come from the floor, wall, or column.

**On June 19, 2023**, TEKTIS power components changed design. Power components manufactured before June 19, 2023 are not compatible with power components manufactured after June 19, 2023. ▶ See *Power Components Transition Details* on page 234.

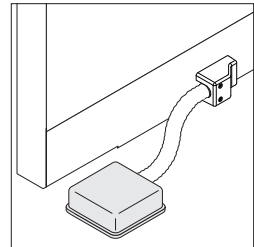
**Connector on end of base power infeed harness** occupies one receptacle location in powerblock.



**Flexible harness** secures hardwired connection to building monument. The harness must be back fed through the base trim prior to connection into the building monument.

**Cover** is included with base power to conceal the connection.

## Product Details



**Power-in** brings power to panel run by connecting to a designated receptacle location on either end of the powerway. Power-ins fit standard-size receptacle openings if the green end of the powerway is located behind the receptacle opening.

**Paint color** is required for base power-in for use in New York.

**Special requirements** are needed for San Francisco.

▶ See page 17





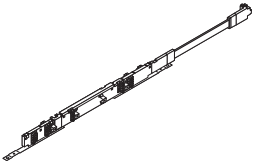
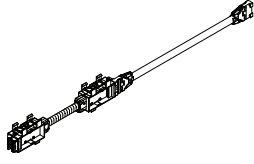
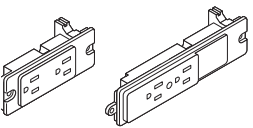

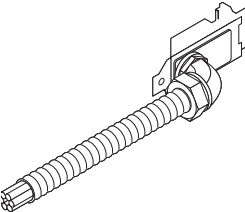
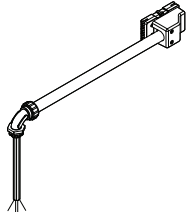
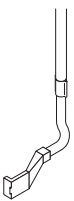
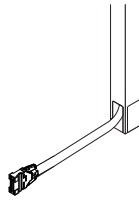
# Power Components Transition Details

On June 19, 2023, TEKTIS power components changed design. Power components manufactured before June 19, 2023 are not compatible with power components manufactured after June 19, 2023.

The style numbers of power component have changed. The panel style numbers have not changed. Any panel segment ordered with power after June 19, 2023 will include the new power component design.

How power is specified remains unchanged. Power can be optioned on to the panel segment. Powerways can be specified as installed in the factory or installed in the field.

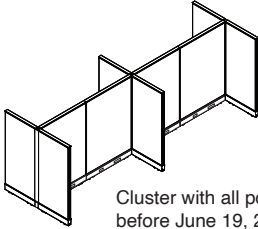
Components included in the design change are powerways, receptacles, base power-ins, and the harness included in the power pole.

Power before June 19, 2023	Power after June 19, 2023
<b>Powerways</b>	
	
<b>Receptacles</b>	
 <p data-bbox="146 1081 324 1108">Standard      Larger</p>	
<b>Base Power-Ins</b>	
	
<b>Power Harness in Power Pole</b>	
	

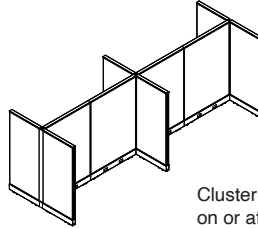
<b>Difference between power components</b>		
<b>What is different</b>	<b>Power before June 19, 2023</b>	<b>Power after June 19, 2023</b>
<b>Connector flag/harness</b>	Mesh connector flag is not removable from the powerway.	Mesh connector flag is removable from the powerway.
<b>Power access in 24" and 30" wide panel segments</b>	24"W and 30"W base covers have a standard-size opening on one side of the panel and larger size opening on the reverse side.	24"W and 30"W base covers have standard-size openings on both sides of the panel.
<b>Receptacle size</b>	Receptacles were available in two sizes– standard and larger.	All receptacles are standard size.
<b>Receptacle cutout locations on base covers</b>	Receptacle location differs before and after June 19, 2023. See details under <i>Receptacle Location Change</i> . Page 237	Receptacle location differs before and after June 19, 2023. See details under <i>Receptacle Location Change</i> . Page 237
<b>Base power-in</b>	Connection at receptacle location does not include an aesthetic cover.	Connection at receptacle location includes an aesthetic cover.
<b>Receptacle connection to powerway</b>	Receptacle connect to powerway with screws.	Receptacle snaps into the powerway without any screws.
<b>Wiring schematics</b>	All five wiring schematics available. Color-coding and keying have changed.	All five wiring schematics available. Color coding and keying have changed.

**Planning with power components manufactured before and after June 19, 2023.**

Power components manufactured before June 19, 2023 can still be used but do not connect to power components manufactured on or after June 19, 2023. The following two approaches can be used when both power systems are used:

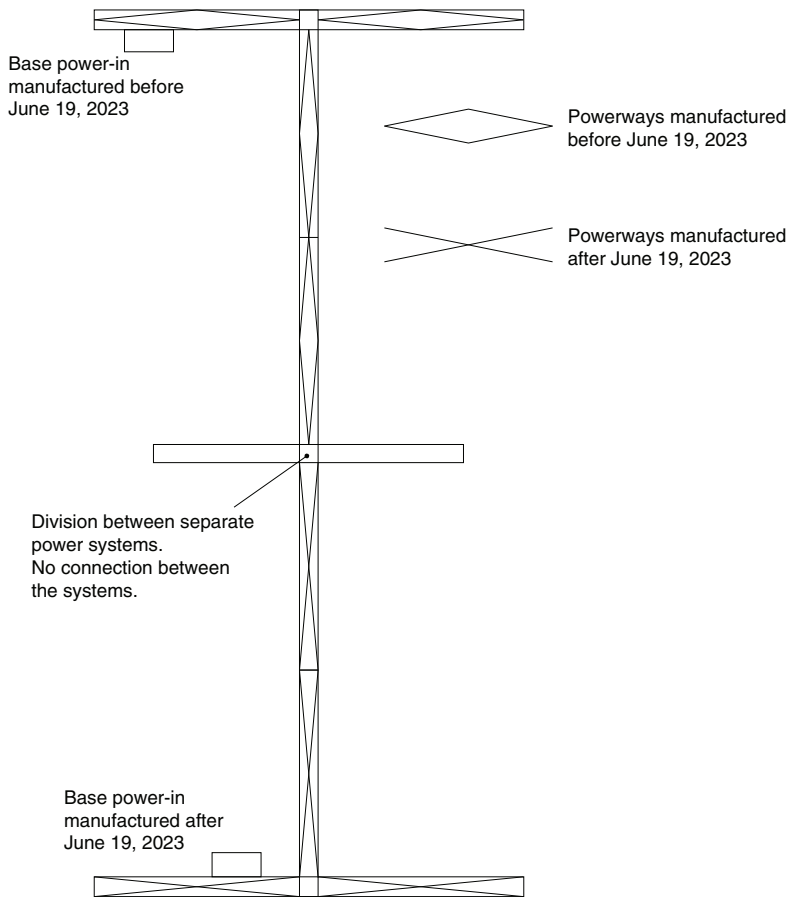


Cluster with all power components manufactured before June 19, 2023.



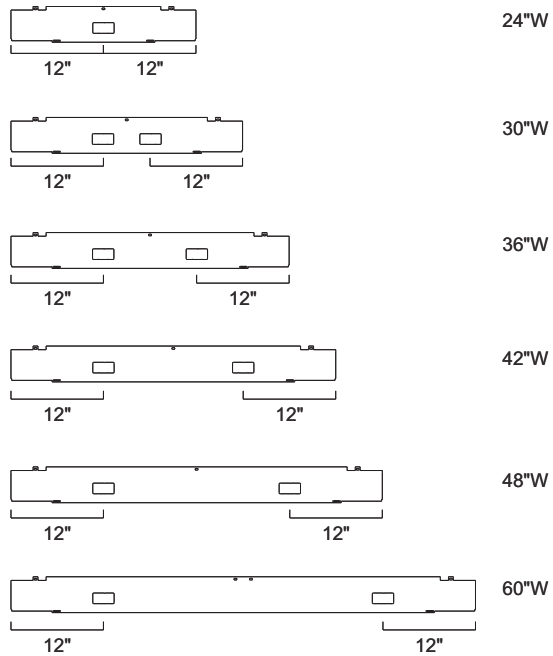
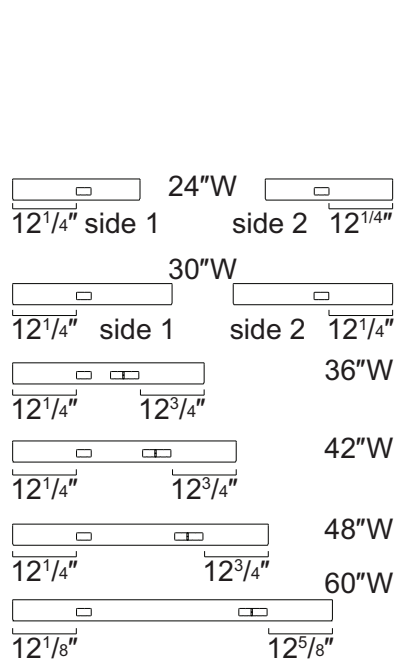
Cluster with all power components manufactured on or after June 19, 2023.

Organize by cluster: Power systems can be organized by workstation cluster. Some clusters can use power components manufactured before June 19, 2023 and other clusters can utilize power components manufactured on or after June 19, 2023.



Utilize multiple infeeds in a single cluster: A single workstation cluster can use both power systems by utilizing multiple infeeds. Power components manufactured before June 19, 2023 can power part of the workstation and have its infeed and power components manufactured on or after June 19, 2023 can power part of the workstation and have its infeed. Each power system covers part of the workstation and the two systems do not connect to one another.

**Receptacle location change**



**Receptacle location for base Trims manufactured before June 19, 2023**

**Receptacle locations for base trims manufactured after June 19, 2023**

**Status of power components manufactured before June 19, 2023**

Powerways, panel connectors, receptacles, base power-ins and harnesses included in the power pole manufactured before June 19, 2023 are no longer supported.

Basecovers with receptacle cutouts for the receptacle locations of the pre-June 19, 2023 powerways are supported as service parts.

Receptacle knockout fillers for both the pre-June 19, 2023 and post-June 19, 2023 are available as a service part.

The pre-June 19, 2023 wire separator, which supports the powerway in the panel, is available as a service part.

**How to convert a TEKTIS panel manufactured before June 19, 2023 with post June 19, 2023 power components.**

1. Remove all pre-June 19, 2023 power components and the pre-June 19, 2023 wire separator.
2. Order from service parts a post June 19, 2023 wire separator, a post June 19, 2023 powerway and a post June 19, 2023 set of base covers of the appropriate width. Powerways, wire separators, and base covers are not available as style numbers.
3. Add post June 19, 2023 components to base area of the panel frame manufactured before June 19, 2023.

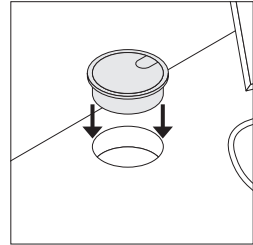
# Worksurface-Height Grommet

**Power** can be accessed at or near worksurface height by using a grommet.



**Grommet**

## Product Details



**Grommets** are available in packages of 10 to finish exposed edges of field-installed openings in the worksurface for vertical cable routing.

**Grommets** are available in black plastic only.

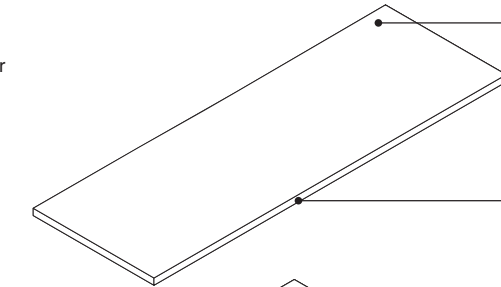


# Worksurfaces

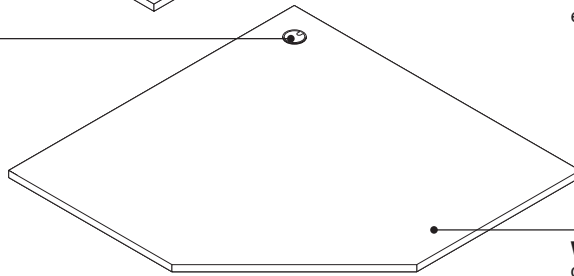
**Worksurface** has a wood core with laminate top and plastic edge band. Low-Pressure Laminates are available. Plastic edge band color is selectable.

**Systems worksurfaces —with 1/2" cord drop** feature built-in cable management flexibility, allowing cords to drop below the worksurface at any point along the back edge.

**Systems worksurfaces —full depth** feature a tighter fit to panels for a cleaner aesthetic.



**Full-depth worksurfaces** fit flush against panels.

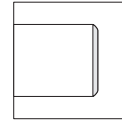


**Grommet** is standard on corner worksurfaces only. Field-installed grommet requires a 3" diameter hole in the worksurface.

**Front (user's) edge** is a plastic edge band with a 3 mm radius. Back and side edges are flat.

**Worksurface** has a wood core with a Low-Pressure Laminate surface and is 13/16" thick.

## Product Details

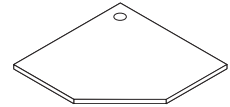


3 mm edge profile

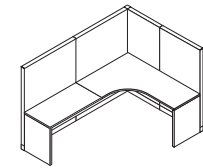
**PVC-free, 3 mm edge profiles** are proprietary polyolefin blend for all solid colors and seven woodgrain finishes. Matching 1 mm side and back edges are also PVC-free.

▶ Page 000

**Edge profile finishes** are specified separately from laminate color.

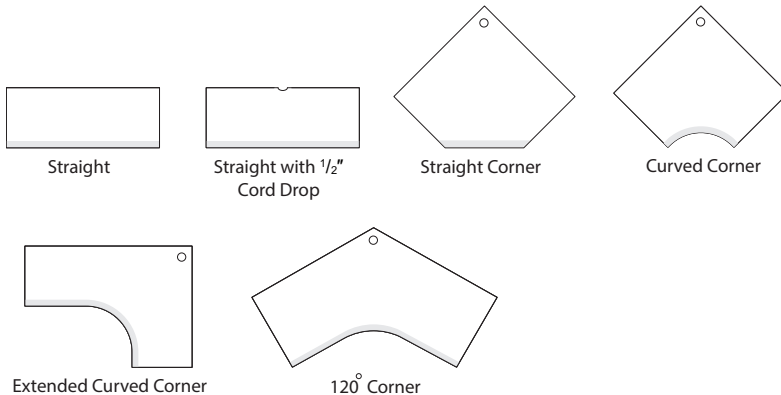


**Corner bracket** is included to connect the back corner of worksurface to panels.



**30"D straight cantilevered worksurfaces** require additional floor support along the front edge, such as a pedestal, end panel, post leg, side support bracket, or an adjacent return worksurface.

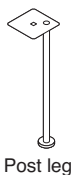
## Edge Profiles



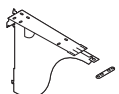
**Edge Profile** is applied to front (user's) edge only.



**Connections**



Post leg



Cantilever with tie plate



Universal Cantilever with tie plate



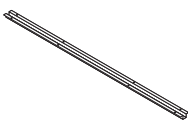
Side support brackets



Tie plates



In-line support plate



Reinforcing channel

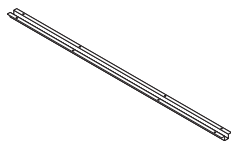


End panels—standard height

**Supports** are ordered separately and installed in the field. The following supports are available for use with worksurfaces:

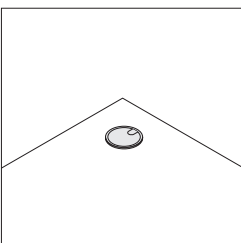
- Post leg
- Cantilever with tie plate
- Universal cantilever with tie plate
- Side support brackets
- Tie plates
- In-line support plate
- Reinforcing channel
- On-module end panel

**Cantilever with tie plate** works in left-hand, right-hand, or shared applications.



**Worksurface spans greater than 54"** require additional support of a cantilever, pedestal, intermediate support, or leg. Exception; worksurfaces can span up to 60" in heavy load applications and up to 72" in light load applications if a reinforcing channel is used. Reinforcing channel must be specified separately. ▶ Specifying, page 374

**Wiring & Cabling**



**Grommet** is standard on corner worksurfaces.

**Surface Materials**

**Low-Pressure Laminate Worksurfaces**

- Laminate

**Front (user's) edge(s)**

- Plastic

**Back and side edges**

- Plastic color default to match user's edge



Straight



Straight corner



Curved corner



Left-hand extended curved corner



Right-hand extended curved corner

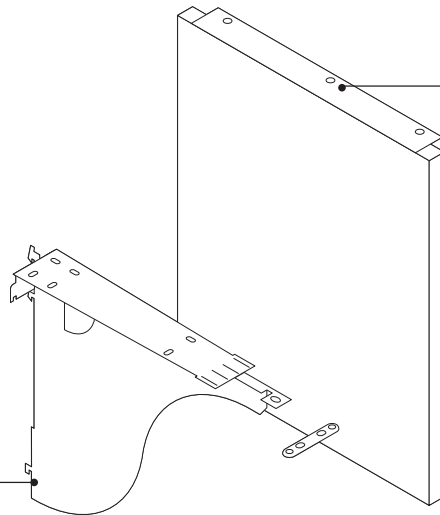


120° Corner

**Worksurfaces** are available in a wide variety of worksurface shapes. Directional laminate grain direction is shown.

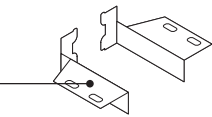
# Worksurface Legs and Supports

**On-module supports** can be used to panel support worksurfaces in various configurations.

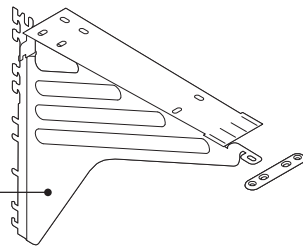


**End panel** can be used to support the end of a work surface at seated height.

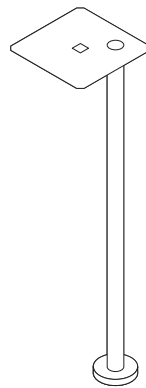
**Cantilever** can be used to panel-support a work surface at any height.



**Side support brackets** can be used to support the ends of straight and corner worksurfaces and to support the back corner of any corner work surface.



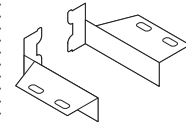
**Universal cantilever** features alignment tab used to set a depth for straight worksurfaces with 1/2" cord drop. This tab is bent down when installing full-depth worksurfaces.



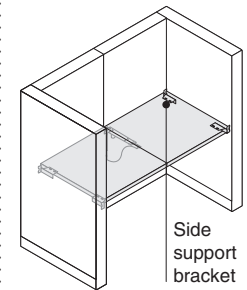
**Post Leg**

## Product Details

**On-module work surface supports** engage the slots in the vertical uprights of panels.

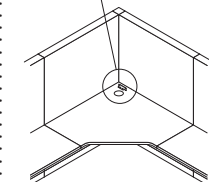
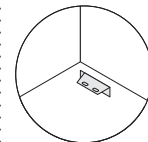


**Side support brackets** support worksurfaces at any height in 1" increments. Brackets ship as a left- and right-hand pair and are ordered separately.



**Side support bracket**

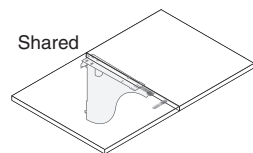
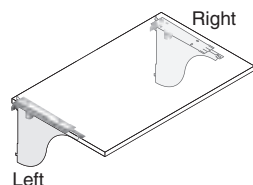
**Side support brackets** can be used to support the end of a work surface that is wrapped by a panel with the same width dimension that matches the work surface depth.



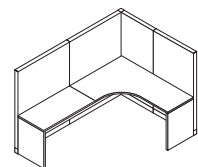
**Single side support bracket** can be used to support the rear corner of corner, extended corner, and 120° corner worksurfaces. It is standard with these corner worksurfaces.

## Actual Dimensions

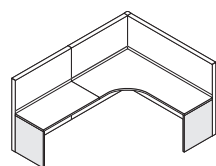
	<b>Universal cantilever</b>	<b>Cantilever</b>	<b>End panel</b>	<b>Post leg</b>
Height	12 1/4"	13"	28 1/2"	28 1/2"
Depth	15 1/2"	16"	23 3/4" or 29 3/4"	N.A.
Glide Range	N.A.	N.A.	1 1/4"	2"



**Cantilevers** support worksurfaces at any height in 1" increments. Cantilever is non-handed and can be used to support either end of a worksurface, or shared to support two worksurfaces at the same height simultaneously. One tie plate ships with each cantilever.



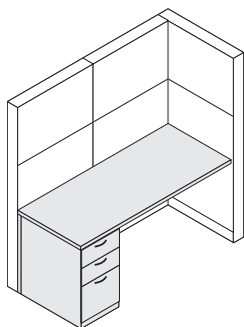
**30°D straight, cantilevered worksurfaces** require additional floor support along the front edge, such as a pedestal, end panel, post leg, side support bracket, or an adjacent return worksurface.



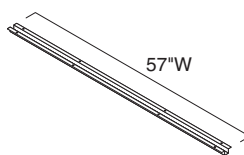
**End panels** can be used to support the end of a worksurface for additional panel stability. Refer to the applicable panel stability guidelines for specific requirements.  
▶ See page 216

**End panels** are available in seated height, and cannot be used in freestanding applications.

**All panel mounted supports** can be removed and repositioned later without any permanent damage to panels or skins.



**Pedestals and lateral files with a filler** can be used to support the end of a worksurface in place of an end panel.



**Worksurface spans greater than 54"** require additional support of a cantilever, pedestal, intermediate support, or leg. Exception; worksurfaces can span up to 60" in heavy load applications and up to 72" in light load applications if a reinforcing channel is used. Reinforcing channel must be specified separately.  
▶ Specifying, page 374

### Surface Materials

#### Side support bracket and reinforcing channel

- Black paint only

#### Cantilever, post leg, and end panel

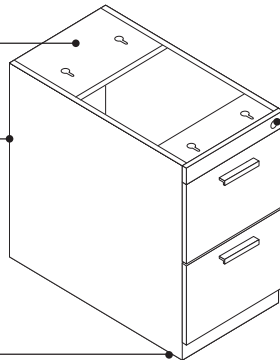
- Paint

# Pedestals

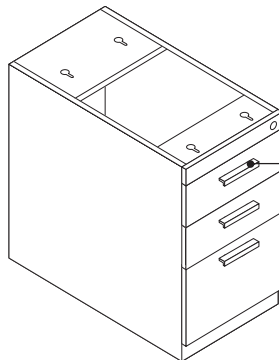
**Pedestals** provide fixed storage for personal items and filing of infrequently referenced materials.

**Top of pedestal** is open to attach beneath the worksurface.

**Finished back and sides** are standard.



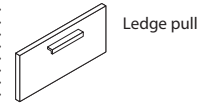
**Leveling glides on pedestals** adjust to install furniture on uneven floors. Leveling glide range is 1".



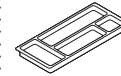
**Locks** ship with a lock face ring and removable plastic plug to accommodate a lock cylinder installed on site.

**Ledge pulls** are available on drawers.

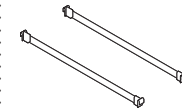
## Product Details



**Ledge pulls** are available on drawers.



**Pencil tray for use with fixed pedestals** are included and available as an option.



**To file legal-size or side-to-side letter-size filing in pedestal file drawers**, rails are included with pedestals and available as an option.

**Counterweight packages** are required to ensure product stability in freestanding applications and must be added. Counterweights are available as Steelcase Service Parts (**1444111001SR**).

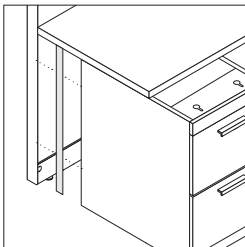
## Actual Dimensions

### Fixed Pedestals

Depth	21 <sup>3</sup> / <sub>16</sub> " , 27 <sup>13</sup> / <sub>16</sub> "
Width	15"
Height	27"

### Connections

**Fixed pedestals** are intended for use under a panel-mounted or freestanding worksurface. Attachment hardware is provided.



**Pedestal filler**, ordered separately, adds structure and fills the gap between the pedestal and panel. Pedestal filler works with panels only.  
 ▶ Page 259

**Additional supports** are required if worksurface overhang is 7" or larger.

### Wiring & Cabling

**Fixed pedestals** do not accommodate cable-routing. Plan accordingly when installing pedestals underneath worksurfaces with grommets or other cable-routing accessories.

### Surface Materials

#### Pedestals

- Case**
- 4799 Platinum Metallic
- Ledge pull** (default)
- 4799 Platinum Metallic

- Case**
- 7207 Black
- Ledge pull** (default)
- 7207 Black

- Case**
- 7243 Seagull
- Ledge pull** (default)
- 4799 Platinum Metallic

### Shipping

**Fixed pedestals** are normally shipped in heavy-duty, recyclable stretch wrap to reduce the amount of corrugated board needed.

# Bins

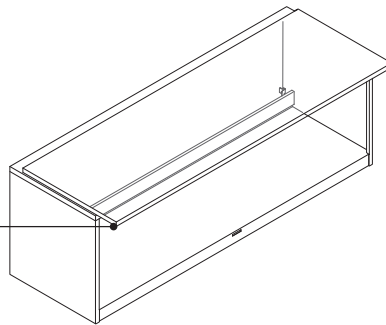
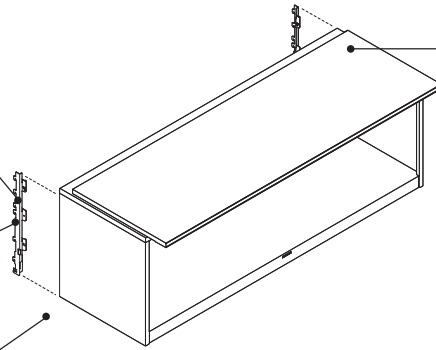
**Bins** can be attached to TEKTIS with integrated hooks. These storage bins provide overhead storage in the workspace.

**On-module attachment hooks** are integral to the end supports and are used to mount bins on panels of the same width as bins.

**Safety catch** locks overhead storage unit to frame to prevent accidental removal.

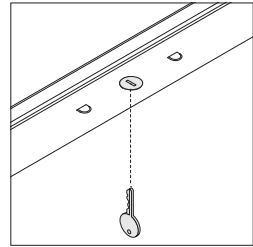
**Bin** is steel and ships assembled.

**Backstop** prevents notebooks and equipment from damaging the surface of the panels or walls.



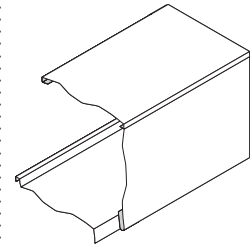
**Flat-front lift-up doors** open and close quietly. When up, the doors rest on top of the case to provide more storage space inside.

## Product Details



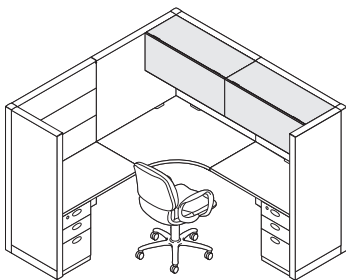
**Lock in bin** is concealed from view beneath the shelf. Field-installed locks are standard with random keying options. Master-keyed locks are also available.

► *Lock and Keying*, page 376



**Back of storage bin** is open to allow panel surface to show. Metal backstop prevents contents of bin from damaging panel surface.

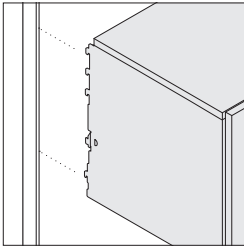
**Overhead storage bin height** accepts standard and A4 binders.



## Actual Dimensions

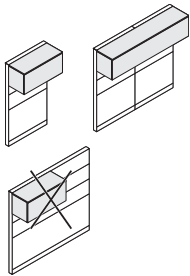
<b>Depth</b>	15 <sup>3</sup> / <sub>4</sub> "
<b>Width</b>	24", 30", 36", 42", 48", 60", or 72"
<b>Height</b>	16 <sup>1</sup> / <sub>4</sub> "

**Connections**

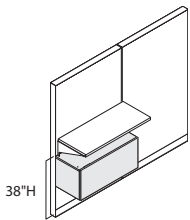


**Steel support hooks on end** supports insert into the slotted channel of a panel or wall channel and lock into place with a safety catch.

**On-module steel support hooks** can be used above and adjacent to TEKTIS panels.



**Width of overhead bin** must match the width of the panel or panels that it is attached to. Bin may span up to two frames.



**Bin** may be mounted at 38"H or lower if another panel-mounted component prevents it from being seated upon.

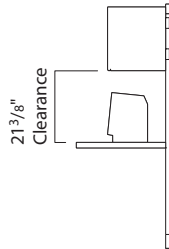
**Bins** cannot be attached to upmount brackets.

**Surface Materials**

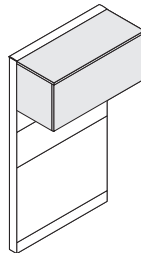
**Overhead bin**  
• Paint

**Lock**  
• 9201 Polished Chrome

**Application Topics**

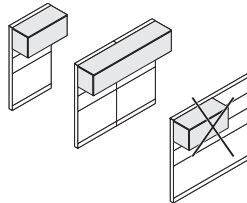


**Clearance between work surfaces and bottom of overhead bins** is 21<sup>3</sup>/<sub>8</sub>" when storage unit is installed in the highest position on a 66"H panel and glides are adjusted all the way into the panel.



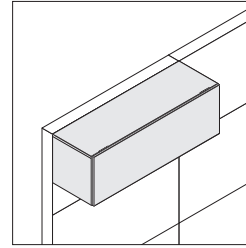
**On-module brackets and hooks** are used to mount overhead bins and common shelves to panels with vertical slot patterns. Panels can support on-module attachment brackets.

**Common shelves** can attach on-module to panels.



**Width of overhead storage unit** must match the width of the panel or panels that it is attached to. Storage bins or shelves may span up to two panels.

**Additional support for stability** may be required when shelves and overhead storage bins are attached to panels. Loads on the opposite sides of the panels increases stability.

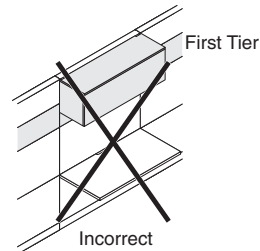
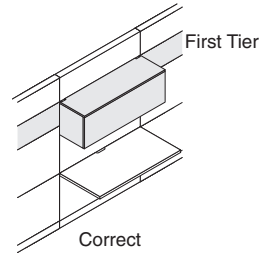


**On-module attachment brackets** install in panel seams.

**On-module brackets** can be used with a panel stacker on panels. Follow standard panel stacker guidelines for each panel.

**Stability Guidelines**

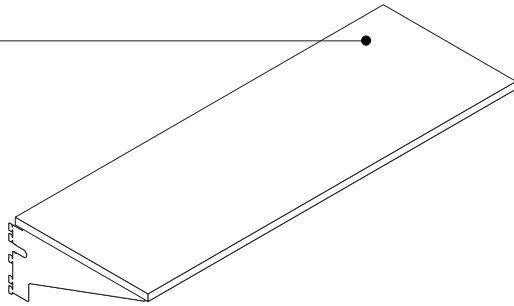
▶ Page



**Bins and shelves** can hang from the first stacked tier only.

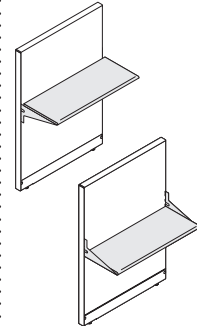
# Laminate Common Shelves

**Laminate common shelf** has a wood core and is covered with Low-Pressure Laminate. Plastic edge band is selectable.  
*Tip: For anticipated heavy loads on 42" and 48"W laminate common shelves, a field-installed reinforcing channel (AMQTSATRC) can be used.*  
 ▶ page 261

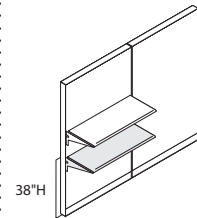


Laminate common shelf

## Product Details



**Laminate common shelf** ships with steel support brackets. Support brackets hook into the vertical panel slots or wall channel and lock into place with a safety catch. Support brackets can be used in either orientation.



**Shelf** may be mounted at 38"H or lower if another panel-mounted component prevents it from being seated upon.

## Surface Materials

### Shelf

- Laminate

### Edge

- Plastic

### Supports

- Paint

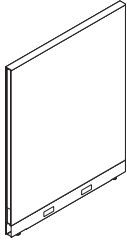
## Actual Dimensions

<b>Depth</b>	15"
<b>Width</b>	24", 30", 36", 42", or 48"
<b>Height</b>	7 <sup>3</sup> / <sub>4</sub> "



# Tektis

## Monolithic Panels



Tip: Factory-included powerway for field installation option replaces need to order separate powerways.

Tip: Remember to order end-of-run trim and vertical corner trim packages.

Tip: Factory-installed wire separator is only an option on panels without power. A wire separator is included with the powerway in panels specified with power.

### Standard Includes

- Tackable acoustical panel with two fabric surfaces: fabric price group 01
- Base covers with receptacle knockouts: paint price group 01
- Low top cap: paint price group 01
- Top cap aligner: black plastic
- Universal connector package
- Frame: Fire Retardant polyurethane foam.

### Options

Trim Finish	Paint Price Group 01	No cost
	Paint Price Group 02	+\$13
Fabric Direction	Horizontal	No cost
Power Installation	Factory Installation	No cost
	Field Installation	No cost
Powerway Option	No Powerway	No cost
	Shared Powerway	+\$172
	4 Circuit 3+D	+\$202
	Separate Neutral Powerway	+\$213
	4 Circuit 2+2	+\$253
	4 Circuit 3I+1	+\$253

### Specification Information

Style Number	Dimensions Height	Base Prices					
		Width					
		24"	30"	36"	42"	48"	60"

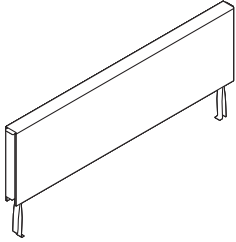
### Tackable Acoustical Panels

AMQTSAPF	42"	\$492	\$511	\$560	\$620	\$660	\$757
	48"	\$511	\$559	\$598	\$679	\$728	\$802
	54"	\$515	\$572	\$608	\$695	\$741	\$808
	66"	\$525	\$598	\$636	\$717	\$790	\$896



# Tektis

## Panel Stackers



*Tip: Remember to order end-of-run trim and vertical corner trim packages.*

*Tip: When adding a stacker to existing panels with a power or cable pole connected at L-, T-, or X- corner, the universal panel connector can not be used. Contact orders@amqsolutions.com to order service parts for special connections.*

### Standard Includes

- Tackable acoustical stacker: fabric price group 01
- Frame: Fire Retardant polyurethane foam.
- Universal connector package
- Two stacking fork connectors

### Options

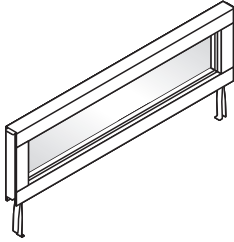
Fabric Direction    Horizontal    No cost

### Specification Information

Style Number	Dimensions Height	Prices Width						
		24"	30"	36"	42"	48"	60"	72"

### Tackable Acoustical Panel Stackers

AMQTSAPS	Height	24"	30"	36"	42"	48"	60"	72"
	12"	\$378	\$392	\$425	\$476	\$505	\$577	\$587
	18"	\$435	\$463	\$510	\$568	\$599	\$688	\$695
	24"	\$454	\$487	\$537	\$595	\$626	\$717	\$728



*Tip: Only one glass stacker per panel is allowed.*

*Tip: Remember to order change-of-height connectors.*

*Tip: Remember to order end-of-run trim and vertical corner trim packages.*

**Standard Includes**

- Glass stacker: 6500 Clear glass
- Border: paint price group 01
- Frame: Fire Retardant polyurethane foam.
- Universal connector package
- Two stacking fork connectors

**Options**

Trim Finish	Paint Price Group 01	No cost
	Paint Price Group 02	+\$13

**Specification Information**

Style Number	Dimensions Height	Base Prices						
		Width						
		24"	30"	36"	42"	48"	60"	72"

**Glass Panel Stackers**

AMQTSAPSG	Height	24"	30"	36"	42"	48"	60"	72"
	12"	\$622	\$650	\$708	\$794	\$842	\$961	\$971
	18"	\$742	\$774	\$848	\$947	\$1000	\$1149	\$1162
	24"	\$780	\$810	\$888	\$990	\$1047	\$1204	\$1217



# Tektis

## Panel Trim



### Standard Includes

- End-of-run trim: paint price group 01
- One low trim end cap: plastic to match paint

### Options

Trim Finish	Paint Price Group 01	No cost
	Paint Price Group 02	+\$13

### Specification Information

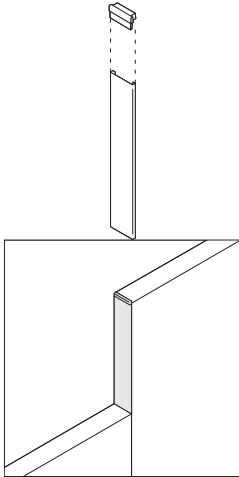
Style Number	Corresponding Panel Height	Base Prices
--------------	----------------------------	-------------

### Vertical End-of-Run Trim

<b>AMQTSAPTE</b>	42"	\$69
	48"	\$69
	54"	\$69
	60"	\$69
	66"	\$69
	72"	\$69
	78"	\$69

# Tektis

## Panel Trim



Tip: Remember to order change-of-height connectors.

### Standard Includes

- Change-of-height trim: paint price group 01
- One plastic low trim end cap to match paint

### Options

Trim Finish	Paint Price Group 01	No cost
	Paint Price Group 02	+\$13

### Specification Information

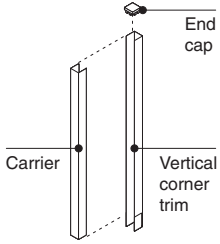
Style Number	Height	Base Prices
--------------	--------	-------------

#### Vertical In-Line Change-of-Height Trim

Style Number	Height	Base Prices
<b>AMQTSAPTXS</b>	6"	\$69
	12"	\$69
	18"	\$69
	24"	\$69
	36"	\$69

# Tektis

## Panel Trim



### Standard Includes

- Vertical corner trim: paint price group 01
- One low trim end cap: plastic to match paint
- Carrier: Fire Retardant polyurethane foam.

### Options

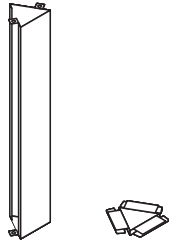
Trim Finish	Paint Price Group 01	No cost
	Paint Price Group 02	+\$13

### Specification Information

Style Number	Trim Height	Carrier Height	Base Prices
--------------	-------------	----------------	-------------

#### Vertical Corner Trim

<b>AMQTSAPTC</b>	42"	42"	\$99
	48"	48"	\$99
	54"	54"	\$99
	66"	66"	\$99



**Standard Includes**

- Corner trim: paint price group 01
- Low trim end caps for two- or three-way connections (one each): plastic to match paint

**Options**

Trim Finish	Paint Price Group 01	No cost
	Paint Price Group 02	+\$13

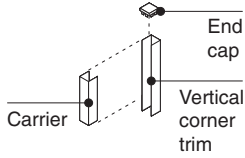
**Specification Information**

Style Number	Height	Base Prices
<b>120° Vertical Corner Trims</b>		
<b>AMQTSAPTCY</b>	42"	\$130
	48"	\$130
	54"	\$130
	66"	\$130



# Tektis

## Panel Trim



*Tip: Vertical corner change-of-height trims can be used with panel stackers.*

### Standard Includes

- Vertical corner trim: paint price group 01
- One low trim end cap: plastic to match paint
- Carrier: Fire Retardant polyurethane foam.

### Options

Trim Finish	Paint Price Group 01	No cost
	Paint Price Group 02	+\$13

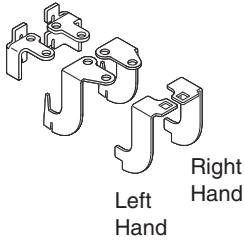
### Specification Information

Style Number	Trim Height	Base Prices
--------------	-------------	-------------

### Vertical Corner Change-of-Height Trims

<b>AMQTSAPTXC</b>	6"	\$69
	12"	\$69
	18"	\$69
	24"	\$69





Tip: Change-of-height connections must be used at top of base panel and each stacker whenever possible to increase stability.

**Standard Includes**

- Two corner and two in-line connectors: paint

**Specification Information**

Style Number      Price

**Change-of-Height In-Line and Corner Panel Connector Package**

**AMQTSAPBCOH**    \$41



**Standard Includes**

- Wall start connector package: black paint

**Specification Information**

Style Number      Price

**Wall Start Connector Package**

**AMQTSAPBWS66**    \$41



Tip: Two-way, 120° connection requires one package. Three-way, 120° connection requires three packages.

Tip: 120° connector does not allow change-of-height connections.

**Standard Includes**

- 120° connectors: Fire Retardant polyurethane foam.
- Package includes two 120° connectors and eight screws

**Specification Information**

Style Number      Price

**120° Connectors**

**AMQTSAPB120**    \$41



# Tektis

## Worksurface Legs and Supports


### Standard Includes

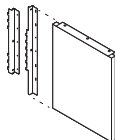
- Post leg, end panel, and cantilever: paint price group 01
- Worksurface supports and channels: black paint
- 2 3/4" adjustable glides on legs
- Attachment hardware

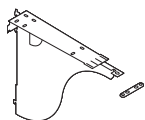
### Options

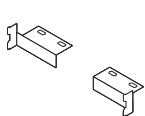
End Panel Finish	Paint Price Group 01	No cost
	Paint Price Group 02	+\$37
Leg Finish	Paint Price Group 01	No cost
	Paint Price Group 02	+\$16

### Specification Information

Style Number	Dimensions	Base Prices
<b>Post Leg</b>		
 <b>AMQTSATP27</b>	27"H	\$160

<b>On-Module End Panel</b>			
	<b>AMQTSATEP</b>	24"D 27"H	\$486
		30"D 27"H	\$555

<b>Cantilever with Tie Plate</b>			
	<b>AMQTSATCANT</b>	16"D 13"H	\$117

<b>Side Support Brackets to Connect Worksurface to Panel</b>			
	<b>AMQTSATSIDE</b>		\$48

# Tektis

## Fixed Pedestals

*Tip: Fixed pedestals are intended for use under a panel mounted or freestanding worksurfaces.*

*Tip: File drawer rails are required to file legal-sized files or side-to-side letter-sized files in pedestal.*

*Tip: Counterweight packages are required to ensure product stability in freestanding applications and must be added. Counterweights are available in Steelcase Service Parts (1444111001SR).*

### Standard Includes

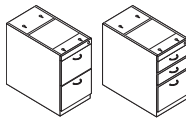
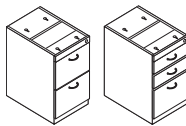
- Pedestal: paint price group 01
- Ledge pull: metal
- Lock face ring with plastic plug to accommodate lock cylinder: 0835 Black
- Attachment hardware
- Lock cylinder included in package, field-installed
- Steel ball-bearing suspensions on box and file drawers
- Package of two rails: black
- Pencil tray: black only
- Adjustable glides: black

### Options

Case Finish	Paint Price Group 01 Paint Price Group 02	No cost +\$10
Pull Finish	Paint Price Group 01 Paint Price Group 02	No cost +\$6
Pencil Tray	With Pencil Tray	+\$21
Drawer Rail Option	With Drawer Rail	+\$21
Keys	Standard Key Plug Master Key Plug	No cost +\$37

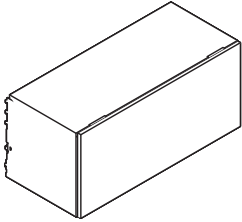
### Specification Information

Style Number	Dimensions			File Drawers	Counterweight Package	Base Price
	Depth	Width	Height			
<b>Fixed Pedestals</b>						
<b>AMQTS2PFFU</b>	22"	15"	27"	File, File	Not required	\$535
<b>AMQTS2PBBFU</b>	22"	15"	27"	Box, Box, File	Not required	\$564
<b>AMQTS2PFFU</b>	28"	15"	27"	File, File	Not required	\$581
<b>AMQTS2PBBFU</b>	28"	15"	27"	Box, Box, File	Not required	\$613



# Tektis

## Bins



Tip: Tektis bins cannot be upmounted.

### Standard Includes

- Overhead bin with lift-up door: paint price group 01
- Shelf backstop
- On-module attachment hooks with safety catch
- Lock face ring with plastic plug to accommodate lock cylinder: 0835 Black
- Lock cylinder included in package, field-installed

### Options

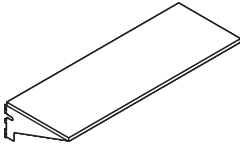
Case Finish	Paint Price Group 01	No cost
	Paint Price Group 02	+\$10

### Specification Information

Style Number	Dimensions			Number of Doors	Base Prices
	Depth	Width	Height		
<b>Bins with Flat Fronts</b>					
<b>AMQTSASUBL</b>	15 3/4"	24"	16 1/4"	1	\$572
	15 3/4"	30"	16 1/4"	1	\$598
	15 3/4"	36"	16 1/4"	1	\$622
	15 3/4"	42"	16 1/4"	1	\$648
	15 3/4"	48"	16 1/4"	1	\$681
	15 3/4"	60"	16 1/4"	2	\$1053
	15 3/4"	72"	16 1/4"	2	\$1159

# Tektis

## Laminate Common Shelves



*Tip: For anticipated heavy loads on 42"W and 48"W laminate common shelves, a 39"W field-installed reinforcing channel (AMQTSATRC) can be used.*

### Standard Includes

- 1 3/16"-thick shelf: Low-Pressure Laminate price group 01
- 3 mm radius profile edge: plastic
- Support brackets: paint price group 01

### Options

Bracket Finish	Paint Price Group 01	No cost
	Paint Price Group 02	+\$10

### Specification Information

Style Number	Dimensions			Base Prices
	Depth	Width	Height	

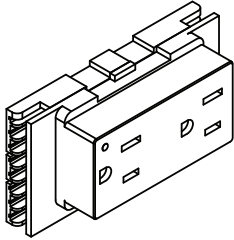
### Laminate Common Shelves

<b>AMQTSASLCL</b>	15"	24"	7 3/4"	\$155
	15"	30"	7 3/4"	\$160
	15"	36"	7 3/4"	\$169
	15"	42"	7 3/4"	\$182
	15"	48"	7 3/4"	\$198



# Tektis

## Panel Wiring and Cabling



*Tip: You must specify receptacle to match wiring schematic used in other components.*

### Standard Includes

- Package of six powerway receptacles: 6000 Black

### Options

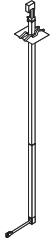
Controlled Stamp	No Stamp	No cost
	With Controlled Stamp	+\$25

### Specification Information

Style Number	Description	Size	Prices
<b>15-Amp Receptacles</b>			
<b>3-Circuit with Shared Neutral</b>			
<b>AMQ TSAESB</b>	Line 1	Standard Size	\$286
	Line 2	Standard Size	\$286
	Line 3	Standard Size	\$286
<b>3-Circuit with Separate Neutral</b>			
<b>AMQ TSAESB</b>	Line A	Standard Size	\$427
	Line B	Standard Size	\$427
	Line C	Larger Size	\$556
<b>4-Circuit 3+D</b>			
<b>AMQ TSAEDASB</b>	Line 1	Standard Size	\$286
	Line 2	Standard Size	\$286
	Line 3	Standard Size	\$286
	Line 4	Larger Size	\$371
<b>4-Circuit with 2+2 Wiring</b>			
<b>AMQ TSAEDASB</b>	Line 1	Standard Size	\$317
	Line 2	Standard Size	\$317
	Line 3	Standard Size	\$427
	Line 4	Larger Size	\$427
<b>4-Circuit with 3I+1 Wiring</b>			
<b>AMQ TSAEDASB</b>	Line 1	Standard Size	\$427
	Line 2	Standard Size	\$427
	Line 3	Standard Size	\$427
	Line 4	Larger Size	\$556

# Tektis

## Panel Wiring and Cabling



### Standard Includes

- Power pole: paint price group 01
- Ceiling trim plate: 4790 Sodium paint only
- Harness with 3-circuit, and shared neutral
- Junction box
- Mounting brackets
- Pair of corner change-of-height connectors

### Options

Power Finish	Paint Price Group 01	No cost
	Paint Price Group 02	+\$13
Harness Option	Shared Harness	No cost
	Separate Neutral Harness	+\$16
Wiring Option	4 Circuit 3+D	No cost
	4 Circuit 2+2	+\$16
	4 Circuit 3I+1	+\$16

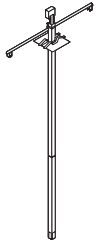
### Specification Information

Panel Height	Style Number	Base Price	Style Number	Base Price
3-Circuit		4-Circuit		
42"	<b>AMQSAEP3B</b>	\$603	<b>AMQSAEP4B</b>	\$684
48"	<b>AMQSAEP3B</b>	\$603	<b>AMQSAEP4B</b>	\$684
54"	<b>AMQSAEP3B</b>	\$603	<b>AMQSAEP4B</b>	\$684
66"	<b>AMQSAEP3B</b>	\$603	<b>AMQSAEP4B</b>	\$684



# Tektis

## Panel Wiring and Cabling



### Standard Includes

- Cable pole: paint price group 01
- Ceiling trim plate: 4790 Sodium paint only
- Junction box
- Mounting brackets
- Pair of corner change-of-height connectors

### Options

Power Finish	Paint Price Group 01	No cost
	Paint Price Group 02	+\$13

### Specification Information

Style Number	Panel Height	Base Price
--------------	--------------	------------

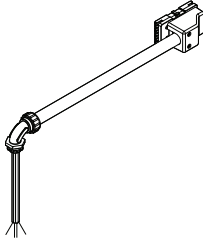
#### 2" x 2" Cable Poles

<b>AMQTSAEPC</b>	42"	\$549
	48"	\$549
	54"	\$549
	66"	\$549



# Tektis

## Panel Wiring and Cabling



### Standard Includes

- Power infeed cover: black plastic only
- 6' long, 1/2" diameter conduit: black plastic only
- 3-circuit with shared neutral

### Options

Wiring Option		
4 Circuit 3+D		No cost
Shared Powerway Wiring		No cost
Separate Neutral Wiring		+\$50
4 Circuit 2+2		+\$61
4 Circuit 3I+1		+\$61

### Specification Information

Style Number	Base Prices
--------------	-------------

#### 3-Circuit Shared Neutral Wiring Schematic

<b>AMQTSAE98669B</b>	\$347
----------------------	-------

For Use In San Francisco

<b>AMQTSAE98669SFB</b>	\$347
------------------------	-------

#### 4-Circuit 3+D Wiring Schematic

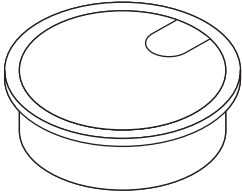
<b>AMQTSAE986694B</b>	\$380
-----------------------	-------

For Use In San Francisco

<b>AMQTSAE986694SFB</b>	\$380
-------------------------	-------

# Tektis

## Panel Wiring and Cabling



*Tip: Grommet requires a 3" diameter hole in the worksurface.*

### Standard Includes

- Package of 10 grommets: black plastic

### Specification Information

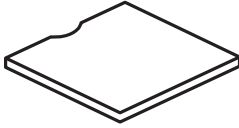
Style Number	Price
--------------	-------

### Grommet Package

<b>AMQ TSAEGROM</b>	\$70
---------------------	------

# Tektis

## Straight Worksurfaces



### Standard Includes

- 1 3/16"-thick worksurface: Low-Pressure Laminate price group 01
- 3 mm radius profile edge on user's side: plastic
- Side and back edges: plastic default to match user's side
- 1/2" cord drop along the back edge for cable management

### Options

Depth	23 1/2"	Prices below
	29 1/2"	Prices below
Width	24"	Prices below
	30"	Prices below
	36"	Prices below
	42"	Prices below
	48"	Prices below
	54"	Prices below
	60"	Prices below
	72"	Prices below
Scallop	No Scallop	No cost
	With Scallop	No cost
Edge Finish	Plastic - PG1	No cost

### Specification Information

Style Number	Dimensions Depth	Base Prices									
		Width									
		24"	30"	36"	42"	48"	54"	60"	66"	72"	

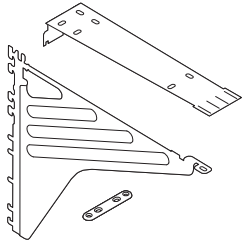
### Straight Worksurfaces—with 1/2" Cord Drop

AMQCDWS	Dimensions	\$178	\$187	\$203	\$231	\$265	\$302	\$331	\$362	\$371
	23 1/2"									
	29 1/2"	\$197	\$218	\$240	\$269	\$296	\$339	\$380	\$411	\$446



# Tektis

## Worksurface Legs and Supports



### Standard Includes

- Cantilever: paint
- Tie plate
- Attachment hardware

### Options

Support Finish	Paint Price Group 01	No cost
	Paint Price Group 02	No cost

### Specification Information

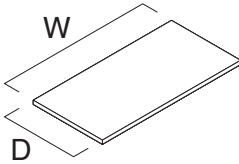
Style Number    Price

#### Universal Cantilever with Tie Plate

**AMQUCANT**    \$134

# Tektis

## Straight Worksurfaces



### Standard Includes

- 1 3/16"-thick worksurface: Low-Pressure Laminate price group 01
- 3 mm radius profile edge on user's side: plastic
- Side and back edges: plastic default to match user's side

### Specification Information

Style Number	Dimensions Depth	Prices Width									
		24"	30"	36"	42"	48"	54"	60"	66"	72"	

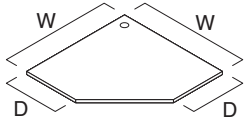
### Straight Worksurfaces—with Full Depth

AMQTSAWLR	24"	30"	36"	42"	48"	54"	60"	66"	72"
	\$178	\$187	\$203	\$231	\$265	\$302	\$331	\$362	\$371
	\$197	\$218	\$240	\$269	\$296	\$339	\$380	\$411	\$446



# Tektis

## Straight Corner Worksurfaces



### Standard Includes

- 1 3/16"-thick worksurface: Low-Pressure Laminate price group 01
- 3 mm radius profile edge on user's side: plastic
- Side and back edges: plastic default to match user's side
- Grommet: black plastic only
- Corner bracket: black paint only

### Specification Information

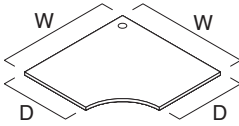
Style Number	Dimensions Depth	Prices Width		
		36"	42"	48"

### Straight Corner Worksurfaces

AMQTSAWLCF	24"	\$377	\$434	\$469
	30"	N.A.	N.A.	\$505

# Tektis

## Curved Corner Worksurfaces



### Standard Includes

- 1 3/16"-thick worksurface: Low-Pressure Laminate price group 01
- 3 mm radius profile edge on user's side: plastic
- Side and back edges: plastic default to match user's side
- Grommet: black plastic only
- Corner bracket: black paint only

### Specification Information

Style Number	Dimensions		Prices		
	Depth	Width			
			36"	42"	48"

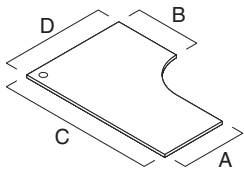
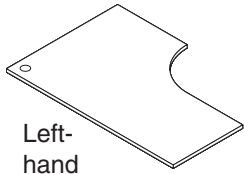
### Curved Corner Worksurfaces

AMQTSAWLCC	24"	\$414	\$458	\$505
	30"	N.A.	N.A.	\$584



# Tektis

## Left-Hand Extended Curved Corner Worksurfaces



*Tip: Long worksurface spans require additional support.*

### Standard Includes

- 1 3/16"-thick worksurface: Low-Pressure Laminate price group 01
- 3 mm radius profile edge on user's side: plastic
- Side and back edges: plastic default to match user's side
- Grommet: black plastic only
- Corner bracket: black paint only

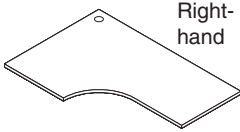
### Specification Information

Style Number	Dimensions				Prices
	A	B	C	D	

### Left-Hand Extended Curved Corner Worksurfaces

<b>AMQTSAWLEL</b>	24"	24"	60"	48"	\$683
	24"	24"	72"	48"	\$814
	30"	30"	60"	48"	\$723
	30"	30"	72"	48"	\$861



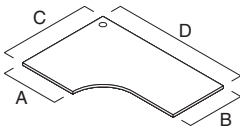


Right-hand

**Standard Includes**

- 1 3/16"-thick worksurface: Low-Pressure Laminate price group 01
- 3 mm radius profile edge on user's side: plastic
- Side and back edges: plastic default to match user's side
- Grommet: black plastic only
- Corner bracket: black paint only

**Specification Information**



Style Number	Dimensions				Prices
	A	B	C	D	

**Right-Hand Extended Curved Corner Worksurfaces**

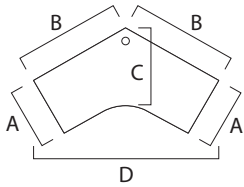
<b>AMQTSAWLER</b>	24"	24"	48"	60"	\$683
	24"	24"	48"	72"	\$814
	30"	30"	48"	60"	\$723
	30"	30"	48"	72"	\$861

*Tip: Long worksurface spans require additional support.*



# Tektis

## 120° Corner Worksurfaces



### Standard Includes

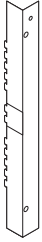
- 1 3/16"-thick worksurface: Low-Pressure Laminate price group 01
- 3 mm radius profile edge on user's side: plastic
- Side and back edges: plastic default to match user's side
- Grommet: black plastic only
- Corner bracket: black paint only

### Specification Information

Style Number	Dimensions				Prices
	A	B	C	D	
<b>120° Corner Worksurfaces</b>					
<b>AMQTSAWLY</b>	24"	36"	30 1/2"	63 11/32"	\$703
	24"	42"	30 1/2"	72 3/4"	\$753
	24"	48"	30 1/2"	85 5/32"	\$831

# Tektis

## Fixed Pedestal Accessories



Tip: When using a pedestal to anchor the end of a panel run, you must use a pedestal filler.

### Standard Includes

- Filler: paint
- Attachment hardware

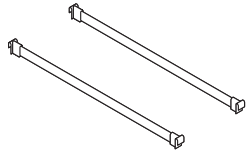
### Specification Information

Style Number	Dimensions			Price
	Depth	Width	Height	

### Pedestal Filler

For Use with Under-Worksurface Pedestal to Attach to Tektis Panel System

<b>AMQTS2FILLER</b>	2 3/16"	1"	27"	\$69
---------------------	---------	----	-----	------



Tip: Two rails per drawer accommodate side-to-side filing of letter-, A4-, and legal-size hanging folders.

### Standard Includes

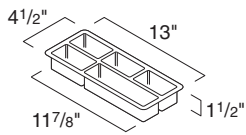
- Package of two rails: black only

### Specification Information

Style Number	Width	Price
--------------	-------	-------

### Rails

<b>AMQRXADRL15</b>	12"	\$31
--------------------	-----	------



Tip: Pencil trays for use with fixed pedestals are available as optional accessories.

### Standard Includes

- Pencil tray: black only

### Specification Information

Style Number	Price
--------------	-------

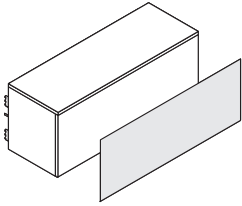
### Pencil Tray

For Use in Fixed Pedestals

<b>AMQRPXDP</b>	\$42
-----------------	------

# Tektis

## Flexible Markerboard Surface



### Standard Includes

- Flexible, magnetic markerboard surface to attach to door of overhead storage bin: white plastic

### Specification Information

Style Number	Dimensions		Prices
	Width	Height	

#### Flexible Markerboard Surface

<b>AMQRMBB</b>	30"	16 1/4"	\$146
	36"	16 1/4"	\$155
	42"	16 1/4"	\$160
	48"	16 1/4"	\$169

# Surface Materials

## Paint

*Tip: All products may not be available in all colors listed below.*

### Price Group 1

Applies to:

- Pulls

### Textured Paint

7207 Black

Applies to:

- Cable pole
- Laminate common shelf brackets
- New York base-in power
- Panel trim
- Power pole
- Vertical trim

### Textured Paint

7207 Black  
7225 Sand  
7238 Fieldstone  
7243 Seagull

Applies to:

- Cantilever
- End panel
- Fixed pedestal
- Pedestal filler
- Post legs

### Textured Paint

7207 Black  
7243 Seagull

Applies to:

- Cable pole
- Cantilever
- End panel
- Fixed pedestal
- Laminate common shelf brackets
- New York base-in power
- Panel trim
- Pedestal pillar
- Post legs
- Power pole
- Pulls
- Vertical trim

### Price Group 2

#### Smooth Metallic Paint

4799 Platinum Metallic

## Laminate

Applies to:

- Laminate common shelf
- Worksurfaces

### Low-Pressure Laminate

24L0 Graphite Walnut  
25L5 Virginia Walnut LPL  
25L8 Clear Walnut LPL  
26L1 Natural Cherry V2 LPL  
2L09 Clear Maple LPL  
2L30 Arctic White LPL  
2L83 Seagull LPL  
2L84 Milk LPL  
2LAK Clear Oak  
2LAT Acacia LPL  
2LCN Clay Noce LPL  
2LCW Clay Wenge LPL

Applies to:

- Laminate common shelf
  - Worksurfaces
- 6009 Arctic White  
6034 Natural Cherry  
6052 Milk  
6053 Seagull  
6213 Acacia  
6219 Clear Oak  
6231 Graphite Walnut  
6237 Clear Maple  
6242 Virginia Walnut  
6245 Clear Walnut  
6706 Clay Wenge  
6709 Clay Noce

## Plastic

6009 Arctic White  
6034 Natural Cherry  
6052 Milk  
6053 Seagull  
6213 Acacia  
6219 Clear Oak  
6231 Graphite  
6237 Clear Maple  
6242 Virginia Walnut  
6245 Clear Walnut  
6706 Clay Wenge  
6709 Clay Noce

*Tip: Light color plastic edges are susceptible to degradation due to normal wear and tear. Staining (e.g., ball point pen or clothing dyes such as blue jeans) and dirt effects are more pronounced in light colors and are not considered defects.*

## Metal

Applies to:

- Bins
- 9201 Polished Chrome

## Surface Fabric

Applies to:

- Monolithic panels
- Stacker panels

### Alloy





P525 Polar  
P526 Skim  
P527 Bubbly  
P528 Tern  
P529 Shore  
P530 Asti  
P531 Silver  
P532 Oxide  
P533 Element  
P534 Construct  
P535 Currency  
P536 Iron

### Boccie

P200 New Rice  
P201 New Almond  
P203 New Camel  
P204 New Opal  
P205 New Mist  
P206 New Plum  
P208 New Spearmint  
P209 New Sky

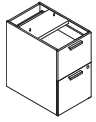


# EMBANK

			
<b>Statement of Line</b>	<b>280</b>	<b>Specifying</b>	
			
<b>Product Details</b>			
Fixed and Mobile Pedestals	<b>290</b>	Fixed Pedestals	<b>329</b>
One-High, 1.5-High, and Two-High Lateral Files and Lower Storage	<b>292</b>	Mobile Pedestals	<b>330</b>
Three-High and Four-High Lateral Files	<b>294</b>	One-High, 1.5-High, and Two-High Lateral Files	<b>332</b>
Credenzas	<b>296</b>	Three-High and Four-High Lateral Files	<b>334</b>
Common Top	<b>299</b>	One-High, 1.5-High, and Two-High Lower Storage	<b>335</b>
Desks, Desk Shells, Returns, Return Shells, and Bridge	<b>300</b>	Cushions	<b>337</b>
D-Shape and P-Shape Worksurfaces	<b>303</b>	Credenzas	<b>338</b>
Towers and Wardrobes	<b>304</b>	Common Top	<b>342</b>
Bookcases	<b>306</b>	Desks and Desk Shells	<b>343</b>
Overheads and Organizer	<b>308</b>	Returns and Return Shells	<b>345</b>
Tackboard	<b>310</b>	Bridge	<b>347</b>
Tables	<b>312</b>	D-Shape and P-Shape Worksurfaces	<b>348</b>
<b>Application Topics</b>		Towers	<b>350</b>
Table Tops, Legs, and Base Combinations	<b>318</b>	Wardrobes	<b>356</b>
Rectangular Conference Table Power Unit	<b>320</b>	Bookcases	<b>357</b>
Directional Laminate and Edge Profile Detail	<b>321</b>	Overheads and Organizer	<b>359</b>
Storage Capacities and Dimensions	<b>322</b>	Tackboard	<b>364</b>
Finish Availability Matrix	<b>328</b>	Tables	<b>365</b>
		Leg and Table Base	<b>371</b>
		Modesty Panel	<b>372</b>
		Accessories	<b>373</b>
			
		<b>Resources</b>	<b>375</b>

# Statement of Line

## EMBANK



Understanding  
 ▶ Page 290  
 Specifying  
 ▶ Page 329



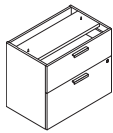
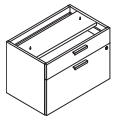
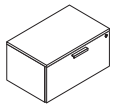
Understanding  
 ▶ Page 290  
 Specifying  
 ▶ Page 330

### EMBANK Fixed Pedestal

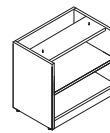
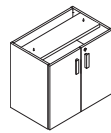
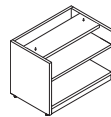
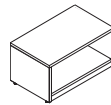
	15 <sup>3</sup> / <sub>4</sub> "W
27 <sup>5</sup> / <sub>16</sub> "H	●

### EMBANK Mobile Pedestals

	15 <sup>3</sup> / <sub>4</sub> "W
23 <sup>2</sup> / <sub>3</sub> "H	●
27"H	●



Understanding  
 ▶ Page 292  
 Specifying  
 ▶ Page 332



Understanding  
 ▶ Page 292  
 Specifying  
 ▶ Page 335

\* The case on One-High, 1.5-High, and Two-High open units is 18<sup>7</sup>/<sub>8</sub>"D and 24"D for lateral files

\* The case on Two-High units can be 22<sup>3</sup>/<sub>4</sub>"D for lateral files.

\* The top matches the depth of units with drawers and doors.

\*The case on One-High, 1.5-High, and Two-High open units is 18<sup>7</sup>/<sub>8</sub>"D and 24"D for lower storage.

\*The case on Two-High units can be 22<sup>3</sup>/<sub>4</sub>"D for lower storage.

\*The top matches the depth of units with drawers and doors.

### EMBANK Lateral Files

		30"W	36"W
<b>One-High</b>	15 <sup>3</sup> / <sub>8</sub> "H	●	●
<b>1.5-High</b>	21 <sup>3</sup> / <sub>8</sub> "H	●	●
<b>Two-High</b>	27 <sup>5</sup> / <sub>16</sub> "H	●	●

Tip: Height is without top. Tops can be optioned off for ganged applications.

Tip: Units specified with recessed back option will always come without top.

### EMBANK Lower Storage

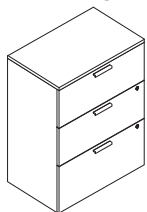
		30"W	36"W
<b>One-High</b>	15 <sup>3</sup> / <sub>8</sub> "H	●	●
<b>1.5-High</b>	21 <sup>3</sup> / <sub>8</sub> "H	●	●
<b>Two-High</b>	27 <sup>5</sup> / <sub>16</sub> "H	●	●

Tip: Height is without top. Tops can be optioned off for ganged applications.

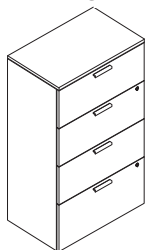
Tip: Units specified with recessed back option will always come without top.



**Three-High**



**Four-High**



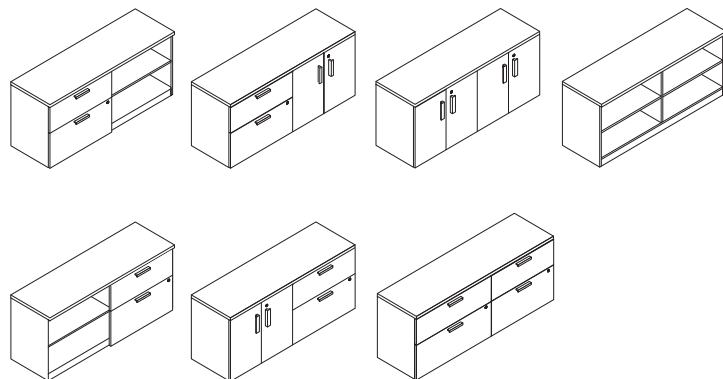
Understanding  
 ▶ Page 294  
 Specifying  
 ▶ Page 334

**EMBANK Three-High and Four-High Lateral Files**

		30"W	36"W
<b>Three-High</b>	40 <sup>1</sup> / <sub>3</sub> "H	●	●
<b>Four-High</b>	52 <sup>1</sup> / <sub>3</sub> "H	●	●

*Tip: Three-High and Four-High laterals are available with top only.*

**Two-High**

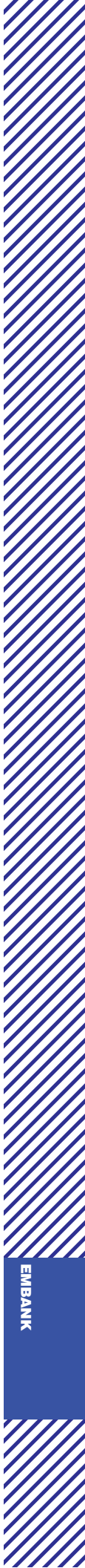


Understanding  
 ▶ Page 296  
 Specifying  
 ▶ Page 338

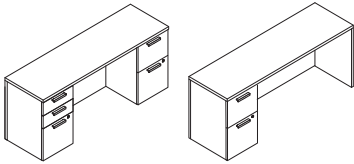
**EMBANK Full Storage Credenzas**

	60"W	66"W	72"W
27 <sup>5</sup> / <sub>16</sub> "H	●	●	●

*Tip: Height is shown without top. Top can be optioned on.*



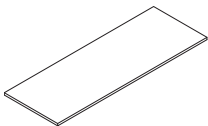
Statement of Line, EMBANK, continued



Understanding  
 ▶ Page 296  
 Specifying  
 ▶ Page 340

**EMBANK Credenzas with Kneespace**

	66"W	72"W
24"D	●	●

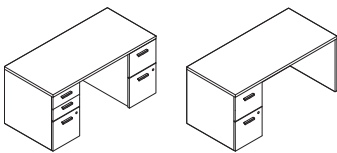


Understanding  
 ▶ Page 299  
 Specifying  
 ▶ Page 342

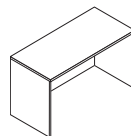
**EMBANK Common Tops**

	45 <sup>11</sup> / <sub>16</sub> "W	51 <sup>11</sup> / <sub>16</sub> "W	59 <sup>3</sup> / <sub>4</sub> "W	65 <sup>3</sup> / <sub>4</sub> "W	71 <sup>3</sup> / <sub>4</sub> "W	89 <sup>9</sup> / <sub>16</sub> "W	89 <sup>13</sup> / <sub>16</sub> "W	95 <sup>13</sup> / <sub>16</sub> "W
18 <sup>7</sup> / <sub>8</sub> "D	●	●	●	●	●	●	●	●
24"D	●	●	●	●	●	●	●	●
30"D	●	●	●	●	●	●	●	●

Tip: Common Top thickness is equal to 1<sup>1</sup>/<sub>8</sub>".



Understanding  
 ▶ Page 300  
 Specifying  
 ▶ Page 343



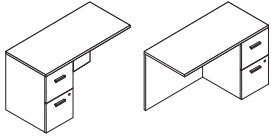
Understanding  
 ▶ Page 300  
 Specifying  
 ▶ Page 343

**EMBANK Desks with Pedestals**

	60"W	66"W	72"W
30"D	●	●	●
36"D			●

**EMBANK Desk Shells**

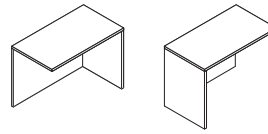
	60"W	66"W	72"W
24"D	●	●	●
30"D	●	●	●
36"D			●



Understanding  
 ▶ Page 300  
 Specifying  
 ▶ Page 343

### EMBANK Returns with Pedestal

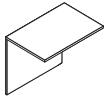
	42"W	48"W
24"D	●	●



Understanding  
 ▶ Page 300  
 Specifying  
 ▶ Page 345

### EMBANK Return Shells

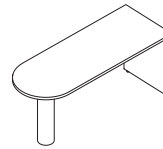
	42"W	48"W
24"D	●	●



Understanding  
 ▶ Page 300  
 Specifying  
 ▶ Page 347

### EMBANK Bridges

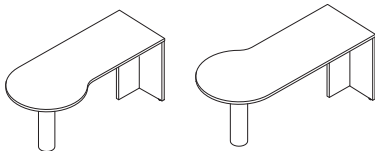
	36"W	42"W	48"W
24"D	●	●	●



Understanding  
 ▶ Page 303  
 Specifying  
 ▶ Page 348

### EMBANK D-Shape Worksurfaces

	60"W	66"W	72"W
30"D	●	●	●
36"D	●	●	●



Right-hand unit

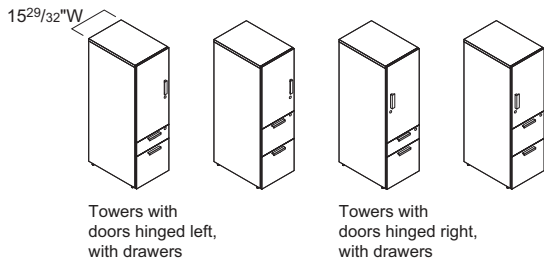
Left-hand unit

Understanding  
 ▶ Page 303  
 Specifying  
 ▶ Page 348

### EMBANK P-Shape Worksurfaces

		60"W	66"W	72"W
<b>Depth B</b>	30"D, 36"D, 42"D	●	●	●
<b>Depth C</b>	24"D, 30"D, 36"D	●	●	●

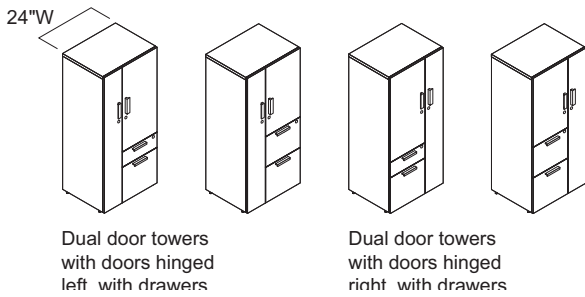
Statement of Line, EMBANK, continued



Understanding  
 ▶ Page 304  
 Specifying  
 ▶ Page 350

**EMBANK Single-Door Towers**

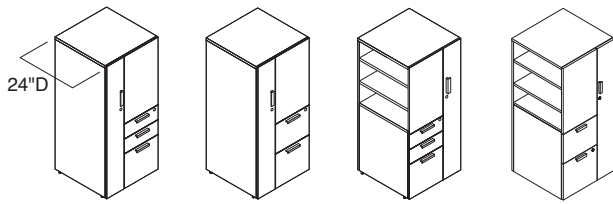
	15 <sup>29</sup> / <sub>32</sub> "W
41 <sup>25</sup> / <sub>32</sub> "H	●
47 <sup>31</sup> / <sub>32</sub> "H	●
54 <sup>1</sup> / <sub>8</sub> "H	●
66 <sup>1</sup> / <sub>2</sub> "H	●



Understanding  
 ▶ Page 304  
 Specifying  
 ▶ Page 352

**EMBANK Dual-Door Towers**

	24"W
41 <sup>25</sup> / <sub>32</sub> "H	●
47 <sup>31</sup> / <sub>32</sub> "H	●
54 <sup>1</sup> / <sub>8</sub> "H	●
66 <sup>1</sup> / <sub>2</sub> "H	●



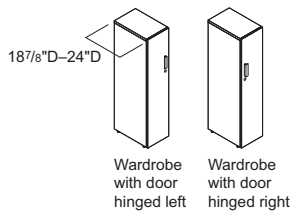
Side access towers with doors hinged left, with drawers

Side access towers with doors hinged right, with drawers

Understanding  
 ▶ Page 304  
 Specifying  
 ▶ Page 354

### EMBANK Side Access Towers

	24"W
41 <sup>25</sup> / <sub>32</sub> "H	●
47 <sup>31</sup> / <sub>32</sub> "H	●
54 <sup>1</sup> / <sub>8</sub> "H	●
66 <sup>1</sup> / <sub>2</sub> "H	●



Wardrobe with door hinged left

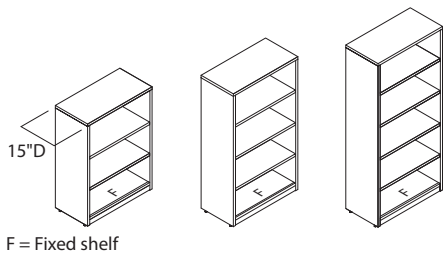
Wardrobe with door hinged right

Understanding  
 ▶ Page 304  
 Specifying  
 ▶ Page 356

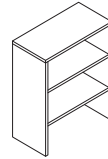
### EMBANK Wardrobes

	12"W
41 <sup>25</sup> / <sub>32</sub> "H	●
47 <sup>31</sup> / <sub>32</sub> "H	●
54 <sup>1</sup> / <sub>8</sub> "H	●

Statement of Line, EMBANK, continued



Understanding  
 ▶ Page 306  
 Specifying  
 ▶ Page 357



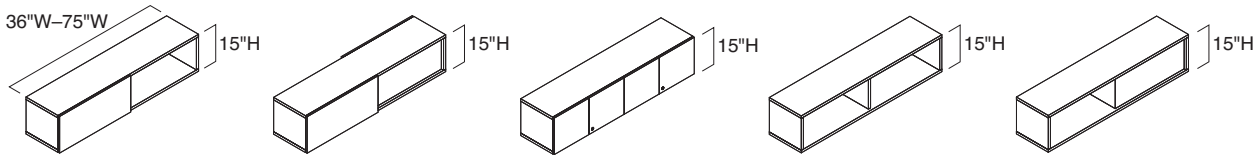
Understanding  
 ▶ Page 306  
 Specifying  
 ▶ Page 358

**EMBAK Bookcases**

	30"W	36"W
41 <sup>25</sup> / <sub>32</sub> "H	●	●
47 <sup>31</sup> / <sub>32</sub> "H	●	●
54 <sup>1</sup> / <sub>8</sub> "H	●	●
66 <sup>1</sup> / <sub>2</sub> "H	●	●
72 <sup>11</sup> / <sub>16</sub> "H	●	●

**EMBAK Stacking Bookcases**

	30"W	36"W
25 <sup>5</sup> / <sub>8</sub> "H	●	●
37 <sup>31</sup> / <sub>32</sub> "H	●	●
44 <sup>3</sup> / <sub>16</sub> "H	●	●



Overhead with sliding door

Overhead with sliding door, shared

Overhead with hinged doors

Overhead with open front

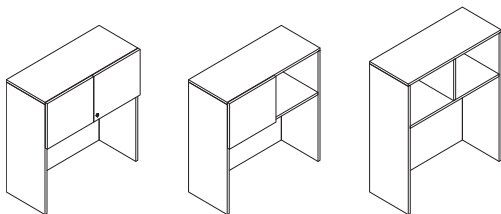
Overhead with open front, shared

Understanding  
 ▶ Page 308  
 Specifying  
 ▶ Page 359

**EMBAK Overheads with Sliding Doors, Hinged Doors, or Open Fronts**

	36"W	42"W	48"W	54"W	60"W	66"W	72"W
15"D without doors	●	●	●	●	●	●	●
16"D with doors	●	●	●	●	●	●	●

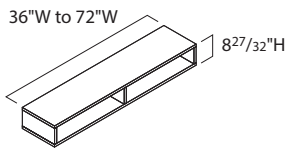
Tip: Height of overheads when specified with panel mount option is 15<sup>7</sup>/<sub>16</sub>"H.



Understanding  
 ▶ Page 308  
 Specifying  
 ▶ Page 361

**EMBAK Stacking Overheads with Hinged Doors, Sliding Doors, or Open Fronts**

	60"W	66"W	72"W
15"D without doors	●	●	●
16"D with doors	●	●	●



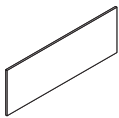
Personal Organizer

Understanding  
 ▶ Page 308  
 Specifying  
 ▶ Page 363

### EMBANK Organizers

	36"W	42"W	48"W	54"W	60"W	66"W	72"W
15"D Personal	●	●	●	●	●	●	●

Tip: Height of organizers when specified with no bracket option is 8<sup>27</sup>/<sub>32</sub>"H.  
 Tip: 72"W organizers have three equal-spaced vertical supports.

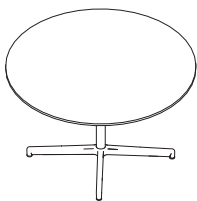


Understanding  
 ▶ Page 310  
 Specifying  
 ▶ Page 364

### EMBANK Tackboards

	36"W	42"W	48"W	60"W	66"W	72"W
20 <sup>1</sup> / <sub>4</sub> "H	●	●	●	●	●	●
26 <sup>1</sup> / <sub>4</sub> "H	●	●	●	●	●	●

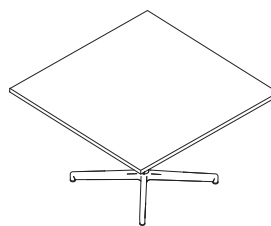
Tip: Tackboard thickness is equal to 1".  
 Tip: Tackboard thickness includes a core tackboard, spacer, and attachment hardware.



Understanding  
 ▶ Page 312  
 Specifying  
 ▶ Page 365

### EMBANK Social Table—Round

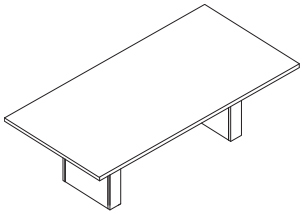
	36" Dia.	48" Dia.
28"H	●	●



Understanding  
 ▶ Page 312  
 Specifying  
 ▶ Page 365

### EMBANK Social Table—Square

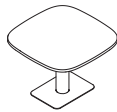
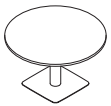
	36"W	48"W
28"H	●	●



Understanding  
 ▶ Page 312  
 Specifying  
 ▶ Page 366

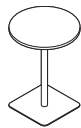
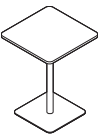
**EMBANK Conference Tables—Rectangle**

	72"W	96"W	120"W	144"W
36 <sup>1</sup> / <sub>4</sub> "D	●	●	●	●
48"D	●	●	●	●



Understanding  
 ▶ Page 314  
 Specifying  
 ▶ Pages 368 and 369

**EMBANK Collaborative Table—Square or Round**



Understanding  
 ▶ Page 314  
 Specifying  
 ▶ Page 367

**EMBANK Café Height Table—Square or Round**





Understanding  
 ▶ Page 320  
 Specifying  
 ▶ Page 370

**Power**



Specifying  
 ▶ Page 371

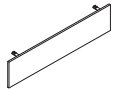
**EMBANK Leg and Table Base—Square Leg**

2"W

27<sup>1</sup>/<sub>4</sub>"H ●

*Tip: Square leg is 2" in depth.*

*Tip: Pair four legs with an Embank common top to create a table top desk or two legs to support an Embank return worksurface.*



Specifying  
 ▶ Page 372

**EMBANK Modesty Panel**

	36"W	48"W	60"W
13 <sup>3</sup> / <sub>4</sub> "H	●	●	●

# EMBank Pedestals

Fixed and Mobile

**Fixed pedestals** are floor standing and can support worksurfaces at 27<sup>11</sup>/<sub>32</sub>"H.  
 ▶ Specifying, page 329–330

**Top** is open on fixed pedestals and accommodates attachment to a work surface. Attachment hardware is included.

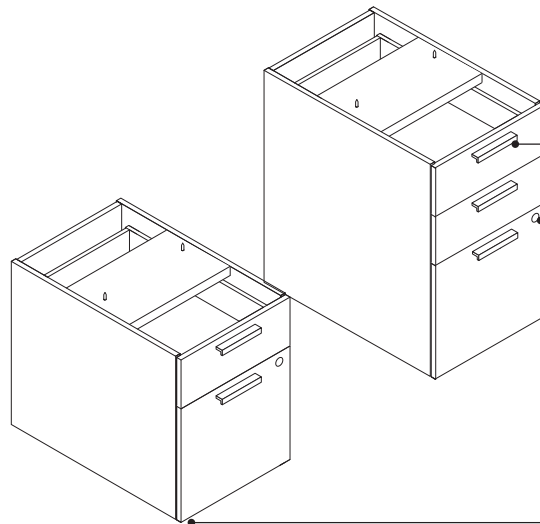
**Drawer fronts** are available in Low-Pressure Laminate and are full to the bottom of the case (no toe kick).

**Finished back and sides** are standard on pedestals.

**File drawers** open their full depth for total access to the contents and have an integrated U-channel on the drawer bodies for hanging file folder frames.

**Mobile pedestals** can be moved wherever storage is needed. They provide an auxiliary worksurface when you need more space to spread out your work.  
 ▶ Specifying, page 330

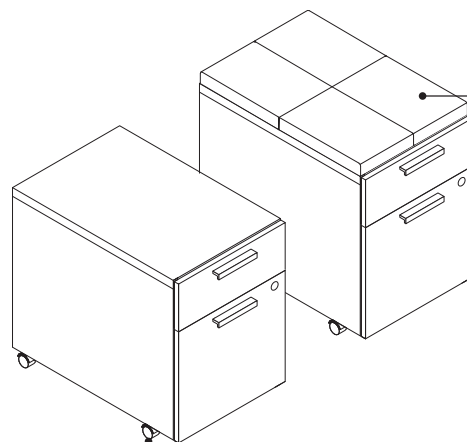
**Top on mobile pedestal** is 1<sup>1</sup>/<sub>8</sub>" thick and is available in Low-Pressure Laminate.



**Pulls on pedestals** are available in a ledge style only.

**Lock** is standard on pedestals. Lock is located in the bottom drawer, and locks the drawer it is located in and the one above. Locks are standard on lateral files and secure all drawers. Lock cylinders are field-installed.

**Leveling glides** adjust to install pedestals on uneven floors and have a 1<sup>1</sup>/<sub>2</sub>" adjustable glide range.



**Mobile pedestal cushion top** provides a temporary seat ideal for informal gatherings. Cushion top is ordered separately and requires field installation.  
 ▶ Specifying, page 283  
*Tip: Two-High mobile pedestals with a cushion top will not fit under a desk.*

**Four casters** are hard composition and non-locking, with a full-rotation swivel.

## Actual Dimensions

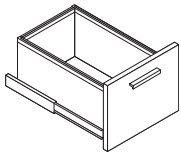
	Mobile Pedestals Box/File
<b>Depth</b>	18 <sup>7</sup> / <sub>8</sub> " and 22"
<b>Width</b>	15 <sup>3</sup> / <sub>4</sub> "
<b>Height</b>	23 <sup>2</sup> / <sub>3</sub> "

	Fixed Pedestals Box/Box/File and File/File
<b>Depth</b>	24" and 30"
<b>Width</b>	15 <sup>3</sup> / <sub>4</sub> "
<b>Height</b>	27 <sup>5</sup> / <sub>16</sub> "

	Mobile Pedestals Box/Box/File and File/File
<b>Depth</b>	22"
<b>Width</b>	15 <sup>3</sup> / <sub>4</sub> "
<b>Height</b>	30 <sup>2</sup> / <sub>3</sub> "

**Product Details**

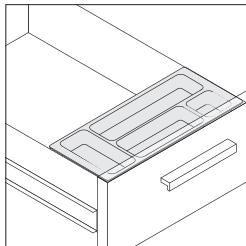
**Box drawers** are black, bore and dowel construction.



**File drawer body** is standard with integrated U-channel to accommodate hanging folder files.

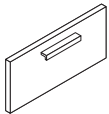
**All pedestal file drawers** accommodate front-to-back and side-to-side letter filing.

**24"D and 30"D pedestal file drawers** also accommodate side-to-side legal filing.



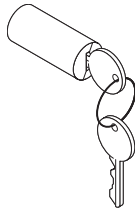
**Pencil tray to hold small office supplies** is standard with pedestals with box drawers.

**27<sup>5</sup>/<sub>16</sub>"H fixed pedestal** can be used in combination with other Two-High lower storage to create a variety of storage options.

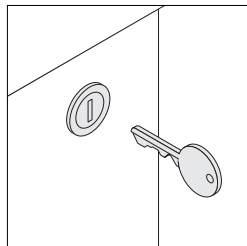


Ledge pull

**Pulls** are available in a ledge style only.



**Lock cylinders** are field-installed. Pedestals are shipped installed with plugs, with lock cylinders separate.

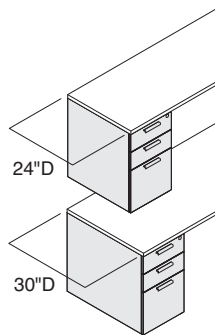


▶ Lock and Keying, page 376

**Counterweight packages** are included and required to ensure product stability.

**Mobile pedestal cushion top** is field installed with screws. See assembly instructions for details.

**Connections**



**Fixed pedestals** are intended to attach under a worksurface for security and support. Pedestals can be paired with EMBANK common top.

**Fixed pedestals** are not to be used alone as a free-standing unit, and must be used with other furniture.

**Pedestals using common tops** must be attached to other storage, a perpendicular worksurface, or a panel. A maximum 6" overhang of the worksurface is allowed on either side, or back.

**Surface Materials**

**EMBANK storage** can be specified with contrasting case, headset, top laminate finishes, and edgeband.

**Pedestal case, headsets, and top**

- 24L0 Graphite Walnut
- 25L5 Virginia Walnut
- 25L8 Clear Walnut
- 26L1 Natural Cherry
- 2L09 Clear Maple
- 2L30 Arctic White
- 2L83 Seagull
- 2L84 Milk
- 2LAK Clear Oak
- 2LAT Acacia
- 2LAW Ash Wenge
- 2LCN Clay Noce
- 2LCW Clay Wenge

**Ledge pull**

- 4799 Platinum Metallic
- 7207 Black

**Lock**

- 9201 Polished Chrome

**Drawer bodies, drawer suspensions, and glides**

- Black

**Cushion top**

- Upholstery

**Application Topics**

**Storage capacities and dimensions**

▶ Page 322

# EMBANK One-High, 1.5-High, and Two-High Lower Storage and Lateral Files

**One-High, 1.5-High, and Two-High EMBANK lower storage and lateral files** are floor standing and can support worksurfaces at 15<sup>3</sup>/<sub>8</sub>"H, 21<sup>3</sup>/<sub>8</sub>"H, or 27<sup>5</sup>/<sub>16</sub>"H.

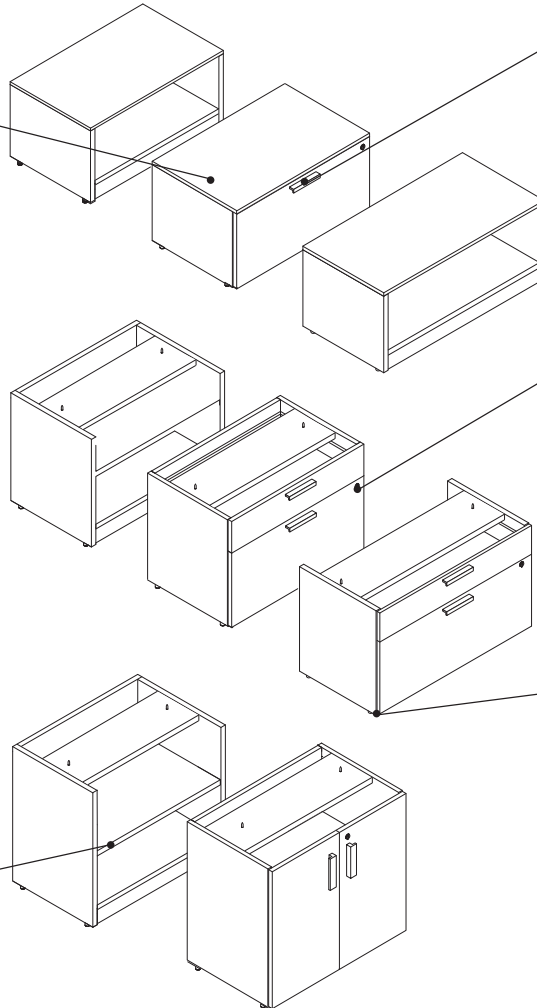
**Top** can be optioned on to low storage and laterals, and are 1<sup>1</sup>/<sub>8</sub>" thick. If no top is selected, low storage and laterals accommodate attachment to a worksurface or common top. Attachment hardware is included.

**Drawer and door fronts** are available in Low-Pressure Laminate are full to the bottom of the case (no toe kick).

**Finished back and sides** are standard on low storage and lateral files.

**File drawers** open their full depth for total access to the contents and have an integrated U-channel on the drawer bodies for hanging file folder frames.

**Adjustable shelf thickness** is <sup>3</sup>/<sub>4</sub>".



**Pull on low storage with doors and laterals** is available in a ledge style only.

**Lock** is standard on low storage with doors and lateral files. Lock is located in the top left corner of the right handed door of low storage with doors. Lock is located in the bottom drawer of lateral files, and locks the drawer it is located in and the one above. Locks are standard on lateral files and secure all drawers. Lock cylinders are field-installed.

**Leveling glides** adjust to install low storage and laterals on uneven floors and have a 1<sup>1</sup>/<sub>4</sub>" adjustable glide range.

## Actual Dimensions

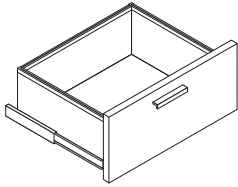
	One-High File	1.5-High Box/File and Open/File	Two-High Cabinet
<b>Depth</b>	24"	24"	24"
<b>Width</b>	30" and 36"	30" and 36"	30" and 36"
<b>Height</b>	15 <sup>3</sup> / <sub>8</sub> "	21 <sup>3</sup> / <sub>8</sub> "	27 <sup>5</sup> / <sub>16</sub> "
	One-High Open Low Storage	1.5-High Open Low Storage	Two-High Open Low Storage
<b>Depth</b>	24"	24"	24"
<b>Width</b>	30" and 36"	30" and 36"	30" and 36"
<b>Height</b>	15 <sup>3</sup> / <sub>8</sub> "	21 <sup>3</sup> / <sub>8</sub> "	27 <sup>5</sup> / <sub>16</sub> "

\* The top (if specified) matches the depth of units with drawers and doors.

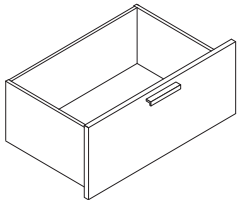
Tip: All heights are without top. Add either 1<sup>1</sup>/<sub>8</sub>" to achieve overall height with top.

## Product Details

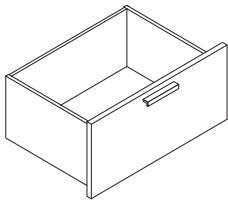
**Drawers** are black, bore and dowel construction.



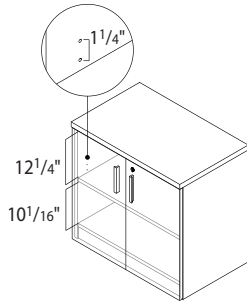
**File drawer body** is standard with integrated U-channel to accommodate hanging folder files.



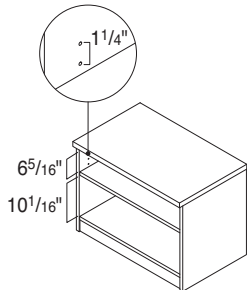
**36" W file drawers** accommodate front-to-back and side-to-side letter filing, as well as front-to-back legal filing. 24"D file drawers also accommodate side-to-side legal filing.



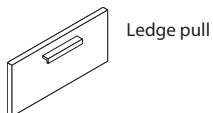
**30" W file drawers** accommodate front-to-back and side-to-side letter filing, as well as front-to-back legal filing. 24"D file drawers also accommodate side-to-side legal filing.



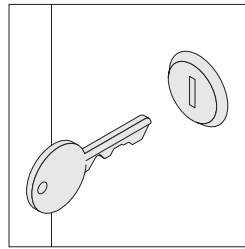
**Two-High lower storage** has three holes for adjustable shelf placement, spaced 1 1/4" apart. When the adjustable shelf is in the bottom position, the top shelf has 12 1/4" of usable space, and the bottom shelf has 10 1/16" of usable space.



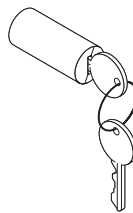
**1.5-High lower storage** has three holes for adjustable shelf placement, spaced 1 1/4" apart. When the adjustable shelf is in the bottom position, the top shelf has 6 5/16" of usable space, and the bottom shelf has 10 1/16" of usable space.



**Pulls** are available in a ledge style only.



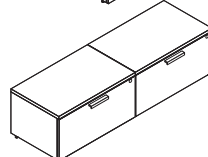
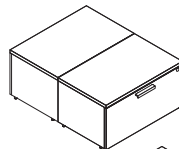
**Locks** are field-installed. Low storage with doors and lateral files are shipped installed with plugs with the lock cylinders separate.



► Lock and Keying, page 376

**Counterweight packages** are included and required to ensure product stability.

**One fixed shelf** is included in 1.5-High and Two-High open and hinged door configurations.



**Ganging hardware** is available to provide alignment by joining adjacent components side-by-side, back-to-back, or both.

**Side-by-side units with individual tops** will result in a nominal 3/32" gap.

## Surface Materials

**EMBANK storage** can be specified with different case, headset, and top laminate finishes.

### Low storage or lateral file case, headsets, and top

- 24L0 Graphite Walnut
- 25L5 Virginia Walnut
- 25L8 Clear Walnut
- 26L1 Natural Cherry
- 2L09 Clear Maple
- 2L30 Arctic White
- 2L83 Seagull
- 2L84 Milk
- 2LAK Clear Oak
- 2LAT Acacia
- 2LAW Ash Wenge
- 2LCN Clay Noce
- 2LCW Clay Wenge

### Ledge pull

- 4799 Platinum Metallic
- 7207 Black

### Lock

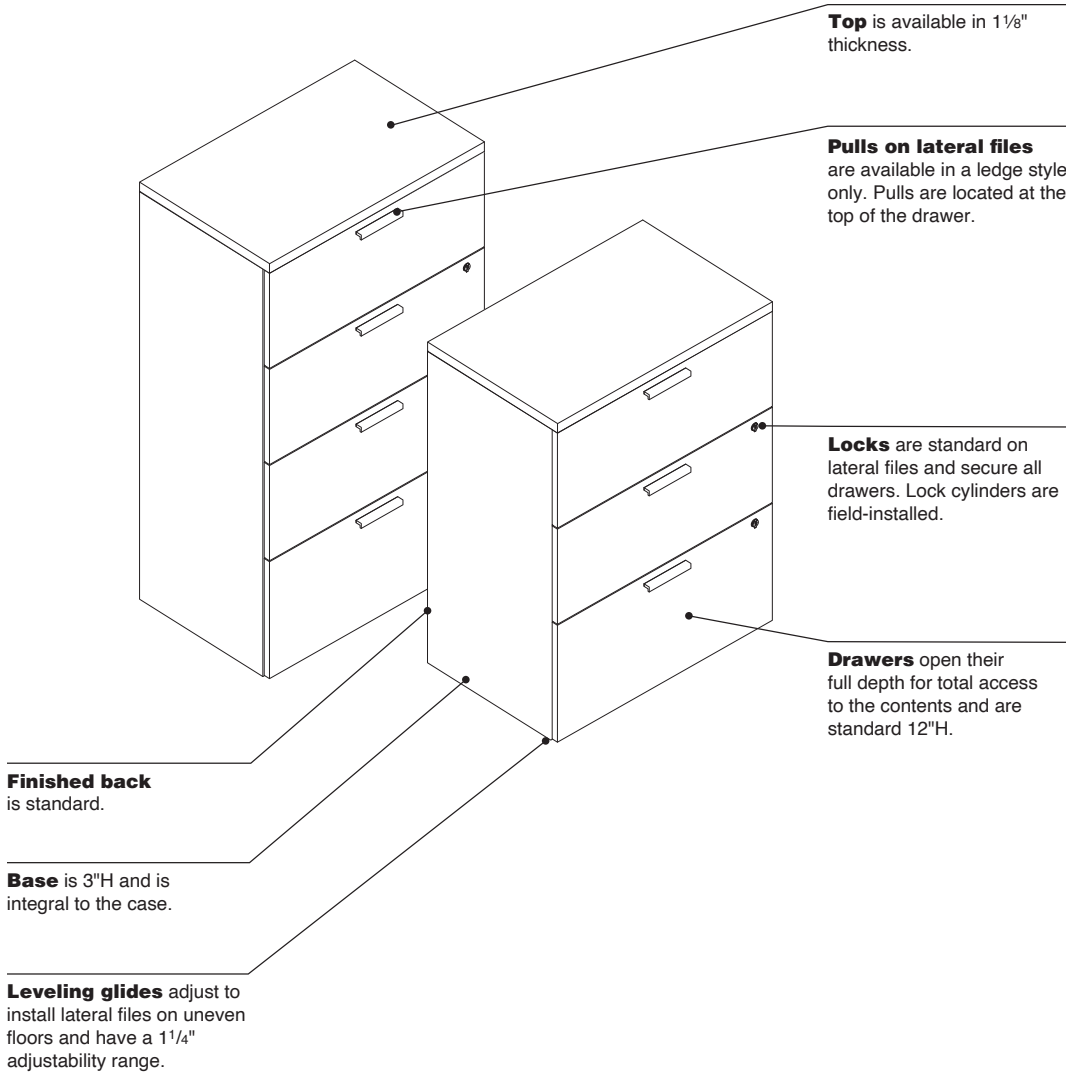
- 9201 Polished Chrome

### Drawer bodies, drawer suspensions, and glides

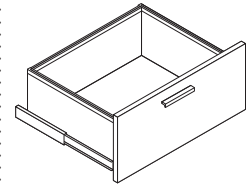
- Black

# EMBANK Three-High and Four-High Lateral Files

**Lateral files** are ideal for high-density paper storage.

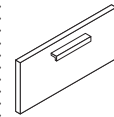


## Product Details



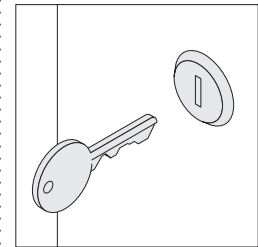
**File drawer body** is standard with integral top rail to accommodate hanging folder files. Drawers are a black bore and dowel construction with a proud front.

**Safety interlock system** allows only one drawer or roll-out shelf to be opened at a time.

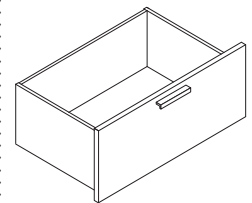


Ledge pull

**Pulls** are available in a ledge style only.



**Locks** are field-installed. Lateral files are shipped installed with plugs, with lock cylinders separate.

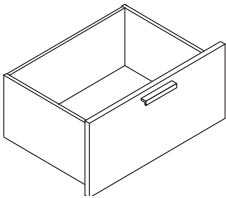


**36"W file drawers** accommodate front-to-back and side-to-side letter filing, as well as front-to-back legal filing.

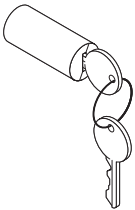
## Actual Dimensions

	Three-High	Four-High
Depth	18 7/8"	18 7/8"
Width	30" and 36"	30" and 36"
Height	40 1/3"	52 1/3"

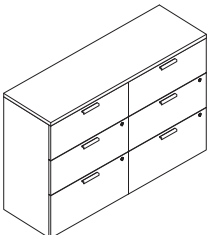
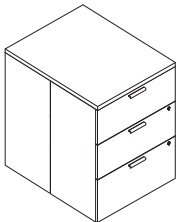
*Tip: Heights shown are with a top.*



**30"W file drawers** accommodate front-to-back and side-to-side letter filing, as well as front-to-back legal filing.



► *Lock and Keying*, page 309



**Ganging hardware** is available to provide alignment by joining adjacent components side-by-side, back-to-back, or both.

**Counterweight packages** are included and required to ensure product stability.

### Surface Materials

**EMBANK lateral files** can be specified with different case, headset, and top laminate finishes.

### Lateral file case, headsets, and top

- 24L0 Graphite Walnut
- 25L5 Virginia Walnut
- 25L8 Clear Walnut
- 26L1 Natural Cherry
- 2L09 Clear Maple
- 2L30 Arctic White
- 2L83 Seagull
- 2L84 Milk
- 2LAK Clear Oak
- 2LAT Acacia
- 2LAW Ash Wenge
- 2LCN Clay Noce
- 2LCW Clay Wenge

### Ledge pull

- 4799 Platinum Metallic
- 7207 Black

### Lock

- 9201 Polished Chrome

### Drawer bodies, drawer suspensions, and glides

- Black

### Application Topics

#### Storage Capacities and Dimensions

► Page 322

# EMBANK Credenzas

**Credenzas** come in various depths, heights, and storage configurations.

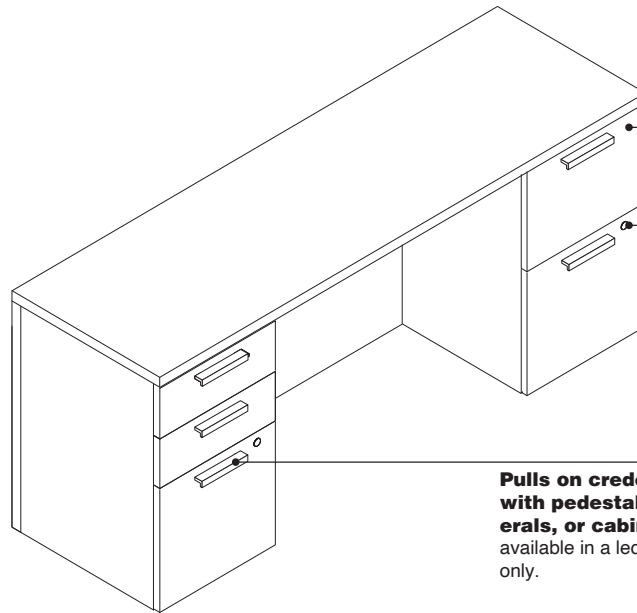
**Full storage credenzas** are available in 24"D and a two-high height.

**Top** are available in a 1½" thicknesses.

**Finished back** is included on all full storage credenzas.

**Credenzas with kneespace** are available in 24"D, and single or double pedestal configurations.

**Modesty panels** are available on credenzas with kneespace in either full height or ¼-height.



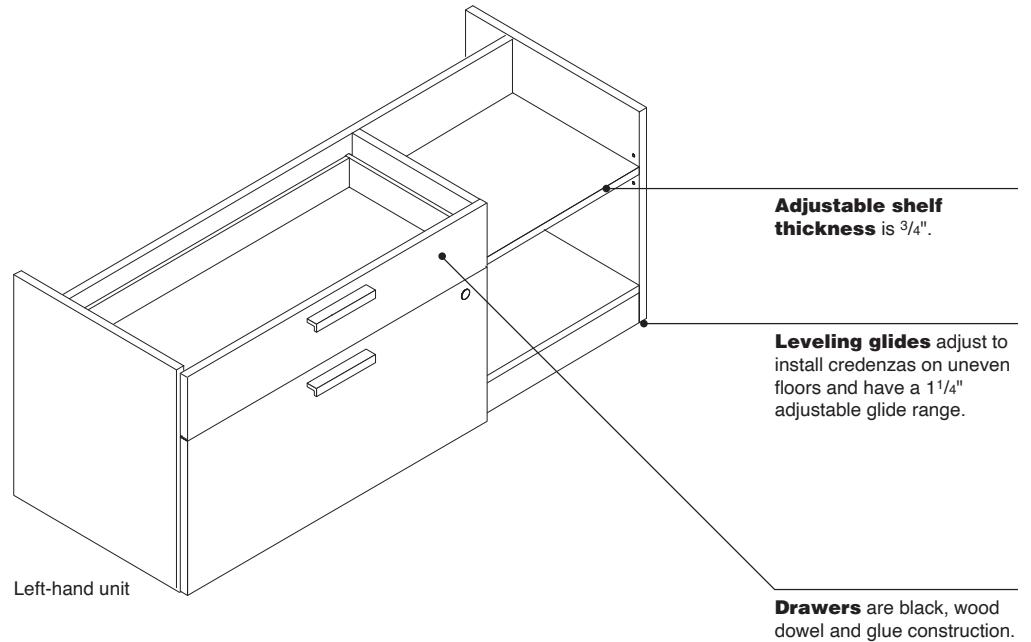
**Drawers** are black bore and dowel construction.

**Lock** is standard on credenzas with pedestals, laterals, or cabinets. Lock is located in either the bottom drawer, and locks the drawer it is located in and the one above, or the right-handed door. Lock cylinders are standard and are field-installed.

▶ Lock and Keying, page 376

**Pulls on credenzas with pedestals, laterals, or cabinets** are available in a ledge style only.





**Actual Dimensions**

**Full Storage Credenzas**

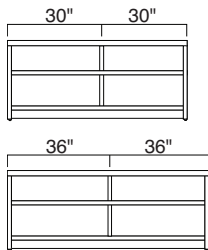
	<b>Open/Open</b>	<b>Open/ Lateral File</b>	<b>Lateral File/ Lateral File</b>	<b>Lateral File/ Cabinet</b>	<b>Cabinet/ Cabinet</b>
Depth	24"	24"	24"	24"	24"
Width	60", 66", and 72"	60", 66", and 72"	60", 66", and 72"	60", 66", and 72"	60", 66", and 72"
Height	$27\frac{5}{16}$ "	$27\frac{5}{16}$ "	$27\frac{5}{16}$ "	$27\frac{5}{16}$ "	$27\frac{5}{16}$ "

**Credenzas with Kneespace**

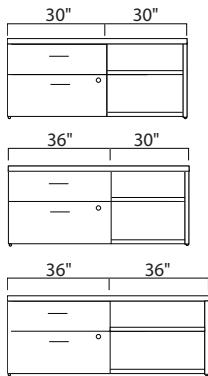
	<b>Single Pedestal</b>	<b>Double Pedestal</b>
Depth	24"	24"
Width	66" and 72"	66" and 72"
Height	$28\frac{7}{16}$ "	$28\frac{7}{16}$ "

*Tip: Credenzas with kneespace are standard with a  $1\frac{1}{8}$ "-thick top, included in the overall height.*

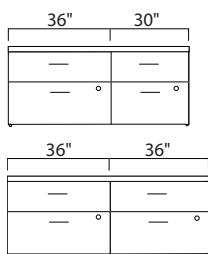
**Product Details**



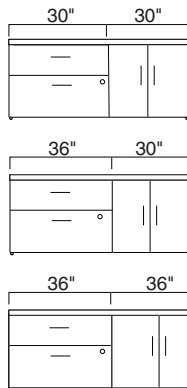
**Open/open credenzas** are divided evenly with a single center support in all widths.



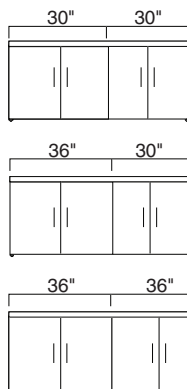
**Open/lateral file credenzas in 60"W** include 30"W file drawers. 66"W and 72"W open/lateral file credenzas include 36"W file drawers.



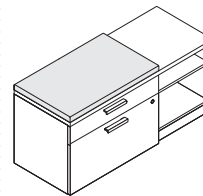
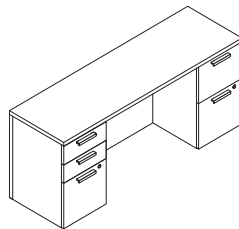
**Lateral file/lateral file credenzas in 60"W** include 30"W file drawers. 66"W lateral file/lateral file credenzas include 36"W (left) and 30"W (right) file drawers. 72"W lateral file/lateral file credenzas include 36"W file drawers.



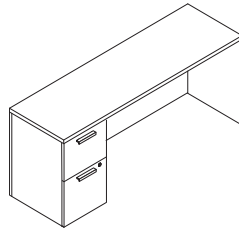
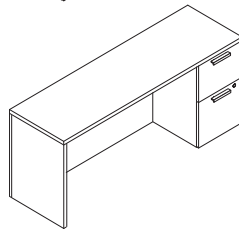
**Lateral file/cabinet credenzas in 60"W** include 30"W file drawers. 66"W and 72"W lateral file/cabinet credenzas include 36"W file drawers.  
*Tip: "Handedness" option of lateral file/open or lateral file/cabinet credenzas determine the location of the lateral file.*



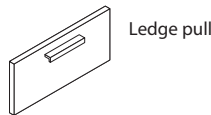
**Cabinet/cabinet credenzas** are divided evenly with a double center support in 60"W, 66"W, and 72"W cases. All widths include four doors.



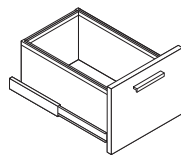
**Basic cushion** is available for use on credenzas. Basic cushions are ordered separately and requires field-installation.  
*Tip: Basic cushion is available on EMBANK credenzas with a top only.*



**Credenzas with kneespace** are available in 66"W and 72"W include either a left, right, or double pedestal configuration.



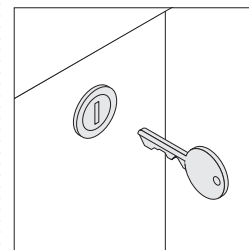
**Pulls** are available in a ledge style only.



**File drawer body** is standard with integrated U-channel to accommodate hanging folder files.

**Modesty panels and back panels** have horizontal grain direction.

**End panels** have vertical grain direction.



**Locks** cylinders are standard and are field-installed.  
▶ Lock and Keying, page 376

**Counterweight packages** are required to ensure product stability and are included in credenzas.

**Storage capacities and dimensions**  
▶ See page 322

**Surface Materials**

**EMBANK credenzas** can be specified with different case, headset, and top laminate finishes.

**Credenza case, headsets, and top**

- 24L0 Graphite Walnut
- 25L5 Virginia Walnut
- 25L8 Clear Walnut
- 26L1 Natural Cherry
- 2L09 Clear Maple
- 2L30 Arctic White
- 2L83 Seagull
- 2L84 Milk
- 2LAK Clear Oak
- 2LAT Acacia
- 2LAW Ash Wenge
- 2LCN Clay Noce
- 2LCW Clay Wenge

**Ledge pull**

- 4799 Platinum Metallic
- 7207 Black

**Lock**

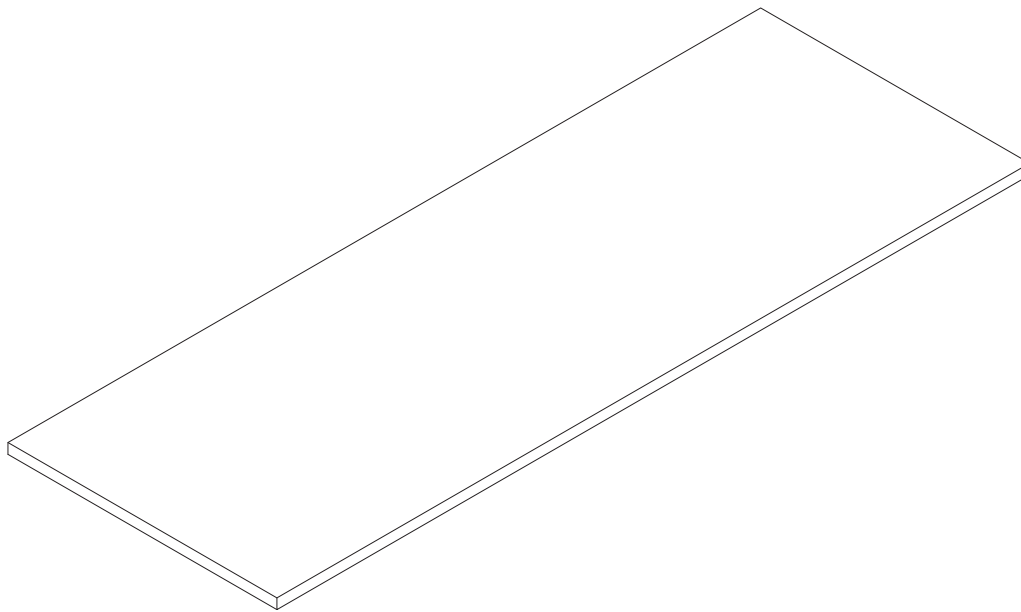
- 9201 Polished Chrome

**Drawer bodies, drawer suspensions, and glides**

- Black

**EMBANK common top** is used to create storage applications with a seamless top, or as a table or desk with legs.

**EMBANK worksurfaces and tops** use a 1<sup>1</sup>/<sub>8</sub>" core.

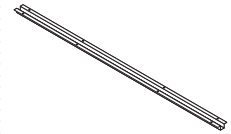


## Product Details

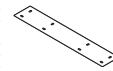
**Common tops** are available in Low-Pressure Laminate.

**Common tops** are standard 1<sup>1</sup>/<sub>8</sub>" thick.

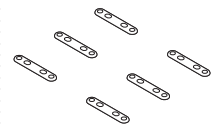
**Common tops** have 3 mm plastic edge banding on the front (user's) side. Sides and back have matching 1 mm edge.



**Reinforcing channels** must be used with tops larger than 54"W for 54"W or more of unsupported kneespace. Any common top used as a table with legs equal to or larger than 30"D x 72"W requires two reinforcing channels.



**Support plates** are available to connect two worksurfaces and allow one to support the other.



**Tie plates** are available to provide added strength and alignment between two worksurfaces.

## Surface Materials

- Top**
- 24L0 Graphite Walnut
  - 25L5 Virginia Walnut
  - 25L8 Clear Walnut
  - 26L1 Natural Cherry
  - 2L09 Clear Maple
  - 2L30 Arctic White
  - 2L83 Seagull
  - 2L84 Milk
  - 2LAK Clear Oak
  - 2LAT Acacia
  - 2LAW Ash Wenge
  - 2LCN Clay Noce
  - 2LCW Clay Wenge

- Edge**
- Plastic

## Actual Dimensions

EMBANK Common Top	
Depth	18 <sup>7</sup> / <sub>8</sub> ", 24", and 30"
Width	45 <sup>11</sup> / <sub>16</sub> ", 51 <sup>11</sup> / <sub>16</sub> ", 59 <sup>3</sup> / <sub>4</sub> ", 65 <sup>3</sup> / <sub>4</sub> ", 71 <sup>3</sup> / <sub>4</sub> ", 89 <sup>9</sup> / <sub>16</sub> ", 89 <sup>13</sup> / <sub>16</sub> ", and 95 <sup>13</sup> / <sub>16</sub> "
Worksurface/ Top Thickness – 1 <sup>1</sup> / <sub>8</sub> " core	1 <sup>1</sup> / <sub>8</sub> "

# EMBANK Desks, Desk Shells, Returns, Return Shells, and Bridges

**Desks** are freestanding and are available with and without pedestals, to create a desk shell, single pedestal desk, or double pedestal desk.

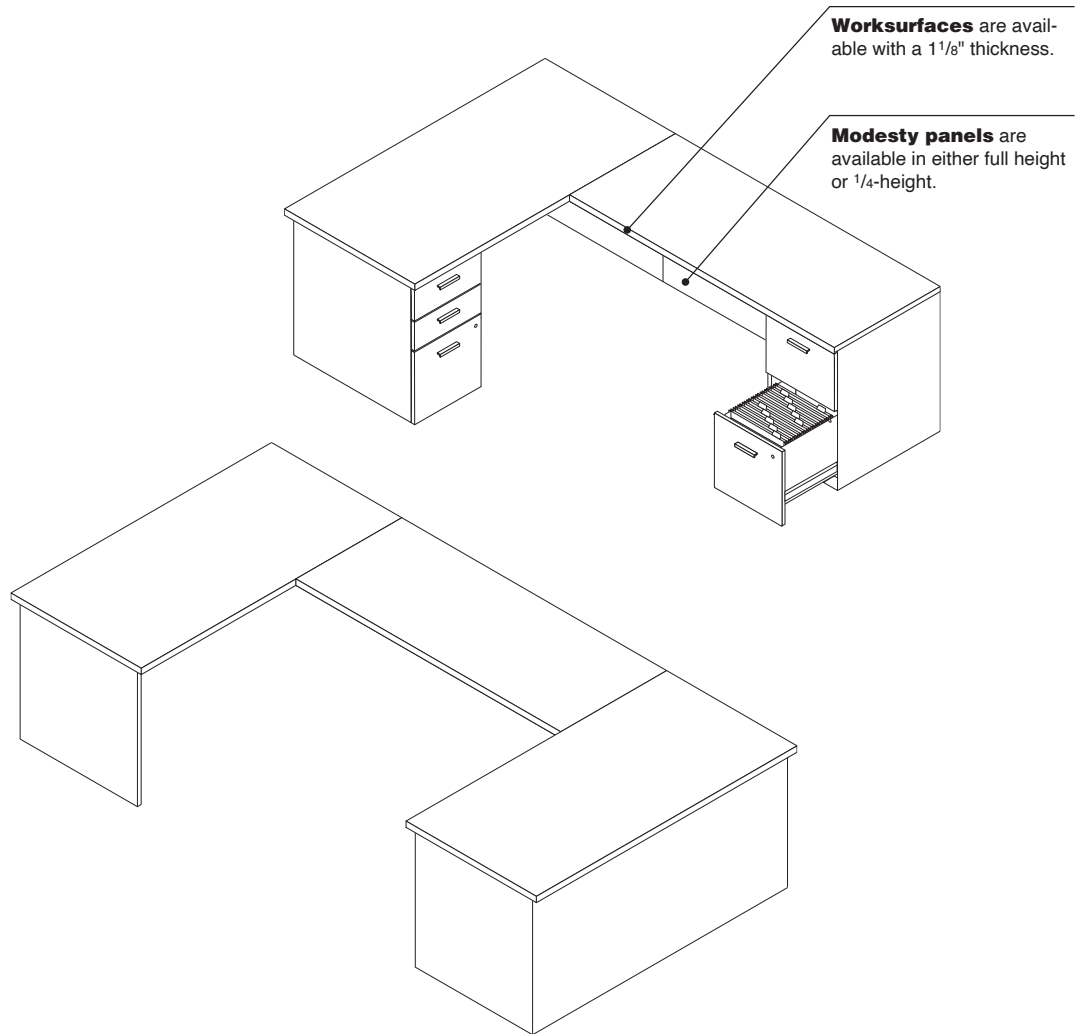
► Specifying, page 343

**Returns** are available with and without pedestals, to create a single pedestal return or return shell. Returns attach to desks or credenzas to form an L-shape configuration. Attachment brackets are included with returns.

► Specifying, page 345

**Bridges** must attach to a worksurface on each side to create a U-shape configuration. Attachment brackets are included with bridges.

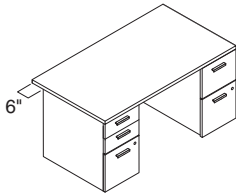
► Specifying, page 347



Actual Dimensions					
	Desks (with pedestal)	Desk Shells	Returns	Return Shells	Bridges
Depth	30" and 36"	24", 30", and 36"	24"	24"	24"
Width	60"–72"	60"–72"	42" or 48"	42" or 48"	36", 42", and 48"
Height	28 <sup>7</sup> / <sub>16</sub> "	28 <sup>7</sup> / <sub>16</sub> "	28 <sup>7</sup> / <sub>16</sub> "	28 <sup>7</sup> / <sub>16</sub> "	28 <sup>7</sup> / <sub>16</sub> "

*Tip: Height shown is with a 1 1/8" top specification.  
 \*Not all widths are available with all depths. See specification pages.*

## Product Details



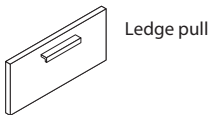
**36" D desks** have a 6" overhang on the visitor side. End panels/pedestals will be 30" D.

**Lock** is standard on desks and returns with pedestals. Lock is located in the bottom drawer, and locks the drawer it is located in, and the one above. Lock cylinders are standard and are field-installed.

**Leveling glides** adjust to install desks and returns on uneven floors and have a 1¼" adjustable glide range.

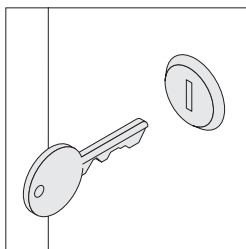
**Modesty panels** have horizontal grain direction.

**End panels** have vertical grain direction.



Ledge pull

**Pulls** are available in a ledge style only.



**Locks** are standard on desks and returns with storage. Lock cylinders are standard and are field-installed. ▶ Lock and Keying, page 376

**Counterweight packages** are included and required to ensure product stability.

**Back and end panel configurations** differ depending on the modesty panel and support options selected.

## Surface Materials

**EMBANK desks, returns, and bridges** can be specified with different case, headset, and top laminate finishes.

### Desk, return, and bridge case, headsets, and top

- 24L0 Graphite Walnut
- 25L5 Virginia Walnut
- 25L8 Clear Walnut
- 26L1 Natural Cherry
- 2L09 Clear Maple
- 2L30 Arctic White
- 2L83 Seagull
- 2L84 Milk
- 2LAK Clear Oak
- 2LAT Acacia
- 2LAW Ash Wenge
- 2LCN Clay Noce
- 2LCW Clay Wenge

### Ledge pull

- 4799 Platinum Metallic
- 7207 Black

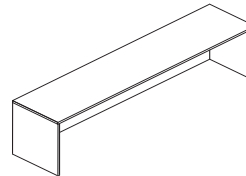
### Lock

- 9201 Polished Chrome

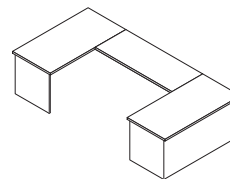
### Drawer bodies, drawer suspensions, and glides

- Black

## Application Topics



**60" W or wider desk shells** require a reinforcing channel, due to unsupported knee space 54" or greater. 72" W or greater desks receive a center support.



**If a bridge is specified in a U-shaped configuration**, a reinforcing channel must be used with 54" W or more of unsupported knee space.

**When specifying a reinforcing channel**, use the largest available size that fits within the open kneespace.

### Storage capacities and dimensions

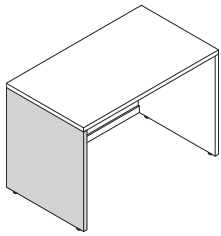
▶ Page 322

**Back and end panel configurations** vary depending on the modesty panel and storage options selected.

**Desks**

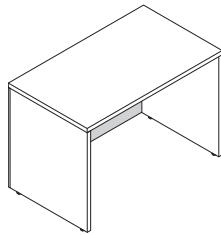
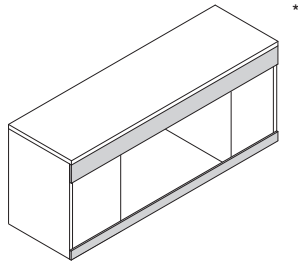
**End Panel Over Back Panel**

- Desks with 1/4-height modesty panel + two end panels.



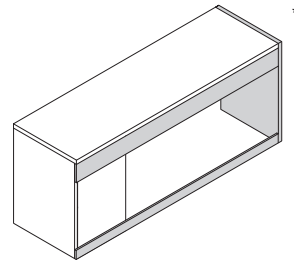
**Back Panel Over End Panel**

- Desks with 1/4-height modesty panel + two pedestals
- Desks with full modesty panel



**Mix**

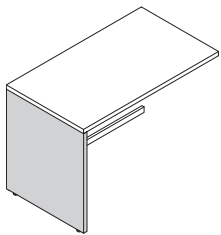
- Desks with 1/4-height modesty panel + one pedestal + end panel



**Returns**

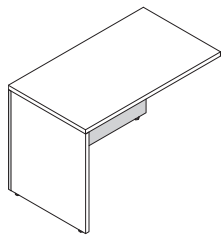
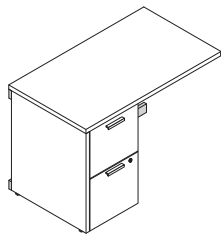
**End Panel Over Back Panel**

- Returns with 1/4-height modesty panel + end panel



**Back Panel Over End Panel**

- Returns with 1/4-height modesty panel + pedestal
- Returns with full modesty panel



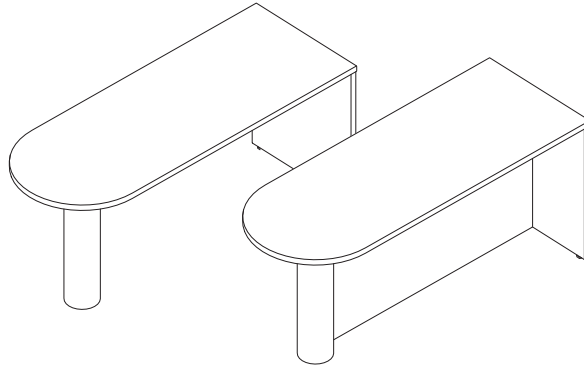
\*Back of desk shown

# EMBANK D-Shape and P-Shape Worksurfaces

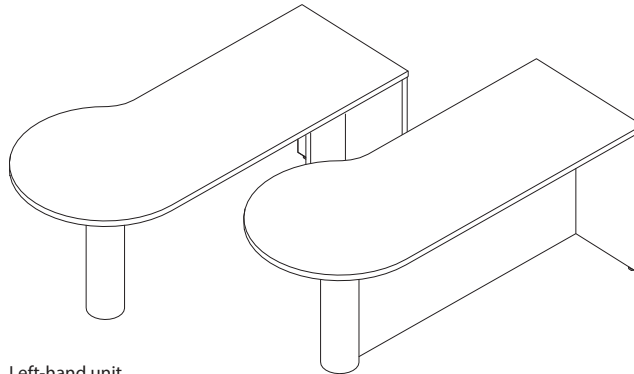
EMBANK D-Shape and P-Shape Worksurfaces

**EMBANK D- and P-shape worksurfaces** offer unique support for meetings.

**D-Shape**



**P-Shape**



Left-hand unit

## Product Details

**D- and P-shape worksurfaces** must be attached to a bridge, return, or adjoining worksurface to form a flush-height, L- or U-shaped configuration and to provide stability. Right-hand P-shape worksurfaces pair with left-hand returns. Left-hand P-shape worksurfaces pair with right-hand returns.

**D- and P-shape worksurfaces** include an end panel, and are available with and without modesty panels.

**Modesty panels** are available in either full height or 1/4-height. Full-height modesty panels go to the floor.

**Column leg diameter** is 6".

## Surface Materials

### Case (end and modesty panel) and top

- 24L0 Graphite Walnut
- 25L5 Virginia Walnut
- 25L8 Clear Walnut
- 26L1 Natural Cherry
- 2L09 Clear Maple
- 2L30 Arctic White
- 2L83 Seagull
- 2L84 Milk
- 2LAK Clear Oak
- 2LAT Acacia
- 2LAW Ash Wenge
- 2LCN Clay Noce
- 2LCW Clay Wenge

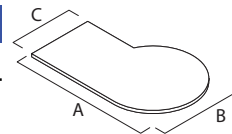
### Column leg

- 4799 Platinum Metallic
- 7207 Black

## Actual Dimensions

### EMBANK D-Shape and P-Shape Worksurface Modular Sizes

D-Shape Worksurfaces	
<b>Depth</b>	30", 36"
<b>Width</b>	60", 66", 72"
P-Shape Worksurfaces	
<b>Depth B Range</b>	30", 36", 42"
<b>Depth C Range</b>	24", 30", 36"
<b>Width A Range</b>	60", 66", 72"



Right-hand unit

# EMBANK Towers and Wardrobes

**Towers and wardrobes** provide storage for a variety of work and personal items including: paper, binders, books, and coats.

**Towers** are available in a variety of box and file drawer configurations.

**Locker space** is 8" wide and standard with a coat hook on the hinge side of the door.

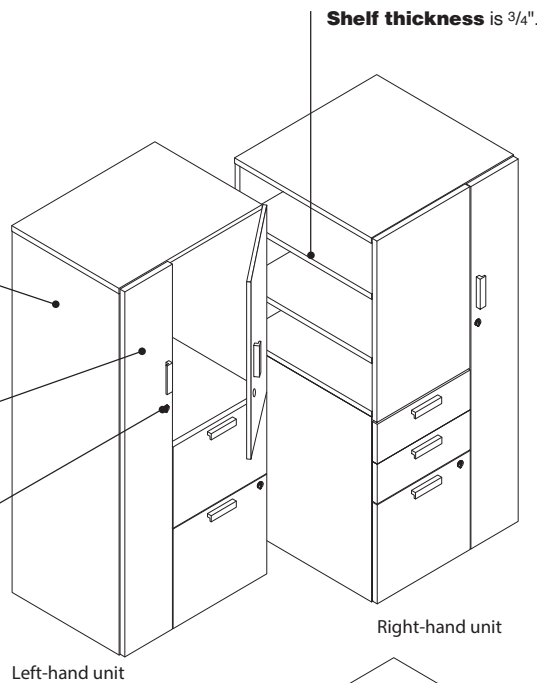
**Locks** are standard on door and drawers. Lock cylinders are standard and are field-installed.

▶ Lock and Keying, page 376

**Finished back** is standard.

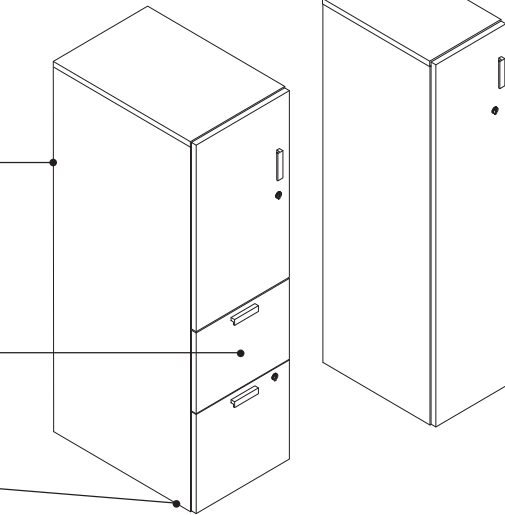
**Drawers** open their full depth for total access to the contents.

**Leveling glides** adjust to install tower and wardrobe on uneven floors and have a 1<sup>1</sup>/<sub>4</sub>" adjustable range.



Left-hand unit

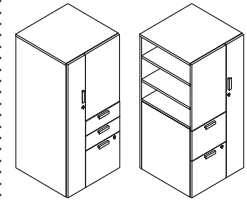
Right-hand unit



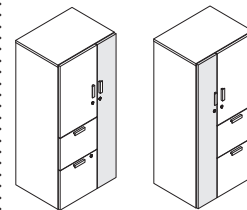
## Actual Dimensions

	Single Door with Drawers	Dual Door with Drawers	Side Access Tower with Drawers	Single Door Wardrobe
Depth	24"	24"	24"	24"
Width	15 <sup>29</sup> / <sub>32</sub> "	24"	24"	12"
Height	41 <sup>25</sup> / <sub>32</sub> ", 47 <sup>31</sup> / <sub>32</sub> ", 54 <sup>1</sup> / <sub>8</sub> ", and 66 <sup>1</sup> / <sub>2</sub> "	41 <sup>25</sup> / <sub>32</sub> ", 47 <sup>31</sup> / <sub>32</sub> ", 54 <sup>1</sup> / <sub>8</sub> ", and 66 <sup>1</sup> / <sub>2</sub> "	41 <sup>25</sup> / <sub>32</sub> ", 47 <sup>31</sup> / <sub>32</sub> ", 54 <sup>1</sup> / <sub>8</sub> ", and 66 <sup>1</sup> / <sub>2</sub> "	41 <sup>25</sup> / <sub>32</sub> ", 47 <sup>31</sup> / <sub>32</sub> ", and 54 <sup>1</sup> / <sub>8</sub> "

## Product Details



**Tower and wardrobe** combines coat storage, box and file drawers, and shelves.

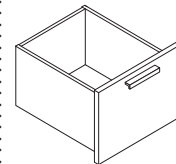


Door hinged on left

Door hinged on right

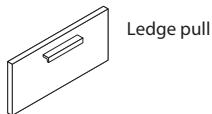
**Door on wardrobe** is full height and can be hinged on the left or right. Coat hook is always located on the same side as the door hinge.

**Box drawers** are a black, bore and dowel construction.



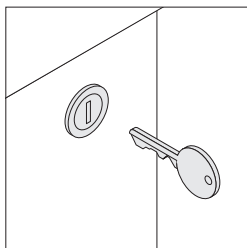
**File drawer body** is standard with integral top rail to accommodate hanging file folders.





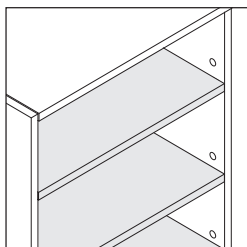
Ledge pull

**Pulls** are available in a ledge style only.



**Locks** come standard on towers and wardrobes. Lock cylinders are standard and are field-installed.

▶ Lock and Keying, page 376



**Adjustable shelves on 54<sup>1</sup>/<sub>8</sub>"H and 66<sup>1</sup>/<sub>2</sub>"H side access towers** are recessed from the side of the tower.

**AMQCRTWSABBFL, AMQCRTWSABBFR, AMQCRTWSAFFL, and AMQCRTWSAFFR:**

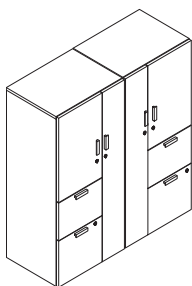
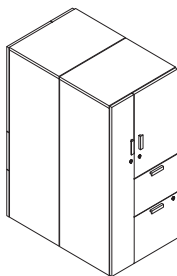
- **41<sup>25</sup>/<sub>32</sub>"H and 47<sup>31</sup>/<sub>32</sub>"H towers** have one bottom fixed shelf.
- **54<sup>1</sup>/<sub>8</sub>"H towers** have one bottom fixed shelf and one adjustable shelf.
- **66<sup>1</sup>/<sub>2</sub>"H towers** have one bottom fixed shelf and two adjustable shelves.

**AMQCRTWBFL, AMQCRTWBFR, AMQCRTWFFL, AMQCRTWFFR, AMQCRTWDBFL, AMQCRTWDBFR, AMQCRTWDFFL, and AMQCRTWDFFR, Box/ File configuration:**

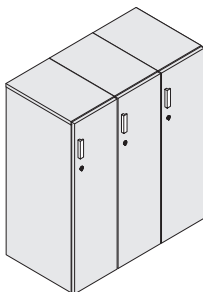
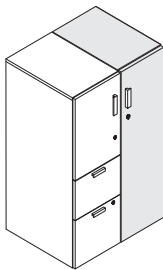
- **41<sup>25</sup>/<sub>32</sub>"H towers** have one bottom fixed shelf.
- **47<sup>31</sup>/<sub>32</sub>"H and 54<sup>1</sup>/<sub>8</sub>"H towers** have one bottom fixed shelf and one adjustable shelf.
- **66<sup>1</sup>/<sub>2</sub>"H towers** have one bottom fixed shelf and two adjustable shelves.

**AMQCRTWBFL, AMQCRTWBFR, AMQCRTWFFL, AMQCRTWFFR, AMQCRTWDBFL, AMQCRTWDBFR, AMQCRTWDFFL, and AMQCRTWDFFR, File/ File configuration:**

- **41<sup>25</sup>/<sub>32</sub>"H and 47<sup>31</sup>/<sub>32</sub>"H towers** have one bottom fixed shelf.
- **54<sup>1</sup>/<sub>8</sub>"H towers** have one bottom fixed shelf and one adjustable shelf.
- **66<sup>1</sup>/<sub>2</sub>"H towers** have one bottom fixed shelf and two adjustable shelves.

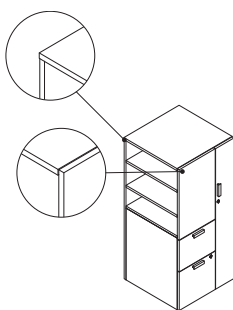


**Ganging hardware** is available to provide alignment by joining adjacent storage components side-by-side, back-to-back, or both.



**Wardrobes** must be attached to two additional wardrobes, another storage unit, or a wall to ensure stability and prevent wardrobe from tipping over. Contact [orders@amqsolutions.com](mailto:orders@amqsolutions.com) to order service parts for special connections.

**Counterweight packages** are included and required to ensure product stability.



**Side access tower construction** is as follows:

- Front panel over top panel
- Top panel over back panel

## Surface Materials

**EMBANK storage** can be specified with different case and headset laminate finishes.

**Tower door fronts and front panels** will not have matching grain direction with drawer fronts.

**Low storage or lateral file case and headsets**

- 24L0 Graphite Walnut
- 25L5 Virginia Walnut
- 25L8 Clear Walnut
- 26L1 Natural Cherry
- 2L09 Clear Maple
- 2L30 Arctic White
- 2L83 Seagull
- 2L84 Milk
- 2LAK Clear Oak
- 2LAT Acacia
- 2LAW Ash Wenge
- 2LCN Clay Noce
- 2LCW Clay Wenge

**Ledge pull**

- 4799 Platinum Metallic
- 7207 Black

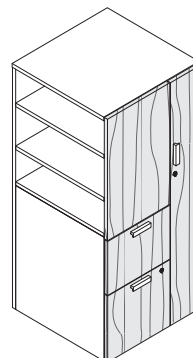
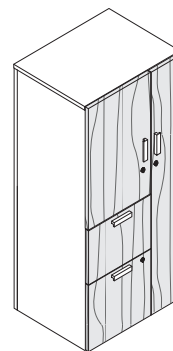
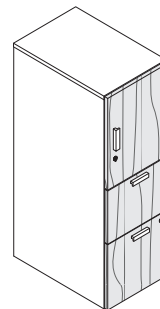
**Lock**

- 9201 Polished Chrome

**Drawer bodies, drawer suspensions, and glides**

- Black

## Grain Direction



*Tip: Tower door fronts will not have matching grain direction with drawer fronts.*

# EMBANK Bookcases

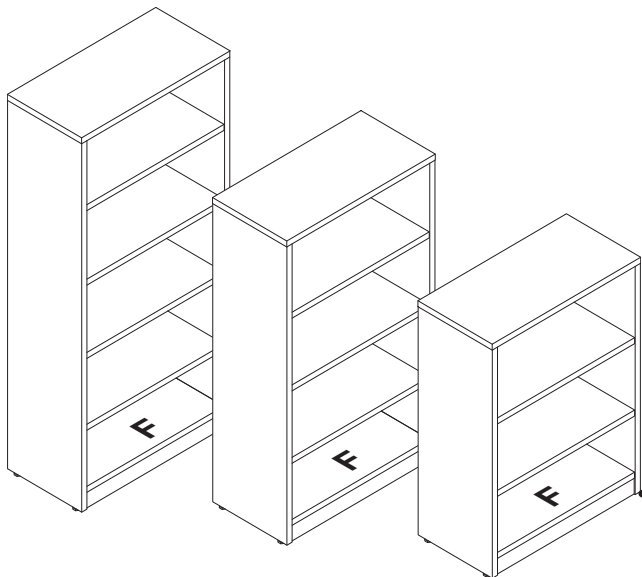
**Bookcases** offer convenient storage for binders, books, and other objects.

**Top** is standard 1"H laminate.

**Finished back** is standard.

**Shelves** adjust in 1<sup>1</sup>/<sub>4</sub>" vertical increments using a reversible bracket.

**Shelf thickness** is 3<sup>3</sup>/<sub>4</sub>".



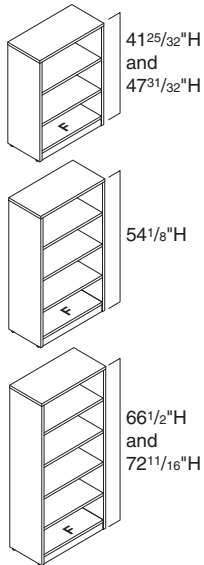
**Leveling glides** adjust up to 1<sup>1</sup>/<sub>4</sub>" to install bookcase on uneven floors.

## Actual Dimensions

	Bookcase	Stacking Bookcase
Depth	15"	15"
Width	30" and 36"	30" and 36"
Height	41 <sup>25</sup> / <sub>32</sub> ", 47 <sup>31</sup> / <sub>32</sub> ", 54 <sup>1</sup> / <sub>8</sub> ", 66 <sup>1</sup> / <sub>2</sub> ", and 72 <sup>11</sup> / <sub>16</sub> "	25 <sup>5</sup> / <sub>8</sub> ", 37 <sup>31</sup> / <sub>32</sub> ", and 44 <sup>3</sup> / <sub>16</sub> "

**Product Details**

**Bookcases** are available with adjustable shelves. Shelves can be repositioned without using tools.

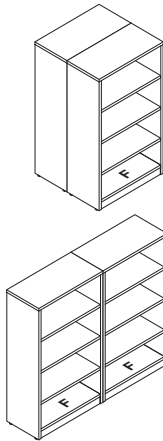


**The number of adjustable shelves per bookcase** depends on case height:

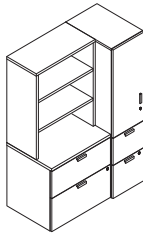
- 41<sup>25</sup>/<sub>32</sub>"H—2 adjustable shelves
- 47<sup>31</sup>/<sub>32</sub>"H—2 adjustable shelves
- 54<sup>1</sup>/<sub>8</sub>"H—3 adjustable shelves
- 66<sup>1</sup>/<sub>2</sub>"H—4 adjustable shelves
- 72<sup>11</sup>/<sub>16</sub>"H—4 adjustable shelves

**25<sup>5</sup>/<sub>8</sub>"H stacking bookcases** include adjustable shelf. All other heights include two adjustable shelves.

**Standard-size binders** will fit in bookcases with adjustable shelves.



**Ganging hardware** is available to provide alignment by joining adjacent components side-by-side, back-to-back, or both. EMBANK bookcases 66<sup>1</sup>/<sub>2</sub>"H and larger must be placed against a wall, if not ganged back-to-back.



**Stacking bookcases** are designed to align with other EMBANK tall storage. 25<sup>5</sup>/<sub>8</sub>"H stacking bookcases align with 54<sup>1</sup>/<sub>8</sub>"H tall storage. 37<sup>3</sup>/<sub>16</sub>"H stacking bookcases align with 66<sup>1</sup>/<sub>2</sub>"H tall storage. 44<sup>3</sup>/<sub>16</sub>" stacking bookcases align with 72<sup>11</sup>/<sub>16</sub>"H tall storage.

**When specifying stacking bookcases,** selecting the correct worksurface thickness of the application ensures that the stacking bookcase aligns with other tall storage.

**Stacking bookcases** must be used with One-High, 1.5-High, or Two-High laterals or lower storage. Stacking bookcases cannot be freestanding.

**Surface Materials**

**Bookcase case**

- 24L0 Graphite Walnut
- 25L5 Virginia Walnut
- 25L8 Clear Walnut
- 26L1 Natural Cherry
- 2L09 Clear Maple
- 2L30 Arctic White
- 2L83 Seagull
- 2L84 Milk
- 2LAK Clear Oak
- 2LAT Acacia
- 2LAW Ash Wenge
- 2LCN Clay Noce
- 2LCW Clay Wenge

**Adjustable shelf brackets**

- Brushed nickel

**Application Topics**

**Storage Capacities and Dimensions**

▶ Page 322

**66<sup>1</sup>/<sub>2</sub>"H and 72<sup>11</sup>/<sub>16</sub>"H freestanding bookcases** need to be placed back-to-back or against the wall.

**Stacking bookcases** can be shorter than the supporting worksurface as long as a worksurface support or side panel of a storage unit is used under the worksurface within 6" of where the side of the stacking bookcase is loaded.

# EMBANK Overheads and Organizers

**EMBANK overheads and organizers** provide storage above a worksurface and can be used in a variety of applications.

**Sliding door overheads** have a non-locking sliding door. Door is available in Low-Pressure Laminate, and optional markerboard surface.  
*Tip: Markerboard is slightly thicker than the standard laminate.*

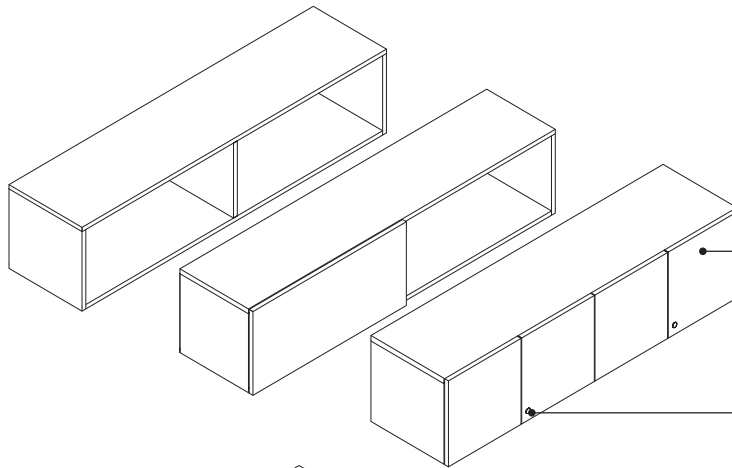
**Hinged door overheads** have two, three, or four locking doors depending on width. Doors are available in Low-Pressure Laminate.

**Open overheads** have two equal-spaced openings.

**Stacking overheads** have end panels that allow the storage to sit on top of a worksurface. Stacking overheads allow for easy installation, and do not require anchoring to a wall. Stacking overheads must be placed up against a wall or back to back with a similar height unit.

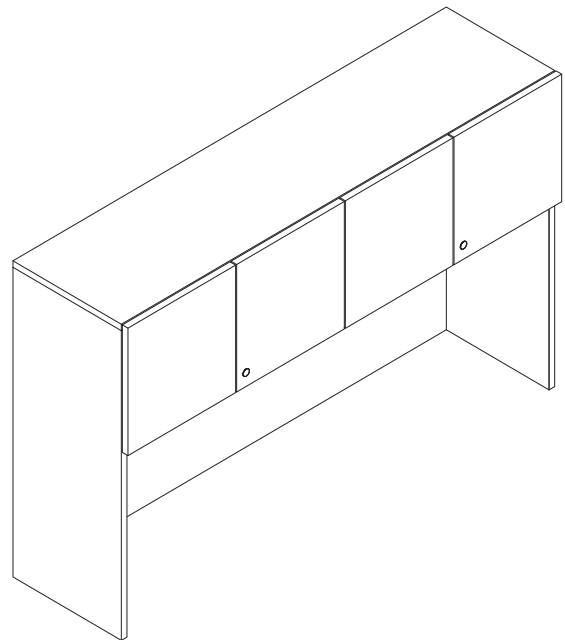
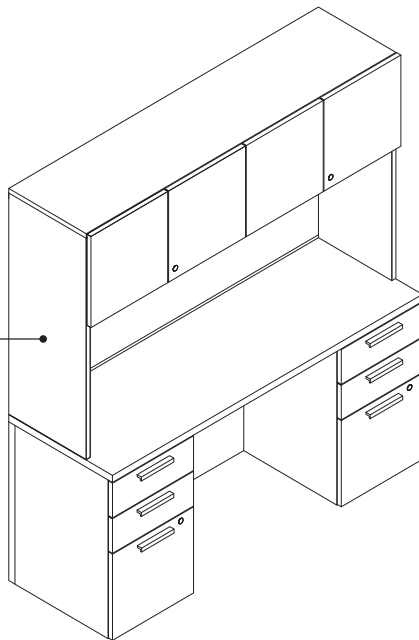
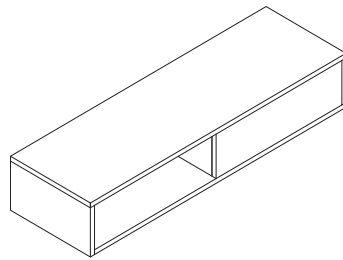
**Stacking overheads** include a 1 1/2" reveal for cable management.

**Finished top, back, and sides** are standard on overheads and organizers.



**Personal overhead and organizer configurations** provide access on one side of a unit. Cases have a fixed divider in the middle.

**Lock** is standard on overheads with hinged doors. Lock cylinders are standard and are field-installed.



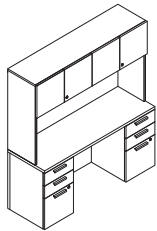
## Actual Dimensions

### Standard Widths

	Overheads with Sliding or Hinged Doors	Overheads with Open Fronts	Organizer
Depth	16"	15"	15"
Width	36", 42", 48", 60", 66", and 72"	36", 42", 48", 60", 66", and 72"	36", 42", 48", 60", 66", and 72"
Height	15"	15"	8 <sup>27</sup> / <sub>32</sub> "

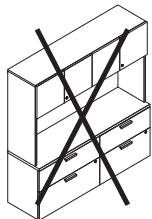
**Product Details**

**Organizers** are available personal or shared. Personal provides storage on one side only. Shared storage is divided down the center, with half storage on one side and half storage on the opposite side. Personal storage has a center divider.



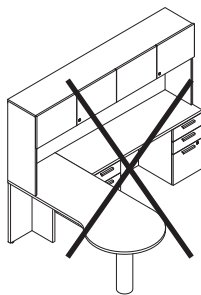
**Stacking overheads**

attach to the top of a credenza, desk, desk shell, or Two-High freestanding laterals or low storage, using hardware included with the overhead unit. When placed on top of multiple lateral files or low storage, the storage units must be ganged together. Stacking overheads have a 1½" reveal for cable pass-through.



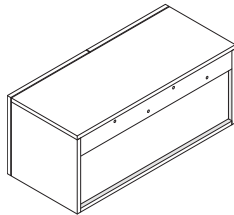
**Stacking overheads**

cannot be used with lateral file/lateral file credenza configurations.

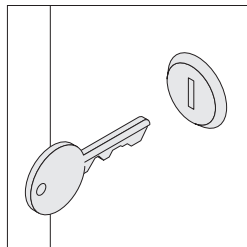


**Stacking overheads**

cannot be used with P- or D-shape freestanding worksurfaces.



**Wall mount overheads** have a 1" gap between the back panel and end panel.



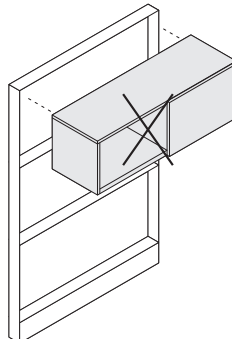
**Locks** are standard on overheads with hinged doors. Lock cylinders are standard and are field-installed.

▶ Lock and Keying, page 376

**Stacking overheads**

are designed to align with other EMBANK tall storage heights. 38"H stacking overheads align with 66"H tall storage. 44"H stacking overheads align with 72"H tall storage. Selecting the correct worksurface thickness of the application ensures that the stacking overhead aligns with other tall storage.

**Application Topics**



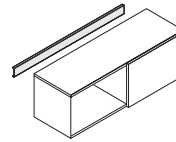
**Hanging components** cannot hang in front of a double-pane window.

**Bracket options**

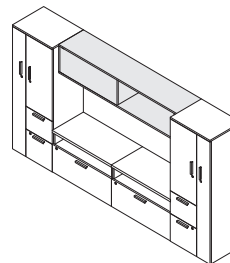
▶ See below

**Stacking overheads** can be shorter than the supporting worksurface as long as a worksurface support or side panel of a storage unit is used under the worksurface within 6" of where the side of the stacking bookcase is loaded.

**Connections**



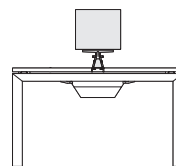
**Horizontal wall attachment brackets** are available to attach overhead storage to the wall of building.



**Overheads and organizers** have many different attachment methods.

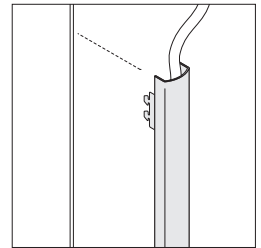
▶ See below

**Overhead cabinets** can attach so they align with tower, vertical cabinet, and panel heights.



**Storage** is always centered on the dual-sided bench when used in parallel application.

**Wiring and Cabling**



**Vertical wire managers** are available to conceal cords that are routed from light mounted beneath overhead storage.

**Surface Materials**

**Case and headsets**

- 24L0 Graphite Walnut
- 25L5 Virginia Walnut
- 25L8 Clear Walnut
- 26L1 Natural Cherry
- 2L09 Clear Maple
- 2L30 Arctic White
- 2L83 Seagull
- 2L84 Milk
- 2LAK Clear Oak
- 2LAT Acacia
- 2LAW Ash Wenge
- 2LCN Clay Noce
- 2LCW Clay Wenge
- Markerboard—sliding door only

**Locks**

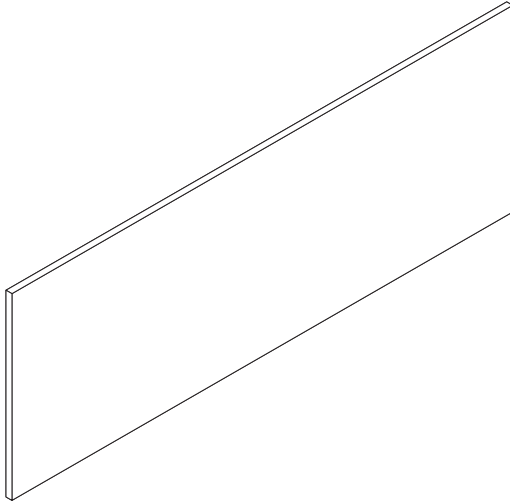
- 9201 Polished Chrome

**Bracket Options**

	<b>Personal Overhead/Organizer</b>	<b>Shared Overhead/Organizer</b>
<b>Wall Mount</b>	Select wall mount option. Brackets included.	N.A.
<b>Suspended between EMBANK Towers</b>	Select suspended between towers option. Order cabinet-to-cabinet attachment kit ( <b>AMQAWAK</b> ) separately.	Select suspended between towers option. Order cabinet-to-cabinet attachment kit ( <b>AMQAWAK</b> ) separately.

# EMBANK Tackboard

**Tackboard** finishes the space between an overhead unit and a worksurface. It is a fabric-covered tackable surface.



## Product Details

**Tackboards** provide a fabric covered tackable surface above the worksurface.

**The ends of wall-mounted tackboards** are finished.

**Tackboards for use with stacking overhead applications** will automatically deduct 2¼" from the overall width of the tackboard. Specify the width of the overhead it is being used with.

**Stacking overheads** include a 1½" space at the bottom of the end panel for cable management. When specifying a tackboard with a stacking overhead, remove 1½" from the overall height to account for this clearance.

- 37.9875"H stacking overheads should use a 21.4375"H tackboard for cable management.
- 44.17475"H stacking overhead would use a 27.6875"H tackboard or cable management.

## Connections

**Tackboards** attach with hook and loop fasteners. The attachment hardware is standard with the tackboard for field installation.

## Surface Materials

### Tackboards

#### Fabric Price Group 01

- 5F07 Blue
- 5F08 Navy
- 5F16 Grey
- 5F17 Black
- 5G64 Alpine
- 5G65 Tornado

#### Fabric Price Group 03

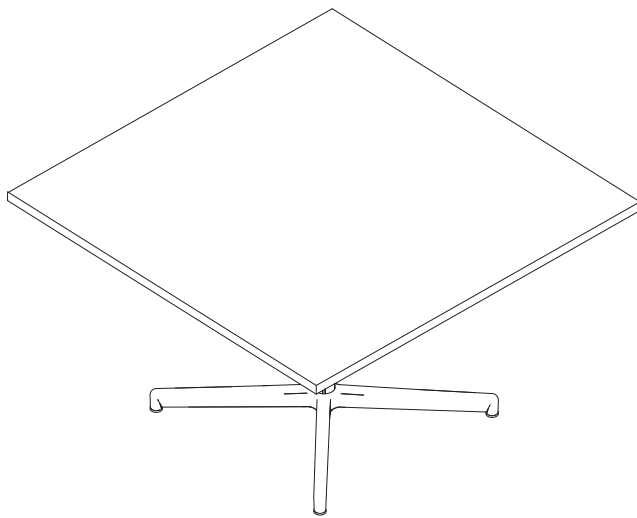
- 5H11 Poppy
- 5H12 Tangelo
- 5H13 Citrine (Citron)
- 5H14 Avocado
- 5H16 Indigo
- 5H17 Mallard
- 5H18 Teak
- 5H19 Cumulus
- 5H20 Pewter
- 5H21 Gunmetal
- 5H22 Ink
- 5H23 Rose Quartz
- 5H24 Sea Salt
- 5H25 Storm Cloud
- 5H26 Olivine

## Actual Dimensions

<b>Width</b>	36", 42", 48", 60", 66", and 72"
<b>Height</b>	20¼" and 26¼"
<b>Thickness</b>	1"

*Tip: Thickness includes a core tackboard, spacer, and attachment hardware.*

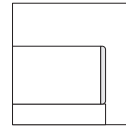
**EMBANK social tables** with X-style bases are ideal for quick meetings with a relaxed posture.



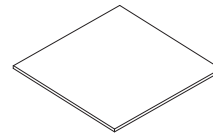
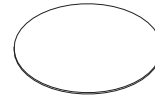
## Product Details

**Table tops** have a wood core with a Low-Pressure Laminate surface.

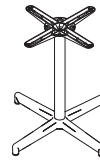
**Table tops** are available in 1 1/8" core thickness.



**Table tops** features a 3 mm square edge profile.



**EMBANK table tops** are available in round or square shapes.



**Steel X- bases** are available in 26"W and 36"W.

*Tip: When specifying a conference table, base size is predetermined by the selections made, and cannot be changed.*

## Surface Materials

### Table top

- 24L0 Graphite Walnut
- 25L5 Virginia Walnut
- 25L8 Clear Walnut
- 26L1 Natural Cherry
- 2L09 Clear Maple
- 2L30 Arctic White
- 2L83 Seagull
- 2L84 Milk
- 2LAK Clear Oak
- 2LAT Acacia
- 2LAW Ash Wenge
- 2LCN Clay Noce
- 2LCW Clay Wenge

### X-base

- Paint
- Polished Chrome

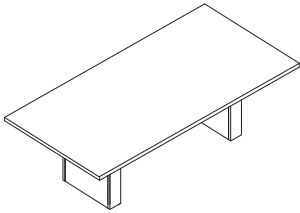
## Actual Dimensions

### EMBANK Tables

	Round	Square
<b>Diameter</b>	36", 48"	N.A.
<b>Depth</b>	N.A.	N.A.
<b>Width</b>	N.A.	36", 48"
<b>Height</b>	28"	28"

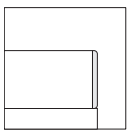
# EMBANK Rectangular Conference Tables

## Product Details



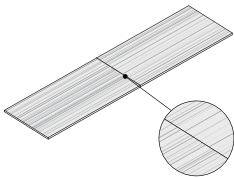
**Table tops** have a wood core with a Low-Pressure Laminate surface.

**Table tops** are available in 1 1/8" core thickness.

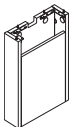


**Table tops** features a 3 mm square edge profile.

**Two-piece tops** will occur when the top is in Low-Pressure Laminate and is greater than or equal to 96"W. Tops will be split into two equal sections and ship with connecting hardware.



**Two-piece tops** will not have matching grain patterns.



**Rectangular table base** is available in Low-Pressure Laminate, and accommodates routing of power and data cords. Access is provided by a hinged door.

## Surface Materials

### Table top and rectangular table base

- 24L0 Graphite Walnut
- 25L5 Virginia Walnut
- 25L8 Clear Walnut
- 26L1 Natural Cherry
- 2L09 Clear Maple
- 2L30 Arctic White
- 2L83 Seagull
- 2L84 Milk
- 2LAK Clear Oak
- 2LAT Acacia
- 2LAW Ash Wenge
- 2LCN Clay Noce
- 2LCW Clay Wenge

### Edge profile

- 3 mm plastic

### Hinged door power unit

- 8043 Clear Anodized Aluminum

### Power outlet

- Black plastic

### Power cord

- Black plastic

## Power, Wiring & Cabling

**Grommet option** allows for either no grommet or hinged door power unit.

### Hinged door power unit

has two power outlets and openings for two data ports. The bottom of the units is open to allow pass-through of power and data cables to the floor. Available as an option on conference table tops. The door has a 6' power cord.

### Rectangular table base

accommodates routing of power and data cords. Access is provided by a hinged door.



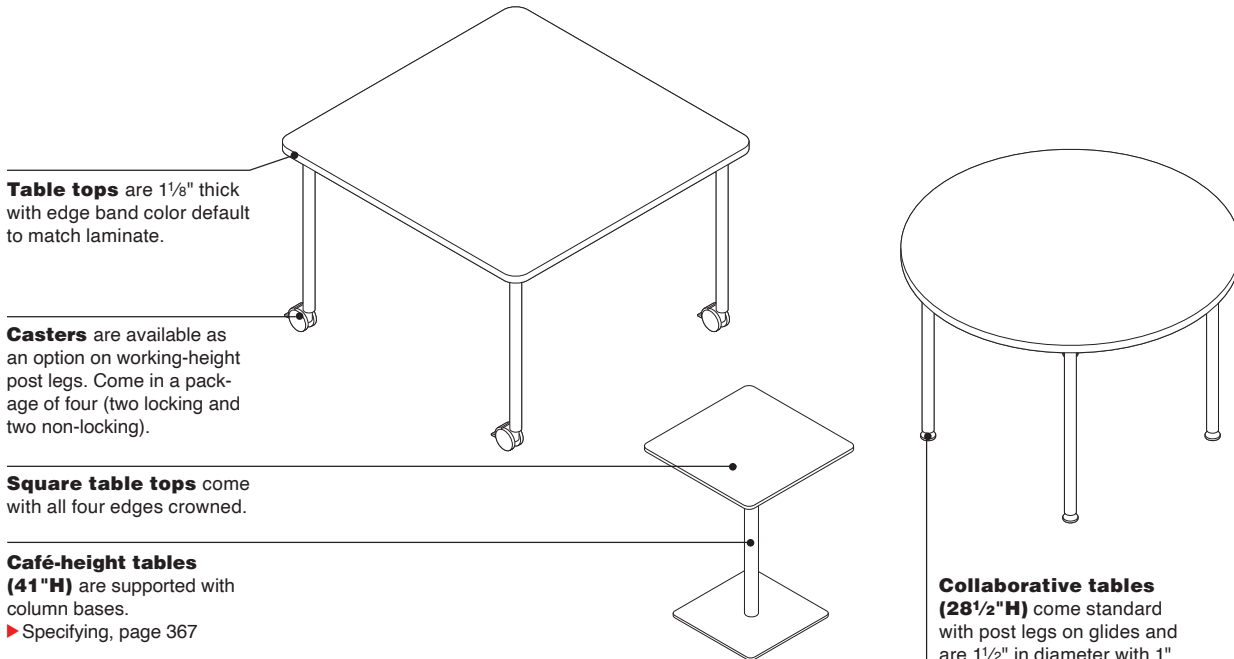


# EMBANK Collaborative Table & Cafe Height Table

## Embank collaborative and café height tables

come in two heights and two shapes.

► Specifying, pages 367–369



**Table tops** are 1 1/8" thick with edge band color default to match laminate.

**Casters** are available as an option on working-height post legs. Come in a package of four (two locking and two non-locking).

**Square table tops** come with all four edges crowned.

**Café-height tables (41"H)** are supported with column bases.

► Specifying, page 367

**Power** can be added to the collaborative and café height table, ordered as a separate style number.

► See page 370

**Collaborative tables (28 1/2"H)** come standard with post legs on glides and are 1 1/2" in diameter with 1" of leveling. Casters and column bases are available as an option on this table.

### Actual Dimensions

	Collaborative	Café-Height
Square	●	●
Round	●	●

### Product Details

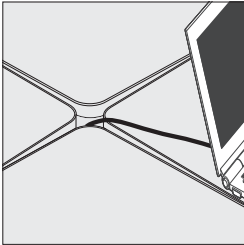
**Embank tables** come in two heights and two shapes:

- Collaborative, 28½"H. Shapes—Square, round,
- Café or standing height, 42"H. Shapes—Square and round.

**Table tops** are 1½" thick with edge band color default to match laminate.

**Bases** vary in size depending on the size of the table top.

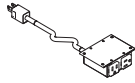
▶ See page 316



**Square tops** come with all four edges crowned.

### Power Specifications

**Single power unit** comes standard with plastic clips and two Velcro straps for cord management.



#### Single power unit

- Two power or one power/one dual USB-A
- 10 or 15 foot cord length

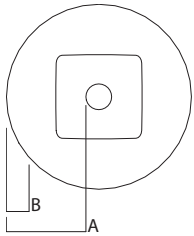
Determining power cord length depends on the size of the table top and distance to power source.

### Column Matrix

**Column and base sizes** are determined by the size of the table top.

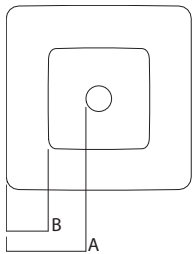
Table Width	Up to 30"W	31-54"W	55"-72"W
<b>Column Size</b>	One 3" Column	One 5" Column	Two 5" Column

# EMBANK Collaborative & Cafe Height Table—Column Style Base Dimensions



## Round Worksurfaces

Width	To Column Dim A	To Base Dim B
30"	13½"	4"
36"	15¾"	7"
48"	21¾"	12"



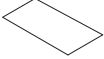
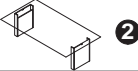
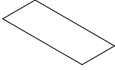
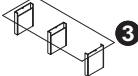
## Square Worksurfaces

Width	To Column Dim A	To Base Dim B
30"	13½"	4"
36"	15¾"	7"
48"	21¾"	12"



# EMBANK Table Tops, Legs, and Base Combinations

Rectangular Conference Table










	Rectangular Base		Steel X-Base	
	18"	24"	26"	36"
 Rectangle Tops 36 <sup>1</sup> / <sub>4</sub> "D– 48"D x 72"W–96"W	N.A.	 <b>2</b>	N.A.	N.A.
 Rectangle Tops 36 <sup>1</sup> / <sub>4</sub> "D– 48"D x 120"W–144"W	N.A.	 <b>3</b>	N.A.	N.A.

**1** = Number of base units to order.

# EMBANK Table Tops, Legs, and Base Combinations

EMBANK Table Tops, Legs,  
and Base Combinations

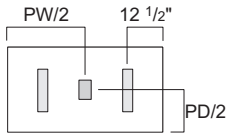
Social Table

		Rectangular Base	Steel X-Base	
		 24"	 26"	 36"
	Round Tops 36"W	N.A.		N.A.
	Round Tops 48"W	N.A.	N.A.	
	Square Tops 36"W and 48"W	N.A.	N.A.	

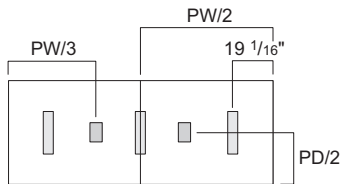
# EMBANK Rectangular Conference Table Power Unit

## Hinged Door Power Unit and Rectangular Base Locations

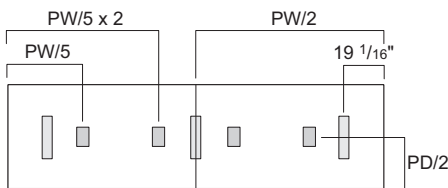
### Rectangular Tops



PW = 72"



PW = 96" or 120"

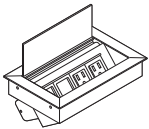


PW = 144"

PW = Planned Width  
PD = Planned Depth

Rectangular Base Location =   
Hinged Door Power Unit =

### Hinged Door Power Unit



#### Product Details

**Hinged door power unit** provides two electrical outlets and two open ports for data adapters. Power unit features a hinged door that opens 90° for access to power and data and is flush with the worksurface when closed. It has a 6' cord with grounded plug. Available on conference table tops only.

**Hinged door power unit** is field installed in a factory cut hole.

#### Surface Materials

- Power Unit**
- 8043 Clear Anodized Aluminum
- Outlet**
- Black plastic only
- Power Cord**
- Black plastic only

#### Actual Dimensions

**Depth** 5<sup>3</sup>/<sub>8</sub>"

**Width** 8<sup>3</sup>/<sub>8</sub>"

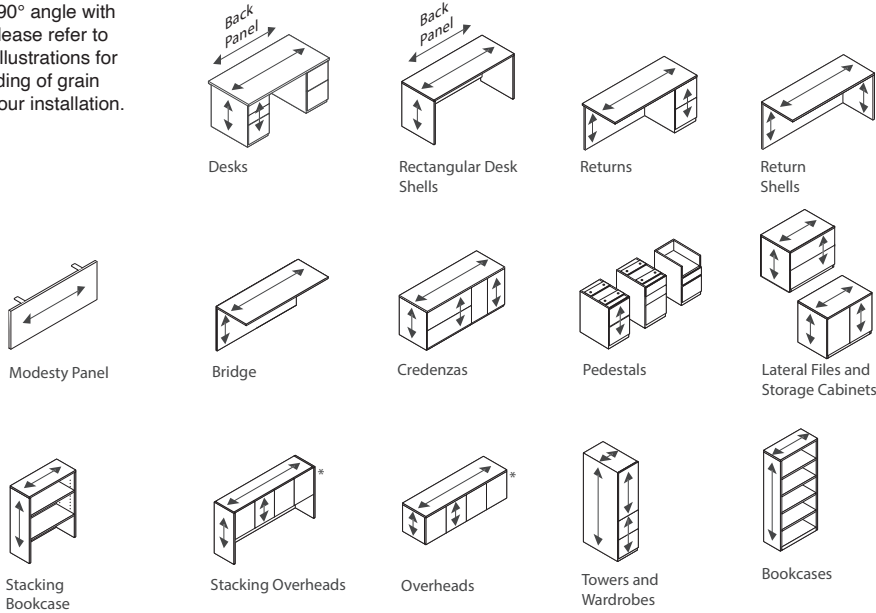
**Height** 3<sup>1</sup>/<sub>2</sub>"

**Power cord length** 6'



# Directional Laminate and Edge Profile Detail

**The appearance of laminate** may change slightly depending on the angle from which it is viewed. This natural phenomenon is called polarization, and it can be seen on natural veneer, and to a lesser extent on composite veneer. Polarization is often noticed on worksurfaces installed at a 90° angle with each other. Please refer to the following illustrations for an understanding of grain direction on your installation.

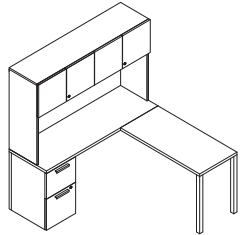


\* 36"W–61½"W overhead back panels have vertical grain direction. 63"W–75"W overhead back panels have horizontal grain direction.  
 \* Towers, wardrobes, bookcases, returns, return shells, and bridges back/modesty panels have vertical grain direction.  
 \* Desks, desk shells, and credenza back/modesty panels have horizontal grain direction.

## Product Details



**3 mm radius front edge profile**  
(1/8" thick)



### 3 mm Edge Profile Locations

#### User side only

#### Worksurfaces:

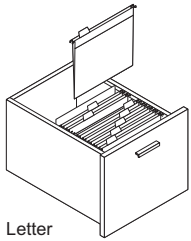
- Desks
- Desk shells
- Credenzas
- Returns
- Bridges

#### Tops:

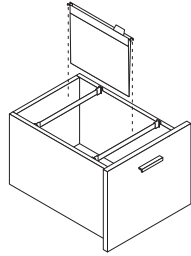
- Lateral files
- Lower storage
- Credenzas
- Storage cabinets
- Overhead storage and wall-mounted overhead storage
- Towers
- Wardrobes
- Bookcases

# Storage Capacities and Dimensions

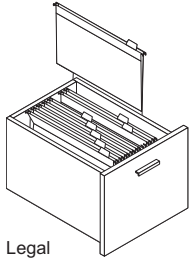
## Filing Types



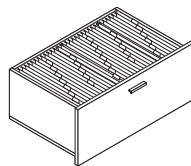
Letter



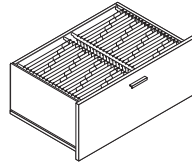
Side-to-side letter



Legal



Side-to-side legal



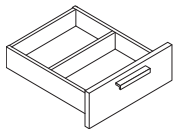
Front-to-back legal

Rails adjust outward for letter-size.

## Pedestal Drawers

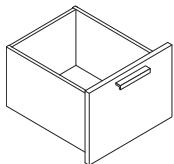
For pedestals, desks, returns, credenzas, and towers

### 6"H Box Drawers



Size/Type	Inside Dimensions			Inside Height Clearance
	D	W	H	
18"D Drawer	12 <sup>1</sup> / <sub>6</sub> "	12 <sup>1</sup> / <sub>6</sub> "	2 <sup>3</sup> / <sub>4</sub> "	4 <sup>2</sup> / <sub>5</sub> "
22 <sup>3</sup> / <sub>4</sub> "D Drawer	12 <sup>1</sup> / <sub>6</sub> "	12 <sup>1</sup> / <sub>6</sub> "	2 <sup>3</sup> / <sub>4</sub> "	4 <sup>2</sup> / <sub>5</sub> "
24"D Drawer	15 <sup>1</sup> / <sub>6</sub> "	12 <sup>1</sup> / <sub>6</sub> "	2 <sup>3</sup> / <sub>4</sub> "	4 <sup>2</sup> / <sub>5</sub> "
30"D Drawer	15 <sup>1</sup> / <sub>6</sub> "	12 <sup>1</sup> / <sub>6</sub> "	2 <sup>3</sup> / <sub>4</sub> "	4 <sup>2</sup> / <sub>5</sub> "

### 12"H File Drawers

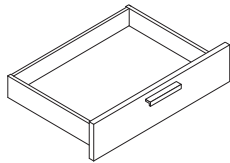


Size/Type	Inside Dimensions			Inside Height Clearance	Letter-Sized Storage	Legal-Sized Storage
	D	W	H			
18"D Drawer	12 <sup>1</sup> / <sub>6</sub> "	12 <sup>1</sup> / <sub>6</sub> "	9 <sup>1</sup> / <sub>6</sub> "	10 <sup>31</sup> / <sub>32</sub> "	12" front-to-back 12" side-to-side	N.A.
22 <sup>3</sup> / <sub>4</sub> "D Drawer	12 <sup>1</sup> / <sub>6</sub> "	12 <sup>1</sup> / <sub>6</sub> "	9 <sup>1</sup> / <sub>6</sub> "	10 <sup>31</sup> / <sub>32</sub> "	12" front-to-back 12" side-to-side	N.A.
24"D Drawer	15 <sup>1</sup> / <sub>6</sub> "	12 <sup>1</sup> / <sub>6</sub> "	9 <sup>1</sup> / <sub>6</sub> "	10 <sup>31</sup> / <sub>32</sub> "	15" front-to-back 12" side-to-side	12" side-to-side
30"D Drawer	15 <sup>1</sup> / <sub>6</sub> "	12 <sup>1</sup> / <sub>6</sub> "	9 <sup>1</sup> / <sub>6</sub> "	10 <sup>31</sup> / <sub>32</sub> "	15" front-to-back 12" side-to-side	12" side-to-side

## Lateral File Drawers

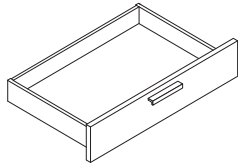
For lateral files and credenzas

### 30"W Box Drawers



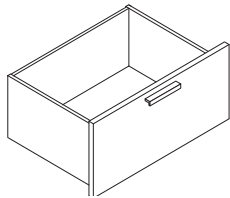
Size/Type	Inside Dimensions			Inside Height Clearance
	D	W	H	
18"D Drawer	12 <sup>1</sup> / <sub>6</sub> "	25 <sup>2</sup> / <sub>3</sub> "	2 <sup>4</sup> / <sub>5</sub> "	4 <sup>7</sup> / <sub>8</sub> "
22 <sup>3</sup> / <sub>4</sub> "D Drawer	12 <sup>1</sup> / <sub>6</sub> "	25 <sup>2</sup> / <sub>3</sub> "	2 <sup>4</sup> / <sub>5</sub> "	4 <sup>7</sup> / <sub>8</sub> "
24"D Drawer	15 <sup>1</sup> / <sub>6</sub> "	25 <sup>2</sup> / <sub>3</sub> "	2 <sup>4</sup> / <sub>5</sub> "	4 <sup>7</sup> / <sub>8</sub> "

### 36"W Box Drawers



Size/Type	Inside Dimensions			Inside Height Clearance
	D	W	H	
18"D Drawer	12 <sup>1</sup> / <sub>6</sub> "	31 <sup>2</sup> / <sub>3</sub> "	2 <sup>4</sup> / <sub>5</sub> "	4 <sup>7</sup> / <sub>8</sub> "
22 <sup>3</sup> / <sub>4</sub> "D Drawer	12 <sup>1</sup> / <sub>6</sub> "	31 <sup>2</sup> / <sub>3</sub> "	2 <sup>4</sup> / <sub>5</sub> "	4 <sup>7</sup> / <sub>8</sub> "
24"D Drawer	15 <sup>1</sup> / <sub>6</sub> "	31 <sup>2</sup> / <sub>3</sub> "	2 <sup>4</sup> / <sub>5</sub> "	4 <sup>7</sup> / <sub>8</sub> "

### 30"W File Drawers

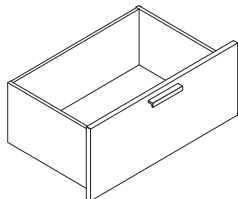


Size/Type	Inside Dimensions			Inside Height Clearance	Letter-Sized Storage	Legal-Sized Storage
	D	W	H			
18"D Drawer	12 <sup>1</sup> / <sub>6</sub> "	25 <sup>2</sup> / <sub>3</sub> "	9 <sup>1</sup> / <sub>6</sub> "	10 <sup>31</sup> / <sub>32</sub> "*	24" front-to-back* 25" side-to-side	12" front-to-back
22 <sup>3</sup> / <sub>4</sub> "D Drawer	12 <sup>1</sup> / <sub>6</sub> "	25 <sup>2</sup> / <sub>3</sub> "	9 <sup>1</sup> / <sub>6</sub> "	10 <sup>31</sup> / <sub>32</sub> "*	24" front-to-back* 25" side-to-side	12" front-to-back
24"D Drawer	15 <sup>1</sup> / <sub>6</sub> "	25 <sup>2</sup> / <sub>3</sub> "	9 <sup>1</sup> / <sub>6</sub> "	10 <sup>31</sup> / <sub>32</sub> "*	30" front-to-back* 25" side-to-side	15" front-to-back + 10" 25" side-to-side

\*Three-High and Four-High lateral files have an inside clearance height of 10<sup>1</sup>/<sub>4</sub>" on top drawer and third drawer down.

\*Two rows

### 36"W File Drawers



Size/Type	Inside Dimensions			Inside Height Clearance	Letter-Sized Storage	Legal-Sized Storage
	D	W	H			
18"D Drawer	12 <sup>1</sup> / <sub>6</sub> "	31 <sup>2</sup> / <sub>3</sub> "	9 <sup>1</sup> / <sub>6</sub> "	10 <sup>31</sup> / <sub>32</sub> "*	24" front-to-back* 31" side-to-side	24" front-to-back*
22 <sup>3</sup> / <sub>4</sub> "D Drawer	12 <sup>1</sup> / <sub>6</sub> "	31 <sup>2</sup> / <sub>3</sub> "	9 <sup>1</sup> / <sub>6</sub> "	10 <sup>31</sup> / <sub>32</sub> "*	24" front-to-back* 31" side-to-side	24" front-to-back*
24"D Drawer	15 <sup>1</sup> / <sub>6</sub> "	31 <sup>2</sup> / <sub>3</sub> "	9 <sup>1</sup> / <sub>6</sub> "	10 <sup>31</sup> / <sub>32</sub> "*	30" front-to-back* 31" side-to-side	30" front-to-back 31" side-to-side

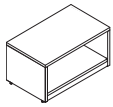
\*Three-High and Four-High lateral files have an inside clearance height of 10<sup>1</sup>/<sub>4</sub>" on top drawer and third drawer down.

\*Two rows

## Lateral File Drawers, continued

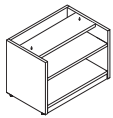
For lateral files and credenzas

### One-High Low Storage Units



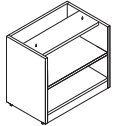
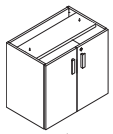
Size/Type	Inside Dimensions		
	D	W	H
30"W x 18"D	17"	28 <sup>1</sup> / <sub>4</sub> "	11 <sup>1</sup> / <sub>5</sub> "
36"W x 18"D	17"	34 <sup>1</sup> / <sub>4</sub> "	11 <sup>1</sup> / <sub>5</sub> "
42"W x 18"D	17"	40 <sup>1</sup> / <sub>4</sub> "	11 <sup>1</sup> / <sub>5</sub> "
30"W x 24"D	22 <sup>1</sup> / <sub>6</sub> "	28 <sup>1</sup> / <sub>4</sub> "	11 <sup>1</sup> / <sub>5</sub> "
36"W x 24"D	22 <sup>1</sup> / <sub>6</sub> "	34 <sup>1</sup> / <sub>4</sub> "	11 <sup>1</sup> / <sub>5</sub> "
42"W x 24"D	22 <sup>1</sup> / <sub>6</sub> "	40 <sup>1</sup> / <sub>4</sub> "	11 <sup>1</sup> / <sub>5</sub> "

### 1.5-High Low Storage Units



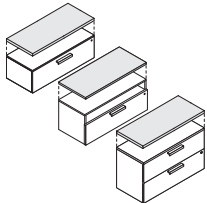
Size/Type	Inside Dimensions		
	D	W	H
30"W x 18"D	17"	28 <sup>1</sup> / <sub>4</sub> "	17 <sup>1</sup> / <sub>5</sub> "
36"W x 18"D	17"	34 <sup>1</sup> / <sub>4</sub> "	17 <sup>1</sup> / <sub>5</sub> "
42"W x 18"D	17"	40 <sup>1</sup> / <sub>4</sub> "	17 <sup>1</sup> / <sub>5</sub> "
30"W x 24"D	22 <sup>1</sup> / <sub>6</sub> "	28 <sup>1</sup> / <sub>4</sub> "	17 <sup>1</sup> / <sub>5</sub> "
36"W x 24"D	22 <sup>1</sup> / <sub>6</sub> "	34 <sup>1</sup> / <sub>4</sub> "	17 <sup>1</sup> / <sub>5</sub> "
42"W x 24"D	22 <sup>1</sup> / <sub>6</sub> "	40 <sup>1</sup> / <sub>4</sub> "	17 <sup>1</sup> / <sub>5</sub> "

### Two-High Low Storage Units



Size/Type	Inside Dimensions		
	D	W	H
30"W x 24"D	22 <sup>1</sup> / <sub>6</sub> "	28 <sup>1</sup> / <sub>4</sub> "	25 <sup>1</sup> / <sub>5</sub> "
36"W x 24"D	22 <sup>1</sup> / <sub>6</sub> "	34 <sup>1</sup> / <sub>4</sub> "	25 <sup>1</sup> / <sub>5</sub> "

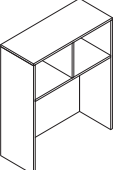
### Cushions

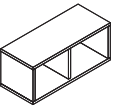


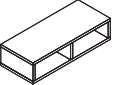
Size/Type	Inside Dimensions		
	D	W	H
30"W x 24"D	23 <sup>1</sup> / <sub>8</sub> "	30"	1"
36"W x 24"D	23 <sup>1</sup> / <sub>8</sub> "	36"	1"

*Tip: Bracing option would allow cushion to work without a top.*

## Overheads and Organizers

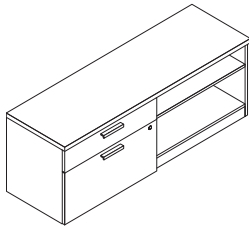
Stacking Overhead	Size/Type	Inside Dimensions		
		D	W	H
	60"W	13 <sup>9</sup> / <sub>10</sub> "	57 <sup>4</sup> / <sub>5</sub> "	12 <sup>7</sup> / <sub>8</sub> "
	66"W	13 <sup>9</sup> / <sub>10</sub> "	63 <sup>4</sup> / <sub>5</sub> "	12 <sup>7</sup> / <sub>8</sub> "
	72"W	13 <sup>9</sup> / <sub>10</sub> "	69 <sup>4</sup> / <sub>5</sub> "	12 <sup>7</sup> / <sub>8</sub> "

Overhead	Size/Type	Inside Dimensions		H (for all other)
		D (for Wall Mount)	W	
	36"W	13 <sup>1</sup> / <sub>6</sub> "	33 <sup>4</sup> / <sub>5</sub> "	12 <sup>7</sup> / <sub>8</sub> "
	42"W	13 <sup>1</sup> / <sub>6</sub> "	39 <sup>4</sup> / <sub>5</sub> "	12 <sup>7</sup> / <sub>8</sub> "
	48"W	13 <sup>1</sup> / <sub>6</sub> "	45 <sup>4</sup> / <sub>5</sub> "	12 <sup>7</sup> / <sub>8</sub> "
	54"W	13 <sup>1</sup> / <sub>6</sub> "	51 <sup>4</sup> / <sub>5</sub> "	12 <sup>7</sup> / <sub>8</sub> "
	60"W	13 <sup>1</sup> / <sub>6</sub> "	57 <sup>4</sup> / <sub>5</sub> "	12 <sup>7</sup> / <sub>8</sub> "
	66"W	13 <sup>1</sup> / <sub>6</sub> "	63 <sup>4</sup> / <sub>5</sub> "	12 <sup>7</sup> / <sub>8</sub> "
	72"W	13 <sup>1</sup> / <sub>6</sub> "	69 <sup>4</sup> / <sub>5</sub> "	12 <sup>7</sup> / <sub>8</sub> "

Organizer	Size/Type	Inside Dimensions		H (for all other)
		D (for Wall Mount)	W	
	36"W	13 <sup>1</sup> / <sub>6</sub> "	33 <sup>4</sup> / <sub>5</sub> "	6 <sup>2</sup> / <sub>5</sub> "
	42"W	13 <sup>1</sup> / <sub>6</sub> "	39 <sup>4</sup> / <sub>5</sub> "	7 <sup>2</sup> / <sub>5</sub> "
	48"W	13 <sup>1</sup> / <sub>6</sub> "	45 <sup>4</sup> / <sub>5</sub> "	8 <sup>2</sup> / <sub>5</sub> "
	54"W	13 <sup>1</sup> / <sub>6</sub> "	51 <sup>4</sup> / <sub>5</sub> "	9 <sup>2</sup> / <sub>5</sub> "
	60"W	13 <sup>1</sup> / <sub>6</sub> "	57 <sup>4</sup> / <sub>5</sub> "	10 <sup>2</sup> / <sub>5</sub> "
	66"W	13 <sup>1</sup> / <sub>6</sub> "	63 <sup>4</sup> / <sub>5</sub> "	11 <sup>2</sup> / <sub>5</sub> "
	72"W	13 <sup>1</sup> / <sub>6</sub> "	69 <sup>4</sup> / <sub>5</sub> "	12 <sup>2</sup> / <sub>5</sub> "

### Credenzas

#### Open Side, 1.5-High

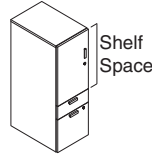


Size/Type	Inside Dimensions		
	D	W	H
60"W x 24"D	21 <sup>9</sup> / <sub>20</sub> "	29 <sup>1</sup> / <sub>20</sub> "	16 <sup>7</sup> / <sub>16</sub> "
66"W x 24"D	21 <sup>9</sup> / <sub>20</sub> "	29 <sup>1</sup> / <sub>20</sub> "	16 <sup>7</sup> / <sub>16</sub> "
72"W x 24"D	21 <sup>9</sup> / <sub>20</sub> "	35 <sup>1</sup> / <sub>20</sub> "	16 <sup>7</sup> / <sub>16</sub> "

Tip: For drawer inside dimensions, please see pedestals and lateral drawers.

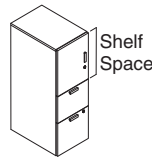
### Towers

#### Single Door, Box/File



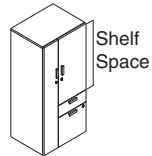
Size/Type	Inside Dimensions		
	D	W	H
42"H	22 <sup>1</sup> / <sub>5</sub> "	14 <sup>1</sup> / <sub>5</sub> "	19 <sup>1</sup> / <sub>10</sub> "
48"H	22 <sup>1</sup> / <sub>5</sub> "	14 <sup>1</sup> / <sub>5</sub> "	29 <sup>9</sup> / <sub>10</sub> "
54"H	22 <sup>1</sup> / <sub>5</sub> "	14 <sup>1</sup> / <sub>5</sub> "	31 <sup>15</sup> / <sub>32</sub> "
66"H	22 <sup>1</sup> / <sub>5</sub> "	14 <sup>1</sup> / <sub>5</sub> "	43 <sup>13</sup> / <sub>16</sub> "

#### Single Door, File/File



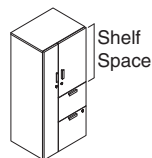
Size/Type	Inside Dimensions		
	D	W	H
42"H	22 <sup>1</sup> / <sub>5</sub> "	14 <sup>1</sup> / <sub>5</sub> "	13 <sup>1</sup> / <sub>20</sub> "
48"H	22 <sup>1</sup> / <sub>5</sub> "	14 <sup>1</sup> / <sub>5</sub> "	19 <sup>1</sup> / <sub>4</sub> "
54"H	22 <sup>1</sup> / <sub>5</sub> "	14 <sup>1</sup> / <sub>5</sub> "	25 <sup>2</sup> / <sub>5</sub> "
66"H	22 <sup>1</sup> / <sub>5</sub> "	14 <sup>1</sup> / <sub>5</sub> "	37 <sup>3</sup> / <sub>4</sub> "

#### Dual Door, Box/File



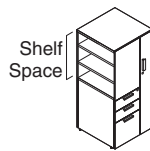
Size/Type	Inside Dimensions		
	D	W	H
42"H x 24"D	22 <sup>1</sup> / <sub>5</sub> "	14 <sup>1</sup> / <sub>5</sub> "	19 <sup>1</sup> / <sub>10</sub> "
48"H x 24"D	22 <sup>1</sup> / <sub>5</sub> "	14 <sup>1</sup> / <sub>5</sub> "	29 <sup>9</sup> / <sub>10</sub> "
54"H x 24"D	22 <sup>1</sup> / <sub>5</sub> "	14 <sup>1</sup> / <sub>5</sub> "	31 <sup>15</sup> / <sub>32</sub> "
66"H x 24"D	22 <sup>1</sup> / <sub>5</sub> "	14 <sup>1</sup> / <sub>5</sub> "	43 <sup>13</sup> / <sub>16</sub> "

#### Dual Door, File/File

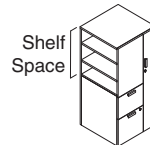


Size/Type	Inside Dimensions		
	D	W	H
42"H x 24"D	22 <sup>1</sup> / <sub>5</sub> "	14 <sup>1</sup> / <sub>5</sub> "	13 <sup>1</sup> / <sub>20</sub> "
48"H x 24"D	22 <sup>1</sup> / <sub>5</sub> "	14 <sup>1</sup> / <sub>5</sub> "	19 <sup>1</sup> / <sub>4</sub> "
54"H x 24"D	22 <sup>1</sup> / <sub>5</sub> "	14 <sup>1</sup> / <sub>5</sub> "	25 <sup>2</sup> / <sub>5</sub> "
66"H x 24"D	22 <sup>1</sup> / <sub>5</sub> "	14 <sup>1</sup> / <sub>5</sub> "	37 <sup>3</sup> / <sub>4</sub> "

#### Side Access

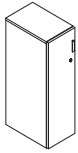


Size/Type	Inside Dimensions		
	D	W	H
42"H	15 <sup>1</sup> / <sub>20</sub> "	22 <sup>1</sup> / <sub>4</sub> "	12 <sup>7</sup> / <sub>16</sub> "
48"H	15 <sup>1</sup> / <sub>20</sub> "	22 <sup>1</sup> / <sub>4</sub> "	18 <sup>3</sup> / <sub>5</sub> "
54"H	15 <sup>1</sup> / <sub>20</sub> "	22 <sup>1</sup> / <sub>4</sub> "	24 <sup>25</sup> / <sub>32</sub> "
66"H	15 <sup>1</sup> / <sub>20</sub> "	22 <sup>1</sup> / <sub>4</sub> "	37 <sup>5</sup> / <sub>32</sub> "



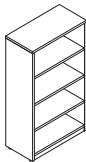
Tip: For drawer inside dimensions, please see pedestals and lateral drawers.

## Wardrobes



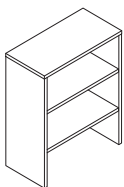
Size/Type	Inside Dimensions		
	D	W	H
42"H x 24"D	22 <sup>1</sup> / <sub>5</sub> "	10 <sup>1</sup> / <sub>4</sub> "	36 <sup>13</sup> / <sub>16</sub> "
48"H x 24"D	22 <sup>1</sup> / <sub>5</sub> "	10 <sup>1</sup> / <sub>4</sub> "	43"
54"H x 24"D	22 <sup>1</sup> / <sub>5</sub> "	10 <sup>1</sup> / <sub>4</sub> "	49 <sup>1</sup> / <sub>5</sub> "

## Bookcases



Size/Type	Inside Dimensions		Top Shelf Space	Bottom Shelf Space	Row of Binders Accommodated
	D	W			
42"H x 30"W	14 <sup>5</sup> / <sub>36</sub> "	27 <sup>4</sup> / <sub>5</sub> "	12 <sup>19</sup> / <sub>32</sub> "	9 <sup>17</sup> / <sub>18</sub> "	2
48"H x 30"W	14 <sup>5</sup> / <sub>36</sub> "	27 <sup>4</sup> / <sub>5</sub> "	13 <sup>31</sup> / <sub>32</sub> "	12 <sup>3</sup> / <sub>16</sub> "	2
54"H x 30"W	14 <sup>5</sup> / <sub>36</sub> "	27 <sup>4</sup> / <sub>5</sub> "	12 <sup>1</sup> / <sub>8</sub> "	9 <sup>17</sup> / <sub>18</sub> "	3
66"H x 30"W	14 <sup>5</sup> / <sub>36</sub> "	27 <sup>4</sup> / <sub>5</sub> "	11 <sup>11</sup> / <sub>32</sub> "	9 <sup>17</sup> / <sub>18</sub> "	4
72"H x 30"W	14 <sup>5</sup> / <sub>36</sub> "	27 <sup>4</sup> / <sub>5</sub> "	13 <sup>1</sup> / <sub>5</sub> "	9 <sup>17</sup> / <sub>18</sub> "	4
42"H x 36"W	14 <sup>5</sup> / <sub>36</sub> "	33 <sup>4</sup> / <sub>5</sub> "	12 <sup>19</sup> / <sub>32</sub> "	9 <sup>17</sup> / <sub>18</sub> "	2
48"H x 36"W	14 <sup>5</sup> / <sub>36</sub> "	33 <sup>4</sup> / <sub>5</sub> "	13 <sup>31</sup> / <sub>32</sub> "	12 <sup>3</sup> / <sub>16</sub> "	2
54"H x 36"W	14 <sup>5</sup> / <sub>36</sub> "	33 <sup>4</sup> / <sub>5</sub> "	12 <sup>1</sup> / <sub>8</sub> "	9 <sup>17</sup> / <sub>18</sub> "	3
66"H x 36"W	14 <sup>5</sup> / <sub>36</sub> "	33 <sup>4</sup> / <sub>5</sub> "	11 <sup>11</sup> / <sub>32</sub> "	9 <sup>17</sup> / <sub>18</sub> "	4
72"H x 36"W	14 <sup>5</sup> / <sub>36</sub> "	33 <sup>4</sup> / <sub>5</sub> "	13 <sup>1</sup> / <sub>5</sub> "	9 <sup>17</sup> / <sub>18</sub> "	4

## Stacking Bookcases



Size/Type	Inside Dimensions		Top Shelf Space	Bottom Shelf Space	2nd from Bottom
	D	W			
25 <sup>5</sup> / <sub>8</sub> "H x 30"W	14 <sup>1</sup> / <sub>10</sub> "	27 <sup>3</sup> / <sub>4</sub> "	12 <sup>1</sup> / <sub>8</sub> "	11 <sup>2</sup> / <sub>5</sub> "	N.A.
37 <sup>3</sup> / <sub>32</sub> "H x 30"W	14 <sup>1</sup> / <sub>10</sub> "	27 <sup>3</sup> / <sub>4</sub> "	11 <sup>3</sup> / <sub>8</sub> "	11 <sup>2</sup> / <sub>5</sub> "	12 <sup>3</sup> / <sub>16</sub> "
44 <sup>3</sup> / <sub>16</sub> "H x 30"W	14 <sup>1</sup> / <sub>10</sub> "	27 <sup>3</sup> / <sub>4</sub> "	13 <sup>1</sup> / <sub>4</sub> "	13 <sup>5</sup> / <sub>8</sub> "	14 <sup>1</sup> / <sub>5</sub> "
25 <sup>5</sup> / <sub>8</sub> "H x 36"W	14 <sup>1</sup> / <sub>10</sub> "	33 <sup>3</sup> / <sub>4</sub> "	12 <sup>1</sup> / <sub>8</sub> "	11 <sup>2</sup> / <sub>5</sub> "	N.A.
37 <sup>3</sup> / <sub>32</sub> "H x 36"W	14 <sup>1</sup> / <sub>10</sub> "	33 <sup>3</sup> / <sub>4</sub> "	11 <sup>3</sup> / <sub>8</sub> "	11 <sup>2</sup> / <sub>5</sub> "	12 <sup>3</sup> / <sub>16</sub> "
44 <sup>3</sup> / <sub>16</sub> "H x 36"W	14 <sup>1</sup> / <sub>10</sub> "	33 <sup>3</sup> / <sub>4</sub> "	13 <sup>1</sup> / <sub>4</sub> "	13 <sup>5</sup> / <sub>8</sub> "	14 <sup>1</sup> / <sub>5</sub> "

# EMBANK Finish Availability Matrix

	Credenzas	Desks	Common Tops	D and P Shape Tops	Fixed Pedestals	Mobile Pedestals	Low Storage/Lateral Files	3/4 High Laterals	Bridges	Towers/Wardrobes	Book-cases	Overheads/Organizers
<b>Top</b>	X	X	X	X	X	X	X	X	X			
<b>Case</b>	X	X		X	X	X	X	X	X	X	X	X
<b>Headset</b>	X	X			X	X	X	X		X		X
<b>Edgeband</b>	X	X	X	X		X	X	X	X			

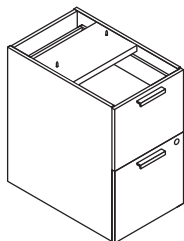
Tip: Social tables are available with contrasting top and edgeband finish, collaborative tables must have matching tops and edge bands.

Tip: Rectangular conference tables allow for a contrasting base in addition to the top and edgeband.

## Edgeband Finish      Top, Case, and Headset Finish

6009 Arctic White	2L30 Arctic White
6034 Natural Cherry	26L1 Natural Cherry
6052 Milk	2L84 Milk
6053 Seagull	2L83 Seagull
6213 Acacia	2LAT Acacia
6219 Clear Oak	2LAK Clear Oak
6231 Graphite Walnut	24L0 Graphite Walnut
6237 Clear Maple	2L09 Clear Maple
6242 Virginia Walnut	25L5 Virginia Walnut
6245 Clear Walnut	25L8 Clear Walnut
6703 Ash Wenge	2LAW Ash Wenge
6706 Clay Wenge	2LCW Clay Wenge
6709 Clay Noce	2LCN Clay Noce





*Tip: Specify fixed pedestals as structural support. It is recommended to use fixed pedestals under a common top.*

*Tip: Fixed pedestals cannot be specified for credenzas or desks. If storage is required for credenzas or desks, please specify these products with storage already attached.*

### Standard Includes

- Fixed pedestal, 1.5-High and Two-High: Low-Pressure Laminate case with matching or contrasting Low-Pressure Laminate headset
- Finished back
- Bore and dowel drawer construction: black
- One fastened metal filing system per file drawer: black only
- Full extension, heavy-duty ball bearing drawer suspensions
- One pencil tray is included in units with a box drawer
- Lock plug
- Lock cylinder included in package, field-installed
- Counterweight
- Attachment hardware
- 1 1/4" adjustable leveling glides
- Shipped fully assembled

### Options

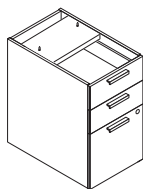
Depth	24"	Price below
	30"	Price below
Case Finish	Laminate LPL Price Group 01	No cost
Headset Finish	Laminate LPL Price Group 01	No cost
Pull	Ledge Pull	No cost
Pull Finish	Paint Price Group 01	No cost
	Paint Price Group 02	No cost
Drawer Configuration	Box/Box/File	Price below
	File/File	Price below
Keys	Standard Key Plug	No cost
	Master Key Plug	+\$37
Lock Finish	Polished Chrome	No cost

### Specification Information

Dimensions			Style	Base
D	W	H	Number	Prices
				LPL Case
				LPL Headset

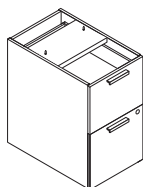
### Two-High Fixed Pedestals

#### Two Box Drawers, and One File Drawer



24"	15 3/4"	27 5/16"	<b>AMQCRPD2HBBF</b>	\$1045
30"	15 3/4"	27 5/16"	<b>AMQCRPD2HBBF</b>	\$1164

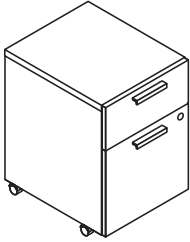
#### Two File Drawers



24"	15 3/4"	27 5/16"	<b>AMQCRPD2HFF</b>	\$1045
30"	15 3/4"	27 5/16"	<b>AMQCRPD2HFF</b>	\$1164

# Embank

## Mobile Pedestals



Tip: Specify mobile pedestals as stand-alone unit.

### Standard Includes

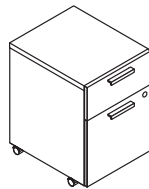
- Mobile pedestal, 1.5-High and Two-High: Low-Pressure Laminate case with matching or contrasting Low-Pressure Laminate headset
- Top: Low-Pressure Laminate price group 01
- Finished back
- Bore and dowel drawer construction: black
- One fastened metal filing system per file drawer: black only
- Full extension, heavy-duty ball bearing drawer suspensions
- Lock plug
- Lock cylinder included in package, field-installed
- Shipped fully assembled

### Options

Depth	18 7/8" 22"	Price below Price below
Cushion Finish	Billiard	No cost
Case Finish	Laminate LPL Price Group 01	Price below
Headset Finish	Laminate LPL Price Group 01	Price below
Top Surface Finish	Laminate LPL Price Group 01	No cost
Edge Finish	Plastic - PG1	No cost
Pull	Ledge Pull	No cost
Pull Finish	Paint Price Group 01 Paint Price Group 02	No cost No cost
Keys	Standard Key Plug Master Key Plug	No cost +\$37
Lock Finish	Polished Chrome	No cost
Drawer Configuration	Box/Box/File File/File	Price below Price below

### Specification Information

Dimensions			Style Number	Base Prices
D	W	H		
				LPL Case
				LPL Headset and Top



### 1.5-High Mobile Pedestals

#### One Box Drawer and One File Drawer

18 7/8"	15 3/4"	23 2/3"	<b>AMQCRMP15H</b>	\$840
22"	15 3/4"	23 2/3"	<b>AMQCRMP15H</b>	\$904

► Product Information continued on next page

▶ **Product Information continued from previous page**

**Specification Information**

Dimensions			Style	Base
D	W	H	Number	Prices
				LPL Case
				LPL Headset and Top

**Two-High Mobile Pedestals**

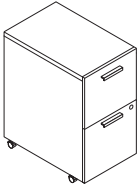
*Tip: Two-High mobile pedestals with a cushion top will not fit under a desk.*

**Two Box Drawers and One File Drawer**



22"	15 3/4"	27"	<b>AMQCRMP2HBBF</b>	\$1241
-----	---------	-----	---------------------	--------

**Two File Drawers**

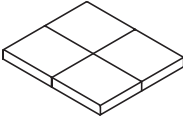


22"	15 3/4"	27"	<b>AMQCRMP2HFF</b>	\$1241
-----	---------	-----	--------------------	--------

Dimensions			Style	Base
D	W	H	Number	Price

**Pedestal Cushion Top**

*Tip: Two-High mobile pedestals with a cushion top will not fit under a desk.*

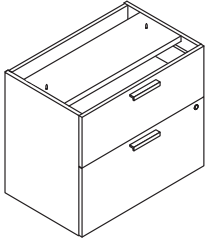


22"	15 3/4"	1 3/4"	<b>AMQCRC</b>	\$426
-----	---------	--------	---------------	-------



# Embank

## One-High, 1.5-High, and Two-High Lateral Files



### Standard Includes

- Lateral file: Low-Pressure Laminate case with matching or contrasting Low-Pressure Laminate headset
- 1" thick top, if selected: Low-Pressure Laminate price group 01
- Finished back
- Bore and dowel laminate drawer construction: black only
- One fastened metal filing system per file drawer: black only
- Full extension, heavy-duty ball bearing drawer suspensions
- Counterweight
- Attachment hardware
- 1 1/4" adjustable leveling glides
- Shipped fully assembled

### Options

Depth	24"	Price below
Width	30"	Price below
	36"	Price below
Top Option	No Top	No cost
	With Top	Price below
Top Surface Finish	Laminate LPL Price Group 01	No cost
Edge Finish	Plastic - PG1	No cost
Drawer Configuration	Box/File	Price below
	File	Price below
	File/File	Price below
Application	Full	No cost
Case Finish	Laminate LPL Price Group 01	No cost
Headset Finish	Laminate LPL Price Group 01	No cost
Lock Finish	Polished Chrome	No cost
Keys	Key Plug	No cost
	Master Key Plug	+\$37
Pull	Ledge Pull	No cost
Pull Finish	Paint Price Group 01	No cost
	Paint Price Group 02	No cost

### Specification Information

#### With Top Option Upcharges

Dimensions		Options
D	W	(Add \$ to Base Price)
LPL		
24"	30"	+\$158
24"	36"	+\$165

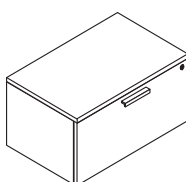
► **Product Information continued on next page**

▶ **Product Information continued from previous page****Specification Information**

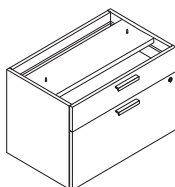
Dimensions			Style Number	Base Prices LPL Case LPL Headset
D	W	H		

**One-High Laterals****One File Drawer**

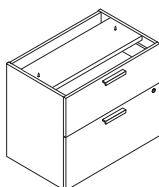
24"	30"	15 3/8"	<b>AMQCRL1H</b>	\$1053
24"	36"	15 3/8"	<b>AMQCRL1H</b>	\$1108

**1.5-High Laterals****One Box, One File Drawer**

24"	30"	21 3/8"	<b>AMQCRL15HBF</b>	\$1370
24"	36"	21 3/8"	<b>AMQCRL15HBF</b>	\$1441

**Two-High Laterals****Two File Drawers**

24"	30"	27 5/16"	<b>AMQCRL2H</b>	\$1563
24"	36"	27 5/16"	<b>AMQCRL2H</b>	\$1644



# Embank

## Three-High and Four-High Lateral Files



### Standard Includes

- Lateral file: Low-Pressure Laminate case with matching or contrasting Low-Pressure Laminate headset
- 1 1/8" thick top: Low-Pressure Laminate price group 01
- Finished back
- Bore and dowel laminate drawer construction: black only
- One fastened metal filing system per file drawer: black only
- Full extension, heavy-duty ball bearing drawer suspensions
- Counterweight
- Attachment hardware
- 1 1/4" adjustable leveling glides
- Shipped fully assembled

### Options

Depth	18 7/8"	Price below
Width	30"	Price below
	36"	Price below
Top Option	With Top	No cost
Top Surface Finish	Laminate LPL Price Group 01	No cost
Lock Finish	Polished Chrome	No cost
Keys	Key Plug	No cost
	Master Key Plug	+\$37
Pull	Ledge Pull	No cost
Pull Finish	Paint Price Group 01	No cost
	Paint Price Group 02	No cost

### Specification Information

Dimensions			Style	Base
D	W	H	Number	Prices
				LPL Case
				LPL Headset

### Three-High Laterals

18 7/8"	30"	39 1/5"	<b>AMQCRL3H</b>	\$2599
18 7/8"	36"	39 1/5"	<b>AMQCRL3H</b>	\$2747



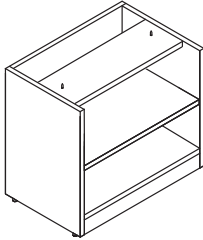
### Four-High Laterals

18 7/8"	30"	51 1/5"	<b>AMQCRL4H</b>	\$2852
18 7/8"	36"	51 1/5"	<b>AMQCRL4H</b>	\$2945



# Embank

## One-High, 1.5-High, and Two-High Lower Storage



### Standard Includes

- Lower storage, if Two-High lower storage is selected: Low-Pressure Laminate case with matching or contrasting Low-Pressure Laminate headset
- 1" thick top, if selected: Low-Pressure Laminate price group 01
- Finished back
- Door option type on Two-High lower storage, if selected
- Pulls on Two-High lower storage, if selected
- Lock on Two-High lower storage, if selected: lock plug
- Lock cylinder included in package, field-installed
- Attachment hardware
- 1 1/4" adjustable leveling glides
- Shipped fully assembled

### Options

Depth	24"	Price below
Width	30"	Price below
	36"	Price below
Top Option	No Top	No cost
	With Top	Price below
Worksurface Thickness	1 1/8"	No cost
Application	Full	No cost
Lock Finish	Polished Chrome	No cost
Keys	Key Plug	No cost
	Master Key Plug	+\$37
Pull	Ledge Pull	No cost
Pull Finish	Paint Price Group 01	No cost
	Paint Price Group 02	No cost
Door Option	Open Door	No cost
	Double Door	Price below

### Specification Information

#### With Top Option Upcharges

Dimensions		Options
D	W	(Add \$ to Base Price)
		LPL PG1
24"	30"	+\$158
24"	36"	+\$165

► **Product Information continued on next page**

# Embank

## One-High, 1.5-High, and Two-High Lower Storage

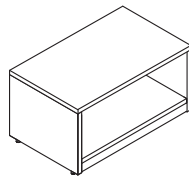
► **Product Information continued from previous page**

### Specification Information

Dimensions			Style	Base
D	W	H	Number	Prices
				LPL Case
				LPL Headset

### One-High Lower Storage

*Pricing at right is for case only. Headsets are not available on open units.*

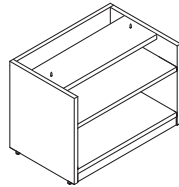


#### Open Configuration

24"	30"	15 3/8"	<b>AMQCRLS1H</b>	\$643
24"	36"	15 3/8"	<b>AMQCRLS1H</b>	\$677

### 1.5-High Lower Storage

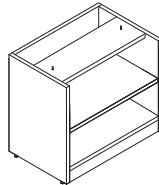
*Pricing at right is for case only. Headsets are not available on open units.*



24"	30"	21 3/8"	<b>AMQCRLS15HO</b>	\$880
24"	36"	21 3/8"	<b>AMQCRLS15HO</b>	\$925

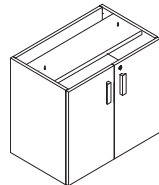
### Two-High Lower Storage - Open

*Pricing at right is for case only. Headsets are not available on open units.*



24"	30"	27 5/16"	<b>AMQCRLS2HO</b>	\$945
24"	36"	27 5/16"	<b>AMQCRLS2HO</b>	\$981

### Two-High Lower Storage with Doors

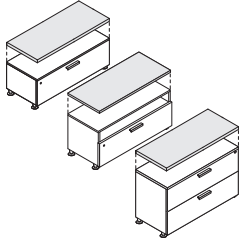


24"	30"	27 5/16"	<b>AMQCRLS2HD</b>	\$1039
24"	36"	27 5/16"	<b>AMQCRLS2HD</b>	\$1089



# Embank

Basic Cushions Enhanced



Tip: Cushion is constructed with a thin solid base.

Tip: Cushion is field-installed and supplies to attach are included.

### Standard Includes

- Enhanced cushion top: fabric price group 03
- Attachment supplies: hook and loop fastener
- Storage brace

### Options

Cushion Finish	Billiard	+\$61
Storage Brace	With Brace	No cost

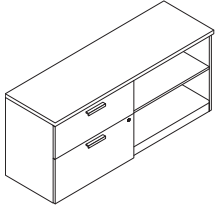
### Specification Information

Dimensions			Style	Base
D	W	H	Number	Price
23 1/8"	30"	1"	<b>AMQRCHE2430</b>	\$499
23 1/8"	36"	1"	<b>AMQRCHE2436</b>	\$516



# Embank

## Credenzas



Left-hand unit

Tip: Counterweight type and quantity varies depending on size and storage configuration. Please refer to the electronic catalog or SmartTools.

Tip: Top is not standard.

### Standard Includes

- Two-High credenza: Low-Pressure Laminate case with matching or contrasting Low-Pressure Laminate headset
- 1 1/8" thick top: Low-Pressure Laminate price group 01
- Adjustable shelf on open storage configuration and cabinet storage configuration
- Finished back
- Lock plug
- Lock cylinder included in package, field-installed
- Counterweight included on units with drawers
- 1 1/4" leveling glides
- Shipped fully assembled

### Options

Depth	24"	Price below
Width	60"	Price below
	66"	Price below
	72"	Price below
Case Finish	Laminate LPL Price Group 01	No cost
Headset Finish	Laminate LPL Price Group 01	No cost
Storage Type	Cabinet/Cabinet	Price below
	Lateral File/Cabinet	Price below
	Lateral File/Lateral File	Price below
	Open/Lateral File	Price below
Top Option	No Top	No cost
	With Top	Price below
Top Surface Finish	Laminate LPL Price Group 01	No cost
Edge Finish	Plastic - PG1	No cost
Application	Full	No cost
Keys	Standard Key Plug	No cost
	Master Key Plug	+\$37
Lock Finish	Polished Chrome	No cost
Pull	Ledge Pull	No cost
Pull Finish	Paint Price Group 01	No cost
	Paint Price Group 02	No cost

### Specification Information

#### With Top Option Upcharges

Dimensions		Options
D	W	(Add \$ to Base Price)
		LPL
24"	60"	+\$239
24"	66"	+\$269
24"	72"	+\$300

► **Product Information continued on next page**

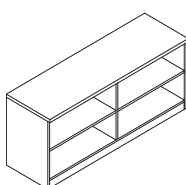
► **Product Information continued from previous page**

### Specification Information

Dimensions			Style Number	Base Prices
D	W	H		
				LPL Case
				LPL Headset

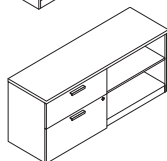
### Two-High Credenzas

*Tip: Height is shown without top.*



#### Open/Open File Configuration

24"	60"	27 5/16"	<b>AMQCRC2HFS00</b>	\$1531
24"	66"	27 5/16"	<b>AMQCRC2HFS00</b>	\$1611
24"	72"	27 5/16"	<b>AMQCRC2HFS00</b>	\$1694



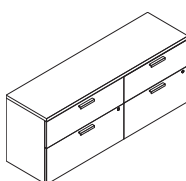
#### Lateral/Open File Configuration

24"	60"	27 5/16"	<b>AMQCRC2HFSLFL</b>	\$2041
24"	66"	27 5/16"	<b>AMQCRC2HFSLFL</b>	\$2137
24"	72"	27 5/16"	<b>AMQCRC2HFSLFL</b>	\$2240

Left-hand unit

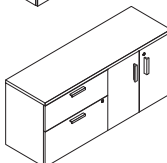
#### Open/Lateral File Configuration

24"	60"	27 5/16"	<b>AMQCRC2HFSLFR</b>	\$2041
24"	66"	27 5/16"	<b>AMQCRC2HFSLFR</b>	\$2137
24"	72"	27 5/16"	<b>AMQCRC2HFSLFR</b>	\$2240



#### Lateral File/Lateral File Configuration

24"	60"	27 5/16"	<b>AMQCRC2HFSLL</b>	\$2648
24"	66"	27 5/16"	<b>AMQCRC2HFSLL</b>	\$2764
24"	72"	27 5/16"	<b>AMQCRC2HFSLL</b>	\$2887



#### Lateral File/Cabinet Configuration

24"	60"	27 5/16"	<b>AMQCRC2HFSLCLFL</b>	\$2137
24"	66"	27 5/16"	<b>AMQCRC2HFSLCLFL</b>	\$2240
24"	72"	27 5/16"	<b>AMQCRC2HFSLCLFL</b>	\$2347

Left-hand unit

#### Cabinet/Lateral File Configuration

24"	60"	27 5/16"	<b>AMQCRC2HFSLCLFR</b>	\$2137
24"	66"	27 5/16"	<b>AMQCRC2HFSLCLFR</b>	\$2240
24"	72"	27 5/16"	<b>AMQCRC2HFSLCLFR</b>	\$2347

► **Product Information continued on next page**

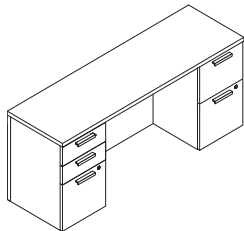
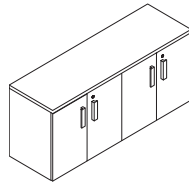
# Embank

## Credenzas

► **Product Information continued from previous page**

### Specification Information

Dimensions	Style Number	Base Prices	
		LPL Case	LPL Headset
D W H			
<b>Cabinet/Cabinet Configuration</b>			
24" 60" 27 5/16"	<b>AMQCRCD2HFSCC</b>	\$1683	
24" 66" 27 5/16"	<b>AMQCRCD2HFSCC</b>	\$1770	
24" 72" 27 5/16"	<b>AMQCRCD2HFSCC</b>	\$1864	



*Tip: Counterweight type and quantity varies depending on size and storage configuration. Please refer to the electronic catalog or SmartTools.*

*Tip: Grain direction of modesty panel runs horizontally. Grain direction of pedestals runs vertically.*

### Standard Includes

- Two-High credenza with kneespace Low-Pressure Laminate case with matching or contrasting Low-Pressure Laminate headset
- 1 1/8" thick top: Low-Pressure Laminate price group 01
- Finished back
- Modesty panel
- Bore and dowel drawer construction: black
- One fastened metal filing system per file drawer: black only
- Full extension, heavy-duty ball bearing drawer suspensions
- One pencil tray is included in units with a box drawer
- Lock cylinder included in package, field-installed
- Lock plug
- Counterweight
- 1 1/4" leveling glides
- Shipped fully assembled

### Options

Depth	24"	Price below
Width	66"	Price below
	72"	Price below
Case Finish	Laminate LPL Price Group 01	No cost
Headset Finish	Laminate LPL Price Group 01	No cost
Top Option	With Top	No cost
Top Surface Finish	Laminate LPL Price Group 01	No cost
Edge Finish	Plastic - PG1	No cost
Application	Full	No cost
Modesty Panel	Full	No cost
	Quarter Height	No cost
Support - Right	Box/Box/File Pedestal	No cost
	File/File Pedestal	No cost

► **Product Information continued on next page**

► **Product Information continued from previous page**

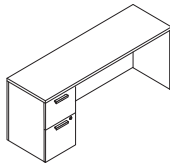
*Tip: Pedestals can be specified as a file/file or box/box/file configurations.*

Options		
Support - Left	Box/Box/File Pedestal	No cost
	File/File Pedestal	No cost
Keys	Standard Key Plug	No cost
	Master Key Plug	+\$37
Lock Finish	Polished Chrome	No cost
Pull	Ledge Pull	No cost
Pull Finish	Paint Price Group 01	No cost
	Paint Price Group 02	No cost

**Specification Information**

Dimensions			Style	Base
D	W	H	Number	Prices
				LPL Case
				LPL Headset

**Two-High Credenzas with Kneespace**



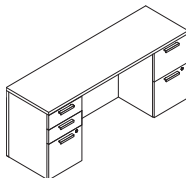
Left-hand unit

**Left Pedestal Configuration**

24"	66"	28 7/16"	<b>AMQCRCD2HKSSPL</b>	\$1923
24"	72"	28 7/16"	<b>AMQCRCD2HKSSPL</b>	\$2046

**Right Pedestal Configuration**

24"	66"	28 7/16"	<b>AMQCRCD2HKSSPR</b>	\$1923
24"	72"	28 7/16"	<b>AMQCRCD2HKSSPR</b>	\$2046



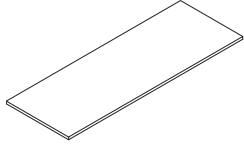
**Double Pedestal Configuration**

24"	66"	28 7/16"	<b>AMQCRCD2HKSDP</b>	\$2480
24"	72"	28 7/16"	<b>AMQCRCD2HKSDP</b>	\$2628



# Embank

## Common Top



### Standard Includes

- 1 1/8" thick top: Low-Pressure Laminate price group 01
- 3 mm edgeband on user's side: plastic price group 01
- 1 mm edgeband on sides and back: plastic price group 01

### Options

Depth	18 7/8"	Price below
	24"	Price below
	30"	Price below
Width	45.68750 in	Price below
	51.68750 in	Price below
	59.75000 in	Price below
	65.75000 in	Price below
	71.75000 in	Price below
	89.56250 in	Price below
	95.81250 in	Price below
Top Surface Finish	Laminate LPL Price Group 01	Price below
Edge Finish	Plastic - PG1	No cost

### Specification Information

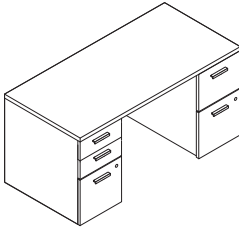
Style Number	Dimensions		Base Prices						
	Modular		Modular						
	Depth	Width	46"W	52"W	60"W	66"W	72"W	90"W	96"W

### Common Top

AMQCRCT	Dimensions	\$164	\$198	\$211	\$228	\$266	\$399	\$424
	18 7/8"D							
	24"D	\$178	\$211	\$226	\$239	\$269	\$446	\$461
	30"D	\$239	\$272	\$292	\$311	\$338	\$498	\$519

# Embank

## Desks and Desk Shells



Tip: Counterweight type and quantity varies depending on size and storage configuration. Please refer to the electronic catalog or SmartTools.

### Standard Includes

- Desk and desk shells with pedestal, if specified: Low-Pressure Laminate case with matching or contrasting Low-Pressure Laminate headset
- 1 1/8" thick top: Low-Pressure Laminate price group 01
- 3 mm radius profile edge on user's side: plastic
- 1 mm edgeband on sides and back: plastic price group 01
- Finished back
- Modesty panel
- Bore and dowel drawer construction: black
- One fastened metal filing system per file drawer: black only
- Full extension, heavy-duty ball bearing drawer suspensions
- Lock plug
- Lock cylinder included in package, field-installed
- Counterweight
- 1 1/4" adjustable leveling glides
- Desk shells shipped ready to assemble
- Desk with pedestal(s) shipped fully assembled
- One pencil tray is included in units with a box drawer

### Options

Depth	24"	Price below
	30"	Price below
	36"	Price below
Width	60"	Price below
	66"	Price below
	72"	Price below
Case Finish	Laminate LPL Price Group 01	No cost
Top Surface Finish	Laminate LPL Price Group 01	No cost
Edge Finish	Plastic - PG1	No cost
Support - Right	Box/Box/File Pedestal	No cost
	File/File Pedestal	No cost
	Full Depth End Panel	No cost
Support - Left	Box/Box/File Pedestal	No cost
	File/File Pedestal	No cost
	Full Depth End Panel	No cost
Modesty Panel	Full	No cost
	Quarter Height	No cost
Headset Finish	Laminate LPL Price Group 01	No cost
Keys	Key Plug	No cost
	Master Key Plug	+\$37
Lock Finish	Polished Chrome	No cost
Pull	Ledge Pull	No cost
Pull Finish	Paint Price Group 01	No cost
	Paint Price Group 02	No cost

Tip: Lock for the box/box/file configuration does not lock the top box drawer.

Tip: Pedestals can be specified as a file/file or box/box/file configurations.

Tip: Grain direction of modesty panel runs horizontally. Grain direction of pedestals runs vertically.

► **Product Information continued on next page**

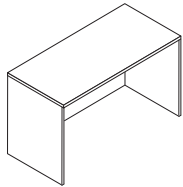


# Embank

## Desks and Desk Shells

► Product Information continued from previous page

### Specification Information



Dimensions			Style	Base
D	W	H	Number	Prices
				LPL Case

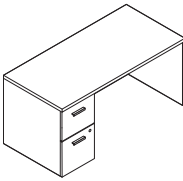
#### Desk Shell with Two Full Depth End Panels

24"	60"	28 7/16"	<b>AMQCRDSSL</b>	\$782
24"	66"	28 7/16"	<b>AMQCRDSSL</b>	\$820
24"	72"	28 7/16"	<b>AMQCRDSSL</b>	\$848
30"	60"	28 7/16"	<b>AMQCRDSSL</b>	\$827
30"	66"	28 7/16"	<b>AMQCRDSSL</b>	\$863
30"	72"	28 7/16"	<b>AMQCRDSSL</b>	\$897
36"	72"	28 7/16"	<b>AMQCRDSSL</b>	\$1114

Dimensions			Style	Base
D	W	H	Number	Prices
				LPL Case
				LPL Headset

#### Desk with One Full Depth End Panel and Left-Hand Pedestal

30"	60"	28 7/16"	<b>AMQCRDSKSL</b>	\$1803
30"	66"	28 7/16"	<b>AMQCRDSKSL</b>	\$1904
30"	72"	28 7/16"	<b>AMQCRDSKSL</b>	\$2001
36"	72"	28 7/16"	<b>AMQCRDSKSL</b>	\$2095



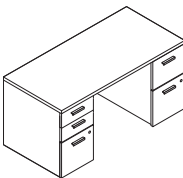
Tip: Pedestals can be specified as a file/file or box/box/file configuration.

#### Desk with One Full Depth End Panel and Right-Hand Pedestal

30"	60"	28 7/16"	<b>AMQCRDSKSPR</b>	\$1803
30"	66"	28 7/16"	<b>AMQCRDSKSPR</b>	\$1904
30"	72"	28 7/16"	<b>AMQCRDSKSPR</b>	\$2001
36"	72"	28 7/16"	<b>AMQCRDSKSPR</b>	\$2095

#### Desk with Two Pedestals

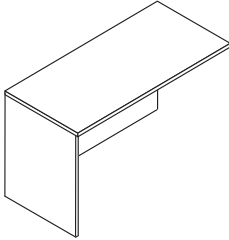
30"	60"	28 7/16"	<b>AMQCRDSKDP</b>	\$2448
30"	66"	28 7/16"	<b>AMQCRDSKDP</b>	\$2572
30"	72"	28 7/16"	<b>AMQCRDSKDP</b>	\$2693
36"	72"	28 7/16"	<b>AMQCRDSKDP</b>	\$2812





# Embank

## Returns and Return Shells



### Standard Includes

- Return and return shells: Low-Pressure Laminate case with matching or contrasting Low-Pressure Laminate headset
- 1 1/8" thick top: Low-Pressure Laminate price group 01
- 3 mm edgeband on user's side: plastic
- 1 mm edgeband on sides and back: plastic price group 01
- Finished back
- Modesty panel
- Bore and dowel drawer construction: black
- One fastened metal filing system per file drawer: black only
- Full extension, heavy-duty ball bearing drawer suspensions
- Lock plug
- Lock cylinder included in package, field-installed
- Attachment hardware
- 1 1/4" adjustable leveling glides
- Returns shipped fully assembled
- Return shells shipped ready to assemble

### Options

Depth	24"	Price below
Width	42"	Price below
	48"	Price below
Case Finish	Laminate LPL Price Group 01	No cost
Top Surface Finish	Laminate LPL Price Group 01	No cost
Edge Finish	Plastic - PG1	No cost
Handedness	Left Hand	No cost
	Right Hand	No cost
Support - Left	Box/Box/File Pedestal	No cost
	File/File Pedestal	No cost
	Full Depth End Panel	No cost
Modesty Panel	Full	No cost
	Quarter Height	No cost
Support - Right	Box/Box/File Pedestal	No cost
	File/File Pedestal	No cost
	Full Depth End Panel	No cost
Headset Finish	Laminate LPL Price Group 01	No cost
Keys	Key Plug	No cost
	Master Key Plug	+\$37
Lock Finish	Polished Chrome	No cost
Pull	Ledge Pull	No cost
Pull Finish	Paint Price Group 01	No cost
	Paint Price Group 02	No cost

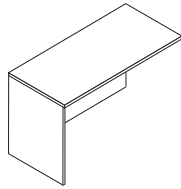
► **Product Information continued on next page**

# Embank

## Returns and Return Shells

► Product Information continued from previous page

### Specification Information



Dimensions			Style	Base
D	W	H	Number	Prices
				LPL Case

#### Return Shell with One Left-Hand Full Depth End Panel

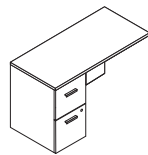
24"	42"	28 7/16"	<b>AMQCRRTNL</b>	\$626
-----	-----	----------	------------------	-------

24"	48"	28 7/16"	<b>AMQCRRTNL</b>	\$683
-----	-----	----------	------------------	-------

#### Return Shell with One Right-Hand Full Depth End Panel

24"	42"	28 7/16"	<b>AMQCRRTNR</b>	\$626
-----	-----	----------	------------------	-------

24"	48"	28 7/16"	<b>AMQCRRTNR</b>	\$683
-----	-----	----------	------------------	-------



Left-hand unit

Dimensions			Style	Base
D	W	H	Number	Prices
				LPL Case
				LPL Headset

#### Return with One Left-Hand Pedestal

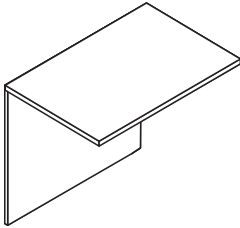
24"	42"	28 7/16"	<b>AMQCRRTNSPL</b>	\$1297
-----	-----	----------	--------------------	--------

24"	48"	28 7/16"	<b>AMQCRRTNSPL</b>	\$1419
-----	-----	----------	--------------------	--------

#### Return with One Right-Hand Pedestal

24"	42"	28 7/16"	<b>AMQCRRTNSPR</b>	\$1297
-----	-----	----------	--------------------	--------

24"	48"	28 7/16"	<b>AMQCRRTNSPR</b>	\$1419
-----	-----	----------	--------------------	--------



**Standard Includes**

- Bridge: Low-Pressure Laminate price group 01
- 1" thick top, if selected: Low-Pressure Laminate price group 01
- Attachment bracket
- 3 mm edgeband on user's side: plastic price group 01
- 1 mm edgeband on sides and back: plastic price group 01
- Modesty panel
- Ships ready to assemble

**Options**

Depth	24"	Price below
Width	36"	Price below
	42"	Price below
	48"	Price below
Case Finish	Laminate LPL Price Group 01	No cost
Top Surface Finish	Laminate LPL Price Group 01	No cost
Edge Finish	Plastic - PG1	No cost
Modesty Panel	Full	No cost
	Quarter Height	No cost

**Specification Information**

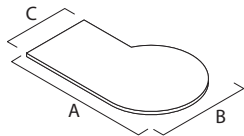
Dimensions			Style	Base
D	W	H	Number	Prices
				LPL Case

<b>Bridge</b>				
24"	36"	27 5/12"	<b>AMQCRBRG</b>	\$468
24"	42"	27 5/12"	<b>AMQCRBRG</b>	\$498
24"	48"	27 5/12"	<b>AMQCRBRG</b>	\$535



# Embank

## D-Shape and P-Shape Worksurfaces



Right-hand unit

Tip: Width and Depth is specified for the D-Shape Top.

Tip: Width A, Depth B, and Depth C is specified for the P-Shape Top.

Tip: Right-hand P-shape worksurfaces pair with left-hand returns. Left-hand P-shape worksurfaces pair with right-hand returns.

### Standard Includes

- Worksurface: Low-Pressure Laminate case with matching or contrasting Low-Pressure Laminate top
- Column leg: paint price group 01
- Adjusting leveling glides
- Ships ready to assemble

### Options

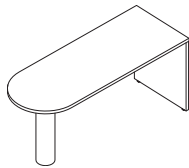
Width	60"	Price below
	66"	Price below
	72"	Price below
Depth	30"	Price below
	36"	Price below
Top Surface Finish	Laminate LPL Price Group 01	No cost
Edge Finish	Plastic - PG1	No cost
Worksurface Thickness	1 1/8"	No cost
Case Finish	Laminate LPL Price Group 01	No cost
Base Finish	Paint Price Group 01	No cost
	Paint Price Group 02	+\$25
Modesty Panel	No Modesty Panel	No cost
	Quarter Height	+\$162
	Full	+\$286
Width A	60"	Price below
	66"	Price below
	72"	Price below
Depth B	30"	Price below
	36"	Price below
	42"	Price below
Depth C	24"	Price below
	30"	Price below
	36"	Price below
Handedness	Left Hand	No cost
	Right Hand	No cost

### Specification Information

Style Number	Dimensions Modular Depth C	Base Prices		
		Modular	60"W	66"W

### D-Shape, Low-Pressure Laminate Case and Top

AMQCRDWKSF	30"D	\$1144	\$1216	\$1281
	36"D	\$1259	\$1330	\$1434



► Product Information continued on next page

# Embank

## D-Shape and P-Shape Worksurfaces

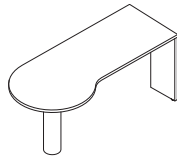
► Product Information continued from previous page

### Specification Information

Style Number	Dimensions Modular Depth C	Base Prices		
		Modular	60"W	66"W 72"W

### P-Shape, Low-Pressure Laminate Case and Top

AMQCRPWKSF	24"D	\$1313	\$1454	\$1664
	30"D	\$1381	\$1530	\$1750
	36"D	\$1452	\$1606	\$1839

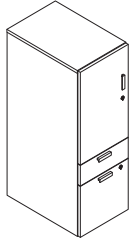


Right-hand unit



# Embank

## Towers



Tip: Nominal dimensions shown in specifying. Please refer to understanding pages for actual dimensions.

### Standard Includes

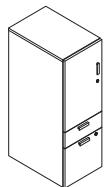
- Single-door tower: Low-Pressure Laminate case with matching or contrasting Low-Pressure Laminate headset
- 1" thick top: laminate to match case
- Lock plug
- Lock cylinder included in package, field-installed
- Counterweights
- 1 1/4" leveling glides
- Shipped fully assembled
- Bore and dowel drawer construction: black

### Options

Depth	24"	Price below
Width	15 3/4"	Price below
Height	41 25/32"	Price below
	47 31/32"	Price below
	54 1/8"	Price below
	66 1/2"	Price below
Case Finish	Laminate LPL Price Group 01	No cost
Headset Finish	Laminate LPL Price Group 01	No cost
Drawer Configuration	Box/File	Price below
	File/File	Price below
Keys	Key Plug	No cost
	Master Key Plug	+\$37
Lock Finish	Polished Chrome	No cost
Pull	Ledge Pull	No cost
Pull Finish	Paint Price Group 01	No cost
	Paint Price Group 02	No cost

### Specification Information

Dimensions			Style	Base
D	W	H	Number	Prices
				LPL Case
				LPL Headset



Single Left-Hinged Door Tower with One Box Drawer and One File Drawer				
24"	15 3/4"	41 25/32"	<b>AMQCRTWBFL</b>	\$1973
24"	15 3/4"	47 31/32"	<b>AMQCRTWBFL</b>	\$2063
24"	15 3/4"	54 1/8"	<b>AMQCRTWBFL</b>	\$2162
24"	15 3/4"	66 1/2"	<b>AMQCRTWBFL</b>	\$2265

► Product Information continued on next page

► **Product Information continued from previous page**

**Specification Information**

Dimensions			Style	Base
D	W	H	Number	Prices
				LPL Case
				LPL Headset



**Single Right-Hinged Door Tower with One Box Drawer and One File Drawer**

24"	15 3/4"	41 25/32"	<b>AMQCRTWBFR</b>	\$1973
24"	15 3/4"	47 31/32"	<b>AMQCRTWBFR</b>	\$2063
24"	15 3/4"	54 1/8"	<b>AMQCRTWBFR</b>	\$2162
24"	15 3/4"	66 1/2"	<b>AMQCRTWBFR</b>	\$2265



**Single Left-Hinged Door Tower with Two File Drawers**

24"	15 3/4"	41 25/32"	<b>AMQCRTWFFL</b>	\$2045
24"	15 3/4"	47 31/32"	<b>AMQCRTWFFL</b>	\$2142
24"	15 3/4"	54 1/8"	<b>AMQCRTWFFL</b>	\$2244
24"	15 3/4"	66 1/2"	<b>AMQCRTWFFL</b>	\$2350



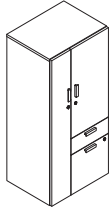
**Single Right-Hinged Door Tower with Two File Drawers**

24"	15 3/4"	41 25/32"	<b>AMQCRTWFFR</b>	\$2045
24"	15 3/4"	47 31/32"	<b>AMQCRTWFFR</b>	\$2142
24"	15 3/4"	54 1/8"	<b>AMQCRTWFFR</b>	\$2244
24"	15 3/4"	66 1/2"	<b>AMQCRTWFFR</b>	\$2350



# Embank

## Towers



Left-hand unit

### Standard Includes

- Dual-door tower: Low-Pressure Laminate case with matching or contrasting Low-Pressure Laminate headset
- 1" thick top: laminate to match case
- Coat hook: brushed nickel only
- Lock plug
- Lock cylinder included in package, field-installed
- Counterweights
- 1 1/4" leveling glides
- Shipped fully assembled
- Bore and dowel drawer construction: black

### Options

Depth	24"	Price below
Width	24"	Price below
Height	41 25/32"	Price below
	47 31/32"	Price below
	54 1/8"	Price below
	66 1/2"	Price below
Case Finish	Laminate LPL Price Group 01	No cost
Headset Finish	Laminate LPL Price Group 01	No cost
Drawer Configuration	Box/File	Price below
	File/File	Price below
Handedness	Left Hand	No cost
	Right Hand	No cost
Keys	Key Plug	No cost
	Master Key Plug	+\$37
Lock Finish	Polished Chrome	No cost
Pull	Ledge Pull	No cost
Pull Finish	Paint Price Group 01	No cost
	Paint Price Group 02	No cost

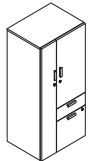
Tip: Handedness determines the location of the wardrobe.

### Specification Information

Dimensions			Style	Base
D	W	H	Number	Prices
				LPL Case
				LPL Headset

### Dual Left-Hand Door Tower with One Box Drawer and One File Drawer

24"	24"	41 25/32"	<b>AMQCRTWDBFL</b>	\$2098
24"	24"	47 31/32"	<b>AMQCRTWDBFL</b>	\$2198
24"	24"	54 1/8"	<b>AMQCRTWDBFL</b>	\$2448
24"	24"	66 1/2"	<b>AMQCRTWDBFL</b>	\$2671



Left-hand unit

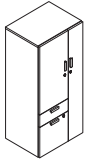
► Product Information continued on next page



► **Product Information continued from previous page**

**Specification Information**

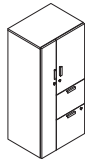
Dimensions			Style	Base
D	W	H	Number	Prices
				LPL Case
				LPL Headset



Right-hand unit

**Dual Right-Hand Door Tower with One Box Drawer and One File Drawer**

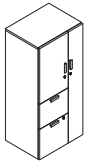
24"	24"	41 25/32"	<b>AMQCRTWDBFR</b>	\$2098
24"	24"	47 31/32"	<b>AMQCRTWDBFR</b>	\$2198
24"	24"	54 1/8"	<b>AMQCRTWDBFR</b>	\$2448
24"	24"	66 1/2"	<b>AMQCRTWDBFR</b>	\$2671



Left-hand unit

**Dual Door Tower with Two File Drawers, Wardrobe Left**

24"	15 3/4"	41 25/32"	<b>AMQCRTWDFFL</b>	\$2178
24"	15 3/4"	47 31/32"	<b>AMQCRTWDFFL</b>	\$2282
24"	15 3/4"	54 1/8"	<b>AMQCRTWDFFL</b>	\$2542
24"	15 3/4"	66 1/2"	<b>AMQCRTWDFFL</b>	\$2773



Right-hand unit

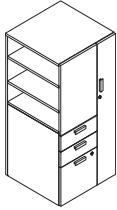
**Dual Right-Hinged Door Tower with Two File Drawers, Wardrobe Right**

24"	15 3/4"	41 25/32"	<b>AMQCRTWDFFR</b>	\$2178
24"	15 3/4"	47 31/32"	<b>AMQCRTWDFFR</b>	\$2282
24"	15 3/4"	54 1/8"	<b>AMQCRTWDFFR</b>	\$2542
24"	15 3/4"	66 1/2"	<b>AMQCRTWDFFR</b>	\$2773



# Embank

## Towers



Right-hand unit

### Standard Includes

- Side access tower: Low-Pressure Laminate case with matching or contrasting Low-Pressure Laminate headset
- 1" thick top: laminate to match case
- Coat hook: brushed nickel only
- Lock plug
- Lock cylinder included in package, field-installed
- Counterweights
- 1 1/4" leveling glides
- Shipped fully assembled
- Bore and dowel drawer construction: black

### Options

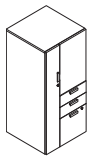
Depth	24"	Price below
Width	24"	Price below
Height	41 25/32"	Price below
	47 31/32"	Price below
	54 1/8"	Price below
	66 1/2"	Price below
Case Finish	Laminate LPL Price Group 01	No cost
Headset Finish	Laminate LPL Price Group 01	No cost
Drawer Configuration	Box/Box/File	Price below
	File/File	Price below
Keys	Key Plug	No cost
	Master Key Plug	+\$37
Lock Finish	Polished Chrome	No cost
Pull	Ledge Pull	No cost
Pull Finish	Paint Price Group 01	No cost
	Paint Price Group 02	No cost

### Specification Information

Dimensions			Style	Base
D	W	H	Number	Prices
				LPL Case
				LPL Headset

### Side Access Left-Hand Tower with Two Box Drawers and One File Drawer

24"	24"	41 25/32"	<b>AMQCRTWSABBFL</b>	\$2267
24"	24"	47 31/32"	<b>AMQCRTWSABBFL</b>	\$2374
24"	24"	54 1/8"	<b>AMQCRTWSABBFL</b>	\$2488
24"	24"	66 1/2"	<b>AMQCRTWSABBFL</b>	\$2609



Left-hand unit

► Product Information continued on next page

► **Product Information continued from previous page**

**Specification Information**

Dimensions			Style	Base
D	W	H	Number	Prices
				LPL Case
				LPL Headset



Right-hand unit

**Side Access Right-Hand Tower with Two Box Drawers/One File Drawer**

24"	24"	41 25/32"	<b>AMQCRTWSABBFR</b>	\$2267
24"	24"	47 31/32"	<b>AMQCRTWSABBFR</b>	\$2374
24"	24"	54 1/8"	<b>AMQCRTWSABBFR</b>	\$2488
24"	24"	66 1/2"	<b>AMQCRTWSABBFR</b>	\$2609



Left-hand unit

**Side Access Left-Hand Tower with Two File Drawers**

24"	24"	41 25/32"	<b>AMQCRTWSAFFL</b>	\$2185
24"	24"	47 31/32"	<b>AMQCRTWSAFFL</b>	\$2291
24"	24"	54 1/8"	<b>AMQCRTWSAFFL</b>	\$2400
24"	24"	66 1/2"	<b>AMQCRTWSAFFL</b>	\$2515



Right-hand unit

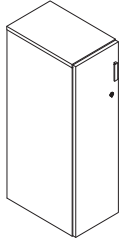
**Side Access Right-Hand Tower with Two File Drawers**

24"	24"	41 25/32"	<b>AMQCRTWSAFFR</b>	\$2185
24"	24"	47 31/32"	<b>AMQCRTWSAFFR</b>	\$2291
24"	24"	54 1/8"	<b>AMQCRTWSAFFR</b>	\$2400
24"	24"	66 1/2"	<b>AMQCRTWSAFFR</b>	\$2515



# Embank

## Wardrobes



*Tip: Wardrobe must be attached to two additional wardrobes, another storage unit, or a wall to ensure stability and prevent wardrobe from tipping.*

### Standard Includes

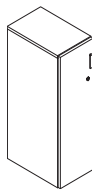
- Wardrobe: Low-Pressure Laminate case with matching or contrasting Low-Pressure Laminate headset
- 1" thick table top: laminate to match case
- Coat hook: brushed nickel only
- Lock plug
- 1 1/4" leveling glides
- Lock cylinder included in package, field-installed
- Shipped fully assembled

### Options

Depth	24"	Price below
Width	12"	Price below
Height	41 25/32"	Price below
	47 31/32"	Price below
	54 1/8"	Price below
Case Finish	Laminate LPL Price Group 01	No cost
Headset Finish	Laminate LPL Price Group 01	No cost
Keys	Key Plug	No cost
	Master Key Plug	+\$37
Lock Finish	Polished Chrome	No cost
Pull	Ledge Pull	No cost
Pull Finish	Paint Price Group 01	No cost
	Paint Price Group 02	No cost

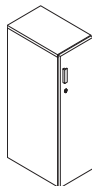
### Specification Information

Dimensions			Style	Base
D	W	H	Number	Prices
				LPL Case
				LPL Headset



### Wardrobes-Hinged Left

24"	12"	41 25/32"	<b>AMQCRWDL</b>	\$1073
24"	12"	47 31/32"	<b>AMQCRWDL</b>	\$1129
24"	12"	54 1/8"	<b>AMQCRWDL</b>	\$1189



### Wardrobes-Hinged Right

24"	12"	41 25/32"	<b>AMQCRWDR</b>	\$1073
24"	12"	47 31/32"	<b>AMQCRWDR</b>	\$1129
24"	12"	54 1/8"	<b>AMQCRWDR</b>	\$1189

**Standard Includes**

- Bookcase: Low-Pressure Laminate price group 01
- 1" thick table top: laminate to match case
- Adjustable shelf: laminate to match case
- Brackets for shelves: brushed nickel only
- 1 1/4" leveling glides
- Shipped fully assembled

**Options**

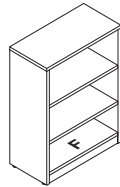
Width	30"	Prices below
	36"	Prices below
Height	41 25/32"	Prices below
	47 31/32"	Prices below
	54 1/8"	Prices below
	66 1/2"	Prices below
	72 11/16"	Prices below
Case Finish	Laminate LPL Price Group 01	No cost

**Specification Information**

Dimensions			Style	Base
D	W	H	Number	Prices

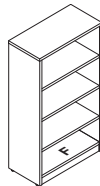
LPL Case

**Bookcases with Adjustable Shelves**



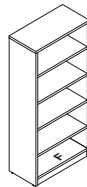
**Two Adjustable Shelves**

15"	30"	41 25/32"	<b>AMQCRBK</b>	\$1022
15"	36"	41 25/32"	<b>AMQCRBK</b>	\$1042
15"	30"	47 31/32"	<b>AMQCRBK</b>	\$1064
15"	36"	47 31/32"	<b>AMQCRBK</b>	\$1084



**Three Adjustable Shelves**

15"	30"	54 1/8"	<b>AMQCRBK</b>	\$1108
15"	36"	54 1/8"	<b>AMQCRBK</b>	\$1130



**Four Adjustable Shelves**

15"	30"	66 1/2"	<b>AMQCRBK</b>	\$1155
15"	36"	66 1/2"	<b>AMQCRBK</b>	\$1177
15"	30"	72 11/16"	<b>AMQCRBK</b>	\$1299
15"	36"	72 11/16"	<b>AMQCRBK</b>	\$1325

# Embank

## Bookcases

### Standard Includes

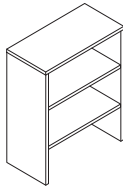
- Stacking bookcase: Low-Pressure Laminate price group 01
- 1" thick top: laminate to match case
- Adjustable shelf: laminate to match case
- Attachment hardware
- Shipped fully assembled

### Options

Width	30"	Prices below
	36"	Prices below
Height	25 5/8"	Prices below
	37 31/32"	Prices below
	44 3/16"	Prices below
Case Finish	Laminate LPL Price Group 01	No cost

### Specification Information

Dimensions			Style	Base
D	W	H	Number	Prices
				LPL Case

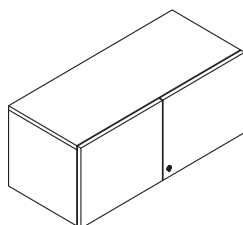


### Stacking Bookcase with Adjustable Shelves

15"	30"	25 5/8"	<b>AMQCRBKS</b>	\$803
15"	30"	37 31/32"	<b>AMQCRBKS</b>	\$836
15"	30"	44 3/16"	<b>AMQCRBKS</b>	\$893
15"	36"	25 5/8"	<b>AMQCRBKS</b>	\$819
15"	36"	37 31/32"	<b>AMQCRBKS</b>	\$851
15"	36"	44 3/16"	<b>AMQCRBKS</b>	\$912

# Embank

## Overheads and Organizer



*Tip: Handedness is determined while in the seated position.*

*Tip: Overheads with sliding doors do not lock.*

*Tip: Overheads with three doors will have two doors hinged right. Overheads with four doors will have two doors hinged left, and two hinged right. Doors will always open from the center out.*

*Tip: White markerboard (2977) headset finish available with sliding doors only.*

### Standard Includes

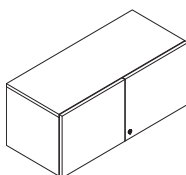
- Overhead: Low-Pressure Laminate case with matching or contrasting Low-Pressure Laminate headset
- Lock plug on overheads with hinged doors only
- Lock cylinder included in package, field-installed
- Wood dowel and glue drawer construction: black
- Shipped fully assembled

### Options

Width	36"	Price below
	42"	Price below
	48"	Price below
	60"	Price below
	66"	Price below
	72"	Price below
Case Finish	Laminate LPL Price Group 01	No cost
Headset Finish	Laminate LPL Price Group 01	No cost
Door Type	Hinged Doors	No cost
	Sliding Doors	No cost
Attachment Brackets	Suspended between Towers	No cost
	Wall Mount Brackets	36"W□66"W: +\$141 72"W: +\$191
Keys	Key Plug	No cost
	Master Key Plug	+\$37
Lock Finish	Polished Chrome	No cost
Door Surface Type	Laminate	Price below
	Markerboard	Price below

### Specification Information

Dimensions			Number of Doors	Style Number	Base Prices	Option (Add \$ to Base Price)
D	W	H				
					<b>LPL Case</b>	<b>Markerboard Door</b>
					<b>LPL Headset</b>	



### Overhead with Hinged Doors

16"	36"	15"	2	<b>AMQCROHHD</b>	\$731	N.A.
16"	42"	15"	3	<b>AMQCROHHD</b>	\$847	N.A.
16"	48"	15"	3	<b>AMQCROHHD</b>	\$969	N.A.
16"	60"	15"	3	<b>AMQCROHHD</b>	\$1204	N.A.
16"	66"	15"	4	<b>AMQCROHHD</b>	\$1325	N.A.
16"	72"	15"	4	<b>AMQCROHHD</b>	\$1393	N.A.

► Product Information continued on next page

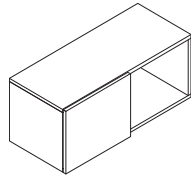
# Embank

## Overheads and Organizer

► Product Information continued from previous page

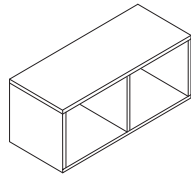
### Specification Information

Dimensions			Number	Style	Base	Option
D	W	H	of Doors	Number	Prices	(Add \$ to Base Price)
					LPL Case	Markerboard Door
					LPL Headset	



#### Overhead with Sliding Doors

16"	36"	15"	1	<b>AMQCROHSDP</b>	\$636	+\$112
16"	42"	15"	1	<b>AMQCROHSDP</b>	\$752	+\$136
16"	48"	15"	1	<b>AMQCROHSDP</b>	\$875	+\$150
16"	60"	15"	1	<b>AMQCROHSDP</b>	\$1109	+\$213
16"	66"	15"	1	<b>AMQCROHSDP</b>	\$1230	+\$253
16"	72"	15"	1	<b>AMQCROHSDP</b>	\$1298	+\$272



#### Overhead with No Doors, Open

*Pricing at right is for case only. Headsets are not available on open units.*

15"	36"	15"	N.A.	<b>AMQCROHOP</b>	\$459	N.A.
15"	42"	15"	N.A.	<b>AMQCROHOP</b>	\$576	N.A.
15"	48"	15"	N.A.	<b>AMQCROHOP</b>	\$697	N.A.
15"	60"	15"	N.A.	<b>AMQCROHOP</b>	\$932	N.A.
15"	66"	15"	N.A.	<b>AMQCROHOP</b>	\$1053	N.A.
15"	72"	15"	N.A.	<b>AMQCROHOP</b>	\$1119	N.A.



# Embank

## Overheads and Organizer

Tip: Stacking overheads with sliding doors do not lock.

Tip: Overheads with three doors will have two doors hinged right. Overheads with four doors will have two doors hinged left, and two hinged right. Doors will always open from the center out.

Tip: 37.98725"H overheads align with 66 1/2"H storage. 44.17475"H overheads align with 72"H storage.

Tip: White markerboard (2977) headset finish available with sliding doors only.

Tip: Stacking overheads cannot be used with lateral file/lateral file credenza configurations.

Tip: 15"H refers to the height of the storage case.

### Standard Includes

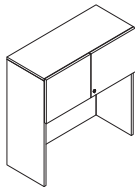
- Stacking overhead: Low-Pressure Laminate case with matching or contrasting Low-Pressure Laminate headset
- Lock plug on overheads with hinged doors only
- Lock cylinder included in package, field-installed
- Attachment hardware

### Options

Width	60"	Price below
	66"	Price below
	72"	Price below
Height	37.98725 in	Price below
	44.17475 in	Price below
Worksurface Thickness	1 1/8"	No cost
Case Finish	Laminate LPL Price Group 01	No cost
Door Type	Hinged Doors	No cost
	Sliding Doors	No cost
Headset Finish	Laminate LPL Price Group 01	No cost
Keys	Key Plug	No cost
	Master Key Plug	+\$37
Lock Finish	Polished Chrome	No cost
Door Surface Type	Laminate	Price below
	Markerboard	Price below

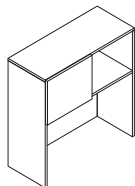
### Specification Information

Dimensions			Number of Doors	Style Number	Base Prices	Option (Add \$ to Base Price)
D	W	H				
					LPL Case	Markerboard
						Door
					LPL Headset	



#### Stacking Overhead with Hinged Doors

16"	60"	15"	3	<b>AMQCROHSHD</b>	\$1562	N.A.
16"	66"	15"	4	<b>AMQCROHSHD</b>	\$1684	N.A.
16"	72"	15"	4	<b>AMQCROHSHD</b>	\$1802	N.A.



#### Stacking Overhead with Sliding Door

16"	60"	15"	1	<b>AMQCROHSSD</b>	\$1466	+\$283
16"	66"	15"	1	<b>AMQCROHSSD</b>	\$1588	+\$325
16"	72"	15"	1	<b>AMQCROHSSD</b>	\$1707	+\$370

► Product Information continued on next page



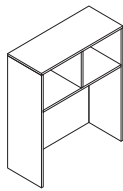
# Embank

## Overheads and Organizer

▶ **Product Information continued from previous page**

### Specification Information

Dimensions			Number	Style	Base	Option
D	W	H	of Doors	Number	Prices	(Add \$ to Base Price)
					LPL Case	Markerboard
					Door	
					LPL	
					Headset	



### Stacking Overhead with No Doors, Open

*Pricing at right is for case only. Headsets are not available on open units.*

15"	60"	15"	N.A.	<b>AMQCROHS</b>	\$1093	N.A.
15"	66"	15"	N.A.	<b>AMQCROHS</b>	\$1217	N.A.
15"	72"	15"	N.A.	<b>AMQCROHS</b>	\$1331	N.A.

# Embank

## Overheads and Organizer

### Standard Includes

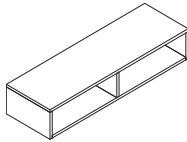
- Organizer: Low-Pressure Laminate case, price group 01

### Options

Width	36"	Price below
	42"	Price below
	48"	Price below
	60"	Price below
	66"	Price below
	72"	Price below
Case Finish	Laminate LPL Price Group 01	No cost
Attachment Brackets	Suspended between Towers	No cost
	Wall Mount Brackets	36"W□66"W: +\$141 72"W: +\$191

### Specification Information

Dimensions			Style	Base
D	W	H	Number	Prices
				LPL Case

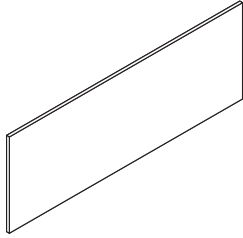


#### Organizer, Personal

15"	36"	8 27/32"	<b>AMQCRORP</b>	\$885
15"	42"	8 27/32"	<b>AMQCRORP</b>	\$967
15"	48"	8 27/32"	<b>AMQCRORP</b>	\$978
15"	60"	8 27/32"	<b>AMQCRORP</b>	\$1007
15"	66"	8 27/32"	<b>AMQCRORP</b>	\$1053
15"	72"	8 27/32"	<b>AMQCRORP</b>	\$1110

# Embank

## Tackboard



*Tip: Remove 1 1/2" in height from the tackboard if paired with a stacking overhead to utilize cable passthrough.*

*Tip: Tackboard comes with a spacer for a shelf light cord to be routed to the cable passthrough at the bottom of the overhead storage cabinet.*

*Tip: Tackboards cannot be attached to walls covered by textured paint or wallpaper.*

*Tip: Width denotes the width of the overhead the tackboard is pairing with. The application option will account for any dimensional changes needed. By selecting stacking, 2 1/4" will be removed from the overall width of the tackboard. By selecting wall mount, tackboard will ship with the exact specified width.*

### Standard Includes

- Tackboard: fabric price group 01
- Attachment hardware
- Modular sizes:
  - Width: 36"W–72"W
  - Height: 20 1/4"H and 26 1/4"H

### Options

Height	20 1/4"	Price below
	26 1/4"	Price below
Width	36"	Price below
	42"	Price below
	48"	Price below
	60"	Price below
	66"	Price below
	72"	Price below
Tackboard Finish	Fabric Price Group 01	No cost
	Fabric Price Group 03	+\$45
Application	Stacking	No cost
	Wall Mount	No cost
Fabric Direction	Horizontal	No cost

### Specification Information

Dimensions			Base Prices					
Modular	Style	Modular						
Height	Number	Width	36"W	42"W	48"W	60"W	66"W	72"W

### Fabric Tackboard

20 1/4"H	<b>AMQCRTB</b>	\$413	\$436	\$455	\$518	\$561	\$623
26 1/4"H	<b>AMQCRTB</b>	\$453	\$478	\$501	\$568	\$617	\$687

*Tip: All round and square table configurations receive a 36" steel X-base with the exception of the 36" Dia. round table which receives a 26" steel X-base.*

**Standard Includes**

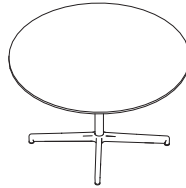
- Top: Low-Pressure Laminate price group 01 with 3 mm plastic square edge
- Table base
- Ships ready to assemble

**Options**

Diameter	36"	Price below
	48"	Price below
Top Surface Finish	Laminate LPL Price Group 01	No cost
Edge Finish	Plastic - PG1	No cost
Base Type	X-Base	No cost
X-Base Finish	Paint Price Group 01	No cost
	Paint Price Group 02	+\$23
Width	36"	Price below
	48"	Price below

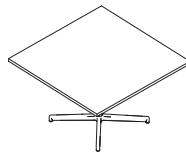
**Specification Information**

Style Number	Dimensions		Base Prices
	Diameter/Width	Height	LPL



**EMBANK Social Table - Round**

AMQCRRTBL	36" Dia.	28"H	\$1011
	48" Dia.	28"H	\$1275



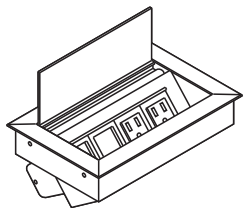
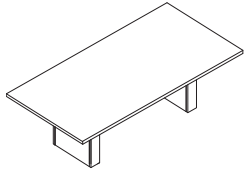
**EMBANK Social Table - Square**

AMQCRSQTBL	36" Dia.	28"H	\$1011
	48" Dia.	28"H	\$1275



# Embank

## Tables



Tip: Hinged power doors have a 5 5/16"D, 8 5/16"W, and 2"H.

Tip: 72"W and 96"W tables receive two rectangular bases and 120"W and 144"W tables receive three rectangular bases.

Tip: Widths 96"-144" have two-piece tops and will not have matching grain direction.

Tip: One hinged power door comes with 72"W tables, two hinged power doors with 96"W and 120"W tables, and four hinged power doors with 144"W tables.

### Standard Includes

- Top: Low-Pressure Laminate price group 01 with 3 mm plastic square edge
- Table base
- Reinforcing channels, if selected
- Ships ready to assemble

### Options

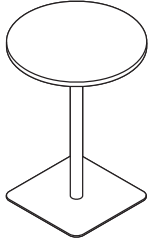
Depth	36 1/4"	Price below
	48"	Price below
Width	120"	Price below
	144"	Price below
	72"	Price below
	96"	Price below
Worksurface Thickness	1 1/8"	No cost
Top Surface Finish	Laminate LPL Price Group 01	No cost
Base Type	Rectangular Base	No cost
Rectangular Base Finish	Laminate LPL Price Group 01	No cost
Power Option	No Power	No cost
	Hinged Door	+\$543 per door

### Specification Information

Style Number	Dimensions		Base Prices				
	Modular	Modular	Modular	72"W	96"W	120"W	144"W
	Depth	Height	Width				

### EMBANK Conference Table - Rectangular

Style Number	Dimensions	Base Prices	72"W	96"W	120"W	144"W
AMQCRRECTBL	36 1/4"D	28"H	\$1711	\$2058	\$2167	\$2693
	48"D	28"H	\$1881	\$2305	\$2472	\$3061



**Standard Includes**

- 1 1/8" thick table top: Low-Pressure Laminate (LPL) price group 01
- Edge band: default color to match laminate
- Column base: paint price group 01

**Options**

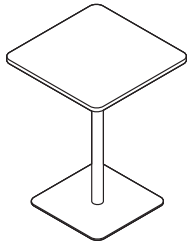
Base Finish	Paint Price Group 01	No cost
	Paint Price Group 02	No cost
Diameter	30"	Price below
	36"	Price below

**Specification Information**

Style Number	Dimensions		Price
	Diameter		

**EMBANK Cafe-Height Table - Round**

<b>EMCAFERDTBL</b>	30"	\$1059
	36"	\$1266



**Standard Includes**

- 1 1/8" thick table top: Low-Pressure Laminate (LPL) price group 01
- Edge band: default color to match laminate
- Column base: paint price group 01

**Options**

Base Finish	Paint Price Group 01	No cost
	Paint Price Group 02	No cost
Width	30"	Price below
	36"	Price below

**Specification Information**

Style Number	Dimensions		Price
	Depth	Width	

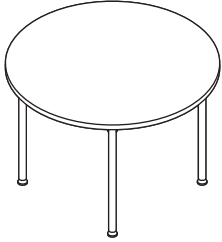
**EMBANK Cafe-Height Table - Square**

<b>EMCAFESQTBL</b>	30"	30"	\$1059
	30"	36"	\$1266
	36"	30"	\$1059
	36"	36"	\$1266



# Embank

## Tables



Tip: Glides on post legs are 1 1/2" long and provide 1" of leveling.

### Standard Includes

- 1 1/8" thick table top: Low-Pressure Laminate (LPL) price group 01
- Edge band: default color to match laminate
- Post legs: paint price group 01
- Glides, if post legs are selected

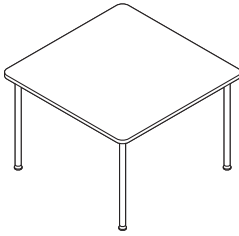
### Options

Diameter	30"	Price below
	36"	Price below
	48"	Price below
Base Type	Post Legs	No cost
	Column	Prices below
Base Finish	Paint Price Group 01	No cost
	Paint Price Group 02	No cost
Castors or Glides	Glides	No cost
	2 Locking & 2 NI Casters	+\$67

### Specification Information

Style Number	Dimensions Diameter	Base Price	Column Leg Option (add \$ to Base Price)
<b>EMBANK Collaborative Table - Round</b>			
<b>EMWRDTBL</b>	30"	\$788	+\$194
	36"	\$843	+\$411
	48"	\$908	+\$557





*Tip: Glides on post legs are 1 1/2" long and provide 1" of leveling.*

**Standard Includes**

- 1 1/8" thick table top: Low-Pressure Laminate (LPL) price group 01
- Edge band: default color to match laminate
- Post legs: paint price group 01
- Glides, if post legs are selected

**Options**

Width	30"	Price below
	36"	Price below
	48"	Price below
Base Type	Post Legs	No cost
	Column	Prices below
Base Finish	Paint Price Group 01	No cost
	Paint Price Group 02	No cost
Castors or Glides	Glides	No cost
	2 Locking & 2 NI Casters	+\$67

**Specification Information**

Style Number	Dimensions		Base Price	Column Leg Option (add \$ to Base Price)
	Depth	Width		

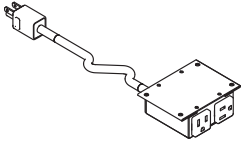
**EMBANK Collaborative Table - Square**

<b>EMWRSQTBL</b>	30"	30"	\$788	+\$194
	30"	36"	\$843	+\$411
	30"	48"	\$908	+\$557
	36"	30"	\$788	+\$194
	36"	36"	\$843	+\$411
	36"	48"	\$908	+\$557



# Embank

## Tables



*Tip: When USB-A is specified, there are two USB ports.*

### Standard Includes

- 10' power cord with wall plug
- Two simplex receptacles
- Two velcro cord management straps
- Hardware and plastic cord management clips

### Options

Power Configuration	2 Power	No cost
	1 Power   1 USB A	+\$133

### Specification Information

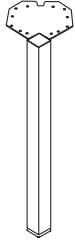
Style Number      Base Price

### Single Unit Power Module

**EMUWPOWER** \$203

# Embank

## Legs and Table Bases



### Standard Includes

- Square legs: paint price group 01
- Adjusting leveling glides: black plastic
- Ships ready to assemble

### Options

Leg Height	28"	Price below
Base Finish	Paint Price Group 01	No cost
	Paint Price Group 02	+\$34

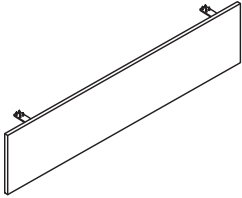
### Specification Information

Dimensions			Style	Base
D	W	H	Number	Price
2"	2"	27 1/4"	<b>AMQCRSQB</b>	\$200



# Embank

## Modesty Panel



### Standard Includes

- Modesty panel: Low-Pressure Laminate price group 01
- Bracket: paint price group 01, Merle
- Ships ready to assemble

### Options

Width	36"	Price below
	48"	Price below
	60"	Price below
Modesty Panel Finish	Laminate LPL Price Group 01	No cost

### Specification Information

Style Number	Dimensions Height	Base Prices		
		Modular Width	36"W	48"W

### Low-Pressure Laminate

<b>AMQCRMP</b>	13 3/4"	\$413	\$468	\$522
----------------	---------	-------	-------	-------

*Tip: Ganging hardware is used to provide rigidity between cabinets mounted side by side in a panel or wall-mounted application.*

**Standard Includes**

- Attachment kit, four bolts and nuts per kit, if selected: bronze only

**Specification Information**

Style	Quantity	Price
-------	----------	-------

Number

---

**Attachment Kit, Cabinet to Cabinet Application**

---

<b>AMQAWAK</b>	1	\$47
----------------	---	------



# Embank

## Tektis and Embank Shared Accessories

*Tip: Reinforcing channels are needed for 54"W of unsupported kneespace.*

*Tip: Support plates are available to connect two worksurfaces and allow one to support the other.*

*Tip: Tie plates are available to provide added strength and alignment between two worksurfaces.*

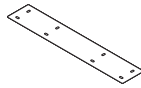
### Standard Includes

- Worksurface supports and channels: black paint
- Attachment hardware

### Specification Information

Style Number	Dimensions	Prices
--------------	------------	--------

#### In-Line Support Plates



<b>AMQTSATPL</b>	14"D	\$87
	20"D	\$87

#### Package of Six Tie Plates for Side-by-Side Worksurfaces



<b>AMQTSATTIE</b>	7"L	\$122
-------------------	-----	-------

#### Reinforcing Channels



<b>AMQTSATRC</b>	39"W	\$61
	48"W	\$64
	57"W	\$67
	72"W	\$144

---

# Resources

---

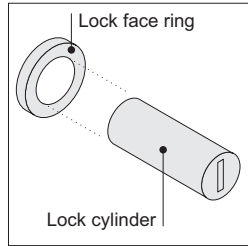
**Lock and Keying**

**376**

# Lock and Keying

## For TEKTIS, UPTAKE, and EMBANK Products

**All locking products** are standard with field-installed, keyed-random locks. Locks will ship with lock plug installed. Lock cylinder will be packaged separately and field-installed.



**Locks** consist of a field-installed lock cylinder and a field-installed lock face ring.




**Two types of locks** are available — the standard keying system (FR series) and the master keying system (XF series). All the locks in the XF series can be opened with a single master key.

### Field-Installed Keying




**Field-installed locks** are always key random (standard) or master key random (option). Key random means that the locks will be assigned arbitrarily at the factory with key numbers ranging from FR305 to FR454 (Master keying numbers: XF1001 to XF1150). All locks within a unit will be keyed alike.

*Tip: Random keying can mean that different furniture units will have the same key number.*

#### Key Random

-  FR305
-  FR421
-  FR305

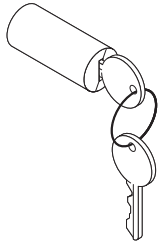
or

-  XF1011
  -  XF1042
  -  XF1011
- } XF Master Key

#### Required to Specify

<b>Master key random</b>	No cost	Specify with master key random.
--------------------------	---------	---------------------------------





## Standard Includes

- Lock cylinder, keyed random:
  - 9201 Polished Chrome
- Two keys

## Options

Lock Finish	Polished Chrome	No cost
Keys	Master Key Random	No cost
	Standard Key Random	No cost

## Specification Information

Color	Style Number	Price
-------	--------------	-------

### FR Series (Standard Keying System) – Lock Cylinder

Polished Chrome	<b>AMQLOCK9201FR</b>	No cost
-----------------	----------------------	---------

### XF Series (Master Keying System) – Lock Cylinder

Polished Chrome	<b>AMQLOCK9201XF</b>	No cost
-----------------	----------------------	---------



---

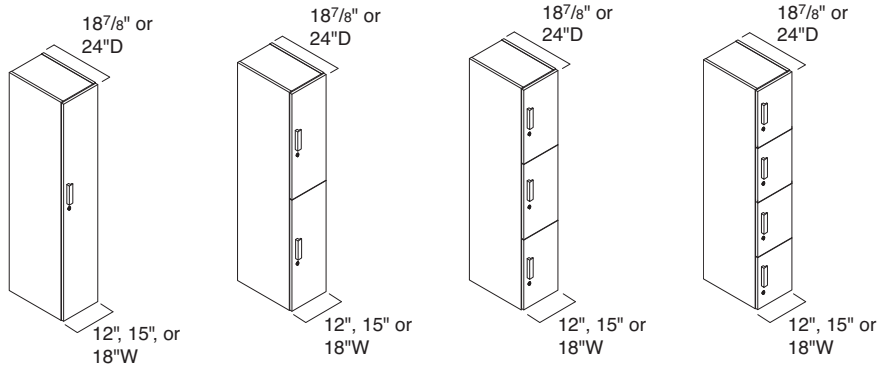
# Understanding UPTAKE Lockers

 <b>Statement of Line</b>	<b>380</b>
 <b>UPTAKE Lockers</b>	<b>382</b>
<b>Interior Configuration Rules</b>	<b>384</b>
<b>Stability Guidelines</b>	<b>386</b>
<b>Electronic Lock Option</b>	<b>387</b>
<b>UPTAKE Digilock Keys</b>	<b>388</b>

# Statement of Line

UPTAKE Lockers

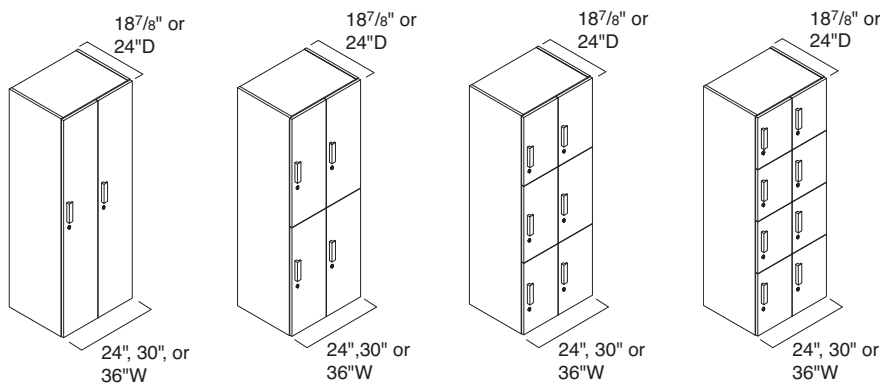
## Single-Wide Lockers



Understanding  
 ▶ Page 382  
 Specifying  
 ▶ Page 390

	1-Door	2-Door	3-Door	4-Door
41.75"H	●	●	N.A.	N.A.
47.9375"H	●	●	●	N.A.
54.125"H	●	●	●	N.A.
66.5"H	●	●	●	●
72"H	●	●	●	●

## Double-Wide Lockers



Understanding  
 ▶ Page 382  
 Specifying  
 ▶ Page 390

	2-Door	4-Door	6-Door	8-Door
41.75"H	●	●	N.A.	N.A.
47.9375"H	●	●	●	N.A.
54.125"H	●	●	●	N.A.
66.5"H	●	●	●	●
72"H	●	●	●	●

## Shelves



Understanding  
 ▶ Page 382  
 Specifying  
 ▶ Page 399

### Adjustable Shelf—Single-Wide Locker

	12"W	15"W	18"W
18.875"D	●	●	●
24"D	●	●	●



Understanding  
 ▶ Page 382  
 Specifying  
 ▶ Page 399

### Adjustable Shelf—Double-Wide Locker

	24"W	30"W	36"W
18.875"D	●	●	●
24"D	●	●	●

*Tip: Width of shelf is sized to fit one shelf into one side of double-wide locker. If a shelf is required for each side of double-wide locker order a quantity of two shelves.*

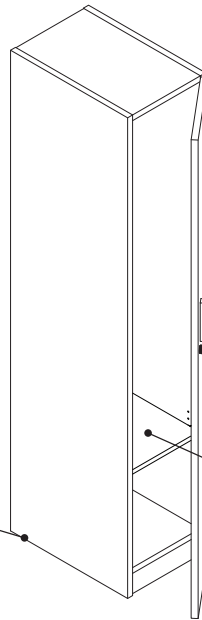
# UPTAKE Lockers

**UPTAKE lockers** provide a space to store a variety of objects including coats, bags, and personal belongings.  
 ▶ Specifying, page 390

**Coat hooks or coat rod** can be specified.

**Leveling glides** adjust to install on uneven floors and have a 1" adjustable range.

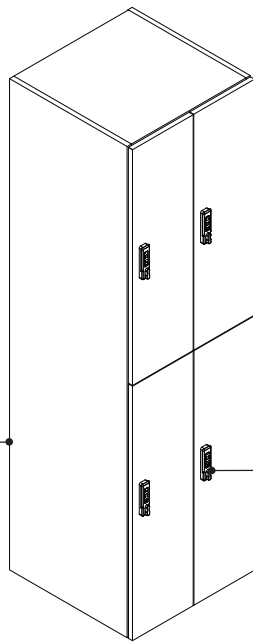
**Finished back** is standard.



**Single-Wide Locker**

**Ledge pulls** come standard when keyed locks are specified.

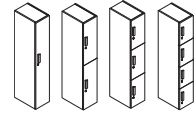
**Adjustable shelf** is available as an option to aid in the division of storage space when needed.



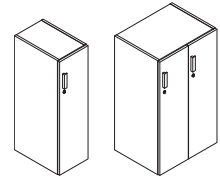
**Double-Wide Locker**

**Digilock VERSA electronic keypad locks** are available as an option.

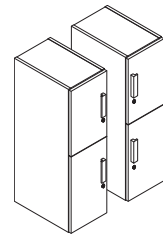
## Product Details



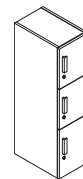
**Four different door configurations** are available.



**Single- or double-wide lockers** are available.



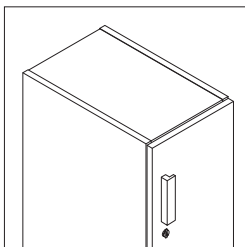
**Door on locker** can be hinged on the left or right. Pull and lock are located on the opposite side of the hinge.



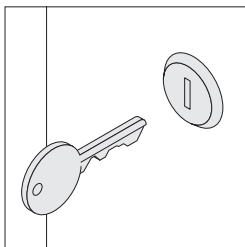
**Headset** available in full front only.

## Actual Dimensions

<b>Depth</b>		18 <sup>7</sup> / <sub>8</sub> " or 24"
<b>Width</b>	Single wide	12", 15", or 18"
	Double wide	24", 30", or 36"
<b>Height</b>		41.75", 47.9375", 54.125", 66.5", or 72"

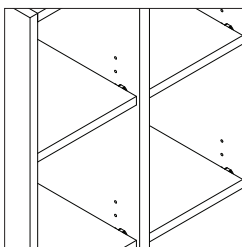


**The inset top construction** provides consistent door gaps and a tighter fit of adjacent units when ganged together.



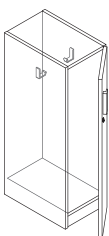
**If the ledge pull** is specified, locks are available factory-installed and are keyed random only. Master-keyed locks are also available. **▶ Lock and Keying, page 376**

**Application Topics**



**Adjustable shelves** can be added to lockers for additional storage or piling space. Shelves are recessed from the side of the locker. A maximum of two adjustable shelves can be added. See interior configuration rules for restrictions. **▶ See Interior Configuration Rules for restrictions, page 384.**

**1-door lockers 54" H and above** have a fixed shelf located at the top. *Tip: See interior configuration rules for size restrictions for coat hooks, coat rods, and adjustable shelves.* **▶ Page 384.**



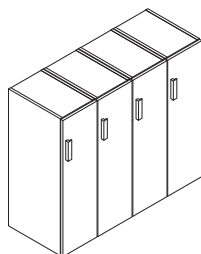
**A pair of coat hooks** are standard in each opening for 1-door and 2-door units. Coat hooks are available as an option in 3-door and 4-door units.



**Digilock Versa electronic keypad locks, mounted in a vertical orientation,** are available as an option.

**Digilock Versa electronic keypad locks** are powered by two lithium 2450 batteries.

**Programming and manager keys** must be ordered separately.



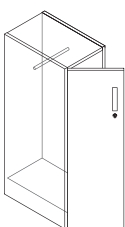
**Individual single- or double-wide lockers** cannot stand alone. They must be ganged to other lockers or secured to the building structure. Minimum locker numbers depend on depth and width. **▶ See Stability Guidelines on page 386.**

**Ganging hardware, provided,** joins adjacent storage units side-by-side, back-to-back, or both.

**Storage Capacities and Dimensions** **▶ Page 322**

**Surface Materials**

- Case**
  - Low-Pressure Laminate
- Headsets**
  - Low-Pressure Laminate
- Ledge pull**
  - 4799 Platinum Metallic
  - 7207 Black
- Keyed lock**
  - 9201 Polished Chrome
- Electronic lock**
  - 9221 Brushed Nickel



**Coat rod** is available as an option on 1-door and 2-door units that are 24"D only.



Ledge pull

**Ledge pulls on lockers** are defaulted when standard or master key plug is specified. No pull is available when electronic locks are specified.

# Interior Configuration Rules

## 1-Door Single Wide and 2-Door Double Wide

	No Coat Hooks and 1 Adjustable Shelf	No Coat Hooks and 2 Adjustable Shelves	Coat Hooks and No Adjustable Shelf	Coat Hooks and 1 Adjustable Shelf	Coat Hooks and 2 Adjustable Shelves	Coat Rod* and No Adjustable Shelf
<b>Height of Unit</b>						
41.75"	●	N.A.	●	●	N.A.	●
47.9375"	●	●	●	●	●	●
54.125"	●	N.A.	●	●	N.A.	●
66.5"	●	●	●	●	●	●
72"	●	●	●	●	●	●

\* Tip: In order to specify coat rod, depth must equal 24"D for all heights.

## 2-Door Single Wide and 4-Door Double Wide

	No Coat Hooks and 1 Adjustable Shelf	No Coat Hooks and 2 Adjustable Shelves	Coat Hooks and No Adjustable Shelf	Coat Hooks and 1 Adjustable Shelf	Coat Hooks and 2 Adjustable Shelves	Coat Rod* and No Adjustable Shelf
<b>Height of Unit</b>						
41.75"	N.A.	N.A.	●	N.A.	N.A.	N.A.
47.9375"	●	N.A.	●	●	N.A.	N.A.
54.125"	●	N.A.	●	●	N.A.	N.A.
66.5"	●	N.A.	●	●	N.A.	N.A.
72"	●	●	●	●	●	●

\* Tip: In order to specify coat rod, depth must equal 24"D for all heights.

## 3-Door Single Wide and 6-Door Double Wide

	No Coat Hooks and 1 Adjustable Shelf	No Coat Hooks and 2 Adjustable Shelves	Coat Hooks and No Adjustable Shelf	Coat Hooks and 1 Adjustable Shelf	Coat Hooks and 2 Adjustable Shelves	Coat Rod* and No Adjustable Shelf
<b>Height of Unit</b>						
47.9375"	N.A.	N.A.	●	N.A.	N.A.	N.A.
54.125"	N.A.	N.A.	●	N.A.	N.A.	N.A.
66.5"	N.A.	N.A.	●	N.A.	N.A.	N.A.
72"	●	N.A.	●	●	N.A.	N.A.

\* Tip: In order to specify coat rod, depth must equal 24"D for all heights.



## 4-Door Single Wide and 8-Door Double Wide

	No Coat Hooks and 1 Adjustable Shelf	No Coat Hooks and 2 Adjustable Shelves	Coat Hooks and No Adjustable Shelf	Coat Hooks and 1 Adjustable Shelf	Coat Hooks and 2 Adjustable Shelves	Coat Rod* and No Adjustable Shelf
<b>Height of Unit</b>						
66.5"	N.A.	N.A.	●	N.A.	N.A.	N.A.
72"	N.A.	N.A.	●	N.A.	N.A.	N.A.

\* Tip: In order to specify coat rod, depth must equal 24"D for all heights.

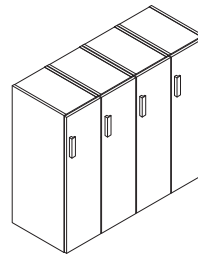
# Stability Guidelines

## Single Run of Lockers

Individual single- or double-wide lockers cannot stand alone. If not secured to the building structure, the minimum locker numbers that need to be ganged depend on depth, height, and width, and are shown in the table below.

If locker widths vary in the application, rules for the narrowest width applies. A double-wide locker counts as two lockers.

Locker Depth (inches)	Locker Height (inches)	Locker Width (inches)	Minimum Locker Number
18 ≤ D ≤ 24	≤ 70	any	3
	> 70	≥ 15	4
		< 15	6

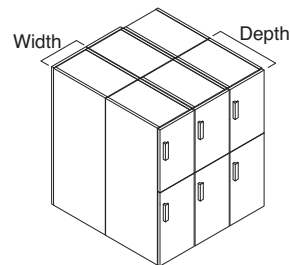


## Back-to-Back Lockers

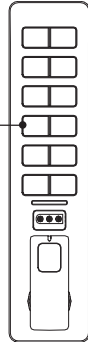
Individual lockers cannot stand alone. If not secured to the building structure, the minimum locker numbers that need to be ganged depend on width and are shown in the table below.

If locker depths are different on both sides, then the rules for the shallower depth applies. A double-wide locker counts as two lockers. These guidelines apply to all locker heights (41.75"–72").

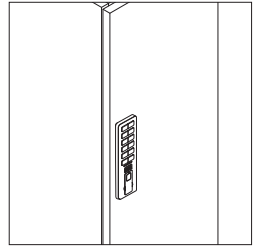
Depth	Locker Width	Minimum Locker Number side-to-side
Any	≥ 12"	2
	> 12"	3



**Keypad** has visual and audible indicators.



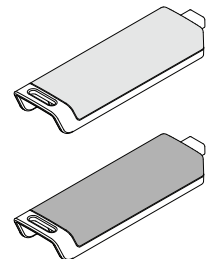
## Product Details



**Digilock Versa electronic keypad locks** are surface mounted on the door.

**Digilock Versa electronic keypad locks** come set to a shared use mode. The user locks with their credential and unlocks with the same credential. Once unlocked, the lock is reset for another user.

**Digilock Versa electronic keypad locks** are powered by two lithium 2450 batteries.



**The programming key and manager key,** ordered separately, are required if the electronic lock option is selected.  
▶ Specifying, page 400

## Surface Materials

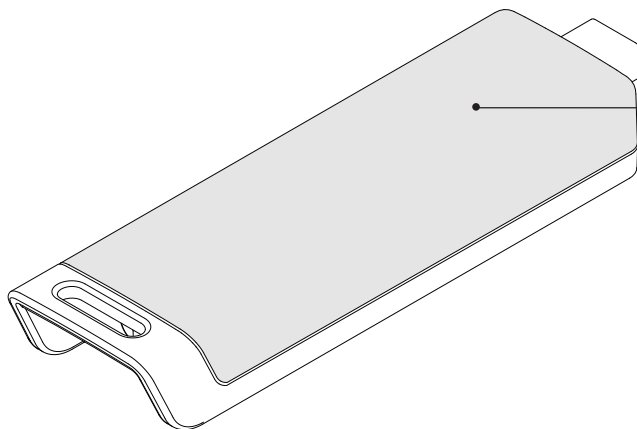
**Lock body**  
• 9211 Nickel

# UPTAKE Digilock Keys

## Digilock Versa electronic

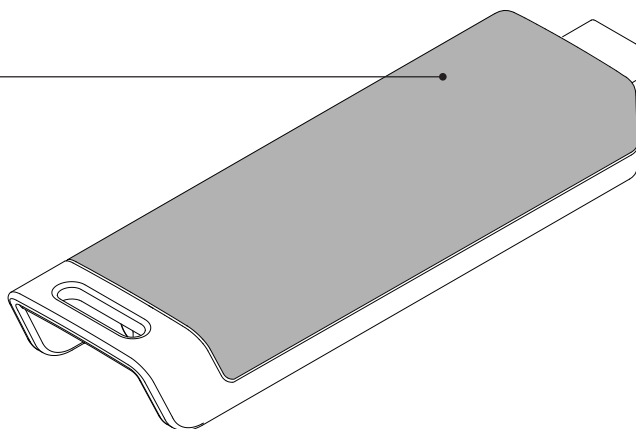
**keypad locks** enable facility managers to modify lock programming with a unique programming key and override locks using manager keys. Programming and manager keys are required if keyless lock option is selected.

► Specifying, page 400

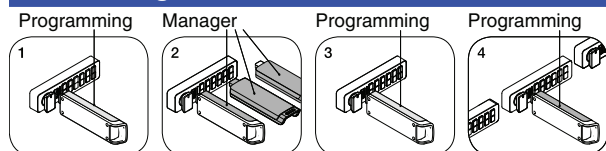


**The programming key** is used during installation to pair the manager key to the lock.

**The manager key** is used to override the lock when a credential is lost or forgotten or the battery loses power. Additional manager keys can be paired at any time. One manager keys may be paired to infinite locks; however, each lock may only pair with up to six manager keys.



## How to Program



1. Insert the programming key. A two-toned beep will be heard and the LED light will start to flash.
2. While the LED light is flashing, insert one manager key at a time. A beep will be heard for each manager key that is programmed.
3. Insert the programming key. A two-toned beep will be heard and the LED light will stop flashing.
4. Repeat previous steps for each lock.

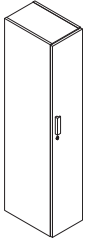
*Tip: The locks will arrive in the factory setting. During the process of pairing the manager key(s), the locks will be programmed into the shared setting.*

---

# Specifying UPTAKE Lockers

<b>UPTAKE Lockers</b>	<b>390</b>
<b>UPTAKE Adjustable Shelf</b>	<b>399</b>
<b>UPTAKE Digilock Keys</b>	<b>400</b>

# Uptake Lockers



*Tip: Lockers have an inset top construction which provides consistent door gaps and a tighter fit of adjacent units when ganged together.*

*Tip: Heights do not apply to all configurations.*

*Tip: Pricing is per shelf. Adjustable shelf option applies per opening.*

*Tip: If Digilock Versa is selected, the Digilock programming key and manager key must be specified separately for proper setup. Additional keys are available.*

*Tip: Shelf option is per opening. For example, if one adjustable shelf is optioned on a 3-door unit, three adjustable shelves will be included.*

*Tip: Coat rod available on 24"D lockers only regardless of height.*

## Standard Includes

- Locker: Low-Pressure Laminate (LPL) price group 01
- Headset: Low-Pressure Laminate (LPL) price group 01
- Ledge pull: metal
- Lock face ring with plastic plug to accommodate lock cylinder: 9201 Polished Chrome
- Fixed shelf on one-door units 54"H and taller
- Two coat hooks on 18"D locker, if selected
- One coat rod on 24"D locker, if selected
- 1 1/4" adjustable leveling glides
- Ganging hardware

## Options

Depth	18 7/8"	Prices below
	24"	Prices below
Width	12"	Prices below
	15"	Prices below
	18"	Prices below
	24"	Prices below
	30"	Prices below
	36"	Prices below
Height	41 3/4"	Prices below
	47 7/8"	Prices below
	54 1/8"	Prices below
	66 1/2"	Prices below
	72"	Prices below
Door Type	Door Hinged Left	No cost
	Door Hinged Right	No cost
Lock Option	Standard Key Plug	No cost
	Master Key Plug	+\$37
	Digilock Versa Keypad - Std	+\$230
Pull	Ledge Pull	No cost
	No Pull	No cost
Adjustable Shelf	No Adjustable Shelf	No cost
	One Adjustable Shelf	Prices below
	Two Adjustable Shelves	Prices below
Interior Configuration	Coat Hooks	No cost
	No Hook	No cost
	Coat Rod	+\$22

► **Product Information continued on next page**

# Uptake Lockers

► Product Information continued from previous page

## Specification Information

Dimensions      Add to Base Price  
Width    Depth

### Adjustable Shelf for Use with Single Wide

12"	18.875"	+\$67
12"	24"	+\$72
15"	18.875"	+\$77
15"	24"	+\$82
18"	18.875"	+\$87
18"	24"	+\$92

### Adjustable Shelf for Use with Double Wide

24"	18.875"	+\$67
24"	24"	+\$72
30"	18.875"	+\$77
30"	24"	+\$82
36"	18.875"	+\$87
36"	24"	+\$92

UPTAKE Lockers

Style                      Dimensions                      U.S. Base Prices  
Number      Width    Depth    Height

### Single Lockers - One Door



Style Number	Width	Depth	Height	U.S. Base Prices
<b>EMLKS1</b>	12"	18.875"	41.75"	\$1265
	12"	18.875"	47.9375"	\$1300
	12"	18.875"	54.125"	\$1335
	12"	18.875"	66.5"	\$1370
	12"	18.875"	72"	\$1404
	12"	24"	41.75"	\$1300
	12"	24"	47.9375"	\$1335
	12"	24"	54.125"	\$1370
	12"	24"	66.5"	\$1404
	12"	24"	72"	\$1439

► Product Information continued on next page

# Uptake Lockers

► Product Information continued from previous page

## Specification Information

Style Number	Dimensions			U.S. Base Prices
	Width	Depth	Height	
<b>EMLKS1</b>	15"	18.875"	41.75"	\$1300
	15"	18.875"	47.9375"	\$1335
	15"	18.875"	54.125"	\$1370
	15"	18.875"	66.5"	\$1404
	15"	18.875"	72"	\$1439
	15"	24"	41.75"	\$1335
	15"	24"	47.9375"	\$1370
	15"	24"	54.125"	\$1404
	15"	24"	66.5"	\$1439
	15"	24"	72"	\$1474
	18"	18.875"	41.75"	\$1335
	18"	18.875"	47.9375"	\$1370
18"	18.875"	54.125"	\$1404	
18"	18.875"	66.5"	\$1439	
18"	18.875"	72"	\$1474	
18"	24"	41.75"	\$1370	
18"	24"	47.9375"	\$1404	
18"	24"	54.125"	\$1439	
18"	24"	66.5"	\$1474	
18"	24"	72"	\$1509	

### Single Lockers - Two Door



<b>EMLKS2</b>	12"	18.875"	41.75"	\$1360
	12"	18.875"	47.9375"	\$1395
	12"	18.875"	54.125"	\$1430
	12"	18.875"	66.5"	\$1465
	12"	18.875"	72"	\$1500
	12"	24"	41.75"	\$1395
	12"	24"	47.9375"	\$1430
	12"	24"	54.125"	\$1465
	12"	24"	66.5"	\$1500
	12"	24"	72"	\$1535

► Product Information continued on next page



# Uptake Lockers

► Product Information continued from previous page

## Specification Information

Style Number	Dimensions			U.S. Base Prices
	Width	Depth	Height	
<b>EMLKS2</b>	15"	18.875"	41.75"	\$1395
	15"	18.875"	47.9375"	\$1430
	15"	18.875"	54.125"	\$1465
	15"	18.875"	66.5"	\$1500
	15"	18.875"	72"	\$1535
	15"	24"	41.75"	\$1430
	15"	24"	47.9375"	\$1465
	15"	24"	54.125"	\$1500
	15"	24"	66.5"	\$1535
	15"	24"	72"	\$1570
	18"	18.875"	41.75"	\$1430
	18"	18.875"	47.9375"	\$1465
18"	18.875"	54.125"	\$1500	
18"	18.875"	66.5"	\$1535	
18"	18.875"	72"	\$1570	
18"	24"	41.75"	\$1465	
18"	24"	47.9375"	\$1500	
18"	24"	54.125"	\$1535	
18"	24"	66.5"	\$1570	
18"	24"	72"	\$1605	

UPTAKE Lockers

### Single Lockers - Three Door



<b>EMLKS3</b>	12"	18.875"	47.9375"	\$1492
	12"	18.875"	54.125"	\$1527
	12"	18.875"	66.5"	\$1562
	12"	18.875"	72"	\$1596
	12"	24"	47.9375"	\$1527
	12"	24"	54.125"	\$1562
	12"	24"	66.5"	\$1596
	12"	24"	72"	\$1631

► Product Information continued on next page

# Uptake Lockers

► Product Information continued from previous page

## Specification Information

Style Number	Dimensions			U.S. Base Prices
	Width	Depth	Height	
<b>EMLKS3</b>	15"	18.875"	47.9375"	\$1527
	15"	18.875"	54.125"	\$1562
	15"	18.875"	66.5"	\$1596
	15"	18.875"	72"	\$1631
	15"	24"	47.9375"	\$1562
	15"	24"	54.125"	\$1596
	15"	24"	66.5"	\$1631
	15"	24"	72"	\$1666
	18"	18.875"	47.9375"	\$1562
	18"	18.875"	54.125"	\$1596
	18"	18.875"	66.5"	\$1631
	18"	18.875"	72"	\$1666
	18"	24"	47.9375"	\$1596
	18"	24"	54.125"	\$1631
	18"	24"	66.5"	\$1666
	18"	24"	72"	\$1701

### Single Lockers - Four Door



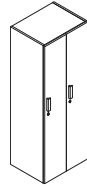
<b>EMLKS4</b>	12"	18.875"	66.5"	\$1657
	12"	18.875"	72"	\$1692
	12"	24"	66.5"	\$1692
	12"	24"	72"	\$1727
	15"	18.875"	66.5"	\$1692
	15"	18.875"	72"	\$1727
	15"	24"	66.5"	\$1727
	15"	24"	72"	\$1762
	18"	18.875"	66.5"	\$1727
	18"	18.875"	72"	\$1762
	18"	24"	66.5"	\$1762
	18"	24"	72"	\$1797

► Product Information continued on next page

# Uptake Lockers

► Product Information continued from previous page

## Specification Information



Style Number	Dimensions			U.S. Base Prices
	Width	Depth	Height	

### Double Lockers - Two Door

Style Number	Width	Depth	Height	U.S. Base Prices
<b>EMLKD2</b>	24"	18.875"	41.75"	\$2276
	24"	18.875"	47.9375"	\$2339
	24"	18.875"	54.125"	\$2401
	24"	18.875"	66.5"	\$2465
	24"	18.875"	72"	\$2528
	24"	24"	41.75"	\$2339
	24"	24"	47.9375"	\$2401
	24"	24"	54.125"	\$2465
	24"	24"	66.5"	\$2528
	24"	24"	72"	\$2590
	30"	18.875"	41.75"	\$2339
	30"	18.875"	47.9375"	\$2401
	30"	18.875"	54.125"	\$2465
	30"	18.875"	66.5"	\$2528
	30"	18.875"	72"	\$2590
	30"	24"	41.75"	\$2401
	30"	24"	47.9375"	\$2465
	30"	24"	54.125"	\$2528
	30"	24"	66.5"	\$2590
	30"	24"	72"	\$2653
	36"	18.875"	41.75"	\$2401
	36"	18.875"	47.9375"	\$2465
	36"	18.875"	54.125"	\$2528
	36"	18.875"	66.5"	\$2590
	36"	18.875"	72"	\$2653
	36"	24"	41.75"	\$2465
	36"	24"	47.9375"	\$2528
	36"	24"	54.125"	\$2590
	36"	24"	66.5"	\$2653
	36"	24"	72"	\$2716

UPTAKE Lockers

► Product Information continued on next page

# Uptake Lockers

► Product Information continued from previous page

## Specification Information



Style Number	Dimensions			U.S. Base Prices
	Width	Depth	Height	

### Double Lockers - Four Door

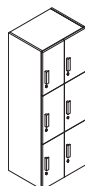
Style Number	Width	Depth	Height	U.S. Base Prices
<b>EMLKD4</b>	24"	18.875"	41.75"	\$2449
	24"	18.875"	47.9375"	\$2511
	24"	18.875"	54.125"	\$2575
	24"	18.875"	66.5"	\$2638
	24"	18.875"	72"	\$2700
	24"	24"	41.75"	\$2511
	24"	24"	47.9375"	\$2575
	24"	24"	54.125"	\$2638
	24"	24"	66.5"	\$2700
	24"	24"	72"	\$2763
	30"	18.875"	41.75"	\$2511
	30"	18.875"	47.9375"	\$2575
	30"	18.875"	54.125"	\$2638
	30"	18.875"	66.5"	\$2700
	30"	18.875"	72"	\$2763
	30"	24"	41.75"	\$2575
	30"	24"	47.9375"	\$2638
	30"	24"	54.125"	\$2700
	30"	24"	66.5"	\$2763
	30"	24"	72"	\$2825
	36"	18.875"	41.75"	\$2575
	36"	18.875"	47.9375"	\$2638
	36"	18.875"	54.125"	\$2700
	36"	18.875"	66.5"	\$2763
	36"	18.875"	72"	\$2825
	36"	24"	41.75"	\$2638
	36"	24"	47.9375"	\$2700
	36"	24"	54.125"	\$2763
	36"	24"	66.5"	\$2825
	36"	24"	72"	\$2889

► Product Information continued on next page

# Uptake Lockers

► Product Information continued from previous page

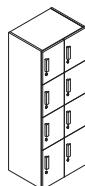
## Specification Information



Style Number	Dimensions			U.S. Base Prices
	Width	Depth	Height	

### Double Lockers - Six Door

<b>EMLKD6</b>	24"	18.875"	47.9375"	\$2685
	24"	18.875"	54.125"	\$2747
	24"	18.875"	66.5"	\$2810
	24"	18.875"	72"	\$2873
	24"	24"	47.9375"	\$2747
	24"	24"	54.125"	\$2810
	24"	24"	66.5"	\$2873
	24"	24"	72"	\$2936
	30"	18.875"	47.9375"	\$2747
	30"	18.875"	54.125"	\$2810
	30"	18.875"	66.5"	\$2873
	30"	18.875"	72"	\$2936
	30"	24"	47.9375"	\$2810
	30"	24"	54.125"	\$2873
	30"	24"	66.5"	\$2936
	30"	24"	72"	\$2999
	36"	18.875"	47.9375"	\$2810
	36"	18.875"	54.125"	\$2873
	36"	18.875"	66.5"	\$2936
	36"	18.875"	72"	\$2999
	36"	24"	47.9375"	\$2873
	36"	24"	54.125"	\$2936
	36"	24"	66.5"	\$2999
	36"	24"	72"	\$3062



### Double Lockers - Eight Door

<b>EMLKD8</b>	24"	18.875"	66.5"	\$2982
	24"	18.875"	72"	\$3046
	24"	24"	66.5"	\$3046
	24"	24"	72"	\$3109

► Product Information continued on next page

UPTAKE Lockers

# Uptake Lockers

▶ **Product Information continued from previous page**

## Specification Information

Style Number	Dimensions			U.S. Base Prices
	Width	Depth	Height	
<b>EMLKD8</b>	30"	18.875"	66.5"	\$3046
	30"	18.875"	72"	\$3109
	30"	24"	66.5"	\$3109
	30"	24"	72"	\$3171
36"	18.875"	66.5"	\$3109	
36"	18.875"	72"	\$3171	
36"	24"	66.5"	\$3171	
36"	24"	72"	\$3234	

# Uptake Lockers

Tip: Widths do not apply to all configurations.

Tip: Adjustable shelf for double locker includes one shelf for use in one side of the double locker.

Tip: Width listed for double locker is locker width, shelf width will be sized to fit in one side of double locker.

Tip: EMLKSHFS and EMLKSHFD should only be specified as separate line items if extra adjustable shelves are needed beyond what can be optioned on. Otherwise, specify adjustable shelves as options within the locker style numbers.

## Standard Includes

- Shelf: Low-Pressure Laminate case, price group 01
- Mounting hardware

## Options

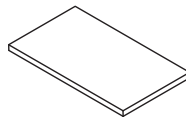
Depth	18 7/8"	Prices below
	24"	Prices below
Width	12"	Prices below
	15"	Prices below
	18"	Prices below

## Specification Information

Style Number	Dimensions		U.S. Base Prices
	Width	Depth	

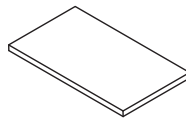
### Adjustable Shelf - Single Locker

EMLKSHFS	Width	Depth	U.S. Base Prices
	12"	18.875"	\$67
	12"	24"	\$72
	15"	18.875"	\$77
	15"	24"	\$82
	18"	18.875"	\$87
	18"	24"	\$92



### Adjustable Shelf - Double Locker

EMLKSHFD	Width	Depth	U.S. Base Prices
	12"	18.875"	\$67
	12"	24"	\$72
	15"	18.875"	\$77
	15"	24"	\$82
	18"	18.875"	\$87
	18"	24"	\$92



# Uptake Lockers

*Tip: Digilock keys are only for use with the keyless option. If keyless is selected, the programming key and manager key must be specified.*

*Tip: The manager key is available as an accommodation to the locking unit.*

## Standard Includes

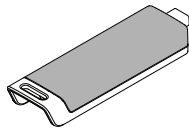
- Digilock key
- Instructions

## Specification Information

Style Number	U.S. Price
--------------	------------

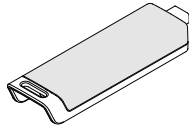
### Manager Key

**EMLKMKEY** \$98



### Programming Key


**EMLKPKEY** \$124





---

# West Elm Furniture



<b>Statement of Line</b>	<b>402</b>
<hr/>	
<b>Greenpoint</b>	
Understanding	<b>406</b>
Specifying	<b>408</b>
<b>Linear Personal Table</b>	
Specifying	<b>411</b>
<b>Lily Pad Nesting Tables</b>	
Specifying	<b>412</b>
<b>Maisie Side Tables</b>	
Specifying	<b>414</b>
<b>Nolan Side Table</b>	
Specifying	<b>415</b>
<b>Stump Side Table</b>	
Specifying	<b>416</b>

---

# Statement of Line

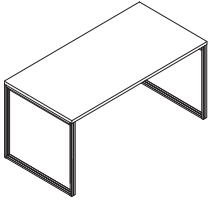
---

## Furniture

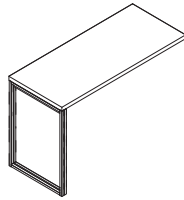
### Greenpoint Private Office

---

#### Desks and Returns



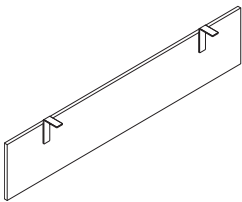
**Private Desk**  
Understanding  
▶ Page 406  
Specifying  
▶ Page 408



**Desk Return with Leg**  
Understanding  
▶ Page 406  
Specifying  
▶ Page 409

---

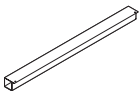
#### Modesty Panel



Understanding  
▶ Page 406  
Specifying  
▶ Page 409

---

#### Wire Managers



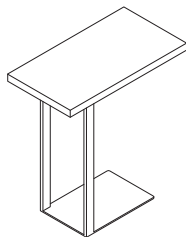
**1 3/4" D Wire Manager**  
Specifying  
▶ Page 410



**Wire Clip**  
Specifying  
▶ Page 410

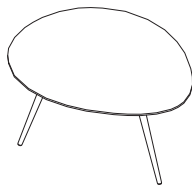
**Furniture, continued**

**Linear Personal Table**



Specifying  
▶ Page 411

**Lily Pad Nesting Tables**



**Lily Pad—16"H**  
Specifying  
▶ Page 412

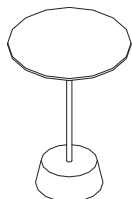


**Lily Pad—18"H**  
Specifying  
▶ Page 412

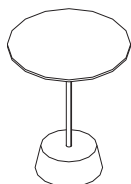


**Lily Pad—20"H**  
Specifying  
▶ Page 413

**Maisie Side Tables**



**Maisie—22"H**  
Specifying  
▶ Page 414

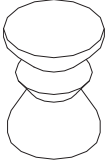


**Maisie—25"H**  
Specifying  
▶ Page 414

---

**Furniture, continued**

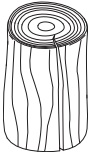
**Nolan Side Table**



Specifying  
▶ Page 415

---

**Stump Side Table**

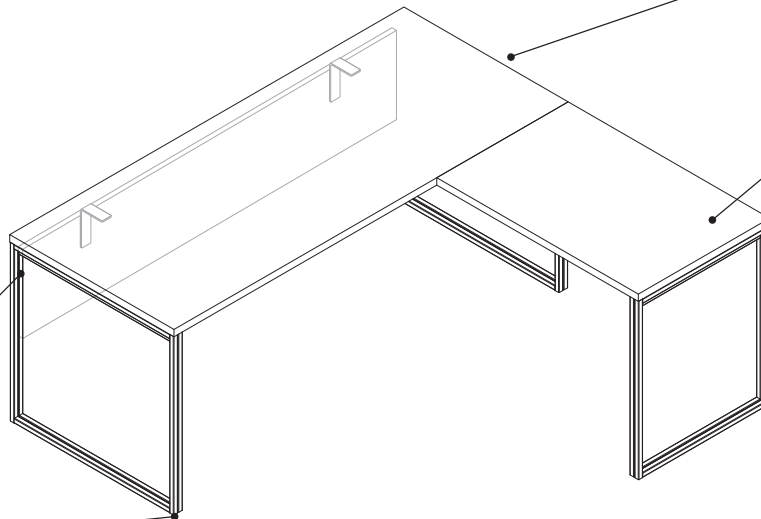


Specifying  
▶ Page 416



# Greenpoint Private Office

**Greenpoint private office** offers a contemporary take on the private office with its distinct visual language and fresh material options.



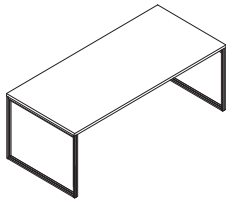
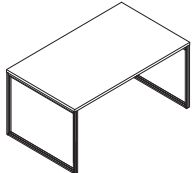
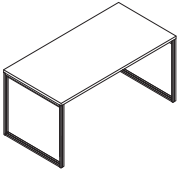
**Private desk worksur-**  
**faces** are 1 $\frac{1}{8}$ " thick. They  
are specified with High-  
Pressure Laminate. Height  
of the private desk is 29 $\frac{1}{2}$ ".

**Desk returns** are avail-  
able for private desks and  
can be specified with a leg  
support.

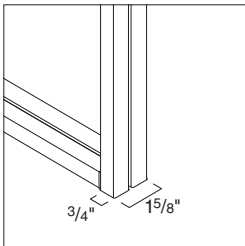
**A modesty panel** is avail-  
able and ordered separately.  
They can be specified in  
High-Pressure Laminate.  
Modesty panel can be  
mounted flush or inset.

**Leveling glides** provide  
1 $\frac{1}{2}$ " adjustment.

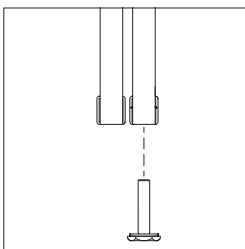
**Product Details**



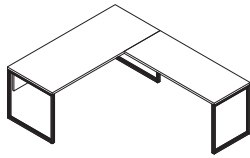
**Private desks** are available in a range of sizes and come standard with two legs. Desk returns and modesty panels are also available.



**Legs** are welded metal.

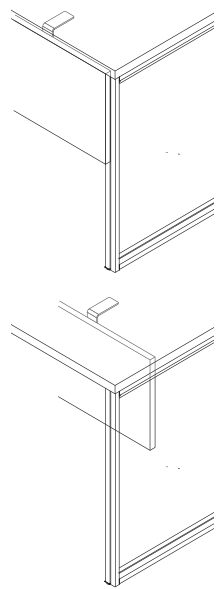


**Glide**s are adjustable and provide 1 1/2" adjustment.



**Desk returns** are used with private desks to form L-shape configurations, where everything is in reach.

**Modesty panels** cannot be used on the return side of this configuration.



**Modesty panel** can be mounted flush or inset. Height can be adjusted to provide cord pass-through.

**Surface Materials**

**Worksurface and modesty panel**

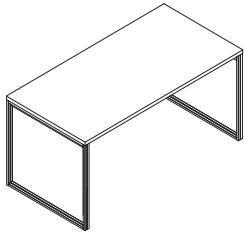
- 2409 Clear Maple
- 2410 Graphite Walnut
- 2412 Natural Cherry
- 2535 Virginia Walnut
- 2538 Clear Walnut
- 2730 Arctic White
- 2759 Warm White
- 2883 Seagull
- 2884 Milk
- 2HAK Clear Oak
- 2HAT Acacia
- 2LAW Ash Wenge
- 2HCN Clay Noce
- 2HCW Clay Wenge

**Frame and base**

- 4799 Platinum Metallic
- 7207 Black

# West Elm Furniture

## Greenpoint



### Standard Includes

- Desk worksurface: High-Pressure Laminate price group 01
- Square tube legs (frame): paint price group 01
- 1 1/2" leveling glides

### Options

Depth	30"	Prices below
Width	60"	Prices below
	66"	Prices below
	72"	Prices below
Top Surface Finish	Laminate HPL Price Group 01	No cost
Edge Finish	Plastic - PG1	No cost
Frame Finish	Paint Price Group 01	No cost
	Paint Price Group 02	+\$41

### Specification Information

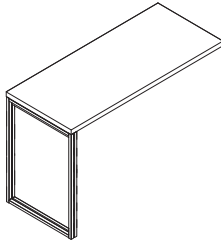
Style Number	Dimensions Depth	Base Prices		
		Width		
		60"	66"	72"

### Greenpoint Private Desk

Laminate HPL Price Group 01

<b>AMQWESINDPD</b>	30"	\$2141	\$2202	\$2265
--------------------	-----	--------	--------	--------





**Standard Includes**

- Desk worksurface: High-Pressure Laminate price group 01
- Square tube legs (frame): paint price group 01
- 1 1/2" leveling glides

**Options**

Depth	24"	Prices below
Width	42"	Prices below
	48"	Prices below
Top Surface Finish	Laminate HPL Price Group 01	No cost
Edge Finish	Plastic - PG1	No cost
Frame Finish	Paint Price Group 01	No cost
	Paint Price Group 02	+\$19

**Specification Information**

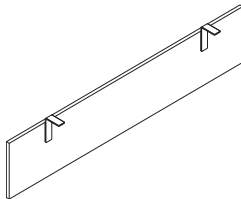
Style Number	Dimensions		Base Prices	
	Depth		Width	
			42"	48"

**Greenpoint Desk Return with Leg**

Laminate HPL Price Group 01

<b>AMQWESINDRL</b>	24"	\$1183	\$1243
--------------------	-----	--------	--------

West Elm Furniture



**Standard Includes**

- Modesty panel: High-Pressure Laminate price group 01
- Mounting brackets: black paint

**Options**

Width	60"	No cost
	66"	No cost
	72"	No cost
Modesty Panel Finish	Laminate HPL Price Group 01	No cost

**Specification Information**

Style Number	Dimensions		Prices		
	Height		Width		
			60"	66"	72"

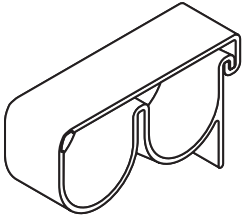
**Greenpoint Modesty Panel**

Laminate HPL Price Group 01

<b>AMQWESINDMP</b>	12 1/2"	\$504	\$532	\$558
--------------------	---------	-------	-------	-------

# West Elm Furniture

Greenpoint



### Standard Includes

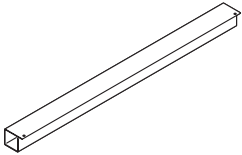
- Carton of six wire clips: black plastic only
- Foam tape
- Mounting screws

### Specification Information

Style Number	Price
--------------	-------

### Wire Clip, Package of 6

<b>AMQ999CHT</b>	\$106
------------------	-------



### Standard Includes

- Attachment hardware
- Wire manager: 6000 Black

### Specification Information

Dimensions	Weight	Style Number	Price
------------	--------	--------------	-------

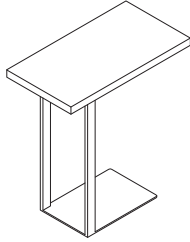
D	W	H	
---	---	---	--

### 1 3/4"D Wire Manager

1 3/4"	30"	1 3/4"	0.56 lb	<b>AMQAWM30</b>	\$70
--------	-----	--------	---------	-----------------	------

# West Elm Furniture

## Linear Personal Table



### Standard Includes

- Table: natural oak

### Specification Information

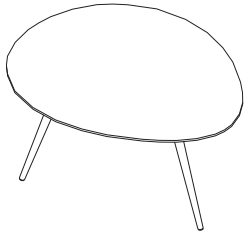
Style Number	Dimensions			Price
	Depth	Width	Height	

### Linear Personal Table

<b>AMQWEM8</b>	13"	24"	26"	\$673
----------------	-----	-----	-----	-------

# West Elm Furniture

## Lily Pad Nesting Tables



### Standard Includes

- Table: dry erase board

### Options

Color	Dry Erase Board	No cost
	Walnut	+\$255
	White Marble	+\$744

### Specification Information

Style Number	Dimensions			Base Price
	Depth	Width	Height	

### Lily Pad Nesting Table

<b>AMQWEM7</b>	25"	30"	16"	\$792
----------------	-----	-----	-----	-------



### Standard Includes

- Table: dry erase board

### Options

Color	Dry Erase Board	No cost
	Walnut	+\$275
	White Marble	+\$765

### Specification Information

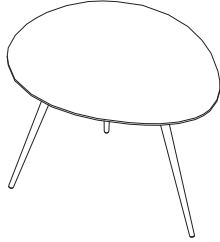
Style Number	Dimensions			Base Price
	Depth	Width	Height	

### Lily Pad Nesting Table

<b>AMQWEM59</b>	25"	30"	18"	\$812
-----------------	-----	-----	-----	-------

# West Elm Furniture

## Lily Pad Nesting Tables



### Standard Includes

- Table: dry erase board

### Options

Color	Dry Erase Board	No cost
	Walnut	+\$301
	White Marble	+\$791

### Specification Information

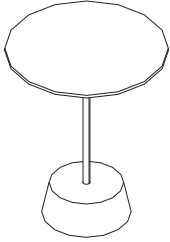
Style Number	Dimensions			Base Price
	Depth	Width	Height	

### Lily Pad Nesting Table

<b>AMQWEM60</b>	25"	30"	20"	\$825
-----------------	-----	-----	-----	-------

# West Elm Furniture

## Maisie Side Tables



### Standard Includes

- Table: walnut veneer

### Options

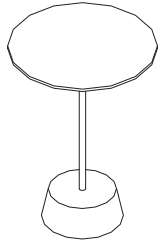
Color		
	Walnut	No cost
	Marble	+\$222

### Specification Information

Style Number	Dimensions		Base Price
	Dia.	Height	

### Maisie Side Table

<b>AMQWEM11</b>	18"	22"	\$851
-----------------	-----	-----	-------



### Standard Includes

- Table: walnut veneer

### Options

Color		
	Walnut	No cost
	Marble	+\$229

### Specification Information

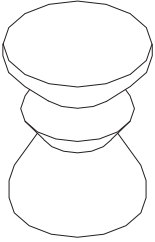
Style Number	Dimensions		Base Price
	Dia.	Height	

### Maisie Side Table

<b>AMQWEM4</b>	18"	25"	\$884
----------------	-----	-----	-------

# West Elm Furniture

## Nolan Side Table



### Standard Includes

- Table: antique brass

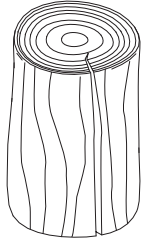
### Specification Information

Style Number	Dimensions		Price
	Dia.	Height	
<b>Nolan Side Table</b>			
<b>AMQWEM9</b>	14"	18"	\$525

West Elm Furniture

# West Elm Furniture

## Stump Side Table



*Tip: This style number is subject to inventory availability.*

### Standard Includes

- Table: solid cypress

### Specification Information

Style Number	Dimensions		Price
	Dia.	Height	

### Stump Side Table

<b>AMQWEM5</b>	12 1/2"	19"	\$668
----------------	---------	-----	-------



---

# AMQ Seating

<b>JAKU</b>	<b>419</b>
<b>SIYA</b>	<b>427</b>
<b>ZILO</b>	<b>433</b>
<b>PERSONALITY PLUS</b>	<b>441</b>
<b>BODI</b>	<b>447</b>
<b>FL-X</b>	<b>451</b>
<b>TIZU</b>	<b>455</b>
<b>BIXBY</b>	<b>461</b>
<b>WEST ELM SEATING</b>	<b>471</b>



---

# JAKU



## JAKU

Understanding	<b>420</b>
Specifying	<b>421</b>

## Jaku Features

---

Frame available in White and Black

---

Base available in Polished Aluminum, White and Black

---

Removable Seat Covers

---

Smart Sync Mechanism with Variable Back Stop with Tension Adjustment

---

Step Sync Mech with Multi-Position Back Lock and Tension Knob

---

3-Way Adjustable or Fixed Arms

---

Adjustable Lumbar Support

---

Seat Depth Adjustment (seat slider)

---

Waterfall Seat Design

---

Fully Assembled option

---



## Jaku Specifications

Weight Capacity	275 lbs
Net Weight	38 lbs
Back Dimensions	18.25"w x 22"h
Seat Dimensions	19.25"w x 19.75"d
Seat Height	17" - 20.25"
Back Height	39.25" - 42.5"
Arms Span (outside edges)	24.25" - 26.75"
Adjustable Seat Depth	16.5" - 17.75"
Base Width	27"
Body Frame Material	Nylon
Base Materials	Polished Aluminum and Nylon
Cushion Seats	Polyurethane fill
Seat Covers	Removable with velcro closure
Mesh Back Material	Polyester
Castors	Soft* (Black or White/Grey)
Certifications	ANSI/BIFMA X5.1-2017 TB117-2013 Indoor Advantage Gold™



Tip: Illustration above shows a fully assembled chair which is not included in the base price.

### Standard Includes

- 3 1/4" pneumatic seat-height adjustment (17.0" - 20.25")
- Plastic frame
- Plastic base
- Seat depth adjustment (seat slider)
- Fabric price group 1 upholstery design on seat
- Removable seat covers with velcro closure
- Fixed arms
- Adjustable lumbar support
- Mesh back
- Step Sync Mechanism with multi-position back lock and tension knob
- 2 1/2" diameter, soft-composition, dual-wheel black casters

### Options

Backrest Finish	Black W/ Black Mesh Adj Lumbar	No cost
	White W/ Grey Mesh Adj. Lumbar	+\$11
Seat Pan	Black Plastic Seat Shell	No cost
	Grey Plastic Seat Shell	+\$7
Seat Cover Finish	Fabric Price Group 01	No cost
	Fabric Price Group 02	+\$19
	Fabric Price Group 03	+\$38
	Polyurethane - Price Group 4	+\$68
Armrests	Fixed, Black	No cost
	Fixed, White	+\$5
	3-Way Adjustable, Black	+\$43
	3-Way Adjustable, White	+\$48
Mechanism	Step Sync Mechanism, Black	No cost
	Smart Sync Mechanism, Black	+\$62
	Smart Sync Mechanism, Grey	+\$63
Cylinder	Smart Sync Cylinder, Chrome	No cost
	Smart Sync Cylinder, Black	No cost
	Smart Sync Cylinder, White	No cost
	Step Sync Cylinder, Black	No cost
	Step Sync Cylinder, Chrome	No cost
	Step Sync Cylinder, White	No cost
Base Option	Black Base	No cost
	White Base	+\$13
	Polished Aluminum Base	+\$31
Castors or Glides	Soft, Black	No cost
	Soft, 2-Tone Grey	+\$5
Packaging	Knocked down	No cost
	Fully Assembled	+\$93

### Specification Information

Style Number      Base Price

## JAKU Chair

**JAKU**CHAIR      \$758

# JAKU

## JAKU



Tip: Illustration above shows a fully assembled chair which is not included in the base price.

Tip: This pre-configured chair includes: Smart Sync mechanism, 3-way adjustable arms, polished aluminum base, and white/grey casters.

### Standard Includes

- 3 1/4" pneumatic seat-height adjustment (17.0" - 20.25")
- Adjustable lumbar support
- Backrest: white with grey mesh
- Smart Sync mechanism with tension dial and variable back stop
- 3-way adjustable arms
- 2 1/2" diameter, soft-composition, dual-wheel white/grey casters
- Polished aluminum base

### Options

Seat Cover Finish	Fabric Price Group 01	No cost
	Fabric Price Group 02	+\$18
	Fabric Price Group 03	+\$37
	Polyurethane - Price Group 4	+\$68
Packaging	Knocked down	No cost
	Fully Assembled	+\$93

### Specification Information

Style Number    Base Price

## JAKU Pre-Configured Chair

**JAKU001**    \$925



Tip: Illustration above shows a fully assembled chair which is not included in the base price.

Tip: This pre-configured chair includes: Step Sync mechanism, 3-way adjustable arms, polished aluminum base, and white/grey casters.

### Standard Includes

- 3 1/4" pneumatic seat-height adjustment (17.0" - 20.25")
- Adjustable lumbar support
- Backrest: white with grey mesh
- Step Sync Mechanism with multi-position back lock and tension knob
- 3-way adjustable arms
- 2 1/2" diameter, soft-composition, dual-wheel white/grey casters
- Polished aluminum base

### Options

Seat Cover Finish	Fabric Price Group 01	No cost
	Fabric Price Group 02	+\$18
	Fabric Price Group 03	+\$37
	Polyurethane - Price Group 4	+\$68
Packaging	Knocked down	No cost
	Fully Assembled	+\$93

### Specification Information

Style Number    Base Price

## JAKU Pre-Configured Chair

**JAKU002**    \$862



Tip: Illustration above shows a fully assembled chair which is not included in the base price.

Tip: This pre-configured chair includes: Smart Sync mechanism, 3-way adjustable arms, white base, and white/grey casters.

**Standard Includes**

- 3 1/4" pneumatic seat-height adjustment (17.0" - 20.25")
- Adjustable lumbar support
- Backrest: white with grey mesh
- Smart Sync mechanism with tension dial and variable back stop
- 3-way adjustable arms
- 2 1/2" diameter, soft-composition, dual-wheel white/grey casters
- White base

**Options**

Seat Cover Finish	Fabric Price Group 01	No cost
	Fabric Price Group 02	+\$18
	Fabric Price Group 03	+\$37
	Polyurethane - Price Group 4	+\$68
Packaging	Knocked down	No cost
	Fully Assembled	+\$93

**Specification Information**

Style Number    Base Price

**JAKU Pre-Configured Chair**

**JAKU003**    \$907



Tip: Illustration above shows a fully assembled chair which is not included in the base price.

Tip: This pre-configured chair includes: Smart Sync mechanism, 3-way adjustable arms, polished aluminum base, and black casters.

**Standard Includes**

- 3 1/4" pneumatic seat-height adjustment (17.0" - 20.25")
- Adjustable lumbar support
- Backrest: black with black mesh
- Smart Sync mechanism with tension dial and variable back stop
- 3-way adjustable arms
- 2 1/2" diameter, soft-composition, dual-wheel black casters
- Polished aluminum base

**Options**

Seat Cover Finish	Fabric Price Group 01	No cost
	Fabric Price Group 02	+\$18
	Fabric Price Group 03	+\$37
	Polyurethane - Price Group 4	+\$68
Packaging	Knocked down	No cost
	Fully Assembled	+\$93

**Specification Information**

Style Number    Base Price

**JAKU Pre-Configured Chair**

**JAKU004**    \$895



**JAKU****JAKU**

Tip: Illustration above shows a fully assembled chair which is not included in the base price.

Tip: This pre-configured chair includes: Step Sync mechanism, 3-way adjustable arms, polished aluminum base, and black casters.

**Standard Includes**

- 3 1/4" pneumatic seat-height adjustment (17.0" - 20.25")
- Adjustable lumbar support
- Backrest: black with black mesh
- Step Sync Mechanism with multi-position back lock and tension knob
- 3-way adjustable arms
- 2 1/2" diameter, soft-composition, dual-wheel black casters
- Polished aluminum base

**Options**

Seat Cover Finish	Fabric Price Group 01	No cost
	Fabric Price Group 02	+\$18
	Fabric Price Group 03	+\$37
	Polyurethane - Price Group 4	+\$68
Packaging	Knocked down	No cost
	Fully Assembled	+\$93

**Specification Information**

Style Number    Base Price

**JAKU Pre-Configured Chair**

**JAKU005**    \$832



Tip: Illustration above shows a fully assembled chair which is not included in the base price.

Tip: This pre-configured chair includes: Smart Sync mechanism, 3-way adjustable arms, black base, and black casters.

**Standard Includes**

- 3 1/4" pneumatic seat-height adjustment (17.0" - 20.25")
- Adjustable lumbar support
- Backrest: black with black mesh
- Smart Sync mechanism with tension dial and variable back stop
- 3-way adjustable arms
- 2 1/2" diameter, soft-composition, dual-wheel black casters
- Black base

**Options**

Seat Cover Finish	Fabric Price Group 01	No cost
	Fabric Price Group 02	+\$18
	Fabric Price Group 03	+\$37
	Polyurethane - Price Group 4	+\$68
Packaging	Knocked down	No cost
	Fully Assembled	+\$93

**Specification Information**

Style Number    Base Price

**JAKU Pre-Configured Chair**

**JAKU006**    \$863





Tip: Illustration above shows a fully assembled chair which is not included in the base price.

Tip: This pre-configured chair includes: Smart Sync mechanism, fixed arms, polished aluminum base, and white/grey casters.

**Standard Includes**

- 3 1/4" pneumatic seat-height adjustment (17.0" - 20.25")
- Backrest: white with grey mesh
- Smart Sync mechanism with tension dial and variable back stop
- Fixed arms
- Adjustable lumbar support
- 2 1/2" diameter, soft-composition, dual-wheel white/grey casters
- Polished aluminum base

**Options**

Seat Cover Finish	Fabric Price Group 01	No cost
	Fabric Price Group 02	+\$18
	Fabric Price Group 03	+\$37
	Polyurethane - Price Group 4	+\$68
Packaging	Knocked down	No cost
	Fully Assembled	+\$93

**Specification Information**

Style Number    Base Price

**JAKU Pre-Configured Chair**

**JAKU007**    \$882



Tip: Illustration above shows a fully assembled chair which is not included in the base price.

Tip: This pre-configured chair includes: Smart Sync mechanism, fixed arms, polished aluminum base, and black casters.

**Standard Includes**

- 3 1/4" pneumatic seat-height adjustment (17.0" - 20.25")
- Backrest: black with black mesh
- Smart Sync mechanism with tension dial and variable back stop
- Fixed arms
- Adjustable lumbar support
- 2 1/2" diameter, soft-composition, dual-wheel black casters
- Polished aluminum base

**Options**

Seat Cover Finish	Fabric Price Group 01	No cost
	Fabric Price Group 02	+\$18
	Fabric Price Group 03	+\$37
	Polyurethane - Price Group 4	+\$68
Packaging	Knocked down	No cost
	Fully Assembled	+\$93

**Specification Information**

Style Number    Base Price

**JAKU Pre-Configured Chair**

**JAKU008**    \$851

# JAKU

JAKU



### Standard Includes

- Seat cover

### Specification Information

Style Number	Price Group	Prices
--------------	-------------	--------

#### JAKU Seat Cover

<b>JAKUSEATCOVER</b>	Fabric Price Group 01	\$61
	Fabric Price Group 02	\$80
	Fabric Price Group 03	\$99
	Polyurethane Price Group 04	\$129

---

# SIYA



## SIYA

Understanding	428
Specifying	429

## Siya Features

---

Frame available in White and Black

---

Base available in Polished Aluminum, White and Black

---

Removable Seat Covers

---

Synchronized Mechanism with Tension Adjustment

---

Multi-Position Back Lock

---

4-Way Width Adjustable Arms

---

Adjustable Lumbar Support

---

Seat Depth Adjustment (seat slider)

---

Waterfall Seat Design

---

Fully Assembled option

---



## Siya Specifications

Weight Capacity	275 lbs
Net Weight	39 lbs
Back Dimensions	18.5" w x 23.4" h
Seat Dimensions	19.5" w x 19.3" d
Seat Height	17.25" - 21.25"
Back Height	41.25" - 45.25"
Arms Span (outside edges)	24.6" - 26.4"
Adjustable Seat Depth	16.25" - 17.5"
Base Width	27"
Body Frame Material	Nylon
Base Materials	Polished Aluminum and Nylon
Cushion Seats	Polyurethane fill
Seat Covers	Removable with zip closure
Mesh Back Material	Polyester/Polyelastomer/Nylon
Castors	Soft* (Black or White/Grey)
Certifications	ANSI/BIFMA X5.1-2017 TB117-2013 Indoor Advantage Gold™



*Tip: Illustration above shows a fully assembled chair which is not included in the base price.*

**Standard Includes**

- 4" pneumatic seat-height adjustment (17.25" - 21.25")
- Plastic frame
- Plastic base
- Seat depth adjustment (seat slider)
- Fabric price group 1 upholstery design on seat
- Removable seat covers with zip closure
- 4-way adjustable arms
- Adjustable lumbar support
- Mesh back
- Multi-position back lock
- Synchronized mechanism with tension adjustment
- 2 1/2" diameter, soft-composition, dual-wheel black casters

**Options**

Backrest Finish	Black W/ Black Mesh Adj Lumbar	No cost
	White W/ Grey Mesh Adj. Lumbar	+\$12
Seat Pan	Black Plastic Seat Shell	No cost
	White Plastic Seat Shell	+\$7
Seat Cover Finish	Fabric Price Group 01	No cost
	Fabric Price Group 02	+\$19
	Fabric Price Group 03	+\$38
	Polyurethane - Price Group 4	+\$68
Armrests	4-Way Adjustable, Black	No cost
	4-Way Adjustable, White	+\$6
Base Option	Black Base	No cost
	White Base	+\$11
	Polished Aluminum Base	+\$30
Castors or Glides	Soft, Black	No cost
	Soft, 2-Tone Grey	+\$5
Packaging	Knocked down	No cost
	Fully Assembled	+\$93

**Specification Information**

**Style Number**   **Base Price**

**SIYA Chair**

**SIYACHAIR**   \$812



# SIYA

## SIYA



Tip: Illustration above shows a fully assembled chair which is not included in the base price.

Tip: This pre-configured chair includes: synchronized mechanism, 4-way adjustable arms, polished aluminum base, and white/grey casters.

### Standard Includes

- 4" pneumatic seat-height adjustment (17.25" - 21.25")
- Adjustable lumbar support
- Synchronized mechanism with tension adjustment
- Backrest: white with grey mesh
- Multi-position back lock
- 4-way adjustable arms
- 2 1/2" diameter, soft-composition, dual-wheel white/grey casters
- Polished aluminum base

### Options

Seat Cover Finish	Fabric Price Group	Price
	Fabric Price Group 01	No cost
	Fabric Price Group 02	+\$18
	Fabric Price Group 03	+\$37
	Polyurethane - Price Group 4	+\$68

### Specification Information

Style Number    Base Price

## SIYA Pre-Configured Chair

**SIYA001**      \$872



Tip: Illustration above shows a fully assembled chair which is not included in the base price.

Tip: This pre-configured chair includes: synchronized mechanism, 4-way adjustable arms, white base, and white/grey casters.

### Standard Includes

- 4" pneumatic seat-height adjustment (17.25" - 21.25")
- Adjustable lumbar support
- Synchronized mechanism with tension adjustment
- Backrest: white with grey mesh
- Multi-position back lock
- 4-way adjustable arms
- 2 1/2" diameter, soft-composition, dual-wheel white/grey casters
- White base

### Options

Seat Cover Finish	Fabric Price Group	Price
	Fabric Price Group 01	No cost
	Fabric Price Group 02	+\$18
	Fabric Price Group 03	+\$37
	Polyurethane - Price Group 4	+\$68

### Specification Information

Style Number    Base Price

## SIYA Pre-Configured Chair

**SIYA002**      \$853



Tip: Illustration above shows a fully assembled chair which is not included in the base price.

Tip: This pre-configured chair includes: synchronized mechanism, 4-way adjustable arms, polished aluminum base, and black casters.

**Standard Includes**

- 4" pneumatic seat-height adjustment (17.25" - 21.25")
- Adjustable lumbar support
- Synchronized mechanism with tension adjustment
- Backrest: black with black mesh
- Multi-position back lock
- 4-way adjustable arms
- 2 1/2" diameter, soft-composition, dual-wheel black casters
- Polished aluminum base

**Options**

Seat Cover Finish	Fabric Price Group 01	No cost
	Fabric Price Group 02	+\$18
	Fabric Price Group 03	+\$37
	Polyurethane - Price Group 4	+\$68

**Specification Information**

Style Number    Base Price

**SIYA Pre-Configured Chair**

**SIYA003**      \$843



Tip: Illustration above shows a fully assembled chair which is not included in the base price.

Tip: This pre-configured chair includes: synchronized mechanism, 4-way adjustable arms, black base, and black casters.

**Standard Includes**

- 4" pneumatic seat-height adjustment (17.25" - 21.25")
- Adjustable lumbar support
- Synchronized mechanism with tension adjustment
- Backrest: black with black mesh
- Multi-position back lock
- 4-way adjustable arms
- 2 1/2" diameter, soft-composition, dual-wheel black casters
- Black base

**Options**

Seat Cover Finish	Fabric Price Group 01	No cost
	Fabric Price Group 02	+\$18
	Fabric Price Group 03	+\$37
	Polyurethane - Price Group 4	+\$68

**Specification Information**

Style Number    Base Price

**SIYA Pre-Configured Chair**

**SIYA004**      \$812



# SIYA

SIYA



### Standard Includes

- Seat cover

### Specification Information

Style Number	Price Group	Prices
--------------	-------------	--------

#### SIYA Seat Cover

<b>SIYASEATCOVER</b>	Fabric Price Group 01	\$61
	Fabric Price Group 02	\$80
	Fabric Price Group 03	\$99
	Polyurethane Price Group 04	\$129



---

# ZILO



## ZILO

Understanding	<b>434</b>
Specifying	<b>435</b>

## Zilo Features

Choose from standard configurations or customize your own

Available in Black, White or All Mesh

Choose from Mid or High Back

Full Syncro Mechanism with Tension Adjuster

2 Position Lock with Sliding Seat Mechanism

3-way Adjustable or Fixed Loop Arm styles

Adjustable Lumbar Support

Removable Seat Covers in 3 material options (fabric, leather and polyurethane)



## Zilo Specifications

Weight Capacity	275 lbs
Net Weight	38 lbs
Height Range	39.5" - 43.5"
High Back Dimensions	18"w x 21.5"h
Mid-Back Dimensions	18"w x 18.5"h
Seat Dimensions	19.25"w x 20"d
Seat Height Range	18.5" - 22.75"
Arms Span (outside edges)	25.25" - 26.5"
Body Frame Material	Nylon
Base Materials	Polished Aluminum and Nylon
Base Width	Nylon: 27" / Polished Aluminum: 27.5"
Cushion Seats	Polyurethane fill
Seat Covers	Removable with velcro closure
Mesh Back Material	Polyester/Polyelastomer/Nylon
Castors	Soft* PU (Black or White/Grey)
Certifications	ANSI/BIFMA X5.1-2017 TB117-2013 Indoor Advantage Gold™



Tip: Illustration above shows a fully assembled chair which is not included in the base price.

**Standard Includes**

- 4 1/4" pneumatic seat-height adjustment (18.5" - 22.75")
- Plastic frame
- Plastic base
- Seat depth adjustment (seat slider)
- Fabric price group 1 upholstery design on seat
- Removable seat covers with velcro closure
- Fixed loop arms
- Adjustable lumbar support
- Mesh back
- Synchronized mechanism with tension adjustment
- 2 1/2" diameter, soft-composition, dual-wheel black casters

**Options**

Backrest Finish	Mid Back - Black, 22.5" High	No cost
	Mid Back - White, 22.5" High	+\$12
	High Back-Black Mesh,26" High	+\$50
	High-Black Mesh for Mesh Seat	+\$50
	High Back - White, 26" High	+\$62
Seat Pan	Black Plastic Seat Shell	No cost
	White Plastic Seat Shell	+\$7
	Black Shell,for All Mesh Chair	+\$204
Seat Cover Finish	Fabric Price Group 01	No cost
	Fabric Price Group 02	+\$19
	Fabric Price Group 03	+\$38
	Polyurethane - Price Group 4	+\$68
	Leather - Price Group 7	+\$149
Armrests	Fixed Loop, Black	No cost
	Fixed Loop, White	+\$6
	3-Way Adjustable, Black	+\$35
	3-Way Adjustable, White	+\$43
	Mechanism	Synchro W/ Tension Adjust
Swivel,Draft Ring W/ Ext. Cyl.		+\$168
Base Option	Black Base	No cost
	White Base	+\$13
	Polished Aluminum Base	+\$31
Castors or Glides	Soft, Black	No cost
	Soft, 2-Tone Grey	+\$5
Packaging	Knocked down	No cost
	Fully Assembled	+\$93

**Specification Information**

Style Number    Base Price

**ZILO Task Chair**

**ZILOCHAIR** \$679



**ZILO****ZILO**

Tip: Illustration above shows a fully assembled chair which is not included in the base price.

Tip: This pre-configured chair includes: synchronized mechanism, mesh back, 3-way adjustable arms, polished aluminum base, and white casters.

**Standard Includes**

- 4 1/4" pneumatic seat-height adjustment (18.5" - 22.75")
- Adjustable lumbar support
- Synchronized mechanism with tension adjustment
- High backrest: white with grey mesh
- 3-way adjustable arms
- 2 1/2" diameter, soft-composition, dual-wheel white casters
- Polished aluminum base

**Options**

Seat Cover Finish	Fabric Price Group 01	No cost
	Fabric Price Group 02	+\$18
	Fabric Price Group 03	+\$37
	Polyurethane - Price Group 4	+\$68
	Leather - Price Group 7	+\$148
Packaging	Knocked down	No cost
	Fully Assembled	+\$93

**Specification Information**

Style Number    Base Price

**ZILO Pre-Configured Chair**

**ZILO001**      \$828



Tip: Illustration above shows a fully assembled chair which is not included in the base price.

Tip: This pre-configured chair includes: synchronized mechanism, mesh back, 3-way adjustable arms, white base, and white casters.

**Standard Includes**

- 4 1/4" pneumatic seat-height adjustment (18.5" - 22.75")
- Adjustable lumbar support
- Synchronized mechanism with tension adjustment
- High backrest: white with grey mesh
- 3-way adjustable arms
- 2 1/2" diameter, soft-composition, dual-wheel white casters
- White base

**Options**

Seat Cover Finish	Fabric Price Group 01	No cost
	Fabric Price Group 02	+\$18
	Fabric Price Group 03	+\$37
	Polyurethane - Price Group 4	+\$68
	Leather - Price Group 7	+\$148
Packaging	Knocked down	No cost
	Fully Assembled	+\$93

**Specification Information**

Style Number    Base Price

**ZILO Pre-Configured Chair**

**ZILO002**      \$810



Tip: Illustration above shows a fully assembled chair which is not included in the base price.

Tip: This pre-configured chair includes: synchronized mechanism, mesh back, 3-way adjustable arms, polished aluminum base, and black casters.

**Standard Includes**

- 4 1/4" pneumatic seat-height adjustment (18.5" - 22.75")
- Adjustable lumbar support
- Synchronized mechanism with tension adjustment
- High backrest: black with black mesh
- 3-way adjustable arms
- 2 1/2" diameter, soft-composition, dual-wheel black casters
- Polished aluminum base

**Options**

Seat Cover Finish	Fabric Price Group 01	No cost
	Fabric Price Group 02	+\$18
	Fabric Price Group 03	+\$37
	Polyurethane - Price Group 4	+\$68
	Leather - Price Group 7	+\$148
Packaging	Knocked down	No cost
	Fully Assembled	+\$93

**Specification Information**

Style Number    Base Price

**ZILO Pre-Configured Chair**

**ZILO003**      \$794



Tip: Illustration above shows a fully assembled chair which is not included in the base price.

Tip: This pre-configured chair includes: synchronized mechanism, mesh back, 3-way adjustable arms, black base, and black casters.

**Standard Includes**

- 4 1/4" pneumatic seat-height adjustment (18.5" - 22.75")
- Adjustable lumbar support
- Synchronized mechanism with tension adjustment
- High backrest: black with black mesh
- 3-way adjustable arms
- 2 1/2" diameter, soft-composition, dual-wheel black casters
- Black base

**Options**

Seat Cover Finish	Fabric Price Group 01	No cost
	Fabric Price Group 02	+\$18
	Fabric Price Group 03	+\$37
	Polyurethane - Price Group 4	+\$68
	Leather - Price Group 7	+\$148
Packaging	Knocked down	No cost
	Fully Assembled	+\$93

**Specification Information**

Style Number    Base Price

**ZILO Pre-Configured Chair**

**ZILO004**      \$763



# ZILO

## ZILO



Tip: Illustration above shows a fully assembled chair which is not included in the base price.

Tip: This pre-configured chair includes: synchronized mechanism, mesh back and seat, 3-way adjustable arms, polished aluminum base, and black casters.

### Standard Includes

- 4 1/4" pneumatic seat-height adjustment (18.5" - 22.75")
- Adjustable lumbar support
- Synchronized mechanism with tension adjustment
- Mesh back and seat
- High backrest: black with black mesh
- 3-way adjustable arms
- 2 1/2" diameter, soft-composition, dual-wheel black casters
- Polished aluminum base

### Options

Packaging	Knocked down	No cost
	Fully Assembled	+\$93

### Specification Information

Style Number    Base Price

#### ZILO Pre-Configured Chair

**ZILO005**      \$856



Tip: Illustration above shows a fully assembled chair which is not included in the base price.

Tip: This pre-configured chair includes: synchronized mechanism, mesh back, fixed loop arms, polished aluminum base, and white casters.

### Standard Includes

- 4 1/4" pneumatic seat-height adjustment (18.5" - 22.75")
- Adjustable lumbar support
- Synchronized mechanism with tension adjustment
- High backrest: white with grey mesh
- 3-way adjustable arms
- 2 1/2" diameter, soft-composition, dual-wheel white casters
- Polished aluminum base

### Options

Seat Cover Finish	Fabric Price Group 01	No cost
	Fabric Price Group 02	+\$18
	Fabric Price Group 03	+\$37
	Polyurethane - Price Group 4	+\$68
	Leather - Price Group 7	+\$148
Packaging	Knocked down	No cost
	Fully Assembled	+\$93

### Specification Information

Style Number    Base Price

#### ZILO Pre-Configured Chair

**ZILO006**      \$791



Tip: Illustration above shows a fully assembled chair which is not included in the base price.

Tip: This pre-configured chair includes: synchronized mechanism, mesh back, fixed loop arms, polished aluminum base, and black casters.

**Standard Includes**

- 4 1/4" pneumatic seat-height adjustment (18.5" - 22.75")
- Adjustable lumbar support
- Synchronized mechanism with tension adjustment
- High backrest: black with black mesh
- Fixed loop arms
- 2 1/2" diameter, soft-composition, dual-wheel black casters
- Polished aluminum base

**Options**

Seat Cover Finish	Fabric Price Group 01	No cost
	Fabric Price Group 02	+\$18
	Fabric Price Group 03	+\$37
	Polyurethane - Price Group 4	+\$68
	Leather - Price Group 7	+\$148
Packaging	Knocked down	No cost
	Fully Assembled	+\$93

**Specification Information**

Style Number    Base Price

**ZILO Pre-Configured Chair**

**ZILO007**      \$759



Tip: Illustration above shows a fully assembled chair which is not included in the base price.

Tip: This pre-configured chair includes: synchronized mechanism, mesh back, swivel, fixed loop arms, polished aluminum base, and white casters.

**Standard Includes**

- 4 1/4" pneumatic seat-height adjustment (18.5" - 22.75")
- Adjustable lumbar support
- Synchronized mechanism with tension adjustment
- Mid-backrest: white with grey mesh
- Fixed loop arms
- Swivel, drafting ring with extended cylinder
- 2 1/2" diameter, soft-composition, dual-wheel white casters
- Polished aluminum base

**Options**

Seat Cover Finish	Fabric Price Group 01	No cost
	Fabric Price Group 02	+\$18
	Fabric Price Group 03	+\$37
	Polyurethane - Price Group 4	+\$68
	Leather - Price Group 7	+\$148
Packaging	Knocked down	No cost
	Fully Assembled	+\$93

**Specification Information**

Style Number    Base Price

**ZILO Pre-Configured Chair**

**ZILO008**      \$908



# ZILO

ZILO



### Standard Includes

- Seat cover

### Specification Information

Style Number	Price Group	Prices
--------------	-------------	--------

#### ZILO Seat Cover

<b>ZILOSEATCOVER</b>	Fabric Price Group 01	\$61
	Fabric Price Group 02	\$80
	Fabric Price Group 03	\$99
	Polyurethane Price Group 04	\$129
	Leather Price Group 07	\$210



---

# PERSONALITY PLUS

---

## PERSONALITY PLUS

Understanding	442
Specifying	443

# Personality Plus Features

- Chair or Stool
- Frame available in Seagull or Black
- Base available in Polished Aluminum, Seagull, and Black\*
- Weight Activated Mechanism with 40% Boost Setting
- 4-Way, 1-Way Adjustable Arms or Armless
- Adjustable Lumbar Support
- Seat Depth Adjustment (seat slider)
- Optional Headrest
- Fully Assembled option

*\*Tip: Stool base is only available in polished aluminum.*



# Personality Plus Specifications

Weight Capacity	275 lbs
Net Weight	37 lbs
Height Range	37.75" - 42.375"
Back Dimensions	16.38"W x 22.83"H
Seat Dimensions	17.72"D x 18.03"W
Seat Height Range	16.30" - 20.87"
Arms Span (outside edges)	18.74"
Body Frame Material	Nylon
Base Materials	Polished Aluminum and Nylon
Base Width	Nylon: 27" / Polished Aluminum: 27.5"
Cushion Seats	Polyurethane fill
Seat Covers	Drawstring upholstery
Mesh Back Material	34% Polyamide, 66% Polyester
Castors	Hard or Soft with roll control (Black)
Certifications	ANSI/BIFMA X5.1-2017 TB117-2013 Indoor Advantage Gold™



Tip: Illustration above shows chair with arms, which is not included in the base price.

Tip: When ordering 6205 Black frame, mesh is AR02 Black. 6053 Seagull frame, mesh is AR01 Grey.

Tip: Castors available in black only.

Tip: Soft castor is roll-control.

Tip: Headrest finish matches frame finish.

Tip: Armrests available in black only.

Tip: Plastic base finish matches frame finish. Polished aluminum base available on black or seagull frame.

### Standard Includes

- 4.5" pneumatic seat-height adjustment (16.3" - 20.8")
- Plastic frame: black
- Plastic base
- 2.75" seat depth adjustment (seat slider)
- Back: air mesh
- Fabric price group 1 upholstery design on seat
- Armless
- Adjustable lumbar support
- Weight activated mechanism
- 2 1/2" diameter, hard-composition, dual-wheel black castors

### Options

Seat Finish	Fabric Price Group 01	No cost
	Fabric Price Group 02	+\$19
	Fabric Price Group 03	+\$38
	Polyurethane - Price Group 4	+\$68
Frame Finish	Black Frame, Black Back	No cost
	Seagull Frame, Grey Back	+\$24
Castors or Glides	Hard Castors	No cost
	Soft Castors	+\$36
Headrest Option	No Headrest	No cost
	With Headrest	+\$75
Armrests	Armless	No cost
	Height Adjustable Arm (1-D)	+\$50
	4-D Arm	+\$100
Base Option	Black Base	No cost
	Seagull Base	No cost
	Polished Aluminum Base	+\$31
Packaging	Knocked down	No cost
	Fully Assembled	+\$93

### Specification Information

Style Number    Base Price

## PERSONALITY PLUS Task Chair

PPCHAIR    \$650

# PERSONALITY PLUS



Tip: Illustration above shows chair with arms, which is not included in the base price.

Tip: Personality Plus stool available with a polished aluminum base only.

Tip: When ordering 6205 Black frame, mesh is AR02 Black. 6053 Seagull frame, mesh is AR01 Grey.

Tip: Castors available in black only.

Tip: Soft castor is roll-control.

Tip: Headrest finish matches frame finish.

Tip: Armrests available in black only.

## Standard Includes

- 10.25" pneumatic seat-height adjustment (22.63" - 32.88")
- Plastic frame: black
- Base: polished aluminum
- 2.75" seat depth adjustment (seat slider)
- Back: air mesh
- Fabric price group 1 upholstery design on seat
- Armless
- Adjustable lumbar support
- Weight activated mechanism
- Column and adjustable footring: black
- 2 1/2" diameter, hard-composition, dual-wheel black castors

## Options

Seat Finish	Fabric Price Group 01	No cost
	Fabric Price Group 02	+\$19
	Fabric Price Group 03	+\$38
	Polyurethane - Price Group 4	+\$68
Frame Finish	Black Frame, Black Back	No cost
	Seagull Frame, Grey Back	+\$24
Castors or Glides	Hard Castors	No cost
	Soft Castors	+\$36
Headrest Option	No Headrest	No cost
	With Headrest	+\$75
Armrests	Armless	No cost
	Height Adjustable Arm (1-D)	+\$50
	4-D Arm	+\$100
Packaging	Knocked down	No cost
	Fully Assembled	+\$93

## Specification Information

Style Number    Base Price

### PERSONALITY PLUS Stool

**PPSTOOL**    \$931

# PERSONALITY PLUS



## Standard Includes

- Headrest frame: plastic
- Headrest: tpu black
- 1.5" adjustment range

## Options

Headrest Finish	Black Headrest	No cost
	Seagull Headrest	No cost
Packaging	Knocked down	No cost

## Specification Information

Style Number	Price
--------------	-------

### PERSONALITY PLUS Headrest

**PPHEADREST** \$75





---

# BODI

---

## BODI

Understanding	448
Specifying	449

# Bodi Features

- Available in Black and White frames
- Syncro with Tension Adjuster and Locking Mechanism
- Adjustable Armrest with PU Pad
- Adjustable Lumbar Support
- Seat Depth Adjustment (seat slider)
- Removable/Washable Seat Covers



# Bodi Specifications

Weight Capacity	275 lbs
Net Weight	33 lbs
Height Range	37.25" - 42.75"h
Back Dimensions	19"w x 23.75"h
Seat Dimensions	19"w x 20"d
Seat Height Range	17.5" - 23"
Arms Span (outside edges)	24.25"
Base Width	27"
Base / Body Frame Material	Nylon
Cushion Seats	Polyurethane fill
Seat Covers	Removable, with zip closure
Castors	Soft* PU (Black or White/Grey)
Mesh Back Material	Polyester/Polyelastomer/Nylon
Certifications	ANSI/BIFMA X5.1-2017 TB117-2013 Indoor Advantage Gold™





Tip: Illustration above shows a fully assembled chair which is not included in the base price.

**Standard Includes**

- 5 1/2" pneumatic seat-height adjustment (17.5" - 23")
- Plastic frame
- Plastic base
- Seat depth adjustment (seat slider)
- Fabric price group 1 upholstery design on seat
- Removable seat covers with zip closure
- 1-way adjustable arms
- Mesh back
- Multi-position back lock
- Adjustable lumbar support
- Synchronized mechanism with tension adjustment and locking mechanism
- 2 1/2" diameter, soft-composition, dual-wheel black casters

**Options**

Frame Finish	Black Frame, Black Back	No cost
	White Frame, White Back	+\$63
Seat Cover Finish	Fabric Price Group 01	No cost
	Fabric Price Group 02	+\$18
	Fabric Price Group 03	+\$37
	Polyurethane - Price Group 4	+\$68
Packaging	Knocked down	No cost
	Fully Assembled	+\$93

**Specification Information**

Style Number    Base Price

**BODI Task Chair**

**BODICHAIR** \$624



**Standard Includes**

- Seat cover

**Specification Information**

Style Number    Price Group    Prices

**BODI Seat Cover**

<b>BODISEATCOVER</b>	Fabric Price Group 01	\$61
	Fabric Price Group 02	\$80
	Fabric Price Group 03	\$99
	Polyurethane Price Group 04	\$129



---

# FL-X

---

## FL-X

Understanding	<b>452</b>
Specifying	<b>453</b>

## FL-X Features

---

Weight activated back tilt mechanism

---

Height adjustable

---

Shell or Mesh back

---

Smooth coated armrest pads

---

Seat colors in 11 fabrics and 3 vinyl

---

Available in Black, White and Light Grey/White

---

Mesh back includes additional lumbar support piece

---

Optional fabric back cover for Shell back

---



## FL-X Specifications

---

Weight Capacity	275 lbs
-----------------	---------

---

Net Weight	36 lbs
------------	--------

---

Chair Total Height	37"—41.5"
--------------------	-----------

---

Height Adjustable Range	4.7"
-------------------------	------

---

Base Width	27"
------------	-----

---

Back Dimensions	16.5"w x 22"h
-----------------	---------------

---

Seat Dimensions	18"w x 19.5"d
-----------------	---------------

---

Seat Height Range	16"—21"
-------------------	---------

---

Arms Span (outside edges)	24.5"
---------------------------	-------

---

Body Frame Material	Nylon
---------------------	-------

---

Base Material	Nylon
---------------	-------

---

Cushion Seat	Polyurethane foam and fabric
--------------	------------------------------

---

Castors	Nylon, soft* (Black & White/Grey)
---------	-----------------------------------

---



Tip: Illustration above shows a fully assembled chair which is not included in the base price.

Tip: Base finish matches frame finish.

Tip: White frame, white back not available with mesh back.

Tip: Back finish applicable to fabric back cover only.

**Standard Includes**

- 4" pneumatic seat-height adjustment (16" - 21")
- Plastic frame
- Plastic base
- Plastic perforated back shell
- Seat depth adjustment (seat slider)
- Fabric price group 1 upholstery design on seat
- Fixed arms
- Adjustable lumbar support
- 2 1/2" diameter, soft-composition, dual-wheel black casters

**Options**

Frame Finish	Black Frame, Black Back	No cost
	White Frame, Light Grey Back	+\$32
	White Frame, White Back	+\$64
Back Type	Shell Back	No cost
	Mesh Back	+\$32
	Fabric Back Cover	+\$74
Back Finish	Fabric Price Group 01	No cost
	Fabric Price Group 02	+\$31
Seat Cover Finish	Fabric Price Group 01	No cost
	Fabric Price Group 02	+\$32
	Vinyl Price Group 04	+\$82
Cylinder	Standard	No cost
	Drafting Ring W/ Extended Heig	+\$204
Packaging	Knocked down	No cost
	Fully Assembled	+\$93

**Specification Information**

Style Number	Base Price
<b>FL-X Chair</b>	
<b>FLXXCHAIR</b>	\$865

# FL-X

## FL-X



*Tip: Contains the entire seat assembly: cushion, fabric, and inner seat pan.*

### Standard Includes

- Seat cover

### Specification Information

Style Number	Price Group	Prices
--------------	-------------	--------

### FL-X Seat Cover and Assembly

<b>FLXXSEATCOVER</b>	Fabric Price Group 01	\$136
	Fabric Price Group 02	\$167
	Vinyl Price Group 04	\$217



### Standard Includes

- Back cover

### Specification Information

Style Number	Price Group	Prices
--------------	-------------	--------

### FL-X Back Cover

<b>FLXXBACKCOVER</b>	Fabric Price Group 01	\$74
	Fabric Price Group 02	\$105

---

# TIZU

## TIZU

Understanding

**456**

Specifying

**458**

TIZU

## Tizu Work Features

---

Height adjustable

---

Mesh back with lumbar support or plastic back

---

Fixed Loop Arms or Armless with torsion tilt

---

Removable seat covers in Buzz, Era, Connect and Brisa Collections

---

Available in Black with Black base and White with Chrome base

---



## Tizu Work Specifications

Weight Capacity	275 lbs
Net Weight	27 lbs.
Chair Total Height	37" - 41"
Height Adjustable Range	4"
Base Width	26.5"
Back Width (top)	17"
Seat Dimensions	17.75"w x 18.5"d
Seat Height Range	18" - 22"
Arms Span (outside edges)	23.5"
Body Frame Material	Nylon
Base Material	Nylon (Black) / Aluminum (Grey)
Mesh Back Material	Polyester/Polyelastomer/Nylon
Cushion Seat	Polyurethane foam / fabric
Castors	Soft* PU (Black or White/Grey)
Certifications	ANSI/BIFMA X5.1-2017 TB117-2013 Indoor Advantage Gold™



## Tizu Features

---

Nesting

---

Available in Black and White

---

Mesh back with lumbar support or plastic back

---

Torsion Tension with Fixed Loop Arms or Armless

---

Removable seat covers in Buzz, Era, Connect and Brisa Collections

---

Glides Available

---



## Tizu Specifications

Weight Capacity	275 lbs
Net Weight	22 lbs
Seat Dimension	17.75" w x 18.5" d
Back Dimensions	19" w x 20" h
Arms Span (outside edges)	23.5"
Legs Dimension	19.25" w x 20.5" d
Seat Height from Floor	19"
Back Height from Floor	37.5"
Nesting Depth Increase	11" (per chair – average of 10 nested chairs)
Body Frame Material	Plastic
Leg Frame Materials	Steel
Cushion Seats	Polyurethane fill
Castors	Soft* PU (Black or White/Grey)
Seat Covers	Removable with zip closure
Mesh Back Material	Polyester/Polyelastomer/Nylon
Certifications	ANSI/BIFMA X5.1-2017 TB117-2013 Indoor Advantage Gold™



**Standard Includes**

- 4" pneumatic seat-height adjustment (18" - 22")
- Plastic frame
- Plastic base
- Seat depth adjustment (seat slider)
- Fabric price group 1 upholstery design on seat
- Removable seat covers with zip closure
- Adjustable lumbar support
- Mesh back
- 2 1/2" diameter, soft-composition, dual-wheel black casters
- Armless

**Options**

Frame Finish	Black Frame, Black Back	No cost
	White Frame, White Back	+\$45
Back Type	Mesh Back	Black: +\$173 White: +\$186
	Plastic Back	Black: +\$192 White: +\$211
Seat Cover Finish	Fabric Price Group 01	No cost
	Fabric Price Group 02	+\$18
	Fabric Price Group 03	+\$37
	Polyurethane - Price Group 4	+\$68
Armrests	Armless	Black: No cost White: +\$5
	Fixed Loop	Black: +\$43 White: +\$50
Base Option	Black Base	No cost
	Polished Aluminum Base	No cost
Castors or Glides	Soft, 2-Tone Grey	No cost
	Soft, Black	No cost
Packaging	Knocked down	No cost
	Fully Assembled	+\$93

*Tip: Black frame only available with black base and soft, black castors or glides.*

*Tip: White frame only available with polished aluminum base and soft, 2-tone grey castors or glides.*

*Tip: Armrests upcharge only applicable to mesh back back type.*

*Tip: Armless option not available with plastic back.*

**Specification Information**

Style Number    Base Price

**TIZU Task Chair**

**TIZUWORK**    \$554



### Standard Includes

- 4-prong nesting base
- Plastic frame
- Steel base
- Fabric price group 1 upholstery design on seat
- Removable seat covers with zip closure
- Fixed lumbar support
- Mesh back
- 2 1/2" diameter, soft-composition, dual-wheel black casters
- Armless

### Options

*Tip: Black frame only available with chrome base and soft, black castors or glides.*

*Tip: White frame only available with white or platinum base and soft, 2-tone grey castors or glides.*

*Tip: Armrests upcharge only applicable to mesh back back type.*

*Tip: Armless option not available with plastic back.*

Frame Finish	Black Frame, Black Back	No cost
	White Frame, White Back	No cost
Back Type	Mesh Back	Black: +\$173 White: +\$186
	Plastic Back	Black: +\$192 White: +\$211
Seat Cover Finish	Fabric Price Group 01	No cost
	Fabric Price Group 02	+\$18
	Fabric Price Group 03	+\$37
	Polyurethane - Price Group 4	+\$68
Armrests	Armless	Black: No cost White: +\$5
	Fixed Loop	Black: +\$43 White: +\$50
Base Option	Chrome Base	No cost
	Platinum Base	No cost
	White Base	+\$14
Castors or Glides	Soft, 2-Tone Grey	No cost
	Soft, Black	No cost
	Glides, Black	+\$61
Packaging	Knocked down	No cost
	Fully Assembled	+\$93

### Specification Information

Style Number    Base Price

## TIZU Nest Chair

**TIZUNEST**    \$407

**TIZU**  
TIZU



**Standard Includes**

- Seat cover

**Options**

Seat Cover Finish	Fabric Price Group	Price
	Fabric Price Group 01	No cost
	Fabric Price Group 02	+\$19
	Fabric Price Group 03	+\$38
	Polyurethane - Price Group 4	+\$68

**Specification Information**

Style Number      Prices

**TIZU Seat Cover**

**TIZUSEATCOVER**    \$61



**Standard Includes**

- Set of four glides: black

**Specification Information**

Style Number    Price

**TIZU Glides (Set of 4)**

**TIZU-GLD**    \$61

---

# BIXBY

## **BIXBY**

Understanding	<b>462</b>
Specifying	<b>464</b>

## Bixby Features

Nestable and stackable

Breathable, flexible perforated back design

Contoured seat reduces pressure points and evenly distributes weight for greater comfort

Fixed arms or armless

Fully upholstered, upholstered seat, upholstered back or all plastic

Hard glides or soft castors

4 frame colors

8 interchangeable plastic seat and back colors

Seat and back cushion available in 11 fabric colors

Ships Fully Assembled



## Bixby Specifications

Weight Capacity	275 lbs
Net Weight	15 lbs
Seat Dimension	17.5"w x 18.25"d
Back Dimensions	19"w x 17.5"h
Arms Span (outside edges)	25"
Legs Dimension	22"w x 19"d
Seat Height from Floor	18"
Back Height from Floor	34.5"
Tablet Surface	14.25"w x 11"d
Nesting Depth Increase	7" (per chair)
Stacking Density	6 high (on floor)
Body Material	Plastic
Leg Frame Materials	Steel
Cushion Seats	Polyurethane fill
Castors	Soft PU (Black or 2-tone Grey)
Glides	Hard
Certifications	ANSI/BIFMA X5.1-2017 TB117-2013 Indoor Advantage Gold™

## Bixby Lite Work Features

Height adjustable

Breathable, flexible perforated back design

Contoured seat reduces pressure points and evenly distributes weight for greater comfort

Fixed arms or armless

Fully upholstered, upholstered seat, upholstered back or all plastic

8 interchangeable plastic seat and back colors

Seat and back cushion available in 11 fabric colors

Ships Fully Assembled

Optional Drafting Ring Lift Extension



## Bixby Lite Work Specifications

Weight Capacity	275 lbs
Net Weight	20 lbs
Seat Dimension	17.5"w x 18.25"d
Back Dimensions	19"w x 17.5"h
Arms Span (outside edges)	25"
Seat Height from Floor	14.6"–18.6" 21.8"–29.8" (Stool)
Back Height from Floor	32.1"–36.1" 39.3"–47.3" (Stool)
Body Material	Steel
Base Materials	Polished Aluminum & Nylon
Cushion Seats	Polyurethane fill
Castors	Soft PU (Black or 2-tone Grey)
Certifications	ANSI/BIFMA X5.1-2017 TB117-2013 Indoor Advantage Gold™

# BIXBY

## BIXBY



Tip: Chairs stack 6 high.

### Standard Includes

- 4-prong nesting base with 7" depth increase
- Plastic perforated back shell
- Plastic seat shell
- Steel base
- Hard glides: color-matched to frame

### Options

Cushion Option	Back	+\$78
	Seat	+\$78
	Seat and Back	+\$157
Seat Cushion Finish	Era	No cost
Back Cushion Finish	Era	No cost
Frame Finish	Paint	No cost
Seat Shell Finish	Plastic	No cost
Back Shell Finish	Plastic	No cost
Castors or Glides	Hard Glides	No cost
	Soft Castors	+\$31

### Specification Information

Style Number      Base Price

#### BIXBY Chair

**BXBYCHAIR**      \$403





*Tip: Table, storage tray, and ganging cap only included with armless configuration. Ganging cap is not compatible with tablet.*

*Tip: Chairs stack 6 high.*

**Standard Includes**

- 4-prong nesting base with 7" depth increase
- Plastic perforated back shell
- Plastic seat shell
- Steel base
- Hard glides: color-matched to frame

**Options**

Cushion Option	Back	+\$78
	Seat	+\$78
	Seat and Back	+\$157
Seat Cushion Finish	Era	No cost
Back Cushion Finish	Era	No cost
Frame Finish	Paint	No cost
Seat Shell Finish	Plastic	No cost
Back Shell Finish	Plastic	No cost
Castors or Glides	Hard Glides	No cost
	Soft Castors	+\$31
Accessory	Ganging Cap	+\$40
	Tablet Arm, Right Hand	+\$224
Ganging Cap Finish	Plastic	No cost
Storage Tray	Storage Tray	+\$73
Storage Tray Finish	Plastic	No cost

**Specification Information**

Style Number	Base Price
<b>BIXBY Chair, Armless</b>	
<b>BXBYARMLESS</b>	\$331



# BIXBY

## BIXBY



Tip: BIXBY tablet, storage tray, ganging cap, and dolly not compatible with **BXBYWORK** or **BXBYSTOOL**.

### Standard Includes

- 4" pneumatic seat-height adjustment (14.6" - 18.6")
- Plastic perforated back shell
- Plastic seat shell
- Plastic base
- 2 1/2" diameter, soft-composition, dual-wheel black casters
- Armless

### Options

Cushion Option	Back	+\$78
	Seat	+\$78
	Seat and Back	+\$157
Seat Cushion Finish	Era	No cost
Back Cushion Finish	Era	No cost
Frame Finish	Paint	No cost
Seat Shell Finish	Plastic	No cost
Back Shell Finish	Plastic	No cost
Base Option	Black Base	No cost
	White Base	+\$11
	Polished Aluminum Base	+\$30
Armrests	Armless	No cost
	Fixed	+\$72
Castors or Glides	Soft, Black	No cost
	Soft, 2-Tone Grey	+\$5

### Specification Information

Style Number      Base Price

#### BIXBY Lite Work

**BXBYWORK**      \$580



Tip: BIXBY tablet, storage tray, ganging cap, and dolly not compatible with **BXBYWORK** or **BXBYSTOOL**.

**Standard Includes**

- 8" pneumatic seat-height adjustment (21.8" - 29.8")
- Plastic perforated back shell
- Plastic seat shell
- Plastic base
- 2 1/2" diameter, soft-composition, dual-wheel black casters
- Column and adjustable footring: black
- Armless

**Options**

Cushion Option	Back	+\$78
	Seat	+\$78
	Seat and Back	+\$157
Seat Cushion Finish	Era	No cost
Back Cushion Finish	Era	No cost
Frame Finish	Paint	No cost
Seat Shell Finish	Plastic	No cost
Back Shell Finish	Plastic	No cost
Base Option	Black Base	No cost
	White Base	+\$11
	Polished Aluminum Base	+\$30
Armrests	Armless	No cost
	Fixed	+\$72
Castors or Glides	Soft, Black	No cost
	Soft, 2-Tone Grey	+\$5

**Specification Information**

Style Number	Base Price
<b>BIXBY Lite Stool</b>	
<b>BXBYSTOOL</b>	\$685



# BIXBY

## BIXBY



### Standard Includes

- Storage dolly with locking casters: Platinum

### Specification Information

Style Number      Price

## BIXBY Dolly

**BIXBY-DOLLY** \$578



### Standard Includes

- Storage and ganging tray: black or platinum

### Options

Storage Tray Finish	Plastic	No cost
---------------------	---------	---------

### Specification Information

Style Number      Price

## BIXBY Storage and Ganging Tray

**BXBYSTORAGE** \$73



### Standard Includes

- Ganging cap: black or platinum

### Options

Ganging Cap Finish	Plastic	No cost
--------------------	---------	---------

### Specification Information

Style Number      Price

## BIXBY Ganging Cap

**BXBYGANGCAP** \$40



**Standard Includes**

- 14.25"W x 11"D tablet arm: paint

**Options**

Frame Finish	Paint	No cost
--------------	-------	---------

**Specification Information**

Style Number	Price
--------------	-------

**BIXBY Tablet Arm**

<b>BXBYTABLETARM</b>	\$224
----------------------	-------





---

# West Elm Seating

---

<b>Statement of Line</b>	<b>472</b>
--------------------------	------------

<b>Brighton Lounge Seating</b>	
Understanding	<b>476</b>
Specifying	<b>495</b>
<b>Mesa Lounge Seating</b>	
Understanding	<b>480</b>
Specifying	<b>500</b>
<b>Nimbus</b>	
Specifying	<b>503</b>
<b>Sterling</b>	
Understanding	<b>484</b>
Specifying	<b>504</b>
<b>Lucas</b>	
Understanding	<b>488</b>
Specifying	<b>507</b>
<b>Slope</b>	
Understanding	<b>492</b>
Specifying	<b>508</b>

# Statement of Line

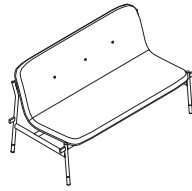
## Seating

### Brighton

#### Lounge Seating



**Brighton One-Seat Lounge**  
Understanding  
▶ Page 476  
Specifying  
▶ Page 495



**Brighton Two-Seat Lounge**  
Understanding  
▶ Page 476  
Specifying  
▶ Page 496



**Brighton Ottoman**  
Understanding  
▶ Page 476  
Specifying  
▶ Page 496

#### Occasional Tables



**Brighton 90° Ganging Table**  
Understanding  
▶ Page 477  
Specifying  
▶ Page 497



**Brighton Straight Ganging Table**  
Understanding  
▶ Page 477  
Specifying  
▶ Page 497



**Brighton End Table**  
Understanding  
▶ Page 477  
Specifying  
▶ Page 498



**Brighton Square Table**  
Understanding  
▶ Page 477  
Specifying  
▶ Page 498



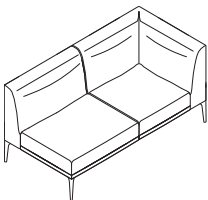
**Brighton Rectangle Table**  
Understanding  
▶ Page 477  
Specifying  
▶ Page 499

#### Accessories

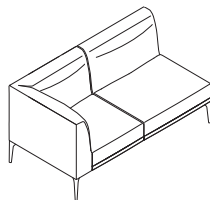


**Brighton Module Power**  
Specifying  
▶ Page 499

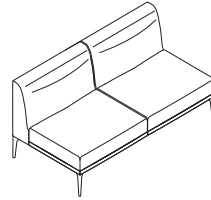
### Mesa



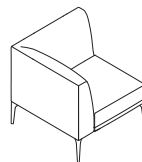
**Mesa Left-Hand Chaise Lounge**  
Understanding  
▶ Page 480  
Specifying  
▶ Page 500



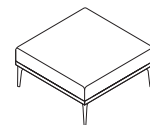
**Mesa Right-Hand Chaise Lounge**  
Understanding  
▶ Page 480  
Specifying  
▶ Page 500



**Mesa Two-Seat Lounge**  
Understanding  
▶ Page 480  
Specifying  
▶ Page 501



**Mesa Corner Lounge**  
Understanding  
▶ Page 480  
Specifying  
▶ Page 501

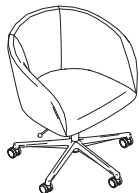


**Ottoman**  
Understanding  
▶ Page 480  
Specifying  
▶ Page 502



## Seating, continued

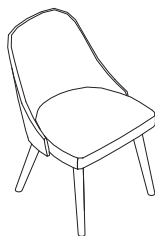
### Nimbus



#### Nimbus Conference Chair

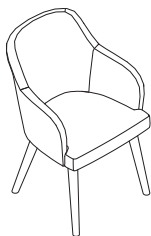
Specifying  
▶ Page 503

### Sterling



#### Sterling 4-Leg Armless Guest Chair

Specifying  
▶ Page 504



#### Sterling 4-Leg with Arms Guest Chair

Specifying  
▶ Page 504



#### Sterling Bar Height Armless Stool

Specifying  
▶ Page 505



#### Sterling 5-Star Armless Conference Chair

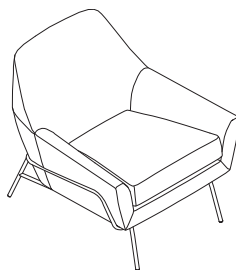
Specifying  
▶ Page 505



#### Sterling 5-Star with Arms Conference Chair

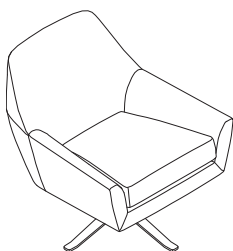
Specifying  
▶ Page 506

### Lucas



#### Lucas Wire Chair

Specifying  
▶ Page 507



#### Lucas Swivel Chair

Specifying  
▶ Page 507

# Statement of Line

## Seating, continued

### Slope



**Slope Guest Chair**  
Specifying  
▶ Page 508



**Slope Lounge Chair**  
Specifying  
▶ Page 508



**Slope Bar Height Stool**  
Specifying  
▶ Page 509



**Slope Height-Adjustable Conference Chair**  
Specifying  
▶ Page 509



**Slope Stacking Chair**  
Specifying  
▶ Page 510

### Slope—Stocked



**Slope Guest Chair—Stocked**  
Specifying  
▶ Page 511



**Slope Lounge Chair—Stocked**  
Specifying  
▶ Page 511



**Slope Bar Stool—Stocked**  
Specifying  
▶ Page 511



**Slope Conference Chair—Stocked**  
Specifying  
▶ Page 512



# Brighton Lounge Seating

**Inspired by the traditional wood frame joinery of mid-century design,** Brighton lounge seating offers an updated take with sleek metal construction. It's configurability allows Brighton to arrange into infinite formations, while freestanding lounge and table options create even more choice.

**Ganging tables** are available in laminate. Tables come with ganging brackets to attach between or on the end of lounge units.

**Frame caps** are offered in black paint.

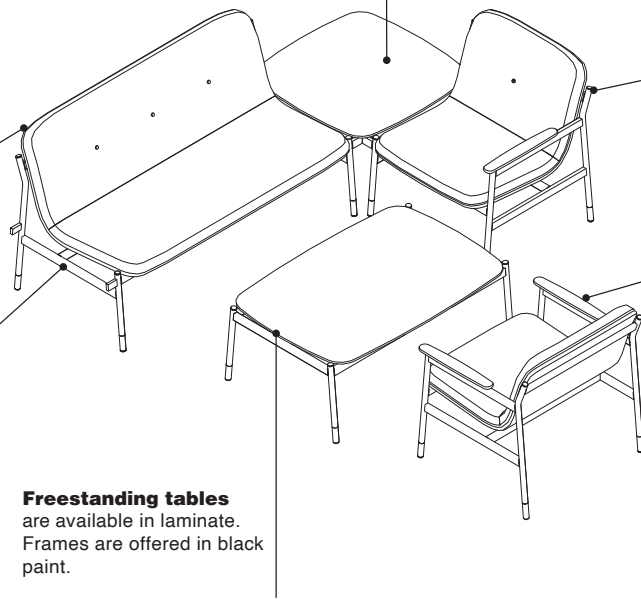
**Lounge seat and backs** are fully upholstered.

**Arms** are available on lounge units. Arm caps are black oak.

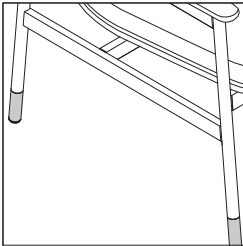
**Frames** are offered in black paint.

**Frame feet** are black paint.

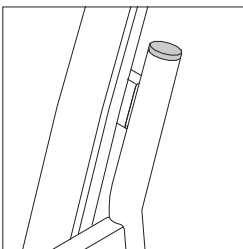
**Freestanding tables** are available in laminate. Frames are offered in black paint.



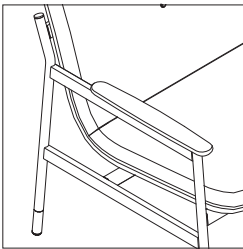
**Product Details**



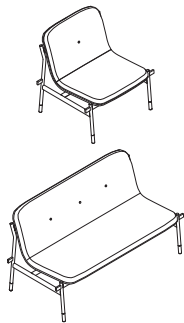
**Frame feet** are offered in black paint.



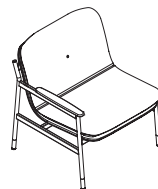
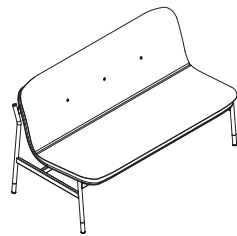
**Frame caps** are offered in black paint.



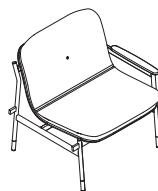
**Armcaps** are solid oak wood and are available on both one- and two-seat lounges in black oak.



**Button tufting** is standard on all lounges that are upholstered in fabric. One-seat lounges come standard with one button, two-seat lounges come with three buttons.



Arm Right



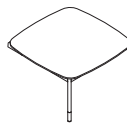
Arm Left

**One- and two-seat lounges** are available with and without arms and can be specified with ganging hardware or as freestanding.

**Lounges** must be specified with ganging hardware when used with end or ganging tables. Ganging hardware and arms cannot be specified on the same side of a lounge unit.



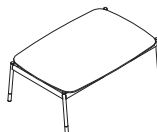
**Ottoman** is upholstered with a metal frame that is available in black paint.



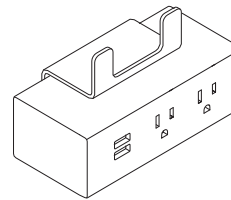
**Ganging tables** are available in two options: 90° and straight. Tables can be attached facing either direction and must be attached between lounge units.



**End table** is available in one size 28" square and can be added to either side of a lounge unit.



**Freestanding tables** are available in 28" square and 28"D x 42"W rectangle.



**Power module** has a 9' cord.

**Surface Materials**

**Upholstery**

- Billiard

**Table tops**

- High-Pressure Laminate

**Frames**

- 7207 Black

**Feet and caps**

- 7207 Black

**Arms**

- VP03 Black Oak

**Power**

- 6000 Black

**Dimensions**

▶ Page 478

# Dimensions

## Brighton Lounge Seating

Features	Overall Depth	Width	Height	Functional Seat Depth	Seat Width	Seat Height from Floor
----------	---------------	-------	--------	-----------------------	------------	------------------------

### Brighton

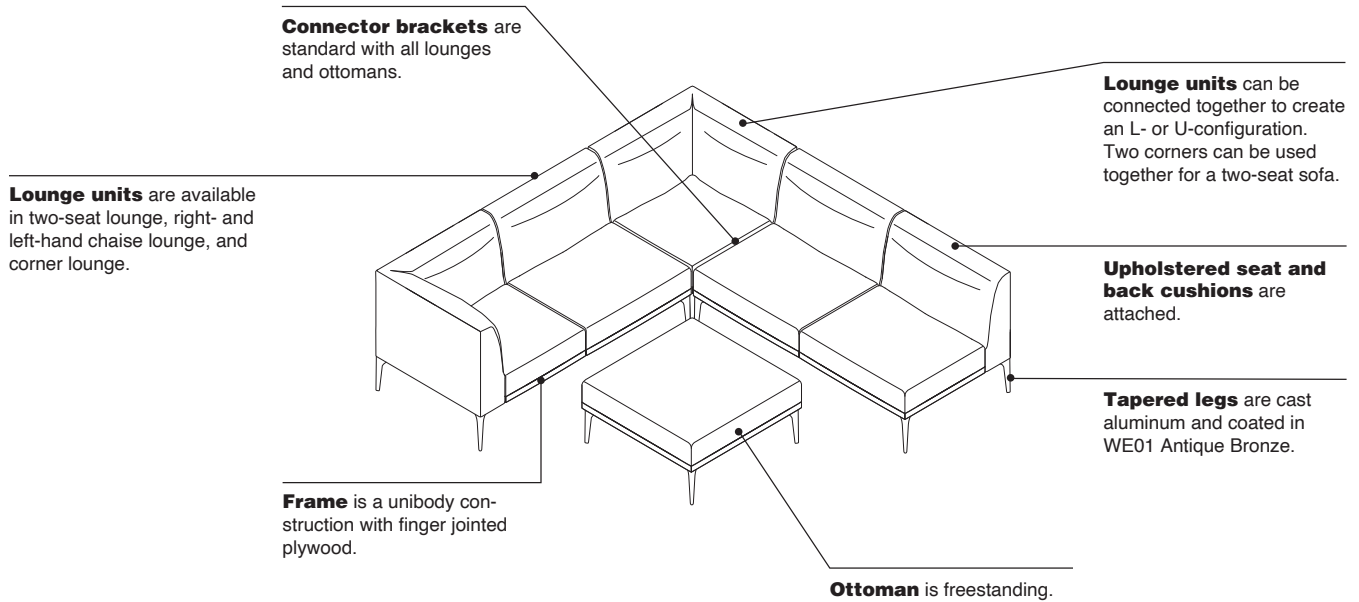
#### Lounge Seating

One-Seat Lounge	29 <sup>3</sup> / <sub>4</sub> "	29 <sup>7</sup> / <sub>8</sub> "	33 <sup>1</sup> / <sub>16</sub> "	19 <sup>7</sup> / <sub>16</sub> "	26 <sup>1</sup> / <sub>4</sub> "	17 <sup>7</sup> / <sub>16</sub> "
Two-Seat Lounge	29 <sup>3</sup> / <sub>4</sub> "	57 <sup>9</sup> / <sub>16</sub> "	33 <sup>1</sup> / <sub>16</sub> "	19 <sup>7</sup> / <sub>16</sub> "	54"	17 <sup>7</sup> / <sub>16</sub> "
Ottoman	16 <sup>3</sup> / <sub>32</sub> "	19 <sup>15</sup> / <sub>32</sub> "	16 <sup>23</sup> / <sub>32</sub> "	N.A.	N.A.	N.A.
90° Ganging Table	29"	29"	15 <sup>11</sup> / <sub>16</sub> "	N.A.	N.A.	N.A.
End Table	28 <sup>1</sup> / <sub>2</sub> "	28 <sup>1</sup> / <sub>4</sub> "	15 <sup>11</sup> / <sub>16</sub> "	N.A.	N.A.	N.A.
Square Table	28 <sup>1</sup> / <sub>2</sub> "	28 <sup>1</sup> / <sub>4</sub> "	15 <sup>11</sup> / <sub>16</sub> "	N.A.	N.A.	N.A.
Rectangle Table	28 <sup>1</sup> / <sub>2</sub> "	42"	15 <sup>11</sup> / <sub>16</sub> "	N.A.	N.A.	N.A.



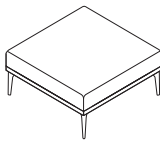
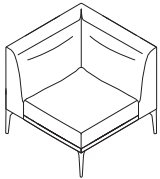
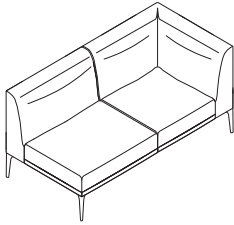
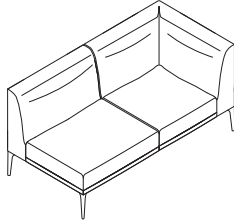
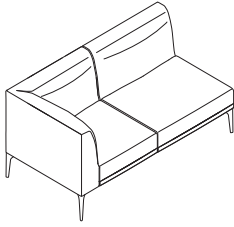
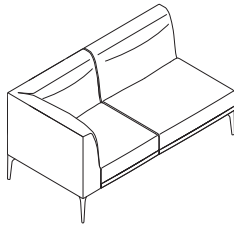
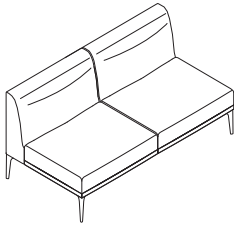
# Mesa Lounge Seating

**Mesa lounge seating** adds style to any workspace with its modern form and tapered legs. Modular pieces can easily create common areas of any size.



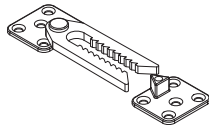


**Product Details**



**Lounge seating** features five fully upholstered, complementary models: two-seater lounge, right-hand chaise lounge, left-hand chaise lounge, corner lounge, and ottoman. All models feature a four-leg, cast aluminum base with a powder coat painted finish.

**Chaise lounge** can be specified in a right- or left-hand configuration.  
*Tip: Handedness is determined while in the seated position.*



**Integrated ganging device** is included and keeps units aligned.

**Surface Materials**

**Upholstery**

- Billiard

**Legs**

- WE01 Antique Bronze  
*Tip: Contrasting fabric is not available on Mesa.*

**Dimensions**

▶ Page 482

# Dimensions

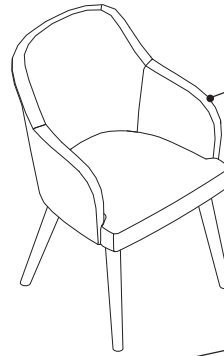
## Mesa Lounge Seating

• Features	• Overall Depth	Width	Height	• Functional Seat Depth	• Seat Width	• Seat Height from Floor
<b>Mesa</b>						
<b>Lounge Seating</b>						
Two-Seat	32 <sup>1</sup> / <sub>4</sub> "	64 <sup>1</sup> / <sub>4</sub> "	28 <sup>3</sup> / <sub>4</sub> "	22 <sup>3</sup> / <sub>4</sub> "	64 <sup>1</sup> / <sub>4</sub> "	17 <sup>3</sup> / <sub>4</sub> "
Chaise	32 <sup>1</sup> / <sub>4</sub> "	64 <sup>1</sup> / <sub>4</sub> "	28 <sup>3</sup> / <sub>4</sub> "	22 <sup>3</sup> / <sub>4</sub> "	55"	17 <sup>3</sup> / <sub>4</sub> "
Corner	32 <sup>1</sup> / <sub>4</sub> "	32 <sup>1</sup> / <sub>4</sub> "	28 <sup>3</sup> / <sub>4</sub> "	22 <sup>3</sup> / <sub>4</sub> "	22 <sup>3</sup> / <sub>4</sub> "	17 <sup>3</sup> / <sub>4</sub> "
Ottoman	32 <sup>1</sup> / <sub>4</sub> "	32 <sup>1</sup> / <sub>4</sub> "	17 <sup>3</sup> / <sub>4</sub> "	N.A.	N.A.	N.A.

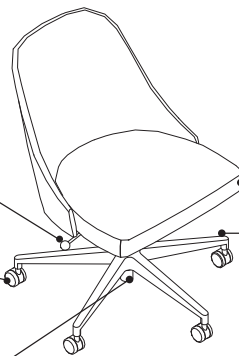


# Sterling Seating

**Sterling** is a family of seating inspired by classic mid-century design. The style and generous sit brings retro-inspired comfort to the office. Hardwood legs or a classic aluminum base and arm options make the Sterling collection relevant across the floor plan.



**Arms** are optional on guest chair and conference chair. Arms are always upholstered.

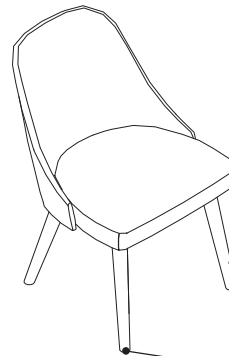


**Optional tilt mechanism** enhances user comfort. Available on the five-star base.

**Seat height** adjusts 5", from 16<sup>1</sup>/<sub>2</sub>"H to 21<sup>1</sup>/<sub>2</sub>"H, with a pneumatic adjustment mechanism.

**Casters** have hard, dual-wheels that roll smoothly on carpets.

**Five-star base** is aluminum and available polished or in black paint.

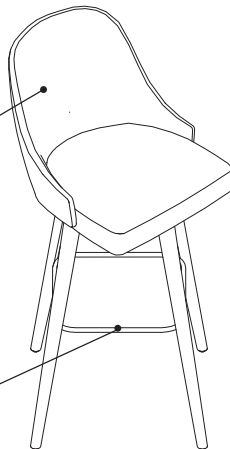


**Pneumatic cylinder** is always black.

**Wood leg** is beech hardwood and available in VP03 Black Oak.

**Sterling stools** have a 360° swivel feature that comes standard and does not have auto-return feature.

**Glides** are polyethylene for superior durability on carpeted and hard floors.



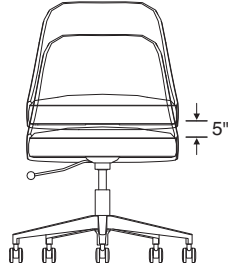
**Sterling stools** include footrest for added comfort. *Tip: The footrest is 8<sup>1</sup>/<sub>2</sub>" from the ground on the counter-height stool and 14<sup>1</sup>/<sub>4</sub>" on the bar-height stool.*

**Product Details**

**Five-star, and four-leg** chairs are available with and without arms.

**Optional tilt mechanism** is available on five-star chairs and has 10° rearward and 2° forward tilt range. The seat and back always remain in a fixed position relative to each other (i.e. no recline).

**360° adjustable height swivel mechanism** is standard on five-star base.

**Adjustment Features****Seat Adjustments**

**Seat height** adjusts pneumatically. To lower, pull lever up while seated. To raise, pull lever up and keep your weight off the chair.

**Surface Materials****Upholstery**

- Billiard

**Four-leg and stool base**

- VP03 Black Oak

**Five-star base**

- 7207 Black
- 8046 Polished Aluminum

**Casters and glides**

- 6205 Black

**All seating with standard upholstery fabrics**

complies with requirements of the State of California Technical Bulletin 117-2013. All standard seating is labeled to be in compliance with California 117-2013.

**Dimensions**

▶ Page 486

# Dimensions

## Sterling Seating

Features	Overall Depth	Width	Height	Functional Seat Depth	Seat Width	Seat Height from Floor	Back Width	Back Height from Seat	Arm Height from Floor
<b>West Elm Work Sterling</b>									
<b>Guest Chairs</b>									
	25 <sup>1</sup> / <sub>8</sub> "	26 <sup>3</sup> / <sub>4</sub> "	32 <sup>5</sup> / <sub>8</sub> "	18 <sup>5</sup> / <sub>8</sub> "	22"	18 <sup>1</sup> / <sub>2</sub> "	21"	15 <sup>1</sup> / <sub>2</sub> "	26 <sup>1</sup> / <sub>2</sub> "
<b>Guest Chairs—Armless</b>									
	24 <sup>1</sup> / <sub>2</sub> "	23 <sup>1</sup> / <sub>2</sub> "	32 <sup>5</sup> / <sub>8</sub> "	18 <sup>5</sup> / <sub>8</sub> "	22"	18 <sup>1</sup> / <sub>2</sub> "	21"	15 <sup>1</sup> / <sub>2</sub> "	N.A.
<b>Conference Chairs—Five-Star with Arms</b>									
	25 <sup>1</sup> / <sub>8</sub> "	26 <sup>3</sup> / <sub>4</sub> "	31 <sup>3</sup> / <sub>4</sub> "–36 <sup>3</sup> / <sub>4</sub> "	18 <sup>5</sup> / <sub>8</sub> "	22"	16 <sup>1</sup> / <sub>2</sub> "–21 <sup>1</sup> / <sub>2</sub> "	21"	15 <sup>1</sup> / <sub>2</sub> "	25 <sup>1</sup> / <sub>4</sub> "
<b>Conference Chairs—Five-Star Armless</b>									
	24 <sup>1</sup> / <sub>2</sub> "	23 <sup>1</sup> / <sub>2</sub> "	31 <sup>3</sup> / <sub>4</sub> "–36 <sup>3</sup> / <sub>4</sub> "	18 <sup>5</sup> / <sub>8</sub> "	22"	16 <sup>1</sup> / <sub>2</sub> "–21 <sup>1</sup> / <sub>2</sub> "	21"	15 <sup>1</sup> / <sub>2</sub> "	N.A.
<b>Bar Height Stool</b>									
	26 <sup>1</sup> / <sub>4</sub> "	26 <sup>1</sup> / <sub>4</sub> "	44"	17"	17 <sup>1</sup> / <sub>2</sub> "	32"	19 <sup>1</sup> / <sub>4</sub> "	12 <sup>3</sup> / <sub>8</sub> "	N.A.

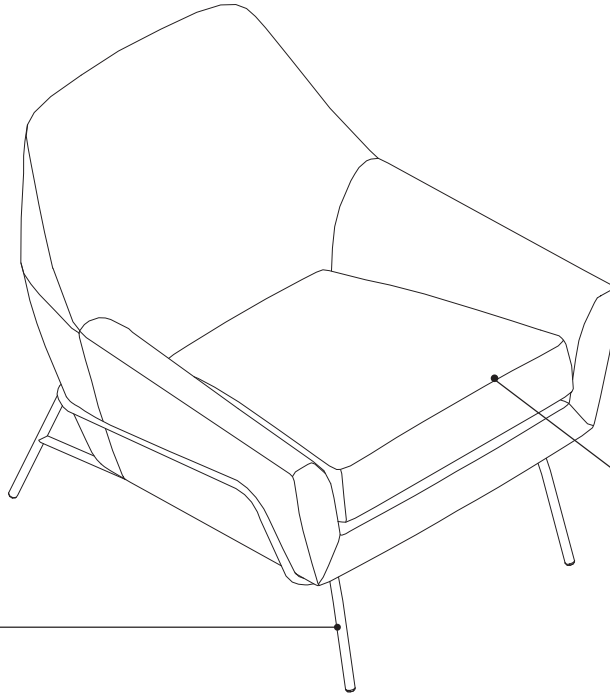
\*Overall width does not include the base.  
The diameter of the chair with the five-star base is 26".



# Lucas Seating

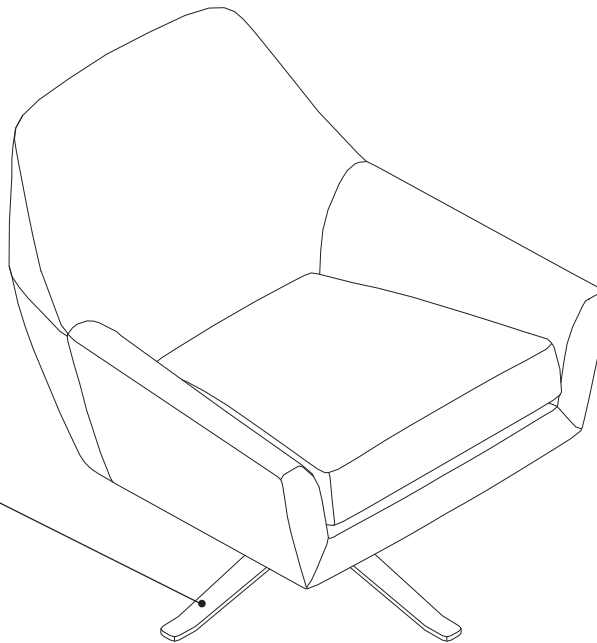
**Modern lines** give Lucas a streamlined look, while a wide seat and reclined pitch make it a comfortable spot to sit during long meetings and busy days.

**Lucas** comes standard with arms at a height of 20½".



**Seat height on wire base chair** is fixed at 18½".

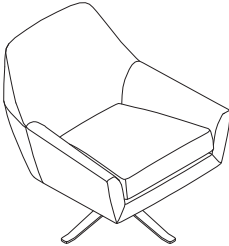
**The wire base** comes standard in West Elm WE05 Burnished Bronze with black glides.



**Swivel base** comes standard in 8046 Polished Aluminum. Swivel is a full 360° without an automatic return.



**Product Details**



**Cushion** is detachable.

**All product in the Lucas product line** ships fully assembled.

**Surface Materials**

**Swivel base** is 8046 Polished Aluminum.

**Wire base** is WE05 West Elm Burnished Bronze.

**Upholstery**  
• Billiard

**Contrasting fabric** is not available.

# Dimensions

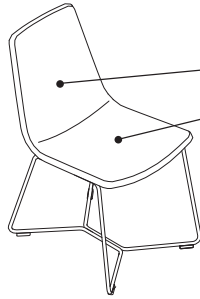
Lucas Seating

• Features	• Overall Depth	• Width	• Height	• Seat Depth	• Seat Width	• Seat Height	• Arm Height
<b>Lucas Seating</b>							
<b>Wire Base Chair</b>							
	32"	30½"	31"	21"	22"	18½"	20½"
<b>Swivel Base Chair</b>							
	32"	30½"	31"	21"	22"	20¾"	20½"

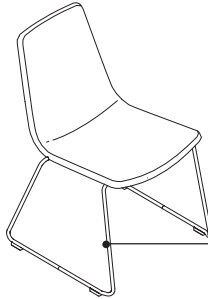


# Slope Seating

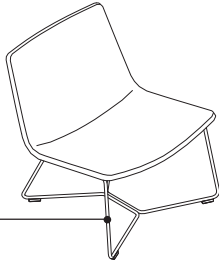
**Simple yet timeless design** allows the Slope family of seating to blend seamlessly into the modern office. A wide range of paint colors and upholstery options ranging from muted to playful add personality.



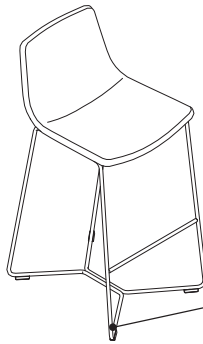
**Seat and back** are always fully upholstered.



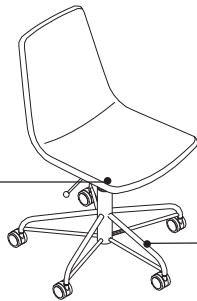
**Stackable base configuration** allows for easier storage and cleaning. Stacking chairs can be stacked up to five high.



**Wire frame base** is painted.



**Glides** are polyethylene for superior durability on carpeted and hard floors. Glides are available in black.



**Five-star base** is available in hot rolled steel finish or black paint.

**Seat height** adjusts 4", from 17½"H to 20½"H, with a pneumatic adjustment mechanism.

## Product Details



Guest chair



Stacking chair



Lounge chair



Bar-height stool



Conference chair

**Five-star and wire-frame bases** are available for guest chair and stool.

**360° adjustable height swivel mechanism** is standard on five-star base models.

**Slope** ships knocked down and the seat must be assembled to the frame on site, with the exception of the stacker with arms and the guest chair with arms which ship fully assembled. All slope styles come in a single carton.

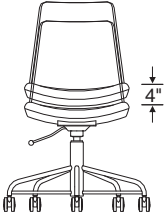
**Arms** are available as an option for guest, stacking, and conference chair.

**Slope stacking chairs** can be stacked up to five chairs high.

	Made-to-order	Stocked
Guest Chair	<b>AMQWESSLPCG</b>	<b>AMQWEM1</b>
Stacking Chair	<b>AMQWESSLPCS</b>	N.A.
Lounge Chair	<b>AMQWESSLPCL</b>	<b>AMQWEM2</b>
Conference Chair	<b>AMQWESSLPCC</b>	<b>AMQWEM3</b>
Bar Stool	<b>AMQWESSLPSB</b>	<b>AMQWEM66</b>

## Adjustment Features

### Seat Adjustments



### Conference Chair

#### Seat height adjusts

pneumatically. To lower, pull lever up while seated. To raise, pull lever up and keep your weight off the chair.

## Surface Materials

### Stocked Slope chairs

are only available in pre-configured base color and leather combinations. When Saddle or Fog leather are specified, the base will be Hot Rolled Steel. When Aegean leather is specified, the base will be Antique Brass.

### Seat and back upholstery

- Billiard

### Wire frame base

- Paint

### Five-star base

- 7207 Black
- Hot-rolled steel

### Casters

- 6205 Black

### Glides

- 6205 Black

### All seating with standard upholstery fabrics

complies with requirements of the State of California Technical Bulletin 117-2013. All standard seating is labeled to be in compliance with California 117-2013.

## Dimensions

▶ Page 494

# Dimensions

## Slope Seating

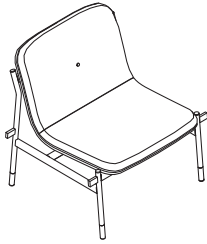
Features	Overall Depth	Width	Height	Functional Seat Depth	Seat Width	Seat Height from Floor	Back Width	Back Height from Seat
<b>Slope Seating</b>								
<b>Guest Chair</b>								
	21½"	19¼"	33¼"	17¾"	17¾"	18¾"	16¾"	18¾"
<b>Stacking Chair</b>								
	21½"	19¼"	33¼"	17¾"	17¾"	18¾"	16¾"	18¾"
<b>Lounge Chair</b>								
	26½"	26½"	28"	21¾"	26½"	15¾"	25¾"	19¼"
<b>Bar Stool</b>								
	21½"	19¼"	40"	17¾"	17¾"	29½"	14¼"	13"
<b>Conference Chair</b>								
	21½"	19¼"	32" – 36"	17¾"	17¾"	17½" – 20½"	16¾"	18¾"

\* Overall width does not include the base.

Tip: The diameter of the chair with the five-arm base is 25".

# West Elm Seating

## Brighton



*Tip: Handedness is determined while in the seated position.*

### Standard Includes

- Fully upholstered lounge chair: fabric price group 03
- Frame: paint price group 01
- Frame caps: paint price group 01
- Frame feet: paint price group 01
- Arms, if selected: veneer price group 01

### Options

Color Scheme	Non Contrasting	No cost
Inner Finish	Billiard	No cost
Outer Finish	Billiard	No cost
Frame Finish	Textured Paint	No cost
Arm Position	No Arm	No cost
	Arm Left	+\$240
	Arm Right	+\$240
	Arms-Left & Right	+\$480
Arms Finish	Rift Cut/Low Sheen	No cost
Ganging	Not Ganging	No cost
	Left	+\$57
	Right	+\$57
	Left and Right	+\$114
Foot Finish	Textured Paint	No cost
Cap Surface Finish	Textured Paint	No cost

### Specification Information

Style Number	Base Price
--------------	------------

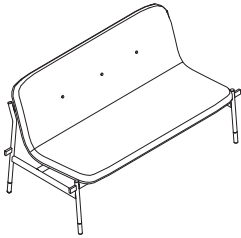
### Brighton One Seat Lounge Chair

<b>AMQWESARYLNG1</b>	\$2292
----------------------	--------

West Elm Seating

# West Elm Seating

## Brighton



Tip: Handedness is determined while in the seated position.

### Standard Includes

- Fully upholstered lounge chair: fabric price group 03
- Frame: paint price group 01
- Frame caps: paint price group 01
- Frame feet: paint price group 01
- Arms, if selected: veneer price group 01

### Options

Color Scheme	Non Contrasting	No cost
Inner Finish	Billiard	No cost
Outer Finish	Billiard	No cost
Frame Finish	Textured Paint	No cost
Arm Position	No Arm	No cost
	Arm Left	+\$240
	Arm Right	+\$240
	Arms-Left & Right	+\$480
Arms Finish	Rift Cut/Low Sheen	No cost
Ganging	Not Ganging	No cost
	Left	+\$57
	Right	+\$57
	Left and Right	+\$114
Foot Finish	Textured Paint	No cost
Cap Surface Finish	Textured Paint	No cost

### Specification Information

Style Number	Base Price
--------------	------------

### Brighton Two Seat Lounge Chair

**AMQWESARYLNG2** \$3447



### Standard Includes

- Fully upholstered ottoman: fabric price group 03
- Frame: paint price group 01
- Frame caps: paint price group 01

### Options

Upholstery Finish	Billiard	No cost
Frame Finish	Textured Paint	No cost
Cap Surface Finish	Textured Paint	No cost

### Specification Information

Style Number	Price
--------------	-------

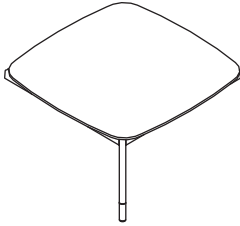
### Brighton Ottoman

**AMQWESARYO** \$706



# West Elm Seating

## Brighton



*Tip: Ganging tables or end table must be used when specifying ganging hardware on lounge units. Ganging hardware and arms cannot be specified on the same side of a lounge unit.*

### Standard Includes

- Table: High-Pressure Laminate price group 01 with 3 mm plastic edge
- Frame: paint price group 01
- Frame feet: paint price group 01
- Ganging brackets: plastic

### Options

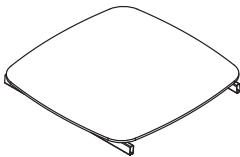
Frame Finish	Textured Paint	No cost
Top Surface Finish	Laminate HPL Price Group 01	No cost
Edge Finish	Plastic - PG1	No cost
Ganging	Left and Right	No cost
Foot Finish	Textured Paint	No cost

### Specification Information

Style Number	Price
--------------	-------

### Brighton 90° Ganging Table

**AMQWESARYTBL90** \$1236



*Tip: Ganging tables or end table must be used when specifying ganging hardware on lounge units. Ganging hardware and arms cannot be specified on the same side of a lounge unit.*

### Standard Includes

- Table: High-Pressure Laminate price group 01 with 3 mm plastic edge
- Frame: paint price group 01
- Ganging brackets: plastic

### Options

Frame Finish	Textured Paint	No cost
Top Surface Finish	Laminate HPL Price Group 01	No cost
Edge Finish	Plastic - PG1	No cost
Ganging	Left and Right	No cost

### Specification Information

Style Number	Price
--------------	-------

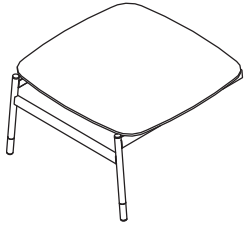
### Brighton Straight Ganging Table

**AMQWESARYTBLSG** \$1168

West Elm Seating

# West Elm Seating

## Brighton



*Tip: Ganging tables or end table must be used when specifying ganging hardware on lounge units. Ganging hardware and arms cannot be specified on the same side of a lounge unit.*

### Standard Includes

- Table: High-Pressure Laminate price group 01 with 3 mm plastic edge
- Frame: paint price group 01
- Frame feet: paint price group 01
- Frame caps: paint price group 01
- Ganging brackets: plastic

### Options

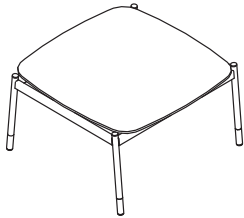
Frame Finish	Textured Paint	No cost
Top Surface Finish	Laminate HPL Price Group 01	No cost
Edge Finish	Plastic - PG1	No cost
Ganging	Left Right	No cost No cost
Foot Finish	Textured Paint	No cost
Cap Surface Finish	Textured Paint	No cost

### Specification Information

Style Number	Price
--------------	-------

### Brighton End Table

**AMQWESARYTBLED** \$1298



### Standard Includes

- Table: High-Pressure Laminate price group 01 with 3 mm plastic edge
- Frame: paint price group 01
- Frame caps: paint price group 01
- Frame feet: paint price group 01

### Options

Frame Finish	Textured Paint	No cost
Top Surface Finish	Laminate HPL Price Group 01	No cost
Edge Finish	Plastic - PG1	No cost
Foot Finish	Textured Paint	No cost
Cap Surface Finish	Textured Paint	No cost

### Specification Information

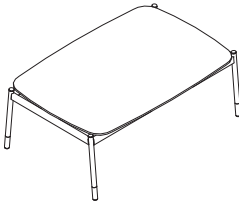
Style Number	Price
--------------	-------

### Brighton Square Table

**AMQWESARYTBLSQ** \$1430

# West Elm Seating

## Brighton



### Standard Includes

- Table: High-Pressure Laminate price group 01 with 3 mm plastic edge
- Frame: paint price group 01
- Frame caps: paint price group 01
- Frame feet: paint price group 01

### Options

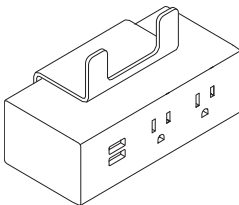
Frame Finish	Textured Paint	No cost
Top Surface Finish	Laminate HPL Price Group 01	No cost
Edge Finish	Plastic - PG1	No cost
Foot Finish	Textured Paint	No cost
Cap Surface Finish	Textured Paint	No cost

### Specification Information

Style Number	Price
--------------	-------

## Brighton Rectangle Table

**AMQWESARYTBLRT** \$1625



### Standard Includes

- 9' cord with three-prong plug: black plastic only
- Power module: 6000 Black

### Options

Power Configuration	2 Power 1 USB	No cost
Power Finish	Plastic - PG1	No cost

### Specification Information

Style Number	Price
--------------	-------

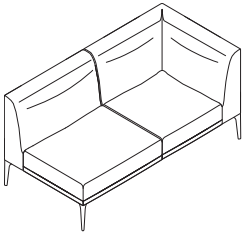
## Brighton Module Power

**AMQWESARYPWR** \$425

West Elm Seating

# West Elm Seating

## Mesa



Tip: Handedness is determined while in the seated position.

### Standard Includes

- Fully upholstered non-contrasting lounge: fabric price group 03
- Four leg cast aluminum base: WE01 Antique Bronze
- Ganging brackets: plastic

### Options

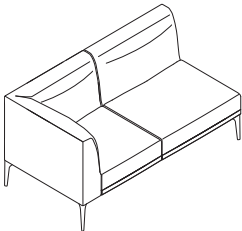
Inner Finish	Billiard	No cost
Outer Finish	Billiard	No cost
Leg Finish	Smooth Paint	No cost

### Specification Information

Style Number                      Price

### Mesa Chaise Lounge - Left Hand

**AMQWESMESCHLH**    \$5414



Tip: Handedness is determined while in the seated position.

### Standard Includes

- Fully upholstered non-contrasting lounge: fabric price group 03
- Four leg cast aluminum base: WE01 Antique Bronze
- Ganging brackets: plastic

### Options

Inner Finish	Billiard	No cost
Outer Finish	Billiard	No cost
Leg Finish	Smooth Paint	No cost

### Specification Information

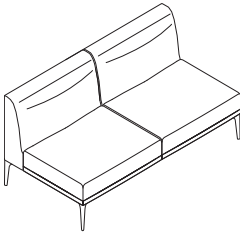
Style Number                      Price

### Mesa Chaise Lounge - Right Hand

**AMQWESMESCHRH**    \$5414

# West Elm Seating

## Mesa



### Standard Includes

- Fully upholstered non-contrasting lounge: fabric price group 03
- Four leg cast aluminum base: WE01 Antique Bronze
- Ganging brackets: plastic

### Options

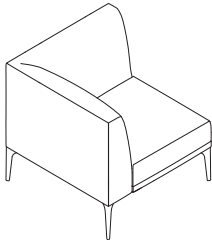
Inner Finish	Billiard	No cost
Outer Finish	Billiard	No cost
Leg Finish	Smooth Paint	No cost

### Specification Information

Style Number      Price

### Mesa Armless Lounge

**AMQWESMES2SEAT**    \$4920



### Standard Includes

- Fully upholstered non-contrasting lounge: fabric price group 03
- Four leg cast aluminum base: WE01 Antique Bronze
- Ganging brackets: plastic

### Options

Inner Finish	Billiard	No cost
Outer Finish	Billiard	No cost
Leg Finish	Smooth Paint	No cost

### Specification Information

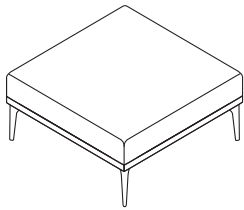
Style Number      Price

### Mesa Corner Lounge Unit

**AMQWESMESC**    \$3192

# West Elm Seating

## Mesa



### Standard Includes

- Fully upholstered ottoman: fabric price group 03
- Four leg cast aluminum base: WE01 Antique Bronze

### Options

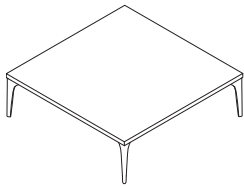
Upholstery Finish	Billiard	No cost
Leg Finish	Smooth Paint	No cost

### Specification Information

Style Number	Price
--------------	-------

#### Mesa Ottoman

**AMQWESMESO** \$2176



### Standard Includes

- Painted table: black

### Options

Color	Black	No cost
-------	-------	---------

### Specification Information

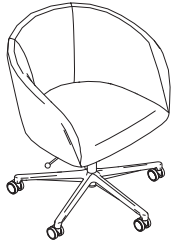
Style Number	Price
--------------	-------

#### Mesa Coffee Table

**AMQWEM68** \$1624

# West Elm Seating

## Nimbus



### Standard Includes

- Fully upholstered seat
- 5-star base: antique bronze

### Options

Color	Platinum	No cost
-------	----------	---------

### Specification Information

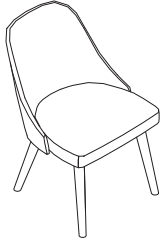
Style Number	Price
--------------	-------

### Nimbus Conference Chair

<b>AMQWEM70</b>	\$1098
-----------------	--------

# West Elm Seating

## Sterling



*Tip: Seat and back finish are non-contrasting and will match.*

### Standard Includes

- Fully upholstered seat with back: fabric price group 03
- Legs (base): VP03 Black Oak
- Glides: plastic

### Options

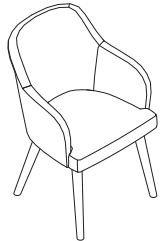
Back Finish	Billiard	No cost
Seat Finish	Billiard	No cost

### Specification Information

Style Number	Price
--------------	-------

## Sterling 4-Leg Armless Guest Chair

**AMQWESMDC4NA** \$1180



*Tip: Seat and back finish are non-contrasting and will match.*

### Standard Includes

- Fully upholstered seat with back: fabric price group 03
- Legs (base): VP03 Black Oak
- Glides: plastic

### Options

Back Finish	Billiard	No cost
Seat Finish	Billiard	No cost

### Specification Information

Style Number	Price
--------------	-------

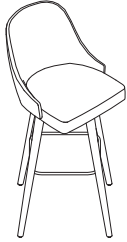
## Sterling 4-Leg with Arms Guest Chair

**AMQWESMDC4WA** \$1319



# West Elm Seating

## Sterling



Tip: Seat and back finish are non-contrasting and will match.

### Standard Includes

- Fully upholstered seat with back: fabric price group 03
- Legs (base): VP03 Black Oak
- Glides: plastic

### Options

Back Finish	Billiard	No cost
Seat Finish	Billiard	No cost

### Specification Information

Style Number	Price
--------------	-------

## Sterling Bar Height Armless Stool

**AMQWESMDCSBHNA** \$1504



Tip: Seat and back finish are non-contrasting and will match.

### Standard Includes

- Fully upholstered seat with back: fabric price group 03
- Five-star adjustable base: paint price group 01
- Hard casters: 6205 Black

### Options

Back Finish	Billiard	No cost
Seat Finish	Billiard	No cost
Base Finish	Paint Price Group 02	No cost
	Polished Aluminum	+\$126
Tilt Mechanism	Without Tilt	No cost
	With Tilt	+\$98

### Specification Information

Style Number	Base Price
--------------	------------

## Sterling 5-Star Armless Conference Chair

**AMQWESMDC5NA** \$1321

West Elm Seating

# West Elm Seating

## Sterling



*Tip: Seat and back finish are non-contrasting and will match.*

### Standard Includes

- Fully upholstered seat with back: fabric price group 03
- Five-star adjustable base: paint price group 01
- Hard casters: 6205 Black

### Options

Back Finish	Billiard	No cost
Seat Finish	Billiard	No cost
Base Finish	Paint Price Group 02	No cost
	Polished Aluminum	+\$126
Tilt Mechanism	Without Tilt	No cost
	With Tilt	+\$98

### Specification Information

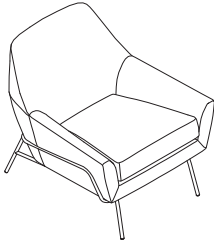
Style Number      Base Price

## Sterling 5-Star with Arms Conference Chair

**AMQWESMDC5WA** \$1446

# West Elm Seating

Lucas



### Standard Includes

- Fully upholstered seat with back: fabric price group 03
- Wire frame base: WE05 West Elm Burnished Bronze

### Options

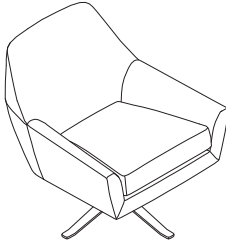
Upholstery Finish	Billiard	No cost
-------------------	----------	---------

### Specification Information

Style Number	Price
--------------	-------

### Lucas Wire Chair

**AMQWESLUCW** \$2794



### Standard Includes

- Fully upholstered seat with back: fabric price group 03
- Swivel base: 8046 Polished Aluminum

### Options

Upholstery Finish	Billiard	No cost
-------------------	----------	---------

### Specification Information

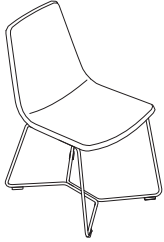
Style Number	Price
--------------	-------

### Lucas Swivel Chair

**AMQWESLUCS** \$2995

# West Elm Seating

## Slope



Tip: Slope guest chair with arms is shipped fully assembled; without arms will require assembly.

Tip: Upholstery and paint available on Steelcase Slope. Licensed Slope (stocked) guest chair available in saddle or fog with a hot rolled steel frame. Licensed Slope guest chair is also available in aegean leather with antique brass frame.

### Standard Includes

- Fully upholstered seat with back: fabric price group 03
- Wire frame base: paint price group 01
- Glides: 6205 Black

### Options

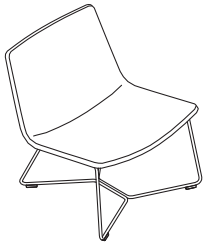
Upholstery Finish	Billiard	No cost
Base Finish	Paint Price Group 01	No cost
	Paint Price Group 02	+\$41
Arm Type	Without Arm	No cost
	With Arm	+\$159

### Specification Information

Style Number      Base Price

### Slope Guest Chair

**AMQWESSLPCG** \$908



Tip: Upholstery and paint available on Steelcase Slope. Licensed Slope (stocked) lounge chair only available in saddle and fog with hot rolled steel frame.

### Standard Includes

- Fully upholstered seat with back: fabric price group 03
- Wire frame base: paint price group 01
- Glides: 6205 Black
- Requires assembly

### Options

Upholstery Finish	Billiard	No cost
Base Finish	Paint Price Group 01	No cost
	Paint Price Group 02	+\$41

### Specification Information

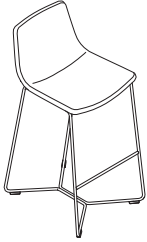
Style Number      Base Price

### Slope Lounge Chair

**AMQWESSLPCL** \$1256

# West Elm Seating

## Slope



*Tip: Upholstery and paint available on Steelcase Slope. Licensed Slope (stocked) bar height stool is only available in saddle with hot rolled steel frame.*

### Standard Includes

- Fully upholstered seat with back: fabric price group 03
- Wire frame base: paint price group 01
- Glides: 6205 Black
- Requires assembly

### Options

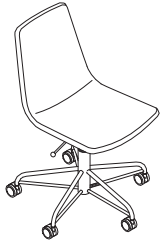
Upholstery Finish	Billiard	No cost
Base Finish	Paint Price Group 01	No cost
	Paint Price Group 02	+\$41

### Specification Information

Style Number      Base Price

## Slope Bar Height Stool

**AMQWESSLPSB** \$1174



*Tip: Upholstery and paint available on Steelcase Slope. Licensed Slope (stocked) conference chair only available in saddle and fog with hot rolled steel frame.*

### Standard Includes

- Fully upholstered seat with back: fabric price group 03
- Five-star adjustable base: paint price group 01
- Hard casters: 6205 Black
- Requires assembly

### Options

Upholstery Finish	Billiard	No cost
Arm Type	Without Arm	No cost
	With Arm	+\$159

### Specification Information

Style Number      Base Price

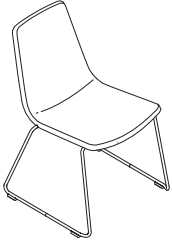
## Slope Height-Adjustable Conference Chair

**AMQWESSLPCC** \$1227

West Elm Seating

# West Elm Seating

## Slope



*Tip: Slope stacking chair with arms is shipped fully assembled; without arms will require assembly.*

### Standard Includes

- Fully upholstered seat with back: fabric price group 03
- Wire frame base: paint price group 01
- Glides: 6205 Black

### Options

Upholstery Finish	Billiard	No cost
Base Finish	Paint Price Group 01	No cost
	Paint Price Group 02	+\$41
Arm Type	Without Arm	No cost
	With Arm	+\$159

### Specification Information

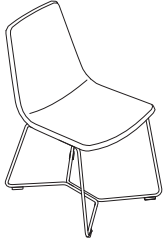
Style Number	Base Price
--------------	------------

### Slope Stacking Chair

**AMQWESSLPCS** \$919

# West Elm Seating

## Slope - Stocked



*Tip: Licensed Slope (stocked) guest chair available in saddle or fog with a hot rolled steel frame. Licensed Slope guest chair is also available in aegean leather with antique brass frame.*

### Standard Includes

- Fully upholstered seat with back: leather
- Wire frame base

### Options

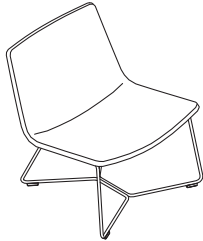
Color		
Aegean		No cost
Fog		No cost
Saddle		No cost

### Specification Information

Dimensions			Style Number	Price
D	W	H		

### Slope Guest Chair - Stocked

21 1/2"	19 1/4"	33 1/4"	<b>AMQWEM1</b>	\$941
---------	---------	---------	----------------	-------



### Standard Includes

- Fully upholstered seat with back: leather
- Wire frame base: WE00 Hot Rolled Steel

### Options

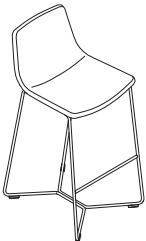
Color		
Fog		No cost
Saddle		No cost

### Specification Information

Dimensions			Style Number	Price
D	W	H		

### Slope Lounge Chair - Stocked

26 1/2"	26 1/2"	28"	<b>AMQWEM2</b>	\$1190
---------	---------	-----	----------------	--------



### Standard Includes

- Fully upholstered seat with back: saddle leather
- Wire frame base: WE00 Hot Rolled Steel

### Specification Information

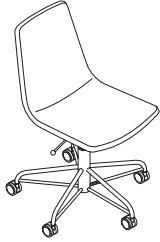
Dimensions			Style Number	Price
D	W	H		

### Slope Bar Stool - Stocked

21 1/2"	19 1/4"	40"	<b>AMQWEM66</b>	\$1024
---------	---------	-----	-----------------	--------

# West Elm Seating

Slope - Stocked



### Standard Includes

- Fully upholstered seat with back: leather
- Five-star adjustable base: WE00 Hot Rolled Steel

### Options

Color	Fog	No cost
	Saddle	No cost

### Specification Information

Dimensions			Style Number	Price
D	W	H		

### Slope Conference Chair - Stocked

21 1/2"	19 1/4"	32" - 36"	<b>AMQWEM3</b>	\$1190
---------	---------	-----------	----------------	--------



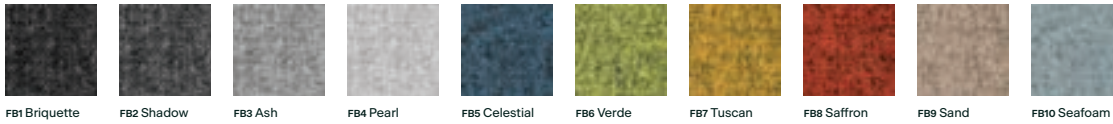
---

# Resources

<b>Furniture Finishes</b>	<b>514</b>
<b>Seating Finishes</b>	<b>516</b>
<b>Style Number Index</b>	<b>518</b>

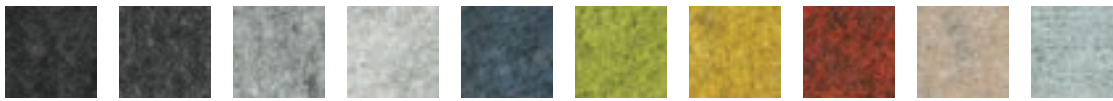
# Furniture Finishes

## Fabric Verve Collection



FB1 Briquette    FB2 Shadow    FB3 Ash    FB4 Pearl    FB5 Celestial    FB6 Verde    FB7 Tuscan    FB8 Saffron    FB9 Sand    FB10 Seafoam

## Felt Verve Collection



FC1 Briquette    FC2 Shadow    FC3 Ash    FC4 Pearl    FC5 Celestial    FC6 Verde    FC7 Tuscan    FC8 Saffron    FC9 Sand    FC10 Seafoam

## Metals



F1 Platinum    F2 White    F3 Black    F4 Merle    F5 Celestial    F6 Verde    F7 Tuscan    F8 Saffron

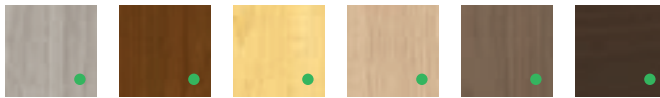


7207 Black    4799 Platinum Metallic    7243 Seagull    7225 Sand    7238 Fieldstone

## Laminates



w2.1 Milk White 2L84 (LPL) 2884 (HPL)    w2.2 Maple    w2.3 Teak    w2.4 Walnut    w2.5 Arctic White 2L30 (LPL) 2730 (HPL)    w2.6 Seagull 2L83 (LPL) 2883 (HPL)    w2.7 Ash Wenge    w2.8 Clay Wenge 2LCW (LPL) 2HCW (HPL)    w2.9 Acacia 2LAT (LPL) 2HAT (HPL)    w2.10 Graphite Walnut 24L0 (LPL) 2410 (HPL)

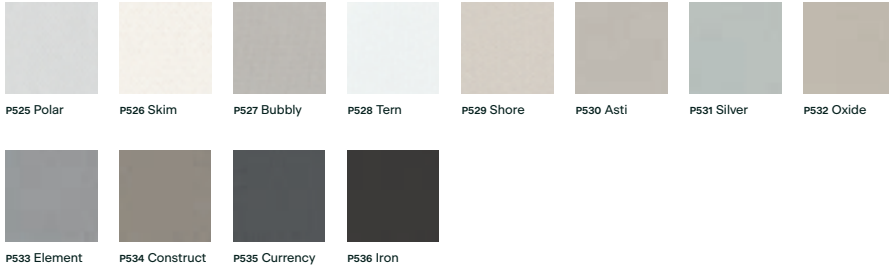


Clay Noce 2LCN (LPL) 2HCN (HPL)    Natural Cherry 26L1 (LPL) 2412 (HPL)    Clear Maple 2L09 (LPL) 2409 (HPL)    Clear Oak 2LAK (LPL) 2HAK (HPL)    Virginia Walnut 25L5 (LPL) 2535 (HPL)    Clear Walnut 25L8 (LPL) 2538 (HPL)

- Kinex, Activ, Concur
- Embank, Tektis, Greenpoint, Brighton

**Note** Please view material swatches before specifying. Printed colors may vary from actual fabric. View material specs and cleaning instructions on our web site at [www.amqsolutions.com](http://www.amqsolutions.com)

## Fabric Alloy Collection



## Fabric Boccie Collection



## Designtex Billiard Multi-Use Collection



**Note** Please view material swatches before specifying. Printed colors may vary from actual fabric.  
View material specs and cleaning instructions on our web site at [www.amqsolutions.com](http://www.amqsolutions.com)

# Seating Finishes

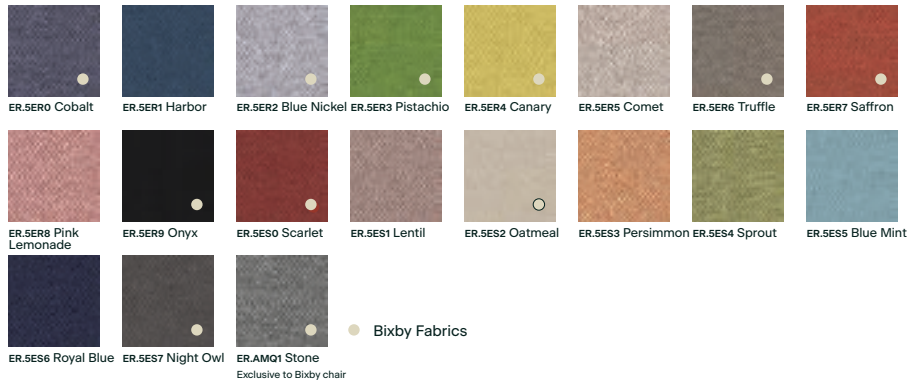
## Fabric Buzz Collection Grade 1



Fabric Specifications	
Content	100% Polyester (Antimony Free Yarn)*
Weight	14.5 oz. per linear yard
Width	54 inches
Abrasion	100,000 double rubs
Environmental Characteristics	*Antimony Less Than 100 ppm
Flammability	California Technical Bulletin #133



## Fabric Era Collection Grade 2



Fabric Specifications	
Content	100% Polyester (Antimony Free Yarn)*
Weight	14.24 oz. per linear yard
Width	54 inches
Abrasion	100,000 double rubs
Environmental Characteristics	*Antimony Less Than 100 ppm, Oeko-Tex Certified
Flammability	California Technical Bulletin #133



## Fabric Connect Collection Grade 3



Fabric Specifications	
Content	100% Polyester (Antimony Free Yarn)*
Weight	16.4 oz. per linear yard
Width	62 inches
Abrasion	100,000 double rubs
Environmental Characteristics	*Antimony Less Than 100 ppm, Cradle to Cradle Certified™ Bronze
Flammability	California Technical Bulletin #133



**Note** Please view material swatches before specifying. Printed colors may vary from actual fabric. View material specs and cleaning instructions on our web site at [www.amqsolutions.com](http://www.amqsolutions.com)

## Polyurethane Brisa Collection Grade 4



Fabric Specifications	
Content	100% Polyurethane
Weight	13.8 ozs per linear yard
Width	54 inches
Abrasion	200,000 double rubs
Environmental Characteristics	Bleach Cleanable
Flammability	California Technical Bulletin #133



## Fabric Elements Collection Grade 1



**FI-X** ○ FL-X fabric back colors indicated with white dot

Fabric Specifications	
Content	98% Recycled Polyester, 2% Spandex
Weight	(per sq. m) 326g
Thickness	1.1mm
Width	58"
Flammability	California Bulletin 117. Section E CS 191-53 Class 1

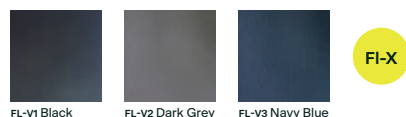
## Fabric Milan Collection Grade 2



**FI-X** ○ FL-X fabric back colors indicated with white dot

Fabric Specifications	
Content	100% Polyester
Weight	(per sq. m) 243g
Width	58"
Flammability	California Bulletin 117. Section E

## Vinyl Grade 4



**FI-X**

## Leather Grade 7



**Zilo**

## Plastic



**Bixby**

○ Bixby frame indicated with white dot

**Note** Please view material swatches before specifying. Printed colors may vary from actual fabric. View material specs and cleaning instructions on our web site at [www.amqsolutions.com](http://www.amqsolutions.com)

# Style Number Index

Style Number	Page	Description
<b>3FHPHANGINGPNL</b>	137	3F Hanging Panel
<b>3FHPMOUNTKIT</b>	143	3F Pnl Rail Mount Kit
<b>3FHPRAILKIT</b>	143	3F Pnl Rail Mount Kit
<b>3FSNCORNERCNECT</b>	144	3F Screens Corner Connector
<b>3FSNFIXEDPRVCYBKT</b>	145	3F Scrns Pvcy Mod Scrns Bracket
<b>3FSNHALFDESK</b>	140	3F Screens Half Desk L Screen
<b>3FSNHEIGHTADJBKT</b>	146	3F Screens Height AdjBracket
<b>3FSNHOODED</b>	142	3F Screens ILINE Scn Mount Clip
<b>3FSNILINEMOUNT</b>	147	3F Screen,ILINE Scn Mnt Clip,Set of 2
<b>3FSNKINEXCLIP</b>	146	3F Scrns KINEX Scm Clip
<b>3FSNLINEAR</b>	139	3F Screens Linear
<b>3FSNLSCREEN</b>	139	3F Screens L Screen
<b>3FSNSLEEVEBKT</b>	144	3F Screens Sleeve Bracket
<b>3FSNTOPMNTCLAMPBKT</b>	145	3F Scrns Top Mnt Bracket Clamp
<b>3FSNTOPMOUNTBKT</b>	144	3F Screens Top Mount Bracket
<b>3FSNUSCREEN</b>	141	3F Screens U Screen
<b>3FWTTILE</b>	138	3F Wall Tile
<b>ACTIV-CASTORS</b>	76	ACTIV Castors for Bases
<b>ACTVBASE90120</b>	75	ACTIV PRO 3 Base 90/120
<b>ACTVBASES3</b>	73	ACTIV PRO 2 Base 3 Stage
<b>ACTVDESKS3</b>	72	ACTIV Desk Stage 3
<b>ACTVFEET</b>	77	ACTIV Feet
<b>ACTVPRO120</b>	75	ACTIV Desk 120 Degree
<b>ACTVPRO90</b>	74	ACTIV Desk 90 Degree
<b>ACTVRETURNWKSF</b>	78	ACTIV Return Worksurface
<b>ACTVSHORTSTRETCH</b>	76	ACTIV Short Stretcherbar
<b>ACTVSTRETCHERBAR72</b>	76	ACTIV Stretcherbar
<b>ACTVWIRETRAY</b>	182	ACTIV Wire Tray 36"W
<b>ACTVWORKSURF120</b>	78	ACTIV 120 Degree Worksurface
<b>ACTVWORKSURFACE</b>	78	ACTIV Worksurface
<b>ADCLIP</b>	102	AMOB I Desk Magnetic Accessory Clip
<b>ADDCBL</b>	103	AMOB I Desktop Cable Organizer
<b>ADF54</b>	99	AMOB I 54" Focus Desk
<b>ADF60</b>	100	AMOB I 60" Focus Desk
<b>ADFORG</b>	104	AMOB I Magnetic File Holder
<b>ADLED54</b>	102	AMOB I Desk 54" LED Task Light
<b>ADLED60</b>	102	AMOB I Desk 60" LED Task Light
<b>ADMP54</b>	102	AMOB I Desk 54" Modesty Panel
<b>ADMP60</b>	102	AMOB I Desk 60" Modesty Panel
<b>ADO54</b>	97	AMOB I 54" One Desk
<b>ADO60</b>	98	AMOB I 60" One Desk
<b>ADPSC</b>	103	AMOB I Desk Privacy Screen Connector
<b>ADSCUB</b>	103	AMOB I Undermount Cubby
<b>ADSDMA</b>	101	AMOB I Desk Snap-in Single Mntr Arm
<b>ADTB54</b>	101	AMOB I Desk 54" Tackboard
<b>ADTB60</b>	101	AMOB I Desk 60" Tackboard
<b>ADUBSKT</b>	104	AMOB I Magnetic Pencil Holder
<b>ADUCUP</b>	103	AMOB I Magnetic Utility Holder
<b>ADWB54</b>	101	AMOB I Desk 54" Tackboard
<b>ADWB60</b>	101	AMOB I Desk 60" Whiteboard
<b>AMQ9999CHT</b>	410	Greenpoint Wire Clip
<b>AMQAWAK</b>	373	EMBANK Cabinet Attachment Kit
<b>AMQAWM30</b>	410	Greenpoint Wire Manager
<b>AMQCDWS</b>	267	Tektis- Cord Drop Worksurfaces

Style Number	Page	Description
<b>AMQCFINTRO</b>	183	WORK TOOLS Intro Single
<b>AMQCFINTRODSLIDE</b>	183	WORK TOOLS Intro Dual Assembly
<b>AMQCRBK</b>	357	EMBANK Bookcase
<b>AMQCRBKs</b>	358	EMBANK Stacking Bookcase
<b>AMQCRBRG</b>	347	EMBANK Bridge
<b>AMQCRC</b>	331	EMBANK Mobile Ped Cushion
<b>AMQCRCD2HFSCC</b>	340	EMBANK Two-High Credenza
<b>AMQCRCD2HFSLCLFL</b>	339	EMBANK Two-High Credenza
<b>AMQCRCD2HFSLCFLFR</b>	339	EMBANK Two-High Credenza
<b>AMQCRCD2HFSLFL</b>	339	EMBANK Two-High Credenza
<b>AMQCRCD2HFSLFR</b>	339	EMBANK Two-High Credenza
<b>AMQCRCD2HFSLL</b>	339	EMBANK Two-High Credenza
<b>AMQCRCD2HFSOO</b>	339	EMBANK Two-High Credenzas
<b>AMQCRCD2HKSDP</b>	341	EMBANK Two-High Credenza
<b>AMQCRCD2HKSSPL</b>	341	EMBANK Two-High Credenza
<b>AMQCRCD2HKSSPR</b>	341	EMBANK Two-High Credenza
<b>AMQCRCT</b>	342	EMBANK Common Top
<b>AMQCRDShL</b>	344	EMBANK Desk Shell
<b>AMQCRDskDP</b>	344	EMBANK Desk Shell
<b>AMQCRDskSPL</b>	344	EMBANK Desk Shell
<b>AMQCRDskSPR</b>	344	EMBANK Desk Shell
<b>AMQCRDWKSF</b>	348	EMBANK D-Shaped WS
<b>AMQCRL15HBF</b>	333	EMBANK 1.5-High Lateral File
<b>AMQCRL1H</b>	333	EMBANK 1-High Lateral File
<b>AMQCRL2H</b>	333	EMBANK 2-High Lateral File
<b>AMQCRL3H</b>	334	EMBANK 3-High Lateral File
<b>AMQCRL4H</b>	334	EMBANK 4-High Lateral File
<b>AMQCRLS15HO</b>	336	EMBANK 1.5-High Lower Storage
<b>AMQCRLS1H</b>	336	EMBANK 1-High Lower Storage
<b>AMQCRLS2HD</b>	336	EMBANK 2-High Lower Storage
<b>AMQCRLS2HO</b>	336	EMBANK 2-High Lower Storage
<b>AMQCRMP</b>	372	EMBANK Modesty Panel
<b>AMQCRMP15H</b>	330	EMBANK 1.5-High Mobile Ped
<b>AMQCRMP2HBBF</b>	331	EMBANK 2-High Mobile Ped
<b>AMQCRMP2HFF</b>	331	EMBANK 2-High Mobile Ped
<b>AMQCROHHD</b>	359	EMBANK Overhead
<b>AMQCROHOP</b>	360	EMBANK Overhead
<b>AMQCROHS</b>	362	EMBANK Stacking Overhead
<b>AMQCROHSDP</b>	360	EMBANK Overhead
<b>AMQCROHSHD</b>	361	EMBANK Stacking Overhead
<b>AMQCROHSSD</b>	361	EMBANK Stacking Overhead
<b>AMQCRORP</b>	363	EMBANK Personal Organizer
<b>AMQCRPD2HBBF</b>	329	EMBANK 2-High Fixed Ped
<b>AMQCRPD2HFF</b>	329	EMBANK 2-High Fixed Ped
<b>AMQCRPWKSF</b>	349	EMBANK P-Shaped WS
<b>AMQCRRECTBL</b>	366	EMBANK Rect Table
<b>AMQCRRTBL</b>	365	EMBANK Round Table
<b>AMQCRRTNL</b>	346	EMBANK Return Shell
<b>AMQCRRTNR</b>	346	EMBANK Return Shell
<b>AMQCRRTNSPL</b>	346	EMBANK Return
<b>AMQCRRTNSPR</b>	346	EMBANK Return
<b>AMQCRSQB</b>	371	EMBANK Square leg
<b>AMQCRSQTB</b>	365	EMBANK Square Table
<b>AMQCRTB</b>	364	EMBANK Fabric Tackboard
<b>AMQCRTWBFL</b>	350	EMBANK Tower

Style Number	Page	Description	Style Number	Page	Description
AMQCRTWBFR	351	EMBANK Tower	AMQTSATEP	258	TEKTIS On-Mod End Pnl
AMQCRTWDBFL	352	EMBANK Tower	AMQTSATP27	258	TEKTIS Post Leg
AMQCRTWDBFR	353	EMBANK Tower	AMQTSATPL	374	EMBANK In-Line Support Plt
AMQCRTWDFFL	353	EMBANK Tower	AMQTSATRC	374	EMBANK Reinforcing Channel
AMQCRTWDFFR	353	EMBANK Tower	AMQTSATSIDE	258	TEKTIS Side Support Bracket
AMQCRTWFFL	351	EMBANK Tower	AMQTSATTIE	374	EMBANK Tie Plates
AMQCRTWFFR	351	EMBANK Tower	AMQTSAWLCC	271	TEKTIS Curved Corner WS
AMQCRTWSABBFL	354	EMBANK Tower	AMQTSAWLCF	270	TEKTIS Straight Corner WS
AMQCRTWSABBFR	355	EMBANK Tower	AMQTSAWLEL	272	TEKTIS LH Ext Curved Corner WS
AMQCRTWSAFFL	355	EMBANK Tower	AMQTSAWLER	273	TEKTIS RH Ext Curved Corner WS
AMQCRTWSAFFR	355	EMBANK Tower	AMQTSAWLR	269	TEKTIS Straight WS
AMQCRWDL	356	EMBANK Wardrobe	AMQTSAWLY	274	TEKTIS 120° Corner WS
AMQCRWDR	356	EMBANK Wardrobe	AMQUCANT	268	Tektis - On-Module Cantilever
AMQDSBULKSTRP	186	WORK TOOLS Bulk Strap Pack	AMQWEM1	511	Slope Guest Chair—Stocked
AMQDSPINTRO	184	WORK TOOLS Pwrstrp Intro	AMQWEM11	414	Maisie Side Table—22"H
AMQDSTRAYLG	185	WORK TOOLS Cbl Mng Kit Lg	AMQWEM2	511	Slope Lounge Chair—Stocked
AMQDSTRAYSM	185	WORK TOOLS Cbl Mng Kit Sm	AMQWEM3	512	Slope Conference Chair—Stocked
AMQLOCK9201FR	377	Lock Cylinder—FR Series	AMQWEM4	414	Maisie Side Table—25"H
AMQLOCK9201XF	377	Lock Cylinder—XR Series	AMQWEM5	416	Stump Side Table
AMQLSCTSKLIGHT1	184	WORK TOOLS LED Intro Sgl	AMQWEM59	412	Lily Pad Nesting Table—18"H
AMQLSCTSKLIGHT2	184	WORK TOOLS LED Intro Dbl	AMQWEM60	413	Lily Pad Nesting Table—20"H
AMQPDCB1	186	WORK TOOLS SOTO Intro Bndl	AMQWEM61	187	Linear Wood LED Task Lamp
AMQPDCB3	186	WORK TOOLS SOTO Box Bndl	AMQWEM66	511	Slope Bar Stool—Stocked
AMQRCHE2430	337	EMBANK Cushion	AMQWEM68	502	Mesa Coffee Tbl
AMQRCHE2436	337	EMBANK Cushion	AMQWEM7	412	Lily Pad Nesting Table—16"H
AMQRMBB	276	TEKTIS Markerboard	AMQWEM70	503	Nimbus Conf Chair
AMQRXPDPT	275	TEKTIS Pencil Tray	AMQWEM8	411	Linear Personal Table
AMQRXADRL15	275	TEKTIS Rail	AMQWEM9	415	Nolan Side Table
AMQTS2FILLER	275	TEKTIS Ped Filler	AMQWESARYLNG1	495	Brighton One Seat Lounge
AMQTS2PBFBF	259	TEKTIS Fixed Ped	AMQWESARYLNG2	496	Brighton Two Seat Lounge
AMQTS2PFFU	259	TEKTIS Fixed Ped	AMQWESARYO	496	Brighton Ottoman
AMQTSAE986694B	265	BASE POWER IN 4 CIRCUIT	AMQWESARYPWR	499	Brighton Power Module
AMQTSAE986694SFB	265	POWER IN-BASE,4 CKT SF	AMQWESARYTBL90	497	Brighton 90° Ganging Table
AMQTSAE98669B	265	TEKTIS Base Power-In	AMQWESARYTBLED	498	Brighton End Table
AMQTSAE98669SFB	265	TEKTIS Base Power-In	AMQWESARYTBLRT	499	Brighton Rect Table
AMQTSAEDASB	262	Duplex Recp, 15-Amp - 4-Circuit 6pk	AMQWESARYTBLSG	497	Brighton Straight Ganging Tbl
AMQTSAEGROM	266	TEKTIS Grommet Package	AMQWESARYTBLSQ	498	Bright Square Table
AMQTSAEP3B	263	TEKTIS 3-Circuit Power Pole	AMQWESINDMP	409	Greenpoint Modesty Panel
AMQTSAEP4B	263	POLE POWER 4 CIRCUIT	AMQWESINDPD	408	Greenpoint Private Desk
AMQTSAEPC	264	TEKTIS Cable Pole	AMQWESINDRL	409	Greenpoint Dsk Rtn w/ Leg
AMQTSAESB	262	TEKTIS 15-Amp Receptacle	AMQWESLUCS	507	Lucas Swivel Chair
AMQTSAPB120	257	TEKTIS 120° Connector	AMQWESLUCW	507	Lucas Wire Chair
AMQTSAPBCOH	257	TEKTIS Connector Pkg	AMQWESMDC4NA	504	Sterling 4-Leg Armless Guest Chair
AMQTSAPBWS66	257	TEKTIS Wall Start Connector Pkg	AMQWESMDC4WA	504	Sterling 4-Leg with Arms Guest Chair
AMQTSAPF	249	TEKTIS Tack Acoustical Pnl	AMQWESMDC5NA	505	Sterling 5-Star Armless Conference Ch
AMQTSAPS	250	TEKTIS Tack Acoustical Pnl Stkr	AMQWESMDC5WA	506	Sterling 5-Star with Arms Conf Ch
AMQTSAPSG	251	TEKTIS Glass Pnl Stkr	AMQWESMDCSBHNA	505	Sterling Bar Height Armless Stool
AMQTSAPTC	254	TEKTIS Vert Corner Trim	AMQWESMES2SEAT	501	Mesa Armless Lounge
AMQTSAPTCY	255	TEKTIS 120° Vert Corner Trim	AMQWESMESC	501	Mesa Corner Lounge
AMQTSAPTE	252	TEKTIS Vert End-of-Run Trim	AMQWESMESCHLH	500	Mesa LH Lounge
AMQTSAPTXC	256	TEKTIS Vert Corner C-O-H Trim	AMQWESMESCHRH	500	Mesa RH Lounge
AMQTSAPTXS	253	TEKTIS Vert In-Line C-O-H Trim	AMQWESMESO	502	Mesa Ottoman
AMQTSASLCL	261	TEKTIS Lam Common Shelf	AMQWESSLPCG	509	Slope Height-Adjustable Conference Ch
AMQTSASUBL	260	TEKTIS Bin	AMQWESSLPCC	508	Slope Guest Chair
AMQTSATCANT	258	TEKTIS Cantilever w/ Tie Plt	AMQWESSLPCL	508	Slope Lounge Chair

Style Number Index, continued

Style Number	Page	Description
<b>AMQWESSLPCS</b>	510	Slope Stacking Chair
<b>AMQWESSLPSB</b>	509	Slope Bar Height Stool
<b>APS2</b>	62	ACTIV PRO 2.0 2 Stage Desk
<b>APS2B</b>	63	ACTIV PRO 2.0 2 Stage Base
<b>APS3</b>	62	ACTIV PRO 2.0 3 Stage Desk
<b>APS3B</b>	63	ACTIV PRO 2.0 3 Stage Base
<b>ATBSK</b>	112	AMOBI Team Felt Baskets
<b>ATDIGITAL</b>	108	AMOBI Team Display with Storage
<b>ATDSP</b>	109	AMOBI Team Display
<b>ATDST</b>	110	AMOBI Team Display with Storage
<b>ATHWL</b>	106	AMOBI Team Half Wall
<b>ATQUICKRELEASE</b>	112	AMOBI Quick Release Assembly
<b>ATSC</b>	111	AMOBI Team Cart with Storage
<b>ATSHelf</b>	113	AMOBI Laminate Shelves
<b>ATSTGASSEMBLY</b>	113	AMOBI Storage Assembly
<b>ATSTR</b>	107	AMOBI Team Half Wall with Storage
<b>ATTBFL</b>	111	AMOBI Team Full Size Tackboard
<b>ATTBHS</b>	111	AMOBI Team Half Size Tackboard
<b>ATTC</b>	110	AMOBI Team Cart
<b>ATWALL</b>	105	AMOBI Team Wall
<b>ATWBFL</b>	112	AMOBI Team Full Size Whiteboard
<b>ATWBHS</b>	112	AMOBI Team Half Size Whiteboard
<b>BIXBY-DOLLY</b>	468	BIXBY Dolly
<b>BODICHAIR</b>	449	BODI Task Chair
<b>BODISEATCOVER</b>	449	BODI Seat Cover
<b>BOOSTPOWER</b>	181	Boost Power Box
<b>BXBYARMLESS</b>	465	BIXBY Chair Armless
<b>BXBYCHAIR</b>	464	BIXBY Chair w Arms
<b>BXBYGANGCAP</b>	468	BIXBY Ganging Cap
<b>BXBYSTOOL</b>	467	BIXBY Lite Stool
<b>BXBYSTORAGE</b>	468	BIXBY Storage and Ganging Tray
<b>BXBYTABLETARM</b>	469	BIXBY Tablet Arm with Tablet
<b>BXBYWORK</b>	466	BIXBY Lite Work
<b>CLCASTERS</b>	88	CLUVO Casters
<b>CLCBASKET</b>	88	CLUVO Cable Basket
<b>CLS2</b>	86	CLUVO 2 Stage Desk
<b>CLS2B</b>	87	CLUVO 2 Stage Base
<b>CLS3</b>	86	CLUVO 3 Stage Desk
<b>CLS3B</b>	87	CLUVO 3 Stage Base
<b>CNCRFRAME</b>	124	CONCUR Frame
<b>CNCRMODESTY</b>	128	CONCUR Modesty Panel
<b>CNCRTABLE</b>	124	CONCUR Table
<b>CNCRtizubNDL</b>	126	CONCUR TIZU Seating bundle
<b>CNCRWORKSURFACE</b>	128	CONCUR Worksurface
<b>CONCUR-EE-CB</b>	127	CONCUR Power Base In-Feed
<b>CONCUR-EE-CNT</b>	127	60" Power Link
<b>CONCUR-EE-JMP</b>	127	24" Power Jumper
<b>CONCUR-GK</b>	127	CONCUR Ganging Kit
<b>EMCAFERDTBL</b>	367	Café-Height Round
<b>EMCAFESQTBL</b>	367	Café Height Square
<b>EMLKD2</b>	395	Locker - Double Wide, 2 Door
<b>EMLKD4</b>	396	Locker - Double Wide, 4 Door
<b>EMLKD6</b>	397	Locker - Double Wide, 6 Door
<b>EMLKD8</b>	397-398	Locker - Double Wide, 8 Door
<b>EMLKMKEY</b>	400	Manager Key

Style Number	Page	Description
<b>EMLKPKEY</b>	400	Programming Key
<b>EMLKS1</b>	391-392	Locker - Single Wide, 1 Door
<b>EMLKS2</b>	392-393	Locker - Single Wide, 2 Door
<b>EMLKS3</b>	393-394	Locker - Single Wide, 3 Door
<b>EMLKS4</b>	394	Locker - Single Wide, 4 Door
<b>EMLKSHFD</b>	399	Shelf - Adjustable, Double Wide Locker
<b>EMLKSHFS</b>	399	Shelf - Adjustable, Single Wide Locker
<b>EMUWPOWER</b>	370	Single Unit Power Module
<b>EMWRDTBL</b>	368	Working-Height Round
<b>EMWRSQTBL</b>	369	Working-Height Square
<b>FLXXBACKCOVER</b>	454	FL-X Chair, Fabric Back Cover
<b>FLXXCHAIR</b>	453	FL-X Chair
<b>FLXXSEATCOVER</b>	454	FL-X Chair, Fabric Seat Cover
<b>ILNEBASE</b>	46	ILINE Base Kit
<b>ILNEBEAM</b>	46	ILINE Beam
<b>ILNECHIPWR</b>	50	ILINE Chicago Power Box
<b>ILNEPOST</b>	46	ILINE Post Kit
<b>ILNEPOWERPOLE</b>	48	ILINE Power Pole
<b>ILNEWIRETRAY</b>	182	ILINE Wire Tray
<b>JAKU001</b>	422	JAKU Pre-Configured Chair
<b>JAKU002</b>	422	JAKU Pre-Configured Chair
<b>JAKU003</b>	423	JAKU Pre-Configured Chair
<b>JAKU004</b>	423	JAKU Pre-Configured Chair
<b>JAKU005</b>	424	JAKU Pre-Configured Chair
<b>JAKU006</b>	424	JAKU Pre-Configured Chair
<b>JAKU007</b>	425	JAKU Pre-Configured Chair
<b>JAKU008</b>	425	JAKU Pre-Configured Chair
<b>JAKUCHAIR</b>	421	JAKU Task Chair
<b>JAKUSEATCOVER</b>	426	AMQ JAKU Seat Cover
<b>JBCNT54</b>	118	AMOBI JumperBox Pwr Conn Kit
<b>JBCNT60</b>	119	AMOBI JumperBox Pwr Conn Kit
<b>JBIF120</b>	118	AMOBI 120" JumperBox Corded Infeed
<b>JBIF72</b>	118	AMOBI 72" JumperBox Corded Infeed
<b>JBWC</b>	118	AMOBI JmprBox Wall Conv and Mnt Plt
<b>KINXBASE</b>	32	KINEX Base
<b>KINXBEAM</b>	34	Kinex- Beam
<b>KINXBENCH</b>	31	KINEX Bench
<b>KINXCHIPWR</b>	50	KINEX Chicago Power Box
<b>KINXCROSSBEAM</b>	34	Kinex- Cross Beam
<b>KINXDBLJUNCTIONBLK</b>	49	KINEX Double sided Jnctn Block
<b>KINXENDPANEL</b>	33	KINEX End Panel
<b>KINXFEET</b>	34	KINEX Feet
<b>KINXPOWERPOLE</b>	48	KINEX Power Pole
<b>KINXSGLJUNCTIONBLK</b>	49	KINEX Single sided Jnctn Block
<b>KINXWORKSURFACE</b>	33	KINEX Worksurface
<b>MONITORARM</b>	182	Single Monitor Arm
<b>PPCHAIR</b>	443	PERSONALITY PLUS Chair
<b>PPHEADREST</b>	445	PERSONALITY PLUS Headrest
<b>PPSTOOL</b>	444	PERSONALITY PLUS Stool
<b>PWRCRECEPTACLE</b>	51	Power C Receptacle for KINEX
<b>PWRENTY</b>	48	Power Entry
<b>PWRGRECEPTACLE</b>	51	ILINE Power G-Receptacle
<b>PWRJUMPER</b>	52	Power Adj Jumper Adapter
<b>PWRJUNCTIONBLK</b>	50	ILINE Double Sided Jnctn Block
<b>REVI-BH</b>	154	REVI Bag Hook



Style Number	Page	Description	Style Number	Page	Description
<b>REVI-FP</b>	154	REVI File Pocket	<b>X-3F-SUSPENSION</b>	143	3F Hanging Pnl Ceil Susp
<b>REVI-PNCLTRY</b>	153	REVI Pencil Tray	<b>X-3F-TAPE</b>	146	3F Wall Tile, Tape 1" x 36 yds
<b>REVICUSHION</b>	153	REVI Cushion	<b>X-E-PB4</b>	181	Eco Power Box 2 outlet
<b>REVILAPTOPSHELF</b>	154	REVI Laptop Shelf	<b>X-E3-BF-CD72</b>	49	3-Cir Corded Pwr Entry Base
<b>REVIPEDESTAL</b>	152	REVI Pedestal	<b>X-E3-YC</b>	52	3-Circuit Y Connector
<b>REVISHELF</b>	153	REVI Undermount Shelf	<b>X-E4-BF-CD72</b>	49	4-Cir Corded Pwr Entry Base
<b>REVIUNDERMOUNT</b>	152	REVI Undermount	<b>X-FCMT</b>	181	ACTIV Soft Cable Mangement
<b>SIYA001</b>	430	SIYA Pre-Configured Chair	<b>ZILO001</b>	436	ZILO Pre-Configured Chair
<b>SIYA002</b>	430	SIYA Pre-Configured Chair	<b>ZILO002</b>	436	ZILO Pre-Configured Chair
<b>SIYA003</b>	431	SIYA Pre-Configured Chair	<b>ZILO003</b>	437	ZILO Pre-Configured Chair
<b>SIYA004</b>	431	SIYA Pre-Configured Chair	<b>ZILO004</b>	437	ZILO Pre-Configured Chair
<b>SIYACHAIR</b>	429	SIYA Task Chair	<b>ZILO005</b>	438	ZILO Pre-Configured Chair
<b>SIYASEATCOVER</b>	432	SIYA Seat Cover	<b>ZILO006</b>	438	ZILO Pre-Configured Chair
<b>SSRSCUSHION</b>	158	S-SERIES Cushion	<b>ZILO007</b>	439	ZILO Pre-Configured Chair
<b>SSRSPEDESTAL</b>	157	S-SERIES Storage Pedestal	<b>ZILO008</b>	439	ZILO Pre-Configured Chair
<b>SSRSSTORAGE</b>	157	S-SERIES Storage, 1.5 H	<b>ZILOCHAIR</b>	435	ZILO Task Chair
<b>SWALLBH</b>	191	Binder Holder	<b>ZILOSEATCOVER</b>	440	ZILO Seat Cover
<b>SWALLCUP</b>	192	Pen/Pencil Cup			
<b>SWALLDISH</b>	192	Double Square Dish			
<b>SWALLFS</b>	187	Freestanding Slatwall Stanchions			
<b>SWALLHB</b>	192	Hanging Brackets			
<b>SWALLHOOK</b>	194	Coat Hook			
<b>SWALLOF</b>	193	Office in a File			
<b>SWALLPF</b>	191	PaperFlo Manager			
<b>SWALLPM</b>	189	Panel-Mount Brackets			
<b>SWALLPM42</b>	189	Panel-Mount Brac for 42H Tektis Panel			
<b>SWALLPS</b>	193	Personal Shelf			
<b>SWALLTACK</b>	194	Tackstrip			
<b>SWALLTC</b>	193	Telephone Caddy			
<b>SWALLTILE</b>	188	Slatwall Tiles			
<b>SWALLTRAY</b>	190	Trays			
<b>SWALLUS</b>	191	Universal Shelves, Single Pack			
<b>SWALLUS3</b>	191	Universal Shelves, Three Pack			
<b>SWALLWB</b>	194	Wastebasket			
<b>SWALLWM</b>	189	Wall-Mount Brackets			
<b>THD1DR</b>	116	AMOB I Thread Pwr Conn One Door			
<b>THD2DR</b>	117	AMOB I Thread Pwr Conn Two Door			
<b>THDADPTR</b>	117	AMOB I Low Profile Plug Adapter			
<b>THDBLK</b>	116	AMOB I Thread Power Conn Blank			
<b>THDIF120</b>	114	AMOB I 120" Thread Power Track			
<b>THDIF72</b>	114	AMOB I 72" Thread Power Track			
<b>THDIF96</b>	114	AMOB I 96" Thread Power Track			
<b>THDNEMA</b>	117	AMOB I Thread Power Conn NEMA			
<b>THDPT120</b>	116	AMOB I 120" Thread Power Track			
<b>THDPT60</b>	115	AMOB I 60" Thread Power Track			
<b>THDPT72</b>	115	AMOB I 72" Thread Power Track			
<b>THDPT84</b>	115	AMOB I 84" Thread Power Track			
<b>THDPT96</b>	115	AMOB I 96" Thread Power Track			
<b>TIZU-GLD</b>	460	AMQ TIZU Glides, Set of 4			
<b>TIZUNEST</b>	459	TIZU Nesting Chair Multipurpose			
<b>TIZUSEATCOVER</b>	460	TIZU Seat Cover			
<b>TIZUWORK</b>	458	TIZU Task Chair			
<b>UBLIGHT17</b>	195	17" Stand Alone Light			
<b>UBLIGHT31</b>	195	31" Stand Alone or Daisy Chain Str Lt			
<b>UBLIGHT44</b>	195	44" Stand Alone or Daisy Chain Str Lt			