



Steelcase | moooi

Moooi Container Table

Square Top Tables

- Bar Height: 70x70cm
- Dining: 70x70cm or 90x90cm
- No power

Round Top Tables

- Bar Height: 70x70cm
- Dining Height: 70cm, 90cm, 120cm, 140cm, 160cm, 180cm
- Power on 120cm tables and larger

Oval Top Tables

- Dining Height Only: 210cm, 260cm
- Power available on both sizes

Bodhi base cover available on **all** configurations

New antiques base available on **select** configurations

NO off-catalogs are allowed for the Container Table. We have all compliant versions available in our offering.



Moooi Container Table | Power

CONTAINER CLASSIC

Square Table

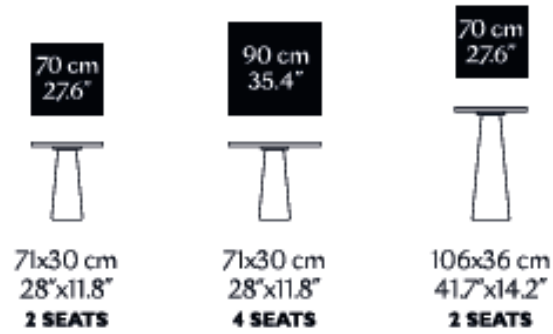

Round Table

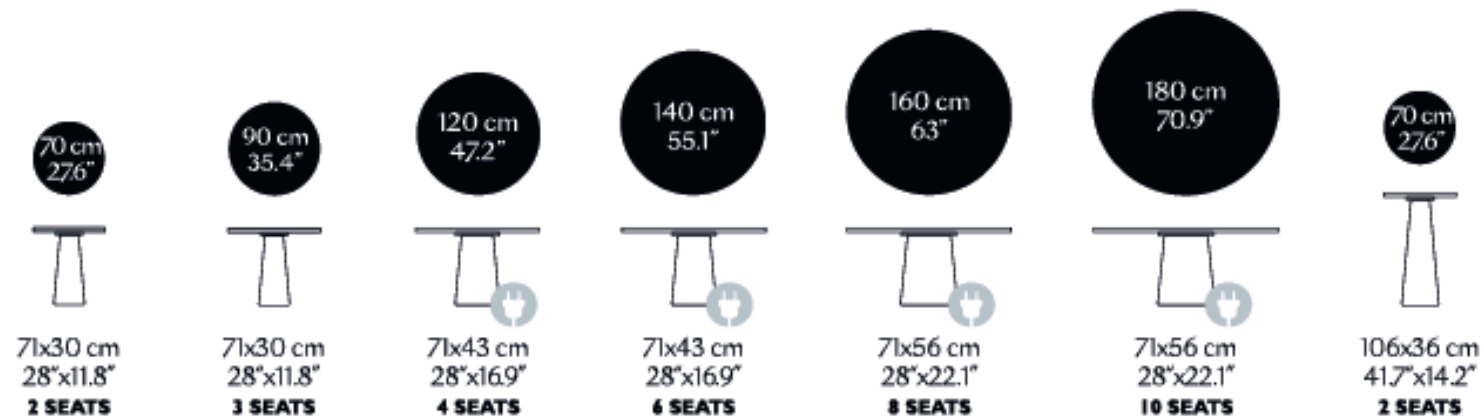

Oval Table

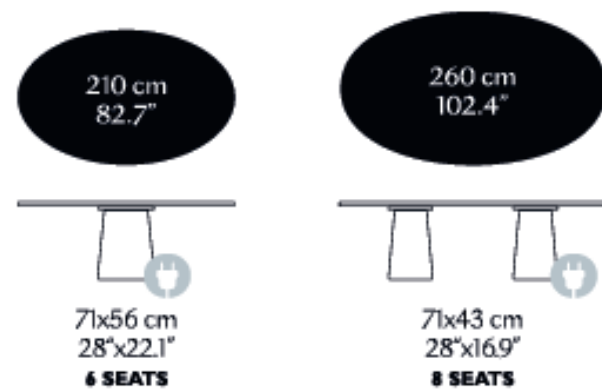

CONTAINER BODHI

Square Table

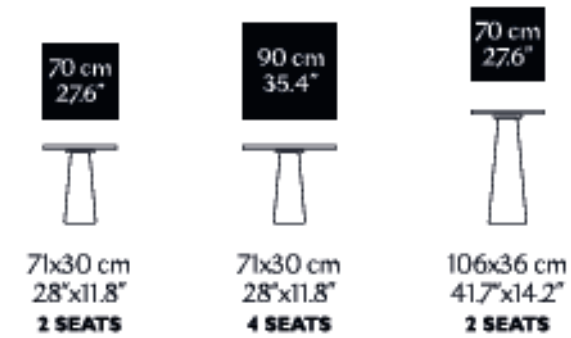

Round Table

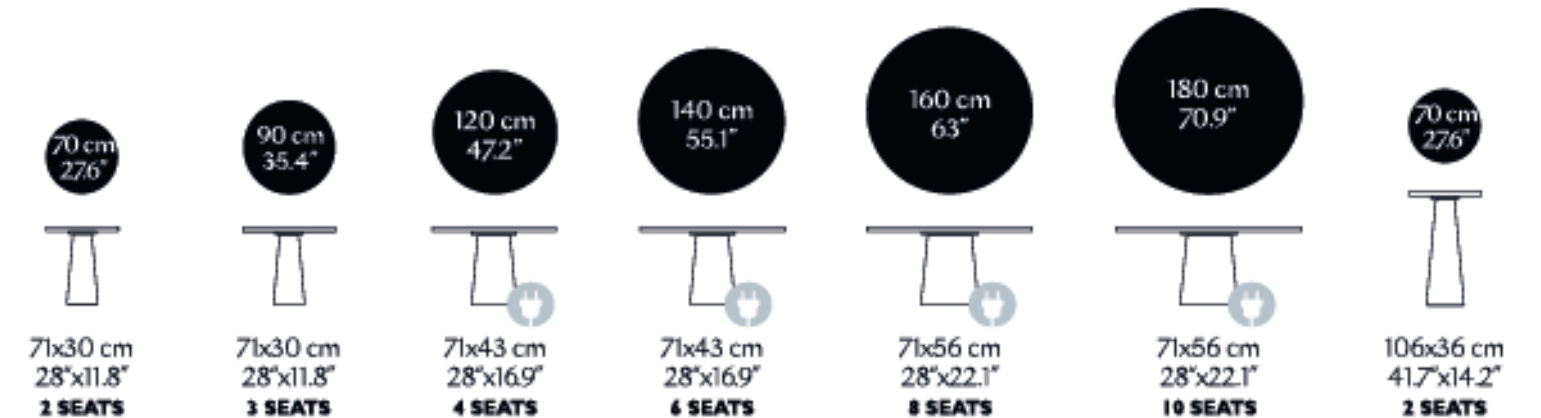

Oval Table

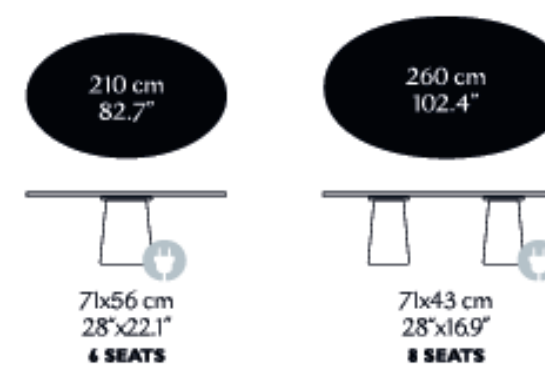

Moooi Container Table | Power

Is the hole always in the middle?

The hole is always in the middle of the Container foot! For instance, the oval 260cm top has 2 Container feet, so then it is not in the middle of the tabletop, it is in the middle of the foot. For the oval table we will have 3 options: no hole, with 1 hole, or with 2 holes, we will make new skus for the 1 and 2 holes.

Bodhi possible when the Power & USB Module is installed?

Bodhi is possible, because it has room on top, creating space at the bottom is therefore possible. So, a Power & USB Module can be installed when also using a Bodhi. The power cord can be feed under the Bodhi.

Do we want / will there be, a possibility to have a hole but not a power module?

Yes, it is possible. But we need to mark them with the hole size in cm, because of course this is a special order.

Moooi Container Table | Power

The module, embedded in the tabletop, contains three socket apertures. Including 2 power sockets and 1 USB A+C sockets.

For aesthetic purposes, the module can be opened and closed by flipping it around.

Every module power cord is hard-wired with an industry standard 800mm wieland GST18 male connector.

Power cord is purchased separately through electrician/3rd party vendor

SOCKET TYPES

· Type F Schuko power socket
+ USB A & C - White

· Type F Schuko power socket
+ USB A & C - Black

· Type B USA power socket
+ USB-A & C - White

· Type B USA power socket
+ USB-A & C - Black

· Type G UK power socket
+ USB-A & C - White

· Type G UK power socket
+ USB-A & C - Black

CONTAINER TABLE FOOT COMPATIBILITY

· 71x43 cm / 28"x16.9"
· 71x56 cm / 28"x22.1"

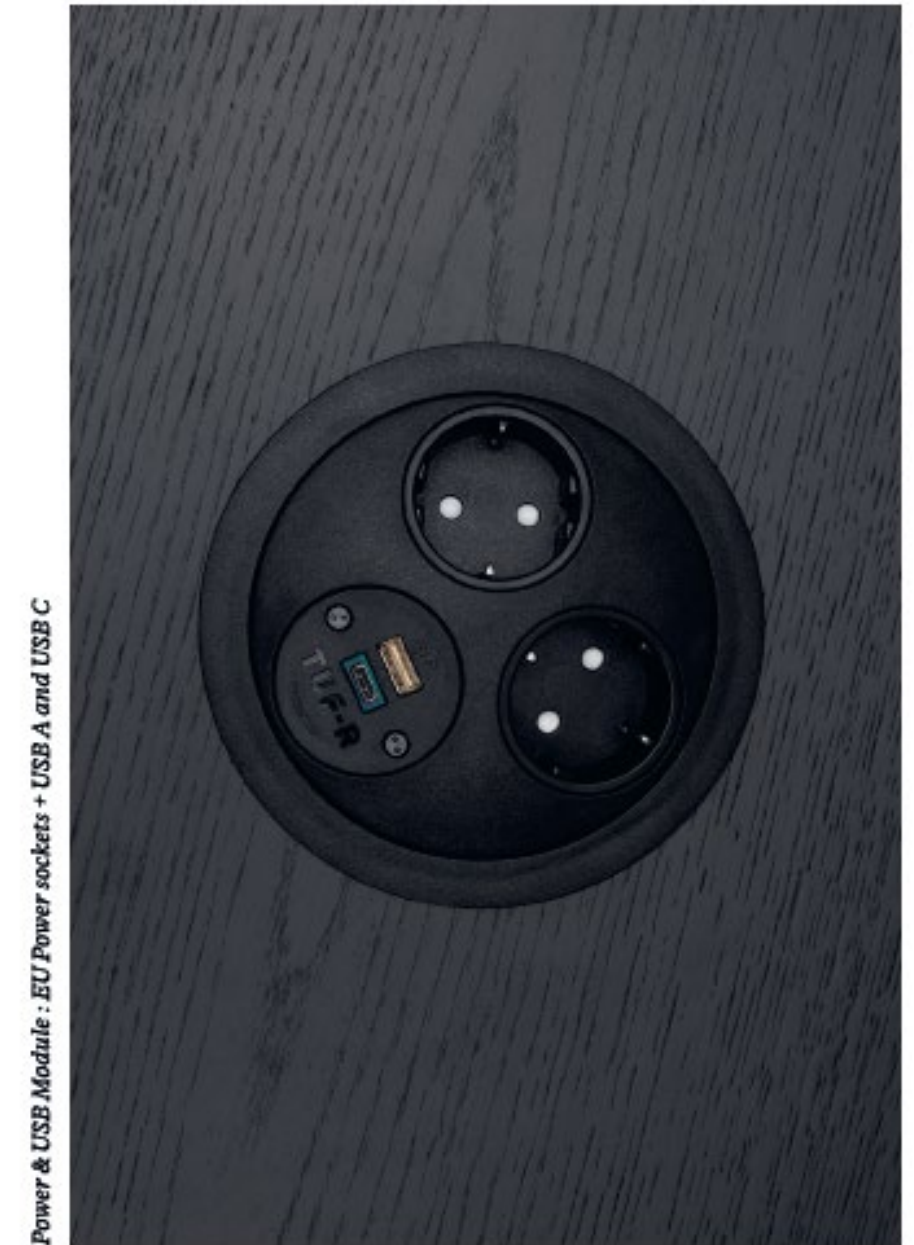

Moooi Container Table | Power

INSTALLATION

Each container tabletop can be ordered with a 128mm hole. The module can be placed in this hole and, thanks to the screwable connection, it can be clamped. So a very simple installation.

1.



2.



3.

