

---

# Migration SE Height-Adjustable Benching

---

<b>Statement of Line</b>	<b>428</b>
--------------------------	------------

## Understanding

Migration SE Height-Adjustable Rectangle Benches and Bases	<b>432</b>
Universal Centered Screens	<b>435</b>
Sarto Centered Screens	<b>436</b>
Boundary Screens	<b>438</b>
FrameOne End Panels	<b>442</b>

## Specifying

Migration SE Height-Adjustable Rectangle Single-Sided Benches	<b>444</b>
Migration SE Height-Adjustable Rectangle Dual-Sided Benches	<b>446</b>
Migration SE Height-Adjustable Rectangle Single-Sided Bases	<b>448</b>
Migration SE Height-Adjustable Rectangle Dual-Sided Bases	<b>449</b>
Accessories	<b>450</b>
Universal Centered Screens and Aligners	<b>452</b>
Sarto Centered Screens	<b>454</b>
Spanning Boundary Screens	<b>456</b>
Single-Sided Boundary Screens	<b>458</b>
FrameOne End Panels	<b>460</b>
FrameOne Dual-Sided End Panels with Utility Pole	<b>462</b>

# Statement of Line

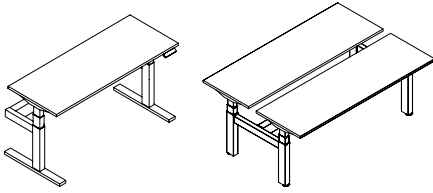

Understanding  
 ▶ Page 432  
 Specifying  
 ▶ Pages 444 and 446

## Migration SE Height-Adjustable Rectangle Benches

	46"W	52"W	58"W	64"W	70"W
23"D	●	●	●	●	●
28"D	●	●	●	●	●

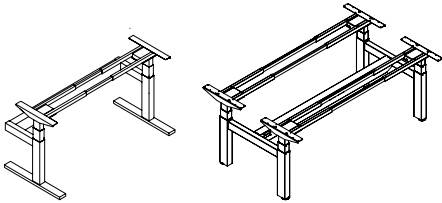

Understanding  
 ▶ Page 432  
 Specifying  
 ▶ Pages 448 and 449

## Migration SE Height-Adjustable Rectangle Bases

	46"W	52"W	58"W	64"W	70"W
23"D	●	●	●	●	●
28"D	●	●	●	●	●

### Accessories for Use with Migration SE Benches

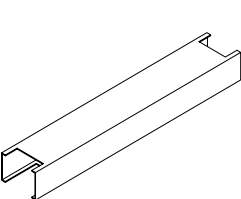

**Connection Kit**  
 Understanding  
 ▶ Pages 432  
 Specifying  
 ▶ Page 450

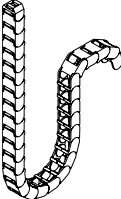

**Cable Riser**  
 Understanding  
 ▶ Page 432  
 Specifying  
 ▶ Page 450

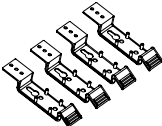

**Cable Brackets**  
 Understanding  
 ▶ Page 432  
 Specifying  
 ▶ Page 451

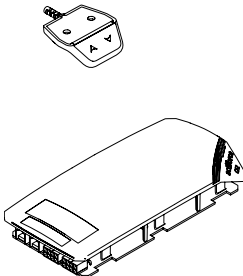

**Desk and Bench Switch Kit**  
 Specifying  
 ▶ Page 451

### Screens for Use with Migration SE Benches

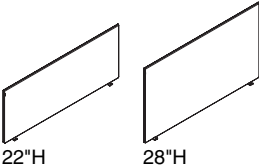

Understanding  
 ▶ Page 435  
 Specifying  
 ▶ Page 452

### Universal Centered Screens for Use with Migration SE Benches

	48"W	54"W	60"W	66"W	72"W
22"H	●	●	●	●	●
28"H	●	●	●	●	●

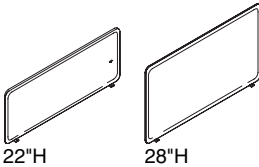

Understanding  
 ▶ Page 436  
 Specifying  
 ▶ Page 454

### Sarto Centered Screens for Use with Migration SE Benches

	48"W	54"W	60"W	66"W	72"W
22"H	●	●	●	●	●
28"H	●	●	●	●	●

**Screens for Use with Migration SE Benches, continued**

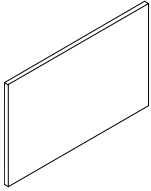

Understanding  
 ▶ Page 438  
 Specifying  
 ▶ Page 456

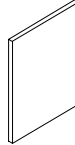

Understanding  
 ▶ Page 438  
 Specifying  
 ▶ Page 458

**Spanning Boundary Screens For Use with Migration SE Dual-Sided Benches**

	50"D	60"D
28½"H	●	●
42"H	●	●
48"H	●	●

*Tip: Overhang widths are available parametric to 1/16" up to 18"W.*

**Single-Sided Boundary Screens For Use with Migration SE Single-Sided Benches**

	23"D	28"D
28½"H	●	●
42"H	●	●
48"H	●	●

*Tip: Overhang widths are available parametric to 1/16" up to 18"W.*

**FrameOne End Panels for Use with Migration SE Benches**

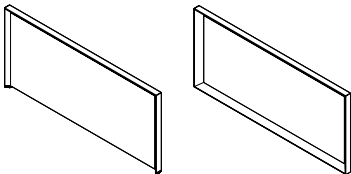

Understanding  
 ▶ Page 442  
 Specifying  
 ▶ Page 460

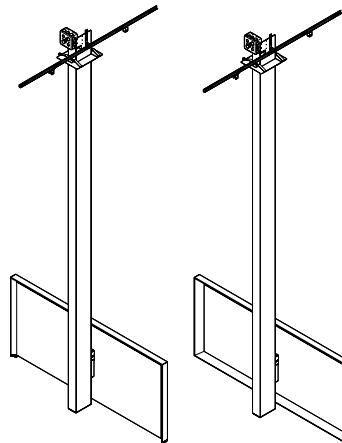

Understanding  
 ▶ Page 442  
 Specifying  
 ▶ Page 462

**FrameOne End Panels for Use with Migration SE Benches**

**FrameOne End Panels with Utility Pole For Use with Migration SE Benches**



# Migration SE Height-Adjustable Rectangle Benches and Bases

**Migration SE** supports wellbeing at work by allowing users to move between seated and standing postures throughout the workday.  
▶ Specifying, page 446

**Desk** has a wood core with a High-Pressure Laminate or wood veneer surface and is 1" thick.

**Leveling glides** adjust 1" to install desk on uneven floors.

**Cable riser** is available as an option on all benches and is used to route cords or cables from the cable tray to the worksurface.

**Leveling glides** adjust ½" to install desk on uneven floors.

**Sarto or Universal screens** are available for use with Migration SE bench and are ordered separately.  
▶ See page 452 for Universal screens and page 454 for Sarto screens.

**Push button controller** adjusts height at a rate of 1¾" per second. Two options are available—up/down or 4 pre-set.

**Base** supports a maximum distributed weight capacity of 250 pounds.  
*Tip: When calculating lifting capacity, subtract the weight of the worksurface.*  
▶ See page 434 for worksurface weights.

**Connection kit** is required to connect dual-sided units to each another. Kit includes data tray extensions.

**Edge** is available in 3 mm edge profile.

**The extended height adjustable base** adjusts from 22¾"–48⅞" in any increment.

**Internal motors with electronic synchronization drive.**

**Corners** are available in both square or radius options. The radius corner option offers both a 2" and 5" radius.

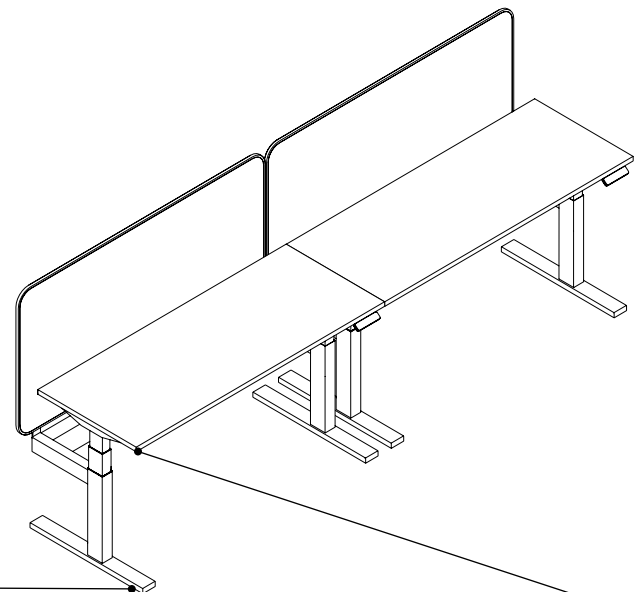
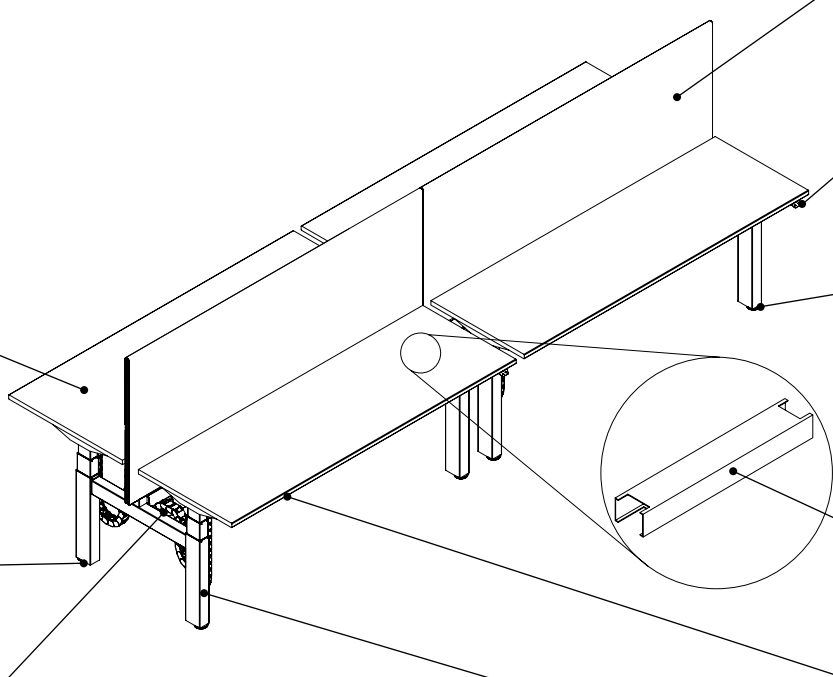

## Product Details

### High-Pressure Laminate Desks

**Front (user's) edge profile** is available in 3 mm edge profile.

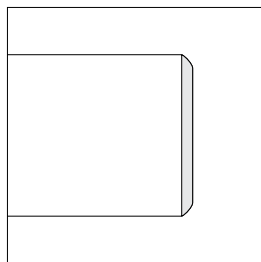

**PVC-free, 3 mm edge profiles** are proprietary polyolefin blend for all solid colors and three woodgrain finishes. Matching 1 mm side and back edges are also PVC-free.

► See *Surface Materials* in this book for specific PVC-free availability, page 551.

**Edge profile finishes** are specified separately from laminate color.

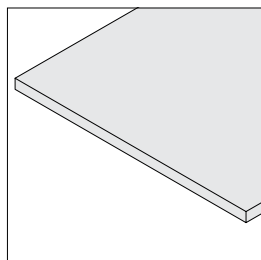

**Square corners** are standard and have 90° corners on all four sides.

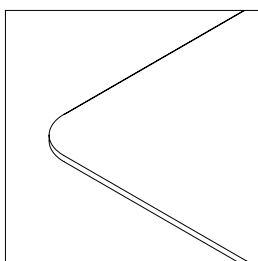
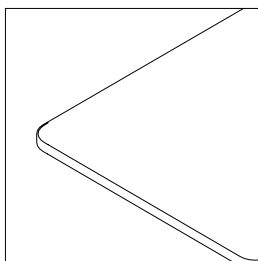

**Radius corners** are available as an option with 2" radius or 5" radius on all four corners and will include 3 mm edge profile on all sides.

### Wood Veneer Desks

**Front (user's) edge profile** is wood veneer with a square (3 mm) radius.

**Side and back edges** are flat. Wood edge color matches finish specified for desk.

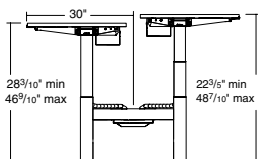

**Migration SE extended height-adjustable bench** adjusts from 22<sup>3</sup>/<sub>5</sub>"–48<sup>7</sup>/<sub>10</sub>" in any increment.

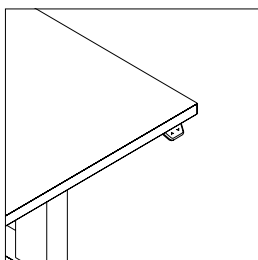

**Up/down controller** is available as an option and easily adjusts height of desk, at a rate of 1<sup>3</sup>/<sub>10</sub>" per second, by simply pushing the up and down arrows.

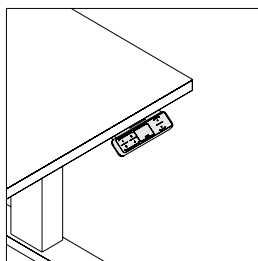

**4 pre-set programmable controller** is available as an option. It allows users to set the seated and standing height positions or pre-set heights for multiple users. When activated, the digital display will show the height of desk.

**Obstruction sensing technology** is standard with all Migration SE benches. The worksurface will backtrack when it makes contact with an object.

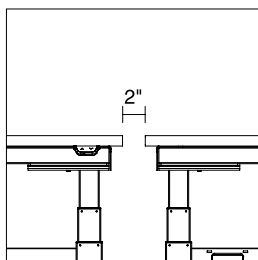

**Bench sizes** are listed in actual dimensions to allow for 2" gap to adjacent worksurface eliminating any pinch points.

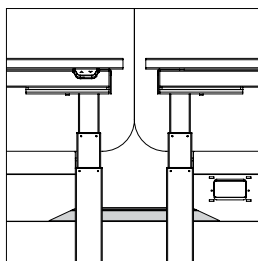

**Connection kit** is required to connect two benches together. The connection kit conceals conduit or wires between benches.

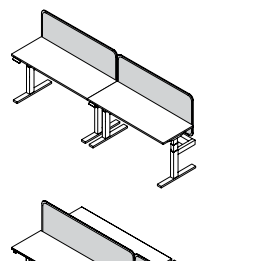

**Centered screens** are attached and centered on the power beam. Screens are always full width. Sarto or Universal screens are available for use with Migration SE bench. Aligner clips are available as a separate style number for use with Universal screens.

## Wiring and Cabling

**Electric motor with whisper quiet operation** adjusts at 1<sup>3</sup>/<sub>10</sub>" per second. Motor is 24V DC and includes a 9' power cord. Motor also has 0.3W standby power.

### Migration SE benches

are listed by ETL. *Tip: Migration SE base only is ETL recognized because alternative worksurfaces do not create an ETL listed product.* ► See page 328

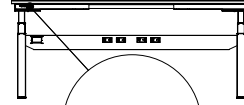
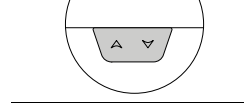
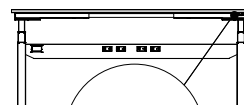

**Controller** can be mounted on either the left- or right-hand side of the top and is field-installed.

**Power and data strips** are field-installed on either a SOTO rail or worksurface. Specify appropriate attachment bracket depending on application.

► See page 451 for *Cable and Power Management*.

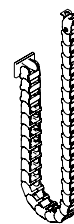

**Cable riser** supports cable management vertically between the power beam cable and the underside of the bench. It is available in 6527 Merle. Cable riser is available as an option. Fence connection option must be selected for use with Migration SE bench.

**Cable riser fence connections inside dimensions** are 1"D x 1"W to accommodate a variety of cord sizes. Overall depth is 2".

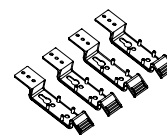

**Cable brackets**, ordered separately, support horizontal cable management below the worksurface.

► Specifying, page 451



**Inside dimensions of cable brackets** are 3<sup>5</sup>/<sub>8</sub>"D x 1<sup>3</sup>/<sub>8</sub>"W x 1<sup>3</sup>/<sub>16</sub>"H.

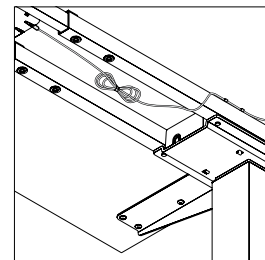

**Cable management** includes two cable clips and two ties to help manage desk cables.

**Surface Materials**

**High-Pressure Laminate Desk**

- Laminate
- ▶ See *Surface Materials Reference Manual*.
- Open Line laminate (option)
- A program including non-Steelcase laminates which are suitable for use on Steelcase products.
- ▶ See *Surface Materials Reference Manual*.

**3 mm edge profile**

- Plastic

**Wood Veneer Desk**

- Wood veneer (standard)
- Customiz stain (option)
- Full-fill finish (option)

**Square 3 mm edge profile**

- Wood veneer to match desk

**Height-adjustable base**

- 4799 Platinum Metallic
- 7207 Black
- 7241 Arctic White
- 7360 Merle

**Integrated storage** cannot be used on Migration SE desk with 5" radius corners.

**Application Topics**

**Moving benches** can collide with other components. Do not install overhead storage, desk-height power, or desk accessories in the path of height-adjustable desks.

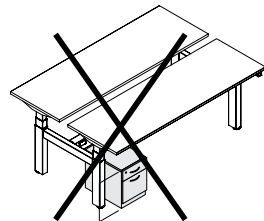

21"H pedestal

**On extended height benches**, any storage higher than 20" will impede height range of desk.

**All assemblies** meet or exceed ANSI/BIFMA standards.

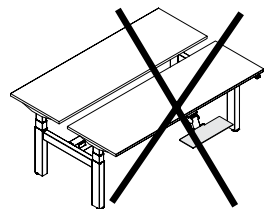

**Keyboard assemblies** are not recommended for use on height-adjustable benches.

**WARNING**

Read base only warranty limitations.  
▶ See page 328 for *Workstation Design Guidelines and Requirements*.

**Installation**

**Benches** ship with pre-drilled holes for mounting bases.

**Height-adjustable base** requires attachment to the worksurface.

**Desk Weight**

	W	D	Overall Depth (Dual-sided)	Worksurface Weight
	Single-Sided Bench		Dual-Sided Benches	
Rectangle— 23"D	46"	23"	50"	30 lb
	52"	23"	50"	34 lb
	58"	23"	50"	38 lb
	64"	23"	50"	42 lb
	70"	23"	50"	46 lb
Rectangle— 28"D	46"	28"	60"	38 lb
	52"	28"	60"	43 lb
	58"	28"	60"	48 lb
	64"	28"	60"	53 lb
	70"	28"	60"	58 lb

**Base** supports a maximum distributed weight capacity of 250 pounds, per worksurface.  
*Tip: When calculating lifting capacity, subtract the weight of the worksurface.*



# Universal Centered Screens

For Use with Migration SE Benches

**Universal centered screen** provide a boundary element along the bench. They are available in two heights to accommodate varying levels of privacy. ▶ Specifying page 452

**Universal screen** is pin tackable.

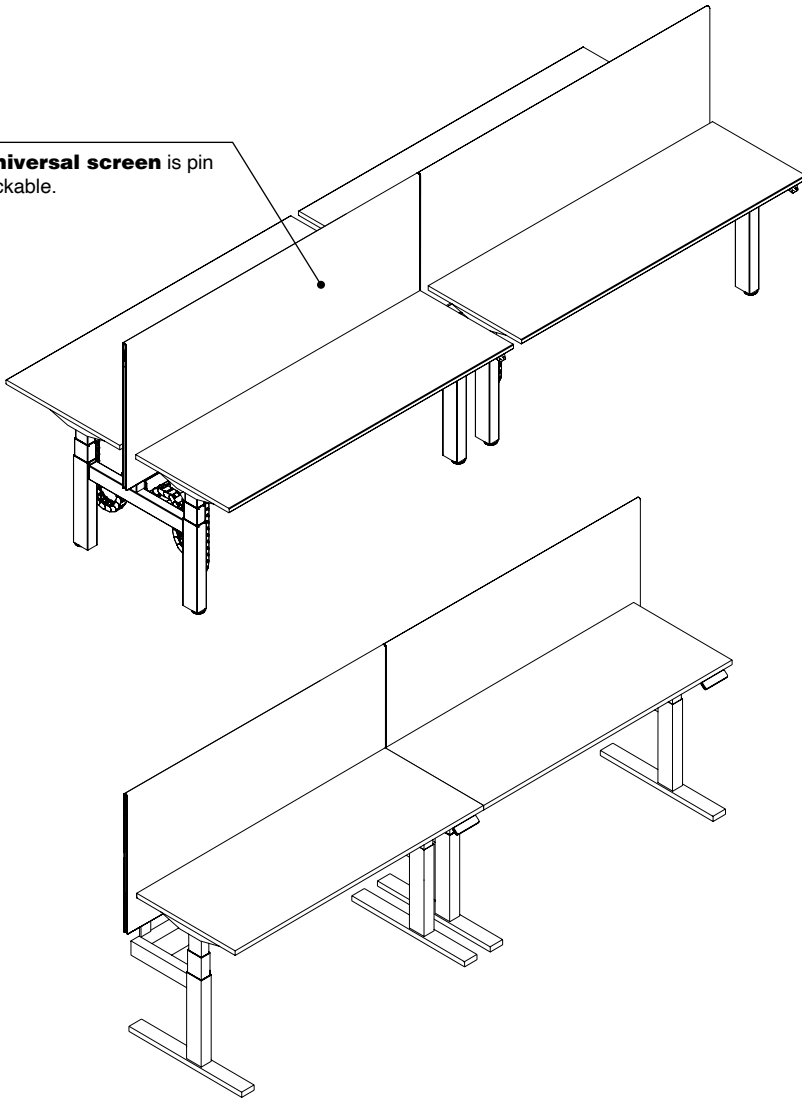

## Actual Dimensions

<b>Width</b>	48", 54", 60", 66", and 72"
<b>Height</b>	22" and 28"
<b>Thickness</b>	3/4"

## Product Details

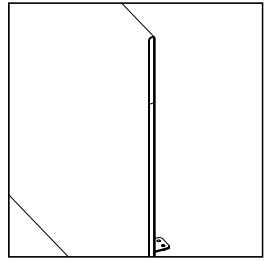

**The edge of the screen** is comprised of two different materials. The upper segment is merle plastic. The lower portion is PET which can be specified in medium heather grey to provide contrast or dark heather grey for a uniform visual.

**The width of the screen** must match the width of the bench.

**Universal screens** are tackable and available in 22"H and 28"H. Screens range in size from 48"W-72"W.

**Universal screens** are mounted on the cross tube. The 22"H screen has an overall height of 42"H from the floor. The 28"H screen has an overall height of 48"H from the floor.

**Universal screens** will be mounted flush with no gap.

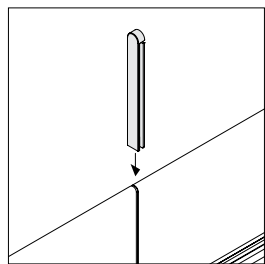

**When fabric screens are placed directly adjacent to each other,** a small aligner can be placed in between the screens at the top to connect them for planar alignment. Aligners are ordered separately in packages of 10.

## Surface Materials

**Screen**  
 • Fabric  
 ▶ See *Surface Materials*, page 551.

**Edge (upper segment)**  
 • 7360 Merle

**Edge (lower segment)**  
 • P630 Medium Heather Grey PET  
 • P631 Dark Heather Grey PET

**Brackets**  
 • 7360 Merle

# Sarto Centered Screens

For Use with Migration SE Benches

## Sarto centered screens

provide a light scale boundary element along the bench. They are available in two heights to accommodate varying levels of privacy.

► Specifying, page 414

Sarto screen is pin tackable.

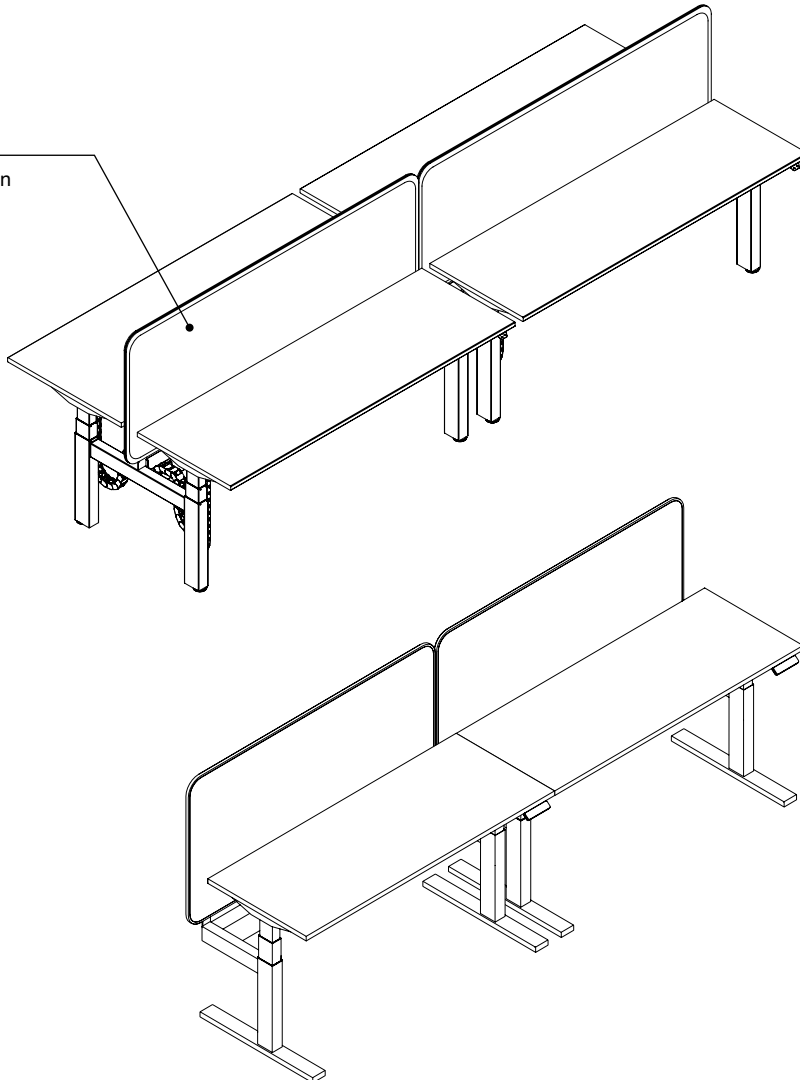

## Actual Dimensions

**Width** 48", 54", 60", 66", and 72"

**Height** 22" and 28"

**Thickness** 9/16"

## Product Details

**The width of the screen** must match the width of the bench.

**Sarto screens** are tackable and available in 22"H and 28"H. Screens range in size from 48"W–72"W.

**Sarto screens** are mounted on the cross tube. The 22"H screen has an overall height of 42"H from the floor. The 28"H screen has an overall height of 48"H from the floor.

**Brackets and hard stops** are included with screens. Two brackets are used on screens 54"W and smaller. Three brackets are used on screens 60"W and larger.

**Sarto screens** will be mounted flush with no gap.

## Surface Materials

### Screen

- Fabric
- See *Surface Materials*, page 551.

### Brackets and hard stops

- 7360 Merle



# Boundary Screens

For Use with Migration SE Benches

**Boundary screens** provide light scale space division and privacy for a variety of work settings.

**Boundary screens** attach to the end of a single- or dual-sided bench to provide aisle way boundary/privacy.   
▶ Specifying, pages 456–458

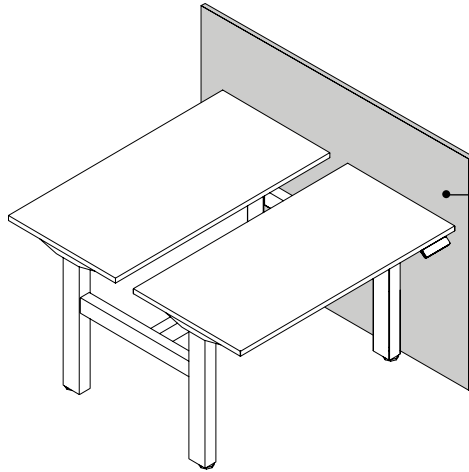

**Boundary screens** are  $1\frac{3}{16}$ " thick. Screens are available in laminate or wood veneer.

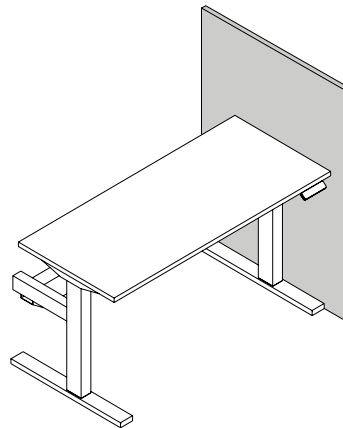

**Boundary screens** come standard with adjustable glides, with a range of  $1\frac{1}{2}$ ". The glides are located  $1\frac{1}{2}$ " from the outside of each edge.

## Product Details

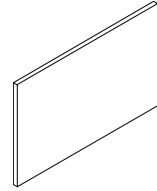

**Boundary screens** attach to single- or dual-sided benches and are available in three heights:  $28\frac{1}{2}$ ", 42", and 48"H.

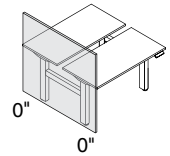

0"  
0"

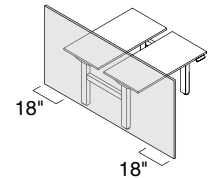

18"  
18"

Modular

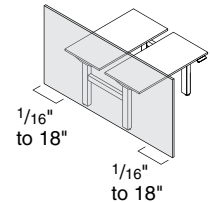

$\frac{1}{16}$ "  
to 18"  
 $\frac{1}{16}$ "  
to 18"

Parametric

**Dual-sided boundary screen width** matches the bench depth. Overhang option is available and can be specified with a modular overhang of 12" or 18" or parametric overhang up to 18" in  $\frac{1}{16}$ " increments.

## Actual Dimensions

<b>Height</b>	28 $\frac{1}{2}$ ", 42", or 48"
<b>Spanning Screen Width for Dual-Sided Bench without 18" Overhang</b>	50 $\frac{31}{32}$ " or 60 $\frac{31}{32}$ "
<b>Spanning Screen Width for Dual-Sided Bench with 18" Overhang</b>	86 $\frac{31}{32}$ " or 96 $\frac{31}{32}$ "
<b>Single-Sided Screen Width for Single-Sided Bench without 18" Overhang</b>	26 $\frac{7}{8}$ " or 31 $\frac{7}{8}$ "
<b>Single-Sided Screen Width for Single-Sided Bench with 18" Overhang</b>	44 $\frac{7}{8}$ " or 49 $\frac{7}{8}$ "
<b>Thickness</b>	$1\frac{3}{16}$ "

*Tip: Boundary screen overhang widths are available parametric in  $\frac{1}{16}$ " increments. See Statement of Line pages for available ranges.*

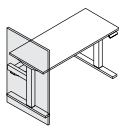

0"

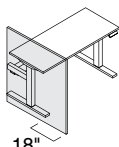

18"

Modular

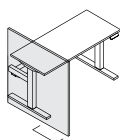
1/16"  
to 18"

Parametric

**Single-sided boundary screens** use one screen segment that spans from the back of the power beam to the front of the worksurface. Overhang option is available and can be specified with a modular overhang of 18", or parametric overhang up to 18" in 1/16" increments.

## Connections

**Boundary screens** come standard with attachment bracket and hardware used for mounting in predrilled locations on the screen.

## Surface Materials

### Bracket

- 4799 Platinum Metallic
- 7207 Black
- 7241 Arctic White
- 7360 Merle

### Boundary screens

- Laminate
- Wood veneer

### Edge

- Plastic

**Open Line laminate** can be applied with vertical grain direction only. Open Line laminates are not allowed on screens that are 60"W or wider. Open Line laminate is only available when specifying modular screens.

### Directional and wood grain laminate

can be applied horizontally on spanning and single-sided boundary screens up to 96"W and vertically up to 60"W. Directional and wood grain laminate can only be applied vertically on split boundary screens.

**Wood veneer grain direction** can be specified horizontal or vertical for all spanning and single-sided boundary screens.

**Application Topics**

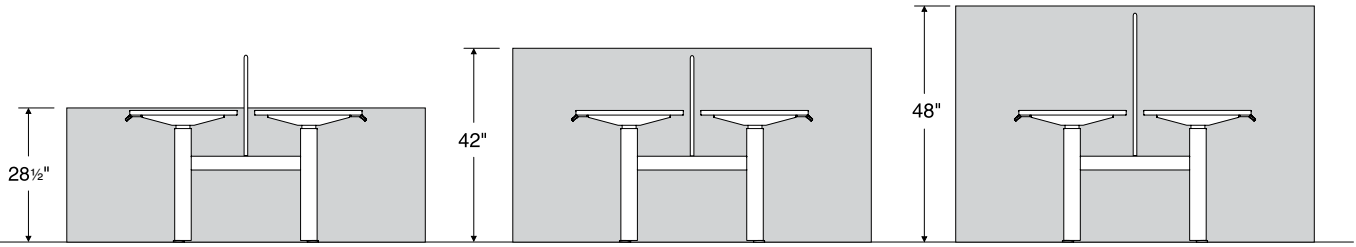

**Boundary screen** installed heights align with centered screen heights of 42"H or 48"H.

**Spanning Boundary Screens**

Dual-Sided Base

Modular

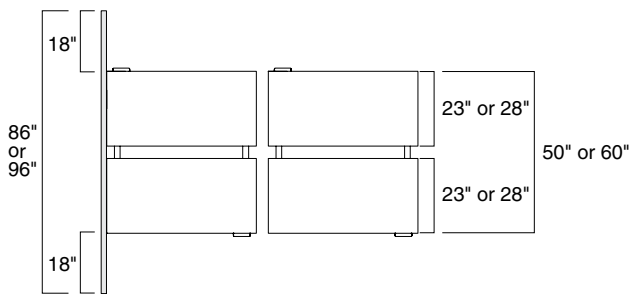

**Overall Width with 18" Overhang**

86<sup>3</sup>/<sub>16</sub>"W  
96<sup>3</sup>/<sub>16</sub>"W

**Modular Width Dual-Sided**

50"D  
60"D

**Single-Sided Boundary Screens**

Single-Sided Base

Modular

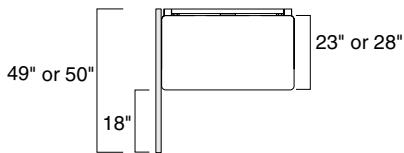

**Overall Width with 18" Overhang**

44<sup>7</sup>/<sub>8</sub>"W  
49<sup>7</sup>/<sub>8</sub>"W

**Modular Width Single-Sided**

23"D  
28"D



# FrameOne End Panels

For Use with Migration SE Bench

**FrameOne end panels or end panels with utility pole** attach to dual-sided or single-sided benches to add a refined, consistent aesthetic to the space.

► Specifying, pages 460–462

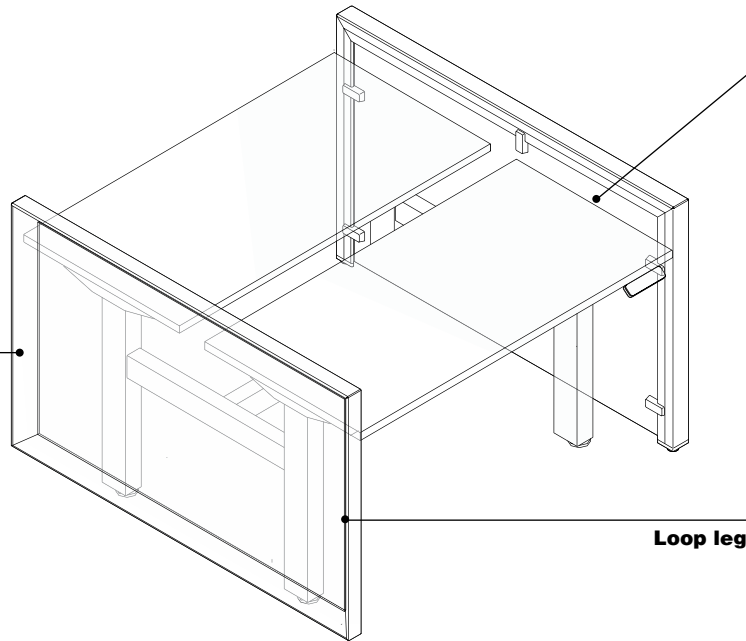

**Legs** are fixed height at 27<sup>1</sup>/<sub>4</sub>".

**1" gap between work-surface and end panel** provides pinch point clearance.

**Loop leg**

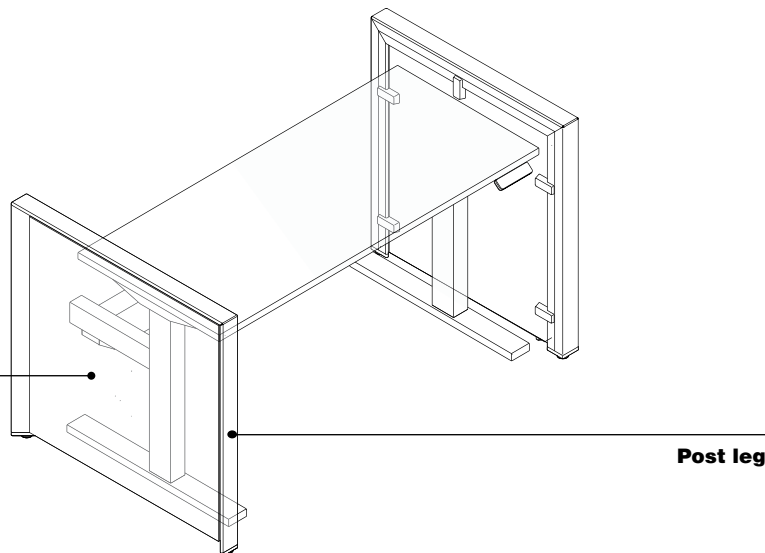

**Infills** are High-Pressure Laminate or veneer.

**Post leg**



**Product Details**

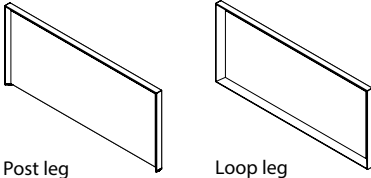

Post leg Loop leg  
**Two FrameOne end panel leg types** are available. Ordered as a single leg with infill.

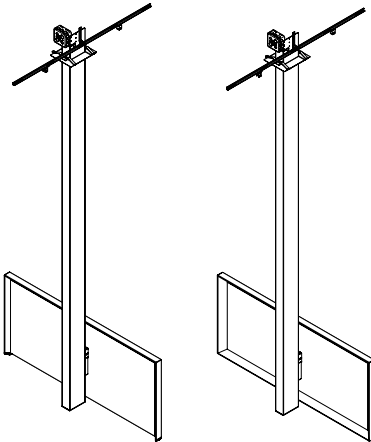

Post leg with utility pole Loop leg with utility pole

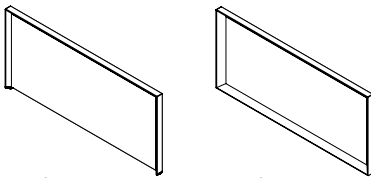

Post leg without utility pole Loop leg without utility pole

**FrameOne end panels** can be ordered with or without the utility pole.

**Connections**

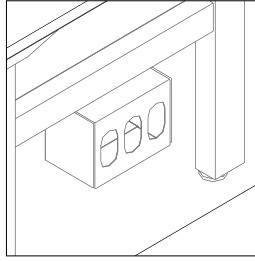

**FrameOne end panel** ships with mounting bracket that connects to the cross tube on Migration SE bench.

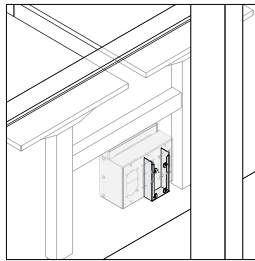

**When specifying FrameOne end panel with utility pole**, connection occurs at the infill and includes a cutout to route cables. FrameOne end panel ships with both connection bracket and utility pole.

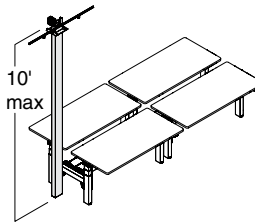

**Utility pole** reaches a maximum ceiling height of 10'. Pole is 3"D x 6"W.

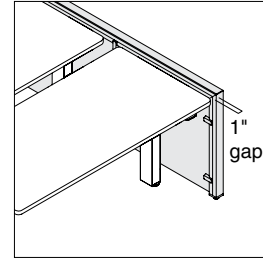

**FrameOne end panel attachment** allows for 1" gap to the adjacent bench eliminating any pinch points.

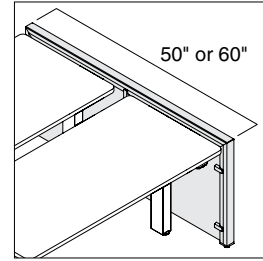

**FrameOne end panel width** aligns with overall worksurface depth of the dual-sided bench.

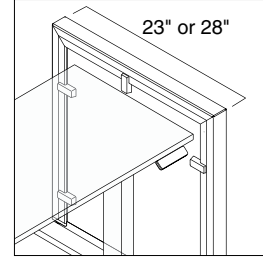

**FrameOne end panel width** aligns with the back of the cable tray on a single-sided bench. End panels are handed and must be specified for use on left or right.

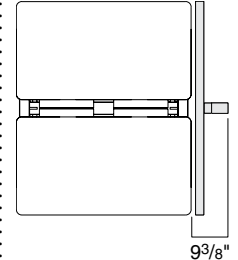

**Connection bench footprint** increases by 9<sup>3</sup>/<sub>8</sub>" for each FrameOne end panel with utility pole that is added.

**Surface Materials**

- Infill**
- High-Pressure Laminate
- Legs and brackets**
- 4799 Platinum Metallic
  - 7207 Black
  - 7241 Arctic White
  - 7360 Merle

- Utility pole**
- Anodized aluminum

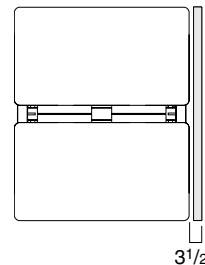

**Bench footprint** increases by 3<sup>1</sup>/<sub>4</sub>" for each FrameOne end panel without utility pole that is added.

# Migration SE Height-Adjustable Rectangle Single-Sided Benches

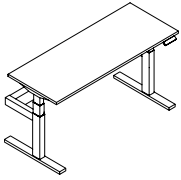

Standard Includes		Required to Specify
<ul style="list-style-type: none"> <li>▶ Need help? Product details, page 432</li> </ul>	<ul style="list-style-type: none"> <li>• Worksurface with square corners: High-Pressure Laminate price group 1 with 3 mm plastic edge</li> <li>• Electric height-adjustable sit-to-stand base: paint price group 1</li> <li>• Power cord: 9'</li> <li>• 1/2" adjustable glides</li> <li>• Attachment hardware</li> <li>• Power beam: paint to match base</li> </ul>	<ol style="list-style-type: none"> <li>1 Style number</li> <li>2 Controller (see below under Required Selections)</li> <li>3 Bench depth</li> <li>4 Bench width</li> <li>5 High-Pressure Laminate or wood color for worksurface</li> <li>6 Plastic color number for profile edge, if selected</li> <li>7 Paint color number for base:               <ul style="list-style-type: none"> <li>4799 Platinum Metallic (upcharge)</li> <li>7207 Black</li> <li>7241 Arctic White</li> <li>7360 Merle</li> </ul> </li> <li>8 Options, if selected (see below)</li> </ol> <ul style="list-style-type: none"> <li>▶ See <i>Surface Materials</i>, page 552.</li> </ul>

*Tip: Any storage higher than 20" will impede lowest height range of worksurface. Do not place storage underneath controller.*

**For laminate group 2 and 3 pricing, please refer to the electronic catalog or SmartTools.**

*Tip: Only single and dual flat panel monitor arm application are permitted for use with 2-leg height-adjustable bench.*

▶ See *Steelcase Worktools Specification Guide*.

*Tip: Base supports a maximum distributed weight capacity of 250 pounds.*

*When calculating lifting capacity, subtract the weight of the worksurface.*

▶ See page 434 for worksurface weights.

Required Selections	U.S. Price	Required to Specify	
<b>Controller</b> <ul style="list-style-type: none"> <li>• Up/down controller</li> <li>• 4 pre-set controller</li> </ul>	No cost +\$ 74	Specify <i>with up/down controller</i> . Specify <i>with 4 pre-set controller</i> .	
<b>Options</b>	<b>U.S. Price</b>	<b>Required to Specify</b>	
<b>Surface Materials</b>	<b>Laminate top</b> <ul style="list-style-type: none"> <li>• Laminate price group 2</li> <li>• Laminate price group 3</li> <li>• Open Line laminate</li> </ul>	See information at left See information at left +\$102	Specify laminate color number. Specify laminate color number. ▶ See <i>Surface Materials Reference Manual</i> .
	<b>Wood veneer desks</b> <ul style="list-style-type: none"> <li>• Wood group 2</li> <li>• Wood group 3</li> <li>• Customiz stain</li> </ul>	+\$102 +\$359 No cost	Specify wood color number. Specify wood color number. Specify <i>with customiz stain</i> . ▶ See <i>Surface Materials Reference Manual</i> .
	<ul style="list-style-type: none"> <li>• Full-fill finish on wood group 1</li> </ul>	+\$102	Specify full-fill finish number.
	<b>Base</b> <ul style="list-style-type: none"> <li>• Paint price group 1</li> <li>• Paint price group 2</li> </ul>	No cost +\$ 44	Specify paint color number. Specify paint color number. ▶ See <i>Surface Materials</i> , page 552.
<b>Cutout Type</b>	<ul style="list-style-type: none"> <li>• Furniture style data</li> <li>• NEMA data</li> </ul>	No cost No cost	Specify <i>with furniture style data</i> . Specify <i>with NEMA data</i> .
<b>Cable Riser</b>	<ul style="list-style-type: none"> <li>• Cable riser</li> </ul>	+\$107	Specify <i>with cable manager</i> .
<b>Corner</b>	<ul style="list-style-type: none"> <li>• Square corner</li> <li>• Radius corner</li> </ul>	No cost +\$ 93	Specify <i>with square corner</i> . Specify <i>with radius corner</i> .
	<b>Corner radius</b> <ul style="list-style-type: none"> <li>• 2" radius</li> <li>• 5" radius</li> </ul>	No cost No cost	Specify <i>with 2" radius</i> . Specify <i>with 5" radius</i> .
<b>Related Products</b>	<ul style="list-style-type: none"> <li>• Centered screens</li> <li>• Cable and power management</li> </ul>		▶ Pages 452 and 454 ▶ Page 451

 **For Canadian Pricing**  
 Multiply U.S. Price by the Canadian price factor.  
 ▶ See page 1 for details.

**Specification Information**

Style Number	Depth	U.S. Base Prices				
		46"W	52"W	58"W	64"W	70"W

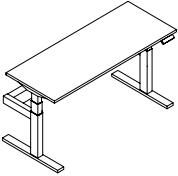

**High-Pressure Laminate Price Group 1 Benches—Extended Height**

MGBELRQS	Depth	46"W	52"W	58"W	64"W	70"W
	23"	\$2781	\$2823	\$2865	\$2909	\$2952
	28"	\$2853	\$2893	\$2938	\$2982	\$3026

**Wood Group 1 Benches—Extended Height**

MGBELRQS	Depth	46"W	52"W	58"W	64"W	70"W
	23"	\$3573	\$3625	\$3678	\$3737	\$3792
	28"	\$3677	\$3730	\$3785	\$3843	\$3899

Migration SE Height-Adjustable Benching

 **For Canadian Pricing**  
 Multiply U.S. Price by the Canadian price factor.  
 ▶ See page 1 for details.

# Migration SE Height-Adjustable Rectangle Dual-Sided Benches

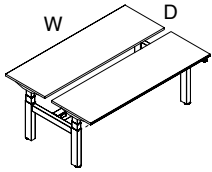

Standard Includes		Required to Specify
<ul style="list-style-type: none"> <li>▶ Need help? Product details, page 432</li> </ul>	<ul style="list-style-type: none"> <li>Two worksurfaces with square corners: High-Pressure Laminate price group 1 with 3 mm plastic edge</li> <li>Two electric height-adjustable sit-to-stand bases: paint price group 1</li> <li>Power cord: 9'</li> <li>1" adjustable glides</li> <li>Attachment hardware</li> <li>Power beam: paint to match base</li> </ul>	<ol style="list-style-type: none"> <li>Style number</li> <li>Controller (see below under Required Selections)</li> <li>Bench depth</li> <li>Bench width</li> <li>High-Pressure Laminate or wood color for worksurface</li> <li>Plastic color number for profile edge, if selected</li> <li>Paint color number for base:               <ul style="list-style-type: none"> <li>4799 Platinum Metallic (upcharge)</li> <li>7207 Black</li> <li>7241 Arctic White</li> <li>7360 Merle</li> </ul> </li> <li>Options, if selected (see below)</li> </ol> <ul style="list-style-type: none"> <li>▶ See <i>Surface Materials</i>, page 552.</li> </ul>

*Tip: Any storage higher than 20" will impede lowest height range of worksurface. Do not place storage underneath controller.*

**For laminate group 2 and 3 pricing, please refer to the electronic catalog or SmartTools.**

*Tip: Only single and dual flat panel monitor arm application are permitted for use with 2-leg height-adjustable bench.*

▶ See *Steelcase Worktools Specification Guide*.

*Tip: Base supports a maximum distributed weight capacity of 250 pounds. When calculating lifting capacity, subtract the weight of the worksurface.*

▶ See page 434 for worksurface weights.

Required Selections	U.S. Price	Required to Specify
<b>Controller</b> <ul style="list-style-type: none"> <li>Up/down controller</li> <li>4 pre-set controller</li> </ul>	No cost +\$148	Specify <i>with up/down controller</i> . Specify <i>with 4 pre-set controller</i> .
Options	U.S. Price	Required to Specify
<b>Surface Materials</b> <ul style="list-style-type: none"> <li><b>Laminate top</b> <ul style="list-style-type: none"> <li>Laminate price group 2</li> <li>Laminate price group 3</li> <li>Open Line laminate</li> </ul> </li> <li><b>Wood veneer desks</b> <ul style="list-style-type: none"> <li>Wood group 2</li> <li>Wood group 3</li> <li>Customiz stain</li> </ul> </li> <li>Full-fill finish on wood group 1</li> <li><b>Base</b> <ul style="list-style-type: none"> <li>Paint price group 1</li> <li>Paint price group 2</li> </ul> </li> </ul>	See information at left See information at left +\$204 +\$204 +\$718 No cost +\$205 No cost +\$ 88	Specify laminate color number. Specify laminate color number. ▶ See <i>Surface Materials Reference Manual</i> . Specify wood color number. Specify wood color number. Specify <i>with customiz stain</i> . ▶ See <i>Surface Materials Reference Manual</i> . Specify full-fill finish number. Specify paint color number. Specify paint color number. ▶ See <i>Surface Materials</i> page 552.
<b>Cutout Type</b> <ul style="list-style-type: none"> <li>Furniture style data</li> <li>NEMA data</li> </ul>	No cost No cost	Specify <i>with furniture style data</i> . Specify <i>with NEMA data</i> .
<b>Cable Riser</b> <ul style="list-style-type: none"> <li>Cable riser</li> </ul>	+\$214	Specify <i>with cable manager</i> .
<b>Corner</b> <ul style="list-style-type: none"> <li>Square corner</li> <li>Radius corner</li> </ul>	No cost +\$186	Specify <i>with square corner</i> . Specify <i>with radius corner</i> .
<b>Corner radius</b> <ul style="list-style-type: none"> <li>2" radius</li> <li>5" radius</li> </ul>	No cost No cost	Specify <i>with 2" radius</i> . Specify <i>with 5" radius</i> .
<b>Related Products</b> <ul style="list-style-type: none"> <li>Centered screens</li> <li>Cable and power management</li> </ul>		▶ Pages 452 and 454 ▶ Page 451



**For Canadian Pricing**  
 Multiply U.S. Price by the Canadian price factor.  
 ▶ See page 1 for details.

**Specification Information**

Style Number	Depth	U.S. Base Prices				
		46"W	52"W	58"W	64"W	70"W

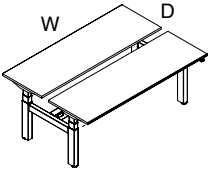

**High-Pressure Laminate Price Group 1 Benches—Extended Height**

MGBELRQD	Depth	46"W	52"W	58"W	64"W	70"W
	23"	\$5206	\$5284	\$5363	\$5443	\$5526
	28"	\$5337	\$5417	\$5499	\$5580	\$5664

**Wood Group 1 Benches—Extended Height**

MGBELRQD	Depth	46"W	52"W	58"W	64"W	70"W
	23"	\$6789	\$6888	\$6987	\$7098	\$7205
	28"	\$6985	\$7090	\$7195	\$7307	\$7409

Migration SE Height-Adjustable Benching

 **For Canadian Pricing**  
 Multiply U.S. Price by the Canadian price factor.  
 ▶ See page 1 for details.

# Migration SE Height-Adjustable Rectangle Single-Sided Bases

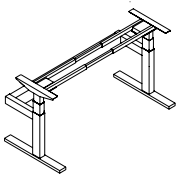

Tip: Attachment hardware is intended for desks 1" to 1 1/16" thick.

Tip: Any storage higher than 20" will impede lowest height range of worksurface. Do not place storage underneath controller.

Tip: Only single and dual flat panel monitor arm application are permitted for use with 2-leg height-adjustable bench.

▶ See Steelcase Worktools Specification Guide.

Tip: Base supports a maximum distributed weight capacity of 250 pounds. When calculating lifting capacity, subtract the weight of the worksurface.

Tip: Worksurface for use on this base needs to be 2" wider than the base.

## WARNING

Read base only warranty limitations.

▶ See page 434 for Workstation Design Guidelines and Requirements.

Standard Includes	Required to Specify
<ul style="list-style-type: none"> <li>▶ Need help? Product details, page 432</li> <li>• Electric height-adjustable sit-to-stand base: paint price group 1</li> <li>• Depth: 23" or 28"</li> <li>• Two power cord: 9'</li> <li>• 1/2" adjustable glides</li> <li>• Attachment hardware</li> </ul>	<ol style="list-style-type: none"> <li>1 Style number</li> <li>2 Depth</li> <li>3 Width</li> <li>4 Paint color number for base:               <ul style="list-style-type: none"> <li>4799 Platinum Metallic (upcharge)</li> <li>7207 Black</li> <li>7241 Arctic White</li> <li>7360 Merle</li> </ul> </li> <li>5 Controller (see below under Required Selections)</li> <li>6 Options, if selected (see below)</li> </ol>

Required Selections	U.S. Price	Required to Specify
<b>Controller</b> <ul style="list-style-type: none"> <li>• Up/down controller</li> <li>• 4 pre-set controller</li> </ul>	No cost +\$ 74	Specify with up/down controller. Specify with 4 pre-set controller.

Options	U.S. Price	Required to Specify
<b>Surface Materials</b> <ul style="list-style-type: none"> <li>• Paint price group 1</li> <li>• Paint price group 2</li> </ul>	No cost +\$ 44	Specify paint color number. Specify paint color number. ▶ See Surface Materials, page 552.
<b>Cutout Type</b> <ul style="list-style-type: none"> <li>• Furniture style data</li> <li>• NEMA data</li> </ul>	No cost No cost	Specify with furniture style data. Specify with NEMA data.
<b>Cable Riser</b> <ul style="list-style-type: none"> <li>• Cable riser</li> </ul>	+\$107	Specify with cable manager.
<b>Related Products</b> <ul style="list-style-type: none"> <li>• Centered screens</li> <li>• Cable and power management</li> </ul>		▶ Pages 452 and 454 ▶ Page 451

Specification Information						
Style Number	Depth	U.S. Base Prices				
		46"W	52"W	58"W	64"W	70"W

Single-Sided Bases—Extended Height						
MGBELRQSB	Depth	46"W	52"W	58"W	64"W	70"W
	23"	\$2382	\$2415	\$2449	\$2490	\$2526
	28"	\$2438	\$2475	\$2514	\$2552	\$2588



**For Canadian Pricing**  
 Multiply U.S. Price by the Canadian price factor.  
 ▶ See page 1 for details.

# Migration SE Height-Adjustable Rectangle Dual-Sided Bases

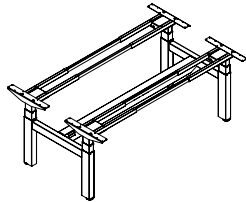

Tip: Attachment hardware is intended for desks 1" to 1 1/8" thick.

Tip: Any storage higher than 20" will impede lowest height range of worksurface. Do not place storage underneath controller.

Tip: Only single and dual flat panel monitor arm application are permitted for use with 2-leg height-adjustable bench.

▶ See *Steelcase Worktools Specification Guide*.

Tip: Base supports a maximum distributed weight capacity of 250 pounds. When calculating lifting capacity, subtract the weight of the worksurface.

Tip: Worksurface for use on this base needs to be 2" wider than the base.

## WARNING

Read base only warranty limitations.  
▶ See page 434 for *Workstation Design Guidelines and Requirements*.

**For Canadian Pricing**  
Multiply U.S. Price by the Canadian price factor.  
▶ See page 1 for details.

### Standard Includes

- ▶ Need help? Product details, page 432
- Two electric height-adjustable sit-to-stand base: paint price group 1
- Depth: 23" or 28"
- Two power cord: 9'
- 1" adjustable glides
- Attachment hardware

### Required to Specify

- 1 Style number
- 2 Depth
- 3 Width
- 4 Paint color number for base:  
4799 Platinum Metallic (upcharge)  
7207 Black  
7241 Arctic White  
7360 Merle
- 5 Controller (see below under Required Selections)
- 6 Options, if selected (see below)

### Required Selections

Required Selections	U.S. Price	Required to Specify
<b>Controller</b>		
• Up/down controller	No cost	Specify with up/down controller.
• 4 pre-set controller	+\$148	Specify with 4 pre-set controller.

### Options

Options	U.S. Price	Required to Specify
<b>Surface Materials</b>		
<b>Base</b>		
• Paint price group 1	No cost	Specify paint color number.
• Paint price group 2	+\$ 88	Specify paint color number. ▶ See <i>Surface Materials</i> , page 552.

Cutout Type	U.S. Price	Required to Specify
• Furniture style data	No cost	Specify with furniture style data.
• NEMA data	No cost	Specify with NEMA data.

Cable Riser	U.S. Price	Required to Specify
• Cable riser	+\$214	Specify with cable manager.

Related Products	U.S. Price	Required to Specify
• Centered screens		▶ Pages 452 and 454
• Cable and power management		▶ Page 451

### Specification Information

Style Number	Depth	U.S. Base Prices				
		46"W	52"W	58"W	64"W	70"W
•	•	•	•	•	•	•

### Dual-Sided Bases—Extended Height

MGBELRQDB	23"	28"	46"W	52"W	58"W	64"W	70"W
	\$4314	\$4423	\$4377	\$4486	\$4445	\$4556	\$4580

Migration SE Height-Adjustable Benching

# Accessories

For Use with Migration SE Benches

## Connection Kit

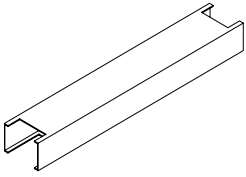

*Tip: Must order connection kit when combining two or more benches.*

Standard Includes		Required to Specify
<ul style="list-style-type: none"> <li>▶ Need help? Product details, page 432</li> </ul>	<ul style="list-style-type: none"> <li>• Connection kit: paint</li> <li>• Hardware</li> </ul>	1 Style number 2 Paint color number for connection kit: 4799 Platinum Metallic 7207 Black 7241 Arctic White 7360 Merle

### Specification Information

Style Number	U.S. Price
<b>MGBCK</b>	\$97

## Cable Riser

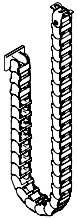

*Tip: Fence connection option must be selected for use with Migration SE bench. Cable riser leg connection does not work with the Migration SE height-adjustable bench.*

*Tip: A magnet is used to connect the cable riser to the power beam.*

Standard Includes		Required to Specify
<ul style="list-style-type: none"> <li>▶ Need help? Product details, page 432</li> </ul>	<ul style="list-style-type: none"> <li>• Cable riser: 7360 Merle paint</li> <li>• Attachment hardware</li> </ul>	Style number

### Specification Information

Style Number	U.S. Price
<b>MIGCR</b>	\$107



### For Canadian Pricing

Multiply U.S. Price by the Canadian price factor.

▶ See page 1 for details.



Desk and bench switch kit will be available  
CY23 Q3.

## Cable Brackets

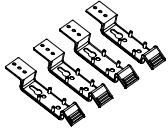

Standard Includes		Required to Specify
<ul style="list-style-type: none"> <li>▶ Need help? Product details, page 432</li> </ul>	<ul style="list-style-type: none"> <li>• Cable brackets, quantity of four: 6527 Merle plastic</li> </ul>	Style number
Specification Information		
Style Number	Weight	U.S. Price
MIGCBK4	0.5 lb	\$52

## Desk and Bench Switch Kit

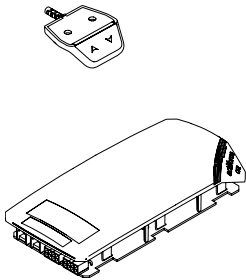

Standard Includes		Required to Specify	
<ul style="list-style-type: none"> <li>• Up/down controller, basic or extended height range control box: black plastic</li> </ul>		1 Style number 2 Options, if selected (see below)	
Options	U.S. Price	Required to Specify	
<b>Controller</b> <ul style="list-style-type: none"> <li>• Up/down controller</li> <li>• 4 pre-set controller</li> </ul>	No cost +\$74	Specify with up/down controller. Specify with 4 pre-set controller.	
<b>Height Range</b> <ul style="list-style-type: none"> <li>• Basic</li> <li>• Extended</li> </ul>	No cost No cost	Specify with basic range. Specify with extended range.	
Specification Information			
Style Number	U.S. Base Price		
MGDSKT	\$281		

Migration SE Height-Adjustable Benching



**For Canadian Pricing**  
 Multiply U.S. Price by the Canadian price factor.  
 ▶ See page 1 for details.



## Aligners for Use with Universal Screens

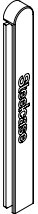

*Tip: Aligners are for use with Universal screens in in-line applications only.*

Standard Includes	Required to Specify
<ul style="list-style-type: none"> <li>▶ Need help? Product details, page 435</li> <li>• Aligners, package of 10: 6527 Merle</li> </ul>	Style number

Specification Information	
Style Number	U.S. Price
<b>UFAL</b>	\$36
·	·

Migration SE Height-Adjustable Benching

 **For Canadian Pricing**  
Multiply U.S. Price by the Canadian price factor.  
▶ See page 1 for details.





# Spanning Boundary Screens

For Use with Migration SE Dual-Sided Benches

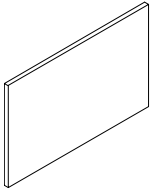

Standard Includes	Required to Specify
<ul style="list-style-type: none"> <li>▶ Need help? Product details, page 438</li> <li>• Screen: High-Pressure Laminate price group 1 or wood group 1 veneer</li> <li>• Edge on laminate screen, if selected: plastic</li> <li>• Height: 28½"H, 42"H, or 48"H</li> <li>• Depth: 50"D or 60"D</li> <li>• Brackets: paint price group 1 and 2</li> </ul>	<ol style="list-style-type: none"> <li>1 Style number</li> <li>2 Screen size type (see below under Required Selections)</li> <li>3 Height (see below under Required Selections)</li> <li>4 Depth</li> <li>5 High-Pressure Laminate or wood veneer color number for screen</li> <li>6 Plastic color number for edge on laminate screen, if selected</li> <li>7 Paint color number for brackets:               <ul style="list-style-type: none"> <li>4799 Platinum Metallic</li> <li>7207 Black</li> <li>7241 Arctic White</li> <li>7360 Merle</li> </ul> </li> <li>8 Options, if selected (see below)</li> </ol> <p>▶ See <i>Surface Materials</i>, page 552.</p>

Required Selections	U.S. Price	Required to Specify
<b>Screen Size Type</b> <ul style="list-style-type: none"> <li>• Modular</li> <li>• Parametric</li> </ul>	No cost No cost	Specify with modular. Specify with parametric.
<b>Height</b> <ul style="list-style-type: none"> <li>• <b>Modular</b></li> <li>• 28½"H</li> <li>• 42"H</li> <li>• 48"H</li> </ul>	Prices at right Prices at right Prices at right	Specify installed height. Specify installed height. Specify installed height.

Options	U.S. Price	Required to Specify
<b>Surface Materials</b> <ul style="list-style-type: none"> <li>• <b>Screen</b></li> <li>• Laminate price group 2</li> <li>• Laminate price group 3</li> <li>• Open Line laminate</li> <li>• Wood group 2</li> <li>• Wood group 3</li> <li>• Customiz stain</li> <li>• Full-fill finish on wood group 1</li> <li>• <b>Grain Direction</b></li> <li>• No direction</li> <li>• Horizontal</li> <li>• Vertical</li> </ul>	See information at left See information at left +\$205 plus cost of laminate +\$204 +\$718 No cost No cost No cost No cost No cost No cost No cost	Specify laminate color number. Specify laminate color number. ▶ See <i>Surface Materials Reference Manual</i> . Specify wood color number. Specify wood color number. Specify with <i>Customiz stain</i> . ▶ See <i>Surface Materials Reference Manual</i> . Specify full-fill finish number. Specify with <i>no grain direction</i> . Specify with <i>horizontal grain direction</i> . Specify with <i>vertical grain direction</i> .
<b>Overhang</b> <ul style="list-style-type: none"> <li>• No overhang</li> <li>• 18" modular overhang</li> <li>• ¼"–18" parametric overhang</li> </ul>	No cost Prices at right Prices at right	Specify with <i>no overhang</i> . Specify with <i>18" modular overhang</i> and select left or right, or left and right. Specify with <i>parametric overhang</i> , select left or right, or left and right, and select overhang width.

**For laminate price group 2 and 3 pricing,** please refer to the electronic catalog or *SmartTools*.

*Tip: Open Line laminate is only available when specifying modular screens, and can be applied with vertical grain direction only.*

*Tip: Full-fill finish codes can be used to simplify specification of veneer boundary screens being used in settings with full-fill veneer products. The screen will not have the final fill coat applied, but the finish color will be consistent with the full-fill products.*



## For Canadian Pricing

Multiply U.S. Price by the Canadian price factor.

▶ See page 1 for details.

**Specification Information**

• Style Number	• Screen Height	• U.S. Base Prices		• Options (Add \$ to Base Price)					
		• Base Depth		• Overhang					
		50"D	60"D	1/16"W—	6"W—	9"W—	12"W—	15"W—	18"W
				5 15/16"W	8 15/16"W	11 15/16"W	14 15/16"W	17 15/16"W	each side
				each side	each side	each side	each side	each side	

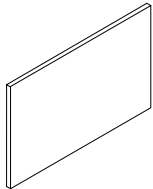

Tip: Upcharge shown includes price of overhang on both sides.

**High-Pressure Laminate Spanning Boundary Screens For Use with Dual-Sided Bench**

MGBBSD	Screen Height	50"D	60"D	1/16"W	6"W	9"W	12"W	15"W	18"W
	28 1/2"H	\$ 472	\$ 550	+\$ 37	+\$ 78	+\$116	+\$154	+\$ 193	+\$ 231
	42"H	\$ 613	\$ 724	+\$ 55	+\$107	+\$158	+\$211	+\$ 263	+\$ 317
	48"H	\$ 744	\$ 873	+\$ 63	+\$122	+\$185	+\$245	+\$ 307	+\$ 366

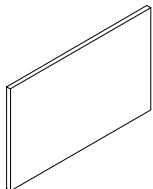

Tip: Upcharge shown includes price of overhang on both sides.

**Wood Veneer Spanning Boundary Screens For Use with Dual-Sided Bench**

MGBBSD	Screen Height	50"D	60"D	1/16"W	6"W	9"W	12"W	15"W	18"W
	28 1/2"H	\$1178	\$1398	+\$142	+\$293	+\$436	+\$581	+\$ 725	+\$ 870
	42"H	\$1572	\$1887	+\$208	+\$413	+\$615	+\$818	+\$1023	+\$1229
	48"H	\$1929	\$2295	+\$237	+\$472	+\$708	+\$945	+\$1180	+\$1413

Migration SE Height-Adjustable Benching



**For Canadian Pricing**  
Multiply U.S. Price by the Canadian price factor.  
▶ See page 1 for details.

# Single-Sided Boundary Screens

For Use with Migration SE Single-Sided Benches

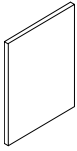

Standard Includes	Required to Specify
<ul style="list-style-type: none"> <li>▶ Need help? Product details, page 438</li> <li>• Screen: High-Pressure Laminate price group 1 or wood group 1 veneer</li> <li>• Edge on laminate screen, if selected: plastic</li> <li>• Height: 28½"H, 42"H, or 48"H</li> <li>• Depth 23"D or 28"D</li> <li>• Brackets: paint price group 1 and 2</li> </ul>	<ol style="list-style-type: none"> <li>1 Style number</li> <li>2 Screen size type (see below under Required Selections)</li> <li>3 Height (see below under Required Selections)</li> <li>4 Depth</li> <li>5 Application (see below under Required Selections)</li> <li>6 High-Pressure Laminate or wood veneer color number for screen</li> <li>7 Plastic color number for edge on laminate screen, if selected</li> <li>8 Paint color number for brackets: 4799 Platinum Metallic 7207 Black 7241 Arctic White 7360 Merle</li> <li>9 Options, if selected (see below)</li> </ol> <p>▶ See <i>Surface Materials</i>, page 552.</p>

Screen Size Type	Required Selections	U.S. Price	Required to Specify
<b>Screen Size Type</b>	• Modular	No cost	Specify <i>with modular</i> .
	• Parametric	No cost	Specify <i>with parametric</i> .
<b>Height</b>	<b>Modular</b>		
	• 28½"H	Prices at right	Specify installed height.
	• 42"H	Prices at right	Specify installed height.
	• 48"H	Prices at right	Specify installed height.
<b>Application</b>	• Left-hand	No cost	Specify <i>with left-hand</i> .
	• Right-hand	No cost	Specify <i>with right-hand</i> .

Surface Materials	Options	U.S. Price	Required to Specify
<b>Surface Materials</b>	<b>Screen</b>		
	• Laminate price group 2	See information at left	Specify laminate color number.
	• Laminate price group 3	See information at left	Specify laminate color number.
	• Open Line laminate	+\$102 plus cost of laminate	▶ See <i>Surface Materials Reference Manual</i> .
	• Wood group 2	+\$102	Specify wood color number.
	• Wood group 3	+\$359	Specify wood color number.
	• Customiz stain	No cost	Specify <i>with Customiz stain</i> .
	• Full-fill finish on wood group 1	No cost	▶ See <i>Surface Materials Reference Manual</i> . Specify full-fill finish number.
	<b>Grain Direction</b>		
	• No direction	No cost	Specify <i>with no grain direction</i> .
• Horizontal	No cost	Specify <i>with horizontal grain direction</i> .	
• Vertical	No cost	Specify <i>with vertical grain direction</i> .	
<b>Overhang</b>	• No overhang	No cost	Specify <i>with no overhang</i> .
	• 18" modular overhang	Prices at right	Specify <i>with 18" modular overhang</i> and select left or right, or left and right.
	• ¼"–18" parametric overhang	Prices at right	Specify <i>with length of parametric overhang</i> , select left or right, or left and right and select overhang width.

**For laminate price group 2 and 3 pricing, please refer to the electronic catalog or SmartTools.**

*Tip: Open Line laminate is only available when specifying modular screens, and can be applied with vertical grain direction only.*

*Tip: Full-fill finish codes can be used to simplify specification of veneer boundary screens being used in settings with full-fill veneer products. The screen will not have the final fill coat applied, but the finish color will be consistent with the full-fill products.*



## For Canadian Pricing

Multiply U.S. Price by the Canadian price factor.

▶ See page 1 for details.



**Specification Information**

• Style Number	• Screen Height	• U.S. Base Prices		• Options (Add \$ to Base Price)					
		• Base Depth		• Overhang					
		23"D	28"D	1/16"W-	6"W-	9"W-	12"W-	15"W-	18"W
				5 15/16"W	8 15/16"W	11 15/16"W	14 15/16"W	17 15/16"W	each side
				each side	each side	each side	each side	each side	

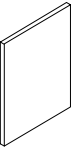

**High-Pressure Laminate Single-Sided Boundary Screens For Use with Single-Sided Benches**

MGBBS	Screen Height	23"D	28"D	1/16"W- <th>6"W- <th>9"W- <th>12"W- <th>15"W- <th>18"W </th></th></th></th></th>	6"W- <th>9"W- <th>12"W- <th>15"W- <th>18"W </th></th></th></th>	9"W- <th>12"W- <th>15"W- <th>18"W </th></th></th>	12"W- <th>15"W- <th>18"W </th></th>	15"W- <th>18"W </th>	18"W
	28 1/2"H	\$ 315	\$ 355	+\$ 21	+\$ 37	+\$ 58	+\$ 78	+\$ 97	+\$116
	42"H	\$ 392	\$ 448	+\$ 27	+\$ 55	+\$ 80	+\$107	+\$133	+\$158
	48"H	\$ 494	\$ 558	+\$ 32	+\$ 62	+\$ 93	+\$122	+\$153	+\$185

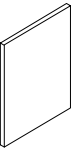

**Wood Veneer Single-Sided Boundary Screens For Use with Single-Sided Benches**

MGBBS	Screen Height	23"D	28"D	1/16"W- <th>6"W- <th>9"W- <th>12"W- <th>15"W- <th>18"W </th></th></th></th></th>	6"W- <th>9"W- <th>12"W- <th>15"W- <th>18"W </th></th></th></th>	9"W- <th>12"W- <th>15"W- <th>18"W </th></th></th>	12"W- <th>15"W- <th>18"W </th></th>	15"W- <th>18"W </th>	18"W
	28 1/2"H	\$ 740	\$ 849	+\$ 76	+\$145	+\$218	+\$293	+\$363	+\$436
	42"H	\$ 942	\$1100	+\$104	+\$208	+\$308	+\$413	+\$513	+\$615
	48"H	\$1208	\$1391	+\$119	+\$236	+\$355	+\$472	+\$590	+\$708

Migration SE Height-Adjustable Benching

 **For Canadian Pricing**  
Multiply U.S. Price by the Canadian price factor.  
▶ See page 1 for details.

# FrameOne End Panels

For Use with Migration SE Bench

Standard Includes	Required to Specify
<ul style="list-style-type: none"> <li>▶ Need help? Product details, page 442</li> <li>• Infill: High-Pressure Laminate price group 1</li> <li>• Leg: paint price group 1</li> <li>• Brackets: paint price group 1 and 2</li> </ul>	<ol style="list-style-type: none"> <li>1 Style number</li> <li>2 Width</li> <li>3 Laminate color number for infill</li> <li>4 Paint color number for leg</li> <li>5 Paint color number for bracket:               <ul style="list-style-type: none"> <li>4799 Platinum Metallic</li> <li>7207 Black</li> <li>7241 Arctic White</li> <li>7360 Merle</li> </ul> </li> <li>6 Options, if selected (see below)</li> </ol> <ul style="list-style-type: none"> <li>▶ See <i>Surface Materials</i>, page 552.</li> </ul>

**For laminate price group 2 pricing, please refer to the electronic catalog or SmartTools.**

*Tip: Wood group 2 and wood group 3 upcharges are in addition to the wood group 1 upcharge.*

*Tip: Legs are fixed-height at 27 1/4".*

Options	U.S. Price	Required to Specify
<b>Surface Materials</b> <ul style="list-style-type: none"> <li>• <b>Panel</b> <ul style="list-style-type: none"> <li>• Laminate price group 2</li> <li>• Open Line laminate</li> </ul> </li> <li>• Wood group 2</li> <li>• Wood group 3</li> <li>• Customiz stain</li> <li>• Full-fill finish on wood group 1</li> </ul>	See information at left +\$102 plus cost of laminate +\$102 +\$359 No cost +\$102	Specify laminate color number. ▶ See <i>Surface Materials Reference Manual</i> .  Specify wood color number. Specify wood color number. Specify with <i>Customiz stain</i> . ▶ See <i>Surface Materials Reference Manual</i> . Specify full-fill finish number.
<b>Legs</b> <ul style="list-style-type: none"> <li>• Paint price group 1</li> <li>• Paint price group 2</li> </ul>	No cost +\$ 22 per side	Specify paint color number. Specify paint color number.
<b>Application for Single-Sided Benches</b> <ul style="list-style-type: none"> <li>• Left-handed</li> <li>• Right-handed</li> </ul>	No cost No cost	Specify with <i>left-handed</i> . Specify with <i>right-handed</i> .
<b>Leg</b> <ul style="list-style-type: none"> <li>• <b>Single-sided</b> <ul style="list-style-type: none"> <li>• Post leg</li> <li>• Loop leg</li> </ul> </li> <li>• <b>Dual-sided</b> <ul style="list-style-type: none"> <li>• Post leg</li> <li>• Loop leg</li> </ul> </li> </ul>	No cost +\$223  No cost +\$372	Specify with <i>post leg</i> . Specify with <i>loop leg</i> .  Specify with <i>post leg</i> . Specify with <i>loop leg</i> .

Specification Information									
Height	Style Number	U.S. Base Prices				Options (Add \$ to Base Price) Wood Group 1			
		23"W	28"W	50"W	60"W	23"W	28"W	50"W	60"W

Single-Sided									
27 1/4"	<b>MGBFEPS</b>	\$1130	\$1254	N.A.	N.A.	+\$187	+\$203	N.A.	N.A.

Dual-Sided									
27 1/4"	<b>MGBFEPD</b>	N.A.	N.A.	\$1887	\$2092	N.A.	N.A.	+\$374	+\$409

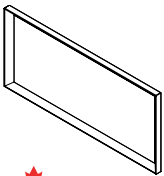
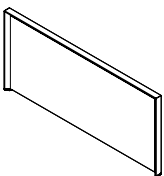

**For Canadian Pricing**  
 Multiply U.S. Price by the Canadian price factor.  
 ▶ See page 1 for details.



# FrameOne Dual-Sided End Panels with Utility Pole

For Use with Migration SE Bench

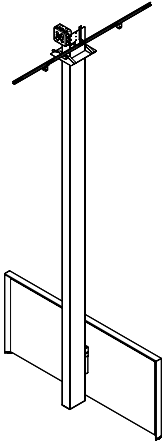

**For laminate price group 2 pricing, please refer to the electronic catalog or SmartTools.**

*Tip: Wood group 2 and wood group 3 upcharges are in addition to the wood group 1 upcharge.*

*Tip: Legs are fixed-height at 27 1/4".*

*Tip: Infeed is ordered separately.*

▶ See page 517

*Tip: Utility pole reaches a maximum ceiling height of 10'. Pole is 3"D x 6"W.*

*Tip: Utility pole can be specified without the end panel.*

Standard Includes	Required to Specify
<ul style="list-style-type: none"> <li>▶ Need help? Product details, page 442</li> <li>• Infill: High-Pressure Laminate price group 1</li> <li>• Leg: paint price group 1</li> <li>• Utility pole: anodized aluminum</li> <li>• Ceiling kit</li> <li>• Brackets: paint price group 1 and 2</li> <li>• Mounting brackets</li> </ul>	<ol style="list-style-type: none"> <li>1 Style number</li> <li>2 Width</li> <li>3 Laminate color number for infill</li> <li>4 Paint color number for leg</li> <li>5 Paint color number for bracket:               <ul style="list-style-type: none"> <li>4799 Platinum Metallic</li> <li>7207 Black</li> <li>7241 Arctic White</li> <li>7360 Merle</li> </ul> </li> <li>6 Options, if selected (see below)</li> </ol> <p>▶ See <i>Surface Materials</i>, page 552.</p>

Options	U.S. Price	Required to Specify
<b>Surface Materials</b> <b>Panel</b> <ul style="list-style-type: none"> <li>• Laminate price group 2</li> <li>• Open Line laminate</li> <li>• Wood group 2</li> <li>• Wood group 3</li> <li>• Customiz stain</li> <li>• Full-fill finish on wood group 1</li> </ul> <b>Legs</b> <ul style="list-style-type: none"> <li>• Paint price group 1</li> <li>• Paint price group 2</li> </ul>	See information at left +\$102 plus cost of laminate +\$102 +\$359 No cost +\$102 No cost No cost +\$ 22 per side	Specify laminate color number. ▶ See <i>Surface Materials Reference Manual</i> . Specify wood color number. Specify wood color number. Specify <i>with Customiz stain</i> . ▶ See <i>Surface Materials Reference Manual</i> . Specify full-fill finish number. Specify paint color number. Specify paint color number.
<b>Application for Single-Sided Benches</b> <ul style="list-style-type: none"> <li>• Left-handed</li> <li>• Right-handed</li> </ul>	No cost No cost	Specify <i>with left-handed</i> . Specify <i>with right-handed</i> .
<b>Leg</b> <b>Single-sided</b> <ul style="list-style-type: none"> <li>• Post leg</li> <li>• Loop leg</li> </ul> <b>Dual-sided</b> <ul style="list-style-type: none"> <li>• Post leg</li> <li>• Loop leg</li> </ul>	No cost +\$223 No cost +\$372	Specify <i>with post leg</i> . Specify <i>with loop leg</i> . Specify <i>with post leg</i> . Specify <i>with loop leg</i> .



## For Canadian Pricing

Multiply U.S. Price by the Canadian price factor.

▶ See page 1 for details.

**Specification Information**

Height	Style Number	U.S. Base Prices				Options (Add \$ to Base Price) Wood Group 1			
		23"W	28"W	50"W	60"W	23"W	28"W	50"W	60"W

**Single-Sided**

27 1/4"	<b>MGBFEPUPS</b>	\$1924	\$2134	N.A.	N.A.	+\$187	+\$203	N.A.	N.A.
---------	------------------	--------	--------	------	------	--------	--------	------	------

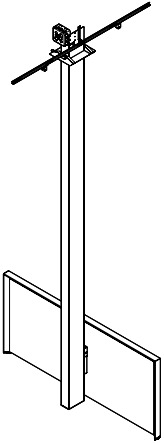

**Dual-Sided**

27 1/4"	<b>MGBFEPUPD</b>	N.A.	N.A.	\$3208	\$3559	N.A.	N.A.	+\$374	+\$409
---------	------------------	------	------	--------	--------	------	------	--------	--------

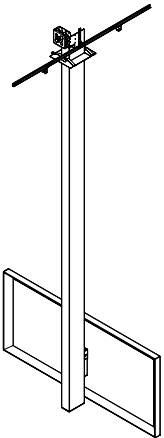

Migration SE Height-Adjustable Benching

 **For Canadian Pricing**  
Multiply U.S. Price by the Canadian price factor.  
▶ See page 1 for details.

