

**Fusion** The bond between people and space

Love how you work.®

**Steelcase**

made in Saudi Arabia

**Manufactured by Steelcase Jeraisy Ltd**

**Visit [steelcase.com.sa](http://steelcase.com.sa)**

**Europe** Espace Européen de l'Entreprise 1, allée d'Oslo, BP 40033 Schiltigheim, 67012 Strasbourg Cedex, France  
tel: +33 3 88 13 30 30 fax: +33 3 88 28 31 78

**North & Latin America** 901, 44th Street, Grand Rapids MI 49508, USA  
tel: +1 616 247 27 10 fax: +1 616 246 40 40

**Asia Pacific & India** 4th floor, N32 Kowa Bldg, 5-2-32 Minami-Azabu, Minato-Ku, Tokyo 106-0047, Japan  
tel: +81 3 3448 9611 fax: +81 3 3448 9617

**Middle East & Africa** Design House unit A2, PO Box 502596, Dubai Media City, Dubai UAE  
tel: +971 4 369 7838 fax: +971 4 369 7837

**Concept and Design** Steelcase **Product Design Fusion** Steelcase **Product Design Amia** Steelcase Design in collaboration with IDEO **Product Design Partito, Please visitor chair and Share It** Stefan Brodbeck – [www.brodbeckdesign.de](http://www.brodbeckdesign.de)  
**Product Design 32 Seconds** Steelcase Design in collaboration with C10 Design and Development **Product Design Please task chair** n/p/k industrial design

DM710ENAS 08/10 © 2009 Steelcase® All rights reserved. All specifications subject to change without notice.



C4109

**Steelcase**

## Insights

- 1 / Footprints are shrinking. Reconfigurations are occurring frequently.
- 2 / Collaboration is happening more and more.
- 3 / Users need a place for personalisation and territoriality.
- 4 / Most desks today don't help people manage piles of documents.
- 5 / Users don't know how to manage cables.



Collaboration at the desk happens more often.

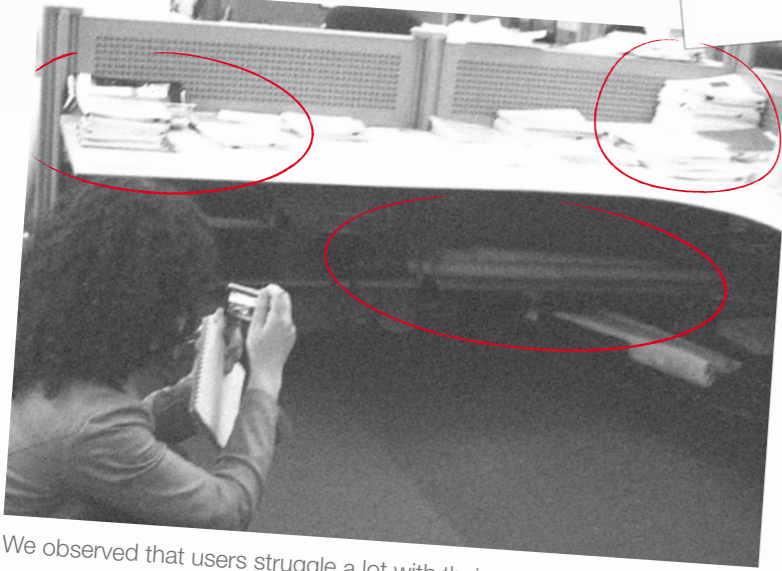

We observed that users struggle a lot with their cable management.

## Fusion The bond between people and space

**The world of work is changing every day.** The challenges of integrating people and space have never been greater. Company footprints are shrinking. Space is being reconfigured more frequently to optimise occupancy and reflect the changing requirements of businesses.

There is also increasing demand for office solutions that strike the right balance between the needs of people using their own workstations while working alongside colleagues.

Satisfying those needs was a question that required innovative thinking.  
The answer is Fusion.

### Why Fusion ?

- ✱ Creates a bond between people and space.
- 🏠 A family of elements that will fit into any company culture.
- ♥ Provides a wide range of creative working platforms.

### فيوجن الرابط بين مكان العمل والمستخدم

عالم الأعمال ومتطلباته يتغير باستمرار , والتحدي بدمج المستخدم مع مكان العمل أصبح الآن أكثر صعوبة. لقد أصبحت المساحات المتاحة لجهات العمل تتصاغر شيئاً فشيئاً . كما زادت الحاجة لإعادة تشكيل مكان العمل وذلك لكي يتم أستغلال المساحة بصورة أمثل و ليوكب ذلك التغيرات السريعة في مجال الأعمال. كما ظهرت حاجة المستخدمين الماسه لحلول مكتبية توفر التوازن بين إعطاء الخصوصية في محطة العمل وسهولة التواصل مع زملاء العمل. أن إيجاد حلول ترضي هذه التطلعات كان سؤالاً بحاجة إلى فكر خلاق للأجابة عليه. وكان الجواب هو فيوجن.

### لماذا فيوجن ؟

- ✱ يربط بين مكان العمل والمستخدم.
- 🏠 مجموعة واسعة من المكونات تناسب مختلف احتياجات الأعمال.
- ♥ خيارات متعددة من أسطح العمل المصممه بشكل فريد.



People want choice.

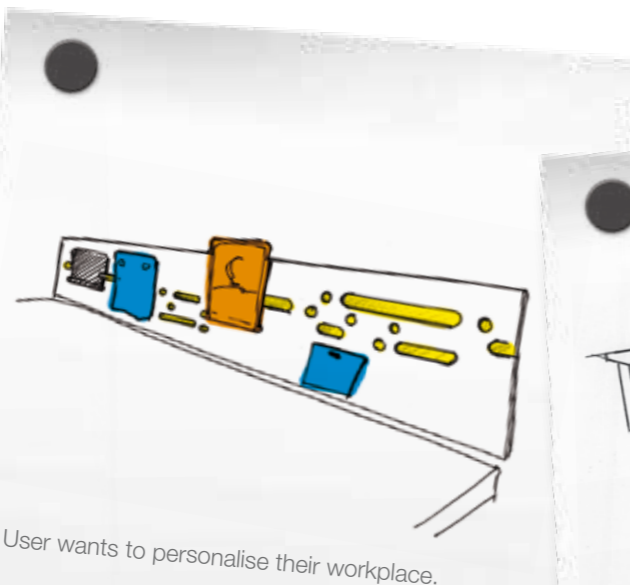

User wants to personalise their workplace.

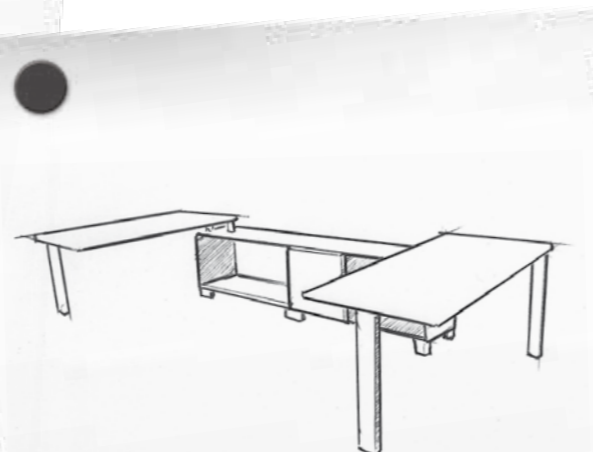

People need quick and easy access to storage.

### Worksurface

Available in various dimensions and shapes. It enables the user to structure their office space flexibly and efficiently without using up unnecessary additional floorspace.

### Top level organisation

Partito rails and shelves and our 1+1 Worktools provides privacy and enables the user to find a place for everything.

## Meeting the challenge of people and space

People working in pairs or small groups are delivering better results for companies at a time when the efficient use of space is crucial.

Staff also need individual workspace and the facility to organise it without facing mountains of files and documents on their desks or struggling with messy cable management. People and space. It's a challenge that Fusion meets successfully.

Fusion brings together the elements of worksurface, storage, desk organisation and cable management and enables the user to enjoy a personally configured workstation that dovetails with their colleagues' workspace. Fusion is an instant solution available in modern or traditional design, a choice of colours and with a range of storage solutions.



### Cable Management

The focus on Fusion's easy installation and user comfort was a major factor in the development of the cable management system.

### Legs

The worksurface/shared platform gives customers an aesthetic choice between C- or 4-leg.

### Storage

The colourful storage units are an integral element of Fusion and provide individual or team storage. Units can replace a leg or be positioned next to the desk.

**30**  
seconds

### Installation in 30 seconds only

Office lay-outs are changing with increasing frequency. A desk system needs the flexibility to be assembled or dismantled easily and quickly. It takes only 30 seconds for 2 people for the basic installation of a Fusion desk which allows customers and users to reconfigure their office quickly - even over a weekend.

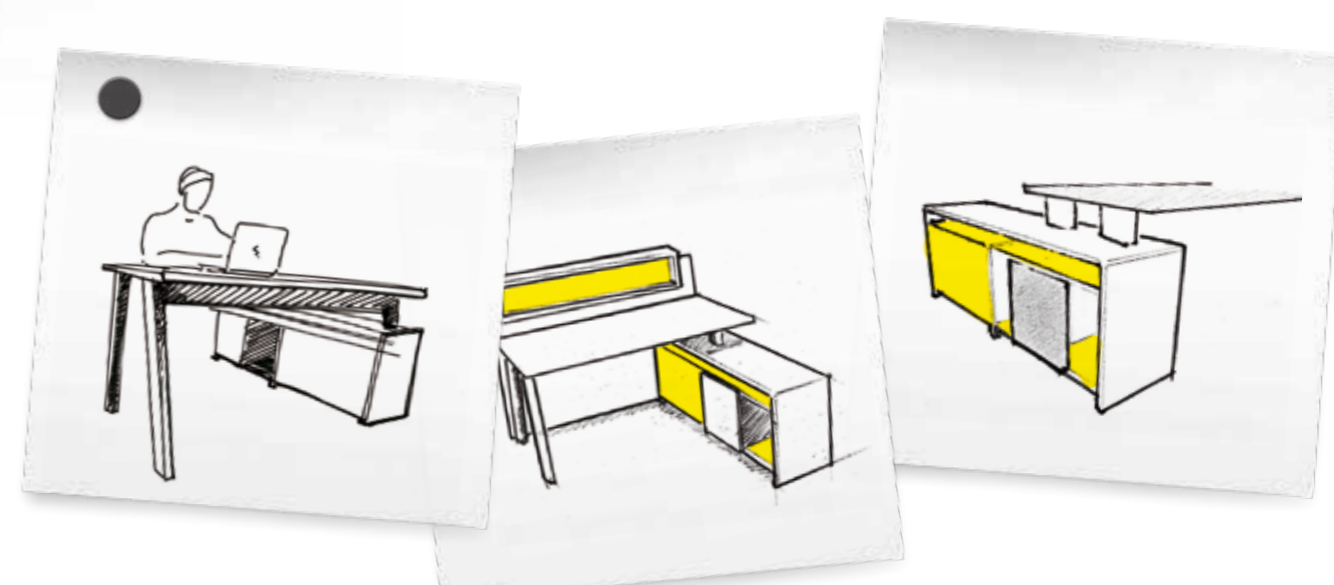



## You, me, us

Fusion is a family of office furniture elements that can satisfy the entire range of applications required by companies in their office environments. It strikes the perfect balance between collaborative and individual work.

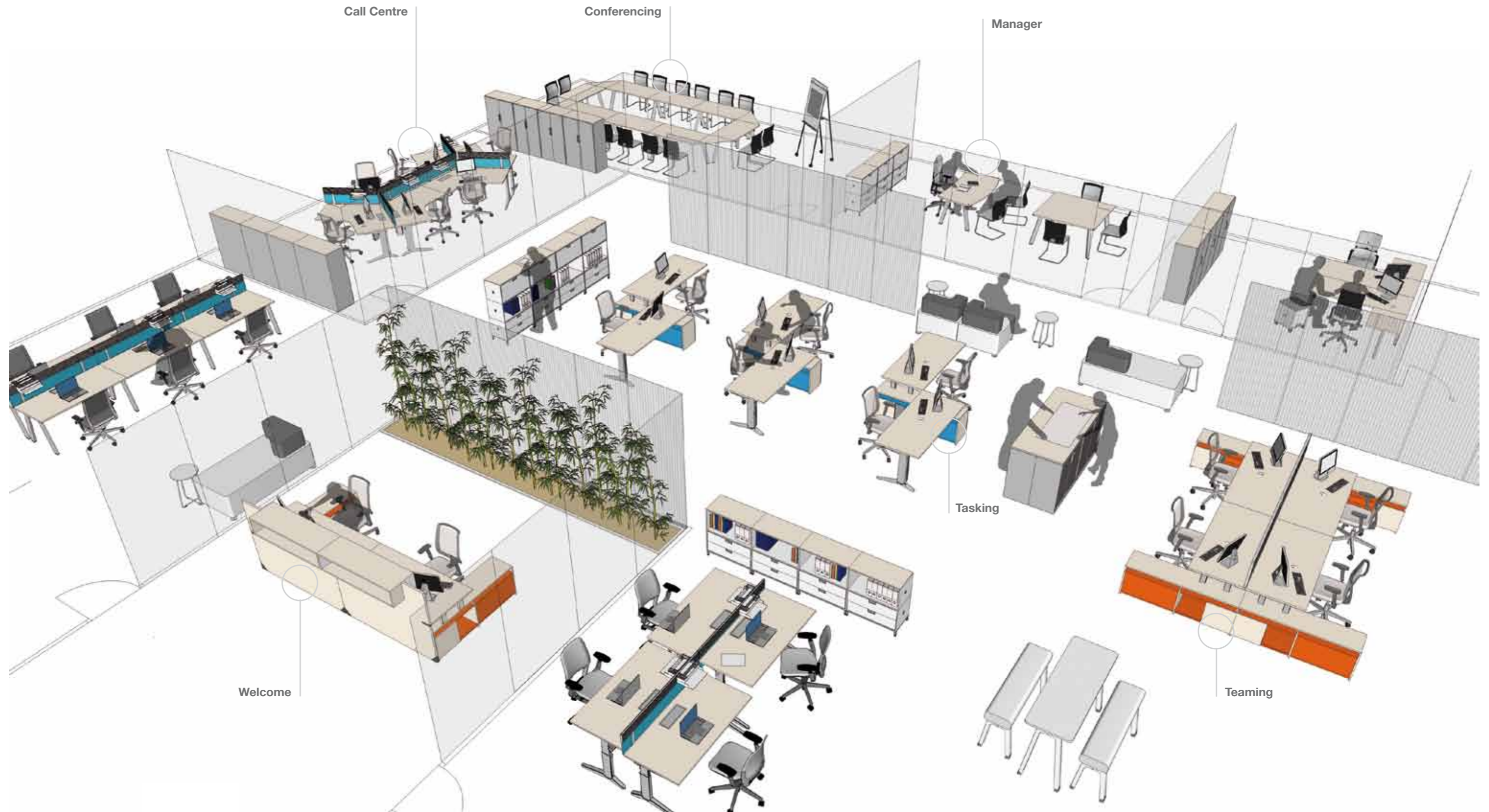

## For a balanced work environment

People working in pairs is proving a successful arrangement for businesses. There is an increasing need to develop individual workspace that encourages the user to concentrate on its own work and interact with others without leaving their desks. This is the modern working environment that Fusion creates.



C5385  
Straight top / 4-leg design / Cable apertures, large capacity cable tray  
Duo lateral storage / Partito rail / Amia task chair

## Perfect for small teams

The drive to create more collaborative working spaces is gathering pace as companies recognise that people working in small groups are delivering improved, tangible business results.

Fusion encourages and facilitates this way of working. With the addition of Partito rails and screens, people can focus on their own work and communicate easily with their colleagues.



C4123  
Symmetric corner top / C-leg design / Cable aperture, large capacity cable tray, standard vertical cable management  
Partito Screen with 1+1 Worktools / 32 Seconds task chairs



## Storage for all

People need quick and easy access to storage that helps keep workstations free from office clutter and help them manage active work, anticipated projects, archived information. Fusion has its own integrated storage, matching the design of the range. Thanks to its 1 or 2 sided door - opening, it can either be used for personal or shared storage.



Optima table top / Shared C-leg design / Top access, standard vertical cable management, large capacity cable tray  
Duo lateral storage / Partito rail with 1+1 Worktools / Reply Air task chairs

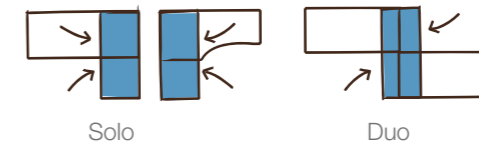

### Personal and team storage solutions

Solo lateral storage: usable on one side

Duo lateral storage: usable on two sides

## Fusion makes space pay

Fusion offers an excellent option for companies looking to optimise team spaces in their offices with a «benching» application.

Due to its contemporary shape and flexibility, offering facilities such as shared desk legs, Fusion makes it easy to build larger configurations in office team space without compromising valuable square metres.



Straight table tops / 4-leg design + shared leg / Top access, large capacity cable tray  
Partito Screen with 1+1 Worktools / Reply Air task chairs

## Fusion and call centres

Maximising people performance amongst large teams, particularly in call centres, is crucially important for businesses.

The ergonomic credentials of Fusion will ensure user comfort while neat cable management will help create tidy workplaces and support greater cabling capacity. Partito screens and rails also assist users with the organisation of their spaces and provide privacy.

The space optimisation qualities of Fusion also make it an ideal choice for call centres.



Pentagon table tops / C-leg design + shared leg / Cable apertures, standard vertical cable management, large capacity cable tray  
Partito Screen with 1+1 Worktools / Reply task chairs



## Fusion at the heart of your meeting room

Fusion covers the full spectrum of office requirements, including elegant and simple solutions for meeting and conference rooms. The elements can be easily adapted to provide a variety of configurations and are available with veneer or protech finishes. Fusion's design and cable management also make the use of laptops and conference call facilities during meetings straightforward.



Squared conferencing tops + extensions / Shared table leg design  
In and Out cable cut out, vertical cable spine / Reply Air task chairs

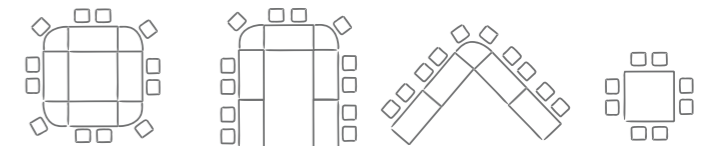



## Fit for team leaders

While Fusion is suited to people working alongside colleagues, it can also be configured as a classic individual workstation, ideal for team managers.

Materials, such as veneer, create a prestigious yet functional appearance and integrated storage units help ensure the workstation enjoys a streamlined and uncluttered look.



Contact table top / C-leg design with modesty panel / Top access and standard vertical cable management  
Please task chair and Please visitor New Design

## A Fusion welcome

Fusion offers an intelligent and effective solution for office entrance areas, lobbies or reception counters.

A welcome counter can easily be attached to a desk and storage units. The result is a smart, colourful and tidy unit giving visitors an attractive welcome and all important first impression.



C4122

## Pride of place

A tidy office is a dream that many companies and their staff would dearly like to fulfil. Cluttered desks and loose cables are all too often the main barrier.

Fusion's desk organisation and a variety of cable management options help people and companies take a significant stride towards the goal of an office that is their pride and joy.

Fusion's design principles encourage structure and cleanliness and make a tidy office a realistic dream. Worksurfaces can be selected with either rounded or straight edges and there is a choice of C-leg or 4-leg support.

### Worksurfaces edge



**Rounded**  
2 rounded corners 35mm on the user side  
+ 2 standard corners 90°/2mm visitor side



**Straight**  
4 standard corner 90°

### Legs



C-leg aesthetic



4-leg aesthetic

## Partito Rail and Shelf

Thanks to Partito Rail and Shelf, users can make better use of vertical space. They enhance organisation while creating a balance between privacy and collaboration.

It's a time saving and efficient storage solution for the user: everything close at hand. Partito Rail offers a huge choice of finishes and colours. In combination with the 1+1 Organisation tools, the user can personalise his or her desk.



**Partito Rail, compatible with any Steelcase desk range - 1 ) 1+1 Binder holder 2 ) 1+1 Toolbox**

### Vertical organisation and personalisation

Partito Rail and Partito Shelf help to make better use of vertical free space and increase the workstation area. They create virtual boundaries between users without isolating. Thanks to different types of infills, users can personalise their own workplace.

### Structural

Compatible with 1+1 Organisation tools, Partito Rail and Partito Shelf are structural enough to hold several tools such as heavy binders and flat screen arms (up to 40kg in total).

### Flexible and transversal

The Partito Rail can be used on any desk thanks to universal C-clamps.

### Partito Rail and Shelf selection of patterns / infills

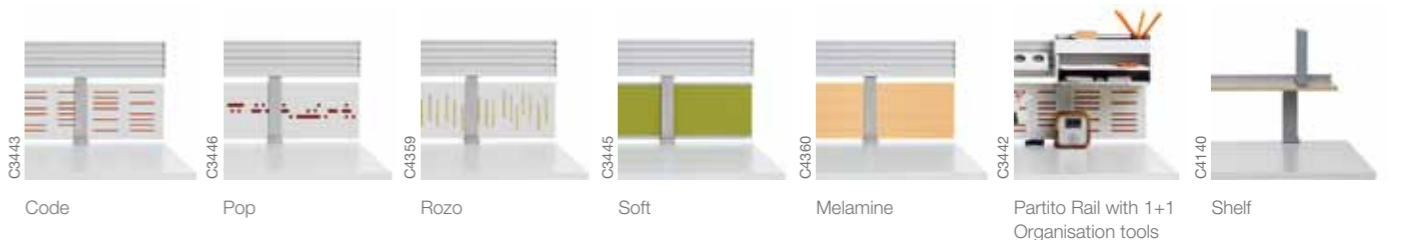



## Cable Management

Fusion's cable management is easy to recognise as all elements come in the same colour code, allowing even the user to properly manage his or her cables. "On surface" cable management is available with outlet boxes and cut-outs. Horizontal and vertical management is provided through a range of unobtrusive trays, brackets and integrated vertical cable management. Hence making sure that your working space remains clutter free.

### On the worksurface's cable management



C4115  
Cable aperture with cover



B3701  
Small top access



B6009  
Top access aluminium

### Horizontal cable management



C4136  
Cable brackets  
In standard (x3)



C4112  
Cable tray  
In option

### Laptop Security



C4138  
On the C-leg

### Vertical cable management



C4113  
C-leg vertical cable riser  
Fixed to the leg in standard



C4110  
4-leg vertical cable clips  
2 per leg clipped to the leg in standard



C5389  
Cable spine  
In option

## System overview

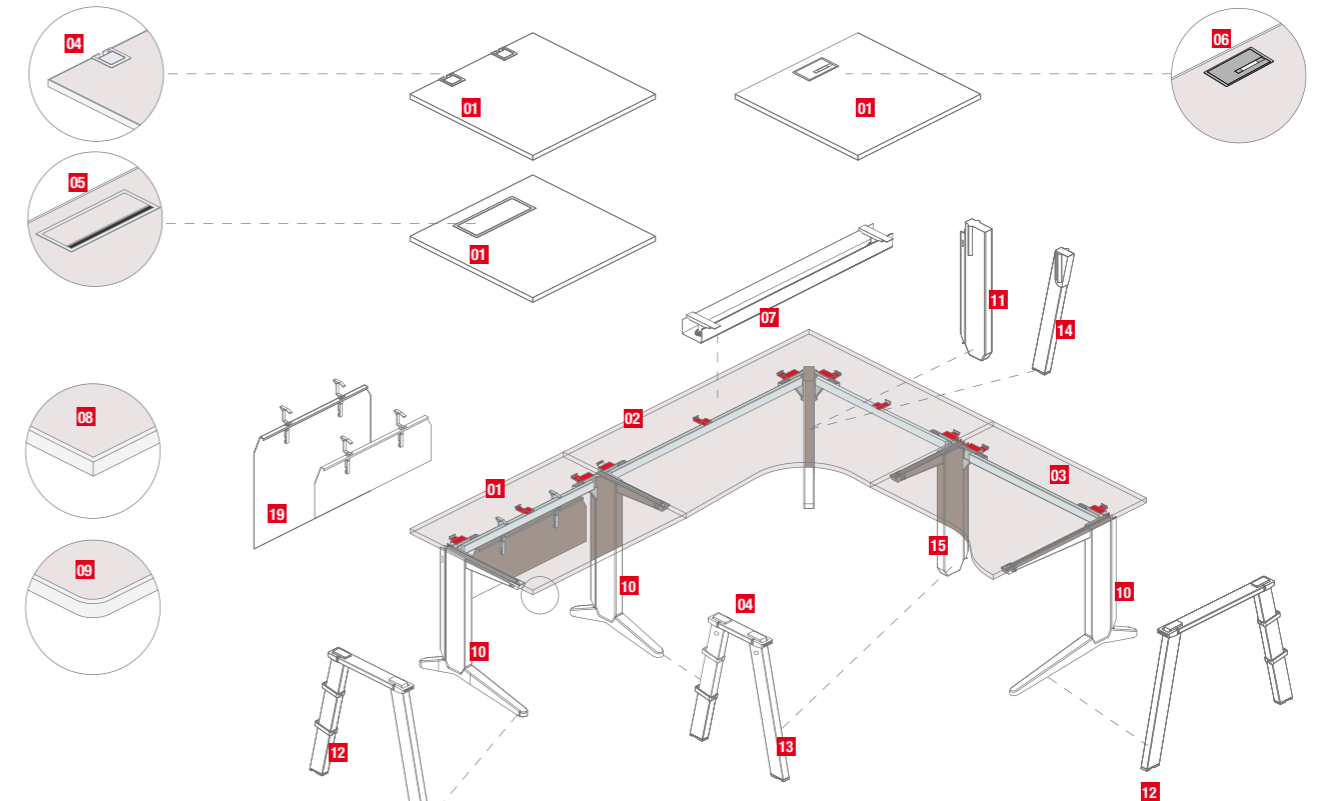

### Workstation

- 01 Straight
- 02 Corner core
- 03 Transition

### Cable management

- 04 Cable apertures (x2)
- 05 Top Access Aluminium
- 06 Small Top Access
- 07 Large capacity cable management

### Top shape

- 08 4 standard corner 90°, straight edge
- 09 Radius 35mm

### Right/left support

- 10 C-leg P660/800/1000mm
- 11 Corner C-leg
- 12 4-legs P660/800/1000mm
- 13 4-legs shared P660/800/1000mm
- 14 Corner 4 legs
- 15 Transition leg
- 16 Tapered leg
- 17 Tilt tapered leg

### Extension

- 18 Extension

### Modesty panel

- 19 Modesty panel

### Legs - H730

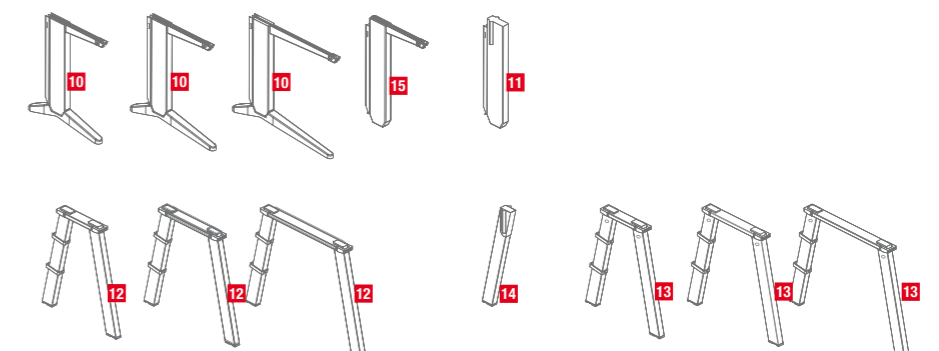

# Statement of line

## Straight



## Compact double wave

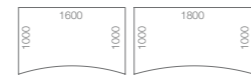

## Transitions

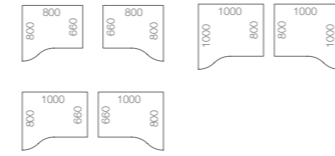

## Optima



## Straight extensions



## 90° junction

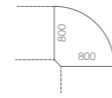

## Other extension tops

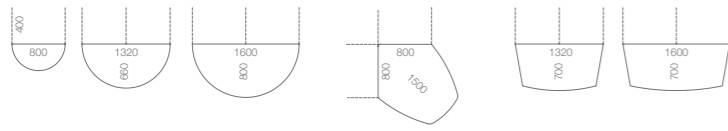

## Asymmetric pentagon

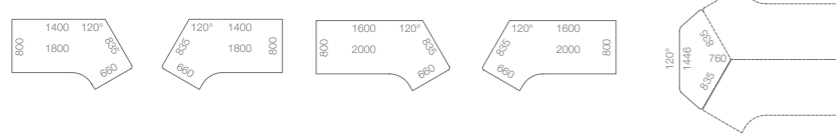

## 120° symmetrical pentagon

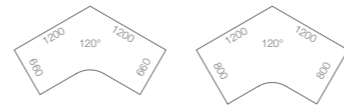

## Symmetric corner cores

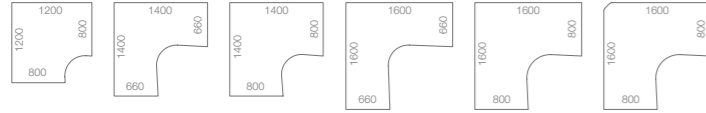

## Asymmetric corner cores

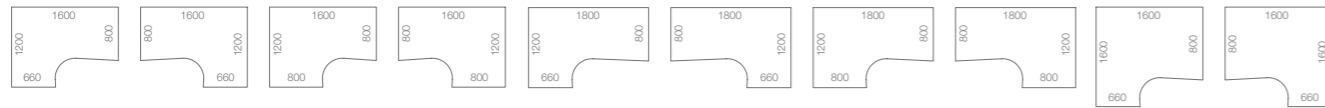

## Compact corner cores

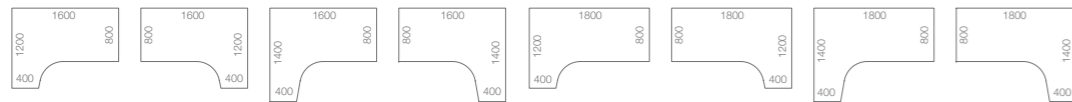

## Reception top

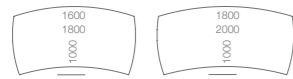

## Asymmetrical compact corner cores



## Straight top + Extension



## Conferencing

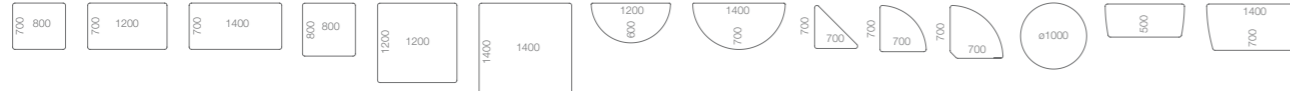

# Storage

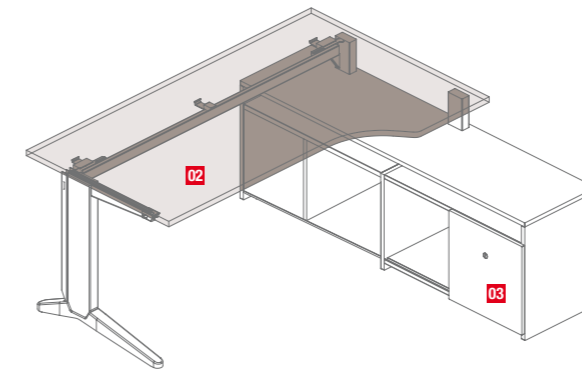
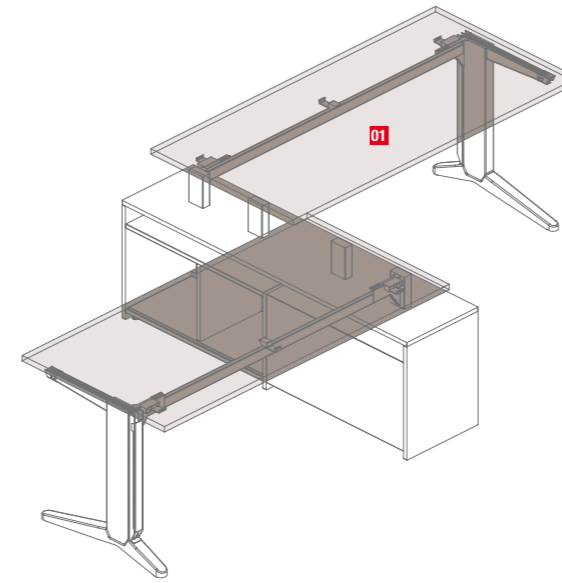

## Straight with storage

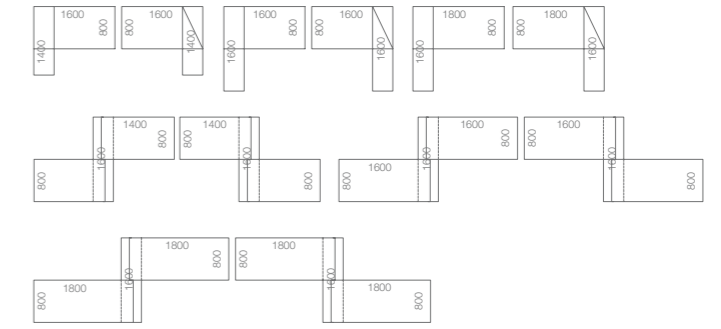

## Optima tops with storage



## Compact corner core with storage

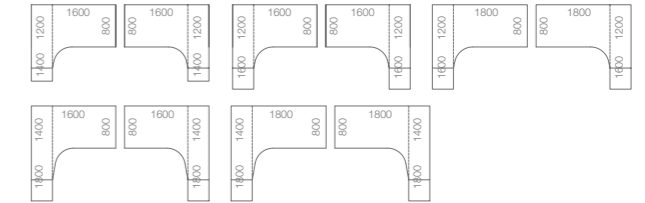

### Lateral storage

- 01 Duo lateral storage + 2 tops Straight
- 02 Solo lateral storage + 1 top Optima
- 03 Sliding door for lateral storage

### Partito shelf

- 05 Single shelf
- 06 Shared shelf
- 07 Book-ends

### Partito rail

- 04 Partito rail

### Worktools

- 08 1+1 long tray
- 09 1+1 A4 letter tray across

## 3rd level organisation

