Collaborative Surfaces Specification Guide

Availability

Electronic price list updated with release 200.N (U.S.) and 156.N (Canada), dated August 19, 2024.

All specifications subject to change without notice. Reference the electronic catalog/Hedberg for current pricing.

Transitional products in this specification guide are **maintained for existing customers only** and are likely to be phased out over time. These products are indicated with a **Ⓜ**. Products that are scheduled to be culled are indicated with an **ⓧ**, followed by the last order entry date.

Surface Materials

The surface materials team has announced the launch of the Finish Library, found at www.steelcase.com/finishlibrary/.

► For a list of all trademarks, refer to the last page of this specification guide. © 2024 Steelcase Inc.

Working with This Specification Guide

Ten Tips: How to Get The Most Out of This Book **2**

Additional Resources **4**

Statement of Line **6**

Material Resources

Wall Mounted **13**

Mobile and Privacy **67**

Accessories **83**

Resources



For Canadian Pricing

Canadian factor can be found at www.steelcase.com/CADpricing/.

Calculate in the following order to avoid rounding errors:

- Multiply the base price and each option by the Canadian factor.
- Round each to the nearest dollar.
- Add base and options for total list price.

Ten Tips: How to Get the Most Out of This Book

Tip 1

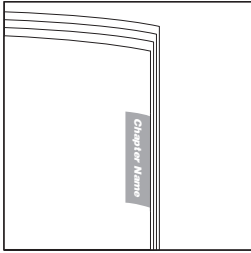

Watch the tabs on the right-hand edges of the pages. They'll always indicate which chapter you are in.

Tip 2

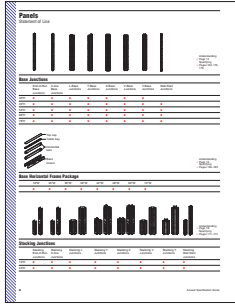

Use the Statement of Line pages for an overview of the available components, their sizes, and page references for additional information. Each *Understanding* chapter includes a statement of line after the table of contents.

Tip 3



Find cross references by looking for page numbers flagged with an arrow.

Tip 4

Study the product detail pages in the *Understanding* section to learn everything an expert knows about specific products. Each product detail page in this section contains the following features, where applicable:

- Product Drawing
- Actual Dimensions
- Product Details
- Connections
- Wiring and Cabling
- Surface Materials
- Application Topics

Product Drawing shows you what the product looks like and points out important features.

Product Details gives specific information on the product and how it is used.

Connections describes how the product is assembled or how it attaches to another product.

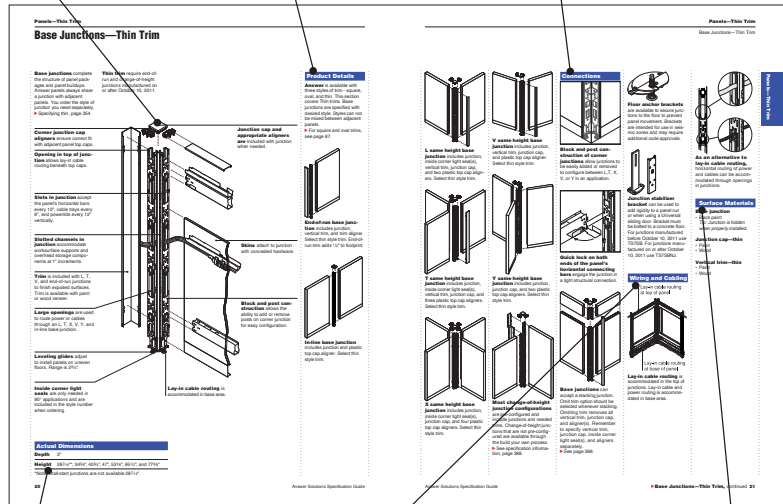

Actual Dimensions table lists the dimensions of the product.

Wiring and Cabling details the power and cable-management and cable routing capabilities of the product.

Surface Materials lists what material is used for each part of the product.

Tip 5

Refer to the specifying pages for all the information needed to order a product. Each product specifying page contains a variety of elements to help you complete a specification:

- Product Drawing
- Standard Includes
- Required to Specify
- Options
- Related Products
- Specification Information
 - Dimensions
 - Style Number
 - Price

Product Drawing shows you what the product looks like.

Standard Includes (under the red or dark grey band) provides a list of what comes standard with the product.

Required to Specify (under the red or dark grey band) itemizes the information that you must provide to order the standard product and the preferred sequence for specification.

Specification Information (under the teal or light grey band) provides product dimensions, style numbers, and prices for the standard product and any surface material choices that are available.

The image shows two pages from a specification guide. The left page is titled 'Base Horizontal Frame Packages—Thin Trim' and features a product drawing of a window frame. Below the drawing are sections for 'Standard Includes', 'Options', and 'Required to Specify'. The right page is titled 'Panel—Thin Trim' and features a product drawing of a window panel. Below the drawing is a 'Specification Information' table with columns for 'Width', 'Style Number', 'LWA', 'Price', and 'Option'. The table lists various window styles and their corresponding prices.

Options (under the black band) lists all the options that apply to the product, their price, and what is required to specify.

Related Products provide specification information for products that are directly related.

Tip 6

Required to Specify

Specify with *Customiz Stain*

Italic typeface on specifying pages usually identifies wording that you should use in your order.

i

Tip 7

To determine how many skins are needed to complete a panel, consult the table at the right.
Tip: Remember to order skins for both sides of the panel buildup.

Watch for tips throughout the text that give you explanations and helpful instructions.

Tip 8

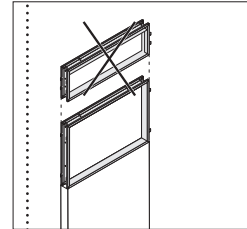

Learn what you cannot do by looking for drawings crossed out with an "X."

Tip 9

Use the surface materials listings in the Surface Materials section of this book to find surface material color numbers.

Tip 10

Style Number	Page
TS7042BL	131
TS7042S	130
TS7048BL	131
TS7048S	130
TS7060BL	131
TS7060S	130
TS7072BL	131

Refer to the style number index when you know a style number and you need to find the page that has more details about the product.

Additional Resources

Collaborative Surfaces products are supported with informational materials, tools, and software to help you plan, specify, and order an installation efficiently.

Printed Materials

Other Specification Guides

Steelcase offers a comprehensive portfolio of furniture and solutions. For the full offering of products, refer to the individual product specification guides. These can be accessed at the www.steelcase.com web site or at village.steelcase.com

Computer Tools

Electronic Catalog

Accurate sales quotations and purchase orders for Steelcase products are created with specification software that uses Steelcase Electronic Catalog data. Use the data to specify and price style numbers and options for every Steelcase product. The data is updated bimonthly by Steelcase and provided to software programs including: the Hedberg Business System, SmartTools—Steelcase's design and specification software (for more information on SmartTools, please email SmartTools@steelcase.com), the ProjectMatrix Project Symbols libraries, as well as 20-20 CAP Studio.

Furniture Symbol Graphic Data

Steelcase creates 2D and 3D furniture symbols (with attributes) for planning and initially specifying Steelcase products. This data is incorporated into several add-on software packages that work in either a Microstation or an AutoCAD drafting environment.

Digital Publications

You can access these digital publications at www.steelcase.com or village.steelcase.com.

Support

Steelcase Capabilities

Steelcase products are distributed, installed, and serviced through a network of more than 600 dealers worldwide. Steelcase is also represented with offices and corporate showrooms in 26 U.S. cities, 4 Canadian cities, and in France, Germany, Great Britain, and Japan. Every Steelcase product meets our exceptionally high standards of quality and durability and comes with the Steelcase assurance of excellence in service.

For ordering or product assistance,

please call your local dealer, the Steelcase Solutions Resource Team, or the Steelcase Solutions Fulfillment Team at 1.888.STEELCASE (1.888.783.3522) or send an e-mail to lineone@steelcase.com.

Call the Steelcase Solutions Resource Team prior to placing an order, when working on a bid, or when you need information about product applications and specifications.

Call the Steelcase Solutions Fulfillment Team if you have submitted an order to Steelcase and you need to speak to your Solutions Fulfillment Team Representative about the order. Also call if you have any post-shipment quality concerns or service parts questions.

For warranty information, please go to: <http://www.steelcase.com/warranty/>.

Outside the U.S.A., Canada, Mexico, Puerto Rico, and the U.S. Virgin Islands, call 1.616.247.2500.

For information about Steelcase, the name of your nearest Steelcase dealer, or for product literature, call 1.800.333.9939 or visit our Web site: www.steelcase.com.

Sustainability

At Steelcase, we believe business can be a force for good. We create long-lasting products that are better for people and better for the planet. Our products and operations use life cycle thinking to meet our commitment to reducing climate change. This commitment is reinforced by practices such as designing to minimize global warming and other life cycle impacts, ensuring material health, and enabling end-of-use strategies.

To learn more at a corporate level, visit: <https://www.steelcase.com/discover/steelcase/esg-overview/environmental/>

Product Environmental Profiles, which provide key environmental attributes such as recycled content, embodied carbon and recyclability, as well as product certifications can be found by searching for Steelcase at Origin.build.

Statement of Line

Wall Mounted

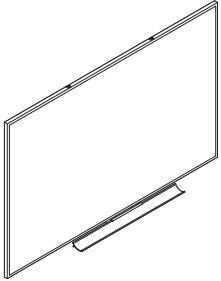

Parametric Premium Whiteboards and Tackboards
Understanding
▶ Pages 16 and 26
Specifying
▶ Pages 28 and 37–38

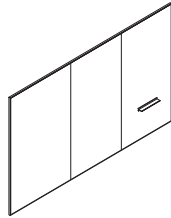

Flow
Understanding
▶ Page 40
Specifying
▶ Page 38

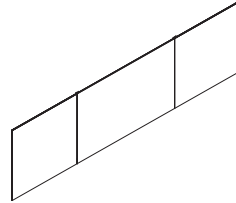

Horizontal Flow
Understanding
▶ Page 44
Specifying
▶ Page 46

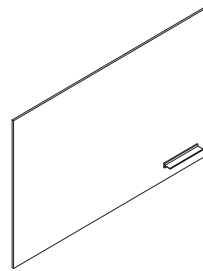

Sans
Understanding
▶ Page 48
Specifying
▶ Page 50

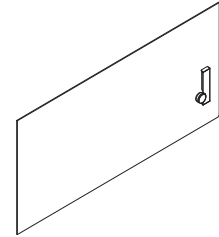

Sans Light
Understanding
▶ Page 51
Specifying
▶ Page 53

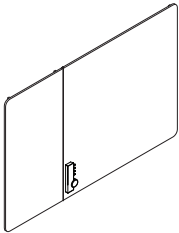

Accord
Understanding
▶ Page 54
Specifying
▶ Page 55

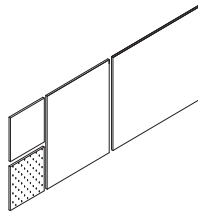

Motif
Understanding
▶ Page 56
Specifying
▶ Pages 57–58

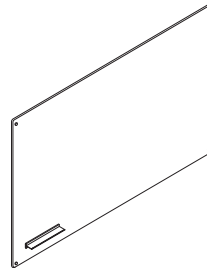

Serif
Understanding
▶ Page 59
Specifying
▶ Page 60

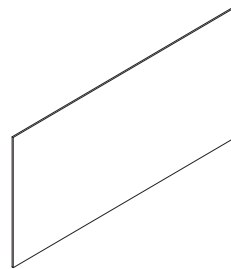

Tac
Understanding
▶ Page 61
Specifying
▶ Page 62

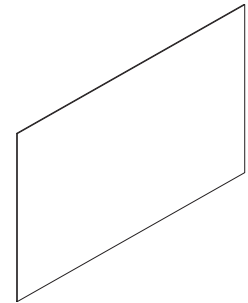

Glass
Understanding
▶ Page 63
Specifying
▶ Page 64

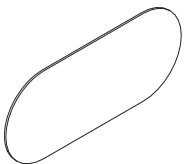

Frank Lloyd Wright Racine Whiteboard
Understanding
▶ Page 65
Specifying
▶ Page 66

Mobile, Privacy, and Accessories

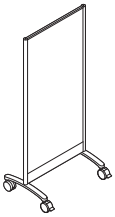

Groupwork Screens

Understanding
 ▶ Page 68
 Specifying
 ▶ Page 70

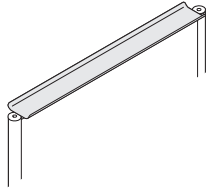

Groupwork Marker Trays

Understanding
 ▶ Page 68
 Specifying
 ▶ Page 72

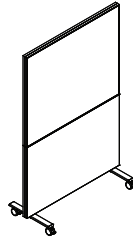

Textura Mobile

Understanding
 ▶ Page 73
 Specifying
 ▶ Page 74



Verb Personal Whiteboard

Understanding
 ▶ Page 73
 Specifying
 ▶ Page 76



Verb Easel

Understanding
 ▶ Page 75
 Specifying
 ▶ Page 77

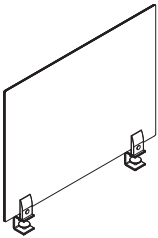

Boundri

Understanding
 ▶ Page 80
 Specifying
 ▶ Page 82

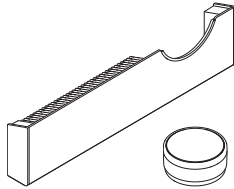

Collaborative ToolBar

Understanding
 ▶ Page 84
 Specifying
 ▶ Page 85

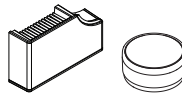

Collaborative ToolBar Mini

Understanding
 ▶ Page 84
 Specifying
 ▶ Page 85



Material Resources

Material Resources	
e ³ environmental CeramicSteel	10
Cleaning/Daily Care and Maintenance	11
Material Description	12

e³ environmental CeramicSteel

The e³ environmental CeramicSteel Difference

Steelcase Premium White Boards incorporate the e³ environmental CeramicSteel surface, which is the first and only ecologically intelligent whiteboard surface to receive a MBDC Cradle to Cradle Bronze certification. Cradle to Cradle certification evaluates products for environmentally safe and healthy materials; energy and water use during production, the ability to recycle and reuse materials, and social responsibility. Steelcase has created its fourth generation of CeramicSteel writing surfaces, e³, which delivers the properties of its best selling writing surface, P³ CeramicSteel, and complies with the Cradle to Cradle certification criteria. Steelcase will continue to follow standards set forth by MBDC Cradle to Cradle certification to reaffirm our commitment to sustainability. For over five decades, millions of boards have been produced around the world using P³ CeramicSteel. Steelcase used this cross section of consumers to gather the information that helped determine what the next generation of writing surfaces should provide. Our internationally renowned R&D team worked with experts in the field of ceramics and technology to create e³ environmental CeramicSteel surface – the new industry standard for superior quality.

The e³ environmental CeramicSteel Advantage

The ceramic finish consists of a specially formulated glass substance applied by machine. The e³ environmental CeramicSteel surface is fused to steel at a temperature of approximately 1500 degrees Fahrenheit for whiteboards. It registers at a minimum of five (5) on the revised Mohs hardness scale.

Benefits of e³

- Ultra-smooth writing surface
- Improved erasability
- Greater color contrast
- Significantly less surface/light distortion
- Optimum eye comfort
- Enhanced visibility
- Reduced chalk pressure, greater adherence
- Increased chalk/surface contrast
- Accepts magnets

Environmental Features

- Enamel fused to cold-rolled enameling-grade steel
- In all coatings, the total amount of heavy metals cadmium, mercury, hexavalent chromium, and lead is less than 0.1%
- All coatings are free of arsenic and antimony
- No Volatile Organic Compounds (VOCs)
- Steel core is made from minimum 30% post-consumer and post-industrial waste
- e³ environmental CeramicSteel surface is 99% recyclable

Maintenance

Before the first use of your CeramicSteel:

- Remove the protective film.
- Wipe board with a clean cloth moistened with a high-quality whiteboard cleaner.
- Wipe surface dry with a clean cloth.

Daily cleaning instructions for your CeramicSteel:

- Wipe surface with a clean cloth moistened with warm water.
- Wipe surface dry with a clean cloth.

More thorough cleaning may be required if writing is left on the board for more than two days.

Textura Fabric Cleaning and Care

Wipe with a damp cloth using soap and water or use proprietary upholstery shampoo.

- For deeper cleaning use alcohol spray or wipes. Bleach can be used by following the guidelines below.
- Anti-bacterial sprays and wipes can be used to wipe down the fabric to disinfect.

General commercial disinfection:

- Use a household bleach (containing approximately 4.5 oz per 100 oz of sodium hypochlorite), which should then be used in a 1:10 dilution.
- Follow the instructions of the brand.
- Measure out the required dose in relation to the quantity of water, soak a white or lightly colored cloth in the solution, squeeze out any excess liquid and gently wipe the fabric before leaving dry.

Acoustic Cleaning and Care

Remove spills immediately using damp, clean cloth. Dab with a clean, soft white cloth dampened with a mild solution of liquid detergent and warm water. Repeat using only clean water, then pat dry with a lint free cloth. Always test in an inconspicuous area first. Avoid using wax polishes, solvents or concentrated abrasives. For more difficult stains, dampen a soft white cloth with a solution of household bleach (10% bleach / 90% water). Dab gently. Repeat using only a clean, water dampened cloth to remove bleach concentration then pat dry with a lint free cloth.

Note: Fabrics have been developed to withstand regular cleaning maintenance and disinfection. Please follow the manufacturer instructions on cleaning and disinfection agents. We recommend spot testing on an inconspicuous part of the material first. Fabric samples are available for testing by contacting samples@polyvision.com.

Markers

Use any high-quality dry erase marker.

CAUTION

For optimal performance, Steelcase recommends the use of high quality solvent-based dry-erase markers, as opposed to water-based dry-erase markers (also called "low odor markers"). Low odor markers do not perform as well as solvent-based because the water takes longer to dry and the ink clings more aggressively to the board's surface, leaving behind a film. Replace markers when almost dry to avoid poor erasability. Replace the eraser felt regularly. Dirty felt or erasers will result in poor erasability.

Removing Permanent Marker

Option 1:

- Write over the top of the permanent marker ink with a dry-erase marker
- Simply erase

Option 2:

- Moisten a clean, dry cloth with isopropyl alcohol
- Wipe the board in a circular motion to loosen marker residue
- Rinse with clear water
- Dry the board with a clean cloth
- Repeat these steps as necessary

Installer's Instructions for Initial Cleaning at Time of Installation

NOTE: These initial cleaning instructions are shipped with every board.

- For initial cleaning, wipe your board with a clean cloth moistened by a mild, alcohol-based cleaner.
- Rinse with clear water. This step is simple, but very important.
- Wipe dry with a clean cloth.

Material Description

e³ environmental CeramicSteel is produced by a controlled, continuous coil-coating process. The surface consists of a steel core of .013" and .019" thickness covered on both sides with thin enamel coatings. The ceramic finish is fused to the steel at a temperature of approximately 1500°F for whiteboard and 1250°F for chalkboard.

Characteristic e³ environmental CeramicSteel

Writeability	Whiteboards can be written on with any dry-erase, semi-permanent, water-soluble, permanent marker, pen, or crayon without damaging the surface. Chalkboards have a superior, low-gloss, matte finish that readily accepts chalk providing a sharp, unbroken line with less pressure and maximum surface adherence.
Visibility	Contrast/waviness for whiteboards (light and dark effects) shall be no greater than 15 when tested with BYK - Gardner Wave Scan 5+ measurement device showing visual acuity (contrast sensitivity) to the human eye at distances greater than 3 meters (10'-0"). Contrast/waviness for chalkboards (light and dark effects) shall be no less than 20 when tested with the contrast measurement test with 773-gram load on chalk. Resolution (visual acuity) shall be based on 3 lines per degree and be visibly maintained beyond the current standard of 3 meters.
Erasability	For whiteboards, dry-erase marker ink can be wiped off easily with a dry cloth or standard eraser. Crayon, semi-permanent, and permanent marker pen inks can be removed with a solvent based cleaner. Chalkboards erase easily with a dry cloth or standard chalk eraser, retains minimal residual chalk dust, and will not leave "ghost writing." Color change (dark/light) after chalk erasing is reduced 60% from traditional surfaces.
Cleanability (Washability)	WET Ghost measurements on chalkboard surfaces before and after wet cleaning shall not exceed a factor of 0.49. For further care and cleaning instructions, refer to the www.steelcase.com/en/products/category/markerboards/static-boards .
Wearability	Vitrified glass-hard ceramic surface fused to light-gauge enameling grade steel at approximately +1250°F for chalkboards and +1500°F for whiteboards. High resistance to impact damage, abrasion, scratching, and color fading. The e ³ environmental CeramicSteel surface registers at a minimum of 5 for chalkboards and 6.5 for whiteboards on the revised Mohs hardness scale.
Magnet Capability	The e ³ environmental CeramicSteel surfaces are ideal for all magnets and magnetic impregnated materials and will not be scratched or damaged from the contact.
Flame Resistance	The e ³ surface is 100% non-combustible.

Low-Gloss Whiteboards

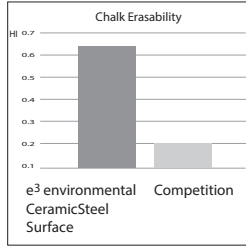

The ultra-smooth finish enables dry markers and chalk to glide easily across the e³ environmental CeramicSteel surface with minimal friction. The surface smoothness allows more dry-erase ink and chalk to be removed, improving erasability and eliminating "ghost writing".

*All whiteboard erasability tests were conducted using High-Gloss e³ environmental CeramicSteel surfaces.

Writeability

Low-Gloss provides the same writing characteristics as High-Gloss.

Erasability

Low-Gloss surfaces will not erase as thoroughly as High-Gloss surfaces. When this occurs, a water-dampened cloth will be required to erase the surface.

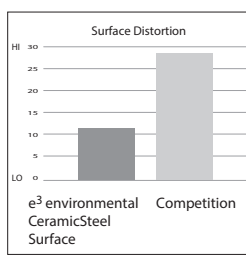

Surface distortion (Orange Peel) has been reduced significantly in direct comparison with the competition's surface.

Cleanability

After normal erasing of Low-Gloss surfaces, solvents may be used to remove harder-to-erase dry marker inks and residue from other pens. Always clear water rinse after using any cleaning agent on the surface.

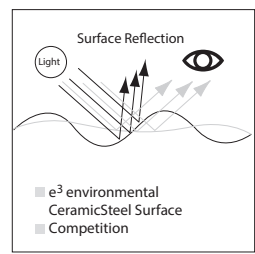

The e³ environmental CeramicSteel surface maximizes the performance of reflected light and reduces surface glare, resulting in improved visibility under a wide range of lighting conditions.

Wall Mounted

Wall Mounted

Understanding Parametrics	14
Parametric Premium Whiteboards and Tackboards	16
Edge Series	18
110 Series	20
555 Series	22
Polyvision Parametric Whiteboards	37
Flow	40
Horizontal Flow	44
Sans	48
Sans Light	51
Accord	54
Motif	56
Serif	59
Tac	61
Glass	63
Frank Lloyd Wright Racine Whiteboard	65

Understanding Parametrics

What is Parametric?

Parametrics is the ability for a customer to change dimensions of a product within pre-engineered limits.

Customers do not have to go through the specials process for dimensional size changes, thus reducing lead times.

Parametric Premium Whiteboards allow for the specification of non-modular sizes in three trim styles to suit a variety of design applications. The two style numbers are PWBWTBRD for whiteboards and PWBTKBRD for tackboards.

► Specifying, page 28

Trim styles:

- Edge Series
- 110 Series
- 555 Series

Parametric Polyvision whiteboards allow for specification of non-modular sizes with or without edge framing, varying by product selected. The two style numbers for Polyvision whiteboards are **PVFLOWPM** for Flow and **SANSPM** for Sans.

Two edge options are available:

- Sans—frameless only, optional accented edge colors
- Flow— anodized aluminum, framed or frameless

Parametric products requiring digital print graphics will need to be quoted by Specials. Refer to Sans, Sans Light, or Parametric Premium Whiteboards (modular sizes only) for standard graphic patterns and finish color options.

Overall Dimensions

Premium whiteboard and tackboard dimensions can be ordered to the $\frac{1}{16}$ of an inch within these ranges.

For whiteboards, the range of sizes is:

- Width: 24.25" to 192.25"
- Height: 18.25" to 48.25"

For tackboards, the range of sizes is:

- Width: 24.25" to 120.25"
- Height: 18.25" to 48.25"

Polyvision whiteboard dimensions vary by product selected and orientation. Dimensions can be ordered to the $\frac{1}{16}$ of an inch within these ranges. The marker tray option is not available for Sans or Flow parametric.

SANSPM the range of sizes is:

Horizontal:

- Width: 24" to 144" (610 mm to 3658 mm)
- Height: 24" to 46.625" (610 mm to 1184 mm)

Vertical:

- Width: 24" to 46.625" (610 mm to 1184 mm)
- Height: 46.6875" to 96" (1186 mm to 2438 mm)

PVFLOWPM the range of sizes is:

- Width: 46.6535 (1185 mm) The width for **PVFLOWPM** is a fixed dimension
- Height: 60" to 96" (1524 mm to 2438 mm)

Parametric Premium Whiteboards and Tackboards

Edge Series, 110 Series, and 555 Series

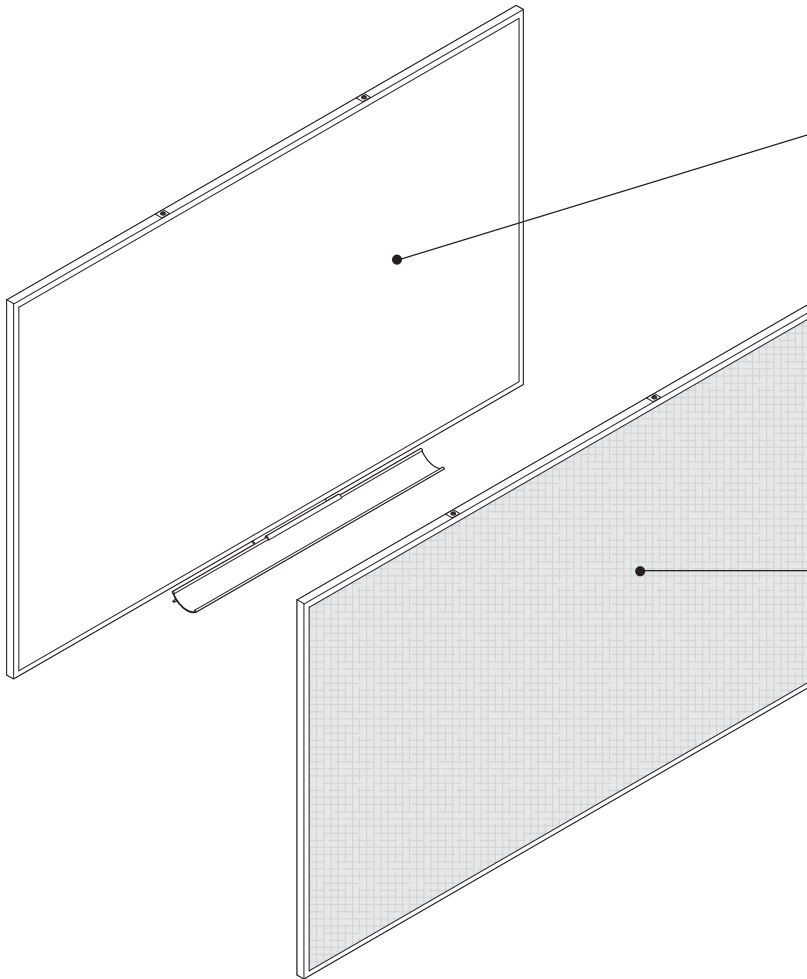

Writing surface is 7655 White High Gloss high-performance e³ environmental CeramicSteel.

Digital printing is available in either standard graphics or custom graphics (requires Polyvision print number) on modular sizes only. Please contact pvstudioteam@polyvision.com to acquire a custom print number.

Trim and marker tray are 8043 Clear Anodized Aluminum.

Tackable surface on tackboards is optional and available in a selection of standard or Select Surface fabrics. COM is also available.

Actual Dimensions

	Edge Series Trim PWBWTBRD PWBTKBRD	110 Series Trim PWBWTBRD PWBTKBRD	555 Series Trim PWBWTBRD PWBTKBRD
Overall Width	W: 24.25" – 192.25" T: 24.25" – 120.25"	W: 24.25" – 192.25" T: 24.25" – 120.25"	W: 24.25" – 192.25" T: 24.25" – 120.25"
Surface Width	1/2" in from Overall Width	1 1/2" in from Overall Width	3 3/4" in from Overall Width
Marker Tray Width (dimension will correspond with Overall Width)	18", 24", 36", 48", 60", 72", or 96"	Full-width (blade style)	Full-width (box style)
Overall Height	18.25" – 48.25"	18.25" – 48.25"	18.25" – 48.25"
Surface Height	3/8" in from Overall Width	1 5/8" in from Overall Width	3 3/4" in from Overall Width
Trim Depth	3/4" or 19 mm	5/8" or 16 mm	1" or 25 mm
Depth from Wall to Trim Face	1 1/8" or 29 mm	7/8" or 22 mm	1" or 25 mm
Marker Tray Depth	3 1/2" or 89 mm	2 5/8" or 67 mm	2 3/4" or 70 mm
Weight (lbs)	W: 9 lb – 189 7/8 lb T : 7 1/2 lb – 87 3/8 lb	W: 14 lb – 188 lb T : 8 lb – 74 lb	W: 14 2/5 lb – 196 lb T : 8 1/2 lb – 75 3/5 lb
Weight (kg)	W: 4.1 kg – 86.1 kg T : 3.4 kg – 39.6 kg	W: 6.4 kg – 85.0 kg T : 3.6 kg – 33.6 kg	W: 6.5 kg – 88.9 kg T : 3.9 kg – 34.3 kg

Edge Series

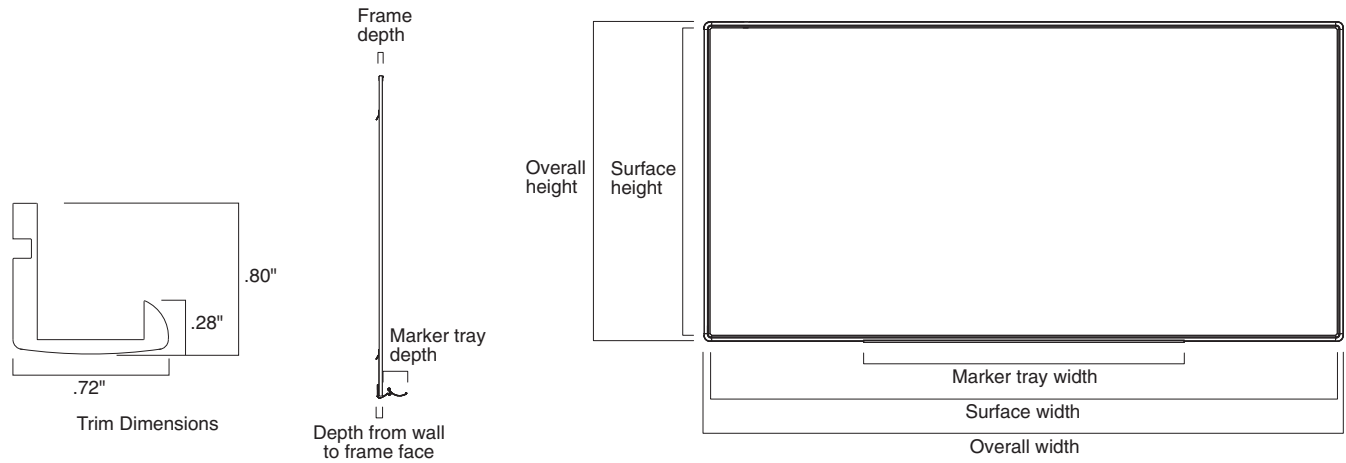

Dimensions				
	24"W x 18"H	36"W x 24"H	36"W x 48"H	48"W x 36"H
Overall Width	24 ¹ / ₄ " or 616 mm	36 ¹ / ₄ " or 921 mm	36 ¹ / ₄ " or 921 mm	48 ¹ / ₄ " or 1226 mm
Surface Width	23 ³ / ₄ " or 603 mm	35 ³ / ₄ " or 908 mm	35 ⁷ / ₈ " or 911 mm	47 ³ / ₄ " or 1213 mm
Marker Tray Width	18" or 457 mm	24" or 610 mm	24" or 610 mm	36" or 914 mm
Overall Height	18 ¹ / ₄ " or 464 mm	24 ¹ / ₄ " or 616 mm	48 ¹ / ₄ " or 1226 mm	36 ¹ / ₄ " or 921 mm
Surface Height	17 ⁷ / ₈ " or 454 mm	23 ⁷ / ₈ " or 606 mm	47 ³ / ₄ " or 1213 mm	35 ⁷ / ₈ " or 911 mm
Frame Depth	3/4" or 19 mm	3/4" or 19 mm	3/4" or 19 mm	3/4" or 19 mm
Depth from Wall to Frame Face	1 ¹ / ₈ " or 29 mm	1 ¹ / ₈ " or 29 mm	1 ¹ / ₈ " or 29 mm	1 ¹ / ₈ " or 29 mm
Marker Tray Depth	3 ¹ / ₂ " or 89 mm	3 ¹ / ₂ " or 89 mm	3 ¹ / ₂ " or 89 mm	3 ¹ / ₂ " or 89 mm
Weight (WB/TB) lbs	W: 9 lb T: 6.5 lb	W: 18 lb T: 13 lb	W: 35 ⁷ / ₈ lb T: 26 ³ / ₈ lb	W: 35 ⁷ / ₈ lb T: 26 ³ / ₈ lb
Weight (WB/TB) kg	W: 4.1 kg T: 2.9 kg	W: 8.2 kg T: 5.9 kg	W: 16.2 kg T: 12 kg	W: 16.2 kg T: 12 kg

► Dimensions, continued on next page

► **Dimensions, continued from previous page**

Dimensions				
	48"W x 48"H	60"W x 48"H	72"W x 48"H	96"W x 48"H
Overall Width	48 ¹ / ₄ " or 1226 mm	60 ¹ / ₄ " or 1530 mm	72 ¹ / ₄ " or 1835 mm	96 ¹ / ₄ " or 2445 mm
Surface Width	47 ³ / ₄ " or 1213 mm	59 ³ / ₄ " or 1518 mm	73 ¹ / ₄ " or 1822 mm	95 ³ / ₄ " or 2432 mm
Marker Tray Width	36" or 914 mm	48" or 1219 mm	48" or 1219 mm	48" or 1219 mm
Overall Height	48 ¹ / ₄ " or 1226 mm	48 ¹ / ₄ " or 1226 mm	48 ¹ / ₄ " or 1226 mm	48 ¹ / ₄ " or 1226 mm
Surface Height	47 ⁷ / ₈ " or 1216 mm	47 ⁷ / ₈ " or 1216 mm	47 ⁷ / ₈ " or 1216 mm	47 ⁷ / ₈ " or 1216 mm
Frame Depth	³ / ₄ " or 19 mm	³ / ₄ " or 19 mm	³ / ₄ " or 19 mm	³ / ₄ " or 19 mm
Depth from Wall to Frame Face	1 ¹ / ₈ " or 29 mm	1 ¹ / ₈ " or 29 mm	1 ¹ / ₈ " or 29 mm	1 ¹ / ₈ " or 29 mm
Marker Tray Depth	3 ¹ / ₂ " or 89 mm	3 ¹ / ₂ " or 89 mm	3 ¹ / ₂ " or 89 mm	3 ¹ / ₂ " or 89 mm
Weight (WB/TB) lbs	W: 47.5 lb T: 35 lb	W: 59.5 lb T: 43 ⁷ / ₈ lb	W: 71 1/3 lb T: 52.5 lb	W: 95 lb T: 70 lb
Weight (WB/TB) kg	W: 27 kg T: 19.9 kg	W: 32.4 kg T: 23.8 kg	W: 32.4 kg T: 23.8 kg	W: 43.1 kg T: 31.7 kg

Dimensions			
	120"W x 48"H	144"W x 48"H	192"W x 48"H
Overall Width	120 ¹ / ₄ " or 3054 mm	144 ¹ / ₄ " or 3664 mm	192 ¹ / ₄ " or 4883 mm
Surface Width	119 ³ / ₄ " or 3651 mm	143 ³ / ₄ " or 3651 mm	191 ³ / ₄ " or 4870 mm
Marker Tray Width	60" or 1524 mm	72" or 1829 mm	96" or 2438 mm
Overall Height	48 ¹ / ₄ " or 1226 mm	48 ¹ / ₄ " or 1226 mm	48 ¹ / ₄ " or 1226 mm
Surface Height	47 ⁷ / ₈ " or 1216 mm	47 ⁷ / ₈ " or 1216 mm	47 ⁷ / ₈ " or 1216 mm
Frame Depth	³ / ₄ " or 19 mm	³ / ₄ " or 19 mm	³ / ₄ " or 19 mm
Depth from Wall to Frame Face	1 ¹ / ₈ " or 29 mm	1 ¹ / ₈ " or 29 mm	1 ¹ / ₈ " or 29 mm
Marker Tray Depth	3 ¹ / ₂ " or 89 mm	3 ¹ / ₂ " or 89 mm	3 ¹ / ₂ " or 89 mm
Weight (WB/TB) lbs	W: 118 ³ / ₄ lb T: 87 ³ / ₈ lb	142 ³ / ₈ lb	189 ⁷ / ₈ lb
Weight (WB/TB) kg	W: 53.8 kg T: 39.6 kg	64.6 kg	86.1 kg

Wall Mounted

110 Series

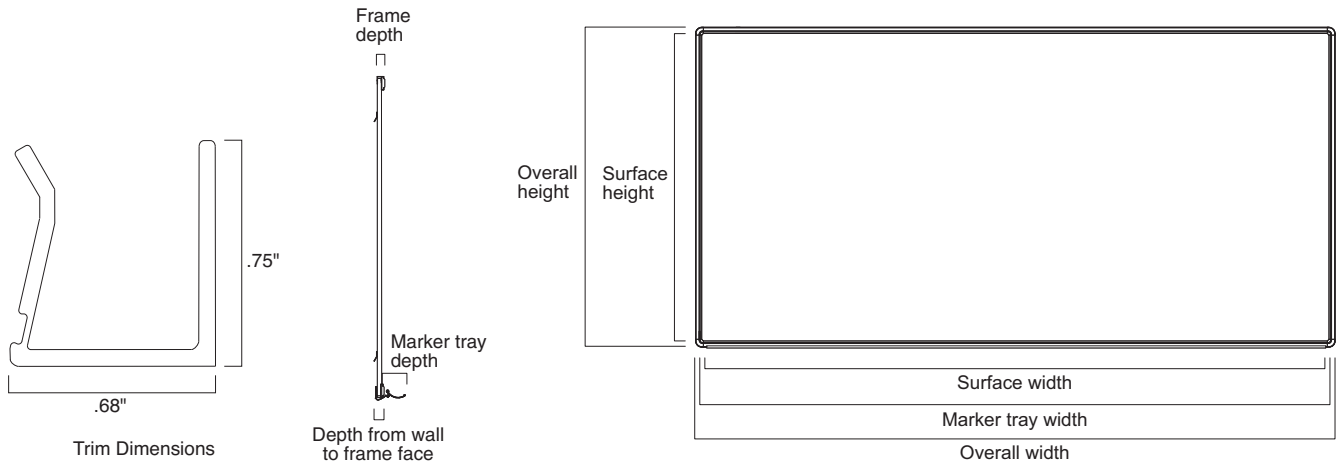

Dimensions					
	24"W x 18"H	36"W x 24"H	36"W x 48"H	48"W x 36"H	48"W x 48"H
Overall Width	24 ¹ / ₄ " or 616 mm	36 ¹ / ₄ " or 921 mm	36 ¹ / ₄ " or 921 mm	48 ¹ / ₄ " or 1226 mm	48 ¹ / ₄ " or 1226 mm
Surface Width	22 ³ / ₄ " or 578 mm	34 ³ / ₄ " or 883 mm	34 ³ / ₄ " or 883 mm	46 ³ / ₄ " or 1187 mm	46 ³ / ₄ " or 1187 mm
Marker Tray Width	22 ¹ / ₂ " or 572 mm	34 ¹ / ₂ " or 876 mm	34 ¹ / ₂ " or 876 mm	46 ¹ / ₂ " or 1181 mm	46 ¹ / ₂ " or 1181 mm
Overall Height	18 ¹ / ₄ " or 464 mm	24 ¹ / ₄ " or 616 mm	48 ¹ / ₄ " or 1226 mm	36 ¹ / ₄ " or 921 mm	48 ¹ / ₄ " or 1226 mm
Surface Height	16 ⁵ / ₈ " or 422 mm	22 ⁵ / ₈ " or 575 mm	46 ⁵ / ₈ " or 1184 mm	34 ³ / ₄ " or 883 mm	46 ⁵ / ₈ " or 1184 mm
Frame Depth	5 ⁸ / ₈ " or 16 mm	5 ⁸ / ₈ " or 16 mm	5 ⁸ / ₈ " or 16 mm	5 ⁸ / ₈ " or 16 mm	5 ⁸ / ₈ " or 16 mm
Depth from Wall to Frame Face	7 ⁸ / ₈ " or 22 mm	7 ⁸ / ₈ " or 22 mm	7 ⁸ / ₈ " or 22 mm	7 ⁸ / ₈ " or 22 mm	7 ⁸ / ₈ " or 22 mm
Marker Tray Depth	2 ⁵ / ₈ " or 67 mm	2 ⁵ / ₈ " or 67 mm	2 ⁵ / ₈ " or 67 mm	2 ⁵ / ₈ " or 67 mm	2 ⁵ / ₈ " or 67 mm
Weight (WB/TB) lbs	W: 10.4 lb T: 6 lb	W: 19.5 lb T: 12 lb	W: 35.5 lb T: 26 ¹ / ₈ lb	W: 35 lb T: 26 ¹ / ₈ lb	W: 47 lb T: 33.5 lb
Weight (WB/TB) kg	W: 4.6 kg T: 2.7 kg	W: 8.8 kg T: 5.4 kg	W: 16 kg T: 11.4 kg	W: 16 kg T: 11.4 kg	W: 21.3 kg T: 15.2 kg

► Dimensions, continued on next page

► **Dimensions, continued from previous page**

Dimensions				
	60"W x 48"H	72"W x 48"H	96"W x 48"H	120"W x 48"H
Overall Width	60 ¹ / ₄ " or 1530 mm	72 ¹ / ₄ " or 1835 mm	96 ¹ / ₄ " or 2445 mm	120 ¹ / ₄ " or 3054 mm
Surface Width	58 ³ / ₄ " or 1492 mm	70 ³ / ₄ " or 1797 mm	94 ³ / ₄ " or 2407 mm	118 ³ / ₄ " or 3016 mm
Marker Tray Width	58 ¹ / ₂ " or 1486 mm	70 ¹ / ₂ " or 1791 mm	94 ¹ / ₂ " or 2400 mm	118 ¹ / ₂ " or 3010 mm
Overall Height	48 ¹ / ₄ " or 1226 mm	48 ¹ / ₄ " or 1226 mm	48 ¹ / ₄ " or 1226 mm	48 ¹ / ₄ " or 1226 mm
Surface Height	46 ⁵ / ₈ " or 1184 mm	46 ⁵ / ₈ " or 1184 mm	46 ⁵ / ₈ " or 1184 mm	46 ⁵ / ₈ " or 1184 mm
Frame Depth	⁵ / ₈ " or 16 mm	⁵ / ₈ " or 16 mm	⁵ / ₈ " or 16 mm	⁵ / ₈ " or 16 mm
Depth from Wall to Frame Face	⁷ / ₈ " or 22 mm	⁷ / ₈ " or 22 mm	⁷ / ₈ " or 22 mm	⁷ / ₈ " or 22 mm
Marker Tray Depth	2 ⁵ / ₈ " or 67 mm	2 ⁵ / ₈ " or 67 mm	2 ⁵ / ₈ " or 67 mm	2 ⁵ / ₈ " or 67 mm
Weight (WB/TB) lbs	W: 58 ¹ / ₂ lb T: 41 ⁵ / ₈ lb	W: 70.5 lb T: 50 ³ / ₈ lb	W: 94 lb T: 67 lb	117 ¹ / ₂ lb
Weight (WB/TB) kg	W: 26.7 kg T: 19 kg	W: 32 kg T: 22.8 kg	W: 42.6 kg T: 30.4 kg	53.3 kg

Dimensions		
	144"W x 48"H	192"W x 48"H
Overall Width	144 ¹ / ₄ " or 3664 mm	192 ¹ / ₄ " or 4883 mm
Surface Width	142 ³ / ₄ " or 3626 mm	190 ³ / ₄ " or 4858 mm
Marker Tray Width	142 ¹ / ₂ " or 3620 mm	190 ¹ / ₂ " or 4839 mm
Overall Height	48 ¹ / ₄ " or 1226 mm	48 ¹ / ₄ " or 1226 mm
Surface Height	46 ⁵ / ₈ " or 1184 mm	46 ⁵ / ₈ " or 1184 mm
Frame Depth	⁵ / ₈ " or 16 mm	⁵ / ₈ " or 16 mm
Depth from Wall to Frame Face	⁷ / ₈ " or 22 mm	⁷ / ₈ " or 22 mm
Marker Tray Depth	2 ⁵ / ₈ " or 67 mm	2 ⁵ / ₈ " or 67 mm
Weight (WB/TB) lbs	141 lb	188 lb
Weight (WB/TB) kg	64.0 kg	85.0 kg

Wall Mounted

555 Series

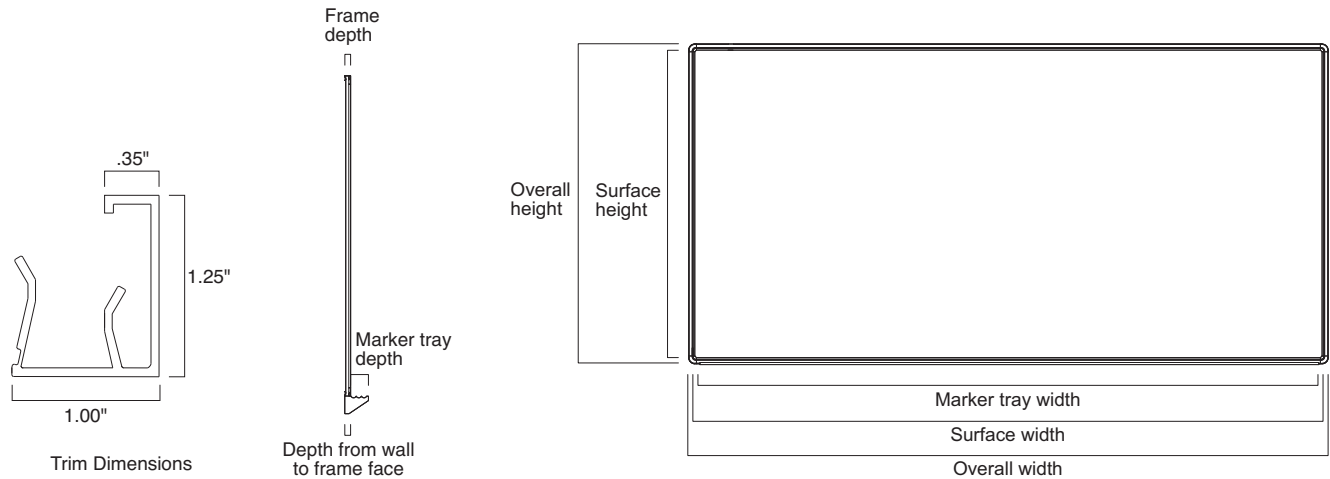

Dimensions				
	24"W x 18"H	36"W x 24"H	36"W x 48"H	48"W x 36"H
Overall Width	24 ¹ / ₄ " or 616 mm	36 ¹ / ₄ " or 921 mm	36 ¹ / ₄ " or 921 mm	48 ¹ / ₄ " or 1226 mm
Surface Width	21 ³ / ₄ " or 552 mm	33 ³ / ₄ " or 857 mm	33 ³ / ₄ " or 857 mm	33 ³ / ₄ " or 857 mm
Marker Tray Width	21 ¹ / ₂ " or 546 mm	33 ¹ / ₂ " or 851 mm	33 ¹ / ₂ " or 851 mm	33 ¹ / ₂ " or 851 mm
Overall Height	18 ¹ / ₄ " or 464 mm	24 ¹ / ₄ " or 616 mm	48 ¹ / ₄ " or 1226 mm	36 ¹ / ₄ " or 921 mm
Surface Height	14 ¹ / ₂ " or 368 mm	20 ¹ / ₂ " or 521 mm	44 ¹ / ₂ " or 1130 mm	44 ¹ / ₂ " or 1130 mm
Frame Depth	1" or 25 mm	1" or 25 mm	1" or 25 mm	1" or 25 mm
Depth from Wall to Frame Face	1" or 25 mm	1" or 25 mm	1" or 25 mm	1" or 25 mm
Marker Tray Depth	2 ³ / ₄ " or 70 mm	2 ³ / ₄ " or 70 mm	2 ³ / ₄ " or 70 mm	2 ³ / ₄ " or 70 mm
Weight (WB/TB) lbs	W: 10.4 lb T: 6.5 lb	W: 19.5 lb T: 12.5 lb	W: 36 ⁷ / ₈ lb T: 25 ⁷ / ₈ lb	W: 36 ⁷ / ₈ lb T: 25 ⁷ / ₈ lb
Weight (WB/TB) kg	W: 4.6 kg T: 2.9 kg	W: 8.8 kg T: 5.7 kg	W: 16.7 kg T: 11.7 kg	W: 16.7 kg T: 11.7 kg

► Dimensions, continued on next page

► **Dimensions, continued from previous page**

Dimensions				
	48"W x 48"H	60"W x 48"H	72"W x 48"H	96"W x 48"H
Overall Width	48 ¹ / ₄ " or 1226 mm	60 ¹ / ₄ " or 1530 mm	72 ¹ / ₄ " or 1835 mm	96 ¹ / ₄ " or 2445 mm
Surface Width	45 ³ / ₄ " or 1162 mm	57 ³ / ₄ " or 1467 mm	69 ³ / ₄ " or 1772 mm	93 ³ / ₄ " or 2381 mm
Marker Tray Width	45 ¹ / ₂ " or 1156 mm	57 ¹ / ₂ " or 1461 mm	69 ¹ / ₂ " or 1765 mm	93 ¹ / ₂ " or 2375 mm
Overall Height	48 ¹ / ₄ " or 1226 mm	48 ¹ / ₄ " or 1226 mm	48 ¹ / ₄ " or 1226 mm	48 ¹ / ₄ " or 1226 mm
Surface Height	44 ¹ / ₂ " or 1130 mm	44 ¹ / ₂ " or 1130 mm	44 ¹ / ₂ " or 1130 mm	44 ¹ / ₂ " or 1130 mm
Frame Depth	1" or 25 mm	1" or 25 mm	1" or 25 mm	1" or 25 mm
Depth from Wall to Frame Face	1" or 25 mm	1" or 25 mm	1" or 25 mm	1" or 25 mm
Marker Tray Depth	2 ³ / ₄ " or 70 mm	2 ³ / ₄ " or 70 mm	2 ³ / ₄ " or 70 mm	2 ³ / ₄ " or 70 mm
Weight (WB/TB) lbs	W: 49 lb T: 34.5	W: 61 ³ / ₈ lb T: 43 ¹ / ₈ lb	W: 73.5 lb T: 51 ⁷ / ₈ lb	W: 98 lb T: 69 lb
Weight (WB/TB) kg	W: 22.2 kg T: 15.7 kg	W: 27.8 kg T: 19.6 kg	W: 33.3 kg T: 23.5 kg	W: 44.5 kg T: 31.3 kg

Dimensions			
	120"W x 48"H	144"W x 48"H	192"W x 48"H
Overall Width	120 ¹ / ₄ " or 3054 mm	144 ¹ / ₄ " or 3664 mm	192 ¹ / ₄ " or 4883 mm
Surface Width	117 ³ / ₄ " or 2991 mm	141 ³ / ₄ " or 3600 mm	189 ³ / ₄ " or 4820 mm
Marker Tray Width	117 ¹ / ₂ " or 2985 mm	141 ¹ / ₂ " or 3594 mm	189 ¹ / ₂ " or 4813 mm
Overall Height	48 ¹ / ₄ " or 1226 mm	48 ¹ / ₄ " or 1226 mm	48 ¹ / ₄ " or 1226 mm
Surface Height	44 ¹ / ₂ " or 1130 mm	44 ¹ / ₂ " or 1130 mm	44 ¹ / ₂ " or 1130 mm
Frame Depth	1" or 25 mm	1" or 25 mm	1" or 25 mm
Depth from Wall to Frame Face	1" or 25 mm	1" or 25 mm	1" or 25 mm
Marker Tray Depth	2 ³ / ₄ " or 70 mm	2 ³ / ₄ " or 70 mm	2 ³ / ₄ " or 70 mm
Weight (WB/TB) lbs	122 ¹ / ₂ lb	147 lb	196 lb
Weight (WB/TB) kg	55.6 kg	66.7 kg	88.9 kg

Wall Mounted

Trim and Marker Trays:

Edge Series

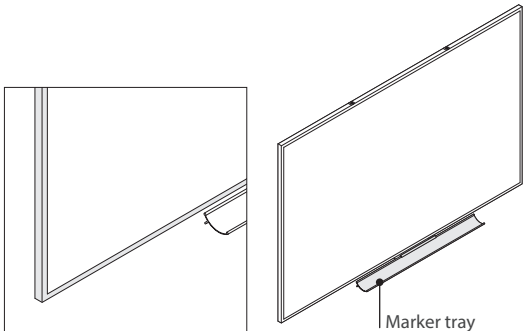

Trim is 1/4" with undersized marker tray. Both are clear anodized aluminum. Trim is also available in 4750 Champagne Metallic.

555 Series

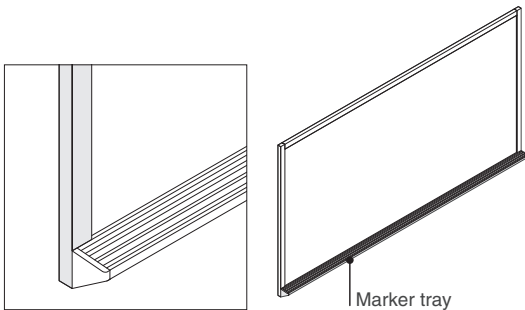

Trim is 1 1/4" with full width box style marker tray. Both are clear anodized aluminum.

110 Series

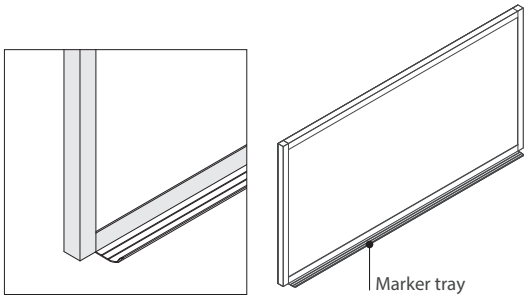

Trim is 3/4" with full width blade style marker tray. Both are clear anodized aluminum.

Product Details

Sizes of whiteboards and tackboards are nominal and parametric; refer to actual dimensions for exact specifications.

Modular size option allows specification of height and width in pre-defined combinations.

Whiteboards		Tackboards	
Height	Width	Height	Width
18.25	24.25	18.25	24.25
24.25	36.25	24.25	36.25
36.25	48.25	36.25	48.25
48.25	36.25	48.25	36.25
48.25	48.25	48.25	48.25
48.25	60.25	48.25	60.25
48.25	72.25	48.25	72.25
48.25	96.25	48.25	96.25
48.25	120.25	48.25	120.25
48.25	144.25*		
48.25	192.25*		

Tackboard construction is 3/8" fiber board over 1/8" hardboard.

Fabric is available on tackboards only and comes in a selection of standard or Select Surface fabrics. COM is also available.

▶ See page 92

The tray width for Edge Series will correspond to the overall whiteboard width. See the matrix below for the breakdown. The tray width for 110 and 555 Series will be the width of the board.

Board Width (Inches)	Tray Width
24.25000– 36.00000	18"
36.06250– 48.00000	24"
48.06250– 60.00000	36"
60.06250– 72.00000	48"
72.06250– 96.00000	48"
96.06250–120.00000	60"
120.06250–144.00000	72"
144.06250–192.25000	96"

A no tray option is also available for whiteboards.

Connections

Edge Series

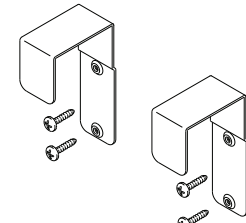
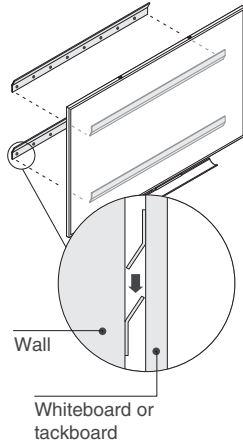

2" over panel bracket/hook mounting system allows for Premium Whiteboards to be mounted on Kick and Avenir.

3" over panel bracket/hook mounting system allows for Premium Whiteboards to be mounted on Answer and Montage.

110/555 Series

Metal cleat-mounting system is standard on Edge Series.

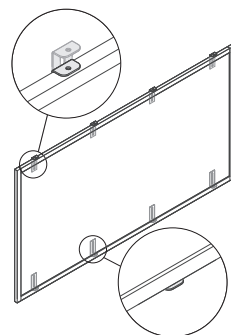
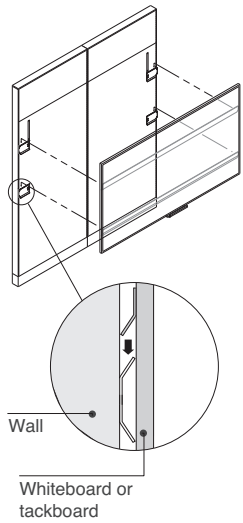

Wall-anchored mounting system is standard on 110 and 555 Series.

On- and off-module bracket allows for Premium Whiteboards to be mounted on Privacy Wall, Answer, or Kick using a standard metal cleat-mounting system.

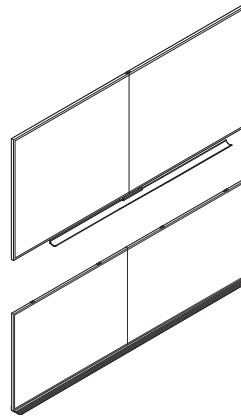

Spline joints allow larger format boards to be delivered in two equal pieces and require assembly on-site. There will be a visible seam where the boards and marker trays are joined that will not hinder the performance or writeability of the board in any way. They are available as options with upcharge on Edge, 110, and 555 trim types 120.25" and larger in width.

Additional options for 110 and 555 Series include maprail, map hook/clips, flag holder, and roller bracket.

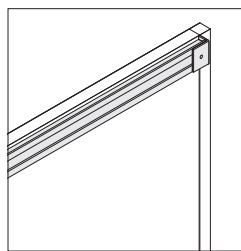

1" maprail is of cork construction and allows for versatility with accessories. Maprail is not available on tackboards.

Map hook/clip, flag holder, and roller bracket must be specified with maprail; cannot be specified separately.

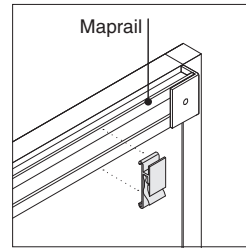

1" map hook/clip comes as a set of two and allows for ease in hanging maps and charts for presentation purposes.

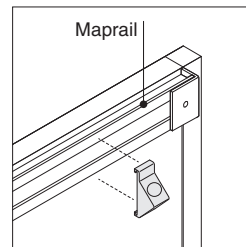

1" flag holder allows for convenient hanging of flags.

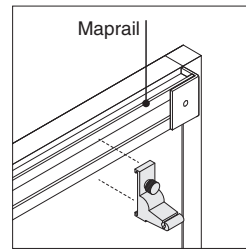

Roller bracket holds maps or roll-up projection screens and can be ordered if 1" maprail option is selected. Roller bracket is not available on tackboard.

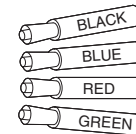

Package of four dry-erase markers (black, blue, red, and green) and one eraser is included with whiteboards.

Parametric Premium Whiteboards and Tackboards, continued

PPPW (Privacy Wall) and On/Off Module Bracket Application Guide

PPPW (Privacy Wall) Bracket Application Guide

- On- and off-module bracket for installation of whiteboards and tackboards on Privacy Wall, Answer, and Kick.
- Allows Premium Whiteboards to be mounted on Privacy Wall, Answer, Avenir, or Kick using a standard metal cleat mounting system.
- Ideal application on a Privacy Wall or when spanning multiple Answer/Kick panels with a single whiteboard.
- Not for use with 110 and 555 Series.
- Cannot install two boards at right angles.
- Ships with four or six non-handed brackets; field-modify for application by removing tabs per instructions.
- The required minimum number of PPPW (Privacy Wall) Brackets must be installed to ensure secure application of board.
- Brackets must be installed in the correct orientation; i.e. left or right hand, as indicated in the key and diagrams below.

NOTE: Space between panel face and rear of board is $\pm 1/4"$.

Standard Mounting Height and Centerline Application

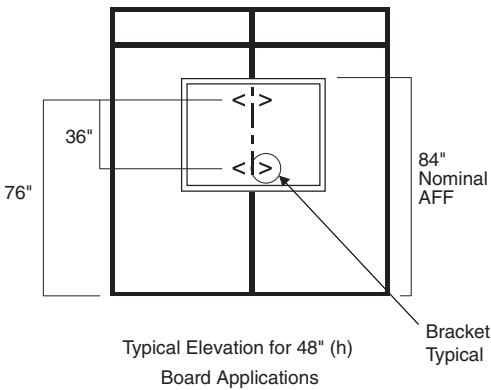

- 48"H x 48"W only

On-Module — Minimum Bracket Application

Board Width	48"	60"	72"	84"	96"	120"	144"	168"	192"
Minimum Number of Brackets	4	4	4	4	4	4	6	6	6

KEY:

- > Right Hand Application of PPPW Bracket
- < Left Hand Application of PPPW Bracket

Asymmetrical Off-Module Overhang Allowances and Minimum Bracket Application

Board Width	60"	72"	84"	96"	120"	144"	168"	192"
Minimum Number of Brackets	4	4	4	4	4	6	6	6
Dimension A - Maximum Overhang	18"	22"	25"	29"	36"	38"	38"	38"

NOTE: Bracket direction must be the same as the overhang direction. This example shows right hand bracket installation with right hand overhang.

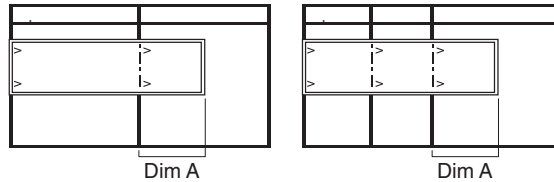

Symmetrical Off-Module Overhang Allowances and Minimum Bracket Application

Board Width	60"	72"	84"	96"	120"	144"	168"	192"
Minimum Number of Brackets	4	4	4	4	4	6	6	6
Dimension B - Maximum Overhang	18"	22"	25"	29"	36"	38"	38"	38"

NOTE: Dimension B must be equal on both the left and the right. For example, a 60" board may have a maximum 18" overhang both left and right side.

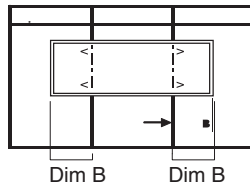

Digital printing is offered on Parametric Premium Whiteboards, Sans, Sans Light, and Flow products. Digital print graphics are permanently baked into the CeramicSteel surface and are scratch, abrasion, bacteria, chemical, fire, and graffiti resistant. Both standard and custom options are available.

Tip: Flow only available with custom option.

Standard Digital Print Options for Sans, Sans Light, and Premium Whiteboards

Patterns available in:

- 7676 Saffron
- 7677 Peacock
- 7678 Sea Salt
- 7679 Sterling Dark
- 7681 Sand
- 7682 Black

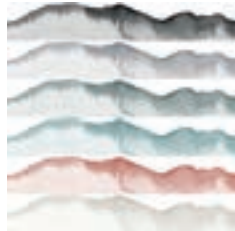

PV55 Agate



PV56 Brushstroke



PV57 Code



PV58 Data



PV59 DNA



PV60 Hive



PV61 Skyline



PV62 Soundwave



PV63 Speed



PV64 Summit

Patterns available in:

- 7679 Sterling Dark
- 7682 Black

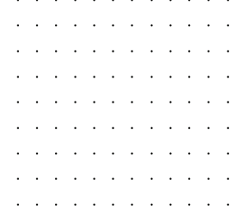

PV65 Dot Grid



PV66 Line Grid

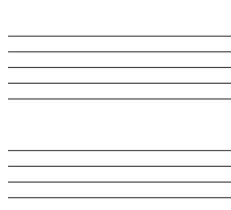

PV67 Music Lines

Tip: For custom graphics, please contact pvstudioteam@polyvision.com to acquire a custom print number.

Parametric Premium Whiteboards and Tackboards

Edge Series, 110 Series, and 555 Series

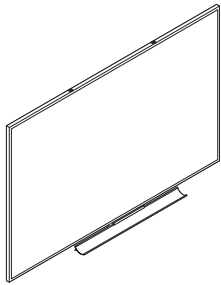

Tip: See CeramicSteel Cleaning/Daily Care and Maintenance for additional information.

▶ Page 11

Tip: Select parametric size option to specify parametric height and width dimensions within the available range. Select modular size option to specify pre-defined height and width dimension combinations.

Tip: Parametric sizes can be specified to the 1/16 of an inch.

Tip: Only digital print graphic patterns dot grid, line grid, music lines, or custom graphic are available on 18"H x 24"W and 24"H x 36"W boards.

Tip: Digital print available on whiteboard, modular sizes only.

Tip: For custom graphics, please contact pvstudioteam@polyvision.com to acquire a custom print number.

Tip: If width is exactly 120.25000"W, digital print or spline joint can be specified, but not both.



For Canadian Pricing

Multiply U.S. Price by the Canadian price factor.

▶ See page 1 for details.

Standard Includes		Required to Specify
▶ Need help? Product details, page 36	<ul style="list-style-type: none"> Height: 18.25" – 48.25" Width: 24.25" – 192.25" e³ environmental CeramicSteel writing surface: 7655 White High Gloss Package of four dry-erase markers (black, blue, red, and green) and one eraser on whiteboards, if selected Fabric on tackboards, if selected If Edge Series selected: <ul style="list-style-type: none"> – Frame and marker tray: 8043 Clear Anodized Aluminum – Metal cleat-mounting system If 110 Series selected: <ul style="list-style-type: none"> – 3/4" Frame and full-width marker tray: 8043 Clear Anodized Aluminum – Wall-anchored mounting system hardware If 555 Series selected: <ul style="list-style-type: none"> – 1 1/4" Frame and full-width marker tray: 8043 Clear Anodized Aluminum – Wall-anchored mounting system hardware 	<ol style="list-style-type: none"> Style number Size (see below under Required Selections) Trim type (see below under Required Selections) Height Width Fabric color number for tackboard, if selected Options, if selected (see below) <p>▶ See <i>Surface Materials</i>, page 92</p>

	Required Selections	U.S. Price	Required to Specify
Size	<ul style="list-style-type: none"> Parametric Modular 	No cost No cost	Specify <i>Parametric</i> . Specify <i>Modular</i> .
Trim Type	<ul style="list-style-type: none"> Edge Series 110 Series 555 Series 	No cost No cost No cost	Specify with <i>Edge Series trim</i> . Specify with <i>110 Series trim</i> . Specify with <i>555 Series trim</i> .

	Options	U.S. Price	Required to Specify
Surface Materials	<p>Frame</p> <ul style="list-style-type: none"> Champagne trim on frame (Available on Edge Series) <p>Fabric surface on tackboards</p> <ul style="list-style-type: none"> Fabric price group 1 Fabric price group 2 Fabric price group 3 Fabric price group 4 Fabric price group 5 Fabric price group 6 Fabric price group 7 Fabric price group 8 Fabric price group 9 Fabric price group 10 Fabric price group COM <p>Fabric direction on tackboards</p> <ul style="list-style-type: none"> Horizontal application Vertical application <p>Digital print graphic</p> <ul style="list-style-type: none"> 18"H x 24"W 24"H x 36"W 36"H x 48"W 48"H x 36"W 48"H x 48"W 48"H x 60"W 48"H x 72"W 48"H x 96"W 48"H x 120"W 	Prices at right Prices at right Prices at right Prices at right Prices at right Prices at right Prices at right Prices at right Prices at right Prices at right Prices at right Prices at right No cost No cost +\$285 +\$311 +\$400 +\$400 +\$416 +\$485 +\$541 +\$641 +\$766	Specify with <i>4750 Champagne Metallic trim</i> . Specify fabric color number. Specify fabric color number. Specify fabric color number. Specify fabric color number. Specify fabric color number. Specify fabric color number. Specify fabric color number. Specify fabric color number. Specify fabric color number. Specify fabric color number. Specify fabric color number. Specify fabric color number. Specify with <i>horizontal application</i> . Specify with <i>vertical application</i> . Specify standard or custom print number. Specify standard or custom print number. Specify standard or custom print number. Specify standard or custom print number. Specify standard or custom print number. Specify standard or custom print number. Specify standard or custom print number. Specify standard or custom print number. Specify standard or custom print number. Specify standard or custom print number.

▶ Options, continued on next page

► Options, continued from previous page

	Options	U.S. Price	Required to Specify
Surface Materials, continued	Digital print application		
	• Top	No cost	Specify with top application.
	• Bottom	No cost	Specify with bottom application.
No Marker Tray	Whiteboard width (inches)		
	• 24.25000–36.25000	–\$ 36.21	Specify no tray.
	• 36.31250–48.25000	–\$ 46.07	Specify no tray.
	• 48.31250–60.25000	–\$ 54.88	Specify no tray.
	• 60.31250–72.25000	–\$ 64.93	Specify no tray.
	• 72.31250–96.25000	–\$ 64.93	Specify no tray.
	• 96.31250–120.25000	–\$ 92.38	Specify no tray.
	• 120.31250–144.25000	–\$102.23	Specify no tray.
	• 144.31250–192.25000	–\$119.81	Specify no tray.

Edge Series

On- and Off-Module Brackets	• Available on 24.25"W x 18.25"H to 192.25"W x 48.25"H whiteboards	+\$181.78	Specify with on- and off- module brackets.
Over Panel Bracket/Hook	Available on 24.25"W to 60.25"W whiteboards		
	• 2" over panel bracket/hook	+\$124.18	Specify with 2" over panel brackets.
	• 3" over panel bracket/hook	+\$124.18	Specify with 3" over panel brackets.
Spline Joint	• Available on 120.25"W to 192.25"W whiteboards	+\$347.70	Specify with spline joint.

110 Series/555 Series

1" Maprail	Whiteboard width (inches)		
	• 24.25000–36.25000	+\$ 13.18	Specify with maprail.
	• 36.31250–48.25000	+\$ 21.58	Specify with maprail.
	• 48.31250–60.25000	+\$ 25.99	Specify with maprail.
	• 60.31250–72.25000	+\$ 34.78	Specify with maprail.
	• 72.31250–96.25000	+\$ 47.56	Specify with maprail.
	• 96.31250–120.25000	+\$ 64.93	Specify with maprail.
	• 120.31250–144.25000	+\$ 79.20	Specify with maprail.
	• 144.31250–192.25000	+\$103.70	Specify with maprail.
1" Map Hook/Clip	Whiteboard width (inches)		
	• 24.25000–60.18750	+\$ 2.96 (2 hooks)	Specify with map hook/clip.
	• 60.25000–120.18750	+\$ 5.92 (4 hooks)	Specify with map hook/clip.
	• 120.25000–144.25000	+\$ 8.88 (6 hooks)	Specify with map hook/clip.
	• 144.31250–192.25000	+\$ 11.84 (8 hooks)	Specify with map hook/clip.
1" Flag Holder	• Available on whiteboards	+\$ 18.66	Specify with flag holder.
Roller Bracket	• Available on whiteboards	+\$ 13.80	Specify with roller bracket.
Spline Joint	• Available on 120.25"W to 192.25"W whiteboards	+\$347.70	Specify with spline joint.

► Specification Information, on next page

Tip: The width of the whiteboard will determine the price of the maprail.

Tip: 1" maprail option must be selected if ordering 1" maphook/clip, 1" flag holder, or roller bracket.

Tip: The width of the whiteboard will determine the price of the hooks.

Wall Mounted



For Canadian Pricing

Multiply U.S. Price by the Canadian price factor.

► See page 1 for details.

► Options, on previous page

Specification Information

• Style • Number	• Square • Feet	• U.S. • Base • Price (Per sq/ft)	• Option (Add \$ to Base Price) • Frame • Champagne • Trim
---------------------	--------------------	--	---

Edge Series — Whiteboard

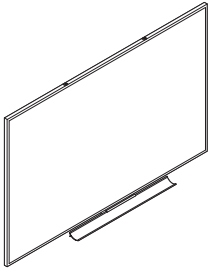

PWBWTBRD	3.07335 – 5.99999	\$185.42	+\$ 80.29
	6.00000 – 11.99999	\$101.77	+\$112.56
	12.00000 – 15.99999	\$ 65.88	+\$159.30
	16.00000 – 19.99999	\$ 51.43	+\$179.88
	20.00000 – 23.99999	\$ 48.00	+\$200.28
	24.00000 – 31.99999	\$ 44.69	+\$223.65
	32.00000 – 39.99999	\$ 39.75	+\$271.87
	40.00000 – 47.99999	\$ 38.01	+\$314.33
	48.00000 – 63.99999	\$ 36.97	+\$364.03
	64.00000 – 64.41710	\$ 33.29	+\$447.30

► Specification Information, continued on next page



For Canadian Pricing

Multiply U.S. Price by the Canadian price factor.

► See page 1 for details.

► Specification Information, continued from previous page

Specification Information

• Style Number	• Square Feet	• U.S. Base Price (Per sq/ft)	• Options (Add \$ to Base Price)					
			• Frame Champagne Trim	• Fabric Price Group 1	• Fabric Price Group 2	• Fabric Price Group 3	• Fabric Price Group 4	• Fabric Price Group 5

Edge Series — Tackboard

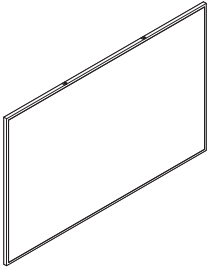

PWBTKBRD	3.07335 – 5.99999	\$185.42	+\$ 80.29	No cost	+\$66.23	+\$ 81.90	+\$115.09	+\$154.44
	6.00000 – 11.99999	\$101.77	+\$112.56	No cost	+\$66.23	+\$ 81.90	+\$115.09	+\$154.44
	12.00000 – 15.99999	\$ 65.88	+\$159.30	No cost	+\$66.23	+\$ 81.90	+\$115.09	+\$154.44
	16.00000 – 19.99999	\$ 51.43	+\$179.88	No cost	+\$66.23	+\$ 81.90	+\$115.09	+\$154.44
	20.00000 – 23.99999	\$ 48.00	+\$200.28	No cost	+\$77.52	+\$ 96.49	+\$146.84	+\$192.32
	24.00000 – 31.99999	\$ 44.69	+\$223.65	No cost	+\$86.28	+\$113.63	+\$175.66	+\$232.54
	32.00000 – 39.99999	\$ 39.75	+\$271.87	No cost	+\$89.19	+\$116.58	+\$194.07	+\$255.32
	40.00000 – 40.29210	\$ 38.01	+\$314.33	No cost	+\$96.49	+\$138.08	+\$231.66	+\$307.97

Wall Mounted

					• Fabric Price Group 6	• Fabric Price Group 7	• Fabric Price Group 8	• Fabric Price Group 9	• Fabric Price Group 10
									• Fabric Price Group COM

Edge Series — Tackboard, continued

	+\$200.32	+\$251.68	+\$310.01	+\$374.55	+\$446.12	+\$27.35
	+\$200.32	+\$251.68	+\$310.01	+\$374.55	+\$446.12	+\$27.35
	+\$200.32	+\$251.68	+\$310.01	+\$374.55	+\$446.12	+\$27.35
	+\$200.32	+\$251.68	+\$310.01	+\$374.55	+\$446.12	+\$27.35
	+\$244.37	+\$301.97	+\$363.21	+\$432.70	+\$509.39	+\$27.35
	+\$293.56	+\$361.29	+\$426.99	+\$505.99	+\$587.08	+\$27.35
	+\$322.19	+\$395.14	+\$462.06	+\$544.79	+\$632.94	+\$27.35
	+\$379.78	+\$460.85	+\$530.56	+\$621.31	+\$711.42	+\$27.35

► Specification Information, continued on next page



For Canadian Pricing

Multiply U.S. Price by the
Canadian price factor.

► See page 1 for details.

► **Specification Information, continued from previous page**

Specification Information

Style Number	Square Feet	U.S. Base Price (Per sq/ft)
--------------	-------------	--------------------------------

110 Series—Whiteboard

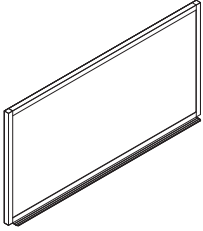

PWBWTBRD	3.07335 – 5.99999	\$87.96
	6.00000 – 11.99999	\$50.49
	12.00000 – 15.99999	\$36.89
	16.00000 – 19.99999	\$32.24
	20.00000 – 23.99999	\$30.89
	24.00000 – 31.99999	\$30.13
	32.00000 – 39.99999	\$28.49
	40.00000 – 47.99999	\$28.69
	48.00000 – 63.99999	\$28.20
	64.00000 – 64.41710	\$26.76

► **Specification Information, continued on next page**



For Canadian Pricing

Multiply U.S. Price by the Canadian price factor.

► See page 1 for details.

► Specification Information, continued from previous page

Specification Information

• Style Number	• Square Feet	• U.S. Base Price (Per sq/ft)	• Options (Add \$ to Base Price)				
			Fabric Price Group 1	Fabric Price Group 2	Fabric Price Group 3	Fabric Price Group 4	Fabric Price Group 5

110 Series—Tackboard

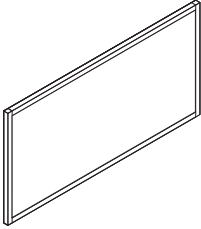

PWBTKBRD	3.07335 – 5.99999	\$43.17	No cost	+\$66.23	+\$ 81.90	+\$115.09	+\$154.44
	6.00000 – 11.99999	\$35.34	No cost	+\$66.23	+\$ 81.90	+\$115.09	+\$154.44
	12.00000 – 15.99999	\$30.49	No cost	+\$66.23	+\$ 81.90	+\$115.09	+\$154.44
	16.00000 – 19.99999	\$27.71	No cost	+\$66.23	+\$ 81.90	+\$115.09	+\$154.44
	20.00000 – 23.99999	\$26.48	No cost	+\$77.52	+\$ 96.49	+\$146.84	+\$192.32
	24.00000 – 31.99999	\$24.18	No cost	+\$86.28	+\$113.63	+\$175.66	+\$232.54
	32.00000 – 39.99999	\$21.56	No cost	+\$89.19	+\$116.58	+\$194.07	+\$255.32
	40.00000 – 40.29210	\$21.44	No cost	+\$96.49	+\$138.08	+\$231.66	+\$307.97

Wall Mounted

			Fabric Price Group 6	Fabric Price Group 7	Fabric Price Group 8	Fabric Price Group 9	Fabric Price Group 10	Fabric Price Group COM
--	--	--	----------------------------	----------------------------	----------------------------	----------------------------	-----------------------------	---------------------------------

110 Series — Tackboard, continued

			+\$200.32	+\$251.68	+\$310.01	+\$374.55	+\$446.12	+\$27.35
			+\$200.32	+\$251.68	+\$310.01	+\$374.55	+\$446.12	+\$27.35
			+\$200.32	+\$251.68	+\$310.01	+\$374.55	+\$446.12	+\$27.35
			+\$200.32	+\$251.68	+\$310.01	+\$374.55	+\$446.12	+\$27.35
			+\$244.37	+\$301.97	+\$363.21	+\$432.70	+\$509.39	+\$27.35
			+\$293.56	+\$361.29	+\$426.99	+\$505.99	+\$587.08	+\$27.35
			+\$322.19	+\$395.14	+\$462.06	+\$544.79	+\$632.94	+\$27.35
			+\$379.78	+\$460.85	+\$530.56	+\$621.31	+\$711.42	+\$27.35

► Specification Information, continued on next page



For Canadian Pricing

Multiply U.S. Price by the
Canadian price factor.

► See page 1 for details.

► **Specification Information, continued from previous page**

Specification Information

Style Number	Square Feet	U.S. Base Price (Per sq/ft)
--------------	-------------	-----------------------------

555 Series—Whiteboard

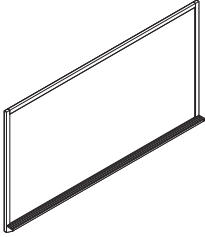

PWBWTBRD	Style Number Range	U.S. Base Price
	3.07335 – 5.99999	\$108.10
	6.00000 – 11.99999	\$ 61.99
	12.00000 – 15.99999	\$ 41.22
	16.00000 – 19.99999	\$ 35.31
	20.00000 – 23.99999	\$ 33.64
	24.00000 – 31.99999	\$ 33.68
	32.00000 – 39.99999	\$ 31.46
	40.00000 – 47.99999	\$ 31.83
	48.00000 – 63.99999	\$ 31.15
	64.00000 – 64.41710	\$ 30.41

► **Specification Information, continued on next page**



For Canadian Pricing

Multiply U.S. Price by the Canadian price factor.

► See page 1 for details.

► Specification Information, continued from previous page

Specification Information

Style Number	Square Feet	U.S. Base Price (Per sq/ft)	Options (Add \$ to Base Price)				
			Fabric Price Group 1	Fabric Price Group 2	Fabric Price Group 3	Fabric Price Group 4	Fabric Price Group 5

555 Series — Tackboard

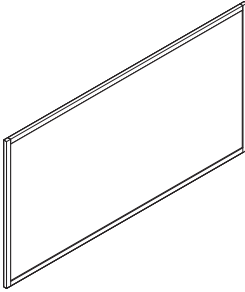

PWBTKBRD	3.07335 – 5.99999	\$47.56	No cost	+\$66.23	+\$ 81.90	+\$115.09	+\$154.44
	6.00000 – 11.99999	\$39.15	No cost	+\$66.23	+\$ 81.90	+\$115.09	+\$154.44
	12.00000 – 15.99999	\$34.73	No cost	+\$66.23	+\$ 81.90	+\$115.09	+\$154.44
	16.00000 – 19.99999	\$30.72	No cost	+\$66.23	+\$ 81.90	+\$115.09	+\$154.44
	20.00000 – 23.99999	\$29.15	No cost	+\$77.52	+\$ 96.49	+\$146.84	+\$192.32
	24.00000 – 31.99999	\$27.46	No cost	+\$86.28	+\$113.63	+\$175.66	+\$232.54
	32.00000 – 39.99999	\$26.47	No cost	+\$89.19	+\$116.58	+\$194.07	+\$255.32
	40.00000 – 40.29210	\$26.18	No cost	+\$96.49	+\$138.08	+\$231.66	+\$307.97

Wall Mounted

	Fabric Price Group 6	Fabric Price Group 7	Fabric Price Group 8	Fabric Price Group 9	Fabric Price Group 10	Fabric Price Group COM
--	----------------------	----------------------	----------------------	----------------------	-----------------------	------------------------

555 Series — Tackboard, continued

+\$200.32	+\$251.68	+\$310.01	+\$374.55	+\$446.12	+\$27.35
+\$200.32	+\$251.68	+\$310.01	+\$374.55	+\$446.12	+\$27.35
+\$200.32	+\$251.68	+\$310.01	+\$374.55	+\$446.12	+\$27.35
+\$200.32	+\$251.68	+\$310.01	+\$374.55	+\$446.12	+\$27.35
+\$244.37	+\$301.97	+\$363.21	+\$432.70	+\$509.39	+\$27.35
+\$293.56	+\$361.29	+\$426.99	+\$505.99	+\$587.08	+\$27.35
+\$322.19	+\$395.14	+\$462.06	+\$544.79	+\$632.94	+\$27.35
+\$379.78	+\$460.85	+\$530.56	+\$621.31	+\$711.42	+\$27.35



For Canadian Pricing
Multiply U.S. Price by the
Canadian price factor.
► See page 1 for details.

Polyvision Parametric Whiteboards

Sans and Flow

Accented edge optional for parametric Sans.

Trim optional for parametric Flow.

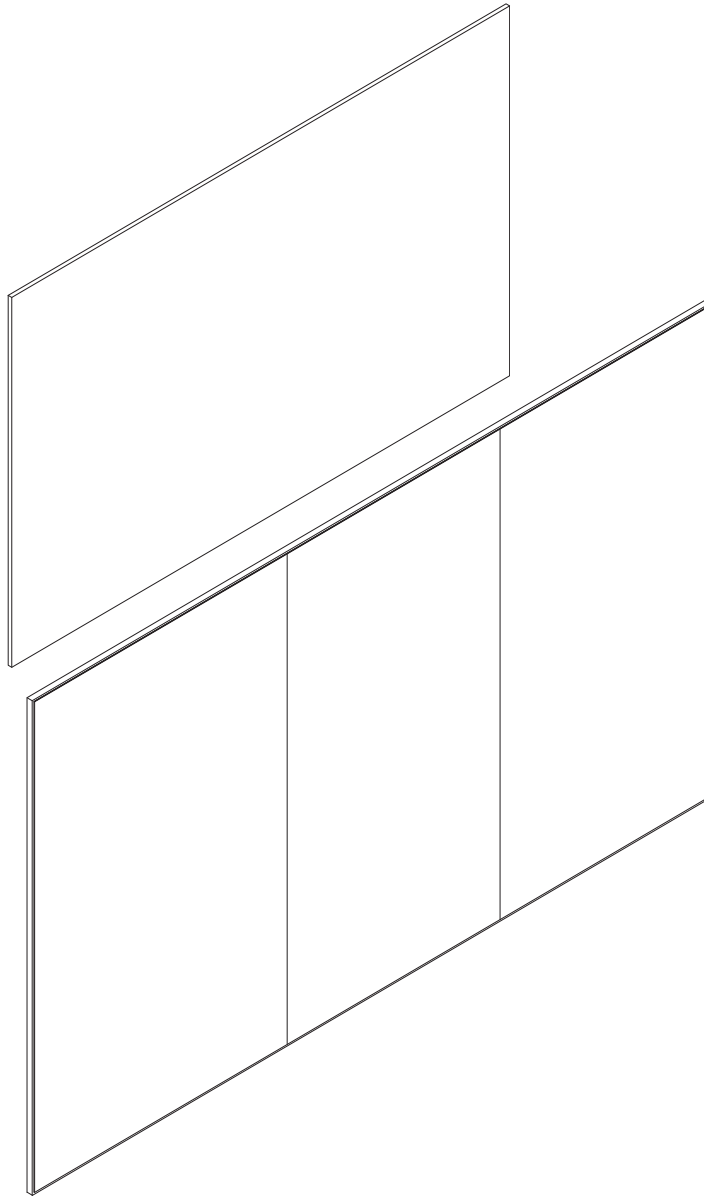

Writing surface is available in chalkboard or markerboard material types.

SANSPM

- 7655 White High Gloss
- 7661 Gray Chalk 6502C CS
- 7671 Arctic White 2 CS
- 7673 Merle CS
- 7674 Platinum Solid CS
- PV09 Hygienic White Gloss

PVFLOWPM

- 7655 White High Gloss
- 7661 Gray Chalk 6502C CS
- 7671 Arctic White 2 CS
- PV09 Hygienic White Gloss

Actual Dimensions

	Sans Series	Sans Series	Flow Series	Flow Series
	SANSPM	SANSPM	PVFLOWPM	PVFLOWPM
Edge Treatment	Frameless	Frameless	Frameless	Framed
Panel Orientation	Horizontal	Vertical	Vertical	Vertical
Overall Width (per panel)	24"–144"	24"–46.625"	46.6535"	46.6535"
Overall Height (per panel)	24"–46.625"	46.6875"–96"	60"–96"	60"–96"
Panel Thickness	1/2"	1/2"	1/2"	1/2"
Depth from Wall to Face	1"	1"	3/4"	1"
Weight (lb)	7 lb–168 lb	7 lb–102 lb	60 lb–102 lb	60 lb–102 lb
Weight (kg)	3.17 kg–72.20 kg	3.17 kg–46.26 kg	27.21 kg–46.26 kg	27.21 kg–46.26 kg

Polyvision Parametric Whiteboards

Sans

Polyvision Parametric
Whiteboards

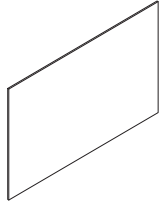

Standard Includes	Required to Specify
<ul style="list-style-type: none"> ▶ Need help? Product details, page 36 • Panel: Polyvision CeramicSteel • Attachment hardware • Z-brackets available in two orientations Size Ranges: Horizontal: – Width: 24" to 144" (610 mm–3658 mm) – Height: 24" to 46.625" (610 mm–1184 mm) Vertical: – Width: 24" to 46.625" (610 mm–1184 mm) – Height: 46.6875" to 96" (1186 mm–2438 mm) 	<ol style="list-style-type: none"> 1 Style number 2 Panel Orientation (see below under Required Selections) 3 Size (see below under Required Selections) 4 Surface type (see below under Required Selections) 5 CeramicSteel color number for panel: 7655 White High Gloss 7661 Gray Chalk 6502C CS 7671 Arctic White 2 CS 7673 Merle CS 7674 Platinum Solid CS PV09 Hygienic White Gloss 6 Options, if selected (see below)

Tip: Parametric sizes can be specified to the 1/16 of an inch.

Tip: 7661 Gray Chalk 6502C CS is a true chalk-board surface. Chalk sticks and liquid chalk can be used. Liquid chalk requires wet erase.

	Required Selections	U.S. Price	Required to Specify
Panel Orientation	<ul style="list-style-type: none"> • Horizontal • Vertical 	Prices below Prices below	Specify with <i>horizontal</i> . Specify with <i>vertical</i> .
Size	<ul style="list-style-type: none"> • Height • Width 	Prices below Prices below	Specify according to the orientation height range. Specify according to the orientation width range.
Surface Type	<ul style="list-style-type: none"> • Chalkboard • Markerboard 	No cost No cost	Specify with <i>chalkboard</i> . Specify with <i>markerboard</i> .

Tip: Accessories are sold separately.

Tip: See CeramicSteel Cleaning/Daily Care and Maintenance for additional information.

▶ Page 11

	Options	U.S. Price	Required to Specify
Surface Materials	<ul style="list-style-type: none"> • Ceramic price group 1 • Ceramic price group 2 	No cost +\$152	Specify ceramic color number. Specify ceramic color number.
	Contrasting <ul style="list-style-type: none"> • Non-contrasting accented edge • Contrasting accented edge 	No cost +\$135	Specify with <i>non-contrasting accented edge</i> . Specify with <i>contrasting accented edge</i> .
Related Products	<ul style="list-style-type: none"> • Accessories 		▶ Page 87

Specification Information				
Style Number	Orientation	Height Range	Width Range	U.S. Base Price
SANSPM	Horizontal	24"–46.625"	Up to 48"	\$1650
		24"–46.625"	48.062"–72"	\$2250
		24"–46.625"	72.062"–96"	\$2600
		24"–46.625"	96.062"–120"	\$3650
		24"–46.625"	120.062"–144"	\$4025
	Vertical	46.687"–72"	24"–46.625"	\$2250
		72.062"–96"	24"–46.625"	\$2600

 **For Canadian Pricing**
Multiply U.S. Price by the Canadian price factor.
▶ See page 1 for details.

Polyvision Parametric Whiteboards

Flow

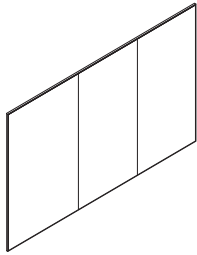

Tip: Illustration above shows a three-panel system.

Tip: Parametric sizes can be specified to the 1/16 of an inch.

Tip: A panel quantity of one is not available as frameless. Refer to Sans or Sans Light in vertical orientation.

Tip: Individual panel width is 46.65". Width times number of panels equals total system width.

Tip: 7661 Gray Chalk 6502C CS is a true chalkboard surface. Chalk sticks and liquid chalk can be used. Liquid chalk requires wet erase.

Tip: Accessories are sold separately.

Tip: See CeramicSteel Cleaning/Daily Care and Maintenance for additional information.

▶ Page 11

Standard Includes		Required to Specify
▶ Need help? Product details, page 36	<ul style="list-style-type: none"> Panel(s): Polyvision CeramicSteel Attachment hardware Spline joints, included with multiple panels system 	<ol style="list-style-type: none"> Style number Height (see below under Required Selections) Frame (see below under Required Selections) Panel quantity (see below under Required Selections) Surface type (see below under Required Selections) CeramicSteel color number for panel: <ul style="list-style-type: none"> 7655 White High Gloss 7661 Gray Chalk 6502C CS 7671 Arctic White 2 CS PV09 Hygienic White Gloss Options, if selected (see below)

	Required Selections	U.S. Price	Required to Specify
Height	• 60"H–96"H	Prices below	Specify with 60"H–96"H.
Frame	• Frame • Frameless	No cost No cost	Specify with frame. Specify without frame.
Panel Quantity	• Frame quantity of one to eight • Frameless quantity of two to eight	Prices below Prices below	Specify number of panels. Specify number of panels.
Surface Type	• Chalkboard • Markerboard	No cost No cost	Specify with chalkboard. Specify with markerboard.

	Options	U.S. Price	Required to Specify
Surface Materials	Surface <ul style="list-style-type: none"> Ceramic price group 1 Ceramic price group 2 	No cost +\$152 per panel	Specify ceramic color number. Specify ceramic color number.
Related Products	<ul style="list-style-type: none"> Dry erase markers Magnetic eraser with marker holder Accessories 		<ul style="list-style-type: none"> ▶ Page 88 ▶ Page 86 ▶ Page 87

Specification Information				
Style Number	Height Range	Panel Quantity	System Width	U.S. Base Price (per system)
PVFLOWPM	60"–72"	1	46.654"	\$ 2695
		2	93.307"	\$ 5145
		3	139.961"	\$ 7595
		4	186.614"	\$10,045
		5	233.268"	\$12,495
		6	279.921"	\$14,945
		7	326.575"	\$17,395
		8	373.228"	\$19,845

▶ Specification Information, continued on next page



For Canadian Pricing

Multiply U.S. Price by the Canadian price factor.

▶ See page 1 for details.

► **Specification Information, continued from previous page**

Specification Information

Style Number	Height Range	Panel Quantity	System Width	U.S. Base Price (per system)
PVFLOWPM	72.0625"–96"	1	46.654"	\$ 3145
		2	93.307"	\$ 6045
		3	139.961"	\$ 8945
		4	186.614"	\$11,845
		5	233.268"	\$14,745
		6	279.921"	\$17,645
		7	326.575"	\$20,545
		8	373.228"	\$23,445

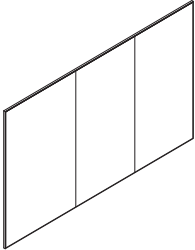

Tip: Illustration above shows a three-panel system.

Wall Mounted



For Canadian Pricing

Multiply U.S. Price by the Canadian price factor.

► See page 1 for details.

Flow

Flow is a modular panel system with no vertical joint covers providing a large format writing surface. Available as frameless or with outer aluminum frame.

For custom capability and parametrics for special sizes, please see *Parametric Collaborative Surfaces*.

▶ See page 38

Right-end panel position

Intermediate panel position

Left-end panel position

Outer frame is extruded, clear anodized aluminum.

CeramicSteel surface is offered in 7655 White High Gloss, 7661 Gray Chalk 6502C CS, 7671 Arctic White 2 CS or PV09 Hygienic White Gloss. 7661 Gray Chalk 6502C CS requires chalk sticks or liquid chalk for writing.

Custom graphic option is available. Polyvision print number required. Please contact pvstudioteam@polyvision.com to acquire a custom print number.

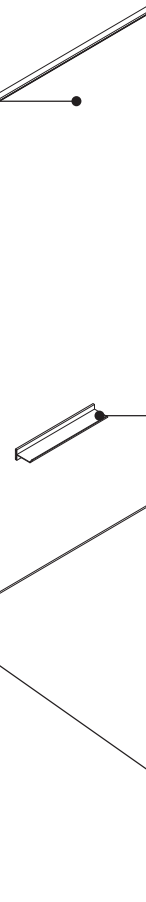

Marker tray, dry erase markers, and eraser

come standard with white gloss finish for single panel and right-end panel options. If gray chalk finish is selected then an eraser and marker tray come standard. The optional toolbar kit includes markers or chalk sticks depending on the surface type, a round magnetic eraser with replacement microfiber cloths, and the magnetic toolbar to store the writing accessories.

Inner vertical joint allows for a frameless panel seam.

Frameless Flow, has a precision cut and sealed edge with durable lacquer painted edge. Edges are waterjet cut and sealed with high quality paint. Edges show striations. Frameless edge comes standard in the same finish as specified CeramicSteel color number of the panel.

Actual Dimensions

	Flow (72"H)	Flow (95¼"H)	Flow Frameless (72"H)	Flow Frameless (95¼"H)
Single Panel Height	72" or 1830 mm	95¼" or 2420 mm	72" or 1830 mm	95¼" or 2420 mm
Single Panel Width	46.6535" or 1185 mm	46.6535" or 1185 mm	46.6535" or 1185 mm	46.6535" or 1185 mm
Depth	½" or 13 mm	½" or 13 mm	½" or 13 mm	½" or 13 mm
Depth from Wall to Face	¾" or 19 mm	¾" or 19 mm	1" or 27 mm	1" or 27 mm
Weight (lbs)	62 lb	82 lb	62 lb	82 lb
Weight (kgs)	28 kg	37 kg	28 kg	37 kg

Tip: Dimensions are actual with a height and width tolerance of +/- 1 mm. Selections in electronic catalog are rounded up to the nearest whole number.

Flow Wall System Dimensions

Panel Quantity	Framed Flow Width	Frameless Flow Width
1	47.1435" or 1197 mm	N.A.
2	93.797" or 2382 mm	93.307" or 2370 mm
3	140.451" or 3567 mm	139.961" or 3555 mm
4	187.105" or 4752 mm	186.615" or 4740 mm
5	233.759" or 5937 mm	233.269" or 5925 mm
6	280.413" or 7122 mm	279.923" or 7110 mm
7	327.067" or 8308 mm	326.577" or 8295 mm
8	373.721" or 9493 mm	373.231" or 9480 mm

Tip: Dimensions are actual with a height and width tolerance of +/- 1 mm. Selections in electronic catalog are rounded up to the nearest whole number.

Flow

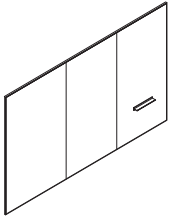

Standard Includes	Required to Specify
<ul style="list-style-type: none"> ▶ Need help? Product details, page 40 • Panel(s): Polyvision CeramicSteel • Attachment hardware • Spline joints, included with multiple panels system • Accessories: basic kit 	<ol style="list-style-type: none"> 1 Style number 2 Height (see below under Required Selections) 3 Frame (see below under Required Selections) 4 Panel quantity (see below under Required Selections) 5 Surface type (see below under Required Selections) 6 CeramicSteel color number for panel: 7655 White High Gloss 7661 Gray Chalk 6502C CS 7671 Arctic White 2 CS PV09 Hygienic White Gloss 7 Options, if selected (see below)

Tip: Height dimensions listed are nominal.

Tip: A panel quantity of one is not available as frameless. Refer to Sans or Sans Light in vertical orientation.

Tip: One accessory kit will be included with each wall system. Not provided with each panel.

Tip: 7661 Gray Chalk 6502C CS is a true chalkboard surface. Chalk sticks and liquid chalk can be used. Liquid chalk requires wet erase.

Tip: See CeramicSteel Cleaning/Daily Care and Maintenance for additional information.
▶ Page 11

Tip: For custom graphics, please contact pvstudioteam@polyvision.com to acquire a custom print number.

Height	Required Selections	U.S. Price	Required to Specify
	<ul style="list-style-type: none"> • 72"H • 95"H 	Prices below Prices below	Specify with 72" high. Specify with 95" high.
	<ul style="list-style-type: none"> • Frame • Frameless 	No cost No cost	Specify with frame. Specify without frame.
	<ul style="list-style-type: none"> • Frame quantity of one to eight • Frameless quantity of two to eight 	Prices below Prices below	Specify number of panels. Specify number of panels.
	<ul style="list-style-type: none"> • Chalkboard • Markerboard 	No cost No cost	Specify with chalkboard. Specify with markerboard.

Options	U.S. Price	Required to Specify
Surface Materials <ul style="list-style-type: none"> • Ceramic price group 1 • Ceramic price group 2 • Custom graphic 72"H panel • Custom graphic 95"H panel 	No cost +\$ 152 per panel +\$1596 per panel +\$1966 per panel	Specify ceramic color number. Specify ceramic color number. Specify custom graphic number. Specify custom graphic number.
Accessory Kit <ul style="list-style-type: none"> • Basic kit • Toolbar kit 	No cost +\$ 206	Specify with basic kit. Specify with toolbar kit.

Related Products <ul style="list-style-type: none"> • Dry erase markers • Magnetic eraser with marker holder • Accessories 	<ul style="list-style-type: none"> ▶ Page 88 ▶ Page 86 ▶ Page 87
--	---

Specification Information			
Style Number	Panel Quantity	U.S. Base Prices	
		72"H	95"H
PVFLOW	1	\$ 1995	\$ 2458
	2	\$ 3990	\$ 4916
	3	\$ 5985	\$ 7374
	4	\$ 7980	\$ 9832
	5	\$ 9975	\$12,290
	6	\$11,970	\$14,748
	7	\$13,965	\$17,206
	8	\$15,960	\$19,664

For Canadian Pricing
Multiply U.S. Price by the Canadian price factor.
▶ See page 1 for details.

Horizontal Flow

Horizontal Flow is a multi-panel panel system with no vertical joint covers providing a large and long format writing surface. Available as frameless or with outer aluminum frame.

Inner vertical joint allows for a frameless, splined panel seam.

Outer frame is extruded, clear anodized aluminum. Frameless available as an option.

CeramicSteel surface is offered in 7655 White High Gloss, 7661 Gray Chalk 6502C CS, 7671 Arctic White 2 CS or PV09 Hygienic White Gloss. 7661 Gray Chalk 6502C CS requires chalk sticks or liquid chalk for writing.

Custom graphic option is available. Polyvision print number required. Please contact pvstudioteam@polyvision.com to acquire a custom print number.

Marker tray, dry erase markers, and eraser come standard with white gloss finish for single panel and right-end panel options. If gray chalk finish is selected then an eraser and marker tray come standard. The optional toolbar kit includes markers or chalk sticks depending on the surface type, a round magnetic eraser with replacement microfiber cloths, and the magnetic toolbar to store the writing accessories.

Frameless Horizontal Flow, has a precision cut and sealed edge with durable lacquer painted edge. Edges are waterjet cut and sealed with high quality paint. Edges show striations. Frameless edge comes standard in the same finish as specified CeramicSteel color number of the panel.

Actual Dimensions

	Horizontal Flow (48"W)	Horizontal Flow (72"W)	Horizontal Flow (95 ¹ / ₄ "W)
Single Panel Width	48" or 1220 mm	72" or 1830 mm	95.28" or 2420 mm
Single Panel Height	46.6535" or 1185 mm	46.6535" or 1185 mm	46.6535" or 1185 mm
Depth	1/2" or 13 mm	1/2" or 13 mm	1/2" or 13 mm
Depth from Wall to Face	3/4" or 19 mm	3/4" or 19 mm	3/4" or 19 mm
Weight (lbs)	55.1 lb	62 lb	82 lb
Weight (kgs)	25 kg	28 kg	37 kg

Tip: Dimensions are actual with a height and width tolerance of +/- 1 mm. Selections in electronic catalog are rounded up to the nearest whole number.

Horizontal Flow Wall System Dimensions

Wall System Width Options	Framed Horizontal Flow Width	Frameless Horizontal Flow Width
12'	144 ¹ / ₂ " or 3671 mm	144" or 3658 mm
14'	168 ¹ / ₂ " or 4280 mm	168" or 4267 mm
16'	192 ¹ / ₂ " or 4890 mm	192" or 4877 mm
18'	216 ¹ / ₂ " or 5499 mm	216" or 5486 mm
20'	240 ¹ / ₂ " or 6109 mm	240" or 6096 mm
24'	288 ¹ / ₂ " or 7328 mm	288" or 7315 mm
30'	360 ¹ / ₂ " or 9157 mm	360" or 9144 mm

Panel Quantities and Layout by Total Width

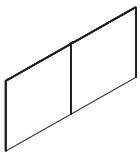

144" : 72" + 72"

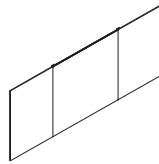

168" : 48" + 72" + 48"

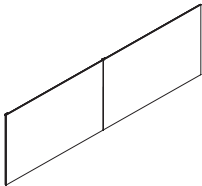

192" : 95¹/₄" + 95¹/₄"

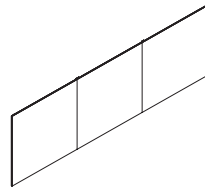

216" : 72" + 72" + 72"

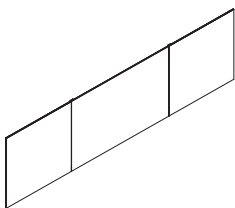

240" : 72" + 95¹/₄" + 72"

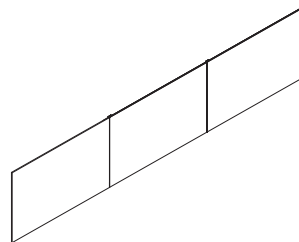

288" : 95¹/₄" + 95¹/₄" + 95¹/₄"

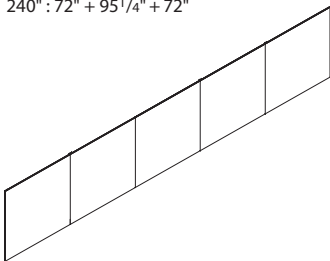

360" : 72" + 72" + 72" + 72" + 72"

Tip: Panel configurations outside of these layouts are considered custom. Dimensions are actual with a height and width tolerance of +/- 1 mm. Selections in electronic catalog are rounded up to the nearest whole number.

Horizontal Flow

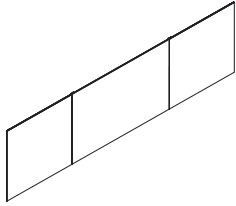

Standard Includes	Required to Specify
<ul style="list-style-type: none"> ▶ Need help? Product details, page 44 • Panel(s): Polyvision CeramicSteel • Attachment hardware • Spline joints, included with multiple panels system • Accessories: basic kit 	<ol style="list-style-type: none"> 1 Style number 2 Frame (see below under Required Selections) 3 Height (see below under Required Selections) 4 Width (see below under Required Selections) 5 Surface Type (see below under Required Selections) 6 CeramicSteel color number for panel: <ul style="list-style-type: none"> 7655 White High Gloss 7661 Gray Chalk 6502C CS 7671 Arctic White 2 CS PV09 Hygienic White Gloss 7 Options, if selected (see below) <p>▶ See <i>Surface Materials</i>, page 92</p>

Tip: Height dimensions listed are nominal.

Tip: Width is the total dimension by multiple panels being splined together. These are not single pieces in specified lengths.

Tip: 7661 Gray Chalk 6502C CS is a true chalkboard surface. Chalk sticks and liquid chalk can be used. Liquid chalk requires wet erase.

Tip: See *CeramicSteel Cleaning/Daily Care and Maintenance* for additional information.

▶ Page 11

Tip: One basic accessory kit will be included with each wall system. Not provided with each panel.

Tip: Sizes are nominal.

Tip: Horizontal Flow (framed) as 8' total width should be ordered from the Flow section. Refer to **PVFLOW**.

Tip: Horizontal Flow (frameless) as 8' total width should be ordered from the Sans section. Refer to **SANS**.

Tip: For custom graphics, please contact pvstudioteam@polyvision.com to acquire a custom print number.

Required Selections	U.S. Price	Required to Specify
Frame <ul style="list-style-type: none"> • Frame • Frameless 	No cost No cost	Specify <i>with frame</i> . Specify <i>without frame</i> .
Height <ul style="list-style-type: none"> • 47"H 	Prices at right	Specify <i>with 47" high</i> .
Width <ul style="list-style-type: none"> • 144"W • 168"W • 192"W • 216"W • 240"W • 288"W • 360"W 	Prices at right Prices at right Prices at right Prices at right Prices at right Prices at right Prices at right	Specify <i>with 144" width</i> . Specify <i>with 168" width</i> . Specify <i>with 192" width</i> . Specify <i>with 216" width</i> . Specify <i>with 240" width</i> . Specify <i>with 288" width</i> . Specify <i>with 360" width</i> .
Surface Type <ul style="list-style-type: none"> • Chalkboard • Markerboard 	No cost No cost	Specify <i>with chalkboard</i> . Specify <i>with markerboard</i> .
Options	U.S. Price	Required to Specify
Surface Materials <ul style="list-style-type: none"> • Ceramic price group 1 • Ceramic price group 2 • Custom graphic 144"W • Custom graphic 168"W • Custom graphic 192"W • Custom graphic 216"W • Custom graphic 240"W • Custom graphic 288"W • Custom graphic 360"W 	No cost +\$152 per panel Price at right Price at right Price at right Price at right Price at right Price at right Price at right	Specify ceramic color number. Specify ceramic color number. Specify custom graphic number. Specify custom graphic number. Specify custom graphic number. Specify custom graphic number. Specify custom graphic number. Specify custom graphic number. Specify custom graphic number.
Accessory Kit <ul style="list-style-type: none"> • Basic kit • Toolbar kit 	No cost +\$206	Specify <i>with basic kit</i> . Specify <i>with toolbar kit</i> .
Related Products <ul style="list-style-type: none"> • Dry erase markers • Magnetic eraser with marker holder • Accessories 		▶ Page 88 ▶ Page 86 ▶ Page 87

Specification Information

• Style Number	• Dimension Width	• U.S. Base Price	• Option (Add \$ to Base Price)
		47"H	Custom Graphic
HZPVFLOW	144"	\$ 5449	+\$4359
	168"	\$ 5994	+\$4795
	192"	\$ 6539	+\$5231
	216"	\$ 7629	+\$6103
	240"	\$ 8719	+\$6975
	288"	\$ 9809	+\$7847
	360"	\$11,989	+\$9591

Wall Mounted



For Canadian Pricing

Multiply U.S. Price by the Canadian price factor.

▶ See page 1 for details.

Sans

Sans is a writing board with streamlined, precision cut, frameless edges. Orientation of writing board can be mounted horizontally or vertically.

For custom capability and parametrics for special sizes, please see *Parametric Collaborative Surfaces*.

▶ See page 50

Frameless edge comes standard in the same finish as the specified CeramicSteel color number of the panel. Contrasting options are also available. Panel thickness is 1/2" or 13 mm.

CeramicSteel surface is offered in 7655 White High Gloss, 7661 Gray Chalk 6502C CS, 7671 Arctic White 2 CS, 7673 Merle CS, 7674 Platinum Solid CS, and PV09 Hygienic White. 7661 Gray Chalk 6502C CS is a true chalkboard surface that requires chalk sticks or liquid chalk for writing.
Tip: Available with standard graphics and custom graphics. Please contact pvstudioteam@polyvision.com to acquire a custom print number.

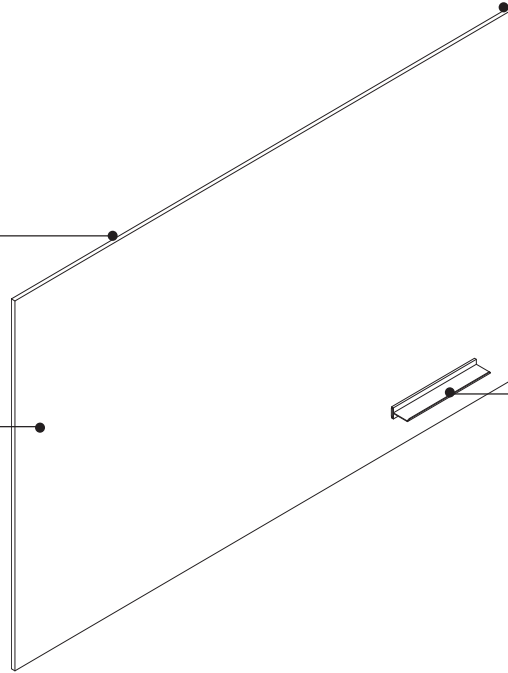

Edges are waterjet cut and sealed with high quality paint. Edges show striations.

Marker tray, dry erase markers, and eraser come standard with all markerboard surfaces. If chalkboard finish is selected then an eraser and marker tray come standard. The optional toolbar kit includes markers or chalk sticks depending on the surface type, a round magnetic eraser with replacement microfiber cloths, and the magnetic toolbar to store the writing accessories.

Actual Dimensions (Horizontal Orientation)

	Sans (48"W)	Sans (72"W)	Sans (95"W)
Overall Height	46.6535" or 1185 mm	46.6535" or 1185 mm	46.6535" or 1185 mm
Overall Width	48" or 1220 mm	72" or 1830 mm	95" or 2420 mm
Depth	1/2" or 13 mm	1/2" or 13 mm	1/2" or 13 mm
Depth from Wall to Face	1" or 25 mm	1" or 25 mm	1" or 25 mm
Weight (lbs)	55 lb	82 lb	97 lb
Weight (kgs)	25 kg	37 kg	44 kg

Actual Dimensions (Vertical Orientation)

	Sans (72"H)	Sans (95"H)
Overall Height	72" or 1830 mm	95" or 2420 mm
Overall Width	46.6535" or 1185 mm	46.6535" or 1185 mm
Depth	1/2" or 13 mm	1/2" or 13 mm
Depth from Wall to Face	1" or 25 mm	1" or 25 mm
Weight (lbs)	82 lb	97 lb
Weight (kgs)	37 kg	44 kg

Tip: Dimensions are actual with a height and width tolerance of +/- 1 mm. Selections in electronic catalog are rounded up to the nearest whole number.

Product Details

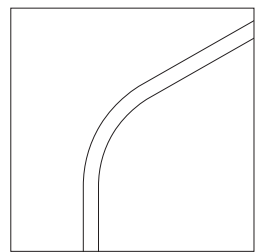

Rounded corners can be selected for the Sans board. Standard corner option is 90-degree, radius is R45. Compatible with accented edge options.

Digital printing is offered on Parametric Premium Whiteboards, Sans, Sans Light, and Flow products. Digital print graphics are permanently baked into the CeramicSteel surface and are scratch, abrasion, bacteria, chemical, fire, and graffiti resistant. Both standard and custom options are available.

Tip: Flow only available with custom option.

Standard Digital Print Options for Sans, Sans Light, and Premium Whiteboards

Patterns available in:

- 7676 Saffron
- 7677 Peacock
- 7678 Sea Salt
- 7679 Sterling Dark
- 7681 Sand
- 7682 Black

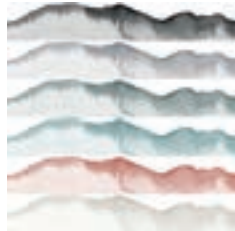

PV55 Agate



PV56 Brushstroke



PV57 Code



PV58 Data



PV59 DNA



PV60 Hive

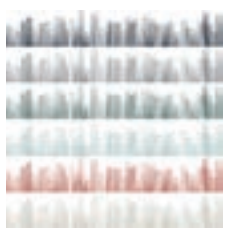

PV61 Skyline



PV62 Soundwave



PV63 Speed



PV64 Summit

Patterns available in:

- 7679 Sterling Dark
- 7682 Black

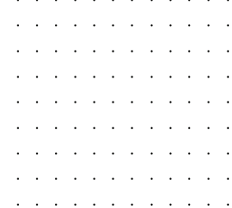

PV65 Dot Grid

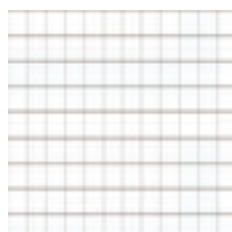

PV66 Line Grid

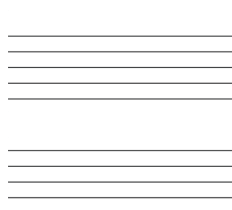

PV67 Music Lines

Tip: For custom graphics, please contact pvstudioteam@polyvision.com to acquire a custom print number.

Sans

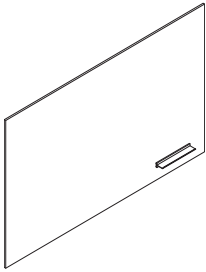

► Need help? Product details, page 48

Standard Includes

- Panel: Polyvision CeramicSteel
- Attachment hardware
- Magnetic marker tray, dry erase markers, and eraser if 7655 White High Gloss, 7671 Arctic White 2 CS, 7673 Merle CS, 7674 Platinum Solid CS, or PV09 Hygienic White Gloss is selected
- Magnetic marker tray and eraser if 7661 Gray Chalk 6502C CS is selected
- Accented edge: paint price groups 1, 2, and 3, if contrasting is selected

Required to Specify

- 1 Style number
 - 2 Size (see below under Required Selections)
 - 3 Corner shape (see below under Required Selections)
 - 4 Surface type (see below under Required Selections)
 - 5 CeramicSteel color number for panel:
 - 7655 White High Gloss
 - 7661 Gray Chalk 6502C CS
 - 7671 Arctic White 2 CS
 - 7673 Merle CS
 - 7674 Platinum Solid CS
 - PV09 Hygienic White Gloss
 - 6 Options, if selected (see below)
- See *Surface Materials*, page 92

Tip: Accessories come with all Sans boards. Accessories vary by surface type and color. All Sans boards include a logo on the bottom right corner.

Tip: Mounting hardware will be installed on the back of the board to support vertical installation when 72"H or 95"H is specified.

Tip: See CeramicSteel Cleaning/Daily Care and Maintenance for additional information.
► Page 11

Tip: Contrasting accented edge can only be specified when the panel is selected in 7655 White High Gloss and 7671 Arctic White 2 CS.

Tip: 7661 Gray Chalk 6502C CS is a true chalkboard surface. Chalk sticks and liquid chalk can be used. Liquid chalk requires wet erase.

Tip: Graphics not available with rounded corners.

Tip: For custom graphics, please contact pvstudioteam@polyvision.com to acquire a custom print number.

	Required Selections	U.S. Price	Required to Specify
Size	Horizontal		
	<ul style="list-style-type: none"> • 47"H x 48"W • 47"H x 72"W • 47"H x 95"W 	Prices below Prices below Prices below	Specify with 47"H x 48"W. Specify with 47"H x 72"W. Specify with 47"H x 95"W.
	Vertical		
	<ul style="list-style-type: none"> • 72"H x 47"W • 95"H x 47"W 	Prices below Prices below	Specify with 72"H x 47"W. Specify with 95"H x 47"W.
Corner Shape	<ul style="list-style-type: none"> • 90 degree corner • Rounded corner 	No cost No cost	Specify with 90 degree corner. Specify with rounded corner.
	Surface Type	<ul style="list-style-type: none"> • Chalkboard • Markerboard 	No cost No cost

	Options	U.S. Price	Required to Specify
Surface Materials	Surface		
	<ul style="list-style-type: none"> • Ceramic price group 1 • Ceramic price group 2 • Graphic 47"H x 48"W • Graphic 47"H x 72"W • Graphic 47"H x 95"W • Graphic 72"H x 47"W • Graphic 95"H x 47"W 	No cost +\$ 152 +\$1105 +\$1475 +\$1718 +\$1475 +\$1718	Specify ceramic color number. Specify ceramic color number. Specify standard or custom graphic number. Specify standard or custom graphic number. Specify standard or custom graphic number. Specify standard or custom graphic number. Specify standard or custom graphic number.
	Contrasting		
	<ul style="list-style-type: none"> • Non-contrasting accented edge • Contrasting accented edge 	No cost +\$ 135	Specify with non-contrasting accented edge. Specify with contrasting accented edge.
Accessory Kit	<ul style="list-style-type: none"> • Basic kit • Toolbar kit 	No cost +\$ 206	Specify with basic kit. Specify with toolbar kit.
Related Products	<ul style="list-style-type: none"> • Accessories 		► Page 87

Specification Information

Style Number	Dimension Height	U.S. Base Prices			
		47"W	48"W	72"W	95"W
SANS	47"	N.A.	\$1381	\$1844	\$2148
	72"	\$1844	N.A.	N.A.	N.A.
	95"	\$2148	N.A.	N.A.	N.A.



For Canadian Pricing
Multiply U.S. Price by the Canadian price factor.
► See page 1 for details.

Sans Light is a writing board with streamlined, precision cut, frameless edges. Orientation of writing board can be mounted horizontally or vertically.

Frameless edge comes standard in the same finish as the specified CeramicSteel color number of the panel. Contrasting options are also available. Panel thickness is 1/4" or 6 1/2 mm.

CeramicSteel surface is offered in 7655 White High Gloss, 7661 Gray Chalk 6502C CS, 7671 Arctic White 2 CS, 7673 Merle CS, 7674 Platinum Solid CS, and PV09 Hygienic White Gloss. 7661 Gray Chalk 6502C CS is a true chalkboard surface and requires chalk sticks or liquid chalk for writing.
Tip: Available with standard graphics and custom graphics. Please contact pvstudioteam@polyvision.com to acquire a custom print number.

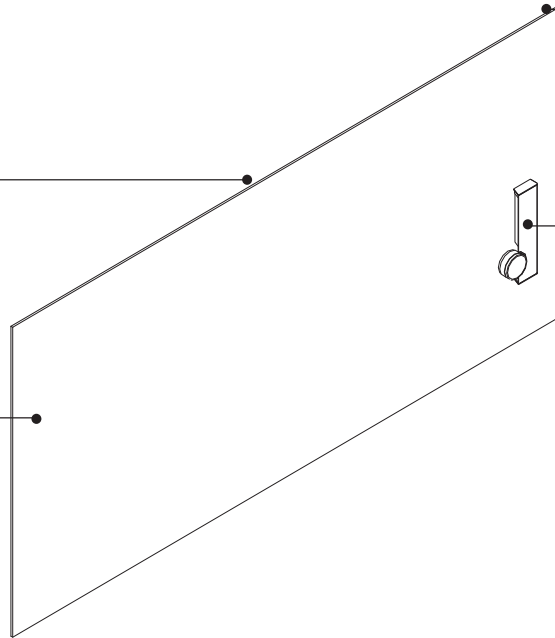

Edges are waterjet cut and sealed with high quality paint. Edges show striations.

The toolbar kit includes markers or chalk sticks depending on the surface type, a round magnetic eraser with replacement microfiber cloths, and the magnetic toolbar to store the writing accessories.

Wall Mounted

Actual Dimensions (Horizontal Orientation)

	Sans Light (48"W)	Sans Light (72"W)	Sans Light (95"W)
Overall Height	46.6535" or 1185 mm	46.6535" or 1185 mm	46.6535" or 1185 mm
Overall Width	48" or 1220 mm	72" or 1830 mm	95" or 2420 mm
Depth	1/4" or 6 1/2 mm	1/4" or 6 1/2 mm	1/4" or 6 1/2 mm
Depth from Wall to Face	4/5" or 20 1/2 mm	4/5" or 20 1/2 mm	4/5" or 20 1/2 mm
Weight (lbs)	34 lb	50 lb	66 lb
Weight (kgs)	15 3/5 kg	22 1/2 kg	30 kg

Actual Dimensions (Vertical Orientation)

	Sans Light (72"H)	Sans Light (95"H)
Overall Height	72" or 1830 mm	95" or 2420 mm
Overall Width	46.6535" or 1185 mm	46.6535" or 1185 mm
Depth	1/4" or 6 1/2 mm	1/4" or 6 1/2 mm
Depth from Wall to Face	4/5" or 20 1/2 mm	4/5" or 20 1/2 mm
Weight (lbs)	50 lb	66 lb
Weight (kgs)	22 1/2 kg	30 kg

Tip: Dimensions are actual with a height and width tolerance of +/- 1 mm. Selections in electronic catalog are rounded up to the nearest whole number.

Product Details

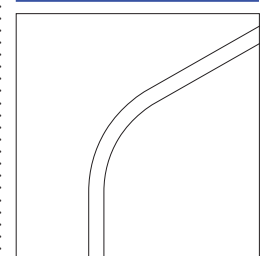

Rounded corners can be selected for the Sans board. Standard corner option is 90-degree, radius is R45. Compatible with accented edge options.

Digital Print Options

Digital printing is offered on Parametric Premium Whiteboards, Sans, Sans Light, and Flow products. Digital print graphics are permanently baked into the CeramicSteel surface and are scratch, abrasion, bacteria, chemical, fire, and graffiti resistant. Both standard and custom options are available.

Tip: Flow only available with custom option.

Standard Digital Print Options for Sans, Sans Light, and Premium Whiteboards

Patterns available in:

- 7676 Saffron
- 7677 Peacock
- 7678 Sea Salt
- 7679 Sterling Dark
- 7681 Sand
- 7682 Black

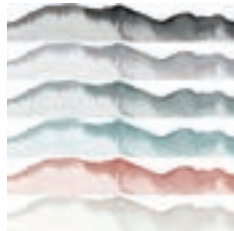

PV55 Agate



PV56 Brushstroke



PV57 Code



PV58 Data



PV59 DNA



PV60 Hive

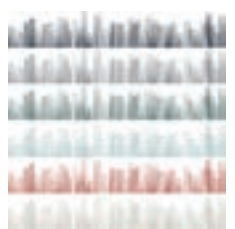

PV61 Skyline



PV62 Soundwave

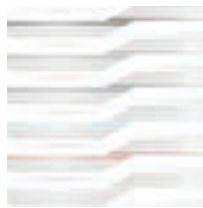

PV63 Speed



PV64 Summit

Patterns available in:

- 7679 Sterling Dark
- 7682 Black

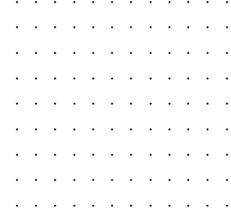

PV65 Dot Grid

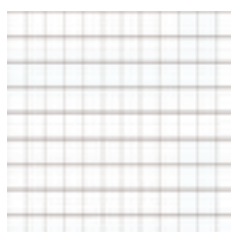

PV66 Line Grid

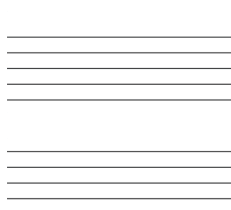

PV67 Music Lines

Tip: For custom graphics, please contact pvstudioteam@polyvision.com to acquire a custom print number.

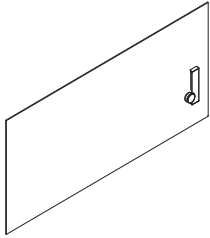

▶ Need help? Product details, page 51

Standard Includes	Required to Specify
<ul style="list-style-type: none"> Panel: Polyvision CeramicSteel Attachment hardware Standard toolbar kit with 7655 White High Gloss, 7671 Arctic White 2 CS, 7674 Platinum Solid CS, or PV09 Hygienic White Gloss. Neon toolbar kit with 7673 Merle CS. Chalk toolbar kit with 7661 Gray Chalk 6502 CS. 	<ol style="list-style-type: none"> Style number Size (see below under Required Selections) Corner shape (see below under Required Selections) Surface type (see below under Required Selections) CeramicSteel color number for panel: <ul style="list-style-type: none"> 7655 White High Gloss 7661 Gray Chalk 6502C CS 7671 Arctic White 2 CS 7673 Merle CS 7674 Platinum Solid CS PV09 Hygienic White Gloss Options, if selected (see below) <p>▶ See <i>Surface Materials</i>, page 92</p>

Tip: Accessories come with all Sans boards. Accessories vary by surface type and color. All Sans boards include a logo on the bottom right corner.

Tip: Mounting hardware will be installed on the back of the board to support vertical installation when 72"H or 95"H is specified.

Tip: See CeramicSteel Cleaning/Daily Care and Maintenance for additional information.
▶ Page 11

Tip: Contrasting accented edge can only be specified when the panel is selected in 7671 Arctic White 2 CS.

Tip: 7661 Gray Chalk 6502C CS is a true chalkboard surface. Chalk sticks and liquid chalk can be used. Liquid chalk requires wet erase.

Tip: Graphics not available with rounded corners.

Tip: For custom graphics, please contact pvstudioteam@polyvision.com to acquire a custom print number.

Required Selections	U.S. Price	Required to Specify
Size		
Horizontal		
<ul style="list-style-type: none"> 47"H x 48"W 47"H x 72"W 47"H x 95"W 	Prices below Prices below Prices below	Specify with 47"H x 48"W. Specify with 47"H x 72"W. Specify with 47"H x 95"W.
Vertical		
<ul style="list-style-type: none"> 72"H x 47"W 95"H x 47"W 	Prices below Prices below	Specify with 72"H x 47"W. Specify with 95"H x 47"W.
Corner Shape		
<ul style="list-style-type: none"> 90 degree corner Rounded corner 	No cost No cost	Specify with 90 degree corner. Specify with rounded corner.
Surface Type		
<ul style="list-style-type: none"> Chalkboard Markerboard 	No cost No cost	Specify with chalkboard. Specify with markerboard.

Options	U.S. Price	Required to Specify
Surface Materials		
Surface		
<ul style="list-style-type: none"> Ceramic price group 1 Ceramic price group 2 Graphic 47"H x 48"W Graphic 47"H x 72"W Graphic 47"H x 95"W Graphic 72"H x 47"W Graphic 95"H x 47"W 	No cost +\$ 152 +\$1477 +\$1586 +\$1696 +\$1586 +\$1696	Specify ceramic color number. Specify ceramic color number. Specify standard or custom graphic number. Specify standard or custom graphic number. Specify standard or custom graphic number. Specify standard or custom graphic number. Specify standard or custom graphic number.
Contrasting		
<ul style="list-style-type: none"> Non-contrasting accented edge Contrasting accented edge 	No cost +\$ 135	Specify with non-contrasting accented edge. Specify with contrasting accented edge.
Related Products	<ul style="list-style-type: none"> Accessories 	▶ Page 87

Specification Information					
Style Number	Dimension Height	U.S. Base Prices			
		47"W	48"W	72"W	95"W
PVLTSANS	47"	N.A.	\$1846	\$1982	\$2120
	72"	\$1982	N.A.	N.A.	N.A.
	95"	\$2120	N.A.	N.A.	N.A.

 **For Canadian Pricing**
 Multiply U.S. Price by the Canadian price factor.
 ▶ See page 1 for details.

Accord

Accord is a combination board where writing and sound absorbing features are combined in a streamlined, precision cut, and frameless design.

Frameless edge comes standard in the same finish as the specified color number of the panel. Contrasting options are also available.

Bumper consists of matte black ABS divider that separates acoustic and CeramicSteel material.

Tackable board with sound absorbing properties is available in different colors and prints.

Sound diffusing acoustic panel made from 100% recycled material.

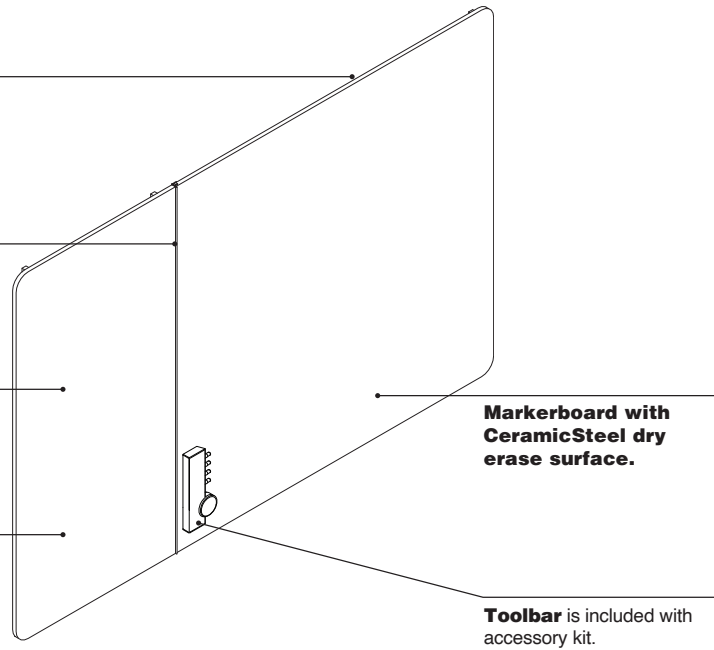

Product Details

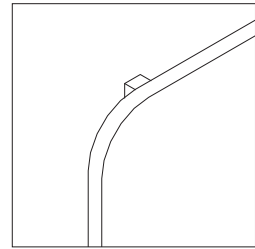

Accord features four rounded corners R45 mm and installs with Z-brackets. The markerboard has a 1/2" MDF core. Acoustic material has a 12 mm core. Acoustic Material: Cost effective sound solution—NRC = 0.45–0.80 for 12 mm.

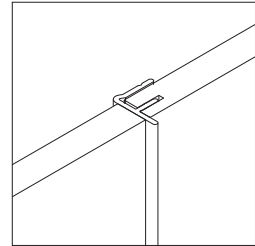

Accord features 4 mm protection bumper, material ABS.

Actual Dimensions

Accord	Height	Width	Depth	Depth from Wall to Face of Writing Surface	Depth Divider Bumper to Face of Writing Surface	Weight (lbs)	Weight (kg)
Horizontal Double	47" or 1185 mm	94" or 2375 mm	0.51" or 13 mm	0.86" or 22 mm	0.15" or 4 mm	52.69 lbs	23.9 kg
	47" or 1185 mm	119" or 3020 mm	0.51" or 13 mm	0.86" or 22 mm	0.15" or 4 mm	76.27 lbs	34.6 kg
	47" or 1185 mm	142" or 3610 mm	0.51" or 13 mm	0.86" or 22 mm	0.15" or 4 mm	97.66 lbs	44.3 kg
Vertical Double	72" or 1830 mm	94" or 2375 mm	0.51" or 13 mm	0.86" or 22 mm	0.15" or 4 mm	81.57 lbs	37 kg
	95" or 2420 mm	94" or 2375 mm	0.51" or 13 mm	0.86" or 22 mm	0.15" or 4 mm	107.36 lbs	48.7 kg
Horizontal Left	47" or 1185 mm	70" or 1780 mm	0.51" or 13 mm	0.86" or 22 mm	0.15" or 4 mm	48.06 lbs	21.8 kg
	47" or 1185 mm	94" or 2425 mm	0.51" or 13 mm	0.86" or 22 mm	0.15" or 4 mm	71.65 lbs	32.5 kg
	47" or 1185 mm	119" or 3015 mm	0.51" or 13 mm	0.86" or 22 mm	0.15" or 4 mm	93.03 lbs	42.2 kg
Vertical Left	72" or 1830 mm	70" or 1780 mm	0.51" or 13 mm	0.86" or 22 mm	0.15" or 4 mm	74.29 lbs	33.7 kg
	95" or 2420 mm	70" or 1780 mm	0.51" or 13 mm	0.86" or 22 mm	0.15" or 4 mm	97.88 lbs	44.4 kg
Horizontal Right	47" or 1185 mm	70" or 1780 mm	0.51" or 13 mm	0.86" or 22 mm	0.15" or 4 mm	48.06 lbs	21.8 kg
	47" or 1185 mm	94" or 2425 mm	0.51" or 13 mm	0.86" or 22 mm	0.15" or 4 mm	71.65 lbs	32.5 kg
	47" or 1185 mm	119" or 3015 mm	0.51" or 13 mm	0.86" or 22 mm	0.15" or 4 mm	93.03 lbs	42.2 kg
Vertical Right	72" or 1830 mm	70" or 1780 mm	0.51" or 13 mm	0.86" or 22 mm	0.15" or 4 mm	74.29 lbs	33.7 kg
	95" or 2420 mm	70" or 1780 mm	0.51" or 13 mm	0.86" or 22 mm	0.15" or 4 mm	97.88 lbs	44.4 kg

Tip: Dimensions are actual with a height and width tolerance of +/- 1 mm. Selections in electronic catalog are rounded up to the nearest whole number.

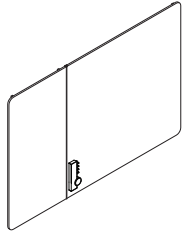

Tip: Accord only available with a single CeramicSteel panel application. Panel comes standard with accessories.

Tip: See CeramicSteel Cleaning/Daily Care and Maintenance for additional information.
▶ Page 11

Tip: Refer to panel layouts for acoustic panel quantity and placement.

Standard Includes		Required to Specify
▶ Need help? Product details, page 54	<ul style="list-style-type: none"> • Polyvision CeramicSteel markerboard with bumper divider and PET tackable acoustic panel(s) • Attachment hardware • Accessories: toolbar kit 	<ol style="list-style-type: none"> 1 Style number 2 Height (see below under Required Selections) 3 Width (see below under Required Selections) 4 Acoustic panel quantity (see below under Required Selections) 5 CeramicSteel color number for markerboard: 7655 White High Gloss 7671 Arctic White 2 CS 6 PET color number for acoustic panel(s) 7 Options, if selected (see below) <p>▶ See Surface Materials, page 92</p>

	Required Selections	U.S. Price	Required to Specify
Height	<ul style="list-style-type: none"> • 47"H • 72"H • 95"H 	<p>Prices below</p> <p>Prices below</p> <p>Prices below</p>	<p>Specify with 47"H.</p> <p>Specify with 72"H.</p> <p>Specify with 95"H.</p>
Width	<ul style="list-style-type: none"> • 70"W • 94"W • 119"W • 142"W 	<p>Prices below</p> <p>Prices below</p> <p>Prices below</p> <p>Prices below</p>	<p>Specify with 70"W.</p> <p>Specify with 94"W.</p> <p>Specify with 119"W.</p> <p>Specify with 142"W.</p>
Acoustic Panel Quantity	<ul style="list-style-type: none"> • Quantity 1 • Quantity 2 	<p>Prices below</p> <p>Prices below</p>	<p>Specify one acoustic panel.</p> <p>Specify two acoustic panels.</p>

	Options	U.S. Price	Required to Specify
Surface Materials	Markerboard edge <ul style="list-style-type: none"> • Ceramic price group 1 • Paint price group 1 • Paint price group 3 	<p>No cost</p> <p>No cost</p> <p>+\$124</p>	<p>Specify edge finish color number.</p> <p>Specify edge finish color number.</p> <p>Specify edge finish color number.</p>
Related Products	<ul style="list-style-type: none"> • Accessories 		▶ Page 87

Specification Information				
Style Number	Dimensions W	U.S. Base Prices		
		47"H	72"H	95"H
Panel Quantity 1				
PVMRGE	70"	\$2496	\$3396	\$3696
	94"	\$2996	N.A.	N.A.
	119"	\$3196	N.A.	N.A.
	142"	N.A.	N.A.	N.A.
Panel Quantity 2				
PVMRGE	70"	N.A.	N.A.	N.A.
	94"	\$3396	\$4796	\$5096
	119"	\$3896	N.A.	N.A.
	142"	\$4096	N.A.	N.A.

Tip: Panel quantity refers to the number of acoustic panels selected.

 **For Canadian Pricing**
Multiply U.S. Price by the Canadian price factor.
▶ See page 1 for details.

Motif

Motif is a high-performance collaborative panel that can be configured in countless ways to turn unused wall space into places where teams express and share ideas together. Flexible placement encourages spontaneous inspiration while a superior Polyvision CeramicSteel writable worksurface helps teams effectively capture ideas.

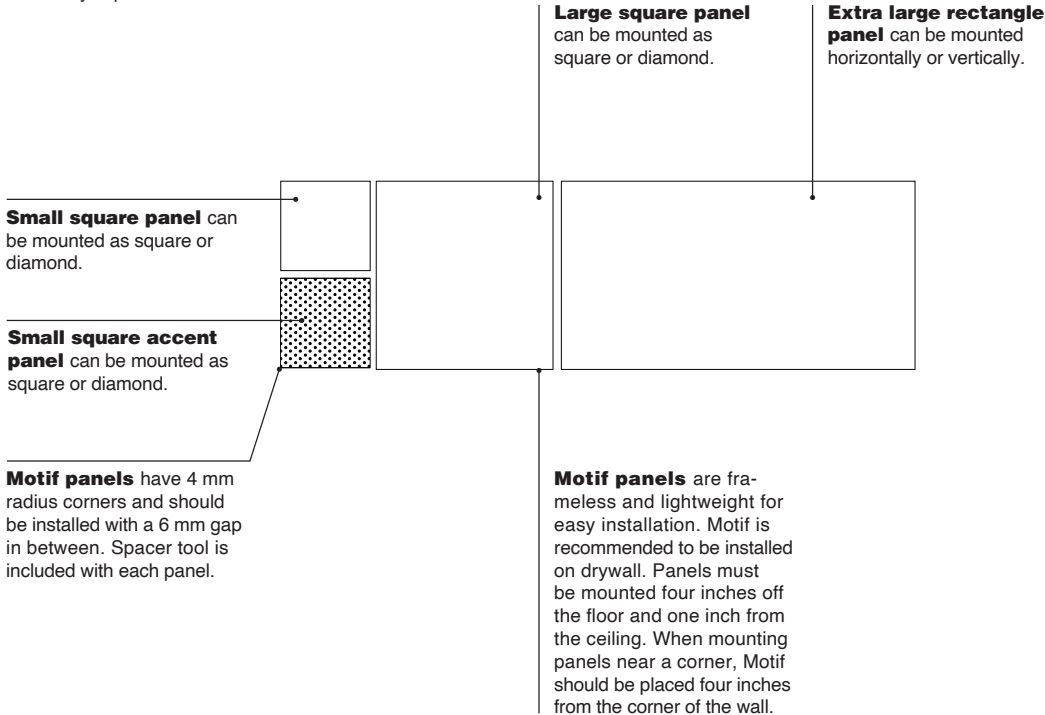

Product Details

Standard Digital Print Options for Motif Boards

- 22½" x 22½"
- PV11 Grey Calendar CS
- PV12 Grey Grid CS

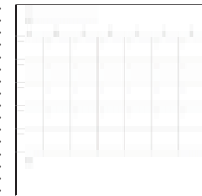

Calendar Grid

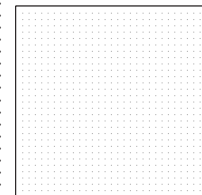

Grey Grid

Motif boards are available in Polyvision CeramicSteel. Standard digital print options are printed on 7671 Arctic White 2 CS.

Actual Dimensions

	Small Square Panel	Large Square Panel	Extra Large Rectangle Panel	Small Square Accent Panel
Single Panel Height	22½" or 572 mm	45¼" or 1150 mm	45¼" or 1150 mm 90¾" or 2306 mm	22½" or 572 mm
Single Panel Width	22½" or 572 mm	45¼" or 1150 mm	90¾" or 2306 mm 45¼" or 1150 mm	22½" or 572 mm
Depth	.157" or 4 mm	.157" or 4 mm	.157" or 4 mm	.157" or 4 mm
Depth from Wall to Face	1⅝" or 32⅛ mm	1⅝" or 32⅛ mm	1⅝" or 32⅛ mm	1⅝" or 32⅛ mm
Weight (lbs)	5.7 lb	23.32 lb	46.78 lb	5.7 lb
Weight (kgs)	2.62 kg	10.58 kg	21.22 kg	2.62 kg

Tip: Dimensions are actual with a height and width tolerance of +/- 1 mm.

Tip: A neon marker will come standard if Merle CS or Sterling Dark Solid CS are specified on the panel. If Seagull CS, Platinum Solid CS, or Arctic White 2 CS are selected then a standard black marker will come standard.

Tip: 90³/₄"H panels are only available as 45¹/₄"W.

Tip: Small square and large square panels can be mounted as square or diamond.

Tip: Extra large rectangle panel can be mounted horizontally or vertically (45¹/₄"H x 90³/₄"W or 90³/₄"H x 45¹/₄"W).

Tip: PV11 Grey Calendar Grid CS and PV12 Grey Grid CS are offered only on small square size panels.

Tip: See CeramicSteel Cleaning/Daily Care and Maintenance for additional information.

▶ Page 11

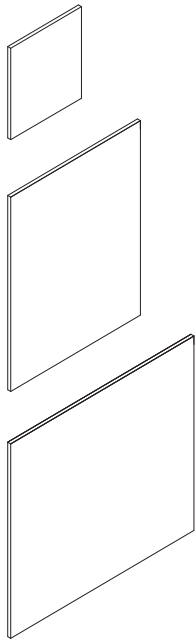

For Canadian Pricing

Multiply U.S. Price by the Canadian price factor.

▶ See page 1 for details.

Standard Includes	Required to Specify
-------------------	---------------------

<ul style="list-style-type: none"> ▶ Need help? Product details, page 56 • Panel: Polyvision CeramicSteel • Dry erase marker • Attachment hardware • Installation template 	<ol style="list-style-type: none"> 1 Style number 2 Panel size (see below under Required Selections) 3 CeramicSteel color number for panel: <ul style="list-style-type: none"> 7671 Arctic White 2 CS 7672 Seagull CS 7673 Merle CS 7674 Platinum Solid CS 7675 Sterling Dark Solid CS PV11 Grey Calendar Grid CS PV12 Grey Grid CS
---	--

Panel Size	Required Selections	U.S. Price	Required to Specify
------------	---------------------	------------	---------------------

Panel Size	• Small square panel (22 ¹ / ₂ "H x 22 ¹ / ₂ "W)	Prices below	Specify with <i>small square panel</i> .
	• Large square panel (45 ¹ / ₄ "H x 45 ¹ / ₄ "W)	Prices below	Specify with <i>large square panel</i> .
	• Extra large rectangle panel (45 ¹ / ₄ "H x 90 ³ / ₄ "W)	Prices below	Specify with <i>extra large rectangle panel</i> .
	• Extra large rectangle panel (90 ³ / ₄ "H x 45 ¹ / ₄ "W)	Prices below	Specify with <i>extra large rectangle panel</i> .

Related Products	<ul style="list-style-type: none"> • Dry erase markers • Magnetic eraser with marker holder • Motif accent panel • Accessories 	<ul style="list-style-type: none"> ▶ Page 87 ▶ Page 87 ▶ Page 58 ▶ Page 87
-------------------------	--	--

Specification Information			
Style Number	Dimensions W H		U.S. Price

Small Square Panel

MTFPNL	22 ¹ / ₂ "	22 ¹ / ₂ "	\$ 546

Large Square Panel

MTFPNL	45 ¹ / ₄ "	45 ¹ / ₄ "	\$1506

Extra Large Rectangle Panel

MTFPNL	90 ³ / ₄ "	45 ¹ / ₄ "	\$2741
	45 ¹ / ₄ "	90 ³ / ₄ "	\$2741

Wall Mounted

Motif Accent Panel

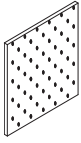

Tip: Small square accent panel can be mounted as square or diamond.

Tip: See CeramicSteel Cleaning/Daily Care and Maintenance for additional information.

▶ Page 11

Standard Includes	Required to Specify
<ul style="list-style-type: none"> ▶ Need help? Product details, page 56 • Panel: Polyvision CeramicSteel: 7665 Saffron Pattern CS • Attachment hardware • Installation template 	<ul style="list-style-type: none"> Style number

Related Products
<ul style="list-style-type: none"> • Dry erase markers ▶ Page 87 • Magnetic eraser with marker holder ▶ Page 87 • Motif panels ▶ Page 57 • Accessories ▶ Page 87

Specification Information		
• Style Number	• Dimensions W H	• U.S. Price

Small Square Accent Panel

MTFPNLA	22½" 22½"	\$546



For Canadian Pricing

Multiply U.S. Price by the Canadian price factor.

▶ See page 1 for details.

Serif is a thin CeramicSteel writing board mounted with standoff mounts in a satin chrome finish. Precision cut edges are sealed with a durable lacquer, while rounded corners provide a modern, premium look. Orientation of writing board can be mounted horizontally or vertically.

Frameless edge comes standard in the same finish as the specified CeramicSteel color number of the panel. Frameless edge corners have a 4 mm radius. Contrasting options are also available.

CeramicSteel surface is offered in 7655 White High Gloss or PV09 Hygienic White Gloss.

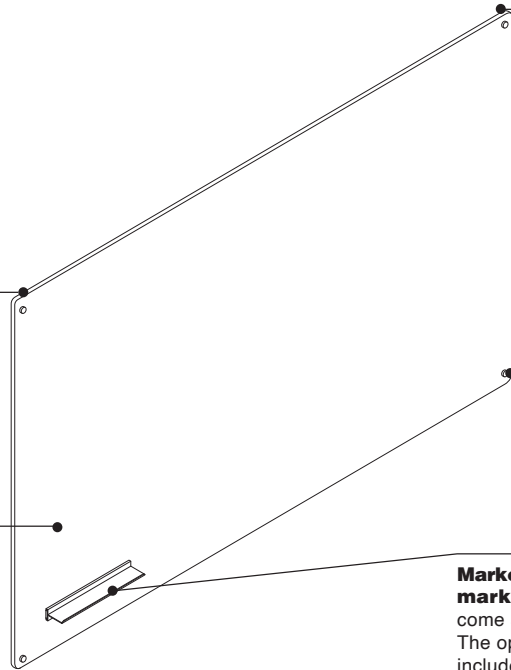

Edges are waterjet cut and sealed with high quality paint. Edges show striations.

Mounting comes standard with standoff mounts. Mounts vary by size of panel.

Marker tray, dry erase markers, and eraser come standard with Serif. The optional toolbar kit includes markers or chalk sticks depending on the surface type, a round magnetic eraser with replacement microfiber cloths, and the magnetic toolbar to store the writing accessories.

Wall Mounted

Actual Dimensions (Horizontal Orientation)

	Serif (47"W)	Serif (72"W)	Serif (95"W)
Overall Height	46.6535" or 1185 mm	46.6535" or 1185 mm	46.6535" or 1185 mm
Overall Width	46.6535" or 1185 mm	72" or 1830 mm	95" or 2420 mm
Depth	1/4" or 6 1/2 mm	1/4" or 6 1/2 mm	1/4" or 6 1/2 mm
Depth from Wall to Face	3/4" or 19 mm	3/4" or 19 mm	3/4" or 19 mm
Weight (lbs)	32 lb	50 lb	66 lb
Weight (kgs)	15 kg	23 kg	30 kg

Actual Dimensions (Vertical Orientation)

	Serif (72"H)	Serif (95"H)
Overall Height	72" or 1830 mm	95" or 2420 mm
Overall Width	46.6535" or 1185 mm	46.6535" or 1185 mm
Depth	1/4" or 6 1/2 mm	1/4" or 6 1/2 mm
Depth from Wall to Face	3/4" or 19 mm	3/4" or 19 mm
Weight (lbs)	50 lb	66 lb
Weight (kgs)	23 kg	30 kg

Tip: Dimensions are actual with a height and width tolerance of +/- 1 mm. Selections in electronic catalog are rounded up to the nearest whole number.

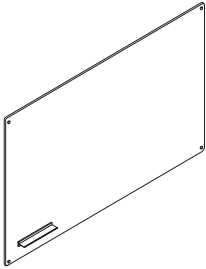

Tip: See CeramicSteel Cleaning/Daily Care and Maintenance for additional information.
 ▶ Page 11

Standard Includes		Required to Specify
▶ Need help? Product details, page 59	<ul style="list-style-type: none"> Panel: Polyvision CeramicSteel Attachment hardware <ul style="list-style-type: none"> – Four standoff mounts, if 47"H x 47"W is selected – Six standoff mounts, if 47"H x 72"W or 47"H x 95"W is selected Magnetic marker tray, dry erase markers, and eraser Accented edge: paint, if contrasting is selected 	<ol style="list-style-type: none"> Style number Size (see below under Required Selections) CeramicSteel color number for panel: 7655 White High Gloss PV09 Hygienic White Gloss Options, if selected (see below) ▶ See <i>Surface Materials</i> , page 92

	Required Selections	U.S. Price	Required to Specify
Size	Horizontal		
	<ul style="list-style-type: none"> 47"H x 47"W 47"H x 72"W 47"H x 95"W 	Price below Price below Price below	Specify with 47"H x 47"W. Specify with 47"H x 72"W. Specify with 47"H x 95"W.
	Vertical		
	<ul style="list-style-type: none"> 72"H x 47"W 95"H x 47"W 	Price below Price below	Specify with 72"H x 47"W. Specify with 95"H x 47"W.

	Options	U.S. Price	Required to Specify
Surface Materials	Surface		
	<ul style="list-style-type: none"> Ceramic price group 1 Ceramic price group 2 	No cost +\$152	Specify ceramic color number. Specify ceramic color number.
	Contrasting		
	<ul style="list-style-type: none"> Non-contrasting accented edge Contrasting accented edge 	No cost +\$135	Specify with non-contrasting accented edge. Specify with contrasting accented edge.
Accessory Kit	<ul style="list-style-type: none"> Basic kit Toolbar kit 	No cost +\$206	Specify with basic kit. Specify with toolbar kit.
Related Products	<ul style="list-style-type: none"> Accessories 		▶ Page 87

Specification Information				
Style Number	Dimension Height	U.S. Base Prices		
		47"W	72"W	95"W
SERIF	47"	\$1509	\$1646	\$1921
	72"	\$1646	N.A.	N.A.
	95"	\$1921	N.A.	N.A.



For Canadian Pricing
 Multiply U.S. Price by the Canadian price factor.
 ▶ See page 1 for details.

Frameless, fabric wrapped tackboard—

Tac adds another dimension to collaboration by providing a pinnable, flexible space where your best ideas can come to life.

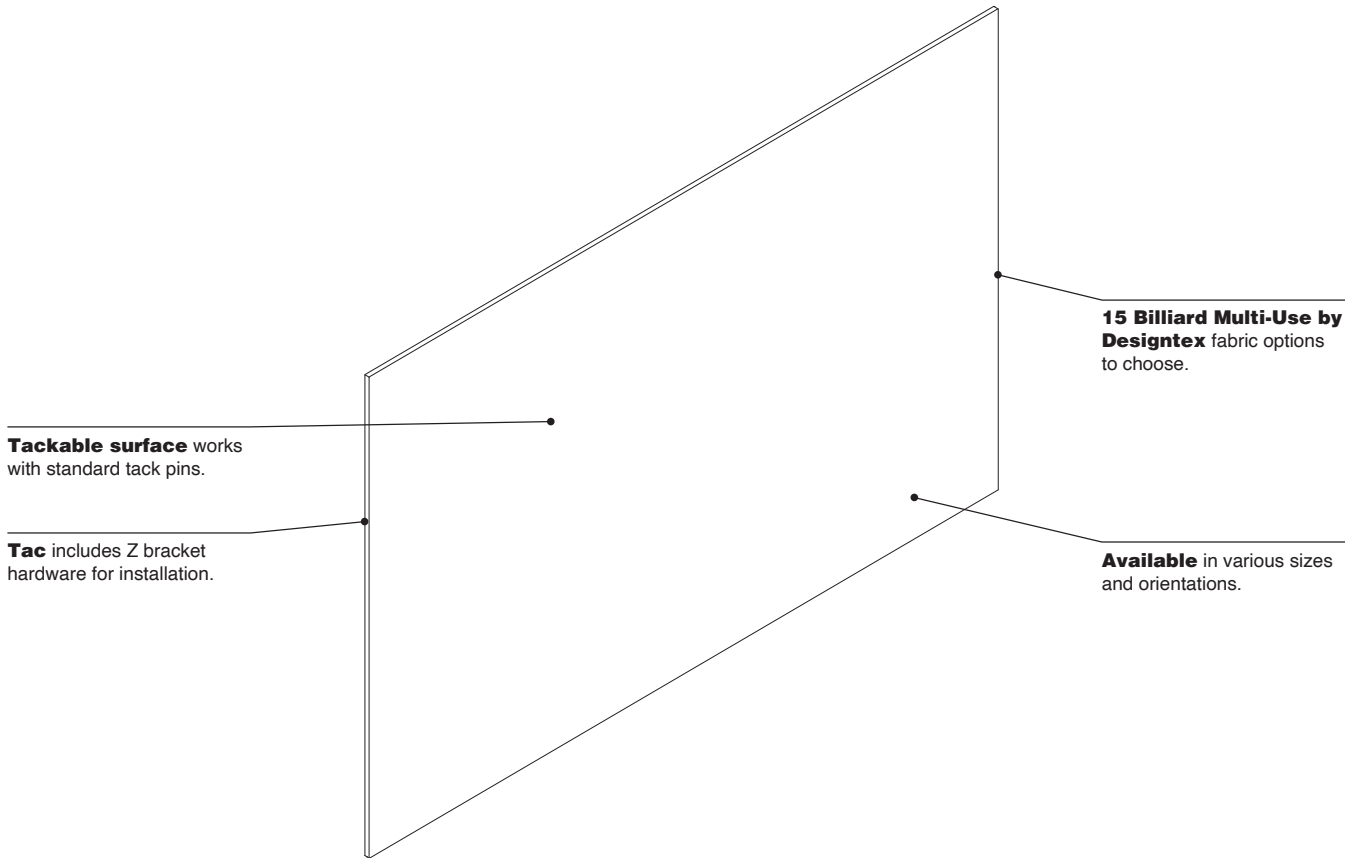

Wall Mounted

Actual Dimensions

	Tac Small Square	Tac Small Rectangle	Tac Medium Rectangle	Tac Large Rectangle
Depth	3/4"	3/4"	3/4"	3/4"
Width	24"	48"	72"	96"
Height	24"	36"	48"	48"
Depth from wall to face	1 1/4"	1 1/4"	1 1/4"	1 1/4"
Weight (lb)	5	17	62	80
Weight (kg)	2.27	7.71	28.12	36.28

Tip: Rectangles available in horizontal and vertical orientation. Dimensions are actual with a height and width tolerance of +/- 1 mm.

Tac

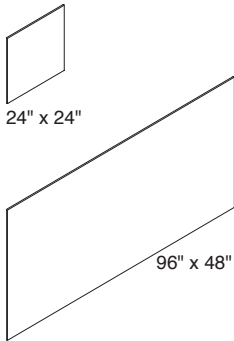

Tip: Fabric direction runs horizontal for horizontal orientation. Fabric direction runs vertical for vertical orientation.

Tip: Clean only with water-based or solvent-based cleaner. Do not saturate.

Standard Includes	Required to Specify
<ul style="list-style-type: none"> ▶ Need help? Product details, page 61 • Tackboard: Billiard Multi-Use by Designtex fabric wrapped • Z-bracket mounting hardware • Cleaning instructions 	<ol style="list-style-type: none"> 1 Style number 2 Size (see below under Required Selections) 3 Tackboard fabric <ul style="list-style-type: none"> ▶ See <i>Surface Materials</i>, page 92.

Size	Required Selections	U.S. Price	Required to Specify
Horizontal	• 24"H x 24"W	Price below	Specify with 24"H x 24"W.
	• 36"H x 48"W	Price below	Specify with 36"H x 48"W.
	• 48"H x 72"W	Price below	Specify with 48"H x 72"W.
	• 48"H x 96"W	Price below	Specify with 48"H x 96"W.
Vertical	• 48"H x 36"W	Price below	Specify with 48"H x 36"W.
	• 72"H x 48"W	Price below	Specify with 72"H x 48"W.
	• 96"H x 48"W	Price below	Specify with 96"H x 48"W.

Related Products	U.S. Price	Required to Specify
• Textura		▶ Page 74

Specification Information			
Style Number	Dimensions H W		U.S. Price
TAC	Horizontal		
	24"	24"	\$ 792
	36"	48"	\$1189
	48"	72"	\$1717
	48"	96"	\$2049
	Vertical		
	48"	36"	\$1189
	72"	48"	\$1717
	96"	48"	\$2049



For Canadian Pricing
 Multiply U.S. Price by the Canadian price factor.
 ▶ See page 1 for details.

High quality glassboard

is made with $\frac{3}{16}$ " thick low-iron tempered glass and is non-porous, non-ghosting, and non-staining. With the ability to configure both vertically or horizontally, the compact structure of this glassboard sits close to the wall using a Z-bracket installation. Accepts rare earth magnets.

Thin, smooth, frameless edge.

Glass surface is offered in 25 color options.
Tip: For information on custom color finishes, please contact pvstudioteam@polyvision.com.

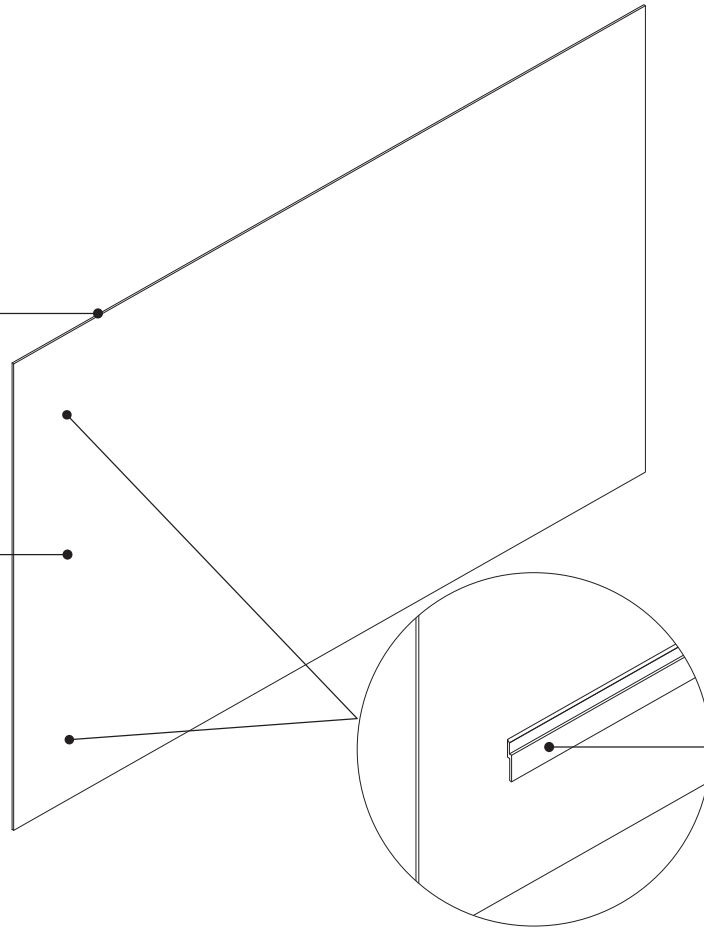

Glassboard mounted to the wall with Z-brackets.

Wall Mounted

Actual Dimensions (Horizontal Orientation)

	Glass (48"W)	Glass (72"W)	Glass (96"W)
Overall Height	48" or 1220 mm	48" or 1220 mm	48" or 1220 mm
Overall Width	48" or 1220 mm	72" or 1830 mm	96" or 2439 mm
Depth	$\frac{3}{16}$ " or 5 mm	$\frac{3}{16}$ " or 5 mm	$\frac{3}{16}$ " or 5 mm
Depth from Wall to Face	$\frac{7}{16}$ " or 11.1 mm	$\frac{7}{16}$ " or 11.1 mm	$\frac{7}{16}$ " or 11.1 mm
Weight (lbs)	51 lb	76.5 lb	102 lb
Weight (kgs)	25.4 kg	38.1 kg	50.8 kg

Tip: Sizes are nominal.

Actual Dimensions (Vertical Orientation)

	Glass (72"H)	Glass (96"H)
Overall Height	72" or 1830 mm	96" or 2439 mm
Overall Width	48" or 1220 mm	48" or 1220 mm
Depth	$\frac{3}{16}$ " or 5 mm	$\frac{3}{16}$ " or 5 mm
Depth from Wall to Face	$\frac{7}{16}$ " or 11.1 mm	$\frac{7}{16}$ " or 11.1 mm
Weight (lbs)	76.5 lb	102 lb
Weight (kgs)	38.1 kg	50.8 kg

Glass

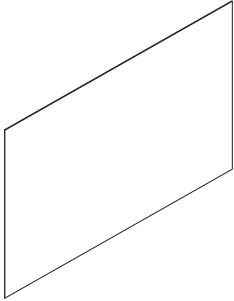

Tip: Glassboards have a steel backer that support use for rare earth magnetic accessories.

Tip: Not compatible with toolbar.

Tip: Rectangle glassboards are available in horizontal or vertical orientation. Hardware is attached during manufacturing. Orientation must be selected during the ordering process.

Standard Includes	Required to Specify
<ul style="list-style-type: none"> ▶ Need help? Product details, page 63 • Glassboard: back painted, magnetic glass • Z-bracket mounting hardware • Cleaning instructions 	<ol style="list-style-type: none"> 1 Style number 2 Size (see below under Required Selections) 3 Back painted glass color number <p>▶ See <i>Surface Materials</i>, page 92.</p>

Size	Required Selections	U.S. Price	Required to Specify
	Horizontal		
	• 48"H x 48"W	Prices below	Specify with 48"H x 48"W.
	• 48"H x 72"W	Prices below	Specify with 48"H x 72"W.
	Vertical		
	• 48"H x 96"W	Prices below	Specify with 48"H x 96"W.
	• 72"H x 48"W	Prices below	Specify with 72"H x 48"W.
	• 96"H x 48"W	Prices below	Specify with 96"H x 48"W.

Specification Information			
Style Number	Dimensions		U.S. Price
	H	W	
PVGLASS	Horizontal		
	48"	48"	\$2396
	48"	72"	\$3354
	48"	96"	\$4237
	Vertical		
	72"	48"	\$3354
96"	48"	\$4237	



For Canadian Pricing
 Multiply U.S. Price by the Canadian price factor.
 ▶ See page 1 for details.

Frank Lloyd Wright Racine Whiteboard

Frank Lloyd Wright
Racine Whiteboard

Wall Mounted

The Frank Lloyd Wright Racine whiteboard represents the natural, organic shape and depth of the Frank Lloyd Wright Racine furniture collection while maintaining highly functional properties. The writing surface is CeramicSteel and the solution can be customized with accented edges and acoustic/tack material available in numerous colors and patterns.

Frameless edge comes standard in the same finish as the specified CeramicSteel color number of the panel. Contrasting options are also available to match acoustic materials. Panel thickness is 1/2" or 13 mm.

Acoustic/tack material is an optional feature. Tackable board with 6 mm sound absorbing properties is available in different colors.

Edges are waterjet cut and sealed with high quality paint. Edges show striations.

CeramicSteel surface is offered in 7671 Arctic White 2 CS.

Optional toolbar kit includes markers, a round-magnetic eraser with replacement microfiber cloths, and the magnetic toolbar to store the writing accessories.

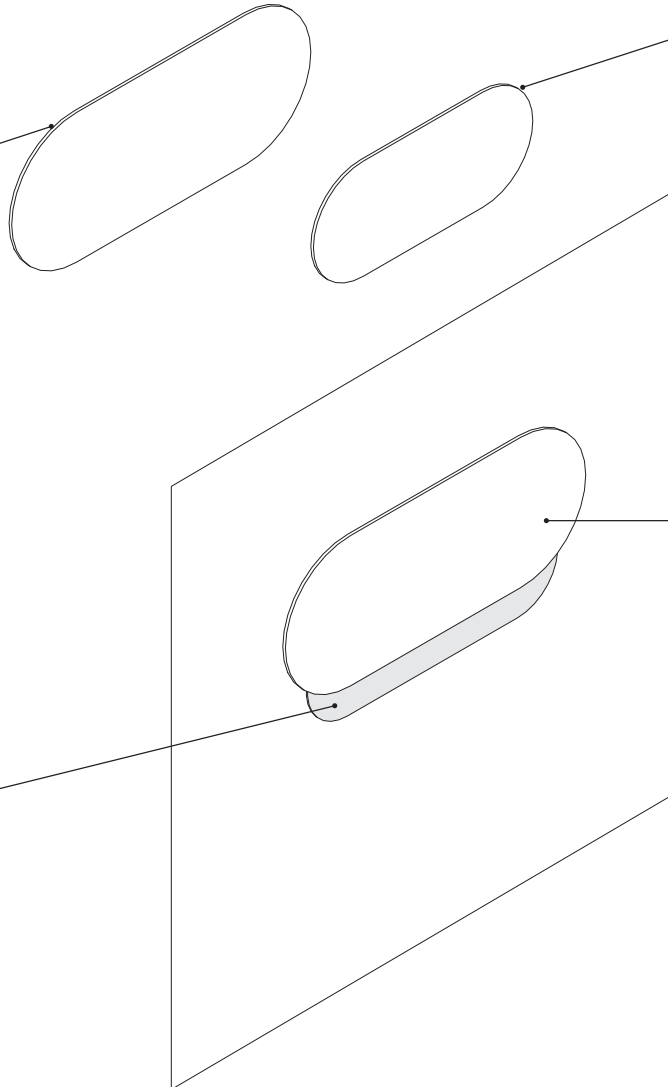

Actual Dimensions

	Small	Large
Overall Height	20" or 508 mm	26" or 660 mm
Overall Width	44" or 1118 mm	60" or 1524 mm
Depth	1/2" or 13 mm	1/2" or 13 mm
Depth from Wall to Face	1" or 25 mm	1" or 25 mm
Weight (lbs)	40 lb	65 lb
Weight (kgs)	18 kg	29 kg

Tip: Dimensions are actual with a height and width tolerance of +/- 1 mm.

Frank Lloyd Wright Racine Whiteboard

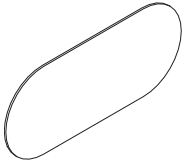

Tip: Mounting hardware will be installed on the back of the board.

Tip: See CeramicSteel Cleaning/Daily Care and Maintenance for additional information.
▶ Page 11

Tip: Contrasting accented edge can only be specified when the acoustic surface is selected.

Tip: Sizes are nominal.

Standard Includes		Required to Specify
▶ Need help? Product details, page 65	<ul style="list-style-type: none"> Whiteboard: 7671 Arctic White 2 CS CeramicSteel Attachment hardware 	1 Style number 2 Size (see below under Required Selections) 3 Options, if selected (see below) ▶ See Surface Materials, page 92

Size	Required Selections	U.S. Price	Required to Specify
	Horizontal		
	<ul style="list-style-type: none"> 20"H x 44"W 26"H x 60"W 	Prices below Prices below	Specify with 20"H x 44"W. Specify with 26"H x 60"W.

	Options	U.S. Price	Required to Specify
Accented Edge	<ul style="list-style-type: none"> Non-contrasting accented edge Contrasting accented edge 	No cost +\$135	Specify with non-contrasting accented edge. Specify with contrasting accented edge.
Acoustic Surface	<ul style="list-style-type: none"> Small (20"H x 44"W) Large (26"H x 60"W) 	+\$150 +\$400	Specify with small acoustic panel. Specify with large acoustic panel.
Accessory Kit	<ul style="list-style-type: none"> Toolbar kit 	+\$206	Specify with toolbar kit.
Related Products	<ul style="list-style-type: none"> Accessories 		▶ Page 87

Specification Information			
Style Number	Dimensions		U.S. Base Prices
	H	W	
Small			
FLWBRD	20"	44"	\$1299
Large			
FLWBRD	26"	60"	\$1999
:	:	:	:



For Canadian Pricing
 Multiply U.S. Price by the Canadian price factor.
 ▶ See page 1 for details.

Mobile and Privacy

Mobile and Privacy

Groupwork Screens and Marker Trays	68
Textura Mobile	73
Verb Whiteboards and Easels	75
Boundri	80

Groupwork Screens and Marker Trays

Screens are available with laminate markerboards on both sides, e³ CeramicSteel on both sides, or tackboard on both sides. Screens are available in two heights—54"H and 66"H—and five widths—24"W, 30"W, 36"W, 42"W, and 48"W—to coordinate with Kick panel systems.

► Specifying, page 70

Laminate markerboard surface has a non-glare writing surface and accepts all standard dry-erase markers. e³ CeramicSteel surface is magnetic.

Four-leg base is standard on screens.

Four locking casters allow for easy movement.

Tackboard surface is available in a variety of fabric options.

Laminate markerboard surface is available in the U.S. only. For Canada orders, specify either e³ CeramicSteel on both surfaces or tackboard on both sides.

Levelers adjust 1/4" for uneven floors. Levelers do not slide and should be used in applications where infrequent movement is required.

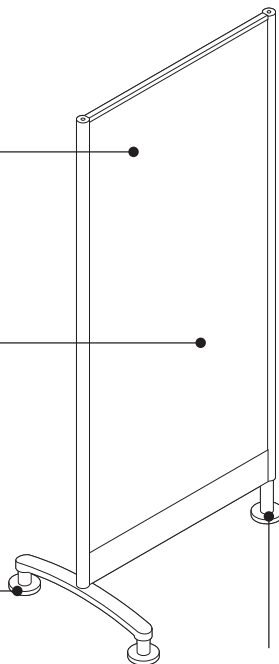
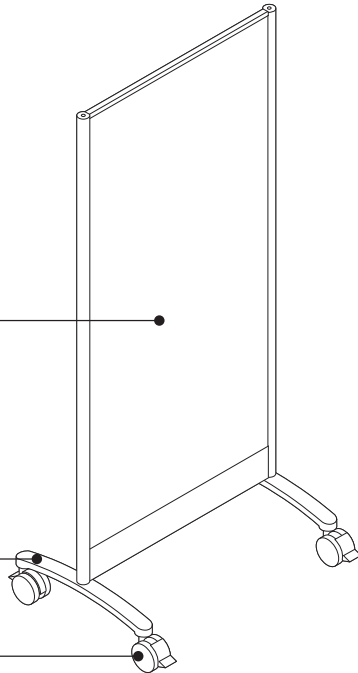

Three-leg base is available on 54"H screens only as an option to create a privacy wall.

Product Details

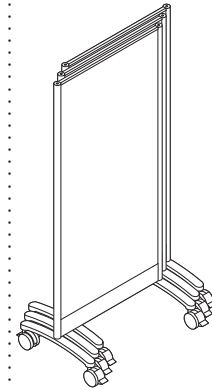

Screens nest easily and require minimal space. The leg bases are 16"D, and each screen nested adds another 1 1/2" to the depth.

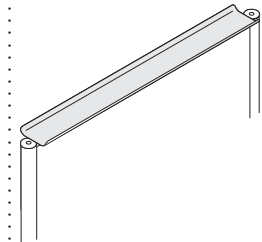

Marker tray is available to hold dry erasers and markers. The tray is attached on top of the screen top cap. Marker trays are available in all five screen widths.

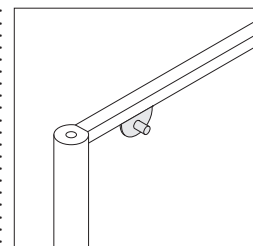

Flip-chart pegs are available as an option on the top cap. They are positioned 17 7/8" apart center to center and are available on one side only. Flip-chart peg top cap works in conjunction with marker trays.

Groupwork Screens

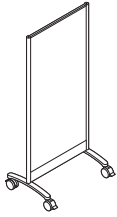

Tip: Screens must be specified with fabric on both sides, e³ CeramicSteel on both sides, or laminate on both sides. For Canada, screens are available in fabric or e³ CeramicSteel on both sides only.

Tip: See CeramicSteel Cleaning/Daily Care and Maintenance for additional information.
▶ Page 11

Tip: 54"H screens are available in vertical or horizontal fabric direction. 66"H screens are available in vertical fabric direction only.

Tip: e³ CeramicSteel writing surface is magnetic.

Tip: Three-leg base is used when two or more screens are placed next to each other on angles. Four-leg bases can be used next to each other only in a straight configuration.

Tip: 66"H screens are not available with the three-leg base option.

Tip: Levelers have 1/4" adjustment (higher only) and do not slide. If frequent movement is needed, order screen with casters.

Tip: Flip-chart pegs, located 17⁵/₈" apart, are located on only one side of the top cap.



For Canadian Pricing
Multiply U.S. Price by the Canadian price factor.
▶ See page 1 for details.

Standard Includes		Required to Specify
▶ Need help? Product details, page 68	<ul style="list-style-type: none"> Tackboard, both sides if selected: Price group A Horizontal or vertical fabric direction, if 54"H screens is selected Vertical fabric direction, if 66"H screen is selected e³ CeramicSteel writing surface, both sides, if selected: 7655 e³ CeramicSteel White High Gloss Laminate markerboard, both sides, if selected: 2977 White Markerboard Laminate Frame, top cap, uprights, bottom channel, and four-leg base: paint price group 1 Four-leg base with four locking casters: black plastic Attachment hardware Shipped ready to assemble 	<ol style="list-style-type: none"> Style number Fabric color number, 7655 e³ CeramicSteel White High Gloss, or 2977 White Markerboard Laminate for side 1 Fabric color number, 7655 e³ CeramicSteel White High Gloss, or 2977 White Markerboard Laminate for side 2 Fabric direction for 54"H screen, if selected Paint color number for frame Options, if selected (see below) <p>▶ See Surface Materials, page 92</p>

Options	U.S. Price	Required to Specify	
Surface Materials	Fabric surface on tackboard		
<ul style="list-style-type: none"> Price group A Fabric price group 1 Fabric price group 2 Fabric price group 3 Fabric price group 4 Fabric price group 5 Fabric price group 6 Fabric price group 6 Fabric price group 7 Fabric price group 9 Fabric price group 10 Fabric price group COM 	<ul style="list-style-type: none"> No cost +\$ 5 per side +\$ 32 per side +\$ 48 per side +\$ 66 per side +\$ 86 per side +\$107 per side +\$126 per side +\$146 per side +\$166 per side +\$186 per side +\$ 61 per side 	<ul style="list-style-type: none"> Specify fabric color number. Specify fabric color number. Specify fabric color number. Specify fabric color number. Specify fabric color number. Specify fabric color number. Specify fabric color number. Specify fabric color number. Specify fabric color number. Specify fabric color number. Specify fabric color number. <p>▶ See <i>Surface Materials Reference Manual</i>.</p>	
	Fabric direction		
<ul style="list-style-type: none"> Horizontal application Vertical application 	<ul style="list-style-type: none"> No cost No cost 	<ul style="list-style-type: none"> Specify with horizontal application. Specify with vertical application. 	
	e³ CeramicSteel writing surface		
<ul style="list-style-type: none"> e³ CeramicSteel surface on both sides 	<ul style="list-style-type: none"> +\$ 88 	<ul style="list-style-type: none"> Specify with 7655 White High Gloss. 	
	Laminate markerboard		
<ul style="list-style-type: none"> 2977 White Markerboard Laminate 	<ul style="list-style-type: none"> No cost 	<ul style="list-style-type: none"> Specify with 2977 White Markerboard Laminate. 	
	Frame and base		
<ul style="list-style-type: none"> Paint price group 1 Paint price group 2 	<ul style="list-style-type: none"> No cost +\$ 45 	<ul style="list-style-type: none"> Specify paint color number. Specify paint color number. 	
Base	<ul style="list-style-type: none"> Three-leg base with three black plastic locking casters 	<ul style="list-style-type: none"> No cost 	<ul style="list-style-type: none"> Specify with three-leg base.
Levelers	<ul style="list-style-type: none"> Levelers (three or four) 	<ul style="list-style-type: none"> No cost 	<ul style="list-style-type: none"> Specify with levelers.
Flip-Chart Pegs	<ul style="list-style-type: none"> Top cap with flip-chart pegs on one side 	<ul style="list-style-type: none"> +\$ 50 	<ul style="list-style-type: none"> Specify with flip-chart pegs.
Related Products	<ul style="list-style-type: none"> Marker trays 		<ul style="list-style-type: none"> ▶ Page 72

Specification Information

Dimensions			Style Number	U.S. Base Price
D	W	H		

54"H Screens

16"	24"	54"	TS4S2454	\$1036
16"	30"	54"	TS4S3054	\$1088
16"	36"	54"	TS4S3654	\$1133
16"	42"	54"	TS4S4254	\$1183
16"	48"	54"	TS4S4854	\$1235

66"H Screens

16"	24"	66"	TS4S2466	\$1133
16"	30"	66"	TS4S3066	\$1183
16"	36"	66"	TS4S3666	\$1235
16"	42"	66"	TS4S4266	\$1283
16"	48"	66"	TS4S4866	\$1331

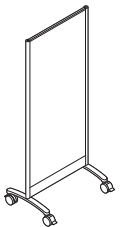
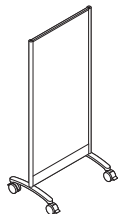

Mobile and Privacy

 **For Canadian Pricing**
 Multiply U.S. Price by the Canadian price factor.
 ▶ See page 1 for details.

Marker Trays

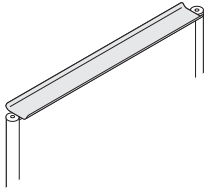

Tip: Attachment hardware is included with screen. Tray is affixed to the top cap.

Standard Includes		Required to Specify
<ul style="list-style-type: none"> ▶ Need help? Product details, page 68 	<ul style="list-style-type: none"> • Marker tray: paint price group 1 	<ul style="list-style-type: none"> 1 Style number 2 Paint color number for marker tray 3 Options, if selected (see below) ▶ See Surface Materials, page 92

Options	U.S. Price	Required to Specify
Surface Materials <ul style="list-style-type: none"> • Paint price group 1 • Paint price group 2 	No cost +\$12	Specify paint color number. Specify paint color number.

Specification Information				
Dimensions			Style	U.S.
D	W	H	Number	Base Price
2 1/2"	24"	1/2"	TS4SR24	\$ 80
2 1/2"	30"	1/2"	TS4SR30	\$ 87
2 1/2"	36"	1/2"	TS4SR36	\$102
2 1/2"	42"	1/2"	TS4SR42	\$108
2 1/2"	48"	1/2"	TS4SR48	\$117
:	:	:	:	:



For Canadian Pricing
Multiply U.S. Price by the Canadian price factor.
▶ See page 1 for details.

Textura mobile blends sound-diffusing acoustic panels with durable CeramicSteel writing surfaces for a multi-purpose collaborative worktool on wheels.

► Specifying, page 74

Powdercoat traffic white aluminum frame

Surface finish available in 7671 Arctic White 2 CS or PV09 Hygienic White Gloss. Single- or double-sided whiteboard option is available. The single sided option has one side all acoustic.

Acoustic panel fabric selection is the same for both sides. Not intended for use as tackboard.

Locking casters

Accessories are not included. Refer to related products for toolbar accessories.

Side A defaults to markerboard and acoustic panel. Side B offers a selection between markerboard and acoustical panel or acoustical panel only. Acoustical panel only is fabric covered top to bottom.

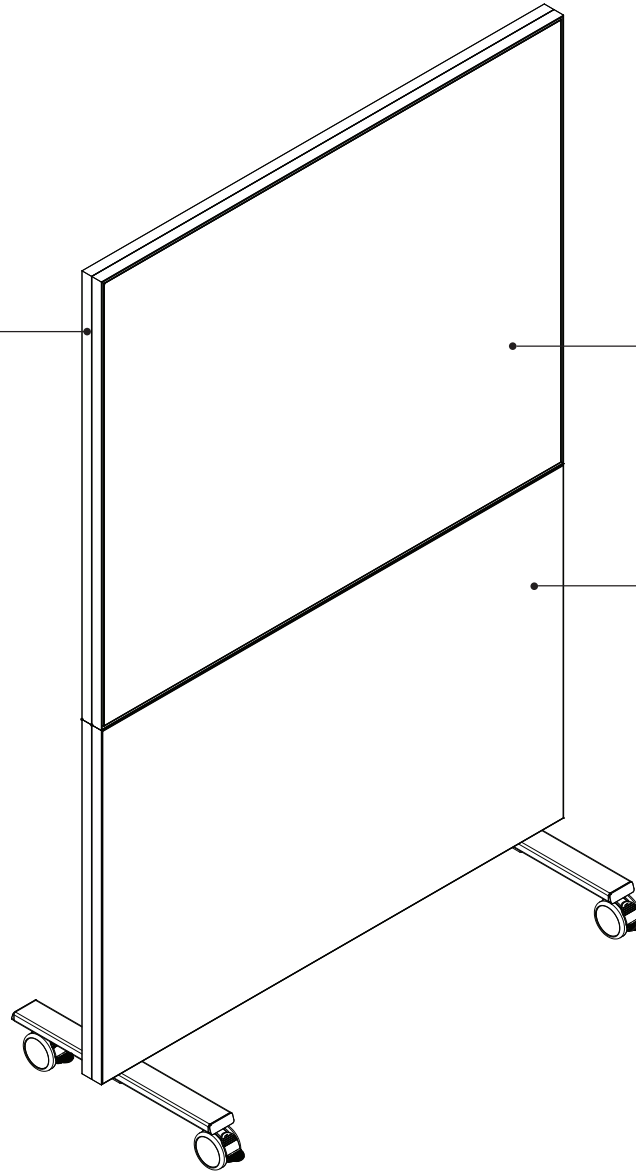

Actual Dimensions

	Single-Sided Whiteboard	Double-Sided Whiteboard
Overall Height	75" or 1905 mm	75" or 1905 mm
Overall Width	46 ⁷ / ₈ " or 1190 mm	46 ⁷ / ₈ " or 1190 mm
Depth (board)	2" or 50 mm	2" or 50 mm
Depth (base)	20 ⁵ / ₁₆ " or 516 mm	20 ⁵ / ₁₆ " or 516 mm
Weight	66 lbs or 30 kg	86 lbs or 39 kg

Textura Mobile

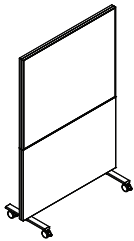

	Standard Includes	Required to Specify
<ul style="list-style-type: none"> ▶ Need help? Product details, page 73 	<ul style="list-style-type: none"> • Mobile stand with locking casters • Single- or double-sided whiteboard comes in 7671 Arctic White 2 CS or PV09 Hygienic White Gloss markerboard • Acoustic fabric at bottom for double-sided stands. Single-sided stands receive one side with acoustic top and bottom. 	<ol style="list-style-type: none"> 1 Style number 2 Acoustic panel fabric, if selected: <ul style="list-style-type: none"> DB55 Slip DB56 Marianna DB57 Madura DB58 Tortuga DB59 Solano DB60 Blizzard DB61 Havana DB62 Scuba PV49 Callan PV50 Tallow PV51 Aruba PV52 Paseo PV53 Sligo 3 CeramicSteel color number for panel: <ul style="list-style-type: none"> 7671 Arctic White 2 CS PV09 Hygienic White Gloss 4 Options, if selected (see below) <ul style="list-style-type: none"> ▶ See <i>Surface Materials</i>, page 92.

	Options	U.S. Price	Required to Specify
Surface Materials	<ul style="list-style-type: none"> • Acoustic panel fabric 	No cost	Specify with <i>fabric</i> and select color number.
	<p>Surface</p> <ul style="list-style-type: none"> • Ceramic price group 1 • Ceramic price group 2 for single-sided markerboard • Ceramic price group 2 for double-sided markerboard 	<ul style="list-style-type: none"> No cost +\$104 +\$152 	<ul style="list-style-type: none"> Specify with ceramic color number. Specify with ceramic color number. Specify with ceramic color number.
Markerboard	<ul style="list-style-type: none"> • Side A markerboard and acoustic panel only • Side B acoustic panel only • Side B markerboard and acoustic panel 	<ul style="list-style-type: none"> Price below No cost Price below 	<ul style="list-style-type: none"> Specify with <i>markerboard and acoustic panel</i>. Specify with <i>acoustic panel only</i>. Specify with <i>markerboard and acoustic panel</i>.
Related Products	<ul style="list-style-type: none"> • Accessories 		▶ Page 87

Specification Information				
Dimensions		Style Number	U.S. Prices	
W	H		Single-Sided Markerboard	Double-Sided Markerboard
46 ⁷ / ₈ "	75"	PVCFSTND	\$4103	\$4649

 **For Canadian Pricing**
 Multiply U.S. Price by the Canadian price factor.
 ▶ See page 1 for details.

Verb easel facilitates effective display, storage, and presentation of Verb whiteboards.

Verb wall track offers additional display options for the Verb whiteboards and can add functionality to otherwise blank walls.

Product Details



Two-sided easel comes standard with two shelves on each side and is 36"W.

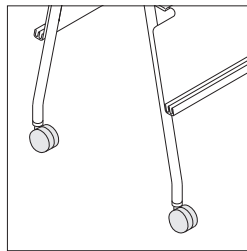

Each easel comes standard with casters for ease of mobility.

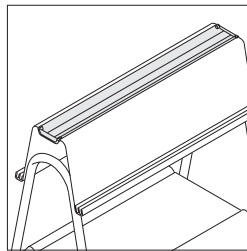

The easel top shelf can be used to store markers and erasers and is available only in 6249 platinum solid finish.



Wall track comes in 6' and 8' lengths and is made from extruded anodized aluminum. It may be easily cut to length in the field.

Each wall track comes standard with hooks for use with the whiteboards.

Maintenance

- Wipe board with a clean cloth moistened by a liquid markerboard cleaner or a solution of 50% water and 50% isopropyl alcohol.
- Rinse with clear water.
- Wipe dry with a clean cloth. If your board is used daily, the cleaning should be performed at least 2-3 times a week.

More thorough cleaning may be required if writing is left on the board for more than two days.

Markers

Use any high-quality dry erase marker.

CAUTION! The use of Low Odor markers may cause ghosting to occur. If Low Odor markers have been used, the surface can be completely cleaned by following the cleaning instructions above. Remember to discard eraser if used with Low Odor markers.

Removing Permanent Marker

Option 1:

- Write over the top of the permanent marker ink with a dry-erase marker
- Simply erase

Option 2:

- Moisten a clean, dry cloth with isopropyl alcohol
- Wipe the board in a circular motion to loosen marker residue
- Rinse with clear water
- Dry the board with a clean cloth
- Repeat these steps as necessary

Installer's Instructions for Initial Cleaning at Time of Installation

NOTE: These initial cleaning instructions are shipped with every board.

- For initial cleaning, wipe your board with a clean cloth moistened by a mild, alcohol-based cleaner.
- Rinse with clear water. This step is simple, but very important.
- Wipe dry with a clean cloth.

Surface Materials

Easel Frame/Legs

- 4750 Champagne Metallic
- 4799 Platinum Metallic
- 7360 Merle

Easel Display Shelf

- 7360 Merle

Easel Shelf Inserts and Top Cap

- 6249 Platinum Solid

Wall Track Hook

- 6249 Platinum Solid

Personal Whiteboard



Tip: See CeramicSteel Cleaning/Daily Care and Maintenance for additional information.
 ▶ Page 11

Standard Includes	Required to Specify
• Two-sided e ³ CeramicSteel with urethane edge molding	Style number

Specification Information			
Dimensions		Style	U.S.
H	W	Number	Price
18"	23"	VWB2	\$279
:	:	:	:



For Canadian Pricing
 Multiply U.S. Price by the Canadian price factor.
 ▶ See page 1 for details.



Standard Includes		Required to Specify
<ul style="list-style-type: none"> ▶ Need help? Product details, page 75 	<ul style="list-style-type: none"> • Steel display shelves: 7360 Merle • Frame/legs: paint group 1 • Casters: black • Trough: 6249 Platinum Solid • Shipped assembled/wrapped 	<ul style="list-style-type: none"> 1 Style number 2 Frame/leg paint color number 3 Options, if selected (see below) ▶ See <i>Surface Materials</i>, page 92.

Options	U.S. Price	Required to Specify
Surface Materials <ul style="list-style-type: none"> • Paint price group 1 • Paint price group 2 	Frame/legs <ul style="list-style-type: none"> • Paint price group 1: No cost • Paint price group 2: +\$48 	<ul style="list-style-type: none"> Specify paint color number. Specify paint color number.

Specification Information			
Dimensions		Style	U.S. Base
D	W	Number	Price
24"	36"	VE36	\$2305

Mobile and Privacy

 **For Canadian Pricing**
 Multiply U.S. Price by the Canadian price factor.
 ▶ See page 1 for details.

Wall Track



Tip: The wall track style numbers come with four or five hooks. Additional wall track hooks are available.

Standard Includes		Required to Specify
▶ Need help? Product details, page 75	<ul style="list-style-type: none"> • Anodized aluminum track • Cork insert • Plastic hooks 	Style number

Specification Information				
• Dimensions		• Number of Plastic Hooks	• Style Number	• U.S. Price
D	W			
:	:	:	:	:
:	:	:	:	:

Wall Track

1"	6'	4	VWT6	\$388
1"	8'	5	VWT8	\$476
:	:	:	:	:

Wall Track Hook

		1	VWTH	\$ 34
:	:	:	:	:



For Canadian Pricing

Multiply U.S. Price by the Canadian price factor.

▶ See page 1 for details.

Boundri

Boundri is a privacy screen made from thick double-sided Polyvision CeramicSteel featuring adjustable mounts that make it easy to transform almost any desk or table into a private workspace. The multifaceted tool can help employees and students maintain safe distances and provide them a personal collaboration tool to keep track of daily tasks and reminders.

Boundri screens are 1/5" thick and corners have a 3/20" radius.

Edges are coated with high quality, durable paint that matches the surface finish.

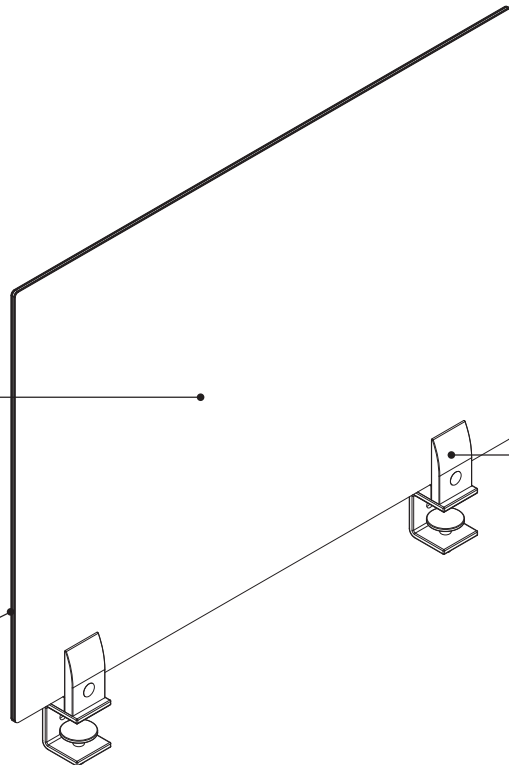

Boundri screens are attached with adjustable mounts. 18" and 24" height screens that are available in 24", 36", 48", 60", and 72" widths. The screen and hardware may be used on (nominal) 1/4" to 1 1/4" thick worksurfaces.

Product Details

Boundri screens include adjustable brackets with divider/writing surface element for most height-adjustable desks and fixed worksurfaces.

Screens are double-sided CeramicSteel and can be mounted to various desks and worksurfaces using the adjustable mounting hardware.

When applying the Boundri screen to the side of Migration or Migration SE desk, at least a 2" overhang is required.

Mounts are not compatible with Elective Elements worksurfaces.

Mounts are movable to accommodate various features or interferences on a minimum tabletop thickness of 1/4" or 6 mm and a maximum tabletop thickness of 1 1/4" or 34 mm.

The number of mounts varies by size of the screen specified. Refer to the mount table below.

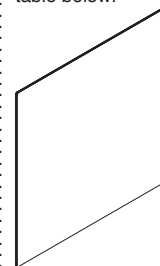

The edge of the screen is coated with a high quality, durable paint that matches the surface finish. Corners have a 4 mm radius.

The screen and hardware may be used on a minimum tabletop thickness of 1/4" or 6 mm and a maximum tabletop thickness of 1 1/4" or 34 mm.

The width of the screen can be equal to or less than the width of the worksurface to which it will attach. Some restrictions apply due to location of worksurface legs and supports.

Actual Dimensions

Height	18", 24"
Width	24", 36", 48", 60", or 72"
Depth	1 1/64" or 4 2/5 mm
18"H Weight (lbs)	7, 10, 13, 17, or 20
24"H Weight (lbs)	9, 14, 18, 22, or 27

Tip: Panel sizes are nominal.

Mount Table

Screen Size (Height x Width)	Number of mounts
18" x 24", 18" x 36", 24" x 24", and 24" x 36"	2
18" x 48", 24" x 36", and 24" x 48"	3
18" x 60", 18" x 72", 24" x 60", and 24" x 72"	4

Application Topics

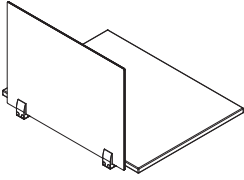

Privacy/Back Mount

Mount assembles with the screen grip section attaching to the exterior side of the adjustable table-top clamp. Position supports screen installation with zero space gap.

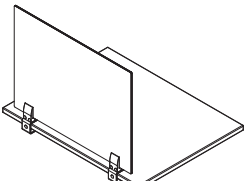

Privacy/Top Mount

Mount assembles with the screen grip section attaching to the top side of the adjustable table-top clamp. Application supports screen installation with space gap of $\frac{5}{8}$ " above worksurface.

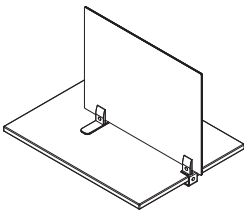

Side Divider/Top Mount

Multiple mount assembly types are required for this application. Edge bracket assemblies with the screen grip section attaching to the top side of the adjustable table-top clamp. Screen grip piece is positioned to support screen direction. Table-top mount uses screen grip and table top plate is positioned to support screen direction. Application supports screen installation with space gap of $\frac{5}{8}$ " above worksurface.

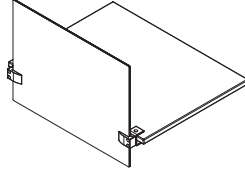

Privacy/Modesty

Mount assembles with the screen grip section attaching to the exterior side of the adjustable table-top clamp. Screen clamp is rotated 90° prior to attachment. Position supports divider screen installation with benefit of modesty panel.

Boundri screens mount to worksurfaces using an adjustable mount with tightening screw. Bracket positioning is moveable with suggested placement by screen size.

Screen heights and widths cannot be adjusted in the field. Placement of screens on worksurfaces can be adjusted in the field.

Privacy configuration allows screen heights and widths to be determined by the orientation of the screen installed.

Modesty is limited to 7 $\frac{1}{2}$ " on height adjustable desks to maintain proper clearances. Recommended for 18" x 24", 18" x 36", 24" x 24", and 24" x 36" sizes. Larger panels not recommended for use in this orientation.

Boundri panels to be used with FrameOne do not ship with **FMSK2** or **FMSK3** brackets. Additional brackets would need to be purchased separately. Contact your Collaborative Surfaces Representative with any questions: collabsolutions@steelcase.com.

Boundri

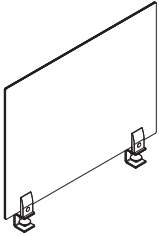

Tip: See *CeramicSteel Cleaning/Daily Care and Maintenance* for additional information.
 ▶ Page 11

Tip: PV09 Hygienic White Gloss is not available on 24"H panels.

Tip: Adjustable divider mount also sold separately as a single mount without a panel that can be assembled four different ways.

Standard Includes	Required to Specify
<ul style="list-style-type: none"> ▶ Need help? Product details, page 80 • Panel: double-sided Polyvision CeramicSteel ceramic price group 1 • Black anodized adjustable mounts: quantity varies by size • Installation instructions • Cleaning instructions 	<ol style="list-style-type: none"> 1 Style number 2 Height 3 Width 4 CeramicSteel color number for panel: <ul style="list-style-type: none"> 7671 Arctic White 2 CS 7673 Merle CS 7674 Platinum Solid CS PV09 Hygienic White Gloss 5 Options, if selected (see below) ▶ See <i>Surface Materials</i> , page 92.

	Options	U.S. Price	Required to Specify
Height	<ul style="list-style-type: none"> • 18"H • 24"H 	Prices below Prices below	Specify with 18"H. Specify with 24"H.
Width	<ul style="list-style-type: none"> • 24"W • 36"W • 48"W • 60"W • 72"W 	Prices below Prices below Prices below Prices below Prices below	Specify with 24"W. Specify with 36"W. Specify with 48"W. Specify with 60"W. Specify with 72"W.
Surface Materials	Surface <ul style="list-style-type: none"> • Ceramic price group 1 • Ceramic price group 2 	No cost +\$104	Specify ceramic color number. Specify ceramic color number.
Related Products	<ul style="list-style-type: none"> • Dry erase markers • Magnetic eraser with marker holder • Accessories 		▶ Page 88 ▶ Page 86 ▶ Page 87

Specification Information						
Style Number	Height	U.S. Base Prices				
		24"W	36"W	48"W	60"W	72"W
PVDVSCRN	18"	\$1097	\$1303	\$1509	\$1783	\$1960
	24"	\$1138	\$1372	\$1550	\$1823	\$2003

Adjustable Divider Mount	
PVDVMNT	\$ 104

 **For Canadian Pricing**
 Multiply U.S. Price by the Canadian price factor.
 ▶ See page 1 for details.

Accessories

Accessories

84

Accessories

Collaborative ToolBars

Collaborative ToolBar is an elegant design element that enhances the functionality of any Polyvision CeramicSteel markerboard. With a unique docking station, it offers a thoughtful home for a magnetic eraser and markers or chalk, ensuring tools stay organized and secure. The ToolBar is intuitive to use, easy to clean, and provides users with the freedom to orient the kit anywhere on the board. With a design that feels good to the touch, it blends functionality with a premium aesthetic.

Kits are available for different writing board finishes. Markers are included with the standard and neon kits. Chalk sticks are included with the chalkboard kits. All kits include a round magnetic eraser and two replacement microfiber cloths.

Chalk sticks come with brand chalk stick holders.

ToolBar mini is a smaller version that comes standard with two markers and the round magnetic eraser.

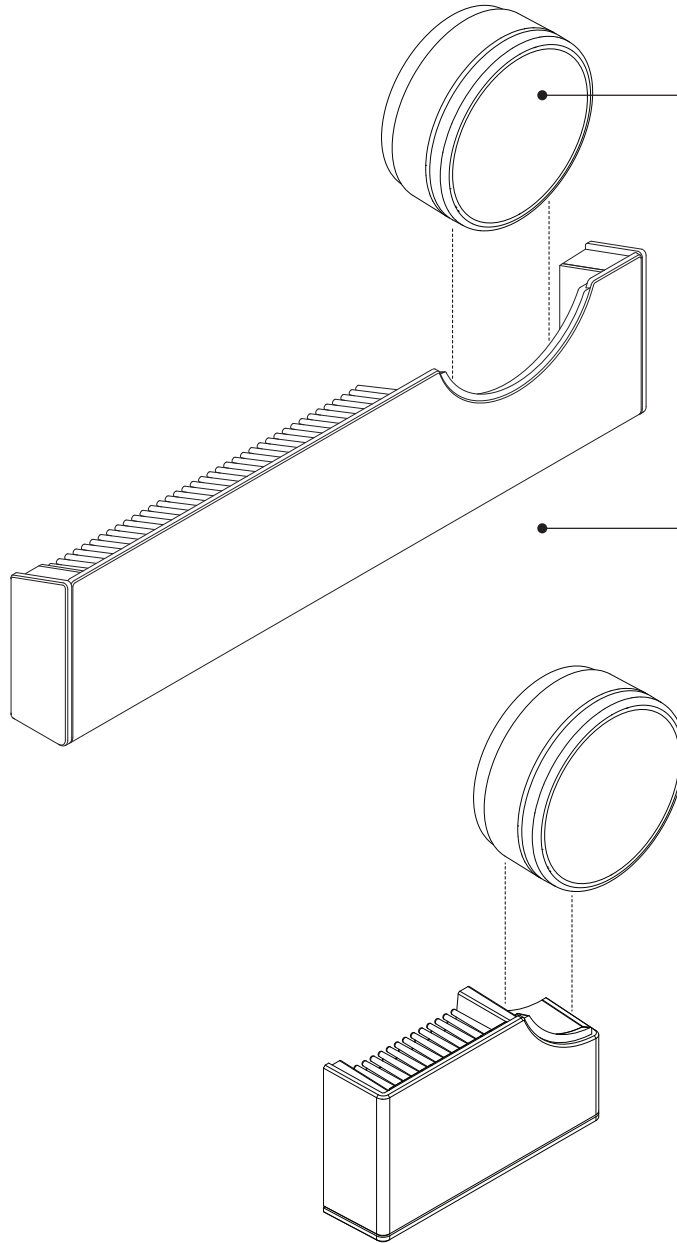

Round magnetic eraser fits effortlessly in the docking station.

The versatile ToolBar can be positioned both horizontally and vertically.

ToolBar and eraser come standard in a black satin finish.

Actual Dimensions

	ToolBar	ToolBar Mini	Eraser
Depth	1 $\frac{2}{5}$ " or 35 mm	1 $\frac{2}{5}$ " or 35 mm	1 $\frac{3}{5}$ " or 42 mm
Overall Width	3 $\frac{3}{10}$ " or 85 mm	3" or 75 mm	3 $\frac{1}{2}$ " or 90 mm
Overall Height	13 $\frac{3}{5}$ " or 346 mm	5" or 132 mm	3 $\frac{1}{2}$ " or 90 mm
Weight (lbs)	1 lb	0.7 lb	0.23 lb
Weight (kgs)	0.45 kg	0.31 kg	0.10 kg

Collaborative ToolBar

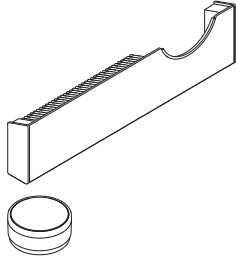

Tip: See CeramicSteel Cleaning/Daily Care and Maintenance for additional information.

▶ Page 11

Tip: ToolBar is not compatible with **PVGLASS**.

	Standard Includes	Required to Specify
▶ Need help? Product details, page 84	<ul style="list-style-type: none"> Standard kit, if selected: ToolBar, round magnetic eraser, four markers (red, green, blue, and black), and two extra microfiber cloths for eraser Neon kit, if selected: ToolBar, round magnetic eraser, five expo neon markers (pink, blue, green, orange, and yellow), and two extra microfiber cloths for eraser Chalkboard kit, if selected: ToolBar, round magnetic eraser, four white chalk sticks, four chalk stick holders, and two extra microfiber cloths for eraser 	1 Style number 2 ToolBar kit type (see below under Required Selections)

	Required Selections	U.S. Price	Required to Specify
ToolBar Kit Type	<ul style="list-style-type: none"> Standard kit Neon kit Chalkboard kit 	No cost No cost No cost	Specify with <i>standard kit</i> . Specify with <i>neon kit</i> . Specify with <i>chalkboard kit</i> .

Specification Information	
Style Number	U.S. Price
PVTOOLBAR	\$206

Collaborative ToolBar Mini

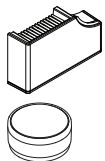

Tip: See CeramicSteel Cleaning/Daily Care and Maintenance for additional information.

▶ Page 11

Tip: ToolBar mini is not compatible with **PVGLASS**.

	Standard Includes	Required to Specify
▶ Need help? Product details, page 84	<ul style="list-style-type: none"> ToolBar mini, round magnetic eraser, 2 markers (black and blue) and two extra microfiber cloths for eraser 	Style number

Specification Information	
Style Number	U.S. Price
PVTLBMINI	\$150

 **For Canadian Pricing**
 Multiply U.S. Price by the Canadian price factor.
 ▶ See page 1 for details.

Round Magnetic Eraser



Standard Includes	Required to Specify
<ul style="list-style-type: none"> ▶ Need help? Product details, page 84 • Round magnetic eraser 	Style number

Specification Information	
• Style Number	• U.S. Price
PVRME	\$34
⋮	⋮

Replacement Microfiber Cloths for Eraser

Tip: Compatible with round magnetic eraser.

Standard Includes	Required to Specify
<ul style="list-style-type: none"> ▶ Need help? Product details, page 84 • 10 replacement microfiber cloths 	Style number

Specification Information	
• Style Number	• U.S. Price
PVMFC	\$21
⋮	⋮

Magnetic Eraser with Marker Holder

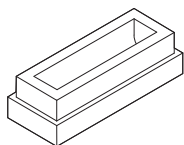

Tip: Eraser will hold one dry erase marker.

Standard Includes	Required to Specify
<ul style="list-style-type: none"> • Magnetic eraser with marker holder 	Style number

Specification Information	
• Style Number	• U.S. Price
MEP1	\$44
⋮	⋮



For Canadian Pricing
 Multiply U.S. Price by the Canadian price factor.
 ▶ See page 1 for details.

Magnetic Eraser Felt Replacements

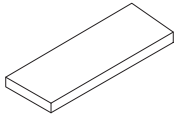

Standard Includes		Required to Specify
<ul style="list-style-type: none"> Replacement felt 		Style number
Specification Information		
Style Number	U.S. Price	
ERF5	\$5	

Eraser

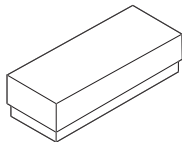

Standard Includes		Required to Specify
<ul style="list-style-type: none"> Eraser 		Style number
Specification Information		
Style Number	U.S. Price	
RE1	\$7	

Set of Four V-Board Markers

Standard Includes		Required to Specify
<ul style="list-style-type: none"> ▶ Need help? Product details, page 84 	<ul style="list-style-type: none"> Four V-Board markers 	Style number

Related Products	
<ul style="list-style-type: none"> Neon dry erase markers (MP5N) 	▶ Page 88

Tip: V-Board markers are for use with standard kit. Neon dry erase markers are for use with neon kit.

Specification Information		
Style Number	U.S. Price	
PVMKRS	\$17	

 **For Canadian Pricing**
 Multiply U.S. Price by the Canadian price factor.
 ▶ See page 1 for details.

Dry Erase Markers

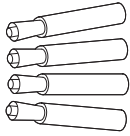

Standard Includes	Required to Specify
• Dry erase markers	Style number

Specification Information

Style Number	U.S. Price
--------------	------------

Twelve Black Markers

1MP12	\$44
--------------	------

Twelve Blue Markers

2MP12	\$44
--------------	------

Twelve Red Markers

3MP12	\$44
--------------	------

Twelve Green Markers

4MP12	\$44
--------------	------

Three Black, Three Blue, Three Red, and Three Green Markers

MP12	\$44
-------------	------

One Black, One Blue, One Red, and One Green Marker

MP4	\$11
------------	------

One Neon Green, One Neon Blue, One Neon Pink, One Neon Orange, and One Neon Yellow Marker

MP5N	\$22
-------------	------



For Canadian Pricing
 Multiply U.S. Price by the Canadian price factor.
 ▶ See page 1 for details.

Chalk Sticks

Standard Includes		Required to Specify
▶ Need help? Product details, page 84	• 10 chalk sticks	Style number
Specification Information		
Style Number	U.S. Price	
White Chalk Sticks		
PVWCLK	\$5	
Colored Chalk Sticks		
PVCCLK	\$5	

Chalk Stick Holders

Standard Includes		Required to Specify
▶ Need help? Product details, page 84	• Four chalk stick holders • Four white chalk sticks	Style number
Specification Information		
Style Number	U.S. Price	
PVCSH	\$8	

 **For Canadian Pricing**
Multiply U.S. Price by the
Canadian price factor.
▶ See page 1 for details.

Magnetic Marker Trays

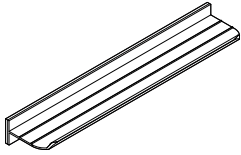

Standard Includes	Required to Specify
<ul style="list-style-type: none"> Marker tray: 8043 Clear Anodized Aluminum 	Style number

Specification Information

Style Number	U.S. Price

12" Magnetic Marker Tray

MCR12	\$ 85

24" Magnetic Marker Tray

MCR24	\$113



For Canadian Pricing
 Multiply U.S. Price by the
 Canadian price factor.
 ▶ See page 1 for details.

Resources

Resources

Surface Materials	92
Availability Matrices	94
Style Number Index	96

Surface Materials

This listing includes all surface material and/or finish choices applicable to Collaborative Surfaces. Not all surface material and/or finish choices are available on all products. Please refer to the Finish Matrices. ▶ See page 94 for specific product availability.

Paint

Steelcase Surfaces

Applies to:

- Groupwork screens

Price Group 1

7207 Black

Price Group 2

4798 Sterling Metallic
4799 Platinum Metallic

Applies to:

- Parametric Premium whiteboards edge trim

Price Group 2

4750 Champagne Metallic

Applies to:

- Sans accented edge
- Sans light accented edge
- Serif accented edge
- Frank Lloyd Wright Racine accented edge

Tip: Refer to Frameless Whiteboards with Accented Edges Availability Matrix for accented edge color availability, see page 95.

Price Group 1

7190 Platinum Solid

Price Group 2

0835 Black

Price Group 3

PV01 Pomegranate
PV02 Papaya
PV03 Mango
PV04 Ivy
PV05 Azure
PV06 Truffle
PV07 Plum

Accent Paint

4AV4 Baltic
4AX1 Citron
4AY2 Chili
4CZ5 Honey
4CZ6 Lagoon

Ⓜ = Established

Applies to:

- Verb easel frame/legs

Price Group 1

Textured Paint
7360 Merle

Price Group 2

Smooth Metallic Paint
4750 Champagne Metallic
4799 Platinum Metallic

Metal Paint

Steelcase Surfaces

Applies to:

- Parametric Premium whiteboards
- Flow framed

Price Group 2

8043 Clear Anodized Aluminum

Whiteboard Surface

Steelcase Surfaces

Whiteboards are standard in white high-gloss 7655 e³ environmental CeramicSteel. Optional screenprint patterns are available to provide a guide for writing or drawing. See below for patterns.

Tip: Refer to the CeramicSteel Surface availability matrix for product availability, see page 94.

Standard (e³ environmental CeramicSteel):

7655 White High Gloss
7661 Gray Chalk 6502C CS
7665 Saffron Pattern
7671 Arctic White 2 CS
7672 Seagull
7673 Merle CS
7674 Platinum Solid CS
7675 Sterling Dark
PV09 Hygienic White Gloss*
PV11 Grey Calendar Grid CS
PV12 Grey Grid CS

*PV09 Hygienic White Gloss finish is not available on the 24"H Boundri screen.

Optional digital print on e³ environmental CeramicSteel:

Applies to:

- Parametric Premium whiteboards
- Sans
- Sans light

Standard Graphic

PV55 Agate
PV56 Brushstroke
PV57 Code
PV58 Data
PV59 DNA
PV60 Hive
PV61 Skyline
PV62 Soundwave
PV63 Speed
PV64 Summit
PV65 Dot Grid
PV66 Line Grid
PV68 Music Lines

Graphic Color

7676 Saffron
7677 Peacock
7678 Sea Salt
7679 Sterling Dark
7682 Black
7681 Sand

Back Painted Glass

High quality glassboard is made with 3/16" thick low-iron tempered glass and is non-porous, non-ghosting, and non-staining.

Applies to:

- Glass

6521 Truffle
6571 Aubergine
6575 Peacock
6576 Jungle
6577 Merlot
6578 Lagoon
6579 Saffron
6581 Blue Jay
6584 Tangerine
6586 Green Citrine/
Citrus Green

6588 Purple Berry
6589 Mercury
6591 Merle
6593 Grayscale
6595 Winter
6597 Honey
6BB1 Cloud
6BB2 Rose Quartz
6BB3 Olivine
ACB Black
ACC Sea Salt/
Crystal Spring
ACM Moonlight
ACS Sage
PV34 Peacock Feather
PV38 Coastline

Vertical Surface Fabric

Fabric Tackboard Surfaces

Tackboard surfaces are available in select Steelcase and Designtex fabrics. All fabrics are applied railroaded, i.e. salvages parallel to floor.

Applies to:

- Parametric Premium tackboards
- Groupwork screens

Steelcase Surfaces

Price Group A

Sprite

5540 Khaki
5541 Snow
5543 Linen
5544 Sherbet
5545 Powder
5547 Sky

Price Group 1

Abacus Ⓜ

P123 Portico
P124 Opus
P125 Cusp
P126 Artifact

Alloy

P525 Polar
P526 Skim
P527 Bubbly
P528 Tern
P529 Shore
P530 Asti
P531 Silver
P532 Oxide
P533 Element
P534 Construct
P535 Currency
P536 Iron

Boccie

P200 New Rice
P201 New Almond
P203 New Camel
P204 New Opal
P205 New Mist
P206 New Plum
P208 New Spearmint
P209 New Sky

Buzz2

5F03 Tomato
5F04 Red Ⓜ
5F05 Burgundy
5F06 Sky Ⓜ
5F07 Blue
5F08 Navy
5F15 Stone
5F16 Grey
5F17 Black
5G50 Dunegrass
5G51 Sable
5G55 Pumpkin
5G57 Rouge
5G59 Meadow
5G61 Cyan
5G62 Atlantic
5G63 Crocus
5G64 Alpine
5G65 Tornado

Charm

P505 Shell
P506 Mimosa
P507 Birch
P508 Sparkle
P510 Debut
P511 Clover
P513 Twilight

Optic

P540 Hazel
P541 Twinkle
P542 Orion
P543 Seaglass
P546 Whiskey
P547 Bath
P548 Whisper
P549 Breezy
P551 Glimmer

Pianista

P420 Sand
P421 Mist
P422 Rain
P423 Natural
P424 Café
P425 Denim
P426 Carbon
P427 Stone
P428 Flax
P429 Oat
P430 Wheat
P431 Maize

Rhythm

P555 Allegro
P556 Tempo
P557 Refrain
P558 Pitch
P560 Melody
P562 Opus

Tinsel

P516 Lit
P517 Ego
P518 Fizz
P519 Muse
P520 Depth
P521 Bliss
P522 Grow
P523 Dolce

Price Group 2**Bariolage**

- G200 New Etude
- G201 New Andante **E**
- G202 New Cantata **E**
- G203 New Adagio
- G204 New Melody
- G205 New Ballata

Code

- 5FA1 Fossil
- 5FA2 Gabbro
- 5FA3 Reed
- 5FA4 Bluff
- 5FA5 Sea Salt
- 5FA6 Cannon
- 5FA7 Tussah
- 5FA8 Mica
- 5FA9 Ecu
- 5FB1 Bamboo

Dovetail by Designtex

- 5H39 Light Mocha
- 5H40 Pebble
- 5H41 Warm White
- 5H42 Sandstone
- 5H43 Honeycomb
- 5H44 Terra
- 5H45 Honeydew
- 5H46 Denim
- 5H47 Storm
- 5H48 Ice Blue
- 5H49 Aura
- 5H50 Darkest Grey

Flip: Orbit

- 5F85 Mud Pie **E**
- 5F87 Petoskey
- 5F88 Pluto **E**
- 5F89 Papyrus
- 5F91 Blizzard
- 5F92 Briquette

Flip: TexHex

- 5F75 Mud Pie **E**
- 5F77 Petoskey
- 5F78 Pluto **E**
- 5F79 Papyrus
- 5F97 Blizzard
- 5F98 Briquette

Fresco

- G001 Sandrift
- G002 Mistiblu
- G003 Faon
- G006 Chamoline

E = Established**Intersection**

- P211 Summit
- P212 Chalk
- P213 Lace

Latch

- P600 Seashell
- P601 Clam
- P602 Eggshell
- P603 Zen
- P604 Cool Gray
- P605 Armor
- P606 Sentinel
- P607 Rye
- P608 Billow
- P609 Nimbus

SoftNext

- 5H27 Obsidian
- 5H28 Foggy Night
- 5H29 Greystone
- 5H30 Mocha
- 5H31 Clay
- 5H32 Sandstone
- 5H33 Chalk
- 5H34 Midnight
- 5H35 Blue Mica
- 5H36 Jade
- 5H37 Burnt Umber
- 5H38 Cinnabar

Stencil

- P455 Midnight
- P456 Mulberry
- P457 Cracked Pepper
- P458 Denim
- P459 Chartreuse
- P460 Bittersweet
- P461 Mauvelous
- P462 Bermuda
- P463 Concrete
- P464 Orchid
- P465 Parchment
- P466 Silk
- P467 Sea Salt
- P468 Honeydew
- P469 Sepia

Price Group 3**Billiard Multi-Use by Designtex**

- 5H11 Poppy
- 5H12 Tangelo
- 5H13 Citrine/Citron
- 5H14 Avocado
- 5H16 Indigo
- 5H17 Mallard
- 5H18 Teak
- 5H19 Cumulus
- 5H20 Pewter
- 5H21 Gunmetal
- 5H22 Ink
- 5H23 Rose Quartz
- 5H24 Sea Salt
- 5H25 Storm Cloud
- 5H26 Olivine

Acoustic Panel Surfaces**Steelcase Surfaces****Price Group 1****PET**

- Applies to:
- Accord acoustic panel

- PV39 Stone
- PV40 Dusk
- PV41 Storm
- PV42 Space
- PV43 Aqua
- PV44 Arbor

- Applies to:
- Frank Lloyd Wright Racine whiteboard acoustic panel

- PV39 Stone
- PV40 Dusk
- PV41 Storm
- PV54 Shadow

Carlow

- Applies to:
- Textura mobile acoustic panel

- PV49 Callan
- PV50 Tallow
- PV51 Aruba

Lucia

- Applies to:
- Textura mobile acoustic panel

- PV52 Paseo
- PV53 Sligo
- DB55 Slip
- DB56 Marianna
- DB57 Madura
- DB58 Tortuga
- DB59 Solano
- DB60 Blizzard
- DB61 Havana
- DB62 Scuba

Dovetail

- Applies to:
- Tac panel
- 5H39 Light Mocha
- 5H40 Pebble
- 5H41 Warm White
- 5H42 Sandstone
- 5H43 Honeycomb
- 5H44 Terra
- 5H45 Honeydew
- 5H46 Denim
- 5H47 Storm
- 5H48 Ice Blue
- 5H49 Aura
- 5H50 Darkest Grey

SoftNext

- Applies to:
- Tac panel

- 5H27 Obsidian
- 5H28 Foggy Night
- 5H29 Greystone
- 5H30 Mocha
- 5H31 Clay
- 5H32 Sandstone
- 5H33 Chalk
- 5H34 Midnight
- 5H35 Blue Mica
- 5H36 Jade
- 5H37 Burnt Umber
- 5H38 Cinnabar

Billiard Multi-Use by Designtex

- Applies to:
- Tac panel

- 5H11 Poppy
- 5H12 Tangelo
- 5H13 Citrine/Citron
- 5H14 Avocado
- 5H16 Indigo
- 5H17 Mallard
- 5H18 Teak
- 5H19 Cumulus
- 5H20 Pewter
- 5H21 Gunmetal
- 5H22 Ink
- 5H23 Rose Quartz
- 5H24 Sea Salt
- 5H25 Storm Cloud
- 5H26 Olivine

Select Surfaces

For information on products within Select Surfaces, including accent paints and fabrics from Designtex, Gabriel, Kvadrat, and Pollack, please refer to the *Surface Materials Reference Manual* or visit [Steelcase.com/selectsurfaces](https://www.steelcase.com/selectsurfaces).

Custom Surfaces**Price Group COM (Customer's Own Material)****Fabric Approval and Yardage**

To confirm whether a particular COM material has already been tested for use on a specific Steelcase product or to determine actual yardage requirements:

- Visit www.steelcase.com

For additional information regarding Customer's Own Material, call

1.888.STEELCASE (1.888.783.3522) or send an e-mail to lineone@steelcase.com.

Laminate Markerboard**Steelcase Surfaces**

- Applies to:
- Groupwork screens
- 2977 White Markerboard Laminate

Availability Matrices

Trim Availability Matrix

Legend

- = Not available
- = Available
- = Available with exceptions

	4750 Champagne Metallic	4798 Sterling Metallic	4799 Platinum Metallic	7207 Black	8043 Clear Anodized Aluminum
Flow	•	•	•	•	■
Groupwork Screens	•	■	■	■	•
Parametric Premium Whiteboards	□	•	•	•	■

CeramicSteel Surface Availability Matrix

Legend

- = Not available
- = Available
- = Available with exceptions

	7655 White High Gloss	7661 Gray Chalk 6502C CS	7665 Saffron Pattern	7671 Arctic White 2 CS	7672 Seagull	7673 Merle CS	7674 Platinum Solid CS	7675 Sterling Dark Solid	PV09 Hygienic White Gloss	PV11 Grey Calendar Grid CS	PV12 Grey Grid CS
Accord	■	•	•	■	•	•	•	•	•	•	•
Boundri	•	•	•	■	•	■	■	•	□	•	•
Flow and Flow Parametric	■	■	•	■	•	•	•	•	■	•	•
Frank Lloyd Wright Racine Whiteboard	•	•	•	■	•	•	•	•	•	•	•
Groupwork Screens	■	•	•	•	•	•	•	•	•	•	•
Motif	•	•	•	■	■	■	■	■	•	■	■
Motif (Accented)	•	•	■	•	•	•	•	•	•	•	•
Parametric Premium Whiteboards	■	•	•	•	•	•	•	•	•	•	•
Sans and Sans Parametric	■	■	•	■	•	■	■	•	■	•	•
Sans Light	■	■	•	■	•	■	■	•	■	•	•
Serif	■	•	•	•	•	•	•	•	■	•	•
Textura Mobile	•	•	•	■	•	•	•	•	■	•	•
Verb Personal Whiteboard	■	•	•	•	•	•	•	•	•	•	•

Digital Print Availability Matrix

Legend

- = Not available
- = Available
- = Available with exceptions

	PV55 Agate	PV56 Brushstroke	PV57 Code	PV58 Data	PV59 DNA	PV60 Hive	PV61 Skyline	PV62 Soundwave	PV63 Speed	PV64 Summit	PV65 Dot Grid	PV66 Line Grid	PV68 Music Lines	Custom Graphic
Accord	•	•	•	•	•	•	•	•	•	•	•	•	•	•
Boundri	•	•	•	•	•	•	•	•	•	•	•	•	•	•
Flow	•	•	•	•	•	•	•	•	•	•	•	•	•	■
Frank Lloyd Wright Racine Whiteboard	•	•	•	•	•	•	•	•	•	•	•	•	•	•
Motif	•	•	•	•	•	•	•	•	•	•	•	•	•	•
Motif (Accented)	•	•	•	•	•	•	•	•	•	•	•	•	•	•
Parametric Premium Whiteboards	■	■	■	■	■	■	■	■	■	■	■	■	■	■
Sans	■	■	■	■	■	■	■	■	■	■	■	■	■	■
Sans Light	■	■	■	■	■	■	■	■	■	■	■	■	■	■
Serif	•	•	•	•	•	•	•	•	•	•	•	•	•	•
Textura Mobile	•	•	•	•	•	•	•	•	•	•	•	•	•	•

Frameless Whiteboards with Accented Edges Availability Matrix

Legend

- = Not available
- = Available
- = Available with exceptions

	e ³ Environmental CeramicSteel	Ceramic	7661 Gray Chalk 6502C CS	7671 Arctic White 2 CS	7673 Merle CS	7674 Platinum Solid CS	Paint	0835 Black	7190 Platinum Solid	PV01 Pomegranate	PV02 Papaya	PV03 Mango	PV04 Ivy	PV05 Azure	PV06 Truffle	PV07 Plum	Accent Paint	4AV4 Baltic	4AX1 Citron	4AY2 Chili	4CZ5 Honey	4CZ6 Lagoon
Frank Lloyd Wright Racine Whiteboard	7671 Arctic White 2 CS	•	■	•	•	•	■	■	•	•	•	•	•	•	■	•	•	•	•	•	•	■
Sans	7655 White High Gloss	•	•	•	•	•	■	■	■	■	■	■	■	■	■	■	■	■	■	■	■	■
	7661 Gray Chalk 6502C CS	■	•	•	•	•	•	•	•	•	•	•	•	•	•	•	•	•	•	•	•	•
	7671 Arctic White 2 CS	•	■	•	•	•	■	■	■	■	■	■	■	■	■	■	■	■	■	■	■	■
	7673 Merle CS	•	•	■	•	•	•	•	•	•	•	•	•	•	•	•	•	•	•	•	•	•
Sans Light	7655 White High Gloss	•	•	■	•	•	■	■	■	■	■	■	■	■	■	■	■	■	■	■	■	■
	7661 Gray Chalk 6502C CS	■	•	•	•	•	•	•	•	•	•	•	•	•	•	•	•	•	•	•	•	•
	7671 Arctic White 2 CS	•	■	•	•	•	■	■	■	■	■	■	■	■	■	■	■	■	■	■	■	■
	7673 Merle CS	•	•	■	•	•	•	•	•	•	•	•	•	•	•	•	•	•	•	•	•	•
Serif	7674 Platinum Solid CS	•	•	•	■	•	•	•	•	•	•	•	•	•	•	•	•	•	•	•	•	•
	7655 White High Gloss	•	•	■	•	•	■	■	■	■	■	■	■	■	■	■	■	■	■	■	■	■

Style Number Index

Style Number	Page	Description
1MP12	88	Markers-Dry Erase
2MP12	88	Markers-Dry Erase
3MP12	88	Markers-Dry Erase
4MP12	88	Markers-Dry Erase
ERF5	87	Felt-Replacement For Magnetic Eraser
FLWBRD	66	Racine Whiteboard
HZPVFLOW	47	Horizontal Flow
MCR12	90	Tray-Magnetic, Marker
MCR24	90	Tray-Magnetic, Marker
MEP1	86	Eraser-Magnetic, with Marker Holder
MP12	88	Markers-Dry Erase
MP4	88	Markers-Dry Erase
MP5N	88	Markers-Dry Erase
MTFPNL	57	a ³ CeramicSteel Motif Panels
MTFPNLA	58	a ³ CeramicSteel Motif Accent Panel
PVCCLK	89	Colored Chalk Sticks
PVCFSTND	74	Textura Mobile
PVCSH	89	Chalk Stick Holders
PVDVMNT	82	Boundri Mounts
PVDVSCRN	82	Boundri
PVFLOW	42	Flow
PVFLOWPM	38-39	Para Polyvision Whiteboard, Flow Series
PVGLASS	64	Glass
PVLTSANS	53	CeramicSteel Sans Light
PVMFC	86	Replacement Microfiber Cloths
PVMKRS	87	Set of Four V-Board Markers
PVMRGE	55	Accord
PVRME	86	Round Magnetic Eraser
PVTLBMINI	85	Collaborative ToolBar Mini
PVTOOLBAR	85	Collaborative ToolBar
PVWCLK	89	White Chalk Sticks
PWBTKBRD	31, 33, 35	Tackboard
PWBWTBRD	30, 32, 34	Whiteboard
RE1	87	Eraser-Regular
SANS	50	CeramicSteel Sans
SANSMP	37	Para Polyvision Whiteboard, Sans Series
SERIF	60	CeramicSteel Serif
TAC	62	Tac
TS4S2454	71	Groupwork Screen
TS4S2466	71	Groupwork Screen
TS4S3054	71	Groupwork Screen
TS4S3066	71	Groupwork Screen
TS4S3654	71	Groupwork Screen
TS4S3666	71	Groupwork Screen
TS4S4254	71	Groupwork Screen
TS4S4266	71	Groupwork Screen
TS4S4854	71	Groupwork Screen
TS4S4866	71	Groupwork Screen
TS4SR24	72	Groupwork Marker Tray
TS4SR30	72	Groupwork Marker Tray
TS4SR36	72	Groupwork Marker Tray
TS4SR42	72	Groupwork Marker Tray
TS4SR48	72	Groupwork Marker Tray
VE36	77	Easel
VWB2	76	Personal Whiteboard

Style Number	Page	Description
VWT6	78	Wall Track
VWT8	78	Wall Track
VWTH	78	Wall Track

Trademark List

™/® The following is a non-exhaustive list of trademarks and registered trademarks for products of Steelcase Inc. or one of its related corporate entities: Agree, Airtouch, Alight, Amia, Answer, Aspekt, Avenir, Await, B-Free, Ballet, Bassline, Bindu, Bivi, Bix, Bottomline, Brody, Buoy, Cachet, Campfire, Capa, CF Series, CG_1, Chord, Circa, Clipper, Cobi, Collaboration, Convene, Coupe, Cura, Currency, dash, Divisio, Duo, E-Table 2, Edge Series, Elbrook, Elective Elements, Embold, Empath, Everwall, Exponents, Folio, FrameOne, Gesture, Groupwork, Host, Hosu, i2i, Jenny, Kart, Kathryn, Kick, Lagunitas, Leap, Leela, LessThanFive, LiveBack, LiveSeat, Mackinac, Marien152, Max-Stacker, media:scape, Migration, Millbrae, Mineral, Mitra, Montage, Montara650, MoreThanFive, Move, Node, Ocular, Ology, Opus, Paperflo, Passerelle, Player, Pocket, Potrero415, QiVi, Radia, Regard, Relay, Reply, Ripple, Roam, Sarto, Scoop, Sebastopol, Senti Series, Senza, Shortcut, Sidewalk, Siento, Sieste, SILQ, Soffio, Sorrel, SOTO, Steelcase Eclipse, Steelcase Flex, Steelcase Karman, Steelcase Relay, Steelcase Rise, Steelcase Series, Surround, SW_1, Switch, Sync, Tava, Tenor, Think, Thoughtful, Thread, Together, Train, Trees, Turnstone, Umami, Underscore, V.I.A., Verb, Verge, Verlay, Victor2, Visalia, WorkValet, and X-tenz.

™/® The following are trademarks or registered trademarks of AMQ Solutions, LLC: 3F, Activ, Amobi, Bixby, Bodi, Cluvo, Concur, Embank, FL-X, Iline, Jaku, Kinex, Personality Plus, Revi, S-Series, Siya, Tektis, Tizu, Uptake, and Zilo.

™/® The following are trademarks or registered trademarks of Orangebox Ltd., Cardiff, UK: Air3, Aspect, Avi, Away from the Desk, Border, Campers & Dens, Coppice, Cubb, Kirm, On the QT, Ramsey, Skomer, Sully, Track-B, and Vale.

™/® The following are trademarks or registered trademarks of Viccarbe Habitat, S.L.: Aleta, Cambio, Designed in The Sun, Foro, Funda, Holy Day, Kelly, Last Minute, Noha, Savina, Sistema, Sistema, Viable, and Wrapp.

® The following are registered brands of Steelcase Inc. and its family of companies: Steelcase, AMQ, Coalesse, Designtex, Halcon, Orangebox, Smith System, and Viccarbe.

® The following registered trademarks are under license from AWI Licensing Company, Dover, DE: SoundScapes, DuraBrite, BioBlock, and Armstrong.

® The following registered trademarks are under license from Byrne Electrical, Rockford, MI: Interport, Mini-Port, Axil Z, and Ellora.

® The following is a registered trademark of DuPont, Wilmington, DE: Corian.

® The following is a registered trademark of Genlyte Thomas Company, Louisville, KY: Lightolier.

® The following is a registered trademark of Hilti Corporation, FL-9494 Schaan, Principality of Liechtenstein: Hilti.

® The following is a registered trademark of Leviton Manufacturing Company, Little Neck, NY: Decora.

® The following is a registered trademark of Mechanical Plastics Corp, Elmsford, NY: Toggler.

® The following is a registered trademark of Microsoft Corporation, Redmond, WA: Microsoft.

® The following are registered trademarks of Orangebox Ltd., Cardiff, UK: Orangebox.

® The following is a registered trademark of Panduit Corporation, Lockport, IL: Panduit.

® The following is a registered trademark of Trav (Press), Cuneo, Italy: Assisa.

® The following is a registered trademark of Virtual Ink, Boston, MA: mimioActive.

® The following registered trademarks are under license from Wilkhahn Furniture Products: Avera, Senzo, Versal, and Wilkhahn FS.

® The following are registered trademarks of Polyvision Corp: Flow, Motif, Polyvision, Sans, and Serif.

® The following is a registered trademark of Wilsonart International, Temple, TX: Chemsurf.

® The following is a registered trademark of Wiremold, West Hartford, CT: Wiremold.

® The following is a registered trademark of EMU Group S.P.A., Perugia, Italy: EMU.

® The following is a registered trademark of Security People, Inc.: Digilock.

® The following are registered trademarks of Natural Capital Partners Europe Limited: CarbonNeutral and the CarbonNeutral Certified logo.

™ The following is a trademark of Microsoft Corporation, Redmond, WA: Windows.

™ The following is a trademark of Rodman Industries, Inc., Oconomowoc, WI: ResinCore1.

™ The following is a trademark of Ultrafabrics, LLC, Elmsford, NY: Ultraleather.

™ The following trademarks are under license from Wilkhahn Furniture products: Cana, Linus, Logon, Picto, Range, Stitz, Thema, Timetable, and Tubis.

™ The following trademarks are under license from Walter Knoll: Andoo, Bob, Lazlo, Lox, Ribbon, and Together.

™ The following trademarks are under license from PP Mobler: Bar and Flag Halyard.

™ The following trademarks are under license from Carl Hansen: Elbow, Paddle, Shell, Wing, and Wishbone.

™ The following trademarks are under license from Cambridge Sound Management, LLC Cambridge, MA: QtPro Soundmasking, Qt Quiet Technology, and Sonet Qt.

™ The following is a trademark of Electri-Cable Assemblies, Shelton, CT: Interact.

™ The following is a trademark of Clestra Hauserman: IRYS.

™ The following is a trademark of Wiesner-Hager Möbel GmbH: Nooi.

™ The following are trademarks of Polyvision: Accord, a3, e3, Boundri, and Nota.

™ The following is a trademark of Bostock Company, Inc: SnapCab.

™ The following is a trademark of Williams-Sonoma, Inc: West Elm.

™ The following is a trademark of Elena Marquina Testor: nanimarquina.

™ The following is a trademark of Forbo International SA: Forbo.

Trademarks used herein are the property of Steelcase Inc. or their respective owners.