Airtouch



Understanding

Height-Adjustable Worksurfaces **202**



Height-Adjustable Worksurfaces

Universal Tables **206**

Universal Systems **208**

Airtouch Height-Adjustable Worksurfaces

Airtouch worksurfaces

support computer-intensive users and mobile users in single occupant, multi-occupant, or high-churn environments. They allow users to quickly and effortlessly raise and lower their worksurfaces between seated and standing positions.

► Specifying, page 206

Worksurface has a wood core with a High-Pressure Laminate surface and is 1³/₁₆" thick.

Edge is available in 3 mm profile.

Base allows unique applications without having to tether any power cords.

Leveling glides adjust 1" to install unit on uneven floors.

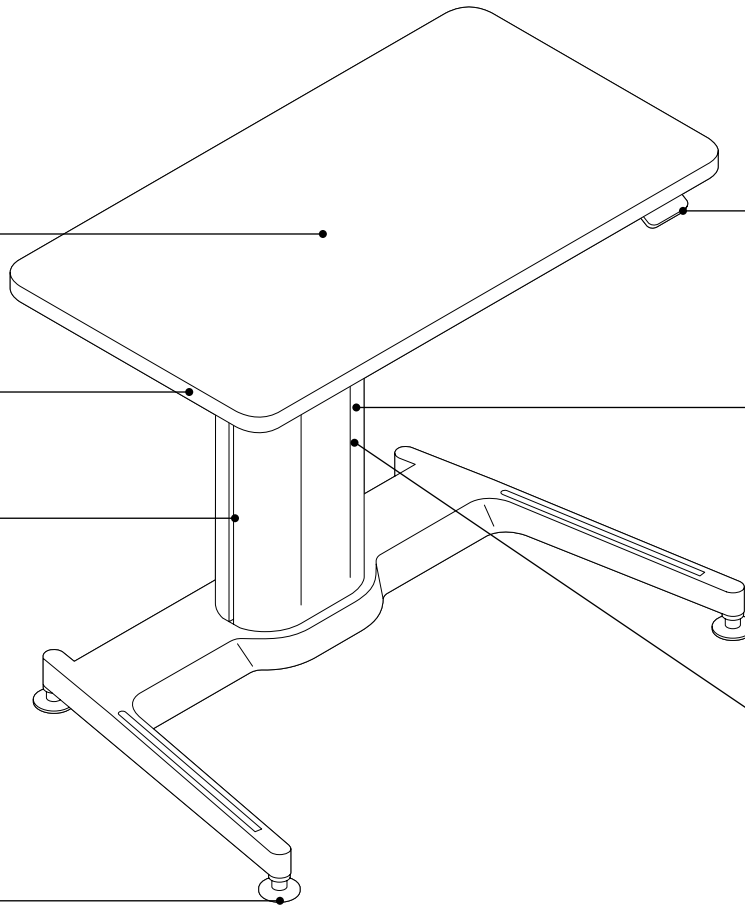

Ergonomic lift handle activates smooth, effortless height adjustments.

Airtouch has an adjustment feature on the column which allows the unit to function properly with any weight up to 150 pounds.
Tip: When calculating lifting capacity, subtract the weight of the worksurface.
► See page 205 for worksurface weights.

Height-adjustable column adjusts from 26"H to 43"H in any increment.

Product Details

High-Pressure Laminate Worksurfaces

Front (user's) edge profile is available in 3 mm edge profile.

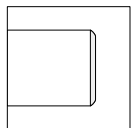

3 mm edge profile

PVC-free, 3 mm edge profiles are proprietary polyolefin blend for all solid colors and seven woodgrain finishes. Matching 1 mm side and back edges are also PVC-free. See surface material listing in this book for specific PVC-free availability.
Tip: Universal Tables have a continuous 3 mm edge.

Edge profile finishes are specified separately from laminate color.

Edge profile provides a flush interface with universal pedestals.

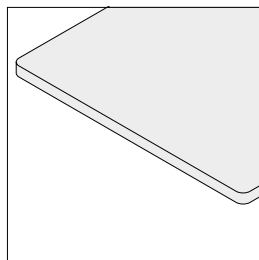

Universal tables have 2" radius corners on all four sides with a continuous user's edge. Radius corners eliminate sharp edges and are appropriate for free-standing furniture.

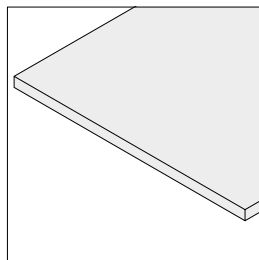

Universal Systems have 90° corners on all four sides with a front user's edge.

Airtouch height-adjustable tables are available in straight and corner shapes.

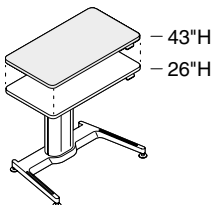

Airtouch worksurfaces adjust 26"H to 43"H in any increment.

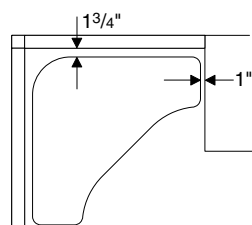

At least a 1³/₄" gap must separate backs of a table and panels to accommodate cables and prevent pinching. A 1" gap separates sides and adjacent furniture.

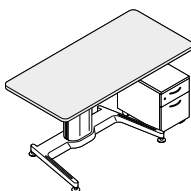

Worksurface overhang for pedestal storage varies by shape and size of work surface.

Surface Materials

High-Pressure Laminate Tables

- Laminate
- ▶ See *Surface Materials Reference Manual*.

- Open Line laminate (option)
- A program including non-Steelcase laminates which are suitable for use on Steelcase products.
- ▶ See *Surface Materials Reference Manual*.

- 3 mm**
- Plastic

Height-adjustable base

- 4799 Platinum
- 7207 Black

Height-adjustable column

- 4799 Platinum paint

Application Topics

Moving tables can collide with other components. Do not install overhead storage, desk-height power, or desk accessories in the path of height-adjustable worksurfaces.

Airtouch is designed to support up to 150 pounds including the work surface. An adjustable feature on the column allows the amount of lift assist to be set for various cargo loads.

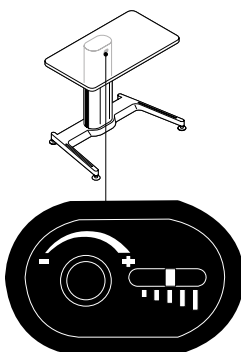

The gauge located near the top of the column shows the amount of lift assist in use. The amount of lift assist can be dialed up for heavier loads and dialed down for lighter loads. If the unit is not moving smoothly, the lift assist mechanism needs to be adjusted. For example, if the top raises too fast, dial the lift assist down. If the top is difficult to raise, dial the lift assist up.

Typical worktool weights are:

- Laptop 5–8 lb
- Small flat screen 10–16 lb
- Monitor arm 10–14 lb
- Desk lamp 5–10 lb
- Keyboard 2–3 lb
- Inch of paper 2¹/₂ lb
- Desk phone 3–5 lb

Worksurface travels at the speed designated by the user. Users can adjust the table from seated to standing in one natural motion (approximately 1 second).

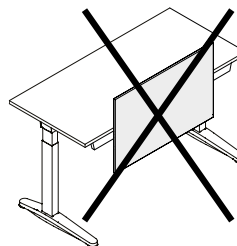

Universal boundary screens are not permitted on height-adjustable desks, as they do not pass minimum safety requirements which could result in the desk tipping over.

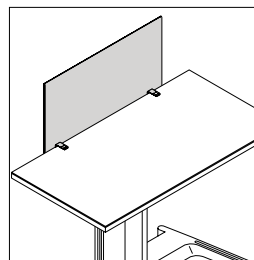

Screens mount to worksurfaces in privacy or below the work surface for modesty.
▶ See *Worktools Compatibility Charts*, page 38, for help determining appropriate screen widths for each Airtouch work surface size.

SOTO rail and SlatRail mount to worksurfaces to support worktools, freeing up work surface space.

- ▶ See *Worktools Compatibility Charts*, page 38, for help determining appropriate SOTO rail and SlatRail widths for each Airtouch work surface size.

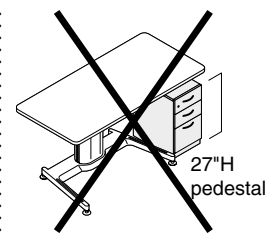

Any storage higher than 24¹/₂" will impede the lower height range of work surface.

Tip: Do not place storage underneath paddle.

Worksurface weight plates may be necessary to order if there is not enough weight on the work surface. Applications using the smallest width work surface without additional worktools (i.e. touch-down spaces) will require these counterweights (946900053SR).

All assemblies meet or exceed ANSI/BIFMA standards.

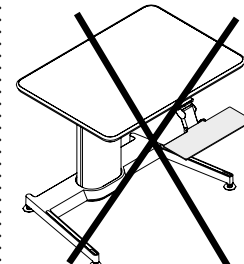

Keyboard assemblies are not allowed on height-adjustable desks. They do not meet minimum safety requirements.

Installation

Worksurfaces ship with pre-drilled holes for mounting bases.

Airtouch column requires attachment to the base and work surface.

Airtouch Height-Adjustable Worksurfaces, continued

Base supports a maximum distributed weight capacity of 150 pounds.

Tip: When calculating lifting capacity, subtract the weight of the worksurface.

Worksurface Weight

| Worksurface Shape | W | LD | RD | Style Number | Worksurface Weight |
|---|-----|----------------------------------|----------------------------------|--------------|--------------------|
| Universal Tables | | | | | |
| Rectangular – 22 ¹ / ₄ "D | 40" | 22 ¹ / ₄ " | 22 ¹ / ₄ " | BAPSS2442 | 30.6 lb |
| | 46" | 22 ¹ / ₄ " | 22 ¹ / ₄ " | BAPSS2448 | 35.0 lb |
| | 58" | 22 ¹ / ₄ " | 22 ¹ / ₄ " | BAPSS2460 | 44.8 lb |

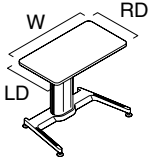

| | | | | | |
|---|-----|----------------------------------|----------------------------------|-----------|---------|
| Rectangular – 28 ¹ / ₄ "D | 40" | 28 ¹ / ₄ " | 28 ¹ / ₄ " | BAPSS3042 | 38.3 lb |
| | 46" | 28 ¹ / ₄ " | 28 ¹ / ₄ " | BAPSS3048 | 44.8 lb |
| | 58" | 28 ¹ / ₄ " | 28 ¹ / ₄ " | BAPSS3060 | 55.8 lb |

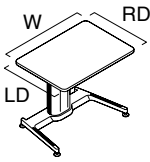

| Worksurface Shape | LW | LD | RW | RD | Style Number | Worksurface Weight |
|-------------------|----------------------------------|----------------------------------|----------------------------------|----------------------------------|--------------|--------------------|
| 90° Corner | 39 ¹ / ₄ " | 22 ¹ / ₄ " | 39 ¹ / ₄ " | 22 ¹ / ₄ " | BAPSC2442 | 45.9 lb |
| | 45 ¹ / ₄ " | 22 ¹ / ₄ " | 45 ¹ / ₄ " | 22 ¹ / ₄ " | BAPSC2448 | 59.0 lb |

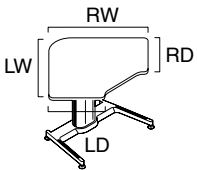

| | | | | | | |
|------------|-----|----------------------------------|-----|----------------------------------|----------|---------|
| 120° Equal | 34" | 22 ¹ / ₄ " | 34" | 22 ¹ / ₄ " | BAPB2436 | 55.8 lb |
|------------|-----|----------------------------------|-----|----------------------------------|----------|---------|

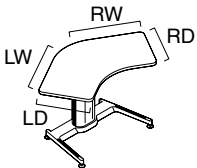

Worksurface Weight

| Worksurface Shape | W | LD | RD | Style Number | Worksurface Weight |
|-------------------|---|----|----|--------------|--------------------|
|-------------------|---|----|----|--------------|--------------------|

For use with Universal Systems

| | | | | | |
|---------------------|-----|------|------|-----------|---------|
| Rectangular – 22¼"D | 40" | 22¼" | 22¼" | UAPSS2442 | 30.6 lb |
| | 46" | 22¼" | 22¼" | UAPSS2448 | 35.0 lb |
| | 58" | 22¼" | 22¼" | UAPSS2460 | 44.8 lb |

| | | | | | |
|---------------------|-----|------|------|-----------|---------|
| Rectangular – 28¼"D | 40" | 28¼" | 28¼" | UAPSS3042 | 38.3 lb |
| | 46" | 28¼" | 28¼" | UAPSS3048 | 44.8 lb |
| | 58" | 28¼" | 28¼" | UAPSS3060 | 55.8 lb |

| Worksurface Shape | LW | LD | RW | RD | Style Number | Worksurface Weight |
|-------------------|----|----|----|----|--------------|--------------------|
|-------------------|----|----|----|----|--------------|--------------------|

| | | | | | | |
|------------|------|------|------|------|-----------|---------|
| 90° Corner | 39¼" | 16¼" | 39¼" | 16¼" | UAPSC1842 | 30.6 lb |
| | 39¼" | 22¼" | 39¼" | 22¼" | UAPSC2442 | 45.9 lb |
| | 45¼" | 22¼" | 45¼" | 22¼" | UAPSC2448 | 59.0 lb |

| | | | | | | |
|------------|-----|------|-----|------|----------|---------|
| 120° Equal | 34" | 22¼" | 34" | 22¼" | UAPB2436 | 55.8 lb |
|------------|-----|------|-----|------|----------|---------|

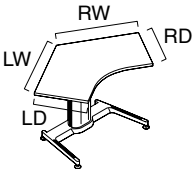
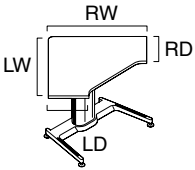
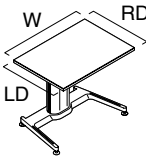
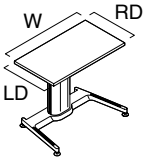

Airtouch Height-Adjustable Worksurfaces

High-Pressure Laminate Universal Tables

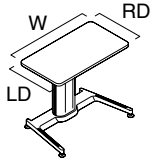

Tip: Airtouch height-adjustable base requires assembly and attachment to the worksurface.

Tip: Worksurfaces ship with pre-drilled holes for mounting bases.

Tip: Any storage higher than 24½" will impede the lower height range of the worksurface. Do not place storage underneath paddle.

For laminate group 2 and 3 pricing, please refer to the electronic catalog or SmartTools.

Tip: An adjustment feature on the column allows the unit to function properly with any load up to 150 pounds, including the worksurface.

Tip: Counterweights may be necessary to order if there is not enough load on the worksurface. Order service part (946900053SR).

Tip: For help determining privacy/modesty screen, SOTO rail, and SlatRail width compatibility, see Worktools Compatibility Charts, page 38.

Tip: Wood veneer worksurface options are available through specials.

Tip: Paint surface options apply to base only. Paint surface option does not apply to column.

Tip: Only single and dual flat panel monitor arm applications are permitted for use with single column height-adjustable tables.



For Canadian Pricing

Multiply U.S. Price by the Canadian price factor.

▶ See page 1 for details.

| Standard Includes | | Required to Specify |
|--|--|--|
| ▶ Need help? Product details, page 202 | <ul style="list-style-type: none"> High-Pressure Laminate price group 1 High-Pressure Laminate worksurface edge: plastic 3 mm edge Worksurface corners: radius Height-adjustable column mechanism: 4799 Platinum Height-adjustable mechanism base: paint Attachment hardware | <ol style="list-style-type: none"> Style number High-Pressure Laminate color number for worksurface Plastic color number for profile edge on laminate worksurface Paint color number for base: 4799 Platinum Metallic 7207 Black Options, if selected (see below) <p>▶ See Surface Materials, page 274.</p> |

| Options | U.S. Price | Required to Specify |
|--|--|---|
| Surface Materials <ul style="list-style-type: none"> Paint price group 1 Paint price group 2 Laminate price group 2 Laminate price group 3 Open Line laminate | No cost +\$ 57 See information below See information below +\$102 plus cost of laminate | Specify paint color number. Specify paint color number. Specify laminate color number. Specify laminate color number. ▶ See <i>Surface Materials Reference Manual</i> . |
| Related Products <ul style="list-style-type: none"> Slatwall, SlatRail, and Freestanding Worktools SOTO rail Flat panel arms Privacy/modesty screens Acrylic screens Cable and power management | | ▶ See <i>Steelcase Worktools Specification Guide</i> . ▶ See <i>Steelcase Worktools Specification Guide</i> . ▶ See <i>Steelcase Worktools Specification Guide</i> . ▶ Pages 241–242 ▶ Page 226 ▶ Page 263 |

Specification Information

U.S. Base Price
High-Pressure Laminate



| • Dimensions | | | • Style Number | • Plastic 3 mm Edge |
|--------------|----|----|-------------------|---------------------------|
| W | LD | RD | | |
| | | | | |

Rectangular Tables

22 1/4" D

| | | | | |
|-----|---------|---------|------------------|--------|
| 40" | 22 1/4" | 22 1/4" | BAPSS2442 | \$3501 |
| 46" | 22 1/4" | 22 1/4" | BAPSS2448 | \$3551 |
| 58" | 22 1/4" | 22 1/4" | BAPSS2460 | \$3661 |

28 1/4" D

| | | | | |
|-----|---------|---------|------------------|--------|
| 40" | 28 1/4" | 28 1/4" | BAPSS3042 | \$3644 |
| 46" | 28 1/4" | 28 1/4" | BAPSS3048 | \$3699 |
| 58" | 28 1/4" | 28 1/4" | BAPSS3060 | \$3813 |

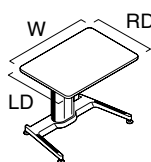
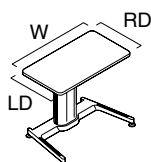

Tip: 58" privacy/modesty screens should not be specified with 22 1/4" D rectangular worksurfaces.

Tip: Base supports a maximum distributed weight capacity of 150 pounds. When calculating lifting capacity, subtract the weight of the worksurface.

► See page 205 worksurface weights.

Specification Information

U.S. Base Price
High-Pressure Laminate



| • Dimensions | | | | • Style Number | • Plastic 3 mm Edge |
|--------------|----|----|----|-------------------|---------------------------|
| LW | LD | RW | RD | | |
| | | | | | |

90° Corner Tables

| | | | | | |
|---------|---------|---------|---------|------------------|--------|
| 39 1/4" | 22 1/4" | 39 1/4" | 22 1/4" | BAPSC2442 | \$3831 |
| 45 1/4" | 22 1/4" | 45 1/4" | 22 1/4" | BAPSC2448 | \$3893 |

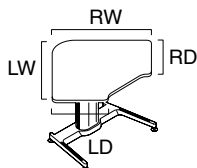

120° Equal Table

| | | | | | |
|-----|---------|-----|---------|-----------------|--------|
| 34" | 22 1/4" | 34" | 22 1/4" | BAPB2436 | \$4325 |
|-----|---------|-----|---------|-----------------|--------|

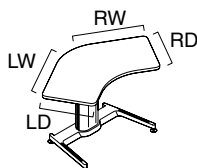

For Canadian Pricing

Multiply U.S. Price by the Canadian price factor.

► See page 1 for details.

Airtouch Height-Adjustable Worksurfaces

High-Pressure Laminate Universal Systems

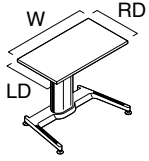

Tip: Airtouch height-adjustable base requires assembly and attachment to the worksurface.

Tip: Worksurfaces ship with pre-drilled holes for mounting bases.

Tip: An adjustment feature on the column allows the unit to function properly with any load up to 150 pounds, including the worksurface.

For laminate group 2 and 3 pricing, please refer to the electronic catalog or SmartTools.

Tip: Any storage higher than 24 1/2" will impede the lower height range of the worksurface. Do not place storage underneath paddle.

Tip: Counterweights may be necessary to order if there is not enough load on the worksurface. Order service part (946900053SR).

Tip: For help determining privacy/modesty screen, SOTO rail, and SlatRail width compatibility, see Worktools Compatibility Charts, page 38.

Tip: Wood veneer worksurface options are available through specials.

Tip: Only single and dual flat panel monitor arm applications are permitted for use with single column height-adjustable tables.

Tip: Paint surface options apply to base only. Paint surface option does not apply to column.



For Canadian Pricing

Multiply U.S. Price by the Canadian price factor.

▶ See page 1 for details.

| Standard Includes | | Required to Specify |
|--|---|--|
| ▶ Need help? Product details, page 202 | <ul style="list-style-type: none"> High-Pressure Laminate price group 1 High-Pressure Laminate worksurface edge: plastic 3 mm edge Worksurface corners: 90° Height-adjustable column mechanism: 4799 Platinum Height-adjustable mechanism base: paint Attachment hardware | <ol style="list-style-type: none"> Style number High-Pressure Laminate color number for worksurface Plastic color number for profile edge on laminate worksurface Paint color number for base: 4799 Platinum Metallic 7207 Black Options, if selected (see below) <ul style="list-style-type: none"> ▶ See Surface Materials, page 274. |

| Options | U.S. Price | Required to Specify |
|--|--|---|
| Surface Materials <ul style="list-style-type: none"> Paint price group 1 Paint price group 2 Laminate price group 2 Laminate price group 3 Open Line laminate | No cost +\$ 57 See information below See information below +\$102 plus cost of laminate | Specify paint color number. Specify paint color number. Specify laminate color number. Specify laminate color number. ▶ See <i>Surface Materials Reference Manual</i> . |
| Related Products <ul style="list-style-type: none"> Slatwall, SlatRail, and Freestanding Worktools SOTO rail Flat panel arms Privacy/modesty screens Acrylic screens Cable and power management | | ▶ See <i>Steelcase Worktools Specification Guide</i> . ▶ See <i>Steelcase Worktools Specification Guide</i> . ▶ See <i>Steelcase Worktools Specification Guide</i> . ▶ Pages 241–242 ▶ Page 260 ▶ Page 263 |

Tip: 58" privacy/modesty screens should not be specified with 22¼"D rectangular worksurfaces.

Specification Information

| • Dimensions | | | • Style Number | • Plastic 3 mm Edge | U.S. Base Price High-Pressure Laminate |
|--------------|----|----|----------------|---------------------|---|
| W | LD | RD | | | |
| | | | | | |



Rectangular Worksurfaces

| 22¼"D | | | | | |
|-------|------|------|------------------|--------|--|
| 40" | 22¼" | 22¼" | UAPSS2442 | \$3427 | |
| 46" | 22¼" | 22¼" | UAPSS2448 | \$3476 | |
| 58" | 22¼" | 22¼" | UAPSS2460 | \$3568 | |

| 28¼"D | | | | | |
|-------|------|------|------------------|--------|--|
| 40" | 28¼" | 28¼" | UAPSS3042 | \$3551 | |
| 46" | 28¼" | 28¼" | UAPSS3048 | \$3605 | |
| 58" | 28¼" | 28¼" | UAPSS3060 | \$3713 | |

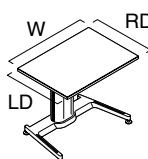
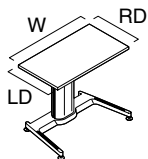

Specification Information

| • Dimensions | | | | • Style Number | • Plastic 3 mm Edge | U.S. Base Price High-Pressure Laminate |
|--------------|----|----|----|----------------|---------------------|---|
| LW | LD | RW | RD | | | |
| | | | | | | |



No Suffix

90° Corner Worksurfaces

| | | | | | |
|------|------|------|------|------------------|--------|
| 39¼" | 16¼" | 39¼" | 16¼" | UAPSC1842 | \$3673 |
| 39¼" | 22¼" | 39¼" | 22¼" | UAPSC2442 | \$3697 |
| 45¼" | 22¼" | 45¼" | 22¼" | UAPSC2448 | \$3753 |

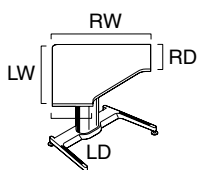

120° Equal Worksurface

| | | | | | |
|-----|------|-----|------|-----------------|--------|
| 34" | 22¼" | 34" | 22¼" | UAPB2436 | \$4178 |
|-----|------|-----|------|-----------------|--------|

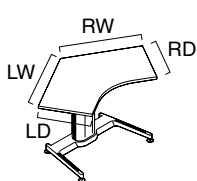

 **For Canadian Pricing**
Multiply U.S. Price by the Canadian price factor.
▶ See page 1 for details.

