

Steelcase®



Steelcase Worktools

Visit steelcase.com



facebook.com/Steelcase



twitter.com/Steelcase



youtube.com/SteelcaseTV

Concept and Design / Steelcase
DW006EN 05/24 © 2024 Steelcase Inc. All rights reserved. All specifications subject to change without notice.
Printed on at least 60% recycled paper. Cert no. BV-COC-858659. Printed in France by OTT Imprimeurs – Wasselonne.



Steelcase



Tools for the new worker

Work is changing. Workers are more mobile and work is more collaborative. Individual workspaces are smaller—often shared—and must adapt quickly to different users and workstyles.

Proper lighting, efficient organisational worktools and adjustable computer support tools give employees the ability to choose how and where they work, contributing to overall employee wellbeing and a more supportive, productive workspace.

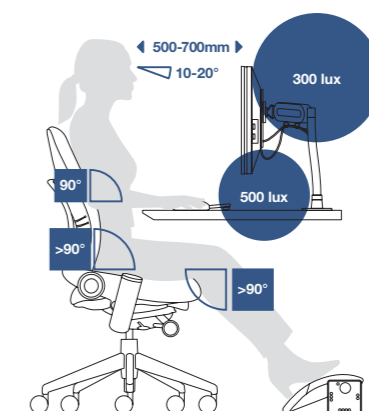

C8932

ERGONOMICS AT THE WORKSTATION

Steelcase worktools optimise posture, lighting, screen height and screen distance to minimise strain on the eyes and the body's tension zones. All worktools are based on the European Display Screen Directive 90/270/EEC and its recommendations.

Lighting

Task lighting is an essential part of today's healthy and productive work environments. Users appreciate control over personal lighting that allows them to position it where they need it and to adjust it to their various tasks. Steelcase lighting solutions include the industry-leading dash LED Task Light—engineered to reduce eyestrain—as well as innovative lighting options designed to support individual workers' needs and complement both new and existing environments.



16-0061450



16-0061435

DASH TASK LIGHT

Featuring clean lines, fluid movement and a timeless aesthetic, the dash and dash mini LED Task Lights provide optimal lighting in nearly every environment. Yielding a soft, consistent pool of light that “falls off” considerably less than that of other LED lamps, dash and dash mini are as much about improving how we work as they are about making a subtle statement with their design.



16-0061478

DASH MINI TASK LIGHT

The smaller of the two dash LED task lights, dash mini has a compact design that maximises space and delivers optimal light. Also available with an integrated occupancy sensor for additional energy savings.



17-0080418

COOLER TO THE TOUCH

The dash task light's innovative design features a convection airflow solution that minimizes heat transfer, keeping the light head from becoming hot.



18-0100711

DISTRIBUTED LIGHT

dash produces a more evenly distributed light pool.



17-0079847

ENERGY SAVINGS

An optional Passive Infrared (PIR) occupancy sensor—with a 36" activation range — turns the light off when it is not in use to avoid unnecessary energy use and extend lamp life.

ORGANISATIONAL WORKTOOLS

Whether it's a mobile worker sharing a temporary workspace or an employee using the space on an ongoing basis—by easily adapting to each of their needs, organisational worktools create a more efficient, comfortable and productive workspace.

Better tools create smarter storage. 43% of European office workers feel that they would benefit from increased storage space. But what if they just needed proper organisation tools? 1+1 Worktools offer a broad range of unique and versatile solutions for storing and organising. By helping users make more efficient use of existing storage units and space, organisational worktools can reduce the need for increases in capacity.

47%

of European workers waste up to 30 minutes a day searching for information.

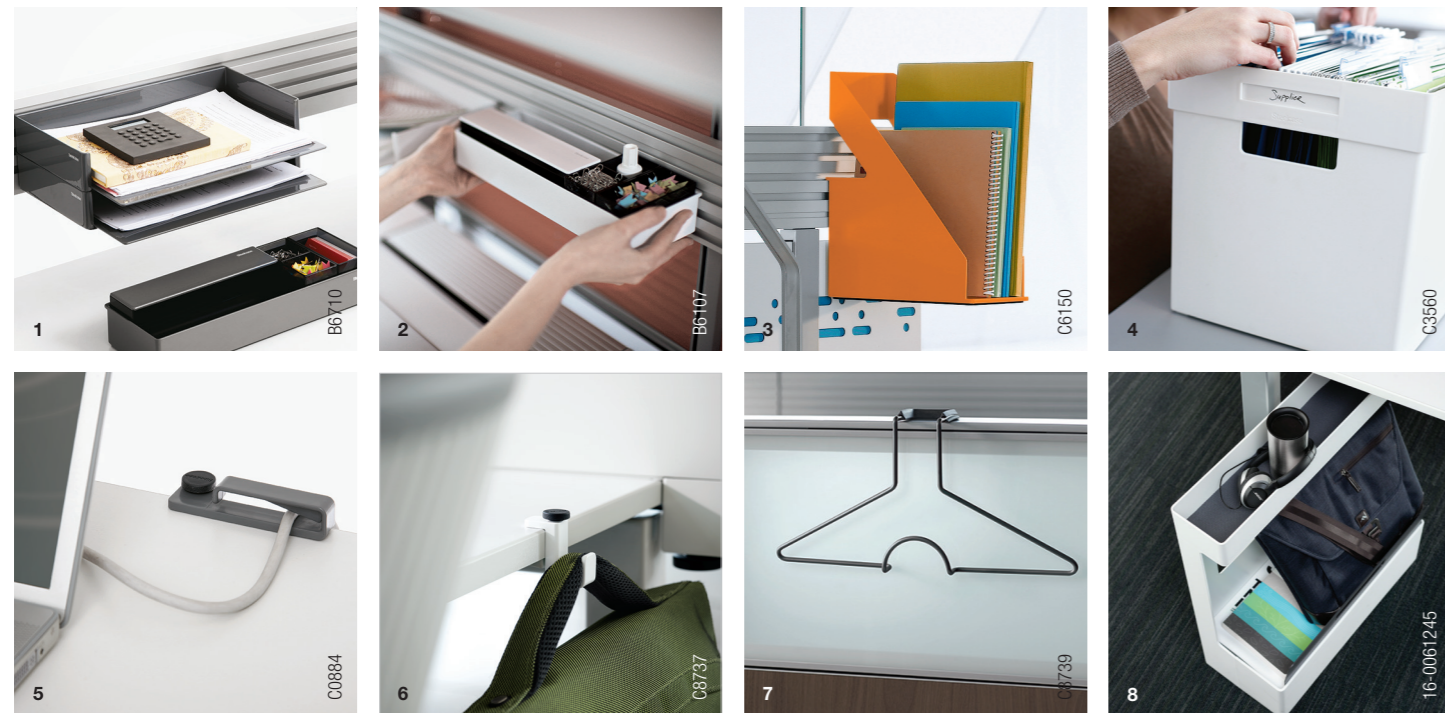

1+1 ORGANISATIONAL WORKTOOLS

1. LETTER TRAY
2. TOOLBOX
3. BINDER HOLDER
4. BOX
5. CABLE STOP
6. HOOK
7. FLAT TOP HANGER
8. MOBILE CADDY

Welcome tools

As organisations grow, it becomes more important to augment current workspaces, increasing efficiency and decreasing overhead costs. 1+1 Welcome Tools enhance real estate by meeting more employee needs and utilising vertical space in smaller work environments.

Ergonomic support is also crucial and wellbeing at work is a global challenge. Different work modes and workstyles require different ergonomic support. Worktools help create organisational logic and ergonomic well-being. People are more effective if their workspace adjusts to the many ways they work.

8 minutes per day

All workers today are mobile to some degree. The average worker spends 8 minutes per transition to settle in and refocus.

Source: Research conducted by Steelcase and IDEO



DESK PAD

Find a sense of personal boundary at shared or open benches while supporting wrists and forearms. Available with or without antimicrobial treatment.



MOBILE CADDY

is a smart storage on castors offering a place to stow personal items.



ERGO EDGE

provides support for wrists and forearms and creates a personal boundary.



FUNCTIONAL SCREEN

provides workers with organisation, boundaries and privacy.



MONITOR BRIDGE

reclaims worksurfaces by securing and elevating monitors, tablets and laptops as second screens, while clearing the space in front of the user, providing additional vertical organisation.

Computer support tools

Knowledge relies on technology, yet technology is constantly evolving—changing form and shape. Computer support tools are integrated into the workplace and allow for ergonomics, space saving and flexibility. These tools are highly customisable, allowing individuals to maximise their workspace, reduce fatigue and eyestrain, and make the most of their technology.

97%

of workers want access to tools and technology.

Source: Steelcase CoreNet global survey 2011



SCREEN SUPPORT

1. FSMA INTRO
2. PLURIO
3. FSMA
4. PLURIO MULTIPLE DISPLAY SUPPORT
5. VOLLEY

Power access

Today, technology defines our world. It's the support for a range of workstyles – nomadic, conferencing, tasking, teaming. That's why quick, easy access to data, power and technology networks has become essential.

Forget about wasting time looking for connection points. Steelcase offers a full range of power access devices that will allow users fast and easy connection to devices and data.



USB CHARGING STATION

provides a space for users to charge up to three devices with USB cables and can be freestanding or secured with adhesive strips.



STEELCASE POWER HUB

Steelcase Power Hub is a flexible, fast-charging and affordable solution that provides workers with one of the top desired amenities — power.



STEELCASE IN & OUT

allows easy and above the desk connection access to plug in equipment. It is designed for meeting and training rooms.



CONNECTING HUB

allows quick and easy access to data, power and technology networks. Connecting hub enhances mobile work and hot desking.



INTEGRATED TOP ACCESS

provides intuitive access to power and data with a soft opening and closing mechanism.

STATEMENT OF LINE

ORGANISATION | 1+1 WELCOME TOOLS



Mobile Caddy Functional Screen Personal Pocket Desk pad Ergo edge

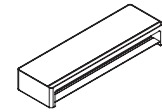

Monitor bridge

POWER ACCESS | CABLE MANAGEMENT

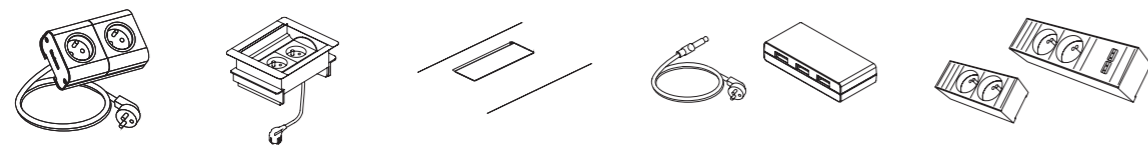

Connecting Hub In & Out Integrated Top Access USB Charging Station Power Hub

ORGANISATION | 1+1 ORGANISATIONAL WORKTOOLS

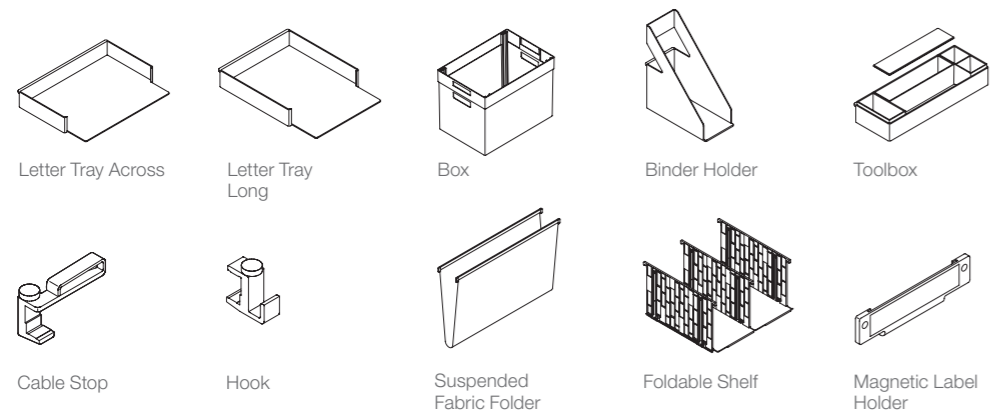

Letter Tray Across Letter Tray Long Box Binder Holder Toolbox
Cable Stop Hook Suspended Fabric Folder Foldable Shelf Magnetic Label Holder

ORGANISATION | OTHER ACCESSORIES



Flat Top Hanger Wastebasket

LIGHTING



dash dash mini Eclipse

STATEMENT OF LINE

COMPUTER SUPPORT TOOLS

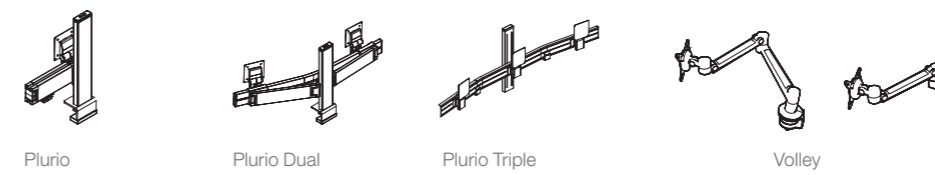

Plurio Plurio Dual Plurio Triple Volley

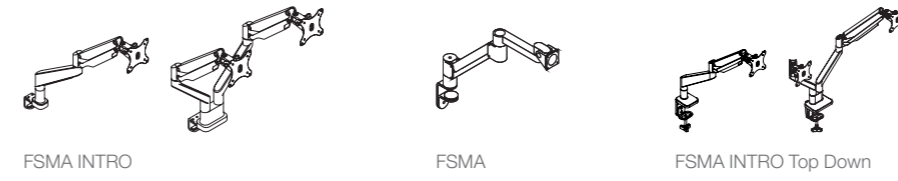

FSMA INTRO FSMA FSMA INTRO Top Down

SURFACE MATERIALS

Surface materials shown in brochure:

1+1 ORGANISATIONAL TOOLS

- Glossy White
- Glossy Grey

Accent colours are available for letter tray across, binder holder and toolbox.

- AL Chili Red
- AU Ocean Blue
- OA Light Orange
- SZ Apple Green

LIGHTING

- Arctic White
- Black
- Platinum

Accent colours are available for dash.

- WM Arctic White
- NL Low-Gloss Black
- SL Platinum
- Q7 Tangerine
- Q9 Scarlet
- V3 Blue Jay
- Q8 Wasabi

COMPUTER SUPPORT TOOLS

- Aluminum (Profile only)
- Platinum (Silver)
- White (Rigid only)

FLAT SCREEN MONITOR ARM

- Aluminum

1+1 WELCOME TOOLS FABRIC PADS

- Scarlet
- Blue Jay
- Pepper

FOAM

- Merle

Colours are representative and may vary slightly from actual material.

SUSTAINABILITY

At its heart, sustainability at Steelcase is about people. It's about creating and supporting the economic, environmental and social conditions that allow people and communities to reach their full potential.

Research and insights direct our path.

It's not only about creating goods, it's about creating good. It's not only about creating value, it's about living our values. It's not just about reducing our footprint, it's about expanding our reach. It's about creating lasting and meaningful change to enable the long-term wellbeing of current and future generations.

Innovative products and solutions result.

In the development of our products, we work to consider each stage of the life cycle: from materials extraction, production, transport, use and reuse, until the end of its life. We demonstrate performance through third-party verified certifications and voluntary product declarations.

Steelcase's sustainability promises, actions, and results are communicated in an annual Corporate Sustainability Report.