Steelcase Worktools and Height-Adjustable Worksurfaces and Benching Volume 9

Terms and Conditions	2
Sample Order Form	10
Participating Steelcase Dealers	12
Steelcase Showrooms and Manufacturing Locations	18

Product Information	
Organizational Worktools (SIN 711.2)	19
Lighting (SIN 711.2/711.1)	57
Computer Support Tools (SIN 711.2)	75
Height-Adjustable Worksurfaces (SIN 711.2)	191
Height-Adjustable Benching (SIN 711.2)	297

Surface Materials	317
Resources	327

► For a list of all trademarks, refer to the last page of this specification guide.

Terms and Conditions

Customer Information

For more information, please contact your participating Steelcase GSA dealer.

For more information, please contact your participating Steelcase GSA dealer.

For more information, please contact your participating Steelcase GSA dealer.

For more information, please contact your participating Steelcase GSA dealer.

For more information, please contact your participating Steelcase GSA dealer.

For more information, please contact your participating Steelcase GSA dealer.

For more information, please contact your participating Steelcase GSA dealer.

For more information, please contact your participating Steelcase GSA dealer.

Sample Order Form

Sample Order Form

ORDER FOR SUPPLIES OR SERVICES			PAGE	OF	PAGES
IMPORTANT: Mark all packages and papers with contract and/or order numbers.					
DATE OF ORDER 1 6-1-04	CONTRACT NO. (If any) 2 GS-27F-0014V	ORDER NO. 3 10 - 000	REQUISITION/REFERENCE NO.		
ISSUING OFFICE (Address correspondence to) 4 GSA 1 Town Street City, State, Zip Name and Telephone Number		SHIP TO: (Consignee and address, ZIP Code) 5 GSA 2 Town Street City, State, Zip Name and Telephone Number			
TO: CONTRACTOR (Name, address and ZIP Code) 6 Steelcase Inc. c/o Participating Dealer 901 44th Street, SE Grand Rapids, MI 49508 Attn: Solutions Fullfillment Team CH-2W-SS (GSA)		Cage Code: 39880		TYPE OF ORDER <input type="checkbox"/> A. PURCHASE — Reference your _____ Please furnish the following on the terms and conditions specified on both sides of this order and on the attached sheets, if any, including delivery as indicated. This purchase is negotiated under authority of: <input type="checkbox"/> B. DELIVERY — Except for billing instructions on the reverse, this delivery order is subject to instructions contained on this side only of this form and is issued subject to the terms and conditions of the above-numbered contract.	
ACCOUNTING AND APPROPRIATION DATA			REQUISITIONING OFFICE		
			BUSINESS CLASSIFICATION (Check appropriate box(es)) 20 <input type="checkbox"/> SMALL <input checked="" type="checkbox"/> OTHER THAN SMALL <input type="checkbox"/> DIS-ADVANTAGED <input type="checkbox"/> WOMEN-OWNED		
FCA DESTINATION 7		GOVERNMENT NO.	DELIVER TO FCA DESTINATION ON OR BEFORE (Date) 8 ARO date	DISCOUNT TERMS 9 Net 30 days	
PLACE OF INSPECTION AND ACCEPTANCE					

(See reverse for Rejections)

ITEM NO. (A)	SUPPLIES OR SERVICES (B)	QUANTITY ORDERED (C)	UNIT (D)	UNIT PRICE (E)	AMOUNT (F)	QUANTITY ACCEPTED (G)	
1	10 One lot of Steelcase Office Furniture: See attached specifications	13 1		14 \$000	15 \$000		
2	11 Design: \$55.41/hour	2	hrs	\$000	\$000		
3	12 Installation	1		\$000	\$000		
SEE BILLING INSTRUCTIONS ON REVERSE		SHIPPING POINT		GROSS SHIPPING WEIGHT		INVOICE NO.	
		MAIL INVOICE TO: (Include ZIP Code) 17 GSA, 3 Town Street, City, State, Zip				16 \$000	(H) TOT. (Cont. pages) ◀ (I) GRAND TOTAL ◀

UNITED STATES OF AMERICA BY (Signature) 18 Contracting Officer signature and telephone no.	NAME (Typed) 19 John Doe, Department Manager TITLE: CONTRACTING/ORDERING OFFICER
--	---

NSN 7540_01_152_8083

50347-101

OPTIONAL FORM 347 (10-83)
Prescribed by GSA
FAR (48 CFR) 53.213 (e)

- 1 Order date
- 2 Contract number
- 3 Order number
- 4 Issuing office: Requester name and telephone number
- 5 Shipping address: Contact name and telephone number
- 6 Contractor:
Steelcase Inc.
c/o Participating Dealer
901 - 44th Street, S.E.
Grand Rapids, MI 49508
Attn: Solutions Fulfillment Team
- 7 FCA destination
- 8 ARO date (After Receipt of Order)
- 9 Terms: Net 30 days
- 10 Complete product description, including SIN number, style number, all applicable surface materials.
- 11 Separate line for design
- 12 Separate line for installation
- 13 Quantity ordered
- 14 Individual unit price
- 15 Amount (quantity x unit price)
- 16 Total cost
- 17 Invoice address
- 18 Authorized contracting officer signature and telephone number
- 19 Authorized contracting officer name and title (typed)
- 20 Steelcase is the seller of record and is not registered as "small," "disadvantaged," or "woman-owned." If one of these boxes is checked in error, a modification will be required.

Please note on order that all invoice payments must be sent to:

Steelcase Inc.
62087 Collection Center Dr.
Chicago, IL 60693-0620

Participating Steelcase Dealers

Alabama

Dekalb Office of Alabama
2901 Second Ave South
Birmingham, AL 35233
Phone: (205) 933-9100

Kyser OfficeWorks Inc.
2400 Spruce Street
Montgomery, AL 36107-3150
Phone: (334) 834-9400
Fax: (334) 262-0701

OEC Business Interiors
104 East I-65 Service Road North
Mobile, AL 36607-2501
Phone: (251) 471-3368
Fax: (251) 471-0019

Office Interiors by OSCO
1300 Meridian Street
Suite 203
Huntsville, AL 35801
Phone: (256) 604-5696
Fax: (256) 604-5699

OSCO Inc.
229 Grant Street SE
Decatur, AL 35601-2511
Phone: (256) 340-5100
Fax: (256) 340-5108

Alaska

Capital Office Systems
1120 East 35th Avenue
Anchorage, AK 99508-4257
Phone: (907) 777-1500
Fax: (907) 777-1515

Capital Office Systems
3201 Industrial Avenue
Fairbanks, AK 99701-7370
Phone: (907) 456-3946
Fax: (907) 452-6257

Capital Office Systems
3143 Channel Drive
Juneau, AK 99801-7214
Phone: (907) 780-3636
Fax: (907) 780-2290

Arizona

Atmosphere Commercial Interiors
8530 S Priest Drive
Tempe, Arizona 85284-1902
Phone: (602) 252-6971
Fax: (602) 252-8222

Atmosphere Commercial Interiors
Suite 105
4585 South Coach Drive
Tucson, Arizona 85714-3462
Phone: (520) 792-4200
Fax: (540) 791-9568

Atmosphere Commercial Interiors
Suite 100
88 East Broadway Boulevard
Tucson, Arizona 85701-1720
Phone: (520) 792-4200
Fax: (540) 791-9568

Arkansas

ImageWorks
Suite B
1424 North Shackleford
Little Rock, AR 72211
Phone: (501) 944-7501

Today's Office Inc.
717 West 7th Street
Little Rock, AR 72201-4044
Phone: (501) 375-5050
Fax: (501) 375-1350

Today's Office Inc.
3157 West Sunset Avenue
Springdale, AR 72762-4945
Phone: (479) 751-5861
Fax: (479) 756-2233

California

BKM Office Environments
Suite A
2111 Portola Road
Ventura, CA 93003-7723
Phone: (805) 339-6388
Fax: (805) 336-9131

BKM San Diego
Suite 100
9201 Spectrum Center Blvd.
San Diego, CA 92123-1407
Phone: (858) 569-4700
Fax: (858) 277-8931

One Workplace L. Ferrari
2500 De La Cruz Blvd.
Santa Clara, CA 95050
Phone: (669) 800-2500
Fax: (669) 800-2501

One Workplace L. Ferrari
7220 Edgewater Drive
Oakland, CA 94621
Phone: (510) 729-7800
Fax: (510) 729-7801

One Workplace L. Ferrari
475 Brannan Street
San Francisco, CA 94107-1731
Phone: (415) 357-2200
Fax: (415) 357-2201

Peninsula Business Interiors
325 Main Street
Salinas, CA 93901-2705
Phone: (831) 757-4107
Fax: (831) 757-1339

Tangram Interiors
Suite 102
4057 W Shaw Ave
Fresno, CA 93722-6212
Phone: (559) 275-7070
Fax: (559) 275-7080

Tangram Interiors
Suite 100
2850 South Red Hill Avenue
Santa Ana, CA 92705-5532
Phone: (949) 955-6700
Fax: (949) 955-6799

Tangram Interiors
9200 Sorensen Avenue
Santa Fe Springs, CA 90670-2645
Phone: (562) 365-5000
Fax: (562) 365-5399

United Corporate Furnishings
1780 North Market Blvd.
Sacramento, CA 95834-1997
Phone: (916) 553-5900
Fax: (916) 553-5800

Colorado

Office Outfitters & Planners Inc.
749 Main Street
Grand Junction, CO 81501-3535
Phone: (970) 245-6300
Fax: (970) 245-6301

OfficeScapes
2506 Zeppelin Rd
Colorado Springs, CO 80916
Phone: (719) 574-1113
Fax: (719) 574-1133

OfficeScapes
9900 East 51st Avenue
Denver, CO 80238-2430
Phone: (303) 574-1115
Fax: (303) 574-1116

OfficeScapes
Suite 180
4812 McMurry Avenue
Fort Collins, CO 80525-6222
Phone: (970) 223-5959
Fax: (970) 223-5858

Connecticut

Red Thread
300 East River Drive
East Hartford, CT 06108-4205
Phone: (860) 528-9981
Fax: (860) 528-1843

Red Thread
47 & 63 Leffett Street
East Hartford, CT 06108
Phone: (860) 528-9981
Fax: (860) 528-1843

Red Thread
340 Woodmont Road
Milford, CT 06460-3702
Phone: (203) 874-7754
Fax: (203) 876-7915

Red Thread
22 Marsh Hill Road
Orange, CT 06477
Phone: (203) 795-5597
Fax: (203) 795-5915

Red Thread
1930 West Main Street
Stamford, CT 06902-4521
Phone: (203) 324-3138
Fax: (203) 348-9884
Red Thread
40 Main Street
Torrington, CT 06790
Phone: (860) 482-2679
Fax: (860) 482-3590

Delaware

Corporate Interiors Inc.
223 Lisa Drive
New Castle, DE 19720-4193
Phone: (302) 323-9100
Fax: (302) 323-9251

Florida

American Business Interiors
2015 Waverly Place
Melbourne, FL 32901-5444
Phone: (321) 723-5003
Fax: (321) 984-4221

Empire Office
Suite 140
2 Oakwood Boulevard
Hollywood, FL 33020
Phone: (954) 707-6200

Empire Office
South Florida
3201 Commerce Parkway
Miramar, FL 33025-3908
Phone: (954) 435-7300
Fax: (954) 435-7212

Empire Office
Suite 17
2315 Lynx Lane
Orlando, FL 32804
Phone: (407) 628-2400

Empire Office
5112 West Linebaugh Avenue
Tampa, FL 33624
Phone: (813) 418-3300

Empire Office
Suite 2
7830 Byron Drive
West Palm Beach, FL 33404-3332
Phone: (561) 840-8600
Fax: (561) 840-1873

Leitz & Reed Office Products
1119 Florida Avenue
Lynn Haven, FL 32444-4622
Phone: (850) 271-2600
Fax: (850) 271-0076

OEC Business Interiors
1601 NW 80th Boulevard
Gainesville, FL 32606-9140
Phone: (352) 332-1192
Fax: (352) 333-8002

OEC Business Interiors
2393 SW College Road
Ocala, FL 34474-1661
Phone: (352) 620-2888
Fax: (352) 620-2891

OEC Business Interiors
3914 North Davis Highway
Pensacola, FL 32503-2746
Phone: (850) 438-1100
Fax: (850) 432-0003

Office Furniture & Design Concepts
11866 Metro Parkway
Ft. Myers, FL 33966-1307
Phone: (239) 337-1212
Fax: (239) 337-4910

Perdue Office Interiors
Suite 100
5 W Forsyth
Jacksonville, FL 32256-7440
Phone: (904) 737-5858
Fax: (904) 737-6088

Perdue Office Interiors
Suite C7
1516 Capital Circle SE
Tallahassee, FL 32301
Phone: (850) 383-4225

Georgia

Advent Business Interiors
Suite 3
2925 Ledo Road
Albany, GA 31707
Phone: (229) 439-7418
Fax: (229) 435-1279

Commercial Furnishings
598 Third St
Macon, GA 31201-2640
Phone: (478) 765-1515
Fax: (478) 765-1506

DeKalb Office Environments
1320 Ridgeland Parkway
Alpharetta, GA 30004-8442
Phone: (770) 360-0200
Fax: (770) 360-0305

McWaters Inc.
3708 Benchmark Drive
Augusta, GA 30907
Phone: (706) 396-5400
Fax: (706) 396-5401

McWaters Inc.
117 Prosperity Drive
Savannah, GA 31408-9551
Phone: (912) 352-9000
Fax: (912) 352-2034

Hawaii

Interior Showplace Ltd.
956 Queen Street
Honolulu, HI 96814-4118
Phone: (808) 593-8420
Fax: (808) 591-8324

Idaho

Porter's Office Products
435 West Center Street
Pocatello, ID 83204-3241
Phone: (208) 232-1233
Fax: (208) 232-8759

Porter's Office Products
1050 North 2nd East
Rexburg, ID 83440-5127
Phone: (208) 356-4616
Fax: (208) 356-8901

Office Environment Company
623 South Americana Blvd.
Boise, ID 83702-5120
Phone: (208) 385-0507
Fax: (208) 385-9392

Illinois

A. Pomerantz
Suite 940
222 Merchandise Mart Plaza
Chicago, IL 60654-1223
Phone: (312) 929-3335
Fax: (312) 929-3311

Business Furniture
Suite 100
205 N Main St
Bloomington, IL 61701
Phone: (309) 829-4036
Fax: (309) 829-4180

Business Furniture
305 SW Walter St 4R
Peoria, IL 61602
Phone: (309) 264-5740
Fax: (309) 829-4180

Egyptian Business Furniture
129 West Main Street
Belleville, IL 62220-1501
Phone: (618) 234-2323
Fax: (618) 236-3295

Interiors for Business Inc.
409 N River Street
Batavia, IL 60510-2359
Phone: (630) 761-1070
Fax: (630) 761-1065

Lincoln Office
205 Eastgate Drive
Washington, IL 61571-9238
Phone: (309) 427-2500
Fax: (309) 427-2625

OEC Business Interiors, Inc.
900 N Church Road
Elmhurst, IL 60126-1014
Phone: (630) 589-5503
Fax: (630) 589-5637

Office Concepts
1142 N North Branch Street
Chicago, IL 60642
Phone: (312) 942-1100
Fax: (312) 942-9840

Office Concepts
13820 West Business Center Drive
Lake Forest, IL 60045-1181
Phone: (847) 573-8890
Fax: (847) 573-8891

Indiana

Business Furnishings LLC
4102 Meghan Beeler Court
South Bend, IN 46628
Phone: (574) 243-3255
Fax: (574) 243-3266

Business Furniture LLC
6102 Victory Way
Indianapolis, IN 46278-2934
Phone: (317) 216-1600
Fax: (317) 216-1601

Corporate Design Inc.
Suite 400
1419 West Lloyd Expressway
Evansville, IN 47710-1002
Phone: (812) 422-3000
Fax: (812) 422-3413

Lincoln Office
1200 Arrowhead Court
Crown Point, IN 46307-8222
Phone: (219) 662-2777
Fax: (219) 662-7770

Iowa

Lincoln Office
1026 Mound St
Davenport, IA 52803
Phone: (563) 322-5660

Tallgrass Business Resources
Highway 6 West
218 Second Street
Coralville, IA 52241-2608
Phone: (319) 338-3135
Fax: (319) 338-7484

Workspace Inc.
309 Locust Street
Des Moines, IA 50309-1788
Phone: (515) 288-7090
Fax: (515) 288-0250

Kansas

Design Central Inc.
152 South 5th Street
Salina, KS 67401
Phone: (785) 825-4131
Fax: (785) 825-4778

Scott Rice Office Interiors
224 East Douglas
Wichita, KS 67211-1640
Phone: (316) 269-2700
Fax: (316) 269-3527

Scott Rice Office Works
14720 West 105th Street
Lenexa, KS 66215-4414
Phone: (913) 888-7600
Fax: (913) 227-7793

Kentucky

Office Resources Inc.
530 Corvette Drive
Bowling Green, KY 42101-7132
Phone: (270) 781-5858
Fax: (270) 781-5884

Office Resources Inc.
576 East Main Street
Frankfort, KY 40601-2343
Phone: (502) 875-3300
Fax: (502) 875-2782

Office Resources Inc.
101 Bradley Drive
Nicholasville, KY 40356-9121
Phone: (859) 885-6161
Fax: (859) 885-9610

Office Resources Inc.
816 East Broadway
Louisville, KY 40204-1053
Phone: (502) 589-8400
Fax: (502) 589-8408

Louisiana

Bath Business Services
610 Market Street
Shreveport, LA 71101-3643
Phone: (318) 221-7141
Fax: (318) 425-7117

Bath Business Services
309 North 4th Street
Monroe, LA 71201-6741
Phone: (318) 361-9986
Fax: (318) 361-9997

Frost-Barber Inc.
9322 Interline Avenue
Baton Rouge, LA 70809-1966
Phone: (225) 926-5000
Fax: (225) 926-5011

Workplace Solutions
401 St. Joseph Street.
New Orleans, LA 70130
Phone: (504) 522-9558
Fax: (504) 522-7070

Participating Steelcase Dealers, continued

Maine

Red Thread
174 Cash Street
South Portland, ME 04106
Phone: (207) 774-4900
Fax: (207) 774-8155

Red Thread
869-873 Main Street
Westbrook, ME 04092
Phone: (207) 774-4900
Fax: (207) 774-8155

Maryland

Arbee Associates
6311 Ammendale Road
Beltsville, MD 20705-1249
Phone: (410) 385-5180
Fax: (410) 385-5199

Arbee Associates
9300 Gaither Road
Gaithersburg, MD 20877
Phone: (301) 963-3900
Fax: (301) 977-1734

Dancker, Sellaw & Douglas Inc.
Suite 309
509 S Exeter Street
Baltimore, MD 21202
Phone: (301) 671-2541
Fax: (301) 797-1504

Dancker, Sellaw & Douglas Inc.
13621 Crayton Blvd.
Hagerstown, MD 21742-2335
Phone: (301) 797-3120
Fax: (301) 797-1407

Dancker, Sellaw & Douglas Inc.
Suite 203
575 South Charles Street
Baltimore, MD 21201-2428
Phone: (410) 547-8700
Fax: (410) 547-6677

Dancker, Sellaw & Douglas Inc.
9200 Alaking Court
Suite 100
Capitol Heights, MD 20743
Phone: (301) 350-8700
Fax: (301) 350-9393

Massachusetts

Red Thread
22 Boston Wharf Road
8th Floor
Boston, MA 02210-1838
Phone: (617) 439-4900
Fax: (617) 439-4131

Red Thread
Suite 150
293 Boston Post Road West
Marlborough, MA 01752-4615
Phone: (508) 449-6550
Fax: (508) 449-6570

Red Thread
Suite 1108
1350 Main Street
Springfield, MA 01103
Phone: (413) 736-1802

Red Thread
100 Fordham Road
Wilmington, MA 01887
Phone: (978) 658-3900
Fax: (978) 694-4107

Michigan

Custer Office Environments Inc.
2435 Plaza Drive
Benton Harbor, MI 49022-2229
Phone: (616) 926-8719
Fax: (616) 926-9482

Custer Office Environments Inc.
217 Grandville Ave SW
Grand Rapids, MI 49503-4013
Phone: (616) 458-6322
Fax: (616) 458-1117

Custer Office Environments Inc.
5737 East Cork Street
Kalamazoo, MI 49048-9668
Phone: (269) 342-3919
Fax: (269) 342-3923

Custer Office Environments
442 East Michigan
Marquette, MI 49885
Phone: (906) 226-1161
Fax: (906) 226-1164

Custer Office Environments
120 East Front Street
Traverse City, MI 49684
Phone: (616) 402-8489

NBS
701 Salzburg Avenue
Bay City, MI 48706-5390
Phone: (989) 895-8574
Fax: (989) 895-8545

NBS
5133 West Grand River Avenue
Lansing, MI 48906-9117
Phone: (517) 886-0072
Fax: (517) 886-0014

NBS
2595 Bellingham Drive
Troy, MI 48083-2036
Phone: (248) 823-5400
Fax: (248) 823-5401

Minnesota

Atmosphere Commercial Interiors
Suite 350
81 South 9th Street
Minneapolis, MN 55402-3226
Phone: (612) 343-0868
Fax: (612) 332-5733

Burgher Office Equipment Company
101 East Chestnut Street
Virginia, MN 55792-2512
Phone: (218) 749-2661
Fax: (218) 749-2662

Duluth Typewriter & Business Furniture
30 N 3rd. Ave W
Duluth, MN 55802-1607
Phone: (218) 722-5811
Fax: (218) 722-4876

General Office Products Company
4521 Highway 7
Minneapolis, MN 55416-4098
Phone: (952) 925-7500
Fax: (952) 925-7531

Mississippi

Barefield & Company
251 West South Street
Jackson, MS 39203-3636
Phone: (601) 354-4960
Fax: (601) 353-6231

OEC Business Interiors
12199 Highway 49 N.
Suite 300
Gulfport, MS 39503-3167
Phone: (228) 539-9575
Fax: (228) 539-9566

Missouri

Color-Art Integrated Interiors
1325 North Warson Road
Saint Louis, MO 63132-1807
Phone: (314) 432-3000
Fax: (314) 993-2752

Marathon Office Interiors
1715 Paris Road
Columbia, MO 65201-5571
Phone: (573) 875-7115
Fax: (573) 875-7116

Scott Rice
100 East Spring Street
Neosho, MO 64850
Phone: (417) 623-7232
Fax: (918) 362-4303

Montana

KR Office Interiors
119 North 7th Avenue
Bozeman, MT 59715
Phone: (406) 587-3775
Fax: (406) 587-4636

KR Office Interiors
1710 North Montana Avenue
Helena, MT 59601
Phone: (406) 513-1004
Fax: (406) 513-1006

Missoula's Office City
115 West Broadway Street
Missoula, MT 59802-4217
Phone: (406) 543-7171
Fax: (406) 543-4254

Peterson's Quality Office Equipment
502 North 32nd Street
Billings, MT 59101-6003
Phone: (406) 245-5151
Fax: (406) 245-7516

Western Office Equipment
317 2nd Street South
Great Falls, MT 59405-1802
Phone: (406) 761-7473
Fax: (406) 761-0245

Nebraska

Eakes Office Plus
2911 13th Street
Columbus, NE 68601-4829
Phone: (402) 564-2679
Fax: (402) 564-0295

Eakes Office Plus
Suite 201
2630 North Yager Road
Fremont, NE 68025-7800
Phone: (402) 941-5001
Fax: (402) 941-5002

Eakes Office Plus
617 West Third Street
Grand Island, NE 68801-5946
Phone: (308) 382-8026
Fax: (308) 382-7401

Eakes Office Plus
839 West Second Street
Hastings, NE 68901-5099
Phone: (402) 463-2537
Fax: (402) 463-6802

Eakes Office Plus
2401 Avenue A
Kearney, NE 68847-5498
Phone: (308) 234-2538
Fax: (308) 234-2540

Eakes Office Plus
110 N 35th Street
Lincoln, NE 68503
Phone: (402) 438-6700
Fax: (402) 438-6701

Eakes Office Plus
201 South 1st Street
Norfolk, NE 68701-5303
Phone: (402) 371-4181
Fax: (402) 371-5139

Eakes Office Plus
520 North Vine Street
North Platte, NE 69101-3954
Phone: (308) 534-7800
Fax: (308) 534-3936

Sheppard's Business Interiors Inc.
6221 South 58th Street
Lincoln, NE 68516-3679
Phone: (402) 441-0070
Fax: (402) 476-9710

Sheppard's Business Interiors Inc.
725 South 72nd Street
Omaha, NE 68114-4665
Phone: (402) 393-8888
Fax: (402) 393-0113

Nevada

Machabee Office Environments
6435 Sunset Corporate Drive
Las Vegas, NV 89120-2798
Phone: (702) 263-8800
Fax: (702) 263-8801

Machabee Office Environments
1335 Greg Parkway #101
Sparks, NV 89431
Phone: (775) 329-3145
Fax: (775) 786-5710

New Hampshire

Red Thread
Suite 103
650 Elm Street
Manchester, NH 03101-1160
Phone: (603) 668-5511
Fax: (603) 668-6851

New Jersey

Arbee Associates
1531 South Washington Avenue
Piscataway, NJ 08854-3815
Phone: (732) 424-3900
Fax: (732) 752-6034

Concepts Office Furnishings
280 North Midland Avenue
Building J
Saddle Brook, NJ 07663-5708
Phone: (201) 727-9110
Fax: (201) 727-9112

Dancker, Sellw, and Douglas
291 Evans Way
Somerville, NJ 08876-3766
Phone: (908) 231-1600
Fax: (908) 231-6469

W.S. Goff Company Inc.
5104 Oakland Blvd.
Mays Landing, NJ 08330-2016
Phone: (609) 625-5600
Fax: (609) 625-5633

New Mexico

Business Environments
5351 Wilshire Avenue, N.E.
Albuquerque, NM 87113-1834
Phone: (505) 888-4400
Fax: (505) 889-9146

New York

AFD Contract Furniture Inc
810 7th Avenue
New York, NY 10019
Phone: (212) 721-7100
Fax: (212) 721-7175

Business Environments by Ras Inc.
1 Interstate Avenue
Albany, NY 12205
Phone: (518) 273-9359
Fax: (518) 272-1552

Empire Office Inc.
105 Madison Avenue
New York, NY 10016-8810
Phone: (212) 607-5500
Fax: (212) 607-5654

Merkel-Donohue
1 Woodbury Boulevard
Rochester, NY 14604-1895
Phone: (585) 325-7696
Fax: (585) 325-3065

Prentice Office Environments
472 Franklin Street
Buffalo, NY 14202-1302
Phone: (716) 884-8452
Fax: (716) 884-0894

Stevens Office Interiors
6804 Manlius Center Road
East Syracuse, NY 13057-3902
Phone: (315) 479-5595
Fax: (315) 428-1688

Waldner's Business Environments
125 Route 110
Farmingdale, NY 11735-4864
Phone: (631) 844-9300
Fax: (631) 694-3503

Waldner's Business Environments
215 Lexington Avenue, 9th Floor
New York, NY 10016-6023
Phone: (212) 696-7500
Fax: (212) 696-7699

Waldner's Business Environments
411 Theodore Fremd Avenue
3rd Floor, South Building
Rye, NY 10580-1410
Phone: (914) 921-8500
Fax: (914) 921-0991

North Carolina

Benton Office Interiors Inc.
301 Nash Street West
Wilson, NC 27893-3834
Phone: (252) 237-6176
Fax: (252) 237-9316

Office Environments Inc.
11407 Granite Street
Charlotte, NC 28273-6429
Phone: (704) 714-7200
Fax: (704) 714-7400

Young Office Environments
of Asheville Inc.
71 Thompson St
Asheville, NC 28803-2328
Phone: (888) 202-0508
Fax: (828) 505-1974

Storr Office Environments Inc.
496 Gallimore Dairy Road
Greensboro, NC 27409-9202
Phone: (336) 217-4500
Fax: (336) 217-4501

Storr Office Environments Inc.
10800 World Trade Blvd.
Raleigh, NC 27617-4200
Phone: (919) 313-3700
Fax: (919) 313-3701

Williams Office Environments Inc.
407 Ray Avenue
Fayetteville, NC 28301-4915
Phone: (910) 483-0354
Fax: (910) 486-4077

North Dakota

Fireside Office Products Inc.
1713 East Bismarck Expressway
Bismarck, ND 58504-6706
Phone: (701) 258-8586
Fax: (701) 223-9598

Gaffaney's of Grand Forks
1809 13th Avenue North
Grand Forks, ND 58203-2323
Phone: (701) 746-6466
Fax: (701) 746-0737

Hannaher's Inc.
4324 20th Avenue SW
Fargo, ND 58103-4434
Phone: (701) 277-7222
Fax: (701) 277-7097

Ohio

Business Furniture
8 North Main Street
Dayton, OH 45439
Phone: (937) 293-1010
Fax: (937) 293-7501

Loth Inc.
3574 East Kemper Road
Cincinnati, OH 45241-2009
Phone: (513) 554-4900
Fax: (513) 554-8737

Loth Company
855 Grandview Avenue
Columbus, OH 43215-1123
Phone: (614) 487-4000
Fax: (614) 487-4306

NBS
4 North St. Clair Street
Toledo, OH 43604
Phone: (419) 662-2040
Fax: (419) 662-2041

Ohio Desk
34 Swartz Road
Akron, OH 44319
Phone: (330) 499-1030

Ohio Desk Company
1122 Prospect Avenue
Cleveland, OH 44115-1292
Phone: (216) 623-0600
Fax: (216) 623-0611

Ohio Desk
5100 Market Street
Youngstown, OH 44512
Phone: (330) 782-3331

Oklahoma

Scott Rice
2900 North Hemlock Circle
Broken Arrow, OK 74012-1185
Phone: (918) 362-4300
Fax: (918) 362-4303

Scott Rice
7501 Broadway Ext
Oklahoma City, OK 73116-9015
Phone: (405) 848-2224
Fax: (405) 848-3999

Oregon

Smith CFI
Suite 103/104
150 SW Scalehouse Loop
Bend, OR 97702
Phone: (541) 317-8777
Fax: (541) 317-2833

Smith CFI
620 NE 19th Avenue
Portland, OR 97232-2832
Phone: (503) 226-4151
Fax: (503) 226-9233

Participating Steelcase Dealers, continued

Pennsylvania

A. Pomerantz & Company
Suite 7000
701 Market Street
Philadelphia, PA 19106-1597
Phone: (215) 408-2100
Fax: (215) 408-2110

Corporate Interiors
Suite 200
161 Washington Street
Conshohocken, PA 19428-2083
Phone: (610) 631-5400
Fax: (610) 631-2720

Creative Business Interiors Ltd.
145 Stewart Road
Wilkes-Barre, PA 18706
Phone: (570) 288-7211
Fax: (570) 970-5817

Franklin Interiors
Suite 600
2740 Smallman Street
Pittsburgh, PA 15222-4720
Phone: (412) 261-2525
Fax: (412) 255-4089

Interior Workplace Solutions LLC.
6765 Ambassador Drive
Allentown, PA 18106-9510
Phone: (610) 391-0733
Fax: (610) 391-1155

Interior Workplace Solutions LLC.
Suite B-25
2209 Quarry Drive
Reading, PA 19609-1155
Phone: (610) 670-1800
Fax: (610) 670-8181

McCartney's Inc.
819 Howard Avenue
Altoona, PA 16601-4727
Phone: (814) 505-1111
Fax: (814) 949-6197

Phillips Group
501 Fulling Mill Road
Middletown, PA 17057-5926
Phone: (717) 944-0400
Fax: (717) 948-5289

Phillips Office Products
1630 Manheim Pike
Lancaster, PA 17601-6800
Phone: (717) 560-9999
Fax: (717) 560-9996

South Carolina

Aiken Office Supply Inc.
2560 Whiskey Road
Aiken, SC 29803-9664
Phone: (803) 648-8339
Fax: (803) 649-4470

McWaters Inc.
1104 Shop Road
Columbia, SC 29201-4743
Phone: (803) 256-8303
Fax: (803) 252-5567

McWaters Inc.
3841 Commercial Center Drive
Ladson, SC 29456-4146
Phone: (843) 486-1823

Wulbern-Koval Company Inc.
1111 Morrison Drive
Charleston, SC 29403-3119
Phone: (843) 577-7666
Fax: (843) 577-7299

Young Office Environments
1280 Ridge Road
Greenville, SC 29607-4626
Phone: (864) 281-9500
Fax: (864) 281-9555

South Dakota

Interstate Office Products Inc.
228 South Main Avenue
Sioux Falls, SD 57104-6310
Phone: (605) 339-0300
Fax: (605) 339-1989

Western Stationers
714 Saint Joseph Street
Rapid City, SD 57701-2721
Phone: (605) 342-3310
Fax: (605) 342-4746

Tennessee

Bentco Office Solutions
1501 Stuart Street
Chattanooga, TN 37406
Phone: (423) 756-4437
Fax: (423) 756-6198

Interior Design Services Inc.
209 Powell Place
Brentwood, TN 37027-7522
Phone: (615) 376-1200
Fax: (615) 376-1245

Memphis Business Interiors
4539 West Distriplex Drive
Memphis, TN 38118-7280
Phone: (901) 360-8899
Fax: (901) 360-8370

Workspace Interiors
Suite 300
200 E. Main Street
Kingsport, TN 37660-4354
Phone: (423) 392-2600

Workspace Interiors
Suite 300
200 E. Main Street
Kingsport, TN 37660-4354
Phone: (423) 392-2600
Fax: (423) 392-2601

Workspace Interiors
2820 Middlebrook Pike
Knoxville, TN 39721
Phone: (865) 223-5404
Fax: (865) 223-5405

Texas

Abilene Printing & Stationery
218 Cedar Street
Abilene, TX 79601-5720
Phone: (915) 677-2673
Fax: (915) 675-6963

BKM Total Office of Texas
9755 Clifford Drive
Dallas, TX 75220
Phone: (214) 902-7200
Fax: (214) 902-7201

Business Interiors
1111 Valley View Lane
Irving, TX 75061-6008
Phone: (817) 858-2000
Fax: (817) 858-2020

McCoys Inc.
6869 Old Katy Road
Houston, TX 77024-2105
Phone: (713) 862-4600
Fax: (713) 862-7676

Rockford Business Interiors
211 East Riverside Drive
Austin, TX 78704-1203
Phone: (512) 442-0703
Fax: (512) 442-6555

Texas Wilson Office Furniture & Services
5801 George McVay Drive
McAllen, Texas 78503
Phone: (210) 647-8800
Fax: (210) 647-3110

Texas Wilson Office Furniture & Services
6812 Fairgrounds Pkwy
San Antonio, TX 78238-4536
Phone: (210) 647-8800
Fax: (210) 647-3110

West Supply Company
1601 Scurry
Big Spring, TX 79720
Phone: (432) 264-1788
Fax: (432) 264-1789

West Supply Company
2 South Chadbourne Street
San Angelo, TX 76903-5875
Phone: (325) 655-8181
Fax: (325) 655-5480

Utah

MidWest Office Furniture
987 South West Temple
Salt Lake City, UT 84101-2988
Phone: (801) 359-7681
Fax: (801) 355-2713

Vermont

Red Thread
150 Pioneer Drive
Williston, VT 05495-7543
Phone: (802) 862-0434
Fax: (802) 862-0729

Virginia

Barrows
1302 Rockland Avenue
Roanoke, VA 24012-3838
Phone: (540) 362-5700
Fax: (540) 362-4826

Creative Office Environments
11798 North Lakeridge Boulevard
Ashland, VA 23005-8152
Phone: (804) 329-0400
Fax: (804) 321-3134

Creative Office Environments LLC
650 Peter Jefferson Parkway #140
Charlottesville, VA 22911
Phone: (434) 327-1898
Fax: (434) 327-1896

Creative Office Environments LLC
Suite C
500 Woodlake Circle
Chesapeake, VA 23320-2807
Phone: (757) 549-4801
Fax: (757) 549-2795

reDistrict
Suite 675
2107 Wilson Boulevard
Arlington, VA 22201
Phone: (703) 276-8901
Fax: (703) 276-8908

Washington

OpenSquare
6th Floor
5601 Sixth Avenue South
Seattle, WA 98108-2522
Phone: (206) 768-8000
Fax: (206) 768-0236

OpenSquare
126 South Sheridan Street
Spokane, WA 99202-1527
Phone: (509) 483-1000
Fax: (509) 483-1011

Wisconsin

Forrer Business Interiors Inc.
555 West Estabrook Blvd.
Milwaukee, WI 53212-1066
Phone: (414) 906-3200
Fax: (414) 906-3299

Puerto Rico

AFD Contract Furnishings
Suite 250
350 Chardon Avenue
Torre Chardon
San Juan, Puerto Rico 00918-2123
Phone: (787) 754-2938
Fax: (787) 754-8076

Steelcase Showrooms and Manufacturing Locations

Showrooms

Atlanta

Steelcase Inc.
Suite AL-175
303 Peachtree Center
Atlanta, GA 30303
Phone: (404) 523-2201

Chicago

Steelcase Worklife Chicago
Suite 300
222 Merchandise Mart
Chicago, IL 60654-1174
Phone: (312) 321-3720

Chicago

Coalesse
Suite 1032
222 Merchandise Mart
Chicago, IL 60654
Phone: (312) 467-1783

Dallas

Steelcase Inc.
1616 Hi Line Drive
Dallas, TX 75207
Phone: (214) 871-3044

Grand Rapids

Steelcase Inc.
901 44th Street, SE
Grand Rapids, MI 49508-7594
Phone: (616) 247-2710

New York

Steelcase Worklife New York
4 Columbus Circle
New York, NY 10019-1100
Phone: (212) 445-8800

Philadelphia

Steelcase Inc.
One Liberty Place
1650 Market Street, 3rd Floor
Philadelphia, PA 19103-7307
Phone: (215) 561-5331

San Francisco

Steelcase Inc.
Suite 110
475 Brannan Street
San Francisco, CA 94107
Phone: (415) 344-6700

Santa Monica

Steelcase Inc.
1217 2nd Street
Santa Monica, CA 90401-1180
Phone: (310) 633-2200

Washington D.C.

Steelcase Inc.
1121 14th Street NW
4th Floor
Washington, DC 20005

Manufacturing Sites

Amex de Mexico

Calle 5 Sur No.160
Ciudad Industrial
Tijuana, Mexico B.C. 22500
Phone: 52-662-342-6234

Athens

214 Durham Drive
Athens, AL 35611
Phone: (256) 232-8112

Grand Rapids Wood Furniture

4100 68th Street SE
Caledonia, MI 49316
Phone: (616) 698-5735

Kentwood Distribution Center

4384 52nd Street SE
Kentwood, MI 49512-9673

Kentwood West

4360 52nd Street SE
Kentwood, MI 49512

Details

901 44th Street SE
Grand Rapids, MI 49508
Phone: (616) 247-2710

Reynosa Plant

Ave. Prologis S/N Ed. 8 Suite
801 Prologis Park Pharr Bridge
Reynosa,
Tamaulipas, Mx CP. 88780
Phone: 52-899-263-9000

Organizational Worktools

► For more detailed product information, see the *Steelcase Worktools Specification Guide* or consult your Steelcase dealer.

Statement of Line	20
--------------------------	-----------

Specifying	
Slatwall (SIN 711.2)	26
SlatRail (SIN 711.2)	30
Slatwall, SlatRail, and Freestanding Worktools (SIN 711.2)	33
SOTO Worktools (SIN 711.2)	45
Screens (SIN 711.2)	55

Statement of Line

Slatwall

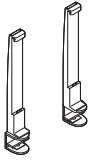

Specifying
▶ Page 26

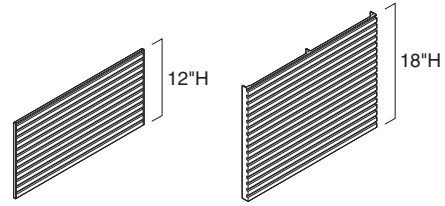

Specifying
▶ Page 27

Freestanding Slatwall Stanchions

Slatwall Tiles

	24"W	30"W	36"W	42"W	45"W	48"W	60"W
12"H	●	●	●	●	●	●	●
18"H	●	●	●	●	●	●	●

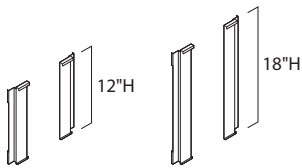

Specifying
▶ Page 28

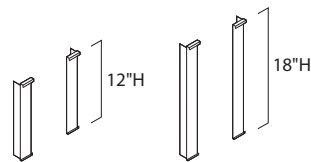

Specifying
▶ Page 28

Slatwall Panel-Mount Brackets

12"H 18"H



Slatwall Wall-Mount Brackets

12"H 18"H

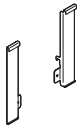

Specifying
▶ Page 28

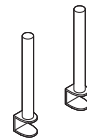

Specifying
▶ Page 30

Slatwall Post and Beam Brackets

12"H



Freestanding SlatRail Stanchions

SlatRail

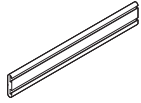

Specifying
▶ Page 31



Specifying
▶ Page 32

SlatRail

24"W	30"W	36"W	42"W	45"W	48"W	60"W
●	●	●	●	●	●	●











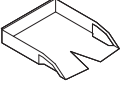
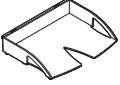
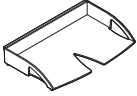

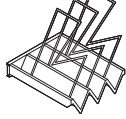
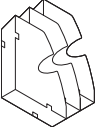
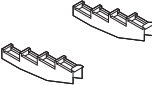



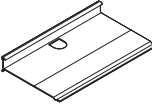
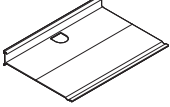

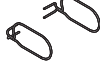

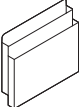
SlatRail Panel-Mount Brackets

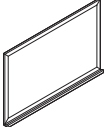

Specifying
▶ Page 32

SlatRail Wall-Mount Brackets

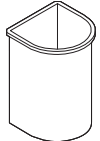
Slatwall, SlatRail, and Freestanding Worktools

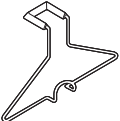
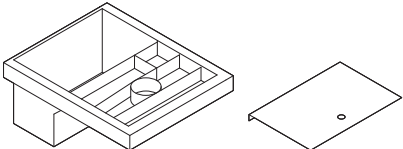
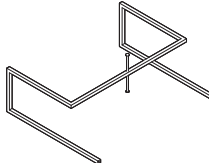
 10" Portrait Letter Tray Specifying ▶ Page 33	 12" Landscape Letter Tray Specifying ▶ Page 33	 15" Landscape Legal Tray Specifying ▶ Page 33	 Binder Holder Specifying ▶ Page 34	 PaperFlo Manager Specifying ▶ Page 34
 Universal Shelves Specifying ▶ Page 35	 Hanging Brackets Specifying ▶ Page 35	 Pen/Pencil Cup Specifying ▶ Page 36	 Double Square Dish Specifying ▶ Page 36	 Office in a File Specifying ▶ Page 37
 Mini Shelf Specifying ▶ Page 37	 Portrait Slatshelves Specifying ▶ Page 38	 Landscape Slatshelves Specifying ▶ Page 38	 Slatshelf Labels Specifying ▶ Page 38	 Slatshelf Dividers Specifying ▶ Page 39
 Personal Shelf Specifying ▶ Page 39	 Chart/File Holder Specifying ▶ Page 39	 Glove Box Specifying ▶ Page 40	 Telephone Caddy Specifying ▶ Page 40	 Tackstrip Specifying ▶ Page 40
 Utility Hook Specifying ▶ Page 41	 Work Tags Specifying ▶ Page 41	 Markerboard Specifying ▶ Page 41	 Cable Rings Specifying ▶ Page 42	 Wastebasket Specifying ▶ Page 42
 Coat Hook Specifying ▶ Page 42	 Flat Top Hanger Specifying ▶ Page 43	 Pelican Pencil Drawers and Security Lid Specifying ▶ Page 43	 Pelican Installation Bar Specifying ▶ Page 44	

SOTO Worktools

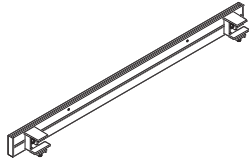

Specifying
▶ Page 45

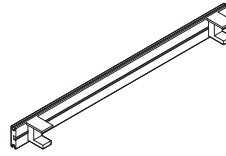

Specifying
▶ Page 46

SOTO Rails

28"W	34"W	40"W	46"W	52"W	58"W	64"W
●	●	●	●	●	●	●

SOTO Rails For Use with Tour

52"W	58"W	64"W
●	●	●

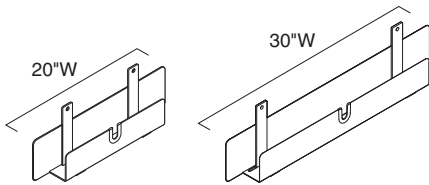

Specifying
▶ Page 46

SOTO Cableways

20"W	30"W
●	●

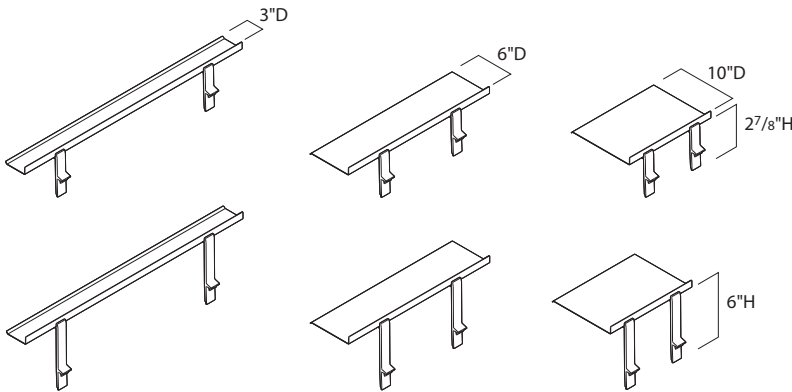

Specifying
▶ Page 47

SOTO Shelves

	14"W	24"W	36"W
3"D	●		●
6"D	●	●	
10"D	●	●	

SOTO Worktools, continued

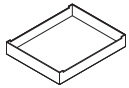

SOTO Pile Box
Specifying
▶ Page 48

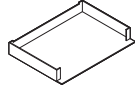

SOTO Landscape Letter Box
Specifying
▶ Page 48



SOTO Tool Box
Specifying
▶ Page 48

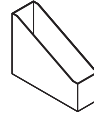

SOTO Diagonal File Box
Specifying
▶ Page 49



SOTO Utility Box
Specifying
▶ Page 49

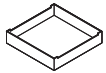

SOTO Personal Box
Specifying
▶ Page 49

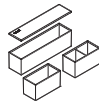

SOTO Storage Boxes Set of Three
Specifying
▶ Page 50

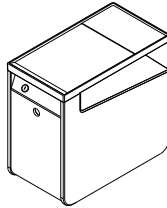

SOTO Personal Console
Specifying
▶ Page 50

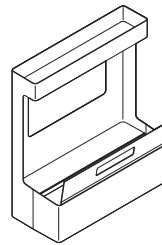

SOTO Mobile Caddy
Specifying
▶ Page 51

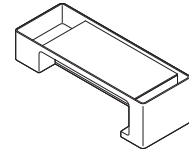

SOTO Launch Pad
Specifying
▶ Page 51

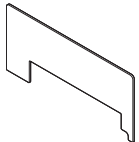

SOTO Launch Pad Divider Screen
Specifying
▶ Page 52

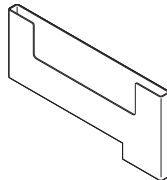

SOTO Functional Screen
Specifying
▶ Page 52



SOTO Personal Pocket
Specifying
▶ Page 52



SOTO Cable Clip
Specifying
▶ Page 53



SOTO Personal Hook
Specifying
▶ Page 53

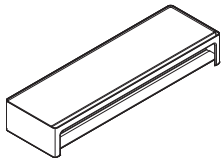

SOTO Monitor Bridge
Specifying
▶ Page 53

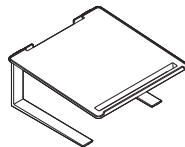

SOTO Laptop Shelf
Specifying
▶ Page 54

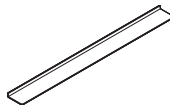

SOTO Ergo Edge
Specifying
▶ Page 54

Steelcase Screens

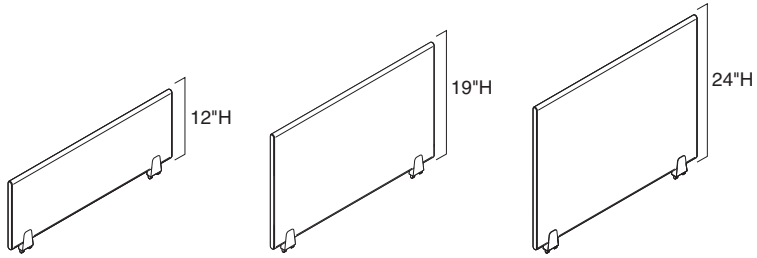

Specifying
▶ Page 55

Fixed Personal/Modesty Screens

	30"W	36"W	42"W	48"W
12"H	●	●	●	●
19"H	●	●	●	●
24"H	●	●	●	●

Slatwall

SIN 711.2

Freestanding Slatwall Stanchions

For Use on Worksurfaces 3/4" to 2" thick

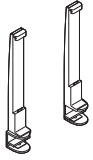

Tip: Positions top of Slatwall a fixed height of 15 1/2" above mounting surface.

Tip: Slatwall can overhang stanchions up to 12".

Tip: Worksurface/table must be able to support 60 lb.

Tip: Stanchion cannot be used in a corner application or on a glass surface.

Tip: Requires 18"D work-surface and uses 2" surface footprint.

Tip: Freestanding Slatwall stanchion is for use with 12"H tiles only.

Standard Includes	Required to Specify
<ul style="list-style-type: none"> • Pair of Slatwall; paint • Non-marring rubber feet 	<ul style="list-style-type: none"> 1 Style number 2 Paint color number for slatwall brackets: <ul style="list-style-type: none"> 0835 Black 4750 Champagne 4799 Platinum

Related Products
<ul style="list-style-type: none"> • Slatwall tiles

▶ Page 27

Specification Information

• Dimensions			• Weight	• Style	• Price
D	W	H		Number	
3"	3 1/2"	16"	3.5 lb	WFCS	\$145

Slatwall Tiles

Tip: Total dimensions of Worktools specified should not exceed Slatwall dimensions.

Tip: Slatwall is not dedicated to the exact panel width; a 12" overhang is acceptable.

Tip: Two Slatwall tiles cannot be used in a corner application.

Tip: Tiles require a minimum worksurface depth of 18" for stability.

Tip: A clearance of 2" is required under worksurface to accommodate C-clamp.

Tip: Tiles cannot be used on glass, bullnose, knife edge, or other non-standard work-surface edges.

Tip: Supports up to 140 lb.

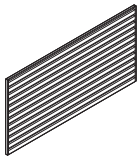

Tip: Slatwall is 1/8" shorter than stated without end caps installed.

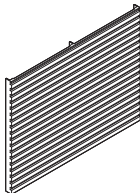

Standard Includes

- Slatwall tile: paint

Required to Specify

- 1 Style number
- 2 Paint color number for slatwall tile:
 - 0835 Black
 - 4799 Platinum
 - 4750 Champagne

Related Products

- Slatwall brackets
- Freestanding Slatwall stanchions
- Slatwall and SlatRail worktools

- ▶ Page 28
- ▶ Page 26
- ▶ Page 33

Specification Information

• Dimensions			• Weight	• Style	• Price
D	W	H		Number	

12"H Tiles

1/2"	24"	12"	4.5 lb	WS24	\$116
1/2"	30"	12"	5.7 lb	WS30	\$130
1/2"	36"	12"	6.8 lb	WS36	\$145
1/2"	42"	12"	8 lb	WS42	\$169
1/2"	45"	12"	8.5 lb	WS45	\$180
1/2"	48"	12"	9.1 lb	WS48	\$193
1/2"	60"	12"	11.4 lb	WS60	\$241
:	:	:	:	:	:

18"H Tiles

1 1/8"	24"	18"	4.04 lb	WS2418H	\$244
1 1/8"	30"	18"	11.5 lb	WS3018H	\$278
1 1/8"	36"	18"	13.16 lb	WS3618H	\$312
1 1/8"	42"	18"	15.62 lb	WS4218H	\$344
1 1/8"	45"	18"	16.5 lb	WS4518H	\$378
1 1/8"	48"	18"	17.28 lb	WS4818H	\$414
1 1/8"	60"	18"	19 lb	WS6018H	\$447
:	:	:	:	:	:

Slatwall, continued

SIN 711.2

Slatwall Brackets

Tip: Wall-mount brackets must be mounted to a wall stud.

Tip: Brackets for use with 42"H panels cannot be used with transaction top worksurfaces.

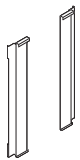
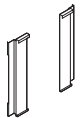

Standard Includes	Required to Specify
-------------------	---------------------

- Pair of slatwall brackets: paint

- 1 Style number
- 2 Paint color number for slatwall brackets:
 - 0835 Black
 - 4750 Champagne
 - 4799 Platinum

Related Products

- Slatwall tiles ▶ Page 27

Specification Information			
• Dimensions	• Weight	• Style	• Price
W H	:	Number	:

12"H Panel-Mount Brackets

For Use with Answer, Kick, and Privacy Wall

2"	12 1/3"	2 lb	WSWANS	\$ 37
----	---------	------	---------------	-------

For Use with Avenir and Series 9000

2"	12 1/3"	2 lb	WSWUSA	\$ 37
----	---------	------	---------------	-------

For Use with Answer and Kick 42"H Panels

2"	12 1/3"	2 lb	WSW42AN	\$ 72
----	---------	------	----------------	-------

For Use with Avenir 42"H Panels

2"	12 1/3"	2 lb	WSW42AV	\$ 72
----	---------	------	----------------	-------

For Use with Series 9000 42"H Panels

2"	12 1/3"	2 lb	WSW42S9	\$ 72
----	---------	------	----------------	-------

18"H Panel-Mount Brackets

Standard

2"	18"	3.5 lb	WSWUSA18	\$104
----	-----	--------	-----------------	-------

For Use with Answer, Kick, and Privacy Wall

2"	18"	3.5 lb	WSWANS18	\$104
----	-----	--------	-----------------	-------

▶ **Specification Information, continued on next page**

► Specification Information, continued from previous page

Specification Information

• Dimensions		• Weight	• Style Number	• Price
W	H			

Wall-Mount Brackets

12"H Standard

2"	12 ¹ / ₃ "	2 lb	WSWM	\$ 37
----	----------------------------------	------	-------------	-------

18"H Standard

2"	18"	3.5 lb	WSWM18	\$104
----	-----	--------	---------------	-------

12"H Brackets For Use with Post and Beam

2"	12 ¹ / ₃ "	2.5 lb	WSWPBOF12	\$104
----	----------------------------------	--------	------------------	-------

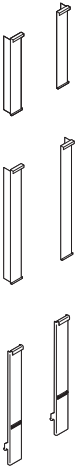

SlatRail

SIN 711.2

Freestanding SlatRail Stanchions

For Use on Worksurfaces and Materials 1/2" to 1 3/4" thick

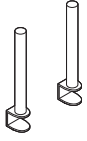

Tip: Positions top of SlatRail a fixed height of 12 3/4" above mounting surface.

Tip: Worksurface/table must be able to support 100 lb.

Tip: Stanchion cannot be used in a corner application or on a glass surface.

Tip: Requires 18"D worksurface and uses 2 1/2" surface footprint.

Tip: A clearance of 2" is required under worksurface to accommodate C-clamp.

Tip: Actual width of usable SlatRail is 3 1/8" less than stated when installed using freestanding stanchions.

Standard Includes	Required to Specify
-------------------	---------------------

- Pair of SlatRail stanchions: paint

- 1 Style number
- 2 Paint color number for SlatRail stanchions:
 - 0835 Black
 - 4750 Champagne
 - 4799 Platinum

Related Products

- SlatRail

▶ Page 31

Specification Information						
• Dimensions			• Weight	• Style	• Price	
D	W	H		Number		

1 1/2"	1 1/2"	13 1/2"	4 lb	WSRFS	\$127	
•	•	•	•	•	•	

SlatRail

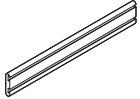

Tip: When mounting SlatRail with stanchions in combination with a cableway, see Worktools Compatibility Charts, page 212.

Tip: To determine appropriate SlatRail with stanchions width when mounting to height-adjustable work-surfaces, see Worktools Compatibility Charts, page 212.

Tip: SlatRail requires a minimum worksurface depth of 18" for stability.

Tip: Total dimensions of worktools specified should not exceed SlatRail dimensions.

Tip: Two SlatRails cannot be used in a corner application.

Tip: Not applicable on glass surfaces.

Tip: Actual width of usable SlatRail is 3/8" less than stated when installed using freestanding stanchions.

Tip: Supports up to 100 lb.

Standard Includes	Required to Specify
<ul style="list-style-type: none"> SlatRail: paint 	1 Style number 2 Paint color number for SlatRail: 0835 Black 4750 Champagne 4799 Platinum

Related Products	
<ul style="list-style-type: none"> Freestanding SlatRail stanchions SlatRail panel-mount brackets SlatRail wall-mount brackets Slatwall and SlatRail worktools 	<ul style="list-style-type: none"> ▶ Page 30 ▶ Page 32 ▶ Page 32 ▶ Page 33

Specification Information					
• Dimensions			• Weight	• Style Number	• Price
D	W	H			
3/4"	24"	4"	2 lb	WSR24	\$ 68
3/4"	30"	4"	3 lb	WSR30	\$ 81
3/4"	36"	4"	3 lb	WSR36	\$ 93
3/4"	42"	4"	3.5 lb	WSR42	\$106
3/4"	48"	4"	4 lb	WSR48	\$118
3/4"	60"	4"	4.5 lb	WSR60	\$144
.

SlatRail, continued

SIN 711.2

SlatRail Panel-Mount Brackets



Tip: Answer, Avenir, Kick, Privacy Wall, and Series 9000 furniture systems accommodate the SlatRail panel-mount brackets.

Standard Includes	Required to Specify
<ul style="list-style-type: none"> • Pair of SlatRail panel-mount brackets: paint 	<ul style="list-style-type: none"> 1 Style number 2 Paint color number for SlatRail panel-mount brackets: <ul style="list-style-type: none"> 0835 Black 4750 Champagne 4799 Platinum
Related Products	
<ul style="list-style-type: none"> • SlatRail 	▶ Page 31

Specification Information				
• Dimensions		• Weight	• Style Number	• Price
W	H			
2½"	4½"	1.5 lb	WSRU1	\$39
:	:	:	:	:

SlatRail Wall-Mount Brackets



Tip: Wall-mount brackets must be installed in a wall stud.

Standard Includes	Required to Specify
<ul style="list-style-type: none"> • Pair of SlatRail wall-mount brackets: paint 	<ul style="list-style-type: none"> 1 Style number 2 Paint color number for SlatRail panel-mount brackets: <ul style="list-style-type: none"> 0835 Black 4750 Champagne 4799 Platinum
Related Products	
<ul style="list-style-type: none"> • SlatRail 	▶ Page 31

Specification Information					
• Dimensions			• Weight	• Style Number	• Price
D	W	H			
2¾"	¾"	4¾"	1.5 lb	WSRW	\$39
:	:	:	:	:	:

Slatwall, SlatRail, and Freestanding Worktools

SIN 711.2

Trays

Tip: Trays do not interlock when installed on slatwall.

Standard Includes	Required to Specify
<ul style="list-style-type: none"> Tray: plastic 	<ul style="list-style-type: none"> 1 Style number 2 Plastic color number for letter tray: <ul style="list-style-type: none"> 6000 Black 6009 Arctic White 6544 Frost 6546 Rain

Related Products	
<ul style="list-style-type: none"> Slatwall tiles SlatRail 	<ul style="list-style-type: none"> ▶ Page 27 ▶ Page 31

Specification Information

• Dimensions			• Weight	• Style	• Price
D	W	H		Number	
Portrait Letter Tray					
12½"	10 ³ / ₁₆ "	2½"	1.5 lb	WLTS	\$37
Landscape Letter Tray					
10"	12½"	2½"	1.5 lb	WLT12L	\$37
Landscape Legal Tray					
10"	15½"	2½"	1.75 lb	WLG15L	\$37

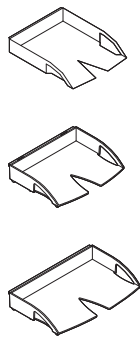

Organizational Worktools

Slatwall, SlatRail, and Freestanding Worktools, continued

SIN 711.2

Binder Holder

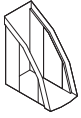

Tip: Binder holder requires 9 1/2" H clearance under bins or shelves.

Standard Includes **Required to Specify**

- Binder holder: plastic

- 1 Style number
- 2 Plastic color number for binder holder:
 - 6000 Black
 - 6009 Arctic White
 - 6544 Frost
 - 6546 Rain

Related Products

- Slatwall tiles
- SlatRail

- ▶ Page 27
- ▶ Page 31

Specification Information

• Dimensions			• Weight	• Style	• Price
D	W	H		Number	
9 1/8"	4 3/4"	11 3/8"	1.2 lb	WBHS	\$37

PaperFlo Manager

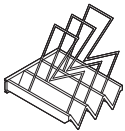

Tip: PaperFlo manager requires 11" clearance under bins.

Standard Includes **Required to Specify**

- PaperFlo manager: plastic

- 1 Style number
- 2 Plastic color number for PaperFlo manager:
 - 6000 Black
 - 6009 Arctic White
 - 6544 Frost
 - 6546 Rain

Specification Information

• Dimensions			• Weight	• Style	• Price
D	W	H		Number	
12"	9 3/4"	9 3/4"	2 lb	WPFS	\$90

Universal Shelves

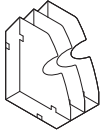

Tip: Universal shelves are not recommended for use on SlatRail.

Tip: Shelves do not interlock when installed on Slatwall.

Standard Includes	Required to Specify
<ul style="list-style-type: none"> Shelf: plastic 	1 Style number 2 Plastic color number for shelf: 6000 Black 6009 Arctic White 6544 Frost 6546 Rain

Specification Information

Dimensions			Weight	Style Number	Price
D	W	H			
Single Pack					
9½"	2¾"	12"	0.5 lb	WUS	\$22
Three Pack					
9½"	2¾"	12"	1.5 lb	WUS3	\$64

Hanging Brackets

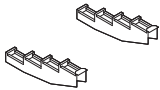

Tip: Hanging brackets require 6" clearance from top step of bracket to access files under bin and a 9" clearance from the bottom step to the top of worksurface to allow files to hang freely.

Tip: Hanging brackets are recommended using in pairs only. Brackets should not be shared when mounting multiple brackets side by side.

Standard Includes	Required to Specify
<ul style="list-style-type: none"> Hanging brackets: plastic 	1 Style number 2 Plastic color number for hanging brackets: 6000 Black 6009 Arctic White 6544 Frost 6546 Rain

Related Products

<ul style="list-style-type: none"> Slatwall tiles SlatRail 	<ul style="list-style-type: none"> ▶ Page 27 ▶ Page 31
--	--

Specification Information

Dimensions			Weight	Style Number	Price
D	W	H			
9¾"	1½"	1¼"	1 lb	WHB	\$37

Slatwall, SlatRail, and Freestanding Worktools, continued

SIN 711.2

Pen/Pencil Cup



Standard Includes **Required to Specify**

- Pen/pencil cup: plastic
- 1 Style number
 - 2 Plastic color number for pen/pencil cup:
 - 6000 Black
 - 6009 Arctic White
 - 6544 Frost
 - 6546 Rain

Related Products

- Slatwall tiles ▶ Page 27
- SlatRail ▶ Page 31

Specification Information

Dimensions			Weight	Style Number	Price
D	W	H			
4"	3 1/4"	3 5/8"	0.5 lb	WPCS	\$37

Double Square Dish



Standard Includes **Required to Specify**

- Double square dish: plastic
 - Attachment bracket
- 1 Style number
 - 2 Plastic color number for square dish:
 - 6000 Black
 - 6009 Arctic White
 - 6544 Frost
 - 6546 Rain

Related Products

- Slatwall tiles ▶ Page 27
- SlatRail ▶ Page 31

Specification Information

Dimensions			Weight	Style Number	Price
D	W	H			
4"	9 3/4"	1 1/2"	0.5 lb	WSQS	\$37

Office in a File

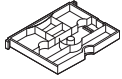

Standard Includes	Required to Specify
<ul style="list-style-type: none"> Storage file: plastic Built-in tape dispenser Translucent cover 	1 Style number 2 Plastic color number for storage file: 6000 Black 6009 Arctic White 6544 Frost 6546 Rain

Specification Information

Dimensions			Weight	Style Number	Price
D	W	H			
9 ⁵ / ₈ "	12 ¹ / ₄ "	1 ³ / ₈ "	1.5 lb	WOFS	\$37

Mini Shelf



Standard Includes	Required to Specify
<ul style="list-style-type: none"> Shelf: plastic 	1 Style number 2 Plastic color number for shelf: 6000 Black 6009 Arctic White 6544 Frost 6546 Rain

Related Products

<ul style="list-style-type: none"> Slatwall tiles SlatRail 	<ul style="list-style-type: none"> ▶ Page 27 ▶ Page 31
--	--

Specification Information

Dimensions			Weight	Style Number	Price
D	W	H			
10"	8"	1 ⁷ / ₈ "	0.5 lb	KMINI	\$26

Slatwall, SlatRail, and Freestanding Worktools, continued

SIN 711.2

Slatshelves

Tip: 12"W and 18"W shelves mount on Slatwall tiles or SlatRails.

Tip: Shelf should be mounted 18" above worksurface when installing Underline light.

Tip: 12"W shelf does not support Underline light.

Tip: 24"W shelves do not mount on 24"W Slatwall tile or 24"W SlatRail.

Tip: For Cisco phones specify 12"W shelf.

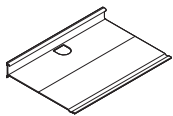
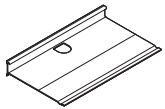

Standard Includes	Required to Specify
-------------------	---------------------

- Slatshelf: paint

- 1 Style number
- 2 Paint color number for slatshelf:
 - 0835 Black
 - 4750 Champagne
 - 7018 Pewter

Related Products

- Slatwall tiles
- SlatRail

- ▶ Page 27
- ▶ Page 31

Specification Information					
• Dimensions			• Weight	• Style	• Price
D	W	H		Number	

D	W	H	Weight	Style Number	Price
---	---	---	--------	--------------	-------

Landscape

10 ⁵ / ₈ "	12"	2 ³ / ₈ "	3.5 lb	WSS12L	\$126
10 ⁵ / ₈ "	18"	2 ³ / ₈ "	3.75 lb	WSS18L	\$130
10 ⁵ / ₈ "	24"	2 ³ / ₈ "	4.75 lb	WSS24L	\$145

Portrait

12 ⁵ / ₈ "	18"	2 ³ / ₈ "	4.5 lb	WSS18P	\$136
12 ⁵ / ₈ "	24"	2 ³ / ₈ "	5.5 lb	WSS24P	\$150

Slatshelf Labels



Standard Includes	Required to Specify
-------------------	---------------------

- Labels, package of three wet-erase: 6544 Frost

- Style number

Specification Information					
• Dimensions			• Weight	• Style	• Price
D	W	H		Number	

5/8"	2"	3/8"	0.1 lb	WSSL	\$7
------	----	------	--------	-------------	-----

Slatshelf Dividers



Standard Includes	Required to Specify
<ul style="list-style-type: none"> • Pair of dividers: polar gray 	Style number

Specification Information

• Dimensions		• Weight	• Style Number	• Price
D	H			
8 ³ / ₈ "	3"	0.4 lb	WSSD	\$18
·	·	·	·	·

Personal Shelf

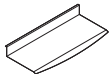

Standard Includes	Required to Specify
<ul style="list-style-type: none"> • Personal shelf: paint 	1 Style number 2 Paint color number for personal shelf: 0835 Black 4750 Champagne 7018 Pewter

Related Products

- Slatwall tiles ▶ Page 27
- SlatRail ▶ Page 31

Specification Information

• Dimensions		• Weight	• Style Number	• Price
D	W			
7 ¹ / ₈ "	13 ¹ / ₂ "	3 lb	WSPS	\$42
·	·	·	·	·

Chart/File Holder

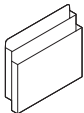

Standard Includes	Required to Specify
<ul style="list-style-type: none"> • Two-tier holder: 7018 Pewter 	Style number

Specification Information

• Dimensions			• Weight	• Style Number	• Price
D	W	H			
2 ¹ / ₂ "	12"	10 ¹ / ₂ "	4.5 lb	HCCHT	\$181
·	·	·	·	·	·

Slatwall, SlatRail, and Freestanding Worktools, continued

SIN 711.2

Glove Box



Tip: Glove box accommodates standard size tissue box.

Standard Includes	Required to Specify
<ul style="list-style-type: none"> Glove box: 7018 Pewter 	Style number

Specification Information

• Dimensions			• Weight	• Style Number	• Price
D	W	H			
3¼"	10"	3"	1 lb	HCGB	\$60

Telephone Caddy



Tip: Telephone caddy is not compatible with Cisco phones.

Tip: 4¾" clearance required to install on Slatwall or SlatRail.

Standard Includes	Required to Specify
<ul style="list-style-type: none"> Telephone caddy: paint 	1 Style number 2 Paint color number for telephone caddy: 0835 Black 4750 Champagne 7018 Pewter

Related Products

- Slatwall tiles ▶ Page 27
- SlatRail ▶ Page 31

Specification Information

• Dimensions			• Weight	• Style Number	• Price
D	W	H			
2"	8"	11"	6 lb	WTCS	\$91

Tackstrip



Standard Includes	Required to Specify
<ul style="list-style-type: none"> Tackstrip: 6000 Black 	Style number

Specification Information

• Dimensions			• Weight	• Style Number	• Price
D	W	H			
5/16"	15"	3½"	0.5 lb	WTBS	\$43

Utility Hook



Standard Includes	Required to Specify
<ul style="list-style-type: none"> Utility hook: paint 	1 Style number 2 Paint color number for utility hook: 0835 Black 4750 Champagne 7018 Pewter

Specification Information					
Dimensions			Weight	Style Number	Price
D	W	H			
1¾"	3½"	2"	0.25 lb	WHOOK	\$37

Work Tags



Tip: Tags are wet-erase and reusable.

Standard Includes	Required to Specify
<ul style="list-style-type: none"> Tags, package of 10: 6544 Frost 	Style number

Specification Information					
Dimensions			Weight	Style Number	Price
D	W	H			
1½"	2¾"	5/16"	1 lb	WWT	\$37

Markerboard

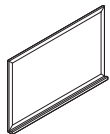

Tip: Not recommended for use on SlatRail.

Standard Includes	Required to Specify
<ul style="list-style-type: none"> Dry-erase markerboard Frame: aluminum Integrated holder for dry-erase markers 	Style number

Specification Information					
Dimensions			Weight	Style Number	Price
D	W	H			
1"	17¾"	11¾"	1.75 lb	WMB	\$103

Slatwall, SlatRail, and Freestanding Worktools, continued

SIN 711.2

Cable Rings



Standard Includes	Required to Specify
<ul style="list-style-type: none"> • Cable ring, package of 4: plastic 	1 Style number 2 Plastic color for cable ring: 6000 Black 6009 Arctic White 6544 Frost

Specification Information					
• Dimensions			• Weight	• Style	• Price
D	W	H		Number	
1"	1½"	1"	0.25 lb	KCR	\$30

Wastebasket

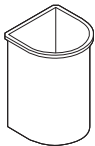

Standard Includes	Required to Specify
<ul style="list-style-type: none"> • Wastebasket: 6000 Black • Labels, if selected 	Style number

Specification Information					
• Dimensions			• Weight	• Style	• Price
D	W	H		Number	
10"	10"	15"	5 lb	DWBE	\$42

Wastebasket

10"	10"	15"	5 lb	DWBE	\$42
-----	-----	-----	------	-------------	------

Recycling Labels

				DRCY	No cost
--	--	--	--	-------------	---------

Coat Hook



Tip: Coat hook not recommended for use at end of panel run configurations.

Tip: Maximum weight for coat hook is 10 lb.

Standard Includes	Required to Specify
<ul style="list-style-type: none"> • Coat hook: paint 	1 Style number 2 Paint color number for coat hook: 0835 Black 7018 Pewter

Specification Information					
• Dimensions			• Weight	• Style	• Price
D	W	H		Number	
7/8"	2½"	2¼"	0.15 lb	WCH	\$17

Flat Top Hanger

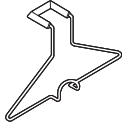

Tip: Maximum weight for hanger is 10 lb.

Standard Includes	Required to Specify
<ul style="list-style-type: none"> Hanger: paint Rubber sleeve 	1 Style number 2 Paint color number for hanger: 0835 Black 4750 Champagne

Specification Information					
• Dimensions			• Weight	• Style	• Price
D	W	H		Number	
3"	15½"	7¾"	1 lb	FTH	\$22
:	:	:	:	:	:

Pelican Pencil Drawers

Tip: Drawer requires a 24" unobstructed worksurface depth and 20"W clearance.

Tip: For locks to be keyed alike to other Steelcase locks, specify a non-locking drawer and order locking plugs separately (service part number 877209201SR). Field installation will be required.

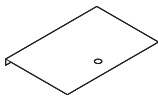
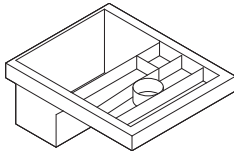

Standard Includes	Required to Specify
<ul style="list-style-type: none"> Pencil drawer: 6000 Black File bars Lock, if selected Security lid, if selected 	Style number

Specification Information					
• Dimensions			• Weight	• Style	• Price
D	W	H		Number	
23"	19"	2"	22 lb	WDPDL	\$347
:	:	:	:	:	:

Non-Locking Pencil Drawer

23"	19"	2"	22 lb	WDPDL	\$343
:	:	:	:	:	:

Locking Pencil Drawer

23"	19"	2"	22 lb	WDPDL	\$347
:	:	:	:	:	:

Security Lid

				WDPL	\$ 97
:	:	:	:	:	:

Slatwall, SlatRail, and Freestanding Worktools, continued

SIN 711.2

Pelican Installation Bar

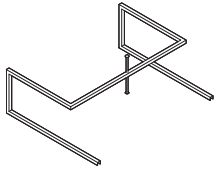

Standard Includes	Required to Specify
• Installation bar	Style number

Specification Information

• Dimensions			• Weight	• Style Number	• Price
D	W	H			
17"	21½"	7"	5 lb	WIB	\$165
:	:	:	:	:	:

SOTO Worktools

SIN 711.2

SOTO Rails

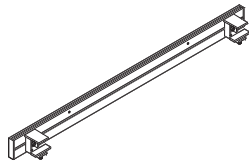

Tip: The colors for plastic end caps are defaulted by bracket color.

▶ See *Worktools Specification Guide* for default finish matrix.

Tip: Rails clamp to free-standing worksurfaces or material up to 2" thick. Rails are not applicable for glass surfaces.

Tip: Not applicable on glass surfaces.

Tip: Allow 1" clearance between worksurface and rail for cable management. Allow 2" for rail mount installed behind a worksurface, and 3¾" overall to install the rail.

Tip: Maximum weight load for rails is 2 lb per lineal inch.

Tip: Each clamp requires a 2" footprint above the worksurface, and a 3¼" clearance below the worksurface.

Tip: Rails require a minimum worksurface depth of 18" for stability.

Standard Includes	Required to Specify
<ul style="list-style-type: none"> • Rail: 4799 Platinum Metallic • Brackets and stanchions: 4799 Platinum Metallic 	1 Style number 2 Options, if selected (see below)

Options	Price	Required to Specify
Surface Materials • Rail	• Paint price group 3 +\$25	Specify paint color number. ▶ See <i>Surface Materials Reference Manual</i> for accent paint options.
Related Products	• SOTO worktools • SOTO shelves	▶ Page 45 ▶ Page 47

Specification Information

• Dimensions			• Weight	• Style Number	• Base Price
D	W	H			
1"	28"	3¼"	4.6 lb	DSR28	\$197
1"	34"	3¼"	5.2 lb	DSR34	\$208
1"	40"	3¼"	5.75 lb	DSR40	\$220
1"	46"	3¼"	6.3 lb	DSR46	\$233
1"	52"	3¼"	6.9 lb	DSR52	\$245
1"	58"	3¼"	7.5 lb	DSR58	\$257
1"	64"	3¼"	8 lb	DSR64	\$270

SOTO Worktools, continued

SIN 711.2

SOTO Rails for Use with Tour

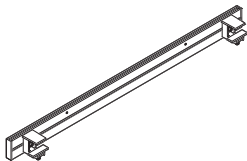

Tip: Allow 1" clearance between worksurface and rail for cable management. Allow 2" for rail mount installed behind a worksurface, and 3/4" overall to install the rail.

Tip: The colors for plastic end caps are defaulted by bracket color.
 ▶ See Worktools Specification Guide for default finishes.

Tip: Maximum weight load for rails is 2 lb per lineal inch.
 Tip: Each clamp requires a 2" footprint above the worksurface, and a 3/4" clearance below the worksurface.

Tip: Tour rails clamp to Tour bench troughs. Rails are not applicable for glass surfaces.

Standard Includes		Required to Specify	
<ul style="list-style-type: none"> • Rail: 4799 Platinum Metallic • Brackets and stanchions: 4799 Platinum Metallic 		1 Style number 2 Options, if selected (see below)	

Options	Price	Required to Specify
Surface Materials Rail <ul style="list-style-type: none"> • Paint price group 3 	+\$25	Specify paint color number. ▶ See <i>Surface Materials Reference Manual</i> for accent paint options.
Related Products <ul style="list-style-type: none"> • SOTO worktools • SOTO shelves 		▶ Page 45 ▶ Page 47

Specification Information						
Corresponding Table Top Width	Dimensions			Weight	Style Number	Base Price
	D	W	H			
60"	1"	52"	3/4"	6.9 lb	DSRT52	\$245
66"	1"	58"	3/4"	7.5 lb	DSRT58	\$257
72"	1"	64"	3/4"	8 lb	DSRT64	\$270

Tip: Rails require a minimum worksurface depth of 18" for stability.

SOTO Cableways

Tip: Cableway hangs fixed at 8" below the worksurface.

Tip: The colors for plastic components are defaulted by bracket color.
 ▶ See Worktools Specification Guide for default paint matrix.

Standard Includes		Required to Specify	
<ul style="list-style-type: none"> • Cableway: 4799 Platinum Metallic • Brackets: 4799 Platinum Metallic 		1 Style number 2 Options, if selected (see below)	

Options	Price	Required to Specify
Surface Materials Rail <ul style="list-style-type: none"> • Paint price group 3 	+\$20	Specify paint color number. ▶ See <i>Surface Materials Reference Manual</i> for accent paint options.
Related Products <ul style="list-style-type: none"> • SOTO worktools • SOTO shelves 		▶ Page 45 ▶ Page 47

Specification Information						
Dimensions	Dimensions			Weight	Style Number	Base Price
	D	W	H			
2 1/2"	20"	8"		2 lb	DSCW20	\$145
2 1/2"	30"	8"		2.5 lb	DSCW30	\$163

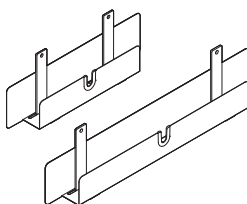

SOTO Shelves

Tip: All SOTO shelves allow for 2⁷/₈" or 6" between work-surface and bottom of shelf.

Tip: The colors for plastic spacers are defaulted by stanchion color.

► See *Worktools Specification Guide* for default finish matrix.

Standard Includes	Required to Specify
<ul style="list-style-type: none"> Shelf: paint Stanchions: <ul style="list-style-type: none"> – 4799 Platinum Metallic, if 4799 Platinum Metallic selected on shelf – Paint price group 1, if 4231 Arctic White selected on shelf 	<ol style="list-style-type: none"> Style number Paint color number for shelf: <ul style="list-style-type: none"> 4231 Arctic White 4799 Platinum Metallic Paint color number for stanchions, if 4231 Arctic White is selected on shelf: <ul style="list-style-type: none"> 4799 Platinum Metallic 7360 Merle Options, if selected (see below)

Options	Price	Required to Specify
Surface Materials Shelf <ul style="list-style-type: none"> Paint price group 3 	+\$20	Specify paint color number. ► See <i>Surface Materials Reference Manual</i> for accent paint options.

Specification Information

Dimensions	Weight	Style Number	Base Price
D	W	H	

36"W Standard Shelf			
3 ¹ / ₂ "	36"	6 ⁹ / ₁₀ "	3.9 lb
			DSSA363
			\$144

36"W High Shelf			
3 ¹ / ₂ "	36"	10"	4.2 lb
			DSSA363H
			\$149

24"W Standard Shelves			
6 ³ / ₄ "	24"	6 ⁹ / ₁₀ "	4.9 lb
			DSSA246
			\$149
10 ¹ / ₄ "	24"	6 ⁹ / ₁₀ "	6.4 lb
			DSSA2410
			\$159

24"W High Shelves			
6 ³ / ₄ "	24"	10"	5.3 lb
			DSSA246H
			\$154
10 ¹ / ₄ "	24"	10"	6.7 lb
			DSSA2410H
			\$164

14"W Standard Shelves			
3 ¹ / ₂ "	14"	6 ⁹ / ₁₀ "	2.2 lb
			DSSA143
			\$138
6 ³ / ₄ "	14"	6 ⁹ / ₁₀ "	3.6 lb
			DSSA146
			\$144
10 ¹ / ₄ "	14"	6 ⁹ / ₁₀ "	4.4 lb
			DSSA1410
			\$154

14"W High Shelves			
3 ¹ / ₂ "	14"	10"	2.5 lb
			DSSA143H
			\$144
6 ³ / ₄ "	14"	10"	3.9 lb
			DSSA146H
			\$149
10 ¹ / ₄ "	14"	10"	4.7 lb
			DSSA1410H
			\$159

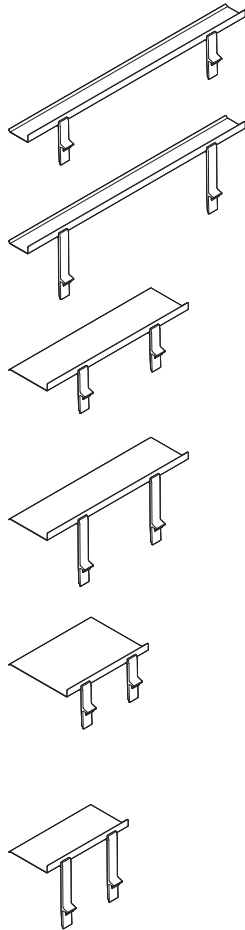

SOTO Worktools, continued

SIN 711.2

SOTO Pile Box

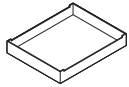

Standard Includes	Required to Specify
<ul style="list-style-type: none"> • Pile box: plastic 	1 Style number 2 Plastic color number for box: 6009 Arctic White 6302 Baltic 6338 Chili 6527 Merle 6BE2 Light Peacock 6BE3 Cotton Candy

Specification Information					
• Dimensions			• Weight	• Style Number	• Price
D	W	H			
9 ⁷ / ₈ "	12 ¹ / ₄ "	2"	0.7 lb	DSSPB	\$38
:	:	:	:	:	:

SOTO Landscape Letter Box

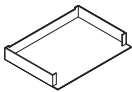

Standard Includes	Required to Specify
<ul style="list-style-type: none"> • Landscape letter box: plastic 	1 Style number 2 Plastic color number for box: 6009 Arctic White 6302 Baltic 6338 Chili 6527 Merle 6BE2 Light Peacock 6BE3 Cotton Candy

Specification Information					
• Dimensions			• Weight	• Style Number	• Price
D	W	H			
9 ⁷ / ₈ "	13 ³ / ₄ "	2"	0.8 lb	DSSLB	\$38
:	:	:	:	:	:

SOTO Tool Box



Tip: Tool box contains removable semi-opaque insert to separate pens from sticky notes.

Standard Includes	Required to Specify
<ul style="list-style-type: none"> • Tool box: plastic 	1 Style number 2 Plastic color number for box: 6009 Arctic White 6302 Baltic 6338 Chili 6527 Merle 6BE2 Light Peacock 6BE3 Cotton Candy

Specification Information					
• Dimensions			• Weight	• Style Number	• Price
D	W	H			
3 ¹ / ₂ "	3 ¹ / ₄ "	3 ¹ / ₂ "	0.3 lb	DSTB	\$33
:	:	:	:	:	:

SOTO Diagonal File Box

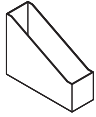

Standard Includes	Required to Specify
<ul style="list-style-type: none"> Diagonal file box: plastic 	1 Style number 2 Plastic color number for box: 6009 Arctic White 6302 Baltic 6338 Chili 6527 Merle 6BE2 Light Peacock 6BE3 Cotton Candy

Specification Information					
• Dimensions			• Weight	• Style Number	• Price
D	W	H			
12¼"	4"	9⅞"	0.5 lb	DSDFB	\$38
:	:	:	:	:	:

SOTO Utility Box



Standard Includes	Required to Specify
<ul style="list-style-type: none"> Utility box: plastic 	1 Style number 2 Plastic color number for box: 6009 Arctic White 6302 Baltic 6338 Chili 6527 Merle 6BE2 Light Peacock 6BE3 Cotton Candy

Specification Information					
• Dimensions			• Weight	• Style Number	• Price
D	W	H			
3⅞"	9"	1¼"	0.3 lb	DSUB	\$33
:	:	:	:	:	:

SOTO Personal Box

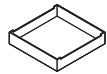

Standard Includes	Required to Specify
<ul style="list-style-type: none"> Personal box: plastic 	1 Style number 2 Plastic color number for box: 6009 Arctic White 6302 Baltic 6338 Chili 6527 Merle 6BE2 Light Peacock 6BE3 Cotton Candy

Specification Information					
• Dimensions			• Weight	• Style Number	• Price
D	W	H			
9"	9"	2"	0.3 lb	DSPB	\$33
:	:	:	:	:	:

SOTO Worktools, continued

SIN 711.2

SOTO Storage Boxes, Set of Three

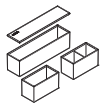

Tip: The storage box set fits inside the personal box.

Tip: The box dimensions are:

- Open rectangle box with or without divider 2¹/₈"D x 4¹/₄"W x 2³/₈"H
- Long rectangle box with lid 2¹/₈"D x 8⁵/₈"W x 2³/₈"H

Standard Includes	Required to Specify
<ul style="list-style-type: none"> • Set of three storage boxes: semi-opaque boxes with white cover 	Style number

Specification Information

Style Number	Weight	Price
DSSB	0.4 lb	\$38

SOTO Personal Console

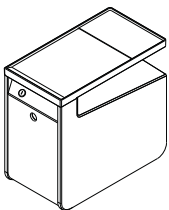

Tip: SOTO personal console charging options include USB ports (two ports, 2.1A each) and Qi wireless charging (5W).

Tip: Height-adjustable work-surface controllers and sliding top release mechanisms should be placed on the opposite side of the work-surface from the personal console.

Tip: SOTO personal console should be placed inboard of legs by a 1/2" and is not to be placed on an overhang.

Tip: SOTO personal console can only be mounted on square worksurface edge profiles between 1/2" and 1 1/2" thick.

Standard Includes	Required to Specify
<ul style="list-style-type: none"> • Personal console: 6009 Arctic White • Tambour door: 6527 Merle • Fabric colored pad: dark grey felt • 12V power supply with 72" black cord (charging versions) • Lock, keyed random: 6205 Black 	1 Style number 2 Options, if selected (see below)

Options	Price	Required to Specify
Surface Materials <ul style="list-style-type: none"> • Grey felt • Fabric finish set 1 • Fabric finish set 2 	No cost +\$ 37 +\$ 79	Specify grey felt. Specify fabric color number. Specify fabric color number. ▶ See <i>Surface Materials</i> , page 318.
Charging Options <ul style="list-style-type: none"> • None • USB charging • USB with Qi wireless charging 	No cost +\$ 75 +\$245	Specify <i>with no USB</i> . Specify <i>with USB</i> . Specify <i>with USB and Qi wireless</i> .

Specification Information

Dimensions D W	Style Number	Base Price
16 ³ / ₄ " 9"	DSPC	\$475

SOTO Mobile Caddy

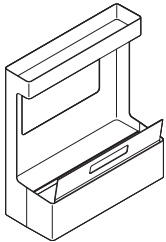

Standard Includes	Required to Specify
<ul style="list-style-type: none"> Mobile caddy: 6009 Arctic White Fabric covered pad: dark grey felt 	1 Style number 2 Options, if selected (see below) ▶ See <i>Surface Materials</i> , page 318.

Options	Price	Required to Specify
Surface Materials Fabric covered pad <ul style="list-style-type: none"> Grey felt Fabric finish set 1 Fabric finish set 2 	No cost +\$37 +\$79	Specify grey felt. Specify fabric color number. Specify fabric color number.

Specification Information					
Dimensions			Weight	Style Number	Base Price
D	W	H			
21 1/4"	9 1/2"	23 3/4"	16.8 lb	DSMC	\$425

SOTO Launch Pad

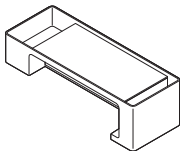

Standard Includes	Required to Specify
<ul style="list-style-type: none"> Launch pad: plastic Fabric pad: grey felt Powered, if selected: 3 outlets on each side, 9' power cord, cable management clips 	1 Style number 2 Plastic color number for launch pad: 6009 Arctic White 6527 Merle 3 Options, if selected (see below)

Options	Price	Required to Specify
Surface Materials Fabric covered pad <ul style="list-style-type: none"> Grey felt Fabric finish set 1 Fabric finish set 2 	No cost +\$37 +\$79	Specify grey felt. Specify fabric color number. Specify fabric color number. ▶ See <i>Surface Materials</i> , page 318.

Specification Information					
Dimensions			Weight	Style Number	Base Price
D	W	H			
Non-Powered Launch Pad					
24"	9"	5"	7.75 lb	DSLPLNP	\$280
Powered Launch Pad					
24"	9"	5"	10.1 lb	DSLPLP	\$425

SOTO Worktools, continued

SIN 711.2

SOTO Launch Pad Divider Screen

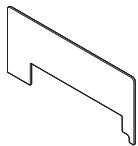

Tip: Screen is 14"H off work-surface when installed.

Standard Includes	Required to Specify
-------------------	---------------------

- Screen: 6544 Frost

Style number

Specification Information					
• Dimensions			• Weight	• Style	• Price
D	W	H		Number	

23 ⁵ / ₈ "	3 ¹ / ₁₆ "	9 ¹ / ₂ "	2.1 lb	DSLPS	\$108
:	:	:	:	:	:

SOTO Functional Screen

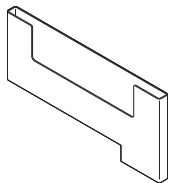

Tip: Screens cannot be used on glass, bullnose, knife edge, or other non-standard worksurface edges.

Tip: All height-adjustable worksurface controllers must be mounted clear of installed screen.

Standard Includes	Required to Specify
-------------------	---------------------

- Functional screen: plastic

- 1 Style number
- 2 Plastic color number for launch pad:
6009 Arctic White
6527 Merle

Specification Information					
• Dimensions			• Weight	• Style	• Price
D	W	H		Number	

28 ¹ / ₂ "	1 ³ / ₄ "	14"	5.1 lb	DSFS	\$257
:	:	:	:	:	:

SOTO Personal Pocket



Tip: Personal pocket fits on mobile caddy and functional screen, or can be ganged together while freestanding.

Standard Includes	Required to Specify
-------------------	---------------------

- Personal pocket: 6000 Black

Style number

Specification Information					
• Dimensions			• Weight	• Style	• Price
D	W	H		Number	

11 ³ / ₄ "	2"	5 ¹ / ₂ "	1.1 lb	DSPP	\$38
:	:	:	:	:	:

SOTO Cable Clip



Tip: Clips cannot be used with glass, bullnose, knife edge, or other non-standard worksurface edges.

Standard Includes	Required to Specify
<ul style="list-style-type: none"> Cable clip: plastic 	1 Style number 2 Plastic color number for cable clip: 6009 Arctic White 6059 Sterling Dark Solid

Specification Information

• Dimensions			• Weight	• Style Number	• Price
D	W	H			
2"	1"	2"	0.5 lb	DCCLIP	\$23

SOTO Personal Hook



Tip: Hooks cannot be used with glass, bullnose, knife edge, or other non-standard worksurface edges.

Standard Includes	Required to Specify
<ul style="list-style-type: none"> Personal hook: plastic 	1 Style number 2 Plastic color number for personal hook: 6009 Arctic White 6059 Sterling Dark Solid

Specification Information

• Dimensions			• Weight	• Style Number	• Price
D	W	H			
2"	¾"	2"	0.5 lb	DPHOOK	\$23

SOTO Monitor Bridge

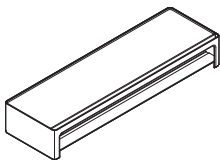

Standard Includes	Required to Specify
<ul style="list-style-type: none"> Monitor bridge: plastic Fabric covered pad: dark grey felt 	1 Style number 2 Plastic color number for monitor bridge: 6009 Arctic White 6527 Merle 3 Options, if selected (see below)

Options	Price	Required to Specify
Surface Materials <ul style="list-style-type: none"> Merle shelf 	+\$67	Specify with 6527 Merle.
Fabric covered pad <ul style="list-style-type: none"> Grey felt Fabric finish set 1 Fabric finish set 2 	No cost +\$37 +\$79	Specify grey felt. Specify fabric color number. Specify fabric color number. ▶ See <i>Surface Materials</i> , page 318.

Specification Information

• Dimensions			• Weight	• Style Number	• Base Price
D	W	H			
9"	29 ² / ₁₆ "	4½"	4.1 lb	DSMB	\$205

SOTO Worktools, continued

SIN 711.2

SOTO Laptop Shelf

Standard Includes	Required to Specify
<ul style="list-style-type: none"> Laptop shelf: 6009 Arctic White Stanchion: 4799 Platinum 	Style number

Specification Information

• Dimensions	• Weight	• Style	• Price
D W H	:	Number	:

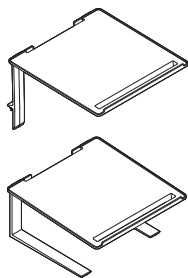

Rail-Mounted					
14 ³ / ₄ "	14"	9 ⁵ / ₈ "	2.7 lb	DSL SRM	\$149

Freestanding					
14 ³ / ₄ "	14"	7"	3 lb	DSL S	\$164

Tip: To prevent tipping with freestanding unit, press only on middle to rear of product.

Tip: Laptop shelf is able to accommodate side or rear mounted docking stations.

SOTO Ergo Edge

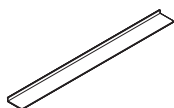

Tip: Ergo edge not applicable for use with glass, bull-nose, knife-edge, or other non-standard worksurface edge.

Tip: Ergo edge must be stored flat.

Tip: Antimicrobial version is treated with Bactiblock.

Tip: Ergo edge front lip extends 1/2" down front edge of worksurface.

Standard Includes	Required to Specify
<ul style="list-style-type: none"> Ergo edge: 6527 Merle Antimicrobial edge 	1 Style number 2 Options (see below)

Options	Price	Required to Specify
Edge Type • Non-antimicrobial	No cost	Specify with non-antimicrobial.

Specification Information

• Dimensions	• Weight	• Style	• Price
D W H	:	Number	:

2 ¹ / ₂ "	27"	7 ¹ / ₁₀ "	0.21 lb	DSEE	\$97

Screens

SIN 711.2

Fixed Personal/Modesty Screens

Standard Includes	Required to Specify
<ul style="list-style-type: none"> Personal/modesty screens: fabric price group 1 Brackets: 4799 Platinum 	<ul style="list-style-type: none"> 1 Style number 2 Fabric color number for screen 3 Options, if selected (see below) ▶ See <i>Surface Materials</i>, page 318.

Surface Materials	Options	Price			Required to Specify
	Fabric	12"H	19½"H	24"H	
	• Fabric price group 1	No cost	No cost	No cost	Specify fabric color number. Specify fabric color number. Specify fabric color number. Specify fabric color number. ▶ See <i>Surface Materials Reference Manual</i> .
	• Fabric price group 2	+\$24	+\$ 33	+\$ 39	
	• Fabric price group 3	+\$64	+\$ 87	+\$111	
	• Fabric price group 4	+\$83	+\$111	+\$136	
	• Customer's Own Material (COM)	+\$16	+\$ 16	+\$ 16	

Tip: When using COM fabric, it is recommended that non-patterned fabric be used to provide a consistent visual between adjacent screens, and from one side to the other.

Specification Information

Width	Style Number	Base Price
-------	--------------	------------

12"H Screens

30"	CQSF3012	\$162
36"	CQSF3612	\$189
42"	CQSF4212	\$214
48"	CQSF4812	\$241
:	:	:

19½"H Screens

30"	CQSF3019	\$250
36"	CQSF3619	\$277
42"	CQSF4219	\$303
48"	CQSF4819	\$329
:	:	:

24"H Screens

30"	CQSF3024	\$337
36"	CQSF3624	\$365
42"	CQSF4224	\$390
48"	CQSF4824	\$417
:	:	:

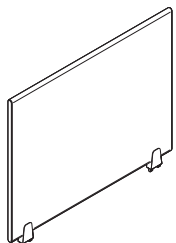
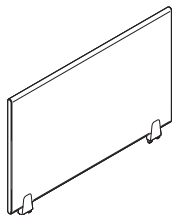
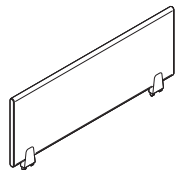

Tip: 24"H screens are not intended for use in the modesty position.



Lighting

► For more detailed product information, see the *Steelcase Worktools Specification Guide* or consult your Steelcase dealer.



Statement of Line and Comparison **58**



Specifying

dash LED Lights (SIN 711.2)	62
dash mini LED Lights (SIN 711.2)	64
SOTO LED Lights (SIN 711.2)	66
SOTO Extended LED Lights (SIN 711.2)	67
Mini SOTO LED Light (SIN 711.2)	68
Mini SOTO Extended LED Light (SIN 711.2)	69
LED Radial Desktop Lights (SIN 711.2)	70
LED Linear Desktop Lights (SIN 711.2)	71
LED Linear Shelf Lights (SIN 711.1)	72

Statement of Line and Comparison

Task lights offer end users added control and adjustability to place the proper amount of task lighting to create a holistic work setting.

LED Lights

dash and dash mini LED Lights

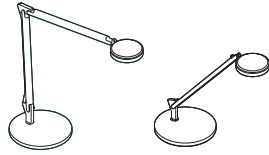

SOTO and SOTO Extended LED Lights

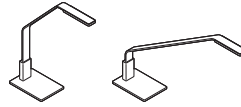

Mini SOTO and Mini SOTO Extended LED Lights



Mounting Options

- Freestanding
- C-clamp
- Slatwall
- Panel
- Rails—SOTO, c:scape, EE, FrameOne, Campfire, and Tour

- Freestanding
- Rails—SOTO, c:scape, EE, FrameOne, Campfire, and Tour

- Magnetic or screw mount

Specifying
▶ Page 62

Specifying
▶ Page 66

Specifying
▶ Page 68

Watts/Lumens/Efficacy	11.3 Watts/503 Lumens/44.5 Efficacy	4.8 Watts/ 258 Lumens/53.8 Efficacy	4.8 Watts/ 258 Lumens/53.8 Efficacy
Color Rendering Index	84	83	83
Color Temperature	3500K	3500K	3500K
Horizontal Arm Range	Standard 0"–32" Mini 0"–20½"	Standard 12¼" Extended 21¾"	N.A.
Vertical Height Adjustment	Standard 2"–22¾" Mini 0"–19⅞"	Standard 14¾" Extended 13"	N.A.
Tilt/Swivel	360° at base and head	• Not available	• Not available
Replacement Lamp/Bulb	• Not available	• Not available	• Not available
Average Rated Lamp Life	• 50,000 hrs.	• 50,000 hrs.	• 50,000 hrs.
Finish Options	• Paint: Arctic White (4231), Low Gloss Black (4710), Platinum Metallic (4799), or accent paint*	• Paint: Arctic White (4231), Low Gloss Black (4710), or Platinum Metallic (4799)	• Platinum Metallic (4799)
Electronic Dimmer	• 100%–15%	• Not available	• Not available
Occupancy Sensor	• Available	• Not available	• Not available

* For complete listing of accent paints, see *Surface Materials Reference Manual*.

Task lights offer end users added control and adjustability to place the proper amount of task lighting to create a holistic work setting.

LED Lights

LED Radial and Linear Desktop Lights

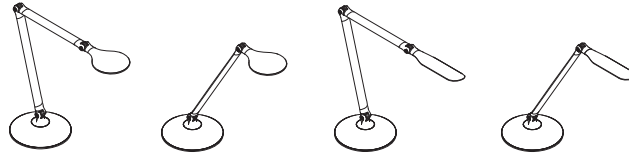

Mounting Options	<ul style="list-style-type: none"> • Freestanding • Freestanding with USB • C-clamp • Slatwall • Panel • Rails-SOTO, Ology, c:scape, Elective Elements, FrameOne, Campfire, and Tour • Through mount • Theft deterrent through-mount 	
	Specifying ▶ Pages 70 and 71	
Watts/Lumens/Efficacy	7.5 Watts/ 337 Lumens/ 44.9 Efficacy	
Color Rendering Index	85	
Color Temperature	3500K	
Horizontal Arm Range	Radial Double 8"–20½" Single 0"–13"	Linear Double 10"–22½" Single 2"–15"
Vertical Height Adjustment	Radial Double 6"–21½" Single 13"–16½"	Linear Double 6"–21½" Single 13"–16½"
Tilt/Swivel	90° vertical tilt at head and 320° at base	
Replacement Lamp/Bulb	• Not available	
Average Rated Lamp Life	• 50,000 hrs.	
Finish Options	<ul style="list-style-type: none"> • Paint: Arctic White (4231), Low Gloss Black (4710), Platinum Metallic (4799), or accent paint* 	
Electronic Dimmer	• 100%–15%	
Occupancy Sensor	• Available	

* For complete listing of accent paints, see *Surface Materials Reference Manual*.

Statement of Line and Comparison, continued

Shelf lights offer end users added control and adjustability to place the proper amount of shelf lighting to create a holistic work setting. Ideally suited for recessed mount applications to bottom of bin or shelf.

Shelf Lights

LED Linear Shelf Lights

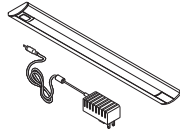

Mounting	<ul style="list-style-type: none"> Standard includes magnetic mount for steel bins and shelves. Each light length comes with set quantity of mounting brackets for both steel and wood applications. 				
	Specifying ▶ Page 72				
Depth	2"				
Width	17", 31", 44", or 58"				
Number of LEDs	17"W 24 47	31"W 48 94	44"W 72 141	58"W 96 188	Standard Output LEDs High Output LEDs
Watts/Lumens/Efficacy	17"W 7.8 444 57	31"W 17.6 980 55.6	44"W 25.9 1412 54.5	58"W 33.6 1791 53.3	Standard Output Watts Lumens Efficacy
	17"W 10.9 44 68	31"W 23.4 1590 68	44"W 34.3 2290 67	58"W 43.5 2807 64.5	High Output Watts Lumens Efficacy
Color Rendering Index	84				
Color Temperature	3500K				
Description	With its low profile and available four widths, the LED linear light will fit in a variety of shelving and overhead storage applications. Beneficial features of this fixture include: energy efficient LEDs, continuous dimming, automatic turn off after 10 hours, and optional occupancy sensor.				
Finish Options	<ul style="list-style-type: none"> 4231 Arctic White body with Arctic White (6009) end caps or 0835 Black body with Black (6000) end caps. 				
Optics	<ul style="list-style-type: none"> Polycarbonate matte film 				
Ballasts	<ul style="list-style-type: none"> Energy saving low-voltage power supply 				
Electronic Dimmer	<ul style="list-style-type: none"> Standard on all lights 				
Average Rated Lamp Life	<ul style="list-style-type: none"> 50,000 hrs. 				
Warranty	<ul style="list-style-type: none"> Power supply - 5 years Fixture - 12 years 				

dash LED Lights

SIN 711.2

Tip: For applications that include an integrated SOTO rail; Ology, FrameOne, c:scape, Campfire, Tour, or SOTO rail; specify dash rail mount with integrated SOTO bracket. dash can be mounted in front of privacy screens, Slatwall, or FrameOne center screen.

Tip: 90° mini extension cord can be used with Ology bench, FrameOne, or where power receptacles are located in confined spaces.

► See Worktools Specification Guide.

Tip: Applications that include a rail mounted dash to Elective Elements Tech Zone will need to choose the optional Elective Elements Tech Zone rail mount bracket. Elective Elements Tech Zone rail mount bracket cannot be used with privacy screens, Slatwall, or FrameOne center screens. The light must be mounted adjacent to the screens or Slatwall.

Tip: For a complete listing of accent paints, see Surface Materials Reference Manual.

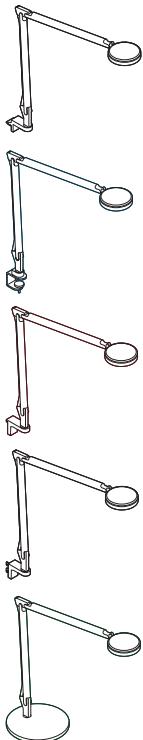

Standard Includes	Required to Specify
<ul style="list-style-type: none"> • Task light and mounting bracket: paint price group 1 • 11.3-watt LED 3500K • Continuous range dimmer • 9' low voltage modular cord: black plastic only • Integrated SOTO rail bracket 	1 Style number 2 Paint color number for light: 4231 Arctic White 4710 Low Gloss Black 4799 Platinum Metallic 3 Options, if selected (see below) ► See <i>Surface Materials</i> , page 318.

Options	Price	Required to Specify
Surface Materials <ul style="list-style-type: none"> • Paint price group 3 	+\$28	Specify paint color number. ► See <i>Surface Materials Reference Manual</i> for accent paint options.
Rail Bracket <ul style="list-style-type: none"> • Elective Elements Tech Zone bracket 	No cost	Specify with <i>EE Tech Zone</i> bracket.

Specification Information

• Dimensions			• Weight	• Style	• Base
D	W	H		Number	Price

Rail-Mounted					
37"	¾"	24¼"	1.7 lb	LDASHR	\$511

C-Clamp Mount					
37"	¾"	24¼"	2.2 lb	LDASHC	\$511

Panel-Mounted For Use with Answer, Series 9000, Avenir, and Kick					
37"	¾"	24¼"	2 lb	LDASHP	\$511

Slatwall- and SlatRail-Mounted					
37"	¾"	24¼"	2 lb	LDASHS	\$511

Freestanding					
37"	8¼"	25"	9.65 lb	LDASHF	\$511

dash LED Lights

With Occupancy Sensor

SIN 711.2

Tip: For applications that include an integrated SOTO rail; Ology, FrameOne, c:scape, Campfire, Tour, or SOTO rail; specify dash rail mount with integrated SOTO bracket. dash can be mounted in front of privacy screens, Slatwall, or FrameOne center screen.

Tip: 90° mini extension cord can be used with Ology bench, FrameOne, or where power receptacles are located in confined spaces.

▶ See Worktools Specification Guide.

Tip: Applications that include a rail mounted dash to Elective Elements Tech Zone will need to choose the optional Elective Elements Tech Zone rail mount bracket. Elective Elements Tech Zone rail mount bracket cannot be used with privacy screens, Slatwall, or FrameOne center screens. The light must be mounted adjacent to the screens or Slatwall.

Tip: For a complete listing of accent paints, see Surface Materials Reference Manual.

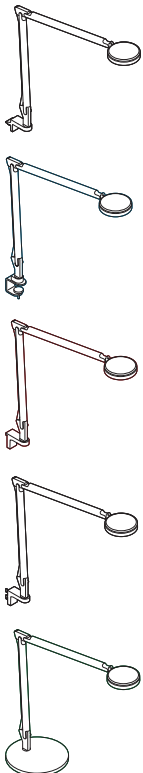

Standard Includes	Required to Specify
<ul style="list-style-type: none"> • Task light and mounting bracket: paint price group 1 • Occupancy sensor • 11.3-watt LED 3500K • Continuous range dimmer • 9' low voltage modular cord: black plastic only • Integrated SOTO rail bracket 	<ol style="list-style-type: none"> 1 Style number 2 Paint color number for light: <ul style="list-style-type: none"> 4231 Arctic White 4710 Low Gloss Black 4799 Platinum Metallic 3 Options, if selected (see below) <ul style="list-style-type: none"> ▶ See <i>Surface Materials</i>, page 318.

Options	Price	Required to Specify
Surface Materials <ul style="list-style-type: none"> • Paint price group 3 	+\$28	Specify paint color number. ▶ See <i>Surface Materials Reference Manual</i> for accent paint options.
Rail Bracket <ul style="list-style-type: none"> • Elective Elements Tech Zone bracket 	No cost	Specify with <i>EE Tech Zone</i> bracket.

Specification Information

• Dimensions	• Weight	• Style	• Base
D W H	:	Number	Price

Rail-Mounted

37"	¾"	24¼"	1.7 lb	LDASHOR	\$562
-----	----	------	--------	----------------	-------

C-Clamp Mount

37"	¾"	24¼"	2.2 lb	LDASHOC	\$562
-----	----	------	--------	----------------	-------

Panel-Mounted For Use with Answer, Series 9000, Avenir, and Kick

37"	¾"	24¼"	2 lb	LDASHOP	\$562
-----	----	------	------	----------------	-------

Slatwall- and SlatRail-Mounted

37"	¾"	24¼"	2 lb	LDASHOS	\$562
-----	----	------	------	----------------	-------

Freestanding

37"	8¼"	25"	9.65 lb	LDASHOF	\$562
-----	-----	-----	---------	----------------	-------



dash mini LED Lights

SIN 711.2

Tip: For applications that include an integrated SOTO rail; Ology, FrameOne, c:scape, Campfire, Tour, or SOTO rail; specify dash rail mount with integrated SOTO bracket. dash can be mounted in front of privacy screens, Slatwall, or FrameOne center screen.

Tip: 90° mini extension cord can be used with Ology bench, FrameOne, or where power receptacles are located in confined spaces.

▶ See Worktools Specification Guide.

Tip: Applications that include a rail mounted dash to Elective Elements Tech Zone will need to choose the optional Elective Elements Tech Zone rail mount bracket. Elective Elements Tech Zone rail mount bracket cannot be used with privacy screens, Slatwall, or FrameOne center screens. The light must be mounted adjacent to the screens or Slatwall.

Tip: For a complete listing of accent paints, see Surface Materials Reference Manual.

Standard Includes	Required to Specify
<ul style="list-style-type: none"> • Task light and mounting bracket: paint price group 1 • 11.3-watt LED 3500K • Continuous range dimmer • 9' low voltage modular cord: black plastic only • Integrated SOTO rail bracket 	1 Style number 2 Paint color number for light: 4231 Arctic White 4710 Low Gloss Black 4799 Platinum Metallic 3 Options, if selected (see below) ▶ See Surface Materials, page 318.

Options	Price	Required to Specify
Surface Materials <ul style="list-style-type: none"> • Paint price group 3 	+\$28	Specify paint color number. ▶ See Surface Materials Reference Manual for accent paint options.
Rail Bracket <ul style="list-style-type: none"> • Elective Elements Tech Zone bracket 	No cost	Specify with EE Tech Zone bracket.

Specification Information

Dimensions			Weight	Style Number	Base Price
D	W	H			

Rail-Mounted

24"	3/4"	20 3/8"	1.3 lb	LDASHMINIR	\$420
:	:	:	:	:	:

C-Clamp Mount

24"	3/4"	20 3/8"	1.8 lb	LDASHMINIC	\$420
:	:	:	:	:	:

Panel-Mounted For Use with Answer, Series 9000, Avenir, and Kick

24"	3/4"	20 3/8"	1.6 lb	LDASHMINIP	\$420
:	:	:	:	:	:

Slatwall- and SlatRail-Mounted

24"	3/4"	20 3/8"	1.6 lb	LDASHMINIS	\$420
:	:	:	:	:	:

Freestanding

24"	8 1/4"	21 1/10"	9.25 lb	LDASHMINIF	\$420
:	:	:	:	:	:

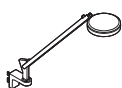

dash mini LED Lights

With Occupancy Sensor

SIN 711.2

Tip: For applications that include an integrated SOTO rail; Ology, FrameOne, c:scape, Campfire, Tour, or SOTO rail; specify dash rail mount with integrated SOTO bracket. dash can be mounted in front of privacy screens, Slatwall, or FrameOne center screen.

Tip: 90° mini extension cord can be used with Ology bench, FrameOne, or where power receptacles are located in confined spaces.

▶ See *Worktools Specification Guide*.

Tip: Applications that include a rail mounted dash to Elective Elements Tech Zone will need to choose the optional Elective Elements Tech Zone rail mount bracket. Elective Elements Tech Zone rail mount bracket cannot be used with privacy screens, Slatwall, or FrameOne center screens. The light must be mounted adjacent to the screens or Slatwall.

Standard Includes	Required to Specify
<ul style="list-style-type: none"> • Task light and mounting bracket: paint price group 1 • 11.3-watt LED 3500K • Continuous range dimmer • 9' low voltage modular cord: black plastic only • Occupancy sensor • Integrated SOTO rail bracket 	<ol style="list-style-type: none"> 1 Style number 2 Paint color number for light: <ul style="list-style-type: none"> 4231 Arctic White 4710 Low Gloss Black 4799 Platinum Metallic 3 Options, if selected (see below) <ul style="list-style-type: none"> ▶ See <i>Surface Materials</i>, page 318.

Options	Price	Required to Specify
Surface Materials <ul style="list-style-type: none"> • Paint price group 3 	+\$28	Specify paint color number. ▶ See <i>Surface Materials Reference Manual</i> for accent paint options.
Rail Bracket <ul style="list-style-type: none"> • Elective Elements Tech Zone bracket 	No cost	Specify with <i>EE Tech Zone</i> bracket.

Specification Information

• Dimensions			• Weight	• Style Number	• Base Price
D	W	H			

Rail-Mounted					
24"	3/4"	20 3/8"	1.3 lb	LDASHMINIOR	\$471

C-Clamp Mount					
24"	3/4"	20 3/8"	1.8 lb	LDASHMINIOC	\$471

Panel-Mounted For Use with Answer, Series 9000, Avenir, and Kick					
24"	3/4"	20 3/8"	1.6 lb	LDASHMINIOP	\$471

Slatwall- and SlatRail-Mounted					
24"	3/4"	20 3/8"	1.6 lb	LDASHMINIOS	\$471

Freestanding					
24"	8 1/4"	21 1/10"	9.25 lb	LDASHMINIOF	\$471



SOTO LED Lights

SIN 711.2

Tip: SOTO LED may not occupy the same space as a SOTO 3½"W, 6¾"W, or 10¼"W shelf. The angle of the extended arm will not extend over the shelf. Mount next to shelf or slatwall.

Tip: 90° mini extension cord can be used with Ology bench, FrameOne, or where power receptacles are located in confined spaces. ▶ See Worktools Specification Guide.

Tip: Rail mounted SOTO LEDs will fit in front of c:scape privacy screens.

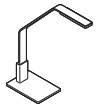

Standard Includes	Required to Specify
-------------------	---------------------

- Task light and mounting bracket: paint
- 4.8-watt LED 3500K
- 9' low voltage modular cord: black plastic only

- 1 Style number
- 2 Paint color number for light:
 - 4231 Arctic White
 - 4710 Low Gloss Black
 - 4799 Platinum

Specification Information					
• Dimensions			• Weight	• Style	• Price
D	W	H		Number	

D	W	H	Weight	Style Number	Price
---	---	---	--------	--------------	-------

Rail-Mounted

12¾"	1½"	14¼"	0.6 lb	DSLEDR	\$295
•	•	•	•	•	•

Freestanding

12¾"	4¼"	14¾"	2.2 lb	DSLEDF	\$321
•	•	•	•	•	•

SOTO Extended LED Lights

SIN 711.2

Tip: SOTO Extended LED may not occupy the same space as a SOTO 3"W, 6"W or 10"W shelf. The angle of the extended arm will not extend over the shelf. Mount next to shelf or slatwall.

Tip: 90° mini extension cord can be used with Ology bench, FrameOne, or where power receptacles are located in confined spaces. ▶ See Worktools Specification Guide.



Tip: Rail mounted SOTO LEDs will fit in front of c:scape privacy screens.

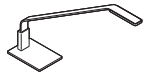

Standard Includes	Required to Specify
-------------------	---------------------

- Task light and mounting bracket: paint
- 4.8-watt LED 3500K
- 9' low voltage modular cord: black plastic only

- 1 Style number
- 2 Paint color number for light:
 - 4231 Arctic White
 - 4710 Low Gloss Black
 - 4799 Platinum

Specification Information					
• Dimensions			• Weight	• Style	• Price
D	W	H		Number	

Rail-Mounted

21¼"	1½"	14¼"	0.7 lb	DSLEDER	\$348
:	:	:	:	:	:

Freestanding

21¾"	4¼"	14¾"	2.3 lb	DSLEDEF	\$374
:	:	:	:	:	:

Mini SOTO LED Light

SIN 711.2



Tip: 90° mini extension cord can be used with Ology bench, FrameOne, or where power receptacles are located in confined spaces.

▶ See *Worktools Specification Guide*.

Standard Includes	Required to Specify
<ul style="list-style-type: none"> • Task light and mounting bracket: 4799 Platinum Metallic • 4.8-watt LED 3500K • 9' low voltage modular cord: black plastic only 	<ul style="list-style-type: none"> • Style number

Specification Information					
• Dimensions			• Weight	• Style	• Price
D	W	H		Number	
1 3/8"	7"	5/8"	0.3 lb	LMINILED	\$236
:	:	:	:	:	:

Mini SOTO Extended LED Light

Mini SOTO Extended
LED Light

SIN 711.2



Tip: 90° mini extension cord can be used with Ology bench, FrameOne, or where power receptacles are located in confined spaces. ▶ See Worktools Specification Guide.

Standard Includes	Required to Specify
<ul style="list-style-type: none"> • Task light and mounting bracket: 4799 Platinum Metallic • 4.8-watt LED 3500K • 9' low voltage modular cord: black plastic only 	<ul style="list-style-type: none"> • Style number

Specification Information					
• Dimensions			• Weight	• Style	• Price
D	W	H		Number	
1 ³ / ₈ "	11 ⁷ / ₈ "	5 ⁵ / ₈ "	0.5 lb	LMINILEDE	\$260

Lighting

LED Radial Desktop Lights

SIN 711.2

Standard Includes	Required to Specify
<ul style="list-style-type: none"> • Task light and mounting bracket: paint price group 1 • 18 watt power supply with 9' black with 4' silver cord with quick connector • Continuous range dimmer • Automatic turn off program • 7.5-watt LED 3500K 	<ol style="list-style-type: none"> 1 Style number 2 Paint color number for light: <ul style="list-style-type: none"> 4231 Arctic White 4710 Low Gloss Black 4799 Platinum Metallic 3 Options, if selected (see below) <ul style="list-style-type: none"> ▶ See <i>Surface Materials</i>, page 318.

Tip: For a complete listing of accent paints, see Surface Materials Reference Manual.

Tip: Must be registered in PerfectMatch program when ordering accent finishes. Registration is available at no charge.

Tip: Through-mount and theft deterrent through-mount brackets can only be used with worksurfaces that are 1"D to 1¾"D. They are not for use with turnstone Bivi, FrameOne, or c:scape worksurfaces under 1"D.

Options	Price	Required to Specify
Surface Materials <ul style="list-style-type: none"> • Paint price group 3 	+\$ 28	Specify paint color number. ▶ See <i>Surface Materials Reference Manual</i> for accent paint options.
Occupancy Sensor <ul style="list-style-type: none"> • With occupancy sensor 	+\$111	Specify <i>with occupancy sensor</i> .
Base/Mounting Brackets <ul style="list-style-type: none"> • Freestanding base • C-clamp mount bracket • Slatwall mount bracket • Integrated rail-mount bracket • Panel-mount bracket • Through-mount bracket • Theft deterrent through-mount bracket • Freestanding base with USB 	No cost No cost No cost No cost No cost No cost No cost +\$ 50	Specify <i>with freestanding base</i> . Specify <i>with C-clamp mount bracket</i> . Specify <i>with Slatwall mount bracket</i> . Specify <i>with integrated rail-mount bracket</i> . Specify <i>with panel-mount bracket</i> . Specify <i>with through-mount bracket</i> . Specify <i>with theft deterrent through-mount bracket</i> . Specify <i>with freestanding base with USB</i> .

Specification Information

• Dimensions			• Style	• Base
D	W	H	Number	Price

LED Radial Single Arm Light

13"	6"	16½"	LLRDS	\$330
•	•	•	•	•

LED Radial Double Arm Light

20½"	6"	21½"	LLRDD	\$376
•	•	•	•	•



LED Linear Desktop Lights

SIN 711.2

Standard Includes	Required to Specify
<ul style="list-style-type: none"> • Task light and mounting bracket: paint price group 1 • 18 watt power supply with 9' black with 4' silver cord with quick connector • Continuous range dimmer • Automatic turn off program • 7.5-watt LED 3500K 	<ol style="list-style-type: none"> 1 Style number 2 Paint color number for light: <ul style="list-style-type: none"> 4231 Arctic White 4710 Low Gloss Black 4799 Platinum Metallic 3 Options, if selected (see below) <ul style="list-style-type: none"> ▶ See <i>Surface Materials</i>, page 318.

Tip: For a complete listing of accent paints, see Surface Materials Reference Manual.

Tip: Must be registered in PerfectMatch program when ordering accent finishes. Registration is available at no charge.

Tip: Through-mount and theft deterrent through-mount brackets can only be used with worksurfaces that are 1"D to 1¾"D. They are not for use with turnstone Bivi, FrameOne, or c:scape worksurfaces under 1"D.

Options	Price	Required to Specify
Surface Materials <ul style="list-style-type: none"> • Paint price group 3 	+\$ 28	Specify paint color number. ▶ See <i>Surface Materials Reference Manual</i> for accent paint options.
Occupancy Sensor <ul style="list-style-type: none"> • With occupancy sensor 	+\$111	Specify <i>with occupancy sensor</i> .
Base/Mounting Brackets <ul style="list-style-type: none"> • Freestanding base • C-clamp mount bracket • Slatwall-mount bracket • Integrated rail-mount bracket • Panel-mount bracket • Through-mount bracket • Theft deterrent through-mount bracket • Freestanding base with USB 	No cost No cost No cost No cost No cost No cost No cost +\$ 50	Specify <i>with freestanding base</i> . Specify <i>with C-clamp mount bracket</i> . Specify <i>with Slatwall-mount bracket</i> . Specify <i>with integrated rail-mount bracket</i> . Specify <i>with panel-mount bracket</i> . Specify <i>with through-mount bracket</i> . Specify <i>with theft deterrent through-mount bracket</i> . Specify <i>with freestanding base with USB</i> .

Specification Information

Dimensions			Style	Base
D	W	H	Number	Price

LED Linear Single Arm Light

15"	6"	16½"	LLLDS	\$330

LED Linear Double Arm Light

22½"	6"	21½"	LLLDD	\$376



Lighting

LED Linear Shelf Lights

SIN 711.1

Tip: The power supply for the 17" stand alone only uses a straight plug with a 9' 18 watt 24 volt wall transformer. The power supply for the 31", 44", 58", or 17" starter light uses a 11' 60 watt compact in-line brick with straight plug.

Standard Includes	Required to Specify
<ul style="list-style-type: none"> • Task light and mounting bracket: 4231 Arctic White • Power supply with cord: black • Soft touch switch • Magnetic and wood mounting brackets • Continuous range dimmer • Automatic turn off program • Color temperature 3500K 	<ul style="list-style-type: none"> 1 Style number 2 Options, if selected (see below)

Options	Price	Required to Specify
Surface Materials <ul style="list-style-type: none"> • Painted light housing in 0835 Black 	+\$ 12	Specify with 0835 Black.
Occupancy Sensor <ul style="list-style-type: none"> • 17"W, 31"W, 44"W, and 58"W with stand alone or daisy chain starter 	+\$123	Specify with occupancy sensor.
High Output <ul style="list-style-type: none"> • 17"W with stand alone, starter, or secondary • 31"W, 44"W, and 58"W with stand alone or daisy chain starter, or secondary 	+\$ 77 +\$133	Specify with high output. Specify with high output.

Specification Information				
• Dimensions			• Style	• Base
D	W	H	Number	Price

17" Stand Alone Light

2"	17"	7/10"	LLL17	\$253
:	:	:	:	:

17" Daisy Chain Starter Light

2"	17"	7/10"	LLL17YA	\$296
:	:	:	:	:

17" Daisy Chain Secondary Light

2"	17"	7/10"	LLL17YB	\$221
:	:	:	:	:

31" Stand Alone or Daisy Chain Starter Light

2"	31"	7/10"	LLL31	\$411
:	:	:	:	:

31" Daisy Chain Secondary Light

2"	31"	7/10"	LLL31YB	\$341
:	:	:	:	:

► **Specification Information, continued on next page**

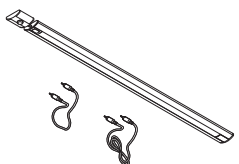
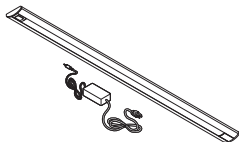
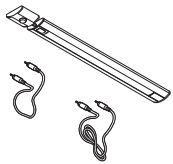
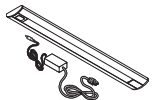
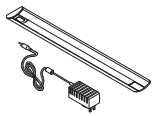

SIN 711.1

► Specification Information, continued from previous page

Specification Information

Dimensions			Style	Base
D	W	H	Number	Price

44" Stand Alone or Daisy Chain Starter Light

2"	44"	7/10"	LLL44	\$546
:	:	:	:	:

44" Daisy Chain Secondary Light

2"	44"	7/10"	LLL44YB	\$458
:	:	:	:	:

58" Stand Alone or Daisy Chain Starter Light

2"	58"	7/10"	LLL58	\$700
:	:	:	:	:

58" Daisy Chain Secondary Light

2"	58"	7/10"	LLL58YB	\$494
:	:	:	:	:

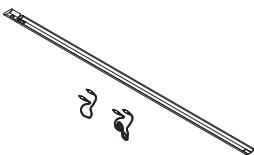
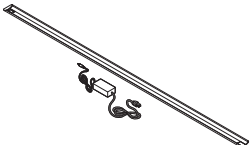
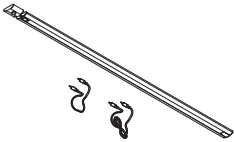
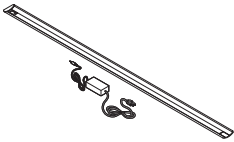

Computer Support Tools

► For more detailed product information, see the *Steelcase Worktools Specification Guide* or consult your Steelcase dealer.



Statement of Line **76**



Specifying

Mechanisms and Tracks (SIN 711.2)	86
Keyboard Platforms (SIN 711.2)	91
Palm Rests (SIN 711.2)	100
Keyboard Assemblies (SIN 711.2)	104
Technology Worktools and Cable Management (SIN 711.2)	132

Eyesite

Flat Panel Monitor Arm Support Assemblies (SIN 711.2)	138
Eyesite Modular Components (SIN 711.2)	158
Eyesite Mounting Brackets (SIN 711.2)	162
CF Series Flat Panel Monitor Arms and Supports (SIN 711.2)	163
FYI Single Flat Panel Monitor Arms and Supports with Mounting Brackets (SIN 711.2)	184
FYI Dual Flat Panel Monitor Arms and Supports with Mounting Brackets (SIN 711.2)	185
FYI Flat Panel Monitor Arms and Supports with Mounting Brackets (SIN 711.2)	186

Statement of Line

Mechanisms with Tracks

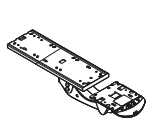

Stella Standard Mechanism with 20" Track
Specifying
▶ Page 86

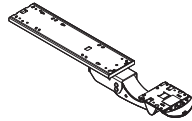

Stella Extended Mechanism with 23" Track
Specifying
▶ Page 86

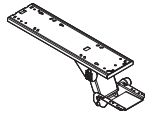

5" Lift and Lock Mechanism with 18" Track
Specifying
▶ Page 86

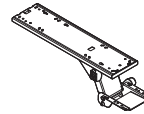

5" Lift and Lock Mechanism with 22" Track
Specifying
▶ Page 87

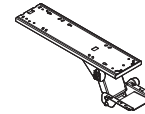

5" Lift and Lock Mechanism with 23" Track
Specifying
▶ Page 87

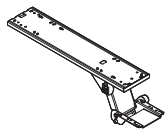

7" Lift and Lock Mechanism with 18" Track
Specifying
▶ Page 87

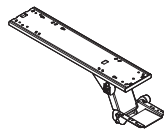

7" Lift and Lock Mechanism with 26" Track
Specifying
▶ Page 88

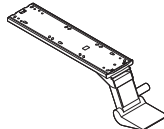

Dial Indicator6 Mechanism with 23" Track
Specifying
▶ Page 88

Mechanisms without Tracks



Stella Standard Mechanism
Specifying
▶ Page 88



Stella Extended Mechanism
Specifying
▶ Page 89



5" Lift and Lock Mechanism
Specifying
▶ Page 89



7" Lift and Lock Mechanism
Specifying
▶ Page 89



Dial Indicator6 Mechanism
Specifying
▶ Page 90



Specifying
▶ Page 90

Tracks

11"L 12"L 17"L 18"L 20"L 22"L 23"L 26"L



Keyboard Platforms



Slider Keyboard Platforms
Specifying
▶ Page 91



Jules Keyboard Platforms
Specifying
▶ Page 92

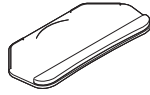

17" and 21" Diagonal Keyboard Platforms
Specifying
▶ Page 93



18" Radius Keyboard Platform
Specifying
▶ Page 93

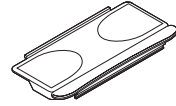

Classic Rectangular Platform
Specifying
▶ Page 94

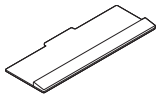

26" Keyboard Platform
Specifying
▶ Page 95

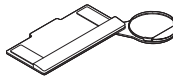

19" Keyboard Platform
Specifying
▶ Page 96

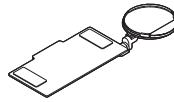

19" Keyboard Platform with Articulating Mouse
Specifying
▶ Page 97

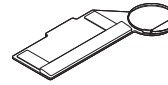

Enviro Platform
Specifying
▶ Page 98

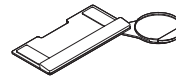

FrameOne/c:scape Platform
Specifying
▶ Page 99

Freestanding and Slider Palm Rests



Standard Adjustable Foam Palm Rest
Specifying
▶ Page 100

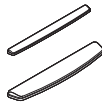

Cushioned Replacement Pad
Specifying
▶ Page 100



Slider Platform Mousing Surface Palm Rest
Specifying
▶ Page 101

19" and 26" Green-Gel Palm Rests



19" Green-Gel Palm Rest
Specifying
▶ Page 101



26" Green-Gel Palm Rest
Specifying
▶ Page 101

Tip: 19" palm rest is for use with 19", 26", and Enviro keyboard platforms. 26" palm rest is for use with 26" keyboard platform only.

Statement of Line, continued

Classic Rectangular Platform Palm Rests



Full-Width, Fixed-Height Palm Rest
Specifying
▶ Page 102

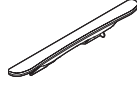

Full-Width, Height-Adjustable Palm Rest
Specifying
▶ Page 102



Positionable Palm Rest
Specifying
▶ Page 102

Jules Platform Palm Rest



Standard Foam Palm Rest
Specifying
▶ Page 103



Extended Foam Palm Rest
Specifying
▶ Page 103

Radius and Diagonal Platform Palm Rest

Stella Standard Keyboard Assemblies

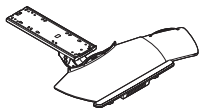

Slider Keyboard Platform with Stella Standard Mechanism
Specifying
▶ Page 104

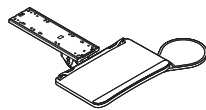

Jules Keyboard Platform with Stella Standard Mechanism
Specifying
▶ Page 104

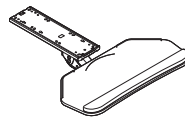

Diagonal Keyboard Platform with Stella Standard Mechanism
Specifying
▶ Page 104

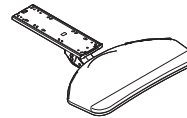

Radius Keyboard Platform with Stella Standard Mechanism
Specifying
▶ Page 104

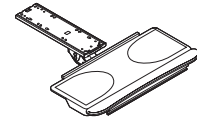

Classic Rectangular Keyboard Platform with Stella Standard Mechanism
Specifying
▶ Page 104

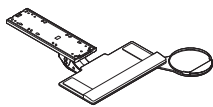

19" Keyboard Platform with Stella Standard Mechanism
Specifying
▶ Page 104

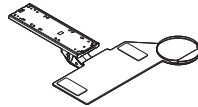

Enviro Keyboard Platform with Stella Standard Mechanism
Specifying
▶ Page 104

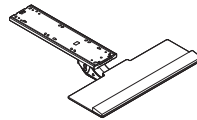

26" Keyboard Platform with Stella Standard Mechanism
Specifying
▶ Page 104

Stella Extended Keyboard Assemblies

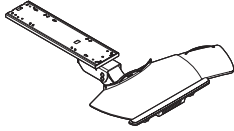

Slider Keyboard Platform with Stella Extended Mechanism
Specifying
▶ Page 108

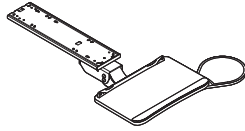

Jules Keyboard Platform with Stella Extended Mechanism
Specifying
▶ Page 108

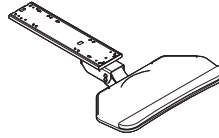

Diagonal Keyboard Platform with Stella Extended Mechanism
Specifying
▶ Page 108

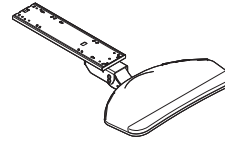

Radius Keyboard Platform with Stella Extended Mechanism
Specifying
▶ Page 108

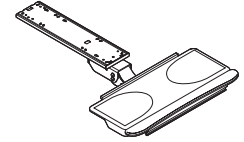

Classic Rectangular Keyboard Platform with Stella Extended Mechanism
Specifying
▶ Page 108

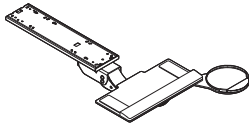

19" Keyboard Platform with Stella Extended Mechanism
Specifying
▶ Page 108

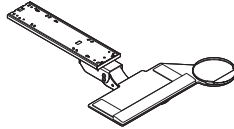

Enviro Keyboard Platform with Stella Extended Mechanism
Specifying
▶ Page 108

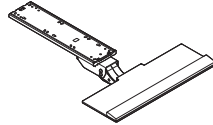

26" Keyboard Platform with Stella Extended Mechanism
Specifying
▶ Page 108

5" Lift and Lock Keyboard Assemblies

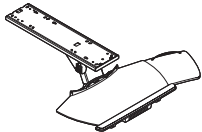

Slider Keyboard Platform with 5" Lift and Lock Mechanism
Specifying
▶ Page 114

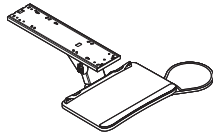

Jules Keyboard Platform with 5" Lift and Lock Mechanism
Specifying
▶ Page 114

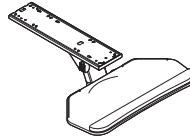

Diagonal Keyboard Platform with 5" Lift and Lock Mechanism
Specifying
▶ Page 114

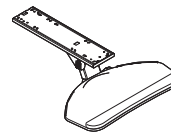

Radius Keyboard Platform with 5" Lift and Lock Mechanism
Specifying
▶ Page 114

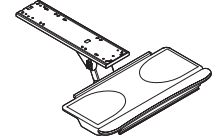

Classic Rectangular Keyboard Platform with 5" Lift and Lock Mechanism
Specifying
▶ Page 114

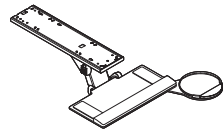

19" Keyboard Platform with 5" Lift and Lock Mechanism
Specifying
▶ Page 114
Tip: 18"L and 22"L tracks are not for use with all platforms. See specification pages for platform and track compatibility.

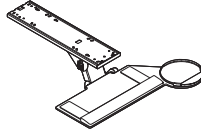

Enviro Keyboard Platform with 5" Lift and Lock Mechanism
Specifying
▶ Page 114

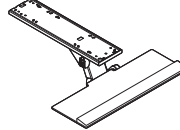

26" Keyboard Platform with 5" Lift and Lock Mechanism
Specifying
▶ Pages 118

Statement of Line, continued

7" Lift and Lock Keyboard Assemblies

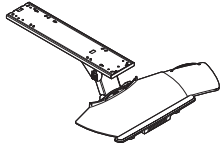

Slider Keyboard Platform with 7" Lift and Lock Mechanism
 Specifying
 ▶ Pages 124

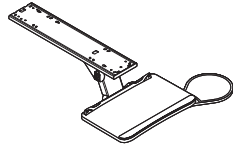

Jules Keyboard Platform with 7" Lift and Lock Mechanism
 Specifying
 ▶ Pages 124

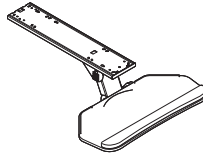

Diagonal Keyboard Platform with 7" Lift and Lock Mechanism
 Specifying
 ▶ Pages 124

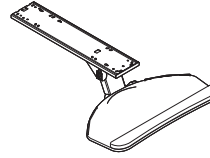

Radius Keyboard Platform with 7" Lift and Lock Mechanism
 Specifying
 ▶ Pages 124

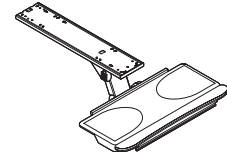

Classic Rectangular Keyboard Platform with 7" Lift and Lock Mechanism
 Specifying
 ▶ Pages 124

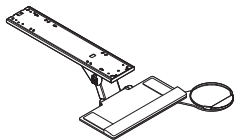

19" Keyboard Platform with 7" Lift and Lock Mechanism
 Specifying
 ▶ Pages 124

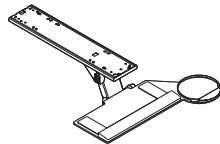

Enviro Keyboard Platform with 7" Lift and Lock Mechanism
 Specifying
 ▶ Pages 124

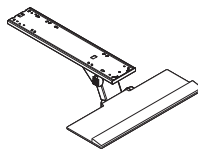

26" Keyboard Platform with 7" Lift and Lock Mechanism
 Specifying
 ▶ Pages 124

Tip: 18"L tracks are not for use with all platforms. See specification pages for platform and track compatibility.

Dial Indicator6 Keyboard Assemblies

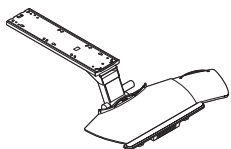

Slider Keyboard Platform with Dial Indicator6 Mechanism
 Specifying
 ▶ Page 128

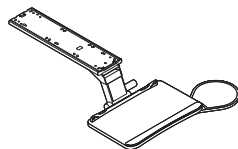

Jules Keyboard Platform with Dial Indicator6 Mechanism
 Specifying
 ▶ Page 128

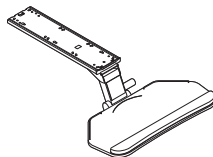

Diagonal Keyboard Platform with Dial Indicator6 Mechanism
 Specifying
 ▶ Page 128

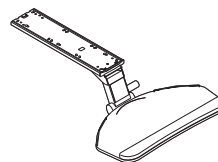

Radius Keyboard Platform with Dial Indicator6 Mechanism
 Specifying
 ▶ Page 128

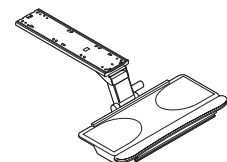

Classic Rectangular Keyboard Platform with Dial Indicator6 Mechanism
 Specifying
 ▶ Page 128

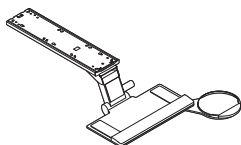

19" Keyboard Platform with Dial Indicator6 Mechanism
 Specifying
 ▶ Page 128

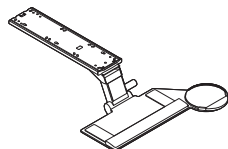

Enviro Keyboard Platform with Dial Indicator6 Mechanism
 Specifying
 ▶ Page 128

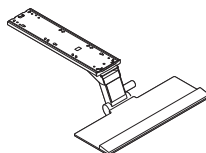

26" Keyboard Platform with Dial Indicator6 Mechanism
 Specifying
 ▶ Page 128

Technology Worktools and Cable Management



Corner Filler
Specifying
▶ Page 132

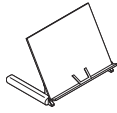

Freestanding In-Line Document Support
Specifying
▶ Page 132

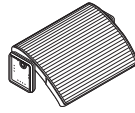

Adjustable Foot Rest
Specifying
▶ Page 133



Mobile Collapsible Laptop Support
Specifying
▶ Page 133

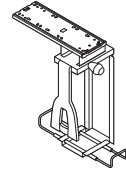

Vertical Locking CPU Cradle
Specifying
▶ Page 133

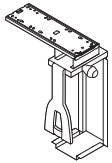

Vertical Non-Locking CPU Cradle
Specifying
▶ Page 134



Vertical Cable Carrier
Specifying
▶ Page 134

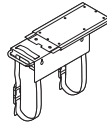

Vertical Processor Standard Sling
Specifying
▶ Page 135



Vertical Processor Fixed Sling
Specifying
▶ Page 135

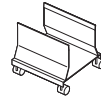

CPU Trolley
Specifying
▶ Page 135



Slatwall/SlatRail Mounted CPU Cradle
Specifying
▶ Page 135

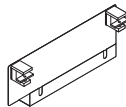

Cableways
Specifying
▶ Page 136

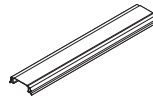

6"D Wire Managers
Specifying
▶ Page 137

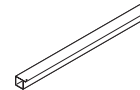

1 3/4"D Wire Managers
Specifying
▶ Page 137

Eyesite Flat Panel Monitor Arm Support Assemblies



Eyesite Single Display Support
Specifying
▶ Page 138

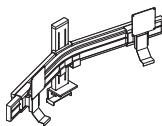

Eyesite Adjustable Dual Display Support
Specifying
▶ Page 140

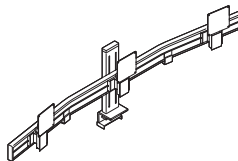

Eyesite Static Triple Display Support
Specifying
▶ Page 144



Eyesite Static One-Over-One Display Support
Specifying
▶ Page 146

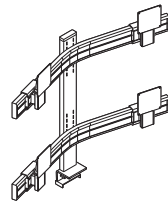

Eyesite Static Two-Over-Two Display Support
Specifying
▶ Page 148

Eyesite Flat Panel Monitor Arm Support Assemblies, continued

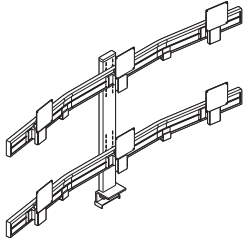

Eyesite Static Three-Over-Three Display Support
Specifying
▶ Page 151

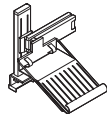

Eyesite Single Laptop Support
Specifying
▶ Page 152

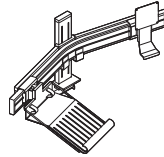

Eyesite Dual Laptop Support
Specifying
▶ Page 154



Single Arm
Specifying
▶ Page 158

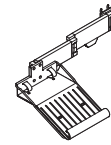

Single Arm with Laptop Support
Specifying
▶ Page 158

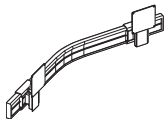

Dual Static Yoke
Specifying
▶ Page 158

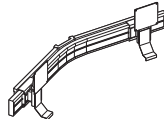

Dual Adjustable Yoke
Specifying
▶ Page 158

Eyesite Modular Components



Single Arm
Specifying
▶ Page 158

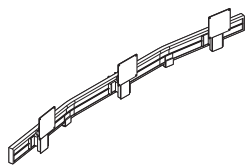

Triple Static Yoke
Specifying
▶ Page 158



12\"/>



18\"/>



26\"/>

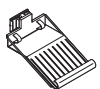

Laptop Component
Specifying
▶ Page 160



VESA Bracket/Hook
Specifying
▶ Page 160



VESA Bracket Assembly—Slide
Specifying
▶ Page 160

Eyesite Mounting Brackets



C-clamp Bracket
Specifying
▶ Page 162



Through-Mount Bracket
Specifying
▶ Page 162



FrameOne Bracket
Specifying
▶ Page 162



c:scape Bracket—Desk Only
Specifying
▶ Page 162

CF Series Flat Panel Monitor Arms and Supports

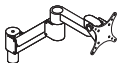

Light-Duty Arms
Specifying
▶ Page 163

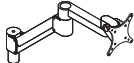

Standard Arms
Specifying
▶ Page 163

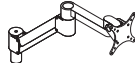

Heavy-Duty Arm
Specifying
▶ Page 163



Maximum-Duty Arm
Specifying
▶ Page 164

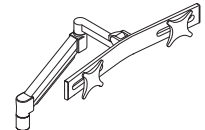

Standard-Duty Monitor Arm with Dual-Bar Arm and Standard Tilt Head
Specifying
▶ Page 165

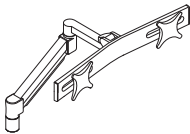

Heavy-Duty Monitor Arm with Dual-Bar Arm and Standard Tilt Head
Specifying
▶ Page 165

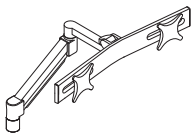

Maximum-Duty Monitor Arm with Dual-Bar Arm, Heavy-Duty Spring Tilt Head
Specifying
▶ Page 166



Single Flat Panel Monitor Pole Mount with Arm
Specifying
▶ Page 167

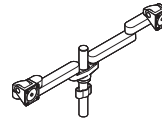

Dual Flat Panel Monitor Pole Mount with Arm
Specifying
▶ Page 167



Flat Panel Pole Mount without Arm
Specifying
▶ Page 168



Single Static Modular Monitor Arm Assembly with Pole
Specifying
▶ Page 168



Single Static One-Over-One Monitor Arm Assembly with Pole
Specifying
▶ Page 169

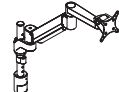

Single Dynamic Modular Monitor Arm Assembly with Pole
Specifying
▶ Page 170

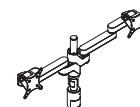

Dual Static Modular Monitor Arm Assembly with Pole
Specifying
▶ Page 171

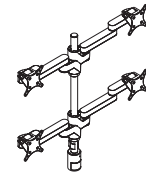

Dual Static Modular Monitor Arm Assembly with Pole
Specifying
▶ Page 172

CF Series Flat Panel Monitor Arms and Supports, continued

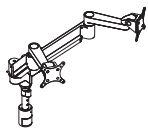

Dual Dynamic Modular Monitor Arm Assembly with Pole
 Specifying
 ▶ Page 173

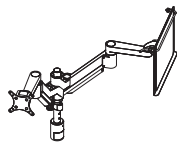

Dual Dynamic Modular Monitor Arm Assembly with Laptop Holder and with Pole
 Specifying
 ▶ Page 174

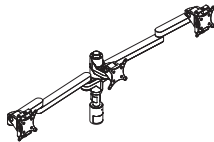

Triple Static Modular Monitor Arm Assembly with Pole
 Specifying
 ▶ Page 175

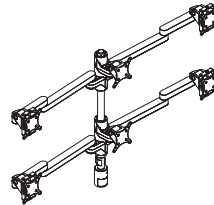

Static Modular Three-Over-Three Monitor Arm Assembly with Pole
 Specifying
 ▶ Page 176

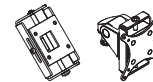

Adjustable Tilt Head Monitor Arm Adapters
 Specifying
 ▶ Page 177

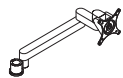

Single Flat Panel Pole Arm
 Specifying
 ▶ Page 178

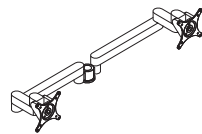

Dual Flat Panel Pole Arm
 Specifying
 ▶ Page 178

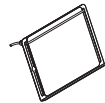

Laptop Holder Platform
 Specifying
 ▶ Page 179



Desk-Clamp/Grommet Bracket
 Specifying
 ▶ Page 180



Through-Mount Bracket
 Specifying
 ▶ Page 180



Desk-Clamp/Grommet/Through-Mount Bracket
 Specifying
 ▶ Page 180



Wall/Reverse Wall Mount Bracket
 Specifying
 ▶ Page 180



Slatwall Bracket
 Specifying
 ▶ Page 180



Maximum-Duty Arm Bracket
 Specifying
 ▶ Page 181



Modular Pole Mount C-Clamp Bracket
 Specifying
 ▶ Page 181



FrameOne Bracket
 Specifying
 ▶ Page 181



c:space Bracket
 Specifying
 ▶ Page 181



T-Shape Dual Base Bracket
 Specifying
 ▶ Page 181

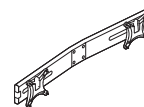

Dual-Bar Bracket
 Specifying
 ▶ Page 181



6" Flat Panel Arm Extender
 Specifying
 ▶ Page 182



Modular Articulating Arm Extensions for Pole Mount Assemblies
 Specifying
 ▶ Page 182



Wall-Mount Monitor Support
 Specifying
 ▶ Page 182



Modular Arm Bracket Connector
 Specifying
 ▶ Page 183



LED Monitor Lights with Bracket
 Specifying
 ▶ Page 183

FYI Flat Panel Monitor Arms and Supports

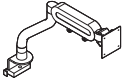

FYI Single Flat Panel Monitor Arm with Mounting Brackets
Specifying
▶ Page 184

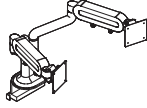

FYI Dual Flat Panel Monitor Arms with Mounting Brackets
Specifying
▶ Page 185

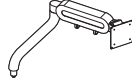

FYI Flat Panel Monitor Arm without Mounting Bracket
Specifying
▶ Page 186



FYI Upper Arm
Specifying
▶ Page 186



FYI Tilt/Pan Only
Specifying
▶ Page 187



Wall Mount Bracket
Specifying
▶ Page 187



Slatwall/SlatRail Bracket
Specifying
▶ Page 187

FYI Sync Flat Panel Monitor Arms and Supports

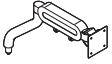

FYI Sync Upper Monitor Arm
Specifying
▶ Page 188

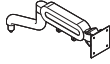

FYI Sync Lower Monitor Arm
Specifying
▶ Page 188

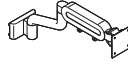

FYI Sync Lower Monitor Arm with Slatwall/SlatRail Mount
Specifying
▶ Page 188

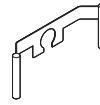

FYI Monitor Handle For Use with Sync
Specifying
▶ Page 188



FYI Sync Hardware Pack
Specifying
▶ Page 188

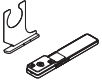

LED Monitor Light with Bracket
Specifying
▶ Page 189

Mechanisms and Tracks

SIN 711.2

Stella Standard Mechanism with 20" Track

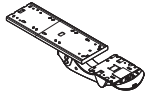

Tip: Mechanism requires 20"D worksurface clearance.

Standard Includes	Required to Specify
<ul style="list-style-type: none"> Standard Stella mechanism and track: 0835 Black 	Style number

Specification Information					
• Dimensions			• Weight	• Style Number	• Price
D	W	H			
16"	6 1/2"	6"	15.5 lb	SS20	\$297
·	·	·	·	·	·

Stella Extended Mechanism with 23" Track

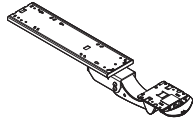

Tip: Mechanism requires 23"D worksurface clearance.

Tip: Extended mechanism recommended for less than 18" radius or 17" diagonal applications.

Standard Includes	Required to Specify
<ul style="list-style-type: none"> Extended Stella mechanism and track: 0835 Black 	Style number

Specification Information					
• Dimensions			• Weight	• Style Number	• Price
D	W	H			
20"	6 1/2"	6"	18.5 lb	SE23	\$314
·	·	·	·	·	·

5" Lift and Lock Mechanism with 18" Track

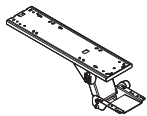

Standard Includes	Required to Specify
<ul style="list-style-type: none"> 5" Lift and Lock mechanism and track: 0835 Black 	Style number

Specification Information					
• Dimensions			• Weight	• Style Number	• Price
D	W	H			
15 1/2"	4"	2 1/4"	11.5 lb	L518	\$160
·	·	·	·	·	·

5" Lift and Lock Mechanism with 22" Track

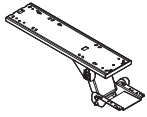

Standard Includes

- 5" Lift and Lock mechanism and track: 0835 Black

Required to Specify

Style number

Specification Information

• Dimensions			• Weight	• Style Number	• Price
D	W	H			
15½"	4"	2¼"	11.5 lb	L522	\$160

5" Lift and Lock Mechanism with 23" Track

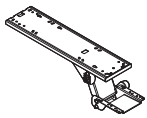

Tip: Mechanism requires 23"D worksurface clearance.

Standard Includes

- 5" Lift and Lock mechanism and track: 0835 Black

Required to Specify

Style number

Specification Information

• Dimensions			• Weight	• Style Number	• Price
D	W	H			
15½"	4"	2¼"	11.5 lb	L523	\$160

7" Lift and Lock Mechanism with 18" Track

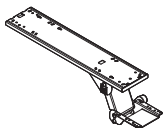

Tip: Extended mechanism recommended for less than 18" radius or 17" diagonal applications.

Standard Includes

- 7" Lift and Lock mechanism and track: 0835 Black

Required to Specify

Style number

Specification Information

• Dimensions			• Weight	• Style Number	• Price
D	W	H			
17½"	4"	2¼"	12.5 lb	L718	\$160

Mechanisms and Tracks, continued

SIN 711.2

7" Lift and Lock Mechanism with 26" Track

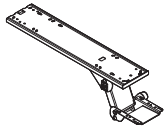

Tip: Mechanism requires 26"D worksurface clearance.

Tip: Extended mechanism recommended for less than 18" radius or 17" diagonal applications.

Standard Includes	Required to Specify
<ul style="list-style-type: none"> 7" Lift and Lock mechanism and track: 0835 Black 	Style number

Specification Information					
• Dimensions			• Weight	• Style Number	• Price
D	W	H			
17½"	4"	2¼"	12.5 lb	L726	\$160
·	·	·	·	·	·

Dial Indicator6 Mechanism with 23" Track

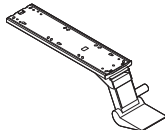

Tip: Mechanism requires 23"D worksurface clearance.

Standard Includes	Required to Specify
<ul style="list-style-type: none"> Dial Indicator6 mechanism and track: 0835 Black 	Style number

Specification Information					
• Dimensions			• Weight	• Style Number	• Price
D	W	H			
17½"	4"	2¼"	8.5 lb	D623	\$233
·	·	·	·	·	·

Stella Standard Mechanism Only



Tip: Mechanism requires a 20"L track to completely store platform under the worksurface.

Standard Includes	Required to Specify
<ul style="list-style-type: none"> Stella Standard mechanism: 0835 Black Attachment hardware 	Style number

Specification Information		
• Weight	• Style Number	• Price
12 lb	SS	\$281
·	·	·

Stella Extended Mechanism Only



Tip: Mechanism requires a 23"L track to completely store platform under the worksurface.

Tip: Extended mechanism recommended for less than 18" radius or 17" diagonal applications.

Standard Includes	Required to Specify
<ul style="list-style-type: none"> Stella Extended mechanism: 0835 Black Attachment hardware 	Style number

Specification Information

Weight	Style Number	Price
15 lb	SE	\$297

5" Lift and Lock Mechanism Only



Tip: Mechanism requires a 23"L track to completely store platform under the worksurface.

Standard Includes	Required to Specify
<ul style="list-style-type: none"> 5" Lift and Lock mechanism: 0835 Black Attachment hardware 	Style number

Specification Information

Weight	Style Number	Price
8 lb	L5	\$144

7" Lift and Lock Mechanism Only



Tip: Mechanism requires a 26"L track to completely store platform under the worksurface.

Tip: Extended mechanism recommended for less than 18" radius or 17" diagonal applications.

Standard Includes	Required to Specify
<ul style="list-style-type: none"> 7" Lift and Lock mechanism: 0835 Black Attachment hardware 	Style number

Specification Information

Weight	Style Number	Price
9 lb	L7	\$144

Mechanisms and Tracks, continued

SIN 711.2

Dial Indicator6 Mechanism Only



Tip: Mechanism requires a 23"L track to completely store platform under the worksurface.

Standard Includes		Required to Specify
<ul style="list-style-type: none"> Dial Indicator6 mechanism: 0835 Black Attachment hardware 		Style number

Specification Information		
Weight	Style Number	Price
5 lb	D6	\$216

Tracks

For Use with Stella Standard, Stella Extended, 5", and 7" Lift and Lock, and Dial Indicator6 Mechanisms



Tip: Attachment hardware and end cap not included. Order service part 18711701SR, if required.

Tip: 11"L and 17"L tracks are recommended for use with c:scape and FrameOne 24"D and 30"D worksurfaces.

Standard Includes		Required to Specify
<ul style="list-style-type: none"> Track: 0835 Black 		Style number

Specification Information			
Dimensions Length	Weight	Style Number	Price
11"	3.5 lb	Q11T	\$17
12"	3.5 lb	Q12T	\$17
17"	3.5 lb	Q17T	\$17
18"	3.5 lb	Q18T	\$17
20"	3.5 lb	Q20T	\$17
22"	3.5 lb	Q22T	\$17
23"	3.5 lb	Q23T	\$17
26"	3.5 lb	Q26T	\$17

Dual Pivot Plate

Tip: Dual pivot plate mounts between keyboard platform and mechanism to allow additional rotation.

Standard Includes		Required to Specify
<ul style="list-style-type: none"> Dual pivot plate: 0835 Black 		Style number

Specification Information				
Dimensions			Style Number	Price
D	W	H	Number	
1"	6"	6"	X04815	\$39

Keyboard Platforms

SIN 711.2

Slider Keyboard Platforms

Tip: Slider keyboard platforms are for use in straight, 21" diagonal, and 22" radius applications.

Tip: Extended mechanism required for less than 18" radius or 17" diagonal applications.

Tip: Slider keyboard platform required 20"W of knee-space clearance below worksurface.

Tip: When using MS Natural Keyboard, specify platform without palm rest.

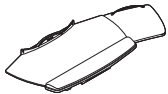

Standard Includes	Required to Specify
<ul style="list-style-type: none"> • Keyboard platform: 7027 Charcoal paint • Foam palm rest, if selected • 8"D x 8"W ambidextrous sliding mouse surface 	Style number

Specification Information					
• Dimensions			• Weight	• Style	• Price
D	W	H		Number	
Without Palm Rest					
9 1/2"	20"	2"	7 lb	SL1000	\$179
With 1 1/2" Standard Adjustable Palm Rest					
9 1/2"	20"	2"	8 lb	SL10SA	\$219
With 3" Deeper Adjustable Palm Rest					
9 1/2"	20"	2"	8 lb	SL10DA	\$239

Computer Support Tools

Keyboard Platforms, continued

SIN 711.2

Jules Keyboard Platforms

Tip: Jules keyboard platforms are for use in straight, 17" diagonal, and 18" radius applications.

Tip: Extended mechanism required for 12" radius corner applications.

Tip: Jules keyboard platform requires 20"W of kneespace clearance below worksurface.

Tip: For use with MS Natural Keyboard, specify platform without palm rest.

Tip: Jules keyboard platform is 19" wide without the ambidextrous, sliding mouse surface.



Standard Includes	Required to Specify
<ul style="list-style-type: none"> Keyboard platform: 6288 Charcoal plastic 8 1/2"D x 8 1/2"W ambidextrous, sliding mouse surface Foam palm rest, if selected 	Style number

Specification Information

• Dimensions			• Weight	• Style	• Price
D	W	H		Number	
:	:	:	:	:	:

Without Palm Rest

12"	19"	2 1/2"	3 lb	JP1000	\$ 87
:	:	:	:	:	:

With Standard Foam Palm Rest

12"	19"	2 1/2"	3.08 lb	JP10SF	\$115
:	:	:	:	:	:

17" and 21" Diagonal Keyboard Platforms with Extended Foam Palm Rest

Tip: Diagonal platforms are for use in 17" and 21" diagonal applications.

Tip: Diagonal keyboard platform require 28"W of kneespace clearance below worksurface.

Tip: Diagonal keyboard platform not recommended for use with MS Natural Keyboard.

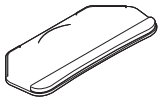
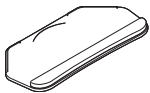

Standard Includes	Required to Specify
<ul style="list-style-type: none"> • Keyboard platform: 6288 Charcoal plastic • Ambidextrous, integrated mouse surface • Foam palm rest 	Style number

Specification Information					
Dimensions			Weight	Style Number	Price
D	W	H			
17" Diagonal Platform					
12 ¹ / ₂ "	27 ¹ / ₂ "	³ / ₄ "	7 lb	1710EF	\$161
21" Diagonal Platform					
12 ¹ / ₂ "	27 ¹ / ₂ "	³ / ₄ "	7 lb	2110EF	\$161

18" Radius Keyboard Platform with Extended Foam Palm Rest



Tip: Radius keyboard platform is for use in 18" radius application only.

Tip: Radius keyboard platform require 28"W of kneespace clearance below worksurface.

Tip: Radius keyboard platform not recommended for use with MS Natural Keyboard.

Standard Includes	Required to Specify
<ul style="list-style-type: none"> • Keyboard platform: 6288 Charcoal plastic • Ambidextrous, integrated mouse surface • Foam palm rest 	Style number

Specification Information					
Dimensions			Weight	Style Number	Price
D	W	H			
14"	27 ¹ / ₂ "	³ / ₄ "	7 lb	1810EF	\$161

Keyboard Platforms, continued

SIN 711.2

Classic Rectangular Keyboard Platforms

Tip: Classic Rectangular keyboard platforms are for straight applications only.

Tip: Classic Rectangular with positionable palm rest is available in 4750 Champagne and 7027 Charcoal only.

Tip: Classic Rectangular with full-width, fixed height palm rest is available in 7018 Pewter and 7027 Charcoal only.

Tip: Classic Rectangular keyboard platforms require 28"W of kneespace clearance below worksurface.

Tip: When using MS Natural Keyboard, specify platform without palm rest.

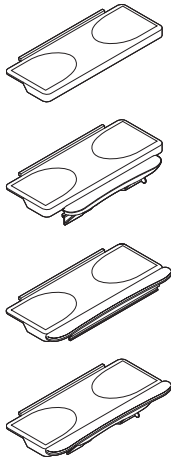

Standard Includes	Required to Specify
<ul style="list-style-type: none"> • Keyboard platform: 7027 Charcoal paint • Ambidextrous, integrated mouse surface • Foam palm rest, if selected 	Style number

Specification Information

• Dimensions			• Weight	• Style Number	• Price
D	W	H			
Without Palm Rest					
10 ¹ / ₄ "	27 ¹ / ₂ "	2 ¹ / ₂ "	8.5 lb	CR1000	\$110
With Positionable Palm Rest					
10 ¹ / ₄ "	27 ¹ / ₂ "	2 ¹ / ₂ "	10.5 lb	CR10PP	\$199
With Full-Width, Fixed-Height Palm Rest					
10 ¹ / ₄ "	27 ¹ / ₂ "	2 ¹ / ₂ "	9.5 lb	CR10FF	\$190
With Full-Width, Adjustable Palm Rest					
10 ¹ / ₄ "	27 ¹ / ₂ "	2 ¹ / ₂ "	10.5 lb	CR10FA	\$217

26" Keyboard Platforms

Tip: 26" keyboard platform is for use in straight application only.

Tip: 26" keyboard platforms require 26" of kneespace clearance below worksurface.

Tip: When using MS Natural Keyboard, specify platform without palm rest.

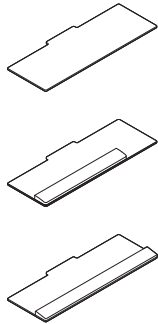

Standard Includes	Required to Specify
<ul style="list-style-type: none"> Keyboard platform: 7027 Charcoal paint Ambidextrous, integrated mouse surface Green-Gel palm rest, if selected 	1 Style number 2 Palm rest type (see below under Required Selections)

Required Selections	Price	Required to Specify
Palm Rest		
<ul style="list-style-type: none"> Non-antimicrobial Antimicrobial 	No cost No cost	Specify with <i>non-antimicrobial</i> . Specify with <i>antimicrobial</i> .

Specification Information

Dimensions			Weight	Style Number	Price
D	W	H			

Without Palm Rest

9 ³ / ₄ "	26"	1/4"	4 lb	261000	\$131
---------------------------------	-----	------	------	---------------	-------

With 19" Green-Gel Palm Rest

9 ³ / ₄ "	26"	1/4"	4.9 lb	2610GG	\$153
---------------------------------	-----	------	--------	---------------	-------

With 26" Green-Gel Palm Rest

9 ³ / ₄ "	26"	1/4"	5 lb	261026GG	\$159
---------------------------------	-----	------	------	-----------------	-------

Keyboard Platforms, continued

SIN 711.2

19" Keyboard Platforms

Tip: 19" keyboard platforms are for use in straight, 17" diagonal, and 18" radius applications.

Tip: Extended mechanism required for 12" radius corner applications.

Tip: 19" keyboard platforms require 28"W of kneespace clearance.

Tip: When using MS Natural Keyboard, specify platform without palm rest.

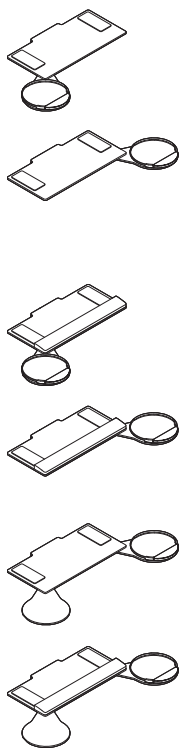

Standard Includes	Required to Specify
-------------------	---------------------

- | | |
|---|--|
| <ul style="list-style-type: none"> • Keyboard platform: 7027 Charcoal paint • 9" diameter same-plane swivel mouse surface • Mouse pad with mouse retention fence/wire management • Green-Gel palm rest, if selected | <ul style="list-style-type: none"> 1 Style number 2 Palm rest type (see below under Required Selections) |
|---|--|

Required Selections	Price	Required to Specify
---------------------	-------	---------------------

- | | | |
|---|--------------------|--|
| Palm Rest <ul style="list-style-type: none"> • Non-antimicrobial • Antimicrobial | No cost
No cost | Specify with <i>non-antimicrobial</i> .
Specify with <i>antimicrobial</i> . |
|---|--------------------|--|

Specification Information

Dimensions			Weight	Style Number	Price
D	W	H			
:	:	:	:	:	:
:	:	:	:	:	:

Without Palm Rest

Left-Handed

9 ³ / ₄ "	19"	1/4"	3.5 lb	19ML00	\$120
---------------------------------	-----	------	--------	---------------	-------

Right-Handed

9 ³ / ₄ "	19"	1/4"	3.5 lb	19MR00	\$120
:	:	:	:	:	:

With Green-Gel Palm Rest

Left-Handed

9 ³ / ₄ "	19"	1/4"	4.4 lb	19MLGG	\$142
---------------------------------	-----	------	--------	---------------	-------

Right-Handed

9 ³ / ₄ "	19"	1/4"	4.4 lb	19MRGG	\$142
:	:	:	:	:	:

19" Dual-Mouse Platform without Palm Rest

9 ³ / ₄ "	19"	1/4"	4 lb	19MD00	\$165
:	:	:	:	:	:

19" Dual-Mouse Platform with Green-Gel Palm Rest

9 ³ / ₄ "	19"	1/4"	4.9 lb	19MDGG	\$187
:	:	:	:	:	:

19" Keyboard Platforms with Articulating Mouse

Tip: 19" keyboard platforms are for use in straight, 17" diagonal, and 12" radius applications.

Tip: Extended mechanism required for 12" radius corner applications.

Tip: 19" platform with articulating mouse, requires 21½"W of kneespace clearance below worksurface.

Tip: Mouse surface allows six different height positions and can be positioned over 10 key or used on the same horizontal plane as the platform.

Tip: When using MS Natural Keyboard, specify platform without palm rest.

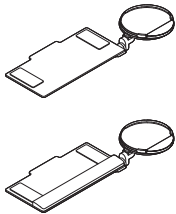

Standard Includes	Required to Specify
<ul style="list-style-type: none"> Keyboard platform: 7027 Charcoal paint 9" diameter height-adjustable swivel mouse surface Mouse pad with mouse retention fence/wire management Green-Gel palm rest, if selected 	<ul style="list-style-type: none"> 1 Style number 2 Palm rest type (see below under Required Selections)

Required Selections	Price	Required to Specify
Palm Rest <ul style="list-style-type: none"> Non-antimicrobial Antimicrobial 	No cost No cost	Specify with non-antimicrobial. Specify with antimicrobial.

Specification Information

• Dimensions			• Weight	• Style	• Price
D	W	H	:	Number	:
:	:	:	:	:	:

Without Palm Rest

9¾"	19"	1/4"	4 lb	19AM00	\$203
:	:	:	:	:	:

With Green-Gel Palm Rest

9¾"	19"	1/4"	4.9 lb	19AMGG	\$224
:	:	:	:	:	:

Keyboard Platforms, continued

SIN 711.2

Enviro Keyboard Platforms

Tip: Enviro keyboard platforms are for use in straight, 17" diagonal, and 18" radius applications.

Tip: Enviro keyboard platform requires 28"W of kneespace clearance below worksurface.

Tip: When using MS Natural Keyboard, specify platform without palm rest.

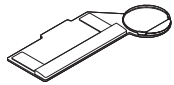
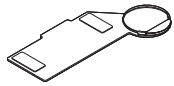

Standard Includes	Required to Specify
<ul style="list-style-type: none"> • Keyboard platform: 7027 Charcoal paint • Reversible platform for left- or right-hand use • Mouse pad with mouse retention fence/wire management • Green-Gel palm rest, if selected 	<ul style="list-style-type: none"> 1 Style number 2 Palm rest type (see below under Required Selections)

Palm Rest	Required Selections	Price	Required to Specify
	<ul style="list-style-type: none"> • Non-antimicrobial • Antimicrobial 	<ul style="list-style-type: none"> No cost No cost 	<ul style="list-style-type: none"> Specify with non-antimicrobial. Specify with antimicrobial.

Specification Information

• Dimensions			• Weight	• Style	• Price
D	W	H		Number	
:	:	:	:	:	:
:	:	:	:	:	:

Without Palm Rest

14 ¹ / ₂ "	28"	³ / ₄ "	3.5 lb	EN1000	\$120
:	:	:	:	:	:

With Green-Gel Palm Rest

14 ¹ / ₂ "	28"	³ / ₄ "	4.4 lb	EN10GG	\$142
:	:	:	:	:	:

FrameOne/c:scape Keyboard Platforms

Tip: FrameOne/c:scape keyboard platform is for use with FrameOne, c:scape, and shallow depth worksurface applications only.

Tip: FrameOne/c:scape keyboard platform is for use with Stella Standard mechanisms only.

Tip: FrameOne/c:scape keyboard platform requires 28"W of kneespace clearance below worksurface.

Tip: FrameOne/c:scape keyboard platform will stow under 30"D FrameOne and c:scape worksurfaces when used with a 17"L track and Stella Standard mechanism.

Tip: FrameOne/c:scape platform will not stow under 24"D FrameOne or c:scape worksurfaces.

Tip: When using MS Natural Keyboard, specify platform without palm rest.

Standard Includes	Required to Specify
<ul style="list-style-type: none"> Keyboard platform: 7027 Charcoal paint 9" diameter swiveling mouse surface Mouse pad with mouse retention fence/wire management Green-Gel palm rest, if selected 	<ul style="list-style-type: none"> 1 Style number 2 Palm rest type (see below under Required Selections)

Required Selections	Price	Required to Specify
Palm Rest <ul style="list-style-type: none"> Non-antimicrobial Antimicrobial 	No cost No cost	Specify with <i>non-antimicrobial</i> . Specify with <i>antimicrobial</i> .

Specification Information

Dimensions	Weight	Style Number	Price
D W H			

Without Palm Rest

Left-Handed

9"	19"	1/4"	3.5 lb	FOCSML00	\$120
----	-----	------	--------	-----------------	-------

Right-Handed

9"	19"	1/4"	3.5 lb	FOCSMR00	\$120
----	-----	------	--------	-----------------	-------

With Green-Gel Palm Rest

Left-Handed

9"	19"	1/4"	4.4 lb	FOCSMLGG	\$142
----	-----	------	--------	-----------------	-------

Right-Handed

9"	19"	1/4"	4.4 lb	FOCSMRGG	\$142
----	-----	------	--------	-----------------	-------

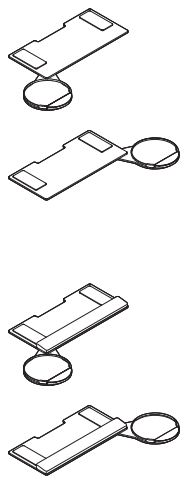

Palm Rests

SIN 711.2

Standard Adjustable Foam Palm Rest

For Use with Freestanding Palm Rest or Slider Keyboard Platforms



Standard Includes	Required to Specify
• Foam palm rest: 7027 Charcoal paint	Style number

Specification Information

• Dimensions			• Weight	• Style Number	• Price
D	W	H			
3"	18"	2"	1 lb	SA	\$40
:	:	:	:	:	:

Cushioned Replacement Pads

For Use with Freestanding Palm Rest or Slider Keyboard Platforms

Tip: Replacement pad snaps down into existing palm rest.



Standard Includes	Required to Specify
• Pad: 7027 Charcoal paint	Style number

Specification Information

• Dimensions			• Weight	• Style Number	• Price
D	W	H			
1 1/2"			1 lb	CSWP	\$36
3"			1 lb	CSWPD	\$56
:	:	:	:	:	:

Slider Platform Mousing Surface Palm Rest



Tip: Slider platform mousing surface palm rest is for use with Slider keyboard platforms only.

Tip: Palm rest must be removed to slide mouse surface.

Standard Includes				Required to Specify	
• Foam palm rest: 7027 Charcoal paint				Style number	
Specification Information					
• Dimensions			• Weight	• Style Number	• Price
D	W	H			
1 1/2"	6 5/8"	1"	1 lb	SMPRS	\$53

19" Green-Gel Palm Rest

For Use with 19", 26", Enviro, or FrameOne/c:scape Keyboard Platforms



Tip: 19" palm rest is for use with 19", 26", Enviro, and FrameOne/c:scape platforms.

Standard Includes				Required to Specify	
• Palm rest: 0835 Black				Style number	
Specification Information					
• Dimensions			• Weight	• Style Number	• Price
D	W	H			
3/4"	19"	2 1/2"	0.9 lb	GG	\$23

26" Green-Gel Palm Rest

For Use with 26" Keyboard Platforms



Tip: 26" palm rest is for use with 26" keyboard platform only.

Standard Includes				Required to Specify	
• Palm rest: 0835 Black				Style number	
Specification Information					
• Dimensions			• Weight	• Style Number	• Price
D	W	H			
3/4"	26"	2 1/2"	1 lb	26GG	\$28

Palm Rests, continued

SIN 711.2

Full-Width, Fixed-Height Palm Rest

For Use with Classic Rectangular Platforms



Standard Includes	Required to Specify
• Palm rest: 7027 Charcoal paint	Style number

Specification Information

• Dimensions			• Weight	• Style	• Price
D	W	H		Number	
2 1/2"	27 1/2"	2 1/2"	1 lb	FF	\$82
:	:	:	:	:	:

Full-Width, Height-Adjustable Palm Rest

For Use with Classic Rectangular Platforms



Standard Includes	Required to Specify
• Palm rest: 7027 Charcoal paint	Style number

Specification Information

• Dimensions			• Weight	• Style	• Price
D	W	H		Number	
2 1/2"	27 1/2"	2 1/2"	2 lb	FA	\$114
:	:	:	:	:	:

Positionable Palm Rest

For Use with Classic Rectangular Platforms



Tip: Palm rest can be positioned on the left- or right-hand side.

Standard Includes	Required to Specify
• Palm rest: 7027 Charcoal paint	Style number

Specification Information

• Dimensions			• Weight	• Style	• Price
D	W	H		Number	
2"	19 1/2"	2 1/2"	2 lb	PP	\$92
:	:	:	:	:	:

Standard Foam Palm Rest

For Use with Jules Platforms



Standard Includes	Required to Specify
-------------------	---------------------

- Palm rest: 6288 Charcoal plastic

Style number

Specification Information					
• Dimensions			• Weight	• Style	• Price
D	W	H		Number	

3/4"	18 1/2"	2 1/2"	0.08 lb	SF	\$28
------	---------	--------	---------	-----------	------

Extended Foam Palm Rest

For Use with Diagonal and Radius Platforms



Standard Includes	Required to Specify
-------------------	---------------------

- Palm rest: 6288 Charcoal plastic

Style number

Specification Information					
• Dimensions			• Weight	• Style	• Price
D	W	H		Number	

3/4"	26"	2 1/2"	0.1 lb	EF	\$33
------	-----	--------	--------	-----------	------

Keyboard Assemblies

SIN 711.2

Stella Standard Keyboard Assemblies

Tip: Jules platform can be used in 12" radius corners when used with an extended mechanism.

Tip: Be sure to consider the mechanism track length in relationship to the work surface depth.

Standard Includes	Required to Specify
<ul style="list-style-type: none"> Mechanism and 20"L track: 0835 Black Keyboard platform: <ul style="list-style-type: none"> Slider and Classic Rectangular: 7027 Charcoal paint Jules, Diagonal, and Radius: 6288 Charcoal plastic 19", 26", and Enviro: 7027 Charcoal paint Mouse surface: <ul style="list-style-type: none"> Slider and Jules: ambidextrous, sliding mouse surface Diagonal, Radius, Classic Rectangular, and 26": ambidextrous, integrated mouse surface 19" and Enviro: 9" diameter same-plane, swivel mouse surface Palm rest, if selected 	<ul style="list-style-type: none"> 1 Style number 2 Palm rest type, if green-gel palm rest is selected (see below under Required Selections)

Required Selections	Price	Required to Specify
Palm Rest <ul style="list-style-type: none"> Non-antimicrobial Antimicrobial 	No cost No cost	Specify with <i>non-antimicrobial</i> . Specify with <i>antimicrobial</i> .

Specification Information

Dimensions	Style	Price
D W H	Number	
:	:	:
:	:	:

Slider Platforms

Without Palm Rest

9 1/2"	20"	3"	SS20SL1000	\$476
--------	-----	----	-------------------	-------

With Standard Palm Rest

9 1/2"	20"	3"	SS20SL10SA	\$516
--------	-----	----	-------------------	-------

With Deep Palm Rest

9 1/2"	20"	3"	SS20SL10DA	\$536
--------	-----	----	-------------------	-------

Jules Platforms

Without Palm Rest

12"	18 3/4"	5 5/8"	SS20JP1000	\$384
-----	---------	--------	-------------------	-------

With Standard Foam Palm Rest

12"	18 3/4"	5 5/8"	SS20JP10SF	\$412
-----	---------	--------	-------------------	-------

► **Specification Information, continued on next page**

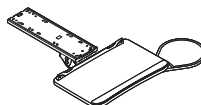
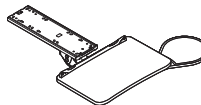
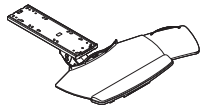
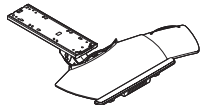
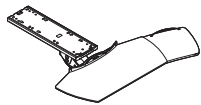

► Specification Information, continued from previous page

Specification Information

Dimensions			Style Number	Price
D	W	H		

Diagonal Platforms

17" with Extended Foam Palm Rest

12"	27½"	3"	SS201710EF	\$458
-----	------	----	-------------------	-------

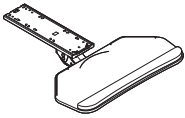

21" with Extended Foam Palm Rest

12"	27½"	3"	SS202110EF	\$458
-----	------	----	-------------------	-------

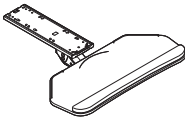

Radius Platform

18" with Extended Foam Palm Rest

14"	27½"	3"	SS201810EF	\$458
-----	------	----	-------------------	-------

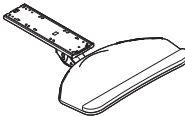

Classic Rectangular Platforms

Without Palm Rest

10¼"	27½"	5⅝"	SS20CR1000	\$407
------	------	-----	-------------------	-------

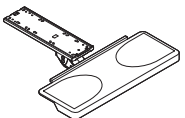

With Positionable Palm Rest

10¼"	27½"	5⅝"	SS20CR10PP	\$496
------	------	-----	-------------------	-------

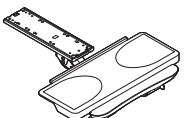

With Full-Width, Fixed-Height Palm Rest

10¼"	27½"	5⅝"	SS20CR10FF	\$487
------	------	-----	-------------------	-------

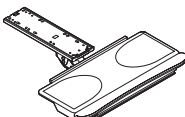

With Full-Width, Height-Adjustable Palm Rest

10¼"	27½"	5⅝"	SS20CR10FA	\$514
------	------	-----	-------------------	-------

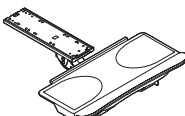

► Specification Information, continued on next page

Keyboard Assemblies, continued

SIN 711.2

► Specification Information, continued from previous page

Specification Information

Dimensions			Style Number	Price
D	W	H		

19" Platforms without Palm Rest

Left-Handed

9 ³ / ₄ "	19"	3"	SS2019ML00	\$417
---------------------------------	-----	----	-------------------	-------

Right-Handed

9 ³ / ₄ "	19"	3"	SS2019MR00	\$417
---------------------------------	-----	----	-------------------	-------

Dual Mouse

9 ³ / ₄ "	19"	3"	SS2019MD00	\$462
---------------------------------	-----	----	-------------------	-------

With Articulating Mouse Surface

9 ³ / ₄ "	19"	3"	SS2019AM00	\$500
---------------------------------	-----	----	-------------------	-------

19" Platforms with Green-Gel Palm Rest

Left-Handed

9 ³ / ₄ "	19"	3"	SS2019MLGG	\$439
---------------------------------	-----	----	-------------------	-------

Right-Handed

9 ³ / ₄ "	19"	3"	SS2019MRGG	\$439
---------------------------------	-----	----	-------------------	-------

Dual Mouse

9 ³ / ₄ "	19"	3"	SS2019MDGG	\$484
---------------------------------	-----	----	-------------------	-------

With Articulating Mouse Surface

9 ³ / ₄ "	19"	3"	SS2019AMGG	\$521
---------------------------------	-----	----	-------------------	-------

► Specification Information, continued on next page

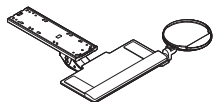
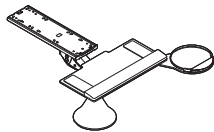
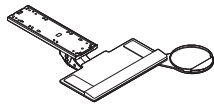
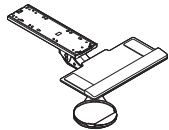
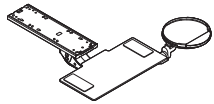
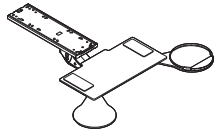
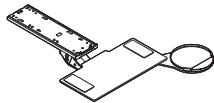
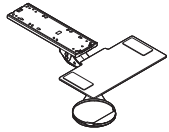

► Specification Information, continued from previous page

Specification Information

Dimensions			Style Number	Price
D	W	H		

Enviro Platforms

Without Palm Rest

14 ¹ / ₂ "	28"	3"	SS20EN1000	\$417
----------------------------------	-----	----	-------------------	-------

With Green Gel Palm Rest

14 ¹ / ₂ "	28"	3"	SS20EN10GG	\$439
----------------------------------	-----	----	-------------------	-------

26" Platforms

Without Palm Rest

9 ³ / ₄ "	26"	3"	SS20261000	\$428
---------------------------------	-----	----	-------------------	-------

With 19" Green Gel Palm Rest

9 ³ / ₄ "	26"	3"	SS202610GG	\$450
---------------------------------	-----	----	-------------------	-------

With 26" Green Gel Palm Rest

9 ³ / ₄ "	26"	3"	SS20261026GG	\$456
---------------------------------	-----	----	---------------------	-------

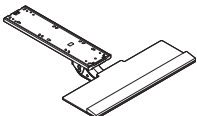
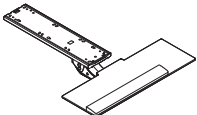
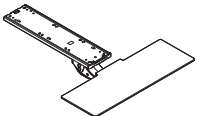
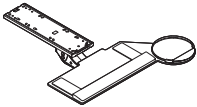
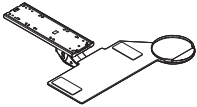

Keyboard Assemblies, continued

SIN 711.2

Stella Extended Keyboard Assemblies

Tip: Be sure to consider the mechanism track length in relationship to the work surface depth.

Standard Includes	Required to Specify
<ul style="list-style-type: none"> • Mechanism and 23"L track: 0835 Black • Keyboard platform: <ul style="list-style-type: none"> – Slider and Classic Rectangular: 7027 Charcoal paint – Jules, Diagonal, and Radius: 6288 Charcoal plastic – 19", 26" and Enviro: 7027 Charcoal paint • Mouse surface: <ul style="list-style-type: none"> – Slider and Jules: ambidextrous, sliding mouse surface – Diagonal, Radius, Classic Rectangular, and 26": ambidextrous, integrated mouse surface – 19" and Enviro: 9" diameter same-plane, swivel mouse surface • Palm rest, if selected 	<ul style="list-style-type: none"> 1 Style number 2 Palm rest type, if green-gel palm rest is selected (see below under Required Selections)

Required Selections	Price	Required to Specify
Palm Rest <ul style="list-style-type: none"> • Non-antimicrobial • Antimicrobial 	No cost No cost	Specify <i>with non-antimicrobial</i> . Specify <i>with antimicrobial</i> .

Specification Information

Dimensions	Style	Price
D W H	Number	
:	:	:

Slider Platforms

With Standard Palm Rest

9 ¹ / ₂ "	20"	3"	SE23SL10SA	\$533
---------------------------------	-----	----	-------------------	-------

With Deep Palm Rest

9 ¹ / ₂ "	20"	3"	SE23SL10DA	\$553
:	:	:	:	:

Jules Platforms

Without Palm Rest

12"	18 ³ / ₄ "	5 ⁵ / ₈ "	SE23JP1000	\$401
-----	----------------------------------	---------------------------------	-------------------	-------

With Standard Foam Palm Rest

12"	18 ³ / ₄ "	5 ⁵ / ₈ "	SE23JP10SF	\$429
:	:	:	:	:

► **Specification Information, continued on next page**

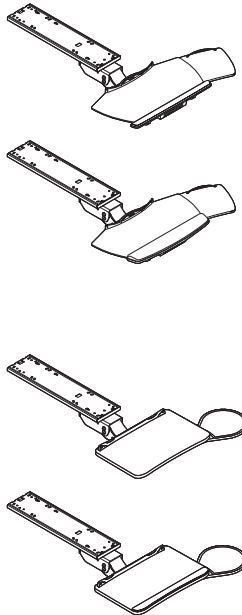

► Specification Information, continued from previous page

Specification Information

Dimensions			Style	Price
D	W	H	Number	
:	:	:	:	:

Diagonal Platforms

17" with Extended Foam Palm Rest

12 ¹ / ₂ "	27 ¹ / ₂ "	3"	SE231710EF	\$475
----------------------------------	----------------------------------	----	-------------------	-------

21" with Extended Foam Palm Rest

12 ¹ / ₂ "	27 ¹ / ₂ "	3"	SE232110EF	\$475
----------------------------------	----------------------------------	----	-------------------	-------

Radius Platform

18" with Extended Foam Palm Rest

14"	27 ¹ / ₂ "	3"	SE231810EF	\$475
-----	----------------------------------	----	-------------------	-------

Classic Rectangular Platforms

Without Palm Rest

10 ¹ / ₄ "	27 ¹ / ₂ "	5 ⁵ / ₈ "	SE23CR1000	\$424
----------------------------------	----------------------------------	---------------------------------	-------------------	-------

With Positionable Palm Rest

10 ¹ / ₄ "	27 ¹ / ₂ "	5 ⁵ / ₈ "	SE23CR10PP	\$513
----------------------------------	----------------------------------	---------------------------------	-------------------	-------

With Full-Width, Fixed-Height Palm Rest

10 ¹ / ₄ "	27 ¹ / ₂ "	5 ⁵ / ₈ "	SE23CR10FF	\$504
----------------------------------	----------------------------------	---------------------------------	-------------------	-------

With Full-Width, Height-Adjustable Palm Rest

10 ¹ / ₄ "	27 ¹ / ₂ "	5 ⁵ / ₈ "	SE23CR10FA	\$531
----------------------------------	----------------------------------	---------------------------------	-------------------	-------

► Specification Information, continued on next page

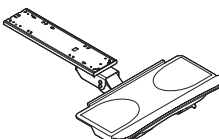
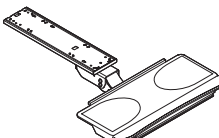
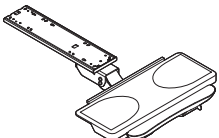
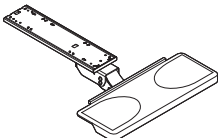
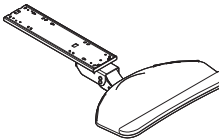
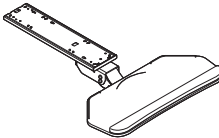
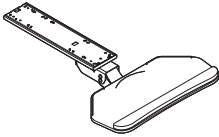

Keyboard Assemblies, continued

SIN 711.2

► Specification Information, continued from previous page

Specification Information

Dimensions			Style Number	Price
D	W	H		

19" Platforms without Palm Rest

Left-Handed

9 ³ / ₄ "	19"	3"	SE2319ML00	\$434
---------------------------------	-----	----	-------------------	-------

Right-Handed

9 ³ / ₄ "	19"	3"	SE2319MR00	\$434
---------------------------------	-----	----	-------------------	-------

Dual Mouse

9 ³ / ₄ "	19"	3"	SE2319MD00	\$479
---------------------------------	-----	----	-------------------	-------

With Articulating Mouse Surface

9 ³ / ₄ "	19"	3"	SE2319AM00	\$517
---------------------------------	-----	----	-------------------	-------

19" Platforms with Green-Gel Palm Rest

Left-Handed

9 ³ / ₄ "	19"	3"	SE2319MLGG	\$456
---------------------------------	-----	----	-------------------	-------

Right-Handed

9 ³ / ₄ "	19"	3"	SE2319MRGG	\$456
---------------------------------	-----	----	-------------------	-------

Dual Mouse

9 ³ / ₄ "	19"	3"	SE2319MDGG	\$501
---------------------------------	-----	----	-------------------	-------

With Articulating Mouse Surface

9 ³ / ₄ "	19"	3"	SE2319AMGG	\$538
---------------------------------	-----	----	-------------------	-------

► Specification Information, continued on next page

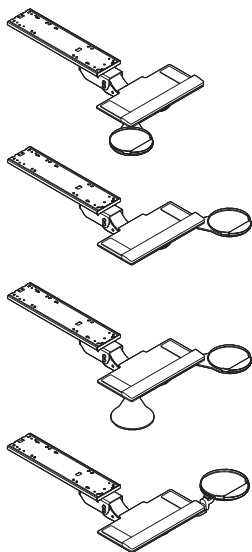
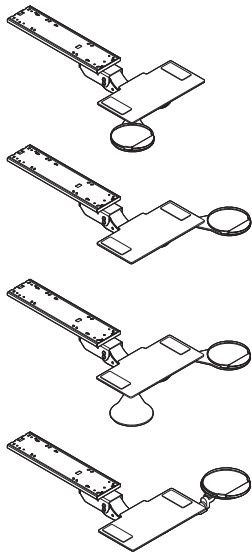

► Specification Information, continued from previous page

Specification Information

Dimensions			Style Number	Price
D	W	H		

Enviro Platforms

Without Palm Rest

14 ¹ / ₂ "	28"	3"	SE23EN1000	\$434
----------------------------------	-----	----	-------------------	-------

With Green Gel Palm Rest

14 ¹ / ₂ "	28"	3"	SE23EN10GG	\$456
----------------------------------	-----	----	-------------------	-------

26" Platforms

Without Palm Rest

9 ³ / ₄ "	26"	5 ⁵ / ₈ "	SE23261000	\$445
---------------------------------	-----	---------------------------------	-------------------	-------

With 19" Green Gel Palm Rest

9 ³ / ₄ "	26"	3"	SE232610GG	\$467
---------------------------------	-----	----	-------------------	-------

With 26" Green Gel Palm Rest

9 ³ / ₄ "	26"	3"	SE23261026GG	\$473
---------------------------------	-----	----	---------------------	-------

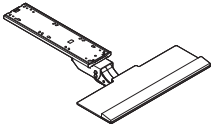
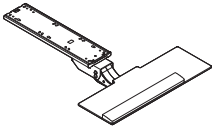
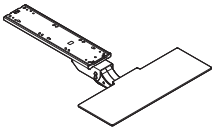
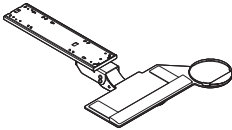
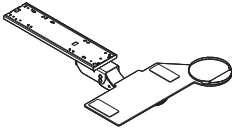

Computer Support Tools

Keyboard Assemblies, continued

SIN 711.2

5" Lift and Lock Keyboard Assemblies

with 18"L Track

Tip: Be sure to consider the mechanism track length in relationship to the work surface depth.

Standard Includes **Required to Specify**

- Mechanism and 18"L track: 0835 Black
- Keyboard platform:
 - 19" and Enviro: 7027 Charcoal paint
- Mouse surface:
 - 19" and Enviro: 9" diameter same-plane, swivel mouse surface
- Palm rest, if selected

- 1 Style number
- 2 Palm rest type, if green-gel palm rest is selected (see below under Required Selections)

Required Selections **Price** **Required to Specify**

Palm Rest	<ul style="list-style-type: none"> • Non-antimicrobial • Antimicrobial 	No cost No cost	Specify <i>with non-antimicrobial.</i> Specify <i>with antimicrobial.</i>
------------------	--	--------------------	--

Specification Information

• Dimensions			• Style	• Price
D	W	H	Number	
:	:	:	:	:
:	:	:	:	:

19" Platforms without Palm Rest

Left-Handed

9 ³ / ₄ "	19"	3"	L51819ML00	\$280
---------------------------------	-----	----	-------------------	-------

Right-Handed

9 ³ / ₄ "	19"	3"	L51819MR00	\$280
---------------------------------	-----	----	-------------------	-------

Dual Mouse

9 ³ / ₄ "	19"	3"	L51819MD00	\$325
---------------------------------	-----	----	-------------------	-------

With Articulating Mouse Surface

9 ³ / ₄ "	19"	3"	L51819AM00	\$363
---------------------------------	-----	----	-------------------	-------

► **Specification Information, continued on next page**

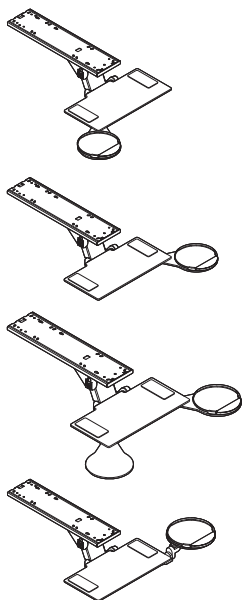

► Specification Information, continued from previous page

Specification Information

Dimensions			Style	Price
D	W	H	Number	

19" Platforms with Green-Gel Palm Rest

Left-Handed

9 ³ / ₄ "	19"	3"	L51819MLGG	\$302
---------------------------------	-----	----	-------------------	-------

Right-Handed

9 ³ / ₄ "	19"	3"	L51819MRGG	\$302
---------------------------------	-----	----	-------------------	-------

Dual Mouse

9 ³ / ₄ "	19"	3"	L51819MDGG	\$347
---------------------------------	-----	----	-------------------	-------

With Articulating Mouse Surface

9 ³ / ₄ "	19"	3"	L51819AMGG	\$384
---------------------------------	-----	----	-------------------	-------

Enviro Platforms

Without Palm Rest

14 ¹ / ₂ "	28"	3"	L518EN1000	\$280
----------------------------------	-----	----	-------------------	-------

With Green Gel Palm Rest

14 ¹ / ₂ "	28"	3"	L518EN10GG	\$302
----------------------------------	-----	----	-------------------	-------

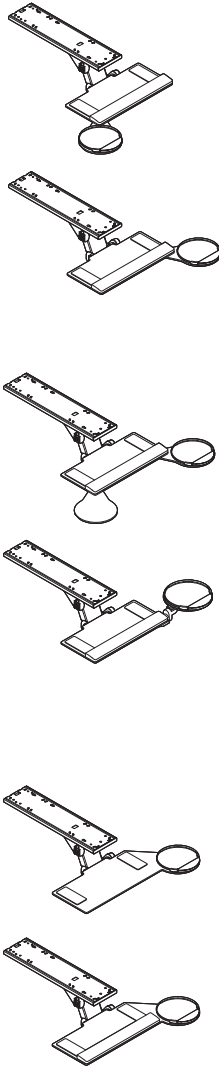

Keyboard Assemblies, continued

SIN 711.2

5" Lift and Lock Keyboard Assemblies

with 22"L Track

Tip: Be sure to consider the mechanism track length in relationship to the work surface depth.

Standard Includes **Required to Specify**

- | | |
|--|--|
| <ul style="list-style-type: none"> • Mechanism and 22"L track: 0835 Black • Keyboard platform: <ul style="list-style-type: none"> – Slider and Classic Rectangular: 7027 Charcoal paint – Jules, Diagonal, and Radius: 6288 Charcoal plastic – 19", 26", and Enviro: 7027 Charcoal paint • Mouse surface: <ul style="list-style-type: none"> – Slider and Jules: ambidextrous, sliding mouse surface – Diagonal, Radius, Classic Rectangular, and 26" ambidextrous, integrated mouse surface – 19" and Enviro: 9" diameter same-plane, swivel mouse surface • Palm rest, if selected | <ul style="list-style-type: none"> 1 Style number 2 Palm rest type, if green-gel palm rest is selected (see below under Required Selections) |
|--|--|

Required Selections **Price** **Required to Specify**

Palm Rest	<ul style="list-style-type: none"> • Non-antimicrobial • Antimicrobial 	No cost No cost	Specify <i>with non-antimicrobial</i> . Specify <i>with antimicrobial</i> .
------------------	--	--------------------	--

Specification Information

• Dimensions	• Style	• Price
D W H	Number	
•••	•••	•••

Slider Platforms

Without Palm Rest

9½"	20"	3"	L522SL1000	\$339
-----	-----	----	-------------------	-------

With Standard Palm Rest

9½"	20"	3"	L522SL10SA	\$379
-----	-----	----	-------------------	-------

With Deep Palm Rest

9½"	20"	3"	L522SL10DA	\$399
-----	-----	----	-------------------	-------

Jules Platforms

Without Palm Rest

12"	18¾"	5⅝"	L522JP1000	\$247
-----	------	-----	-------------------	-------

With Standard Foam Palm Rest

12"	18¾"	5⅝"	L522JP10SF	\$275
-----	------	-----	-------------------	-------

► **Specification Information, continued on next page**

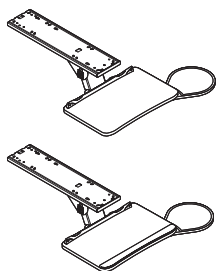
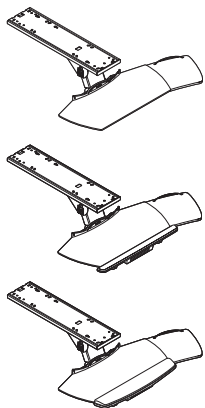

► Specification Information, continued from previous page

Specification Information

Dimensions			Style	Price
D	W	H	Number	

Diagonal Platforms

17" with Extended Foam Palm Rest

12 ¹ / ₂ "	27 ¹ / ₂ "	3"	L5221710EF	\$321
----------------------------------	----------------------------------	----	-------------------	-------

21" with Extended Foam Palm Rest

12 ¹ / ₂ "	27 ¹ / ₂ "	3"	L5222110EF	\$321
----------------------------------	----------------------------------	----	-------------------	-------

Radius Platform

18" with Extended Foam Palm Rest

14 ¹ / ₂ "	27 ¹ / ₂ "	3"	L5221810EF	\$321
----------------------------------	----------------------------------	----	-------------------	-------

Classic Rectangular Platforms

Without Palm Rest

10 ¹ / ₄ "	27 ¹ / ₂ "	5 ⁵ / ₈ "	L522CR1000	\$270
----------------------------------	----------------------------------	---------------------------------	-------------------	-------

With Positionable Palm Rest

10 ¹ / ₄ "	27 ¹ / ₂ "	5 ⁵ / ₈ "	L522CR10PP	\$359
----------------------------------	----------------------------------	---------------------------------	-------------------	-------

With Full-Width, Fixed-Height Palm Rest

10 ¹ / ₄ "	27 ¹ / ₂ "	5 ⁵ / ₈ "	L522CR10FF	\$350
----------------------------------	----------------------------------	---------------------------------	-------------------	-------

With Full-Width, Height-Adjustable Palm Rest

10 ¹ / ₄ "	27 ¹ / ₂ "	5 ⁵ / ₈ "	L522CR10FA	\$377
----------------------------------	----------------------------------	---------------------------------	-------------------	-------

► Specification Information, continued on next page

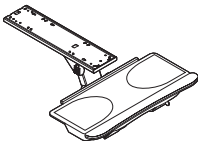
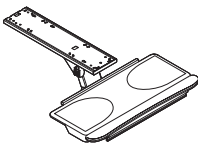
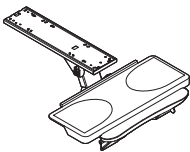
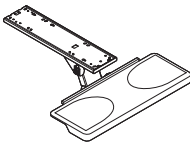
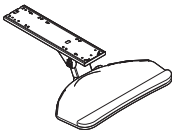
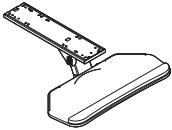
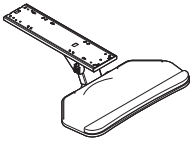

Keyboard Assemblies, continued

SIN 711.2

► Specification Information, continued from previous page

Specification Information

Dimensions			Style	Price
D	W	H	Number	

19" Platforms without Palm Rest

Left-Handed

9 ³ / ₄ "	19"	3"	L52219ML00	\$280
---------------------------------	-----	----	-------------------	-------

Right-Handed

9 ³ / ₄ "	19"	3"	L52219MR00	\$280
---------------------------------	-----	----	-------------------	-------

Dual Mouse

9 ³ / ₄ "	19"	3"	L52219MD00	\$325
---------------------------------	-----	----	-------------------	-------

With Articulating Mouse Surface

9 ³ / ₄ "	19"	3"	L52219AM00	\$363
---------------------------------	-----	----	-------------------	-------

19" Platforms with Green-Gel Palm Rest

Left-Handed

9 ³ / ₄ "	19"	3"	L52219MLGG	\$302
---------------------------------	-----	----	-------------------	-------

Right-Handed

9 ³ / ₄ "	19"	3"	L52219MRGG	\$302
---------------------------------	-----	----	-------------------	-------

Dual Mouse

9 ³ / ₄ "	19"	3"	L52219MDGG	\$347
---------------------------------	-----	----	-------------------	-------

With Articulating Mouse Surface

9 ³ / ₄ "	19"	3"	L52219AMGG	\$384
---------------------------------	-----	----	-------------------	-------

► Specification Information, continued on next page

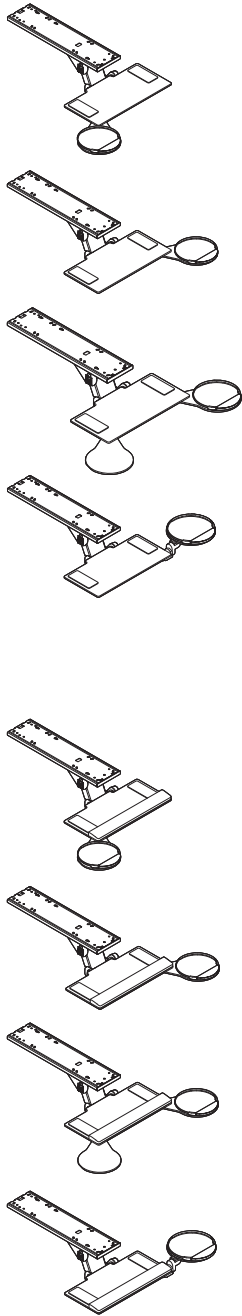

► Specification Information, continued from previous page

Specification Information

• Dimensions			• Style	• Price
D	W	H	Number	

Enviro Platforms

Without Palm Rest

14 ¹ / ₂ "	28"	3"	L522EN1000	\$280
----------------------------------	-----	----	-------------------	-------

With Green Gel Palm Rest

14 ¹ / ₂ "	28"	3"	L522EN10GG	\$302
----------------------------------	-----	----	-------------------	-------

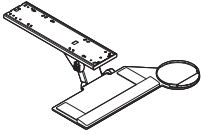
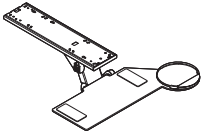

Keyboard Assemblies, continued

SIN 711.2

5" Lift and Lock Keyboard Assemblies

with 23"L Track

Tip: Be sure to consider the mechanism track length in relationship to the work surface depth.

Standard Includes	Required to Specify
<ul style="list-style-type: none"> • Mechanism and 23"L track: 0835 Black • Keyboard platform: <ul style="list-style-type: none"> – Slider and Classic Rectangular: 7027 Charcoal paint – Jules, Diagonal, and Radius: 6288 Charcoal plastic – 19", 26", and Enviro: 7027 Charcoal paint • Mouse surface: <ul style="list-style-type: none"> – Slider and Jules: ambidextrous, sliding mouse surface – Diagonal, Radius, Classic Rectangular, and 26": ambidextrous, integrated mouse surface – 19" and Enviro: 9" diameter same-plane, swivel mouse surface • Palm rest, if selected 	<ul style="list-style-type: none"> 1 Style number 2 Palm rest type, if green-gel palm rest is selected (see below under Required Selections)

Required Selections	Price	Required to Specify
Palm Rest <ul style="list-style-type: none"> • Non-antimicrobial • Antimicrobial 	No cost No cost	Specify <i>with non-antimicrobial</i> . Specify <i>with antimicrobial</i> .

Specification Information

Dimensions	Style	Price
D W H	Number	

Slider Platforms

With Standard Palm Rest

9½"	20"	3"	L523SL10SA	\$379
-----	-----	----	-------------------	-------

With Deep Palm Rest

9½"	20"	3"	L523SL10DA	\$399
-----	-----	----	-------------------	-------

Jules Platforms

Without Palm Rest

12"	18¾"	5⅝"	L523JP1000	\$247
-----	------	-----	-------------------	-------

With Standard Foam Palm Rest

12"	18¾"	5⅝"	L523JP10SF	\$275
-----	------	-----	-------------------	-------

► **Specification Information, continued on next page**

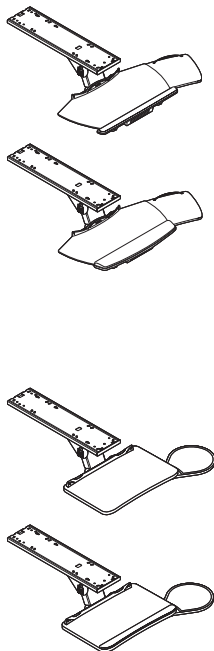

► Specification Information, continued from previous page

Specification Information

Dimensions			Style	Price
D	W	H	Number	

Diagonal Platforms

17" with Extended Foam Palm Rest

12 ¹ / ₂ "	27 ¹ / ₂ "	3"	L5231710EF	\$321
----------------------------------	----------------------------------	----	-------------------	-------

21" with Extended Foam Palm Rest

12 ¹ / ₂ "	27 ¹ / ₂ "	3"	L5232110EF	\$321
----------------------------------	----------------------------------	----	-------------------	-------

Radius Platform

18" with Extended Foam Palm Rest

14 ¹ / ₂ "	27 ¹ / ₂ "	3"	L5231810EF	\$321
----------------------------------	----------------------------------	----	-------------------	-------

Classic Rectangular Platforms

Without Palm Rest

10 ¹ / ₄ "	27 ¹ / ₂ "	5 ⁵ / ₈ "	L523CR1000	\$270
----------------------------------	----------------------------------	---------------------------------	-------------------	-------

With Positionable Palm Rest

10 ¹ / ₄ "	27 ¹ / ₂ "	5 ⁵ / ₈ "	L523CR10PP	\$359
----------------------------------	----------------------------------	---------------------------------	-------------------	-------

With Full-Width, Fixed-Height Palm Rest

10 ¹ / ₄ "	27 ¹ / ₂ "	5 ⁵ / ₈ "	L523CR10FF	\$350
----------------------------------	----------------------------------	---------------------------------	-------------------	-------

With Full-Width, Height-Adjustable Palm Rest

10 ¹ / ₄ "	27 ¹ / ₂ "	5 ⁵ / ₈ "	L523CR10FA	\$377
----------------------------------	----------------------------------	---------------------------------	-------------------	-------

► Specification Information, continued on next page

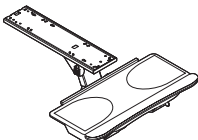
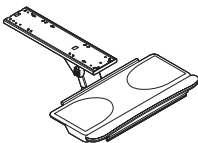
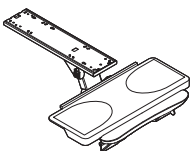
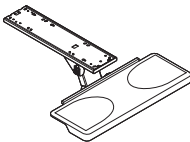
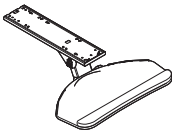
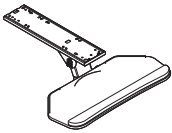
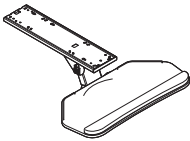

Keyboard Assemblies, continued

SIN 711.2

► Specification Information, continued from previous page

Specification Information

Dimensions			Style	Price
D	W	H	Number	

19" Platforms without Palm Rest

Left-Handed

9 ³ / ₄ "	19"	3"	L52319ML00	\$280
---------------------------------	-----	----	-------------------	-------

Right-Handed

9 ³ / ₄ "	19"	3"	L52319MR00	\$280
---------------------------------	-----	----	-------------------	-------

Dual Mouse

9 ³ / ₄ "	19"	3"	L52319MD00	\$325
---------------------------------	-----	----	-------------------	-------

With Articulating Mouse Surface

9 ³ / ₄ "	19"	3"	L52319AM00	\$363
---------------------------------	-----	----	-------------------	-------

19" Platforms with Green-Gel Palm Rest

Left-Handed

9 ³ / ₄ "	19"	3"	L52319MLGG	\$302
---------------------------------	-----	----	-------------------	-------

Right-Handed

9 ³ / ₄ "	19"	3"	L52319MRGG	\$302
---------------------------------	-----	----	-------------------	-------

Dual Mouse

9 ³ / ₄ "	19"	3"	L52319MDGG	\$347
---------------------------------	-----	----	-------------------	-------

With Articulating Mouse Surface

9 ³ / ₄ "	19"	3"	L52319AMGG	\$384
---------------------------------	-----	----	-------------------	-------

► Specification Information, continued on next page

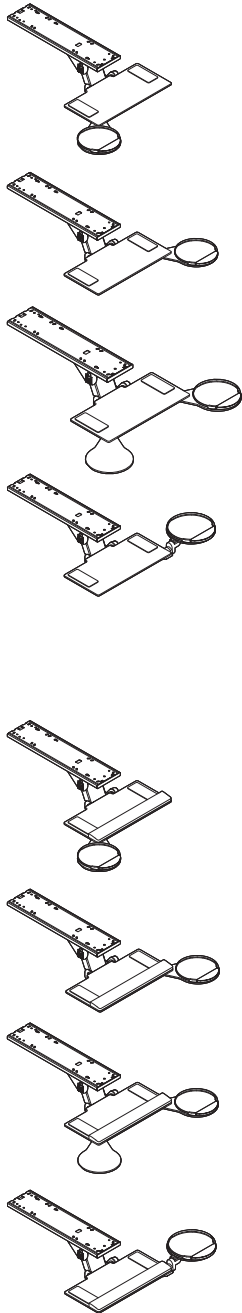

► Specification Information, continued from previous page

Specification Information

• Dimensions			• Style	• Price
D	W	H	Number	

Enviro Platforms

Without Palm Rest

14 ¹ / ₂ "	28"	3"	L523EN1000	\$280
----------------------------------	-----	----	-------------------	-------

With Green Gel Palm Rest

14 ¹ / ₂ "	28"	3"	L523EN10GG	\$302
----------------------------------	-----	----	-------------------	-------

26" Platforms

Without Palm Rest

9 ³ / ₄ "	26"	3"	L523261000	\$291
---------------------------------	-----	----	-------------------	-------

With 19" Green Gel Palm Rest

9 ³ / ₄ "	26"	3"	L5232610GG	\$313
---------------------------------	-----	----	-------------------	-------

With 26" Green Gel Palm Rest

9 ³ / ₄ "	26"	3"	L523261026GG	\$319
---------------------------------	-----	----	---------------------	-------

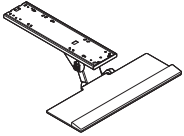
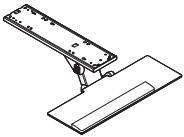
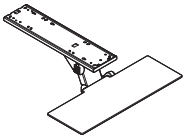
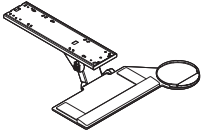
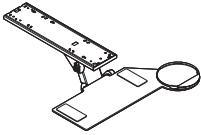

Keyboard Assemblies, continued

SIN 711.2

7" Lift and Lock Keyboard Assemblies

with 18"L Track

Tip: Be sure to consider the mechanism track length in relationship to the work surface depth.

Standard Includes	Required to Specify
-------------------	---------------------

- Mechanism and 18"L track: 0835 Black
- Keyboard platform:
 - 19", 26" and Enviro: 7027 Charcoal paint
- Mouse surface:
 - 19" and Enviro: 9" diameter same-plane, swivel mouse surface
- Palm rest, if selected

- 1 Style number
- 2 Palm rest type, if green-gel palm rest is selected (see below under Required Selections)

Palm Rest	Required Selections	Price	Required to Specify
-----------	---------------------	-------	---------------------

- | | | | |
|------------------|--|--------------------|--|
| Palm Rest | <ul style="list-style-type: none"> • Non-antimicrobial • Antimicrobial | No cost
No cost | Specify <i>with non-antimicrobial</i> .
Specify <i>with antimicrobial</i> . |
|------------------|--|--------------------|--|

Specification Information

• Dimensions	• Style	• Price
D W H	Number	

19" Platforms without Palm Rest

With Articulating Mouse Surface

9 ³ / ₄ "	19"	3"	L71819AM00	\$363
---------------------------------	-----	----	-------------------	-------

19" Platforms with Green-Gel Palm Rest

Left-Handed

9 ³ / ₄ "	19"	3"	L71819MLGG	\$302
---------------------------------	-----	----	-------------------	-------

Right-Handed

9 ³ / ₄ "	19"	3"	L71819MRGG	\$302
---------------------------------	-----	----	-------------------	-------

Dual Mouse

9 ³ / ₄ "	19"	3"	L71819MDGG	\$347
---------------------------------	-----	----	-------------------	-------

With Articulating Mouse Surface

9 ³ / ₄ "	19"	3"	L71819AMGG	\$384
---------------------------------	-----	----	-------------------	-------

► **Specification Information, continued on next page**

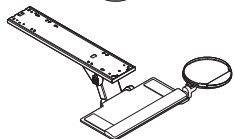
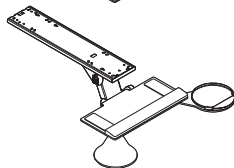
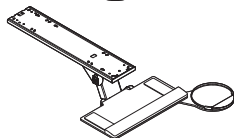
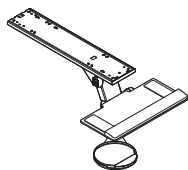
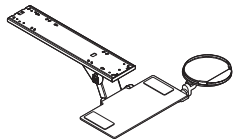

SIN 711.2

► Specification Information, continued from previous page

Specification Information

• Dimensions			• Style	• Price
D	W	H	Number	

Enviro Platforms

With Green Gel Palm Rest

14 ¹ / ₂ "	28"	3"	L718EN10GG	\$302

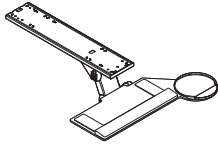

Computer Support Tools

Keyboard Assemblies, continued

SIN 711.2

7" Lift and Lock Keyboard Assemblies

with 26"L Track

Tip: Be sure to consider the mechanism track length in relationship to the work surface depth.

Standard Includes	Required to Specify
<ul style="list-style-type: none"> Mechanism and 26"L track: 0835 Black Keyboard platform: <ul style="list-style-type: none"> Slider and Classic Rectangular: 7027 Charcoal paint Jules, Diagonal, and Radius: 6288 Charcoal plastic 19", 26" and Enviro: 7027 Charcoal paint Mouse surface: <ul style="list-style-type: none"> Slider and Jules: ambidextrous, sliding mouse surface Diagonal, Radius, Classic Rectangular, and 26": ambidextrous, integrated mouse surface 19" and Enviro: 9" diameter same-plane, swivel mouse surface Palm rest, if selected 	<ul style="list-style-type: none"> 1 Style number 2 Palm rest type, if green-gel palm rest is selected (see below under Required Selections)

Required Selections	Price	Required to Specify
Palm Rest <ul style="list-style-type: none"> Non-antimicrobial Antimicrobial 	No cost No cost	Specify <i>with non-antimicrobial</i> . Specify <i>with antimicrobial</i> .

Specification Information

Dimensions	Style	Price
D W H	Number	

Slider Platforms

With Standard Palm Rest

9½"	20"	3"	L726SL10SA	\$379
-----	-----	----	-------------------	-------

With Deep Palm Rest

9½"	20"	3"	L726SL10DA	\$399
-----	-----	----	-------------------	-------

Jules Platforms

Without Palm Rest

12"	18¾"	5⅝"	L726JP1000	\$247
-----	------	-----	-------------------	-------

With Standard Foam Palm Rest

12"	18¾"	5⅝"	L726JP10SF	\$275
-----	------	-----	-------------------	-------

► **Specification Information, continued on next page**

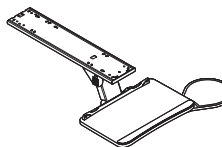
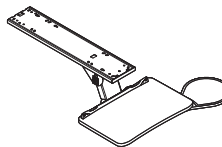
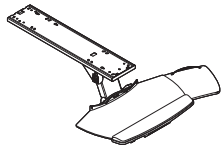
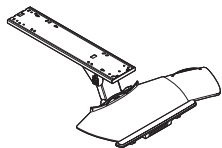

► Specification Information, continued from previous page

Specification Information

Dimensions			Style	Price
D	W	H	Number	

Diagonal Platforms

17" with Extended Foam Palm Rest

12 ¹ / ₂ "	27 ¹ / ₂ "	3"	L7261710EF	\$321
----------------------------------	----------------------------------	----	-------------------	-------

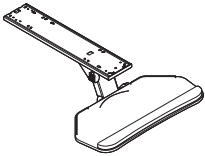

21" with Extended Foam Palm Rest

12 ¹ / ₂ "	27 ¹ / ₂ "	3"	L7262110EF	\$321
----------------------------------	----------------------------------	----	-------------------	-------

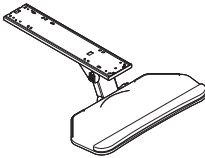

Radius Platform

18" with Extended Foam Palm Rest

14 ¹ / ₂ "	27 ¹ / ₂ "	3"	L7261810EF	\$321
----------------------------------	----------------------------------	----	-------------------	-------

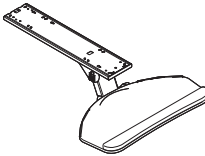

Classic Rectangular Platforms

Without Palm Rest

10 ¹ / ₄ "	27 ¹ / ₂ "	5 ⁵ / ₈ "	L726CR1000	\$270
----------------------------------	----------------------------------	---------------------------------	-------------------	-------

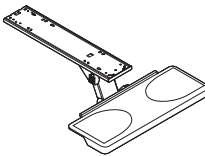

With Positionable Palm Rest

10 ¹ / ₄ "	27 ¹ / ₂ "	5 ⁵ / ₈ "	L726CR10PP	\$359
----------------------------------	----------------------------------	---------------------------------	-------------------	-------

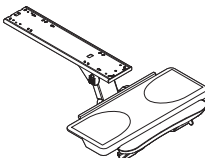

With Full-Width, Fixed-Height Palm Rest

10 ¹ / ₄ "	27 ¹ / ₂ "	5 ⁵ / ₈ "	L726CR10FF	\$350
----------------------------------	----------------------------------	---------------------------------	-------------------	-------

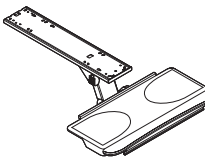

With Full-Width, Height-Adjustable Palm Rest

10 ¹ / ₄ "	27 ¹ / ₂ "	5 ⁵ / ₈ "	L726CR10FA	\$377
----------------------------------	----------------------------------	---------------------------------	-------------------	-------

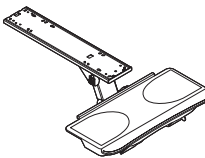

► Specification Information, continued on next page

Computer Support Tools

Keyboard Assemblies, continued

SIN 711.2

► Specification Information, continued from previous page

Specification Information

Dimensions			Style	Price
D	W	H	Number	

19" Platforms without Palm Rest

Left-Handed

9 ³ / ₄ "	19"	3"	L72619ML00	\$280
---------------------------------	-----	----	-------------------	-------

Right-Handed

9 ³ / ₄ "	19"	3"	L72619MR00	\$280
---------------------------------	-----	----	-------------------	-------

Dual Mouse

9 ³ / ₄ "	19"	3"	L72619MD00	\$325
---------------------------------	-----	----	-------------------	-------

With Articulating Mouse Surface

9 ³ / ₄ "	19"	3"	L72619AM00	\$363
---------------------------------	-----	----	-------------------	-------

19" Platforms with Green-Gel Palm Rest

Left-Handed

9 ³ / ₄ "	19"	3"	L72619MLGG	\$302
---------------------------------	-----	----	-------------------	-------

Right-Handed

9 ³ / ₄ "	19"	3"	L72619MRGG	\$302
---------------------------------	-----	----	-------------------	-------

Dual Mouse

9 ³ / ₄ "	19"	3"	L72619MDGG	\$347
---------------------------------	-----	----	-------------------	-------

With Articulating Mouse Surface

9 ³ / ₄ "	19"	3"	L72619AMGG	\$384
---------------------------------	-----	----	-------------------	-------

► Specification Information, continued on next page

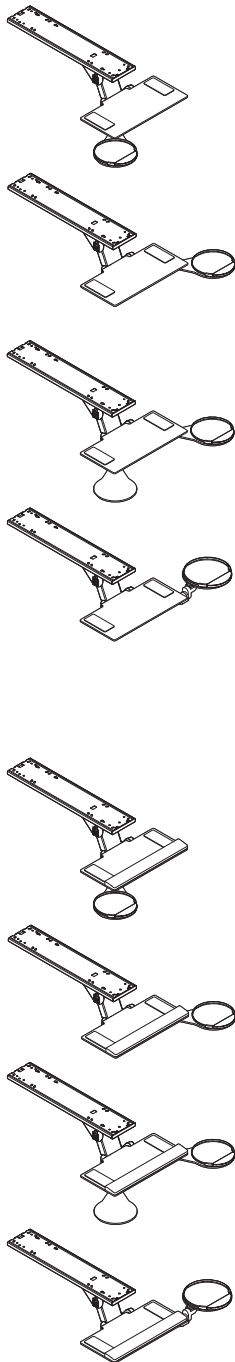

► Specification Information, continued from previous page

Specification Information

Dimensions			Style	Price
D	W	H	Number	

Enviro Platforms

Without Palm Rest

14 ¹ / ₂ "	28"	3"	L726EN1000	\$280
----------------------------------	-----	----	-------------------	-------

With Green Gel Palm Rest

14 ¹ / ₂ "	28"	3"	L726EN10GG	\$302
----------------------------------	-----	----	-------------------	-------

26" Platforms

Without Palm Rest

9 ³ / ₄ "	26"	5 ⁵ / ₈ "	L726261000	\$291
---------------------------------	-----	---------------------------------	-------------------	-------

With 19" Green Gel Palm Rest

9 ³ / ₄ "	26"	3"	L7262610GG	\$313
---------------------------------	-----	----	-------------------	-------

With 26" Green Gel Palm Rest

9 ³ / ₄ "	26"	3"	L726261026GG	\$319
---------------------------------	-----	----	---------------------	-------

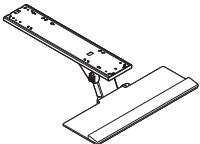
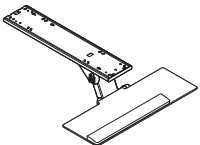
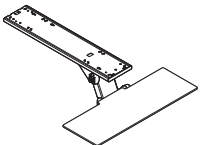
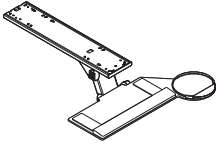
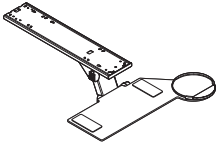

Keyboard Assemblies, continued

SIN 711.2

Dial Indicator6 Keyboard Assemblies

Tip: Be sure to consider the mechanism track length in relationship to the work surface depth.

Standard Includes	Required to Specify
<ul style="list-style-type: none"> • Mechanism and 23"L track: 0835 Black • Keyboard platform: <ul style="list-style-type: none"> – Slider and Classic Rectangular: 7027 Charcoal paint – Jules, Diagonal, and Radius: 6288 Charcoal plastic – 19", 26", and Enviro: 7027 Charcoal paint • Mouse surface: <ul style="list-style-type: none"> – Slider and Jules: ambidextrous, sliding mouse surface – Diagonal, Radius, Classic Rectangular, and 26": ambidextrous, integrated mouse surface – 19" and Enviro: 9" diameter same-plane, swivel mouse surface • Palm rest, if selected 	<ul style="list-style-type: none"> 1 Style number 2 Palm rest type, if green-gel palm rest is selected (see below under Required Selections)

Required Selections	Price	Required to Specify
Palm Rest <ul style="list-style-type: none"> • Non-antimicrobial • Antimicrobial 	No cost No cost	Specify <i>with non-antimicrobial</i> . Specify <i>with antimicrobial</i> .

Specification Information

Dimensions	Style Number	Price
D W H	:	:

Slider Platforms

Without Palm Rest

9 1/2"	20"	3"	D623SL1000	\$412
--------	-----	----	-------------------	-------

With Standard Palm Rest

9 1/2"	20"	3"	D623SL10SA	\$452
--------	-----	----	-------------------	-------

With Deep Palm Rest

9 1/2"	20"	3"	D623SL10DA	\$472
--------	-----	----	-------------------	-------

Jules Platforms

Without Palm Rest

12"	18 3/4"	5 5/8"	D623JP1000	\$320
-----	---------	--------	-------------------	-------

With Standard Foam Palm Rest

12"	18 3/4"	5 5/8"	D623JP10SF	\$348
-----	---------	--------	-------------------	-------

► Specification Information, continued on next page

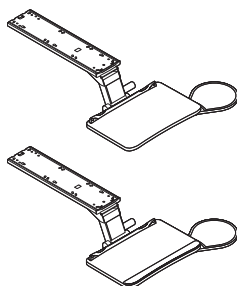
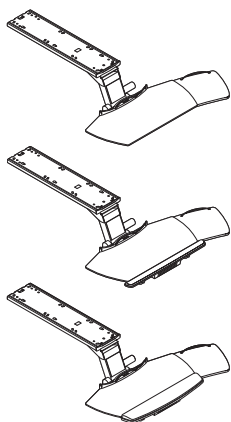

► Specification Information, continued from previous page

Specification Information

Dimensions			Style	Price
D	W	H	Number	

Diagonal Platforms

17" with Extended Foam Palm Rest

12 ¹ / ₂ "	27 ¹ / ₂ "	3"	D6231710EF	\$394
----------------------------------	----------------------------------	----	-------------------	-------

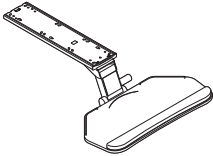

21" with Extended Foam Palm Rest

12 ¹ / ₂ "	27 ¹ / ₂ "	3"	D6232110EF	\$394
----------------------------------	----------------------------------	----	-------------------	-------

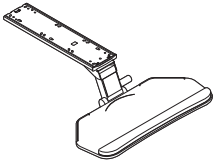

Radius Platform

18" with Extended Foam Palm Rest

14"	27 ¹ / ₂ "	3"	D6231810EF	\$394
-----	----------------------------------	----	-------------------	-------

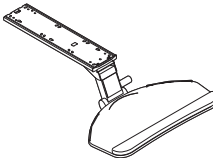

Classic Rectangular Platforms

Without Palm Rest

10 ¹ / ₄ "	27 ¹ / ₂ "	5 ⁵ / ₈ "	D623CR1000	\$343
----------------------------------	----------------------------------	---------------------------------	-------------------	-------

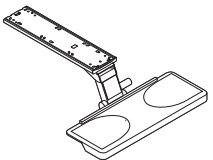

With Positionable Palm Rest

10 ¹ / ₄ "	27 ¹ / ₂ "	5 ⁵ / ₈ "	D623CR10PP	\$432
----------------------------------	----------------------------------	---------------------------------	-------------------	-------

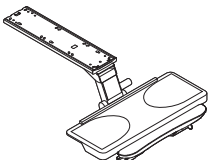

With Full-Width, Fixed-Height Palm Rest

10 ¹ / ₄ "	27 ¹ / ₂ "	5 ⁵ / ₈ "	D623CR10FF	\$423
----------------------------------	----------------------------------	---------------------------------	-------------------	-------

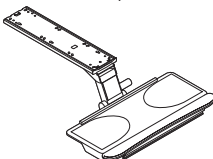

With Full-Width, Height-Adjustable Palm Rest

10 ¹ / ₄ "	27 ¹ / ₂ "	5 ⁵ / ₈ "	D623CR10FA	\$450
----------------------------------	----------------------------------	---------------------------------	-------------------	-------

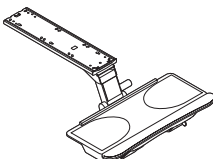

► Specification Information, continued on next page

Keyboard Assemblies, continued

SIN 711.2

► Specification Information, continued from previous page

Specification Information

Dimensions			Style	Price
D	W	H	Number	

19" Platforms without Palm Rest

Left-Handed

9 ³ / ₄ "	19"	3"	D62319ML00	\$353
---------------------------------	-----	----	-------------------	-------

Right-Handed

9 ³ / ₄ "	19"	3"	D62319MR00	\$353
---------------------------------	-----	----	-------------------	-------

Dual Mouse

9 ³ / ₄ "	19"	3"	D62319MD00	\$398
---------------------------------	-----	----	-------------------	-------

With Articulating Mouse Surface

9 ³ / ₄ "	19"	3"	D62319AM00	\$436
---------------------------------	-----	----	-------------------	-------

19" Platforms with Green-Gel Palm Rest

Left-Handed

9 ³ / ₄ "	19"	3"	D62319MLGG	\$375
---------------------------------	-----	----	-------------------	-------

Right-Handed

9 ³ / ₄ "	19"	3"	D62319MRGG	\$375
---------------------------------	-----	----	-------------------	-------

Dual Mouse

9 ³ / ₄ "	19"	3"	D62319MDGG	\$420
---------------------------------	-----	----	-------------------	-------

With Articulating Mouse Surface

9 ³ / ₄ "	19"	3"	D62319AMGG	\$457
---------------------------------	-----	----	-------------------	-------

► Specification Information, continued on next page

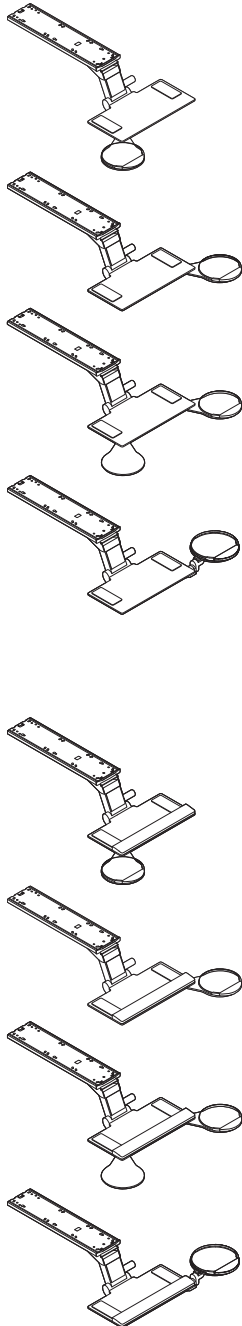

► Specification Information, continued from previous page

Specification Information

Dimensions			Style	Price
D	W	H	Number	

Enviro Platforms

Without Palm Rest

14 ¹ / ₂ "	28"	3"	D623EN1000	\$353
----------------------------------	-----	----	-------------------	-------

With Green Gel Palm Rest

14 ¹ / ₂ "	28"	3"	D623EN10GG	\$375
----------------------------------	-----	----	-------------------	-------

26" Platforms

Without Palm Rest

9 ³ / ₄ "	26"	3"	D623261000	\$364
---------------------------------	-----	----	-------------------	-------

With 19" Green Gel Palm Rest

9 ³ / ₄ "	26"	3"	D6232610GG	\$386
---------------------------------	-----	----	-------------------	-------

With 26" Green Gel Palm Rest

9 ³ / ₄ "	26"	3"	D623261026GG	\$392
---------------------------------	-----	----	---------------------	-------

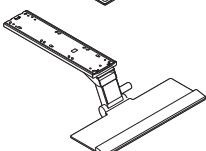
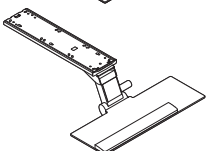
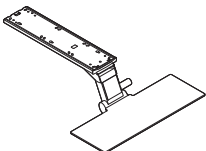
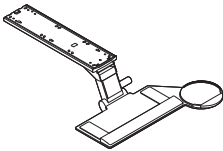
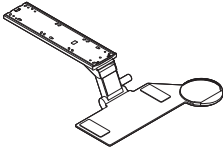

Technology Worktools and Cable Management

SIN 711.2

Corner Fillers

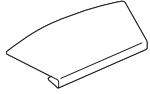

Tip: 18"W corner filler creates a 17" diagonal application. 22"W corner filler creates a 21" diagonal application.

Standard Includes	Required to Specify
• Corner filler: 7027 Charcoal paint	Style number

Specification Information

• Dimensions	• Style	• Price
D W	Number	

18" Corner Fillers

For Use with 1 1/4" Thick Worksurfaces

13"	24"	CCWS18125	\$129
-----	-----	------------------	-------

For Use with 1 1/2" Thick Worksurfaces

13"	24"	CCWS18150	\$129
-----	-----	------------------	-------

For Use with Series 9000 Worksurfaces

13"	24"	CCWS189	\$129
-----	-----	----------------	-------

22" Corner Fillers

For Use with 1 1/4" Thick Worksurfaces

13"	28"	CCWS22125	\$129
-----	-----	------------------	-------

For Use with 1 1/2" Thick Worksurfaces

13"	28"	CCWS22150	\$129
-----	-----	------------------	-------

For Use with Series 9000 Worksurfaces

13"	28"	CCWS229	\$129
-----	-----	----------------	-------

Freestanding In-Line Document Support

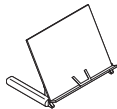

Standard Includes	Required to Specify
• Freestanding in-line document support: 6000 Black	Style number

Specification Information

• Dimensions	• Style	• Price
D W H	Number	
18" 14" 12"	CDFIS14	\$117

Adjustable Foot Rest

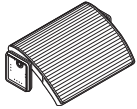

Standard Includes

- Adjustable foot rest: 6000 Black

Required to Specify

Style number

Specification Information

• Dimensions			• Style	• Price
D	W	H	Number	
12"	18"	2"-6"	CFTR	\$129

Mobile Collapsible Laptop Support



Tip: Mobile collapsible laptop support is for use with laptops that open past 90° only.

Standard Includes

- Laptop support: brushed aluminum

Required to Specify

Style number

Specification Information

• Dimensions			• Style	• Price
D	W	H	Number	
9½"	12¼"	½"-7"	CMLSA	\$112

Vertical Locking CPU Cradle

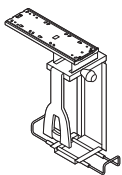

Tip: Vertical CPU cradle supports CPUs 3½"W to 9"W, 15"D to 22"D, 12½"H to 22½"H and up to 85 lb.

Tip: CPU cradle requires 18" clearance under the worksurface.

Standard Includes

- CPU cradle: 0835 Black
- Soft touch knob with locking system for side clamp adjustment
- 17" track
- Lock mechanism

Required to Specify

Style number

Specification Information

• Dimensions			• Style	• Price
D	W	H	Number	
15"	4"	18¼"	CPRCCL	\$207

SIN 711.2

Vertical Non-Locking CPU Cradle

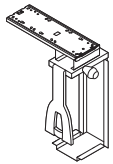

Tip: Vertical CPU cradle supports CPUs 3½"W to 9"W, 15"D to 22"D, 12½"H to 22½"H and up to 85 lb.

Tip: CPU cradle requires 18" clearance under the worksurface.

Standard Includes	Required to Specify
-------------------	---------------------

- CPU cradle: 0835 Black
- Soft touch knob for side clamp adjustment
- 17"L track

Style number

Specification Information				
• Dimensions			• Style	• Price
D	W	H	Number	

17"	3½"	18¼"	CPRCCN	\$178
-----	-----	------	---------------	-------

Vertical Cable Carrier



Tip: Vertical cable carrier is recommended for use with height-adjustable worksurfaces.

Tip: Vertical cable carrier affixes under the worksurface and has a weighted base to hold it in place.

Standard Includes	Required to Specify
-------------------	---------------------

- Cable carrier: 6688 Steel
- Attachment hardware

Style number

Specification Information				
• Dimensions		• Style	• Price	
W	H	Number		

2½"	52"	AHCC	\$154	
-----	-----	-------------	-------	--

Vertical Processor Slings

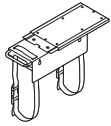

Tip: CPU must be at least 10"D and 3½"W for both standard and fixed vertical processor slings.

Tip: Standard vertical processor sling supports CPUs with perimeters of 53" and 75 lb.

Tip: Standard vertical processor requires 18" clearance under the worksurface.

Standard Includes	Required to Specify
<ul style="list-style-type: none"> Vertical processor sling: 7207 Textured Black 17"L track for standard vertical processor sling, if selected 	Style number

Specification Information

Dimensions			Style	Price
D	W	H	Number	
:	:	:	:	:

Standard

18"	5½"	2½"	CPRSL	\$146
:	:	:	:	:

Fixed (For Use with c:scape, FrameOne, and Ology)

10¾"	3¾"	6"	CPRSLFO	\$122
:	:	:	:	:

Tip: Fixed vertical processor sling supports CPUs with perimeters of 53" and 50 lb.

Tip: Fixed vertical processor sling requires 12" clearance under the worksurface.

Tip: Fixed vertical processor sling is mounted in a fixed position.

CPU Trolley

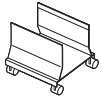

Tip: Trolley supports CPUs from 5¼"W to 8½"W and up to 85 lb.

Tip: CPU trolley requires a maximum 10"W floor clearance when fully expanded.

Standard Includes	Required to Specify
<ul style="list-style-type: none"> CPU trolley that supports CPU vertically: 6029 Chalk Two locking and two non-locking casters 	Style number

Specification Information

Dimensions			Style	Price
D	W	H	Number	
:	:	:	:	:

11"	10"	10"	QACPUT	\$109
:	:	:	:	:

Slatwall/SlatRail Mounted CPU Cradle



Tip: Small CPU cradle accommodates CPUs with perimeters up to 44" and 20 lb.

Standard Includes	Required to Specify
<ul style="list-style-type: none"> Cradle: 7018 Pewter 	Style number

Specification Information

Dimensions			Style	Price
D	W	H	Number	
:	:	:	:	:

Small CPU Cradle

3¾"	7"	9¾"	HCCPUS	\$95
:	:	:	:	:

Technology Worktools and Cable Management, continued

SIN 711.2

Cableways

Tip: Cableway with universal clamp can be used in combination with privacy and modesty screens.

▶ See page 292

Tip: Cableways may need to be shorter than worksurface width. To determine screen/cableway and height-adjustable worksurface compatibility, see Worktools Compatibility Charts, page 212.

Tip: Cableways are not recommended for use with 22¹/₄"D rectangular Airtouch worksurfaces.

Tip: Cableways with universal clamp are 3" shorter than privacy and modesty screen widths.

Tip: 55"W and 61"W cableways ship with three universal clamps or horizontal brackets. All other cableway widths ship with two universal clamps or horizontal brackets.

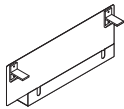

Tip: To determine SlatRail compatibility and mounting requirements, see Height-Adjustable Desks Specification Guide.

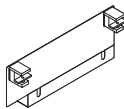

Standard Includes	Required to Specify
<ul style="list-style-type: none"> • Cableway: paint • Universal clamp, if selected: paint to match cableway • Horizontal mounting bracket, if selected: paint to match cableway 	1 Style number 2 Paint color number for cableway: 0835 Black 4799 Platinum Metallic

Specification Information

• Dimensions			• Weight	• Style	• Price
D	W	H		Number	

With Horizontal Mounting Bracket

2 ¹ / ₂ "	25"	8"	7.45 lb	AHORZ25	\$ 72
2 ¹ / ₂ "	31"	8"	8.40 lb	AHORZ31	\$ 92
2 ¹ / ₂ "	37"	8"	9.35 lb	AHORZ37	\$111
2 ¹ / ₂ "	43"	8"	10.30 lb	AHORZ43	\$127
2 ¹ / ₂ "	49"	8"	11.25 lb	AHORZ49	\$148
2 ¹ / ₂ "	55"	8"	14.20 lb	AHORZ55	\$177
2 ¹ / ₂ "	61"	8"	15.15 lb	AHORZ61	\$194

With Universal Clamp

2 ¹ / ₂ "	25"	8"	4.70 lb	AC25	\$154
2 ¹ / ₂ "	31"	8"	5.65 lb	AC31	\$171
2 ¹ / ₂ "	37"	8"	6.60 lb	AC37	\$189
2 ¹ / ₂ "	43"	8"	7.55 lb	AC43	\$206
2 ¹ / ₂ "	49"	8"	8.50 lb	AC49	\$222
2 ¹ / ₂ "	55"	8"	9.95 lb	AC55	\$269
2 ¹ / ₂ "	61"	8"	10.91 lb	AC61	\$285

6"D Wire Managers

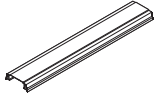

Tip: Wire manager attaches to a clip that is affixed to the underside of a worksurface.

Standard Includes	Required to Specify
<ul style="list-style-type: none"> Wire manager: 6000 Black or 6249 Platinum Attachment hardware 	<ul style="list-style-type: none"> 1 Style number 2 Plastic color number for wire manager

Specification Information						
Dimensions			Weight	Style Number	Price	
D	W	H				
6"	30 ¹ / ₂ "	2"	0.13 lb	AWMXL30	\$ 67	
6"	36 ¹ / ₂ "	2"	0.24 lb	AWMXL36	\$ 77	
6"	42 ¹ / ₂ "	2"	0.34 lb	AWMXL42	\$ 87	
6"	48 ¹ / ₂ "	2"	0.44 lb	AWMXL48	\$ 97	
6"	54 ¹ / ₂ "	2"	0.56 lb	AWMXL54	\$108	
6"	60 ¹ / ₂ "	2"	0.65 lb	AWMXL60	\$118	

1³/₄"D Wire Managers

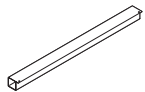

Tip: Actual width of AWM23 is 23¹/₄".

Standard Includes	Required to Specify
<ul style="list-style-type: none"> Wire manager: 6000 Black Attachment hardware 	Style number

Specification Information						
Dimensions			Weight	Style Number	Price	
D	W	H				
1 ³ / ₄ "	6"	1 ³ / ₄ "	0.13 lb	AWM06	\$23	
1 ³ / ₄ "	12"	1 ³ / ₄ "	0.24 lb	AWM12	\$30	
1 ³ / ₄ "	18"	1 ³ / ₄ "	0.34 lb	AWM18	\$35	
1 ³ / ₄ "	23"	1 ³ / ₄ "	0.44 lb	AWM23	\$40	
1 ³ / ₄ "	30"	1 ³ / ₄ "	0.56 lb	AWM30	\$46	
1 ³ / ₄ "	35"	1 ³ / ₄ "	0.65 lb	AWM35	\$51	
1 ³ / ₄ "	42"	1 ³ / ₄ "	0.77 lb	AWM42	\$57	
1 ³ / ₄ "	48"	1 ³ / ₄ "	0.88 lb	AWM48	\$63	

Eyesite Flat Panel Monitor Arm Support Assemblies

SIN 711.2

Eyesite Single Display Supports

Tip: Eyesite single display support is for use with monitors up to 20 lb.

Tip: For large monitor screens (20"+), order standard columns. For small monitor screens (17"-19"), order extended columns.
▶ Page 159

Standard Includes	Required to Specify
<ul style="list-style-type: none"> • Monitor arm: 4799 Platinum Metallic • Mounting bracket: 4799 Platinum Metallic 	1 Style number 2 Options, if selected (see below)

Options	Price	Required to Specify
Ology Brackets <ul style="list-style-type: none"> • C-clamp mount for use without power data access door • C-clamp mount for use with power data access door • Rail mount bracket 	No cost +\$75 +\$80	Specify with C-clamp mount for use without power data access door. Specify with C-clamp mount for use with power data access door. Specify with rail mount bracket.

Specification Information					
Dimensions			Weight	Style Number	Base Price
D	W	H			

12"H Standard Crank Adjustment Column

C-Clamp Mount

6 ⁵ / ₈ "	11 ⁵ / ₈ "	15 ¹ / ₂ "	11 lb	FPAC1CC	\$363
---------------------------------	----------------------------------	----------------------------------	-------	----------------	-------

Ology Bracket Mount

6 ⁵ / ₈ "	11 ⁵ / ₈ "	15 ¹ / ₂ "	11 lb	FPAC1OL	\$363
---------------------------------	----------------------------------	----------------------------------	-------	----------------	-------

c:scape BvCKET Mount

6 ⁵ / ₈ "	11 ⁵ / ₈ "	15 ¹ / ₂ "	11 lb	FPAC1CS	\$416
---------------------------------	----------------------------------	----------------------------------	-------	----------------	-------

▶ **Specification Information, continued on next page**



Tip: Ology bracket mount is available with optional brackets. See options above.

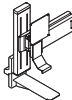

Tip: Eyesite arms should only be mounted to c:scape desks that are tethered to either the beam, another desk, or 1 1/2-High low storage with a connect zone.

Tip: Monitor cables that connect to the rear of the monitor near the VESA plate will not fit properly on the Eyesite monitor arm.

Tip: Eyesite is not recommended with 22 1/4"D Airtouch worksurfaces due to C-clamp interference with the lifting column.

Tip: Eyesite display supports will not fit in front of station mounted Slatwall and SlatRail when using a C-clamp bracket. A through-mount bracket is recommended.

Tip: Monitor arms and lap-top supports with C-clamp brackets are not recommended on Universal Tables with P-edge as the user's edge wraps all the way around table. Universal Systems Worksurfaces with P-edge will work as the user's edge is applied to the front only.

► Specification Information, continued from previous page

Specification Information

• Dimensions			• Weight	• Style	• Price
D	W	H		Number	

12"H Standard Crank Adjustment Column, continued

Through-Mount

6 ⁵ / ₈ "	11 ⁵ / ₈ "	15 ¹ / ₂ "	10 lb	FPAC1TM	\$363
---------------------------------	----------------------------------	----------------------------------	-------	----------------	-------

FrameOne Mount

6 ⁵ / ₈ "	11 ⁵ / ₈ "	15 ¹ / ₂ "	10 lb	FPAC1FO	\$410
---------------------------------	----------------------------------	----------------------------------	-------	----------------	-------



Tip: When mounting dual or triple Eyesite on stand-alone, single-sided FrameOne base units, the worksurface must be 66"W or greater and must be used with Eyesite standard crank adjustable column only.

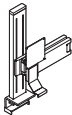
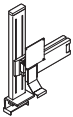

Tip: Ology bracket mount is available with optional brackets. See options on previous page.

18"H Extended Crank Adjustment Column

C-Clamp Mount

6 ⁵ / ₈ "	11 ⁵ / ₈ "	20"	12 lb	FPAEC1CC	\$416
---------------------------------	----------------------------------	-----	-------	-----------------	-------

Ology Bracket Mount

6 ⁵ / ₈ "	11 ⁵ / ₈ "	20"	12 lb	FPAEC1OL	\$416
---------------------------------	----------------------------------	-----	-------	-----------------	-------

c:scape Bracket Mount

6 ⁵ / ₈ "	11 ⁵ / ₈ "	20"	12 lb	FPAEC1CS	\$469
---------------------------------	----------------------------------	-----	-------	-----------------	-------

Through-Mount

6 ⁵ / ₈ "	11 ⁵ / ₈ "	20"	11 lb	FPAEC1TM	\$416
---------------------------------	----------------------------------	-----	-------	-----------------	-------

FrameOne Mount

6 ⁵ / ₈ "	11 ⁵ / ₈ "	20"	11 lb	FPAEC1FO	\$463
---------------------------------	----------------------------------	-----	-------	-----------------	-------

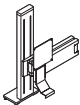
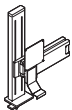
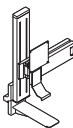

Tip: Eyesite columns may be mounted back to back on double-sided FrameOne worksurfaces when using FrameOne brackets.

Bivi Mount

6 ⁵ / ₈ "	11 ⁵ / ₈ "	20"	11 lb	FPAEC1BIVI	\$486
---------------------------------	----------------------------------	-----	-------	-------------------	-------

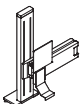

Tip: Bivi bracket to be used with Eyesite single support, dual display support, and dual laptop support with extended crank adjust columns only.

Eyesite Flat Panel Monitor Arm Support Assemblies, continued

SIN 711.2

Eyesite Dual Display Supports

Tip: Eyesite dual display support is for use with two monitors up to 27" or less screens and up to 20 lb each. 27" monitors should be use with extended 18" column assemblies or taller.

Standard Includes	Required to Specify
<ul style="list-style-type: none"> • Monitor arm: 4799 Platinum Metallic • Mounting bracket: 4799 Platinum Metallic 	1 Style number 2 Options, if selected (see below)

Bracket	Options	Price	Required to Specify
Bracket	• Without pivot	No cost	Specify <i>without pivot</i> .
	• With pivot	+\$18	Specify <i>with pivot</i> .
Ology Brackets	• C-clamp mount for use without power data access door	No cost	Specify <i>with C-clamp mount for use without power data access door</i> .
	• C-clamp mount for use with power data access door	+\$75	Specify <i>with C-clamp mount for use with power data access door</i> .
	• Rail mount bracket	+\$80	Specify <i>with rail mount bracket</i> .

Specification Information					
• Dimensions			• Weight	• Style	• Base
D	W	H		Number	Price
:	:	:	:	:	:
:	:	:	:	:	:

12"H Standard Crank Adjustment Column with Dual Yoke and Focal Adjustment

C-Clamp Mount

8½"	31"	15½"	16 lb	FPAC2CC	\$640
-----	-----	------	-------	----------------	-------

Ology Bracket Mount

8½"	31"	15½"	16 lb	FPAC2OL	\$640
-----	-----	------	-------	----------------	-------

c:scape Bracket Mount

8½"	31"	15½"	16 lb	FPAC2CS	\$693
-----	-----	------	-------	----------------	-------

► **Specification Information, continued on next page**

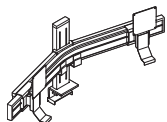
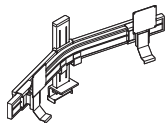

Tip: Ology bracket mount is available with optional brackets. See options above.

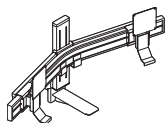

Tip: Eyesite arms should only be mounted to c:scape desks that are tethered to either the beam, another desk, or 1½-High low storage with a connect zone.

Tip: Monitor cables that connect to the rear of the monitor near the VESA plate will not fit properly on the Eyesite monitor arm.

Tip: Eyesite is not recommended with 22¼"D Airtouch worksurfaces due to C-clamp interference with the lifting column.

Tip: Eyesite display supports will not fit in front of stanchion mounted Slatwall and SlatRail when using a C-clamp bracket. A through-mount bracket is recommended.

Tip: Monitor arms and lap-top supports with C-clamp brackets are not recommended on Universal Tables with P-edge as the user's edge wraps all the way around table. Universal Systems Worksurfaces with P-edge will work as the user's edge is applied to the front only.

► Specification Information, continued from previous page

Specification Information

Dimensions			Weight	Style Number	Base Price
D	W	H			

12"H Standard Crank Adjustment Column with Dual Yoke and Focal Adjustment, continued

Through-Mount

8½"	31"	15½"	15 lb	FPAC2TM	\$640
-----	-----	------	-------	----------------	-------

FrameOne Mount

8½"	31"	15½"	15 lb	FPAC2FO	\$693
-----	-----	------	-------	----------------	-------

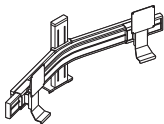
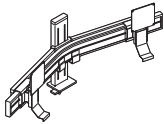

Tip: When mounting dual or triple Eyesite on stand-alone, single-sided FrameOne base units, the worksurface must be 66"W or greater and must be used with Eyesite standard crank adjustable column only.

18"H Extended Crank Adjustment Column with Dual Yoke and Focal Adjustment

C-Clamp Mount

8½"	31"	20"	17 lb	FPAEC2CC	\$693
-----	-----	-----	-------	-----------------	-------

Ology Bracket Mount

8½"	31"	20"	17 lb	FPAEC2OL	\$693
-----	-----	-----	-------	-----------------	-------

cscape Bracket Mount

8½"	31"	20"	17 lb	FPAEC2CS	\$746
-----	-----	-----	-------	-----------------	-------

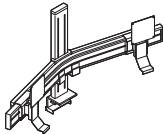
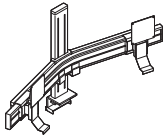

Tip: Ology bracket mount is available with optional brackets. See options above.

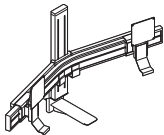

► Specification Information, continued on next page

Eyesite Flat Panel Monitor Arm Support Assemblies, continued

SIN 711.2

► Specification Information, continued from previous page

Specification Information

Dimensions			Weight	Style Number	Base Price
D	W	H			

18"H Extended Crank Adjustment Column with Dual Yoke and Focal Adjustment continued

Through-Mount

8½"	31"	20"	16 lb	FPAEC2TM	\$693
-----	-----	-----	-------	-----------------	-------

FrameOne Mount

8½"	31"	20"	16 lb	FPAEC2FO	\$746
-----	-----	-----	-------	-----------------	-------

Bivi Mount

8½"	31"	20"	16 lb	FPAEC2BIVI	\$763
-----	-----	-----	-------	-------------------	-------

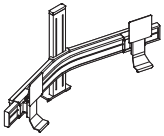
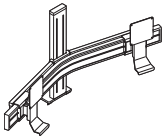
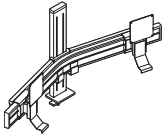

Tip: Bivi bracket to be used with Eyesite single support, dual display support, and dual laptop support with extended crank adjust columns only.

Eyesite Flat Panel Monitor Arm Support Assemblies, continued

SIN 711.2

Eyesite Triple Display Supports

Tip: Eyesite triple display support is for use with three monitors up to 24" screens and 15 lb each.

Standard Includes	Required to Specify
<ul style="list-style-type: none"> • Monitor arm: 4799 Platinum Metallic • Mounting bracket: 4799 Platinum Metallic 	1 Style number 2 Options, if selected (see below)

Options	Price	Required to Specify
Bracket <ul style="list-style-type: none"> • Without pivot • With pivot 	No cost +\$27	Specify <i>without pivot</i> . Specify <i>with pivot</i> .
Ology Brackets <ul style="list-style-type: none"> • C-clamp mount for use without power data access door • C-clamp mount for use with power data access door • Rail mount bracket 	No cost +\$75 +\$80	Specify <i>with C-clamp mount for use without power data access door</i> . Specify <i>with C-clamp mount for use with power data access door</i> . Specify <i>with rail mount bracket</i> .

Specification Information				
Dimensions	Weight	Style	Base	Price
D	W	H	Number	Price

12"H Standard Crank Adjustment Column with Triple Yoke and without Focal Adjustment

C-Clamp Mount				
77/8"	54 1/2"	15 1/2"	14 lb	FPAFC3CC \$693

Ology Bracket Mount				
77/8"	54 1/2"	15 1/2"	14 lb	FPAFC3OL \$693

c:scape Bracket Mount				
77/8"	54 1/2"	15 1/2"	14 lb	FPAFC3CS \$746

► **Specification Information, continued on next page**

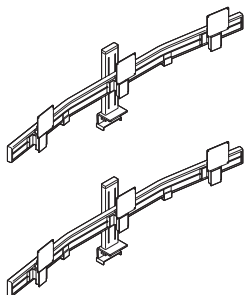

Tip: Ology bracket mount is available with optional brackets. See options above.

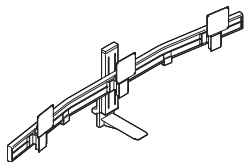

Tip: Eyesite arms should only be mounted to c:scape desks that are tethered to either the beam, another desk, or 1 1/2"-High low storage with a connect zone.

Tip: Monitor cables that connect to the rear of the monitor near the VESA plate will not fit properly on the Eyesite monitor arm.

Tip: Eyesite is not recommended with 22 1/4"D Airtouch worksurfaces due to C-clamp interference with the lifting column.

Tip: Eyesite display supports will not fit in front of stanchion mounted Slatwall and SlatRail when using a C-clamp bracket. A through-mount bracket is recommended.

Tip: Monitor arms and laptop supports with C-clamp brackets are not recommended on Universal Tables with P-edge as the user's edge wraps all the way around table. Universal Systems Worksurfaces with P-edge will work as the user's edge is applied to the front only.

► Specification Information, continued from previous page

Specification Information

Dimensions			Weight	Style Number	Base Price
D	W	H			

12"H Standard Crank Adjustment Column with Triple Yoke and without Focal Adjustment, continued

Through-Mount

7 ⁷ / ₈ "	54 ¹ / ₂ "	15 ¹ / ₂ "	13 lb	FPAFC3TM	\$693
---------------------------------	----------------------------------	----------------------------------	-------	-----------------	-------

18"H Extended Crank Adjustment Column

C-Clamp Mount

7 ⁷ / ₈ "	54 ¹ / ₂ "	20"	15 lb	FPAFEC3CC	\$746
---------------------------------	----------------------------------	-----	-------	------------------	-------

Ology Bracket Mount

7 ⁷ / ₈ "	54 ¹ / ₂ "	20"	20 lb	FPAFEC3OL	\$746
---------------------------------	----------------------------------	-----	-------	------------------	-------

c:scape Bracket Mount

7 ⁷ / ₈ "	54 ¹ / ₂ "	20"	15 lb	FPAFEC3CS	\$800
---------------------------------	----------------------------------	-----	-------	------------------	-------

Through-Mount

7 ⁷ / ₈ "	54 ¹ / ₂ "	20"	14 lb	FPAFEC3TM	\$746
---------------------------------	----------------------------------	-----	-------	------------------	-------

FrameOne Mount

7 ⁷ / ₈ "	54 ¹ / ₂ "	20"	14 lb	FPAFEC3FO	\$800
---------------------------------	----------------------------------	-----	-------	------------------	-------

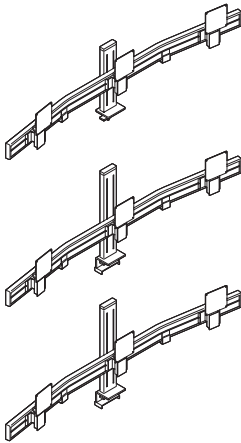

Tip: Ology bracket mount is available with optional brackets. See options on previous page.

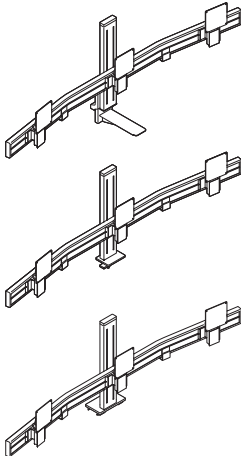

Tip: Eyesite arms should only be mounted to c:scape desks that are tethered to either the beam, another desk, or 1¹/₂-High low storage with a connect zone.

Tip: Monitor cables that connect to the rear of the monitor near the VESA plate will not fit properly on the Eyesite monitor arm.

Tip: Eyesite is not recommended with 22¹/₄"D Airtouch worksurfaces due to C-clamp interference with the lifting column.

Tip: Eyesite display supports will not fit in front of station mounted Slatwall and SlatRail when using a C-clamp bracket. A through-mount bracket is recommended.

Eyesite Flat Panel Monitor Arm Support Assemblies, continued

SIN 711.2

Eyesite Static One-Over-One Display Supports

Tip: Eyesite static one-over-one display support is for use with two monitors up to 30" and 25 lb each.

Tip: Monitor cables that connect to the rear of the monitor near the VESA plate will not fit properly on the Eyesite monitor arm.

Standard Includes	Required to Specify
<ul style="list-style-type: none"> Extended static column: 4799 Platinum Metallic Mounting bracket: 4799 Platinum Metallic 	1 Style number 2 Options, if selected (see below)

Options	Price	Required to Specify
Ology Brackets		
• C-clamp mount for use without power data access door	No cost	Specify with C-clamp mount for use without power data access door.
• C-clamp mount for use with power data access door	+\$75	Specify with C-clamp mount for use with power data access door.
• Rail mount bracket	+\$80	Specify with rail mount bracket.

Specification Information					
Dimensions			Weight	Style Number	Base Price
D	W	H			

26"H Extended Static Column

C-Clamp Mount

5 ³ / ₄ "	4 ¹ / ₈ "	31 ³ / ₄ "	11 lb	FPAS101CC	\$410
---------------------------------	---------------------------------	----------------------------------	-------	------------------	-------

Ology Bracket Mount

5 ³ / ₄ "	4 ¹ / ₈ "	31 ³ / ₄ "	11 lb	FPAS101OL	\$410
---------------------------------	---------------------------------	----------------------------------	-------	------------------	-------

c:scape Bracket Mount

5 ³ / ₄ "	4 ¹ / ₈ "	31 ³ / ₄ "	11 lb	FPAS101CS	\$463
---------------------------------	---------------------------------	----------------------------------	-------	------------------	-------

► Specification Information, continued on next page

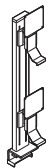
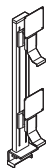

Tip: Ology bracket mount is available with optional brackets. See options above.

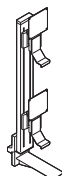

Tip: Eyesite arms should only be mounted to c:scape desks that are tethered to either the beam, another desk, or 1 1/2-High low storage with a connect zone.

Tip: Eyesite is not recommended with 22 1/4"D Airtouch worksurfaces due to C-clamp interference with the lifting column.

Tip: Eyesite display supports will not fit in front of stationion mounted Slatwall and SlatRail when using a C-clamp bracket. A through-mount bracket is recommended.

Tip: Monitor arms and laptop supports with C-clamp brackets are not recommended on Universal Tables with P-edge as the user's edge wraps all the way around table. Universal Systems Worksurfaces with P-edge will work as the user's edge is applied to the front only.

► Specification Information, continued from previous page

Specification Information

• Dimensions			• Weight	• Style	• Price
D	W	H		Number	

26"H Extended Static Column, continued

Through-Mount

5 ³ / ₄ "	4 ¹ / ₈ "	31 ³ / ₄ "	10 lb	FPAS1O1TM	\$410
---------------------------------	---------------------------------	----------------------------------	-------	------------------	-------

FrameOne Mount

5 ³ / ₄ "	4 ¹ / ₈ "	31 ³ / ₄ "	10 lb	FPAS1O1FO	\$458
---------------------------------	---------------------------------	----------------------------------	-------	------------------	-------

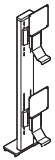

Tip: When mounting dual or triple Eyesite on stand-alone, single-sided FrameOne base units, the worksurface must be 66"W or greater and must be used with Eyesite standard crank adjustable column only.

Eyesite Flat Panel Monitor Arm Support Assemblies, continued

SIN 711.2

Eyesite Two-Over-Two Display Supports

Tip: Eyesite dual display support is for use with two monitors up to 24" screens and 15 lb each.

Tip: Bar-over-bar applications utilize the 26" extended static column only. Bar-over-bar is not permitted on c:scape, Bivi, or big table. Bar-over-bar may be used with FrameOne utilizing the static, non-focal adjusting dual and triple static yokes.

Tip: Bar-over-bar applications may be used with Series 3, 5, and 7 work-surfaces with three column base configurations. Bar-over-bar applications are not permitted for use with Airtouch, any Series 3, 5, and 7 worksurfaces with two column-base configurations, or any freestanding table with casters.

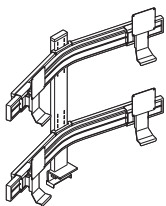
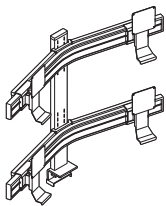

Standard Includes	Required to Specify
<ul style="list-style-type: none"> • Monitor arm: 4799 Platinum Metallic • Mounting bracket: 4799 Platinum Metallic 	1 Style number 2 Options, if selected (see below)

Bracket	Options	Price	Required to Specify
Bracket	• Without pivot	No cost	Specify <i>without pivot</i> .
	• With pivot	+\$36	Specify <i>with pivot</i> .
Ology Brackets	• C-clamp mount for use without power data access door	No cost	Specify <i>with C-clamp mount for use without power data access door</i> .
	• C-clamp mount for use with power data access door	+\$75	Specify <i>with C-clamp mount for use with power data access door</i> .
	• Rail mount bracket	+\$80	Specify <i>with rail mount bracket</i> .

Specification Information					
• Dimensions			• Weight	• Style	• Base
D	W	H		Number	Price
•	•	•	•	•	•
•	•	•	•	•	•
•	•	•	•	•	•

26"H Extended Static Column with Dual Yoke and Focal Adjustment

C-Clamp Mount					
8 1/2"	31"	26"	27 lb	FPAC2BBDCC	\$1183

Ology Bracket Mount					
8 1/2"	31"	26"	27 lb	FPAC2BBDOL	\$1183

► Specification Information, continued on next page

► Specification Information, continued from previous page

Specification Information

Dimensions			Weight	Style	Base
D	W	H		Number	Price

26"H Extended Static Column with Dual Yoke and Focal Adjustment, continued

Through-Mount

8½"	31"	26"	27 lb	FPAC2BBDTM	\$1183
-----	-----	-----	-------	-------------------	--------

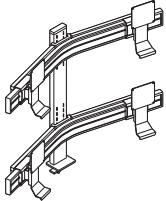

Tip: Monitor cables that connect to the rear of the monitor near the VESA plate will not fit properly on the Eyesite monitor arm.

26"H Extended Static Column with Dual Yoke and without Focal Adjustment

C-Clamp Mount

8½"	31"	26"	17 lb	FPAC2BBSCC	\$1087
-----	-----	-----	-------	-------------------	--------

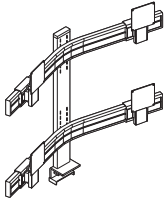

Ology Bracket Mount

8½"	31"	26"	17 lb	FPAC2BBSOL	\$1087
-----	-----	-----	-------	-------------------	--------

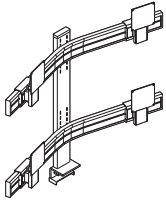

Through-Mount

8½"	31"	26"	17 lb	FPAC2BBSTM	\$1087
-----	-----	-----	-------	-------------------	--------

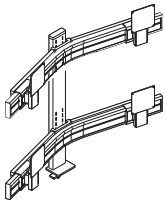

► Specification Information, continued on next page

Eyesite Flat Panel Monitor Arm Support Assemblies, continued

SIN 711.2

► Specification Information, continued from previous page

Specification Information

• Dimensions			• Weight	• Style	• Base
D	W	H		Number	Price

26"H Extended Static Column with Dual Yoke and without Focal Adjustment, continued

FrameOne Mount

8½"	31"	26"	17 lb	FPAC2BBSFO	\$1138
-----	-----	-----	-------	-------------------	--------

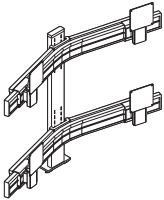

Tip: When mounting dual or triple Eyesite on stand-alone, single-sided FrameOne base units, the worksurface must be 66"W or greater.

Tip: Bar-over-bar applications for use with FrameOne must be used with static columns without focal adjustment yokes only.

Tip: Bar-over-bar applications are not permitted for use with c:scape worksurfaces.

Tip: Eyesite display supports will not fit in front of station mounted Slatwall and SlatRail when using a C-clamp bracket. A through-mount bracket is recommended.

Tip: Monitor arms and laptop supports with C-clamp brackets are not recommended on Universal Tables with P-edge as the user's edge wraps all the way around table. Universal Systems Worksurfaces with P-edge will work as the user's edge is applied to the front only.

Eyesite Three-Over-Three Display Supports

Tip: Eyesite triple display support is for use with three monitors up to 24" screens and 15 lb each.

Tip: Static yoke must be used when mounting a bar-over-bar application to FrameOne.

Tip: Bar-over-bar applications utilize the 26" extended static column only. Bar-over-bar is not permitted on c-scape, Bivi, or big table. Bar-over-bar may be used with FrameOne utilizing the static, non-focal adjusting dual and triple static yokes.

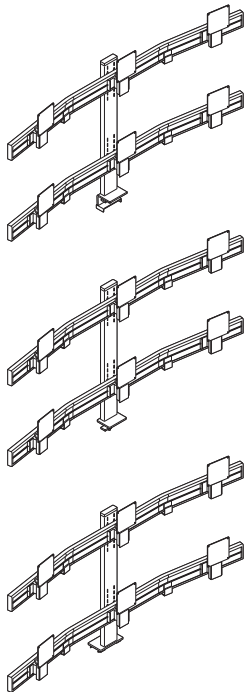

Tip: Bar-over-bar applications may be used with Series 3, 5, and 7 worksurfaces with three column base configurations. Bar-over-bar applications are not permitted for use with Airtouch, any Series 3, 5, and 7 worksurfaces with two column-base configurations, or any freestanding table with casters.

Standard Includes	Required to Specify
<ul style="list-style-type: none"> • Monitor arm: 4799 Platinum Metallic • Mounting bracket: 4799 Platinum Metallic 	1 Style number 2 Options, if selected (see below)

Options	Price	Required to Specify
Bracket <ul style="list-style-type: none"> • Without pivot • With pivot 	No cost +\$54	Specify <i>without pivot</i> . Specify <i>with pivot</i> .

Specification Information					
Dimensions			Weight	Style	Base
D	W	H		Number	Price

26"H Extended Static Column with Triple Yoke and without Focal Adjustment

C-Clamp Mount					
7 ⁷ / ₈ "	54 ¹ / ₂ "	26"	23 lb	FPAC3BBSCC	\$1289

Through-Mount					
7 ⁷ / ₈ "	54 ¹ / ₂ "	26"	23 lb	FPAC3BBSTM	\$1289

FrameOne Mount					
7 ⁷ / ₈ "	54 ¹ / ₂ "	26"	23 lb	FPAC3BBSFO	\$1343

Tip: Monitor cables that connect to the rear of the monitor near the VESA plate will not fit properly on the Eyesite monitor arm.

Tip: Eyesite display supports will not fit in front of station mounted Slatwall and SlatRail when using a C-clamp bracket. A through-mount bracket is recommended.

Tip: Monitor arms and laptop supports with C-clamp brackets are not recommended on Universal Tables with P-edge as the user's edge wraps all the way around table. Universal Systems Worksurfaces with P-edge will work as the user's edge is applied to the front only.

Eyesite Flat Panel Monitor Arm Support Assemblies, continued

SIN 711.2

Eyesite Single Laptop Supports

Tip: Eyesite flat panel monitor arms with laptop supports are not recommended for use with docking stations.

Tip: Supports laptops up to 20 lb.

Tip: Eyesite is not recommended with 22 1/4" D Airtouch worksurfaces due to C-clamp interference with the lifting column.

Tip: Eyesite display supports will not fit in front of Slatwall and SlatRail when using a C-clamp bracket a through-mount bracket is recommended.

Tip: Monitor arms and laptop supports with C-clamp brackets are not recommended on Universal Tables with P-edge as the user's edge wraps all the way around table. Universal Systems Worksurfaces with P-edge will work as the user's edge is applied to the front only.

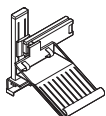
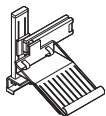

Tip: Ology bracket mount is available with optional brackets. See options above.

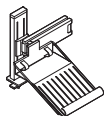
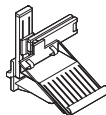

Standard Includes	Required to Specify
<ul style="list-style-type: none"> • Monitor arm: 4799 Platinum Metallic • Laptop support and adjustment column: 4799 Platinum Metallic • Mounting bracket: 4799 Platinum Metallic 	<ul style="list-style-type: none"> 1 Style number 2 Options, if selected (see below)

Options	Price	Required to Specify
Ology Brackets <ul style="list-style-type: none"> • C-clamp mount for use without power data access door • C-clamp mount for use with power data access door • Rail mount bracket 	<ul style="list-style-type: none"> No cost +\$75 +\$80 	<ul style="list-style-type: none"> Specify with C-clamp mount for use without power data access door. Specify with C-clamp mount for use with power data access door. Specify with rail mount bracket.

Specification Information			
Dimensions	Weight	Style	Price
D W H	:	Number	:

12"H Standard Crank Adjustment Column

C-Clamp Mount

16"	11 5/8"	15 1/2"	15 lb	FPALC1CC	\$390
-----	---------	---------	-------	-----------------	-------

Ology Bracket Mount

16"	11 5/8"	15 1/2"	14 lb	FPALC1OL	\$390
-----	---------	---------	-------	-----------------	-------

c:scape Mount

16"	11 5/8"	15 1/2"	15 lb	FPALC1CS	\$443
-----	---------	---------	-------	-----------------	-------

Through-Mount

16"	11 5/8"	15 1/2"	14 lb	FPALC1TM	\$390
-----	---------	---------	-------	-----------------	-------

► **Specification Information, continued on next page**

► Specification Information, continued from previous page

Specification Information

• Dimensions			• Weight	• Style Number	• Price
D	W	H			

12"H Standard Crank Adjustment Column, continued

FrameOne Mount

16"	11 ⁵ / ₈ "	15 ¹ / ₂ "	14 lb	FPALC1FO	\$501
-----	----------------------------------	----------------------------------	-------	-----------------	-------

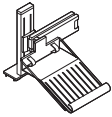

Tip: When mounting dual or triple Eyesite on stand-alone, single-sided FrameOne base units, the worksurface must be 66"W or greater and must be used with Eyesite standard crank adjustable column only.

18"H Extended Crank Adjustment Column

C-Clamp Mount

16"	11 ⁵ / ₈ "	19 ⁷ / ₈ "	16 lb	FPAELC1CC	\$443
-----	----------------------------------	----------------------------------	-------	------------------	-------

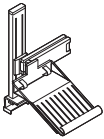

Ology Bracket Mount

16"	11 ⁵ / ₈ "	19 ⁷ / ₈ "	15 lb	FPAELC1OL	\$443
-----	----------------------------------	----------------------------------	-------	------------------	-------

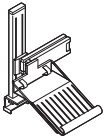

Tip: Ology bracket mount is available with optional brackets. See options on previous page.

c:scape Mount

16"	11 ⁵ / ₈ "	19 ⁷ / ₈ "	16 lb	FPAELC1CS	\$496
-----	----------------------------------	----------------------------------	-------	------------------	-------

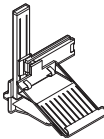

Through-Mount

16"	11 ⁵ / ₈ "	19 ⁷ / ₈ "	15 lb	FPAELC1TM	\$443
-----	----------------------------------	----------------------------------	-------	------------------	-------

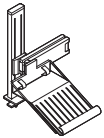

FrameOne Mount

16"	11 ⁵ / ₈ "	19 ⁷ / ₈ "	15 lb	FPAELC1FO	\$555
-----	----------------------------------	----------------------------------	-------	------------------	-------

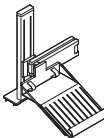

Bivi Mount

16"	11 ⁵ / ₈ "	19 ⁷ / ₈ "	15 lb	FPAELC1BIVI	\$513
-----	----------------------------------	----------------------------------	-------	--------------------	-------

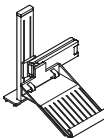

Tip: Bivi bracket to be used with Eyesite single support, dual display support, and dual laptop support with extended crank adjust columns only.

Eyesite Flat Panel Monitor Arm Support Assemblies, continued

SIN 711.2

Eyesite Dual Laptop Supports

Tip: Eyesite dual display support is for use with two monitors up to 27" or less screens and up to 20 lb each. 27" monitors should be used with extended 18" column assemblies or taller.

Tip: Eyesite flat panel monitor arms with laptop supports are not recommended for use with docking stations.

Standard Includes	Required to Specify
-------------------	---------------------

- | | |
|--|--|
| <ul style="list-style-type: none"> • Monitor arm: 4799 Platinum Metallic Metallic • Laptop support and adjustment column: 4799 Platinum Metallic • Mounting bracket: 4799 Platinum Metallic | <ul style="list-style-type: none"> 1 Style number 2 Options, if selected (see below) |
|--|--|

Options	Price	Required to Specify
---------	-------	---------------------

Bracket	<ul style="list-style-type: none"> • Without pivot • With pivot 	No cost +\$18	Specify <i>without pivot</i> . Specify <i>with pivot</i> .
Ology Brackets	<ul style="list-style-type: none"> • C-clamp mount for use without power data access door • C-clamp mount for use with power data access door • Rail mount bracket 	No cost +\$75 +\$80	Specify <i>with C-clamp mount for use without power data access door</i> . Specify <i>with C-clamp mount for use with power data access door</i> . Specify <i>with rail mount bracket</i> .

Specification Information			
Dimensions	Weight	Style	Base
D	W	H	Price

:	:	:	:
:	:	:	:

12"H Standard Crank Adjustment Column

C-Clamp Mount

17"	31"	15½"	20 lb	FPALC2CC	\$687
-----	-----	------	-------	-----------------	-------

Ology Bracket Mount

17"	31"	15½"	20 lb	FPALC2OL	\$687
-----	-----	------	-------	-----------------	-------

c:scape Mount

17"	31"	15½"	20 lb	FPALC2CS	\$741
-----	-----	------	-------	-----------------	-------

Through-Mount

17"	31"	15½"	19 lb	FPALC2TM	\$687
-----	-----	------	-------	-----------------	-------

► Specification Information, continued on next page

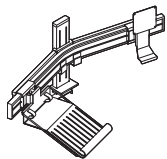
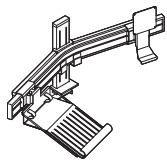

Tip: Ology bracket mount is available with optional brackets. See options above.

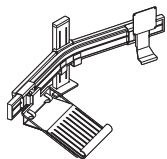
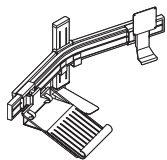

► **Specification Information, continued from previous page**

Specification Information

• Dimensions			• Weight	• Style	• Base
D	W	H		Number	Price

12"H Standard Crank Adjustment Column, continued

FrameOne Mount					
17"	31"	15½"	19 lb	FPALC2FO	\$741

► **Specification Information, continued on next page**

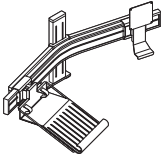

Tip: When mounting dual or triple Eyesite on stand-alone, single-sided FrameOne base units, the worksurface must be 66"W or greater and must be used with Eyesite standard crank adjustable column only.

Tip: When planning with stand-alone, single-sided FrameOne base units, and dual or triple monitor arms, the worksurface must be 66"W or greater and monitor arm must be 15½"H maximum.

Tip: Monitor arms and lap-top supports with C-clamp brackets are not recommended on Universal Tables with P-edge as the user's edge wraps all the way around table. Universal Systems Worksurfaces with P-edge will work as the user's edge is applied to the front only.

Tip: Monitor cables that connect to the rear of the monitor near the VESA plate will not fit properly on the Eyesite monitor arm.

Tip: Eyesite is not recommended with 22¼"D Airtouch worksurfaces due to C-clamp interference with the lifting column.

Tip: Eyesite display supports will not fit in front of stanchion mounted Slatwall and SlatRail when using a C-clamp bracket. A through-mount bracket is recommended.

Tip: Eyesite arms should only be mounted to c:scape desks that are tethered to either the beam, another desk, or 1½-High low storage with a connect zone.

Eyesite Flat Panel Monitor Arm Support Assemblies, continued

SIN 711.2

► Specification Information, continued from previous page

Specification Information

Dimensions			Weight	Style Number	Base Price
D	W	H			

18"H Extended Crank Adjustment Column

C-Clamp Mount

17"	31"	19 ⁷ / ₈ "	21 lb	FPAELC2CC	\$741
-----	-----	----------------------------------	-------	------------------	-------

Ology Bracket Mount

17"	31"	19 ⁷ / ₈ "	21 lb	FPAELC2OL	\$741
-----	-----	----------------------------------	-------	------------------	-------

c:scape Mount

17"	31"	19 ⁷ / ₈ "	21 lb	FPAELC2CS	\$796
-----	-----	----------------------------------	-------	------------------	-------

Through-Mount

17"	31"	19 ⁷ / ₈ "	20 lb	FPAELC2TM	\$741
-----	-----	----------------------------------	-------	------------------	-------

FrameOne Mount

17"	31"	19 ⁷ / ₈ "	20 lb	FPAELC2FO	\$796
-----	-----	----------------------------------	-------	------------------	-------

Bivi Mount

17"	31"	19 ⁷ / ₈ "	20 lb	FPAELC2BIVI	\$813
-----	-----	----------------------------------	-------	--------------------	-------

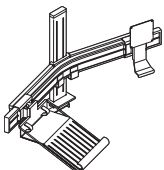
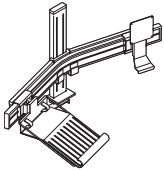

Tip: Ology bracket mount is available with optional brackets. See options on previous page.

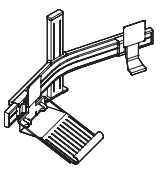
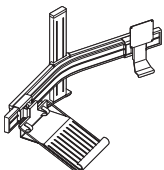
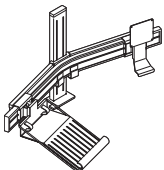
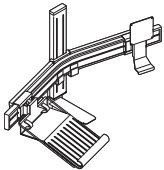

Tip: Bivi bracket to be used with Eyesite single support, dual display support, and dual laptop support with extended crank adjust columns only.

Eyesite Flat Panel Monitor
Arm Support Assemblies

SIN 711.2

Eyesite Modular Components

SIN 711.2

Modular Arm Components

Tip: Column and mounting bracket must be ordered separately.

Standard Includes	Required to Specify
<ul style="list-style-type: none"> Modular arm components: 4799 Platinum Metallic 	1 Style number 2 Options, if selected (see below)

Options	Price	Required to Specify
Bracket		
<ul style="list-style-type: none"> Without pivot 	No cost	Specify <i>without pivot</i> .
<ul style="list-style-type: none"> Dual adjustable yoke or dual static yoke with pivot 	+\$18	Specify <i>with pivot</i> .
<ul style="list-style-type: none"> Triple static yoke with pivot 	+\$27	Specify <i>with pivot</i> .

Specification Information

• Dimensions	• Weight	• Style	• Base
D W H	:	Number	Price

Single Flex Mount Arm

4 ⁵ / ₈ "	11 ⁵ / ₈ "	9 ¹ / ₂ "	5 lb	FPC1	\$163
:	:	:	:	:	:



Tip: Eyesite single flex mount, when used with monitors with weight concentration at bottom of monitors or all-in-one monitors with CPUs, may be prone to drift.

Single Direct Mount Arm with Laptop Support

4 ⁵ / ₈ "	11 ⁵ / ₈ "	9 ¹ / ₂ "	6 lb	FPCL1	\$283
:	:	:	:	:	:

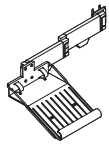

Dual Static Yoke

5"	31"	3"	5 lb	FPC2SB	\$441
:	:	:	:	:	:

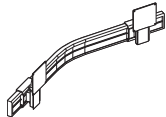

Dual Adjustable Yoke

5"	31"	3"	10 lb	FPC2	\$499
:	:	:	:	:	:

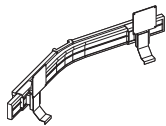

Triple Static Yoke

3"	54 ¹ / ₄ "	3"	8 lb	FPC3	\$538
:	:	:	:	:	:

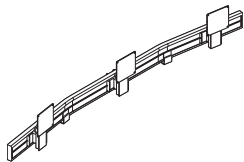

Columns

Tip: For large monitor screens (20"+), order standard columns. For small monitor screens (17"-19"), order extended columns.

Tip: Modular component and mount option must be ordered separately.



Tip: 26"H extended static column must be used for two-over-two and three-over-three applications.

Standard Includes	Required to Specify
• Column: 4799 Platinum Metallic	Style number

Specification Information

• Dimensions			• Weight	• Style Number	• Price
D	W	H			
12" Standard Crank					
1"	3"	12 ¹ / ₂ "	3.35 lb	FPCSCC	\$165
•	•	•	•	•	•
18" Extended Crank					
1"	3"	17 ³ / ₈ "	4.5 lb	FPCECC	\$219
•	•	•	•	•	•
26" Extended Static					
1"	3"	26 ¹ / ₂ "	5 lb	FPCESC	\$200
•	•	•	•	•	•

Eyesite Modular Components, continued

SIN 711.2

Laptop Component

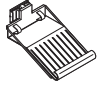

Standard Includes				Required to Specify	
• Laptop component: 4799 Platinum Metallic				Style number	
Specification Information					
• Dimensions			• Weight	• Style Number	• Price
D	W	H			
14"	10"	7"	3.4 lb	FPCL	\$132

VESA Bracket/Hook



Tip: VESA bracket/hook is for use with static column.

Standard Includes				Required to Specify	
• Bracket/hook: 4799 Platinum Metallic				Style number	
Specification Information					
• Dimensions			• Weight	• Style Number	• Price
D	W	H			
2 ¹ / ₂ "	4 ¹ / ₂ "	10"	1.7 lb	FPCHTV	\$112

VESA Bracket Assembly—Slide



Tip: VESA/bracket assembly-slide is for use with dual yoke or triple yoke modular components.

Standard Includes				Required to Specify	
• Bracket assembly: 4799 Platinum Metallic				1 Style number 2 Options, if selected (see below)	
Bracket		Options	Price	Required to Specify	
		• Without pivot	No cost	Specify <i>without pivot</i> .	
		• With pivot	+\$9	Specify <i>with pivot</i> .	
Specification Information					
• Dimensions			• Weight	• Style Number	• Base Price
D	W	H			
2 ⁵ / ₁₆ "	4 ⁵ / ₁₆ "	9 ¹ / ₂ "	1.25 lb	FPCFTV	\$112

Eyesite Extended Static Column with VESA Bracket/Hook

Eyesite Extended
Static Column with
VESA Bracket/Hook

SIN 711.2

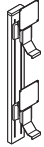

Tip: For large monitor screens (20"+), order standard columns. For small monitor screens (17"-19"), order extended columns.

▶ Page 160

Tip: Mounting brackets must be ordered separately.

Standard Includes	Required to Specify
<ul style="list-style-type: none"> Modular assembly: 4799 Platinum Metallic 	Style number

Specification Information					
• Dimensions			• Weight	• Style	• Price
D	W	H		Number	
5 ³ / ₄ "	4 ¹ / ₈ "	29 ³ / ₄ "	9 lb	FPAS101	\$363
:	:	:	:	:	:

Eyesite Mounting Brackets

SIN 711.2

Tip: Eyesite is not recommended with 22 1/4" D Airtouch worksurfaces due to C-clamp interference with the lifting column.

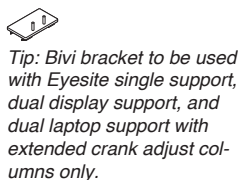
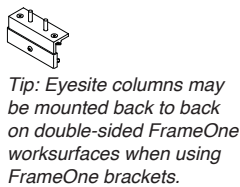
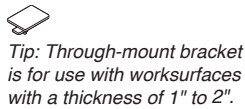
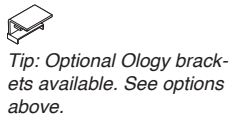
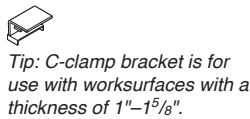
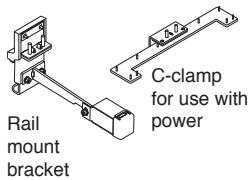

Standard Includes	Required to Specify
-------------------	---------------------

- | | |
|-----------------------------------|--|
| • Bracket: 4799 Platinum Metallic | 1 Style number
2 Options, if selected (see below) |
|-----------------------------------|--|

Options	Price	Required to Specify
---------	-------	---------------------

- | | | |
|-----------------------|---|---|
| Ology Brackets | • C-clamp mount for use without power data access door
• C-clamp mount for use with power data access door
• Rail mount bracket | No cost
+\$75
+\$80 |
| | | Specify with C-clamp mount for use without power data access door.
Specify with C-clamp mount for use with power data access door.
Specify with rail mount bracket. |

Specification Information					
• Dimensions			• Weight	• Style Number	• Base Price
D	W	H	:	:	:

C-Clamp Bracket					
-----------------	--	--	--	--	--

3"	4"	2 1/2"	2 lb	FPCCC	\$ 50
:	:	:	:	:	:

Ology Bracket					
---------------	--	--	--	--	--

3"	4"	2 1/2"	2 lb	FPCOL	\$ 50
:	:	:	:	:	:

Through-Mount Bracket					
-----------------------	--	--	--	--	--

3"	4"	1/4"	1.3 lb	FPCTM	\$ 50
:	:	:	:	:	:

FrameOne Bracket					
------------------	--	--	--	--	--

3"	4"	1/4"	1.5 lb	FPCFO	\$ 88
:	:	:	:	:	:

c:scape Bracket					
-----------------	--	--	--	--	--

4"	10"	6 1/2"	2.5 lb	FPCCS	\$107
:	:	:	:	:	:

Bivi Bracket					
--------------	--	--	--	--	--

3"	4"	1/4"	1.5 lb	FPCBIVI	\$124
:	:	:	:	:	:

CF Series Flat Panel Monitor Arms and Supports

CF Series Flat Panel Monitor Arms and Supports

SIN 711.2

CF Series Flat Panel Light-Duty, Standard, and Heavy Duty Monitor Arms

Standard Includes	Required to Specify
<ul style="list-style-type: none"> • Monitor arm: paint • Standard tilt head • No mounting bracket 	<ol style="list-style-type: none"> 1 Style number 2 Paint color number for monitor arm: 0835 Black 7018 Pewter ZW01 Pearl Snow 3 Tilt head mechanism (See Required Selections below) 4 Options, if selected (see below)

Required Selections	Price	Required to Specify
Tilt head Mechanism <ul style="list-style-type: none"> • Standard tilt head • Heavy-duty spring tilt head 	No cost +\$ 26	Specify with <i>standard tilt head</i> . Specify with <i>heavy-duty spring tilt head</i> .

Options	Price	Required to Specify
Brackets <ul style="list-style-type: none"> • No bracket • Desk C-clamp/grommet • Through-mount • Desk C-clamp/through-mount grommet • Wall/reverse wall mount • Slatwall • FrameOne • c:scape 	No cost +\$ 50 +\$ 50 +\$ 50 +\$ 50 +\$ 90 +\$103	Specify with <i>no bracket</i> . Specify with <i>desk C-clamp/grommet bracket</i> . Specify with <i>through-mount bracket</i> . Specify with <i>desk C-clamp/through-mount grommet bracket</i> . Specify with <i>wall/reverse wall mount bracket</i> . Specify with <i>Slatwall bracket</i> . Specify with <i>FrameOne bracket</i> . Specify with <i>c:scape bracket</i> .

Tip: Bracket color will match selected monitor arm color.

Specification Information		
Weight	Style Number	Base Price

Light-Duty Monitor Arms

5 lb	CF450	\$355
6 lb	CF500	\$380
:	:	:

Standard Monitor Arms

10.5 lb	CF600	\$389
10.5 lb	CF800	\$396
:	:	:

Heavy-Duty Monitor Arm

10.5 lb	CF1000	\$430
:	:	:

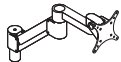

Tip: CF450 arm supports monitors 6–19 lb. CF500 arm supports monitors 2–12.5 lb.

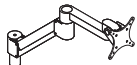

Tip: CF600 arm supports monitors 5–17 lb. CF800 arm supports monitors 9–25 lb.

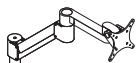

Tip: Heavy-duty arm, CF1000 supports 11-28 lb.

Tip: CF450, CF500, CF600, CF800, and CF1000 cannot be used with maximum-duty arm bracket CFSPSGLBASE.

Tip: Slatwall skin brace package is required when mounting a flat panel monitor arm on an Answer slatwall skin.

Tip: When mounting CF Series arm brackets to Slatwall, bracket must be mounted no further than 10" away from Slatwall mounting bracket. If application does not allow bracket to be installed within the 10" range, an additional bracket or brackets should be installed within 10" of desired arm location.

Tip: Two single arms can be mounted on 18"H or 24"H Answer slatwall skin that has an installed brace package. For optimal stability, the monitor arm should be mounted as shown below:

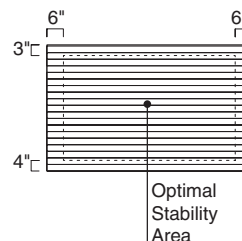

CF Series Flat Panel Monitor Arms and Supports, continued

SIN 711.2

CF Series Flat Panel Maximum-Duty Monitor Arm and Support

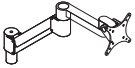

Tip: Maximum-duty arm supports monitors 13–40 lb.

Tip: Maximum-duty monitor arm is standard with a heavy-duty spring tilt head mechanism only.

Tip: CF2500 can only be used with the maximum-duty arm bracket (CFSPSGLBASE).

Tip: Bracket color will match selected monitor arm color.

Standard Includes	Required to Specify
-------------------	---------------------

- Monitor arm: paint
- Heavy-duty spring tilt head mechanism
- No mounting bracket

- 1 Style number
- 2 Paint color number for monitor arm:
0835 Black
7018 Pewter
ZW01 Pearl Snow
- 3 Options, if selected (see below)

Options	Price	Required to Specify
---------	-------	---------------------

Brackets	<ul style="list-style-type: none"> • No bracket • Maximum-duty arm 	No cost +\$60	Specify <i>with no bracket</i> . Specify <i>with maximum-duty arm bracket</i> .
-----------------	--	------------------	--

Specification Information		
Weight	Style Number	Base Price

12 lb	CF2500	\$495
:	:	:
:	:	:

CF Series Flat Panel Monitor Arm Assemblies with Dual-Bar Arm

Standard Includes	Required to Specify
<ul style="list-style-type: none"> • Monitor arm: paint • Heavy-duty tilt head • Dual-bar arm: 7018 Pewter • No mounting bracket 	<ol style="list-style-type: none"> 1 Style number 2 Paint color number for monitor arm: <ul style="list-style-type: none"> 0835 Black 7018 Pewter ZW01 Pearl Snow 3 Options, if selected (see below)

Options	Price	Required to Specify
Brackets		
• No bracket	No cost	Specify with <i>no bracket</i> .
• Desk C-clamp/grommet	+\$ 50	Specify with <i>desk C-clamp/grommet bracket</i> .
• Through-mount	+\$ 50	Specify with <i>through-mount bracket</i> .
• Desk C-clamp/through-mount grommet	+\$ 50	Specify with <i>desk C-clamp/through-mount grommet bracket</i> .
• Wall/reverse wall mount	+\$ 50	Specify with <i>wall/reverse wall mount grommet bracket</i> .
• Slatwall	+\$ 50	Specify with <i>Slatwall bracket</i> .
• FrameOne	+\$ 90	Specify with <i>FrameOne bracket</i> .
• c:scape	+\$103	Specify with <i>c:scape bracket</i> .

Tip: Bracket color will match selected monitor arm color.

Tip: Bivi mounting bracket requires additional Bivi brace (TS8TMBRAC).
 ▶ See turnstone Specification Guide.

Tip: Grommet mount requires 2" or larger hole.

Specification Information		
Weight	Style Number	Base Price

Standard Monitor Arm with Dual-Bar Arm, Heavy-Duty Tilt Head

18 lb	CF800DUALBAR	\$641
:	:	:

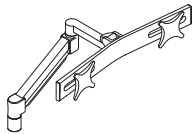

Tip: When using dual-bar arm the standard arm supports monitors 4–20 lb total weight.

Heavy-Duty Monitor Arm with Dual-Bar Arm, Heavy-Duty Tilt Head

13 lb	CF1000DUALBAR	\$676
:	:	:

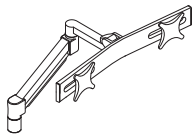

Tip: When using dual-bar arm the heavy-duty arm supports monitors 6–26 lb total weight.

CF Series Flat Panel Monitor Arms and Supports, continued

SIN 711.2

CF Series Flat Panel Maximum-Duty Monitor Arm Assembly with Dual-Bar Arm

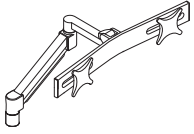

Tip: When using dual-bar arm the maximum-duty arm supports monitors 8–39 lb total weight.

Tip: Bracket color will match selected monitor arm color.

Standard Includes		Required to Specify	
-------------------	--	---------------------	--

- Monitor arm: paint
- Heavy-duty spring tilt head
- Dual-bar arm: 7018 Pewter
- No mounting bracket

- 1 Style number
- 2 Paint color number for monitor arm:
0835 Black
7018 Pewter
ZW01 Pearl Snow
- 3 Options, if selected (see below)

Options	Price	Required to Specify
---------	-------	---------------------

Brackets	<ul style="list-style-type: none"> • No bracket • Maximum-duty arm 	No cost +\$60	Specify <i>with no bracket</i> . Specify <i>with maximum-duty arm bracket</i> .
-----------------	--	------------------	--

Specification Information		
Weight	Style Number	Base Price

21 lb	CF2500DUALBAR	\$716
-------	----------------------	-------

CF Series Flat Panel Monitor Pole Mounts with Arms

Standard Includes	Required to Specify
<ul style="list-style-type: none"> • Monitor arm pole mount: paint • 12" pole • Tilt head mechanism • Standard tilt head • No mounting bracket 	1 Style number 2 Paint color number for pole mount: 0835 Black 7018 Pewter ZW01 Pearl Snow 3 Tilt head mechanism (See Required Selections below) 4 Options, if selected (see below)

Required Selections	Price	Required to Specify
Tilt head Mechanism		
Single		
• Standard tilt head	No cost	Specify with <i>standard tilt head</i> .
• Heavy-duty spring tilt head	+\$ 26	Specify with <i>heavy-duty spring tilt head</i> .
Double		
• Standard tilt head	No cost	Specify with <i>standard tilt head</i> .
• Heavy-duty spring tilt head	+\$ 56	Specify with <i>heavy-duty spring tilt head</i> .

Options	Price	Required to Specify
Brackets		
• No bracket	No cost	Specify with <i>no bracket</i> .
• Desk C-clamp/grommet	+\$ 50	Specify with <i>desk C-clamp/grommet bracket</i> .
• Through-mount	+\$ 50	Specify with <i>through-mount bracket</i> .
• Desk C-clamp/through-mount grommet	+\$ 50	Specify with <i>desk C-clamp/through-mount grommet bracket</i> .
• Wall/reverse wall mount	+\$ 50	Specify with <i>wall/reverse wall mount bracket</i> .
• Slatwall (single-arm only)	+\$ 51	Specify with <i>Slatwall bracket</i> .
• Bivi	+\$ 51	Specify with <i>Bivi bracket</i> .
• FrameOne	+\$ 90	Specify with <i>FrameOne bracket</i> .
• c:scape	+\$103	Specify with <i>c:scape bracket</i> .

Tip: Bracket color will match selected monitor arm color.

Tip: Bivi mounting bracket requires additional Bivi brace (TS8TMBRAC).
▶ See turnstone Specification Guide.

Tip: Grommet mount requires 2" or larger hole.



Tip: Lower arm is 8" in length and upper arm is 4" in length. Tilt head included.

Tip: Single-arm pole mount supports monitors up to 25 pounds.

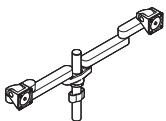

Tip: Double-arm pole mount supports two 24" monitors (16:9 aspect ratio, 22"W side to side) up to 25 pounds per monitor. Use of 24" monitors will reduce available focal depth adjustment.

Specification Information

Height	Weight	Style Number	Base Price
12"	6 lb	CFSHA	\$325

Single-Arm Pole Mount

12"	6 lb	CFSHA	\$325
-----	------	-------	-------

Double-Arm Pole Mount

12"	11.5 lb	CFDHA	\$555
-----	---------	-------	-------

Tip: Double-arm pole is not recommended for use with Slatwall mounting bracket.

Tip: Slatwall skin brace package is required when mounting a flat panel monitor arm on an Answer slatwall skin.

Tip: Two single arms can be mounted on 18"H or 24"H Answer slatwall skin that has an installed brace package. For optimal stability, the monitor arm should be mounted as shown below:

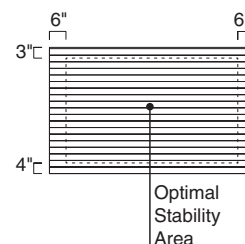

CF Series Flat Panel Monitor Arms and Supports, continued

SIN 711.2

CF Series Flat Panel Pole Without Arms



Tip: Assemblies using CFP28 may not exceed 15 lb per monitor.

Tip: CFSPSGLBASE is recommended for use with CFP28 and monitor over monitor configurations.

Tip: A through-mount bracket is recommended when CFP28 is used in monitor-over-monitor configurations. Do not use C-clamp mount bracket.

Tip: CFP14, CFP28, CFSARM, and CFDARM cannot be used with maximum-duty arm bracket CFSPSGLBASE.

Standard Includes	Required to Specify
<ul style="list-style-type: none"> Monitor pole mount: paint 	1 Style number 2 Paint color number for pole mount: 0835 Black 7018 Pewter ZW01 Pearl Snow

Related Products	
<ul style="list-style-type: none"> Flat panel monitor arm Flat panel monitor brackets 	▶ Page 163 ▶ Page 180

Specification Information			
Dimensions	Weight	Style Number	Price
H			
14"	2 lb	CFP14	\$121
28"	3 lb	CFP28	\$159

CF Series Single Static Modular Monitor Arm Assembly



Tip: CFMSP supports monitors up to 30 lb and up to 50".

Tip: CF Series modular c:scape, FrameOne, Bivi mounting brackets are not approved for use on one over one, two over two and three over three applications.

Tip: CF modular pole mount C-clamp can be C-clamped/through-mounted/grommet mounted.

Tip: Bracket color will match selected monitor arm color.

Tip: CF Series modular monitor arm assemblies are standard with standard tilt head, and VESA plate.

Standard Includes	Required to Specify
<ul style="list-style-type: none"> Monitor arm: paint Standard tilt head 	1 Style number 2 Paint color number for monitor arm: 0835 Black 7018 Pewter ZW01 Pearl Snow 3 Tilt head mechanism (see Required Selections below) 4 Options, if selected (see below)

Required Selections	Price	Required to Specify
Tilt Head Mechanism		
<ul style="list-style-type: none"> Standard tilt head Heavy-duty spring tilt head 	No cost +\$26	Specify with <i>standard tilt head</i> . Specify with <i>heavy-duty spring tilt head</i> .

Options	Price	Required to Specify
Brackets		
<ul style="list-style-type: none"> No bracket Modular pole mount C-clamp single tier 	No cost +\$60	Specify with <i>no bracket</i> . Specify with <i>modular pole mount C-clamp single tier bracket</i> .

Specification Information	
Style Number	Base Price
CFMSP	\$176

CF Series Single Static One-Over-One Monitor Arm Assembly



Tip: CFMSSP supports monitors up to 20 lb per monitor and up to 24" per monitor.

Tip: CF modular pole mount C-clamp can be C-clamped/through-mounted/grommet mounted.

Tip: CF Series modular monitor arm assemblies are standard with standard tilt head, and VESA plate.

Tip: Bracket color will match selected monitor arm color.

Standard Includes	Required to Specify
-------------------	---------------------

- Monitor arm: paint
- Standard tilt head

- 1 Style number
- 2 Paint color number for monitor arm:
0835 Black
7018 Pewter
ZW01 Pearl Snow
- 3 Tilt head mechanism (see Required Selections below)
- 4 Options, if selected (see below)

Tilt Head Mechanism	Required Selections	Price	Required to Specify
---------------------	---------------------	-------	---------------------

- Standard tilt head
- Heavy-duty spring tilt head

No cost
+\$52

Specify with standard tilt head.
Specify with heavy-duty spring tilt head.

Brackets	Options	Price	Required to Specify
----------	---------	-------	---------------------

- No bracket
- Modular pole mount C-clamp

No cost
+\$60

Specify with no bracket.
Specify with modular pole mount C-clamp bracket.

Specification Information

Style Number	Base Price
CFMSSP	\$510
.	.
.	.

CF Series Flat Panel Monitor Arms and Supports, continued

SIN 711.2

CF Series Single Dynamic Modular Monitor Arm Assemblies

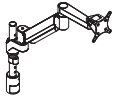

Tip: CF Series modular monitor arm assemblies are standard with standard tilt head, and VESA plate.

Tip: Bracket color will match selected monitor arm color.

Tip: Bivi mounting bracket requires additional Bivi brace (TS8TMBRAC).

▶ See turnstone Specification Guide.

Tip: CF Series single dynamic modular monitor arm assemblies support monitors for various weights and sizes.

▶ See Worktools Specification Guide.

Tip: CF Series modular C-clamp can be grommet mounted and also comes with the flex mount package which allows through-mount.

Standard Includes	Required to Specify
-------------------	---------------------

<ul style="list-style-type: none"> • Monitor arm with pole: paint • Standard tilt head 	<ol style="list-style-type: none"> 1 Style number 2 Paint color number for monitor arm: <ul style="list-style-type: none"> 0835 Black 7018 Pewter ZW01 Pearl Snow 3 Tilt head mechanism (see Required Selections below) 4 Options, if selected (see below)
--	--

Required Selections	Price	Required to Specify
---------------------	-------	---------------------

Tilt Head Mechanism <ul style="list-style-type: none"> • Standard tilt head • Heavy-duty spring tilt head 	No cost +\$26	Specify with standard tilt head. Specify with heavy-duty spring tilt head.
--	------------------	---

Options	Price	Required to Specify
---------	-------	---------------------

Brackets <ul style="list-style-type: none"> • No bracket • Modular pole mount C-clamp single tier 	No cost +\$60	Specify with no bracket. Specify with modular pole mount C-clamp single tier modular.
--	------------------	--

Specification Information	
Style Number	Base Price

CF450MSP	\$333
CF500MSP	\$337
CF600MSP	\$342
CF800MSP	\$345
CF1000MSP	\$366

CF Series Dual Static Modular Monitor Arm Assemblies

Tip: CF Series modular monitor arm assemblies are standard with standard tilt head, and VESA plate.

Tip: CF Series modular C-clamp can be grommet mounted and also comes with the flex mount package which allows through-mount.

Tip: Bracket color will match selected monitor arm color.

Standard Includes		Required to Specify	
-------------------	--	---------------------	--

- Monitor arm: paint
- Standard tilt head

- 1 Style number
- 2 Paint color number for monitor arm:
0835 Black
7018 Pewter
ZW01 Pearl Snow
- 3 Tilt head mechanism (see Required Selections below)
- 4 Options, if selected (see below)

Required Selections	Price	Required to Specify
---------------------	-------	---------------------

- | | | | |
|----------------------------|---|------------------|---|
| Tilt Head Mechanism | <ul style="list-style-type: none"> • Standard tilt head • Heavy-duty spring tilt head | No cost
+\$52 | Specify with <i>standard tilt head</i> .
Specify with <i>heavy-duty spring tilt head</i> . |
|----------------------------|---|------------------|---|

Options	Price	Required to Specify
---------	-------	---------------------

- | | | | |
|-----------------|--|------------------|--|
| Brackets | <ul style="list-style-type: none"> • No bracket • Modular pole mount C-clamp single tier | No cost
+\$60 | Specify with <i>no bracket</i> .
Specify with <i>modular pole mount C-clamp single tier bracket</i> . |
|-----------------|--|------------------|--|

Specification Information

Style Number	Base Price
--------------	------------

Dual Static Monitor Arm Assembly with Pole

CFMDSP	\$443
--------	-------

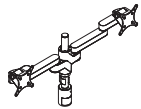

Tip: CFMDSP supports monitors up to 20 lb and up to 24" per monitor.

Wide Dual Static Monitor Arm Assembly with Pole

CFMDSWP	\$481
---------	-------

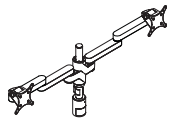

Tip: CFMDSWP supports monitors up to 20 lb and 24" to 30" per monitor.

CF Series Flat Panel Monitor Arms and Supports, continued

SIN 711.2

CF Series Dual Static Modular Monitor Arm Assemblies

Tip: CF Series modular monitor arm assemblies are standard with standard tilt head, and VESA plate.

Tip: CF Series modular C-clamp can be grommet mounted and also comes with the flex mount package which allows through-mount.

Tip: Bracket color will match selected monitor arm color.

Standard Includes	Required to Specify
-------------------	---------------------

<ul style="list-style-type: none"> • Monitor arm: paint • Standard tilt head 	<ol style="list-style-type: none"> 1 Style number 2 Paint color number for monitor arm: 0835 Black 7018 Pewter ZW01 Pearl Snow 3 Tilt head mechanism (see Required Selections below) 4 Options, if selected (see below)
--	---

Required Selections	Price	Required to Specify
---------------------	-------	---------------------

Tilt Head Mechanism <ul style="list-style-type: none"> • Standard tilt head • Heavy-duty spring tilt head 	No cost +\$104	Specify with <i>standard tilt head</i> . Specify with <i>heavy-duty spring tilt head</i> .
--	-------------------	---

Options	Price	Required to Specify
---------	-------	---------------------

Brackets <ul style="list-style-type: none"> • No bracket • Modular pole mount C-clamp two tier 	No cost +\$ 60	Specify with <i>no bracket</i> . Specify with <i>modular pole mount C-clamp two tier bracket</i> .
---	-------------------	---

Specification Information

Style Number	Base Price
--------------	------------

Static Two-Over-Two Monitor Arm Assembly with Pole

CFMDSDSP	\$ 890
-----------------	--------

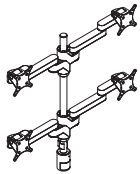

Tip: CFMDSDSP supports monitors up to 12 lb and up to 24" per monitor.

Wide Static Two-Over-Two Monitor Arm Assembly with Pole

CFMDSWDP	\$1045
-----------------	--------

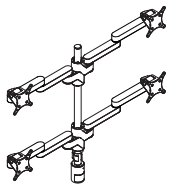

Tip: CFMDSWDP supports monitors up to 12 lb and 30" per monitor.

CF Series Dual Dynamic Modular Monitor Arm Assemblies

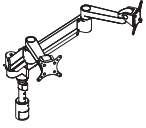

Tip: CF Series dual dynamic modular monitor arm assemblies support monitors for various weights and sizes. ▶ See Worktools Specification Guide.

The C-clamp can be grommet and through mounted.

Tip: CF Series modular monitor arm assemblies are standard with standard tilt head, and VESA plate.

Tip: CF Series modular C-clamp can be grommet mounted and also comes with the flex mount package which allows through-mount.

Tip: Bracket color will match selected monitor arm color.

Tip: CF1000MDDP is limited to 25 lbs per monitor when using FrameOne and c:scape brackets.

Standard Includes	Required to Specify
<ul style="list-style-type: none"> • Monitor arm with pole: paint • Standard tilt head 	<ol style="list-style-type: none"> 1 Style number 2 Paint color number for monitor arm: <ul style="list-style-type: none"> 0835 Black 7018 Pewter ZW01 Pearl Snow 3 Tilt head mechanism (see Required Selections below) 4 Options, if selected (see below)

Required Selections	Price	Required to Specify
Tilt Head Mechanism <ul style="list-style-type: none"> • Standard tilt head • Heavy-duty spring tilt head 	No cost +\$52	Specify with <i>standard tilt head</i> . Specify with <i>heavy-duty spring tilt head</i> .

Options	Price	Required to Specify
Brackets <ul style="list-style-type: none"> • No bracket • Modular pole mount C-clamp single tier 	No cost +\$60	Specify with <i>no bracket</i> . Specify with <i>modular pole mount C-clamp single tier bracket</i> .

Specification Information	
Style Number	Base Price
CF450MDDP	\$599
CF500MDDP	\$603
CF600MDDP	\$611
CF800MDDP	\$626
CF1000MDDP	\$635

Computer Support Tools

CF Series Flat Panel Monitor Arms and Supports, continued

SIN 711.2

CF Series Dual Dynamic Modular Monitor Arm Assemblies

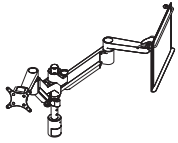

Tip: Supports laptops weighing up to 11 lb.

Tip: For dual dynamic monitor arm assembly with laptop holder, CF500 monitor arm will be designated for laptop holder use. If CF800MDDL is specified, one CF800 arm for the monitor and one CF500 arm for the laptop holder will be ordered.

Tip: CF Series modular monitor arm assemblies are standard with standard tilt head, and VESA plate.

Tip: CF Series modular C-clamp can be grommet mounted and also comes with the flex mount package which allows through-mount.

Tip: Bracket color will match selected monitor arm color.

Standard Includes	Required to Specify
<ul style="list-style-type: none"> • Monitor arm with laptop holder and pole: paint • Standard tilt head 	<ol style="list-style-type: none"> 1 Style number 2 Paint color number for monitor arm: <ul style="list-style-type: none"> 0835 Black 7018 Pewter ZW01 Pearl Snow 3 Tilt head mechanism (see Required Selections below) 4 Options, if selected (see below)

Required Selections	Price	Required to Specify
Tilt Head Mechanism <ul style="list-style-type: none"> • Standard tilt head • Heavy-duty spring tilt head 	No cost +\$26	Specify with standard tilt head. Specify with heavy-duty spring tilt head.

Options	Price	Required to Specify
Brackets <ul style="list-style-type: none"> • No bracket • Modular pole mount C-clamp single tier 	No cost +\$60	Specify with no bracket. Specify with modular pole mount C-clamp single tier bracket.

Specification Information	
Style Number	Base Price
CF450MDDL	\$701
CF500MDDL	\$703
CF600MDDL	\$713
CF800MDDL	\$728
CF1000MDDL	\$737
•	•

CF Series Triple Static Modular Monitor Arm Assemblies

Tip: CF Series modular monitor arm assemblies are standard with standard tilt head, and VESA plate.

Standard Includes	Required to Specify
<ul style="list-style-type: none"> • Monitor arm: paint • Standard tilt head 	<ol style="list-style-type: none"> 1 Style number 2 Paint color number for monitor arm: <ul style="list-style-type: none"> 0835 Black 7018 Pewter ZW01 Pearl Snow 3 Tilt head mechanism (see Required Selections below) 4 Options, if selected (see below)

Required Selections	Price	Required to Specify
Tilt Head Mechanism <ul style="list-style-type: none"> • Standard tilt head • Heavy-duty spring tilt head 	No cost +\$78	Specify with <i>standard tilt head</i> . Specify with <i>heavy-duty spring tilt head</i> .

Tip: Bracket color will match selected monitor arm color.

Options	Price	Required to Specify
Brackets <ul style="list-style-type: none"> • No bracket • Modular pole mount C-clamp single tier 	No cost +\$60	Specify with <i>no bracket</i> . Specify with <i>modular pole mount C-clamp single tier bracket</i> .

Tip: Triple monitor arm includes two fine height adjustable adapter tilt head mechanisms.

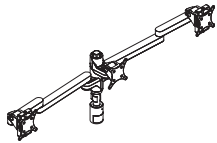

Tip: CFMTSP supports monitors up to 20 lb and up to 24" per monitor and 15 lb when using FrameOne and c:scape brackets.

Specification Information	
Style Number	Base Price
CFMTSP	\$580

Triple Static Monitor Arm Assembly with Pole

CFMTSP	\$580
--------	-------

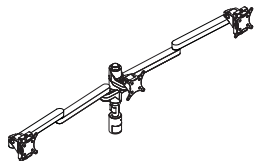

Tip: The C-clamp can be grommet and through-mounted.

Tip: CFMTSWP supports monitors up to 20 lb and 24" to 30" per monitor and 15 lb when using FrameOne and c:scape brackets.

Tip: CF Series modular C-clamp can be grommet mounted and also comes with the flex mount package which allows through-mount.

Wide Triple Static Monitor Arm Assembly with Pole

CFMTSWP	\$640
---------	-------

CF Series Flat Panel Monitor Arms and Supports, continued

SIN 711.2

CF Series Triple Static Modular Monitor Arm Assemblies

Tip: CF Series modular monitor arm assemblies are standard with standard tilt head, and VESA plate.

Standard Includes	Required to Specify
<ul style="list-style-type: none"> • Monitor arm: paint • Standard tilt head 	<ol style="list-style-type: none"> 1 Style number 2 Paint color number for monitor arm: <ul style="list-style-type: none"> 0835 Black 7018 Pewter ZW01 Pearl Snow 3 Tilt head mechanism (see Required Selections below) 4 Options, if selected (see below)

	Required Selections	Price	Required to Specify
Tilt Head Mechanism	<ul style="list-style-type: none"> • Standard tilt head • Heavy-duty spring tilt head 	No cost +\$156	Specify with <i>standard tilt head</i> . Specify with <i>heavy-duty spring tilt head</i> .

	Options	Price	Required to Specify
Brackets	<ul style="list-style-type: none"> • No bracket • Modular pole mount C-clamp two tier 	No cost +\$ 60	Specify with <i>no bracket</i> . Specify with <i>modular pole mount C-clamp two tier bracket</i> .

Tip: Bracket color will match selected monitor arm color.

Tip: Three-over-three monitor arm assembly includes four fine height adjustable adapter tilt heads and two standard tilt heads.

Specification Information

Style Number	Base Price

Static Three-Over-Three Monitor Arm Assembly with Pole

CFMTSTSP	\$1112

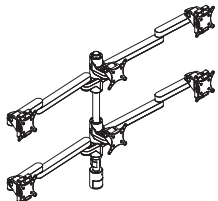

Tip: CFMTSTSP supports monitors up to 10 lb and up to 24" per monitor.

Wide Static Three-Over-Three Monitor Arm Assembly with Pole

CFMTSTWP	\$1240

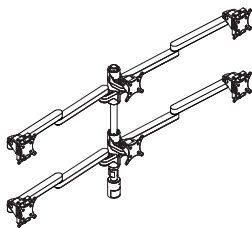

Tip: CFMTSTWP supports monitors up to 10 lb and up to 30" per monitor.

CF Series Adjustable Monitor Arm Adapters

Tip: Use the adjustable monitor adapter with standard tilt head mechanism to add more vertical movement on the CF modular pole system triple assemblies.

Standard Includes	Required to Specify
<ul style="list-style-type: none"> • CFTHSLIDE and CFTHSLIDEHD tilt head: paint • CTHSLIDEWO adapter: Black paint only • Tilt head mechanism, if selected 	<ul style="list-style-type: none"> 1 Style number 2 Paint color number for CFTHSLIDE and CFTHSLIDEHD: <ul style="list-style-type: none"> 0835 Black 7018 Pewter ZW01 Pearl Snow

Specification Information

Style Number	Price

Adjustable Monitor Adapter without Tilt Head Mechanism

CFTHSLIDEWO	\$ 50

Adjustable Monitor Adapter with Standard Tilt Head Mechanism

CFTHSLIDE	\$112

Adjustable Monitor Adapter with Heavy-Duty Tilt Head Mechanism

CFTHSLIDEHD	\$135



Tip: To adjust the monitor height up and down using a static pole, specify the adjustable monitor arm adapter.



CF Series Flat Panel Monitor Arms and Supports, continued

SIN 711.2

CF Series Flat Panel Pole Arms

Tip: See CF Series Monitor Arm Application Guide on www.steelcase.com for all possible arm configurations.

Standard Includes	Required to Specify
<ul style="list-style-type: none"> • Monitor arm: paint • Standard tilt head 	<ol style="list-style-type: none"> 1 Style number 2 Paint color number for arm: <ul style="list-style-type: none"> 0835 Black 7018 Pewter ZW01 Pearl Snow 3 Tilt head mechanism (See Required Selections below)

Required Selections	Price	Required to Specify
Tilt head Mechanism <ul style="list-style-type: none"> • Standard tilt head • Heavy-duty spring tilt head 	No cost +\$26 each	Specify <i>with standard tilt head.</i> Specify <i>with heavy-duty spring tilt head.</i>
Related Products <ul style="list-style-type: none"> • Flat panel monitor arm • Flat panel monitor brackets 		<ul style="list-style-type: none"> ▶ Page 163 ▶ Page 180

Specification Information

Weight	Style Number	Base Price

Single Pole Arm

2 lb	CFSARM	\$123

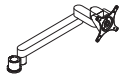

Tip: Lower arm is 8" in length and upper arm is 4" in length. Tilt head included.

Dual Pole Arm

4 lb	CFDARM	\$256

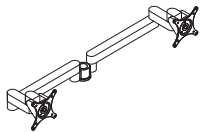

CF Series Tablet and Laptop Holders

Tip: Laptop holder and universal laptop/tablet holder attach to tilt head mechanism (not included).

Tip: The laptop holder platform (CFLHS) and the Universal tablet and laptop support (CFTULT) can be used on CF Series, as well as most monitor arms with a VESA plate and tilt head that has tilt functionality.



Tip: Laptop holder includes black pad to stop laptop slippage. Security cord secures laptop in place.

Standard Includes	Required to Specify
-------------------	---------------------

- Laptop holder, if selected: paint
- Universal laptop/tablet holder, if selected: black/pewter combination

- 1 Style number
- 2 Paint color number for laptop holder, if selected:
0835 Black
7018 Pewter
ZW01 Pearl Snow

Specification Information			
• Dimensions		• Style	• Price
D	W	Number	

D	W	Style Number	Price
---	---	--------------	-------

Laptop Holder Platform

10"	13½"	CFLHS	\$174
-----	------	--------------	-------

Computer Support Tools

CF Series Flat Panel Monitor Arms and Supports, continued

SIN 711.2

CF Series Flat Panel Monitor Brackets

Tip: Flat panel monitor arm must be used with flat panel monitor brackets, ordered separately.

Tip: When mounting CF Series arm brackets to Slatwall, bracket must be mounted no further than 10" away from Slatwall mounting bracket. If application does not allow bracket to be installed within the 10" range, an additional bracket or brackets should be installed within 10" of desired arm location.

Tip: See CF Series Monitor Arm Application Guide on www.steelcase.com for all possible arm configurations.



Tip: C-clamp bracket is for use with worksurfaces with a thickness of 1" to 1 5/8".



Tip: Requires 3/8" diameter through hole. For use with maximum worksurface thickness of 1" with throughmount bracket base plate and 1 5/8" without throughmount bracket base plate.



Tip: CFSPWM is not recommended for drywall, sheet rock, or plaster surfaces.



Tip: When using CFSPSW, limit the CF arm load to 25 lb.

Standard Includes

- Bracket: paint

Required to Specify

- 1 Style number
- 2 Paint color number for bracket:
 - 0835 Black
 - 7018 Pewter
 - ZW01 Pearl Snow

Related Products

- CF Series flat panel monitor arm ▶ Page 163
- CF Series flat panel monitor pole mounts ▶ Page 166

Specification Information

•Weight	•Style Number	•Price
:	:	:
:	:	:

Desk-Clamp/Grommet Bracket

3.5 lb	CFSPC	\$50
:	:	:
:	:	:

Through-Mount Bracket

2.5 lb	CFSPTM	\$50
:	:	:
:	:	:

Desk-Clamp/Grommet/Through-Mount Bracket

3.5 lb	CFSPCTM	\$50
:	:	:
:	:	:

Wall/Reverse Wall Mount Bracket

2.5 lb	CFSPWM	\$50
:	:	:
:	:	:

Slatwall Bracket

3 lb	CFSPSW	\$50
:	:	:
:	:	:

▶ **Specification Information, continued on next page**

► Specification Information, continued from previous page

Specification Information

•Weight	•Style •Number	•Price
---------	-------------------	--------



Tip: Maximum-duty monitor arms CF2500 and flat panel pole CFP28 can be used only with maximum-duty arm bracket CFSPSGLBASE.

Maximum-Duty Arm Bracket

4 lb	CFSPSGLBASE	\$ 60
------	--------------------	-------



Tip: CFSPMODST is used with CFP14 and CFSPMOD is used with CFP28.

Modular Pole Mount C-Clamp Bracket

4 lb	CFSPMOD	\$ 60
------	----------------	-------

Tip: CFSPMOD is recommended for use with CF Series modular assemblies one over one, two over two, and three over three.

Tip: CF Series modular C-clamp also comes with the flex mount package which allows thru-mount.



FrameOne Bracket

3 lb	CFSPFO	\$ 88
------	---------------	-------



c:scape Bracket

3 lb	CFSPCS	\$103
------	---------------	-------



Tip: T-shape dual-base bracket is for use with CF450, CF500, CF800, and CF1000 Series monitor arms. Includes CFSPSGLBASE.

T-Shape Dual-Base Bracket

5 lb	CFSPSHAPEBASE	\$104
------	----------------------	-------

Tip: CFSPSGLBASE is recommended for use with CFP28 and monitor over monitor configurations.

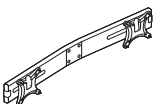

Tip: When using dual-bar bracket, the maximum weight of monitor is 5 lb less than arm support allows with other brackets.

Dual-Bar Bracket

5 lb	CFDUALBAR	\$202
------	------------------	-------

Tip: Heavy-duty spring tilt head option must be specified on monitor arm (ordered separately) when using dual-bar bracket.

Tip: CFDUALBAR is available in 7018 Pewter only.

CF Series Flat Panel Monitor Arms and Supports, continued

SIN 711.2

CF Series 6"H Flat Panel Arm Extender



Standard Includes	Required to Specify
<ul style="list-style-type: none"> • 11" Extender: paint 	<ul style="list-style-type: none"> 1 Style number 2 Paint color number for extender: <ul style="list-style-type: none"> 0835 Black 7018 Pewter ZW01 Pearl Snow

Related Products
<ul style="list-style-type: none"> • CF450, CF500, CF800, and CF1000 monitor arms

Specification Information

Weight	Style Number	Price

For use with CF450, CF500, CF800, and CF1000

1 lb	CFXT6H	\$183

CF Series Modular Articulating Arm Extensions for Pole Mount Assemblies



Tip: CF Series modular arm extensions are interchangeable and retrofitable. Arm extensions support larger monitors.

Tip: Tilt head is not included with the extension arm. Order tilt heads through Service Parts.

Standard Includes	Required to Specify
<ul style="list-style-type: none"> • Articulating extension arm: paint 	<ul style="list-style-type: none"> 1 Style number 2 Paint color number for extender: <ul style="list-style-type: none"> 0835 Black 7018 Pewter ZW01 Pearl Snow

Specification Information

Weight	Style Number	Price

0.5 lb	CFXP4H	\$24
0.8 lb	CFXP8H	\$39
1.1 lb	CFXP12H	\$60

CF Series Wall-Mount Support



Standard Includes	Required to Specify
<ul style="list-style-type: none"> • Wall-mount bracket: paint • Tilt head 	<ul style="list-style-type: none"> 1 Style number 2 Paint color number for bracket: <ul style="list-style-type: none"> 0835 Black 7018 Pewter ZW01 Pearl Snow

Specification Information

Weight	Style Number	Price

Tip: CFWM is not recommended for drywall, sheet rock, or plaster surfaces.

3.5 lb	CFWM	\$119

CF Series Modular Arm Brackets

Standard Includes	Required to Specify
<ul style="list-style-type: none"> • Bracket: paint • Inserts to attach arm extensions and hardware 	1 Style number 2 Paint color number for bracket: 0835 Black 7018 Pewter ZW01 Pearl Snow

Specification Information

Style Number	Price
One Connector	
CFMSC	\$25
Two Connectors	
CFMDC	\$50



Tip: CFMSC connectors are included with CF Series modular assemblies.



Tip: CF Series dynamic arms can be used with the connectors with the connector inserts removed.

LED Monitor Light with Bracket

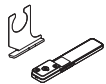

Standard Includes	Required to Specify
<ul style="list-style-type: none"> • Light housing: 4799 Platinum Metallic • Bracket: 0835 Black • 4-watt LED • 9' cord: black plastic only • Attachment hardware 	Style number

Specification Information

Weight	Style Number	Price
For Use with CF Series and FYI Monitor Arms		
0.75 lb	FPALED	\$280
For Use with Sync		
0.75 lb	FPASYNCLEED	\$280

FYI Single Flat Panel Monitor Arms and Supports with Mounting Brackets

SIN 711.2

Tip: FYI flat panel arm support is for use with monitors 5 to 20 lb.

Tip: When planning with stand-alone, single-sided FrameOne base units, the worksurface must be 66"W or greater and utilize no more than one single FYI flat panel monitor arm.

Tip: FYI flat panel monitor arm is not for use in front of stanchion mounted Slatwall.

Tip: The colors for upper arm and cable cover are defaulted by monitor arm.

▶ See *Worktools Specification Guide* for default finishes.

Tip: Monitor arms with C-clamp brackets are not recommended on Universal tables with P-edge as the user's edge wraps all the way around. Universal Systems Worksurfaces with P-edge will work as the user's edge is applied to the front only.

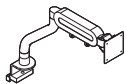

Tip: C-clamp bracket is for use with worksurfaces with a thickness of 3/4" to 1 3/8".

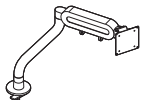

Tip: Through-mount bracket is for use with worksurfaces with a thickness of 1" to 2".

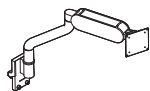
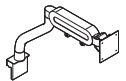

Tip: FYI flat panel monitor arms should only be mounted to c:scape desks that are tethered to either the beam, another desk, or 1 1/2"-High low storage with a connect zone.

Standard Includes	Required to Specify
<ul style="list-style-type: none"> • Monitor arm: paint • 75 mm/100 mm VESA plate • Mounting bracket • Upper arm and cable cover: color defaulted by monitor arm color 	<ul style="list-style-type: none"> 1 Style number 2 Paint color number for monitor arm: <ul style="list-style-type: none"> 4231 Arctic White 4710 Low Gloss Black 4799 Platinum Metallic

Specification Information

• Dimensions			• Weight	• Style	• Price
D	W	H		Number	
:	:	:	:	:	:

C-Clamp Mounting Bracket

4"	14"	15"	13.5 lb	FPASINGLECC	\$384
:	:	:	:	:	:

Through-Mount Mounting Bracket

4"	14"	15"	12.5 lb	FPASINGLETM	\$384
:	:	:	:	:	:

FrameOne Mounting Bracket

4"	14"	15"	13.5 lb	FPASINGLEFO	\$384
:	:	:	:	:	:

c:scape Mounting Bracket

9"	14"	15"	15 lb	DFPASINGLECS	\$425
:	:	:	:	:	:

Tip: Slatwall skin brace package is required when mounting a flat panel monitor arm on an Answer slatwall skin.

Tip: Single monitor arm can be mounted on 12"H slatwall skin that has an installed brace package.

Tip: Two single or one dual monitor arm can be mounted on 18"H or 24"H Answer slatwall skin that has an installed brace package. For optimal stability, the monitor arm should be mounted as shown at right:

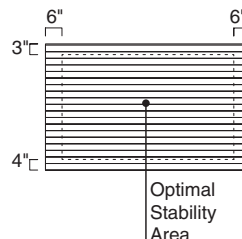

FYI Dual Flat Panel Monitor Arms and Supports with Mounting Brackets

FYI Dual Flat Panel Monitor Arms and Supports with Mounting Brackets

SIN 711.2

Tip: FYI flat panel arm support is for use with monitors 5 to 20 lb each.

Tip: The colors for upper arm and cable cover are defaulted by monitor arm.

▶ See Worktools Specification Guide for default finishes.

Tip: Monitor arms with C-clamp brackets are not recommended on Universal tables with P-edge as the user's edge wraps all the way around. Universal Systems Worksurfaces with P-edge will work as the user's edge is applied to the front only.

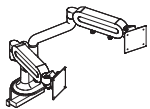

Tip: C-clamp bracket is for use with worksurfaces with a thickness of 1" to 2 1/2".

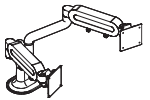

Tip: Through-mount bracket is for use with worksurfaces with a thickness of 1" to 2".

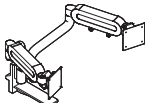

Tip: FYI flat panel monitor arms should only be mounted to c:scape desks that are tethered to either the beam, another desk, or 1 1/2"-High low storage with a connect zone.

Tip: It is not recommended to use an FYI dual flat panel arm on a 24" deep worksurface, due to lack of focal depth adjustment. FYI dual should only be installed on 29" or deeper worksurfaces.

Standard Includes	Required to Specify
<ul style="list-style-type: none"> • Monitor arms: paint • 75 mm/100 mm VESA plates • Mounting brackets • Upper arm and cable cover: color defaulted by monitor arm color 	<ul style="list-style-type: none"> 1 Style number 2 Paint color number for monitor arm: <ul style="list-style-type: none"> 4231 Arctic White 4710 Low Gloss Black 4799 Platinum Metallic

Specification Information

• Dimensions			• Weight	• Style Number	• Price
D	W	H			

C-Clamp Mounting Bracket

5 1/2"	24"	15"	20 lb	FPADUALCC	\$700
--------	-----	-----	-------	------------------	-------

Through-Mount Mounting Bracket

5 1/2"	24"	15"	20 lb	FPADUALTM	\$700
--------	-----	-----	-------	------------------	-------

c:scape Mounting Bracket

9"	24"	15"	27 lb	DFPADUALCS	\$906
----	-----	-----	-------	-------------------	-------

Computer Support Tools

FYI Flat Panel Monitor Arms and Supports without Mounting Brackets

SIN 711.2

FYI Flat Panel Monitor Arm without Mounting Bracket

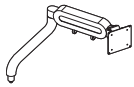

Tip: FYI flat panel arm support is for use with monitors 5 to 20 lb.

Tip: Mounting brackets must be ordered separately.
▶ See page 87

Tip: The colors for upper arm and cable cover are defaulted by monitor arm.
▶ See Worktools Specification Guide for default finishes.

Tip: Except for FPASINGLECC, FPASINGLETM, DFPASINGLECS, and FPASINGLEFO please order modular options and mounting bracket separately.

Standard Includes	Required to Specify
-------------------	---------------------

- | | |
|--|---|
| <ul style="list-style-type: none"> • Monitor arm: paint • 75 mm/100 mm VESA plate • Upper arm and cable cover: color defaulted by monitor arm color | <ul style="list-style-type: none"> 1 Style number 2 Paint color number for flat panel monitor arm: <ul style="list-style-type: none"> 4231 Arctic White 4710 Low Gloss Black 4799 Platinum Metallic |
|--|---|

Related Products

- | | |
|--|--|
| <ul style="list-style-type: none"> • Wall-mount bracket • Slatwall/SlatRail mounting bracket | <ul style="list-style-type: none"> ▶ Page 87 ▶ Page 87 |
|--|--|

Specification Information					
• Dimensions			• Weight	• Style Number	• Price
D	W	H			

4"	14"	15"	10 lb	FPASINGLE	\$335
•	•	•	•	•	•

FYI Upper Arm



Tip: FYI flat panel arm support is for use with monitors 5 to 20 lb.

Tip: Mounting brackets must be ordered separately.
▶ See page 87

Tip: The colors for cable cover are defaulted by monitor arm.
▶ See Worktools Specification Guide.

Tip: When mounting FYI single flat panel arms to Slatwall, bracket must be mounted no further than 10" away from Slatwall mounting bracket. If application does not allow bracket to be installed within the 10" range, an additional bracket or brackets should be installed within 10" of desired arm location.

Standard Includes	Required to Specify
-------------------	---------------------

- | | |
|---|--|
| <ul style="list-style-type: none"> • Monitor arm: paint • Cable cover: <ul style="list-style-type: none"> – 6000 Black, if 4710 Black selected on monitor arm – Plastic price group 1, if 9212 Silver selected on monitor arm • 75 mm/100 mm VESA plate | <ul style="list-style-type: none"> 1 Style number 2 Paint color number for monitor arm: <ul style="list-style-type: none"> 4710 Black 9212 Silver 3 Plastic color number for cable covers, if 9212 Silver is selected on monitor arm: <ul style="list-style-type: none"> 6000 Black 6009 Arctic White 6544 Frost |
|---|--|

Related Products

- | | |
|--|--|
| <ul style="list-style-type: none"> • Wall-mount bracket • Slatwall/SlatRail mounting bracket | <ul style="list-style-type: none"> ▶ Page 87 ▶ Page 87 |
|--|--|

Specification Information					
• Dimensions			• Weight	• Style Number	• Price
D	W	H			

4"	4 ¹ / ₂ "	10"	3.5 lb	FPAUPPER	\$295
•	•	•	•	•	•

FYI Tilt/Pan



Tip: Mounting bracket must be ordered separately.
▶ See below

Standard Includes	Required to Specify
<ul style="list-style-type: none"> Tilt/pan knuckle: bright metal 75 mm/100 mm VESA plate 	Style number

Related Products
<ul style="list-style-type: none"> Wall-mount bracket ▶ See below Slatwall/SlatRail mounting bracket ▶ See below

Specification Information					
Dimensions			Weight	Style Number	Price
D	W	H			
5"	4 1/2"	4 1/2"	2 lb	FPATILTPAN	\$130

FYI Flat Panel Monitor Arm Mounting Brackets

Standard Includes	Required to Specify
<ul style="list-style-type: none"> Bracket: paint 	1 Style number 2 Paint color number for bracket: 4231 Arctic White 4710 Low Gloss Black 4799 Platinum Metallic

Specification Information		
Weight	Style Number	Price

Wall-Mount Bracket		
3 lb	FPAWALL	\$49

Slatwall/SlatRail Mounting Bracket		
2 lb	FPASWR	\$49

C-Clamp Mounting Bracket		
3 lb	14474101SR	\$59

Through-Mount Bracket		
3 lb	14474501SR	\$59



Tip: When mounting FYI single flat panel arms to Slatwall, bracket must be mounted no further than 10" away from Slatwall mounting bracket. If application does not allow bracket to be installed within the 10" range, an additional bracket or brackets should be installed within 10" of desired arm location.

Tip: C-clamp and through-mount brackets are available in Steelcase Service Parts Catalog only.

FYI Flat Panel Monitor Arms and Supports without Mounting Brackets, continued

SIN 711.2

FYI Sync Monitor Arms, Handle, and Mounting Brackets

Tip: FYI flat panel arm support is for use with monitors 5 to 20 lb.

Tip: To use upper or lower monitor arms, specify for use with monitor arm option on the base unit.

Tip: For upper and lower monitor arms, FYI Sync hardware pack must be ordered separately.

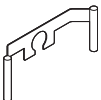
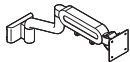
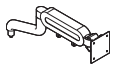
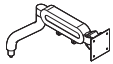

Tip: FPAHANDLE can accept monitors up to 18" of actual horizontal monitor width in a 4:3 format.



Standard Includes	Required to Specify
<ul style="list-style-type: none"> • Monitor arm and handle: 4799 Platinum Metallic • Hardware pack, if selected: 7018 Pewter, if selected 	Style number

Specification Information

• Weight	• Style Number	• Price
:	:	:

Upper Monitor Arm

10 lb	FPASYNCU	\$338
:	:	:

Lower Monitor Arm

4.5 lb	FPASYNCL	\$338
:	:	:

Lower Monitor Arm with Slatwall/SlatRail Mount

6.5 lb	FPASYNCWR	\$384
:	:	:

Handle

1.5 lb	FPAHANDLE	\$226
:	:	:

FYI Sync Hardware Pack

0.75 lb	FPASYNCMT	\$ 48
:	:	:

LED Monitor Light with Bracket

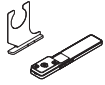

Standard Includes	Required to Specify
<ul style="list-style-type: none"> • Light housing: 4799 Platinum Metallic • Bracket: 0835 Black • 4-watt LED • 9' cord: black plastic only • Attachment hardware 	Style number

Specification Information

• Weight	• Style • Number	• Price
•	•	•

For Use with CF Series and FYI Monitor Arms

0.75 lb	FPALED	\$280
•	•	•

For Use with Sync

0.75 lb	FPASYNLED	\$280
•	•	•

Computer Support Tools



Height-Adjustable Worksurfaces

► For more detailed product information, see the *Height-Adjustable Desks Specification Guide* or consult your Steelcase dealer.

Statement of Line	192
--------------------------	------------

Workstation Design Guidelines and Requirements	207
Height-Adjustable Desks Comparison Chart	208
Worksurface Shape Overview	210
Worksurface Edge Options	211
Worktools Compatibility Charts	212
Worksurface Weights	
Ology Height-Adjustable Worksurface Weights	220
Series 3 Height-Adjustable Worksurface Weights	228
Airtouch Height-Adjustable Worksurface Weights	232
Series 5 Height-Adjustable Worksurface Weights	234

Specifying	
Ology Height-Adjustable Worksurfaces (SIN 711.2)	236
Universal Steel One-High Open Laterals (SIN 711.2)	258
Universal Common Tops (SIN 711.2)	260
Universal Shrouds (SIN 711.2)	262
Universal Filler (SIN 711.2)	263
Series 3 Height-Adjustable Worksurfaces (SIN 711.2)	264
Series 3 Bases (SIN 711.2)	270
Airtouch Height-Adjustable Worksurfaces (SIN 711.1)	272
Series 5 Height-Adjustable Worksurfaces (SIN 711.2)	282
Series 5 Bases (SIN 711.2)	288
FitWork: Walkstation and Sit-to-Walkstation (SIN 711.99)	290
Acrylic Screens (SIN 711.2)	292
Cableways (SIN 711.2)	294
Cable and Power Management (SIN 711.2)	295

Statement of Line

Ology Height-Adjustable Desks

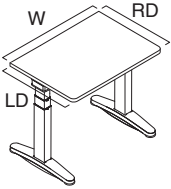

Specifying
▶ Page 236

Rectangular Desks

	34"	40"	46"	52"	58"	64"	70"	76"
23" or 24"D								
29" or 30"D								
35" or 36"D								

Tip: Widths are parametric to 1/16" from 34"W—78"W.

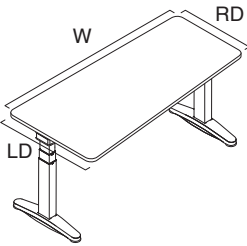

Specifying
▶ Page 240

Tapered Desks*

29" or 30"		23" or 24"	29" or 30"		23" or 24"
29" or 30"		23" or 24"	29" or 30"		23" or 24"

*Left-hand units shown. Right-hand units available.
Tip: Widths are parametric to 1/16" from 58"W—78"W.

Ology Height-Adjustable Desks, continued

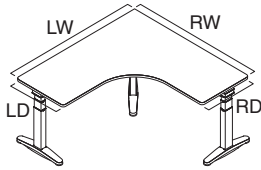

Specifying
▶ Page 244

90° Equal Corner Desks

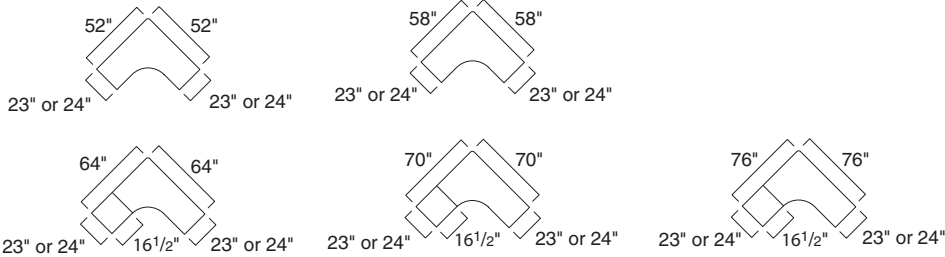

Tip: Widths are parametric to 1/16" from 52"W – 78"W.
Tip: 64"W, 70"W, and 76"W 90° equal worksurfaces ship in two pieces.

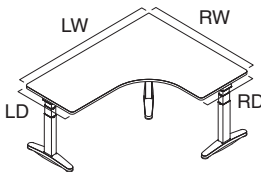

Specifying
▶ Page 244

90° Extended Corner Desks*

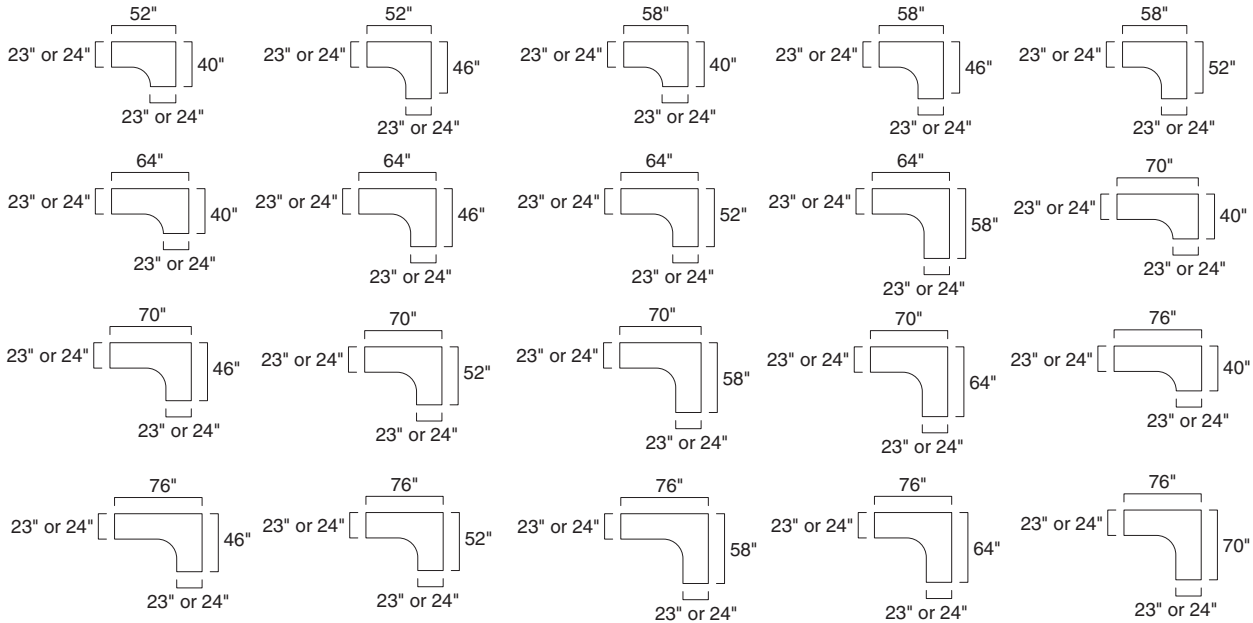

*Left-hand units shown. Right-hand units available.
Tip: Widths are parametric to 1/16" from 40"W – 78"W.

Statement of Line, continued

Ology Height-Adjustable Desks, continued

120° Equal Corner Desks

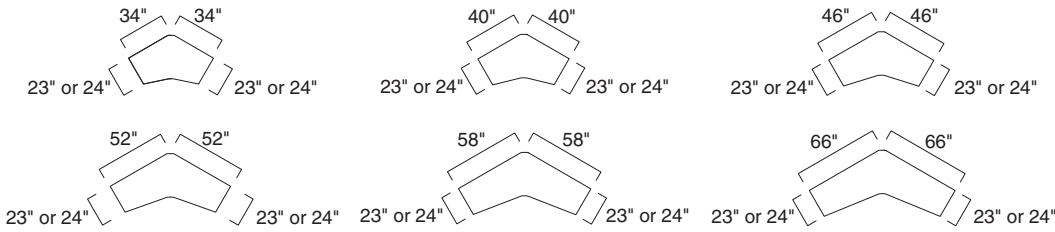

Tip: Widths are parametric to 1/16" from 34"W—64"W.

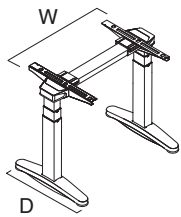

Specifying
▶ Page 250

Rectangular Bases

	34"W	40"W	46"W	52"W	58"W	64"W	70"W	76"W
23"D or 24"D	●	●	●	●	●	●	●	●
29"D or 30"D	●	●	●	●	●	●	●	●
35"D or 36"D	●	●	●	●	●	●	●	●

Tip: Widths are parametric to 1/16" from 34"W—78"W.

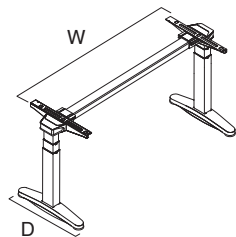

Specifying
▶ Page 250

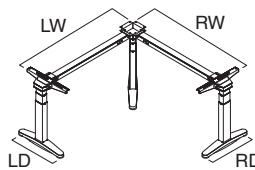

Specifying
▶ Page 250

Tapered Bases*

	58"W	64"W	70"W	76"W
23"D/29"D or 24"D/30"D	●	●	●	●

*Left-hand units shown. Right-hand units available.
Tip: Widths are parametric to 1/16" from 58"W—78"W.

90° Equal Corner Bases

	52"W	58"W	64"W	70"W	76"W
23"D or 24"D	●	●	●	●	●

Tip: Widths are parametric to 1/16" from 52"W—78"W.

Ology Height-Adjustable Desks, continued

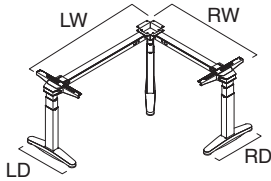

Specifying
▶ Page 250

90° Extended Corner Bases*

	40"W	46"W	52"W	58"W	64"W	70"W	76"W
23"D or 24"D	●	●	●	●	●	●	●

*Left-hand units shown. Right-hand units available.
Tip: Widths are parametric to 1/16" from 40"W—78"W.

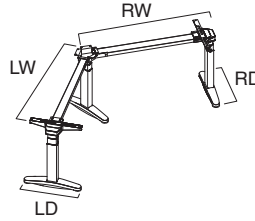

Specifying
▶ Page 250

120° Equal Corner Bases

	34"W	40"W	46"W	52"W	58"W	64"W
23"D or 24"D	●	●	●	●	●	●

Tip: Widths are parametric to 1/16" from 34"W—64"W.

Modesty Panels and Fixed Personal/Modesty Screens

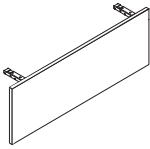

Specifying
▶ Page 255

Modesty Panels

	34"W	40"W	46"W	58"W	64"W	70"W	76"W
14 3/8"H	●	●	●	●	●	●	●

Tip: Widths are parametric to 1/16" from 34"W—78"W.

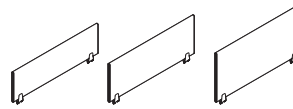

Specifying
▶ Page 256

Fixed Personal/Modesty Screens

	30"W	36"W	42"W	48"W
12"H	●	●	●	●
19 1/2"H	●	●	●	●
24"H	●	●	●	●

Tip: 19 1/2"H and 24"H are for privacy use only.

Cable and Power Management

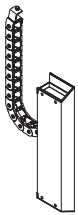

Cable Riser
Specifying
▶ Page 257

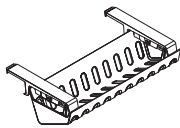

Cable Basket
Specifying
▶ Page 257

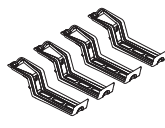

Cable Brackets
Specifying
▶ Page 257

Statement of Line, continued

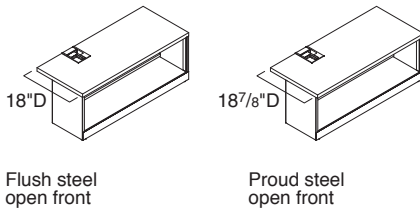

Specifying
▶ Page 258

Universal Steel One-High Open Laterals

	30"W	36"W	42"W
16"H	●	●	●

Drawings show Ology right application.
Units are also available with Ology left application.

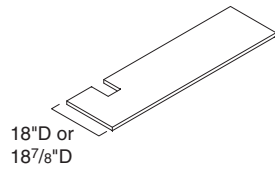

Specifying
▶ Page 260

Universal Common Tops

60"W	66"W	72"W	78"W	84"W	90"W	96"W	108"W
●	●	●	●	●	●	●	●

Drawings show Ology right application.
Units are also available with Ology left application.

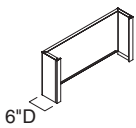

Specifying
▶ Page 262



Specifying
▶ Page 263

Universal Shrouds

Universal Filler

Series 3 Height-Adjustable Worksurfaces

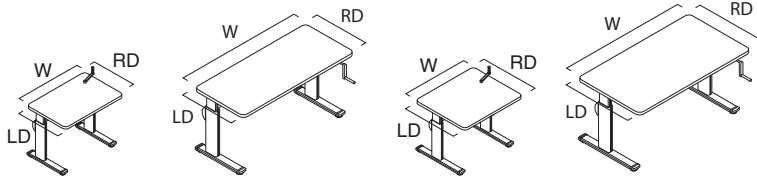

Specifying
▶ Page 264

Rectangular Worksurfaces

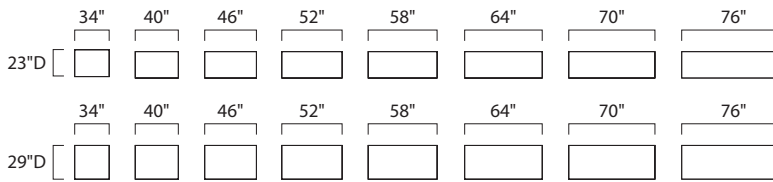

Tip: 34\"/>

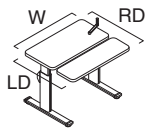

Specifying
▶ Page 264

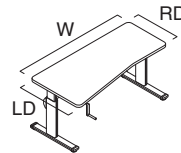

Specifying
▶ Page 264

Rectangular Bi-Level Worksurfaces

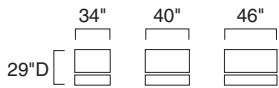

Taper-Flat Worksurfaces*

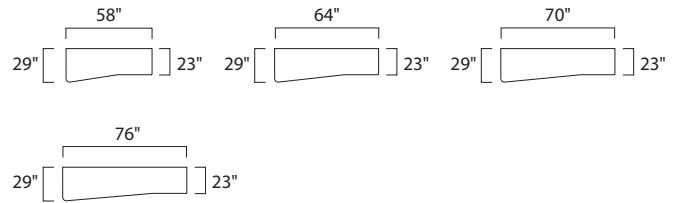

*Left-hand units shown. Right-hand units available.

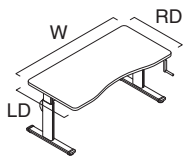

Specifying
▶ Page 264

Concave Worksurfaces



Statement of Line, continued

Series 3 Height-Adjustable Worksurfaces, continued

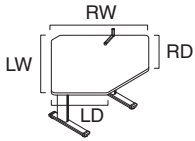

Specifying
▶ Page 264

90° Corner Worksurfaces

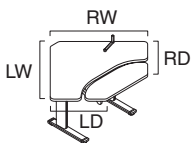
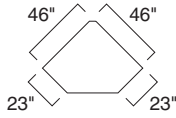
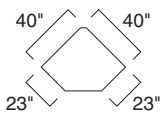

Specifying
▶ Page 264

90° Corner Bi-Level Worksurfaces

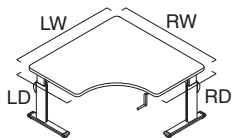
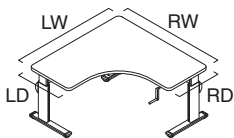
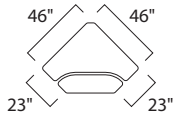
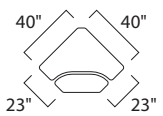

Specifying
▶ Page 264

90° Equal Worksurfaces

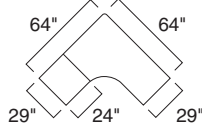
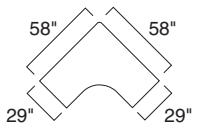
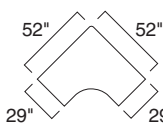
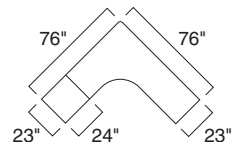
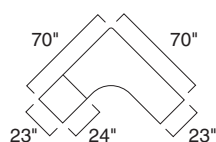
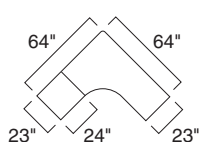
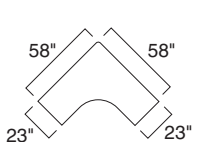
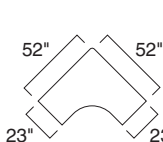

Series 3 Height-Adjustable Worksurfaces, continued

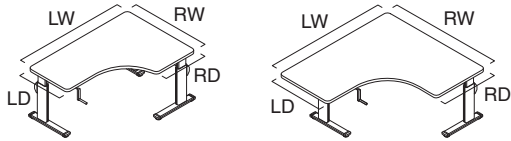

Specifying
▶ Page 264

90° Extended Worksurfaces*

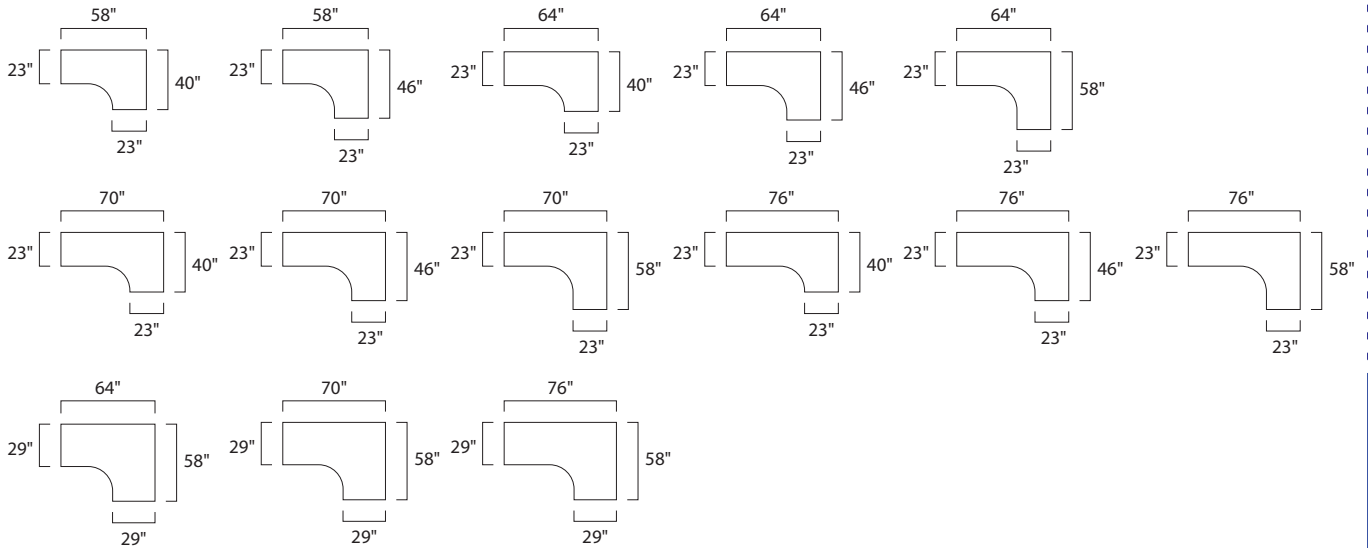

*Left-hand units shown. Right-hand units available.

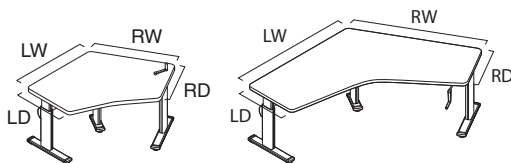

Specifying
▶ Page 264

120° Equal Worksurfaces

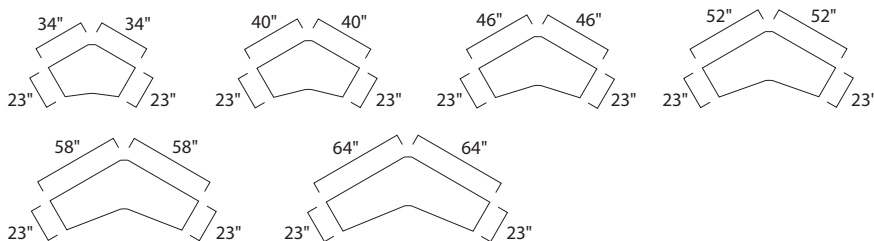

Tip: 34"W x 34"W and 40"W x 40"W worksurfaces are standard with top-mount crank.

Tip: 34"W x 34"W worksurfaces are standard with a two-leg base. All other 120° equal worksurfaces have a three-leg base.

Statement of Line, continued

Series 3 Height-Adjustable Worksurfaces, continued

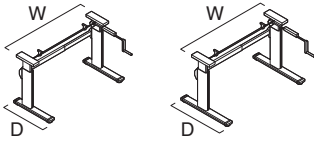

Specifying
▶ Page 270

Rectangular Bases

	46"W-52"W	58"W	64"W-76"W
23"D	●	●	●
29"D	●	●	●

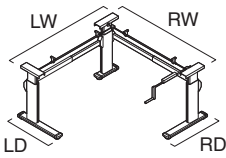

Specifying
▶ Page 270

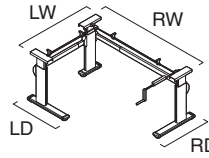

Specifying
▶ Page 270

90° Equal Bases

	52"W	58"W	64"W-76"W
23"-29"D	●	●	●

90° Extended Bases

	40"W	46"W	58"W	64"W-76"W
23"-29"D	●	●	●	●

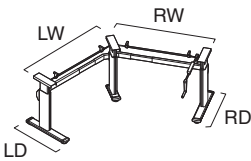

Specifying
▶ Page 270

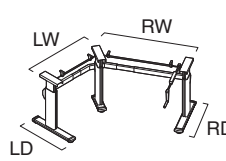

Specifying
▶ Page 270

120° Equal Bases

	46"W-58"W	64"W
23"D	●	●

120° Extended Bases

	34"W	40"W	46"W	58"W	64"W
23"D	●	●	●	●	●

Airtouch Height-Adjustable Worksurfaces

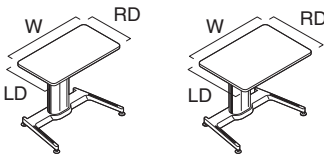

Specifying
▶ Page 272

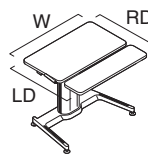

Specifying
▶ Page 272

Rectangular Worksurfaces

22 ¹ / ₄ "D	40"	46"	58"
28 ¹ / ₄ "D	40"	46"	58"

Rectangular Bi-Level Worksurfaces

34 ¹ / ₄ "D	40"	46"
-----------------------------------	-----	-----

Airtouch Height-Adjustable Worksurfaces, continued
 Universal Tables

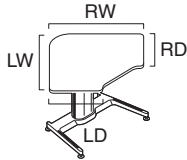

Specifying
 ▶ Page 272

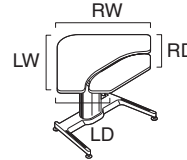

Specifying
 ▶ Page 272

90° Corner Worksurfaces

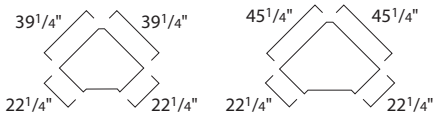

90° Corner Bi-Level Worksurfaces

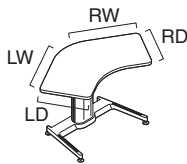
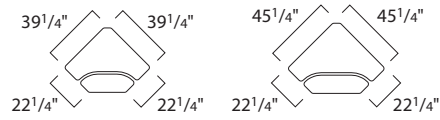

Specifying
 ▶ Page 272

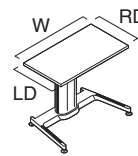

Specifying
 ▶ Page 276

120° Equal Worksurfaces

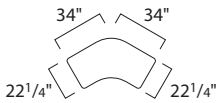

Rectangular Worksurfaces

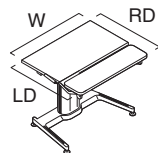
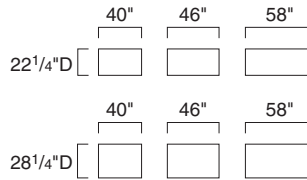

Specifying
 ▶ Page 276

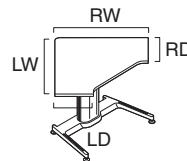

Specifying
 ▶ Page 276

Rectangular Bi-Level Worksurfaces

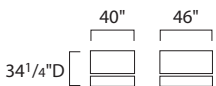

90° Corner Worksurfaces

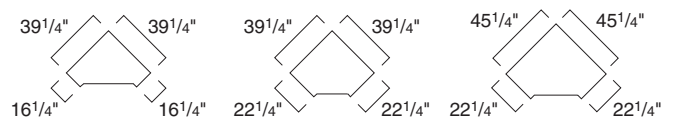

Statement of Line, continued

Airtouch Height-Adjustable Worksurfaces

For Use with Universal Systems

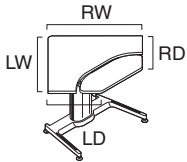

Specifying
▶ Page 276

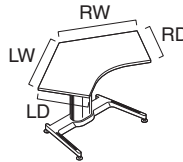

Specifying
▶ Page 276

90° Corner Bi-Level Worksurfaces

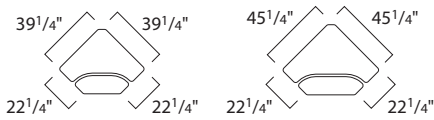

120° Equal Worksurfaces

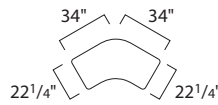

Airtouch Height-Adjustable Worksurfaces

For Use with Series 9000

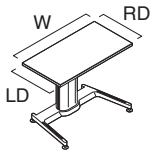

Specifying
▶ Page 280

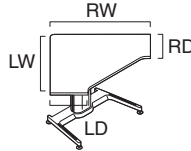

Specifying
▶ Page 280

Rectangular Worksurfaces

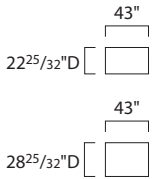

90° Corner Worksurfaces

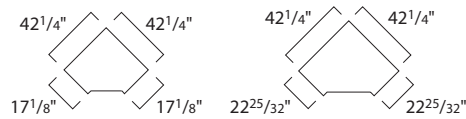

Series 5 Height-Adjustable Worksurfaces

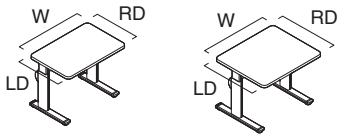

Specifying
▶ Page 282

Rectangular Worksurfaces

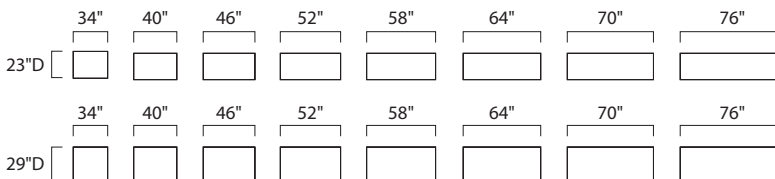

Series 5 Airtouch Height-Adjustable Worksurfaces, continued

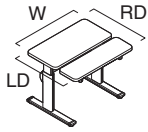

Specifying
▶ Page 282

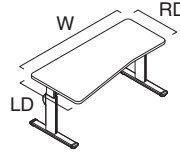

Specifying
▶ Page 282

Rectangular Bi-Level Worksurfaces

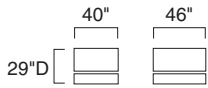

Taper-Flat Worksurfaces*

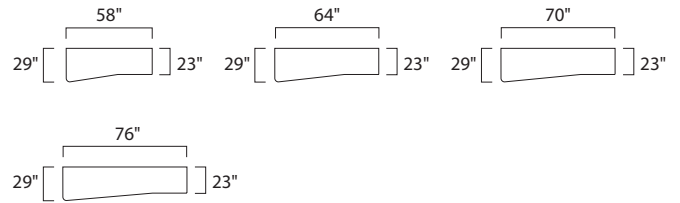

*Left-hand units shown. Right-hand units available.

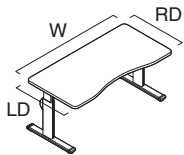

Specifying
▶ Page 282

Concave Worksurfaces

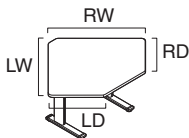
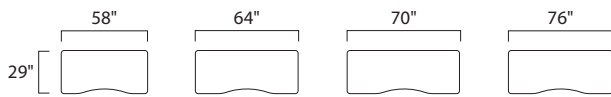

Specifying
▶ Page 282

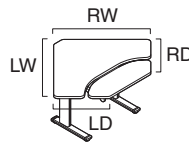

Specifying
▶ Page 282

90° Corner Worksurfaces

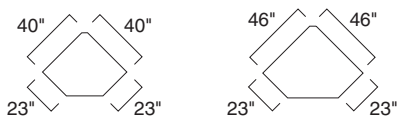

90° Corner Bi-Level Worksurfaces

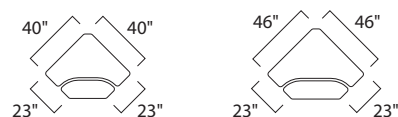

Statement of Line, continued

Series 5 Height-Adjustable Worksurfaces, continued

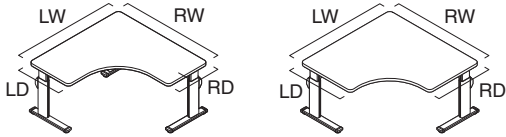

Specifying
▶ Page 282

90° Equal Worksurfaces

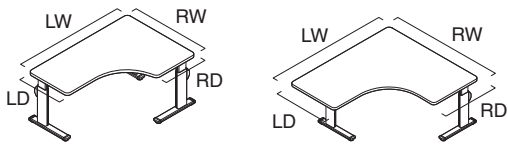
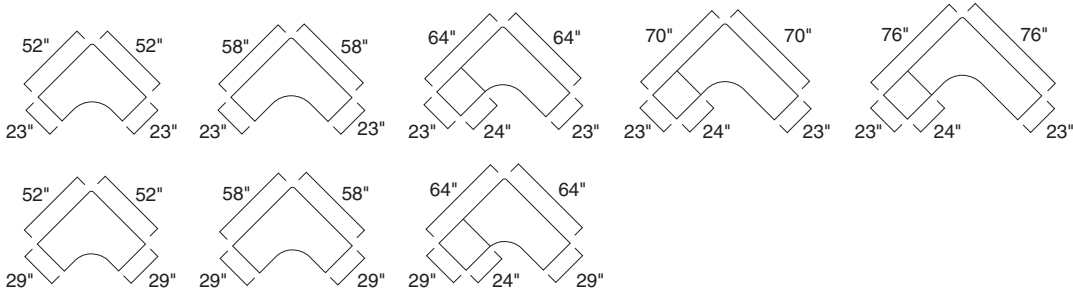

Specifying
▶ Page 282

90° Extended Worksurfaces*

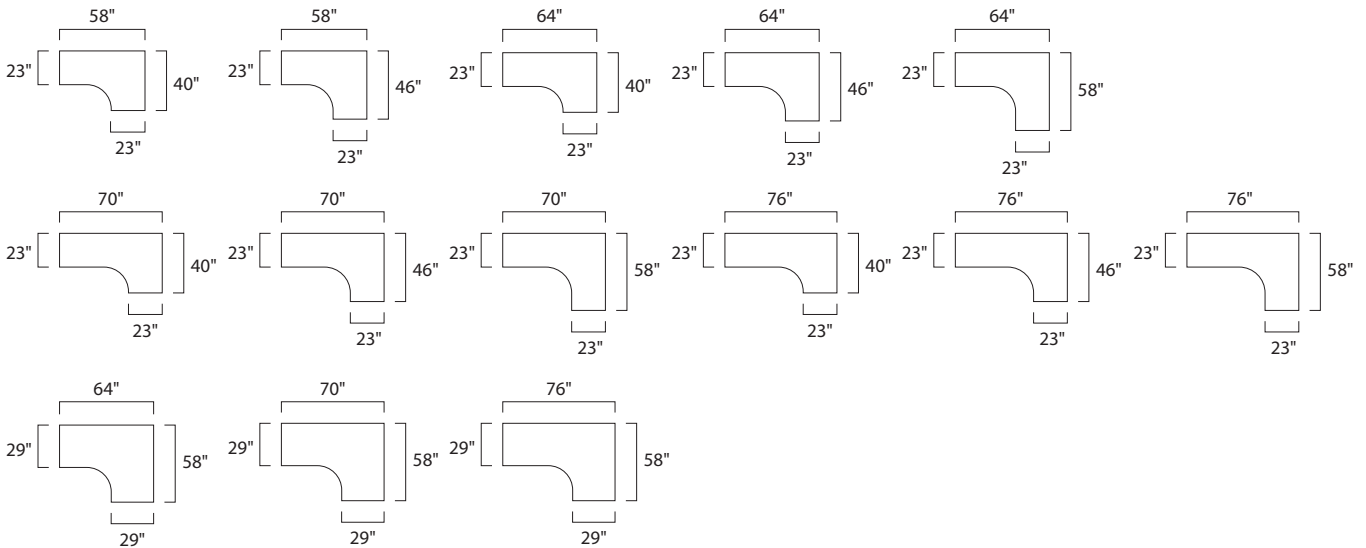

*Left-hand units shown. Right-hand units available.

Series 5 Height-Adjustable Worksurfaces, continued

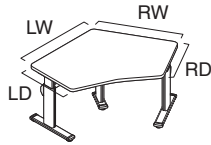

Specifying
▶ Page 282

120° Equal Worksurfaces

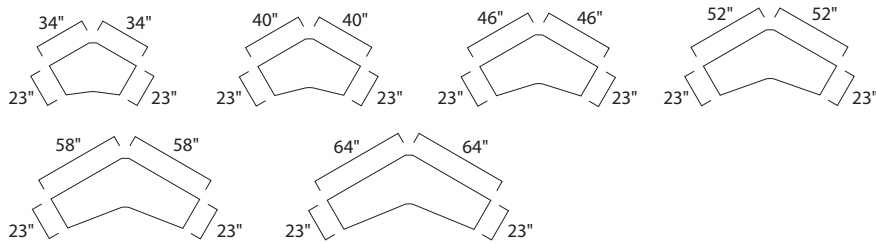

Tip: 34"W x 34"W worksurfaces are standard with a 2-leg base. All other 120° equal worksurfaces have a three-leg base.

Series 5 Bases

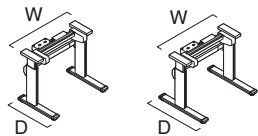

Specifying
▶ Page 288

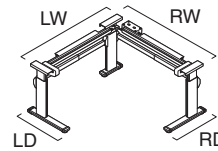

Specifying
▶ Page 288

Rectangular Bases

	34"W-40"W	46"W-52"W	58"W	64"W-76"W
23"D	●	●	●	●
29"D	●	●	●	●

90° Equal Bases

	52"W	58"W	64"W-76"W
23"-29"D	●	●	●

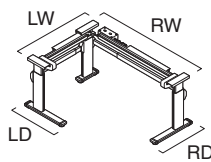

Specifying
▶ Page 288

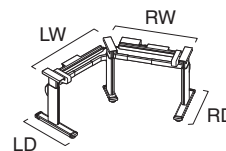

Specifying
▶ Page 288

90° Extended Bases

	40"W	46"W	58"W	64"W-76"W
23"-29"D	●	●	●	●

120° Equal Bases

	40"W	46"W-58"W	64"W
23"D	●	●	●

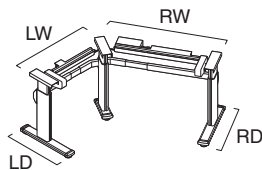

Specifying
▶ Page 288

120° Extended Bases

	34"W	40"W	46"W	58"W	64"W
23"D	●	●	●	●	●

Statement of Line, continued

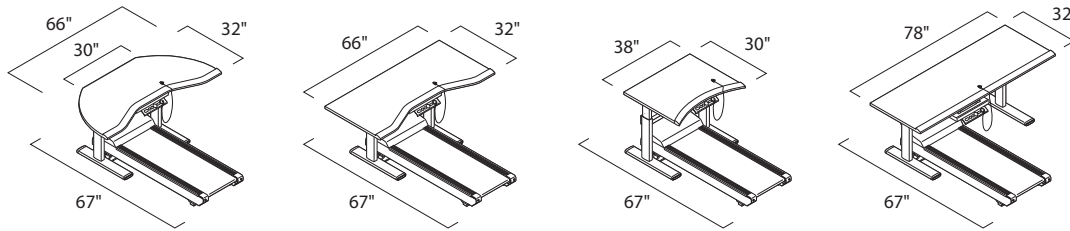

Specifying
▶ Page 290

FitWork: Walkstation and Sit-to-Walkstation

	38"W	66"W	78"W
30"D	●		
32"D	●	●	●

Privacy Screens, Modesty Screens, and Cableways



Specifying
▶ Page 292



Specifying
▶ Page 292

Privacy Screens

	22"W	28"W	34"W	40"W	46"W	52"W	58"W	64"W
22"H	●	●	●	●	●	●	●	●

Modesty Screens

	22"W	28"W	34"W	40"W	46"W	52"W	58"W	64"W
14"H	●	●	●	●	●	●	●	●



Specifying
▶ Page 294

Cableways

	25"W	31"W	37"W	43"W	49"W	55"W	61"W
8"H	●	●	●	●	●	●	●

Cable and Power Management

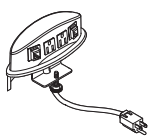

Power/Data with C-clamp
Specifying
▶ Page 295

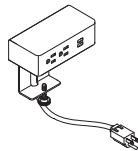

USB Two-Outlet Powerstrip with Clamp Mount
Specifying
▶ Page 295

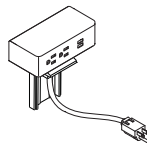

USB Two-Outlet Powerstrip with Rail Mount
Specifying
▶ Page 295

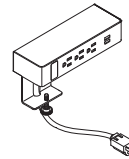

USB Three-Outlet Powerstrip with Clamp Mount
Specifying
▶ Page 296

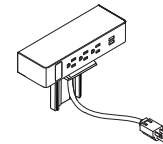

USB Three-Outlet Powerstrip with Rail Mount
Specifying
▶ Page 296

Workstation Design Guidelines and Requirements

Overview

Designed for movement with dynamic seating, adjustable worktools and height-adjustable desks are important for today's office workers.

To determine the best height-adjustable solution, consider these four criteria:

1. **Adjustability Needed:**
What is the height range requirement? (seated or sit-to-stand)
2. **Worksurface Size Needed:**
What does the physical space look like? (worksurface configuration)
3. **Equipment/Tools Used:**
What type of computer equipment and other worktools are being used on the worksurface? (load capacity)
4. **Use:**
What is the height-adjustable desk being used for (individual or shared, touchdown space or full workstation, sit-to-stand or seated)?

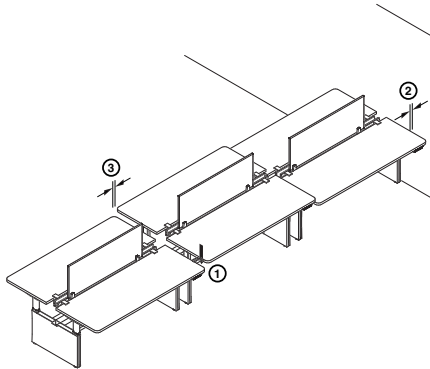

WARNING

Risk of Serious Injury. If not used as intended, moving worksurfaces can pinch or injure people, or damage property. Always follow these Instructions:

1. Keep height-adjustment range free from obstructions above and below the worksurface.
2. Plan for a minimum 1" gap against a panel or wall.
3. Plan for a minimum 1" gap to adjacent furniture.

Tips

Obstructions

Moving worksurfaces can collide with other objects. Do not install overhead storage, stationary pedestals or components in the path of height-adjustable desks.

Weight

The maximum allowable load (varies by height-adjustable bench) should be evenly distributed and must not be exceeded.

Width

Specify a minimum 1" gap to adjacent furniture. This eliminates any pinch points between a height-adjustable desk and a fixed object.

Managing Technology

Design workstations with computer equipment in mind so that the height-adjustment range of the height-adjustable desk is not impeded because of cables.

Power

Plan easy and unobstructed access to power for users at worksurface height through the use of the power access door or power strip.

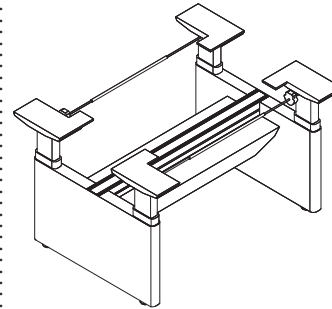

WARNING

Risk of serious injury.

Bases-only warranty limitations and potential for injury: The use of worksurfaces that do not comply with the Steelcase defined criteria and limitations could cause personal injury or property damage due to pinch points, instability, or other problems, and voids all Steelcase Warranties, expressed or implied.

The use of worksurfaces that do not comply with Steelcase criteria voids any Steelcase claims of compliance with ANSI/ BIFMA, UL, LEED, or other applicable requirements. The use of non-Steelcase worksurfaces on Steelcase adjustable-height bases may not be accepted as compliant to municipal electrical codes or OSHA federal workplace standards, because this use does not create an NRTL (UL, ETL, etc.) listed product. Steelcase is not responsible for the ultimate determinations of compliance for height-adjustable bases with non-Steelcase worksurface, and assumes no liability for their compliance with standards when height adjustable bases are used without a Steelcase worksurface as intended.

Worksurface Criteria and Limitations

The use of non-Steelcase worksurfaces is not recommended. Any use of a non-Steelcase worksurface requires additional investigation by the customer regarding the appropriateness for use. It is the sole responsibility of the customer to determine the suitability and safety of the selected worksurface construction and attachment means. The following information is provided as a guideline, but does not address all potential issues. Customers should seek professional guidance as to the appropriateness of their chosen worksurface.

Tips

Height-adjustable bases include fasteners intended for use with Steelcase worksurfaces. These fasteners may be suitable for worksurfaces meeting the following criteria:

- Medium-density or higher particleboard or fiberboard cores, with High- or Low-Pressure Laminates and backers.
- Thickness of 1" or greater (Ology and Migration)
- Thickness of 1 $\frac{3}{8}$ " or greater (Series 3, 5, and 8 bases)
- Fasteners located a minimum distance of 1" from any edge

Height-Adjustable Desks Comparison Chart

Height-adjustable desks transform to meet the needs of someone 5' to 6'4" tall. Adjustables offer five selections; Ology, Series 3, Airtouch, and Series 5.

The chart below will help you determine which product line best meets your needs.

Ology

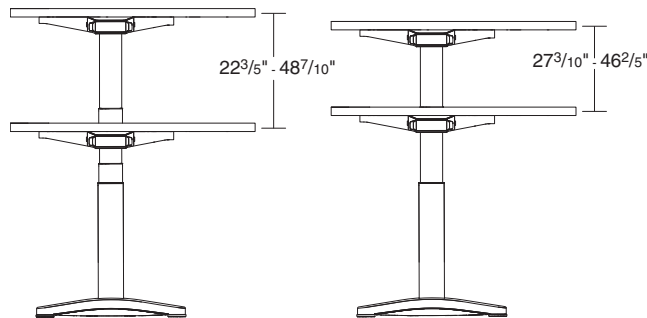

Enhanced sit-to-stand height-adjustability

A push button delivers electric adjustability at 1 1/2" per second. Includes three controller options:

- Simple touch
- Active touch
- 4 Pre-sets

Weight capacity of 314 pounds (2-leg) or 471 pounds (3-leg).

Tip: When calculating lifting capacity, subtract the weight of the worksurface, understructure, and options selected.

▶ See page 220 for worksurface weights.

Series 3

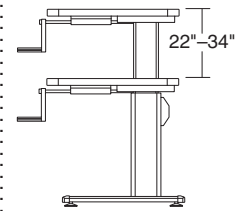

Seated height-adjustability

Crank handle adjusts height at the rate of four turns per inch (2-leg) or six turns per inch (3-leg). Weight capacity of 205 pounds.

Tip: When calculating lifting capacity, subtract the weight of the worksurface.

▶ See page 228 for worksurface weights.

*Small configurations only.
 ** 29"D knee depth requirement for worksurface

Adjustables Comparison Chart

	Ology Sit-to-Stand	Series 3 Seated
Range of Adjustment	22 ³ / ₅ " – 48 ⁷ / ₁₀ "	22" – 34"
With Bi-Level Worksurfaces	N.A.	17 ¹ / ₂ " – 40"
Type of Adjustment	Electric	Crank
Distributed Weight Capacity	314 lb (2-leg) 471 lb (3-leg)	205 lb
Worksurface Weight	See page 220 for worksurface weights	See page 228 for worksurface weights
Worksurface Thickness	1"	1 ³ / ₁₆ "
Controller	Simple touch, Active touch, 4 Pre-sets	Up/Down, Digital Pre-set
Integrated Rail	Yes	No
Integrated Soft Edge	Yes	No
Integrated Power Access Door	Yes	No
Motor	Enclosed	N.A.
Decibel Rating	< 55 dBA	N.A.
Volts	120v AC	N.A.
Amps	2-leg: 2.5A/ 3-leg: 3.75A	N.A.
Watts	2-leg: 300W/ 3-leg: 450W	N.A.
Standby Power	0.1W	N.A.
Frequency and Phase	60 Hz Single Phase	N.A.
Adjustability Speed	1 1/2" per second	4 or 6 turns/1"
Stretcher or Understructure Design	Fixed	Telescoping
Base Only Availability	Yes	Yes
ANSI/BIFMA**	Meet or Exceed	Meet or Exceed

Airtouch

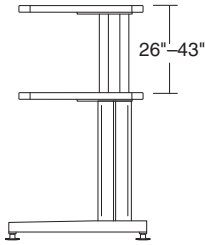

Collaborative height-adjustability

Weight capacity of 150 pounds.

Tip: When calculating lifting capacity, subtract the weight of the worksurface.

▶ See page 232 for worksurface weights.

Series 5

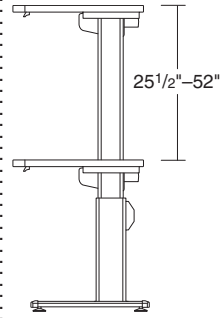

Sit-to-stand height-adjustability

A simple push button delivers electric adjustability at 1⁷/₁₀" per second. Weight capacity of 195 pounds.

Tip: When calculating lifting capacity, subtract the weight of the worksurface.

▶ See page 234 for worksurface weights.

** 29"D knee depth requirement for worksurface

Adjustables Comparison Chart

	Airtouch Sit-to-Stand	Series 5 Sit-to-Stand
Range of Adjustment	26" – 43"	25 ¹ / ₂ " – 52"
With Bi-Level Worksurfaces	21" – 49"	21" – 58"
Type of Adjustment	Counterforce Mechanism	Electric
Distributed Weight Capacity	150 lb	195 lb
Worksurface Weight	See page 232 for worksurface weights	See page 234 for worksurface weights
Worksurface Thickness	1 ³ / ₁₆ "	1 ³ / ₁₆ "
Controller	Paddle	Up/down
Integrated Rail	No	No
Integrated Soft Edge	No	No
Integrated Power Access Door	No	No
Motor	N.A.	Exposed
Decibel Rating	N.A.	<50 dBA
Volts	N.A.	120v AC
Amps	N.A.	4.0A
Watts	N.A.	480W
Standby Power	N.A.	4.5W
Frequency and Phase	N.A.	60 Hz, Single Phase
Adjustability Speed	User speed (1 sec.)	1 ⁷ / ₁₀ "/sec.
Stretcher or Understructure Design	N.A.	Telescoping
Base Only Availability	No	Yes
ANSI/BIFMA**	Meet or Exceed	Meet or Exceed

Worksurface Shape Overview

Extensive worksurface shape and size offering allows designers to meet a variety of planning applications and footprints.



Rectangular
Ology
Migration
Migration SE
Series 5
Airtouch
Series 3

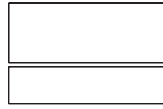

Rectangular Bi-Level
Series 5
Airtouch
Series 3

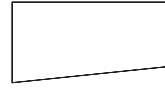

Tapered
Ology

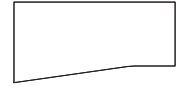

Taper-Flat
Series 5
Series 3



Concave
Series 5
Series 3

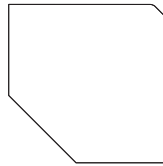

90° Corner
Series 5
Airtouch
Series 3

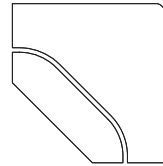

90° Corner Bi-Level
Series 5
Airtouch
Series 3

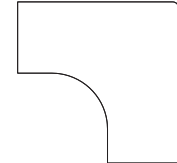

90° Equal
Series 5
Series 3

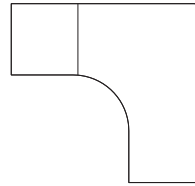

90° Equal *
Ology
Series 5
Series 3

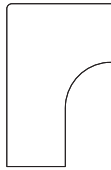

90° Extended
Ology
Series 5
Series 3

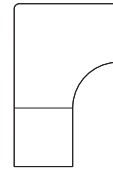

90° Extended *
Ology

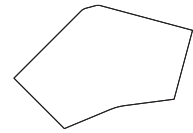

120° Equal
Ology
Series 5
Airtouch
Series 3

Worksurface Edge Options

High-Pressure Laminate Worksurfaces

Front (user's) edge profile is available in four shapes. Universal tables have a continuous edge profile available in four shapes.

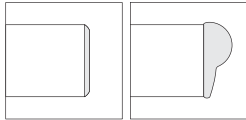

3 mm edge profile P-edge edge profile

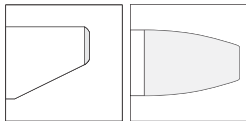

Knife edge profile Urethane edge profile

PVC-free, 3 mm edge profiles are proprietary polyolefin blend for all solid colors and seven woodgrain finishes. Matching 1 mm side and back edges are also PVC-free. See surface material listing in this book for specific PVC-free availability.

Tip: Universal Tables have a continuous 3 mm edge.

Edge profile finishes are specified separately from laminate color.

P-edge profile rises slightly above the laminate surface and curves into a $\frac{3}{8}$ " radius. Back and side edges are flat.

Tip: P-edge profile available on Airtouch height-adjustable worksurfaces only.

Tip: Universal tables have a continuous P-edge profile.

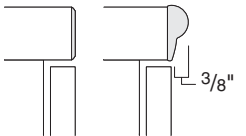

P-edge profile work-surface depths are $\frac{3}{8}$ " deeper than 3 mm edge profile worksurfaces. Both edge profiles provide a flush interface with universal pedestals.

PVC-free, knife edge

with 3 mm edge profile are proprietary blend for solid colors and seven woodgrain finishes. Matching 1 mm side and back edges are also PVC-free.

Tip: Knife edge available on Series 3 and Series 5 height-adjustable worksurfaces only.

Urethane edge profiles are specifiable in black or felt.

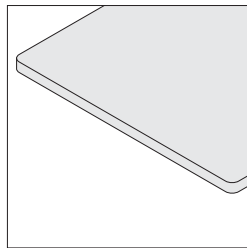

Universal tables have rounded corners on all four sides with a continuous user edge. Radius corners eliminate sharp edges and are appropriate for freestanding furniture.

Tip: Ology, when optioned with rounded corners and with integrated rail, will have 2" radius corners on the two front (user's) corners and 90° corners on the rear two corners.

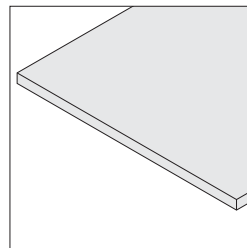

Universal systems, knife edge, urethane edge, and wood veneer worksurfaces have 90° corner on all four sides with a front user's edge.

Wood Veneer Worksurfaces

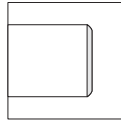

Front (user's) edge profile is wood veneer with a square (3 mm) radius. Back edge and edge that joins to adjacent worksurfaces are flat. Wood edge color matches finish specified for worksurface.

Tip: Wood veneer worksurfaces are available on Ology height-adjustable desks, Series 3 and Series 5 height-adjustable worksurfaces only.

Universal Tables Edge Profiles



Rectangular

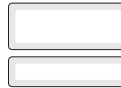

Rectangular Bi-Level



Tapered



Taper-Flat



Concave



90° Corner

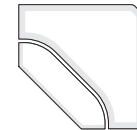

90° Corner Bi-Level

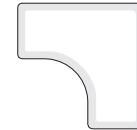

90° Equal



90° Extended

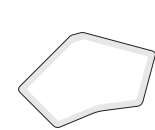

120° Equal

Universal Systems, Knife, Urethane, and Wood Edge Profiles



Rectangular



Rectangular Bi-Level



Tapered

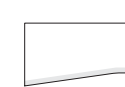

Taper-Flat



Concave

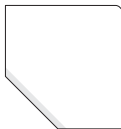

90° Corner

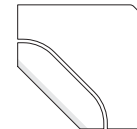

90° Corner Bi-Level

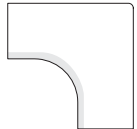

90° Equal



90° Extended

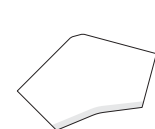

120° Equal

Worktools Compatibility Charts

To determine worksurface compatibility with privacy/modesty screens, cableway, SOTO rail, and SlatRail worktools for each configuration and shape, see compatibility chart below.

Tip: The Ology integrated rail option does not apply to these rules because the rail matches the worksurface width.

Tip: Slatwall stanchions are not applicable because they allow Slatwall to overhang mounting area.

Tip: SlatRail stanchions do not work with the same size screen, SOTO rail, or cableway combination (e.g. 48"W SlatRail will not work with 49"W cableway and 52"W screens) because of clamp location. Specify the SlatRail one size smaller or larger when using in combination (if applicable).

Tip: For worksurfaces with top-mount handles, the handle sweeps in a circle with a 10" diameter which may interfere with mounting worktools.

Ology Desks

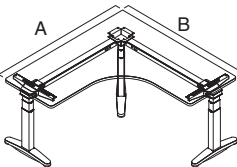
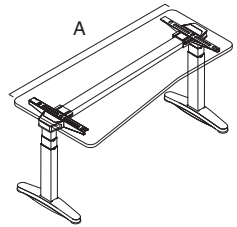
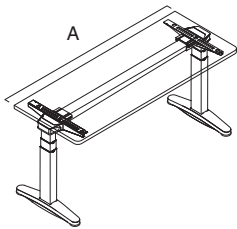

Rectangular and Tapered

Side **A** width

Acrylic Privacy/Modesty/SOTO Rail

Worksurfaces	28"W	34"W	40"W	46"W	52"W	58"W	64"W
34"W	■						
40"W	■	■					
46"W	■	■	■				
52"W	■	■	■	■			
58"W	■	■	■	■	■		
64"W	■	■	■	■	■	■	
70"W	■	■	■	■	■	■	■
76"W	■	■	■	■	■	■	■

25"W 31"W 37"W 43"W 49"W 55"W 61"W

Cableway

Side **A** width

SlatRail

24"W 30"W 36"W 42"W 48"W 60"W

Worksurfaces	24"W	30"W	36"W	42"W	48"W	60"W
34"W	■	■				
40"W	■	■	■			
46"W	■	■	■			
52"W	■	■	■	■		
58"W	■	■	■	■	■	
64"W	■	■	■	■	■	
70"W	■	■	■	■	■	■
76"W	■	■	■	■	■	■

90° Equal

Side **A** width

Acrylic Privacy/Modesty/SOTO Rail

Worksurfaces	28"W	34"W	40"W	46"W	52"W	58"W	64"W
52"W	■	■	■	■			
58"W	■	■	■	■	■		
64"W	■	■	■	■	■	■	
70"W	■	■	■	■	■	■	■
76"W	■	■	■	■	■	■	■

25"W 31"W 37"W 43"W 49"W 55"W 61"W

Cableway

Side **B** width

Acrylic Privacy/Modesty/SOTO Rail

Worksurfaces	28"W	34"W	40"W	46"W	52"W	58"W	64"W
52"W	■	■	■	■			
58"W	■	■	■	■	■		
64"W	■	■	■	■	■	■	
70"W	■	■	■	■	■	■	■
76"W	■	■	■	■	■	■	■

Side **A** width

SlatRail

Worksurfaces	24"W	30"W	36"W	42"W	48"W	60"W
52"W	■	■	■	■	■	
58"W	■	■	■	■	■	
64"W	■	■	■	■	■	■
70"W	■	■	■	■	■	■
76"W	■	■	■	■	■	■

Side **B** width

SlatRail

Worksurfaces	24"W	30"W	36"W	42"W	48"W	60"W
52"W	■	■	■	■	■	
58"W	■	■	■	■	■	
64"W	■	■	■	■	■	■
70"W	■	■	■	■	■	■
76"W	■	■	■	■	■	■

Ology Desks, continued

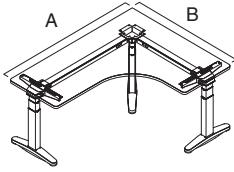

90° Extended

Side A width

Acrylic Privacy/Modesty/SOTO Rail

28"W 34"W 40"W 46"W 52"W 58"W 64"W

Worksurfaces	28"W	34"W	40"W	46"W	52"W	58"W	64"W
40"W							
46"W							
58"W	■	■	■	■	■	■	
64"W	■	■	■	■	■	■	
70"W	■	■	■	■	■	■	■
76"W	■	■	■	■	■	■	■

25"W 31"W 37"W 43"W 49"W 55"W 61"W

Cableway

Side B width

Acrylic Privacy/Modesty/SOTO Rail

28"W 34"W 40"W 46"W 52"W 58"W 64"W

Worksurfaces	28"W	34"W	40"W	46"W	52"W	58"W	64"W
40"W	■	■					
46"W	■	■	■				
58"W	■	■	■	■	■	■	
70"W							
76"W							

Side A width

SlatRail

24"W 30"W 36"W 42"W 48"W 60"W

Worksurfaces	24"W	30"W	36"W	42"W	48"W	60"W
40"W						
46"W						
58"W	■	■	■	■	■	
64"W	■	■	■	■	■	
70"W	■	■	■	■	■	■
76"W	■	■	■	■	■	■

Side B width

SlatRail

24"W 30"W 36"W 42"W 48"W 60"W

Worksurfaces	24"W	30"W	36"W	42"W	48"W	60"W
40"W	■	■	■			
46"W	■	■	■	■		
58"W	■	■	■	■	■	
70"W						
76"W						

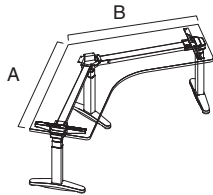

120° Equal

Side A width

Acrylic Privacy/Modesty/SOTO Rail

28"W 34"W 40"W 46"W 52"W 58"W 64"W

Worksurfaces	28"W	34"W	40"W	46"W	52"W	58"W	64"W
34"W	■						
40"W	■	■					
46"W	■	■	■				
52"W	■	■	■	■			
58"W	■	■	■	■	■		
64"W	■	■	■	■	■	■	

25"W 31"W 37"W 43"W 49"W 55"W

Cableway

Side B width

Acrylic Privacy/Modesty/SOTO Rail

28"W 34"W 40"W 46"W 52"W 58"W 64"W

Worksurfaces	28"W	34"W	40"W	46"W	52"W	58"W	64"W
34"W	■						
40"W	■	■					
46"W	■	■	■				
52"W	■	■	■	■			
58"W	■	■	■	■	■		
64"W	■	■	■	■	■	■	■

Side A width

SlatRail

24"W 30"W 36"W 42"W 48"W 60"W

Worksurfaces	24"W	30"W	36"W	42"W	48"W	60"W
34"W	■	■				
40"W	■	■	■			
46"W	■	■	■	■		
52"W	■	■	■	■	■	
58"W	■	■	■	■	■	
64"W	■	■	■	■	■	■

Side B width

SlatRail

24"W 30"W 36"W 42"W 48"W 60"W

Worksurfaces	24"W	30"W	36"W	42"W	48"W	60"W
34"W	■	■				
40"W	■	■	■			
46"W	■	■	■	■		
52"W	■	■	■	■	■	
58"W	■	■	■	■	■	
64"W	■	■	■	■	■	■

Height-Adjustable Worksurfaces

Worktools Compatibility Charts, continued

Series 3 and 5 Worksurfaces

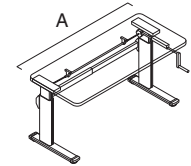
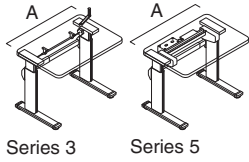

Series 3

Tip: Top-mount handle sizes for Series 3 worksurfaces include 34"W and 40"W rectangular and all rectangular bi-level worksurfaces.

Rectangular, Rectangular Bi-level, Taper-Flat, and Concave

Side **A** width

Acrylic Privacy/Modesty/SOTO Rail

Worksurfaces	28"W	34"W	40"W	46"W	52"W	58"W	64"W
34"W	▲						
40"W	●▲	▲					
46"W	●▲	●▲	●▲				
52"W	●▲	●▲	●▲	●▲			
58"W	●▲	●▲	●▲	●▲	●▲		
64"W	●▲	●▲	●▲	●▲	●▲	●▲	
70"W	●▲	●▲	●▲	●▲	●▲	●▲	●▲
76"W	●▲	●▲	●▲	●▲	●▲	●▲	●▲

Side **A** width

SlatRail

Worksurfaces	24"W	30"W	36"W	42"W	48"W	60"W
34"W	▲					
40"W	●▲	▲				
46"W	●▲	●▲	●▲			
52"W	●▲	●▲	●▲	●▲		
58"W	●▲	●▲	●▲	●▲	●▲	
64"W	●▲	●▲	●▲	●▲	●▲	
70"W	●▲	●▲	●▲	●▲	●▲	●▲
76"W	●▲	●▲	●▲	●▲	●▲	●▲

Cableway

90° Corner and 90° Corner Bi-level

Side **A** width

Acrylic Privacy/Modesty/SOTO Rail

Worksurfaces	28"W	34"W	40"W	46"W	52"W	58"W	64"W
40"W	●▲	●▲					
46"W	●▲	●▲	●▲				

Side **B** width

Acrylic Privacy/Modesty/SOTO Rail

Worksurfaces	28"W	34"W	40"W	46"W	52"W	58"W	64"W
40"W	●▲	●▲					
46"W	●▲	●▲	●▲				

Cableway

Side **A** width

SlatRail

Worksurfaces	24"W	30"W	36"W	42"W	48"W	60"W
40"W	●▲	●▲				
46"W	●▲	●▲	●▲			

Side **B** width

SlatRail

Worksurfaces	24"W	30"W	36"W	42"W	48"W	60"W
40"W	●▲	●▲				
46"W	●▲	●▲	●▲			

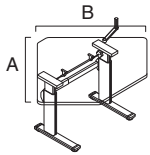

Series 3

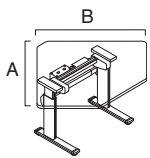

Series 5

Tip: Top-mount handle sizes for Series 3 worksurfaces include all 90° corner and 90° corner bi-level worksurfaces.

Legend

- = Series 3
- ▲ = Series 5

Series 3 and 5 Worksurfaces, continued

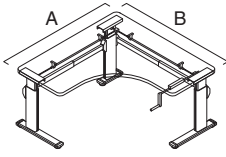

Series 3

90° Equal

Side A width

Acrylic Privacy/Modesty/SOTO Rail

Worksurfaces	Acrylic Privacy/Modesty/SOTO Rail						
	28"W	34"W	40"W	46"W	52"W	58"W	64"W
52"W	●	●	●				
58"W	●	●	●	●			
64"W	●	●	●	●	●		
70"W	●	●	●	●	●	●	
76"W	●	●	●	●	●	●	●

Side B width

Acrylic Privacy/Modesty/SOTO Rail

Worksurfaces	Acrylic Privacy/Modesty/SOTO Rail						
	28"W	34"W	40"W	46"W	52"W	58"W	64"W
52"W	●	●	●	●			
58"W	●	●	●	●	●		
64"W	●	●	●	●	●	●	
70"W	●	●	●	●	●	●	●
76"W	●	●	●	●	●	●	●

Cableway

Side A width

SlatRail

Worksurfaces	SlatRail					
	24"W	30"W	36"W	42"W	48"W	60"W
52"W	●	●	●			
58"W	●	●	●	●		
64"W	●	●	●	●	●	
70"W	●	●	●	●	●	
76"W	●	●	●	●	●	●

Side B width

SlatRail

Worksurfaces	SlatRail					
	24"W	30"W	36"W	42"W	48"W	60"W
52"W	●	●	●	●		
58"W	●	●	●	●	●	
64"W	●	●	●	●	●	
70"W	●	●	●	●	●	●
76"W	●	●	●	●	●	●

Legend

- = Series 3
- ▲ = Series 5

Worktools Compatibility Charts, continued

Series 3 and 5 Worksurfaces, continued

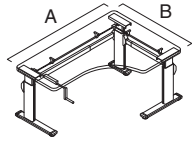

Series 3

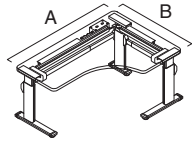

Series 5

Tip: Left-hand units shown.
Right-hand units available.

90° Extended

Side **A** width

Acrylic Privacy/Modesty/SOTO Rail

	28"W	34"W	40"W	46"W	52"W	58"W	64"W
40"W	[Shaded]						
46"W	[Shaded]						
58"W	●▲	●▲	●▲	●▲	●▲		
64"W	●▲	●▲	●▲	●▲	●▲	●▲	
70"W	●▲	●▲	●▲	●▲	●▲	●▲	●▲
76"W	●▲	●▲	●▲	●▲	●▲	●▲	●▲

Worksurfaces

Side **B** width

Acrylic Privacy/Modesty/SOTO Rail

	28"W	34"W	40"W	46"W	52"W	58"W	64"W
40"W	●▲						
46"W	●▲	●▲					
58"W	●▲	●▲	●▲	●▲			
64"W	[Shaded]						
70"W	[Shaded]						
76"W	[Shaded]						

Cableway

Side **A** width

SlatRail

	24"W	30"W	36"W	42"W	48"W	60"W
40"W	[Shaded]					
46"W	[Shaded]					
58"W	●▲	●▲	●▲	●▲	●▲	
64"W	●▲	●▲	●▲	●▲	●▲	
70"W	●▲	●▲	●▲	●▲	●▲	●▲
76"W	●▲	●▲	●▲	●▲	●▲	●▲

Worksurfaces

Side **B** width

SlatRail

	24"W	30"W	36"W	42"W	48"W	60"W
40"W	●▲					
46"W	●▲	●▲				
58"W	●▲	●▲	●▲	●▲		
64"W	[Shaded]					
70"W	[Shaded]					
76"W	[Shaded]					

Legend

- = Series 3
- ▲ = Series 5

Series 3 and 5 Worksurfaces, continued

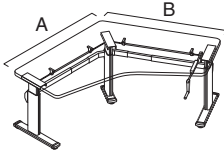

Series 3

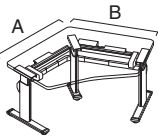

Series 5

Tip: Top-mount handle sizes for Series 3 worksurfaces include 34"W x 34"W and 40"W x 40"W 120° equal worksurfaces only.

120° Equal

Side A width

Acrylic Privacy/Modesty/SOTO Rail

Worksurfaces	28"W	34"W	40"W	46"W	52"W	58"W	64"W
34"W	▲						
40"W	●▲	●▲					
46"W	●▲	●▲	●▲				
52"W	●▲	●▲	●▲	●▲			
58"W	●▲	●▲	●▲	●▲	●▲		
64"W	●▲	●▲	●▲	●▲	●▲	●▲	

Side B width

Acrylic Privacy/Modesty/SOTO Rail

Worksurfaces	28"W	34"W	40"W	46"W	52"W	58"W	64"W
34"W	▲						
40"W	●▲	●▲					
46"W	●▲	●▲	●▲				
52"W	●▲	●▲	●▲	●▲			
58"W	●▲	●▲	●▲	●▲	●▲		
64"W	●▲	●▲	●▲	●▲	●▲	●▲	

Cableway

Side A width

SlatRail

Worksurfaces	24"W	30"W	36"W	42"W	48"W	60"W
34"W	▲					
40"W	●▲	●▲				
46"W	●▲	●▲	●▲			
52"W	●▲	●▲	●▲	●▲		
58"W	●▲	●▲	●▲	●▲	●▲	
64"W	●▲	●▲	●▲	●▲	●▲	

Side B width

SlatRail

Worksurfaces	24"W	30"W	36"W	42"W	48"W	60"W
34"W	▲					
40"W	●▲	●▲				
46"W	●▲	●▲	●▲			
52"W	●▲	●▲	●▲	●▲		
58"W	●▲	●▲	●▲	●▲	●▲	
64"W	●▲	●▲	●▲	●▲	●▲	

Legend

- = Series 3
- ▲ = Series 5

Worktools Compatibility Charts, continued

Airtouch Worksurfaces

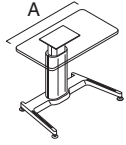

Tip: Cableways are not recommended for use with Airtouch 22 1/4"D rectangular worksurfaces.

Rectangular and Rectangular Bi-level

Worksurfaces	Side A width							Side A width					
	Acrylic Privacy/Modesty/SOTO Rail							SlatRail					
40"W	28"W	34"W	40"W	46"W	52"W	58"W	64"W	24"W	30"W	36"W	42"W	48"W	60"W
46"W	•	•	•					•	•	•	•		
58"W	•	•	•	•	•			•	•	•	•	•	
	25"W	31"W	37"W	43"W	49"W	55"W	61"W						
	Cableway												

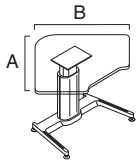

90° Corner and 90° Corner Bi-Level

Worksurfaces	Side A width							Side B width						
	Acrylic Privacy/Modesty/SOTO Rail							Acrylic Privacy/Modesty/SOTO Rail						
39 1/4"W	28"W	34"W	40"W	46"W	52"W	58"W	64"W	28"W	34"W	40"W	46"W	52"W	58"W	64"W
45 1/4"W	•	•	•					•	•	•				
	25"W	31"W	37"W	43"W	49"W	55"W	61"W							
	Cableway													

Worksurfaces	Side A width						Side B width					
	SlatRail						SlatRail					
39 1/4"W	24"W	30"W	36"W	42"W	48"W	60"W	24"W	30"W	36"W	42"W	48"W	60"W
45 1/4"W	•	•	•	•			•	•	•	•		

Airtouch Worksurfaces, continued

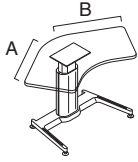

120° Equal

Side **A** width

Side **B** width

Worksurfaces

Acrylic Privacy/Modesty/SOTO Rail

Acrylic Privacy/Modesty/SOTO Rail

	28"W	34"W	40"W	46"W	52"W	58"W	64"W
34"W	●						
	25"W	31"W	37"W	43"W	49"W	55"W	61"W

	28"W	34"W	40"W	46"W	52"W	58"W	64"W
	●						

Cableway

Side **A** width

Side **B** width

Worksurfaces

SlatRail

SlatRail

	24"W	30"W	36"W	42"W	48"W	60"W
34"W	●	●				

	24"W	30"W	36"W	42"W	48"W	60"W
	●	●				

Height-Adjustable Worksurfaces

Ology Height-Adjustable Worksurface Weights

Worksurface Weight

Worksurface Shape **W** **LD** **RD** **Base only Weight (OLELRQB)** **Worksurface Weight**

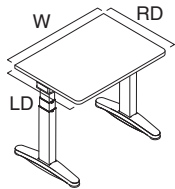

					23"D	24"D
Rectangular	34"	23" or 24"	23" or 24"	59 lb	20 lb	21 lb
	40"	23" or 24"	23" or 24"	61 lb	24 lb	25 lb
	46"	23" or 24"	23" or 24"	62 lb	27 lb	29 lb
	52"	23" or 24"	23" or 24"	64 lb	31 lb	32 lb
	58"	23" or 24"	23" or 24"	66 lb	35 lb	36 lb
	64"	23" or 24"	23" or 24"	67 lb	39 lb	40 lb
	70"	23" or 24"	23" or 24"	69 lb	42 lb	43 lb
	76"	23" or 24"	23" or 24"	71 lb	46 lb	47 lb
					29"D	30"D
	34"	29" or 30"	29" or 30"	61 lb	26 lb	27 lb
	40"	29" or 30"	29" or 30"	63 lb	30 lb	31 lb
	46"	29" or 30"	29" or 30"	65 lb	34 lb	36 lb
	52"	29" or 30"	29" or 30"	67 lb	39 lb	41 lb
	58"	29" or 30"	29" or 30"	69 lb	43 lb	45 lb
	64"	29" or 30"	29" or 30"	71 lb	48 lb	50 lb
	70"	29" or 30"	29" or 30"	73 lb	52 lb	54 lb
	76"	29" or 30"	29" or 30"	75 lb	56 lb	59 lb
					35"D	36"D
	34"	35" or 36"	35" or 36"	64 lb	31 lb	32 lb
	40"	35" or 36"	35" or 36"	66 lb	36 lb	37 lb
	46"	35" or 36"	35" or 36"	68 lb	42 lb	43 lb
	52"	35" or 36"	35" or 36"	70 lb	47 lb	48 lb
	58"	35" or 36"	35" or 36"	72 lb	52 lb	54 lb
	64"	35" or 36"	35" or 36"	74 lb	58 lb	60 lb
	70"	35" or 36"	35" or 36"	76 lb	63 lb	65 lb
	76"	35" or 36"	35" or 36"	78 lb	69 lb	71 lb

Understructure Weight	Options		Soft Edge Weight	Accessory	
	Integrated Rail Weight	Power and Data Access Door Weight		Modesty Panel Weight	
16.9 lb	5.1 lb	N.A.	N.A.	15.2 lb	
18.6 lb	5.8 lb	6.9 lb	N.A.	17.6 lb	
20.3 lb	6.6 lb	6.9 lb	N.A.	20.0 lb	
22.0 lb	7.3 lb	6.9 lb	N.A.	22.4 lb	
23.7 lb	8.0 lb	6.9 lb	N.A.	24.8 lb	
25.4 lb	8.8 lb	6.9 lb	2.6 lb	27.3 lb	
27.1 lb	9.5 lb	6.9 lb	2.6 lb	29.7 lb	
28.9 lb	10.2 lb	6.9 lb	2.6 lb	32.1 lb	
17.9 lb	5.1 lb	N.A.	N.A.	15.2 lb	
19.6 lb	5.8 lb	6.9 lb	N.A.	17.6 lb	
21.3 lb	6.6 lb	6.9 lb	N.A.	20.0 lb	
23.0 lb	7.3 lb	6.9 lb	N.A.	22.4 lb	
24.7 lb	8.0 lb	6.9 lb	N.A.	24.8 lb	
26.4 lb	8.8 lb	6.9 lb	2.6 lb	27.3 lb	
28.1 lb	9.5 lb	6.9 lb	2.6 lb	29.7 lb	
29.9 lb	10.2 lb	6.9 lb	2.6 lb	32.1 lb	
18.9 lb	5.1 lb	N.A.	N.A.	15.2 lb	
20.6 lb	5.8 lb	6.9 lb	N.A.	17.6 lb	
22.3 lb	6.6 lb	6.9 lb	N.A.	20.0 lb	
24.0 lb	7.3 lb	6.9 lb	N.A.	22.4 lb	
25.7 lb	8.0 lb	6.9 lb	N.A.	24.8 lb	
27.4 lb	8.8 lb	6.9 lb	2.6 lb	27.3 lb	
29.1 lb	9.5 lb	6.9 lb	2.6 lb	29.7 lb	
30.9 lb	10.2 lb	6.9 lb	2.6 lb	32.1 lb	

Height-Adjustable Worksurfaces

Ology Height-Adjustable Worksurface Weights, continued

Worksurface Weight, continued

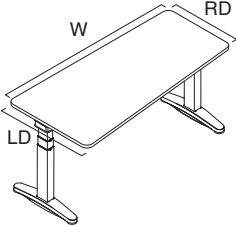
Worksurface Shape	W	LD	RD	• Base only Weight (OLELRTB)	• Worksurface Weight	
					23"D/29"D	24"D/30"D
	58"	29" or 30"	23" or 24"	67 lb	39 lb	40 lb
	64"	29" or 30"	23" or 24"	69 lb	43 lb	45 lb
	70"	29" or 30"	23" or 24"	71 lb	47 lb	49 lb
	76"	29" or 30"	23" or 24"	73 lb	51 lb	53 lb
	58"	23" or 24"	29" or 30"	67 lb	39 lb	40 lb
	64"	23" or 24"	29" or 30"	69 lb	43 lb	45 lb
	70"	23" or 24"	29" or 30"	71 lb	47 lb	49 lb
	76"	23" or 24"	29" or 30"	73 lb	51 lb	53 lb

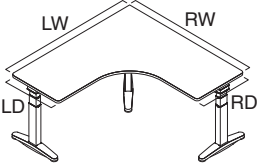
Worksurface Shape	LW	LD	RW	RD	• Base only Weight (OLELLCB)	• Worksurface Weight	
						23"D	24"D
	52"	23" or 24"	52"	23" or 24"	86 lb	58.2 lb	59.2 lb
	58"	23" or 24"	58"	23" or 24"	88 lb	66.6 lb	67.6 lb
	64"	23" or 24"	64"	23" or 24"	90 lb	75.0 lb	77.0 lb
	70"	23" or 24"	70"	23" or 24"	93 lb	83.4 lb	85.4 lb
	76"	23" or 24"	76"	23" or 24"	95 lb	91.8 lb	94.8 lb

• Understructure Weight	• Options		• Soft Edge Weight	• Accessory
	• Integrated Rail Weight	• Power and Data Access Door Weight		
24.2 lb	8.0 lb	6.9 lb	N.A.	24.8 lb
25.9 lb	8.8 lb	6.9 lb	2.6 lb	27.3 lb
27.6 lb	9.5 lb	6.9 lb	2.6 lb	29.7 lb
29.4 lb	10.2 lb	6.9 lb	2.6 lb	32.1 lb
24.2 lb	8.0 lb	6.9 lb	N.A.	24.8 lb
25.9 lb	8.8 lb	6.9 lb	2.6 lb	27.3 lb
27.6 lb	9.5 lb	6.9 lb	2.6 lb	29.7 lb
29.4 lb	10.2 lb	6.9 lb	2.6 lb	32.1 lb

• Understructure Weight	• Options		• Soft Edge Weight
	• Integrated Rail Weight	• Power and Data Access Door Weight	
29.2 lb	15.8 lb	N.A.	N.A.
31.5 lb	17.3 lb	6.9 lb each	N.A.
33.9 lb	18.7 lb	6.9 lb each	N.A.
36.2 lb	20.2 lb	6.9 lb each	N.A.
38.5 lb	21.7 lb	6.9 lb each	N.A.

Height-Adjustable Worksurfaces

Ology Height-Adjustable Worksurface Weights, continued

Worksurface Weight, continued

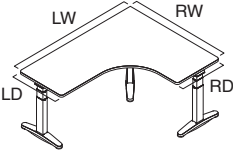
Worksurface Shape	LW	LD	RW	RD	Base only Weight (OLELLCB)	Worksurface Weight	
						23" D	24" D
	40"	23" or 24"	52"	23" or 24"	32.7 lb	49.8 lb	50.8 lb
	40"	23" or 24"	58"	23" or 24"	33.9 lb	54.1 lb	55.1 lb
	40"	23" or 24"	64"	23" or 24"	35.0 lb	58.2 lb	59.2 lb
	40"	23" or 24"	70"	23" or 24"	36.2 lb	62.4 lb	63.4 lb
	40"	23" or 24"	76"	23" or 24"	37.4 lb	66.6 lb	67.6 lb
	46"	23" or 24"	52"	23" or 24"	33.9 lb	54.0 lb	55.0 lb
	46"	23" or 24"	58"	23" or 24"	35.0 lb	58.2 lb	59.2 lb
	46"	23" or 24"	64"	23" or 24"	36.2 lb	62.4 lb	64.4 lb
	46"	23" or 24"	70"	23" or 24"	37.4 lb	66.6 lb	68.6 lb
	46"	23" or 24"	76"	23" or 24"	38.5 lb	70.8 lb	72.8 lb
	52"	23" or 24"	40"	23" or 24"	32.7 lb	49.8 lb	50.8 lb
	52"	23" or 24"	46"	23" or 24"	35.0 lb	54.0 lb	55.0 lb
	52"	23" or 24"	58"	23" or 24"	36.2 lb	62.4 lb	63.4 lb
	52"	23" or 24"	64"	23" or 24"	37.4 lb	66.6 lb	67.6 lb
	52"	23" or 24"	70"	23" or 24"	38.5 lb	70.8 lb	72.8 lb
	52"	23" or 24"	76"	23" or 24"	39.7 lb	75.0 lb	77.0 lb
	58"	23" or 24"	40"	23" or 24"	33.9 lb	54.1 lb	55.1 lb
	58"	23" or 24"	46"	23" or 24"	35.0 lb	58.2 lb	59.2 lb
	58"	23" or 24"	52"	23" or 24"	36.2 lb	62.4 lb	63.4 lb
	58"	23" or 24"	64"	23" or 24"	38.5 lb	70.8 lb	72.8 lb
	58"	23" or 24"	70"	23" or 24"	39.7 lb	75.0 lb	77.0 lb
	58"	23" or 24"	76"	23" or 24"	40.9 lb	79.2 lb	81.2 lb
	64"	23" or 24"	40"	23" or 24"	35.0 lb	58.2 lb	59.2 lb
	64"	23" or 24"	46"	23" or 24"	36.2 lb	62.4 lb	64.4 lb
	64"	23" or 24"	52"	23" or 24"	37.4 lb	66.6 lb	67.6 lb
	64"	23" or 24"	58"	23" or 24"	38.5 lb	70.8 lb	72.8 lb
	64"	23" or 24"	70"	23" or 24"	40.9 lb	79.2 lb	82.2 lb
	64"	23" or 24"	76"	23" or 24"	42.0 lb	83.4 lb	86.4 lb
	70"	23" or 24"	40"	23" or 24"	36.2 lb	62.4 lb	63.4 lb
	70"	23" or 24"	46"	23" or 24"	37.4 lb	66.6 lb	68.6 lb
	70"	23" or 24"	52"	23" or 24"	38.5 lb	70.8 lb	72.8 lb
	70"	23" or 24"	58"	23" or 24"	39.7 lb	75.0 lb	77.0 lb
70"	23" or 24"	64"	23" or 24"	40.9 lb	79.2 lb	82.2 lb	
70"	23" or 24"	76"	23" or 24"	42.0 lb	87.6 lb	90.6 lb	
76"	23" or 24"	40"	23" or 24"	43.2 lb	66.6 lb	67.6 lb	
76"	23" or 24"	46"	23" or 24"	37.4 lb	70.8 lb	72.8 lb	
76"	23" or 24"	52"	23" or 24"	39.7 lb	75.0 lb	77.0 lb	
76"	23" or 24"	58"	23" or 24"	40.9 lb	79.2 lb	81.2 lb	
76"	23" or 24"	64"	23" or 24"	42.0 lb	83.4 lb	86.4 lb	
76"	23" or 24"	70"	23" or 24"	42.0 lb	87.6 lb	90.6 lb	

Understructure Weight	Options		
	Integrated Rail Weight	Power and Data Access Door Weight	Soft Edge Weight
29.8 lb	18.8 lb	6.9 lb	N.A.
31.0 lb	19.9 lb	6.9 lb	N.A.
32.2 lb	20.9 lb	6.9 lb	N.A.
33.3 lb	21.9 lb	6.9 lb	N.A.
34.5 lb	23.0 lb	6.9 lb	N.A.
31.0 lb	19.9 lb	6.9 lb	N.A.
32.2 lb	20.9 lb	6.9 lb	N.A.
33.3 lb	21.9 lb	6.9 lb	N.A.
34.5 lb	23.0 lb	6.9 lb	N.A.
35.7 lb	24.0 lb	6.9 lb	N.A.
29.8 lb	18.8 lb	6.9 lb	N.A.
31.0 lb	19.9 lb	6.9 lb	N.A.
33.3 lb	21.9 lb	6.9 lb	N.A.
34.5 lb	23.0 lb	6.9 lb	N.A.
35.7 lb	24.0 lb	6.9 lb	N.A.
36.9 lb	25.1 lb	6.9 lb	N.A.
31.0 lb	19.9 lb	6.9 lb	N.A.
32.2 lb	20.9 lb	6.9 lb	N.A.
33.3 lb	21.9 lb	6.9 lb	N.A.
35.7 lb	24.0 lb	6.9 lb	N.A.
36.9 lb	25.1 lb	6.9 lb	N.A.
38.1 lb	26.1 lb	6.9 lb	N.A.
32.2 lb	20.9 lb	6.9 lb	N.A.
33.3 lb	21.9 lb	6.9 lb	N.A.
34.5 lb	23.0 lb	6.9 lb	N.A.
35.7 lb	24.0 lb	6.9 lb	N.A.
38.0 lb	26.1 lb	6.9 lb	N.A.
39.2 lb	27.1 lb	6.9 lb	N.A.
33.3 lb	21.9 lb	6.9 lb	N.A.
34.5 lb	23.0 lb	6.9 lb	N.A.
35.7 lb	24.0 lb	6.9 lb	N.A.
36.9 lb	25.1 lb	6.9 lb	N.A.
38.0 lb	26.1 lb	6.9 lb	N.A.
40.4 lb	28.2 lb	6.9 lb	N.A.
34.5 lb	23.0 lb	6.9 lb	N.A.
35.7 lb	24.0 lb	6.9 lb	N.A.
36.9 lb	25.1 lb	6.9 lb	N.A.
38.1 lb	26.1 lb	6.9 lb	N.A.
39.2 lb	27.1 lb	6.9 lb	N.A.
40.4 lb	28.2 lb	6.9 lb	N.A.

Height-Adjustable
Worksurfaces

Ology Height-Adjustable Worksurface Weights, continued

Worksurface Weight, continued

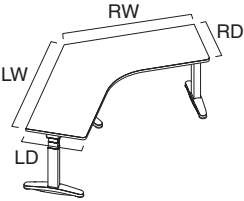
Worksurface Shape	LW	LD	RW	RD	• Base only Weight (OLELWCB)	• Worksurface Weight	
						23" D	24" D
	34"	23" or 24"	34"	23" or 24"	81 lb	38.7 lb	39.7 lb
	40"	23" or 24"	40"	23" or 24"	83 lb	47.1 lb	48.1 lb
	46"	23" or 24"	46"	23" or 24"	85 lb	55.5 lb	56.5 lb
	52"	23" or 24"	52"	23" or 24"	88 lb	63.9 lb	65.9 lb
	58"	23" or 24"	58"	23" or 24"	90 lb	72.3 lb	74.3 lb
	64"	23" or 24"	64"	23" or 24"	92 lb	80.7 lb	82.7 lb

Options			
Understructure Weight	Integrated Rail Weight	Power and Data Access Door Weight	Soft Edge Weight
20.1 lb	11.5 lb	N.A.	N.A.
22.5 lb	13.0 lb	N.A.	N.A.
24.8 lb	14.5 lb	N.A.	N.A.
27.2 lb	15.9 lb	6.9 lb	N.A.
29.5 lb	17.4 lb	6.9 lb	N.A.
31.8 lb	18.9 lb	6.9 lb	N.A.

Series 3 Height-Adjustable Worksurface Weights

Base supports a maximum distributed weight capacity of 205 pounds.
 Tip: When calculating lifting capacity, subtract the weight of the worksurface.

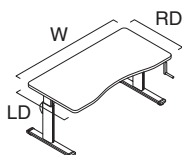
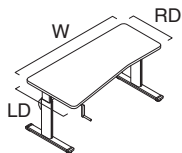
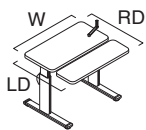
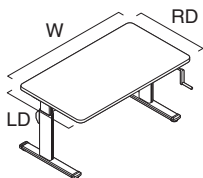
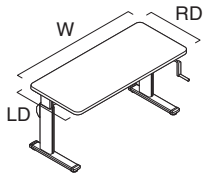

Worksurface Weight

Worksurface Shape	W	LD	RD	Style Number	Worksurface Weight
Rectangular – 23"D	34"	23"	23"	A3RQ342323	27.3 lb
	40"	23"	23"	A3RQ402323	31.7 lb
	46"	23"	23"	A3RQ462323	36.1 lb
	52"	23"	23"	A3RQ522323	40.5 lb
	58"	23"	23"	A3RQ582323	45.9 lb
	64"	23"	23"	A3RQ642323	50.3 lb
	70"	23"	23"	A3RQ702323	54.7 lb
Rectangular – 29"D	34"	29"	29"	A3RQ342929	33.9 lb
	40"	29"	29"	A3RQ402929	39.4 lb
	46"	29"	29"	A3RQ462929	45.9 lb
	52"	29"	29"	A3RQ522929	51.4 lb
	58"	29"	29"	A3RQ582929	56.9 lb
	64"	29"	29"	A3RQ642929	63.4 lb
	70"	29"	29"	A3RQ702929	68.9 lb
Rectangular Bi-level	34"	29"	29"	A3RD342929	43.7 lb
	40"	29"	29"	A3RD402929	51.4 lb
	46"	29"	29"	A3RD462929	58.0 lb
Taper-Flat	58"	29"	23"	A3RT582923	50.3 lb
	64"	29"	23"	A3RT642923	54.7 lb
	70"	29"	23"	A3RT702923	60.1 lb
	76"	29"	23"	A3RT762923	65.6 lb
	58"	23"	29"	A3RT582329	50.3 lb
	64"	23"	29"	A3RT642329	54.7 lb
	70"	23"	29"	A3RT702329	60.1 lb
Concave	58"	29"	29"	A3CQ582929	54.7 lb
	64"	29"	29"	A3CQ642929	60.1 lb
	70"	29"	29"	A3CQ702929	65.6 lb
	76"	29"	29"	A3CQ762929	71.1 lb

Worksurface Weight, continued

Worksurface Shape	LW	LD	RW	RD	Style Number	Worksurface Weight
90° Corner	40"	23"	40"	23"	A3LQ40234023	49.2 lb
	46"	23"	46"	23"	A3LQ46234623	54.7 lb
90° Corner Bi-level	40"	23"	40"	23"	A3LD40234023	60.1 lb
	46"	23"	46"	23"	A3LD46234623	73.3 lb
90° Equal – 23"D	52"	23"	52"	23"	A3LQ52235223	65.6 lb
	58"	23"	58"	23"	A3LQ55235823	74.4 lb
	64"	23"	64"	23"	A3LQ64236423	88.6 lb
	70"	23"	70"	23"	A3LQ70237023	97.3 lb
	76"	23"	76"	23"	A3LQ76237623	106.1 lb
90° Equal – 29"D	52"	29"	52"	29"	A3LQ52295229	76.5 lb
	58"	29"	58"	29"	A3LQ58295829	87.5 lb
	64"	29"	64"	29"	A3LQ64296429	107.2 lb
90° Extended – 23"D	58"	23"	40"	23"	A3LE58234023	61.2 lb
	58"	23"	46"	23"	A3LE58234623	65.6 lb
	64"	23"	40"	23"	A3LE64234023	65.6 lb
	64"	23"	46"	23"	A3LE64234623	70.0 lb
	64"	23"	58"	23"	A3LE64235823	79.8 lb
	70"	23"	40"	23"	A3LE70234023	70.0 lb
	70"	23"	46"	23"	A3LE70234623	79.8 lb
	70"	23"	58"	23"	A3LE70235823	70.0 lb
	76"	23"	40"	23"	A3LE76234023	75.5 lb
	76"	23"	46"	23"	A3LE76234623	84.2 lb
	76"	23"	58"	23"	A3LE76235823	75.5 lb
	40"	23"	58"	23"	A3LE40235823	79.8 lb
	40"	23"	64"	23"	A3LE40236423	88.6 lb
	40"	23"	70"	23"	A3LE40237023	61.2 lb
	40"	23"	76"	23"	A3LE40237623	65.6 lb
	46"	23"	58"	23"	A3LE46235823	70.0 lb
	46"	23"	64"	23"	A3LE46236423	75.5 lb
	46"	23"	70"	23"	A3LE46237023	65.6 lb
	46"	23"	76"	23"	A3LE46237623	70.0 lb
	58"	23"	64"	23"	A3LE58236423	79.8 lb
58"	23"	70"	23"	A3LE58237023	84.2 lb	
58"	23"	76"	23"	A3LE58237623	88.6 lb	

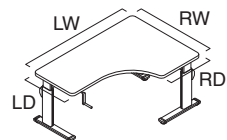
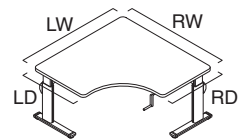
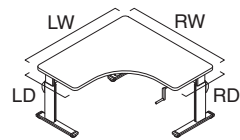
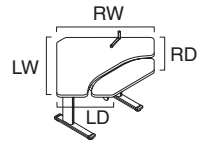
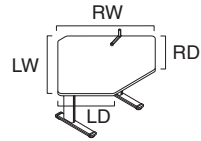

Series 3 Height-Adjustable Worksurface Weights, continued

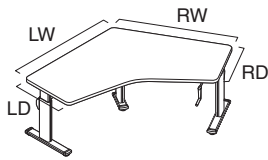
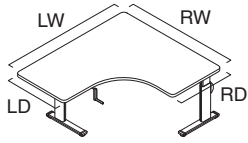

Worksurface Weight, continued

Worksurface Shape	LW	LD	RW	RD	Style Number	Worksurface Weight
90° Extended – 29"D	64"	29"	58"	29"	A3LE64295829	94.0 lb
	70"	29"	64"	29"	A3LE70296429	99.5 lb
	76"	29"	58"	29"	A3LE76295829	105.0 lb
	58"	29"	64"	29"	A3LE58296429	97.3 lb
	58"	29"	70"	29"	A3LE58297029	99.5 lb
	58"	29"	76"	29"	A3LE58297629	105.0 lb
120° Equal	34"	23"	34"	23"	A3WQ34233423	49.2 lb
	40"	23"	40"	23"	A3WQ40234023	59.0 lb
	46"	23"	46"	23"	A3WQ46234623	68.9 lb
	52"	23"	52"	23"	A3WQ52235223	79.8 lb
	58"	23"	58"	23"	A3WQ58235823	89.7 lb
	64"	23"	64"	23"	A3WQ64236423	100.6 lb

Airtouch Height-Adjustable Worksurface Weights

Base supports a maximum distributed weight capacity of 150 pounds.

Tip: When calculating lifting capacity, subtract the weight of the worksurface.

Worksurface Weight

Worksurface Shape	W	LD	RD	Style Number	Worksurface Weight
-------------------	---	----	----	--------------	--------------------

Universal Tables

Rectangular – 22¼"D	40"	22¼"	22¼"	BAPSS2424	30.6 lb
	46"	22¼"	22¼"	BAPSS2448	35.0 lb
	58"	22¼"	22¼"	BAPSS2460	44.8 lb

Rectangular – 28¼"D	40"	28¼"	28¼"	BAPSS3042	38.3 lb
	46"	28¼"	28¼"	BAPSS3048	44.8 lb
	58"	28¼"	28¼"	BAPSS3060	55.8 lb

Rectangular Bi-level	40"	34¼"	34¼"	BAPDS3642	62.3 lb
	46"	34¼"	34¼"	BAPDS3648	70.0 lb

Worksurface Shape	LW	LD	RW	RD	Style Number	Worksurface Weight
-------------------	----	----	----	----	--------------	--------------------

90° Corner	39¼"	22¼"	39¼"	22¼"	BAPSC2442	45.9 lb
	45¼"	22¼"	45¼"	22¼"	BAPSC2448	59.0 lb

90° Corner Bi-Level	39¼"	22¼"	39¼"	22¼"	BAPDC2442	59.0 lb
	45¼"	22¼"	45¼"	22¼"	BAPDC2448	72.2 lb

120° Equal	34"	22¼"	34"	22¼"	BAPB2436	55.8 lb
------------	-----	------	-----	------	----------	---------

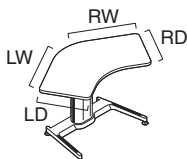
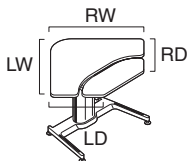
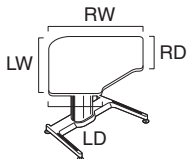
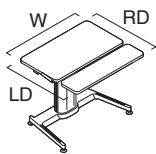
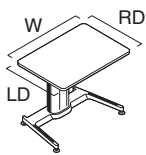
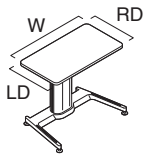

Worksurface Weight, continued

Worksurface Shape	W	LD	RD	Style Number	Worksurface Weight
For use with Universal Systems					
Rectangular – 22 ¹ / ₄ "D	40"	22 ¹ / ₄ "	22 ¹ / ₄ "	UAPSS2424	30.6 lb
	46"	22 ¹ / ₄ "	22 ¹ / ₄ "	UAPSS2448	35.0 lb
	58"	22 ¹ / ₄ "	22 ¹ / ₄ "	UAPSS2460	44.8 lb

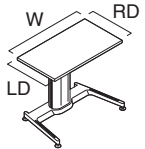

Rectangular – 28 ¹ / ₄ "D	40"	28 ¹ / ₄ "	28 ¹ / ₄ "	UAPSS3042	38.3 lb
	46"	28 ¹ / ₄ "	28 ¹ / ₄ "	UAPSS3048	44.8 lb
	58"	28 ¹ / ₄ "	28 ¹ / ₄ "	UAPSS3060	55.8 lb

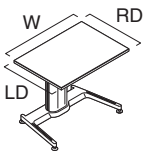

Rectangular Bi-level	40"	34 ¹ / ₄ "	34 ¹ / ₄ "	UAPDS3642	62.3 lb
	46"	34 ¹ / ₄ "	34 ¹ / ₄ "	UAPDS3648	70.0 lb

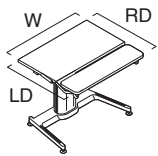

Worksurface Shape	LW	LD	RW	RD	Style Number	Worksurface Weight
90° Corner	39 ¹ / ₄ "	16 ¹ / ₄ "	39 ¹ / ₄ "	16 ¹ / ₄ "	UAPSC1842	30.6 lb
	39 ¹ / ₄ "	22 ¹ / ₄ "	39 ¹ / ₄ "	22 ¹ / ₄ "	UAPSC2442	45.9 lb
	45 ¹ / ₄ "	22 ¹ / ₄ "	45 ¹ / ₄ "	22 ¹ / ₄ "	UAPSC2448	59.0 lb

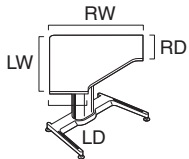

90° Corner Bi-Level	39 ¹ / ₄ "	22 ¹ / ₄ "	39 ¹ / ₄ "	22 ¹ / ₄ "	UAPDC2442	59.0 lb
	45 ¹ / ₄ "	22 ¹ / ₄ "	45 ¹ / ₄ "	22 ¹ / ₄ "	UAPDC2448	72.2 lb

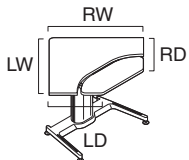

120° Equal	34"	22 ¹ / ₄ "	34"	22 ¹ / ₄ "	UAPB2436	55.8 lb
------------	-----	----------------------------------	-----	----------------------------------	----------	---------

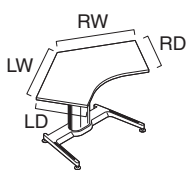

Worksurface Shape	W	LD	RD	Style Number	Worksurface Weight
-------------------	---	----	----	--------------	--------------------

For use with Series 9000

Rectangular	43"	22 ²⁵ / ₃₂ "	22 ²⁵ / ₃₂ "	9UAPSS2545	32.8 lb
	43"	27 ²⁵ / ₃₂ "	27 ²⁵ / ₃₂ "	9UAPSS3045	40.5 lb

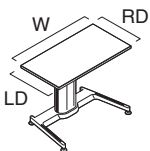

Worksurface Shape	LW	LD	RW	RD	Style Number	Worksurface Weight
90° Corner	42 ¹ / ₄ "	17 ¹ / ₈ "	42 ¹ / ₄ "	17 ¹ / ₈ "	9UAPSC1845	47.0 lb
	42 ¹ / ₄ "	22 ²⁵ / ₃₂ "	42 ¹ / ₄ "	22 ²⁵ / ₃₂ "	9UAPSC2545	51.4 lb

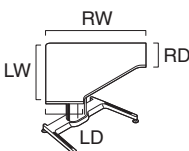

Height-Adjustable
Worksurfaces

Series 5 Height-Adjustable Worksurface Weights

Base supports a maximum distributed weight capacity of 195 pounds.

Tip: When calculating lifting capacity, subtract the weight of the worksurface.

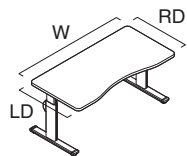
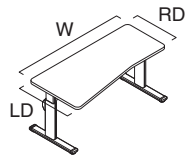
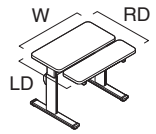
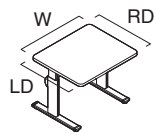
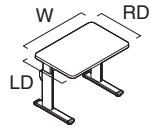

Worksurface Weight					
Worksurface Shape	W	LD	RD	Style Number	Worksurface Weight
Rectangular – 23"D	34"	23"	23"	A5RQ342323	27.3 lb
	40"	23"	23"	A5RQ402323	31.7 lb
	46"	23"	23"	A5RQ462323	36.1 lb
	52"	23"	23"	A5RQ522323	40.5 lb
	58"	23"	23"	A5RQ582323	45.9 lb
	64"	23"	23"	A5RQ642323	50.3 lb
	70"	23"	23"	A5RQ702323	54.7 lb
Rectangular – 29"D	34"	29"	29"	A5RQ342929	33.9 lb
	40"	29"	29"	A5RQ402929	39.4 lb
	46"	29"	29"	A5RQ462929	45.9 lb
	52"	29"	29"	A5RQ522929	51.4 lb
	58"	29"	29"	A5RQ582929	56.9 lb
	64"	29"	29"	A5RQ642929	63.4 lb
	70"	29"	29"	A5RQ702929	68.9 lb
Rectangular Bi-level	40"	29"	29"	A5RD402929	51.4 lb
	46"	29"	29"	A5RD462929	58.0 lb
Taper-Flat	58"	29"	23"	A5RT582923	50.3 lb
	64"	29"	23"	A5RT642923	54.7 lb
	70"	29"	23"	A5RT702923	60.1 lb
	76"	29"	23"	A5RT762923	65.6 lb
	58"	23"	29"	A5RT582329	50.3 lb
	64"	23"	29"	A5RT642329	54.7 lb
	70"	23"	29"	A5RT702329	60.1 lb
Concave	76"	23"	29"	A5RT762329	65.6 lb
	58"	29"	29"	A5CQ582929	54.7 lb
	64"	29"	29"	A5CQ642929	60.1 lb
	70"	29"	29"	A5CQ702929	65.6 lb
	76"	29"	29"	A5CQ762929	71.1 lb

Worksurface Weight, continued

Worksurface Shape	LW	LD	RW	RD	Style Number	Worksurface Weight
90° Corner	40"	23"	40"	23"	A5LQ40234023	49.2 lb
	46"	23"	46"	23"	A5LQ46234623	54.7 lb
90° Corner Bi-level	40"	23"	40"	23"	A5LD40234023	60.1 lb
	46"	23"	46"	23"	A5LD46234623	73.3 lb
90° Extended – 23"D	58"	23"	40"	23"	A5LE58234023	61.2 lb
	58"	23"	46"	23"	A5LE58234623	65.6 lb
	64"	23"	40"	23"	A5LE64234023	65.6 lb
	64"	23"	46"	23"	A5LE64234623	70.0 lb
	64"	23"	58"	23"	A5LE64235823	79.8 lb
	70"	23"	40"	23"	A5LE70234023	70.0 lb
	70"	23"	46"	23"	A5LE70234623	79.8 lb
	70"	23"	58"	23"	A5LE70235823	70.0 lb
	76"	23"	40"	23"	A5LE76234023	75.5 lb
	76"	23"	46"	23"	A5LE76234623	84.2 lb
	76"	23"	58"	23"	A5LE76235823	75.5 lb
	40"	23"	58"	23"	A5LE40235823	79.8 lb
	40"	23"	64"	23"	A5LE40236423	88.6 lb
	40"	23"	70"	23"	A5LE40237023	61.2 lb
	40"	23"	76"	23"	A5LE40237623	65.6 lb
	46"	23"	58"	23"	A5LE46235823	70.0 lb
	46"	23"	64"	23"	A5LE46236423	75.5 lb
	46"	23"	70"	23"	A5LE46237023	65.6 lb
	46"	23"	76"	23"	A5LE46237623	70.0 lb
	90° Extended – 29"D	64"	29"	58"	29"	A5LE64295829
70"		29"	58"	29"	A5LE70296429	99.5 lb
76"		29"	58"	29"	A5LE76295829	105.0 lb
58"		29"	64"	29"	A5LE58296429	97.3 lb
58"		29"	70"	29"	A5LE58297029	99.5 lb
58"		29"	76"	29"	A5LE58297629	105.0 lb
120° Equal		34"	23"	34"	23"	A5WQ34233423
	40"	23"	40"	23"	A5WQ40234023	59.0 lb
	46"	23"	46"	23"	A5WQ46234623	68.9 lb
	52"	23"	52"	23"	A5WQ52235223	79.8 lb
	58"	23"	58"	23"	A5WQ58235823	89.7 lb
	64"	23"	64"	23"	A5WQ64236423	100.6 lb

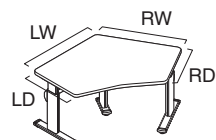
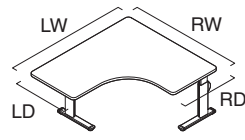
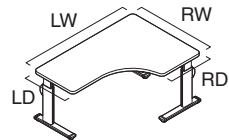
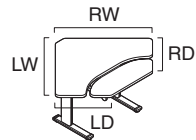
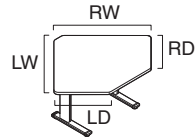

Ology Height-Adjustable Rectangular Desks

High-Pressure Laminate or Wood Veneer

SIN 711.2

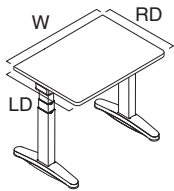

Tip: Any storage higher than 19" or 16 1/2" if the power access door is optioned, will impede lowest height range of worksurface. Do not place storage underneath controller.

Tip: Only single and dual flat panel monitor arm applications are permitted for use with 2-leg height-adjustable desks.

▶ See Steelcase Worktools Specification Guide.

Tip: Base supports a maximum distributed weight capacity of 314 pounds (2-leg) and 471 pounds (3-leg). When calculating lifting capacity, subtract the weight of the worksurface, understructure, and options selected.

▶ See page 220 for worksurface weights.

Tip: Antimicrobial can be specified only when specifying up/down controller and/or soft edge.

Standard Includes	Required to Specify
<ul style="list-style-type: none"> • Worksurface: High-Pressure Laminate with 3 mm plastic edge or wood veneer • Electric height-adjustable sit-to-stand base: paint • Modular widths: 34"–76" • 1/2" adjustable glides • Power cord: 9' • Attachment hardware 	<ol style="list-style-type: none"> 1 Style number 2 Desk depth 3 Desk width 4 High-Pressure Laminate or wood color for worksurface 5 Plastic color number for profile edge on laminate worksurface, if selected 6 Desk corner style, if laminate desk selected (see below under Required Selections) 7 Paint color number for base 4799 Platinum Metallic 7207 Black 7241 Arctic White 7360 Merle 8 Controller (see below under Required Selections) 9 Integrated rail (see below under Required Selections) 10 Antimicrobial or non-antimicrobial surface, if up/down controller selected (see below under Required Selections) 11 Options, if selected (see below) <p>▶ See <i>Surface Materials</i>, page 318.</p>

Required Selections	Price	Required to Specify
Desk Corner Style (Laminate Desks Only) <ul style="list-style-type: none"> • Square corners • Radius corners 	No cost +\$ 60	Specify with <i>square corners</i> . Specify with <i>radius corners</i> .
Controller <ul style="list-style-type: none"> • Up/down controller • 4 Pre-set controller 	No cost +\$112	Specify with <i>up/down controller</i> . Specify with <i>4 pre-set controller</i> .
Integrated Rail <ul style="list-style-type: none"> • Without integrated rail • With integrated rail 	No cost +\$323	Specify <i>without integrated rail</i> . Specify <i>with integrated rail</i> .
Antimicrobial Surface <ul style="list-style-type: none"> • Non-antimicrobial surface • Antimicrobial surface 	No cost No cost	Specify with <i>non-antimicrobial surface</i> . Specify with <i>antimicrobial surface</i> .

Options	Price	Required to Specify
Surface Materials <ul style="list-style-type: none"> • Open Line laminate 	+\$ 67 plus cost of laminate	▶ See <i>Surface Materials Reference Manual</i> .
Wood veneer desks <ul style="list-style-type: none"> • Premium wood 2 • Premium wood 3 • Customiz stain 	+\$ 67 +\$236 No cost	Specify Premium wood 2 finish number. Specify Premium wood 3 finish number. Specify with <i>customiz stain</i> . ▶ See <i>Surface Materials Reference Manual</i> . Specify full-fill finish number.
Base <ul style="list-style-type: none"> • Full-fill finish 	+\$ 67	
<ul style="list-style-type: none"> • Paint price group 1 • Paint price group 2 	No cost +\$ 28	Specify paint color number. Specify paint color number. ▶ See <i>Surface Materials</i> , page 318.
Desk Type <ul style="list-style-type: none"> • Parametric width desk 	No cost	Specify with <i>parametric desk type</i> .
Overhang <ul style="list-style-type: none"> • Desk overhang on left • Desk overhang on right • Desk overhang left and right 	+\$ 55 +\$ 55 +\$110	Specify with <i>desk overhang left</i> . Specify with <i>desk overhang right</i> . Specify with <i>desk overhang left and right</i> .

▶ Options, continued on next page

Tip: 9" overhang is available on desks 64"W and larger. Overhang on both sides is available on 70"W and larger.

SIN 711.2

► Options, continued from previous page

Tip: Soft edge is available on desks 58"W and larger. If overhang left or overhang right is selected, soft edge is available on desks 70"W or 76"W. Soft edge cannot be specified on desks that have overhang on both sides.

Tip: Power and data access door is available on desks 40"W or greater.

Tip: Power access door and soft edge can be positioned left or right on desks that are 64"W or wider for use with One-High universal storage.

Tip: Rectangular desks accommodate either power and data access door or grommet, but not both.

Options	Price	Required to Specify
Soft Edge • With soft edge	+\$248	Specify with soft edge.
Power and Data Access Door, Tray and USB	• Power and data access door, tray and USB: paint group 1 or 2	+\$774
	• Power and data access door, tray and USB: anodized aluminum	+\$784
Power and Data Access Door and Soft Edge Position	• Centered	No cost
	• Left	No cost
	• Right	No cost
Grommet • Grommet	+\$ 39	Specify with grommet and select left- or right-hand side.
Glides • 1" adjustable glides	+\$ 28	Specify with 1" glides.
Related Products	• Modesty panels	► Page 255
	• Fixed personal/modesty screens	► Page 256
	• Cable and power management	► Page 257

Specification Information

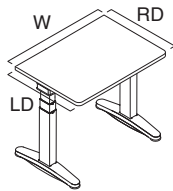

Style Number	Dimensions D	Desk Type	Base Prices							
			34"W	40"W	46"W	52"W	58"W	64"W	70"W	76"W
Modular			34"W	40"W	46"W	52"W	58"W	64"W	70"W	76"W
		Parametric	34"W	36 ¹ / ₁₆ "W	42 ¹ / ₁₆ "W	48 ¹ / ₁₆ "W	54 ¹ / ₁₆ "W	60 ¹ / ₁₆ "W	66 ¹ / ₁₆ "W	72 ¹ / ₁₆ "W
			36"W	42"W	48"W	54"W	60"W	66"W	72"W	78"W

High-Pressure Laminate Desks—Extended Height

OLELRQ	23" or 24"	29" or 30"	35" or 36"						
	\$1580	\$1779	\$1978	\$1630	\$1834	\$2038	\$1680	\$1891	\$2102
	\$1734	\$1951	\$2168	\$1734	\$1951	\$2168	\$1787	\$2012	\$2237
	\$1845	\$2074	\$2303	\$1845	\$2074	\$2303	\$1901	\$2139	\$2377
	\$1960	\$2206	\$2452	\$1960	\$2206	\$2452			

Wood Veneer Desks—Extended Height

OLELRQ	23" or 24"	29" or 30"	35" or 36"						
	\$2101	\$2321	\$2541	\$2101	\$2321	\$2541	\$2159	\$2385	\$2611
	\$2216	\$2450	\$2684	\$2216	\$2450	\$2684	\$2279	\$2519	\$2759
	\$2340	\$2587	\$2834	\$2340	\$2587	\$2834	\$2408	\$2660	\$2912
	\$2472	\$2732	\$2992	\$2472	\$2732	\$2992	\$2541	\$2808	\$3075

► Specification Information, continued on next page

Height-Adjustable Worksurfaces

Ology Height-Adjustable Rectangular Desks, High-Pressure Laminate or Wood Veneer, continued

SIN 711.2

► Specification Information, continued from previous page

Specification Information

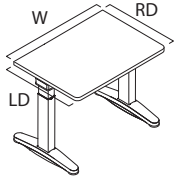

• Style Number	• Dimensions D	• Desk Type	• Base Prices							
			34"W	40"W	46"W	52"W	58"W	64"W	70"W	76"W
		Modular	34"W	40"W	46"W	52"W	58"W	64"W	70"W	76"W
		Parametric	34"W	36½"W	42½"W	48½"W	54½"W	60½"W	66½"W	72½"W
			36"W	42"W	48"W	54"W	60"W	66"W	72"W	78"W

High-Pressure Laminate Desks — Basic Height

OLSLRQ	23" or 24"	29" or 30"	35" or 36"	34"W	40"W	46"W	52"W	58"W	64"W	70"W	76"W
	\$1490	\$1677	\$1865	\$1537	\$1730	\$1922	\$1584	\$1783	\$1956	\$2017	\$2080
				\$2044	\$2210	\$2172	\$2110	\$2172	\$2241	\$2241	\$2312

Wood Veneer Desks — Basic Height

OLSLRQ	23" or 24"	29" or 30"	35" or 36"	34"W	40"W	46"W	52"W	58"W	64"W	70"W	76"W
	\$2011	\$2219	\$2428	\$2066	\$2281	\$2495	\$2120	\$2408	\$2542	\$2610	\$2682
				\$2635	\$2707	\$2781	\$2565	\$2707	\$2781	\$2856	\$2935

Ology
Height-Adjustable
Rectangular Desks

SIN 711.2

Ology Height-Adjustable Tapered Desks

High-Pressure Laminate or Wood Veneer

SIN 711.2

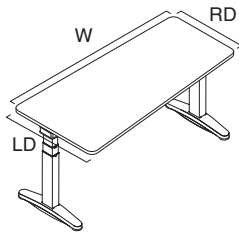

Tip: Any storage higher than 19" or 16 1/2" if the power access door is optioned, will impede lowest height range of worksurface. Do not place storage underneath controller.

Tip: Only single and dual flat panel monitor arm applications are permitted for use with 2-leg height-adjustable desks.

► See Steelcase Worktools Specification Guide.

Tip: Base supports a maximum distributed weight capacity of 314 pounds (2-leg) and 471 pounds (3-leg). When calculating lifting capacity, subtract the weight of the worksurface, understructure, and options selected.

► See page 220 for worksurface weights.

Tip: Antimicrobial can be specified only when specifying up/down controller and/or soft edge.

Standard Includes	Required to Specify
<ul style="list-style-type: none"> • Worksurface: High-Pressure Laminate with 3 mm plastic edge or wood veneer • Electric height-adjustable sit-to-stand base: paint • Modular widths: 58"–76" • 1/2" adjustable glides • Power cord: 9' • Attachment hardware 	<ol style="list-style-type: none"> 1 Style number 2 Desk depth 3 Desk width 4 High-Pressure Laminate or wood color for worksurface 5 Plastic color number for profile edge on laminate worksurface, if selected 6 Desk corner style, if laminate desk selected (see below under Required Selections) 7 Paint color number for base 4799 Platinum Metallic 7207 Black 7241 Arctic White 7360 Merle 8 Controller (see below under Required Selections) 9 Integrated rail (see below under Required Selections) 10 Antimicrobial or non-antimicrobial surface, if up/down controller selected (see below under Required Selections) 11 Options, if selected (see below) <p>► See <i>Surface Materials</i>, page 318.</p>

Required Selections	Price	Required to Specify
Desk Corner Style (Laminate Desks Only) <ul style="list-style-type: none"> • Square corners • Radius corners 	No cost +\$ 60	Specify with <i>square corners</i> . Specify with <i>radius corners</i> .
Controller <ul style="list-style-type: none"> • Up/down controller • 4 Pre-set controller 	No cost +\$112	Specify with <i>up/down controller</i> . Specify with <i>4 pre-set controller</i> .
Integrated Rail <ul style="list-style-type: none"> • Without integrated rail • With integrated rail 	No cost +\$323	Specify <i>without integrated rail</i> . Specify <i>with integrated rail</i> .
Antimicrobial Surface <ul style="list-style-type: none"> • Non-antimicrobial surface • Antimicrobial surface 	No cost No cost	Specify with <i>non-antimicrobial surface</i> . Specify with <i>antimicrobial surface</i> .

Options	Price	Required to Specify
Surface Materials <ul style="list-style-type: none"> • High-Pressure Laminate desks <ul style="list-style-type: none"> • Open Line laminate • Wood veneer desks <ul style="list-style-type: none"> • Premium wood 2 • Premium wood 3 • Customiz stain • Full-fill finish 	+\$ 67 plus cost of laminate +\$ 67 +\$236 No cost +\$ 67	► See <i>Surface Materials Reference Manual</i> . Specify Premium wood 2 finish number. Specify Premium wood 3 finish number. Specify with <i>customiz stain</i> . ► See <i>Surface Materials Reference Manual</i> . Specify full-fill finish number.
Base <ul style="list-style-type: none"> • Paint price group 1 • Paint price group 2 	No cost +\$ 28	Specify paint color number. Specify paint color number. ► See <i>Surface Materials</i> , page 318.
Desk Type <ul style="list-style-type: none"> • Parametric width desk 	No cost	Specify with <i>parametric desk type</i> .

► Options, continued on next page

► Options, continued from previous page

Tip: Soft edge is available on desks 58"W and larger.

Tip: Power access door and soft edge can be positioned left or right on desks that are 64"W or wider for use with One-High universal storage.

Tip: Tapered desks accommodate either power and data access door or grommet, but not both.

Options	Price	Required to Specify
Soft Edge • With soft edge	+\$248	Specify with <i>soft edge</i> .
Power and Data Access Door, Tray and USB • Power and data access door, tray and USB: paint group 1 or 2	+\$774	Specify with <i>power and data access door</i> and select paint color number.
• Power and data access door, tray and USB: anodized aluminum	+\$784	Specify with <i>power and data access door</i> and select anodized aluminum.
Power and Data Access Door and Soft Edge Position • Centered	No cost	Specify with <i>centered position</i> .
• Left	No cost	Specify with <i>left position</i> .
• Right	No cost	Specify with <i>right position</i> .
Grommet • Grommet	+\$ 39	Specify with <i>grommet</i> and select left- or right-hand side.
Glides • 1" adjustable glides	+\$ 28	Specify with <i>1" glides</i> .
Related Products • Modesty panels		► Page 255
• Fixed personal/modesty screens		► Page 256
• Cable and power management		► Page 257

Specification Information

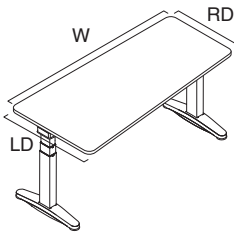

Style Number	Dimensions		Desk Type	Base Prices			
	LD	RD		58"W	64"W	70"W	76"W
			Modular	58"W	64"W	70"W	76"W
			Parametric	58 ¹ / ₁₆ "W–60"W	60 ¹ / ₁₆ "W–66"W	66 ¹ / ₁₆ "W–72"W	72 ¹ / ₁₆ "W–78"W

High-Pressure Laminate Desks—Extended Height

OLELRT	23" or 24"	29" or 30"	\$2012	\$2074	\$2139	\$2206
	29" or 30"	23" or 24"	\$2012	\$2074	\$2139	\$2206

Wood Veneer Desks—Extended Height

OLELRT	23" or 24"	29" or 30"	\$2587	\$2660	\$2732	\$2808
	29" or 30"	23" or 24"	\$2587	\$2660	\$2732	\$2808

► Specification Information, continued on next page

Ology Height-Adjustable Tapered Desks, High-Pressure Laminate or Wood Veneer, continued

SIN 711.2

► Specification Information, continued from previous page

Specification Information

• Style Number	• Dimensions		• Desk Type	• Base Prices			
	LD	RD		58"W	64"W	70"W	76"W
			Modular				
			Parametric	58 ¹ / ₁₆ "W-60"W	60 ¹ / ₁₆ "W-66"W	66 ¹ / ₁₆ "W-72"W	72 ¹ / ₁₆ "W-78"W

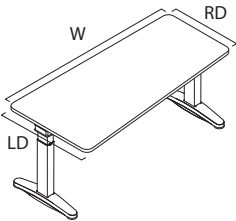

High-Pressure Laminate Desks — Basic Height

OLSLRT	23" or 24"	29" or 30"	\$1897	\$1956	\$2017	\$2080
	29" or 30"	23" or 24"	\$1897	\$1956	\$2017	\$2080

Wood Veneer Desks — Basic Height

OLSLRT	23" or 24"	29" or 30"	\$2472	\$2542	\$2610	\$2682
	29" or 30"	23" or 24"	\$2472	\$2542	\$2610	\$2682

Ology
Height-Adjustable
Tapered Desks

SIN 711.2

Ology Height-Adjustable Corner Desks

High-Pressure Laminate or Wood Veneer

SIN 711.2

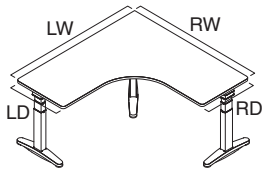

Tip: Any storage higher than 19" or 16 1/2" if the power access door is optioned, will impede lowest height range of worksurface. Do not place storage underneath controller.

Tip: Base supports a maximum distributed weight capacity of 314 pounds (2-leg) and 471 pounds (3-leg). When calculating lifting capacity, subtract the weight of the worksurface, understructure and options selected.

► See page 220 for worksurface weights.

Tip: Antimicrobial can be specified only when specifying up/down controller.

Standard Includes	Required to Specify
<ul style="list-style-type: none"> • Worksurface: High-Pressure Laminate with 3 mm plastic edge or wood veneer • Electric height-adjustable sit-to-stand base: paint • Modular widths: <ul style="list-style-type: none"> – 90° equal corner: 52"–76" – 90° extended corner: 40"–76" – 120° equal corner: 34"–64" • 1/2" adjustable glides • Power cord: 9' • Attachment hardware 	<ol style="list-style-type: none"> 1 Style number 2 Desk depth 3 Desk width 4 High-Pressure Laminate or wood color for worksurface 5 Plastic color number for profile edge on laminate worksurface, if selected 6 Desk corner style, if laminate desk selected (see below under Required Selections) 7 Paint color number for base <ul style="list-style-type: none"> 4799 Platinum Metallic 7207 Black 7241 Arctic White 7360 Merle 8 Controller (see below under Required Selections) 9 Integrated rail (see below under Required Selections) 10 Antimicrobial or non-antimicrobial surface, if up/down controller selected (see below under Required Selections) 11 Options, if selected (see below) <p>► See <i>Surface Materials</i>, page 318.</p>

	Required Selections	Price	Required to Specify
Desk Corner Style (Laminate Desks Only)	<ul style="list-style-type: none"> • Square corners • Radius corners 	No cost +\$ 60	Specify with square corners. Specify with radius corners.
Controller	<ul style="list-style-type: none"> • Up/down controller • 4 Pre-set controller 	No cost +\$112	Specify with up/down controller. Specify with 4 pre-set controller.
Integrated Rail	<ul style="list-style-type: none"> • Without integrated rail • With integrated rail 	No cost +\$646	Specify without integrated rail. Specify with integrated rail.
Antimicrobial Surface	<ul style="list-style-type: none"> • Non-antimicrobial surface • Antimicrobial surface 	No cost No cost	Specify with non-antimicrobial surface. Specify with antimicrobial surface.

	Options	Price	Required to Specify
Surface Materials	High-Pressure Laminate desks		
	<ul style="list-style-type: none"> • Open Line laminate 	+\$ 67 plus cost of laminate	► See <i>Surface Materials Reference Manual</i> .
	Wood veneer desks		
	<ul style="list-style-type: none"> • Premium wood 2 • Premium wood 3 • Customiz stain 	+\$ 67 +\$236 No cost	Specify Premium wood 2 finish number. Specify Premium wood 3 finish number. Specify with customiz stain. ► See <i>Surface Materials Reference Manual</i> . Specify full-fill finish number.
	Base		
	<ul style="list-style-type: none"> • Paint price group 1 • Paint price group 2 	No cost +\$ 42	Specify paint color number. Specify paint color number. ► See <i>Surface Materials</i> , page 318.
Desk Type	<ul style="list-style-type: none"> • Modular width desk • Parametric width desk 	No cost No cost	Specify with modular desk type. Specify with parametric desk type.

► Options, continued on next page

► Options, continued from previous page

Tip: Power and data access door and grommet cannot be located on the same side of the desk.

Tip: Power and data access door is available on desks 58"W or greater.

Tip: When selecting power and data access door or grommet on one side, a cord drop will be standard on opposite side if integrated rail is present.

Options	Price	Required to Specify	
Power and Data Access Door, Tray and USB	• Power and data access door on left or right: paint group 1 or 2	+\$ 774	Specify with power and data access door on left or right and select paint color number.
	• Power and data access door on left or right: anodized aluminum	+\$ 784	Specify with power and data access door on left or right and select anodized aluminum.
	• Power and data access door on left and right: paint group 1 or 2	+\$1548	Specify with power and data access door on left and right and select paint color number.
	• Power and data access door on left and right: anodized aluminum	+\$1568	Specify with power and data access door on left and right and select anodized aluminum.
Grommet	• Grommet on left- or right-hand side.	+\$ 39	Specify with grommet and select left- or right-hand sides.
	• Grommet on left- and right-hand side.	+\$ 78	Specify with grommet and select left- and right-hand sides.
Glides	• 1" adjustable glides	+\$ 42	Specify with 1" glides.
Related Products	• Modesty panels • Fixed personal/modesty screens • Cable and power management		► Page 255 ► Page 256 ► Page 257

Specification Information

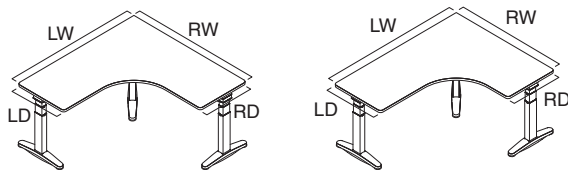

• Style Number	• Dimensions D	• Modular Left Width	• Parametric Left Width	• Modular Right Width	• Base Prices							
					40"W	46"W	52"W	58"W	64"W	70"W	76"W	
					40"W	42 ¹ / ₁₆ "W	48 ¹ / ₁₆ "W	52 ¹ / ₁₆ "W	60 ¹ / ₁₆ "W	66 ¹ / ₁₆ "W	72 ¹ / ₁₆ "W	76"W
					42"W	48"W	52"W	60"W	66"W	72"W	76"W	

90° Corner Desks—Extended Height

High-Pressure Laminate Desks

OLELLC	23" or 24"	40"W	40"W–42"W	N.A.	N.A.	\$2511	\$2511	\$2590	\$2670	\$2752
	23" or 24"	46"W	42 ¹ / ₁₆ "W–48"W	N.A.	N.A.	\$2590	\$2590	\$2670	\$2752	\$2840
	23" or 24"	52"W	48 ¹ / ₁₆ "W–52"W	\$2511	\$2590	\$2590	\$2590	\$2840	\$2929	\$3020
	23" or 24"	58"W	52 ¹ / ₁₆ "W–60"W	\$2511	\$2590	\$2590	\$2752	\$2840	\$2929	\$3020
	23" or 24"	64"W	60 ¹ / ₁₆ "W–66"W	\$2590	\$2670	\$2840	\$2840	\$2929	\$3116	\$3116
	23" or 24"	70"W	66 ¹ / ₁₆ "W–72"W	\$2670	\$2752	\$2929	\$2929	\$3116	\$3116	\$3312
	23" or 24"	76"W	72 ¹ / ₁₆ "W–76"W	\$2752	\$2840	\$3020	\$3020	\$3116	\$3312	\$3312

Tip: Equal corner widths are parametric to 1/16" from 52"W–76"W.

Tip: 90° desks, 60¹/₁₆"W x 60¹/₁₆"W and wider, are manufactured in two pieces. The worksurface split is located on the left side of an equal corner and on the longest side of an extended corner.

► Specification Information, continued on next page

Olgy Height-Adjustable Corner Desks High-Pressure Laminate or Wood Veneer, continued

SIN 711.2

► Specification Information, continued from previous page

Specification Information

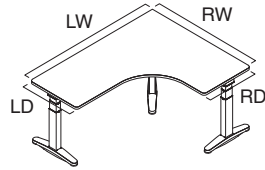
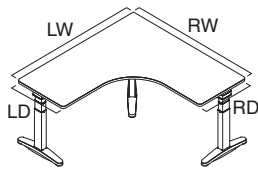

• **Style Number**
• **Dimensions D**

• Modular Left Width
• Parametric Left Width

• Modular Right Width
• Parametric Right Width

• **Base Prices**

40"W	46"W	52"W	58"W	64"W	70"W	76"W
40"W—42"W	42 ¹ / ₁₆ "W—48"W	48 ¹ / ₁₆ "W—52"W	52 ¹ / ₁₆ "W—60"W	60 ¹ / ₁₆ "W—66"W	66 ¹ / ₁₆ "W—72"W	72 ¹ / ₁₆ "W—76"W

90° Corner Desks—Extended Height

Wood Veneer

OLELLC	23" or 24"	40"W	40"W—42"W	N.A.	N.A.	\$3378	\$3378	\$3470	\$3562	\$3660
	23" or 24"	46"W	42 ¹ / ₁₆ "W—48"W	N.A.	N.A.	\$3470	\$3470	\$3562	\$3660	\$3761
	23" or 24"	52"W	48 ¹ / ₁₆ "W—52"W	\$3378	\$3470	\$3470	\$3470	\$3761	\$3863	\$3968
	23" or 24"	58"W	52 ¹ / ₁₆ "W—60"W	\$3378	\$3470	\$3470	\$3660	\$3761	\$3863	\$3968
	23" or 24"	64"W	60 ¹ / ₁₆ "W—66"W	\$3470	\$3562	\$3761	\$3761	\$3863	\$4077	\$4077
	23" or 24"	70"W	66 ¹ / ₁₆ "W—72"W	\$3562	\$3660	\$3863	\$3863	\$4077	\$4077	\$4305
	23" or 24"	76"W	72 ¹ / ₁₆ "W—76"W	\$3660	\$3761	\$3968	\$3968	\$4077	\$4305	\$4305

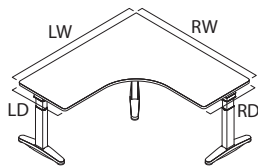
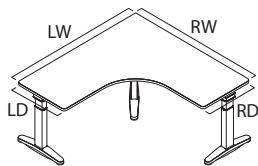

90° Corner Desks — Basic Height

High-Pressure Laminate Desks

OLSLC	23" or 24"	40"W	40"W—42"W	N.A.	N.A.	\$2368	\$2368	\$2443	\$2518	\$2595
	23" or 24"	46"W	42 ¹ / ₁₆ "W—48"W	N.A.	N.A.	\$2443	\$2443	\$2518	\$2595	\$2678
	23" or 24"	52"W	48 ¹ / ₁₆ "W—52"W	\$2368	\$2443	\$2443	\$2443	\$2678	\$2762	\$2848
	23" or 24"	58"W	52 ¹ / ₁₆ "W—60"W	\$2368	\$2443	\$2443	\$2595	\$2678	\$2762	\$2848
	23" or 24"	64"W	60 ¹ / ₁₆ "W—66"W	\$2443	\$2518	\$2678	\$2678	\$2762	\$2938	\$2938
	23" or 24"	70"W	66 ¹ / ₁₆ "W—72"W	\$2518	\$2595	\$2762	\$2762	\$2938	\$2938	\$3123
	23" or 24"	76"W	72 ¹ / ₁₆ "W—76"W	\$2595	\$2678	\$2848	\$2848	\$2938	\$3123	\$3123

Tip: Equal corner widths are parametric to 1/16" from 52"W—76"W.

Tip: 90° desks, 60¹/₁₆"W x 60¹/₁₆"W and wider, are manufactured in two pieces. The worksurface split is located on the left side of an equal corner and on the longest side of an extended corner.

► Specification Information, continued on next page

► Specification Information, continued from previous page

Specification Information											
Style Number	Dimensions				Base Prices						
	D		Modular Right Width	Parametric Right Width	40"W	46"W	52"W	58"W	64"W	70"W	76"W
		Modular Left Width	Parametric Left Width		40"W—42"W	42 ¹ / ₁₆ "W—48"W	48 ¹ / ₁₆ "W—52"W	52 ¹ / ₁₆ "W—60"W	60 ¹ / ₁₆ "W—66"W	66 ¹ / ₁₆ "W—72"W	72 ¹ / ₁₆ "W—76"W

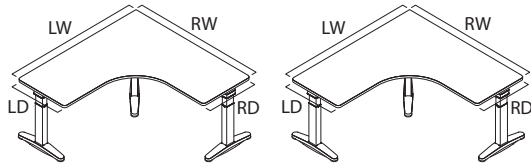

90° Corner Desks — Basic Height

Wood Veneer Desks

OLSLLC	23" or 24"	40"W	40"W—42"W	N.A.	N.A.	\$3235	\$3235	\$3323	\$3410	\$3503
	23" or 24"	46"W	42 ¹ / ₁₆ "W—48"W	N.A.	N.A.	\$3323	\$3323	\$3410	\$3503	\$3599
	23" or 24"	52"W	48 ¹ / ₁₆ "W—52"W	\$3235	\$3323	\$3323	\$3323	\$3599	\$3696	\$3796
	23" or 24"	58"W	52 ¹ / ₁₆ "W—60"W	\$3235	\$3323	\$3323	\$3503	\$3599	\$3696	\$3796
	23" or 24"	64"W	60 ¹ / ₁₆ "W—66"W	\$3323	\$3410	\$3599	\$3599	\$3696	\$3899	\$3899
	23" or 24"	70"W	66 ¹ / ₁₆ "W—72"W	\$3410	\$3503	\$3696	\$3696	\$3899	\$3899	\$4116
	23" or 24"	76"W	72 ¹ / ₁₆ "W—76"W	\$3503	\$3599	\$3796	\$3796	\$3899	\$4116	\$4116

Tip: Equal corner widths are parametric to 1/16" from 52"W—76"W.

Tip: 90° desks, 60¹/₁₆"W x 60¹/₁₆"W and wider, are manufactured in two pieces. The worksurface split is located on the left side of an equal corner and on the longest side of an extended corner.

► Specification Information, continued on next page

Ology Height-Adjustable Corner Desks High-Pressure Laminate or Wood Veneer, continued

SIN 711.2

► Specification Information, continued from previous page

Specification Information

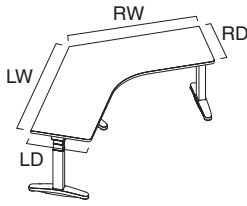

• Style Number	• Dimensions		• Base Prices						
	D	D	Modular Right Width	40"W	46"W	52"W	58"W	64"W	
	• Modular Left Width	• Parametric Left Width	• Parametric Right Width	34"W	36 1/16"W	42 1/16"W	48 1/16"W	54 1/16"W	60 1/16"W
				36"W	42"W	48"W	54"W	60"W	66"W

120° Corner Desks—Extended Height

High-Pressure Laminate Desks

OLELWC	23" or 24"	34"W	34"W–36"W	\$2213	\$2394	\$2545	\$2545	\$2545	\$2627
	23" or 24"	40"W	36 1/16"W–42"W	\$2394	\$2394	\$2545	\$2627	\$2627	\$2710
	23" or 24"	46"W	42 1/16"W–48"W	\$2545	\$2545	\$2545	\$2710	\$2710	\$2794
	23" or 24"	52"W	48 1/16"W–54"W	\$2545	\$2627	\$2710	\$2710	\$2883	\$2883
	23" or 24"	58"W	54 1/16"W–60"W	\$2545	\$2627	\$2710	\$2883	\$2883	\$2974
	23" or 24"	64"W	60 1/16"W–66"W	\$2627	\$2710	\$2794	\$2883	\$2974	\$3066

Wood Veneer Desks

OLELWC	23" or 24"	34"W	34"W–36"W	\$2895	\$3283	\$3455	\$3455	\$3455	\$3549
	23" or 24"	40"W	36 1/16"W–42"W	\$3283	\$3283	\$3455	\$3549	\$3549	\$3646
	23" or 24"	46"W	42 1/16"W–48"W	\$3455	\$3455	\$3455	\$3646	\$3646	\$3744
	23" or 24"	52"W	48 1/16"W–54"W	\$3455	\$3549	\$3646	\$3646	\$3835	\$3835
	23" or 24"	58"W	54 1/16"W–60"W	\$3455	\$3549	\$3646	\$3835	\$3835	\$3938
	23" or 24"	64"W	60 1/16"W–66"W	\$3549	\$3646	\$3744	\$3835	\$3938	\$4044

► Specification Information, continued on next page

► Specification Information, continued from previous page

Specification Information											
Style Number	Dimensions D			Base Prices							
	Modular Left Width	Parametric Left Width		Modular Right Width	Parametric Right Width	34"W	40"W	46"W	52"W	58"W	64"W
						34"W	40"W	46"W	52"W	58"W	64"W
						34"W	36 1/16"W	42 1/16"W	48 1/16"W	54 1/16"W	60 1/16"W
						36"W	42"W	48"W	54"W	60"W	66"W

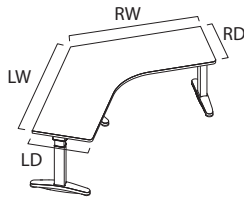

120° Corner Desks — Basic Height

High-Pressure Laminate Desks

OLSLWC	23" or 24"	34"W	34"W-36"W	\$2087	\$2258	\$2400	\$2400	\$2400	\$2478
	23" or 24"	40"W	36 1/16"W-42"W	\$2258	\$2258	\$2400	\$2478	\$2478	\$2556
	23" or 24"	46"W	42 1/16"W-48"W	\$2400	\$2400	\$2400	\$2556	\$2556	\$2635
	23" or 24"	52"W	48 1/16"W-54"W	\$2400	\$2478	\$2556	\$2556	\$2719	\$2719
	23" or 24"	58"W	54 1/16"W-60"W	\$2400	\$2478	\$2556	\$2719	\$2719	\$2804
	23" or 24"	64"W	60 1/16"W-66"W	\$2478	\$2556	\$2635	\$2719	\$2804	\$2892

Wood Veneer Desks

OLSLWC	23" or 24"	34"W	34"W-36"W	\$2769	\$3147	\$3310	\$3310	\$3310	\$3400
	23" or 24"	40"W	36 1/16"W-42"W	\$3147	\$3147	\$3310	\$3400	\$3400	\$3492
	23" or 24"	46"W	42 1/16"W-48"W	\$3310	\$3310	\$3310	\$3492	\$3492	\$3492
	23" or 24"	52"W	48 1/16"W-54"W	\$3310	\$3400	\$3492	\$3492	\$3671	\$3671
	23" or 24"	58"W	54 1/16"W-60"W	\$3310	\$3400	\$3492	\$3671	\$3671	\$3768
	23" or 24"	64"W	60 1/16"W-66"W	\$3400	\$3492	\$3585	\$3671	\$3768	\$3870

Height-Adjustable Worksurfaces

Ology Height-Adjustable Bases

SIN 711.2

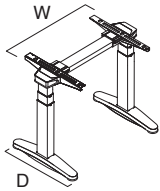

Tip: Any storage higher than 19" will impede lowest height range of worksurface. Do not place storage underneath controller.

Tip: Only single and dual flat panel monitor arm applications are permitted for use with 2-leg height-adjustable desks.

► See Steelcase Worktools Specification Guide.

Tip: Base supports a maximum distributed weight capacity of 314 pounds (2-leg) and 471 pounds (3-leg). When calculating lifting capacity, subtract the weight of the worksurface and understructure.

► See page 220 for understructure weights.

Tip: Antimicrobial can be specified only when specifying up/down controller.

Tip: Attachment hardware is intended for worksurfaces 1" thick only.

Tip: 9" overhang is available on desks 64"W and larger. Overhang on both sides is available on 70"W and 76"W only.

Tip: Overhang is available on rectangular bases only.

⚠ WARNING

Read base only warranty limitations.

► See page 207 for Workstation Design Guidelines and Requirements.

Standard Includes	Required to Specify
<ul style="list-style-type: none"> • Electric height-adjustable sit-to-stand base: paint • Modular width: <ul style="list-style-type: none"> – Rectangular base: 34"–76" – Tapered base: 58"–76" – 90° equal corner base: 52"–76" – 90° extended corner base: 40"–76" – 120° equal corner base: 34"–64" • 1/2" adjustable glides • Power cord: 9' • Attachment hardware 	<ol style="list-style-type: none"> 1 Style number 2 Desk depth 3 Desk width 4 Paint color number for base: <ul style="list-style-type: none"> 4799 Platinum Metallic 7207 Black 7241 Arctic White 7360 Merle 5 Controller (see below under Required Selections) 6 Antimicrobial or non-antimicrobial surface, if up/down controller selected (see below under Required Selections) 7 Options, if selected (see below) <p>► See <i>Surface Materials</i>, page 318.</p>

Required Selections	Price	Required to Specify
Controller <ul style="list-style-type: none"> • Up/down controller • 4 pre-set controller 	No cost +\$112	Specify with <i>up/down controller</i> . Specify with <i>4 pre-set controller</i> .
Antimicrobial Surface <ul style="list-style-type: none"> • Non-antimicrobial surface • Antimicrobial surface 	No cost No cost	Specify with <i>non-antimicrobial surface</i> . Specify with <i>antimicrobial surface</i> .

Options	Price	Required to Specify
Surface Materials <ul style="list-style-type: none"> • Bases • Paint price group 1 • Paint price group 2 for rectangular and tapered bases • Paint price group 2 for corner bases 	No cost +\$ 28 +\$ 42	Specify paint color number. Specify paint color number. Specify paint color number. ► See <i>Surface Materials</i> , page 318.

Desk Type <ul style="list-style-type: none"> • Parametric width desk 	No cost	Specify with <i>parametric desk type</i> .
Overhang <ul style="list-style-type: none"> • Desk overhang on left • Desk overhang on right • Desk overhang left and right 	+\$ 55 +\$ 55 +\$110	Specify with <i>desk overhang left</i> . Specify with <i>desk overhang right</i> . Specify with <i>desk overhang left and right</i> .
Glides <ul style="list-style-type: none"> • 1" adjustable glides 	+\$ 14 per leg	Specify with <i>1" glides</i> .

SIN 711.2

Specification Information

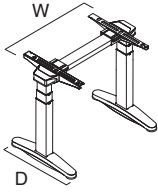

• Style Number	• Dimension D	• Desk Type	• Base Prices							
			34"W	40"W	46"W	52"W	58"W	64"W	70"W	76"W
		Modular	34"W	40"W	46"W	52"W	58"W	64"W	70"W	76"W
		Parametric	34"W	36 ¹ / ₁₆ "W	42 ¹ / ₁₆ "W	48 ¹ / ₁₆ "W	54 ¹ / ₁₆ "W	60 ¹ / ₁₆ "W	66 ¹ / ₁₆ "W	72 ¹ / ₁₆ "W
			36"W	42"W	48"W	54"W	60"W	66"W	72"W	78"W

Rectangular Bases—Extended Height

OLELRQB	23" or 24"	\$1808	\$1808	\$1819	\$1819	\$1833	\$1845	\$1845	\$1845
	29" or 30"	\$1828	\$1828	\$1839	\$1839	\$1850	\$1865	\$1865	\$1865
	35" or 36"	\$1848	\$1848	\$1859	\$1859	\$1867	\$1885	\$1885	\$1885

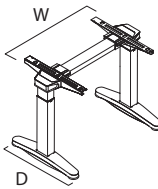

Rectangular Bases — Basic Height

OLSLRQB	23" or 24"	\$1397	\$1443	\$1492	\$1542	\$1591	\$1646	\$1700	\$1740
	29" or 30"	\$1581	\$1633	\$1687	\$1734	\$1744	\$1759	\$1759	\$1759
	35" or 36"	\$1742	\$1742	\$1753	\$1753	\$1761	\$1777	\$1777	\$1777

► Specification Information, continued on next page

Height-Adjustable Worksurfaces

Ology Height-Adjustable Bases, continued

SIN 711.2

► Specification Information, continued from previous page

Specification Information

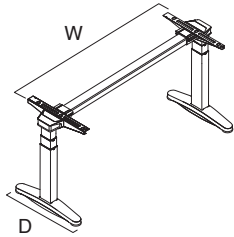

• Style Number	• Dimensions		• Desk Type	• Base Prices			
	LD	RD					
			Modular	58"W	64"W	70"W	76"W
			Parametric	58 ¹ / ₁₆ "W-60"W	60 ¹ / ₁₆ "W-66"W	66 ¹ / ₁₆ "W-72"W	72 ¹ / ₁₆ "W-78"W

Tapered Bases—Extended Height

OLELRTB	23" or 24"	29" or 30"	\$1850	\$1865	\$1865	\$1865
	29" or 30"	23" or 24"	\$1850	\$1865	\$1865	\$1865

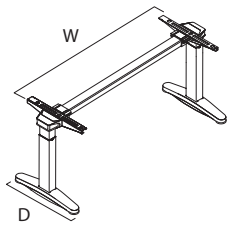

Tapered Bases — Basic Height

OLSLRTB	23" or 24"	29" or 30"	\$1744	\$1759	\$1759	\$1759
	29" or 30"	23" or 24"	\$1744	\$1759	\$1759	\$1759

► Specification Information, continued on next page

► Specification Information, continued from previous page

Specification Information

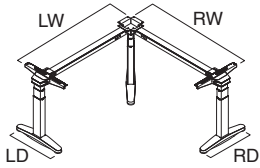

Style Number	Dimensions D	Modular		Parametric		Base Prices						
		Left Width	Right Width	Left Width	Right Width	40"W	46"W	52"W	58"W	64"W	70"W	76"W
						40"W	46"W	52"W	58"W	64"W	70"W	76"W
						40"W	42 ¹ / ₁₆ "W	48 ¹ / ₁₆ "W	52 ¹ / ₁₆ "W	60 ¹ / ₁₆ "W	66 ¹ / ₁₆ "W	72 ¹ / ₁₆ "W
						42"W	48"W	52"W	60"W	66"W	72"W	76"W

90° Corner Bases—Extended Height

OLELLCB	23" or 24"	40"W	40"W—42"W	N.A.	N.A.	\$2374	\$2374	\$2389	\$2389	\$2389
	23" or 24"	46"W	42 ¹ / ₁₆ "W—48"W	N.A.	N.A.	\$2389	\$2389	\$2393	\$2393	\$2393
	23" or 24"	52"W	48 ¹ / ₁₆ "W—52"W	\$2374	\$2389	\$2389	\$2389	\$2398	\$2398	\$2398
	23" or 24"	58"W	52 ¹ / ₁₆ "W—60"W	\$2374	\$2389	\$2389	\$2393	\$2398	\$2398	\$2398
	23" or 24"	64"W	60 ¹ / ₁₆ "W—66"W	\$2389	\$2393	\$2398	\$2398	\$2408	\$2480	\$2480
	23" or 24"	70"W	66 ¹ / ₁₆ "W—72"W	\$2389	\$2393	\$2398	\$2398	\$2480	\$2676	\$2676
	23" or 24"	76"W	72 ¹ / ₁₆ "W—78"W	\$2389	\$2393	\$2398	\$2398	\$2480	\$2676	\$2676

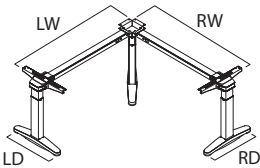

90° Corner Bases — Basic Height

OLSLCB	23" or 24"	40"W	40"W—42"W	N.A.	N.A.	\$2238	\$2238	\$2253	\$2253	\$2253
	23" or 24"	46"W	42 ¹ / ₁₆ "W—48"W	N.A.	N.A.	\$2253	\$2257	\$2257	\$2257	\$2257
	23" or 24"	52"W	48 ¹ / ₁₆ "W—52"W	\$2238	\$2253	\$2253	\$2253	\$2261	\$2261	\$2261
	23" or 24"	58"W	52 ¹ / ₁₆ "W—60"W	\$2238	\$2253	\$2253	\$2253	\$2261	\$2261	\$2261
	23" or 24"	64"W	60 ¹ / ₁₆ "W—66"W	\$2253	\$2257	\$2261	\$2261	\$2271	\$2339	\$2339
	23" or 24"	70"W	66 ¹ / ₁₆ "W—72"W	\$2253	\$2257	\$2261	\$2261	\$2339	\$2524	\$2524
	23" or 24"	76"W	72 ¹ / ₁₆ "W—76"W	\$2253	\$2257	\$2261	\$2261	\$2339	\$2524	\$2524

► Specification Information, continued on next page

Height-Adjustable Worksurfaces

Ology Height-Adjustable Bases, continued

SIN 711.2

► Specification Information, continued from previous page

Specification Information

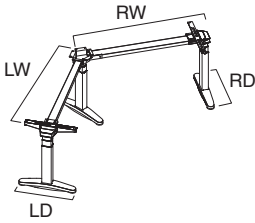

• Style Number	• Dimensions D	• Dimensions		• Base Prices						
		Modular Left Width	Parametric Left Width	Modular Right Width	34"W	40"W	46"W	52"W	58"W	64"W
				Parametric Right Width	34"W	36 ¹ / ₁₆ "W	42 ¹ / ₁₆ "W	48 ¹ / ₁₆ "W	54 ¹ / ₁₆ "W	60 ¹ / ₁₆ "W
					36"W	42"W	48"W	54"W	60"W	66"W

120° Corner Bases—Extended Height

OLELWCB	23" or 24"	34"W	34"W—36"W	\$2357	\$2357	\$2357	\$2357	\$2369	\$2374
		40"W	36 ¹ / ₁₆ "W—42"W	\$2357	\$2357	\$2357	\$2374	\$2374	\$2381
		46"W	42 ¹ / ₁₆ "W—48"W	\$2357	\$2357	\$2381	\$2381	\$2381	\$2386
		52"W	48 ¹ / ₁₆ "W—54"W	\$2357	\$2374	\$2381	\$2381	\$2381	\$2386
		58"W	54 ¹ / ₁₆ "W—60"W	\$2369	\$2374	\$2381	\$2381	\$2381	\$2398
		64"W	60 ¹ / ₁₆ "W—66"W	\$2374	\$2381	\$2386	\$2386	\$2398	\$2403

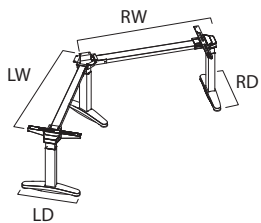

120° Corner Bases — Basic Height

OLSLWCB	23" or 24"	34"W	34"W—36"W	\$2223	\$2223	\$2223	\$2223	\$2234	\$2238
		40"W	36 ¹ / ₁₆ "W—42"W	\$2223	\$2223	\$2223	\$2238	\$2238	\$2246
		46"W	42 ¹ / ₁₆ "W—48"W	\$2223	\$2223	\$2246	\$2246	\$2246	\$2250
		52"W	48 ¹ / ₁₆ "W—54"W	\$2223	\$2238	\$2246	\$2246	\$2246	\$2250
		58"W	54 ¹ / ₁₆ "W—60"W	\$2234	\$2238	\$2246	\$2246	\$2246	\$2261
		64"W	60 ¹ / ₁₆ "W—66"W	\$2238	\$2246	\$2250	\$2250	\$2261	\$2266

Ology Modesty Panels

High-Pressure Laminate or Wood Veneer

SIN 711.2

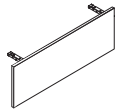

Standard Includes	Required to Specify
<ul style="list-style-type: none"> Panel: High-Pressure Laminate or wood veneer Modular widths: 34"—76" Attachment hardware 	<ol style="list-style-type: none"> Style number Panel type (see below under Required Selections) Panel width High-Pressure Laminate or wood color for panel Options, if selected (see below) <p>▶ See <i>Surface Materials</i>, page 318.</p>

Tip: Modesty panel can match the width of the desk or be shorter than desk.

Tip: Modesty panels cannot be used on desks with integrated rail. To use with the integrated rail, the modesty panel must be undersized by a minimum of 12" (rectangular and tapered) or 7" (90°) and inset from the edge of the worksurface.

Tip: Modular modesty panels are undersized 2½" to account for desks with radius corners.

Tip: Modesty panels are defaulted in the horizontal grain direction for both laminate and wood veneer. Optional vertical grain direction can be specified, however, laminate specification is only allowed up to 60" wide.

Panel Type	Required Selections	Price	Required to Specify
	<ul style="list-style-type: none"> Modular width panel Parametric width panel 	No cost No cost	Specify with <i>modular panel type</i> . Specify with <i>parametric panel type</i> .

Surface Materials	Options	Price	Required to Specify
	High-Pressure Laminate		
	<ul style="list-style-type: none"> Open Line laminate 	+\$ 67 plus cost of laminate	▶ See <i>Surface Materials Reference Manual</i> .
	Wood veneer		
	<ul style="list-style-type: none"> Premium wood 2 Premium wood 3 Customiz stain 	+\$ 67 +\$236 No cost	Specify Premium wood 2 finish number. Specify Premium wood 3 finish number. Specify with <i>customiz stain</i> . ▶ See <i>Surface Materials Reference Manual</i> . Specify full-fill finish number.
	<ul style="list-style-type: none"> Full-fill finish 	+\$ 67	
	Grain direction		
	<ul style="list-style-type: none"> Horizontal grain direction Vertical grain direction 	No cost No cost	Specify with <i>horizontal grain direction</i> . Specify with <i>vertical grain direction</i> .

Height-Adjustable Worksurfaces

Specification Information									
Style Number	Panel Type	Base Prices							
		34"W	40"W	46"W	52"W	58"W	64"W	70"W	76"W
	Modular								
	Parametric	34"W	36½"W	42½"W	48½"W	54½"W	60½"W	66½"W	72½"W
		36"W	42"W	48"W	54"W	60"W	66"W	72"W	78"W
	Weight	15.2 lb	17.6 lb	20.0 lb	22.4 lb	24.8 lb	27.3 lb	29.7 lb	32.1 lb

High-Pressure Laminate

OLMP	34"	40"	46"	52"	58"	64"	70"	76"
	\$189	\$190	\$193	\$196	\$200	\$207	\$210	\$217

Wood Veneer

OLMP	34"	40"	46"	52"	58"	64"	70"	76"
	\$235	\$240	\$245	\$248	\$252	\$260	\$265	\$273

Fixed Personal/Modesty Screens

SIN 711.2

Tip: When using COM fabric, it is recommended that non-patterned fabric be used to provide a consistent visual between adjacent screens, and from one side to the other.

Tip: 19 1/2"H and 24"H are for personal only.

Standard Includes	Required to Specify
-------------------	---------------------

- Personal/modesty screens: fabric price group 1
- Brackets: 4799 Platinum

- 1 Style number
 - 2 Fabric color number for screen
 - 3 Options, if selected (see below)
- ▶ See *Surface Materials*, page 318.

Options		Price			Required to Specify
---------	--	-------	--	--	---------------------

Surface Materials	Fabric	12"H	19 1/2"H	24"H	Required to Specify
	• Fabric price group 1	No cost	No cost	No cost	Specify fabric color number.
	• Fabric price group 2	+\$24	+\$ 33	+\$ 39	Specify fabric color number.
	• Fabric price group 3	+\$64	+\$ 87	+\$111	Specify fabric color number.
	• Fabric price group 4	+\$83	+\$111	+\$136	Specify fabric color number.
	• Customer's Own Material (COM)	+\$16	+\$ 16	+\$ 16	▶ See <i>Surface Materials Reference Manual</i> .

Specification Information

Width	Weight	Style Number	Base Price
-------	--------	--------------	------------

12"H Screens

30"	3.4 lb	CQSF3012	\$162
36"	3.9 lb	CQSF3612	\$189
42"	4.3 lb	CQSF4212	\$214
48"	4.7 lb	CQSF4812	\$241
•	•	•	•

19 1/2"H Screens

30"	4.2 lb	CQSF3019	\$250
36"	4.7 lb	CQSF3619	\$277
42"	5.5 lb	CQSF4219	\$303
48"	6.5 lb	CQSF4819	\$329
•	•	•	•

24"H Screens

30"	4.9 lb	CQSF3024	\$337
36"	5.5 lb	CQSF3624	\$365
42"	6.1 lb	CQSF4224	\$390
48"	7.4 lb	CQSF4824	\$417
•	•	•	•

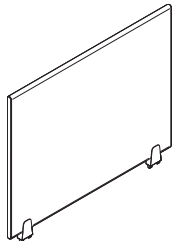
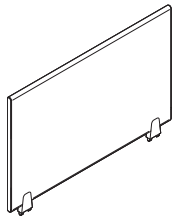
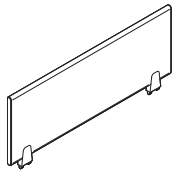

Tip: 19 1/2"H and 24"H screens are not intended for use in the modesty position.

Ology Cable and Power Management

SIN 711.2

Cable Riser

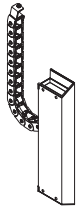

Tip: Cable risers are compatible with Ology desks only.

Standard Includes	Required to Specify
-------------------	---------------------

- Cable riser: 7360 Merle paint
- Attachment hardware

Style number

Specification Information		
Style Number	Weight	Price

OLCR	1.0 lb	\$70
------	--------	------

Cable Basket

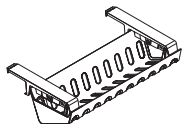

Tip: Cable baskets are compatible with rectangular, tapered, or 90° corner desks 46¹/₆"W or larger and 120° corner desks 40¹/₆"W or larger.

Standard Includes	Required to Specify
-------------------	---------------------

- Cable basket: 6527 Merle plastic

Style number

Specification Information		
Style Number	Weight	Price

OLCB	1.0 lb	\$55
------	--------	------

Cable Brackets

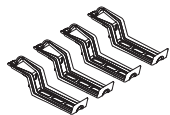

Standard Includes	Required to Specify
-------------------	---------------------

- Cable brackets, quantity of four: 6527 Merle plastic

Style number

Specification Information		
Style Number	Weight	Price

OLCBK4	0.5 lb	\$33
--------	--------	------

Height-Adjustable Worksurfaces

Universal Steel One-High Open Laterals

for Ology Application

SIN 711.2

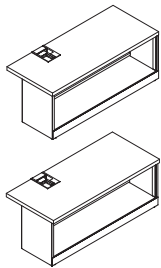

Drawings show right-hand application, left hand is also available.

Tip: Right-hand or left-hand application is determined by which leg of the Ology desk is located inside the storage.

Standard Includes	Required to Specify
<ul style="list-style-type: none"> •Lateral case: paint price group 1 •1³/₁₆"H top: laminate, if selected - Edge: plastic •1³/₁₆"H top: wood, if selected •Four adjustable leveling glides •Grommet •Wire manager •Ganging hardware 	<ol style="list-style-type: none"> 1 Style number 2 Paint color number for lateral case 3 Width (see below under Required Selections) 4 Laminate color number for top, if laminate top selected 5 Plastic color number for edge, if laminate top selected 6 Wood color number for top, if wood top selected 7 Front style (see below under Required Selections) 8 Application (see below under Required Selections) 9 Options, if selected (see below) <p>▶ See <i>Surface Materials</i>, page 318.</p>

Required Selections	Price	Required to Specify
Width <ul style="list-style-type: none"> • 30"W • 36"W • 42"W 	Prices at right Prices at right Prices at right	Specify with 30" width. Specify with 36" width. Specify with 42" width.
Front Style <ul style="list-style-type: none"> • Flush steel front • Proud steel front 	Prices at right Prices at right	Specify with flush steel front. Specify with proud steel front.
Application <ul style="list-style-type: none"> • Right hand • Left hand 	No cost No cost	Specify with right-hand application. Specify with left-hand application.

Options	Price	Required to Specify
Surface Materials <ul style="list-style-type: none"> • Paint price group 1 • Paint price group 2 • Paint price group 3 	No cost +\$ 73 +\$125	Specify paint color number. Specify paint color number. Specify paint color number.
Tops <p>No top</p> <ul style="list-style-type: none"> • For use beneath a common top 	-\$ 94	Specify with no top.
<p>Laminate top</p> <ul style="list-style-type: none"> • Open Line laminate 	+\$ 67 plus cost of laminate	▶ See <i>Surface Materials Reference Manual</i> .
<p>Wood veneer top</p> <ul style="list-style-type: none"> • Wood veneer top • Premium wood 2 • Premium wood 3 • Customiz stain 	+\$394 +\$ 27 +\$ 92 No cost	Specify with wood veneer top and indicate wood finish number. Specify with wood veneer top and indicate Premium wood 2 finish number. Specify with wood veneer top and indicate Premium wood 3 finish number. Specify with customiz stain.
Related Products <ul style="list-style-type: none"> • Universal common tops • Universal steel shrouds • Universal steel filler 		▶ Page 260 ▶ Page 262 ▶ Page 263

Specification Information

Style Number	Dimensions			Base Prices		
	D	W	H	Flush Steel Front	Proud Steel Front	
RSCHAD	18"	18 ⁷ / ₈ "	30"	16"	\$ 930	\$ 984
	18"	18 ⁷ / ₈ "	36"	16"	\$1026	\$1091
	18"	18 ⁷ / ₈ "	42"	16"	\$1120	\$1193

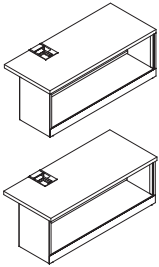

Height-Adjustable Worksurfaces

Universal Common Tops

for Ology Application

SIN 711.2

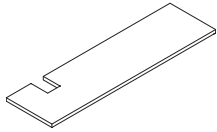

Drawing shows right-hand application, left hand is also available.

Tip: Right-hand or left-hand application is determined by which leg of the Ology desk is located inside the storage.

Premium Wood Pricing:
For Premium wood 2 or Premium wood 3 pricing, please refer to the electronic catalog or SmartTools.

Standard Includes	Required to Specify
<ul style="list-style-type: none"> • 1³/₁₆"H top: laminate, if selected – Edge: plastic • 1³/₁₆"H top: wood, if selected 	<ol style="list-style-type: none"> 1 Style number 2 Width (see below under Required Selections) 4 Laminate color number for top, if laminate top selected 5 Plastic color number for edge, if laminate top selected 6 Wood color number on top, if wood top selected 7 Front style (see below under Required Selections) 8 Application (see below under Required Selections) 9 Options, if selected (see below) <p>▶ See <i>Surface Materials</i>, page 318.</p>

Required Selections	Price	Required to Specify
Width <ul style="list-style-type: none"> • 60"W • 66"W • 72"W • 78"W • 84"W • 90"W • 96"W • 108"W 	<ul style="list-style-type: none"> Prices at right Prices at right Prices at right Prices at right Prices at right Prices at right Prices at right Prices at right 	<ul style="list-style-type: none"> Specify with 60" width. Specify with 66" width. Specify with 72" width. Specify with 78" width. Specify with 84" width. Specify with 90" width. Specify with 96" width. Specify with 108" width.
Front Style <ul style="list-style-type: none"> • Flush front • Proud front 	<ul style="list-style-type: none"> No cost No cost 	<ul style="list-style-type: none"> Specify with flush front. Specify with proud front.
Application <ul style="list-style-type: none"> • Right hand • Left hand 	<ul style="list-style-type: none"> No cost No cost 	<ul style="list-style-type: none"> Specify with right-hand application. Specify with left-hand application.

Options	Price	Required to Specify
Surface Materials <ul style="list-style-type: none"> • Laminate top • Open Line laminate 	<ul style="list-style-type: none"> +\$67 plus cost of laminate 	<ul style="list-style-type: none"> ▶ See <i>Surface Materials Reference Manual</i>.
<ul style="list-style-type: none"> • Wood veneer top • Premium wood 2 • Premium wood 3 • Customiz stain • Full-fill finish 	<ul style="list-style-type: none"> See information at left See information at left No cost Prices at right 	<ul style="list-style-type: none"> Specify with wood veneer top and indicate Premium wood 2 finish number. Specify with wood veneer top and indicate Premium wood 3 finish number. Specify with customiz stain. ▶ See <i>Surface Materials Reference Manual</i>. Specify with full-fill finish and select wood finish number. ▶ See <i>Surface Materials Reference Manual</i>.
Related Products <ul style="list-style-type: none"> • Universal Steel One-High open lateral files • Universal shrouds • Universal filler 		<ul style="list-style-type: none"> ▶ Page 258 ▶ Page 262 ▶ Page 263

SIN 711.2

Specification Information

Style Number	Dimensions		W	Base Prices		Options
	Flush Front	Proud Front		Laminate	Veneer	(Add \$ to Base Price)
						Full-Fill Finish
RATCTHAD	18"	18 ⁷ / ₈ "	60"	\$295	\$ 662	+\$46
	18"	18 ⁷ / ₈ "	66"	\$340	\$ 698	+\$46
	18"	18 ⁷ / ₈ "	72"	\$382	\$ 733	+\$46
	18"	18 ⁷ / ₈ "	78"	\$486	\$ 876	+\$46
	18"	18 ⁷ / ₈ "	84"	\$549	\$ 996	+\$67
	18"	18 ⁷ / ₈ "	90"	\$612	\$1054	+\$67
	18"	18 ⁷ / ₈ "	96"	\$673	\$1161	+\$67
	18"	18 ⁷ / ₈ "	108"	\$810	N.A.	N.A.

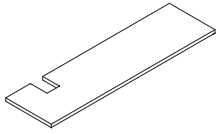

Tip: Can not order veneer on 108"W Universal common top.

Universal Shrouds

for Ology Application

SIN 711.2

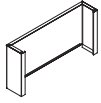

Tip: Universal shroud width must match width of the universal steel One-High open lateral for Ology application.

Standard Includes	Required to Specify
<ul style="list-style-type: none"> • Shroud: paint price group 1 • Attachment hardware 	<ol style="list-style-type: none"> 1 Style number 2 Width (see below under Required Selections) 3 Paint color number for shroud 4 Options, if selected (see below) <p>▶ See <i>Surface Materials</i>, page 318.</p>

Required Selections	Price	Required to Specify
Width	<ul style="list-style-type: none"> • 30"W No cost • 36"W No cost • 42"W No cost 	<ul style="list-style-type: none"> Specify with 30" width. Specify with 36" width. Specify with 42" width.

Options	Price	Required to Specify
Surface Materials	<ul style="list-style-type: none"> • Paint price group 1 No cost • Paint price group 2 +\$29 • Paint price group 3 +\$48 	<ul style="list-style-type: none"> Specify paint color number. Specify paint color number. Specify paint color number.

Related Products	<ul style="list-style-type: none"> • Universal Steel One-High open lateral files 	▶ Page 258
-------------------------	---	------------

Specification Information

• Dimensions		• Style	• Base
D	H	Number	Price
6"	16"	RPXSHAD	\$70
:	:	:	:

Universal Filler

for Ology Application

SIN 711.2



Standard Includes	Required to Specify
-------------------	---------------------

- Filler: paint
- Attachment hardware

- 1 Style number
- 2 Paint color number for filler
- ▶ See *Surface Materials*, page 318.

Required Products	
-------------------	--

Related Products

- Universal Steel One-High open lateral files
- ▶ Page 258

Specification Information			
---------------------------	--	--	--

• Dimensions		• Style	• Price
D	H	Number	
6"	16"	RPXFHAD	\$50

Series 3 Height-Adjustable Worksurfaces

High-Pressure Laminate or Wood Veneer

SIN 711.2

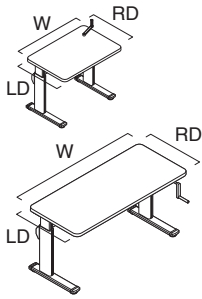

Tip: Series 3 height-adjustable base requires assembly and attachment to work surface.

Tip: Work surface ships with pre-drilled holes for mounting bases.

Tip: Crank handle location is not selectable. Crank handle is front or top mounted.

▶ See *Worktools Compatibility Charts*, page 212.

Tip: Maximum distributed weight capacity is 205 pounds per table. When calculating lifting capacity, subtract the weight of the work surface.
▶ See page 228 for work surface weights.

Tip: Any storage higher than 20¹/₂"H will impede the lowest height range of work surface. Do not place storage underneath handle.

Tip: Work surface overhang for pedestal storage varies by shape and size.

Premium Wood Pricing:

For Premium wood 2 or Premium wood 3 pricing, please refer to the electronic catalog or *SmartTools*.

Tip: For help determining privacy/modesty screen, cableway, SOTO rail, and SlatRail width compatibility.

▶ See *Worktools Compatibility Charts*, page 212.

Tip: For all edge profiles, add a suffix to the style number. (For example, A3RQ342323 becomes A3RQ342323V for wood with square edge profile.)

Standard Includes	Required to Specify
<ul style="list-style-type: none"> High-Pressure Laminate or wood veneer High-Pressure Laminate work surface edges: <ul style="list-style-type: none"> –Universal Tables: plastic 3 mm edge profile on all sides –Universal Systems or knife edge work surfaces: plastic 3 mm edge profile on front edge with matching 1 mm plastic on sides and back –Urethane profile work surfaces: urethane on front edge with matching plastic 3 mm edge profile on sides and back Wood work surface edges: <ul style="list-style-type: none"> –Wood veneer square 3 mm radius on front edge with 1 mm matching veneer flat profile on side and back edges Work surface corners: <ul style="list-style-type: none"> –Radius corners on Universal Tables, if selected –90° corners on Universal Systems, knife edge, urethane, and wood work surface profiles, if selected Height-adjustable base with crank handle: paint Telescoping stretchers Dual-arm spring assist mechanism for bi-level work surfaces, if selected 5/8" adjustable glides Attachment hardware 	<ol style="list-style-type: none"> Style number with appropriate edge profile suffix: <ul style="list-style-type: none"> U Universal Tables Y Universal Systems K Knife edge S Urethane profile V Wood veneer High-Pressure Laminate or wood color number for work surface Plastic or urethane color number for profile edge on laminate work surface, if selected Paint color for base: <ul style="list-style-type: none"> 0835 Black 4799 Platinum Options, if selected (see below) <ul style="list-style-type: none"> ▶ See <i>Surface Materials</i>, page 318.

Options	Price	Required to Specify
Surface Materials	High-Pressure Laminate work surfaces	
<ul style="list-style-type: none"> Open Line laminate 	+\$67 plus cost of laminate	▶ See <i>Surface Materials Reference Manual</i> .
	Wood veneer work surfaces	
<ul style="list-style-type: none"> Premium wood 2 Premium wood 3 Customiz stain Full-fill finish 	<ul style="list-style-type: none"> See information at left See information at left No cost Prices at right 	<ul style="list-style-type: none"> Specify Premium wood 2 finish number. Specify Premium wood 3 finish number. Specify <i>with Customiz stain</i>. ▶ See <i>Surface Materials Reference Manual</i>. Specify full-fill finish number.
Glides	<ul style="list-style-type: none"> 1" adjustable glides 	+\$28 Specify <i>with 1" glides</i> .
Related Products	<ul style="list-style-type: none"> Slatwall, SlatRail, and freestanding worktools SOTO rail/shelves and worktools Flat panel arms Privacy/modesty screens and cableways Cable and power management 	<ul style="list-style-type: none"> ▶ Page 33 ▶ Page 45 ▶ Page 138 ▶ Page 292 ▶ Page 295

Specification Information

Tip: For all edge profiles, add a suffix to the style number. (For example, A3RQ342323 becomes A3RQ342323V for wood with square edge profile.)

Tip: Only single and dual flat panel monitor arm applications are permitted for use with 2-leg height-adjustable tables.

Base Prices

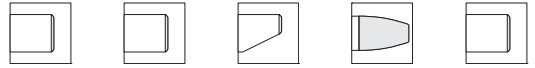

Dimensions W LD RD	Style Number	Universal Tables	Universal Systems	Knife Edge	Urethane Profile	Wood Veneer	Option (Add \$ to Base Price)	
							Suffix U	Suffix Y

Rectangular Worksurfaces

23"D

34"	23"	23"	A3RQ342323	\$1198	\$1141	\$1314	\$1545	\$1662	+\$27
40"	23"	23"	A3RQ402323	\$1235	\$1176	\$1355	\$1589	\$1706	+\$46
46"	23"	23"	A3RQ462323	\$1274	\$1214	\$1392	\$1631	\$1751	+\$46
52"	23"	23"	A3RQ522323	\$1311	\$1250	\$1431	\$1675	\$1797	+\$46
58"	23"	23"	A3RQ582323	\$1353	\$1290	\$1474	\$1721	\$1844	+\$46
64"	23"	23"	A3RQ642323	\$1392	\$1330	\$1517	\$1767	\$1893	+\$67
70"	23"	23"	A3RQ702323	\$1432	\$1369	\$1561	\$1814	\$1941	+\$67
76"	23"	23"	A3RQ762323	\$1477	\$1414	\$1606	\$1866	\$1991	+\$67

29"D

34"	29"	29"	A3RQ342929	\$1401	\$1340	\$1523	\$1762	\$1882	+\$46
40"	29"	29"	A3RQ402929	\$1442	\$1381	\$1566	\$1810	\$1932	+\$46
46"	29"	29"	A3RQ462929	\$1487	\$1424	\$1611	\$1858	\$1983	+\$46
52"	29"	29"	A3RQ522929	\$1532	\$1469	\$1658	\$1910	\$2036	+\$67
58"	29"	29"	A3RQ582929	\$1578	\$1513	\$1706	\$1962	\$2090	+\$67
64"	29"	29"	A3RQ642929	\$1626	\$1561	\$1755	\$2016	\$2145	+\$67
70"	29"	29"	A3RQ702929	\$1675	\$1609	\$1807	\$2070	\$2201	+\$67
76"	29"	29"	A3RQ762929	\$1727	\$1659	\$1858	\$2127	\$2261	+\$67

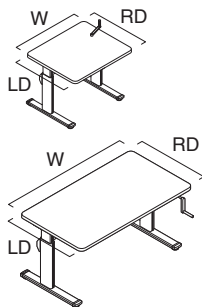
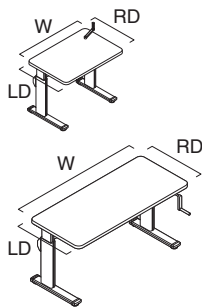

Tip: 34"W and 40"W rectangular worksurfaces have a top mount handle located on right-hand side of worksurface. 46"W to 70"W have a front mount handle.

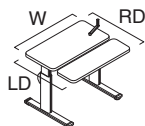

Tip: All bi-level worksurfaces have a top mount handle located on right-hand side of worksurface.

Rectangular Bi-Level Worksurfaces

34"	29"	29"	A3RD342929	\$2309	\$2232	\$2466	\$2779	\$2933	+\$46
40"	29"	29"	A3RD402929	\$2353	\$2274	\$2510	\$2826	\$2985	+\$46
46"	29"	29"	A3RD462929	\$2396	\$2316	\$2557	\$2877	\$3036	+\$46

► **Specification Information, continued on next page**

Height-Adjustable Worksurfaces

Series 3 Height-Adjustable Worksurfaces High-Pressure Laminate or Wood Veneer, continued

SIN 711.2

► Specification Information, continued from previous page

Tip: For all edge profiles, add a suffix to the style number. (For example, A3RQ342323 becomes A3RQ342323V for wood with square edge profile.)

Tip: Taper-flat worksurfaces do not allow for worksurface overhang.

Tip: Taper-flat worksurfaces utilize a 29"D base causing the foot to extend past the worksurface on the 23"D side.

Tip: Only single and dual flat panel monitor arm applications are permitted for use with 2-leg height-adjustable tables.

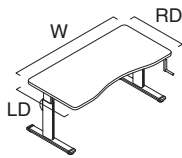
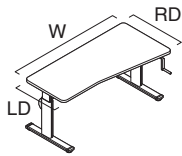
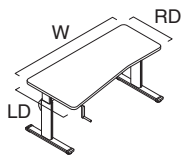

Tip: Concave worksurfaces do not allow for worksurface overhang.

Tip: Center of concave work surface is 25 1/2"D.

Specification Information

Dimensions W LD RD	Style Number	Base Prices					Option (Add \$ to Base Price)
		Universal Tables	Universal Systems	Knife Edge	Urethane Profile	Wood Veneer	
		Suffix U	Suffix Y	Suffix K	Suffix S	Suffix V	Full-Fill Finish

Taper-Flat Worksurfaces

Left-Hand

58"	29"	23"	A3RT582923	\$1578	\$1513	\$1706	\$1962	\$2090	+\$67
64"	29"	23"	A3RT642923	\$1626	\$1561	\$1755	\$2016	\$2145	+\$67
70"	29"	23"	A3RT702923	\$1675	\$1609	\$1807	\$2070	\$2201	+\$67
76"	29"	23"	A3RT762923	\$1727	\$1659	\$1858	\$2127	\$2261	+\$67

Right-Hand

58"	23"	29"	A3RT582329	\$1578	\$1513	\$1706	\$1962	\$2090	+\$67
64"	23"	29"	A3RT642329	\$1626	\$1561	\$1755	\$2016	\$2145	+\$67
70"	23"	29"	A3RT702329	\$1675	\$1609	\$1807	\$2070	\$2201	+\$67
76"	23"	29"	A3RT762329	\$1727	\$1659	\$1858	\$2127	\$2261	+\$67

Concave Worksurfaces

58"	29"	29"	A3CQ582929	\$1578	\$1513	\$1706	\$1962	\$2090	+\$67
64"	29"	29"	A3CQ642929	\$1626	\$1561	\$1755	\$2016	\$2145	+\$67
70"	29"	29"	A3CQ702929	\$1675	\$1609	\$1807	\$2070	\$2201	+\$67
76"	29"	29"	A3CQ762929	\$1727	\$1659	\$1858	\$2127	\$2261	+\$67

► Specification Information, continued on next page

► Specification Information, continued from previous page

Specification Information

Tip: For all edge profiles, add a suffix to the style number. (For example, A3RQ342323 becomes A3RQ342323V for wood with square edge profile.)

Tip: Base only for 90° corner worksurfaces is not available.

Tip: Only single and dual flat panel monitor arm applications are permitted for use with 2-leg height-adjustable tables.

Base Prices

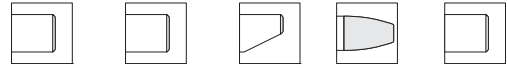

Dimensions LW LD RW RD	Style Number	Universal Tables	Universal Systems	Knife Edge	Urethane Profile	Wood Veneer	Option
							(Add \$ to Base Price)
							Full-Fill Finish
		Suffix U	Suffix Y	Suffix K	Suffix S	Suffix V	

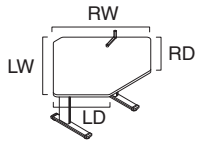

Tip: 40"W x 40"W and 46"W x 46"W 90° worksurfaces have a top mount handle located on right-hand side of worksurface.

90° Corner Worksurfaces

40"	23"	40"	23"	A3LQ40234023	\$1463	\$1373	\$1640	\$1993	\$2171	+\$ 46
46"	23"	46"	23"	A3LQ46234623	\$1507	\$1418	\$1686	\$2046	\$2227	+\$ 67

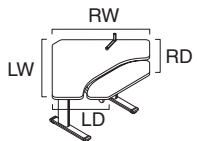

90° Corner Bi-Level Worksurfaces

40"	23"	40"	23"	A3LD40234023	\$2258	\$2151	\$2476	\$2908	\$3126	+\$ 46
46"	23"	46"	23"	A3LD46234623	\$2303	\$2192	\$2522	\$2961	\$3181	+\$ 67

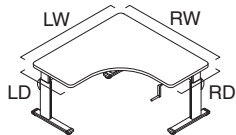

90° Equal Worksurfaces

23"D										
52"	23"	52"	23"	A3LQ52235223	\$2137	\$2040	\$2332	\$2724	\$2919	+\$ 67
58"	23"	58"	23"	A3LQ58235823	\$2270	\$2168	\$2471	\$2873	\$3074	+\$ 67
64"	23"	64"	23"	A3LQ64236423	\$2409	\$2305	\$2617	\$3032	\$3240	+\$ 94
70"	23"	70"	23"	A3LQ70237023	\$2557	\$2449	\$2771	\$3200	\$3412	+\$ 94
76"	23"	76"	23"	A3LQ76237623	\$2713	\$2604	\$2933	\$3376	\$3596	+\$121

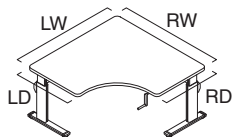

29"D										
52"	29"	52"	29"	A3LQ52295229	\$2270	\$2168	\$2471	\$2873	\$3074	+\$ 67
58"	29"	58"	29"	A3LQ58295829	\$2409	\$2305	\$2617	\$3032	\$3240	+\$ 94
64"	29"	64"	29"	A3LQ64296429	\$2557	\$2449	\$2771	\$3200	\$3412	+\$ s94

Tip: 64"W, 70"W, and 76"W 90° equal worksurfaces ship in two pieces.

► Specification Information, continued on next page

Height-Adjustable Worksurfaces

Series 3 Height-Adjustable Worksurfaces High-Pressure Laminate or Wood Veneer, continued

SIN 711.2

Tip: For all edge profiles, add a suffix to the style number. (For example, A3RQ342323 becomes A3RQ342323V for wood with square edge profile.)

► Specification Information, continued from previous page

Specification Information										
Dimensions		Style	Base Prices					Option		
LW	LD	RW	RD	Number	Universal Tables	Universal Systems	Knife Edge	Urethane Profile	Wood Veneer	(Add \$ to Base Price)
					Suffix U	Suffix Y	Suffix K	Suffix S	Suffix V	Full-Fill Finish

90° Extended Worksurfaces

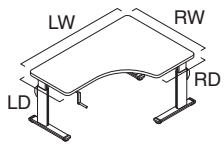

23" D, Left-Hand

58"	23"	40"	23"	A3LE58234023	\$2075	\$1978	\$2269	\$2653	\$2845	+\$67
58"	23"	46"	23"	A3LE58234623	\$2137	\$2040	\$2332	\$2724	\$2919	+\$67
64"	23"	40"	23"	A3LE64234023	\$2137	\$2040	\$2332	\$2724	\$2919	+\$67
64"	23"	46"	23"	A3LE64234623	\$2201	\$2102	\$2400	\$2796	\$2995	+\$67
64"	23"	58"	23"	A3LE64235823	\$2338	\$2235	\$2542	\$2952	\$3157	+\$67
70"	23"	40"	23"	A3LE70234023	\$2201	\$2102	\$2400	\$2796	\$2995	+\$67
70"	23"	46"	23"	A3LE70234623	\$2270	\$2168	\$2471	\$2873	\$3074	+\$67
70"	23"	58"	23"	A3LE70235823	\$2409	\$2305	\$2617	\$3032	\$3240	+\$94
76"	23"	40"	23"	A3LE76234023	\$2270	\$2168	\$2471	\$2873	\$3074	+\$67
76"	23"	46"	23"	A3LE76234623	\$2338	\$2235	\$2542	\$2952	\$3157	+\$67
76"	23"	58"	23"	A3LE76235823	\$2481	\$2375	\$2692	\$3114	\$3324	+\$94

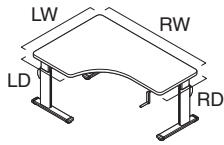

23" D, Right-Hand

40"	23"	58"	23"	A3LE40235823	\$2075	\$1978	\$2269	\$2653	\$2845	+\$67
40"	23"	64"	23"	A3LE40236423	\$2137	\$2040	\$2332	\$2724	\$2919	+\$67
40"	23"	70"	23"	A3LE40237023	\$2201	\$2102	\$2400	\$2796	\$2995	+\$67
40"	23"	76"	23"	A3LE40237623	\$2270	\$2168	\$2471	\$2873	\$3074	+\$67
46"	23"	58"	23"	A3LE46235823	\$2137	\$2040	\$2332	\$2724	\$2919	+\$67
46"	23"	64"	23"	A3LE46236423	\$2201	\$2102	\$2400	\$2796	\$2995	+\$67
46"	23"	70"	23"	A3LE46237023	\$2270	\$2168	\$2471	\$2873	\$3074	+\$67
46"	23"	76"	23"	A3LE46237623	\$2338	\$2235	\$2542	\$2952	\$3157	+\$67
58"	23"	64"	23"	A3LE58236423	\$2338	\$2235	\$2542	\$2952	\$3157	+\$67
58"	23"	70"	23"	A3LE58237023	\$2409	\$2305	\$2617	\$3032	\$3240	+\$94
58"	23"	76"	23"	A3LE58237623	\$2481	\$2375	\$2692	\$3114	\$3324	+\$94

► Specification Information, continued on next page

► Specification Information, continued from previous page

Specification Information

Tip: For all edge profiles, add a suffix to the style number. (For example, A3RQ342323 becomes A3RQ342323V for wood with square edge profile.)

Dimensions				Style	Base Prices					Option
LW	LD	RW	RD	Number	Universal Tables	Universal Systems	Knife Edge	Urethane Profile	Wood Veneer	(Add \$ to Base Price)
					Suffix U	Suffix Y	Suffix K	Suffix S	Suffix V	Full-Fill Finish

90° Extended Worksurfaces, Continued

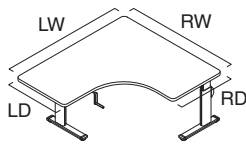

29°D, Left-Hand

64"	29"	58"	29"	A3LE64295829	\$2481	\$2375	\$2692	\$3114	\$3324	+\$ 94
70"	29"	58"	29"	A3LE70295829	\$2557	\$2449	\$2771	\$3200	\$3412	+\$ 94
76"	29"	58"	29"	A3LE76295829	\$2634	\$2524	\$2851	\$3286	\$3503	+\$121

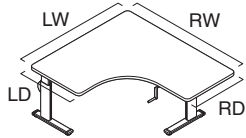

29°D, Right-Hand

58"	29"	64"	29"	A3LE58296429	\$2481	\$2375	\$2692	\$3114	\$3324	+\$ 94
58"	29"	70"	29"	A3LE58297029	\$2557	\$2449	\$2771	\$3200	\$3412	+\$ 94
58"	29"	76"	29"	A3LE58297629	\$2634	\$2524	\$2851	\$3286	\$3503	+\$121

120° Equal Worksurfaces

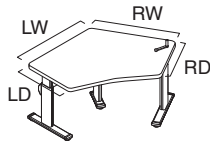

34"	23"	34"	23"	A3WQ34233423	\$1863	\$1787	\$2015	\$2318	\$2470	+\$ 46
40"	23"	40"	23"	A3WQ40234023	\$2026	\$1927	\$2225	\$2620	\$2819	+\$ 46

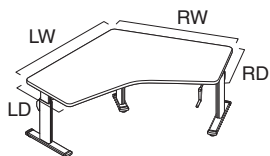

46"	23"	46"	23"	A3WQ46234623	\$2152	\$2051	\$2355	\$2757	\$2959	+\$ 67
52"	23"	52"	23"	A3WQ52235223	\$2285	\$2182	\$2494	\$2908	\$3117	+\$ 67
58"	23"	58"	23"	A3WQ58235823	\$2426	\$2320	\$2639	\$3062	\$3273	+\$ 67
64"	23"	64"	23"	A3WQ64236423	\$2575	\$2466	\$2791	\$3228	\$3444	+\$ 94

Tip: 34"W x 34"W and 40"W x 40"W 120° worksurfaces have a top mount handle located on right-hand side of worksurface.

Height-Adjustable Worksurfaces

Series 3 Bases

SIN 711.2

Tip: Maximum distributed weight capacity is 205 pounds per table. When calculating lifting capacity, subtract the weight of the worksurface.

▶ See page 228 for worksurface weights.

Tip: Maximum distributed load-bearing capacity is 205 lb per table including worksurface.

Tip: Any storage higher than 20½"H will impede lowest height range of worksurface. Do not place storage underneath handle.

Tip: Worksurface overhang for use with pedestals is not recommended for taper-flat and concave worksurfaces.

Tip: Attachment hardware is intended for worksurfaces 1⅜" thick only.

Tip: 29"D bases are recommended for use with taper-flat and concave worksurfaces.

Tip: Only single and dual flat panel monitor arm applications are permitted for use with 2-leg height-adjustable worksurfaces.

⚠ WARNING

Read base only warranty limitations.

▶ See page 207 for Workstation Design Guidelines and Requirements.

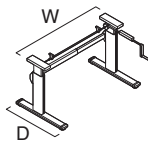
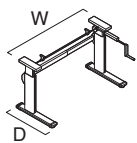

Tip: Bases are not recommended for Series 9000 worksurfaces with height-adjustable channel braces attached to underside of worksurface.

Standard Includes

- Height-adjustable base with crank: paint
- Front crank handle
- Telescoping stretchers
- 5/8" adjustable glides
- Attachment hardware

Required to Specify

- 1 Style number
 - 2 Paint color number for base:
 - 0835 Black
 - 4799 Platinum
 - 3 Handedness of 90° base, if selected
 - 4 Options, if selected (see below)
- ▶ See *Surface Materials*, page 318.

Options

Options	Price	Required to Specify	
Glides	• 1" adjustable glides	+\$28	Specify with 1" glides.
Handedness (For use with 90° worksurfaces)	• Right-hand, 90° extended bases	No cost	Specify with right-hand configuration.
	• Left-hand, 90° extended bases	No cost	Specify with left-hand configuration.

Specification Information

Worksurface Dimensions	Style Number	Base Price
W D		

Rectangular Bases

23" D		
46"-52"	23"	A3RQ46TO5223B \$1180
58"	23"	A3RQ5823B \$1191
64"-76"	23"	A3RQ64TO7623B \$1205
29" D		
46"-52"	29"	A3RQ46TO5229B \$1190
58"	29"	A3RQ5829B \$1204
64"-76"	29"	A3RQ64TO7629B \$1215

▶ **Specification Information, continued on next page**

► Specification Information, continued from previous page

Specification Information

Worksurface Dimensions				Style Number	Base Price
LW	LD	RW	RD		

90° Equal Bases

52"	23"-29"	52"	23"-29"	A3LQ52X52B	\$1853
58"	23"-29"	58"	23"-29"	A3LQ58X58B	\$1858
64"-76"	23"-29"	64"-76"	23"-29"	A3LQ64TO76B	\$1877

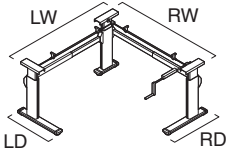

Tip: Right-hand sizes listed; applicable for left-hand workspaces.

90° Extended Bases

40"	23"-29"	58"	23"-29"	A3LE40X58B	\$1843
40"	23"-29"	64"-76"	23"-29"	A3LE40X64TO76B	\$1855
46"	23"-29"	58"	23"-29"	A3LE46X58B	\$1853
46"	23"-29"	64"-76"	23"-29"	A3LE46X64TO76B	\$1858
58"	23"-29"	64"-76"	23"-29"	A3LE58X64TO76B	\$1867

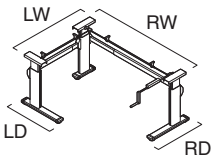

Tip: When using 90° base, the right- or left-hand configuration must be specified.

120° Equal Bases

46"-58"	23"	46"-58"	23"	A3WQ46TO58B	\$1848
64"	23"	64"	23"	A3WQ64X64B	\$1872

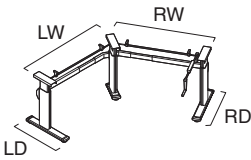

120° Extended Bases

34"	23"	58"	23"	A3WE34X58B	\$1838
34"	23"	64"	23"	A3WE34X64B	\$1843
40"	23"	58"	23"	A3WE40X58B	\$1843
40"	23"	64"	23"	A3WE40X64B	\$1848
46"-58"	23"	46"-58"	23"	A3WQ46TO58B	\$1848
46"	23"	64"	23"	A3WE46X64B	\$1853
58"	23"	64"	23"	A3WE58X64B	\$1867

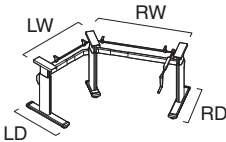

Tip: Right-hand sizes listed; applicable for left-hand workspaces.

Airtouch Height-Adjustable Worksurfaces

High-Pressure Laminate Universal Tables

SIN 711.1

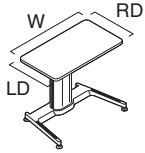

Tip: Airtouch height-adjustable base requires assembly and attachment to the work surface.

Tip: Worksurfaces ship with pre-drilled holes for mounting bases.

Tip: Any storage higher than 24½"H will impede the lower height range of the work surface. Do not place storage underneath paddle.

Tip: An adjustment feature on the column allows the unit to function properly with any load up to 150 lb, including the work surface.

Tip: Counterweights may be necessary to order if there is not enough load on the work surface. Order service part (946900053SR).

Tip: For help determining privacy/modesty screen, cableway, SOTO rail, and SlatRail width compatibility, see Worktools Compatibility Charts, page 212.

Tip: Knife edge, urethane profile and wood veneer work surface options are available through specials.

Tip: Paint surface options apply to base only. Paint surface option does not apply to column.

*Tip: To specify 3 mm edge profile, no suffix is required. For P-edge profile, add suffix **P** to the style number (for example, BAPSS2442P).*

Tip: Only single and dual flat panel monitor arm applications are permitted for use with single column height-adjustable work surfaces.

Tip: Monitor arms with C-clamp brackets should not be specified with P-edge work surfaces.

Standard Includes	Required to Specify
<ul style="list-style-type: none"> High-Pressure Laminate High-Pressure Laminate work surface edge: plastic 3 mm edge or P-edge profile on all sides Work surface corners: radius Height-adjustable column mechanism: 4799 Platinum Height-adjustable mechanism base: paint Dual-arm spring assist mechanism for bi-level work surface, if selected Attachment hardware 	<ol style="list-style-type: none"> Style number with appropriate edge profile suffix: <ul style="list-style-type: none"> P Laminate with plastic P-edge ▶ See edge profiles below. High-Pressure Laminate color number for work surface Plastic color number for profile edge on laminate work surface Paint color number for base: <ul style="list-style-type: none"> 4799 Platinum Metallic 7207 Black 7246 Midnight Metallic Options, if selected (see below) <ul style="list-style-type: none"> ▶ See <i>Surface Materials</i>, page 318.

Options	Price	Required to Specify
Surface Materials <ul style="list-style-type: none"> Paint price group 1 Paint price group 2 Open Line laminate 	No cost +\$38 +\$67 plus cost of laminate	Specify paint color number. Specify paint color number. ▶ See <i>Surface Materials Reference Manual</i> .

Related Products	Options	Price	Required to Specify
<ul style="list-style-type: none"> Slatwall, SlatRail, and freestanding worktools SOTO rail/shelves and worktools Flat panel arms Privacy/modesty screens and cableways Cable and power management 			<ul style="list-style-type: none"> ▶ Page 33 ▶ Page 45 ▶ Page 138 ▶ Page 292 ▶ Page 295

Tip: To specify 3 mm edge profile, no suffix is required. For P-edge profile, add suffix **P** to the style number (for example, BAPSS2442P).

Tip: Eyesite and cableways should not be specified with 22¹/₄"D rectangular worksurfaces.

Tip: 58" privacy/modesty screens should not be specified with 22¹/₄"D rectangular worksurfaces.

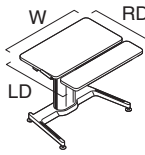
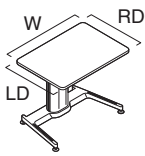
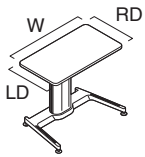

Tip: Base supports a maximum distributed weight capacity of 150 pounds. When calculating lifting capacity, subtract the weight of the worksurface.
▶ See page 232 for worksurface weights.

Specification Information

Dimensions			Style Number	Base Prices High-Pressure Laminate	
W	LD	RD		Plastic 3 mm Edge No Suffix	Plastic P-Edge Suffix P

Rectangular Tables

22¹/₄"D

40"	22 ¹ / ₄ "	22 ¹ / ₄ "	BAPSS2442	\$2236	\$2288
46"	22 ¹ / ₄ "	22 ¹ / ₄ "	BAPSS2448	\$2268	\$2320
58"	22 ¹ / ₄ "	22 ¹ / ₄ "	BAPSS2460	\$2339	\$2400

28¹/₄"D

40"	28 ¹ / ₄ "	28 ¹ / ₄ "	BAPSS3042	\$2328	\$2380
46"	28 ¹ / ₄ "	28 ¹ / ₄ "	BAPSS3048	\$2363	\$2415
58"	28 ¹ / ₄ "	28 ¹ / ₄ "	BAPSS3060	\$2436	\$2497

Rectangular Bi-Level Tables

40"	34 ¹ / ₄ "	34 ¹ / ₄ "	BAPDS3642	\$3136	\$3232
46"	34 ¹ / ₄ "	34 ¹ / ₄ "	BAPDS3648	\$3165	\$3261

▶ **Specification Information, continued on next page**

Airtouch Height-Adjustable Worksurfaces High-Pressure Laminate Universal Tables, continued

SIN 711.1

Tip: To specify 3 mm edge profile, no suffix is required. For P-edge profile, add suffix **P** to the style number (for example, BAPSS2442P).

► Specification Information, continued from previous page

Specification Information

Dimensions				Style Number	Base Prices High-Pressure Laminate	
LW	LD	RW	RD		Plastic 3 mm Edge No Suffix	Plastic P-Edge Suffix P



90° Corner Tables

39 ¹ / ₄ "	22 ¹ / ₄ "	39 ¹ / ₄ "	22 ¹ / ₄ "	BAPSC2442	\$2449	\$2570
45 ¹ / ₄ "	22 ¹ / ₄ "	45 ¹ / ₄ "	22 ¹ / ₄ "	BAPSC2448	\$2489	\$2610

90° Corner Bi-Level Tables

39 ¹ / ₄ "	22 ¹ / ₄ "	39 ¹ / ₄ "	22 ¹ / ₄ "	BAPDC2442	\$3210	\$3402
45 ¹ / ₄ "	22 ¹ / ₄ "	45 ¹ / ₄ "	22 ¹ / ₄ "	BAPDC2448	\$3250	\$3442

120° Equal Table

34"	22 ¹ / ₄ "	34"	22 ¹ / ₄ "	BAPB2436	\$2763	\$2884
-----	----------------------------------	-----	----------------------------------	-----------------	--------	--------

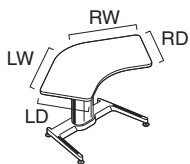
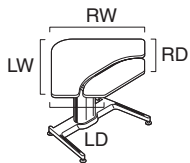
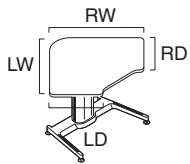

SIN 711.1

Airtouch Height-Adjustable Worksurfaces

High-Pressure Laminate For Use with Universal Systems

SIN 711.1

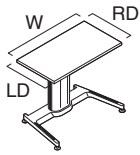

Tip: Airtouch height-adjustable base requires assembly and attachment to the worksurface.

Tip: Worksurfaces ship with pre-drilled holes for mounting bases.

Tip: Any storage higher than 24½"H will impede the lower height range of the worksurface. Do not place storage underneath paddle.

Tip: An adjustment feature on the column allows the unit to function properly with any load up to 150 lb, including the worksurface.

Tip: Counterweights may be necessary to order if there is not enough load on the worksurface. Order service part (946900053SR).

Tip: For help determining privacy/modesty screen, cableway, SOTO rail, and SlatRail width compatibility, see Worktools Compatibility Charts, page 212.

Tip: Knife edge, urethane profile, and wood veneer worksurface options are available through specials.

Tip: Paint surface options apply to base only. Paint surface option does not apply to column.

*Tip: To specify 3 mm edge profile, no suffix is required. For P-edge profile, add suffix **P** to the style number (for example, UAPSS2442P).*

Tip: Only single and dual flat panel monitor arm applications are permitted for use with single column height-adjustable worksurfaces.

Standard Includes	Required to Specify
-------------------	---------------------

- High-Pressure Laminate
- High-Pressure Laminate worksurface edge: plastic 3 mm edge or P-edge profile on front edge of worksurface with matching 1 mm plastic on sides and back
- Worksurface corners: 90°
- Height-adjustable column mechanism: 4799 Platinum
- Height-adjustable mechanism base: paint
- Dual-arm spring assist mechanism for bi-level worksurfaces, if selected
- Attachment hardware

- 1 Style number with appropriate edge profile suffix:
P Laminate with plastic P-edge
 ▶ See edge profiles below.
- 2 High-Pressure Laminate color number for worksurface
- 3 Plastic color number for profile edge on laminate worksurface
- 4 Paint color number for base:
 4799 Platinum Metallic
 7207 Black
 7246 Midnight Metallic
- 5 Options, if selected (see below)
 ▶ See *Surface Materials*, page 318.

Surface Materials	Options	Price	Required to Specify
-------------------	---------	-------	---------------------

Surface Materials

- Paint price group 1
- Paint price group 2
- Open Line laminate

No cost
 +\$38
 +\$67
 plus cost of laminate

- Specify paint color number.
 Specify paint color number.
 ▶ See *Surface Materials Reference Manual*.

Related Products

- Slatwall, SlatRail, and freestanding worktools
- SOTO rail/shelves and worktools
- Flat panel arms
- Privacy/modesty screens and cableways
- Cable and power management

- ▶ Page 33
- ▶ Page 45
- ▶ Page 138
- ▶ Page 292
- ▶ Page 295

Tip: To specify 3 mm edge profile, no suffix is required. For P-edge profile, add suffix **P** to the style number (for example, UAPSS2442P).

Tip: Eyesite and cableways should not be specified with 22¹/₄"D rectangular worksurfaces.

Tip: 58" privacy/modesty screens should not be specified with 22¹/₄"D rectangular worksurfaces.

Specification Information

Dimensions			Style Number	Base Prices High-Pressure Laminate	
W	LD	RD		Plastic 3 mm Edge No Suffix	Plastic P-Edge Suffix P

Rectangular Worksurfaces

22 ¹ / ₄ "D					
40"	22 ¹ / ₄ "	22 ¹ / ₄ "	UAPSS2442	\$2190	\$2242
46"	22 ¹ / ₄ "	22 ¹ / ₄ "	UAPSS2448	\$2220	\$2272
58"	22 ¹ / ₄ "	22 ¹ / ₄ "	UAPSS2460	\$2280	\$2341

28 ¹ / ₄ "D					
40"	28 ¹ / ₄ "	28 ¹ / ₄ "	UAPSS3042	\$2268	\$2320
46"	28 ¹ / ₄ "	28 ¹ / ₄ "	UAPSS3048	\$2303	\$2355
58"	28 ¹ / ₄ "	28 ¹ / ₄ "	UAPSS3060	\$2373	\$2434

Rectangular Bi-Level Worksurfaces

40"	34 ¹ / ₄ "	34 ¹ / ₄ "	UAPDS3642	\$3088	\$3140
46"	34 ¹ / ₄ "	34 ¹ / ₄ "	UAPDS3648	\$3117	\$3169

► **Specification Information, continued on next page**

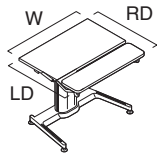
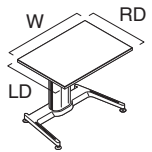

Tip: Base supports a maximum distributed weight capacity of 150 pounds. When calculating lifting capacity, subtract the weight of the worksurface.

► See page 232 for worksurface weights.

Airtouch Height-Adjustable Worksurfaces High-Pressure Laminate For Use with Universal Systems, continued



SIN 711.1

Tip: To specify 3 mm edge profile, no suffix is required. For P-edge profile, add suffix **P** to the style number (for example, BAPSS2442P).

► Specification Information, continued from previous page

Specification Information

**Base Prices
High-Pressure Laminate**

	
Plastic 3 mm Edge	Plastic P-Edge
No Suffix	Suffix P

Dimensions				Style Number	Plastic 3 mm Edge	Plastic P-Edge
LW	LD	RW	RD			

90° Corner Worksurfaces

39 1/4"	16 1/4"	39 1/4"	16 1/4"	UAPSC1842	\$2347	\$2468
39 1/4"	22 1/4"	39 1/4"	22 1/4"	UAPSC2442	\$2362	\$2483
45 1/4"	22 1/4"	45 1/4"	22 1/4"	UAPSC2448	\$2399	\$2520

90° Corner Bi-Level Worksurfaces

39 1/4"	22 1/4"	39 1/4"	22 1/4"	UAPDC2442	\$3123	\$3244
45 1/4"	22 1/4"	45 1/4"	22 1/4"	UAPDC2448	\$3160	\$3281

120° Equal Worksurface

34"	22 1/4"	34"	22 1/4"	UAPB2436	\$2670	\$2791
-----	---------	-----	---------	-----------------	--------	--------

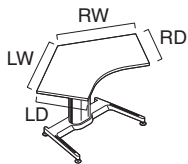
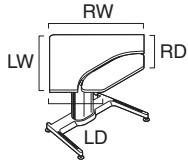
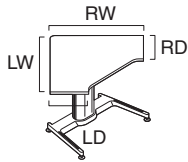

SIN 711.1

Airtouch Height-Adjustable Worksurfaces

High-Pressure Laminate For Use with Series 9000

SIN 711.1

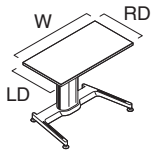

Tip: Airtouch height-adjustable base requires assembly and attachment to the worksurface.

Tip: Worksurfaces ship with pre-drilled holes for mounting bases.

Tip: Any storage higher than 24½"H will impede the lower height range of the worksurface. Do not place storage underneath paddle.

Tip: An adjustment feature on the column allows the unit to function properly with any load up to 150 lb, including the worksurface.

Tip: Counterweights may be necessary to order if there is not enough load on the worksurface. Order service part (946900053SR).

Tip: For help determining privacy/modesty screen, cableway, SOTO rail, and SlatRail width compatibility, see Worktools Compatibility Charts, page 212.

Tip: Knife edge, urethane profile, and wood veneer worksurface options are available through specials.

Tip: Paint surface options apply to base only. Paint surface option does not apply to column.

*Tip: To specify 3 mm edge profile, no suffix is required. For P-edge profile, add suffix **P** to the style number (for example, 9UAPSC1845P).*

Tip: Only single and dual flat panel monitor arm applications are permitted for use with single column height-adjustable worksurfaces.

Standard Includes

- High-Pressure Laminate
- High-Pressure Laminate worksurface edge: plastic 3 mm edge or P-edge profile on front edge of worksurface with matching 1 mm plastic on sides and back
- Worksurface corners: 90°
- Height-adjustable column mechanism: 4799 Platinum
- Height-adjustable mechanism base: paint
- Attachment hardware

Required to Specify

- 1 Style number with appropriate edge profile suffix:
 - ▶ **P** Laminate with plastic P-edge
 - ▶ See edge profiles below.
- 2 High-Pressure Laminate color number for worksurface
- 3 Plastic color number for profile edge on laminate worksurface
- 4 Paint color number for base:
 - 4799 Platinum Metallic
 - 7207 Black
 - 7246 Midnight Metallic
- 5 Options, if selected (see below)
 - ▶ See *Surface Materials*, page 318.

	Options	Price	Required to Specify
Surface Materials	<ul style="list-style-type: none"> • Paint price group 1 • Paint price group 2 • Open Line laminate 	No cost +\$38 +\$67 plus cost of laminate	Specify paint color number. Specify paint color number. ▶ See <i>Surface Materials Reference Manual</i> .
Related Products	<ul style="list-style-type: none"> • Slatwall, SlatRail, and freestanding worktools • SOTO rail/shelves and worktools • Flat panel arms • Privacy/modesty screens and cableways • Cable and power management 		<ul style="list-style-type: none"> ▶ Page 33 ▶ Page 45 ▶ Page 138 ▶ Page 292 ▶ Page 295

Tip: To specify 3 mm edge profile, no suffix is required. For P-edge profile, add suffix **P** to the style number (for example, 9UAPSC1845P).

Tip: Eyesite and cableways should not be specified with 22²⁵/₃₂"D rectangular worksurfaces.

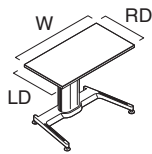

Specification Information

Dimensions			Style Number	Base Prices High-Pressure Laminate	
W	LD	RD		Plastic 3 mm Edge No Suffix	Plastic P-Edge Suffix P

Rectangular Worksurfaces

43"	22 ²⁵ / ₃₂ "	22 ²⁵ / ₃₂ "	9UAPSS2545	\$2220	\$2272
43"	27 ²⁵ / ₃₂ "	27 ²⁵ / ₃₂ "	9UAPSS3045	\$2303	\$2355

Specification Information

Dimensions				Style Number	Base Prices High-Pressure Laminate	
LW	LD	RW	RD		Plastic 3 mm Edge No Suffix	Plastic P-Edge Suffix P

90° Corner Worksurfaces

42 ¹ / ₄ "	17 ¹ / ₈ "	42 ¹ / ₄ "	17 ¹ / ₈ "	9UAPSC1845	\$2362	\$2483
42 ¹ / ₄ "	22 ²⁵ / ₃₂ "	42 ¹ / ₄ "	22 ²⁵ / ₃₂ "	9UAPSC2545	\$2399	\$2520

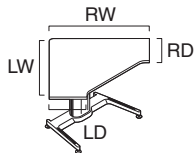

Tip: Base supports a maximum distributed weight capacity of 150 pounds. When calculating lifting capacity, subtract the weight of the worksurface.

► See page 232 for worksurface weights.

Height-Adjustable
Worksurfaces

Series 5 Height-Adjustable Worksurfaces

High-Pressure Laminate or Wood Veneer

SIN 711.2

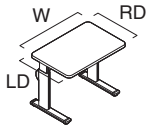

Tip: Series 5 height-adjustable base requires assembly and attachment to the worksurface.

Tip: Worksurface ships with pre-drilled holes for mounting bases.

Tip: Maximum distributed weight capacity is 195 pounds per table. When calculating lifting capacity, subtract the weight of the worksurface.
▶ See page 234, for worksurface weights.

Tip: Maximum distributed load-bearing capacity is 195 lb per table including worksurface.

Tip: Any storage higher than 20"H will impede the lowest height range of worksurface. If the overhang is installed, 24"H storage can be used.

Tip: Only single and dual flat panel monitor arm applications are permitted for use with 2-leg height-adjustable worksurfaces.

Tip: Worksurface overhang for pedestal storage varies by shape and size.

Premium Wood

Pricing: For Premium wood 2 or Premium wood 3 pricing, please refer to the electronic catalog or SmartTools.

Tip: For help determining privacy/modesty screen, cableway, SOTO rail, and SlatRail width compatibility, see Worktools Compatibility Charts, page 212.

Tip: For all edge profiles, add a suffix to the style number. (For example, A5RQ342323 becomes A5RQ342323V for wood with square edge profile.)

Standard Includes	Required to Specify
<ul style="list-style-type: none"> High-Pressure Laminate or wood veneer High-Pressure Laminate worksurface edges: <ul style="list-style-type: none"> –Universal Tables: plastic 3 mm edge profile on all sides –Universal Systems or knife edge worksurfaces: plastic 3 mm edge profile on front edge with matching 1 mm plastic on sides and back –Urethane profile worksurfaces: urethane on front edge with matching plastic 3 mm edge profile on sides and back Wood worksurface edges: <ul style="list-style-type: none"> –Wood veneer square 3 mm radius on front edge with 1 mm matching veneer flat profile on side and back edges Worksurface corners: <ul style="list-style-type: none"> –Radius corners on Universal Tables, if selected –90° corners on Universal Systems, knife edge, urethane, and wood worksurface profiles, if selected Electric height-adjustable sit-to-stand base: paint Push button up/down controller Telescoping stretchers Dual-arm spring assist mechanism for bi-level table, if selected 5/8" adjustable glides Wire manager Drive shaft cover Power cord: 9' Attachment hardware 	<ol style="list-style-type: none"> Style number with appropriate edge profile suffix: <ul style="list-style-type: none"> U Universal Tables Y Universal Systems K Knife edge S Urethane profile V Wood veneer High-Pressure Laminate or wood color number for worksurface Plastic or urethane color number for profile edge on laminate worksurface, if selected Paint color for base: <ul style="list-style-type: none"> 0835 Black 4799 Platinum Options, if selected (see below) <ul style="list-style-type: none"> ▶ See <i>Surface Materials</i>, page 318.

Options	Price	Required to Specify
Surface Materials <ul style="list-style-type: none"> High-Pressure Laminate worksurfaces <ul style="list-style-type: none"> Open Line laminate +\$67 plus cost of laminate Wood veneer worksurfaces <ul style="list-style-type: none"> Premium wood 2 See information at left Specify Premium wood 2 finish number. Premium wood 3 See information at left Specify Premium wood 3 finish number. Specify <i>with Customiz stain</i>. Customiz stain No cost ▶ See <i>Surface Materials Reference Manual</i>. Specify full-fill finish number. Full-fill finish Prices at right 		▶ See <i>Surface Materials Reference Manual</i> .
Glides <ul style="list-style-type: none"> 1" adjustable glides +\$28 		Specify <i>with 1" glides</i> .
Related Products <ul style="list-style-type: none"> Slatwall, SlatRail, and freestanding worktools SOTO rail/shelves and worktools Flat panel arms Privacy/modesty screens and cableways Cable and power management 		<ul style="list-style-type: none"> ▶ Page 33 ▶ Page 45 ▶ Page 138 ▶ Page 292 ▶ Page 295

Tip: For all edge profiles, add a suffix to the style number. (For example, A5RQ342323 becomes A5RQ342323V for wood with square edge profile.)

Tip: Only single and dual flat panel monitor arm applications are permitted for use with 2-leg height-adjustable tables.

Specification Information

Dimensions			Style Number	Base Prices					Option (Add \$ to Base Price)
W	LD	RD		Universal Tables	Universal Systems	Knife Edge	Urethane Profile	Wood Veneer	
				Suffix U	Suffix Y	Suffix K	Suffix S	Suffix V	Full-Fill Finish

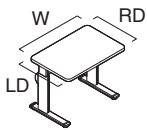

Rectangular Worksurfaces

23" D									
34"	23"	23"	A5RQ342323	\$1666	\$1608	\$1782	\$2014	\$2129	+\$27
40"	23"	23"	A5RQ402323	\$1715	\$1658	\$1836	\$2070	\$2187	+\$46
46"	23"	23"	A5RQ462323	\$1767	\$1708	\$1887	\$2126	\$2244	+\$46
52"	23"	23"	A5RQ522323	\$1822	\$1762	\$1944	\$2186	\$2307	+\$46
58"	23"	23"	A5RQ582323	\$1877	\$1815	\$2000	\$2245	\$2368	+\$46
64"	23"	23"	A5RQ642323	\$1935	\$1873	\$2059	\$2309	\$2436	+\$67
70"	23"	23"	A5RQ702323	\$1991	\$1929	\$2120	\$2373	\$2500	+\$67
76"	23"	23"	A5RQ762323	\$2054	\$1988	\$2183	\$2441	\$2569	+\$67

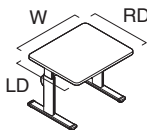

29" D									
34"	29"	29"	A5RQ342929	\$1868	\$1807	\$1986	\$2228	\$2349	+\$46
40"	29"	29"	A5RQ402929	\$1923	\$1862	\$2046	\$2291	\$2413	+\$46
46"	29"	29"	A5RQ462929	\$1981	\$1919	\$2105	\$2355	\$2478	+\$46
52"	29"	29"	A5RQ522929	\$2042	\$1979	\$2168	\$2419	\$2547	+\$67
58"	29"	29"	A5RQ582929	\$2102	\$2040	\$2232	\$2488	\$2615	+\$67
64"	29"	29"	A5RQ642929	\$2168	\$2102	\$2298	\$2558	\$2688	+\$67
70"	29"	29"	A5RQ702929	\$2233	\$2167	\$2364	\$2627	\$2760	+\$67
76"	29"	29"	A5RQ762929	\$2301	\$2234	\$2436	\$2702	\$2836	+\$67

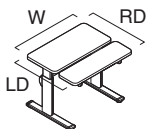

Rectangular Bi-Level Worksurfaces

40"	29"	29"	A5RD402929	\$2833	\$2754	\$2991	\$3307	\$3464	+\$46
46"	29"	29"	A5RD462929	\$2891	\$2812	\$3051	\$3372	\$3529	+\$46

► Specification Information, continued on next page

Tip: The controller must be mounted on the user's right-hand side for all bi-level worksurfaces.

Height-Adjustable Worksurfaces

Series 5 Height-Adjustable Worksurfaces High-Pressure Laminate or Wood Veneer, continued

SIN 711.2

► Specification Information, continued from previous page





Tip: For all edge profiles, add a suffix to the style number. (For example, A5RQ342323 becomes A5RQ342323V for wood with square edge profile.)

Tip: Taper-flat worksurfaces do not allow for worksurface overhang.

Tip: Taper-flat worksurfaces utilize a 29"D base causing the foot to extend past the worksurface on the 23"D side.

Tip: Only single and dual flat panel monitor arm applications are permitted for use with 2-leg height-adjustable worksurfaces.

Specification Information

Dimensions			Style Number	Base Prices					Option (Add \$ to Base Price)
W	LD	RD		Universal Tables	Universal Systems	Knife Edge	Urethane Profile	Wood Veneer	
									
				Suffix U	Suffix Y	Suffix K	Suffix S	Suffix V	Full-Fill Finish

Taper-Flat Worksurfaces

Left-Hand

58"	29"	23"	A5RT582923	\$2102	\$2040	\$2232	\$2488	\$2615	+\$67
64"	29"	23"	A5RT642923	\$2168	\$2102	\$2298	\$2558	\$2688	+\$67
70"	29"	23"	A5RT702923	\$2233	\$2167	\$2364	\$2627	\$2760	+\$67
76"	29"	23"	A5RT762923	\$2301	\$2234	\$2436	\$2702	\$2836	+\$67

Right-Hand

58"	23"	29"	A5RT582329	\$2102	\$2040	\$2232	\$2488	\$2615	+\$67
64"	23"	29"	A5RT642329	\$2168	\$2102	\$2298	\$2558	\$2688	+\$67
70"	23"	29"	A5RT702329	\$2233	\$2167	\$2364	\$2627	\$2760	+\$67
76"	23"	29"	A5RT762329	\$2301	\$2234	\$2436	\$2702	\$2836	+\$67

Concave Worksurfaces

58"	29"	29"	A5CQ582929	\$2102	\$2040	\$2232	\$2488	\$2615	+\$67
64"	29"	29"	A5CQ642929	\$2168	\$2102	\$2298	\$2558	\$2688	+\$67
70"	29"	29"	A5CQ702929	\$2233	\$2167	\$2364	\$2627	\$2760	+\$67
76"	29"	29"	A5CQ762929	\$2301	\$2234	\$2436	\$2702	\$2836	+\$67

► Specification Information, continued on next page

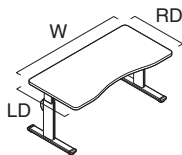
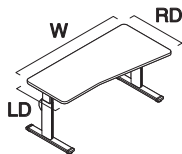
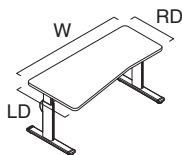

Tip: Concave worksurfaces do not allow for worksurface overhang.

Tip: Center of concave work-surface is 25%D.

► Specification Information, continued from previous page

Specification Information

Tip: For all edge profiles, add a suffix to the style number. (For example, A5RQ342323 becomes A5RQ342323V for wood with square edge profile.)

Tip: Base only for 90° corner worksurfaces is not available.

Tip: The controller must be mounted on the user's right-hand side for all bi-level worksurfaces.

Tip: Only single and dual flat panel monitor arm applications are permitted for use with 2-leg height-adjustable worksurfaces.

Base Prices

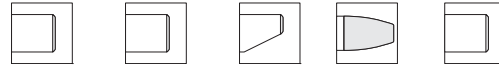

Dimensions				Style	Universal	Universal	Knife	Urethane	Wood	Option
LW	LD	RW	RD	Number	Tables	Systems	Edge	Profile	Veneer	(Add \$ to Base Price)
										Full-Fill Finish
					Suffix U	Suffix Y	Suffix K	Suffix S	Suffix V	

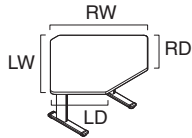

90° Corner Worksurfaces

40"	23"	40"	23"	A5LQ40234023	\$1944	\$1854	\$2122	\$2475	\$2652	+\$46
46"	23"	46"	23"	A5LQ46234623	\$2007	\$1915	\$2185	\$2545	\$2725	+\$67

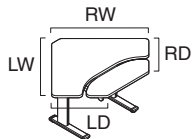

90° Corner Bi-Level Worksurfaces

40"	23"	40"	23"	A5LD40234023	\$2739	\$2632	\$2957	\$3389	\$3607	+\$46
46"	23"	46"	23"	A5LD46234623	\$2800	\$2691	\$3020	\$3459	\$3679	+\$67

Tip: The motors on all 90° corner bi-level are mounted outboard of the lifting columns.

► Specification Information, continued on next page

Height-Adjustable Worksurfaces

Series 5 Height-Adjustable Worksurfaces High-Pressure Laminate or Wood Veneer, continued

SIN 711.2

Tip: For all edge profiles, add a suffix to the style number. (For example, A5RQ342323 becomes A5RQ342323V for wood with square edge profile.)

► Specification Information, continued from previous page

Specification Information

Dimensions				Style Number	Base Prices					Option (Add \$ to Base Price)
LW	LD	RW	RD		Universal Tables	Universal Systems	Knife Edge	Urethane Profile	Wood Veneer	
					Suffix U	Suffix Y	Suffix K	Suffix S	Suffix V	Full-Fill Finish

90° Extended Worksurfaces

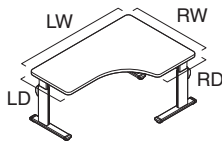

23" D, Left-Hand

58"	23"	40"	23"	A5LE58234023	\$2648	\$2553	\$2842	\$3228	\$3420	+\$67
58"	23"	46"	23"	A5LE58234623	\$2729	\$2632	\$2925	\$3316	\$3512	+\$67
64"	23"	40"	23"	A5LE64234023	\$2729	\$2632	\$2925	\$3316	\$3512	+\$67
64"	23"	46"	23"	A5LE64234623	\$2812	\$2712	\$3009	\$3406	\$3604	+\$67
64"	23"	58"	23"	A5LE64235823	\$2985	\$2882	\$3187	\$3598	\$3803	+\$67
70"	23"	40"	23"	A5LE70234023	\$2812	\$2712	\$3009	\$3406	\$3604	+\$67
70"	23"	46"	23"	A5LE70234623	\$2897	\$2794	\$3098	\$3501	\$3702	+\$67
70"	23"	58"	23"	A5LE70235823	\$3074	\$2971	\$3284	\$3698	\$3905	+\$94
76"	23"	40"	23"	A5LE76234023	\$2897	\$2794	\$3098	\$3501	\$3702	+\$67
76"	23"	46"	23"	A5LE76234623	\$2985	\$2882	\$3187	\$3598	\$3803	+\$67
76"	23"	58"	23"	A5LE76235823	\$3168	\$3062	\$3379	\$3801	\$4010	+\$94

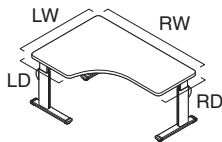

23" D, Right-Hand

40"	23"	58"	23"	A5LE40235823	\$2648	\$2553	\$2842	\$3228	\$3420	+\$67
40"	23"	64"	23"	A5LE40236423	\$2729	\$2632	\$2925	\$3316	\$3512	+\$67
40"	23"	70"	23"	A5LE40237023	\$2812	\$2712	\$3009	\$3406	\$3604	+\$67
40"	23"	76"	23"	A5LE40237623	\$2897	\$2794	\$3098	\$3501	\$3702	+\$67
46"	23"	58"	23"	A5LE46235823	\$2729	\$2632	\$2925	\$3316	\$3512	+\$67
46"	23"	64"	23"	A5LE46236423	\$2812	\$2712	\$3009	\$3406	\$3604	+\$67
46"	23"	70"	23"	A5LE46237023	\$2897	\$2794	\$3098	\$3501	\$3702	+\$67
46"	23"	76"	23"	A5LE46237623	\$2985	\$2882	\$3187	\$3598	\$3803	+\$67
58"	23"	64"	23"	A5LE58236423	\$2985	\$2882	\$3187	\$3598	\$3803	+\$67
58"	23"	70"	23"	A5LE58237023	\$3074	\$2971	\$3284	\$3698	\$3905	+\$94
58"	23"	76"	23"	A5LE58237623	\$3168	\$3062	\$3379	\$3801	\$4010	+\$94

► Specification Information, continued on next page

► Specification Information, continued from previous page

Specification Information

Tip: For all edge profiles, add a suffix to the style number. (For example, A5RQ342323 becomes A5RQ342323V for wood with square edge profile.)

Dimensions				Style Number	Base Prices					Option (Add \$ to Base Price)
LW	LD	RW	RD		Universal Tables	Universal Systems	Knife Edge	Urethane Profile	Wood Veneer	
					Suffix U	Suffix Y	Suffix K	Suffix S	Suffix V	Full-Fill Finish

90° Extended Worksurfaces, Continued

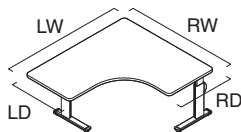

29"D, Left-Hand

64"	29"	58"	29"	A5LE64295829	\$3168	\$3062	\$3379	\$3801	\$4010	+\$ 94
70"	29"	58"	29"	A5LE70295829	\$3264	\$3158	\$3477	\$3905	\$4119	+\$ 94
76"	29"	58"	29"	A5LE76295829	\$3362	\$3253	\$3581	\$4013	\$4231	+\$121

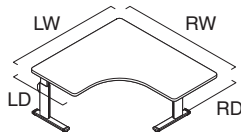

29"D, Right-Hand

58"	29"	64"	29"	A5LE58296429	\$3168	\$3062	\$3379	\$3801	\$4010	+\$ 94
58"	29"	70"	29"	A5LE58297029	\$3264	\$3158	\$3477	\$3905	\$4119	+\$ 94
58"	29"	76"	29"	A5LE58297629	\$3362	\$3253	\$3581	\$4013	\$4231	+\$121

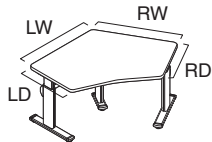

120° Equal Worksurfaces

34"	23"	34"	23"	A5WQ34233423	\$2331	\$2255	\$2482	\$2786	\$2937	+\$ 46
40"	23"	40"	23"	A5WQ40234023	\$2533	\$2436	\$2731	\$3127	\$3325	+\$ 46
46"	23"	46"	23"	A5WQ46234623	\$2690	\$2587	\$2892	\$3296	\$3497	+\$ 67
52"	23"	52"	23"	A5WQ52235223	\$2855	\$2752	\$3063	\$3479	\$3688	+\$ 67
58"	23"	58"	23"	A5WQ58235823	\$3031	\$2925	\$3243	\$3667	\$3877	+\$ 67
64"	23"	64"	23"	A5WQ64236423	\$3217	\$3108	\$3435	\$3869	\$4086	+\$ 94

Tip: 34"W 120° equal work-surfaces have a 2-leg base. All other widths have a 3-leg base.

Height-Adjustable Worksurfaces

Series 5 Bases

SIN 711.2

Tip: Maximum distributed weight capacity is 195 pounds per table. When calculating lifting capacity, subtract the weight of the worksurface.
 ▶ See page 234, for worksurfaces weights.

Tip: Maximum distributed load-bearing capacity is 195 lb per table including worksurface.

Tip: Any storage higher than 20"H will impede the lowest height range of worksurface. If the overhang is installed, 24"H storage can be used.

Tip: Worksurface overhang for use with pedestals is not recommended for taper-flat and concave worksurfaces.

Tip: Attachment hardware is intended for worksurfaces 1³/₁₆" thick only.

Tip: 29"D bases are recommended for use with taper-flat and concave worksurfaces.

Tip: Only single and dual flat panel monitor arm applications are permitted for use with 2-leg height-adjustable worksurfaces.

⚠ WARNING

Read base only warranty limitations.
 ▶ See page 207 for Workstation Design Guidelines and Requirements.

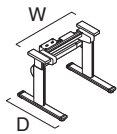
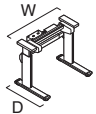

Tip: Bases are not recommended for Series 9000 worksurfaces with height-adjustable channel braces attached to underside of worksurface.

Standard Includes	Required to Specify
<ul style="list-style-type: none"> • Electric height-adjustable sit-to-stand base: paint • Push button up/down controller • Telescoping stretchers • 5/8" adjustable glides • Power cord: 9' • Attachment hardware 	1 Style number 2 Paint color number for base: 0835 Black 4799 Platinum 3 Handedness of 90° base, if selected 4 Options, if selected (see below) ▶ See <i>Surface Materials</i> , page 318.

Options	Price	Required to Specify
Glides • 1" adjustable glides	+\$28	Specify with 1" glides.
Handedness (For use with 90° worksurfaces) • Right-hand, 90° extended bases	No cost	Specify with right-hand configuration.
• Left-hand, 90° extended bases	No cost	Specify with left-hand configuration.

Specification Information

• Worksurface Dimensions W D	• Style Number	• Base Price
---------------------------------	----------------	--------------

Rectangular Bases

23" D		
34"-40"	23"	A5RQ34TO4023B \$1836
46"-52"	23"	A5RQ46TO5223B \$1847
58"	23"	A5RQ5823B \$1861
64"-76"	23"	A5RQ64TO7623B \$1873
29" D		
34"-40"	29"	A5RQ34TO4029B \$1856
46"-52"	29"	A5RQ46TO5229B \$1867
58"	29"	A5RQ5829B \$1878
64"-76"	29"	A5RQ64TO7629B \$1893

▶ Specification Information, continued on next page

► Specification Information, continued from previous page

Specification Information

Worksurface Dimensions				Style Number	Base Price
LW	LD	RW	RD		

90° Equal Bases

52"	23"-29"	52"	23"-29"	A5LQ52X52B	\$2428
58"	23"-29"	58"	23"-29"	A5LQ58X58B	\$2435
64"-76"	23"-29"	64"-76"	23"-29"	A5LQ64T076B	\$2450

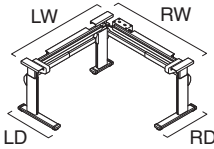

Tip: Right-hand sizes listed; applicable for left-hand workspaces.

90° Extended Bases

40"	23"-29"	58"	23"-29"	A5LE40X58B	\$2416
40"	23"-29"	64"-76"	23"-29"	A5LE40X64T076B	\$2431
46"	23"-29"	58"	23"-29"	A5LE46X58B	\$2428
46"	23"-29"	64"-76"	23"-29"	A5LE46X64T076B	\$2435
58"	23"-29"	64"-76"	23"-29"	A5LE58X64T076B	\$2440

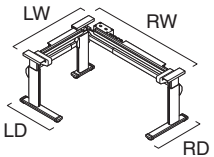

Tip: When using 90° base, the right- or left-hand configuration must be specified.

120° Equal Bases

40"	23"	40"	23"	A5WQ40X40B	\$2399
46"-58"	23"	46"-58"	23"	A5WQ46T058B	\$2423
44"	23"	64"	23"	A5WQ64X64B	\$2445

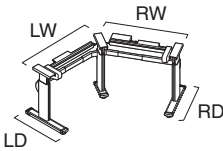

120° Extended Bases

34"	23"	58"	23"	A5WE34X58B	\$2411
34"	23"	64"	23"	A5WE34X64B	\$2416
40"	23"	58"	23"	A5WE40X58B	\$2416
40"	23"	64"	23"	A5WE40X64B	\$2423
46"-58"	23"	46"-58"	23"	A5WQ46T058B	\$2423
46"	23"	64"	23"	A5WE46X64B	\$2428
58"	23"	64"	23"	A5WE58X64B	\$2440

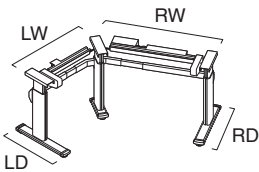

Tip: Right-hand sizes listed; applicable for left-hand workspaces.

FitWork: Walkstation and Sit-to-Walkstation

SIN 711.99

Standard Includes	Required to Specify
<ul style="list-style-type: none"> • Worksurface: High-Pressure Laminate • Worksurface front user's edge: urethane • Back and side edges: matching laminate • Base: paint • Treadmill: 7270 Silverstone • High-torque motor • Digital display and keypad console • Magnetic safety clip • Glides 	<ol style="list-style-type: none"> 1 Style number 2 High-Pressure Laminate color for worksurface 3 Urethane edge color number: 6000 Black 6278 Felt 4 Paint color number for base 5 Options, if selected (see below) <p>▶ See <i>Surface Materials</i>, page 318.</p>

Options	Price	Required to Specify
Surface Materials <ul style="list-style-type: none"> • High-Pressure Laminate worksurfaces • Open Line laminate 	+\$67 plus cost of laminate	▶ See <i>Surface Materials Reference Manual</i> .

Specification Information					
Overall Footprint	Worksurface Dimensions		Weight	Style Number	Base Price
W D	W	D	:	:	:

Walkstations

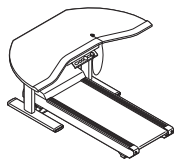

66"	67"	66"	32"	330 lb	A7TG660606H	\$6960
-----	-----	-----	-----	--------	--------------------	--------

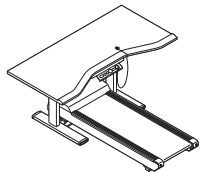

66"	67"	66"	32"	330 lb	A7TR663232H	\$6960
-----	-----	-----	-----	--------	--------------------	--------

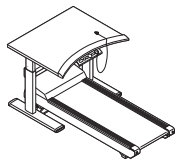

38"	67"	38"	30"	330 lb	A7TR383030H	\$6960
-----	-----	-----	-----	--------	--------------------	--------

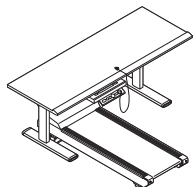

Sit-to-Walkstation

78"	67"	78"	29"	330 lb	A7TR782929H	\$7232
-----	-----	-----	-----	--------	--------------------	--------

Acrylic Screens

SIN 711.2

Tip: Screen may need to be shorter than worksurface width. To determine screen/cableway and height-adjustable worksurface compatibility, see Worktools Compatibility Charts, page 212.

Tip: 58"W and 64"W screens are not recommended for use with 22 1/4"D rectangular Airtouch worksurfaces.



Tip: 58"W and 64"W screens ship with three Universal clamps. All other screen widths ship with two Universal clamps.



Standard Includes	Required to Specify
<ul style="list-style-type: none"> • Screen: 6544 Frost only • Universal clamps: paint 	<ul style="list-style-type: none"> 1 Style number 2 Paint color number for Universal clamp: <ul style="list-style-type: none"> 0835 Black 4799 Platinum

Specification Information

Screen Width	Cableway Width	Style Number	Price
--------------	----------------	--------------	-------

Privacy Screens Only

22"	N.A.	AP22	\$313
28"	N.A.	AP28	\$329
34"	N.A.	AP34	\$346
40"	N.A.	AP40	\$364
46"	N.A.	AP46	\$382
52"	N.A.	AP52	\$400
58"	N.A.	AP58	\$447
64"	N.A.	AP64	\$464
:	:	:	:

Privacy Screens with Cableway

28"	25"	ACP28	\$395
34"	31"	ACP34	\$429
40"	37"	ACP40	\$462
46"	43"	ACP46	\$498
52"	49"	ACP52	\$533
58"	55"	ACP58	\$598
64"	61"	ACP64	\$632
:	:	:	:

Modesty Screens Only

22"	N.A.	AM22	\$285
28"	N.A.	AM28	\$304
34"	N.A.	AM34	\$320
40"	N.A.	AM40	\$337
46"	N.A.	AM46	\$354
52"	N.A.	AM52	\$372
58"	N.A.	AM58	\$418
64"	N.A.	AM64	\$434
:	:	:	:

► **Specification Information, continued on next page**

► Specification Information, continued from previous page

Specification Information

Screen Width	Cableway Width	Style Number	Price
--------------	----------------	--------------	-------



Modesty Screens with Cableway

28"	25"	ACM28	\$372
34"	31"	ACM34	\$406
40"	37"	ACM40	\$439
46"	43"	ACM46	\$476
52"	49"	ACM52	\$507
58"	55"	ACM58	\$571
64"	61"	ACM64	\$605
.	.	.	.

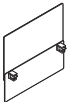

Modesty and Privacy Screens

22"	N.A.	AMP22	\$509
28"	N.A.	AMP28	\$545
34"	N.A.	AMP34	\$579
40"	N.A.	AMP40	\$614
46"	N.A.	AMP46	\$649
52"	N.A.	AMP52	\$685
58"	N.A.	AMP58	\$747
64"	N.A.	AMP64	\$782
.	.	.	.

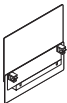

Modesty and Privacy Screens with Cableway

28"	25"	ACMP28	\$614
34"	31"	ACMP34	\$666
40"	37"	ACMP40	\$719
46"	43"	ACMP46	\$771
52"	49"	ACMP52	\$823
58"	55"	ACMP58	\$904
64"	61"	ACMP64	\$956
.	.	.	.

Cableways

SIN 711.2

Tip: Cableway with Universal clamp can be used in combination with privacy and modesty screens.

▶ See page 292

Tip: Cableways may need to be shorter than worksurface width. To determine screen/cableway and height-adjustable worksurface compatibility, see Worktools Compatibility Charts, page 212.

Tip: Cableways are not recommended for use with 22 1/4"D rectangular Airtouch worksurfaces.

Tip: Cableways with Universal clamp are 3" shorter than privacy and modesty screen widths.

Tip: 55"W and 61"W cableways ship with three Universal clamps or horizontal brackets. All other cableway widths ship with two Universal clamps or horizontal brackets.

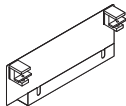
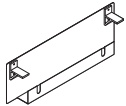

Standard Includes	Required to Specify
<ul style="list-style-type: none"> • Cableway: paint • Universal clamp, if selected: paint to match cableway • Horizontal mounting bracket, if selected: paint to match cableway 	1 Style number 2 Paint color number for cableway: 0835 Black 4799 Platinum

Specification Information

• Dimensions			• Weight	• Style	• Price
D	W	H		Number	

With Horizontal Mounting Bracket

2 1/2"	25"	8"	7.45 lb	AHORZ25	\$ 72
2 1/2"	31"	8"	8.40 lb	AHORZ31	\$ 92
2 1/2"	37"	8"	9.35 lb	AHORZ37	\$111
2 1/2"	43"	8"	10.30 lb	AHORZ43	\$127
2 1/2"	49"	8"	11.25 lb	AHORZ49	\$148
2 1/2"	55"	8"	14.20 lb	AHORZ55	\$177
2 1/2"	61"	8"	15.15 lb	AHORZ61	\$194

With Universal Clamp

2 1/2"	25"	8"	4.70 lb	AC25	\$154
2 1/2"	31"	8"	5.65 lb	AC31	\$171
2 1/2"	37"	8"	6.60 lb	AC37	\$189
2 1/2"	43"	8"	7.55 lb	AC43	\$206
2 1/2"	49"	8"	8.50 lb	AC49	\$222
2 1/2"	55"	8"	9.95 lb	AC55	\$269
2 1/2"	61"	8"	10.91 lb	AC61	\$285

Cable and Power Management

SIN 711.2

Power/Data with C-clamp

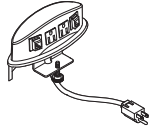

Tip: Power/data extends 1¼" off the back of the worksurface.

Tip: Power/data does not fit between worksurface and screens/cableway.

Standard Includes				Required to Specify	
<ul style="list-style-type: none"> Power/data: 6544 Frost 6' cord: black plastic only 				Style number	
Specification Information					
Dimensions			Weight	Style Number	Price
D	W	H			
3½"	8½"	2½"	1.5 lb	AP2D2CC	\$165

USB Two-Outlet Powerstrip with Clamp Mount

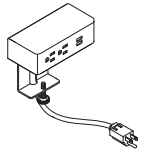

Tip: Clamp accommodates worksurface thicknesses ½" – 1½".

Tip: Each USB port can utilize up to 2.1 amps. Each port is independent of the other.

Standard Includes				Required to Specify	
<ul style="list-style-type: none"> Clamp mount bracket: paint Housing with two USB ports and two power outlets: plastic 9' white cord 				1 Style number 2 Paint color number for bracket: 4140 Arctic White 4799 Platinum Metallic 7360 Merle 3 Plastic color number for housing: 6009 Arctic White 6527 Merle	
Specification Information					
Dimensions			Weight	Style Number	Price
D	W	H			
3⅓"	5½"	1⅘"	4.175 lb	DSPSDUOC	\$279

USB Two-Outlet Powerstrip with Rail Mount

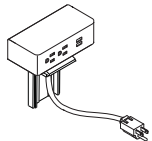

Tip: Each USB port can utilize up to 2.1 amps. Each port is independent of the other.

Standard Includes				Required to Specify	
<ul style="list-style-type: none"> Rail mount bracket: 4799 Platinum Metallic Housing with two USB ports and two power outlets: plastic 9' white cord 				1 Style number 2 Plastic color number for housing: 6009 Arctic White 6527 Merle	
Specification Information					
Dimensions			Weight	Style Number	Price
D	W	H			
3⅓"	5½"	1⅘"	4.175 lb	DSPSDUOR	\$289

Height-Adjustable Worksurfaces

Cable and Power Management, continued

SIN 711.2

USB Three-Outlet Powerstrip with Clamp Mount

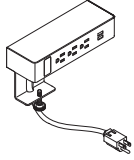

Tip: Clamp accommodates worksurface thicknesses 1/2" – 1 1/2".

Tip: Each USB port can utilize up to 2.1 amps. Each port is independent of the other.

Tip: Data opening accommodates RJ45, HDMI, and VGA faceplates. All three faceplates ship with powerstrip. A filler is also included if termination of data is not required.

Tip: L-com data jacks must be used and are purchased separately through L-com.

Standard Includes	Required to Specify
-------------------	---------------------

- Clamp mount bracket: paint
- Housing with two USB ports, one data port with filler, and three power outlets: plastic
- 9' white cord

- 1 Style number
- 2 Paint color number for bracket:
 - 4140 Arctic White
 - 4799 Platinum Metallic
 - 7360 Merle
- 3 Plastic color number for housing:
 - 6009 Arctic White
 - 6527 Merle

Specification Information					
• Dimensions			• Weight	• Style	• Price
D	W	H		Number	

3 1/8"	8"	1 4/5"	5.043 lb	DSPSTRIOC	\$332
·	·	·	·	·	·

USB Three-Outlet Powerstrip with Rail Mount

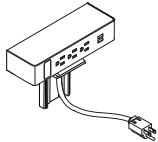

Tip: Each USB port can utilize up to 2.1 amps. Each port is independent of the other.

Tip: Data opening accommodates RJ45, HDMI, and VGA faceplates. All three faceplates ship with powerstrip. A filler is also included if termination of data is not required.

Tip: L-com data jacks must be used and are purchased separately through L-com.

Standard Includes	Required to Specify
-------------------	---------------------

- Rail mount bracket: 4799 Platinum Metallic
- Housing with two USB ports, one data port with filler, and three power outlets: plastic
- 9' white cord

- 1 Style number
- 2 Plastic color number for housing:
 - 6009 Arctic White
 - 6527 Merle

Specification Information					
• Dimensions			• Weight	• Style	• Price
D	W	H		Number	

3 1/8"	8"	1 4/5"	5.043 lb	DSPSTRIOR	\$342
·	·	·	·	·	·

Height-Adjustable Benching

Statement of Line	298
--------------------------	------------

Understanding

Workstation Design Guidelines and Requirements	300
Basics of Ergonomic Seating	301
Basics of Standing and Monitor Arm Positioning	302

Specifying

Ology Height-Adjustable Benching (SIN 711.2)	304
Universal Centered Screens and Aligners (SIN 711.2)	314
Fixed Personal Screen (SIN 711.2)	316

Statement of Line

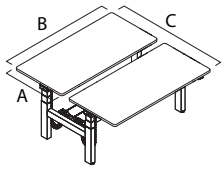

Specifying
▶ Pages 304

Ology Height-Adjustable Dual-Sided Benches

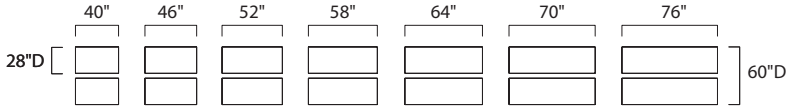

Tip: Widths are parametric to 1/16" from 40"W—78"W.

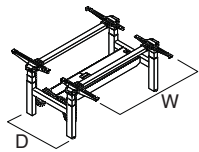

Specifying
▶ Pages 306

Ology Height-Adjustable Dual-Sided Bases

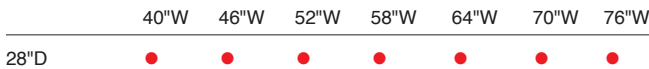

Tip: Widths are parametric to 1/16" from 40"W—78"W.

Accessories for Ology

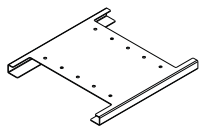

Connection Kit
Specifying
▶ Page 311



End of Run Tray Covers
Specifying
▶ Page 311

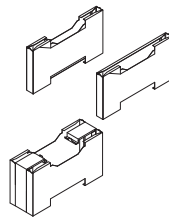

Infill
Specifying
▶ Page 312



Cable Manager
Specifying
▶ Page 312



90° Mini Extension Cord
Specifying
▶ Page 313

Accessories for Ology, continued

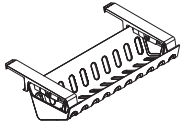

Specifying
▶ Page 313

Cable Basket

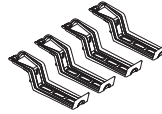

Specifying
▶ Page 313

Cable Brackets

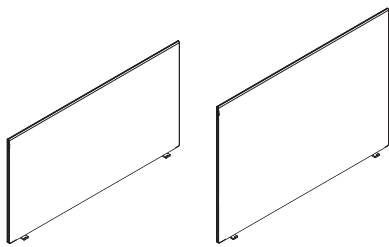

26"H

32"H

Specifying
▶ Page 314

Universal Screens for Use with Ology Dual-Sided Benches

	42"W	48"W	54"W	60"W	66"W	72"W	78"W
26"H	●	●	●	●	●	●	●
32"H	●	●	●	●	●	●	●



Specifying
▶ Page 316

Fixed Personal Screens

	30"W	36"W	42"W	48"W
12"H	●	●	●	●
19½"H	●	●	●	●
24"H	●	●	●	●

Height-Adjustable
Benching

Workstation Design Guidelines and Requirements

Overview

Designed for movement with dynamic seating, adjustable worktools and height-adjustable benches are important for today's office workers.

To determine the best height-adjustable solution, consider these four criteria:

1. **Adjustability Needed**
What is the height range requirement? (seated or sit-to-stand)
2. **Worksurface Size Needed**
What does the physical space look like?
3. **Equipment/Tools Used**
What type of computer equipment and other worktools are being used on the worksurface? (weight capacity)
4. **Use**
What is the height-adjustable desk being used for (individual or shared, touchdown space or full workstation, sit-to-stand or seated)?

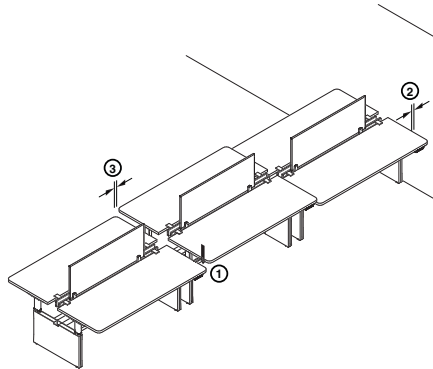

WARNING

Risk of Serious Injury. If not used as intended, moving worksurfaces can pinch or injure people, or damage property. Always follow these Instructions:

1. Keep height-adjustment range free from obstructions above and below the worksurface.
2. Plan for a minimum 1" gap against a panel or wall.
3. Plan for a minimum 1" gap to adjacent furniture.

Tips

Obstructions

Moving worksurfaces can collide with other objects. Do not install overhead storage, stationary pedestals or components in the path of height-adjustable desks.

Weight

The maximum allowable load (varies by height-adjustable bench) should be evenly distributed and must not be exceeded.

Width

Specify a minimum 1" gap to adjacent furniture. This eliminates any pinch points between a height-adjustable desk and a fixed object.

Managing Technology

Design workstations with computer equipment in mind so that the height-adjustment range of the height-adjustable desk is not impeded because of cables.

Power

Plan easy and unobstructed access to power for users at worksurface height through the use of the power access door or power strip.

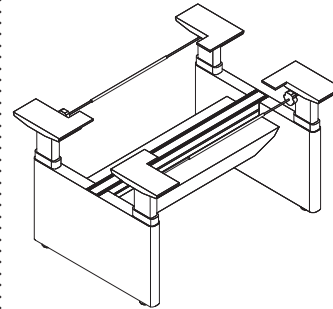

WARNING

Risk of serious injury.

Bases-only warranty limitations and potential for injury: The use of worksurfaces that do not comply with the Steelcase defined criteria and limitations could cause personal injury or property damage due to pinch points, instability, or other problems, and voids all Steelcase Warranties, expressed or implied.

The use of worksurfaces that do not comply with Steelcase criteria voids any Steelcase claims of compliance with ANSI/BIFMA, UL, LEED, or other applicable requirements. The use of non-Steelcase worksurfaces on Steelcase adjustable-height bases may not be accepted as compliant to municipal electrical codes or OSHA federal workplace standards, because this use does not create an NRTL (UL, ETL, etc.) listed product. Steelcase is not responsible for the ultimate determinations of compliance for height-adjustable bases with non-Steelcase worksurface, and assumes no liability for their compliance with standards when height adjustable bases are used without a Steelcase worksurface as intended.

Worksurface Criteria and Limitations

The use of non-Steelcase worksurfaces is not recommended. Any use of a non-Steelcase worksurface requires additional investigation by the customer regarding the appropriateness for use. It is the sole responsibility of the customer to determine the suitability and safety of the selected worksurface construction and attachment means. The following information is provided as a guideline, but does not address all potential issues. Customers should seek professional guidance as to the appropriateness of their chosen worksurface.

Tips

Height-adjustable bases include fasteners intended for use with Steelcase worksurfaces. These fasteners may be suitable for worksurfaces meeting the following criteria:

- Medium-density or higher particleboard or fiberboard cores, with High- or Low-Pressure Laminates and backers.
- Thickness of 1" or greater (Ology and Migration)
- Thickness of 1³/₁₆" or greater (Series 5 and 8 bases)
- Fasteners located a minimum distance of 1" from any edge

Basics of Ergonomic Seating

A well-designed, ergonomically advanced chair that allows a full range of healthy postures throughout the day and can contribute to worker wellness and productivity.

Neck is straight or slightly forward.

Shoulders are relaxed so arms hang naturally.

Back has full contact with the backrest (sit all the way back in your chair).

Elbows and forearms can rest comfortably on the arms of your chair, or on worksurfaces.

Lower back fits into curved lumbar support.

Tension is adjusted so backrest reclines easily, yet provides smooth, even support, and encourages postural change.

Top of monitor should be at eye level.

Screen is 20 to 30 inches from the eyes. Screen is at eye level slightly lower and directly in front of worker so head is not turned.

Wrists should be straight when keying or mousing, not bent up or down.

When keying or mousing, forearms are parallel to the floor.

Thighs are parallel to the floor.

Feet are flat on the floor or on a footrest.

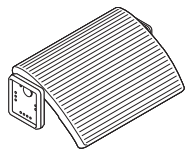
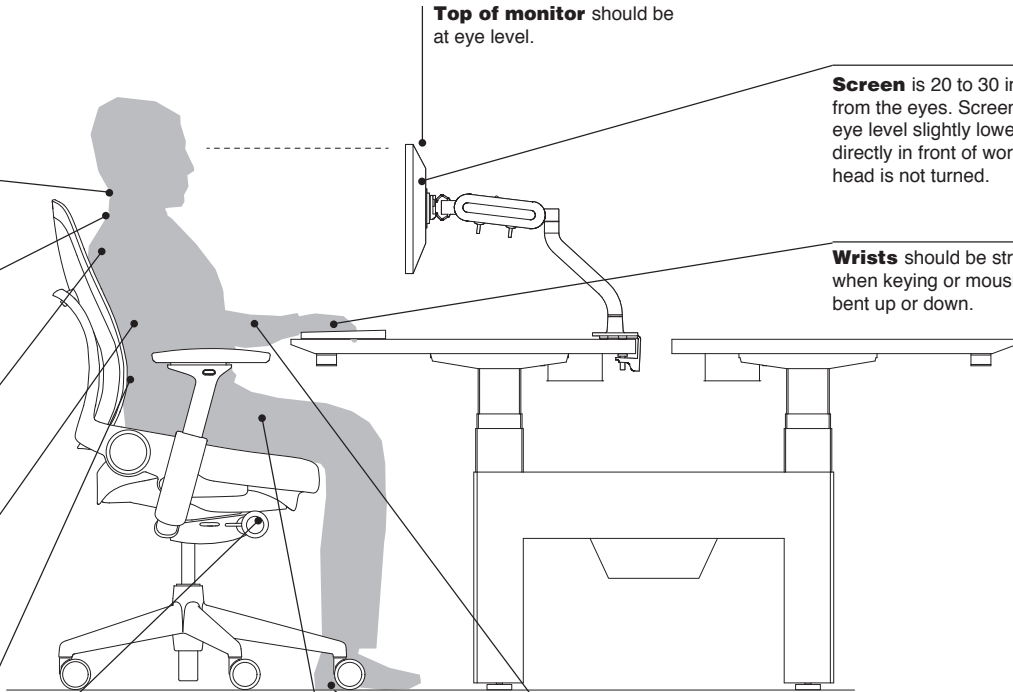

If worksurfaces and keyboard support are not height-adjustable, raise your chair's seat height to achieve the appropriate relationship to your tasks. If this leaves your feet dangling above the floor, use a footrest.

Basics of Standing and Monitor Arm Positioning

Height-adjustable benches, when combined with monitor arms, allow a full range of healthy postures throughout the day and can contribute to worker wellbeing and productivity.

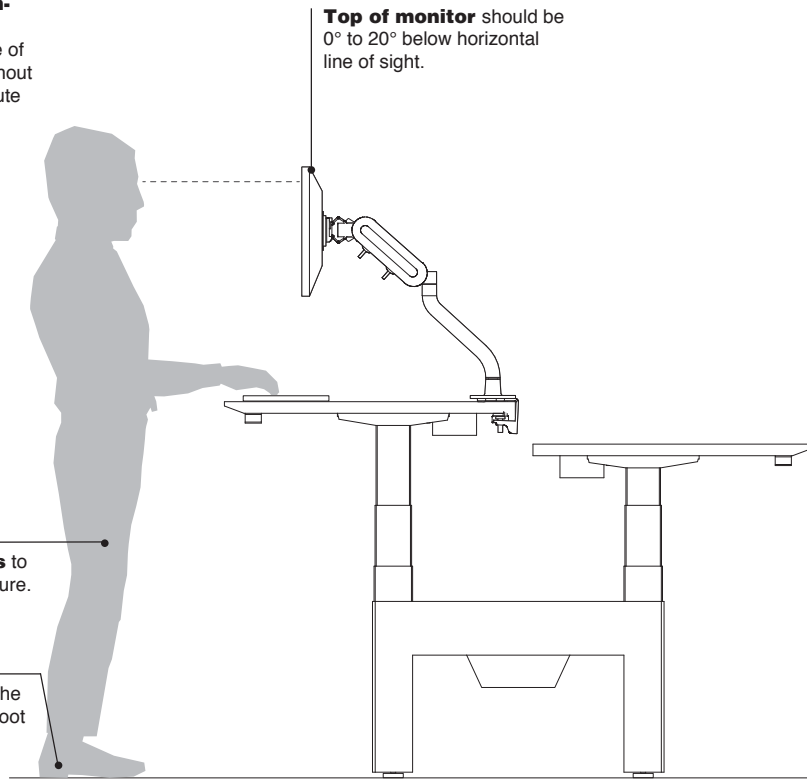

Avoid locking knees to help maintain good posture.

Feet should be flat on the floor or use foot rest or foot pad.

Height

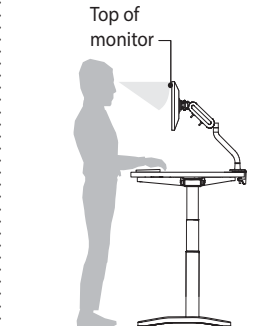

Top of the monitor should be positioned at or slightly below eye level.

Distance

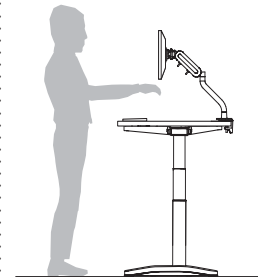

Monitor should be 20" to 30" from the eyes or approximately an arm's length away.

Alignment

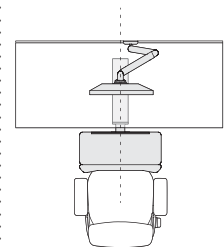

Proper alignment is the key to preventing strain. Computer monitor, keyboard, and mouse should be centered to allow user to see the display without looking downward or to either side. Mouse should be accessible without twisting or reaching. Reference documents should never be flat on desk and should be at the same height as or aligned with the monitor or above keyboard and below the monitor.

**Dual Monitor
Alignment**

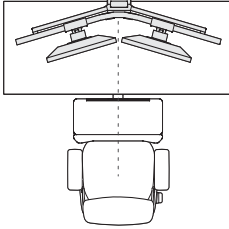

If using two monitors, position the monitor used more often closer. If equally used, center monitors directly in front and angle them in a slight inward "V" shape.

Ology Height-Adjustable Dual-Sided Benches

High-Pressure Laminate or Wood Veneer

SIN 711.2

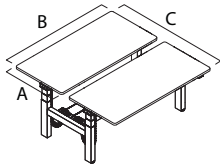

Tip: On extended height bases, any storage higher than 19", or 16½" if the power access door is optioned, will impede lowest height range of bench worksurface. On basic height bases, any storage higher than 23⅞", or 21⅝" if the power access door is optioned, will impede lowest height range of bench worksurface. Do not place storage underneath controller.

Tip: Only single and dual flat panel monitor arm applications are permitted for use with 2-leg height-adjustable benches.

▶ See *Steelcase Worktools Specification Guide*.

Tip: Base supports a maximum distributed weight capacity of 314 pounds (2-leg). When calculating lifting capacity, subtract the weight of the worksurface, understructure, and options selected.

▶ See *Steelcase Benching Specification Guide*.

Tip: Antimicrobial can be specified only when specifying simple touch controller and/or soft edge.

Standard Includes	Required to Specify
<ul style="list-style-type: none"> Two worksurfaces: High-Pressure Laminate with 3 mm plastic edge or wood veneer Two electric height-adjustable sit-to-stand bases: paint 2" adjustable glides Two power cords: 9' Attachment hardware Two perpendicular cable managers Cable tray and covers: paint to match base 	<ol style="list-style-type: none"> Style number Bench width High-Pressure Laminate or wood color for worksurface Plastic color number for profile edge on laminate worksurfaces, if selected Bench corner style, if laminate bench selected (see below under Required Selections) Paint color number for base: 4799 Platinum Metallic 7207 Black 7241 Arctic White 7360 Merle Controller (see below under Required Selections) Integrated rail (see below under Required Selections) Antimicrobial or non-antimicrobial surface, if simple touch controller selected (see below under Required Selections) Options, if selected (see below) <p>▶ See <i>Surface Materials</i>, page 318.</p>

Required Selections	Price	Required to Specify
Bench Corner Style (Laminate Benches Only) <ul style="list-style-type: none"> Square corners Radius corners 	No cost +\$120	Specify <i>with square corners</i> . Specify <i>with radius corners</i> .
Controller <ul style="list-style-type: none"> Simple touch controller Active touch controller 	No cost +\$230	Specify <i>with simple touch controller</i> . Specify <i>with active touch controller</i> .
Integrated Rail <ul style="list-style-type: none"> Without integrated rail With integrated rail 	No cost +\$646	Specify <i>without integrated rail</i> . Specify <i>with integrated rail</i> .
Antimicrobial Surface <ul style="list-style-type: none"> Non-antimicrobial surface Antimicrobial surface 	No cost No cost	Specify <i>with non-antimicrobial surface</i> . Specify <i>with antimicrobial surface</i> .

Options	Price	Required to Specify
Surface Materials <ul style="list-style-type: none"> High-Pressure Laminate benches <ul style="list-style-type: none"> Open Line laminate Wood veneer benches <ul style="list-style-type: none"> Premium wood 2 Premium wood 3 Customiz stain Full-fill finish 	+\$ 67 plus cost of laminate +\$134 +\$472 No cost +\$134	▶ See <i>Surface Materials Reference Manual</i> . Specify Premium wood 2 finish number. Specify Premium wood 3 finish number. Specify <i>with Customiz stain</i> . ▶ See <i>Surface Materials Reference Manual</i> . Specify full-fill finish number.

▶ Options, continued on next page

SIN 711.2

► Options, continued from previous page

Options	Price	Required to Specify
Surface Materials, continued Base <ul style="list-style-type: none"> • Paint price group 1 • Paint price group 2 	No cost +\$ 56	Specify paint color number. Specify paint color number. ► See <i>Surface Materials</i> , page 318.
Bench Type <ul style="list-style-type: none"> • Parametric width bench 	No cost	Specify with <i>parametric bench type</i> .
Data Tray <ul style="list-style-type: none"> • With data tray 	+\$ 69	Specify with <i>data tray</i> .
Cable Manager Application <ul style="list-style-type: none"> • Parallel 	+\$ 40	Specify with <i>parallel application</i> .
Soft Edge <ul style="list-style-type: none"> • With soft edge 	+\$ 496	Specify with <i>soft edge</i> .
Power and Data Access Door, Tray, and USB <ul style="list-style-type: none"> • Power and data access door, tray and USB: paint price group 1 or 2 • Power and data access door, tray and USB: anodized aluminum 	+\$1548 +\$1568	Specify with <i>power and data access door</i> and select paint color number. Specify with <i>power and data access door</i> and select anodized aluminum.
Power and Data Access Door and Soft Edge Position <ul style="list-style-type: none"> • Centered • Left • Right 	No cost No cost No cost	Specify with <i>centered position</i> . Specify with <i>left position</i> . Specify with <i>right position</i> .
Grommet <ul style="list-style-type: none"> • Grommet 	+\$ 78	Specify with <i>grommet</i> .
Related Products <ul style="list-style-type: none"> • Cable manager 		► Page 311

Tip: Soft edge is available on benches 58"W and larger.

Tip: Rectangular benches accommodate either power and data access door or grommet, but not both.

Specification Information

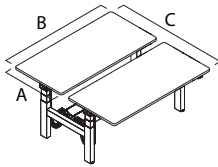

Style Number	Dimensions D	Base Prices							
		Bench Type	40"W	46"W	52"W	58"W	64"W	70"W	76"W
Modular		40"W	46"W	52"W	58"W	64"W	70"W	76"W	
		42 1/16"W	48 1/16"W	54 1/16"W	60 1/16"W	66 1/16"W	72 1/16"W		
Parametric		40"W	42"W	48"W	54"W	60"W	66"W	72"W	
		42"W	44"W	50"W	56"W	62"W	68"W	74"W	

Dual-Sided Laminate Benches — Extended Height

OLBELRQD	28"	\$4347	\$4504	\$4661	\$4816	\$4982	\$5145	\$5308
----------	-----	--------	--------	--------	--------	--------	--------	--------

Dual-Sided Veneer Benches — Extended Height

OLBELRQD	28"	\$5477	\$5650	\$5825	\$5994	\$6184	\$6361	\$6542
----------	-----	--------	--------	--------	--------	--------	--------	--------

Dual-Sided Laminate Benches — Basic Height

OLBSLRQD	28"	\$3999	\$4144	\$4288	\$4431	\$4583	\$4733	\$4883
----------	-----	--------	--------	--------	--------	--------	--------	--------

Dual-Sided Veneer Benches — Basic Height

OLBSLRQD	28"	\$5101	\$5262	\$5424	\$5581	\$5755	\$5919	\$6087
----------	-----	--------	--------	--------	--------	--------	--------	--------

Ology Height-Adjustable Benching

Ology Height-Adjustable Dual-Sided Bases

SIN 711.2

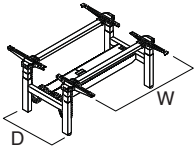

Tip: On extended height bases, any storage higher than 19" will impede lowest height range of bench worksurface. On basic height bases, any storage higher than 23⁷/₁₆" will impede lowest height range of bench worksurface. Do not place storage underneath controller.

Tip: Only single and dual flat panel monitor arm applications are permitted for use with 2-leg height-adjustable benches.

▶ See *Steelcase Worktools Specification Guide*.

Tip: Base supports a maximum distributed weight capacity of 314 pounds (2-leg). When calculating lifting capacity, subtract the weight of the worksurface, understructure, and options selected.

▶ See *Steelcase Benching Specification Guide*.

Tip: Antimicrobial can be specified only when specifying simple touch controller.

Tip: Attachment hardware is intended for worksurfaces 1" thick only.

Standard Includes	Required to Specify
<ul style="list-style-type: none"> Two electric height-adjustable sit-to-stand bases: paint 2" adjustable guides Two power cords: 9' Attachment hardware Two perpendicular cable managers Cable tray and covers: paint to match base 	<ol style="list-style-type: none"> Style number Bench width Paint color number for bases: <ul style="list-style-type: none"> 4799 Platinum Metallic 7207 Black 7241 Arctic White 7360 Merle Controller (see below under Required Selections) Antimicrobial or non-antimicrobial surface, if simple touch controller selected (see below under Required Selections) Options, if selected (see below) <ul style="list-style-type: none"> ▶ See <i>Surface Materials</i>, page 318.

Required Selections	Price	Required to Specify
Controller <ul style="list-style-type: none"> Simple touch controller Active touch controller 	No cost +\$230	Specify with <i>simple touch controller</i> . Specify with <i>active touch controller</i> .
Antimicrobial Surface <ul style="list-style-type: none"> Non-antimicrobial surface Antimicrobial surface 	No cost No cost	Specify with <i>non-antimicrobial surface</i> . Specify with <i>antimicrobial surface</i> .

Options	Price	Required to Specify
Surface Materials <ul style="list-style-type: none"> Bases <ul style="list-style-type: none"> Paint price group 1 Paint price group 2 	No cost +\$ 56	Specify paint color number. Specify paint color number. ▶ See <i>Surface Materials</i> , page 318.
Bench Type <ul style="list-style-type: none"> Parametric width bench 	No cost	Specify with <i>parametric bench type</i> .
Data Tray <ul style="list-style-type: none"> With data tray 	+\$ 69	Specify with <i>data tray</i> .
Cable Manager Application <ul style="list-style-type: none"> Parallel 	+\$ 40	Specify with <i>parallel application</i> .

Specification Information

Style Number	Dimension D	Bench Type	Base Prices						
			40"W	46"W	52"W	58"W	64"W	70"W	76"W
.	.	Modular	40"W	46"W	52"W	58"W	64"W	70"W	76"W
		Parametric	40"W 42"W	42 ¹ / ₁₆ "W 48"W	48 ¹ / ₁₆ "W 54"W	54 ¹ / ₁₆ "W 60"W	60 ¹ / ₁₆ "W 66"W	66 ¹ / ₁₆ "W 72"W	72 ¹ / ₁₆ "W 78"W

Dual-Sided Base — Extended Height

OLBELRQDB	28"	\$4335	\$4398	\$4431	\$4484	\$4554	\$4585	\$4610
.

Dual-Sided Base — Basic Height

OLBSLRQDB	28"	\$3988	\$4046	\$4077	\$4125	\$4190	\$4218	\$4241
.

SIN 711.2

Ology Height-Adjustable Combo Dual-Sided Benches

High-Pressure Laminate or Wood Veneer

SIN 711.2

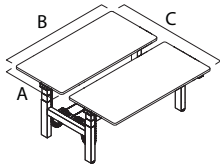

Tip: On extended height bases, any storage higher than 19", or 16½" if the power access door is optioned, will impede lowest height range of bench worksurface. On basic height bases, any storage higher than 23⅞", or 21½" if the power access door is optioned, will impede lowest height range of bench worksurface. Do not place storage underneath controller.

Tip: Base supports a maximum distributed weight capacity of 314 pounds (2-leg). When calculating lifting capacity, subtract the weight of the worksurface, understructure, and options selected.

▶ See *Steelcase Benching Specification Guide*.

Tip: If selecting the same leg type position for both sides of the bench, the non-combo style benches should be used.

Tip: Antimicrobial can be specified only when specifying simple touch controller and/or soft edge.

Standard Includes	Required to Specify
<ul style="list-style-type: none"> • Two worksurfaces, one basic height and one extended height: High-Pressure Laminate with 3 mm plastic edge or wood veneer • Two electric height-adjustable sit-to-stand bases: paint • 2" adjustable glides • Two power cords: 9' • Attachment hardware • Two perpendicular cable managers • Cable tray and covers: paint to match base 	<ol style="list-style-type: none"> 1 Style number 2 Bench width 3 Leg type position one (see below under Required Selections) 4 Leg type position two (see below under Required Selections) 5 High-Pressure Laminate or wood color for worksurface 6 Plastic color number for profile edge on laminate worksurfaces, if selected 7 Bench corner style, if laminate bench selected (see below under Required Selections) 8 Paint color number for base 4799 Platinum Metallic 7207 Black 7241 Arctic White 7360 Merle 9 Controller (see below under Required Selections) 10 Integrated rail (see below under Required Selections) 11 Antimicrobial or non-antimicrobial surface, if simple touch controller selected (see below under Required Selections) 12 Options, if selected (see below) <p>▶ See <i>Surface Materials</i>, page 318.</p>

	Required Selections	Price	Required to Specify
Leg Type Position One	<ul style="list-style-type: none"> • Basic height • Extended height 	Prices at right Prices at right	Specify <i>with basic height</i> . Specify <i>with extended height</i> .
Leg Type Position Two	<ul style="list-style-type: none"> • Basic height • Extended height 	Prices at right Prices at right	Specify <i>with basic height</i> . Specify <i>with extended height</i> .
Bench Corner Style (Laminate Benches Only)	<ul style="list-style-type: none"> • Square corners • Radius corners 	No cost +\$120	Specify <i>with square corners</i> . Specify <i>with radius corners</i> .
Controller	<ul style="list-style-type: none"> • Simple touch controller • Active touch controller 	No cost +\$230	Specify <i>with simple touch controller</i> . Specify <i>with active touch controller</i> .
Integrated Rail	<ul style="list-style-type: none"> • Without integrated rail • With integrated rail 	No cost +\$646	Specify <i>without integrated rail</i> . Specify <i>with integrated rail</i> .
Antimicrobial Surface	<ul style="list-style-type: none"> • Non-antimicrobial surface • Antimicrobial surface 	No cost No cost	Specify <i>with non-antimicrobial surface</i> . Specify <i>with antimicrobial surface</i> .

SIN 711.2

Options	Price	Required to Specify
Surface Materials	High-Pressure Laminate benches	
• Open Line laminate	+\$ 65 plus cost of laminate	▶ See <i>Surface Materials Reference Manual</i> .
	Wood veneer benches	
• Premium wood 2	+\$ 130	Specify Premium wood 2 finish number.
• Premium wood 3	+\$ 460	Specify Premium wood 3 finish number.
• Customiz stain	No cost	Specify with <i>Customiz stain</i> .
• Full-fill finish	+\$ 130	▶ See <i>Surface Materials Reference Manual</i> . Specify full-fill finish number.
	Base	
• Paint price group 1	No cost	Specify paint color number.
• Paint price group 2	+\$ 56	Specify paint color number. ▶ See <i>Surface Materials</i> , page 318.
Bench Type	• Parametric width bench	No cost Specify with <i>parametric bench type</i> .
Data Tray	• With data tray	+\$ 69 Specify with <i>data tray</i> .
Cable Manager Application	• Parallel	+\$ 42 Specify with <i>parallel application</i> .
Soft Edge	• With soft edge	+\$ 496 Specify with <i>soft edge</i> .
Power and Data Access Door, Tray, and USB	• Power and data access door, tray and USB: paint price group 1 or 2	+\$1548 Specify with <i>power and data access door</i> and select paint color number.
	• Power and data access door, tray and USB: anodized aluminum	+\$1568 Specify with <i>power and data access door</i> and select anodized aluminum.
Power and Data Access Door and Soft Edge Position	• Centered	No cost Specify with <i>centered position</i> .
	• Left	No cost Specify with <i>left position</i> .
	• Right	No cost Specify with <i>right position</i> .
Grommet	• Grommet	+\$ 78 Specify with <i>grommet</i> .
Related Products	• Cable manager	▶ Page 312
	• Universal screens	▶ Page 314

Tip: Soft edge is available on benches 58"W and larger.

Tip: Rectangular benches accommodate either power and data access door or grommet, but not both.

Specification Information

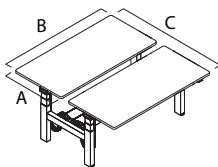

Style Number	Dimensions D	Base Prices						
		Bench Type	40"W	46"W	52"W	58"W	64"W	70"W
Modular	28"	40"W	46"W	52"W	58"W	64"W	70"W	76"W
		42 1/8"W	48 1/8"W	54 1/8"W	60 1/8"W	66 1/8"W	72 1/8"W	78 1/8"W
Parametric	28"	40"W	42 1/8"W	48 1/8"W	54 1/8"W	60 1/8"W	66 1/8"W	72 1/8"W
		42"W	48"W	54"W	60"W	66"W	72"W	78"W

Dual-Sided Laminate Benches — Combo

OLBRQD	28"	\$4173	\$4324	\$4474	\$4623	\$4783	\$4940	\$5096
--------	-----	--------	--------	--------	--------	--------	--------	--------

Dual-Sided Veneer Benches — Combo

OLBRQD	28"	\$5275	\$5442	\$5610	\$5773	\$5955	\$6126	\$6300
--------	-----	--------	--------	--------	--------	--------	--------	--------

Ology Height-Adjustable Benching

Ology Height-Adjustable Combo Dual-Sided Bases

SIN 711.2

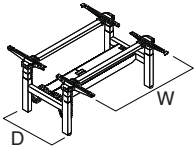

Tip: On extended height bases, any storage higher than 19" will impede lowest height range of bench worksurface. On basic height bases, any storage higher than 23⁷/₁₆" will impede lowest height range of bench worksurface. Do not place storage underneath controller.

Tip: If selecting the same leg type position for both sides of the bench, the non-combo style benches should be used.

Tip: Base supports a maximum distributed weight capacity of 314 pounds (2-leg). When calculating lifting capacity, subtract the weight of the worksurface, understructure, and options selected.

► See Steelcase Benching Specification Guide.

Tip: Antimicrobial can be specified only when specifying simple touch controller.

Tip: Attachment hardware is intended for worksurfaces 1" thick only.

Standard Includes	Required to Specify
<ul style="list-style-type: none"> Two electric height-adjustable sit-to-stand bases, one basic height and one extended height: paint 2" adjustable glides Two power cords: 9' Attachment hardware Two perpendicular cable managers Cable tray and covers: paint to match base 	<ol style="list-style-type: none"> Style number Bench width Leg type position one (see below under Required Selections) Leg type position two (see below under Required Selections) Paint color number for bases <ul style="list-style-type: none"> 4799 Platinum Metallic 7207 Black 7241 Arctic White 7360 Merle Controller (see below under Required Selections) Antimicrobial or non-antimicrobial surface, if simple touch controller selected (see below under Required Selections) Options, if selected (see below) <p>► See <i>Surface Materials</i>, page 318.</p>

Required Selections	Price	Required to Specify
Leg Type Position One <ul style="list-style-type: none"> Basic height Extended height 	Prices at right Prices at right	Specify with <i>basic height</i> . Specify with <i>extended height</i> .
Leg Type Position Two <ul style="list-style-type: none"> Basic height Extended height 	Prices at right Prices at right	Specify with <i>basic height</i> . Specify with <i>extended height</i> .
Controller <ul style="list-style-type: none"> Simple touch controller Active touch controller 	No cost +\$230	Specify with <i>simple touch controller</i> . Specify with <i>active touch controller</i> .
Antimicrobial Surface <ul style="list-style-type: none"> Non-antimicrobial surface Antimicrobial surface 	No cost No cost	Specify with <i>non-antimicrobial surface</i> . Specify with <i>antimicrobial surface</i> .

Options	Price	Required to Specify
Surface Materials <ul style="list-style-type: none"> Bases Paint price group 1 Paint price group 2 	No cost +\$ 56	Specify paint color number. Specify paint color number. ► See <i>Surface Materials</i> , page 318.
Bench Type <ul style="list-style-type: none"> Parametric width bench 	No cost	Specify with <i>parametric bench type</i> .
Data Tray <ul style="list-style-type: none"> With data tray 	+\$ 69	Specify with <i>data tray</i> .
Cable Manager Application <ul style="list-style-type: none"> Parallel 	+\$ 40	Specify with <i>parallel application</i> .

Specification Information

Style Number	Dimension D	Bench Type	Base Prices						
			40"W	46"W	52"W	58"W	64"W	70"W	76"W
		Modular	40"W	46"W	52"W	58"W	64"W	70"W	76"W
		Parametric	40"W	42 ¹ / ₁₆ "W	48 ¹ / ₁₆ "W	54 ¹ / ₁₆ "W	60 ¹ / ₁₆ "W	66 ¹ / ₁₆ "W	72 ¹ / ₁₆ "W
			42"W	48"W	54"W	60"W	66"W	72"W	78"W

Dual-Sided Base — Combo

OLBRQDB	28"	\$4161	\$4222	\$4253	\$4305	\$4372	\$4402	\$4426
----------------	-----	--------	--------	--------	--------	--------	--------	--------

Accessories for Use with Ology Dual-Sided Benches

SIN 711.2

Connection Kit

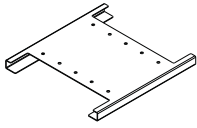

Tip: Must order connection kit when combining two or more benches.

Standard Includes	Required to Specify
-------------------	---------------------

- Connection kit: paint
- Hardware

- 1 Style number
- 2 Paint color number for connection kit:
 - 4799 Platinum Metallic
 - 7207 Black
 - 7241 Arctic White
 - 7360 Merle

Specification Information	
• Style Number	• Price

• Style Number	• Price
OLBCK	\$66

End of Run Tray Covers



Tip: Tray covers can be added to finish off the ends of the cable tray.

Standard Includes	Required to Specify
-------------------	---------------------

- Pair of tray covers: paint

- 1 Style number
- 2 Paint color number for tray covers:
 - 4799 Platinum Metallic
 - 7207 Black
 - 7241 Arctic White
 - 7360 Merle

Specification Information	
• Style Number	• Price

• Style Number	• Price
OLBEC	\$50

Ology Height-Adjustable Benching

Accessories for Use with Ology Dual-Sided Benches, continued

SIN 711.2

Infill

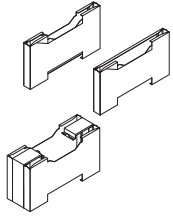

Tip: Intermediate shared application is used when large capacity is required.

Standard Includes	Required to Specify
-------------------	---------------------

Standard Includes	Required to Specify
<ul style="list-style-type: none"> Infill: paint price group 1 End of run: pair Intermediate: pair Intermediate shared: pair and L-bracket fillers Brackets and caps 	<ol style="list-style-type: none"> Style number Infill application (see below under Required Selections) Paint color number for infill Options, if selected (see below) <p>▶ See <i>Surface Materials</i>, page 318.</p>

Required Selections	Price	Required to Specify
---------------------	-------	---------------------

Required Selections	Price	Required to Specify
Infill Application <ul style="list-style-type: none"> End of run Intermediate Intermediate shared 	<ul style="list-style-type: none"> No cost No cost No cost 	<ul style="list-style-type: none"> Specify with <i>end of run</i>. Specify with <i>intermediate</i>. Specify with <i>intermediate shared</i>.

Options	Price	Required to Specify
---------	-------	---------------------

Options	Price	Required to Specify
Surface Materials <ul style="list-style-type: none"> Paint price group 1 Paint price group 2 	<ul style="list-style-type: none"> No cost +\$29 	<ul style="list-style-type: none"> Specify paint color number. Specify paint color number.

Specification Information	
Style Number	Base Price

Style Number	Base Price
OLBFL	\$240

Cable Manager

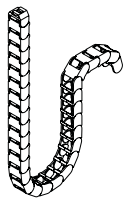

Tip: Cable manager is compatible with Ology bench only. Two cable managers come standard with each dual-sided bench.

Standard Includes	Required to Specify
-------------------	---------------------

Standard Includes	Required to Specify
<ul style="list-style-type: none"> Perpendicular cable manager Attachment hardware 	<ol style="list-style-type: none"> Style number Options, if selected (see below)

Options	Price	Required to Specify
---------	-------	---------------------

Options	Price	Required to Specify
Cable Manager Application <ul style="list-style-type: none"> Parallel 	<ul style="list-style-type: none"> +\$20 	<ul style="list-style-type: none"> Specify with <i>parallel application</i>.

Specification Information	
Style Number	Base Price

Style Number	Base Price
OLBCM	\$50

Cable Basket

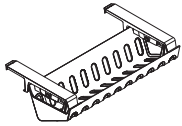

Tip: Cable baskets are compatible with rectangular, tapered, or 90° corner desks 46¹/₆"W or larger and 120° corner desks 40¹/₆"W or larger.

Standard Includes	Required to Specify
• Cable basket: 6527 Merle plastic	Style number

Specification Information

• Style Number	• Weight	• Price
OLCB	1.0 lb	\$55
•	•	•

Cable Brackets

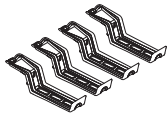

Standard Includes	Required to Specify
• Cable brackets, quantity of four: 6527 Merle plastic	Style number

Specification Information

• Style Number	• Weight	• Price
OLCBK4	0.5 lb	\$33
•	•	•

90° Mini Extension Cord



Tip: 90° mini extension cord can be used with Ology bench, FrameOne, or where power receptacles are located in confined spaces.

Standard Includes	Required to Specify
• 10"L molded NEMA mini extension cord	Style number

Specification Information

• Style Number	• Price
LMINICORD	\$40
•	•

Ology Height-Adjustable Benching

Universal Centered Screens and Aligners

For Use with Ology Benches

SIN 711.2

Universal Centered Screens

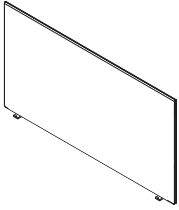

Standard Includes	Required to Specify
<ul style="list-style-type: none"> • Screen: fabric price group 1 • Edge (upper segment): 7360 Merle • Edge (lower segment): felt • Brackets: 7360 Merle 	<ol style="list-style-type: none"> 1 Style number 2 Height (see below under Required Selections) 3 Width (see below under Required Selections) 4 Edge (lower segment) felt color: P630 Light Heather Grey P631 Dark Heather Grey 4 Fabric color number for screen 5 Options, if selected (see below) <p>▶ See <i>Surface Materials</i>, page 318.</p>

	Required Selections	Price	Required to Specify
Height	<ul style="list-style-type: none"> • 26"H • 32"H 	<p>Prices below</p> <p>Prices below</p>	<p>Specify with 26"H.</p> <p>Specify with 32"H.</p>
Width	<ul style="list-style-type: none"> • 42"W • 48"W • 54"W • 60"W • 66"W • 72"W • 78"W 	<p>Prices below</p> <p>Prices below</p> <p>Prices below</p> <p>Prices below</p> <p>Prices below</p> <p>Prices below</p> <p>Prices below</p>	<p>Specify with 42"W.</p> <p>Specify with 48"W.</p> <p>Specify with 54"W.</p> <p>Specify with 60"W.</p> <p>Specify with 66"W.</p> <p>Specify with 72"W.</p> <p>Specify with 78"W.</p>

	Options	Price	Required to Specify
Surface Materials	<ul style="list-style-type: none"> • Fabric price group 1 • Fabric price group 2 • Fabric price group 3 • Fabric price group 4 • Fabric price group 5 • Fabric price group 6 • Fabric price group 7 • Fabric price group 8 • Fabric price group 9 • Fabric price group 10 • Customer's Own Material (COM) 	<p>No cost</p> <p>+\$ 47</p> <p>+\$102</p> <p>+\$124</p> <p>+\$154</p> <p>+\$184</p> <p>+\$214</p> <p>+\$244</p> <p>+\$274</p> <p>+\$304</p> <p>+\$ 16</p>	<p>Specify fabric color number.</p> <p>Specify fabric color number.</p> <p>Specify fabric color number.</p> <p>Specify fabric color number.</p> <p>Specify fabric color number.</p> <p>Specify fabric color number.</p> <p>Specify fabric color number.</p> <p>Specify fabric color number.</p> <p>Specify fabric color number.</p> <p>Specify fabric color number.</p> <p>▶ See <i>Surface Materials Reference Manual</i>.</p>

Specification Information								
• Style Number	• Height	• Base Prices						
		42"W	48"W	54"W	60"W	66"W	72"W	78"W
OLBSC	26"	\$688	\$708	\$728	\$748	\$768	\$788	\$808
	32"	\$826	\$846	\$866	\$886	\$906	\$926	\$946

Tip: 26"H screen will align at a 42" datum. 32"H screen will align at a 48" datum.

Aligners for Use with Universal Screens



Tip: Aligners are for use with Universal screens in in-line applications only.

Standard Includes	Required to Specify
<ul style="list-style-type: none"> Aligners, package of 10: 6527 Merle 	Style number

Specification Information

Style Number	Price
UFAL	\$25

Fixed Personal Screens

SIN 711.2

Standard Includes	Required to Specify
-------------------	---------------------

- Personal screens: fabric price group 1
- Brackets: 4799 Platinum

- 1 Style number
 - 2 Fabric color number for screen
 - 3 Options, if selected (see below)
- ▶ See *Surface Materials*, page 318.

Tip: When using COM fabric, it is recommended that non-patterned fabric be used to provide a consistent visual between adjacent screens, and from one side to the other.

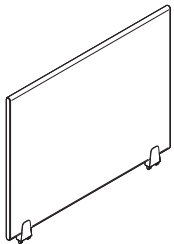
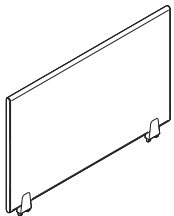
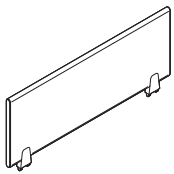

Surface Materials	Options	Price			Required to Specify
-------------------	---------	-------	--	--	---------------------

Surface Materials	Options	12"H	19 1/2"H	24"H	Required to Specify
	• Fabric price group 1	No cost	No cost	No cost	Specify fabric color number.
	• Fabric price group 2	+\$24	+\$ 33	+\$ 39	Specify fabric color number.
	• Fabric price group 3	+\$64	+\$ 87	+\$111	Specify fabric color number.
	• Fabric price group 4	+\$83	+\$111	+\$136	Specify fabric color number.
	• Customer's Own Material (COM)	+\$16	+\$ 16	+\$ 16	▶ See <i>Surface Materials Reference Manual</i> .

Specification Information		
---------------------------	--	--

Width	Style Number	Base Price
-------	--------------	------------

12"H Screens

30"	CQSF3012	\$162
36"	CQSF3612	\$189
42"	CQSF4212	\$214
48"	CQSF4812	\$241

19 1/2"H Screens

30"	CQSF3019	\$250
36"	CQSF3619	\$277
42"	CQSF4219	\$303
48"	CQSF4819	\$329

24"H Screens

30"	CQSF3024	\$337
36"	CQSF3624	\$365
42"	CQSF4224	\$390
48"	CQSF4824	\$417

Surface Materials

Surface Materials	318
Directional Laminate Grain Directions	324
Wood Veneer Grain Directions	325

Surface Materials

This listing includes all the surface material choices that are available for the products in this specification guide.

Resources

For more information about surface materials, refer to the following resources:

- *Steelcase Surface Materials Reference Manual*
- Steelcase Wood Finish Swatch Card
- www.steelcase.com

Additional surface materials specification tools are available to assist you in the specification process—the Surface Materials Binders.

Surface Materials

Binders include:

- A complete set of swatch cards for hard surfaces, vertical surface fabrics, and seating upholstery

Paint

Tip: All products may not be available in all colors listed below.

Applies to:

- Lighting
- Computer support tools
- Organizational worktools
- Flat panel arm

- 0835 Black
- 4140 Arctic White
- 4231 Arctic White Gloss
- 4710 Low Gloss Black
- 4750 Champagne
- 4799 Platinum Metallic
- 7018 Pewter
- 7021 Dark Champagne
- 7027 Charcoal
- 7360 Merle
- ZW01 Pearl Snow

Applies to:

- dash LED light
- dash mini LED light
- LED radial desktop lights
- LED linear desktop lights
- SOTO shelves, rails, and cableways
- FYI monitor arms

► *See Worktools Specification Guide for FYI monitor arms and SOTO shelves, rails, and cableways defaulted color matrix.*

Select Surfaces

Price Group 3

Accent paint

Accent paints allow you to choose from a pre-matched color palette of trend driven colors. Refer to the *Surface Materials Reference Manual* for more information.

Custom Surfaces

Price Group 3

PerfectMatch

PerfectMatch is a service that allows you to create your own paint color. Refer to the *Surface Materials Reference Manual* for more information about this program.

Tip: Price Group 3 paints are not available on height-adjustable worksurface bases.

Applies to:

- Ology bench and power and data access door

Price Group 1

Textured Paint

- 7207 Black
- 7241 Arctic White
- 7360 Merle

Price Group 2

Smooth Metallic Paint

- 4799 Platinum Metallic

Metal/Accessory Paint

Applies to:

- Ology bench power and data access door
- 8043 Clear Anodized Aluminum

Laminate and Edge Finishes

Edge finish is specified separately for all worksurface options, except wood veneer. Urethane profile edge finishes are Black 6000 and Felt 6278. The recommended edge finishes for Universal and knife edge worksurfaces are below.

Applies to:

- Ology desks
- Ology modesty panels
- Series 3 and 5 worksurfaces with Universal and knife edges
- Airtouch
- Universal Steel One-High open lateral tops for Ology
- Universal Common tops for Ology

Laminate Color	Recommended 3 mm or 1 mm Edge Color	Recommended P-Edge Color
Fiber Laminate		
2850 Vanadium Fiber	6654 Sand*	6697 Fog
2851 Rhyme Fiber	6631 Cream*	6654 Sand
2852 Tungsten Fiber	6636 Mist*	6654 Sand
2854 Vellum Fiber	6655 Warm White*	6697 Fog
2859 Novell Fiber	6001 Coffee*	6697 Fog
2860 Granite Fiber	6000 Black*	6000 Black
2861 Coconut Fiber	6654 Sand*	6654 Sand
2862 Stucco Fiber	6053 Seagull*	6053 Seagull
Micro Laminate		
2920 Marl Micro	6053 Seagull*	6053 Seagull
2921 Gypsum Micro	6654 Sand*	6654 Sand
2922 Clay Micro	6654 Sand*	6654 Sand
2923 Shadow Micro	6249 Platinum Solid*	6249 Platinum Solid
Patina Laminate		
2870 Blonde Bronze Patina	6654 Sand*	6654 Sand
2871 Blackened Bronze Patina	6615 Grey V5*	6000 Black
2873 Instant Iron Patina	6615 Grey V5*	6000 Black
Pulp Laminate		
2766 Warm Brown V1	6631 Cream*	6654 Sand
2782 Grey V1	6053 Seagull*	6053 Seagull
Solid Laminate		
2722 Cream	6631 Cream*	6654 Sand
2730 Arctic White	6009 Arctic White*	6009 Arctic White
2746 Black	6000 Black*	6000 Black
2759 Warm White	6655 Warm White*	6654 Sand
2811 Mist	6636 Mist*	6697 Fog
2883 Seagull	6053 Seagull*	6053 Seagull
2884 Milk	6052 Milk*	6052 Milk
2885 Dune	6654 Sand*	6654 Sand
2HMG Merle	6527 Merle	6527 Merle
Speckle Laminate		
2820 Coffee Speckle	6631 Cream*	6654 Sand
2822 Woodrose Speckle	6635 Dawn*	6000 Black
2823 Driftwood Speckle	6631 Cream*	6000 Black
2824 Smoke Speckle	6636 Mist*	6654 Sand
2825 Vanadium Speckle	6619 Ice*	6697 Fog

Laminate and Edge Finishes, continued

Laminate Color	Recommended 3 mm or 1 mm Edge Color	Recommended P-Edge Color
----------------	---	-----------------------------

Textured Woodgrain Laminate—Select Surfaces

2TH2 Fawn Cypress	6T02 Fawn Cypress	6657 Sand
2TH3 Weathered Char	6T03 Weathered Char	6615 Grey V5
2TH4 Saddle Oak	6T04 Saddle Oak	—
2TH5 Veranda Teak	6T05 Veranda Teak	6612 Grey V2
2TH6 Persian Cherry	6T06 Persian Cherry	—
2TH7 Walnut Heights	6T07 Walnut Heights	—

Woodgrain Laminate

2406 Clear Cherry	6234 Clear Cherry*	6000 Black
2409 Clear Maple	6237 Clear Maple*	6654 Sand
2410 Graphite Walnut	6231 Graphite Walnut*	6000 Black
2412 Natural Cherry	6034 Natural Cherry	6000 Black
2422 Medium Cherry	6036 Medium Cherry	6000 Black
2511 Winter on Maple	6037 Winter on Maple	6654 Sand
2538 Clear Walnut	6245 Clear Walnut*	6000 Black
2539 Warm Oak	6246 Warm Oak*	6246 Warm Oak
2592 Blonde on Maple	6038 Blonde on Maple	6654 Sand
2714 Natural Walnut	6041 Natural Walnut	6000 Black
2772 Medium Mahogany on Walnut	6045 Medium Mahogany on Walnut	6000 Black
2HAT Acacia	6213 Acacia	6654 Sand
2HAW Ash Wenge	6703 Ash Wenge	6654 Sand
2HBW Bisque Wenge	6705 Bisque Wenge	6631 Cream
2HCW Clay Wenge	6706 Clay Wenge	6612 Grey V2
2HSW Storm Wenge	6704 Storm Wenge	6615 Grey V5

Turnstone Laminate Collection**

2535 Virginia Walnut	6242 Virginia Walnut	6000 Black
2536 Blackwood	6243 Blackwood	6000 Black
2612 Marbled Maple	6676 Marbled Maple	6000 Black
2614 Chocolate Walnut	6677 Chocolate Walnut	6000 Black
2615 Marbled Cherry	6678 Marbled Cherry	6000 Black

* PVC-free edge banding (also includes: 6689 Brushed Silver, 6694 Slate, 6695 Midnight, and 6698 Fieldstone)

** A selection of laminates and edge bands in this collection are available on Steelcase brand products. This collection is available with standard leadtimes and supported like standard laminates to help make ordering easy.

Tip: Woodgrain Laminates and the Turnstone Laminate Collection are not available as matched sets. The grain patterns will not align.

Laminate

Applies to:
• Ology bench worksurfaces

High-Pressure Laminate**Fiber Laminate**

2850 Vanadium Fiber
2851 Rhyme Fiber
2852 Tungsten Fiber
2854 Vellum Fiber
2859 Novell Fiber
2860 Granite Fiber
2861 Coconut Fiber
2862 Stucco Fiber

Micro Laminate

2920 Marl Micro
2921 Gypsum Micro
2922 Clay Micro
2923 Shadow Micro

Patina Laminate

2870 Blonde Bronze Patina
2871 Blackened Bronze Patina
2873 Instant Iron Patina

Solid Laminate

2722 Cream
2730 Arctic White
2746 Black
2759 Warm White
2811 Mist
2883 Seagull
2884 Milk
2885 Dune
2HMG Merle

Speckle Laminate

2820 Coffee Speckle
2822 Woodrose Speckle
2823 Driftwood Speckle
2824 Smoke Speckle
2825 Vanadium Speckle

Tip: Some wood veneer finishes and woodgrain laminates share the same name. Because of the difference in materials, veneers and laminates of the same name are not an exact match but do coordinate with each other.

Woodgrain Laminate

2406 Clear Cherry
2409 Clear Maple
2410 Graphite Walnut
2412 Natural Cherry
2422 Medium Cherry
2511 Winter on Maple
2538 Clear Walnut
2539 Warm Oak
2592 Blonde on Maple
2714 Natural Walnut
2772 Medium Mahogany on Walnut
2HAK Clear Oak
2HAN Ash Noce
2HAT Acacia
2HAW Ash Wenge
2HBN Bisque Noce
2HBW Bisque Wenge
2HCN Clay Noce
2HCW Clay Wenge
2HSN Storm Noce
2HSW Storm Wenge

Custom Surfaces**Open Line Laminate (OLL)**

This service allows you to order non-standard laminate at an additional processing fee of \$67 U.S. per unit, plus the cost of the laminate.

When processing orders for Open Line laminate on worksurfaces, specify 2900 in the laminate finish field and enter the OLL manufacturer information. Enter the required edge finish as you would a standard laminate.

Laminate Approval and Material Requirements

To confirm whether a particular laminate has already been tested for use on a specific Steelcase product or to determine material square foot requirements:

• Visit www.steelcase.com

For additional information, refer to the *Steelcase Surface Materials Reference Manual*.

Surface Materials, continued

Wood

Applies to:

- Ology desks
- Ology modesty panels
- Series 3 and 5 height-adjustable worksurfaces
- Ology bench worksurface

Steelcase carefully selects veneer and solid wood for consistent color and grain structure. Wood is a natural material and variations will occur in color, grain and texture. These variations are part of the inherent natural beauty of wood and are not considered defects.

All wood products will darken with age and exposure to ultraviolet light. This is especially apparent with cherry and maple veneer. We recommend that desk accessories be rearranged periodically to ensure even aging of wood surfaces.

When storing your wood furniture, please follow the following guidelines:

- Do not store products in trailers
- Store products in areas that simulate office temperatures (60°F to 90°F)
- Store products in areas that maintain constant, office-like humidity levels
- Keep product away from light. Cover products to make sure they are not exposed to light.

Steelcase Surfaces**Veneer**

Veneers are matched for proper balance and consistency. Veneers are available flat cut or quarter cut, except for Oak, which is rift cut. Refer to the *Surface Materials Reference Manual* for descriptions of each cut.

Open-pore finish is a medium gloss finish that leaves the wood grain texture visible to the eye and distinguishable to the touch.

Flat-cut open-pore finish choices

- 3062 FC/OP Graphite Walnut
- 3402 FC/OP Clear Cherry (Aged)
- 3412 FC/OP Natural Cherry
- 3422 FC/OP Medium Cherry
- 3522 FC/OP Clear Maple*
- 3572 FC/OP Amber on Maple
- 3592 FC/OP Blonde on Maple
- 3702 FC/OP Clear Walnut
- 3712 FC/OP Natural Walnut
- 3722 FC/OP Dark Mahogany on Walnut
- 3752 FC/OP Medium Walnut
- 3762 FC/OP Dark Walnut
- 3772 FC/OP Medium Mahogany on Walnut

Quarter-cut open-pore finish choices

- 3042 QC/OP Ash*
- 3222 QC/OP Clear Maple*
- 3272 QC/OP Amber on Maple
- 3292 QC/OP Blonde on Maple
- 3302 QC/OP Clear Walnut
- 3312 QC/OP Natural Walnut
- 3322 QC/OP Dark Mahogany on Walnut
- 3352 QC/OP Medium Walnut
- 3362 QC/OP Dark Walnut
- 3372 QC/OP Medium Mahogany on Walnut
- 3382 QC/OP Graphite Walnut

Rift-cut open-pore finish choices

- 3602 RC/OP Desert Oak
- 3612 RC/OP Warm Oak
- 3692 RC/OP Espresso Oak

Full-fill finish is a medium-gloss finish that completely fills the grain texture, yet allows the grain pattern to be seen. The wood has a lustrous, satiny look, and it is smooth to the touch.

Flat-cut full-fill finish choices

- 3064 FC/FF Graphite Walnut
- 3404 FC/FF Clear Cherry (Aged)
- 3414 FC/FF Natural Cherry
- 3424 FC/FF Medium Cherry
- 3524 FC/FF Clear Maple*
- 3544 FC/FF Blonde on Maple
- 3574 FC/FF Amber on Maple
- 3704 FC/FF Clear Walnut
- 3714 FC/FF Natural Walnut
- 3724 FC/FF Dark Mahogany on Walnut
- 3754 FC/FF Medium Walnut
- 3764 FC/FF Dark Walnut
- 3774 FC/FF Medium Mahogany on Walnut

Premium Veneers

A selection of Premium veneers in this collection are available on most Steelcase brand products. The collection will be available as close to standard leadtimes as possible. However, because adequate supplies of veneer and solids must be secured, all orders will be scheduled individually. Leadtimes will vary based on Premium veneer and Premium solids availability at the time the order is placed. The collection is Graded-In as Wood Group 2 and Wood Group 3, and supported like standard veneers to make ordering easy. Please see the Steelcase surface materials section on village.steelcase.com for sample information and product line availability. All premium veneers are in clear-coat.

Quarter-cut open-pore finish choices

- Wood Group 2**
- 3032 QC/OP Dark Thin Line Bamboo
- 3052 QC/OP Ribbon Sapele

Wood Group 3

- 3832 QC/OP Figured Anegre
- 3842 QC/OP Figured Makore

To ensure an understanding of the color ranges and characteristic variations of natural veneer, a sign-off sheet is required prior to orders being accepted for this clear-coat finish. The sign-off sheet is available through Steelcase advertising stock. Please use form number 09-0000755 for 3032, form number 09-0000757 for 3052, form number 09-0000758 for 3832, and form number 09-0000759 for 3842.

Quarter-cut full-fill finish choices

- 3104 QC/FF Clear Cherry (aged)
- 3224 QC/FF Clear Maple*
- 3274 QC/FF Amber on Maple
- 3294 QC/FF Blonde on Maple
- 3304 QC/FF Clear Walnut
- 3314 QC/FF Natural Walnut
- 3324 QC/FF Dark Mahogany on Walnut
- 3354 QC/FF Medium Walnut
- 3364 QC/FF Dark Walnut
- 3374 QC/FF Medium Mahogany on Walnut
- 3384 QC/FF Graphite Walnut

Rift-cut full-fill finish choices

- 3604 RC/FF Desert Oak
- 3614 RC/FF Warm Oak
- 3694 RC/FF Espresso Oak

**To ensure an understanding of the color ranges and characteristic variations of natural veneer, a sign-off sheet is required prior to orders being accepted for this clear-coat finish. The sign-off sheet is available through Steelcase advertising stock. Please use form number 09-0000756 for 3042, and form number 05-0001370 for 3222 or 3224.*

Select Surfaces

For information on products within Select Surfaces, including accent paints and fabrics from DesignTex, Gabriel, Kvadrat, and Pollack, please refer to the *Surface Materials Reference Manual* or visit steelcase.com/surface-materials under the Select Surfaces section.

Composite Veneer

Composite veneers are an engineered wood intended to create specific grain patterns and characteristics. They are pre-stained and finished with Steelcase's Clarity water-borne UV topcoat, which protects the environment while providing durability and clarity. Only open-pore finishes are available on composite wood. Composite veneer and matching edge bands are available on most Steelcase brand products. Composites, for use as a solid nosing substitute, are not available. Steelcase does not recommend mixing composite veneers with natural solid nosings because composite and natural wood grain and color matching are rarely compatible. Composite veneers are Graded-In as Wood Group 1 pricing.

Flat-cut open-pore finish choices

- 3JDX FC/OP Oak Composite
- 3JFX FC/OP Maple Composite
- 3JHX FC/OP Cherry Composite
- 3JXX FC/OP Walnut Composite

Quarter-cut open-pore finish choices

- 3F8X QC/OP European Walnut Composite
- 3GAX QC/OP Gold Teak Composite
- 3GFX QC/OP Rosewood Composite
- 3GGX QC/OP Zebrano Composite
- 3HGX QC/OP Oak Composite
- 3HVX QC/OP Walnut Composite
- 3JEX QC/OP Maple Composite
- 3JGX QC/OP Cherry Composite
- 3ZNX QC/OP Night Cerused Oak Composite

Natural Veneer

Natural veneer is available in the Select Surfaces offering. Natural veneer may have extended leadtimes. Place your order as you normally would for any other finish, calling out the appropriate finish code. Natural veneers are Graded-In as Wood Group 1 pricing.

The following finishes are available through the natural veneer offering:

Flat-cut open-pore finish choices

35A2 FC/OP Blanch Maple
37A2 FC/OP Thunder
Walnut

Quarter-cut open-pore finish choices

32A2 QC/OP Blanch Maple
33A2 QC/OP Thunder
Walnut

Rift-cut open-pore finish choices

36A2 RC/OP Volcanic Oak

Planked Veneer

Planked veneer is available in the Select Surfaces offering. Planked veneer may have extended leadtimes. Place your order as you normally would for any other finish, calling out the appropriate finish code.

The following finishes are available through the planked veneer offering:

Wood Group 1

3P41 OP Planked Cherry
3P51 OP Planked Maple
3P61 OP Planked Oak
3P71 OP Planked Walnut

Tip: Known for its uniqueness, planked veneer has intentional and natural variations that include, but are not limited to: character marks, grain pattern, color, and natural color aging.

Custom Surfaces

Customiz stain is a service that allows you to create your own stain colors and finishes on standard veneer. Customiz stain color is available on all product lines that offer wood veneer.

A \$500 stain-matching fee applies on CUSTOMIZ requests (Exception: The \$500 fee does not apply on matches to Coalesce standard finishes or for a low-gloss finish request on a standard color). The \$500 fee covers the cost of formulating the Customiz color finish and applies regardless of whether or not an order for product is placed.

In addition, an approval form must be signed to indicate customer acceptance of Customiz match. A \$1,500 initiation fee will be charged prior to first order entry. This initiation fee activates the finish for unlimited use on any Steelcase product for an 18 month time period. After the 18 month time period has lapsed, the Customiz finish may be reactivated for another 18 months for a \$1,000 fee at any point within five years after the \$1,500 initiation fee was paid. If the finish is not reactivated within five years after the \$1,500 initiation fee was paid, the finish will be culled and the customer will need to pay the \$1,500 initiation fee again. All style number related Customiz charges products are no cost as of April 2014. The matching and initiation fees are not discountable.

Customiz stain takes 10 days to formulate. Consult the *Surface Materials Reference Manual* for more information. Custom veneers are also available and must be quoted by Steelcase specials group. Customiz stain on custom veneers takes 2 to 4 weeks to formulate.

Requirements and information on ordering a Customiz stain color are found in the *Surface Materials Reference Manual*.

Plastic**Steelcase Surfaces**

6000 Black
6009 Arctic White
6059 Sterling Dark Solid
6288 Charcoal
6527 Merle
6544 Frost
6546 Rain

Tip: Light color plastic edges are susceptible to degradation due to normal wear and tear. Staining (e.g., ball point pen or clothing dyes such as blue jeans) and dirt effects are more pronounced in light colors and are not considered defects.

Applies to:

- 3 mm edge profile on Ology desks and modesty panels
- Series 3 and 5 Universal and knife edges
- Airtouch worksurfaces
- 1 mm square edge profile on Universal Steel One-High open lateral laminate tops for Ology
- Universal Common tops for Ology

6000 Black
6001 Coffee
6009 Arctic White
6034 Natural Cherry
6036 Medium Cherry
6037 Winter on Maple
6038 Blonde on Maple
6041 Natural Walnut
6045 Medium Mahogany on Walnut
6052 Milk
6053 Seagull
6213 Acacia
6219 Clear Oak
6231 Graphite Walnut
6234 Clear Cherry
6237 Clear Maple
6242 Virginia Walnut
6243 Blackwood
6245 Clear Walnut
6246 Warm Oak
6249 Platinum Solid
6271 Plywood
6527 Merle
6615 Grey V5
6619 Ice
6631 Cream
6635 Dawn
6636 Mist
6654 Sand
6655 Warm White
6676 Marbled Maple
6677 Chocolate Walnut
6678 Marbled Cherry
6689 Brushed Silver
6694 Slate
6695 Midnight
6697 Fog
6698 Fieldstone
6703 Ash Wenge
6704 Storm Wenge
6705 Bisque Wenge
6706 Clay Wenge

Applies to:

- SOTO storage
- 6009 Arctic White
- 6302 Baltic
- 6338 Chili
- 6527 Merle
- 6BE2 Light Peacock
- 6BE3 Cotton Candy

Applies to:

- SOTO functional screen
- SOTO mobile caddy
- SOTO launch pad
- SOTO monitor bridge
- 6009 Arctic White
- 6527 Merle

Applies to:

- 3 mm edge profile on Ology desks and modesty panels
- Series 3 and 5 Universal and knife edges
- Airtouch worksurfaces
- 1 mm square edge profile on Universal Steel One-High open lateral laminate tops for Ology
- Universal Common tops for Ology

Select Surfaces

6T02 Fawn Cypress
6T03 Weathered Char
6T04 Saddle Oak
6T05 Veranda Teak
6T06 Persian Cherry
6T07 Walnut Heights

Surface Materials, continued

Steelcase Surfaces

- Applies to:
- Ology bench worksurfaces
 - 6000 Black*
 - 6001 Coffee
 - 6009 Arctic White*
 - 6034 Natural Cherry
 - 6036 Medium Cherry
 - 6037 Winter on Maple
 - 6038 Blonde on Maple
 - 6041 Natural Walnut
 - 6045 Medium Mahogany on Walnut
 - 6052 Milk*
 - 6053 Seagull*
 - 6213 Acacia*
 - 6219 Clear Oak
 - 6231 Graphite Walnut
 - 6234 Clear Cherry
 - 6237 Clear Maple*
 - 6242 Virginia Walnut
 - 6243 Blackwood
 - 6245 Clear Walnut
 - 6246 Warm Oak
 - 6249 Platinum Solid
 - 6271 Plywood
 - 6527 Merle
 - 6612 Grey V2
 - 6615 Grey V5
 - 6619 Ice
 - 6631 Cream
 - 6635 Dawn
 - 6636 Mist
 - 6654 Sand*
 - 6655 Warm White
 - 6676 Marbled Maple
 - 6677 Chocolate Walnut
 - 6678 Marbled Cherry
 - 6694 Slate
 - 6695 Midnight
 - 6697 Fog
 - 6698 Fieldstone
 - 6703 Ash Wenge
 - 6704 Storm Wenge
 - 6705 Bisque Wenge
 - 6706 Clay Wenge
 - 6707 Ash Noce
 - 6708 Bisque Noce
 - 6709 Clay Noce
 - 6710 Storm Noce

Acrylic

- Applies to:
- Modesty and privacy screens
 - 6544A Acrylic Frost

Vertical Surface Fabric

► See *Surface Materials Reference Manual* for a listing of available fabrics for c:scape and FrameOne Privacy/Modesty Screens.

SOTO Fabric Pads

- Applies to:
- SOTO mobile caddy
 - SOTO launch pad

Standard Fabric Pad

Dark grey felt

Cogent: Connect Fabric Set 1

- 5S17 Tangerine
- 5S18 Scarlet
- 5S21 Blue Jay
- 5S23 Wasabi
- 5S25 Graphite
- 5S27 Malt

Cogent: Connect Fabric Set 2

- 5S15 Coconut
- 5S16 Turmeric/Honey
- 5S19 Concord
- 5S20 Maya Blue
- 5S22 Basil
- 5S24 Nickel
- 5S26 Licorice
- 5S28 Root Beer
- 5S93 Blue Print
- 5S94 Lizard/Jungle
- 5S95 Sailor
- 5S96 Quicksilver
- 5S97 Nugget
- 5S98 Canary
- 5S99 Lipstick/Merlot
- 5SD0 Royal Blue
- 5SD1 Aubergine
- 5SD2 Peacock
- 5SD3 Lagoon
- 5SD4 Saffron

Select Surfaces

For information on products within **Select Surfaces**, including accent paints and fabrics from DesignTex, Gabriel, Kvadrat, and Pollack, please refer to the *Surface Materials Reference Manual* or visit steelcase.com/surface-materials under the Select Surfaces section.

Custom Surfaces

Price Group COM (Customer's Own Material)

Fabric Approval and Yardage

To confirm whether a particular COM material has already been tested for use on a specific Steelcase product or to determine actual yardage requirements:

- Visit www.steelcase.com

Directional Laminate Grain Directions

Directional laminates are standard with the grain directions shown.

Height-Adjustable Worksurfaces—High-Pressure Laminate



Rectangular
Ology
Migration
Migration SE
Series 5
Airtouch
Series 3



Rectangular Bi-Level
Series 5
Airtouch
Series 3



Tapered
Ology



Tapered-Flat
Series 5
Series 3



Concave
Series 5
Series 3



90° Corner
Series 5
Airtouch
Series 3



90° Corner Bi-level
Series 5
Airtouch
Series 3

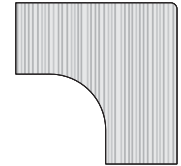

90° Equal
Ology
Series 5
Series 3

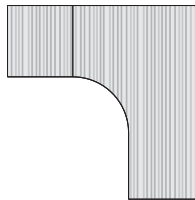

90° Equal
Ology
Series 5
Series 3



90° Extended
Ology
Series 5
Series 3

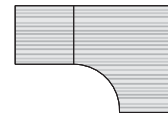

90° Extended
Ology



120° Equal
Ology
Series 5
Airtouch
Series 3



**Modesty Panel Horizontal
Grain Direction**
Ology



**Modesty Panel Vertical
Grain Direction**
Ology

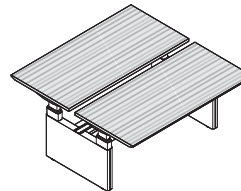

Rectangular
Ology

Wood Veneer Grain Directions

The appearance of wood veneer may change slightly depending on the angle from which it is viewed. This natural phenomenon is called polarization, and it can be seen on natural veneer, and to a lesser extent on composite veneer. Polarization is often noticed on worksurfaces installed at a 90° angle with each other. Please refer to the following illustrations for an understanding of grain direction on your installation.

Wood veneer is available on Series 3 and Series 5 worksurfaces only.

Height-Adjustable Worksurfaces—Wood Veneer

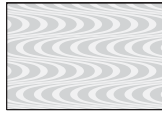

Rectangular
Ology
Series 5
Series 3

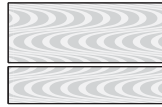

Rectangular Bi-Level
Series 5
Series 3

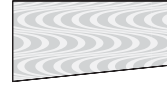

Tapered
Ology

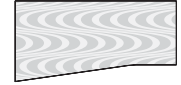

Tapered - Flat
Series 5
Series 3

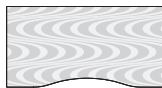

Concave
Series 5
Series 3

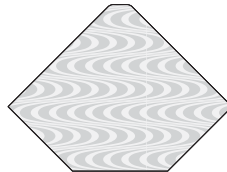

90° Corner
Series 5
Series 3

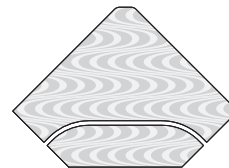

90° Corner Bi-level
Series 5
Series 3

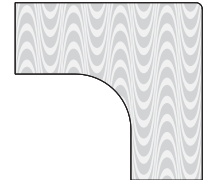

90° Equal
Ology
Series 5
Series 3

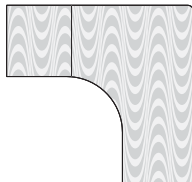

90° Equal
Ology
Series 5
Series 3

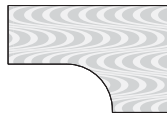

90° Extended
Ology
Series 5
Series 3

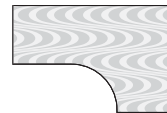

90° Extended
Ology

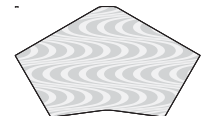

120° Equal
Ology
Series 5
Series 3



Modesty Panel
Ology

Resources

Style Number Index

328

Style Number Index

Style Number	Page	Description
14474101SR	187	FYI Flat Monitor Arm Mounting Bracket
14474501SR	187	FYI Flat Monitor Arm Mounting Bracket
1710EF	93	21" Diagonal Keyboard Pltfrm
1810EF	93	18" Radius Keyboard Pltfrm
19AM00	97	19" Keyboard Pltfrm w/Articulating Mouse
19AMGG	97	19" Keyboard Pltfrm w/Articulating Mouse
19MD00	96	19" Keyboard Pltfrm
19MDGG	96	19" Keyboard Pltfrm
19ML00	96	19" Keyboard Pltfrm
19MLGG	96	19" Keyboard Pltfrm
19MR00	96	19" Keyboard Pltfrm
19MRGG	96	19" Keyboard Pltfrm
2110EF	93	21" Diagonal Keyboard Pltfrm
261000	95	26" Keyboard Pltfrm
261026GG	95	26" Keyboard Pltfrm
2610GG	95	26" Keyboard Pltfrm
26GG	101	26" Green-Gel Palm Rest
9UAPSC1845	281	Airtouch Hgt-Adj Wksf, 90° Corner
9UAPSC2545	281	Airtouch Hgt-Adj Wksf, 90° Corner
9UAPSS2545	281	Airtouch Hgt-Adj Wksf, Rectangular
9UAPSS3045	281	Airtouch Hgt-Adj Wksf, Rectangular
A3CQ582929	266	Series 3 Hgt-Adj Wksf, Concave
A3CQ642929	266	Series 3 Hgt-Adj Wksf, Concave
A3CQ702929	266	Series 3 Hgt-Adj Wksf, Concave
A3CD762929	266	Series 3 Hgt-Adj Wksf, Concave
A3LD40234023	267	Series 3 Hgt-Adj Wksf, 90° Corner Bi-Level
A3LD46234623	267	Series 3 Hgt-Adj Wksf, 90° Corner Bi-Level
A3LE40235823	268	Series 3 Hgt-Adj Wksf, 90° 23"D Extended
A3LE40236423	268	Series 3 Hgt-Adj Wksf, 90° 23"D Extended
A3LE40237023	268	Series 3 Hgt-Adj Wksf, 90° 23"D Extended
A3LE40237623	268	Series 3 Hgt-Adj Wksf, 90° 23"D Extended
A3LE40X58B	271	Series 3 Base, 90° Extended
A3LE40X64T076B	271	Series 3 Base, 90° Extended
A3LE46235823	268	Series 3 Hgt-Adj Wksf, 90° 23"D Extended
A3LE46236423	268	Series 3 Hgt-Adj Wksf, 90° 23"D Extended
A3LE46237023	268	Series 3 Hgt-Adj Wksf, 90° 23"D Extended
A3LE46237623	268	Series 3 Hgt-Adj Wksf, 90° 23"D Extended
A3LE46X58B	271	Series 3 Base, 90° Extended
A3LE46X64T076B	271	Series 3 Base, 90° Extended
A3LE58234023	268	Series 3 Hgt-Adj Wksf, 90° 23"D Extended
A3LE58234623	268	Series 3 Hgt-Adj Wksf, 90° 23"D Extended
A3LE58236423	268	Series 3 Hgt-Adj Wksf, 90° 23"D Extended
A3LE58237023	268	Series 3 Hgt-Adj Wksf, 90° 23"D Extended
A3LE58237623	268	Series 3 Hgt-Adj Wksf, 90° 23"D Extended
A3LE58296429	269	Series 3 Hgt-Adj Wksf, 90° 29"D Extended
A3LE58297029	269	Series 3 Hgt-Adj Wksf, 90° 29"D Extended
A3LE58297629	269	Series 3 Hgt-Adj Wksf, 90° 29"D Extended
A3LE58X64T076B	271	Series 3 Base, 90° Extended
A3LE64234023	268	Series 3 Hgt-Adj Wksf, 90° 23"D Extended
A3LE64234623	268	Series 3 Hgt-Adj Wksf, 90° 23"D Extended
A3LE64235823	268	Series 3 Hgt-Adj Wksf, 90° 23"D Extended
A3LE64295829	269	Series 3 Hgt-Adj Wksf, 90° 29"D Extended
A3LE70234023	268	Series 3 Hgt-Adj Wksf, 90° 23"D Extended
A3LE70234623	268	Series 3 Hgt-Adj Wksf, 90° 23"D Extended
A3LE70235823	268	Series 3 Hgt-Adj Wksf, 90° 23"D Extended

Style Number	Page	Description
A3LE70295829	269	Series 3 Hgt-Adj Wksf, 90° 29"D Extended
A3LE76234023	268	Series 3 Hgt-Adj Wksf, 90° 23"D Extended
A3LE76234623	268	Series 3 Hgt-Adj Wksf, 90° 23"D Extended
A3LE76235823	268	Series 3 Hgt-Adj Wksf, 90° 23"D Extended
A3LE76295829	269	Series 3 Hgt-Adj Wksf, 90° 29"D Extended
A3LQ40234023	267	Series 3 Hgt-Adj Wksf, 90° Corner
A3LQ46234623	267	Series 3 Hgt-Adj Wksf, 90° Corner
A3LQ52235223	267	Series 3 Hgt-Adj Wksf, 90° 23"D Equal
A3LQ52295229	267	Series 3 Hgt-Adj Wksf, 90° 29"D Equal
A3LQ52X52B	271	Series 3 Base, 90° Equal
A3LQ58235823	267	Series 3 Hgt-Adj Wksf, 90° 23"D Equal
A3LQ58295829	267	Series 3 Hgt-Adj Wksf, 90° 29"D Equal
A3LQ58X58B	271	Series 3 Base, 90° Equal
A3LQ64236423	267	Series 3 Hgt-Adj Wksf, 90° 23"D Equal
A3LQ64296429	267	Series 3 Hgt-Adj Wksf, 90° 29"D Equal
A3LQ64T076B	271	Series 3 Base, 90° Equal
A3LQ70237023	267	Series 3 Hgt-Adj Wksf, 90° 23"D Equal
A3LQ76237623	267	Series 3 Hgt-Adj Wksf, 90° 23"D Equal
A3RD342929	265	Series 3 Hgt-Adj Wksf, Rectangular Bi-Level
A3RD402929	265	Series 3 Hgt-Adj Wksf, Rectangular Bi-Level
A3RD462929	265	Series 3 Hgt-Adj Wksf, Rectangular Bi-Level
A3RQ342323	265	Series 3 Hgt-Adj Wksf, 23"D Rectangular
A3RQ342929	265	Series 3 Hgt-Adj Wksf, 29"D Rectangular
A3RQ402323	265	Series 3 Hgt-Adj Wksf, 23"D Rectangular
A3RQ402929	265	Series 3 Hgt-Adj Wksf, 29"D Rectangular
A3RQ462323	265	Series 3 Hgt-Adj Wksf, 23"D Rectangular
A3RQ462929	265	Series 3 Hgt-Adj Wksf, 29"D Rectangular
A3RQ46T05223B	270	Series 3 Base, 23"D Rectangular
A3RQ46T05229B	270	Series 3 Base, 29"D Rectangular
A3RQ522323	265	Series 3 Hgt-Adj Wksf, 23"D Rectangular
A3RQ522929	265	Series 3 Hgt-Adj Wksf, 29"D Rectangular
A3RQ582323	265	Series 3 Hgt-Adj Wksf, 23"D Rectangular
A3RQ5823B	270	Series 3 Base, 23"D Rectangular
A3RQ582929	265	Series 3 Hgt-Adj Wksf, 29"D Rectangular
A3RQ5829B	270	Series 3 Base, 29"D Rectangular
A3RQ642323	265	Series 3 Hgt-Adj Wksf, 23"D Rectangular
A3RQ642929	265	Series 3 Hgt-Adj Wksf, 29"D Rectangular
A3RQ64T07623B	270	Series 3 Base, 23"D Rectangular
A3RQ64T07629B	270	Series 3 Base, 29"D Rectangular
A3RQ702323	265	Series 3 Hgt-Adj Wksf, 23"D Rectangular
A3RQ702929	265	Series 3 Hgt-Adj Wksf, 29"D Rectangular
A3RQ762323	265	Series 3 Hgt-Adj Wksf, 23"D Rectangular
A3RQ762929	265	Series 3 Hgt-Adj Wksf, 29"D Rectangular
A3RT582329	266	Series 3 Hgt-Adj Wksf, Taper-Flat
A3RT582923	266	Series 3 Hgt-Adj Wksf, Taper-Flat
A3RT642329	266	Series 3 Hgt-Adj Wksf, Taper-Flat
A3RT642923	266	Series 3 Hgt-Adj Wksf, Taper-Flat
A3RT702329	266	Series 3 Hgt-Adj Wksf, Taper-Flat
A3RT702923	266	Series 3 Hgt-Adj Wksf, Taper-Flat
A3RT762329	266	Series 3 Hgt-Adj Wksf, Taper-Flat
A3RT762923	266	Series 3 Hgt-Adj Wksf, Taper-Flat
A3WE34X58B	271	Series 3 Base, 120° Extended
A3WE34X64B	271	Series 3 Base, 120° Extended
A3WE40X58B	271	Series 3 Base, 120° Extended
A3WE40X64B	271	Series 3 Base, 120° Extended

Style Number	Page	Description	Style Number	Page	Description
A3WE46X64B	271	Series 3 Base, 120° Extended	A5RD462929	283	Series 5 Hgt-Adj Wksf, Rectangular Bi-Level
A3WE58X64B	271	Series 3 Base, 120° Extended	A5RQ342323	283	Series 5 Hgt-Adj Wksf, 23"D Rectangular
A3WQ34233423	269	Series 3 Hgt-Adj Wksf, 120° Equal	A5RQ342929	283	Series 5 Hgt-Adj Wksf, 29"D Rectangular
A3WQ40234023	269	Series 3 Hgt-Adj Wksf, 120° Equal	A5RQ34T04023B	288	Series 5 Base, 23"D Rectangular
A3WQ46234623	269	Series 3 Hgt-Adj Wksf, 120° Equal	A5RQ34T04029B	288	Series 5 Base, 29"D Rectangular
A3WQ46T058B	271	Series 3 Base, 120° Equal/Extended	A5RQ402323	283	Series 5 Hgt-Adj Wksf, 23"D Rectangular
A3WQ52235223	269	Series 3 Hgt-Adj Wksf, 120° Equal	A5RQ402929	283	Series 5 Hgt-Adj Wksf, 29"D Rectangular
A3WQ58235823	269	Series 3 Hgt-Adj Wksf, 120° Equal	A5RQ462323	283	Series 5 Hgt-Adj Wksf, 23"D Rectangular
A3WQ64236423	269	Series 3 Hgt-Adj Wksf, 120° Equal	A5RQ462929	283	Series 5 Hgt-Adj Wksf, 29"D Rectangular
A3WQ64X64B	271	Series 3 Base, 120° Equal	A5RQ46T05223B	288	Series 5 Base, 23"D Rectangular
A5CQ582929	284	Series 5 Hgt-Adj Wksf, Concave	A5RQ46T05229B	288	Series 5 Base, 29"D Rectangular
A5CQ642929	284	Series 5 Hgt-Adj Wksf, Concave	A5RQ522323	283	Series 5 Hgt-Adj Wksf, 23"D Rectangular
A5CQ702929	284	Series 5 Hgt-Adj Wksf, Concave	A5RQ522929	283	Series 5 Hgt-Adj Wksf, 29"D Rectangular
A5CQ762929	284	Series 5 Hgt-Adj Wksf, Concave	A5RQ582323	283	Series 5 Hgt-Adj Wksf, 23"D Rectangular
A5LD40234023	285	Series 5 Hgt-Adj Wksf, 90° Corner Bi-Level	A5RQ5823B	288	Series 5 Base, 23"D Rectangular
A5LD46234623	285	Series 5 Hgt-Adj Wksf, 90° Corner Bi-Level	A5RQ582929	283	Series 5 Hgt-Adj Wksf, 29"D Rectangular
A5LE40235823	286	Series 5 Hgt-Adj Wksf, 90° Extended	A5RQ5829B	288	Series 5 Base, 29"D Rectangular
A5LE40236423	286	Series 5 Hgt-Adj Wksf, 90° Extended	A5RQ642323	283	Series 5 Hgt-Adj Wksf, 23"D Rectangular
A5LE40237023	286	Series 5 Hgt-Adj Wksf, 90° Extended	A5RQ642929	283	Series 5 Hgt-Adj Wksf, 29"D Rectangular
A5LE40237623	286	Series 5 Hgt-Adj Wksf, 90° 23"D Extended	A5RQ64T07623B	288	Series 5 Base, 23"D Rectangular
A5LE40X58B	289	Series 5 Base, 90° Extended	A5RQ64T07629B	288	Series 5 Base, 29"D Rectangular
A5LE40X64T076B	289	Series 5 Base, 90° Extended	A5RQ702323	283	Series 5 Hgt-Adj Wksf, 23"D Rectangular
A5LE46235823	286	Series 5 Hgt-Adj Wksf, 90° Extended	A5RQ702929	283	Series 5 Hgt-Adj Wksf, 29"D Rectangular
A5LE46236423	286	Series 5 Hgt-Adj Wksf, 90° Extended	A5RQ762323	283	Series 5 Hgt-Adj Wksf, 23"D Rectangular
A5LE46237023	286	Series 5 Hgt-Adj Wksf, 90° Extended	A5RQ762929	283	Series 5 Hgt-Adj Wksf, 29"D Rectangular
A5LE46237623	286	Series 5 Hgt-Adj Wksf, 90° 23"D Extended	A5RT582329	284	Series 5 Hgt-Adj Wksf, Taper-Flat
A5LE46X58B	289	Series 5 Base, 90° Extended	A5RT582923	284	Series 5 Hgt-Adj Wksf, Taper-Flat
A5LE46X64T076B	289	Series 5 Base, 90° Extended	A5RT642329	284	Series 5 Hgt-Adj Wksf, Taper-Flat
A5LE58234023	286	Series 5 Hgt-Adj Wksf, 90° Extended	A5RT642923	284	Series 5 Hgt-Adj Wksf, Taper-Flat
A5LE58234623	286	Series 5 Hgt-Adj Wksf, 90° Extended	A5RT702329	284	Series 5 Hgt-Adj Wksf, Taper-Flat
A5LE58236423	286	Series 5 Hgt-Adj Wksf, 90° Extended	A5RT702923	284	Series 5 Hgt-Adj Wksf, Taper-Flat
A5LE58237023	286	Series 5 Hgt-Adj Wksf, 90° Extended	A5RT762329	284	Series 5 Hgt-Adj Wksf, Taper-Flat
A5LE58237623	286	Series 5 Hgt-Adj Wksf, 90° 23"D Extended	A5RT762923	284	Series 5 Hgt-Adj Wksf, Taper-Flat
A5LE58296429	287	Series 5 Hgt-Adj Wksf, 90° Extended	A5WE34X58B	289	Series 5 Base, 120° Extended
A5LE58297029	287	Series 5 Hgt-Adj Wksf, 90° Extended	A5WE34X64B	289	Series 5 Base, 120° Extended
A5LE58297629	287	Series 5 Hgt-Adj Wksf, 90° 29"D Extended	A5WE40X58B	289	Series 5 Base, 120° Extended
A5LE58X64T076B	289	Series 5 Base, 90° Extended	A5WE40X64B	289	Series 5 Base, 120° Extended
A5LE64234023	286	Series 5 Hgt-Adj Wksf, 90° Extended	A5WE46X64B	289	Series 5 Base, 120° Extended
A5LE64234623	286	Series 5 Hgt-Adj Wksf, 90° Extended	A5WE58X64B	289	Series 5 Base, 120° Extended
A5LE64235823	286	Series 5 Hgt-Adj Wksf, 90° Extended	A5WQ34233423	287	Series 5 Hgt-Adj Wksf, 120° Equal
A5LE64295829	287	Series 5 Hgt-Adj Wksf, 90° Extended	A5WQ40234023	287	Series 5 Hgt-Adj Wksf, 120° Equal
A5LE70234023	286	Series 5 Hgt-Adj Wksf, 90° Extended	A5WQ40X40B	289	Series 5 Base, 120° Equal
A5LE70234623	286	Series 5 Hgt-Adj Wksf, 90° Extended	A5WQ46234623	287	Series 5 Hgt-Adj Wksf, 120° Equal
A5LE70235823	286	Series 5 Hgt-Adj Wksf, 90° Extended	A5WQ46T058B	289	Series 5 Base, 120° Equal/Extended
A5LE70295829	287	Series 5 Hgt-Adj Wksf, 90° Extended	A5WQ52235223	287	Series 5 Hgt-Adj Wksf, 120° Equal
A5LE76234023	286	Series 5 Hgt-Adj Wksf, 90° 23"D Extended	A5WQ58235823	287	Series 5 Hgt-Adj Wksf, 120° Equal
A5LE76234623	286	Series 5 Hgt-Adj Wksf, 90° 23"D Extended	A5WQ64236423	287	Series 5 Hgt-Adj Wksf, 120° Equal
A5LE76235823	286	Series 5 Hgt-Adj Wksf, 90° 23"D Extended	A5WQ64X64B	289	Series 5 Base, 120° Equal
A5LE76295829	287	Series 5 Hgt-Adj Wksf, 90° Extended	A7TG660606H	290	FitWork: Walkstation
A5LQ40234023	285	Series 5 Hgt-Adj Wksf, 90° Corner	A7TR383030H	290	FitWork: Walkstation
A5LQ46234623	285	Series 5 Hgt-Adj Wksf, 90° Corner	A7TR663232H	290	FitWork: Walkstation
A5LQ52X52B	289	Series 5 Base, 90° Equal	A7TR782929H	290	FitWork: Sit-to-Walkstation
A5LQ58X58B	289	Series 5 Base, 90° Equal	AC25	136, 294	Cableway w/Universal Clamp
A5LQ64T076B	289	Series 5 Base, 90° Extended	AC31	136, 294	Cableway w/Universal Clamp
A5RD402929	283	Series 5 Hgt-Adj Wksf, Rectangular Bi-Level	AC37	136, 294	Cableway w/Universal Clamp

Style Number Index, continued

Style Number	Page	Description
AC43	136, 294	Cableway w/Universal Clamp
AC49	136, 294	Cableway w/Universal Clamp
AC55	136, 294	Cableway w/Universal Clamp
AC61	136, 294	Cableway w/Universal Clamp
ACM28	293	28" Modesty Screen w/Cableway
ACM34	293	34" Modesty Screen w/Cableway
ACM40	293	40" Modesty Screen w/Cableway
ACM46	293	46" Modesty Screen w/Cableway
ACM52	293	52" Modesty Screen w/Cableway
ACM58	293	58" Modesty Screen w/Cableway
ACM64	293	64" Modesty Screen w/Cableway
ACMP28	293	28" Modesty and Privacy Screen w/Cableway
ACMP34	293	34" Modesty and Privacy Screen w/Cableway
ACMP40	293	40" Modesty and Privacy Screen w/Cableway
ACMP46	293	46" Modesty and Privacy Screen w/Cableway
ACMP52	293	52" Modesty and Privacy Screen w/Cableway
ACMP58	293	58" Modesty and Privacy Screen w/Cableway
ACMP64	293	64" Modesty and Privacy Screen w/Cableway
ACP28	292	28" Privacy Screen w/Cableway
ACP34	292	34" Privacy Screen w/Cableway
ACP40	292	40" Privacy Screen w/Cableway
ACP46	292	46" Privacy Screen w/Cableway
ACP52	292	52" Privacy Screen w/Cableway
ACP58	292	58" Privacy Screen w/Cableway
ACP64	292	64" Privacy Screen w/Cableway
AHCC	134	Vertical Cable Carrier
AHORZ25	136, 294	Cableway w/Horizontal Mounting Brkt
AHORZ31	136, 294	Cableway w/Horizontal Mounting Brkt
AHORZ37	136, 294	Cableway w/Horizontal Mounting Brkt
AHORZ43	136, 294	Cableway w/Horizontal Mounting Brkt
AHORZ49	136, 294	Cableway w/Horizontal Mounting Brkt
AHORZ55	136, 294	Cableway w/Horizontal Mounting Brkt
AHORZ61	136, 294	Cableway w/Horizontal Mounting Brkt
AM22	292	22" Modesty Screen
AM28	292	28" Modesty Screen
AM34	292	34" Modesty Screen
AM40	292	40" Modesty Screen
AM46	292	46" Modesty Screen
AM52	292	52" Modesty Screen
AM58	292	58" Modesty Screen
AM64	292	64" Modesty Screen
AMP22	293	22" Modesty and Privacy Screen
AMP28	293	28" Modesty and Privacy Screen
AMP34	293	34" Modesty and Privacy Screen
AMP40	293	40" Modesty and Privacy Screen
AMP46	293	46" Modesty and Privacy Screen
AMP52	293	52" Modesty and Privacy Screen
AMP58	293	58" Modesty and Privacy Screen
AMP64	293	64" Modesty and Privacy Screen
AP22	292	22" Privacy Screen
AP28	292	28" Privacy Screen
AP34	292	34" Privacy Screen
AP40	292	40" Privacy Screen
AP46	292	46" Privacy Screen
AP52	292	52" Privacy Screen

Style Number	Page	Description
AP58	292	58" Privacy Screen
AP64	292	64" Privacy Screen
AWM06	137	6" Wire Manager
AWM12	137	12" Wire Manager
AWM18	137	18" Wire Manager
AWM23	137	23" Wire Manager
AWM30	137	30" Wire Manager
AWM35	137	35" Wire Manager
AWM42	137	42" Wire Manager
AWM48	137	48" Wire Manager
AWMXL30	137	6"D Wire Manager
AWMXL36	137	6"D Wire Manager
AWMXL42	137	6"D Wire Manager
AWMXL48	137	6"D Wire Manager
AWMXL54	137	6"D Wire Manager
AWMXL60	137	6"D Wire Manager
BAPB2436	274	Airtouch Hgt-Adj Wksf, 120° Equal
BAPDC2442	274	Airtouch Hgt-Adj Wksf, 90° Corner Bi-Level
BAPDC2448	274	Airtouch Hgt-Adj Wksf, 90° Corner Bi-Level
BAPDS3642	273	Airtouch Hgt-Adj Wksf, Rectangular Bi-Level
BAPDS3648	273	Airtouch Hgt-Adj Wksf, Rectangular Bi-Level
BAPSC2442	274	Airtouch Hgt-Adj Wksf, 90° Corner
BAPSC2448	274	Airtouch Hgt-Adj Wksf, 90° Corner
BAPSS2442	273	Airtouch Hgt-Adj Wksf, 22¼"D Rectangular
BAPSS2448	273	Airtouch Hgt-Adj Wksf, 22¼"D Rectangular
BAPSS2460	273	Airtouch Hgt-Adj Wksf, 22¼"D Rectangular
BAPSS3042	273	Airtouch Hgt-Adj Wksf, 28¼"D Rectangular
BAPSS3048	273	Airtouch Hgt-Adj Wksf, 28¼"D Rectangular
BAPSS3060	273	Airtouch Hgt-Adj Wksf, 28¼"D Rectangular
CCWS18125	132	18" Corner Filler
CCWS18150	132	18" Corner Filler
CCWS189	132	18" Corner Filler
CCWS22125	132	22" Corner Filler
CCWS22150	132	22" Corner Filler
CCWS229	132	22" Corner Filler
CDFIS14	132	Freestanding In-Line Document Support
CF1000	163	CF Series Flat Pnl Monitor Arm, Heavy-Duty
CF1000DUALBAR	165	CF Series Max-Dt Monitor Arm Assy w/DI Brkt
CF1000MDDL	174	CF Series Dual Dynamic Monitor Arm
CF1000MDDP	173	CF Series Dual Dynamic Monitor Arm
CF1000MSP	170	CF Series Single Dynamic Monitor Arm
CF2500	164	CF Series Max-Duty Monitor Arm
CF2500DUALBAR	166	CF Series Max-Dt Monitor Arm Assy w/DI Brkt
CF450	163	CF Series Flat Pnl Monitor Arm, Light-Duty
CF450MDDL	174	CF Series Dual Dynamic Monitor Arm
CF450MDDP	173	CF Series Dual Dynamic Monitor Arm
CF450MSP	170	CF Series Single Dynamic Monitor Arm
CF500	163	CF Series Light-Duty Monitor Arm
CF500MDDL	174	CF Series Dual Dynamic Monitor Arm
CF500MDDP	173	CF Series Dual Dynamic Monitor Arm
CF500MSP	170	CF Series Single Dynamic Monitor Arm
CF600	163	CF Series Standard Monitor Arm
CF600MDDL	174	CF Series Dual Dynamic Monitor Arm
CF600MDDP	173	CF Series Dual Dynamic Monitor Arm
CF600MSP	170	CF Series Single Dynamic Monitor Arm

Style Number	Page	Description	Style Number	Page	Description
CF800	163	CF Series Flat Pnl Monitor Arm, Standard	CQSF4212	55, 256, 316	12"H Fixed Personal/Modesty Screen
CF800DUALBAR	165	CF Series Max-Dt Monitor Arm Assy w/DI Brkt	CQSF4219	55, 256, 316	19"H Fixed Personal/Modesty Screen
CF800MDDL	174	CF Series Dual Dynamic Monitor Arm	CQSF4224	55, 256, 316	24"H Fixed Personal/Modesty Screen
CF800MDDP	173	CF Series Dual Dynamic Monitor Arm	CQSF4812	55, 256, 316	12"H Fixed Personal/Modesty Screen
CF800MSP	170	CF Series Single Dynamic Monitor Arm	CQSF4819	55, 256, 316	19"H Fixed Personal/Modesty Screen
CFDARM	178	CF Series Flat Panel Dual Pole Arm	CQSF4824	55, 256, 316	24"H Fixed Personal/Modesty Screen
CFDHA	167	CF Series Flat Pnl Monitor Pole Mount, Dbl	CR1000	94	Classic Rectangular Keyboard Pltfrm
CFDUALBAR	181	CF Series Dual-Bar Brkt	CR10FA	94	Classic Rectangular Keyboard Pltfrm
CFLHS	179	CF Series Laptop Holder Tray Platform	CR10FF	94	Classic Rectangular Keyboard Pltfrm
CFMDC	183	CF Series Dual Connector Monitor Bracket	CR10PP	94	Classic Rectangular Keyboard Pltfrm
CFMDSDSP	172	CF Series Dual Static Monitor Arm	CSWP	100	Cushioned Replacement Pad
CFMDSDWP	172	CF Series Dual Static Monitor Arm	CSWPD	100	Cushioned Replacement Pad
CFMDSP	171	CF Series Dual Static Monitor Arm	D6	90	Dial Indicator6 Mechanism
CFMDSWP	171	CF Series Dual Static Monitor Arm	D623	88	Dial Indicator6 Mechanism w/23" Track
CFMSC	183	CF Series Single Connector Monitor Bracket	D6231710EF	129	Dial Indicator6 KB Assy, Diagonal Pltfrm
CFMSP	168	CF Series Single Static Monitor Arm	D6231810EF	129	Dial Indicator6 KB Assy, Radius Pltfrm
CFMSSP	169	CF Series Single Static Monitor Arm	D62319AM00	130	Dial Indicator6 KB Assy, 19" Pltfrm
CFMTSP	175	CF Series Triple Static Monitor Arm	D62319AMGG	130	Dial Indicator6 KB Assy, 19" Pltfrm
CFMTSTSP	176	CF Series Triple Static Monitor Arm	D62319MD00	130	Dial Indicator6 KB Assy, 19" Pltfrm
CFMTSTWP	176	CF Series Triple Static Monitor Arm	D62319MDGG	130	Dial Indicator6 KB Assy, 19" Pltfrm
CFMTSWP	175	CF Series Triple Static Monitor Arm	D62319ML00	130	Dial Indicator6 KB Assy, 19" Pltfrm
CFP14	168	CF Series Flat Panel Pole No Arm	D62319MLGG	130	Dial Indicator6 KB Assy, 19" Pltfrm
CFP28	168	CF Series Flat Panel Pole No Arm	D62319MR00	130	Dial Indicator6 KB Assy, 19" Pltfrm
CFSARM	178	CF Series Single Pole Arm	D62319MRGG	130	Dial Indicator6 KB Assy, 19" Pltfrm
CFSHA	167	CF Series Flat Pnl Monitor Pole Mount, Sgl	D6232110EF	129	Dial Indicator6 KB Assy, Diagonal Pltfrm
CFSPC	180	CF Series Flat Pnl Monitor Brkt	D623261000	131	Dial Indicator6 KB Assy, 26" Pltfrm
CFSPCS	181	CF Series Flat Pnl Monitor Brkt	D623261026GG	131	Dial Indicator6 KB Assy, 26" Pltfrm
CFSPCTM	180	CF Series Dsk-Clamp/Grom Thru-Mnt Brkt	D6232610GG	131	Dial Indicator6 KB Assy, 26" Pltfrm
CFSPFO	181	CF Series Flat Pnl Monitor Brkt	D623CR1000	129	Dial Indicator6 KB Assy, Classic Rect Pltfrm
CFSPMOD	181	CF Series Modular Pole	D623CR10FA	129	Dial Indicator6 KB Assy, Classic Rect Pltfrm
CFSPSGLBASE	181	CF Series Max-Duty Arm Brkt	D623CR10FF	129	Dial Indicator6 KB Assy, Classic Rect Pltfrm
CFSPSW	180	CF Series Flat Pnl Monitor Brkt	D623CR10PP	129	Dial Indicator6 KB Assy, Classic Rect Pltfrm
CFSPTM	180	CF Series Flat Pnl Monitor Brkt	D623EN1000	131	Dial Indicator6 KB Assy, Enviro Pltfrm
CFSPTSHAPEBASE	181	CF Series T-Shape Dual-Base Brkt	D623EN10GG	131	Dial Indicator6 KB Assy, Enviro Pltfrm
CFSPWM	180	CF Series Flat Pnl Monitor Brkt	D623JP1000	128	Dial Indicator6 KB Assy, Jules Pltfrm
CFTHSLIDE	177	CF Series Adjustable Monitor Adapter	D623JP10SF	128	Dial Indicator6 KB Assy, Jules Pltfrm
CFTHSLIDEHD	177	CF Series Adjustable Monitor Adapter	D623SL1000	128	Dial Indicator6 KB Assy, Slider Pltfrm
CFTHSLIDEWO	177	CF Series Adjustable Monitor Adapter	D623SL10DA	128	Dial Indicator6 KB Assy, Slider Pltfrm
CFTR	133	Adjustable Foot Rest	D623SL10SA	128	Dial Indicator6 KB Assy, Slider Pltfrm
CFWM	182	CF Series Wall-Mount Support	DCCLIP	53	SOTO Cable Clip
CFXP12H	182	CF Series 12"H Arm Extension	DFPADUALCS	185	FYI Monitor Arm
CFXP4H	182	CF Series 4"H Arm Extension	DFPASINGLECS	184	FYI c:scape Mounting Brkt
CFXP8H	182	CF Series 8"H Arm Extension	DPHOOK	53	SOTO Personal Hook
CFXT6H	182	CF Series 6"H Flat Pnl Arm Extender	DRCY	42	Wastebasket Recycling Labels
CMLSA	133	Mobile Collapsible Laptop Support	DSCW20	46	SOTO Cableway
CPRCCL	133	Vertical Locking CPU Cradle	DSCW30	46	SOTO Cableway
CPRCCN	134	Vertical Non-Locking CPU Cradle	DSDFB	49	SOTO Diag File Box
CPRSL	135	Vert Processor Sling, Freestanding	DSEE	54	SOTO Ergo Edge
CPRSLFO	135	Vert Processor Sling, Fixed	DSFS	52	SOTO Functional Screen
CQSF3012	55, 256, 316	12"H Fixed Personal/Modesty Screen	DSLEDEF	67	SOTO Extended LED Light, Freestanding
CQSF3019	55, 256, 316	19"H Fixed Personal/Modesty Screen	DSLEDER	67	SOTO Extended LED Light, Rail-Mount
CQSF3024	55, 256, 316	24"H Fixed Personal/Modesty Screen	DSLEDF	66	SOTO LED Task Lgt., Freestanding
CQSF3612	55, 256, 316	12"H Fixed Personal/Modesty Screen	DSLEDR	66	SOTO LED Task Lgt., Rail-Mount
CQSF3619	55, 256, 316	19"H Fixed Personal/Modesty Screen	DSLLB	48	SOTO Landscape Letter Box
CQSF3624	55, 256, 316	24"H Fixed Personal/Modesty Screen	DLSLPDS	52	SOTO Launch Pad Div Screen

Style Number Index, continued

Style Number	Page	Description
DSLPLNP	51	SOTO Launch Pad
DSLPLP	51	SOTO Launch Pad
DSLS	54	SOTO Freestand Laptop Shelf
DSLSRM	54	SOTO Rail-Mount Laptop Shelf
DSMB	53	SOTO Monitor Bridge
DSMC	51	SOTO Mobile Caddy
DSPB	49	SOTO Personal Box
DSPC	50	SOTO Personal Caddy
DSPP	52	SOTO Personal Pocket
DSPSDUOC	295	USB Duo Powerstrip w/Clamp Mount
DSPSDUOR	295	USB Two-Outlet Powerstrip w/Rail Mount
DSPSTRIOC	296	USB Triple Powerstrip w/Clamp Mount
DSPSTRIOR	296	USB Three-Outlet Powerstrip w/Rail Mount
DSR28	45	28" SOTO Rail
DSR34	45	34" SOTO Rail
DSR40	45	40" SOTO Rail
DSR46	45	46" SOTO Rail
DSR52	45	52" SOTO Rail
DSR58	45	58" SOTO Rail
DSR64	45	64" SOTO Rail
DSRT52	46	52" SOTO Tour Rail
DSRT58	46	58" SOTO Tour Rail
DSRT64	46	64" SOTO Tour Rail
DSSA1410	47	SOTO Shelf
DSSA1410H	47	SOTO Shelf
DSSA143	47	SOTO Shelf
DSSA143H	47	SOTO Shelf
DSSA146	47	SOTO Shelf
DSSA146H	47	SOTO Shelf
DSSA2410	47	SOTO Shelf
DSSA2410H	47	SOTO Shelf
DSSA246	47	SOTO Shelf
DSSA246H	47	SOTO Shelf
DSSA363	47	SOTO Shelf
DSSA363H	47	SOTO Shelf
DSSB	50	SOTO Stg Box Shelf Set of 3
DSSPB	48	SOTO Pile Box
DSTB	48	SOTO Tool Box
DSUB	49	SOTO Utility Box
DWBE	42	Wastebasket
EF	103	Extended Foam Palm Rest
EN1000	98	Enviro Keyboard Pltfrm
EN10GG	98	Enviro Keyboard Pltfrm
FA	102	Full-Width, Hgt-Adj Palm Rest
FF	102	Full-Width, Fixed-Hgt Palm Rest
FOCSML00	99	FrameOne/c:scape Keyboard Pltfrm
FOCSMLGG	99	FrameOne/c:scape Keyboard Pltfrm
FOCSMR00	99	FrameOne/c:scape Keyboard Pltfrm
FOCSMRGG	99	FrameOne/c:scape Keyboard Pltfrm
FPAC1CC	138	Eyesite Sgl Display Support, Std Crank Adj
FPAC1CS	138	Eyesite Sgl Display Support, Std Crank Adj
FPAC1FO	139	Eyesite Sgl Display Support, Std Crank Adj
FPAC1OL	138	Eyesite Sgl Display Support, Std Crank Adj
FPAC1TM	139	Eyesite Sgl Display Support, Std Crank Adj
FPAC2BBDCC	148	Eyesite Two-Over-Two Display

Style Number	Page	Description
FPAC2BBDOL	148	Eyesite Two-Over-Two Display
FPAC2BBDTM	149	Eyesite Two-Over-Two Display
FPAC2BBSCC	149	Eyesite Static One-Over-One Disp Support
FPAC2BBSFO	150	Eyesite Static One-Over-One Disp Support
FPAC2BBSOL	149	Eyesite Static One-Over-One Disp Support
FPAC2BBSTM	149	Eyesite Static One-Over-One Disp Support
FPAC2CC	140	Eyesite Dual Display Support, Std Crank Adj
FPAC2CS	140	Eyesite Dual Display Support, Std Crank Adj
FPAC2FO	141	Eyesite Dual Display Support, Std Crank Adj
FPAC2OL	140	Eyesite Dual Display Support, Std Crank Adj
FPAC2TM	141	Eyesite Dual Display Support, Std Crank Adj
FPAC3BBSCC	151	Eyesite Mounting Brkt, FrameOne
FPAC3BBSFO	151	Eyesite Mounting Brkt, FrameOne
FPAC3BBSTM	151	Eyesite Mounting Brkt, FrameOne
FPADUALCC	185	C-clamp Mounting Bracket
FPADUALTM	185	Through-Mount Mounting Bracket
FPAEC1BIVI	139	Eyesite Sgl Display Support, Ext Crank Adj
FPAEC1CC	139	Eyesite Sgl Display Support, Ext Crank Adj
FPAEC1CS	139	Eyesite Sgl Display Support, Ext Crank Adj
FPAEC1FO	139	Eyesite Sgl Display Support, Ext Crank Adj
FPAEC1OL	139	Eyesite Sgl Display Support, Ext Crank Adj
FPAEC1TM	139	Eyesite Sgl Display Support, Ext Crank Adj
FPAEC2BIVI	142	Eyesite Dual Display Support, Ext Crank Adj
FPAEC2CC	141	Eyesite Dual Display Support, Ext Crank Adj
FPAEC2CS	141	Eyesite Dual Display Support, Ext Crank Adj
FPAEC2FO	142	Eyesite Dual Display Support, Ext Crank Adj
FPAEC2OL	141	Eyesite Dual Display Support, Ext Crank Adj
FPAEC2TM	142	Eyesite Dual Display Support, Ext Crank Adj
FPAELC1BIVI	153	Eyesite Flat Pnl Mon Arm w/Sgl Lptp Sprt
FPAELC1CC	153	Eyesite Flat Pnl Mon Arm w/Sgl Lptp Sprt
FPAELC1CS	153	Eyesite Flat Pnl Mon Arm w/Sgl Lptp Sprt
FPAELC1FO	153	Eyesite Flat Pnl Mon Arm w/Sgl Lptp Sprt
FPAELC1OL	153	Eyesite Flat Pnl Mon Arm w/Sgl Lptp Sprt
FPAELC1TM	153	Eyesite Flat Pnl Mon Arm w/Sgl Lptp Sprt
FPAELC2BIVI	156	Eyesite Flat Pnl Mon Arm w/Dual Lptp Sprt
FPAELC2CC	156	Eyesite Flat Pnl Mon Arm w/Dual Lptp Sprt
FPAELC2CS	156	Eyesite Flat Pnl Mon Arm w/Dual Lptp Sprt
FPAELC2FO	156	Eyesite Flat Pnl Mon Arm w/Dual Lptp Sprt
FPAELC2OL	156	Eyesite Flat Pnl Mon Arm w/Dual Lptp Sprt
FPAELC2TM	156	Eyesite Flat Pnl Mon Arm w/Dual Lptp Sprt
FPAFC3CC	144	Eyesite Triple Display Support, Std Crank Adj
FPAFC3CS	144	Eyesite Triple Display Sprt, Std Crank Adj
FPAFC3OL	144	Eyesite Triple Display Support, Ext Crank Adj
FPAFC3TM	145	Eyesite Triple Display Support, Std Crank Adj
FPAFEC3CC	145	Eyesite Triple Display Support, Ext Crank Adj
FPAFEC3CS	145	Eyesite Triple Display Sprt, Ext Crank Adj
FPAFEC3FO	145	Eyesite Triple Display Support, Ext Crank Adj
FPAFEC3OL	145	Eyesite Triple Display Support, Ext Crank Adj
FPAFEC3TM	145	Eyesite Triple Display Support, Ext Crank Adj
FPAHANDLE	188	FYI Sync Handle
FPALC1CC	152	Eyesite Flat Pnl Mon Arm w/Sgl Lptp Sprt
FPALC1CS	152	Eyesite Flat Pnl Mon Arm w/Sgl Lptp Sprt
FPALC1FO	153	Eyesite Flat Pnl Mon Arm w/Sgl Lptp Sprt
FPALC1OL	152	Eyesite Flat Pnl Mon Arm w/Sgl Lptp Sprt
FPALC1TM	152	Eyesite Flat Pnl Mon Arm w/Sgl Lptp Sprt

Style Number	Page	Description	Style Number	Page	Description
FPALC2CC	154	Eyesite Flat Pnl Mon Arm w/Dual Lptp Sprt	L51819MD00	112	5" Lift & Lock KB Assy w/18"L Track
FPALC2CS	154	Eyesite Flat Pnl Mon Arm w/Dual Lptp Sprt	L51819MDGG	113	5" Lift & Lock KB Assy w/18"L Track
FPALC2FO	155	Eyesite Flat Pnl Mon Arm w/Dual Lptp Sprt	L51819ML00	112	5" Lift & Lock KB Assy w/18"L Track
FPALC2OL	154	Eyesite Flat Pnl Mon Arm w/Dual Lptp Sprt	L51819MLGG	113	5" Lift & Lock KB Assy w/18"L Track
FPALC2TM	154	Eyesite Flat Pnl Mon Arm w/Dual Lptp Sprt	L51819MR00	112	5" Lift & Lock KB Assy w/18"L Track
FPALED	183, 189	LED w/bracket, CF Series/FYI	L51819MRGG	113	5" Lift & Lock KB Assy w/18"L Track
FPAS101	161	Eyesite Modular Assy, Ext Static Column	L518EN1000	113	5" Lift & Lock KB Assy w/18"L Track
FPAS101CC	146	Eyesite Static One-Over-One Disp Support	L518EN10GG	113	5" Lift & Lock KB Assy w/18"L Track
FPAS101CS	146	Eyesite Static One-Over-One Disp Support	L522	87	5" Lift & Lock Mechanism w/22"L Track
FPAS101FO	147	Eyesite Static One-Over-One Disp Support	L5221710EF	115	5" Lift & Lock KB Assy w/22"L Track
FPAS101OL	146	Eyesite Static One-Over-One Disp Support	L5221810EF	115	5" Lift & Lock KB Assy w/22"L Track
FPAS101TM	147	Eyesite Static One-Over-One Disp Support	L52219AM00	116	5" Lift & Lock KB Assy w/22"L Track
FPASINGLE	186	FYI Flat Pnl Monitor Arm	L52219AMGG	116	5" Lift & Lock KB Assy w/22"L Track
FPASINGLECC	184	FYI C-clamp Mounting Brkt	L52219MD00	116	5" Lift & Lock KB Assy w/22"L Track
FPASINGLEFO	184	FYI FrameOne Mounting Brkt	L52219MDGG	116	5" Lift & Lock KB Assy w/22"L Track
FPASINGLETM	184	FYI Through Mount Mounting Brkt	L52219ML00	116	5" Lift & Lock KB Assy w/22"L Track
FPASWR	187	FYI Flat Pnl Monitor Arm Brkt, Sltrlw/Sltrl	L52219MLGG	116	5" Lift & Lock KB Assy w/22"L Track
FPASYNCL	188	FYI Sync Lower Monitor Arm	L52219MR00	116	5" Lift & Lock KB Assy w/22"L Track
FPASYNCLD	183, 189	LED w/bracket, Sync	L52219MRGG	116	5" Lift & Lock KB Assy w/22"L Track
FPASYNCLM	188	FYI Sync Hardware Pack	L5222110EF	115	5" Lift & Lock KB Assy w/22"L Track
FPASYNCSWR	188	FYI Sync Lower Monitor Arm, Sltrlw/Sltrl	L522CR1000	115	5" Lift & Lock KB Assy w/22"L Track
FPASYNCU	188	FYI Sync Upper Monitor Arm	L522CR10FA	115	5" Lift & Lock KB Assy w/22"L Track
FPATILTPAN	187	FYI Tilt/Pan	L522CR10FF	115	5" Lift & Lock KB Assy w/22"L Track
FPAUPPER	186	FYI Upper Arm	L522CR10PP	115	5" Lift & Lock KB Assy w/22"L Track
FPAWALL	187	FYI Flat Pnl Monitor Arm Brkt, Wall-Mt	L522EN1000	117	5" Lift & Lock KB Assy w/22"L Track
FPC1	158	Eyesite Single Arm Assembly	L522EN10GG	117	5" Lift & Lock KB Assy w/22"L Track
FPC2	158	Eyesite Dual Yolk Arm Assembly	L522JP1000	114	5" Lift & Lock KB Assy w/22"L Track
FPC2SB	158	Eyesite Dual Static Yoke	L522JP10SF	114	5" Lift & Lock KB Assy w/22"L Track
FPC3	158	Eyesite Triple Yolk Arm Assembly	L522SL1000	114	5" Lift & Lock KB Assy w/22"L Track
FPCBIVI	162	Eyesite Mounting Brkt, Bivi	L522SL10DA	114	5" Lift & Lock KB Assy w/22"L Track
FPCCC	162	Eyesite Mounting Brkt, C-clamp	L522SL10SA	114	5" Lift & Lock KB Assy w/22"L Track
FPCCS	162	Eyesite Mounting Brkt, c:scape	L523	87	5" Lift & Lock Mechanism w/23" Track
FPCECC	159	Eyesite 18" Extended Crank Column	L5231710EF	119	5" Lift & Lock KB Assy, Diagonal Pltfrm
FPCESC	159	Eyesite 26" Extended Static Column	L5231810EF	119	5" Lift & Lock KB Assy, Radius Pltfrm
FPCFO	162	Eyesite Mounting Brkt, FrameOne	L52319AM00	120	5" Lift & Lock KB Assy, 19" Pltfrm
FPCFTV	160	Eyesite VESA Brkt Assembly	L52319AMGG	120	5" Lift & Lock KB Assy, 19" Pltfrm
FPCHTV	160	Eyesite VESA Brkt/Hook	L52319MD00	120	5" Lift & Lock KB Assy, 19" Pltfrm
FPCL	160	Eyesite Laptop Component	L52319MDGG	120	5" Lift & Lock KB Assy, 19" Pltfrm
FPCL1	158	Eyesite Single Arm	L52319ML00	120	5" Lift & Lock KB Assy, 19" Pltfrm
FPCOL	162	Eyesite Mounting Brkt, Ology	L52319MLGG	120	5" Lift & Lock KB Assy, 19" Pltfrm
FPCSCC	159	Eyesite 12" Standard Crank Column	L52319MR00	120	5" Lift & Lock KB Assy, 19" Pltfrm
FPCTM	162	Eyesite Mounting Brkt, Through Mount	L52319MRGG	120	5" Lift & Lock KB Assy, 19" Pltfrm
FTH	43	Flat Top Hanger	L5232110EF	119	5" Lift & Lock KB Assy, Diagonal Pltfrm
GG	101	19" Green-Gel Palm Rest	L523261000	121	5" Lift & Lock KB Assy, 26" Pltfrm
HCCHT	39	Chart/File Holder	L523261026GG	121	5" Lift & Lock KB Assy, 26" Pltfrm
HCCPUS	135	Slatwall/SlatRail Mounted CPU Cradle	L5232610GG	121	5" Lift & Lock KB Assy, 26" Pltfrm
HGCB	40	Glove Box	L523CR1000	119	5" Lift & Lock KB Assy, Classic Rect Pltfrm
JP1000	92	Jules Keyboard Pltfrm	L523CR10FA	119	5" Lift & Lock KB Assy, Classic Rect Pltfrm
JP10SF	92	Jules Keyboard Pltfrm	L523CR10FF	119	5" Lift & Lock KB Assy, Classic Rect Pltfrm
KCR	42	Cable Rings	L523CR10PP	119	5" Lift & Lock KB Assy, Classic Rect Pltfrm
KMINI	37	Mini Shelf	L523EN1000	121	5" Lift & Lock KB Assy, Enviro Pltfrm
L5	89	5" Lift & Lock Mechanism	L523EN10GG	121	5" Lift & Lock KB Assy, Enviro Pltfrm
L518	86	5" Lift & Lock Mechanism w/18" Track	L523JP1000	118	5" Lift & Lock KB Assy, Jules Pltfrm
L51819AM00	112	5" Lift & Lock KB Assy w/18"L Track	L523JP10SF	118	5" Lift & Lock KB Assy, Jules Pltfrm
L51819AMGG	113	5" Lift & Lock KB Assy w/18"L Track	L523SL10DA	118	5" Lift & Lock KB Assy, Slider Pltfrm

Style Number Index, continued

Style Number	Page	Description
L523SL10SA	118	5" Lift & Lock KB Assy, Slider Pltfrm
L7	89	7" Lift & Lock Mechanism
L718	87	7" Lift & Lock Mechanism w/18" Track
L71819AM00	122	7" Lift & Lock KB Assy w/18"L Track
L71819AMGG	122	7" Lift & Lock KB Assy w/18"L Track
L71819MDGG	122	7" Lift & Lock KB Assy w/18"L Track
L71819MLGG	122	7" Lift & Lock KB Assy w/18"L Track
L71819MRGG	122	7" Lift & Lock KB Assy w/18"L Track
L718EN10GG	123	7" Lift & Lock KB Assy w/18"L Track
L726	88	7" Lift & Lock Mechanism w/26" Track
L7261710EF	125	7" Lift & Lock KB Assy, Diagonal Pltfrm
L7261810EF	125	7" Lift & Lock KB Assy, Radius Pltfrm
L72619AM00	126	7" Lift & Lock KB Assy, 19" Pltfrm
L72619AMGG	126	7" Lift & Lock KB Assy, 19" Pltfrm
L72619MD00	126	7" Lift & Lock KB Assy, 19" Pltfrm
L72619MDGG	126	7" Lift & Lock KB Assy, 19" Pltfrm
L72619ML00	126	7" Lift & Lock KB Assy, 19" Pltfrm
L72619MLGG	126	7" Lift & Lock KB Assy, 19" Pltfrm
L72619MR00	126	7" Lift & Lock KB Assy, 19" Pltfrm
L72619MRGG	126	7" Lift & Lock KB Assy, 19" Pltfrm
L7262110EF	125	7" Lift & Lock KB Assy, Diagonal Pltfrm
L726261000	127	7" Lift & Lock KB Assy, 26" Pltfrm
L726261026GG	127	7" Lift & Lock KB Assy, 26" Pltfrm
L7262610GG	127	7" Lift & Lock KB Assy, 26" Pltfrm
L726CR1000	125	7" Lift & Lock KB Assy, Classic Rect Pltfrm
L726CR10FA	125	7" Lift & Lock KB Assy, Classic Rect Pltfrm
L726CR10FF	125	7" Lift & Lock KB Assy, Classic Rect Pltfrm
L726CR10PP	125	7" Lift & Lock KB Assy, Classic Rect Pltfrm
L726EN1000	127	7" Lift & Lock KB Assy, Enviro Pltfrm
L726EN10GG	127	7" Lift & Lock KB Assy, Enviro Pltfrm
L726JP1000	124	7" Lift & Lock KB Assy, Jules Pltfrm
L726JP10SF	124	7" Lift & Lock KB Assy, Jules Pltfrm
L726SL10DA	124	7" Lift & Lock KB Assy, Slider Pltfrm
L726SL10SA	124	7" Lift & Lock KB Assy, Slider Pltfrm
LDASHC	62	dash LED Light, C-clamp Mount
LDASHF	62	dash LED Light, Freestanding
LDASHMINIC	64	dash mini LED Light, C-clamp Mount
LDASHMINIF	64	dash mini LED Light, Freestanding
LDASHMINIOC	65	dash mini LED Light, C-clamp Mount
LDASHMINIOF	65	dash mini LED Light, Freestanding
LDASHMINIOP	65	dash mini LED Light, Pnl-Mount
LDASHMINIOR	65	dash mini LED Light, Rail-Mount
LDASHMINIOS	65	dash mini LED Light, Slatwall/SlatRail Mount
LDASHMINIP	64	dash mini LED Light, Pnl-Mount
LDASHMINIR	64	dash mini LED Light, Rail-Mount
LDASHMINIS	64	dash mini LED Light, Slatwall/SlatRail Mount
LDASHOC	63	dash LED Light, C-clamp Mount
LDASHOF	63	dash LED Light, Freestanding
LDASHOP	63	dash LED Light, Pnl-Mount
LDASHOR	63	dash LED Light, Rail-Mount
LDASHOS	63	dash LED Light, Slatwall/SlatRail Mount
LDASHP	62	dash LED Light, Pnl-Mount
LDASHR	62	dash LED Light, Rail-Mount
LDASHS	62	dash LED Light, Slatwall/SlatRail Mount
LLL17	72	LED Linear Shelf Light

Style Number	Page	Description
LLL17YA	72	LED Linear Shelf Light
LLL17YB	72	LED Linear Shelf Light
LLL31	72	LED Linear Shelf Light
LLL31YB	72	LED Linear Shelf Light
LLL44	73	LED Linear Shelf Light
LLL44YB	73	LED Linear Shelf Light
LLL58	73	LED Linear Shelf Light
LLL58YB	73	LED Linear Shelf Light
LLDD	71	LED Linear Desktop Light
LLDS	71	LED Linear Desktop Light
LLRDD	70	LED Radial Desktop Light
LLRDS	70	LED Radial Desktop Light
LMINICORD	313	Mini Extension Cord
LMINILED	68	Mini SOTO LED Light
LMINILEDE	69	Mini SOTO Extended LED Light
OLBCK	311	Connection Kit for Ology-Dual Sided Benches
OLBCM	312	Cable Manager for Ology-Dual Sided Benches
OLBEC	311	Tray Covers for Ology-Dual Sided Benche
OLBELRQD	305	Ology Height-Adjustable Dual-Sided Bchs, Ext.
OLBELRQDB	306	Ology Height-Adjustable Dual-Sided Bss, Ext.
OLBFL	312	Infills for Ology-Dual Sided Benches
OLBRQD	309	Ology Height-Adjust Dual-Sided Bches, Cmb
OLBRQDB	310	Ology Height-Adjust Dual-Sided Bases, Cmb
OLBSC	314	Universal Screens for Ology Dual-Sided Bchs
OLBSLRQD	305	Ology Height-Adjust Dual-Sided Benches, Lmt
OLBSLRQDB	306	Ology Height-Adjust Dual-Sided Bases, Lmt
OLCB	257, 313	Ology, Cable Basket
OLCBK4	257, 313	Ology, Cable Bracket
OLCR	257	Ology, Cable Riser
OLELLC	245-246	Ology, Hgt-Adj Desk, 90° Corner
OLELLCB	253	Ology, Hgt-Adj Bases, 90° Corner
OLELRQ	237	Ology, Hgt-Adj Desk, Rectangular
OLELRQB	251	Ology, Hgt-Adj Desk, Rectangular
OLELRT	241	Ology, Hgt-Adj Desk, Tapered
OLELRTB	252	Ology, Hgt-Adj Base, Tapered
OLELWC	248	Ology, Hgt-Adj Desk, 120° Corner
OLELWCB	254	Ology, Hgt-Adj Base, 120° Corner
OLMP	255	Ology, Modesty Panels
OLSLLC	246-247	Ology, Hgt-Adj Desk, 90° Corner
OLSLLCB	253	Ology, Hgt-Adj Bases, 90° Corner
OLSLRQ	238	Ology, Hgt-Adj Desk, Rectangular
OLSLRQB	251	Ology, Hgt-Adj Bases, Rectangular
OLSLRT	242	Ology, Hgt-Adj Desk, Tapered
OLSLRTB	252	Ology, Hgt-Adj Bases, Tapered
OLSLWC	249	Ology, Hgt-Adj Desk, 120° Corner
OLSLWCB	254	Ology, Hgt-Adj Bases, 120° Corner
PP	102	Positionable Palm Rest
Q11T	90	11" Track
Q12T	90	12" Track
Q17T	90	17" Track
Q18T	90	18" Track
Q20T	90	20" Track
Q22T	90	22" Track
Q23T	90	23" Track
Q26T	90	26" Track

Style Number	Page	Description	Style Number	Page	Description
QACPUT	135	CPU Trolley	SS20CR10FF	105	Stella Std KB Assy, Classic Rect Pltfrm
RATCTHAD	261	Common Top	SS20CR10PP	105	Stella Std KB Assy, Classic Rect Pltfrm
RPXFHAD	263	Filler	SS20EN1000	107	Stella Std KB Assy, Enviro Pltfrm
RPXSHAD	262	Shroud	SS20EN10GG	107	Stella Std KB Assy, Enviro Pltfrm
RSCHAD	259	Univ One-High Open Lat	SS20JP1000	104	Stella Std KB Assy, Jules Pltfrm
SA	100	Standard Adj Foam Palm Rest	SS20JP10SF	104	Stella Std KB Assy, Jules Pltfrm
SE	89	Stella Ext Mechanism	SS20SL1000	104	Stella Std KB Assy, Slider Pltfrm
SE23	86	Stella Ext Mechanism w/23" Track	SS20SL10DA	104	Stella Std KB Assy, Slider Pltfrm
SE231710EF	109	Stella Ext KB Assy, Diagonal Pltfrm	SS20SL10SA	104	Stella Std KB Assy, Slider Pltfrm
SE231810EF	109	Stella Ext KB Assy, Radius Pltfrm	UAPB2436	278	Airtouch Hgt-Adj Wksf, 120° Equal
SE2319AM00	110	Stella Ext KB Assy, 19" Pltfrm	UAPDC2442	278	Airtouch Hgt-Adj Wksf, 90° Corner Bi-Level
SE2319AMGG	110	Stella Ext KB Assy, 19" Pltfrm	UAPDC2448	278	Airtouch Hgt-Adj Wksf, 90° Corner Bi-Level
SE2319MD00	110	Stella Ext KB Assy, 19" Pltfrm	UAPDS3642	277	Airtouch Hgt-Adj Wksf, Rectangular Bi-Level
SE2319MDGG	110	Stella Ext KB Assy, 19" Pltfrm	UAPDS3648	277	Airtouch Hgt-Adj Wksf, Rectangular Bi-Level
SE2319ML00	110	Stella Ext KB Assy, 19" Pltfrm	UAPSC1842	278	Airtouch Hgt-Adj Wksf, 90° Corner
SE2319MLGG	110	Stella Ext KB Assy, 19" Pltfrm	UAPSC2442	278	Airtouch Hgt-Adj Wksf, 90° Corner
SE2319MR00	110	Stella Ext KB Assy, 19" Pltfrm	UAPSC2448	278	Airtouch Hgt-Adj Wksf, 90° Corner
SE2319MRGG	110	Stella Ext KB Assy, 19" Pltfrm	UAPSS2442	277	Airtouch Hgt-Adj Wksf, 22¼"D Rectangular
SE232110EF	109	Stella Ext KB Assy, Diagonal Pltfrm	UAPSS2448	277	Airtouch Hgt-Adj Wksf, 22¼"D Rectangular
SE23261000	111	Stella Ext KB Assy, 26" Pltfrm	UAPSS2460	277	Airtouch Hgt-Adj Wksf, 22¼"D Rectangular
SE23261026GG	111	Stella Ext KB Assy, 26" Pltfrm	UAPSS3042	277	Airtouch Hgt-Adj Wksf, 28¼"D Rectangular
SE232610GG	111	Stella Ext KB Assy, 26" Pltfrm	UAPSS3048	277	Airtouch Hgt-Adj Wksf, 28¼"D Rectangular
SE23CR1000	109	Stella Ext KB Assy, Classic Rect Pltfrm	UAPSS3060	277	Airtouch Hgt-Adj Wksf, 28¼"D Rectangular
SE23CR10FA	109	Stella Ext KB Assy, Classic Rect Pltfrm	UFAL	315	Aligner Clips for Use with Universal Screens
SE23CR10FF	109	Stella Ext KB Assy, Classic Rect Pltfrm	WBHS	34	Binder Holder
SE23CR10PP	109	Stella Ext KB Assy, Classic Rect Pltfrm	WCH	42	Coat Hook
SE23EN1000	111	Stella Ext KB Assy, Enviro Pltfrm	WDPDL	43	Pelican Pencil Drawer, Locking
SE23EN10GG	111	Stella Ext KB Assy, Enviro Pltfrm	WDPDNL	43	Pelican Pencil Drawer, Non-Locking
SE23JP1000	108	Stella Ext KB Assy, Jules Pltfrm	WDPL	43	Pelican Pencil Drawer, Security Lid
SE23JP10SF	108	Stella Ext KB Assy, Jules Pltfrm	WFCS	26	Freestanding Slatwall Stanchions
SE23SL10DA	108	Stella Ext KB Assy, Slider Pltfrm	WHB	35	Hanging Brackets
SE23SL10SA	108	Stella Ext KB Assy, Slider Pltfrm	WHOOK	41	Utility Hook
SF	103	Standard Foam Palm Rest	WIB	44	Pelican Installation Bar
SL1000	91	Slider Keyboard Pltfrm	WLG15L	33	Landscape Legal Tray
SL10DA	91	Slider Keyboard Pltfrm	WLT12L	33	Landscape Letter Tray
SL10SA	91	Slider Keyboard Pltfrm	WLTS	33	Portrait Letter Tray
SMPRS	101	Slider Mousing Surface Palm Rest	WMB	41	Markerboard
SS	88	Stella Standard Mechanism	WOF5	37	Office in a File
SS20	86	Stella Std Mechanism w/20" Track	WPCS	36	Pen/Pencil Cup
SS201710EF	105	Stella Std KB Assy, Diagonal Pltfrm	WPFS	34	PaperFlo Manager
SS201810EF	105	Stella Std KB Assy, Radius Pltfrm	WS24	27	12"H Slatwall Tile
SS2019AM00	106	Stella Std KB Assy, 19" Pltfrm	WS2418H	27	18"H Slatwall Tile
SS2019AMGG	106	Stella Std KB Assy, 19" Pltfrm	WS30	27	12"H Slatwall Tile
SS2019MD00	106	Stella Std KB Assy, 19" Pltfrm	WS3018H	27	18"H Slatwall Tile
SS2019MDGG	106	Stella Std KB Assy, 19" Pltfrm	WS36	27	12"H Slatwall Tile
SS2019ML00	106	Stella Std KB Assy, 19" Pltfrm	WS3618H	27	18"H Slatwall Tile
SS2019MLGG	106	Stella Std KB Assy, 19" Pltfrm	WS42	27	12"H Slatwall Tile
SS2019MR00	106	Stella Std KB Assy, 19" Pltfrm	WS4218H	27	18"H Slatwall Tile
SS2019MRGG	106	Stella Std KB Assy, 19" Pltfrm	WS45	27	12"H Slatwall Tile
SS202110EF	105	Stella Std KB Assy, Diagonal Pltfrm	WS4518H	27	18"H Slatwall Tile
SS20261000	107	Stella Std KB Assy, 26" Pltfrm	WS48	27	12"H Slatwall Tile
SS20261026GG	107	Stella Std KB Assy, 26" Pltfrm	WS4818H	27	18"H Slatwall Tile
SS202610GG	107	Stella Std KB Assy, 26" Pltfrm	WS60	27	12"H Slatwall Tile
SS20CR1000	105	Stella Std KB Assy, Classic Rect Pltfrm	WS6018H	27	18"H Slatwall Tile
SS20CR10FA	105	Stella Std KB Assy, Classic Rect Pltfrm	WSPS	39	Personal Shelf

Style Number Index, continued

Style Number	Page	Description
WSQS	36	Double Square Dish
WSR24	31	24" SlatRail
WSR30	31	30" SlatRail
WSR36	31	36" SlatRail
WSR42	31	42" SlatRail
WSR48	31	48" SlatRail
WSR60	31	60" SlatRail
WSRFS	30	Freestanding SlatRail Stanchions
WSRU1	32	SlatRail Pnl-Mount Brkts
WSRW	32	SlatRail Wall-Mount Brkts
WSS12L	38	Slatshelf, Landscape
WSS18L	38	Slatshelf, Landscape
WSS18P	38	Slatshelf, Portrait
WSS24L	38	Slatshelf, Landscape
WSS24P	38	Slatshelf, Portrait
WSSD	39	Slatshelf Dividers
WSSL	38	Slatshelf Labels
WSW42AN	28	Slatwall Brkt, 12"H Pnl-Mount
WSW42AV	28	Slatwall Brkt, 12"H Pnl-Mount
WSW42S9	28	Slatwall Brkt, 12"H Pnl-Mount
WSWANS	28	Slatwall Brkt, 12"H Pnl-Mount
WSWANS18	28	Slatwall Brkt, 18"H Pnl-Mount
WSWM	29	Slatwall Brkt, 12"H Wall-Mount
WSWM18	29	Slatwall Brkt, 18"H Wall-Mount
WSWPBOF12	29	Slatwall Brkt, 12"H Wall-Mount
WSWUSA	28	Slatwall Brkt, 12"H Pnl-Mount
WSWUSA18	28	Slatwall Brkt, 18"H Pnl-Mount
WTBS	40	Tackstrip
WTCS	40	Telephone Caddy
WUS	35	Universal Shelf, Single
WUS3	35	Universal Shelves, 3-Pack
WWT	41	Work Tags
X04815	90	Dual Pivot Plate

Trademark List

- ® The following are registered trademarks for products of Steelcase Inc. or one of its related corporate entities: 4 o'clock, 900 Series, à la carte, Airtouch, Ally, Amia, Answer, Archipelago, Avenir, Ballet, Bix, Brayton International, Cachet, Canopy, Canto, Chancellor, Coalesse, Confidante, Context, Convene, CopyCam, Criterion, Crushed Can, Currency, dash, Designtex, Details, Detour, Drive, Elective Elements, Ellipse, Ember Chrome, Emerge, E-Table 2, FYI, Garland, Gentry, Ginkgo Biloba, Groupwork, Ideo, Jacket, Jenny, Jersey, Kart, Kick, LaCosta, Leap, Let's B, LiveBack, Max-Stacker, media:scape, Metro, Migrations, Mitra, Montage, Nurture, Oriana, Parade, Pathways, PCT, Permiso, Player, Portal, Power Pincher, Progeny, Protégé, R2, Rally, Relevant, Reply, Rizzi Arc, Sensor, Series 9000, Siento, Sieste, Sine, Softcare, Springboard, Steelcase, Steelcase Design Partnership, Stella, Stow Davis, Swathmore, TeamWork, Technique, Texpress, Think, Thunder, Topo, Train, turnstone, Underline, Unison, Vecta, Viridian, Walden, Wernld, and X-Stack.
- ® The following registered trademarks are under license from AWI Licensing Company, Dover, DE: SoundScapes, DuraBrite, BioBlock, and Armstrong.
- ® The following registered trademarks are under license from Byrne Electrical, Rockford, MI: Interport, Mini-Port, Axil Z, and Ellora.
- ® The following is a registered trademark of DuPont, Wilmington, DE: Corian.
- ® The following is a registered trademark of Genlyte Thomas Company, Louisville, KY: Lightolier.
- ® The following is a registered trademark of Hilti Corporation, FL-9494 Schaan, Principality of Liechtenstein: Hilti.
- ® The following is a registered trademark of Leviton Manufacturing Company, Little Neck, NY: Decora.
- ® The following is a registered trademark of Mechanical Plastics Corp, Elmsford, NY: Toggler.
- ® The following is a registered trademark of Microsoft Corporation, Redmond, WA: Microsoft.
- ® The following is a registered trademark of Panduit Corporation, Lockport, IL: Panduit.
- ® The following is a registered trademark of Trav (Press), Cuneo, Italy: Assisa.
- ® The following is a registered trademark of Virtual Ink, Boston, MA: mimioActive.
- ® The following registered trademarks are under license from Wilkhahn Furniture Products: Avera, Senzo, Versal, and Wilkhahn FS.

- ® The following is a registered trademark of Wilsonart International, Temple, TX: Chemsurf.
- ® The following is a registered trademark of Wiremold, West Hartford, CT: Wiremold.
- ® The following is a registered trademark of EMU Group S.P.A., Perugia, Italy: Emu.
- ™ The following are trademarks for products of Steelcase Inc. or one of its related corporate entities: Access, Active/Passive Shelf, Ainsley, Akira, Alcove, Alerion, Alight, Amaris, American Elect, American Tradition, ap40, Arbor, Arriva, Asana, Ascot, Aspekt, Astor, Await, Bassline, B-Free, Bira, Bivi, Bixby, Bottomline, Brody, Brook, Buoy, Burton, c:scape, Calla, Calm, Camber, Campfire, Capa, Cappuccino, Cesar, Chester, Chord, Circa, Clarendon, Classic Rectangular, Clipper, cobì, Collaboration, Community, Company, Convey, Cortex, Coupe, Crea, Crew, Cura, Cypress, Davenport, Dearborn, Deck, Déjà, Denizen, Denska, Derby, Divisio, Donovan, Dune, Duo, Echo, Edge, Elsna, Empath, Empress, Enea, èno, EnSync, Enviro, Escapade, Exchange, Exponents, Field, Flat Top, FlexFrame, Flip Top, Flute, Folio, FrameOne, FreeFlow, Frontier, Galilei, Gesture, Ginger, Ginkgo, Go Wall, Grip, Groove, Hatchback, Hawthorne, Hitch, Host Collection, Hosu, Huddleboard, i2i, Impact, Indy, InfoLink, IOS, I-Solve, Jack, Jarrah, Jetty, Juice, Kami, Kast, Kathryn, Lagunitas, Lark, L'Attitude, LearnLab, Leela, LessThanFive, Lincoln, Linden, LiveSeat, Loria, Lyric, Malibu, Malibu Too, Mansfield, Marathon, Martini, Mason, Masque, Migration, Millbrae, Mineral, Mingle, Mystic, Mystic Metal, Mystic Wood, Montara650, Montreal, Move, Nadia, Neighbor, nesso, Nickel, Nikko, Nod, Node, Norfolk, Ology, Ontrak, Oom, Opus, Orchid, Outlook Collection, Ovation, Paloma, Paperflo, Parliament, Pasio, Passerelle, Patriarch, Payback, Peek, Pile File, Pisa, Pool, Potrero415, PUCK, QiVi, Quba, Rave, Reed, Regard, Relay, Reunion, Ripple, Riser, Rocco, Rocky, RoomWizard, Runner, Satellite, Sawyer, ScapeSeries, Senti, Sentinel, Senza, Sequoia, Session, ShareLink, Shield, Shortcut, Sidewalk, SILQ, Skylar, Slumber, Smoke, Snug, Soft Leaf, Sonata, Sorrel, SOTO, Southside, Stationkits, Steelcase Series, Stiletto, Surprise!, Surround, Switch, Symphony, Sync, TagWizard, Tava, TeamStudio, TeamTheater, Tenaro, Terrazzo, Theorem, Thread, Topaz, Touchdown, Tour, Tower Too, Trees, Trillium, Trolley, tX2, U-Free, Umami, Underscore, Uno, V.I.A., Verb, Verge, Verlay, Victor2, Visalia, Waldorf, Woodruff, Workspring, and X-tenz.
- ™ The following is a trademark of Microsoft Corporation, Redmond, WA: Windows.
- ™ The following is a trademark of Rodman Industries, Inc., Oconomowoc, WI: ResinCore1.
- ™ The following is a trademark of Ultrafabrics, LLC, Elmsford, NY: Ultraleather.

- ™ The following trademarks are under license from Wilkhahn Furniture products: Cana, Linus, Logon, Picto, Range, Stitz, Thema, Timetable, and Tubis.
- ™ The following trademark is used under license from Cradle to Cradle Products Innovation Institute, Oakland, CA: Cradle to Cradle Certified.
- ™ The following trademarks are under license from Walter Knoll: Andoo, Bob, Lazlo, Lox, Ribbon, and Together.
- ™ The following trademarks are under license from PP Møbler: Bar and Flag Halyard.
- ™ The following trademarks are under license from Viccarbe: Davos, Holy Day, Last Minute, RS, Sistema, and Wrapp.
- ™ The following trademarks are under license from Carl Hansen: Elbow, Paddle, Shell, Wing, and Wishbone.
- ™ The following trademarks are under license from Cambridge Sound Management, LLC, Cambridge, MA: QtPro Soundmasking, Qt Quiet Technology, and Sonet Qt.
- ™ The following is a trademark of Electri-Cable Assemblies, Shelton, CT: Interact.
- ™ The following is a trademark of Clestra Hauserman: IRYS.
- ™ The following is a trademark of Wiesner-Hager Möbel GmbH: Nooi.
- ™ The following are trademarks of PolyVision: a³, e³, Motif, and PolyVision.

Trademarks used here in are the property of Steelcase, Inc. or of their respective owners.