

# Design Options

April 20, 2012

## Contents

<b>Universal Systems Worksurfaces</b>	<b>5</b>
<b>Universal Storage</b>	<b>13</b>
<b>Seating</b>	<b>35</b>
<b>Answer</b>	<b>61</b>
<b>Tackboards</b>	<b>71</b>
<b>Elective Elements 6</b>	<b>79</b>
<b>Montage</b>	<b>87</b>
<b>Post and Beam</b>	<b>127</b>
<b>Kick</b>	<b>137</b>
<b>Wood Casegoods</b>	<b>141</b>
<b>Privacy Wall</b>	<b>175</b>
<b>Nurture</b>	<b>257</b>
<b>c:scape</b>	<b>291</b>
<b>Details</b>	<b>301</b>
<b>Resources</b>	<b>305</b>

► For a list of all trademarks, refer to the last page of this specification guide.



### **For Canadian Pricing**

Calculate in the following order to avoid rounding errors:

- Multiply the base price and each option by 1.03.
- Round each to the nearest dollar.
- Add base and options for total list price.



# About Design Options

---

## Easy specification

Design Options is a collection of commonly requested Specials that are not ordered in sufficient quantity to warrant support as a standard product. Use Design Options when your customer's needs cannot be met with standard products.

**It is available only on the Specials web area on [in2.steelcase.com](http://in2.steelcase.com). Check it regularly. Products may be added or deleted and pricing could change.**

Design Options is for Steelcase and dealer use only, and is not intended for distribution to customers or the design community.

## Placing an order

1. Follow the Required to Specify information from Design Options
2. Include the general quote number and Product ID on your order
3. Select the style number from Design Options

## Additional offerings

If you did not find a solution in Design Options, visit the Specials web area on in2 and complete a request for quote (RFQ) using E-quote.



---

# Universal Systems Worksurfaces

▶ See page 3, *About Design Options*, in the front of this book for pricing and ordering restrictions.

## **Worksurfaces with 1/2" Cord Drop**

Straight Worksurfaces	<b>6</b>
Transition Worksurfaces	<b>7</b>
Extended Corner, Curved-Front Worksurfaces	<b>8</b>
Transaction Worksurfaces	<b>9</b>
Corner, Curved-Front Worksurfaces	<b>11</b>

## **Full-Depth Worksurfaces**

Straight Worksurfaces	<b>12</b>
-----------------------	-----------

# Straight Worksurfaces—with 1/2" Cord Drop

High-Pressure Laminate

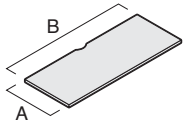

*Tip: Supports for freestanding and panel-mounted applications must be specified separately.*

*Tip: Long work surface spans must be supported with cantilevers, pedestals, leg, or other supports at least every 54". Reinforcing channel (TS7WKSPT) allows the distance between supports to be increased to 60" for work surfaces that will be heavily loaded, or up to 72" for work surfaces with lighter expected loads. Reinforcing channel must be specified separately.*

## What's Special

Worksurfaces are available in a variety of widths.



### For Canadian Pricing

Multiply U.S. Price by the Canadian price factor.

▶ See page 1 for details.

## Standard Includes

- Worksurface: High-Pressure Laminate
- Vinyl 3 mm edge profile
- Plastic default flat profile on side and back edges
- Cable scallop on back edge

## Required to Specify

- 1 General quote number: **SF085013**
  - 2 Style number and Product ID
  - 3 High-Pressure Laminate number for work surface
  - 4 Plastic color number for front edge on laminate work surface
- See Surface Materials in the Answer Solutions Specification Guide.

## Specification Information

				Change to U.S. Base Price
Dimensions		Style Number	Product ID	Vinyl 3 mm Edge
A	B			
18 <sup>3</sup> / <sub>8</sub> "	18"	<b>US1824</b>	SF00133809	+\$110
18 <sup>3</sup> / <sub>8</sub> "	102"	<b>US1896</b>	SF00140997	+\$143
18 <sup>3</sup> / <sub>8</sub> "	108"	<b>US1896</b>	SF00138754	+\$175
18 <sup>3</sup> / <sub>8</sub> "	114"	<b>US1896</b>	SF00152421	+\$208
18 <sup>3</sup> / <sub>8</sub> "	120"	<b>US1896</b>	SF00152422	+\$240
23 <sup>1</sup> / <sub>2</sub> "	18"	<b>US2424</b>	SF00132726	+\$110
23 <sup>1</sup> / <sub>2</sub> "	102"	<b>US2496</b>	SF00134071	+\$146
23 <sup>1</sup> / <sub>2</sub> "	108"	<b>US2496</b>	SF00164558	+\$182
23 <sup>1</sup> / <sub>2</sub> "	114"	<b>US2496</b>	SF00135660	+\$218
23 <sup>1</sup> / <sub>2</sub> "	120"	<b>US2496</b>	SF00143342	+\$255
29 <sup>1</sup> / <sub>2</sub> "	18"	<b>US3024</b>	SF00132289	+\$110
29 <sup>1</sup> / <sub>2</sub> "	78"	<b>US3072</b>	SF00132157	+\$146
29 <sup>1</sup> / <sub>2</sub> "	84"	<b>US3072</b>	SF00132158	+\$182
29 <sup>1</sup> / <sub>2</sub> "	90"	<b>US3072</b>	SF00131909	+\$218
29 <sup>1</sup> / <sub>2</sub> "	96"	<b>US3072</b>	SF00130984	+\$254
29 <sup>1</sup> / <sub>2</sub> "	102"	<b>US3072</b>	SF00132870	+\$290
29 <sup>1</sup> / <sub>2</sub> "	108"	<b>US3072</b>	SF00132875	+\$327
29 <sup>1</sup> / <sub>2</sub> "	114"	<b>US3072</b>	SF00134297	+\$363
29 <sup>1</sup> / <sub>2</sub> "	120"	<b>US3072</b>	SF00132916	+\$399
35 <sup>1</sup> / <sub>2</sub> "	18"	<b>US3024</b>	SF00132014	+\$158
35 <sup>1</sup> / <sub>2</sub> "	24"	<b>US3024</b>	SF00131336	+\$158
35 <sup>1</sup> / <sub>2</sub> "	30"	<b>US3030</b>	SF00131883	+\$160
35 <sup>1</sup> / <sub>2</sub> "	36"	<b>US3036</b>	SF00131884	+\$164
35 <sup>1</sup> / <sub>2</sub> "	42"	<b>US3042</b>	SF00131885	+\$166
35 <sup>1</sup> / <sub>2</sub> "	48"	<b>US3048</b>	SF00131886	+\$176
35 <sup>1</sup> / <sub>2</sub> "	54"	<b>US3054</b>	SF00131887	+\$178



# Transition Worksurfaces—with 1/2" Cord Drop

## High-Pressure Laminate

Transition Worksurfaces—  
with 1/2" Cord Drop

Universal  
Worksurfaces

*Tip: Supports for freestanding and panel-mounted applications must be specified separately.*

*Tip: Long worksurface spans must be supported with cantilevers, pedestals, leg, or other supports at least every 54". Reinforcing channel (TS7WKSPT) allows the distance between supports to be increased to 60" for worksurfaces that will be heavily loaded, or up to 72" for worksurfaces with lighter expected loads. Reinforcing channel must be specified separately.*

### What's Special

Worksurfaces are available in a variety of widths.

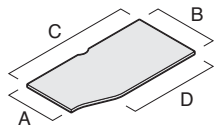
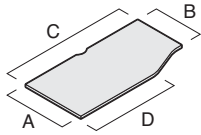

Standard Includes	Required to Specify
-------------------	---------------------

- Worksurface: High-Pressure Laminate
- Vinyl 3 mm edge profile
- Plastic default flat profile on side and back edges
- Cable scallop on back edge

- 1 General quote number: **SF085019**
  - 2 Style number and Product ID
  - 3 High-Pressure Laminate number for worksurface
  - 4 Plastic color number for front edge on laminate worksurface
- See Surface Materials in the Answer Solutions Specification Guide.

### Specification Information

Dimensions				Style Number	Product ID	Change to U.S. Base Price
A	B	C	D			Vinyl 3 mm Edge
						

### Left-Hand Worksurfaces

23 1/2"	18 3/8"	30"	8"	<b>UT2136L</b>	SF00145371	+\$110
29 1/2"	23 1/2"	30"	8"	<b>UT3236L</b>	SF00132324	+\$110
35 1/2"	29 1/2"	48"	26"	<b>UT3248L</b>	SF00132649	+\$203
35 1/2"	29 1/2"	60"	38"	<b>UT3260L</b>	SF00135509	+\$215
29 1/2"	23 1/2"	72"	50"	<b>UT3260L</b>	SF00131910	+\$215

### Right-Hand Worksurfaces

18 3/8"	23 1/2"	30"	8"	<b>UT1236R</b>	SF00143683	+\$110
23 1/2"	29 1/2"	30"	8"	<b>UT2336R</b>	SF00132325	+\$110
29 1/2"	35 1/2"	48"	26"	<b>UT2348R</b>	SF00132652	+\$203
29 1/2"	35 1/2"	60"	38"	<b>UT2360R</b>	SF00135510	+\$215
23 1/2"	29 1/2"	72"	50"	<b>UT2360R</b>	SF00131911	+\$215

 **For Canadian Pricing**  
Multiply U.S. Price by the Canadian price factor.  
▶ See page 1 for details.

# Extended Corner, Curved-Front Worksurfaces—with 1/2" Cord Drop

High-Pressure Laminate

*Tip: Supports must be specified separately, including side support brackets for rear corner support in panel-mounted applications.*

*Tip: Long worksurface spans must be supported with cantilevers, pedestals, leg, or other supports at least every 54" Reinforcing channel (TS7WKSPT) allows the distance between supports to be increased to 60" for worksurfaces that will be heavily loaded, or up to 72" for worksurfaces with lighter expected loads. Reinforcing channel must be specified separately.*

## What's Special

Worksurfaces are available in a variety of widths.

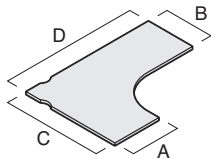
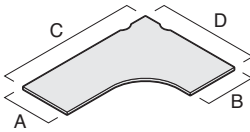

### Standard Includes

- Worksurface: High-Pressure Laminate
- Vinyl 3 mm edge profile
- Plastic default flat profile on side and back edges
- Cable scallops on back edges

### Required to Specify

- 1 General quote number: **SF085020**
  - 2 Style number and Product ID
  - 3 High-Pressure Laminate number for worksurface
  - 4 Plastic color number for front edge on laminate worksurface
- See Surface Materials in the Answer Solutions Specification Guide.

## Specification Information

### Change to U.S. Base Price



Dimensions	Style Number	Product ID	Vinyl 3 mm Edge
A B C D			

### Left-Hand Worksurfaces

23 1/2"	23 1/2"	47 1/2"	35 1/2"	<b>UEC2202L</b>	SF00141100	-\$ 48
23 1/2"	23 1/2"	59 1/2"	35 1/2"	<b>UEC2202L</b>	SF00137154	+\$110
18 3/8"	18 3/8"	59 1/2"	47 1/2"	<b>UEC2208L</b>	SF00140363	+\$110
23 1/2"	23 1/2"	71 1/2"	35 1/2"	<b>UEC2222L</b>	SF00133829	+\$110
29 1/2"	23 1/2"	71 1/2"	41 1/2"	<b>UEC3228L</b>	SF00132327	+\$110
23 1/2"	23 1/2"	71 1/2"	59 1/2"	<b>UEC2228L</b>	SF00133377	+\$366
29 1/2"	23 1/2"	77 1/2"	47 1/2"	<b>UEC3228L</b>	SF00131515	+\$180

### Right-Hand Worksurfaces

23 1/2"	23 1/2"	35 1/2"	47 1/2"	<b>UEC2220R</b>	SF00141101	-\$ 48
23 1/2"	23 1/2"	35 1/2"	59 1/2"	<b>UEC2220R</b>	SF00133824	+\$110
18 3/8"	18 3/8"	47 1/2"	59 1/2"	<b>UEC2280R</b>	SF00140364	+\$110
23 1/2"	23 1/2"	35 1/2"	71 1/2"	<b>UEC2222R</b>	SF00133830	+\$110
23 1/2"	29 1/2"	41 1/2"	71 1/2"	<b>UEC2382R</b>	SF00132326	+\$110
23 1/2"	23 1/2"	59 1/2"	71 1/2"	<b>UEC2282R</b>	SF00133969	+\$366
23 1/2"	29 1/2"	47 1/2"	77 1/2"	<b>UEC2382R</b>	SF00131518	+\$180



### For Canadian Pricing

Multiply U.S. Price by the Canadian price factor.

▶ See page 1 for details.



# Transaction Worksurfaces—Full Width, for use with Answer Panels with Oval Trim

High-Pressure Laminate

Transaction Worksurfaces—Full  
Width, for use with Answer  
Panels with Oval Trim

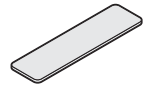

## Standard Includes

- Worksurface: High-Pressure Laminate
- Vinyl 3 mm edge profile
- Top caps for use with Answer panels: paint
- Support brackets: black paint only

## Required to Specify

- 1 General quote number: **SF085021**
  - 2 Style number and Product ID
  - 3 High-Pressure Laminate number for worksurface
  - 4 Plastic color number for front edge on laminate worksurface
- See Surface Materials in the Answer Solutions Specification Guide.

Universal  
Worksurfaces

## What's Special

Worksurfaces are available  
in full width.

## Specification Information

### Change to U.S. Base Price



• Dimensions		• Style Number	• Product ID	• Vinyl 3 mm Edge
A	B			
15"	24"	<b>UTR1630A</b>	SF00139778	+\$110
15"	30"	<b>UTR1636A</b>	SF00132579	+\$110
15"	36"	<b>UTR1642A</b>	SF00133313	+\$110
15"	42"	<b>UTR1648A</b>	SF00134605	+\$110
15"	48"	<b>UTR1660A</b>	SF00133314	+\$110
15"	60"	<b>UTR1660A</b>	SF00133483	+\$110
15"	72"	<b>UTR1660A</b>	SF00132183	+\$187
:	:	:	:	:



### For Canadian Pricing

Multiply U.S. Price by the  
Canadian price factor.

▶ See page 1 for details.

# Transaction Worksurfaces—Full Width, for use with Answer Panels with Square Trim

High-Pressure Laminate

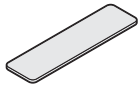

## Standard Includes

- Worksurface: High-Pressure Laminate
- Vinyl 3 mm edge profile
- Top caps for use with Answer panels: paint
- Support brackets: black paint only

## Required to Specify

- 1 General quote number: **SF097493**
  - 2 Style number and Product ID
  - 3 High-Pressure Laminate number for worksurface
  - 4 Plastic color number for front edge on laminate worksurface
- See Surface Materials in the Answer Solutions Specification Guide.

## What's Special

Worksurfaces are available in full width.

## Specification Information

### Change to U.S. Base Price



• Dimensions		• Style Number	• Product ID	• Vinyl 3 mm Edge
A	B			
15"	24"	<b>UTR1630SA</b>	SF00164185	+\$110
15"	30"	<b>UTR1636SA</b>	SF00163786	+\$110
15"	36"	<b>UTR1642SA</b>	SF00165266	+\$110
15"	42"	<b>UTR1648SA</b>	SF00163787	+\$110
15"	48"	<b>UTR1660SA</b>	SF00165267	+\$110
15"	60"	<b>UTR1660SA</b>	SF00167846	+\$110
15"	72"	<b>UTR1660SA</b>	SF00164327	+\$187



### For Canadian Pricing

Multiply U.S. Price by the Canadian price factor.

▶ See page 1 for details.

# Corner, Curved-Front Worksurfaces—with 1/2" Cord Drop

High-Pressure Laminate

Corner, Curved-Front  
Worksurfaces—with 1/2"  
Cord Drop

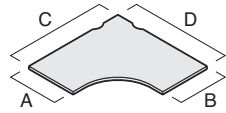

*Tip: Supports must be specified separately, including side support brackets for rear corner support in panel-mounted applications.*

## What's Special

Worksurfaces are available in a variety of widths.

Standard Includes	Required to Specify
<ul style="list-style-type: none"> <li>• Worksurface: High-Pressure Laminate</li> <li>• Vinyl 3 mm edge profile</li> <li>• Plastic default flat profile on side and back edges</li> <li>• Cable scallops on back edges</li> </ul>	<ol style="list-style-type: none"> <li>1 General quote number: <b>SF085022</b></li> <li>2 Style number and Product ID</li> <li>3 High-Pressure Laminate number for worksurface</li> <li>4 Plastic color number for front edge on laminate worksurface</li> </ol> <p>See Surface Materials in the Answer Solutions Specification Guide.</p>

## Specification Information

Dimensions				Style Number	Product ID	Change to U.S. Base Price
A	B	C	D			
29 1/2"	23 1/2"	41 1/2"	41 1/2"	<b>UCC334242</b>	SF00132432	+ \$110
23 1/2"	29 1/2"	41 1/2"	41 1/2"	<b>UCC334242</b>	SF00132433	+ \$110
23 1/2"	23 1/2"	41 1/2"	47 1/2"	<b>UCC224848</b>	SF00136926	+ \$110
23 1/2"	23 1/2"	47 1/2"	41 1/2"	<b>UCC224848</b>	SF00134694	+ \$110
29 1/2"	23 1/2"	47 1/2"	47 1/2"	<b>UCC334848</b>	SF00131301	+ \$110
23 1/2"	29 1/2"	47 1/2"	47 1/2"	<b>UCC334848</b>	SF00131300	+ \$110



 **For Canadian Pricing**  
Multiply U.S. Price by the Canadian price factor.  
▶ See page 1 for details.

# Straight Worksurfaces—Full Depth

High-Pressure Laminate

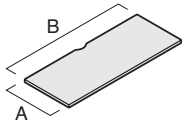

*Tip: Supports for freestanding and panel-mounted applications must be specified separately.*

*Tip: Long work surface spans must be supported with cantilevers, pedestals, leg, or other supports at least every 54". Reinforcing channel (TS7WKSPT) allows the distance between supports to be increased to 60" for work surfaces that will be heavily loaded, or up to 72" for work surfaces with lighter expected loads. Reinforcing channel must be specified separately.*

## What's Special

Worksurfaces are available in a variety of widths.

### Standard Includes

- Worksurface: High-Pressure Laminate
- Laminate worksurface:
  - Plastic 3 mm edge profile on front edge
  - Plastic default flat profile on side and back edges
- Cable scallop on back edge

### Required to Specify

- 1 General quote number: **SF096110**
  - 2 Style number and Product ID
  - 3 High-Pressure Laminate number for worksurface
  - 4 Plastic color number for front edge on laminate worksurface
- See Surface Materials in the Answer Solutions Specification Guide.

### Specification Information

Dimensions		Style Number	Product ID	Plastic 3 mm Edge	Change to U.S. Base Price
A	B				
18 <sup>7</sup> / <sub>8</sub> "	18"	<b>WS1824</b>	SF00176176	+	\$110
18 <sup>7</sup> / <sub>8</sub> "	102"	<b>WS1896</b>	SF00176180	+	\$143
18 <sup>7</sup> / <sub>8</sub> "	108"	<b>WS1896</b>	SF00170154	+	\$175
18 <sup>7</sup> / <sub>8</sub> "	114"	<b>WS1896</b>	SF00176181	+	\$208
18 <sup>7</sup> / <sub>8</sub> "	120"	<b>WS1896</b>	SF00175736	+	\$239
24"	18"	<b>WS2424</b>	SF00170729	+	\$110
24"	102"	<b>WS2496</b>	SF00170232	+	\$146
24"	108"	<b>WS2496</b>	SF00170104	+	\$182
24"	114"	<b>WS2496</b>	SF00172695	+	\$218
24"	120"	<b>WS2496</b>	SF00172189	+	\$254
30"	78"	<b>WS3072</b>	SF00167931	+	\$146
30"	84"	<b>WS3072</b>	SF00168043	+	\$182
30"	90"	<b>WS3072</b>	SF00168739	+	\$218
30"	96"	<b>WS3072</b>	SF00168692	+	\$254
30"	102"	<b>WS3072</b>	SF00176184	+	\$290
30"	108"	<b>WS3072</b>	SF00168023	+	\$326
30"	114"	<b>WS3072</b>	SF00168025	+	\$363
30"	120"	<b>WS3072</b>	SF00176186	+	\$399
:	:	:	:	:	:



### For Canadian Pricing

Multiply U.S. Price by the Canadian price factor.

▶ See page 1 for details.

---

# Universal Storage

▶ See page 3, *About Design Options*, in the front of this book for pricing and ordering restrictions.

<b>Universal Door Front Towers</b>	<b>14</b>
<b>Universal Side Access Towers</b>	<b>18</b>
<b>Universal Workstation Verticals</b>	<b>20</b>
<b>Universal Storage Cabinets without Doors</b>	<b>22</b>
<b>Universal Lockers</b>	<b>24</b>
<b>Universal One-High Lateral Files</b>	<b>26</b>
<b>Universal 1.5-High Lateral Files</b>	<b>28</b>
<b>Universal Open Side Towers</b>	<b>30</b>
<b>Square Edge Storage Tops</b>	<b>32</b>

# Universal Door Front Towers

with Flush Steel, Proud Steel, or Proud Wood Fronts

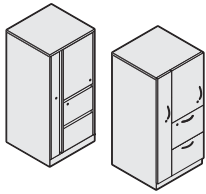

## What's Special

Towers are offered in a variety of configurations.

*Tip: Laminate and wood veneer tops are 3/16" taller than other tops and will add 3/16" to overall case height.*

*Tip: If wood veneer top option is selected, wood veneer top color will default to match wood front.*

### Standard Includes

- Tower: paint price group 1
- 1"H top: paint to match tower
- Integral pulls on units with flush steel fronts
- Contemporary pulls on units with proud steel or proud wood fronts: metal
- Hinged door on units with flush steel or proud steel fronts: paint to match tower
- Hinged door on units with proud wood fronts: wood veneer to match tower
- Lock, keyed random: 9201 Polished Chrome
- Drawer body: black only
- Drawer suspensions: black only
- Two box drawer dividers and one pencil tray in units with 6"H box drawers: black only
- Coat rod: 9201 Polished Chrome
- Four adjustable leveling glides

### Required to Specify

- 1 General quote number: **FC029681**
- 2 Style number with appropriate front style and Product ID
  - F** Flush steel front
  - P** Proud steel front
  - W** Proud wood front
- 3 Paint color number for tower
- 4 Wood color number for door and drawer fronts, if proud wood front selected
- 5 Metal color number for pulls, if proud steel or proud wood front selected:
  - 0835 Black
  - 9201 Polished Chrome
  - 9211 Nickel
  - 9212 Silver
- 6 Options, if selected (see below)
  - See Surface Materials in the Storage and Freestanding Furniture Specification Guide.

	Options	U.S. Price	Required to Specify
<b>Surface Materials</b>	<ul style="list-style-type: none"> <li>• Paint price group 1</li> <li>• Paint price group 2</li> <li>• Paint price group 3</li> </ul>	<ul style="list-style-type: none"> <li>No cost</li> <li>+\$ 70</li> <li>+\$120</li> </ul>	<ul style="list-style-type: none"> <li>Specify paint color number.</li> <li>Specify paint color number.</li> <li>Specify paint color number.</li> </ul>
	<ul style="list-style-type: none"> <li>• Customiz stain on proud wood fronts and top</li> </ul>	<ul style="list-style-type: none"> <li>+\$ 32</li> </ul>	<ul style="list-style-type: none"> <li>Specify with <i>Customiz stain</i>.</li> <li>▶ See <i>Surface Materials Reference Manual</i>.</li> </ul>
<b>Tops with Flush Steel Front, Proud Steel Front, and Proud Wood Front</b>	<b>Laminate top</b>		
	<ul style="list-style-type: none"> <li>• Square edge laminate top</li> </ul>	<ul style="list-style-type: none"> <li>+\$122</li> </ul>	<ul style="list-style-type: none"> <li>Specify with <i>laminate top</i> and indicate laminate color number for top and plastic color number for edges.</li> <li>▶ See <i>Surface Materials Reference Manual</i>.</li> </ul>
	<ul style="list-style-type: none"> <li>• Open Line laminate on laminate top</li> </ul>	<ul style="list-style-type: none"> <li>+\$ 64 plus cost of laminate</li> </ul>	
	<b>Wood veneer top</b>		
	<ul style="list-style-type: none"> <li>• Wood veneer top</li> </ul>	<ul style="list-style-type: none"> <li>+\$367</li> </ul>	<ul style="list-style-type: none"> <li>Specify with <i>wood veneer top</i> and indicate wood color number.</li> <li>Specify with <i>Customiz stain</i>.</li> <li>▶ See <i>Surface Materials Reference Manual</i>.</li> </ul>
	<ul style="list-style-type: none"> <li>• Customiz stain on wood veneer top on units with flush steel or proud steel fronts</li> </ul>	<ul style="list-style-type: none"> <li>+\$ 12</li> </ul>	
<b>Pulls for Proud Steel or Wood Fronts</b>	<ul style="list-style-type: none"> <li>• Handle</li> <li>• Jazz</li> <li>• Bar</li> </ul>	<ul style="list-style-type: none"> <li>No cost</li> <li>+\$ 17 per pull</li> <li>+\$ 24 per pull</li> </ul>	<ul style="list-style-type: none"> <li>Specify with <i>handle pull</i>.</li> <li>Specify with <i>jazz pull</i>.</li> <li>Specify with <i>bar pull</i>.</li> </ul>
	<b>Lock and Keying</b>		
	<ul style="list-style-type: none"> <li>• Ember Chrome</li> </ul>	<ul style="list-style-type: none"> <li>No cost</li> </ul>	<ul style="list-style-type: none"> <li>Specify with <i>9250 Ember Chrome lock</i>.</li> </ul>
	<b>Keying</b>		
	<ul style="list-style-type: none"> <li>• Factory- and field-installed keying</li> </ul>		<ul style="list-style-type: none"> <li>▶ Page 306</li> </ul>



### For Canadian Pricing

Multiply U.S. Price by the Canadian price factor.

▶ See page 1 for details.

Tip: Height dimension listed is for units with 1" top. Overall height will vary if another top is selected.

**Specification Information**

Dimensions		W	H	Style Number	Product ID	Change to U.S. Base Price
D						
Flush Steel Front	Proud Steel/Wood Front					

**Tower with Door Hinged on Left**

**With Two 12"H Drawers, One Fixed Shelf, and One Adjustable Shelf**

23 1/8"	24"	24"	52"	<b>RVD24244LAF</b>	FC00026862	+\$0
23 1/8"	24"	24"	52"	<b>RVD24244LAP</b>	FC00028795	+\$0
23 1/8"	24"	24"	52"	<b>RVD24244LAW</b>	FC00031029	+\$0
29 1/8"	30"	24"	52"	<b>RVD30244LAF</b>	FC00030995	+\$0
29 1/8"	30"	24"	52"	<b>RVD30244LAP</b>	FC00031017	+\$0
29 1/8"	30"	24"	52"	<b>RVD30244LAW</b>	FC00031037	+\$0

**With Two 6"H Drawers, One 12"H Drawer, One Fixed Shelf, and One Adjustable Shelf**

23 1/8"	24"	24"	52"	<b>RVD24244LBF</b>	FC00030968	+\$0
23 1/8"	24"	24"	52"	<b>RVD24244LBP</b>	FC00031013	+\$0
23 1/8"	24"	24"	52"	<b>RVD24244LBW</b>	FC00031031	+\$0
29 1/8"	30"	24"	52"	<b>RVD30244LBF</b>	FC00030997	+\$0
29 1/8"	30"	24"	52"	<b>RVD30244LBP</b>	FC00031019	+\$0
29 1/8"	30"	24"	52"	<b>RVD30244LBW</b>	FC00031039	+\$0

**With Two 12"H Drawers, 37 1/2"H Locking Door, One Fixed Shelf, and Two Adjustable Shelves**

23 1/8"	24"	24"	65 1/2"	<b>RVD24245LCF</b>	FC00029303	+\$0
23 1/8"	24"	24"	65 1/2"	<b>RVD24245LCP</b>	FC00025773	+\$0
23 1/8"	24"	24"	65 1/2"	<b>RVD24245LCW</b>	FC00028079	+\$0
29 1/8"	30"	24"	65 1/2"	<b>RVD30245LCF</b>	FC00030999	+\$0
29 1/8"	30"	24"	65 1/2"	<b>RVD30245LCP</b>	FC00031021	+\$0
29 1/8"	30"	24"	65 1/2"	<b>RVD30245LCW</b>	FC00031041	+\$0

**With Two 6"H Drawers, One 12"H Drawer, 37 1/2"H Locking Door, One Fixed Shelf, and Two Adjustable Shelves**

23 1/8"	24"	24"	65 1/2"	<b>RVD24245LDF</b>	FC00029302	+\$0
23 1/8"	24"	24"	65 1/2"	<b>RVD24245LDP</b>	FC00030975	+\$0
23 1/8"	24"	24"	65 1/2"	<b>RVD24245LDW</b>	FC00031033	+\$0
29 1/8"	30"	24"	65 1/2"	<b>RVD30245LDF</b>	FC00031001	+\$0
29 1/8"	30"	24"	65 1/2"	<b>RVD30245LDP</b>	FC00031023	+\$0
29 1/8"	30"	24"	65 1/2"	<b>RVD30245LDW</b>	FC00031043	+\$0

► Specification Information, continued on next page

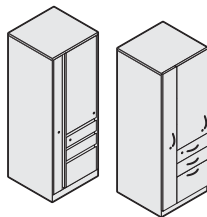
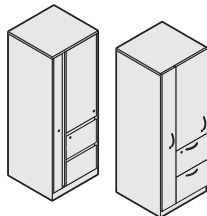
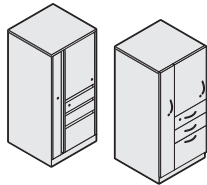
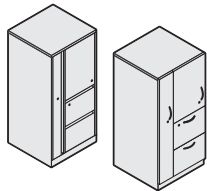

 **For Canadian Pricing**  
 Multiply U.S. Price by the Canadian price factor.  
 ► See page 1 for details.

► Specification Information continued from previous page

**Specification Information**

• Dimensions		W	H	• Style Number	• Product ID	• Change to U.S. Base Price
D	Front					
Flush Steel Front	Proud Steel/Wood Front					

**Tower with Door Hinged on Left, continued**

**With Three 12"H Drawers, 25 1/2"H Locking Door, One Fixed Shelf, and One Adjustable Shelf**

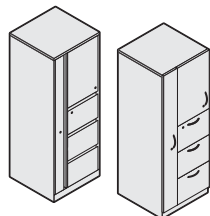

23 1/8"	24"	24"	65 1/2"	<b>RVD24245LCF</b>	FC00026500	+\$0
23 1/8"	24"	24"	65 1/2"	<b>RVD24245LCP</b>	FC00025771	+\$0
23 1/8"	24"	24"	65 1/2"	<b>RVD24245LCW</b>	FC00028015	+\$0
29 1/8"	30"	24"	65 1/2"	<b>RVD30245LCF</b>	FC00031003	+\$0
29 1/8"	30"	24"	65 1/2"	<b>RVD30245LCP</b>	FC00031025	+\$0
29 1/8"	30"	24"	65 1/2"	<b>RVD30245LCW</b>	FC00031045	+\$0

**With Two 6"H Drawers, Two 12"H Drawers, 25 1/2"H Locking Door, One Fixed Shelf, and One Adjustable Shelf**

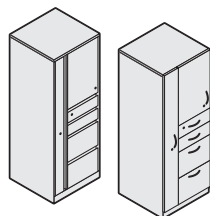

23 1/8"	24"	24"	65 1/2"	<b>RVD24245LDF</b>	FC00030971	+\$0
23 1/8"	24"	24"	65 1/2"	<b>RVD24245LDP</b>	FC00031015	+\$0
23 1/8"	24"	24"	65 1/2"	<b>RVD24245LDW</b>	FC00031035	+\$0
29 1/8"	30"	24"	65 1/2"	<b>RVD30245LDF</b>	FC00031005	+\$0
29 1/8"	30"	24"	65 1/2"	<b>RVD30245LDP</b>	FC00031027	+\$0
29 1/8"	30"	24"	65 1/2"	<b>RVD30245LDW</b>	FC00031047	+\$0

**Tower with Door Hinged on Right**

**With Two 12"H Drawers, One Fixed Shelf, and One Adjustable Shelf**

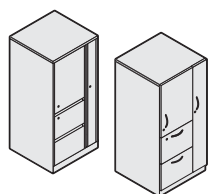

23 1/8"	24"	24"	52"	<b>RVD24244RAF</b>	FC00026863	+\$0
23 1/8"	24"	24"	52"	<b>RVD24244RAP</b>	FC00028796	+\$0
23 1/8"	24"	24"	52"	<b>RVD24244RAW</b>	FC00031030	+\$0
29 1/8"	30"	24"	52"	<b>RVD30244RAF</b>	FC00030996	+\$0
29 1/8"	30"	24"	52"	<b>RVD30244RAP</b>	FC00031018	+\$0
29 1/8"	30"	24"	52"	<b>RVD30244RAW</b>	FC00031038	+\$0

**With Two 6"H Drawers, One 12"H Drawer, One Fixed Shelf, and One Adjustable Shelf**

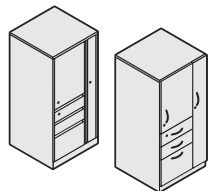

23 1/8"	24"	24"	52"	<b>RVD24244RBF</b>	FC00030969	+\$0
23 1/8"	24"	24"	52"	<b>RVD24244RBP</b>	FC00031014	+\$0
29 1/8"	24"	24"	52"	<b>RVD24244RBW</b>	FC00031032	+\$0
29 1/8"	30"	24"	52"	<b>RVD30244RBF</b>	FC00030998	+\$0
29 1/8"	30"	24"	52"	<b>RVD30244RBP</b>	FC00031020	+\$0
29 1/8"	30"	24"	52"	<b>RVD30244RBW</b>	FC00031040	+\$0

► Specification Information, continued on next page

 **For Canadian Pricing**  
 Multiply U.S. Price by the Canadian price factor.  
 ► See page 1 for details.



► Specification Information, continued from previous page

**Specification Information**

Dimensions		W	H	Style Number	Product ID	Change to U.S. Base Price
D						
Flush Steel Front	Proud Steel/Wood Front					

**Tower with Door Hinged on Right, continued**

**With Two 12"H Drawers, 37½"H Locking Door, One Fixed Shelf, and Two Adjustable Shelves**

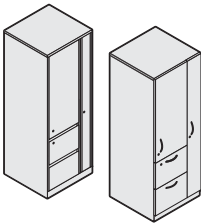

23½"	24"	24"	65½"	<b>RVD24245RCF</b>	FC00029304	+\$0
23½"	24"	24"	65½"	<b>RVD24245RCP</b>	FC00025774	+\$0
23½"	24"	24"	65½"	<b>RVD24245RCW</b>	FC00028080	+\$0
29½"	30"	24"	65½"	<b>RVD30245RCF</b>	FC00031000	+\$0
29½"	30"	24"	65½"	<b>RVD30245RCP</b>	FC00031022	+\$0
29½"	30"	24"	65½"	<b>RVD30245RCW</b>	FC00031042	+\$0

**With Two 6"H Drawers, One 12"H Drawer, 37½"H Locking Door, One Fixed Shelf, and Two Adjustable Shelves**

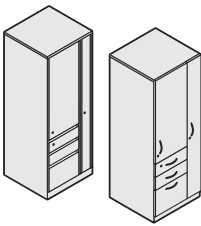

23½"	24"	24"	65½"	<b>RVD24245RDF</b>	FC00030970	+\$0
23½"	24"	24"	65½"	<b>RVD24245RDP</b>	FC00030976	+\$0
23½"	24"	24"	65½"	<b>RVD24245RDW</b>	FC00031034	+\$0
29½"	30"	24"	65½"	<b>RVD30245RDF</b>	FC00031002	+\$0
29½"	30"	24"	65½"	<b>RVD30245RDP</b>	FC00031024	+\$0
29½"	30"	24"	65½"	<b>RVD30245RDW</b>	FC00031044	+\$0

**With Three 12"H Drawers, 25 1/2"H Locking Door, One Fixed Shelf, and One Adjustable Shelf**

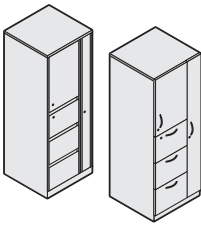

23½"	24"	24"	65½"	<b>RVD24245RCF</b>	FC00026501	+\$0
23½"	24"	24"	65½"	<b>RVD24245RCP</b>	FC00025772	+\$0
23½"	24"	24"	65½"	<b>RVD24245RCW</b>	FC00028016	+\$0
29½"	30"	24"	65½"	<b>RVD30245RCF</b>	FC00031004	+\$0
29½"	30"	24"	65½"	<b>RVD30245RCP</b>	FC00031026	+\$0
29½"	30"	24"	65½"	<b>RVD30245RCW</b>	FC00031046	+\$0

**With Two 6"H Drawers, Two 12"H Drawers, 25½"H Locking Door, One Fixed Shelf, and One Adjustable Shelf**

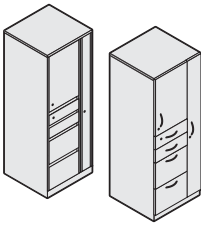

23½"	24"	24"	65½"	<b>RVD24245RDF</b>	FC00030972	+\$0
23½"	24"	24"	65½"	<b>RVD24245RDP</b>	FC00031016	+\$0
23½"	24"	24"	65½"	<b>RVD24245RDW</b>	FC00031036	+\$0
29½"	30"	24"	65½"	<b>RVD30245RDF</b>	FC00031006	+\$0
29½"	30"	24"	65½"	<b>RVD30245RDP</b>	FC00031028	+\$0
29½"	30"	24"	65½"	<b>RVD30245RDW</b>	FC00031048	+\$0

Universal Storage

 **For Canadian Pricing**  
 Multiply U.S. Price by the Canadian price factor.  
 ► See page 1 for details.

# Universal Side Access Towers

With Flush Steel, Proud Steel, or Proud Wood Fronts

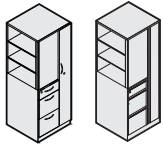

## What's Special

Towers are available with side access.

*Tip: Laminate and wood veneer tops are 3/16" taller than other tops and will add 3/16" to overall case height.*

*Tip: If wood veneer top option is selected, wood veneer top color will default to match wood front.*

## Standard Includes

- Tower: paint price group 1
- 1"H top: paint to match tower
- Door and drawer fronts on units with proud wood fronts: wood veneer
- Integral pulls on units with flush steel fronts
- Contemporary pulls on units with proud steel or proud wood fronts: metal
- Lock, keyed random: 9201 Polished Chrome
- Drawer body: black only
- Adjustable shelves: paint to match tower
- Brackets for adjustable shelves: black
- One box drawer divider and one pencil tray: black only
- Coat rod: 9201 Polished Chrome
- Four adjustable leveling glides

## Required to Specify

- 1 General quote number: **FC029681**
- 2 Style number with appropriate front style and Product ID
  - F** Flush steel front
  - P** Proud steel front
  - W** Proud wood front
- 3 Paint color number for tower
- 4 Wood color number for door and drawer fronts, if proud wood front selected
- 5 Metal color number for pulls, if proud steel or proud wood front selected:
  - 0835 Black
  - 9201 Polished Chrome
  - 9211 Nickel
  - 9212 Silver
- 6 Options, if selected (see below)
  - See Surface Materials in the Storage and Freestanding Furniture Specification Guide.

	Options	U.S. Price	Required to Specify
<b>Surface Materials</b>	<ul style="list-style-type: none"> <li>• Paint price group 1</li> <li>• Paint price group 2</li> <li>• Paint price group 3</li> </ul>	<ul style="list-style-type: none"> <li>No cost</li> <li>+\$ 70</li> <li>+\$120</li> </ul>	<ul style="list-style-type: none"> <li>Specify paint color number.</li> <li>Specify paint color number.</li> <li>Specify paint color number.</li> </ul>
	<ul style="list-style-type: none"> <li>• Customiz stain on proud wood fronts and top</li> </ul>	<ul style="list-style-type: none"> <li>+\$ 32</li> </ul>	<ul style="list-style-type: none"> <li>Specify with <i>Customiz stain</i>.</li> <li>▶ See <i>Surface Materials Reference Manual</i>.</li> </ul>
<b>Tops with Flush Steel</b>	<b>Laminate top</b>		
	<ul style="list-style-type: none"> <li>• Square edge laminate top</li> <li>• Open Line laminate on laminate top</li> </ul>	<ul style="list-style-type: none"> <li>+\$122</li> <li>+\$ 64 plus cost of laminate</li> </ul>	<ul style="list-style-type: none"> <li>Specify with <i>laminate top</i> and indicate</li> <li>▶ See <i>Surface Materials Reference Manual</i>.</li> </ul>
	<b>Wood veneer top</b>		
<ul style="list-style-type: none"> <li>• Wood veneer top</li> <li>• Customiz stain on wood veneer top on units with flush steel or proud steel fronts</li> </ul>	<ul style="list-style-type: none"> <li>+\$367</li> <li>+\$ 12</li> </ul>	<ul style="list-style-type: none"> <li>Specify with <i>wood veneer top</i> and indicate wood color number.</li> <li>Specify with <i>Customiz stain</i>.</li> <li>▶ See <i>Surface Materials Reference Manual</i>.</li> </ul>	
<b>Pulls for Proud Steel or Wood Fronts</b>	<ul style="list-style-type: none"> <li>• Handle</li> <li>• Jazz</li> <li>• Bar</li> </ul>	<ul style="list-style-type: none"> <li>No cost</li> <li>+\$ 17 per pull</li> <li>+\$ 24 per pull</li> </ul>	<ul style="list-style-type: none"> <li>Specify with <i>handle pull</i>.</li> <li>Specify with <i>jazz pull</i>.</li> <li>Specify with <i>bar pull</i>.</li> </ul>
	<b>Lock and Keying</b>		
<ul style="list-style-type: none"> <li>• Lock</li> <li>• Keying</li> </ul>	<ul style="list-style-type: none"> <li>• Ember Chrome</li> <li>• Factory- and field-installed keying</li> </ul>	<ul style="list-style-type: none"> <li>No cost</li> </ul>	<ul style="list-style-type: none"> <li>Specify with <i>9250 Ember Chrome lock</i>.</li> <li>▶ Page 306</li> </ul>



## For Canadian Pricing

Multiply U.S. Price by the Canadian price factor.

▶ See page 1 for details.

**Specification Information**

• Dimensions			• Style	• Product ID	• Change to
D	W	H	Number		U.S. Base Price

**Tower with Door Hinged on Left**

**One Adjustable Shelf, One 6"H Drawer, and Two 12"H Drawers**

23 1/8"	24"	52"	<b>RQS24244LAF</b>	FC00028958	+\$250
24"	24"	52"	<b>RQS24244LAP</b>	FC00028372	+\$250
24"	24"	52"	<b>RQS24244LAW</b>	FC00031055	+\$250
29 1/8"	24"	52"	<b>RQS30244LAF</b>	FC00031049	+\$250
30"	24"	52"	<b>RQS30244LAP</b>	FC00031053	+\$250
30"	24"	52"	<b>RQS30244LAW</b>	FC00031057	+\$250

**Two Adjustable Shelves, One 6"H Drawer, and Two 12"H Drawers**

23 1/8"	24"	65 1/2"	<b>RQS24245LCF</b>	FC00029165	+\$250
24"	24"	65 1/2"	<b>RQS24245LCP</b>	FC00029167	+\$250
24"	24"	65 1/2"	<b>RQS24245LCW</b>	FC00025940	+\$250
29 1/8"	24"	65 1/2"	<b>RQS30245LCF</b>	FC00031051	+\$250
30"	24"	65 1/2"	<b>RQS30245LCP</b>	FC00030813	+\$250
30"	24"	65 1/2"	<b>RQS30245LCW</b>	FC00026456	+\$250

**Tower with Door Hinged on Right**

**One Adjustable Shelf, One 6"H Drawer, and Two 12"H Drawers**

23 1/8"	24"	52"	<b>RQS24244RAF</b>	FC00028959	+\$250
24"	24"	52"	<b>RQS24244RAP</b>	FC00028373	+\$250
24"	24"	52"	<b>RQS24244RAW</b>	FC00031056	+\$250
29 1/8"	24"	52"	<b>RQS30244RAF</b>	FC00031050	+\$250
30"	24"	52"	<b>RQS30244RAP</b>	FC00031054	+\$250
30"	24"	52"	<b>RQS30244RAW</b>	FC00031058	+\$250

**Two Adjustable Shelves, One 6"H Drawer, and Two 12"H Drawers**

23 1/8"	24"	65 1/2"	<b>RQS24245RCF</b>	FC00029166	+\$250
24"	24"	65 1/2"	<b>RQS24245RCP</b>	FC00029168	+\$250
24"	24"	65 1/2"	<b>RQS24245RCW</b>	FC00025941	+\$250
29 1/8"	24"	65 1/2"	<b>RQS30245RCF</b>	FC00031052	+\$250
30"	24"	65 1/2"	<b>RQS30245RCP</b>	FC00030814	+\$250
30"	24"	65 1/2"	<b>RQS30245RCW</b>	FC00026457	+\$250

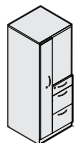

Tip: Height dimension listed is for units with 1" top. Overall height will vary if another top is selected.

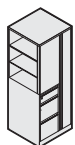
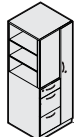

**For Canadian Pricing**  
Multiply U.S. Price by the  
Canadian price factor.  
▶ See page 1 for details.

# Universal Workstation Verticals

With Flush Steel or Proud Steel

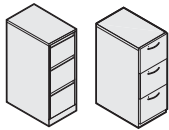

## What's Special

Workstation verticals are available with 3 drawers.

Tip: Laminate and wood veneer tops are  $\frac{3}{16}$ " taller than other tops and will add  $\frac{3}{16}$ " to overall case height.

Tip: If wood veneer top option is selected, wood veneer top color will default to match wood front.

Tip: Counterweight packages are recommended based on case size and interior options.  
▶ See Specification Information on next page.

Tip: Counterweight option should be specified if the cabinet is not ganged to adjacent cabinets or bolted to the floor or wall.

Tip: Counterweight packages ship separately from case and must be installed on site.



**For Canadian Pricing**  
Multiply U.S. Price by the Canadian price factor.  
▶ See page 1 for details.

## Standard Includes

- Vertical: paint price group 1
- 1"H top: paint to match tower
- Integral pulls on units with flush steel fronts
- Contemporary pulls on units with proud steel fronts: metal
- Central lock, keyed random: 9201 Polished Chrome
- Drawer body: black only
- Drawer suspensions: black only
- One pencil tray in units with 6"H box drawers: black only
- Four adjustable leveling glides

## Required to Specify

- 1 General quote number: **FC029681**
- 2 Style number with appropriate front style and Product ID
  - F** Flush steel front
  - P** Proud steel front
  - W** Proud wood front
- 3 Paint color number for tower
- 4 Metal color number for pulls, if proud steel front selected:
  - 0835 Black
  - 9201 Polished Chrome
  - 9211 Nickel
  - 9212 Silver
- 5 Options, if selected (see below)  
See Surface Materials in the Storage and Freestanding Furniture Specification Guide.

	Options	U.S. Price	Required to Specify
<b>Surface Materials</b>	• Paint price group 1	No cost	Specify paint color number.
	• Paint price group 2	+\$ 70	Specify paint color number.
	• Paint price group 3	+\$120	Specify paint color number.
	• Customiz stain on proud wood fronts and top	+\$ 32	Specify with <i>Customiz stain</i> . ▶ See <i>Surface Materials Reference Manual</i> .
<b>Tops with Flush Steel Front and Proud Steel Front</b>	<b>Laminate top</b>		
	• Square edge laminate top	+\$122	Specify with <i>laminate top</i> and indicate laminate color number for top and plastic color number for edges. ▶ See <i>Surface Materials Reference Manual</i> .
	• Open Line laminate on laminate top	+\$ 64 plus cost of laminate	
	<b>Wood veneer top</b>		
	• Wood veneer top	+\$367	Specify with <i>wood veneer top</i> and indicate wood color number. Specify with <i>Customiz stain</i> . ▶ See <i>Surface Materials Reference Manual</i> .
	• Customiz stain on wood veneer top on units with flush steel or proud steel fronts	+\$ 12	
<b>Counterweights</b>	• Tower package	+\$ 80	Specify with <i>counterweight</i> .
<b>Pulls for Proud Steel or Wood Fronts</b>	• Handle	No cost	Specify with <i>handle pull</i> .
	• Jazz	+\$ 17 per pull	Specify with <i>jazz pull</i> .
	• Bar	+\$ 24 per pull	Specify with <i>bar pull</i> .
<b>Lock and Keying</b>	<b>Lock</b>		
	• Ember Chrome	No cost	Specify with <i>9250 Ember Chrome lock</i> .
	<b>Individual locking drawers</b>		
	• For use when limiting drawer access	+\$359	Specify with <i>individual lock</i> .
	<b>Keying</b>		
	• Factory- and field-installed keying		▶ Page 306

**Specification Information**

• Dimensions			• Style	• Product ID	• Change to
D	W	H	Number		U.S. Base Price

**Three 12"H Drawers**

23 1/8"	15"	40"	<b>RWV24154AF</b>	FC00026062	-\$223
24"	15"	40"	<b>RWV24154AP</b>	FC00026212	-\$267
29 1/8"	15"	40"	<b>RWV30154AF</b>	FC00031080	-\$262
30"	15"	40"	<b>RWV30154AP</b>	FC00030601	-\$306

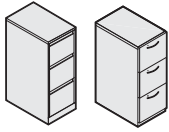

*Tip: Height dimension listed is for units with 1" top. Overall height will vary if another top is selected.*

*Tip: Tower package is the recommended counter-weight package for 3 12"H drawer workstation verticals.*



**For Canadian Pricing**

Multiply U.S. Price by the Canadian price factor.

▶ See page 1 for details.

# Universal Storage Cabinets without Doors

With Flush Top

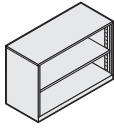

Standard Includes	Required to Specify
<ul style="list-style-type: none"> <li>Storage cabinet: paint price group 1</li> <li>1"H top on unit: flush steel paint to match cabinet</li> <li>Adjustable shelves: paint to match cabinet</li> <li>Brackets for adjustable shelves: black</li> <li>Four adjustable leveling glides</li> </ul>	<ol style="list-style-type: none"> <li>General quote number: <b>FC030047</b></li> <li>Style number and Product ID</li> <li>Paint color number for cabinet</li> <li>Options, if selected (see below)</li> </ol> See Surface Materials in the Storage and Freestanding Furniture Specification Guide.

## What's Special

Storage cabinets are available in a variety of sizes.

	Options	U.S. Price	Required to Specify
<b>Surface Materials</b>	<b>28"H, 40"H, 52"H, or 65½"H cabinets</b>		
	• Paint price group 1	No cost	Specify paint color number.
	• Paint price group 2	+\$ 70	Specify paint color number.
	• Paint price group 3	+\$120	Specify paint color number.
	<b>83½"H cabinets</b>		
	• Paint price group 1	No cost	Specify paint color number.
• Paint price group 2	+\$105	Specify paint color number.	
• Paint price group 3	+\$177	Specify paint color number.	
<b>Tops with Flush Steel Storage Cabinet</b>	<b>Security top</b>		
	• For use on 28"H storage cabinets only	No cost	Specify <i>with security top</i> .
	<b>No top</b>		
	• For use under a worksurface or beneath a common top	-\$ 88	Specify <i>with no top</i> .
	<b>Laminate top</b>		
• Square edge laminate top	+\$122	Specify <i>with laminate top</i> and indicate laminate color number for top and plastic color number for edges. ▶ See <i>Surface Materials Reference Manual</i> .	
• Open Line laminate on laminate top	+\$ 64 plus cost of laminate		
<b>Wood veneer top</b>	• Wood veneer top	+\$367	Specify <i>with wood veneer top</i> and indicate wood color number. Specify <i>with Customiz stain</i> . ▶ See <i>Surface Materials Reference Manual</i> .
	• Customiz stain on wood veneer top	+\$ 12	

Tip: Security top reduces overall height by approximately 1".

Tip: Laminate and wood veneer tops are 3/16" taller than other tops and will add 3/16" to overall case height.



### For Canadian Pricing

Multiply U.S. Price by the Canadian price factor.

▶ See page 1 for details.

**Specification Information**

Dimensions			Style Number	Product ID	Change to U.S. Base Price
D	W	H			

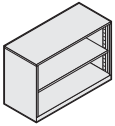

Tip: Height dimension listed is for units with 1" top. Overall height will vary if another top is selected.

**28" Storage Cabinets**

**With One Adjustable Shelf**

18"	30"	28"	<b>RSC18302AF</b>	FC00025938	-\$ 84
18"	36"	28"	<b>RSC18362AF</b>	FC00026238	-\$100
18"	42"	28"	<b>RSC18422AF</b>	FC00026450	-\$110
23 1/8"	30"	28"	<b>RSC24302AF</b>	FC00026994	-\$ 84
23 1/8"	36"	28"	<b>RSC24362AF</b>	FC00026723	-\$100

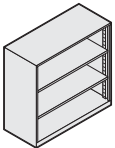

**40" Storage Cabinets**

**With Two Adjustable Shelves**

18"	30"	40"	<b>RSC18303CF</b>	FC00026278	-\$ 92
18"	36"	40"	<b>RSC18363CF</b>	FC00026452	-\$105
18"	42"	40"	<b>RSC18423CF</b>	FC00026272	-\$116
23 1/8"	30"	40"	<b>RSC24303CF</b>	FC00026374	-\$ 92
23 1/8"	36"	40"	<b>RSC24363CF</b>	FC00027011	-\$105

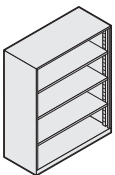

**52" Storage Cabinets**

**With Three Adjustable Shelves**

18"	30"	52"	<b>RSC18304FF</b>	FC00026488	-\$ 98
18"	36"	52"	<b>RSC18364FF</b>	FC00026489	-\$110
18"	42"	52"	<b>RSC18424FF</b>	FC00026490	-\$116
23 1/8"	30"	52"	<b>RSC24304FF</b>	FC00031392	-\$ 98
23 1/8"	36"	52"	<b>RSC24364FF</b>	FC00027432	-\$110

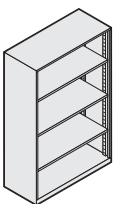

**65 1/2" Storage Cabinets**

**With Four Adjustable Shelf**

18"	30"	65 1/2"	<b>RSC18305KF</b>	FC00025882	-\$187
18"	36"	65 1/2"	<b>RSC18365KF</b>	FC00025895	-\$201
18"	42"	65 1/2"	<b>RSC18425KF</b>	FC00027421	-\$215
23 1/8"	30"	65 1/2"	<b>RSC24305KF</b>	FC00026980	-\$187
23 1/8"	36"	65 1/2"	<b>RSC24365KF</b>	FC00026136	-\$201

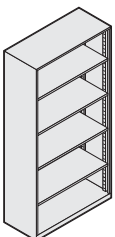

**83 1/2" Storage Cabinets**

**With Five Adjustable Shelves**

18"	30"	83 1/2"	<b>RSC18306QF</b>	FC00025900	-\$205
18"	36"	83 1/2"	<b>RSC18366QF</b>	FC00028220	-\$210
18"	42"	83 1/2"	<b>RSC18426QF</b>	FC00026798	-\$230
23 1/8"	30"	83 1/2"	<b>RSC24306QF</b>	FC00029098	-\$205
23 1/8"	36"	83 1/2"	<b>RSC24366QF</b>	FC00026014	-\$210

# Universal Lockers

with Flush Steel, Proud Steel, or Proud Wood Fronts

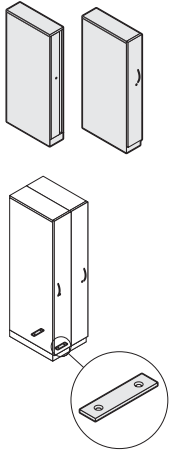

*Tip: Lockers cannot stand alone. They must be ganged to another locker or to a cabinet with the same depth.*

*Tip: Laminate and wood veneer tops are 3/16" taller than other tops and will add 3/16" to overall case height.*

Standard Includes	Required to Specify
<ul style="list-style-type: none"> <li>Lockers: paint price group 1</li> <li>1"H top on units with flush steel or proud steel fronts: paint to match locker</li> <li>1 3/16"H top on units with proud wood fronts: wood veneer to match locker</li> <li>Integral pulls on units with flush steel fronts</li> <li>Contemporary pulls on units with proud steel or proud wood fronts: metal</li> <li>Hinged doors on units with flush steel or proud steel front: paint to match locker</li> <li>Hinged doors on units with proud wood front: wood veneer to match locker</li> <li>Lock, keyed random: 9201 Polished Chrome</li> <li>Coat rod: 9201 Polished Chrome</li> <li>Four adjustable leveling glides</li> </ul>	<ol style="list-style-type: none"> <li>General quote number: <b>FC029681</b></li> <li>Style number with appropriate front style and Product ID               <ul style="list-style-type: none"> <li><b>F</b> Flush steel front</li> <li><b>P</b> Proud steel front</li> <li><b>W</b> Proud wood front</li> </ul> </li> <li>Paint color number for cabinet</li> <li>Wood color number for hinged doors and top, if proud wood front selected</li> <li>Metal color number for pulls, if proud steel or proud wood front selected:               <ul style="list-style-type: none"> <li>0835 Black</li> <li>9201 Polished Chrome</li> <li>9211 Nickel</li> <li>9212 Silver</li> </ul> </li> <li>Options, if selected (see below)               <ul style="list-style-type: none"> <li>See Surface Materials in the Storage and Freestanding Furniture Specification Guide.</li> </ul> </li> </ol>

Options	U.S. Price	Required to Specify
<b>Surface Materials</b> <ul style="list-style-type: none"> <li>52"H or 65 1/2"H cabinets</li> <li>Paint price group 1</li> <li>Paint price group 2</li> <li>Paint price group 3</li> <li>Customiz stain on proud wood fronts: and top</li> </ul>	<ul style="list-style-type: none"> <li>No cost</li> <li>+\$ 70</li> <li>+\$120</li> <li>+\$ 45</li> </ul>	<ul style="list-style-type: none"> <li>Specify paint color number.</li> <li>Specify paint color number.</li> <li>Specify paint color number.</li> <li>Specify with <i>Customiz stain</i>.</li> <li>▶ See <i>Surface Materials Reference Manual</i>.</li> </ul>
<b>Tops with Flush Steel Front and Proud Steel Front</b> <ul style="list-style-type: none"> <li>No top</li> <li>Laminate top               <ul style="list-style-type: none"> <li>Square edge laminate top</li> <li>Open Line laminate on laminate top</li> </ul> </li> <li>Wood veneer top               <ul style="list-style-type: none"> <li>Wood veneer top</li> <li>Customiz stain on wood veneer top</li> </ul> </li> </ul>	<ul style="list-style-type: none"> <li>-\$ 88</li> <li>+\$122</li> <li>+\$ 64 plus cost of laminate</li> <li>+\$367</li> <li>+\$ 12</li> </ul>	<ul style="list-style-type: none"> <li>Specify with <i>no top</i>.</li> <li>Specify with <i>laminate top</i> and indicate laminate color number for top and plastic color number for edges.</li> <li>▶ See <i>Surface Materials Reference Manual</i>.</li> <li>Specify with <i>wood veneer top</i> and indicate wood color number.</li> <li>Specify with <i>Customiz stain</i>.</li> <li>▶ See <i>Surface Materials Reference Manual</i>.</li> </ul>
<b>Top with Proud Wood Front</b> <ul style="list-style-type: none"> <li>No top</li> <li>Laminate top               <ul style="list-style-type: none"> <li>Square edge laminate top</li> <li>Open Line laminate on laminate top</li> </ul> </li> </ul>	<ul style="list-style-type: none"> <li>-\$455</li> <li>-\$245</li> <li>+\$ 64 plus cost of laminate</li> </ul>	<ul style="list-style-type: none"> <li>Specify with <i>no top</i>.</li> <li>Specify with <i>laminate top</i> and indicate laminate color number for top and plastic color number for edges.</li> <li>▶ See <i>Surface Materials Reference Manual</i>.</li> </ul>
<b>Pulls for Proud Steel or Wood Fronts</b> <ul style="list-style-type: none"> <li>Handle</li> <li>Jazz</li> <li>Bar</li> </ul>	<ul style="list-style-type: none"> <li>No cost</li> <li>+\$ 17 per pull</li> <li>+\$ 24 per pull</li> </ul>	<ul style="list-style-type: none"> <li>Specify with <i>handle pull</i>.</li> <li>Specify with <i>jazz pull</i>.</li> <li>Specify with <i>bar pull</i>.</li> </ul>
<b>Lock and Keying</b> <ul style="list-style-type: none"> <li>Lock</li> <li>Keying</li> </ul>	<ul style="list-style-type: none"> <li>Ember Chrome</li> <li>No cost</li> <li>Factory- and field-installed keying</li> </ul>	<ul style="list-style-type: none"> <li>Specify with <i>9250 Ember Chrome lock</i>.</li> <li>▶ Page 306.</li> </ul>

 **For Canadian Pricing**  
 Multiply U.S. Price by the Canadian price factor.  
 ▶ See page 1 for details.



Tip: Height dimension listed is for units with 1" top. Overall height will vary if another top is selected.

**Specification Information**

Dimensions		W	H	Style Number	Product ID	Change to U.S. Base Price
D						
Flush Steel Front	Proud Steel/Wood Front					

**Locker with Door Hinged Left**

**52"H Single Door**

23 1/8"	24"	9"	52"	<b>RWC24306DF</b>	FC00027777	-\$185
23 1/8"	24"	9"	52"	<b>RWC24306DP</b>	FC00031061	-\$222
23 1/8"	24"	9"	52"	<b>RWC24306DW</b>	FC00031067	-\$626
29 1/8"	30"	9"	52"	<b>RWC24306DF</b>	FC00031059	-\$ 85
29 1/8"	30"	9"	52"	<b>RWC24306DP</b>	FC00031063	-\$ 85
29 1/8"	30"	9"	52"	<b>RWC24306DW</b>	FC00031069	-\$576

**65 1/2"H Single Door**

23 1/8"	24"	9"	65 1/2"	<b>RWC24306DF</b>	FC00026759	-\$135
23 1/8"	24"	9"	65 1/2"	<b>RWC24306DP</b>	FC00026843	-\$172
23 1/8"	24"	9"	65 1/2"	<b>RWC24306DW</b>	FC00026860	-\$626
29 1/8"	30"	9"	65 1/2"	<b>RWC24306DF</b>	FC00027952	-\$ 35
29 1/8"	30"	9"	65 1/2"	<b>RWC24306DP</b>	FC00031065	-\$ 35
29 1/8"	30"	9"	65 1/2"	<b>RWC24306DW</b>	FC00031071	-\$526

**Locker with Door Hinged Right**

**52"H Single Door**

23 1/8"	24"	9"	52"	<b>RWC24306DF</b>	FC00027778	-\$185
23 1/8"	24"	9"	52"	<b>RWC24306DP</b>	FC00031062	-\$222
23 1/8"	24"	9"	52"	<b>RWC24306DW</b>	FC00031068	-\$626
29 1/8"	30"	9"	52"	<b>RWC24306DF</b>	FC00031060	-\$ 85
29 1/8"	30"	9"	52"	<b>RWC24306DP</b>	FC00031064	-\$ 85
29 1/8"	30"	9"	52"	<b>RWC24306DW</b>	FC00031070	-\$576

**65 1/2"H Single Door**

23 1/8"	24"	9"	65 1/2"	<b>RWC24306DF</b>	FC00026760	-\$135
23 1/8"	24"	9"	65 1/2"	<b>RWC24306DP</b>	FC00026844	-\$172
23 1/8"	24"	9"	65 1/2"	<b>RWC24306DW</b>	FC00026861	-\$626
29 1/8"	30"	9"	65 1/2"	<b>RWC24306DF</b>	FC00027953	-\$ 35
29 1/8"	30"	9"	65 1/2"	<b>RWC24306DP</b>	FC00031066	-\$ 35
29 1/8"	30"	9"	65 1/2"	<b>RWC24306DW</b>	FC00031072	-\$526

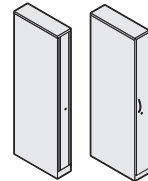
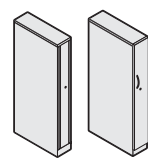
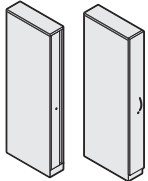
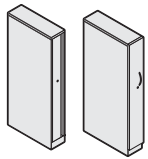

Universal Storage

 **For Canadian Pricing**  
 Multiply U.S. Price by the Canadian price factor.  
 ▶ See page 1 for details.

# Universal One-High Lateral Files

with Proud Steel or Open Fronts

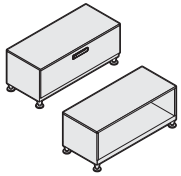

Standard Includes	Required to Specify
<ul style="list-style-type: none"> <li>Lateral file: paint price group 1</li> <li>c:scape pulls on units with proud steel front: metal</li> <li>1"H top on units with proud steel fronts: paint to match file</li> <li>Central lock, keyed random: 9201 Polished Chrome</li> <li>One label holder per drawer: clear plastic</li> <li>Drawer body: black only</li> <li>Drawer suspensions: black only</li> <li>One hanging folder bar per drawer on 18"D units</li> <li>Four adjustable leveling glides</li> <li>Counterweight package, if selected</li> </ul>	<ol style="list-style-type: none"> <li>General quote number: <b>FC036457</b></li> <li>Style number and Product ID</li> <li>Paint color number for file</li> <li>Metal color number for pulls:               <ul style="list-style-type: none"> <li>4140 Arctic White Gloss</li> <li>4144 Black Gloss</li> <li>4799 Platinum</li> <li>9201 Polished Chrome</li> </ul> </li> <li>Options, if selected (see below)</li> </ol>

## What's Special

Includes c:scape glides and pulls.

*Tip: Laminate and wood veneer tops are 3/16" taller than other tops and will add 3/16" to overall case height.*

**Premium Wood Pricing:** To calculate the estimated price for Premium wood veneer top, multiply Customiz stain upcharge by five for Premium wood 2 or by ten for Premium wood 3, then add the price for wood veneer top. For exact pricing, see the electronic catalog.

*Tip: Counterweight packages are recommended based on case size and interior options.*

▶ See Specification Information on next page.

*Tip: Counterweight option should be specified if the cabinet is not ganged to adjacent cabinets or bolted to the floor or wall.*

*Tip: Counterweight packages ship separately from case and must be installed on site.*

Options	U.S. Price	Required to Specify
<b>Surface Materials</b> <ul style="list-style-type: none"> <li>Paint price group 1</li> <li>Paint price group 2</li> <li>Paint price group 3</li> </ul>	No cost +\$ 70 +\$120	Specify paint color number. Specify paint color number. Specify paint color number.
<b>Tops with Proud Steel Front</b> <p><b>No top</b></p> <ul style="list-style-type: none"> <li>For use with a cushion top or beneath a common top</li> </ul> <p><b>Laminate top</b></p> <ul style="list-style-type: none"> <li>Square edge laminate top</li> </ul> <ul style="list-style-type: none"> <li>Open Line laminate on laminate top</li> </ul> <p><b>Wood veneer top</b></p> <ul style="list-style-type: none"> <li>Wood veneer top</li> <li>Premium wood 2</li> <li>Premium wood 3</li> <li>Customiz stain on wood veneer top</li> </ul>	−\$ 88 +\$122 +\$ 64 plus cost of laminate +\$367 See information at left See information at left +\$ 12	Specify with no top. Specify with laminate top and indicate laminate color number for top and plastic color number for edges. ▶ See Surface Materials Reference Manual. Specify with wood veneer top and indicate wood color number. Specify with wood veneer top and indicate Premium wood 2 finish number. Specify with wood veneer top and indicate Premium wood 3 finish number. Specify with Customiz stain. ▶ See Surface Materials Reference Manual.
<b>Drawer Interiors</b> <ul style="list-style-type: none"> <li>Rails for use on 18"D units only</li> <li>Divider package</li> </ul>	No cost No cost	Specify with rails. Specify with divider package.
<b>Counterweights</b> <ul style="list-style-type: none"> <li>Package A</li> <li>Package B</li> <li>Package C</li> </ul>	+\$122 +\$133 +\$144	Specify with counterweight. Specify with counterweight. Specify with counterweight.
<b>Lock and Keying</b> <p><b>Lock</b></p> <ul style="list-style-type: none"> <li>Ember Chrome</li> </ul> <p><b>Keying</b></p> <ul style="list-style-type: none"> <li>Factory- and field-installed keying</li> </ul>	No cost	Specify with 9250 Ember Chrome lock. ▶ Page 306



### For Canadian Pricing

Multiply U.S. Price by the Canadian price factor.

▶ See page 1 for details.

**Specification Information**

Tip: Height dimension listed is for units with 1" top. Overall height will vary if another top is selected.

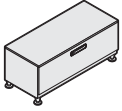

Dimensions			Recommended Counterweight Package	Style Number	Product ID	Change to U.S. Base Price
D	W	H				

**One 12"H Drawer—Proud Steel Front**

18 <sup>7</sup> / <sub>8</sub> "	30"	17 <sup>1</sup> / <sub>4</sub> "	Package A	<b>RCLF18301P</b>	FC00038259	+\$50
18 <sup>7</sup> / <sub>8</sub> "	36"	17 <sup>1</sup> / <sub>4</sub> "	Package B	<b>RCLF18361P</b>	FC00038260	+\$50
18 <sup>7</sup> / <sub>8</sub> "	42"	17 <sup>1</sup> / <sub>4</sub> "	Package C	<b>RCLF18421P</b>	FC00038261	+\$50
:	:	:	:	:	:	:

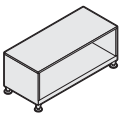

**Open Cabinet—Open Front**

18"	30"	17 <sup>1</sup> / <sub>4</sub> "	N.A.	<b>RSC18301AF</b>	FC00038262	+\$50
18"	36"	17 <sup>1</sup> / <sub>4</sub> "	N.A.	<b>RSC18361AF</b>	FC00038263	+\$50
18"	42"	17 <sup>1</sup> / <sub>4</sub> "	N.A.	<b>RSC18421AF</b>	FC00038264	+\$50
:	:	:	:	:	:	:

Universal  
Storage



**For Canadian Pricing**  
Multiply U.S. Price by the Canadian price factor.  
▶ See page 1 for details.

# Universal 1.5-High Lateral Files

with Proud Steel or Open Fronts

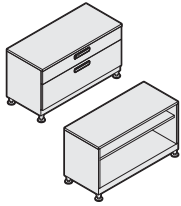

Standard Includes	Required to Specify
<ul style="list-style-type: none"> <li>• Lateral file: paint price group 1</li> <li>• c:scape pulls on units with proud steel front: metal</li> <li>• 1"H top on units with proud steel fronts: paint to match file</li> <li>• Central lock, keyed random: 9201 Polished Chrome</li> <li>• One label holder per drawer: clear plastic</li> <li>• Drawer body: black only</li> <li>• Drawer suspensions: black only</li> <li>• One hanging folder bar per drawer on 18"D units</li> <li>• Four adjustable leveling glides</li> <li>• Counterweight package, if selected</li> <li>• Three dividers per box drawer</li> </ul>	<ol style="list-style-type: none"> <li>1 General quote number: <b>FC036457</b></li> <li>2 Style number and Product ID</li> <li>3 Paint color number for file</li> <li>4 Metal color number for pulls:             <ul style="list-style-type: none"> <li>4140 Arctic White Gloss</li> <li>4144 Black Gloss</li> <li>4799 Platinum</li> <li>9201 Polished Chrome</li> </ul> </li> <li>5 Options, if selected (see below)</li> </ol>

## What's Special

Includes c:scape glides and pulls.

*Tip: Laminate and wood veneer tops are 3/16" taller than other tops and will add 3/16" to overall case height.*

### Premium Wood

**Pricing:** To calculate the estimated price for Premium wood veneer top, multiply Customiz stain upcharge by five for Premium wood 2 or by ten for Premium wood 3, then add the price for wood veneer top. For exact pricing, see the electronic catalog.

*Tip: Counterweight packages are recommended based on case size and interior options.*

*Tip: Counterweight option should be specified if the cabinet is not ganged to adjacent cabinets or bolted to the floor or wall.*

*Tip: Counterweight packages ship separately from case and must be installed on site.*

Options	U.S. Price	Required to Specify
<b>Surface Materials</b> <ul style="list-style-type: none"> <li>• Paint price group 1</li> <li>• Paint price group 2</li> <li>• Paint price group 3</li> </ul>	No cost +\$ 70 +\$120	Specify paint color number. Specify paint color number. Specify paint color number.
<b>Tops with Proud Steel Front</b> <ul style="list-style-type: none"> <li>• <b>No top</b></li> <li>• For use with a cushion top or beneath a common top</li> </ul>	-\$ 88	Specify <i>with no top</i> .
<ul style="list-style-type: none"> <li>• <b>Laminate top</b></li> <li>• Square edge laminate top</li> </ul>	+\$122	Specify <i>with laminate top</i> and indicate laminate color number for top and plastic color number for edges. ▶ See <i>Surface Materials Reference Manual</i> .
<ul style="list-style-type: none"> <li>• Open Line laminate on laminate top</li> </ul>	+\$ 64 plus cost of laminate	▶ See <i>Surface Materials Reference Manual</i> .
<ul style="list-style-type: none"> <li>• <b>Wood veneer top</b></li> <li>• Wood veneer top</li> <li>• Premium wood 2</li> <li>• Premium wood 3</li> <li>• Customiz stain on wood veneer top</li> </ul>	+\$367  See information at left  See information at left  +\$ 12	Specify <i>with wood veneer top</i> and indicate wood color number. Specify <i>with wood veneer top</i> and indicate Premium wood 2 finish number. Specify <i>with wood veneer top</i> and indicate Premium wood 3 finish number. Specify <i>with Customiz stain</i> . ▶ See <i>Surface Materials Reference Manual</i> .
<b>Drawer Interiors</b> <ul style="list-style-type: none"> <li>• Rails for use on 18"D units only</li> <li>• Divider package</li> </ul>	No cost  No cost	Specify <i>with rails</i> .  Specify <i>with divider package</i> .
<b>Counterweights</b> <ul style="list-style-type: none"> <li>• Package A</li> <li>• Package B</li> <li>• Package C</li> <li>• Package D</li> <li>• Package E</li> <li>• Package F</li> </ul>	+\$122 +\$133 +\$144 +\$158 +\$158 +\$158	Specify <i>with counterweight</i> . Specify <i>with counterweight</i> . Specify <i>with counterweight</i> . Specify <i>with counterweight</i> . Specify <i>with counterweight</i> . Specify <i>with counterweight</i> .
<b>Lock and Keying</b> <ul style="list-style-type: none"> <li>• <b>Lock</b></li> <li>• Ember Chrome</li> <li>• Individual locking drawers on 18"D file</li> <li>• Individual locking drawers on 24"D file</li> </ul>	No cost  +\$120  +\$133	Specify <i>with 9250 Ember Chrome lock</i> .  Specify <i>with individual locking drawers</i> .  Specify <i>with individual locking drawers</i> .
<ul style="list-style-type: none"> <li>• <b>Keying</b></li> <li>• Factory- and field-installed keying</li> </ul>		▶ Page 306



### For Canadian Pricing

Multiply U.S. Price by the Canadian price factor.

▶ See page 1 for details.

Tip: Height dimension listed is for units with 1" top. Overall height will vary if another top is selected.

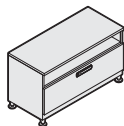
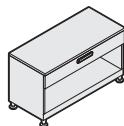
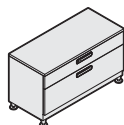
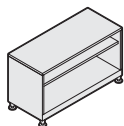

### Specification Information

Dimensions			Recommended Counterweight Package	Style Number	Product ID	Change to U.S. Base Price
D	W	H				
Proud Steel						

### Open-Open Configurations

#### One 6"H Opening with Fixed Shelf and One 12"H Opening with Fixed Shelf

18 <sup>7</sup> / <sub>8</sub> "	30"	23 <sup>1</sup> / <sub>4</sub> "	N.A.	<b>RLF18301AP</b>	FC00038256	+\$50
18 <sup>7</sup> / <sub>8</sub> "	36"	23 <sup>1</sup> / <sub>4</sub> "	N.A.	<b>RLF18361AP</b>	FC00038257	+\$50
18 <sup>7</sup> / <sub>8</sub> "	42"	23 <sup>1</sup> / <sub>4</sub> "	N.A.	<b>RLF18421AP</b>	FC00038258	+\$50
:	:	:	:	:	:	:

### Drawer-Drawer Configurations

#### One 6"H Drawer and One 12"H Drawer

18 <sup>7</sup> / <sub>8</sub> "	30"	23 <sup>1</sup> / <sub>4</sub> "	Package A	<b>RCLF18301BP</b>	FC00037154	+\$50
18 <sup>7</sup> / <sub>8</sub> "	36"	23 <sup>1</sup> / <sub>4</sub> "	Package B	<b>RCLF18361BP</b>	FC00038248	+\$50
18 <sup>7</sup> / <sub>8</sub> "	42"	23 <sup>1</sup> / <sub>4</sub> "	Package C	<b>RCLF18421BP</b>	FC00037975	+\$50
:	:	:	:	:	:	:

### Drawer-Open Configurations

#### One 6"H Drawer and One 12"H Opening with Fixed Shelf

18 <sup>7</sup> / <sub>8</sub> "	30"	23 <sup>1</sup> / <sub>4</sub> "	Package D	<b>RCLF18301CP</b>	FC00038249	+\$50
18 <sup>7</sup> / <sub>8</sub> "	36"	23 <sup>1</sup> / <sub>4</sub> "	Package E	<b>RCLF18361CP</b>	FC00038250	+\$50
18 <sup>7</sup> / <sub>8</sub> "	42"	23 <sup>1</sup> / <sub>4</sub> "	Package F	<b>RCLF18421CP</b>	FC00038251	+\$50
:	:	:	:	:	:	:

### Open-Drawer Configurations

#### One 6"H Opening with Fixed Shelf and One 12"H Drawer

18 <sup>7</sup> / <sub>8</sub> "	30"	23 <sup>1</sup> / <sub>4</sub> "	Package A	<b>RCLF18301DP</b>	FC00038253	+\$50
18 <sup>7</sup> / <sub>8</sub> "	36"	23 <sup>1</sup> / <sub>4</sub> "	Package B	<b>RCLF18361DP</b>	FC00038254	+\$50
18 <sup>7</sup> / <sub>8</sub> "	42"	23 <sup>1</sup> / <sub>4</sub> "	Package C	<b>RCLF18421DP</b>	FC00038255	+\$50
:	:	:	:	:	:	:

 **For Canadian Pricing**  
Multiply U.S. Price by the Canadian price factor.  
▶ See page 1 for details.

# Universal Open Side Towers

with Proud Steel Fronts

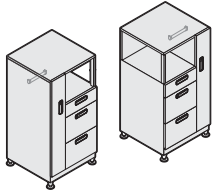

Standard Includes	Required to Specify
<ul style="list-style-type: none"> <li>• Tower: paint price group 1</li> <li>• 1"H top: paint to match tower</li> <li>• Door and drawer fronts on units with proud wood fronts: wood veneer</li> <li>• c:scape pulls on units with proud steel fronts: metal</li> <li>• Lock, keyed random: 9201 Polished Chrome</li> <li>• Drawer body: black only</li> <li>• Adjustable shelves on 52"H and 65½"H: paint to match tower</li> <li>• Brackets for adjustable shelves: black</li> <li>• Post to support adjustable shelf: paint to match tower</li> <li>• One box drawer divider and one pencil tray: black only</li> <li>• Coat rod: 9201 Polished Chrome</li> <li>• Four adjustable leveling glides</li> </ul>	<ol style="list-style-type: none"> <li>1 General quote number: <b>FC036457</b></li> <li>2 Style number and Product ID</li> <li>3 Paint color number for tower</li> <li>4 Metal color number for pulls:               <ul style="list-style-type: none"> <li>4140 Arctic White Gloss</li> <li>4144 Black Gloss</li> <li>4799 Platinum</li> <li>9201 Polished Chrome</li> </ul> </li> <li>5 Options, if selected (see below)</li> </ol>

## What's Special

Includes c:scape glides and pulls.

*Tip: Laminate and wood veneer tops are 3/16" taller than other tops and will add 3/16" to overall case height.*

*Tip: If wood veneer top option is selected, wood veneer top color will default to match wood front.*

**Premium Wood Pricing:** To calculate the estimated price for Premium wood veneer top, multiply Customiz stain upcharge by five for Premium wood 2 or by ten for Premium wood 3, then add the price for wood veneer top. For exact pricing, see the electronic catalog.

Options	U.S. Price	Required to Specify
<b>Surface Materials</b> <ul style="list-style-type: none"> <li>• Paint price group 1</li> <li>• Paint price group 2</li> <li>• Paint price group 3</li> </ul>	<ul style="list-style-type: none"> <li>No cost</li> <li>+\$ 70</li> <li>+\$120</li> </ul>	<ul style="list-style-type: none"> <li>Specify paint color number.</li> <li>Specify paint color number.</li> <li>Specify paint color number.</li> </ul>
<b>Tops with Proud Steel Front</b> <ul style="list-style-type: none"> <li>• <b>Laminate top</b> <ul style="list-style-type: none"> <li>• Square edge laminate top laminate color number for top and plastic color number for edges.</li> <li>• Open Line laminate on laminate top</li> </ul> </li> <li>• <b>Wood veneer top</b> <ul style="list-style-type: none"> <li>• Wood veneer top</li> <li>• Premium wood 2</li> <li>• Premium wood 3</li> <li>• Customiz stain on wood veneer top on units with flush steel or proud steel fronts</li> </ul> </li> </ul>	<ul style="list-style-type: none"> <li>+\$122</li> <li>+\$ 64 plus cost of laminate</li> <li>+\$367</li> <li>See information at left</li> <li>See information at left</li> <li>+\$ 12</li> </ul>	<ul style="list-style-type: none"> <li>Specify with <i>laminate top</i> and indicate</li> <li>▶ See <i>Surface Materials Reference Manual</i>.</li> <li>Specify with <i>wood veneer top</i> and indicate wood color number.</li> <li>Specify with <i>wood veneer top</i> and indicate Premium wood 2 finish number.</li> <li>Specify with <i>wood veneer top</i> and indicate Premium wood 3 finish number.</li> <li>Specify with <i>Customiz stain</i>.</li> <li>▶ See <i>Surface Materials Reference Manual</i>.</li> </ul>
<b>Lock and Keying</b> <ul style="list-style-type: none"> <li>• <b>Lock</b> <ul style="list-style-type: none"> <li>• Ember Chrome</li> </ul> </li> <li>• <b>Keying</b> <ul style="list-style-type: none"> <li>• Factory- and field-installed keying</li> </ul> </li> </ul>	<ul style="list-style-type: none"> <li>No cost</li> </ul>	<ul style="list-style-type: none"> <li>Specify with <i>9250 Ember Chrome lock</i>.</li> <li>▶ Page 306</li> </ul>



**For Canadian Pricing**  
 Multiply U.S. Price by the Canadian price factor.  
 ▶ See page 1 for details.

Tip: Height dimension listed is for units with 1" top. Overall height will vary if another top is selected.



**Specification Information**

• Dimensions			• Style	• Product ID	• Change to
D	W	H	Number		U.S. Base Price
Proud					
Steel					

**Tower with Door Hinged on Left**

**One Adjustable Shelf, One 6"H Drawer, and Two 12"H Drawers**

18 <sup>7</sup> / <sub>8</sub> "	24"	48 <sup>1</sup> / <sub>2</sub> "	<b>RQS242448LAP</b>	FC00038265	+\$154
:	:	:	:	:	:

**Tower with Door Hinged on Right**

**One Adjustable Shelf, One 6"H Drawer, and Two 12"H Drawers**

18 <sup>7</sup> / <sub>8</sub> "	24"	48 <sup>1</sup> / <sub>2</sub> "	<b>RQS242448RAP</b>	FC00038266	+\$154
:	:	:	:	:	:



**For Canadian Pricing**  
 Multiply U.S. Price by the Canadian price factor.  
 ▶ See page 1 for details.

# Square Edge Storage Tops

For Use with Flush and Proud Front Products

Standard Includes	Required to Specify
<ul style="list-style-type: none"> <li>• 1<math>\frac{3}{16}</math>"H top with square edge profile on all sides: laminate or wood</li> <li>• Attachment hardware</li> </ul>	<ol style="list-style-type: none"> <li>1 General quote number: <b>FC030047</b></li> <li>2 Style number and Product ID</li> <li>3 Laminate or wood color number for top</li> <li>4 Plastic color number for 1 mm edges of laminate top</li> <li>5 Options, if selected (see below)</li> </ol> See Surface Materials in the Storage and Freestanding Furniture Specification Guide.

**What's Special**  
Tops are available in a variety of widths.

Options	U.S. Price	Required to Specify
<b>Surface Materials</b> <b>Laminate top</b> <ul style="list-style-type: none"> <li>• Open Line laminate</li> </ul>	+\$64 plus cost of laminate	▶ See <i>Surface Materials Reference Manual</i> .
<b>Wood veneer top</b> <ul style="list-style-type: none"> <li>• Customiz stain on wood veneer top</li> <li>• Full-fill finish on wood veneer</li> </ul>	Prices below and at right Prices below and at right	Specify with <i>Customiz stain</i> . ▶ See <i>Surface Materials Reference Manual</i> . ▶ Specify with <i>full-fill finish</i> and select wood color number. ▶ See <i>Surface Materials Reference Manual</i> .

Specification Information						
Dimensions	Style	Product ID	Change to	Options		
D W H	Number		U.S. Base Price	(Add \$ to Base Price)		
.....	.....	.....	.....	.....	Customiz	Full-Fill
.....	.....	.....	.....	.....	Stain	Finish

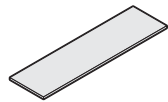

## Laminate Common Tops

36 $\frac{1}{16}$ "	30"	1 $\frac{3}{16}$ "	<b>RATCL3636F</b>	FC00026341	+\$110	N.A.	N.A.
37 $\frac{13}{16}$ "	30"	1 $\frac{3}{16}$ "	<b>RATCL3636P</b>	FC00028979	+\$110	N.A.	N.A.
36 $\frac{1}{16}$ "	42"	1 $\frac{3}{16}$ "	<b>RATCL3672F</b>	FC00026352	+\$110	N.A.	N.A.
37 $\frac{13}{16}$ "	42"	1 $\frac{3}{16}$ "	<b>RATCL3672P</b>	FC00026330	+\$110	N.A.	N.A.
36 $\frac{1}{16}$ "	60 $\frac{1}{16}$ "	1 $\frac{3}{16}$ "	<b>RATCL3672F</b>	FC00025984	+\$110	N.A.	N.A.
37 $\frac{13}{16}$ "	60 $\frac{1}{16}$ "	1 $\frac{3}{16}$ "	<b>RATCL3672P</b>	FC00026986	+\$110	N.A.	N.A.
36 $\frac{1}{16}$ "	78 $\frac{1}{16}$ "	1 $\frac{3}{16}$ "	<b>RATCL3672F</b>	FC00027331	+\$150	N.A.	N.A.
37 $\frac{13}{16}$ "	78 $\frac{1}{16}$ "	1 $\frac{3}{16}$ "	<b>RATCL3672P</b>	FC00027936	+\$150	N.A.	N.A.
36 $\frac{1}{16}$ "	84 $\frac{1}{16}$ "	1 $\frac{3}{16}$ "	<b>RATCL3672F</b>	FC00026322	+\$190	N.A.	N.A.
37 $\frac{13}{16}$ "	84 $\frac{1}{16}$ "	1 $\frac{3}{16}$ "	<b>RATCL3672P</b>	FC00026178	+\$190	N.A.	N.A.
36 $\frac{1}{16}$ "	90 $\frac{1}{8}$ "	1 $\frac{3}{16}$ "	<b>RATCL3672F</b>	FC00027131	+\$230	N.A.	N.A.
37 $\frac{13}{16}$ "	90 $\frac{1}{8}$ "	1 $\frac{3}{16}$ "	<b>RATCL3672P</b>	FC00027922	+\$230	N.A.	N.A.
36 $\frac{1}{16}$ "	96 $\frac{1}{8}$ "	1 $\frac{3}{16}$ "	<b>RATCL3672F</b>	FC00030245	+\$269	N.A.	N.A.
37 $\frac{13}{16}$ "	96 $\frac{1}{8}$ "	1 $\frac{3}{16}$ "	<b>RATCL3672P</b>	FC00028805	+\$269	N.A.	N.A.
36 $\frac{1}{16}$ "	108 $\frac{1}{8}$ "	1 $\frac{3}{16}$ "	<b>RATCL3672F</b>	FC00027648	+\$349	N.A.	N.A.
37 $\frac{13}{16}$ "	108 $\frac{1}{8}$ "	1 $\frac{3}{16}$ "	<b>RATCL3672P</b>	FC00027940	+\$349	N.A.	N.A.
.....	.....	.....	.....	.....	.....	.....	.....

▶ Specification Information, continued on next page

  
**For Canadian Pricing**  
 Multiply U.S. Price by the Canadian price factor.  
 ▶ See page 1 for details.



► **Specification Information, continued from previous page**

**Specification Information**

• Dimensions			• Style Number	• Product ID	• Change to U.S. Base Price	• Options	
D	W	H				(Add \$ to Base Price)	
						• Customiz	• Full-Fill
						• Stain	• Finish

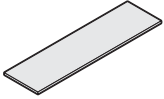

**Wood Common Tops**

18"	108 <sup>1</sup> / <sub>8</sub> "	1 <sup>3</sup> / <sub>16</sub> "	<b>RATCW1896F</b>	FC00026409	+\$245	+\$32	+\$64
18 <sup>7</sup> / <sub>8</sub> "	108 <sup>1</sup> / <sub>8</sub> "	1 <sup>3</sup> / <sub>16</sub> "	<b>RATCW1896P</b>	FC00026625	+\$245	+\$32	+\$64
23 <sup>1</sup> / <sub>8</sub> "	108 <sup>1</sup> / <sub>8</sub> "	1 <sup>3</sup> / <sub>16</sub> "	<b>RATCW2496F</b>	FC00027833	+\$255	+\$32	+\$64
24"	108 <sup>1</sup> / <sub>8</sub> "	1 <sup>3</sup> / <sub>16</sub> "	<b>RATCW2496P</b>	FC00027805	+\$255	+\$32	+\$64
36 <sup>1</sup> / <sub>16</sub> "	36"	1 <sup>3</sup> / <sub>16</sub> "	<b>RATCW3048F</b>	FC00026039	+\$110	+\$22	+\$44
36 <sup>1</sup> / <sub>16</sub> "	42"	1 <sup>3</sup> / <sub>16</sub> "	<b>RATCW3048F</b>	FC00029660	+\$142	+\$22	+\$44
36 <sup>1</sup> / <sub>16</sub> "	60 <sup>1</sup> / <sub>16</sub> "	1 <sup>3</sup> / <sub>16</sub> "	<b>RATCW3060F</b>	FC00027988	+\$254	+\$32	+\$64
36 <sup>1</sup> / <sub>16</sub> "	72 <sup>1</sup> / <sub>16</sub> "	1 <sup>3</sup> / <sub>16</sub> "	<b>RATCW3072F</b>	FC00026038	+\$268	+\$32	+\$64
36 <sup>1</sup> / <sub>16</sub> "	84 <sup>1</sup> / <sub>16</sub> "	1 <sup>3</sup> / <sub>16</sub> "	<b>RATCW3084F</b>	FC00030173	+\$329	+\$45	+\$90
36 <sup>1</sup> / <sub>16</sub> "	90 <sup>1</sup> / <sub>8</sub> "	1 <sup>3</sup> / <sub>16</sub> "	<b>RATCW3090F</b>	FC00026040	+\$342	+\$45	+\$90
36 <sup>1</sup> / <sub>16</sub> "	96 <sup>1</sup> / <sub>8</sub> "	1 <sup>3</sup> / <sub>16</sub> "	<b>RATCW3096F</b>	FC00028421	+\$365	+\$45	+\$90
36 <sup>1</sup> / <sub>16</sub> "	108 <sup>1</sup> / <sub>8</sub> "	1 <sup>3</sup> / <sub>16</sub> "	<b>RATCW3096F</b>	FC00028225	+\$557	+\$45	+\$90
:			:		:		

Universal  
Storage



**For Canadian Pricing**  
Multiply U.S. Price by the  
Canadian price factor.  
► See page 1 for details.



---

# Seating

▶ See page 3, *About Design Options*, in the front of this book for pricing and ordering restrictions.

## **Leap 462 Series**

Chair and Stools With Gross Stabil Soft Wheel Roll-Control Casters	<b>36</b>
Stool With Gross Stabil Soft Wheel Reverse-Braking Casters	<b>38</b>
Petite Chairs	<b>40</b>

## **Criterion 453 Series**

High-Back and Mid-Back Work Chairs and Stools with Special Seat Height	<b>42</b>
High-Back and Mid-Back Stools With Gross Stabil Soft Wheel Roll-Control Casters	<b>44</b>
High-Back and Mid-Back Chairs and Stools With Gross Stabil Soft Wheel Reverse-Braking Casters	<b>45</b>

## **Think 465 Series**

Work Chairs With Glides	<b>46</b>
Stools With Glides	<b>48</b>

## **Amia 482 Series**

Work Chair and Stools with Gross Stabil Soft Wheel With Roll-Control Casters	<b>50</b>
--	-----------

## **Cachet 487 Series**

Swivel-Base Work Chairs With Glides	<b>52</b>
Swivel-Base Stools with Glides	<b>54</b>
Swivel-Base Work Chairs and Stools With Gross Stabil Soft Wheel Reverse-Braking Casters	<b>56</b>

## **Reply 466 Series**

Swivel-Base Stool Work Chairs	<b>58</b>
-------------------------------	-----------

## **Set of Gross Stabil Soft Wheel Roll-Control Casters for Field Installation**

	<b>59</b>
--	-----------

## **Set of Gross Stabil Soft Wheel Reverse-Braking Casters for Field Installation**

	<b>60</b>
--	-----------

# Leap 462 Series Chair and Stools

With Gross Stabil Soft Wheel Roll-Control Casters



## What's Special

Chair and stool are available with Gross Stabil soft wheel roll-control casters. Roll-control casters are weight activated, and will brake when the chair or stool is unoccupied. These casters roll freely when the chair or stool is occupied.

Standard Includes	Required to Specify
<ul style="list-style-type: none"> <li>• Upper back force</li> <li>• 8" pneumatic seat-height adjustment</li> <li>• Variable back stop</li> <li>• Lower back firmness</li> <li>• Passive seat edge angle</li> <li>• Rectilinear independent height-, width-, pivot-, and depth-adjustable arms and soft arm caps, if selected: black plastic</li> <li>• Frame, seat shell, outer back, and five-arm base: plastic</li> <li>• 3" seat depth adjustment</li> <li>• Column and 4" adjustable foot ring: black</li> <li>• Standard upholstery design: fabric price group 1</li> <li>• Gross stabil soft wheel roll-control casters</li> </ul>	<ol style="list-style-type: none"> <li>1 General quote number: <b>CH009855</b></li> <li>2 Style number and Product ID</li> <li>3 Plastic color for frame, seat shell, outer back, and base</li> <li>4 Fabric color number for upholstery on seat and back</li> <li>5 Options, if selected (see below) See Surface Materials in the Seating Specification Guide.</li> </ol>

Options	U.S. Price	Required to Specify
<b>Surface Materials</b>		
<b>Upholstery</b>		
• Fabric price group 1	No cost	Specify fabric color number.
• Fabric price group 2	+\$ 23	Specify fabric color number.
• Fabric price group 3	+\$ 44	Specify fabric color number.
• Fabric price group 4	+\$ 61	Specify fabric color number.
• Fabric price group 5	+\$ 77	Specify fabric color number.
• Fabric price group 6	+\$ 95	Specify fabric color number.
• Fabric price group 7	+\$110	Specify fabric color number.
• Fabric price group 8	+\$138	Specify fabric color number.
• Fabric price group 9	+\$171	Specify fabric color number.
• Fabric price group 10	+\$193	Specify fabric color number.
• Customer's Own Material (COM)	No cost	▶ See <i>Surface Materials Reference Manual</i> to specify.
• Soil-retardant treatment applied to upholstery fabric	+\$ 22	Specify <i>with soil-retardant treatment</i> .
<b>Platinum</b>		
• On frame, base, arm retainer, and outer back	+\$ 80	Specify <i>with 6249 Platinum</i> .
<b>Arms</b>		
• Height-adjustable arms, soft arm caps	-\$ 84	Specify <i>with height-adjustable arms</i> .
• Armless	-\$259	Specify <i>without arms</i> .
<b>Seat Height</b>		
• 7" pneumatic seat-height adjustment	+\$ 54	Specify <i>with 7" pneumatic seat-height adjustment</i> .
<b>Lumbar</b>		
• Without lumbar	-\$ 53	Specify <i>without lumbar</i> .

## Specification Information

Style Number	Product ID	Change to U.S. Base Price
.....	.....	.....

### Work Chair

<b>46216179</b>	CH00008132	+\$ 68
.....	.....	.....

### Stools

<b>46267179</b>	CH00008644	+\$107
<b>46267179S</b>	CH00008929	+\$107
.....	.....	.....





# Leap 462 Series Stools

With Gross Stabil Soft Wheel Reverse-Braking Casters



## What's Special

Stool is available with Gross Stabil soft wheel reverse-braking casters. Reverse-braking casters are weight activated, and will brake when the stool is occupied. These casters will roll freely when the chair/stool is unoccupied.

### Standard Includes

- Upper back force
- 8" pneumatic seat-height adjustment
- Variable back stop
- Lower back firmness
- Passive seat edge angle
- Rectilinear independent height-, width-, pivot-, and depth-adjustable arms and soft arm caps, if selected: black plastic
- Frame, seat shell, outer back, and five-arm base: plastic
- 3" seat depth adjustment
- Column and 4" adjustable foot ring: black
- Standard upholstery design: fabric price group 1
- Gross stabil soft wheel reverse-braking casters

### Required to Specify

- 1 General quote number: **CH009855**
- 2 Style number and Product ID
- 3 Plastic color for frame, seat shell, outer back, and base
- 4 Fabric color number for upholstery on seat and back
- 5 Options, if selected (see below)  
See Surface Materials in the Seating Specification Guide.

	Options	U.S. Price	Required to Specify
<b>Surface Materials</b>	<b>Upholstery on back and seat</b>		
	• Fabric price group 1	No cost	Specify fabric color number.
	• Fabric price group 2	+\$ 23	Specify fabric color number.
	• Fabric price group 3	+\$ 44	Specify fabric color number.
	• Fabric price group 4	+\$ 61	Specify fabric color number.
	• Fabric price group 5	+\$ 77	Specify fabric color number.
	• Fabric price group 6	+\$ 95	Specify fabric color number.
	• Fabric price group 7	+\$110	Specify fabric color number.
	• Fabric price group 8	+\$138	Specify fabric color number.
	• Fabric price group 9	+\$171	Specify fabric color number.
• Fabric price group 10	+\$193	Specify fabric color number.	
• Customer's Own Material (COM)	No cost	▶ See <i>Surface Materials Reference Manual</i> to specify.	
• Soil-retardant treatment applied to upholstery fabric	+\$ 22	Specify with soil-retardant treatment.	
	<b>3D knit on back with upholstery on seat</b>		
	• Fabric price group 1	No cost	Specify fabric color number.
	• Fabric price group 2	+\$ 10	Specify fabric color number.
	• Fabric price group 3	+\$ 23	Specify fabric color number.
	• Fabric price group 4	+\$ 31	Specify fabric color number.
	• Fabric price group 5	+\$ 38	Specify fabric color number.
	• Fabric price group 6	+\$ 47	Specify fabric color number.
	• Fabric price group 7	+\$ 56	Specify fabric color number.
	• Fabric price group 8	+\$ 70	Specify fabric color number.
	• Fabric price group 9	+\$ 85	Specify fabric color number.
• Fabric price group 10	+\$ 98	Specify fabric color number.	
• Customer's Own Material (COM)	No cost	▶ See <i>Surface Materials Reference Manual</i> to specify.	
• Soil-retardant treatment applied to upholstery fabric	+\$ 22	Specify with soil-retardant treatment.	
	<b>Platinum</b>		
• On frame, base, arm retainer, and outer back	+\$ 80	Specify with 6249 Platinum.	
<b>Arms</b>	• Height-adjustable arms, soft arm caps	-\$ 84	Specify with height-adjustable arms.
	• Armless	-\$259	Specify without arms.
<b>Lumbar</b>	• Without lumbar	-\$ 53	Specify without lumbar.



### For Canadian Pricing

Multiply U.S. Price by the Canadian price factor.

▶ See page 1 for details.

**Specification Information**

• Style Number	• Product ID	• Change to U.S. Base Price
----------------	--------------	-----------------------------

**462 Series Leap Stools**

<b>46267189</b>	CH00008664	+\$119
<b>46267179</b>	CH00008789	+\$119
<b>46267179S</b>	CH00009418	+\$119
.	.	.



# Leap 462 Series Petite Chairs



Standard Includes	Required to Specify
<ul style="list-style-type: none"> <li>• Upper back force</li> <li>• 2<sup>3</sup>/<sub>4</sub>" pneumatic seat-height adjustment</li> <li>• Variable back stop</li> <li>• Lower back firmness</li> <li>• Passive seat edge angle</li> <li>• Rectilinear independent height-, width-, pivot-, and depth-adjustable arms and soft arm caps, if selected: black plastic</li> <li>• Seat shell and outer back: plastic</li> <li>• Five-arm base: 6205 Black plastic</li> <li>• 3" seat depth adjustment</li> <li>• Standard upholstery design: fabric price group 1</li> <li>• 5" adjustable lumbar</li> <li>• 2<sup>1</sup>/<sub>2</sub>" diameter, hard composition, dual-wheel casters: black</li> </ul>	<ol style="list-style-type: none"> <li>1 General quote number: <b>CH011582</b></li> <li>2 Style number and Product ID</li> <li>3 Fabric color number for upholstery on seat and back</li> <li>4 Plastic color number for seat shell and outer back</li> <li>5 Options, if selected (see below) See <i>Surface Materials</i> in the Seating Specification Guide.</li> </ol>

Surface Materials	Options	U.S. Price	Required to Specify
	<b>Upholstery on back and seat</b>		
	• Fabric price group 1	No cost	Specify fabric color number.
	• Fabric price group 2	+\$ 23	Specify fabric color number.
	• Fabric price group 3	+\$ 44	Specify fabric color number.
	• Fabric price group 4	+\$ 61	Specify fabric color number.
	• Fabric price group 5	+\$ 77	Specify fabric color number.
	• Fabric price group 6	+\$ 95	Specify fabric color number.
	• Fabric price group 7	+\$110	Specify fabric color number.
	• Fabric price group 8	+\$138	Specify fabric color number.
	• Fabric price group 9	+\$171	Specify fabric color number.
	• Fabric price group 10	+\$193	Specify fabric color number.
	• Customer's Own Material (COM)	No cost	▶ See <i>Surface Materials Reference Manual</i> to specify.
	• Soil-retardant treatment applied to upholstery fabric	+\$ 22	Specify <i>with soil-retardant treatment</i> .
	• Customer's Own Material (COM-Sewn)	+\$ 70	Add suffix <b>S</b> to the style number and specify fabric color number.
	• Steelcase leather upholstery	+\$642	Add suffix <b>S</b> to the style number and specify leather color number.
	• Steelcase vinyl	+\$ 70	Add suffix <b>S</b> to the style number and specify vinyl color number.
	• Customer's Own Leather (COL)	+\$320	Add suffix <b>S</b> to the style number and specify leather color number.
	• Customer's Own Vinyl (COV)	+\$ 70	Add suffix <b>S</b> to the style number and specify vinyl color number.
	• Fire Code Seating (FCS)	+\$ 70	Add suffix <b>F</b> to the style number.
	• Soil-retardant treatment applied to upholstery fabric	+\$ 22	Specify <i>with soil-retardant treatment</i> .
	<b>3D knit on back with upholstery on seat</b>		
	• Fabric price group 1	No cost	Specify fabric color number.
	• Fabric price group 2	+\$ 10	Specify fabric color number.
	• Fabric price group 3	+\$ 23	Specify fabric color number.
	• Fabric price group 4	+\$ 31	Specify fabric color number.
	• Fabric price group 5	+\$ 38	Specify fabric color number.
	• Fabric price group 6	+\$ 47	Specify fabric color number.
	• Fabric price group 7	+\$ 56	Specify fabric color number.
	• Fabric price group 8	+\$ 70	Specify fabric color number.
	• Fabric price group 9	+\$ 85	Specify fabric color number.
	• Fabric price group 10	+\$ 98	Specify fabric color number.
	• Steelcase leather upholstery	+\$320	Add suffix <b>S</b> to the style number and specify leather color number.
	• Steelcase vinyl	+\$ 37	Add suffix <b>S</b> to the style number and specify vinyl color number.
	• Customer's Own Material (COM)	No cost	▶ See <i>Surface Materials Reference Manual</i> to specify.
	• Customer's Own Material (COM-Sewn)	+\$ 37	Add suffix <b>S</b> to the style number and specify fabric number.
	• Customer's Own Leather (COL)	+\$160	Add suffix <b>S</b> to the style number and specify leather color number.



## For Canadian Pricing

Multiply U.S. Price by the Canadian price factor.

▶ See page 1 for details.

▶ **Options, continued on next page**





### What's Special

Chair is special with 6205 Black V1 base and special pneumatic cylinder for an approximate seat height range of 13<sup>1</sup>/<sub>4</sub>" to 16". Also special with the arm width adjustment range reduced to approximately 13<sup>3</sup>/<sub>4</sub>" when the arms are in the narrowest forward facing straight position.

### What's Special

Chair is special with the arm width adjustment reduced to approximately 13<sup>3</sup>/<sub>4</sub>" when the arms are in the narrowest forward facing straight position.

### What's Special

Chair is special with 6205 Black V1 base and special pneumatic cylinder for an approximate seat height range of 13<sup>1</sup>/<sub>4</sub>" to 16".

### Options, continued from previous page

Options	U.S. Price	Required to Specify
<b>Surface Materials, continued</b>	<b>3D knit on back with upholstery on seat, continued</b>	
• Customer's Own Vinyl (COV)	+\$ 37	Add suffix <b>S</b> to the style number and specify vinyl color number.
• Fire Code Seating (FCS)	+\$ 70	Add suffix <b>F</b> to the style number.
• Soil-retardant treatment applied to upholstery fabric	+\$ 22	Specify with soil-retardant treatment.
<b>Arms</b>		
• Height-adjustable arms, soft arm caps	-\$ 84	Specify with height-adjustable arms.
• Armless	-\$259	Specify without arms.
<b>Lumbar</b>		
• Without lumbar	-\$ 53	Specify without lumbar.

### Specification Information

Style Number	Product ID	Change to U.S. Base Price
:	:	:
:	:	:
:	:	:

### Work Chairs with Lower Seat Height and Narrow Arms

<b>46216179</b>	CH00009377	+\$298
<b>46216179S</b>	CH00009949	+\$298
<b>46216189</b>	CH00009586	+\$298
:	:	:

### Work Chairs with Narrow Arms Only

<b>4621679</b>	CH00009033	+\$174
<b>46216179S</b>	CH00010007	+\$174
<b>46216189</b>	CH00009976	+\$174
:	:	:

### Work Chairs with Lower Seat Height Only

<b>46216179</b>	CH00008164	+\$174
<b>46216179S</b>	CH00009147	+\$174
<b>46216189</b>	CH00009231	+\$174
:	:	:



**For Canadian Pricing**  
Multiply U.S. Price by the Canadian price factor.  
▶ See page 1 for details.





### Specification Information

Style Number	Product ID	Change to U.S. Base Price
--------------	------------	---------------------------

#### Seat Height 18"H–23"H Chairs

<b>4535330</b>	CH00005281	+\$205
<b>4535300D</b>	CH00005709	+\$205
<b>4535301D</b>	CH00005397	+\$205
<b>4535330D</b>	CH00005991	+\$205
<b>4535330DP</b>	CH00006692	+\$205
<b>4535330DW</b>	CH00005880	+\$205
<b>4535331DP</b>	CH00005156	+\$205
<b>4535331DW</b>	CH00005644	+\$205

#### Seat Height 20"H–25"H Chairs

<b>4535330</b>	CH00007817	+\$205
<b>4535300D</b>	CH00006683	+\$205
<b>4535301D</b>	CH00006786	+\$205
<b>4535330D</b>	CH00007667	+\$205
<b>4535330DW</b>	CH00006336	+\$205
<b>4535331DP</b>	CH00006449	+\$205
<b>4535331DW</b>	CH00006380	+\$205

#### Seat Height 20"H–25"H Stools

<b>4537300D</b>	CH00006201	+\$205
<b>4537301D</b>	CH00007486	+\$205
<b>4537330DW</b>	CH00007500	+\$205
<b>4537330DP</b>	CH00006927	+\$205
<b>4537331DW</b>	CH00005192	+\$205
<b>4537331DP</b>	CH00006928	+\$205

#### Seat Height 27"H–32"H Stools

<b>4537300D</b>	CH00005525	+\$205
<b>4537301D</b>	CH00006142	+\$205
<b>4537330DP</b>	CH00005505	+\$205
<b>4537330DW</b>	CH00005252	+\$205
<b>4537331DP</b>	CH00006872	+\$205
<b>4537331DW</b>	CH00005158	+\$205



**For Canadian Pricing**  
Multiply U.S. Price by the  
Canadian price factor.  
▶ See page 1 for details.





# Think 465 Series Work Chairs

With Glides



Standard Includes	Required to Specify
<ul style="list-style-type: none"> <li>• 5" pneumatic seat-height adjustment (16"–21")</li> <li>• Your Preference™ control</li> <li>• Seat edge angle</li> <li>• Frame, seat shell, and five-arm plastic base</li> <li>• 2" seat depth adjustment</li> <li>• Height-, width-, pivot-, and depth-adjustable arms</li> <li>• Sewn upholstery design: fabric price group 1</li> <li>• Glides</li> <li>• Assembled</li> </ul>	<ol style="list-style-type: none"> <li>1 General quote number: <b>CH009854</b></li> <li>2 Style number and Product ID</li> <li>3 Plastic color for frame, seat shell, and base</li> <li>4 Fabric color number for upholstery on seat and back</li> <li>5 Options, if selected (see below) See Surface Materials in the Seating Specification Guide.</li> </ol>

**What's Special**  
Chairs are available with glides.

Options	U.S. Price	Required to Specify
<b>Surface Materials</b>		
<b>Upholstery on back and seat</b>		
• Fabric price group 1	No cost	Specify fabric color number.
• Fabric price group 2	+\$ 23	Specify fabric color number.
• Fabric price group 3	+\$ 44	Specify fabric color number.
• Fabric price group 4	+\$ 61	Specify fabric color number.
• Fabric price group 5	+\$ 77	Specify fabric color number.
• Fabric price group 6	+\$ 95	Specify fabric color number.
• Fabric price group 7	+\$110	Specify fabric color number.
• Fabric price group 8	+\$138	Specify fabric color number.
• Fabric price group 9	+\$171	Specify fabric color number.
• Fabric price group 10	+\$193	Specify fabric color number.
• Customer's Own Material (COM)	No cost	▶ See <i>Surface Materials Reference Manual</i> .
• Soil-retardant treatment applied to upholstery fabric	+\$ 22	Specify with soil-retardant treatment.
<b>3D knit on back with upholstery on seat</b>		
• Fabric price group 1	No cost	Specify fabric color number.
• Fabric price group 2	+\$ 10	Specify fabric color number.
• Fabric price group 3	+\$ 23	Specify fabric color number.
• Fabric price group 4	+\$ 31	Specify fabric color number.
• Fabric price group 5	+\$ 38	Specify fabric color number.
• Fabric price group 6	+\$ 47	Specify fabric color number.
• Fabric price group 7	+\$ 56	Specify fabric color number.
• Fabric price group 8	+\$ 70	Specify fabric color number.
• Fabric price group 9	+\$ 85	Specify fabric color number.
• Fabric price group 10	+\$ 98	Specify fabric color number.
• Customer's Own Material (COM)	No cost	▶ See <i>Surface Materials Reference Manual</i> .
• Fire Code Seating (FCS)	+\$ 35	Add suffix <b>F</b> to the style number.
• Soil-retardant treatment applied to upholstery fabric	+\$ 22	Specify with soil-retardant treatment.
<b>Platinum</b>		
• On frame, base, and arm retainer	+\$ 80	Specify with 6249 Platinum.
<b>Arms</b>		
• Fixed arms	–\$ 91	Specify with fixed arms.
<b>Base</b>		
• Aluminum base	+\$130	Specify with aluminum base.
<b>Seat Height</b>		
• 4" pneumatic seat-height adjustment (15"–19")	+\$ 54	Specify with 4" pneumatic seat-height adjustment.
<b>Headrest</b>		
• Headrest	+\$159	Specify with headrest.
<b>Lumbar Height</b>		
• 4¼" travel for additional lumbar support	+\$ 53	Specify with adjustable lumbar height.

  
**For Canadian Pricing**  
Multiply U.S. Price by the Canadian price factor.  
▶ See page 1 for details.

**Specification Information**

• Style Number	• Product ID	• Change to U.S. Base Price
----------------	--------------	-----------------------------

**With Glides**

<b>46540000</b>	CH00008454	+\$34
<b>46543100</b>	CH00008532	+\$34
<b>46543000</b>	CH00008663	+\$34
<b>46541000S</b>	CH00009820	+\$34
<b>46541100S</b>	CH00008541	+\$34
<b>46542100</b>	CH00008672	+\$34
<b>46542000</b>	CH00009614	+\$34



# Think 465 Series Stools

With Glides



## What's Special

Stool is available with glides.

*Tip: Seat height will be approximately 1/2" higher than the standard stool with casters.*

## Standard Includes

- 10" pneumatic seat-height adjustment (22<sup>3</sup>/<sub>4</sub>"–32<sup>3</sup>/<sub>4</sub>" )
- Your Preference control
- Seat edge angle
- Frame, seat shell, and five-arm painted base
- 2" seat depth adjustment
- Height-, width-, pivot-, and depth-adjustable arms
- Column and adjustable foot ring: black
- Standard upholstery design: fabric price group 1
- Glides

## Required to Specify

- 1 General quote number: **CH009854**
- 2 Style number and Product ID
- 3 Plastic color for frame, seat shell, and base
- 4 Fabric color number for upholstery on seat and back
- 5 Options, if selected (see below)  
See Surface Materials in the Seating Specification Guide.

## Options

## U.S. Price

## Required to Specify

### Surface Materials

### Upholstery on seat with 3D Knit back

- |   |         |
|---|---------|
| • Fabric price group 1                                  | No cost |
| • Fabric price group 2                                  | +\$ 10  |
| • Fabric price group 3                                  | +\$ 23  |
| • Fabric price group 4                                  | +\$ 31  |
| • Fabric price group 5                                  | +\$ 38  |
| • Fabric price group 6                                  | +\$ 47  |
| • Fabric price group 7                                  | +\$ 56  |
| • Fabric price group 8                                  | +\$ 70  |
| • Fabric price group 9                                  | +\$ 85  |
| • Fabric price group 10                                 | +\$ 98  |
| • Customer's Own Material (COM)                         | No cost |
| • Soil-retardant treatment applied to upholstery fabric | +\$ 22  |

- Specify fabric color number.  
Specify fabric color number.  
Specify fabric color number.  
Specify fabric color number.  
Specify fabric color number.  
Specify fabric color number.  
Specify fabric color number.  
Specify fabric color number.  
Specify fabric color number.  
Specify fabric color number.  
Specify fabric color number.  
▶ See *Surface Materials Reference Manual* to specify.  
Specify with *soil-retardant treatment*.

### Upholstery on seat and back

- |   |         |
|---|---------|
| • Fabric price group 1                                  | No cost |
| • Fabric price group 2                                  | +\$ 23  |
| • Fabric price group 3                                  | +\$ 44  |
| • Fabric price group 4                                  | +\$ 61  |
| • Fabric price group 5                                  | +\$ 77  |
| • Fabric price group 6                                  | +\$ 95  |
| • Fabric price group 7                                  | +\$110  |
| • Fabric price group 8                                  | +\$138  |
| • Fabric price group 9                                  | +\$171  |
| • Fabric price group 10                                 | +\$193  |
| • Customer's Own Material (COM)                         | No cost |
| • Soil-retardant treatment applied to upholstery fabric | +\$ 22  |

- Specify fabric color number.  
Specify fabric color number.  
Specify fabric color number.  
Specify fabric color number.  
Specify fabric color number.  
Specify fabric color number.  
Specify fabric color number.  
Specify fabric color number.  
Specify fabric color number.  
Specify fabric color number.  
Specify fabric color number.  
▶ See *Surface Materials Reference Manual*.  
Specify with *soil-retardant treatment*.

### Platinum

- |                                    |        |
|------------------------------------|--------|
| • On frame, base, and arm retainer | +\$ 80 |
|------------------------------------|--------|

Specify with *6249 Platinum*.

### Arms

- |              |        |
|--------------|--------|
| • Fixed arms | –\$ 91 |
|--------------|--------|

Specify with *fixed arms*.

### Base

- |                 |        |
|-----------------|--------|
| • Aluminum base | +\$130 |
|-----------------|--------|

Specify with *aluminum base*.

### Headrest

- |            |        |
|------------|--------|
| • Headrest | +\$159 |
|------------|--------|

Specify with *headrest*.

### Lumbar Height

- |  |        |
|--|--------|
| • 4 <sup>1</sup> / <sub>4</sub> " travel for additional lumbar support | +\$ 53 |
|--|--------|

Specify with *adjustable lumbar height*.



## For Canadian Pricing

Multiply U.S. Price by the Canadian price factor.

▶ See page 1 for details.



**Specification Information**

• Style Number	• Product ID	• Change to U.S. Base Price
----------------	--------------	-----------------------------

**With Glides**

<b>46533100</b>	CH00008602	+\$21
<b>46531100S</b>	CH00008582	+\$21
<b>46531000S</b>	CH00008583	+\$21
<b>46532100</b>	CH00008818	+\$21
<b>46533000</b>	CH00008885	+\$21
<b>46532000</b>	CH00009057	+\$21
<b>46530000</b>	CH00009796	+\$21



Seating

 **For Canadian Pricing**  
 Multiply U.S. Price by the Canadian price factor.  
 ▶ See page 1 for details.

# Amia 482 Series Work Chair and Stools

With Gross Stabil Soft Wheel Roll-Control Casters



Standard Includes	Required to Specify
<ul style="list-style-type: none"> <li>• Synchro-tilt mechanism</li> <li>• 5" pneumatic seat-height adjustment</li> <li>• Upright back lock</li> <li>• Rectilinear independent height-, width-, pivot-, and depth-adjustable arms and soft arm caps: black plastic</li> <li>• Frame, seat shell, outer back, and five-arm base: plastic</li> <li>• 3" seat depth adjustment</li> <li>• Passive seat edge angle</li> <li>• Adjustable lumbar</li> <li>• Standard upholstery design: fabric price group 1</li> <li>• Gross stabil soft wheel roll-control casters</li> </ul>	<ol style="list-style-type: none"> <li>1 General quote number: <b>CH009855</b></li> <li>2 Style number and Product ID</li> <li>3 Plastic color for frame, seat shell, outer back, and base</li> <li>4 Fabric color number for upholstery on seat and back</li> <li>5 Options, if selected (see below) See Surface Materials in the Seating Specification Guide.</li> </ol>

## What's Special

Chair and stool are available with Gross Stabil soft wheel roll-control casters. Roll-control casters are weight activated, and will brake when the chair or stool is unoccupied. These casters roll freely when the chair or stool is occupied.

	Options	U.S. Price	Required to Specify
<b>Surface Materials</b>	<b>Upholstery</b>		
	• Fabric price group 1	No cost	Specify fabric color number.
	• Fabric price group 2	+\$ 23	Specify fabric color number.
	• Fabric price group 3	+\$ 44	Specify fabric color number.
	• Fabric price group 4	+\$ 61	Specify fabric color number.
	• Fabric price group 5	+\$ 77	Specify fabric color number.
	• Fabric price group 6	+\$ 95	Specify fabric color number.
	• Fabric price group 7	+\$110	Specify fabric color number.
	• Fabric price group 8	+\$138	Specify fabric color number.
	• Fabric price group 9	+\$171	Specify fabric color number.
• Fabric price group 10	+\$193	Specify fabric color number.	
• Customer's Own Material (COM)	No cost	▶ See <i>Surface Materials Reference Manual</i> to specify	
	• Soil-retardant treatment applied to upholstery fabric	+\$ 22	Specify with <i>soil-retardant treatment</i> .
	<b>Platinum</b>		
	• On frame, base, arm retainer, and outer back	+\$ 80	Specify with <i>6249 Platinum</i> .
<b>Base</b>	• Polished aluminum base	+\$134	Specify with <i>polished aluminum base</i> .
<b>Arms</b>	• Height-adjustable arms, soft arm caps	-\$ 80	Specify with <i>height-adjustable arms</i> .
	• Armless	-\$187	Specify <i>without arms</i> .
<b>Seat Height</b>	• 4" pneumatic seat-height adjustment	+\$ 54	Specify with <i>4" pneumatic seat-height adjustment</i> .

## Specification Information

Style Number	Product ID	Change to U.S. Base Price

### Work Chair

<b>4821410</b>	CH00008749	+\$70
----------------	------------	-------

### Stools

<b>4827410</b>	CH00008598	+\$70
<b>4827410S</b>	CH00009296	+\$70





# Cachet 487 Series Swivel-Base Work Chairs

With Glides



Standard Includes	Required to Specify
<ul style="list-style-type: none"> <li>Balanced-action rocker (BAR) mechanism</li> <li>Frame, seat, back, flip-up arms, and five-arm base: plastic</li> <li>5" pneumatic seat-height adjustment</li> <li>Upholstery, if selected: fabric price group 1</li> <li>Glides</li> </ul>	<ol style="list-style-type: none"> <li>General quote number: <b>CH009854</b></li> <li>Style number and Product ID</li> <li>Plastic color number for frame, seat, back, flip-up arms, and five-arm base</li> <li>Fabric color number for upholstery on seat and back, or seat, if selected</li> <li>Options, if selected (see below)</li> </ol> <p>See Surface Materials in the Seating Specification Guide.</p>

**What's Special**  
Chairs are available with glides.

Surface Materials	Options	U.S. Price	Required to Specify
	<b>Non-upholstered chair</b>		
	<ul style="list-style-type: none"> <li>Fire Code Seating (FCS)</li> </ul>	+\$ 42	Add suffix <b>F</b> to the style number.
	<b>Upholstery on seat</b>		
	<ul style="list-style-type: none"> <li>Fabric price group 1</li> <li>Fabric price group 2</li> <li>Fabric price group 3</li> <li>Fabric price group 4</li> <li>Fabric price group 5</li> <li>Fabric price group 6</li> <li>Fabric price group 7</li> <li>Fabric price group 8</li> <li>Fabric price group 9</li> <li>Fabric price group 10</li> <li>Customer's Own Material (COM)</li> <li>Soil-retardant treatment applied to upholstery fabric</li> </ul>	<ul style="list-style-type: none"> <li>No cost</li> <li>+\$ 10</li> <li>+\$ 23</li> <li>+\$ 31</li> <li>+\$ 38</li> <li>+\$ 47</li> <li>+\$ 56</li> <li>+\$ 70</li> <li>+\$ 85</li> <li>+\$ 98</li> <li>No cost</li> <li>+\$ 22</li> </ul>	<ul style="list-style-type: none"> <li>Specify fabric color number.</li> <li>Specify fabric color number.</li> <li>Specify fabric color number.</li> <li>Specify fabric color number.</li> <li>Specify fabric color number.</li> <li>Specify fabric color number.</li> <li>Specify fabric color number.</li> <li>Specify fabric color number.</li> <li>Specify fabric color number.</li> <li>Specify fabric color number.</li> <li>Specify fabric color number.</li> <li>▶ See <i>Surface Materials Reference Manual</i> to specify.</li> <li>Specify with <i>soil-retardant treatment</i>.</li> </ul>
	<b>Upholstery on seat and back</b>		
	<ul style="list-style-type: none"> <li>Fabric price group 1</li> <li>Fabric price group 2</li> <li>Fabric price group 3</li> <li>Fabric price group 4</li> <li>Fabric price group 5</li> <li>Fabric price group 6</li> <li>Fabric price group 7</li> <li>Fabric price group 8</li> <li>Fabric price group 9</li> <li>Fabric price group 10</li> <li>Customer's Own Material (COM)</li> <li>Soil-retardant treatment applied to upholstery fabric</li> </ul>	<ul style="list-style-type: none"> <li>No cost</li> <li>+\$ 23</li> <li>+\$ 44</li> <li>+\$ 61</li> <li>+\$ 77</li> <li>+\$ 95</li> <li>+\$110</li> <li>+\$138</li> <li>+\$171</li> <li>+\$193</li> <li>No cost</li> <li>+\$ 22</li> </ul>	<ul style="list-style-type: none"> <li>Specify fabric color number.</li> <li>Specify fabric color number.</li> <li>Specify fabric color number.</li> <li>Specify fabric color number.</li> <li>Specify fabric color number.</li> <li>Specify fabric color number.</li> <li>Specify fabric color number.</li> <li>Specify fabric color number.</li> <li>Specify fabric color number.</li> <li>Specify fabric color number.</li> <li>Specify fabric color number.</li> <li>▶ See <i>Surface Materials Reference Manual</i> to specify.</li> <li>Specify with <i>soil-retardant treatment</i>.</li> </ul>

  
**For Canadian Pricing**  
Multiply U.S. Price by the Canadian price factor.  
▶ See page 1 for details.

**Specification Information**

• Style Number	• Product ID	• Change to U.S. Base Price
----------------	--------------	-----------------------------

**Without Upholstery**

<b>4871110</b>	CH00005354	+\$33
----------------	------------	-------

**With Upholstered Seat**

<b>4871210</b>	CH00005387	+\$33
----------------	------------	-------

**With Upholstered Seat and Back**

<b>4871211</b>	CH00008748	+\$33
----------------	------------	-------



Seating



**For Canadian Pricing**

Multiply U.S. Price by the Canadian price factor.

▶ See page 1 for details.

# Cachet 487 Series Swivel-Base Stools

With Glides



## Standard Includes

- Balanced-action rocker (BAR) mechanism
- Frame, seat, back, flip-up arms, and five-arm base: black plastic
- 7<sup>3</sup>/<sub>4</sub>" pneumatic seat-height adjustment
- Upholstery, if selected: fabric price group 1
- Glides

## Required to Specify

- 1 General quote number: **CH009854**
  - 2 Style number and Product ID
  - 3 Fabric color number for upholstery on seat and back, or seat, if selected
  - 4 Options, if selected (see below)
- See Surface Materials in the Seating Specification Guide.

## What's Special

Stools are available with glides.

	Options	U.S. Price	Required to Specify
<b>Surface Materials</b>	<b>Upholstery on seat</b>		
	<ul style="list-style-type: none"> <li>• Fabric price group 1</li> <li>• Fabric price group 2</li> <li>• Fabric price group 3</li> <li>• Fabric price group 4</li> <li>• Fabric price group 5</li> <li>• Fabric price group 6</li> <li>• Fabric price group 7</li> <li>• Fabric price group 8</li> <li>• Fabric price group 9</li> <li>• Fabric price group 10</li> <li>• Customer's Own Material (COM)</li> <li>• Soil-retardant treatment applied to upholstery fabric</li> </ul>	<ul style="list-style-type: none"> <li>No cost</li> <li>+\$ 10</li> <li>+\$ 23</li> <li>+\$ 31</li> <li>+\$ 38</li> <li>+\$ 47</li> <li>+\$ 56</li> <li>+\$ 70</li> <li>+\$ 85</li> <li>+\$ 98</li> <li>No cost</li> <li>+\$ 22</li> </ul>	<ul style="list-style-type: none"> <li>Specify fabric color number.</li> <li>Specify fabric color number.</li> <li>Specify fabric color number.</li> <li>Specify fabric color number.</li> <li>Specify fabric color number.</li> <li>Specify fabric color number.</li> <li>Specify fabric color number.</li> <li>Specify fabric color number.</li> <li>Specify fabric color number.</li> <li>Specify fabric color number.</li> <li>Specify fabric color number.</li> <li>▶ See <i>Surface Materials Reference Manual</i> to specify.</li> <li>Specify with soil-retardant treatment.</li> </ul>
	<b>Upholstery on seat and back</b>		
	<ul style="list-style-type: none"> <li>• Fabric price group 1</li> <li>• Fabric price group 2</li> <li>• Fabric price group 3</li> <li>• Fabric price group 4</li> <li>• Fabric price group 5</li> <li>• Fabric price group 6</li> <li>• Fabric price group 7</li> <li>• Fabric price group 8</li> <li>• Fabric price group 9</li> <li>• Fabric price group 10</li> <li>• Customer's Own Material (COM)</li> <li>• Soil-retardant treatment applied to upholstery fabric</li> </ul>	<ul style="list-style-type: none"> <li>No cost</li> <li>+\$ 23</li> <li>+\$ 44</li> <li>+\$ 61</li> <li>+\$ 77</li> <li>+\$ 95</li> <li>+\$110</li> <li>+\$138</li> <li>+\$171</li> <li>+\$193</li> <li>No cost</li> <li>+\$ 22</li> </ul>	<ul style="list-style-type: none"> <li>Specify fabric color number.</li> <li>Specify fabric color number.</li> <li>Specify fabric color number.</li> <li>Specify fabric color number.</li> <li>Specify fabric color number.</li> <li>Specify fabric color number.</li> <li>Specify fabric color number.</li> <li>Specify fabric color number.</li> <li>Specify fabric color number.</li> <li>Specify fabric color number.</li> <li>Specify fabric color number.</li> <li>▶ See <i>Surface Materials Reference Manual</i> to specify.</li> <li>Specify with soil-retardant treatment.</li> </ul>



## For Canadian Pricing

Multiply U.S. Price by the Canadian price factor.

▶ See page 1 for details.

**Specification Information**

• Style Number	• Product ID	• Change to U.S. Base Price
----------------	--------------	-----------------------------

**Without Upholstery**

<b>4877110</b>	CH00007826	+\$33
----------------	------------	-------

**With Upholstered Seat**

<b>4877210</b>	CH00007102	+\$33
----------------	------------	-------

**With Upholstered Seat and Back**

<b>4877211</b>	CH00007868	+\$33
----------------	------------	-------



**For Canadian Pricing**  
Multiply U.S. Price by the  
Canadian price factor.  
▶ See page 1 for details.

# Cachet 487 Series Swivel-Base Work Chairs and Stools

With Gross Stabil Soft Wheel Reverse-Braking Casters

Standard Includes	Required to Specify
<ul style="list-style-type: none"> <li>Balanced-action rocker (BAR) mechanism</li> <li>Frame, seat, back, flip-up arms, and five-arm base: plastic</li> <li>5" pneumatic seat-height adjustment</li> <li>Upholstery, if selected: fabric price group 1</li> <li>Gross stabil soft wheel reverse-braking casters</li> </ul>	<ol style="list-style-type: none"> <li>General quote number: <b>CH009855</b></li> <li>Style number and Product ID</li> <li>Plastic color number for frame, seat, back, flip-up arms, and five-arm base</li> <li>Fabric color number for upholstery on seat and back, or seat, if selected</li> <li>Options, if selected (see below)</li> </ol> See Surface Materials in the Seating Specification Guide.

**What's Special**

Chair and stool are available with Gross Stabil soft wheel reverse-braking casters. Reverse-braking casters are weight activated, and will brake when the chair or stool is occupied. These casters roll freely when the stool is unoccupied.

Surface Materials	Options	U.S. Price	Required to Specify
	<b>Non-upholstered chair</b>		
	• Fire Code Seating (FCS)	+\$ 42	Add suffix <b>F</b> to the style number.
	<b>Upholstery on seat</b>		
	• Fabric price group 1	No cost	Specify fabric color number.
	• Fabric price group 2	+\$ 10	Specify fabric color number.
	• Fabric price group 3	+\$ 23	Specify fabric color number.
	• Fabric price group 4	+\$ 31	Specify fabric color number.
	• Fabric price group 5	+\$ 38	Specify fabric color number.
	• Fabric price group 6	+\$ 47	Specify fabric color number.
	• Fabric price group 7	+\$ 56	Specify fabric color number.
	• Fabric price group 8	+\$ 70	Specify fabric color number.
	• Fabric price group 9	+\$ 85	Specify fabric color number.
	• Fabric price group 10	+\$ 98	Specify fabric color number.
	• Customer's Own Material (COM)	No cost	▶ See <i>Surface Materials Reference Manual</i> to specify.
	• Soil-retardant treatment applied to upholstery fabric	+\$ 22	Specify with <i>soil-retardant treatment</i> .
	<b>Upholstery on seat and back</b>		
	• Fabric price group 1	No cost	Specify fabric color number.
	• Fabric price group 2	+\$ 23	Specify fabric color number.
	• Fabric price group 3	+\$ 44	Specify fabric color number.
	• Fabric price group 4	+\$ 61	Specify fabric color number.
	• Fabric price group 5	+\$ 77	Specify fabric color number.
	• Fabric price group 6	+\$ 95	Specify fabric color number.
	• Fabric price group 7	+\$110	Specify fabric color number.
	• Fabric price group 8	+\$138	Specify fabric color number.
	• Fabric price group 9	+\$171	Specify fabric color number.
	• Fabric price group 10	+\$193	Specify fabric color number.
	• Customer's Own Material (COM)	No cost	▶ See <i>Surface Materials Reference Manual</i> to specify.
	• Soil-retardant treatment applied to upholstery fabric	+\$ 22	Specify with <i>soil-retardant treatment</i> .

## Specification Information

Style Number	Product ID	Change to U.S. Base Price

### 487 Series Cachet Chairs

<b>4871110</b>	CH00006067	+\$135
<b>4871210</b>	CH00008624	+\$135
<b>4871211</b>	CH00008625	+\$135

### 487 Series Cachet Stools

<b>4877110</b>	CH00007942	+\$135
<b>4877210</b>	CH00007928	+\$135
<b>4877211</b>	CH00008626	+\$135







# Reply 466 Series Swivel-Base Stool Work Chairs



## What's Special

Reply 466 Series Swivel-base work chair with 487 Cachet cylinder and foot ring for an approximate seat height adjustment range of 23½" to 31".

Standard Includes	Required to Specify
<ul style="list-style-type: none"> <li>• Synchro-tilt mechanism</li> <li>• Multi-position back lock</li> <li>• Outer back, seat shell, and five-arm plastic base: plastic</li> <li>• 1½" seat depth adjustment</li> <li>• 2¼" back-height adjustment</li> <li>• Standard upholstery or mesh on back and standard upholstery on seat: fabric price group 1</li> <li>• 2½"-diameter, hard-composition, dual-wheel casters: black</li> </ul>	<ol style="list-style-type: none"> <li>1 General quote number: <b>CH013144</b></li> <li>2 Style number and Product ID</li> <li>3 6205 black only for base and arm tube, if specified</li> <li>4 Fabric color number for upholstery on back and seat or mesh number</li> <li>5 Options, if selected (see below)</li> </ol> <p>See Surface Materials in the Seating Specification Guide.</p>

Options	U.S. Price	Required to Specify
<b>Surface Materials</b>		
<b>Upholstery on Back and Seat</b>		
• Fabric price group 1	No cost	Specify fabric color number.
• Fabric price group 2	+\$ 23	Specify fabric color number.
• Fabric price group 3	+\$ 44	Specify fabric color number.
• Fabric price group 4	+\$ 61	Specify fabric color number.
• Fabric price group 5	+\$ 77	Specify fabric color number.
• Fabric price group 6	+\$ 95	Specify fabric color number.
• Fabric price group 7	+\$110	Specify fabric color number.
• Fabric price group 8	+\$138	Specify fabric color number.
• Fabric price group 9	+\$171	Specify fabric color number.
• Fabric price group 10	+\$193	Specify fabric color number.
• Customer's Own Material (COM)	No cost	▶ See <i>Surface Materials Reference Manual</i> to specify.
• Soil-retardant treatment applied to upholstery fabric	+\$ 22	Specify with <i>soil-retardant treatment</i> .
<b>Mesh Back with Upholstery on Seat</b>		
• Fabric price group 1	No cost	Specify fabric color number.
• Fabric price group 2	+\$ 10	Specify fabric color number.
• Fabric price group 3	+\$ 23	Specify fabric color number.
• Fabric price group 4	+\$ 31	Specify fabric color number.
• Fabric price group 5	+\$ 38	Specify fabric color number.
• Fabric price group 6	+\$ 47	Specify fabric color number.
• Fabric price group 7	+\$ 56	Specify fabric color number.
• Fabric price group 8	+\$ 70	Specify fabric color number.
• Fabric price group 9	+\$ 85	Specify fabric color number.
• Fabric price group 10	+\$ 98	Specify fabric color number.
• Customer's Own Material (COM)	No cost	▶ See <i>Surface Materials Reference Manual</i> to specify.
• Soil-retardant treatment applied to upholstery fabric	+\$ 22	Specify with <i>soil-retardant treatment</i> .
<b>Arms</b>		
• Height-adjustable arms, soft arm caps	+\$ 88	Specify with <i>height-adjustable arms</i> .
• Height-, pivot-, depth-adjustable arms	+\$130	Specify with <i>height-, pivot-, depth-adjustable arms</i> .
<b>Casters</b>		
• Soft, dual-wheel casters for use on hard floors	+\$ 22	Specify with <i>soft casters</i> .

## Specification Information

Style Number	Product ID	Change to U.S. Base Price

## 466 Series Swivel-Base Stool Work Chairs

<b>466160MP</b>	CH00010855	+\$300
<b>466160MT</b>	CH00010855	+\$300
<b>466160MPS</b>	CH00010855	+\$300
<b>466160MTS</b>	CH00010855	+\$300
<b>466160MPF</b>	CH00010855	+\$300
<b>466160MPFS</b>	CH00010855	+\$300



**For Canadian Pricing**  
Multiply U.S. Price by the Canadian price factor.  
▶ See page 1 for details.

# Set of Gross Stabil Soft Wheel Roll-Control Casters

For Field Installation

Set of Gross Stabil Soft  
Wheel Roll-Control Casters

*Tip: Roll-control casters are weight activated, and will brake when the chair or stool is unoccupied. These casters roll freely when the chair or stool is occupied.*

*Tip: Style number 4582905SR is available for field installation on the following product lines: 453 Criterion chairs manufactured after 7/24/00 (excluding Criterion Plus and excluding Criterion stool), 461 Drive chairs, 458 Sensor Size II chairs manufactured after 2/19/01, 433 Protege chairs manufactured after 4/15/07, 490 Move chairs and stools, Turnstone 1.0 Let's B chairs, Turnstone 1.0 Crew task chairs, side chairs, and stools.*

*Tip: Standard style number 4340521SR can be ordered for field installation on the following seating product lines: Leap 462 Series chairs, Think 465 Series chairs, Amia 482 Series chairs and stools, 487 Cachet chairs and stools, and 466 Reply chairs.*

Standard Includes	Required to Specify
-------------------	---------------------

- Set of 5 casters

- 1 General quote number: **CH009855**
- 2 Style number and Product ID

Specification Information		
• Style Number	• Product ID	• Change to U.S. Base Price

• Style Number	• Product ID	• Change to U.S. Base Price
4582905SR	CH00008122	+\$85

Seating

 **For Canadian Pricing**  
Multiply U.S. Price by the Canadian price factor.  
▶ See page 1 for details.

# Set of Gross Stabil Soft Wheel Reverse-Braking Casters

For Field Installation

*Tip: Reverse braking casters are weight-activated and will brake when the chair or stool is occupied. These casters roll freely when the chair or stool is unoccupied.*

*Tip: Style number 4582905SR is available for field installation on the following product lines: 453 Criterion chairs, 462 Leap chairs, 465 Think chairs and stools, 482 Amia chairs and stools, and 487 Cachet chairs and stools.*

Standard Includes	Required to Specify
-------------------	---------------------

- Set of 5 casters

- 1 General quote number: **CH009855**
- 2 Style number and Product ID

Specification Information		
• Style Number	• Product ID	• Change to U.S. Base Price
4582905SR	CH00010198	+\$93
4582905SR	CH00008123	+\$93
:	:	:
:	:	:

---

# Answer

▶ See page 3, *About Design Options*, in the front of this book for pricing and ordering restrictions.

<b>International Powerkit System for Frame Wiring and Cabling</b>	<b>62</b>
<b>International Base Trim</b>	<b>64</b>
<b>International Pass-Through Powerkits</b>	<b>65</b>
<b>International Multi-Purpose Power Infeeds</b>	<b>66</b>
<b>International Modular Harnesses</b>	<b>67</b>
<b>International Wall Starter</b>	<b>68</b>
<b>International H-Connector</b>	<b>69</b>

# International Powerkit System for Frame Wiring and Cabling

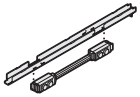

Tip: Can be modified to face opposite sides in field.

Tip: All international power components are UL and CE listed. Power components are subject to local codes and approvals.



**For Canadian Pricing**  
Multiply U.S. Price by the Canadian price factor.  
▶ See page 1 for details.

Standard Includes	Required to Specify
-------------------	---------------------

- |   |  |
|---|--|
| <ul style="list-style-type: none"> <li>1-circuit, 3-wire base powerkit with duplex receptacles: black, all facing one side</li> </ul> | <ul style="list-style-type: none"> <li>1 General quote number: <b>SF126990</b></li> <li>2 Style number and Product ID</li> </ul> |
|---|--|

Specification Information					
Width	Number of Receptacles	Style Number	Outlet Type	Product I.D.	Change to U.S. Price

## 1-Circuit, 3-Wire

24"	1	<b>TS7PK24X</b>	A	SF00218674	+\$ 37
30"	2	<b>TS7PK30X</b>	A	SF00218691	+\$ 74
36"	2	<b>TS7PK36X</b>	A	SF00218693	+\$ 74
42"	2	<b>TS7PK42X</b>	A	SF00218694	+\$ 74
48"	2	<b>TS7PK48X</b>	A	SF00218695	+\$ 74
60"	4	<b>TS7PK60X</b>	A	SF00218696	+\$ 148
72"	4	<b>TS7PK72X</b>	A	SF00218698	+\$ 148
:	:	:	:	:	:
24"	1	<b>TS7PK24X</b>	B	SF00218699	+\$ 37
30"	2	<b>TS7PK30X</b>	B	SF00218700	+\$ 74
36"	2	<b>TS7PK36X</b>	B	SF00218701	+\$ 74
42"	2	<b>TS7PK42X</b>	B	SF00218702	+\$ 74
48"	2	<b>TS7PK48X</b>	B	SF00218703	+\$ 74
60"	4	<b>TS7PK60X</b>	B	SF00218704	+\$ 148
72"	4	<b>TS7PK72X</b>	B	SF00218705	+\$ 148
:	:	:	:	:	:
24"	1	<b>TS7PK24X</b>	C	SF00218765	+\$ 337
30"	2	<b>TS7PK30X</b>	C	SF00218766	+\$ 811
36"	2	<b>TS7PK36X</b>	C	SF00218768	+\$ 821
42"	2	<b>TS7PK42X</b>	C	SF00218769	+\$ 833
48"	2	<b>TS7PK48X</b>	C	SF00218770	+\$ 833
60"	4	<b>TS7PK60X</b>	C	SF00218772	+\$1672
72"	4	<b>TS7PK72X</b>	C	SF00218773	+\$1696
:	:	:	:	:	:
24"	1	<b>TS7PK24X</b>	F	SF00218774	+\$ 337
30"	2	<b>TS7PK30X</b>	F	SF00218775	+\$ 811
36"	2	<b>TS7PK36X</b>	F	SF00218777	+\$ 821
42"	2	<b>TS7PK42X</b>	F	SF00218778	+\$ 833
48"	2	<b>TS7PK48X</b>	F	SF00218779	+\$ 833
60"	4	<b>TS7PK60X</b>	F	SF00218780	+\$1672
72"	4	<b>TS7PK72X</b>	F	SF00218783	+\$1696
:	:	:	:	:	:

▶ **Specification Information, continued on next page**

► **Specification Information, continued from previous page**

**Specification Information**

Width	Number of Receptacles	Style Number	Outlet Type	Product I.D.	Change to U.S. Price
24"	1	<b>TS7PK24X</b>	G	SF00218784	+\$ 367
30"	2	<b>TS7PK30X</b>	G	SF00218786	+\$ 869
36"	2	<b>TS7PK36X</b>	G	SF00218787	+\$ 879
42"	2	<b>TS7PK42X</b>	G	SF00218788	+\$ 891
48"	2	<b>TS7PK48X</b>	G	SF00218789	+\$ 893
60"	4	<b>TS7PK60X</b>	G	SF00218792	+\$1790
72"	4	<b>TS7PK72X</b>	G	SF00218793	+\$1814
:	:	:	:	:	:
24"	1	<b>TS7PK24X</b>	I	SF00218805	+\$ 337
30"	2	<b>TS7PK30X</b>	I	SF00218806	+\$ 811
36"	2	<b>TS7PK36X</b>	I	SF00218807	+\$ 821
42"	2	<b>TS7PK42X</b>	I	SF00218808	+\$ 833
48"	2	<b>TS7PK48X</b>	I	SF00218809	+\$ 833
60"	4	<b>TS7PK60X</b>	I	SF00218811	+\$1672
72"	4	<b>TS7PK72X</b>	I	SF00218813	+\$1696
:	:	:	:	:	:
24"	1	<b>TS7PK24X</b>	L	SF00218815	+\$ 337
30"	2	<b>TS7PK30X</b>	L	SF00218816	+\$ 811
36"	2	<b>TS7PK36X</b>	L	SF00218818	+\$ 821
42"	2	<b>TS7PK42X</b>	L	SF00218819	+\$ 833
48"	2	<b>TS7PK48X</b>	L	SF00218821	+\$ 833
60"	4	<b>TS7PK60X</b>	L	SF00218822	+\$1672
72"	4	<b>TS7PK72X</b>	L	SF00218823	+\$1696
:	:	:	:	:	:



Answer



**For Canadian Pricing**  
Multiply U.S. Price by the  
Canadian price factor.  
► See page 1 for details.

# International Base Trim

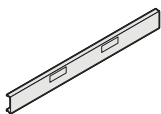

*Tip: All international power components are UL and CE listed. Power components are subject to local codes and approvals.*

## Standard Includes

- Base trim with knockouts for International powerkits

## Required to Specify

- 1 General quote number: **SF126990**
  - 2 Style number and Product ID
  - 3 Paint color number for trim
- See Surface Materials in the Answer Specification Guide.

## Specification Information

Width	Number of Receptacles	Style Number	Product I.D	Change to U.S. Price
-------	-----------------------	--------------	-------------	----------------------

### 1-Circuit, 3-Wire

24"	1	<b>TS724BT</b>	SF00220271	+\$20
30"	2	<b>TS730BT</b>	SF00220271	+\$20
36"	2	<b>TS736BT</b>	SF00220271	+\$20
42"	2	<b>TS742BT</b>	SF00220271	+\$20
48"	2	<b>TS748BT</b>	SF00220271	+\$20
60"	4	<b>TS760BT</b>	SF00220271	+\$20
72"	4	<b>TS772BT</b>	SF00220271	+\$20
:	:	:	:	:



### For Canadian Pricing

Multiply U.S. Price by the Canadian price factor.

▶ See page 1 for details.



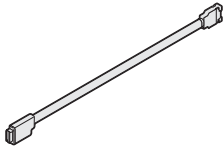

*Tip: All international power components are UL and CE listed. Power components are subject to local codes and approvals.*

Standard Includes	Required to Specify
-------------------	---------------------

- 1-circuit, 3-wire harness with modular connectors

- 1 General quote number: **SF126990**
- 2 Style number and Product ID

Specification Information			
Width	Style Number	Product I.D.	Change to U.S. Price

### 1-Circuit, 3-Wire

Width	Style Number	Product I.D.	Change to U.S. Price
18"	<b>TS7PT18X</b>	SF00218900	+\$0
24"	<b>TS7PT24X</b>	SF00218901	+\$0
30"	<b>TS7PT30X</b>	SF00218902	+\$0
36"	<b>TS7PT36X</b>	SF00218903	+\$0
42"	<b>TS7PT42X</b>	SF00218905	+\$0
48"	<b>TS7PT48X</b>	SF00218906	+\$0
60"	<b>TS7PT60X</b>	SF00218907	+\$0
72"	<b>TS7PT72X</b>	SF00218908	+\$0
:	:	:	:

Answer



**For Canadian Pricing**  
Multiply U.S. Price by the Canadian price factor.  
▶ See page 1 for details.

# International Multi-Purpose Power Infeeds



*Tip: Multi-purpose power infeeds can be used with standard Answer utility poles for ceiling infeed applications.*

*Tip: Multi-purpose power infeeds can be used to bring in floor power. Modular connections are made directly to powerkits and passthrough powerkits. Use standard base knockouts and duplex cable grommets (98863) to create a clean aesthetic where the infeed enters the panel.*

*Tip: All international power components are UL and CE listed. Power components are subject to local codes and approvals.*

Standard Includes	Required to Specify
-------------------	---------------------

- Power infeed cover: black plastic
- 1-circuit, 3-wire 1/2" diameter conduit: black plastic only

- 1 General quote number: **SF126990**
- 2 Style number and Product ID

Specification Information			
Length	Style Number	Product I.D.	Change to U.S. Price

## 1-Circuit, 3-Wire

12'	<b>TS712UPHX</b>	SF00218910	+\$0
24'	<b>TS724UPHX</b>	SF00218911	+\$0
:	:	:	:



### For Canadian Pricing

Multiply U.S. Price by the Canadian price factor.

▶ See page 1 for details.

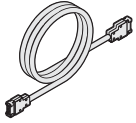

*Tip: All international power components are UL and CE listed. Power components are subject to local codes and approvals.*

Standard Includes	Required to Specify
<ul style="list-style-type: none"> <li>1-circuit, 3-wire conduit with two modular connectors: black base trim/gasket</li> </ul>	<ul style="list-style-type: none"> <li>1 General quote number: <b>SF126990</b></li> <li>2 Style number and Product ID</li> </ul>

### Specification Information

Length	Style Number	Product I.D.	Change to U.S. Price
43"	<b>TS743MHX</b>	SF00218912	+\$0
80"	<b>TS780MHX</b>	SF00218913	+\$0
:	:	:	:

#### 1-Circuit, 3-Wire

43"	<b>TS743MHX</b>	SF00218912	+\$0
80"	<b>TS780MHX</b>	SF00218913	+\$0
:	:	:	:

Answer



**For Canadian Pricing**  
Multiply U.S. Price by the Canadian price factor.  
▶ See page 1 for details.

# International Wall Starter



*Tip: All international power components are UL and CE listed. Power components are subject to local codes and approvals.*

Standard Includes	Required to Specify
Wall unit with faceplate 1-circuit, 3-wire hardwire connection point on one end, modular connection point on opposite end	1 General quote number: <b>SF126990</b> 2 Style number and Product ID

## Specification Information

• Style Number	• Product I.D.	• Change to U.S. Price

### 1-Circuit, 3-Wire

<b>TS76BPX</b>	SF00218914	+\$0



**For Canadian Pricing**  
 Multiply U.S. Price by the Canadian price factor.  
 ▶ See page 1 for details.



*Tip: Use H-connector to send single circuit power into multiple panels. H-connector supports up to three connections.*

*Tip: All international power components are UL and CE listed. Power components are subject to local codes and approvals.*

Standard Includes	Required to Specify
1-circuit, 3-wire connector with two modular connection points: black	1 General quote number: <b>SF126990</b> 2 Style number and Product ID

### Specification Information

Style Number	Product I.D.	Change to U.S. Price

### 1-Circuit, 3-Wire

<b>SPTECH</b>	SF00218915	+\$24

Answer



**For Canadian Pricing**  
Multiply U.S. Price by the Canadian price factor.  
▶ See page 1 for details.



---

# Tackboards

▶ See page 3, *About Design Options*, in the front of this book for pricing and ordering restrictions.

<b>Answer Tackboards</b>	<b>72</b>
<b>Avenir Tackboards</b>	<b>74</b>
<b>Series 9000 Tackboards</b>	<b>76</b>

# Answer Tackboards

For Use with Wall Channels

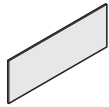

Standard Includes	Required to Specify
-------------------	---------------------

- |   |  |
|---|--|
| <ul style="list-style-type: none"> <li>Tackboard, fabric direction with horizontal application: fabric price group 1</li> </ul> | <ol style="list-style-type: none"> <li>General quote number: <b>SF085025</b></li> <li>Style number and Product ID</li> <li>Fabric color number</li> <li>Options, if selected (see below)</li> </ol> See Surface Materials in the Answer Solutions Specification Guide. |
|---|--|

Surface Materials	Options	U.S. Price	Required to Specify
-------------------	---------	------------	---------------------

<b>Surface Materials</b>	• Fabric price group 1	No cost	Specify fabric color number.
	• Fabric price group 2	+\$14	Specify fabric color number.
	• Fabric price group 3	+\$24	Specify fabric color number.
	• Fabric price group 4	+\$35	Specify fabric color number.
	• Fabric price group 5	+\$55	Specify fabric color number.
	• Fabric price group COM	+\$33	Specify fabric color number.

**Fabric direction on 24"W to 60"W tackboards**

- |                        |         |                                    |
|------------------------|---------|------------------------------------|
| • Vertical application | No cost | Specify with vertical application. |
|------------------------|---------|------------------------------------|

## What's Special

Tackboards are available in a variety of heights.

*Tip: 72"W tackboards accommodate fabric in the horizontal direction only.*

See Specification Guidelines for Directional fabrics in the Answer Solutions Specifications Guide.

## Specification Information

Dimensions W H	Style Number	Product ID	Change to U.S. Base Price
-------------------	-----------------	------------	---------------------------------

### 18"H Tackboards

54" 18"	<b>TS71860TB</b>	SF00116120	+\$109
66" 18"	<b>TS71872TB</b>	SF00116243	+\$106

### 20"H Tackboards

24" 20"	<b>TS71824TB</b>	SF00119802	+\$130
30" 20"	<b>TS71830TB</b>	SF00116035	+\$ 83
36" 20"	<b>TS71836TB</b>	SF00116052	+\$ 81
42" 20"	<b>TS71842TB</b>	SF00116036	+\$ 88
48" 20"	<b>TS71848TB</b>	SF00116037	+\$ 87
60" 20"	<b>TS71860TB</b>	SF00116038	+\$109
72" 20"	<b>TS71872TB</b>	SF00116271	+\$144

### 21"H Tackboards

24" 21"	<b>TS71824TB</b>	SF00118384	+\$ 98
30" 21"	<b>TS71830TB</b>	SF00118385	+\$111
36" 21"	<b>TS71836TB</b>	SF00118387	+\$126
42" 21"	<b>TS71842TB</b>	SF00118388	+\$154
48" 21"	<b>TS71848TB</b>	SF00117220	+\$162
60" 21"	<b>TS71860TB</b>	SF00118390	+\$179
72" 21"	<b>TS71872TB</b>	SF00116371	+\$197

► **Specification Information, continued on next page**



#### For Canadian Pricing

Multiply U.S. Price by the Canadian price factor.

► See page 1 for details.



► Specification Information, continued from previous page

**Specification Information**

• Dimensions		• Style	• Product ID	• Change to
W	H	Number		U.S. Base Price

**22"H Tackboards**

24"	22"	<b>TS71824TB</b>	SF00127811	+\$ 90
30"	22"	<b>TS71830TB</b>	SF00124830	+\$111
36"	22"	<b>TS71836TB</b>	SF00121411	+\$132
42"	22"	<b>TS71842TB</b>	SF00124831	+\$154
48"	22"	<b>TS71848TB</b>	SF00120726	+\$172
60"	22"	<b>TS71860TB</b>	SF00114879	+\$174
72"	22"	<b>TS71872TB</b>	SF00120725	+\$189

**24"H Tackboards**

24"	24"	<b>TS71824TB</b>	SF00128495	+\$106
30"	24"	<b>TS71830TB</b>	SF00119797	+\$130
36"	24"	<b>TS71836TB</b>	SF00115919	+\$152
42"	24"	<b>TS71842TB</b>	SF00121437	+\$176
48"	24"	<b>TS71848TB</b>	SF00115918	+\$196
60"	24"	<b>TS71860TB</b>	SF00115917	+\$234
72"	24"	<b>TS71872TB</b>	SF00119798	+\$240



**For Canadian Pricing**  
 Multiply U.S. Price by the  
 Canadian price factor.  
 ► See page 1 for details.

# Avenir Tackboards

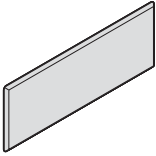

Standard Includes	Required to Specify
<ul style="list-style-type: none"> <li>Tackboard, fabric direction with horizontal application: fabric price group 1</li> <li>Hardware: black paint only</li> </ul>	1 General quote number: <b>SF085030</b> 2 Style number and Product ID 3 Fabric color number for tackboard See Surface Materials in the Avenir Solutions Specification Guide.

Surface Materials	Options	U.S. Price	Required to Specify
	<b>Tackboard</b> <ul style="list-style-type: none"> <li>Fabric price group 1</li> <li>Fabric price group 2</li> <li>Fabric price group 3</li> <li>Fabric price group 4</li> <li>Fabric price group 5</li> <li>Fabric price group COM</li> </ul>	No cost +\$ 12 +\$ 50 +\$ 68 +\$109 +\$ 16	Specify fabric color number. Specify fabric color number. Specify fabric color number. Specify fabric color number. Specify fabric color number. ▶ See <i>Surface Materials Reference Manual</i> to specify.
<b>Fabric direction on 30"W-60"W tackboards</b> <ul style="list-style-type: none"> <li>Vertical application</li> </ul>			No cost Specify with vertical application.

## What's Special

Tackboards are available in a variety of heights.

## Specification Information

Dimensions	Style	Product ID	Change to
W    H	Number		U.S. Base Price

### 17<sup>3</sup>/<sub>4</sub>"H Tackboards

24"	17 <sup>3</sup> / <sub>4</sub> "	<b>TB3018</b>	SF00100635	+\$ 63
35"	17 <sup>3</sup> / <sub>4</sub> "	<b>TB3618</b>	SF00132581	+\$ 71
45"	17 <sup>3</sup> / <sub>4</sub> "	<b>TB4818</b>	SF00131745	+\$ 32
54"	17 <sup>3</sup> / <sub>4</sub> "	<b>TB6018</b>	SF00108023	+\$ 65

### 19<sup>3</sup>/<sub>4</sub>"H Tackboards

24"	19 <sup>3</sup> / <sub>4</sub> "	<b>TB3018</b>	SF00132022	+\$ 64
30"	19 <sup>3</sup> / <sub>4</sub> "	<b>TB3018</b>	SF00130309	+\$ 66
36"	19 <sup>3</sup> / <sub>4</sub> "	<b>TB3618</b>	SF00130310	+\$ 66
42"	19 <sup>3</sup> / <sub>4</sub> "	<b>TB4218</b>	SF00130311	+\$ 67
48"	19 <sup>3</sup> / <sub>4</sub> "	<b>TB4818</b>	SF00130312	+\$ 65
60"	19 <sup>3</sup> / <sub>4</sub> "	<b>TB6018</b>	SF00130313	+\$ 66

### 23<sup>3</sup>/<sub>4</sub>"H Tackboards

24"	23 <sup>3</sup> / <sub>4</sub> "	<b>TB3018</b>	SF00132357	+\$ 68
30"	23 <sup>3</sup> / <sub>4</sub> "	<b>TB3018</b>	SF00130315	+\$111
36"	23 <sup>3</sup> / <sub>4</sub> "	<b>TB3618</b>	SF00130316	+\$141
42"	23 <sup>3</sup> / <sub>4</sub> "	<b>TB4218</b>	SF00130317	+\$164
48"	23 <sup>3</sup> / <sub>4</sub> "	<b>TB4818</b>	SF00130318	+\$177
60"	23 <sup>3</sup> / <sub>4</sub> "	<b>TB6018</b>	SF00130319	+\$195

▶ **Specification Information, continued on next page**



**For Canadian Pricing**  
 Multiply U.S. Price by the Canadian price factor.  
 ▶ See page 1 for details.

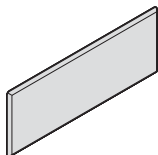

► **Specification Information, continued from previous page**

**Specification Information**

• Dimensions		• Style	• Product ID	• Change to
W	H	Number		U.S. Base Price

**32<sup>3</sup>/<sub>4</sub>"H Tackboards**

24"	32 <sup>3</sup> / <sub>4</sub> "	<b>TB3018</b>	SF00131988	+\$128
30"	32 <sup>3</sup> / <sub>4</sub> "	<b>TB3018</b>	SF00131830	+\$184
36"	32 <sup>3</sup> / <sub>4</sub> "	<b>TB3618</b>	SF00131831	+\$225
42"	32 <sup>3</sup> / <sub>4</sub> "	<b>TB4218</b>	SF00131832	+\$265
48"	32 <sup>3</sup> / <sub>4</sub> "	<b>TB4818</b>	SF00101162	+\$289
60"	32 <sup>3</sup> / <sub>4</sub> "	<b>TB6018</b>	SF00131833	+\$339
:	:	:	:	:



**For Canadian Pricing**  
 Multiply U.S. Price by the  
 Canadian price factor.  
 ► See page 1 for details.

# Series 9000 Tackboards

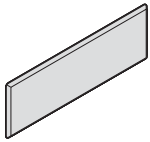

Standard Includes		Required to Specify	
<ul style="list-style-type: none"> <li>Tackboard, fabric direction with horizontal application: fabric price group 1</li> <li>Hardware: black paint only</li> </ul>		<ol style="list-style-type: none"> <li>General quote number: <b>SF085033</b></li> <li>Style number and Product ID</li> <li>Fabric color number for tackboard</li> <li>Options, if selected (see below)</li> </ol> See Surface Materials in the Series 9000 Solutions Specification Guide.	
Surface Materials	Options	U.S. Price	Required to Specify
	<ul style="list-style-type: none"> <li>Fabric price group 1</li> <li>Fabric price group 2</li> <li>Fabric price group 3</li> <li>Fabric price group 4</li> <li>Fabric price group 5</li> <li>Fabric price group COM</li> </ul>	No cost +\$ 12 +\$ 50 +\$ 68 +\$109 +\$ 16	Specify fabric color number. Specify fabric color number. Specify fabric color number. Specify fabric color number. Specify fabric color number. ▶ See <i>Surface Materials Reference Manual</i> to specify.
<b>Fabric direction on 30"W-60"W tackboards</b>			
	<ul style="list-style-type: none"> <li>Vertical application</li> </ul>	No cost	Specify with vertical application.

## What's Special

Tackboards are available in a variety of heights.

Tip: For most fabrics, fabric application is standard in the warp horizontal direction. See Specification Guidelines for Vertical Fabric Applications in the *Series 9000 Specification Guide*, for details on these exceptions. Warp vertical is available as an option.

## Specification Information

Dimensions		Style	Product ID	Change to
W	H	Number		U.S. Base Price

### 15"H Tackboards

25"	15"	<b>981530T</b>	SF00132782	+\$68
48"	15"	<b>981560T</b>	SF00150753	+\$51
72"	15"	<b>981575T</b>	SF00101066	+\$61

### 18"H Tackboards

25"	18"	<b>981830T</b>	SF00100262	+\$69
48"	18"	<b>981860T</b>	SF00131845	+\$73
72"	18"	<b>981875T</b>	SF00132713	+\$77

### 20"H Tackboards

25"	20"	<b>981830T</b>	SF00130282	+\$67
30"	20"	<b>981830T</b>	SF00130283	+\$71
35"	20"	<b>981835T</b>	SF00130284	+\$72
36"	20"	<b>981836T</b>	SF00130285	+\$72
42"	20"	<b>981842T</b>	SF00130286	+\$73
45"	20"	<b>981845T</b>	SF00130287	+\$73
48"	20"	<b>981860T</b>	SF00133888	+\$73
60"	20"	<b>981860T</b>	SF00130288	+\$71
70"	20"	<b>981870T</b>	SF00130289	+\$77

▶ **Specification Information, continued on next page**



### For Canadian Pricing

Multiply U.S. Price by the Canadian price factor.

▶ See page 1 for details.

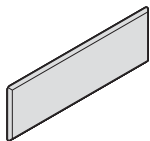

► **Specification Information, continued from previous page**

**Specification Information**

• Dimensions		• Style	• Product ID	• Change to
W	H	Number		U.S. Base Price

**22"H Tackboards**

25"	22"	<b>981830T</b>	SF00130291	+\$ 69
30"	22"	<b>981830T</b>	SF00130292	+\$ 92
35"	22"	<b>981835T</b>	SF00130293	+\$112
36"	22"	<b>981836T</b>	SF00130294	+\$117
42"	22"	<b>981842T</b>	SF00130295	+\$129
45"	22"	<b>981845T</b>	SF00130296	+\$146
48"	22"	<b>981860T</b>	SF00131802	+\$159
60"	22"	<b>981860T</b>	SF00130297	+\$159
70"	22"	<b>981870T</b>	SF00130298	+\$158

**24"H Tackboards**

25"	24"	<b>981830T</b>	SF00130300	+\$ 84
30"	24"	<b>981830T</b>	SF00130301	+\$118
35"	24"	<b>981835T</b>	SF00130302	+\$140
36"	24"	<b>981836T</b>	SF00130303	+\$152
42"	24"	<b>981842T</b>	SF00130304	+\$163
45"	24"	<b>981845T</b>	SF00130305	+\$182
48"	24"	<b>981860T</b>	SF00132671	+\$127
60"	24"	<b>981860T</b>	SF00130306	+\$205
70"	24"	<b>981870T</b>	SF00130307	+\$216

Tackboards

 **For Canadian Pricing**  
 Multiply U.S. Price by the  
 Canadian price factor.  
 ► See page 1 for details.



---

# Elective Elements 6

▶ See page 3, *About Design Options*, in the front of this book for pricing and ordering restrictions.

<b>Straight Worksurfaces</b>	<b>80</b>
<b>Pedestals</b>	<b>81</b>
<b>Single-High Overhead Cabinets</b>	<b>83</b>
<b>Double-High Overhead Cabinets</b>	<b>84</b>
<b>Freestanding Bookcases With Locking Doors</b>	<b>85</b>
<b>Square Grommet with 1/4" Spacer</b>	<b>86</b>

# Straight Worksurfaces

Wood Veneer or Laminate

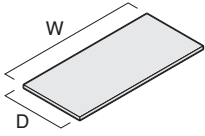

## What's Special

15"W worksurface to go over pedestal.

Tip: Specify a scallop when a service module or hutch kit is used with a task light.

Tip: Refer to the selected panel Specification Guide to order supports for panel applications.

### Standard Includes

- Worksurface: wood veneer or laminate
- Wood worksurface with wood edge:
  - Solid wood edge on user's side
  - Veneer edge on other sides
- Laminate worksurface with plastic edge:
  - 3 mm plastic edge on user's side
  - 1 mm plastic edge on other sides, color defaulted
- Laminate worksurface with wood edge:
  - Solid wood edge on user's side
  - 1 mm plastic edge on other sides, color defaulted

### Required to Specify

- 1 General quote number: **GW054314**
- 2 Style number and Product ID
- 3 Wood or laminate color number for worksurface
- 4 Wood color number or plastic color number for user's side on laminate worksurfaces, if selected

	Options	U.S. Price	Required to Specify
<b>Cable Management</b>	<b>Round grommets</b>		
	• Available on worksurfaces 54"W or smaller: metal	+\$ 63	Center: <i>EGRC</i> and color number.
	• Available on worksurfaces 60"W or larger: metal	+\$ 63	Left: <i>EGRL</i> and color number. Right: <i>EGRR</i> and color number. Center: <i>EGRC</i> and color number.
	<b>Square grommets</b>		
	• Available on worksurfaces 54"W or smaller: aluminum or aluminum with glass door	+\$179 aluminum +\$253 aluminum with glass door	Center: <i>EGSC</i> and color number.
	<b>Scallop</b>		
	• Available on center back only	+\$ 34	Specify with scallop.

### Specification Information

• Dimensions	• Style	• Product ID	• Change to
D W	Number		U.S. Base Price
•	•	•	•

### WS Straight Worksurfaces

18"	15"	<b>E6WS1830</b>	GW00110225	–\$100
18"	18"	<b>E6WS1830</b>	GW00110226	–\$ 95
•	•	•	•	•



#### For Canadian Pricing

Multiply U.S. Price by the Canadian price factor.

▶ See page 1 for details.



# Pedestal

## Wood Veneer or Laminate



### What's Special

42"W lateral file ped to have metal bottomed drawers.

Tip: Glide hole covers are black and are visible in underworksurface bookcases.

Tip: When integral pull is specified with a 9250 Ember Chrome lock, the lock housing is black. When 9201 Polished Chrome lock is specified, the lock housing is nickel.

Tip: Locks not available on pedestals with doors specified with integral or beam pulls.

Tip: When selected, miter fold box drawers include one black plastic pencil tray.

Tip: Order finished back panels or modesty panels when units will be exposed.

Tip: When applying a cushion top to a freestanding 27½"H two-high lateral file, a finished back panel must be used.

**For Canadian Pricing**  
 Multiply U.S. Price by the Canadian price factor.  
 ▶ See page 1 for details.

Standard Includes	Required to Specify
<ul style="list-style-type: none"> <li>Underworksurface storage:                             <ul style="list-style-type: none"> <li>–Wood case with wood front</li> <li>–Laminate case with laminate front</li> <li>–Laminate case with wood front</li> </ul> </li> <li>Unfinished back</li> <li>Unfinished open top</li> <li>Dovetail drawer construction</li> <li>One fastened metal filing system per file drawer: black only</li> <li>One partition per box drawer: solid wood</li> <li>One pencil tray per two box drawers: solid wood</li> <li>Lock, keyed random</li> <li>Counterweight, if selected</li> </ul>	<ol style="list-style-type: none"> <li>General quote number: <b>GW054314</b></li> <li>Style number and Product ID</li> <li>Wood or laminate color number for underworksurface storage</li> <li>Wood color number for wood fronts on laminate cases, if selected</li> <li>Pull shape (see below under Required Selections)</li> <li>Finish color number for pull</li> <li>Finish color number for lock</li> <li>Options, if selected (see below)</li> </ol> See Surface Materials in the Elective Elements 6 Specification Guide.

### Required Selections

**Pull Shape**

Contemporary No cost	Jazz +\$17 each	Deco +\$17 each	Bar +\$23 each	Nile +\$23 each	Integral * +\$23 each	Beam +\$34 each

\* Not available on laminate fronts

Options	U.S. Price	Required to Specify
<b>Lock and Keying</b> <b>Lock</b> <ul style="list-style-type: none"> <li>Ember Chrome</li> <li>Polished Chrome</li> </ul> <b>Keying</b> <ul style="list-style-type: none"> <li>Factory- and field-installed keying units</li> </ul>	No cost No cost	Specify with 9250 Ember Chrome lock. Specify with 9201 Polished Chrome lock.
<b>Miter Fold Drawer</b> <ul style="list-style-type: none"> <li>For two file drawers or two lateral file drawers</li> </ul>	–\$ 10	Specify with miter fold drawers.
<b>Counterweight Package</b> <ul style="list-style-type: none"> <li>Add counterweight package</li> <li>Omit counterweight package on 23¼"D</li> </ul>	No cost –\$114	Specify with counterweight package. Specify with no counterweight package.

### Specification Information

Dimensions	Style Number	Product ID	Change to U.S. Base Price
D W H			
23¼" 42" 27½"	E6PD233627F	GW00092338	+\$575

### PD Pedestal

23¼"	42"	27½"	E6PD233627F	GW00092338	+\$575
------	-----	------	-------------	------------	--------

# Pedestals

Wood Veneer or Laminate



## What's Special

1½ high pedestal with no trough in rear.

### Standard Includes

- Underworksurface storage:
  - Wood case with wood front
  - Laminate case with laminate front
  - Laminate case with wood front
- Unfinished back
- Unfinished open top
- Dovetail drawer construction
- One fastened metal filing system per file drawer: black only
- One partition per box drawer: solid wood
- One pencil tray per two box drawers: solid wood
- Lock, keyed random
- Counterweight, if selected

### Required to Specify

- 1 General quote number: **GW054314**
- 2 Style number and Product ID
- 3 Wood or laminate color number for underworksurface storage
- 4 Wood color number for wood fronts on laminate cases, if selected
- 5 Pull shape (see below under Required Selections)
- 6 Finish color number for pull
- 7 Finish color number for lock
- 8 Options, if selected (see below)  
See Surface Materials in the Elective Elements 6 Specification Guide.

### Required Selections

#### Pull Shape

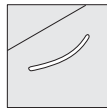

Contemporary  
No cost

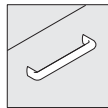

Jazz  
+\$17 each

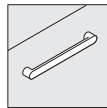

Deco  
+\$17 each

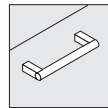

Bar  
+\$23 each

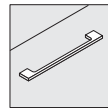

Nile  
+\$23 each

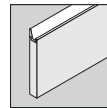

Integral \*  
+\$23 each

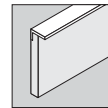

Beam  
+\$34 each

\* Not available on laminate fronts

### Options

### U.S. Price

### Required to Specify

#### Lock and Keying

#### Lock

- Ember Chrome
- Polished Chrome

No cost  
No cost

Specify with 9250 Ember Chrome lock.  
Specify with 9201 Polished Chrome lock.

#### Keying

- Factory- and field-installed keying units

▶ Page 306

#### Counterweight Package

- Add counterweight package
- Omit counterweight package on drawer units

No cost  
–\$57

Specify with counterweight package.  
Specify with no counterweight package.

Tip: When integral pull is specified with a 9250 Ember Chrome lock, the lock housing is black. When 9201 Polished Chrome lock is specified, the lock housing is nickel.

Tip: Order finished back panels or modesty panels when units will be exposed.

### Specification Information

• Dimensions			• Style	• Product ID	• Change to
D	W	H	Number		U.S. Base Price
:	:	:	:	:	:
:	:	:	:	:	:

### PD Pedestals

17¼"	15"	21½"	<b>E6PD171527B</b>	GW00110218	–\$100
23¼"	15"	21½"	<b>E6PD231527B</b>	GW00110220	–\$100
17¼"	18"	21½"	<b>E6PD171827B</b>	GW00110222	–\$100
23¼"	18"	21½"	<b>E6PD231827B</b>	GW00110223	–\$100
:	:	:	:	:	:



#### For Canadian Pricing

Multiply U.S. Price by the Canadian price factor.

▶ See page 1 for details.

# Single-High Overhead Cabinets

Wood Veneer or Laminate

Single-High Overhead  
Cabinets

## What's Special

Single-high overhead cabinets are available with glass doors, and available in 30"W with sliding doors.

Tip: Overhead cabinets cannot attach to 45"H or 55"H Montage panels.

Tip: Sliding doors only cover 1/2 of the opening. Sliding doors do not lock.

Tip: Cabinet-to-cabinet attachment kits are used to provide rigidity between cabinets mounted side by side in a panel- or wall-mounted application.

Tip: Mounting hardware to suspend overhead cabinets between towers and stacking bookcases is ordered separately. See Elective Elements 6 Specification Guide.

Tip: When stacking single-high overhead cabinets with hinged doors, the ADA option should be selected.

Tip: Finished back panels can be specified separately if the back of the cabinet is visible.

See Elective Elements 6 Specification Guide.

Tip: Mounting hardware to attach overhead cabinets to hutch is included with the hutch kit.

Tip: Single-high overheads line up with 65 5/8"H towers and bookcases when mounted on 21 5/8" hutch kits.



### For Canadian Pricing

Multiply U.S. Price by the Canadian price factor.

▶ See page 1 for details.

## Standard Includes

- Overhead cabinet:
  - Wood case with wood front
  - Laminate case with laminate front
  - Laminate case with wood front
- Unfinished back
- Glass hinged doors have self-close hinges
- ADA opening/closing option, if selected
- Sliding doors have safety stops

## Required to Specify

- General quote number: **GW047696**
  - Style number and Product ID
  - Wood or laminate color number for overhead cabinet
  - Wood color number for wood fronts on laminate cases, if selected
- See Surface Materials in the Elective Elements 6 Specification Guide.

## Specification Information

Dimensions			Style	Number	Product ID	Change to
D	W	H	Number	of Doors		U.S. Base Price

## OS Single-High Overheads

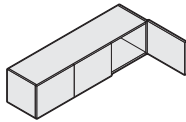

### With Glass Doors

15 3/4"	30"	15"	<b>E60S153015H</b>	2	GW00086299	+\$576
15 3/4"	36"	15"	<b>E60S153615H</b>	2	GW00086211	+\$576
15 3/4"	42"	15"	<b>E60S154215H</b>	3	GW00086210	+\$864
15 3/4"	48"	15"	<b>E60S154815H</b>	3	GW00093644	+\$864

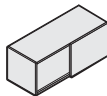

### With Sliding Doors

15 3/4"	30"	15"	<b>E60S153615S</b>	1	GW00091481	+\$50
---------	-----	-----	--------------------	---	------------	-------

# Double-High Overhead Cabinets

Wood Veneer or Laminate

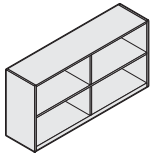

Standard Includes	Required to Specify
<ul style="list-style-type: none"> <li>Overhead cabinet: laminate or wood veneer</li> <li>Unfinished back</li> </ul>	1 General quote number: <b>GW050244</b> 2 Style number and Product ID 3 Laminate or wood veneer color number for overhead cabinet See Surface Materials in the Elective Elements 6 Specification Guide.

## What's Special

15"D and 18"D X 30"H overhead cabinet with miter fold 2½" high valance on bottom and extended sides.

*Tip: This product can not be used with a hutch unit.*

*Tip: Cabinet-to-cabinet attachment kits are used to provide rigidity between cabinets mounted side by side in a wall-mounted application.*

*Tip: Mounting hardware to suspend overhead cabinets between towers is ordered separately. See Elective Elements 6 Specification Guide.*

## Specification Information

Dimensions			Style	Product ID	Change to
D	W	H	Number		U.S. Base Price

### P Open

15"	48"	30"	<b>E6OS154815P</b>	GW00098671-9998	+\$1528
15"	54"	30"	<b>E6OS155415P</b>	GW00098672-9998	+\$1461
15"	60"	30"	<b>E6OD156030P</b>	GW00098673-9999	+\$ 363
15"	66"	30"	<b>E6OD156630P</b>	GW00098725-9999	+\$ 373
15"	72"	30"	<b>E6OD157230P</b>	GW00098674-9999	+\$ 382
15"	78"	30"	<b>E6OD157830P</b>	GW00098675-9999	+\$ 392
15"	84"	30"	<b>E6OD158430P</b>	GW00098676-9999	+\$ 402
15"	90"	30"	<b>E6OD159030P</b>	GW00098677-9999	+\$ 412
15"	96"	30"	<b>E6OD159630P</b>	GW00098678-9999	+\$ 448
18"	48"	30"	<b>E6OS154815P</b>	GW00098729-9999	+\$1721
18"	54"	30"	<b>E6OS155415P</b>	GW00098743-9999	+\$1672
18"	60"	30"	<b>E6OD156030P</b>	GW00098744-9999	+\$ 679
18"	66"	30"	<b>E6OD156630P</b>	GW00098745-9999	+\$ 689
18"	72"	30"	<b>E6OD157230P</b>	GW00098746-9999	+\$ 698
18"	78"	30"	<b>E6OD157830P</b>	GW00098748-9999	+\$ 708
18"	84"	30"	<b>E6OD158430P</b>	GW00098749-9999	+\$ 718
18"	90"	30"	<b>E6OD159030P</b>	GW00098750-9999	+\$ 728
18"	96"	30"	<b>E6OD159630P</b>	GW00098751-9999	+\$ 764



### For Canadian Pricing

Multiply U.S. Price by the Canadian price factor.

▶ See page 1 for details.

# Freestanding Bookcases with Locking Doors

Wood Veneer or Laminate

Freestanding Bookcases  
with Locking Doors

*Tip: Freestanding bookcases that are 77½"H have an unfinished back and must be placed up against a wall or back-to-back.*

Standard Includes	Required to Specify
<ul style="list-style-type: none"> <li>Bookcase with double doors:                             <ul style="list-style-type: none"> <li>–Wood case with wood front</li> <li>–Laminate case with laminate front</li> <li>–Laminate case with wood front</li> </ul> </li> <li>Finished inset back on 45"H and 65⅝"H bookcases</li> <li>Unfinished inset back on 77½"H bookcases</li> <li>Shelves: wood or laminate to match case</li> <li>Lock: 9201 Chrome or 9250 Ember Chrome</li> </ul>	<ol style="list-style-type: none"> <li>General quote number: <b>GW047696</b></li> <li>Style number and Product ID</li> <li>Wood or laminate color number for bookcase</li> <li>Wood color number for wood fronts on laminate cases, if selected</li> <li>Pull shape (see below under Required Selections)</li> <li>Finish color number for pull See Surface Materials in the Elective Elements 6 Specification Guide.</li> </ol>

## What's Special

Bookcases are available with locking doors.

*Tip: Double-door units with integral or beam pulls will have a single pull on the right-hand door.*

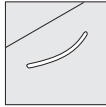
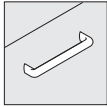
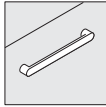
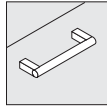
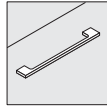
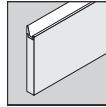
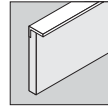
Required Selection						
						
Contemporary No cost	Jazz +\$17 each	Deco +\$17 each	Bar +\$23 each	Nile +\$23 each	Integral * +\$23 each	Beam +\$34 each
* Not available on laminate fronts						

Specification Information			
Dimensions	Style Number	Product ID	Change to U.S. Base Price
D W H			

## BF Freestanding Bookcases

### 45"H Bookcases

#### One Adjustable Shelf, Two Fixed Shelves

15¾"	24"	45"	<b>E6BF152445D</b>	GW00093646	+\$55
15¾"	30"	45"	<b>E6BF153045D</b>	GW00086922	+\$55
15¾"	36"	45"	<b>E6BF153645D</b>	GW00093647	+\$55

### 65⅝"H Bookcases

#### Three Adjustable Shelves, Two Fixed Shelves

15¾"	24"	65⅝"	<b>E6BF152465D</b>	GW00093648	+\$55
15¾"	30"	65⅝"	<b>E6BF153065D</b>	GW00093649	+\$55
15¾"	36"	65⅝"	<b>E6BF153665D</b>	GW00093650	+\$55

### 77½"H Bookcases

#### Four Adjustable Shelves, Two Fixed Shelves

15¾"	24"	77½"	<b>E6BF152477D</b>	GW00093651	+\$55
15¾"	30"	45"	<b>E6BF153077D</b>	GW00093652	+\$55
15¾"	36"	45"	<b>E6BF153677D</b>	GW00093653	+\$55

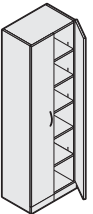
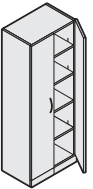
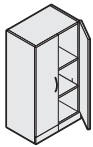

Elective Elements 6

# Square Grommet with 1/4" Spacer

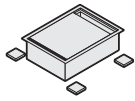

Standard Includes	Required to Specify
-------------------	---------------------

- Elective Elements 6 grommet
- Metal color for grommet

- 1 General quote number: **GW061824**
- 2 Style number and Product ID
- 3 Plastic color:
  - 8043 Clear Anodized Aluminum
  - 8044 Black Anodized Aluminum

## What's Special

Square aluminum grommet to include 1/4" spacers for use with universal tops.

*Tip: Grommet to be field-installed.*

## Specification Information

•Style •Number	•Product ID	•U.S. •Price
<b>AWAG2</b>	GW00122763	\$177
•	•	•



### For Canadian Pricing

Multiply U.S. Price by the Canadian price factor.

▶ See page 1 for details.

---

# Montage

▶ See page 3, *About Design Options*, in the front of this book for pricing and ordering restrictions.

<b>Wall Brackets, End-of-Run Fillers, and Power Poles</b>	<b>88</b>
<b>Door Frames with Four Hinges</b>	<b>90</b>
<b>86"H Door Tie Plates</b>	<b>92</b>
<b>42"H Enhanced Monolithic Frames</b>	<b>95</b>
<b>42"H Enhanced Standard Frames</b>	<b>96</b>
<b>42"H Enhanced Off-Module Frames</b>	<b>97</b>
<b>18"H Vertical Slot Cover</b>	<b>98</b>
<b>Frame Junction Kits</b>	<b>99</b>
<b>Vertical End Trims</b>	<b>103</b>
<b>37"H Enhanced Monolithic Tackable Acoustical Tiles</b>	<b>104</b>
<b>37"H Enhanced Monolithic Wood Tiles</b>	<b>105</b>
<b>10½"H and 18"H Enhanced Tackable Acoustical and High-Performance Acoustical Tiles</b>	<b>106</b>
<b>10½"H and 18"H Enhanced Non-Tackable Tiles</b>	<b>108</b>
<b>10½"H and 18"H Enhanced Laminate Tiles</b>	<b>110</b>
<b>10½"H and 18"H Enhanced Wood Tiles</b>	<b>111</b>
<b>10½"H and 18"H Enhanced Markerboard Tiles</b>	<b>112</b>
<b>18"H Enhanced Slatwall Tiles</b>	<b>113</b>
<b>18"H Enhanced Glass Tile Packages</b>	<b>114</b>
<b>Enhanced Wood Tile Sets</b>	<b>115</b>
<b>Enhanced Wood Tile Sets, Full to the Floor</b>	<b>117</b>
<b>Adjustable Cantilever</b>	<b>119</b>
<b>Enhanced Monolithic Frames with Desk Cavity Below Worksurface</b>	<b>120</b>
<b>Enhanced Standard Frames with Desk Cavity Below Worksurface</b>	<b>122</b>
<b>Enhanced Off-Module Frames with Desk Cavity Below Worksurface</b>	<b>124</b>
<b>On-Module Cantilever for use with Duo Storage</b>	<b>126</b>

# Wall Brackets, End-of-Run Fillers, and Power Poles

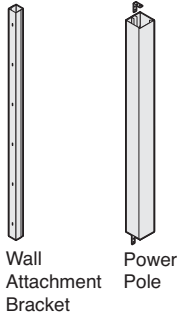

*Tip: Special-width wall attachment brackets fill the space from the end of a Montage frame to a structural wall.*

*Tip: Power poles are for use with standard junctions.*

*Tip: Power poles for end-of-run application, power pole attaches to end of 65"H or 86"H frame and extends from floor to ceiling. Power pole has attachment holes and wiring cutouts to match end of Montage frames.*

*Tip: End-of-run filler extends a panel run by 3". The filler is routed to match end of frame to allow vertical cable transfer. Filler includes a top cap.*

## What's Special

Heights of components are available in a variety of sizes.

### Standard Includes

- Wall attachment bracket: paint
- End-of-Run fillers: paint
- Power and cable poles: paint

### Required to Specify

- 1 General quote number: **CA015129**
  - 2 Style number and Product ID
  - 3 Designate "Special dimension"
  - 4 Paint color number
- See Surface Materials in Montage Solutions Specification Guide.

### Specification Information

Height	Style Number	Product ID	Change to U.S. Base Price
--------	--------------	------------	---------------------------

### Wall Attachment Brackets

#### 1 1/2"-2"W Brackets

38"	<b>ZWS86</b>	CA00017242	+\$22
45"	<b>ZWS86</b>	CA00017243	+\$22
55"	<b>ZWS86</b>	CA00017244	+\$22
65"	<b>ZWS86</b>	CA00017245	+\$22
86"	<b>ZWS86</b>	CA00017246	+\$48
106"	<b>ZWS86</b>	CA00017247	+\$48

#### 2 1/4"-4"W Brackets

38"	<b>ZWS86</b>	CA00017236	+\$22
45"	<b>ZWS86</b>	CA00017237	+\$22
55"	<b>ZWS86</b>	CA00017238	+\$22
65"	<b>ZWS86</b>	CA00017239	+\$22
106"	<b>ZWS86</b>	CA00017240	+\$48

#### 4"-7"W Brackets

38"	<b>ZWS86</b>	CA00017249	+\$22
45"	<b>ZWS86</b>	CA00017250	+\$22
55"	<b>ZWS86</b>	CA00017251	+\$22
65"	<b>ZWS86</b>	CA00017252	+\$22
86"	<b>ZWS86</b>	CA00017253	+\$48
106"	<b>ZWS86</b>	CA00017254	+\$48

### End-of-Run Fillers with Top Cap

45"	<b>ZPP61</b>	CA00017255	+\$74
55"	<b>ZPP61</b>	CA00017256	+\$74
65"	<b>ZPP61</b>	CA00023426	+\$74
86"	<b>ZPP61</b>	CA00023427	+\$74

### Power Poles in Special Heights

108"	<b>ZPP61</b>	CA00026500	+\$74
------	--------------	------------	-------

► **Specification Information, continued on next page**



### For Canadian Pricing

Multiply U.S. Price by the Canadian price factor.

► See page 1 for details.



► **Specification Information, continued from previous page**

**Specification Information**

• Height	• Style Number	• Product ID	• Change to U.S. Base Price
----------	----------------	--------------	-----------------------------

**Power Poles for End-of-Run Applications, Special Height**

45"	<b>ZPP61</b>	CA00017257	+\$74
55"	<b>ZPP61</b>	CA00017258	+\$74
65"	<b>ZPP61</b>	CA00017259	+\$74
86"	<b>ZPP61</b>	CA00023428	+\$74
:	:	:	:



Wall Attachment Bracket



Power Pole



**For Canadian Pricing**

Multiply U.S. Price by the Canadian price factor.

► See page 1 for details.

# Door Frames with Four Hinges

Extra Hinges for Heavy Doors

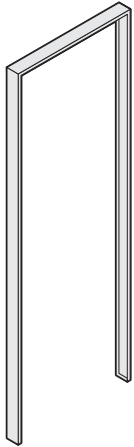

Tip: Four-hinge door frame must match with four-hinge door.

Tip: If customer's own door is being used, request drawing for hinge locations.

Tip: Recommend using four-hinge frames for veneer doors or heavier custom doors.

## What's Special

Door frame is special with four hinges.

Standard Includes	Required to Specify
-------------------	---------------------

- Door frame and four butt hinges: paint

- 1 General quote number: **CA009774**
  - 2 Style number and Product ID
  - 3 Specify "four hinges"
  - 4 Paint color number
  - 5 Options, if selected (see below)
- See Surface Materials in Montage Solutions Specification Guide.

Options	U.S. Price	Required to Specify
---------	------------	---------------------

<b>Surface Materials</b>	<ul style="list-style-type: none"> <li>• Paint price group 1</li> <li>• Paint price group 2</li> <li>• Paint price group 3</li> </ul>	No cost +\$ 6 +\$10	Specify paint color number Specify paint color number. Specify paint color number.
--------------------------	---	---------------------------	--

## Specification Information

Width	Style Number	Product ID	Change to U.S. Base Price

## 86"H Door Frames

### For Left-Hand Door

30"	<b>ZDF3086LH</b>	CA00016935	+\$86
36"	<b>ZDF3686LH</b>	CA00016936	+\$86
42"	<b>ZDF4286LH</b>	CA00016937	+\$88

### For Right-Hand Door

30"	<b>ZDF3086RH</b>	CA00016938	+\$86
36"	<b>ZDF3686RH</b>	CA00016939	+\$86
42"	<b>ZDF4286RH</b>	CA00016940	+\$88



### For Canadian Pricing

Multiply U.S. Price by the Canadian price factor.

▶ See page 1 for details.



# 86"H Door Tie Plates

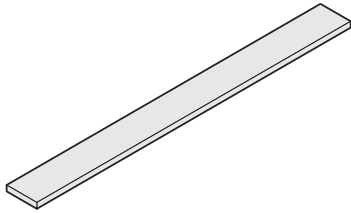

Tip: Door tie plate must be used over door frames in an 86"H application.

Tip: You must supply a floor plan and elevation along with your order to ensure that top cap will be the correct length.

You must specify what is attached on each side of door.

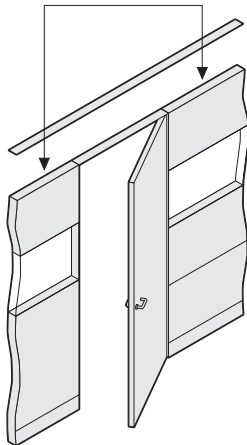

• Not required for floor-to-ceiling applications.

Tip: The following tie plates are used when a Montage swing door has standard Montage frames attached to both the left-hand and right-hand side of the door frame. Choose the tie plate that matches your frame configuration.

## Standard Includes

- Extended top cap: all paint
- Attachment hardware

## Required to Specify

- 1 General quote number: **CA009774**
  - 2 Style number and Product ID
  - 3 Specify "door tie plate"
  - 4 Designate adjacent frame sizes and/or junctions. Specify style of junction.
  - 5 Size of door frame
  - 6 Paint color of top cap
- See Surface Materials in Montage Solutions Specification Guide.

## Specification Information

• Frame	• Door	• Frame	• Width	• Style Number	• Product ID	• Change to U.S. Base Price
24"	30"	24"	78"	<b>ZBC48</b>	CA00017125	+\$91
30"	30"	24"	84"	<b>ZBC48</b>	CA00017126	+\$91
36"	30"	24"	90"	<b>ZBC48</b>	CA00017127	+\$91
42"	30"	24"	96"	<b>ZBC48</b>	CA00017128	+\$91
48"	30"	24"	102"	<b>ZBC48</b>	CA00017129	+\$91
30"	30"	30"	90"	<b>ZBC48</b>	CA00017130	+\$91
36"	30"	30"	96"	<b>ZBC48</b>	CA00017131	+\$91
42"	30"	30"	102"	<b>ZBC48</b>	CA00017132	+\$91
48"	30"	30"	108"	<b>ZBC48</b>	CA00017133	+\$91
36"	30"	36"	102"	<b>ZBC48</b>	CA00017134	+\$91
42"	30"	36"	108"	<b>ZBC48</b>	CA00017135	+\$91
48"	30"	36"	114"	<b>ZBC48</b>	CA00017136	+\$91
42"	30"	42"	114"	<b>ZBC48</b>	CA00017137	+\$91
48"	30"	42"	120"	<b>ZBC48</b>	CA00017138	+\$91
48"	30"	48"	126"	<b>ZBC48</b>	CA00017139	+\$91
24"	36"	24"	84"	<b>ZBC48</b>	CA00017140	+\$91
30"	36"	24"	90"	<b>ZBC48</b>	CA00017141	+\$91
36"	36"	24"	96"	<b>ZBC48</b>	CA00017142	+\$91
42"	36"	24"	102"	<b>ZBC48</b>	CA00017143	+\$91
48"	36"	24"	108"	<b>ZBC48</b>	CA00017144	+\$91
30"	36"	30"	96"	<b>ZBC48</b>	CA00017145	+\$91
36"	36"	30"	102"	<b>ZBC48</b>	CA00017146	+\$91
42"	36"	30"	108"	<b>ZBC48</b>	CA00017147	+\$91
48"	36"	30"	114"	<b>ZBC48</b>	CA00017148	+\$91
36"	36"	36"	108"	<b>ZBC48</b>	CA00017149	+\$91

► Specification Information, continued on next page

## What's Special

86"H door tie plate is special.



### For Canadian Pricing

Multiply U.S. Price by the Canadian price factor.

► See page 1 for details.

► **Specification Information, continued from previous page****Specification Information**

*Tip: The following tie plates are used when a Montage swing door has standard Montage frames attached to both the left-hand and right-hand side of the door frame. Choose the tie plate that matches your frame configuration.*

• Frame	• Door	• Frame	• Width	• Style Number	• Product ID	• Change to U.S. Base Price
42"	36"	36"	114"	<b>ZBC48</b>	CA00017150	+\$91
48"	36"	36"	120"	<b>ZBC48</b>	CA00017151	+\$91
42"	36"	42"	120"	<b>ZBC48</b>	CA00017152	+\$91
48"	36"	42"	126"	<b>ZBC48</b>	CA00017153	+\$91
48"	36"	48"	132"	<b>ZBC48</b>	CA00017154	+\$91
24"	42"	24"	90"	<b>ZBC48</b>	CA00017155	+\$91
30"	42"	24"	96"	<b>ZBC48</b>	CA00017156	+\$91
36"	42"	24"	102"	<b>ZBC48</b>	CA00017157	+\$91
42"	42"	24"	108"	<b>ZBC48</b>	CA00017158	+\$91
48"	42"	24"	114"	<b>ZBC48</b>	CA00017159	+\$91
30"	42"	30"	102"	<b>ZBC48</b>	CA00017160	+\$91
36"	42"	30"	108"	<b>ZBC48</b>	CA00017161	+\$91
42"	42"	30"	114"	<b>ZBC48</b>	CA00017162	+\$91
48"	42"	30"	120"	<b>ZBC48</b>	CA00017163	+\$91
36"	42"	36"	114"	<b>ZBC48</b>	CA00017164	+\$91
42"	42"	36"	120"	<b>ZBC48</b>	CA00017165	+\$91
48"	42"	36"	126"	<b>ZBC48</b>	CA00017166	+\$91
42"	42"	42"	126"	<b>ZBC48</b>	CA00017167	+\$91
48"	42"	42"	132"	<b>ZBC48</b>	CA00017168	+\$91
48"	42"	48"	138"	<b>ZBC48</b>	CA00017169	+\$91
.	.	.	.	.	.	.

► **Specification Information, continued on next page****For Canadian Pricing**

Multiply U.S. Price by the Canadian price factor.

► See page 1 for details.

► **Specification Information, continued from previous page**

**Specification Information**

*Tip: The following tie plates are used when a Montage swing door has a standard Montage frame attached to one side of the frame and a standard Montage junction attached to the other side. Choose the tie plate that matches your frame configuration.*

• Frame	• Door	• Frame	• Width	• Style Number	• Product ID	• Change to U.S. Base Price
<b>3" Junction</b>						
3"	30"	24"	57"	<b>ZBC48</b>	CA00017170	+\$91
3"	30"	30"	63"	<b>ZBC48</b>	CA00017171	+\$91
3"	30"	36"	69"	<b>ZBC48</b>	CA00017172	+\$91
3"	30"	42"	75"	<b>ZBC48</b>	CA00017173	+\$91
3"	30"	48"	81"	<b>ZBC48</b>	CA00017174	+\$91
3"	36"	24"	63"	<b>ZBC48</b>	CA00017175	+\$91
3"	36"	30"	69"	<b>ZBC48</b>	CA00017176	+\$91
3"	36"	36"	75"	<b>ZBC48</b>	CA00017177	+\$91
3"	36"	42"	81"	<b>ZBC48</b>	CA00017178	+\$91
3"	36"	48"	87"	<b>ZBC48</b>	CA00017179	+\$91
3"	42"	24"	69"	<b>ZBC48</b>	CA00017180	+\$91
3"	42"	30"	75"	<b>ZBC48</b>	CA00017181	+\$91
3"	42"	36"	81"	<b>ZBC48</b>	CA00017182	+\$91
3"	42"	42"	87"	<b>ZBC48</b>	CA00017183	+\$91
3"	42"	48"	93"	<b>ZBC48</b>	CA00017184	+\$91
:	:	:	:	:	:	:

*Tip: The following tie plates are used when two Montage swing doors are installed next to a single junction. The tie plate will share the 3" space above the same junction. Choose the tie plate that matches your frame configuration.*

<b>1.5" Junction</b>						
1.5"	30"	24"	55.5"	<b>ZBC48</b>	CA00017185	+\$91
1.5"	30"	30"	61.5"	<b>ZBC48</b>	CA00017186	+\$91
1.5"	30"	36"	67.5"	<b>ZBC48</b>	CA00017187	+\$91
1.5"	30"	42"	73.5"	<b>ZBC48</b>	CA00017188	+\$91
1.5"	30"	48"	79.5"	<b>ZBC48</b>	CA00017189	+\$91
1.5"	36"	24"	61.5"	<b>ZBC48</b>	CA00017190	+\$91
1.5"	36"	30"	67.5"	<b>ZBC48</b>	CA00017191	+\$91
1.5"	36"	36"	73.5"	<b>ZBC48</b>	CA00017192	+\$91
1.5"	36"	42"	79.5"	<b>ZBC48</b>	CA00017193	+\$91
1.5"	36"	48"	85.5"	<b>ZBC48</b>	CA00017194	+\$91
1.5"	42"	24"	67.5"	<b>ZBC48</b>	CA00017195	+\$91
1.5"	42"	30"	73.5"	<b>ZBC48</b>	CA00017196	+\$91
1.5"	42"	36"	79.5"	<b>ZBC48</b>	CA00017197	+\$91
1.5"	42"	42"	85.5"	<b>ZBC48</b>	CA00017198	+\$91
1.5"	42"	48"	91.5"	<b>ZBC48</b>	CA00017199	+\$91
:	:	:	:	:	:	:

 **For Canadian Pricing**  
 Multiply U.S. Price by the Canadian price factor.  
 ► See page 1 for details.

# 42"H Enhanced Monolithic Frames

42"H Enhanced  
Monolithic Frames

Tip: Frame is available in black, sterling or platinum only. You must select a finish.

Tip: Enhanced monolithic frames accommodate enhanced monolithic tiles or enhanced segmented tiles. A horizontal filler strip, ordered separately, must be used at each location where tile segmentation occurs.

Tip: Desk-height cavity can be covered with a 18"H tile. Tile cannot be slatwall, high-performance acoustical, or perforated non-tackable.

Tip: Montage frames do not accept overheads or shelves on any base frame below 65"H.

Tip: Actual height of frame is 42.016"

Tip: Frame accepts 20"H tile in lower segments and a 18"H spec tile in upper segment. If frame has DC, only a standard 10" slatwall will fit above desk cavity, all other tile types are a special 10 1/2"H tile. Actual height of tile is 10.519.

## What's Special

Frames are available 42"H.



**For Canadian Pricing**  
Multiply U.S. Price by the Canadian price factor.  
▶ See page 1 for details.

Standard Includes	Required to Specify
<ul style="list-style-type: none"> <li>• Frame: paint</li> <li>• Top cap: all paint price groups</li> <li>• Base cavity</li> <li>• Desk-height cavity, if selected</li> <li>• In-line connector hardware</li> </ul>	1 General quote number: <b>CA015124</b> 2 Style number and Product ID 3 Frame color number (see option below) 4 Paint color number for top cap 5 Options, if selected (see below) See Surface Materials in Montage Solutions Specification Guide.

Options	U.S. Price	Required to Specify
<b>Surface Materials</b> <ul style="list-style-type: none"> <li>• Paint price group 1</li> <li>• Paint price group 2</li> <li>• Paint price group 3</li> </ul>	No cost +\$41 +\$52	Specify paint color number. Specify paint color number. Specify paint color number.
<b>Top Cap</b> <ul style="list-style-type: none"> <li>• Omit top cap</li> </ul>	No cost	Specify <i>omit top cap</i> .

## Specification Information

### 42"H Monolithic

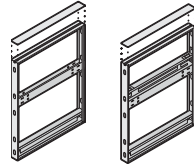

with base cavity

with base and desk-height cavities

Width	Style Number	Product ID	Change to U.S. Base Price
:	:	:	:

### With Base Cavity

18"	<b>ZFM1845</b>	CA00037095	+\$0
24"	<b>ZFM2445</b>	CA00032196	+\$0
30"	<b>ZFM3045</b>	CA00029915	+\$0
36"	<b>ZFM3645</b>	CA00029916	+\$0
42"	<b>ZFM4245</b>	CA00037096	+\$0
48"	<b>ZFM4845</b>	CA00029917	+\$0
:	:	:	:

### With Base and Desk-Height Cavities

18"	<b>ZFM1845DC</b>	CA00037222	+\$0
24"	<b>ZFM2445DC</b>	CA00037223	+\$0
30"	<b>ZFM3045DC</b>	CA00031325	+\$0
36"	<b>ZFM3645DC</b>	CA00037224	+\$0
42"	<b>ZFM4245DC</b>	CA00036913	+\$0
48"	<b>ZFM4845DC</b>	CA00037225	+\$0
:	:	:	:

# 42"H Enhanced Standard Frames

Tip: Desk-height cavity can be covered with a 18"H tile. Tile cannot be slatwall, high-performance acoustical, or perforated non-tackable.

Tip: Frame is available in black, sterling or platinum only. You must select a finish.

Tip: Montage frames do not accept overheads or shelves on any base frame below 65"H.

Tip: Actual height of frame is 42.016"

Tip: Frame accepts 20"H tile in lower segments and a 18" spec tile in upper segment. If frame has DC, only a standard 10" slatwall will fit above desk cavity, all other tile types are a special 10 1/2"H tile. Actual height of tile is 10.519.

## What's Special

Frames are available 42"H.

Standard Includes	Required to Specify
<ul style="list-style-type: none"> <li>• Frame: paint</li> <li>• Top cap: all paint price groups</li> <li>• Base cavity</li> <li>• Desk-height cavity, if selected</li> <li>• In-line connector hardware</li> </ul>	<ol style="list-style-type: none"> <li>1 General quote number: <b>CA015124</b></li> <li>2 Style number and Product ID</li> <li>3 Frame color number (see option below)</li> <li>4 Paint color number for top cap</li> <li>5 Options, if selected (see below)</li> </ol> See Surface Materials in Montage Solutions Specification Guide.

Options	U.S. Price	Required to Specify
<b>Surface Materials</b> <ul style="list-style-type: none"> <li>• Paint price group 1</li> <li>• Paint price group 2</li> <li>• Paint price group 3</li> </ul>	No cost +\$41 +\$52	Specify paint color number. Specify paint color number. Specify paint color number.
<b>Top Cap</b> <ul style="list-style-type: none"> <li>• Omit top cap</li> </ul>	No cost	Specify <i>omit top cap</i> .

## Specification Information

### 42"H Two-High

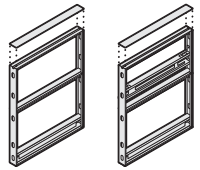

with base cavity

with base and desk-height cavities

Width	Style Number	Product ID	Change to U.S. Base Price
18"	ZFE1845	CA00022312	+\$0
24"	ZFE2445	CA00021277	+\$0
30"	ZFE3045	CA00021276	+\$0
36"	ZFE3645	CA00021275	+\$0
42"	ZFE4245	CA00021461	+\$0
48"	ZFE4845	CA00020591	+\$0

### With Base Cavity

18"	<b>ZFE1845</b>	CA00022312	+\$0
24"	<b>ZFE2445</b>	CA00021277	+\$0
30"	<b>ZFE3045</b>	CA00021276	+\$0
36"	<b>ZFE3645</b>	CA00021275	+\$0
42"	<b>ZFE4245</b>	CA00021461	+\$0
48"	<b>ZFE4845</b>	CA00020591	+\$0

### With Base and Desk-Height Cavities

18"	<b>ZFE1845DC</b>	CA00037226	+\$0
24"	<b>ZFE2445DC</b>	CA00020588	+\$0
30"	<b>ZFE3045DC</b>	CA00020586	+\$0
36"	<b>ZFE3645DC</b>	CA00021471	+\$0
42"	<b>ZFE4245DC</b>	CA00021470	+\$0
48"	<b>ZFE4845DC</b>	CA00028133	+\$0



### For Canadian Pricing

Multiply U.S. Price by the Canadian price factor.

► See page 1 for details.



# 42"H Enhanced Off-Module Frames

42"H Enhanced  
Off-Module Frames

Tip: Desk-height cavity can be covered with a 18"H tile. Tile cannot be slatwall, high-performance acoustical, or perforated non-tackable.

Tip: Frame is available in black, sterling or platinum only. You must select a finish.

Tip: Montage frames do not accept overheads or shelves on any base frame below 65"H.

Tip: Actual height of frame is 42.016"

Tip: Frame accepts 20"H tile in lower segments and a 18" spec tile in upper segment. If frame has DC, only a standard 10" slatwall will fit above desk cavity, all other tile types are a special 10 1/2"H tile. Actual height of tile is 10.519.

## What's Special

Frames are available 42"H.

Standard Includes		Required to Specify
	<ul style="list-style-type: none"> <li>• Frame: paint</li> <li>• Top cap: all paint price groups</li> <li>• Base cavity</li> <li>• Desk-height cavity, if selected</li> <li>• In-line connector hardware</li> </ul>	1 General quote number: <b>CA015124</b> 2 Style number and Product ID 3 Paint color number for top cap 4 Options, if selected (see below) See Surface Materials in Montage Solutions Specification Guide.

Options	U.S. Price	Required to Specify	
<b>Surface Materials</b>	<ul style="list-style-type: none"> <li>• Paint price group 1</li> <li>• Paint price group 2</li> <li>• Paint price group 3</li> </ul>	No cost +\$41 +\$52	Specify paint color number. Specify paint color number. Specify paint color number.
<b>Top Cap</b>	<ul style="list-style-type: none"> <li>• Omit top cap</li> </ul>	No cost	Specify <i>omit top cap</i> .

## Specification Information

### 42"H Two-High

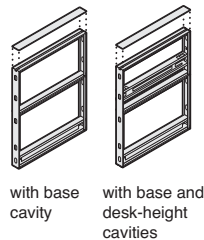

with base cavity

with base and desk-height cavities

Width	Style Number	Product ID	Change to U.S. Base Price
...	...	...	...

### With Base Cavity

18"	<b>ZFOM1845</b>	CA00025764	+\$0
24"	<b>ZFOM2445</b>	CA00022556	+\$0
30"	<b>ZFOM3045</b>	CA00023100	+\$0
36"	<b>ZFOM3645</b>	CA00037232	+\$0
42"	<b>ZFOM4245</b>	CA00023101	+\$0
48"	<b>ZFOM4845</b>	CA00022557	+\$0
...	...	...	...

### With Base and Desk-Height Cavities

18"	<b>ZFOM1845DC</b>	CA00037233	+\$0
24"	<b>ZFOM2445DC</b>	CA00037234	+\$0
30"	<b>ZFOM3045DC</b>	CA00024835	+\$0
36"	<b>ZFOM3645DC</b>	CA00037235	+\$0
42"	<b>ZFOM4245DC</b>	CA00037236	+\$0
48"	<b>ZFOM4845DC</b>	CA00037237	+\$0
...	...	...	...

 **For Canadian Pricing**  
Multiply U.S. Price by the Canadian price factor.  
▶ See page 1 for details.

# 18"H Vertical Slot Cover



*Tip: Slot cover can be moved to the side to allow access to slot if needed.*

*Tip: Each package includes two covers.*

## What's Special

Vertical slot cover is available 18"H.

### Standard Includes

- Two painted slot covers: paint

### Required to Specify

- 1 General quote number: **CA015124**
- 2 Style number and Product ID
- 3 Paint color number for slot covers  
See Surface Materials in Montage Solutions Specification Guide.

### Specification Information

Height	Style Number	Product ID	Change to U.S. Price
18"H	<b>ZSEAL20</b>	CA00033735	+\$2
:	:	:	:



### For Canadian Pricing

Multiply U.S. Price by the Canadian price factor.

▶ See page 1 for details.

## Square L-Junctions

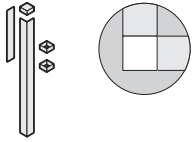

Tip: Connectors are for use with frames that do not have lay-in cable tracks mounted to them.

### What's Special

Junction kits are available for use with 42"H frames.

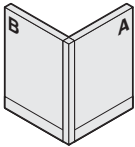

Standard Includes	Required to Specify
<ul style="list-style-type: none"> <li>Two-way square top cap: all paint price groups for aluminum or non-composite open-pore finishes for wood</li> <li>Two-way connectors</li> <li>One square L-cover: all paint price groups for aluminum or non-composite open-pore finishes for wood</li> <li>End trim, if applicable: all paint price groups for aluminum or non-composite open-pore finishes for wood</li> </ul>	<ol style="list-style-type: none"> <li>General quote number: <b>CA015124</b></li> <li>Style number and Product ID</li> <li>Paint color number for top cap, cover, and end trim on aluminum frame</li> <li>Open-pore finish number for top cap, cover, and end trim on wood frame</li> <li>Options, if selected (see below)</li> </ol> See Surface Materials in Montage Solutions Specification Guide.

Options	U.S. Price	Required to Specify
<b>Surface Materials</b> <ul style="list-style-type: none"> <li>Customiz stain on wood</li> </ul>	Prices below	Specify with Customiz stain. ▶ See Surface Materials Reference Manual.

Specification Information								
Height A	Height B	Style Number	Product ID	Change to U.S. Base Price	Style Number	Product ID	Change to U.S. Base Price	Option (Add \$ to Base Price)
:	:	:	:	:	:	:	:	Customiz Stain

## Same-Height Frame Kits

		Aluminum			Wood			
42"	42"	<b>ZJL44S</b>	CA00015957	+\$0	<b>ZJL44SW</b>	CA00030737	+\$98	+\$25
:	:	:	:	:	:	:	:	:

 **For Canadian Pricing**  
 Multiply U.S. Price by the Canadian price factor.  
 ▶ See page 1 for details.

## T-Junctions



Tip: Connectors are for use with frames that do not have lay-in cable tracks mounted to them.

### What's Special

Junction kits are available for use with 42"H frames.

Standard Includes	Required to Specify
<ul style="list-style-type: none"> <li>Top cap, connectors, cover(s), and end trim, if applicable: all paint price groups for aluminum or non-composite open-pore finishes for wood</li> </ul>	<ol style="list-style-type: none"> <li>General quote number: <b>CA015124</b></li> <li>Style number and Product ID</li> <li>Paint color number for top cap, cover(s), and end trim on aluminum frame</li> <li>Open-pore finish number for top cap, cover, and end trim on wood frame</li> <li>Options, if selected (see below)</li> </ol> See Surface Materials in Montage Solutions Specification Guide.

Options	U.S. Price	Required to Specify
<b>Surface Materials</b> <ul style="list-style-type: none"> <li>Customiz stain on wood</li> </ul>	Prices below	Specify with <i>Customiz stain</i> . ▶ See <i>Surface Materials Reference Manual</i> .

Specification Information							
Height	Style	Product ID	Change to	Style	Product ID	Change to	Option
A B C	Number		U.S. Base Price	Number		U.S. Base Price	(Add \$ to Base Price)
:	:	:	:	:	:	:	Customiz Stain

### Same-Height Frame Kits

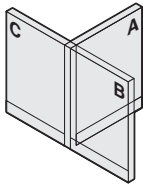

Aluminum				Wood			
42"	42"	42"	<b>ZJT444</b> CA00016114 +\$0	<b>ZJT444W</b>	CA00032072	+\$84	+\$25
:	:	:	:	:	:	:	:



### For Canadian Pricing

Multiply U.S. Price by the Canadian price factor.

▶ See page 1 for details.

## X-Junctions

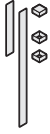

*Tip: Connectors are for use with frames that do not have lay-in cable tracks mounted to them.*

### What's Special

Junction kits are available for use with 42"H frames.

Standard Includes	Required to Specify
-------------------	---------------------

- |  |  |
|--|--|
| <ul style="list-style-type: none"> <li>• Top cap, connectors, cover(s), and end trim, if applicable: all paint price groups for aluminum or non-composite open-pore finishes for wood</li> </ul> | <ol style="list-style-type: none"> <li>1 General quote number: <b>CA015124</b></li> <li>2 Style number and Product ID</li> <li>3 Paint color number for top cap, cover(s), and end trim on aluminum frame</li> <li>4 Open-pore finish number for top cap, cover, and end trim on wood frame</li> <li>5 Options, if selected (see below)</li> </ol> See Surface Materials in Montage Solutions Specification Guide. |
|--|--|

Options	U.S. Price	Required to Specify
---------	------------	---------------------

- |   |                           |   |
|---|---------------------------|---|
| <b>Surface Materials</b> <ul style="list-style-type: none"> <li>• Customiz stain on wood</li> </ul> | Prices below and at right | Specify with <i>Customiz stain</i> .<br>► See <i>Surface Materials Reference Manual</i> . |
|---|---------------------------|---|

### Specification Information

• Height				• Style	• Product ID	• Change to	• Style	• Product ID	• Change to	• Option
A	B	C	D	Number		U.S. Base Price	Number		U.S. Base Price	(Add \$ to Base Price)
										Customiz Stain

### Same-Height Frame Kits

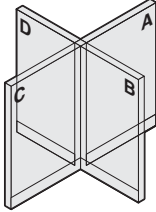

				Aluminum			Wood			
42"	42"	42"	42"	<b>ZJX4444</b>	CA00016111	+\$0	<b>ZJX4444W</b>	CA00037240	+\$77	+\$11



**For Canadian Pricing**  
 Multiply U.S. Price by the Canadian price factor.  
 ► See page 1 for details.

## V-Junctions

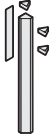

*Tip: Connectors are for use with frames that do not have lay-in cable tracks mounted to them.*

Standard Includes	Required to Specify
<ul style="list-style-type: none"> <li>• Two-way 135° cap: all paint price groups</li> <li>• Two-way 135° connectors</li> <li>• One cover and end trim, if applicable: all paint price groups</li> </ul>	<ul style="list-style-type: none"> <li>1 General quote number: <b>CA015124</b></li> <li>2 Style number and Product ID</li> <li>2 Paint color number for top cap, cover, and end trim</li> </ul> <p>See Surface Materials in Montage Solutions Specification Guide.</p>

### What's Special

Junction kits are available for use with 42"H frames.

### Specification Information

• Height A    B	• Style Number	• Product ID	• Change to U.S. Price
--------------------	-------------------	--------------	---------------------------

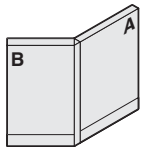

### Same-Height Frame Kits

42"    42"	<b>ZJV44</b>	CA00037241	+ \$0
------------	--------------	------------	-------



**For Canadian Pricing**  
 Multiply U.S. Price by the Canadian price factor.  
 ▶ See page 1 for details.



Tip: Vertical end trim is solid wood and offered in wood finishes that match both composite and open-pore natural veneer finishes.

Tip: Wood end trims must be used with wood top caps.

Tip: When using lay-in cable tracks, you must specify metal end trims for use with lay-in cable tracks.

Tip: Metal end trims must be used with metal top caps.

### What's Special

Vertical end trims are available 42"H.



**For Canadian Pricing**  
 Multiply U.S. Price by the Canadian price factor.  
 ▶ See page 1 for details.

Standard Includes	Required to Specify
<ul style="list-style-type: none"> <li>• Wood vertical end trim, if selected: solid wood</li> <li>• Metal vertical end trim, if selected: all paint price groups</li> <li>• Attachment hardware for metal vertical end trim: wing nuts</li> </ul>	<ol style="list-style-type: none"> <li>1 General quote number: <b>CA015124</b></li> <li>2 Style number and Product ID</li> <li>3 Wood or paint color number for vertical end trim</li> <li>4 Options, if selected (see below)</li> </ol> See Surface Materials in Montage Solutions Specification Guide.

Options	U.S. Price	Required to Specify
<b>Surface Materials</b> <ul style="list-style-type: none"> <li>• Customiz stain on wood</li> </ul>	Prices below	Specify with <i>Customiz stain</i> . ▶ See <i>Surface Materials Reference Manual</i> .

Specification Information				
Height	Style Number	Product ID	Change to U.S. Base Price	Option (Add \$ to Base Price)
42"	<b>ZET45W</b>	CA00037243	+\$55	Customiz Stain

### Wood Vertical End Trim

42"	<b>ZET45W</b>	CA00037243	+\$55	+\$12
-----	---------------	------------	-------	-------

### Metal Vertical End Trim

42"	<b>ZET45</b>	CA00015959	+\$0	N.A.
-----	--------------	------------	------	------

# 37"H Enhanced Monolithic Tackable Acoustical Tiles

For 42" High Frame

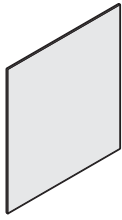

*Tip: Enhanced monolithic tackable acoustical, enhanced high-performance acoustical, and enhanced monolithic wood tiles can be used on enhanced monolithic frames only.*

*Tip: Standard fabric direction on Montage tiles 60"H or less is warp horizontal; warp vertical direction is available as an option.*

*Tip: Enhanced monolithic tackable acoustical tiles cannot be installed on pocket frames.*

## What's Special

Tiles are available 37"H for 42" high frame.

Standard Includes	Required to Specify
-------------------	---------------------

- 37"H tiles, fabric direction with horizontal application: fabric price group 1

- 1 General quote number: **CA015125**
  - 2 Style number and Product ID
  - 3 Fabric color number for tile surface
  - 4 Options, if selected (see below)
- See Surface Materials in Montage Solutions Specification Guide.

Surface Materials	Options	U.S. Price	Required to Specify
-------------------	---------	------------	---------------------

<b>Surface Materials</b>	• Fabric price group 1	No cost	Specify fabric color number. Specify fabric color number. Specify fabric color number. Specify fabric color number. Specify fabric color number. ▶ See <i>Surface Materials Reference Manual</i> to specify.
	• Fabric price group 2	+\$ 24	
	• Fabric price group 3	+\$ 44	
	• Fabric price group 4	+\$ 70	
	• Fabric price group 5	+\$109	
	• Fabric price group COM	+\$ 16	

### Fabric direction

- Vertical application

No cost

- Specify with vertical application.  
▶ See *Surface Materials in Montage Solutions Specification Guide*.

## Specification Information

Width	Style Number	Product ID	Change to U.S. Base Price
-------	--------------	------------	---------------------------

## 37"H Tiles

24"	<b>ZTAM2440</b>	CA00037125	+\$35
30"	<b>ZTAM3040</b>	CA00037126	+\$35
36"	<b>ZTAM3640</b>	CA00037127	+\$35
42"	<b>ZTAM4240</b>	CA00031905	+\$35
48"	<b>ZTAM4840</b>	CA00037128	+\$35



### For Canadian Pricing

Multiply U.S. Price by the Canadian price factor.

- ▶ See page 1 for details.



# 37"H Enhanced Monolithic Wood Tiles

For 42" High Frame

37"H Enhanced  
Monolithic Wood Tiles

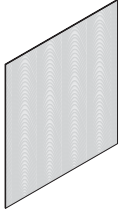

*Tip: Enhanced monolithic tackable acoustical, enhanced high-performance acoustical, and enhanced monolithic wood tiles can be used on enhanced monolithic frames only.*

*Tip: Enhanced monolithic wood tiles cannot be installed on pocket frames.*

## What's Special

Tiles are available 37"H for 42" high frame.

Standard Includes	Required to Specify
<ul style="list-style-type: none"> <li>• Tile: wood</li> </ul>	1 General quote number: <b>CA015125</b> 2 Style number and Product ID 3 Wood color number for tile surface 4 Options, if selected (see below) See Surface Materials in Montage Solutions Specification Guide.

Options	U.S. Price	Required to Specify
<b>Surface Materials</b> <ul style="list-style-type: none"> <li>• Customiz stain on wood</li> </ul>	Prices below	Specify with <i>Customiz stain</i> . ▶ See <i>Surface Materials Reference Manual</i> .

Specification Information				
Width	Style Number	Product ID	Change to U.S. Base Price	Option
.....	.....	.....	.....	(Add \$ to Base Price)
.....	.....	.....	.....	Customiz Stain

## 37"H Tiles

18"	<b>ZTWM1840</b>	CA00037129	+\$60	+\$26
24"	<b>ZTWM2440</b>	CA00036771	+\$60	+\$26
30"	<b>ZTWM3040</b>	CA00036773	+\$60	+\$44
36"	<b>ZTWM3640</b>	CA00036774	+\$60	+\$64
42"	<b>ZTWM4240</b>	CA00037130	+\$60	+\$64
48"	<b>ZTWM4840</b>	CA00036772	+\$60	+\$64
.....	.....	.....	.....	.....



### For Canadian Pricing

Multiply U.S. Price by the Canadian price factor.

▶ See page 1 for details.

# 10½"H and 18"H Enhanced Tackable Acoustical and High-Performance Acoustical Tiles

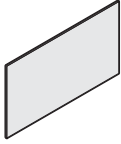

Tip: Enhanced tiles can be used on any enhanced frame, including monolithic frames, and any standard frames manufactured after July 2001.

Exception: Enhanced slatwall tiles can be used on any standard frame regardless of manufacture dates. Refer to compatibility tips. ▶ See Montage Solutions Specification Guide.

Tip: Enhanced tackable acoustical and high-performance tiles cannot be installed on pocket frames.

## What's Special

Tiles are available 10½"H and 18"H.

### Standard Includes

- Tile, fabric direction with horizontal application: fabric price group 1

### Required to Specify

- 1 General quote number: **CA015125**
  - 2 Style number and Product ID
  - 3 Fabric color number for tile surface
  - 4 Options, if selected (see below)
- See Surface Materials in Montage Solutions Specification Guide.

	Options	U.S. Price	Required to Specify
<b>Surface Materials</b>	• Fabric price group 1	No cost	Specify fabric color number.
	• Fabric price group 2	+\$14	Specify fabric color number.
	• Fabric price group 3	+\$24	Specify fabric color number.
	• Fabric price group 4	+\$35	Specify fabric color number.
	• Fabric price group 5	+\$55	Specify fabric color number.
	• Fabric price group COM	+\$16	▶ See <i>Surface Materials Reference Manual</i> to specify.
	<b>Fabric direction</b>		
	• Vertical application	No cost	Specify with vertical application. ▶ See <i>Surface Materials in Montage Solutions Specification Guide</i> .

### Specification Information

Dimensions W H	Style Number	Product ID	Change to U.S. Base Price

### Enhanced Tackable Acoustical Tiles

#### 10½"H Tiles

18"	13"	<b>ZTAE1813</b>	CA00036870	+\$11
24"	13"	<b>ZTAE2413</b>	CA00028199	+\$13
30"	13"	<b>ZTAE3013</b>	CA00028200	+\$16
36"	13"	<b>ZTAE3613</b>	CA00028201	+\$18
42"	13"	<b>ZTAE4213</b>	CA00028202	+\$21
48"	13"	<b>ZTAE4813</b>	CA00028203	+\$24

#### 18"H Tiles

18"	20"	<b>ZTAE1820</b>	CA00019897	+\$13
24"	20"	<b>ZTAE2420</b>	CA00023507	+\$15
30"	20"	<b>ZTAE3020</b>	CA00023508	+\$17
36"	20"	<b>ZTAE3620</b>	CA00023509	+\$20
42"	20"	<b>ZTAE4220</b>	CA00023510	+\$23
48"	20"	<b>ZTAE4820</b>	CA00023511	+\$25



### For Canadian Pricing

Multiply U.S. Price by the Canadian price factor.

▶ See page 1 for details.



# 10½"H and 18"H Enhanced Non-Tackable Tiles

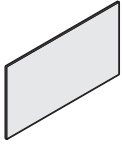

*Tip: Enhanced tiles can be used on any enhanced frame, including monolithic frames, and any standard frames manufactured after July 2001.*  
*Exception: Enhanced slat-wall tiles can be used on any standard frame regardless of manufacture dates.*  
 Refer to compatibility tips.  
 ▶ See *Montage Solutions Specification Guide*.

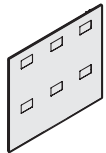

*Tip: Data opening option only available on 20"H tiles.*

*Tip: Patterned options are not available on tiles with data termination option.*

*Tip: Perforated, indented, and dome tile pattern options are not available on fabric-covered tiles. Pattern options are not available on tiles with cutout and base fiber-in.*

*Tip: Perforated tiles ship with metal septum, which will block cable and power routing when used back-to-back.*

*Tip: Dome tiles cannot be used behind off-module bracket connections.*

## Decoding pattern numbers

P = Perforated  
 I = Indented  
 D = Dome  
 Number indicates the quantity of holes or indentations in a 2"W x 1⅜"H area.

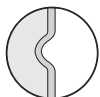

Cross-section through indented tile

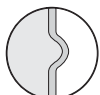

Cross-section through dome tile

Standard Includes		Required to Specify	
	<ul style="list-style-type: none"> <li>Tile: paint price group 1</li> <li>Wedge-shaped connector, if applicable: black plastic only</li> <li>6'-long, ¾" inside diameter conduit, on base fiber-in only: black plastic only</li> </ul>		<ol style="list-style-type: none"> <li>General quote number: <b>CA015125</b></li> <li>Style number and Product ID</li> <li>Paint color number for tile surface</li> <li>Options, if selected (see below) See Surface Materials in Montage Solutions Specification Guide.</li> </ol>
Options		U.S. Price	Required to Specify
<b>Surface Materials</b>	<ul style="list-style-type: none"> <li>Paint price group 1</li> <li>Paint price group 2</li> <li>Paint price group 3</li> </ul>	No cost +\$ 6 +\$10	Specify paint color number. Specify paint color number. Specify paint color number.
	<ul style="list-style-type: none"> <li>Fabric price group 1</li> <li>Fabric price group 2</li> <li>Fabric price group 3</li> <li>Fabric price group 4</li> <li>Fabric price group 5</li> <li>Fabric price group COM</li> </ul>	No cost +\$14 +\$24 +\$35 +\$55 +\$16	Specify fabric color number. Specify fabric color number. Specify fabric color number. Specify fabric color number. Specify fabric color number. Specify fabric color number. ▶ See <i>Surface Materials Reference Manual</i> to specify.
	<b>Fabric direction</b>		
	<ul style="list-style-type: none"> <li>Horizontal application (standard)</li> <li>Vertical application</li> </ul>	No cost No cost	Specify with horizontal application. ▶ See <i>Surface Materials in Montage Solutions Specification Guide</i> . Specify with vertical application. ▶ See <i>Surface Materials in Montage Solutions Specification Guide</i> .
<b>Data Termination Tile</b>	<ul style="list-style-type: none"> <li>Data opening</li> </ul>	+\$27	Specify Nema or Decora and specify upper left, upper center, upper right, lower left, lower center, or lower right.
<b>Metal Tile Patterns</b>	<ul style="list-style-type: none"> <li>18"W</li> </ul>	+\$93	Specify tile pattern number.

## Metal Tile Patterns

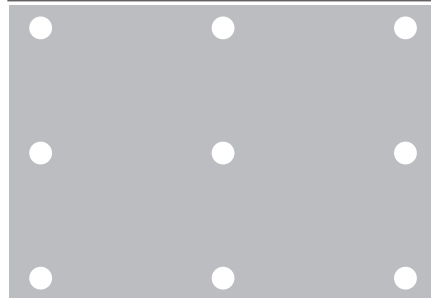

P9, I 9, D9

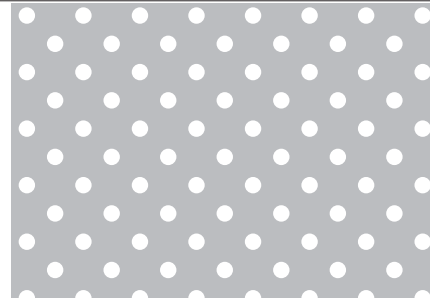

P85

**What's Special**

Tiles are available 10½"H and 18"H.

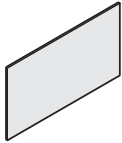

**Specification Information**

Width	Style Number	Product ID	Change to U.S. Base Price
-------	--------------	------------	---------------------------

**10½"H Tiles**

18"	<b>ZTSE1813</b>	CA00037132	+\$ 7
24"	<b>ZTSE2413</b>	CA00037133	+\$ 8
30"	<b>ZTSE3013</b>	CA00037134	+\$ 9
36"	<b>ZTSE3613</b>	CA00037135	+\$10
42"	<b>ZTSE4213</b>	CA00037136	+\$11
48"	<b>ZTSE4813</b>	CA00037137	+\$12

**18"H Tiles**

18"	<b>ZTSE1820</b>	CA00037138	+\$ 8
24"	<b>ZTSE2420</b>	CA00022289	+\$ 8
30"	<b>ZTSE3020</b>	CA00021687	+\$ 9
36"	<b>ZTSE3620</b>	CA00021688	+\$11
42"	<b>ZTSE4220</b>	CA00021689	+\$12
48"	<b>ZTSE4820</b>	CA00022290	+\$13



**For Canadian Pricing**  
Multiply U.S. Price by the  
Canadian price factor.  
▶ See page 1 for details.

# 10½"H and 18"H Enhanced Laminate Tiles

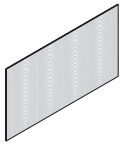

Tip: Enhanced tiles can be used on any enhanced frame, including monolithic frames, and any standard frames manufactured after July 2001.

Exception: Enhanced slat-wall tiles can be used on any standard frame regardless of manufacture dates. Refer to compatibility tips. ▶ See *Surface Materials in Montage Solutions Specification Guide*.

## What's Special

Tiles are available 10½"H and 18"H.

Standard Includes	Required to Specify
<ul style="list-style-type: none"> <li>Tile: laminate</li> </ul>	1 General quote number: <b>CA015125</b> 2 Style number and Product ID 3 Laminate color number for tile surface 4 Options, if selected (see below) See <i>Surface Materials in Montage Solutions Specification Guide</i> .

Options	U.S. Price	Required to Specify
<b>Surface Materials</b> <ul style="list-style-type: none"> <li>Open Line laminate</li> </ul>	+\$64 plus cost of laminate	▶ See <i>Surface Materials Reference Manual</i> to specify.

## Specification Information

Width	Style Number	Product ID	Change to U.S. Base Price
.....	.....	.....	.....

### 10½"H Tiles

18"	<b>ZTLE1813</b>	CA00037139	+\$14
24"	<b>ZTLE2413</b>	CA00037141	+\$15
30"	<b>ZTLE3013</b>	CA00037142	+\$18
36"	<b>ZTLE3613</b>	CA00037143	+\$21
42"	<b>ZTLE4213</b>	CA00037145	+\$23
48"	<b>ZTLE4813</b>	CA00037147	+\$26
.....	.....	.....	.....

### 18"H Tiles

18"	<b>ZTLE1820</b>	CA00037149	+\$14
24"	<b>ZTLE2420</b>	CA00025331	+\$16
30"	<b>ZTLE3020</b>	CA00025365	+\$18
36"	<b>ZTLE3620</b>	CA00025364	+\$21
42"	<b>ZTLE4220</b>	CA00037151	+\$24
48"	<b>ZTLE4820</b>	CA00027553	+\$27
.....	.....	.....	.....



## For Canadian Pricing

Multiply U.S. Price by the Canadian price factor.

▶ See page 1 for details.

# 10 1/2"H and 18"H Enhanced Wood Tiles

10 1/2"H and 18"H  
Enhanced Wood Tiles

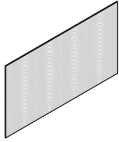

*Tip: Enhanced tiles can be used on any enhanced frame, including monolithic frames, and any standard frames manufactured after July 2001.*

*Exception: Enhanced slat-wall tiles can be used on any standard frame regardless of manufacture dates. Refer to compatibility tips. ▶ See Montage Solutions Specification Guide*

*Tip: Enhanced wood tiles cannot be installed to cover up a desk cavity with Chicago hardwire junction boxes installed.*

## What's Special

Tiles are available 10 1/2"H and 18"H.

Standard Includes	Required to Specify
<ul style="list-style-type: none"> <li>• Tile: wood</li> </ul>	1 General quote number: <b>CA015125</b> 2 Style number and Product ID 3 Wood color number for tile surface 4 Options, if selected (see below) See Surface Materials in Montage Solutions Specification Guide.

Options	U.S. Price	Required to Specify
<b>Surface Materials</b> <ul style="list-style-type: none"> <li>• Customiz stain on wood</li> </ul>	Prices below	Specify with <i>Customiz stain</i> . ▶ See <i>Surface Materials Reference Manual</i> .

Specification Information				
Width	Style Number	Product ID	Change to U.S. Base Price	Option (Add \$ to Base Price)

## 10 1/2"H Tiles

18"	<b>ZTWE1813</b>	CA00037154	+\$ 60	+\$26
24"	<b>ZTWE2413</b>	CA00037155	+\$ 60	+\$26
30"	<b>ZTWE3013</b>	CA00037156	+\$ 70	+\$26
36"	<b>ZTWE3613</b>	CA00037157	+\$ 80	+\$26
42"	<b>ZTWE4213</b>	CA00037158	+\$ 90	+\$26
48"	<b>ZTWE4813</b>	CA00037159	+\$100	+\$26

## 18"H Tiles

18"	<b>ZTWE1820</b>	CA00037163	+\$ 60	+\$26
24"	<b>ZTWE2420</b>	CA00032067	+\$ 60	+\$26
30"	<b>ZTWE3020</b>	CA00030812	+\$ 70	+\$26
36"	<b>ZTWE3620</b>	CA00037167	+\$ 80	+\$26
42"	<b>ZTWE4220</b>	CA00037168	+\$ 90	+\$26
48"	<b>ZTWE4820</b>	CA00037169	+\$100	+\$44



**For Canadian Pricing**  
 Multiply U.S. Price by the Canadian price factor.  
 ▶ See page 1 for details.

# 10½"H and 18"H Enhanced Markerboard Tiles

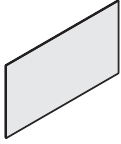

*Tip: Enhanced tiles can be used on any enhanced frame, including monolithic frames, and any standard frames manufactured after July 2001.*

*Exception: Enhanced slat-wall tiles can be used on any standard frame regardless of manufacture dates.*

Refer to compatibility tips.

▶ See *Montage Solutions Specification Guide*.

## What's Special

Tiles are available 10½"H and 18"H.

### Standard Includes

- Whiteboard surface tile for use with dry erase markers

### Required to Specify

- 1 General quote number: **CA015125**
- 2 Style number and Product ID

### Specification Information

Width	Style Number	Product ID	Change to U.S. Price
-------	--------------	------------	----------------------

#### 10½"H Tiles

18"	<b>ZTME1813</b>	CA00037194	+\$16
24"	<b>ZTME2413</b>	CA00037195	+\$17
30"	<b>ZTME3013</b>	CA00037196	+\$20
36"	<b>ZTME3613</b>	CA00037197	+\$22
42"	<b>ZTME4213</b>	CA00037198	+\$25
48"	<b>ZTME4813</b>	CA00037199	+\$28

#### 18"H Tiles

18"	<b>ZTME1820</b>	CA00037201	+\$17
24"	<b>ZTME2420</b>	CA00037202	+\$18
30"	<b>ZTME3020</b>	CA00037203	+\$21
36"	<b>ZTME3620</b>	CA00037050	+\$24
42"	<b>ZTME4220</b>	CA00037204	+\$27
48"	<b>ZTME4820</b>	CA00037205	+\$29



### For Canadian Pricing

Multiply U.S. Price by the Canadian price factor.

▶ See page 1 for details.



# 18"H Enhanced Slatwall Tiles

18"H Enhanced  
Slatwall Tiles

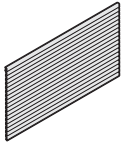

Tip: Enhanced slatwall tiles can be used on any standard frame regardless of manufacture dates. Refer to compatibility tips.

▶ See Montage Solutions Specification Guide.

Tip: Enhanced slatwall tiles cannot be installed on pocket frames.

## What's Special

Tiles are available 18"H.

Standard Includes	Required to Specify
<ul style="list-style-type: none"> <li>Slatwall tile: paint price group 1</li> </ul>	1 General quote number: <b>CA015125</b> 2 Style number and Product ID 3 Paint color number for slatwall tile See Surface Materials in Montage Solutions Specification Guide.

Options	U.S. Price	Required to Specify
<b>Surface Materials</b> <ul style="list-style-type: none"> <li>Paint price group 1</li> <li>Paint price group 2</li> <li>Paint price group 3</li> </ul>	No cost +\$ 6 +\$10	Specify paint color number. Specify paint color number. Specify paint color number.

## Specification Information

Width	Style Number	Product ID	Change to U.S. Price

## 18"H Tiles

18"	<b>ZSWE1820</b>	CA00037206	+\$25
24"	<b>ZSWE2420</b>	CA00029183	+\$27
30"	<b>ZSWE3020</b>	CA00028318	+\$30
36"	<b>ZSWE3620</b>	CA00021468	+\$32
42"	<b>ZSWE4220</b>	CA00027209	+\$37
48"	<b>ZSWE4820</b>	CA00021466	+\$39

## Details Slatwall/SlatRail Worktools

Tip: Details Worktools are available for use on Montage slatwall tiles. Contact: Details  
6100 East Paris Avenue  
5th Floor, Corporate Development Center  
Caledonia, MI 49316  
Telephone 1.800.833.0411  
Fax 1.256.230.6551

Tip: These Details slatwall/slatrail worktools **cannot** be used on Montage work-tool rail tiles specified prior to January 1997. And old Montage work-tool accessories **cannot** be used on the current slatwall tiles.

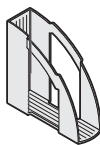

**Binder Holder**

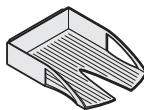

**Letter Tray**

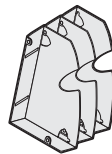

**Universal Shelf**

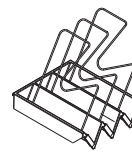

**PaperFlo Manager**

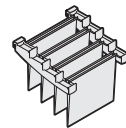

**Hanging Brackets**

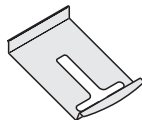

**Telephone Caddy**

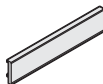

**TackStrip**

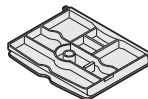

**Office in a File**

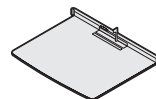

**Workboard**



**Pencil Cup**

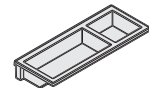

**Double Square Dish**

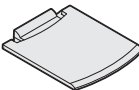

**Mini Shelf**

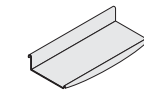

**Personal Shelf**



## For Canadian Pricing

Multiply U.S. Price by the Canadian price factor.

▶ See page 1 for details.

# 18"H Enhanced Glass Tile Packages

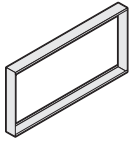

Tip: Frames with glass tile packages installed cannot support overhead storage components.

Tip: Glass tiles cannot be used at worksurface height in front of a worksurface.

Tip: The use of glass on the spine wall is limited to one row in an off-modular connection.

Tip: Enhanced tiles can be used on any enhanced frame, including monolithic frames, and any standard frames manufactured after July 2001.

Exception: Enhanced slat-wall tiles can be used on any standard frame regardless of manufacture dates.

Refer to compatibility tips.

▶ See *Montage Solutions Specification Guide*.

## What's Special

Tiles are available 18"H.

Standard Includes	Required to Specify
<ul style="list-style-type: none"> <li>Two transparent inserts: clear tempered glass</li> <li>Interior trim kit: paint</li> </ul>	<ol style="list-style-type: none"> <li>General quote number: <b>CA015125</b></li> <li>Style number and Product ID</li> <li>Paint color number for interior trim kit</li> <li>Options, if selected (see below)</li> </ol> See Surface Materials in Montage Solutions Specification Guide.

Options	U.S. Price	Required to Specify
<b>Glass Tile Pattern</b>	• Frosted	• +\$118
		Specify with 6530 Frosted Glass pattern.

## Specification Information

Width	Style Number	Product ID	Change to U.S. Price
-------	--------------	------------	----------------------

### 18"H Tiles

18"	<b>ZTGE1820</b>	CA00019902	+\$163
24"	<b>ZTGE2420</b>	CA00021302	+\$181
30"	<b>ZTGE3020</b>	CA00021303	+\$172
36"	<b>ZTGE3620</b>	CA00021304	+\$162
42"	<b>ZTGE4220</b>	CA00021305	+\$143
48"	<b>ZTGE4820</b>	CA00021306	+\$139

## Glass Tile Pattern

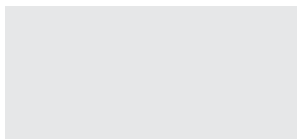

Frosted 6530



### For Canadian Pricing

Multiply U.S. Price by the Canadian price factor.

▶ See page 1 for details.

Standard Includes	Required to Specify
Tiles: wood, necessary to cover one side of panel frame	1 General quote number: <b>CA018025</b> 2 Style number and Product ID 3 Wood color number for tile surfaces 4 Options, if selected (see below) See Surface Materials in Montage Solutions Specification Guide.

Options	U.S. Price	Required to Specify
<b>Surface Materials</b>		
• Premium wood 2	Prices below and at right	Specify Premium wood 2 finish number.
• Premium wood 3	Prices below and at right	Specify Premium wood 2 finish number.
• Customiz stain	Prices below and at right	Specify with <i>Customiz stain</i> . ▶ See <i>Surface Materials Reference Manual</i> .

Specification Information				
Width	Style Number	Product ID	Change to U.S. Price	Options (Add \$ to Base Price)
:	:	:	:	<b>Premium Wood</b> : Customiz : Stain : Wood 2 : Wood 3 :

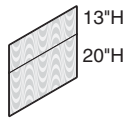

## 33"H Wood Tile Sets

### One 20"H Tile and One 13"H Tile

18"	<b>ZTWM1833</b>	SF00044542	+\$103	+\$130	+\$260	+\$26
24"	<b>ZTWM2433</b>	SF00044543	+\$103	+\$130	+\$260	+\$26
30"	<b>ZTWM3033</b>	SF00044544	+\$127	+\$218	+\$437	+\$44
36"	<b>ZTWM3633</b>	SF00044545	+\$155	+\$322	+\$645	+\$64
42"	<b>ZTWM4233</b>	SF00044546	+\$189	+\$322	+\$645	+\$64
48"	<b>ZTWM4833</b>	SF00044547	+\$221	+\$322	+\$645	+\$64

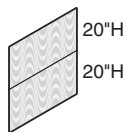

## 40"H Wood Tile Sets

### Two 20"H Tiles

18"	<b>ZTWM1840</b>	SF00044548	+\$145	+\$130	+\$260	+\$26
24"	<b>ZTWM2440</b>	SF00044549	+\$145	+\$130	+\$260	+\$26
30"	<b>ZTWM3040</b>	SF00044550	+\$168	+\$218	+\$437	+\$44
36"	<b>ZTWM3640</b>	SF00044551	+\$196	+\$322	+\$645	+\$64
42"	<b>ZTWM4240</b>	SF00044552	+\$232	+\$322	+\$645	+\$64
48"	<b>ZTWM4840</b>	SF00044553	+\$263	+\$322	+\$645	+\$64

▶ **Specification Information, continued on next page**

 **For Canadian Pricing**  
 Multiply U.S. Price by the Canadian price factor.  
 ▶ See page 1 for details.

► Specification Information, continued from previous page

**Specification Information**

Width	Style Number	Product ID	Change to U.S. Price	Options (Add \$ to Base Price)
				<b>Premium Wood</b> : Customiz : Stain : Wood 2 : Wood 3

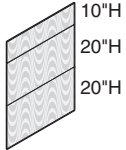

**50"H Wood Tile Sets**

**Two 20"H Tiles and One 10"H Tile**

18"	<b>ZTWM1850</b>	SF00044554	+\$299	+\$218	+\$ 437	+\$ 44
24"	<b>ZTWM2450</b>	SF00044555	+\$299	+\$218	+\$ 437	+\$ 44
30"	<b>ZTWM3050</b>	SF00044556	+\$367	+\$322	+\$ 645	+\$ 64
36"	<b>ZTWM3650</b>	SF00044557	+\$433	+\$322	+\$ 645	+\$ 64
42"	<b>ZTWM4250</b>	SF00044558	+\$513	+\$322	+\$ 645	+\$ 64
48"	<b>ZTWM4850</b>	SF00044559	+\$587	+\$452	+\$ 905	+\$ 90

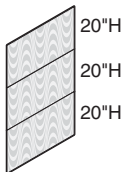

**60"H Wood Tile Sets**

**Three 20"H Tiles**

18"	<b>ZTWM1860</b>	SF00044560	+\$318	+\$322	+\$ 645	+\$ 64
24"	<b>ZTWM2460</b>	SF00044561	+\$318	+\$322	+\$ 645	+\$ 64
30"	<b>ZTWM3060</b>	SF00044562	+\$385	+\$322	+\$ 645	+\$ 64
36"	<b>ZTWM3660</b>	SF00044563	+\$453	+\$322	+\$ 645	+\$ 64
42"	<b>ZTWM4260</b>	SF00044564	+\$533	+\$452	+\$ 905	+\$ 90
48"	<b>ZTWM4860</b>	SF00044565	+\$610	+\$452	+\$ 905	+\$ 90

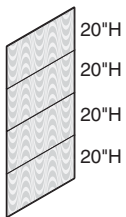

**80"H Wood Tile Sets**

**Four 20"H Tiles**

18"	<b>ZTWM1881</b>	SF00044566	+\$519	+\$322	+\$ 645	+\$ 64
24"	<b>ZTWM2481</b>	SF00044567	+\$519	+\$322	+\$ 645	+\$ 64
30"	<b>ZTWM3081</b>	SF00044568	+\$624	+\$452	+\$ 905	+\$ 90
36"	<b>ZTWM3681</b>	SF00044569	+\$729	+\$572	+\$1114	+\$114
42"	<b>ZTWM4281</b>	SF00044570	+\$840	+\$572	+\$1114	+\$114
48"	<b>ZTWM4881</b>	SF00044571	+\$934	+\$572	+\$1114	+\$114



**For Canadian Pricing**

Multiply U.S. Price by the Canadian price factor.

► See page 1 for details.

# Enhanced Wood Tile Sets

Full to the Floor

Enhanced Wood Tile Sets

Standard Includes	Required to Specify
Tiles: wood, necessary to cover one side of panel frame	1 General quote number: <b>CA018025</b> 2 Style number and Product ID 3 Wood color number for tile surfaces 4 Options, if selected (see below) See Surface Materials in Montage Solutions Specification Guide.

Options	U.S. Price	Required to Specify
<b>Surface Materials</b> <ul style="list-style-type: none"> <li>Premium wood 2</li> <li>Premium wood 3</li> <li>Customiz stain</li> </ul>	Prices below and at right Prices below and at right Prices below and at right	Specify Premium wood 2 finish number. Specify Premium wood 2 finish number. Specify with <i>Customiz stain</i> . ▶ See <i>Surface Materials Reference Manual</i> .

Specification Information				
Width	Style Number	Product ID	Change to U.S. Price	Options (Add \$ to Base Price)
				<b>Premium Wood</b> : Customiz Stain Wood 2 : Wood 3 :

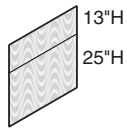

## 38"H Wood Full to the Floor Tile Sets

### One 25"H Tile and One 13"H Tile

18"	<b>ZTWM1833H</b>	SF00044572	+\$103	+\$125	+\$250	+\$26
24"	<b>ZTWM2433H</b>	SF00044573	+\$103	+\$125	+\$250	+\$26
30"	<b>ZTWM3033H</b>	SF00044574	+\$127	+\$210	+\$420	+\$44
36"	<b>ZTWM3633H</b>	SF00044575	+\$155	+\$310	+\$620	+\$64
42"	<b>ZTWM4233H</b>	SF00044576	+\$189	+\$310	+\$620	+\$64
48"	<b>ZTWM4833H</b>	SF00044577	+\$221	+\$310	+\$620	+\$64

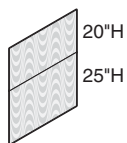

## 45"H Wood Full to the Floor Tile Sets

### One 25"H Tile and One 20"H Tile

18"	<b>ZTWM1840H</b>	SF00044578	+\$145	+\$125	+\$250	+\$26
24"	<b>ZTWM2440H</b>	SF00044579	+\$145	+\$125	+\$250	+\$26
30"	<b>ZTWM3040H</b>	SF00044580	+\$168	+\$210	+\$420	+\$44
36"	<b>ZTWM3640H</b>	SF00044581	+\$196	+\$310	+\$620	+\$64
42"	<b>ZTWM4240H</b>	SF00044582	+\$232	+\$310	+\$620	+\$64
48"	<b>ZTWM4840H</b>	SF00044583	+\$263	+\$310	+\$620	+\$64

▶ **Specification Information, continued on next page**

 **For Canadian Pricing**  
 Multiply U.S. Price by the Canadian price factor.  
 ▶ See page 1 for details.

► **Specification Information, continued from previous page**

**Specification Information**

Width	Style Number	Product ID	Change to U.S. Price	Options (Add \$ to Base Price)		
				<b>Premium Wood</b>	Customiz	
					Stain	
				Wood 2	Wood 3	

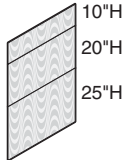

**55\"/>**

**One 25\"/>**

18"	<b>ZTWM1850H</b>	SF00044584	+\$299	+\$210	+\$420	+\$44
24"	<b>ZTWM2450H</b>	SF00044585	+\$299	+\$210	+\$420	+\$44
30"	<b>ZTWM3050H</b>	SF00044586	+\$367	+\$310	+\$620	+\$64
36"	<b>ZTWM3650H</b>	SF00044587	+\$433	+\$310	+\$620	+\$64
42"	<b>ZTWM4250H</b>	SF00044588	+\$513	+\$310	+\$620	+\$64
48"	<b>ZTWM4850H</b>	SF00044589	+\$587	+\$435	+\$870	+\$90

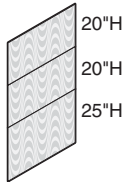

**65\"/>**

**One 25\"/>**

18"	<b>ZTWM1860H</b>	SF00044590	+\$318	+\$310	+\$ 620	+\$ 64
24"	<b>ZTWM2460H</b>	SF00044591	+\$318	+\$310	+\$ 620	+\$ 64
30"	<b>ZTWM3060H</b>	SF00044592	+\$385	+\$310	+\$ 620	+\$ 64
36"	<b>ZTWM3660H</b>	SF00044593	+\$453	+\$310	+\$ 620	+\$ 64
42"	<b>ZTWM4260H</b>	SF00044594	+\$533	+\$435	+\$ 870	+\$ 90
48"	<b>ZTWM4860H</b>	SF00044595	+\$610	+\$435	+\$ 870	+\$ 90

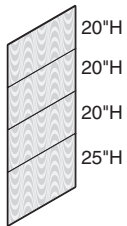

**85\"/>**

**One 25\"/>**

18"	<b>ZTWM1881H</b>	SF00044596	+\$519	+\$310	+\$ 620	+\$ 64
24"	<b>ZTWM2481H</b>	SF00044597	+\$519	+\$310	+\$ 620	+\$ 64
30"	<b>ZTWM3081H</b>	SF00044598	+\$624	+\$435	+\$ 870	+\$ 90
36"	<b>ZTWM3681H</b>	SF00044599	+\$729	+\$550	+\$1100	+\$114
42"	<b>ZTWM4281H</b>	SF00044600	+\$840	+\$550	+\$1100	+\$114
48"	<b>ZTWM4881H</b>	SF00044601	+\$934	+\$550	+\$1100	+\$114



**For Canadian Pricing**

Multiply U.S. Price by the Canadian price factor.

► See page 1 for details.

# Adjustable Cantilever

For Use with Montage Frames

Adjustable Cantilever

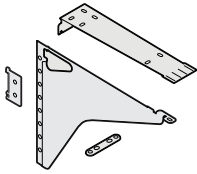

*Tip: Cantilever works in on-module vertical upright situations only.*

*Tip: Cantilever provides (+) or (-) 2" from standard 28½" worksurface height.*

Standard Includes	Required to Specify
-------------------	---------------------

- Cantilever: paint
- Tie plate
- Attachment hardware

- 1 General quote number: **CA015126**
  - 2 Style number and Product ID
  - 3 Paint color number for cantilevers
- See Surface Materials in Montage Solutions Specification Guide.

Specification Information		
Style Number	Product ID	Change to U.S. Price
ZUCANT	CA00022778	+\$151

### What's Special

*Adjustable cantilever is designed for use with frames with desk cavity below worksurface.*



**For Canadian Pricing**  
 Multiply U.S. Price by the Canadian price factor.  
 ▶ See page 1 for details.

# Enhanced Monolithic Frames with Desk Cavity Below Worksurface

Standard Includes	Required to Specify
<ul style="list-style-type: none"> <li>• Frame: paint</li> <li>• Top cap: all paint price groups</li> <li>• Base cavity</li> <li>• Desk-height cavity, if selected</li> <li>• In-line connector hardware</li> </ul>	<ol style="list-style-type: none"> <li>1 General quote number: <b>CA015126</b></li> <li>2 Style number and Product ID</li> <li>3 Frame color number (see options below)</li> <li>4 Paint color number for top cap</li> <li>5 Options, if selected (see below)</li> </ol> See Surface Materials in Montage Solutions Specification Guide.

Tip: Frame is available in black, sterling or platinum only. You must select a finish.

Tip: Enhanced monolithic frames accommodate enhanced monolithic tiles or enhanced segmented tiles. A horizontal filler strip, ordered separately, must be used at each location where tile segmentation occurs.

Tip: Desk-height cavity can be covered with a 20"H tile. Tile cannot be slatwall, high-performance acoustical, or perforated non-tackable.

Tip: Montage frames do not accept overheads or shelves on any base frame below 65"H.

Options	U.S. Price	Required to Specify
<b>Surface Materials</b> <ul style="list-style-type: none"> <li>• Paint price group 1</li> <li>• Paint price group 2</li> <li>• Paint price group 3</li> </ul>	No cost +\$41 +\$52	Specify paint color number. Specify paint color number. Specify paint color number.
<b>Top Cap</b> <ul style="list-style-type: none"> <li>• Omit top cap</li> </ul>	No cost	Specify <i>omit top cap</i> .

## Specification Information

### 38"H Monolithic



with base and desk-height cavities

### 45"H Monolithic

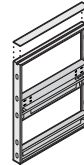

with base and desk-height cavities

Width	Style Number	Product ID	Change to U.S. Base Price	Style Number	Product ID	Change to U.S. Base Price
-------	--------------	------------	---------------------------	--------------	------------	---------------------------

## What's Special

Desk cavity of frame is located beneath worksurface height.

Tip: Frame accepts 13"H tile and desk cavity cover (with-out tray) in lower segment.

## With Base and Desk-Height Cavities

18"	<b>ZFM1838DC</b>	CA00037081	+\$10	<b>ZFM1845DC</b>	CA00036743	+\$10
24"	<b>ZFM2438DC</b>	CA00037082	+\$10	<b>ZFM2445DC</b>	CA00030685	+\$10
30"	<b>ZFM3038DC</b>	CA00032948	+\$10	<b>ZFM3045DC</b>	CA00030679	+\$10
36"	<b>ZFM3638DC</b>	CA00032947	+\$10	<b>ZFM3645DC</b>	CA00030680	+\$10
42"	<b>ZFM4238DC</b>	CA00032946	+\$10	<b>ZFM4245DC</b>	CA00030681	+\$10
48"	<b>ZFM4838DC</b>	CA00032945	+\$10	<b>ZFM4845DC</b>	CA00030682	+\$10

► Specification Information, continued on next page



## For Canadian Pricing

Multiply U.S. Price by the Canadian price factor.

► See page 1 for details.



► **Specification Information, continued from previous page**

**Specification Information**

**55"H Monolithic**

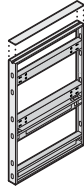

with base and  
desk-height  
cavities

**65"H Monolithic**

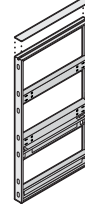

with base and  
desk-height  
cavities

•Width	•Style Number	•Product ID	•Change to U.S. Base Price	•Style Number	•Product ID	•Change to U.S. Base Price
18"	<b>ZFM1855DC</b>	CA00037083	+\$10	<b>ZFM1865DC</b>	CA00037351	+\$10
24"	<b>ZFM2455DC</b>	CA00034554	+\$10	<b>ZFM2465DC</b>	CA00032364	+\$10
30"	<b>ZFM3055DC</b>	CA00031588	+\$10	<b>ZFM3065DC</b>	CA00037376	+\$10
36"	<b>ZFM3655DC</b>	CA00033841	+\$10	<b>ZFM3665DC</b>	CA00037380	+\$10
42"	<b>ZFM4255DC</b>	CA00034501	+\$10	<b>ZFM4265DC</b>	CA00037382	+\$10
48"	<b>ZFM4855DC</b>	CA00035025	+\$10	<b>ZFM4865DC</b>	CA00032146	+\$10



**For Canadian Pricing**  
Multiply U.S. Price by the  
Canadian price factor.  
► See page 1 for details.

# Enhanced Standard Frames with Desk Cavity Below Worksurface

Standard Includes	Required to Specify
<ul style="list-style-type: none"> <li>• Frame: paint</li> <li>• Top cap: all paint price groups</li> <li>• Base cavity</li> <li>• Desk-height cavity, if selected</li> <li>• In-line connector hardware</li> </ul>	1 General quote number: <b>CA015126</b> 2 Style number and Product ID 2 Frame color number (see options below) 3 Paint color number for top cap 4 Options, if selected (see below) See Surface Materials in Montage Solutions Specification Guide.

*Tip: Desk-height cavity can be covered with a 20"H tile. Tile cannot be slatwall, high-performance acoustical, or perforated non-tackable.*

*Tip: Frame accepts 13"H tile and desk cavity cover (without tray) in lower 20"H segment.*

*Tip: Frame is available in black, sterling or platinum only. You must select a finish.*

*Tip: Montage frames do not accept overheads or shelves on any base frame below 65"H.*

Options	U.S. Price	Required to Specify
<b>Surface Materials</b> <ul style="list-style-type: none"> <li>• Paint price group 1</li> <li>• Paint price group 2</li> <li>• Paint price group 3</li> </ul>	No cost +\$41 +\$52	Specify paint color number. Specify paint color number. Specify paint color number.
<b>Top Cap</b> <ul style="list-style-type: none"> <li>• Omit top cap</li> </ul>	No cost	Specify <i>omit top cap</i> .

## Specification Information

**38"H Monolithic**

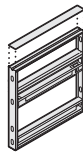

with base and desk-height cavities

**45"H Monolithic**

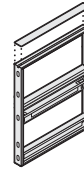

with base and desk-height cavities

### What's Special

Desk cavity of frame is located beneath worksurface height.

Width	Style Number	Product ID	Change to U.S. Base Price	Style Number	Product ID	Change to U.S. Base Price
-------	--------------	------------	---------------------------	--------------	------------	---------------------------

### With Base and Desk-Height Cavities

18"	<b>ZFE1838DC</b>	CA00037392	+\$10	<b>ZFE1845DC</b>	CA00037406	+\$10
24"	<b>ZFE2438DC</b>	CA00037395	+\$10	<b>ZFE2445DC</b>	CA00021858	+\$10
30"	<b>ZFE3038DC</b>	CA00037396	+\$10	<b>ZFE3045DC</b>	CA00025124	+\$10
36"	<b>ZFE3638DC</b>	CA00021660	+\$10	<b>ZFE3645DC</b>	CA00021859	+\$10
42"	<b>ZFE4238DC</b>	CA00021232	+\$10	<b>ZFE4245DC</b>	CA00037417	+\$10
48"	<b>ZFE4838DC</b>	CA00021233	+\$10	<b>ZFE4845DC</b>	CA00021861	+\$10

► **Specification Information, continued on next page**



#### For Canadian Pricing

Multiply U.S. Price by the Canadian price factor.

► See page 1 for details.

► **Specification Information, continued from previous page**

**Specification Information**

**55"H Monolithic**

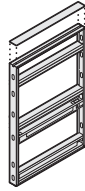

with base and  
desk-height  
cavities

**65"H Monolithic**

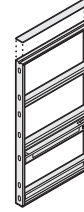

with base and  
desk-height  
cavities

• Width	• Style Number	• Product ID	• Change to U.S. Base Price	• Style Number	• Product ID	• Change to U.S. Base Price
18"	<b>ZFE1855DC</b>	CA00037477	+\$10	<b>ZFE1865DC</b>	CA00037483	+\$10
24"	<b>ZFE2455DC</b>	CA00037478	+\$10	<b>ZFE2465DC</b>	CA00027103	+\$10
30"	<b>ZFE3055DC</b>	CA00037479	+\$10	<b>ZFE3065DC</b>	CA00022795	+\$10
36"	<b>ZFE3655DC</b>	CA00037480	+\$10	<b>ZFE3665DC</b>	CA00021901	+\$10
42"	<b>ZFE4255DC</b>	CA00037481	+\$10	<b>ZFE4265DC</b>	CA00021899	+\$10
48"	<b>ZFE4855DC</b>	CA00037482	+\$10	<b>ZFE4865DC</b>	CA00021900	+\$10



**For Canadian Pricing**  
Multiply U.S. Price by the  
Canadian price factor.  
► See page 1 for details.

# Enhanced Off-Module Frames with Desk Cavity Below Worksurface

Standard Includes	Required to Specify
<ul style="list-style-type: none"> <li>• Frame: paint</li> <li>• Top cap: all paint price groups</li> <li>• Base cavity</li> <li>• Desk-height cavity, if selected</li> <li>• In-line connector hardware</li> </ul>	<ol style="list-style-type: none"> <li>1 General quote number: <b>CA015126</b></li> <li>2 Style number and Product ID</li> <li>2 Paint color number for top cap</li> <li>3 Options, if selected (see below)</li> </ol> See Surface Materials in Montage Solutions Specification Guide.

*Tip: Desk-height cavity can be covered with a 20"H tile. Tile cannot be slatwall, high-performance acoustical, or perforated non-tackable.*

	Options	U.S. Price	Required to Specify
<b>Surface Materials</b>	<ul style="list-style-type: none"> <li>• Paint price group 1</li> <li>• Paint price group 2</li> <li>• Paint price group 3</li> </ul>	No cost +\$41 +\$52	Specify paint color number. Specify paint color number. Specify paint color number.
<b>Top Cap</b>	<ul style="list-style-type: none"> <li>• Omit top cap</li> </ul>	No cost	Specify <i>omit top cap</i> .

*Tip: Frame accepts 13"H tile and desk cavity cover (with-out tray) in lower 20"H segment.*

## Specification Information

*Tip: Frame is available in black, sterling or platinum only. You must select a finish.*

*Tip: Montage frames do not accept overheads or shelves on any base frame below 65"H.*

### 38"H Monolithic

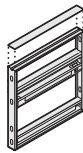

with base and desk-height cavities

### 45"H Monolithic

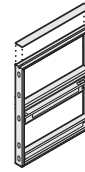

with base and desk-height cavities

### What's Special

*Desk cavity of frame is located beneath worksurface height.*

Width	Style Number	Product ID	Change to U.S. Base Price	Style Number	Product ID	Change to U.S. Base Price
-------	--------------	------------	---------------------------	--------------	------------	---------------------------

### With Base and Desk-Height Cavities

18"	<b>ZFOM1838DC</b>	CA00037485	+\$10	<b>ZFOM1845DC</b>	CA00037486	+\$10
24"	<b>ZFOM2438DC</b>	CA00037487	+\$10	<b>ZFOM2445DC</b>	CA00037488	+\$10
30"	<b>ZFOM3038DC</b>	CA00037489	+\$10	<b>ZFOM3045DC</b>	CA00037491	+\$10
36"	<b>ZFOM3638DC</b>	CA00037490	+\$10	<b>ZFOM3645DC</b>	CA00032392	+\$10
42"	<b>ZFOM4238DC</b>	CA00037492	+\$10	<b>ZFOM4245DC</b>	CA00037493	+\$10
48"	<b>ZFOM4838DC</b>	CA00037494	+\$10	<b>ZFOM4845DC</b>	CA00032548	+\$10

► **Specification Information, continued on next page**



### For Canadian Pricing

Multiply U.S. Price by the Canadian price factor.

► See page 1 for details.

► **Specification Information, continued from previous page**

**Specification Information**

**55"H Three-High**

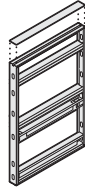

with base and  
desk-height  
cavities

**65"H Three-High**

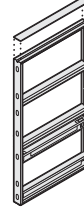

with base and  
desk-height  
cavities

Width	Style Number	Product ID	Change to U.S. Base Price	Style Number	Product ID	Change to U.S. Base Price
18"	<b>ZFOM1855DC</b>	CA00037495	+\$10	<b>ZFOM1865DC</b>	CA00037484	+\$10
24"	<b>ZFOM2455DC</b>	CA00037496	+\$10	<b>ZFOM2465DC</b>	CA00030902	+\$10
30"	<b>ZFOM3055DC</b>	CA00037497	+\$10	<b>ZFOM3065DC</b>	CA00032355	+\$10
36"	<b>ZFOM3655DC</b>	CA00037498	+\$10	<b>ZFOM3665DC</b>	CA00030917	+\$10
42"	<b>ZFOM4255DC</b>	CA00033207	+\$10	<b>ZFOM4265DC</b>	CA00021903	+\$10
48"	<b>ZFOM4855DC</b>	CA00037499	+\$10	<b>ZFOM4865DC</b>	CA00021902	+\$10



**For Canadian Pricing**  
Multiply U.S. Price by the  
Canadian price factor.  
► See page 1 for details.

# On-Module Cantilever for use with Duo Storage

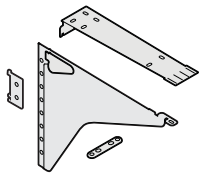

## What's Special

Cantilever for use with Duo Storage.

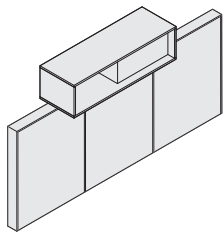

*Tip: Duo mounted on top of Montage frames using standard brackets.*

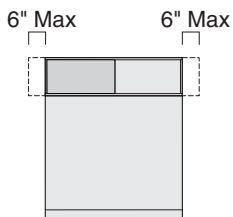

*Tip: For standard bracket applications, Duo cabinet must match width of panels and span at least 2 panel seams with a maximum overhang of 6" on both or either end. For standard brackets, specify ZTTBRK-TFP from the Montage Solutions Specification Guide.*

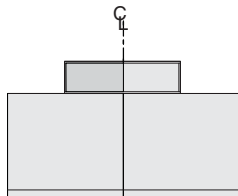

*Tip: For special bracket applications, panel seam must be located at the center point of the Duo cabinet.*

## Standard Includes

- Cantilever: paint
- Tie plate
- Attachment hardware

## Required to Specify

- 1 General quote number: **CA015291**
  - 2 Style number and Product ID
  - 3 Paint color number for cantilevers
- See Surface Materials in Montage Solutions Specification Guide.

## Specification Information

Style Number	Product ID	Change to U.S. Price
ZUCANT	CA00035341	+\$67

---

# Post and Beam

▶ See page 3, *About Design Options*, in the front of this book for pricing and ordering restrictions.

<b>Understanding</b>	<b>128</b>
Recommended Harness Lengths	<b>130</b>

<b>Specifying</b>	
Power Beams	<b>132</b>
Junction Guards	<b>133</b>
Vertical Chases	<b>134</b>
Conversion Hardware for c:scape Privacy Screen	<b>135</b>

# Post and Beam Special Enhancements

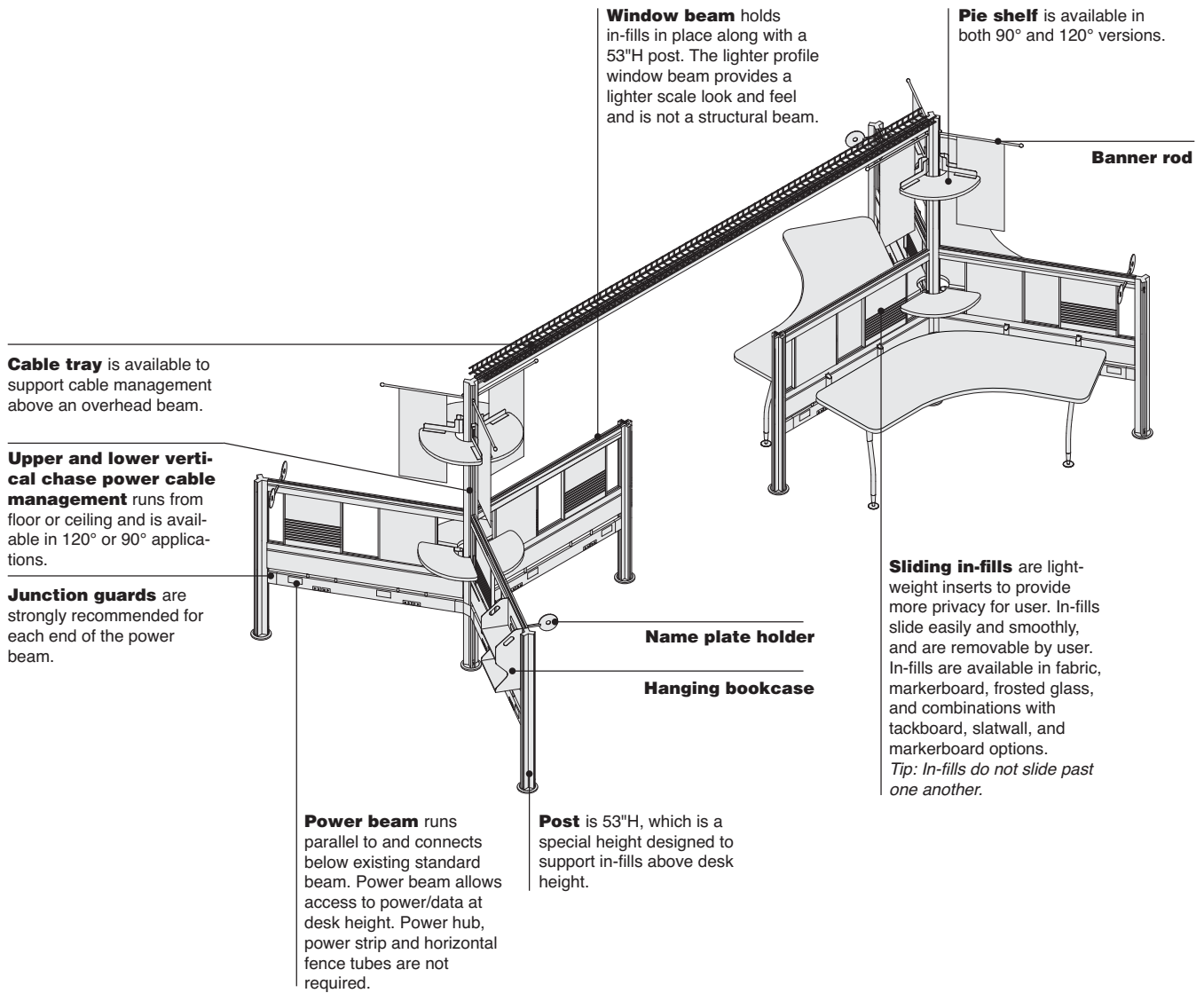





# Recommended Harness Lengths

Tip: Items shown with a Product I.D. are special. They must be submitted through In2 for a special quote.

## 3+1 In-line Harnesses For Use Around Posts

Actual	Description Dimensions	Style Number	Product I.D.
18"	Harness for around post (4' to 4')	N.A.	SF00172748
24"	Harness for around post (4' to 5')	N.A.	SF00213727
28"	Harness for around post (4' to 6')	GSGUH28X	
28"	Harness for around post (4' to 7')	GSGUH28X	
28"	Harness for around post (4' to 8')	GSGUH28X	
30"	Harness for around post (5' to 5')	GSGUH32X	
34"	Harness for around post (5' to 6')	N.A.	SF00206889
34"	Harness for around post (5' to 7')	N.A.	SF00206889
34"	Harness for around post (5' to 8')	N.A.	SF00206889
38"	Harness for around post (6' to 6')	GSGUH38X	
38"	Harness for around post (6' to 7')	GSGUH38X	
38"	Harness for around post (6' to 8')	GSGUH38X	
38"	Harness for around post (7' to 7')	GSGUH38X	
38"	Harness for around post (7' to 8')	GSGUH38X	
38"	Harness for around post (8' to 8')	GSGUH38X	

## 2+2 In-line Harnesses For Use Around Posts

Actual	Description Dimensions	Style Number	Product I.D.
18"	Harness for around post (4' to 4')	N.A.	SF00183824
24"	Harness for around post (4' to 5')	N.A.	SF00209094
28"	Harness for around post (4' to 6')	GSGUH28Y	
28"	Harness for around post (4' to 7')	GSGUH28Y	
28"	Harness for around post (4' to 8')	GSGUH28Y	
30"	Harness for around post (5' to 5')	GSGUH32Y	
34"	Harness for around post (5' to 6')	N.A.	SF00211666
34"	Harness for around post (5' to 7')	N.A.	SF00211666
34"	Harness for around post (5' to 8')	N.A.	SF00211666
38"	Harness for around post (6' to 6')	GSGUH38Y	
38"	Harness for around post (6' to 7')	GSGUH38Y	
38"	Harness for around post (6' to 8')	GSGUH38Y	
38"	Harness for around post (7' to 7')	GSGUH38Y	
38"	Harness for around post (7' to 8')	GSGUH38Y	
38"	Harness for around post (8' to 8')	GSGUH38Y	

Tip: Data covers, jacks, and cable are not included.

**3+1 90 Degrees and 120 Degrees For Use Around Posts**

Actual	Description Dimensions	Style Number	Product I.D.
14"	Harness for around post (4' to 4')	N.A.	SF00172777
20"	Harness for around post (4' to 5')	N.A.	SF00213727
24"	Harness for around post (4' to 6')	N.A.	SF00213727
24"	Harness for around post (4' to 7')	N.A.	SF00213727
24"	Harness for around post (4' to 8')	GSGUH28X	
26"	Harness for around post (5' to 5')	GSGUH32X	
30"	Harness for around post (5' to 6')	GSGUH32X	
30"	Harness for around post (5' to 7')	GSGUH32X	
30"	Harness for around post (5' to 8')	N.A.	SF00206889
34"	Harness for around post (6' to 6')	N.A.	SF00206889
34"	Harness for around post (6' to 7')	N.A.	SF00206889
34"	Harness for around post (6' to 8')	N.A.	SF00206889
34"	Harness for around post (7' to 7')	N.A.	SF00206889
34"	Harness for around post (7' to 8')	N.A.	SF00206889
34"	Harness for around post (8' to 8')	N.A.	SF00206889

**2+2 90 Degrees and 120 Degrees For Use Around Posts**

Actual	Description Dimensions	Style Number	Product I.D.
14"	Harness for around post (4' to 4')	N.A.	SF00183823
20"	Harness for around post (4' to 5')	N.A.	SF00209094
24"	Harness for around post (4' to 6')	GSGUH23P5Y	
24"	Harness for around post (4' to 7')	GSGUH23P5Y	
24"	Harness for around post (4' to 8')	GSGUH28Y	
26"	Harness for around post (5' to 5')	GSGUH32Y	
30"	Harness for around post (5' to 6')	GSGUH32Y	
30"	Harness for around post (5' to 7')	GSGUH32Y	
30"	Harness for around post (5' to 8')	N.A.	SF00211666
34"	Harness for around post (6' to 6')	N.A.	SF00211666
34"	Harness for around post (6' to 7')	N.A.	SF00211666
34"	Harness for around post (6' to 8')	N.A.	SF00211666
34"	Harness for around post (7' to 7')	N.A.	SF00211666
34"	Harness for around post (7' to 8')	N.A.	SF00211666
34"	Harness for around post (8' to 8')	N.A.	SF00211666

Tip: Data covers, jacks, and cable are not included.

# Power Beams

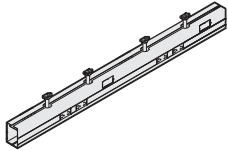

Tip: Line 1, Line 2, Line 3, and Line 4 are from left to right when facing beam.

Tip: The internal harness that connects the two internal power blocks is included. The harness that connects the power beams to each other are specified separately.

Tip: Power beams run parallel to and underneath standard beams and should be ordered the same length as the standard beam.

Tip: Power beam is used with a standard beam, and is designed for at desk-height applications.

Tip: Junction guards are specified separately. Power hub, power strip, and horizontal fence tube are not required.

Tip: Voice/data blocks, covers, and cables are not supplied.

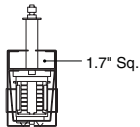

Tip: Use dimensions to help calculate cable capacity.

## Standard Includes

- Power beam: 7018 Pewter paint only
- Internal harness receptacle block: black only
- Attachment hardware
- Receptacles

## Required to Specify

- 1 General quote number: **SF095944**
- 2 Style number and Product ID

## Specification Information

Dimension Length	Style Number	Product ID	U.S. Price
------------------	--------------	------------	------------

### Power Beams, 3 + 1

#### Power on One Side

4'	<b>SPFURN</b>	SF00166794	\$ 950
5'	<b>SPFURN</b>	SF00166041	\$ 965
6'	<b>SPFURN</b>	SF00166795	\$ 980
7'	<b>SPFURN</b>	SF00166797	\$ 995
8'	<b>SPFURN</b>	SF00166799	\$1010

#### Power on Both Side

4'	<b>SPFURN</b>	SF00166793	\$1000
5'	<b>SPFURN</b>	SF00165821	\$1015
6'	<b>SPFURN</b>	SF00165815	\$1030
7'	<b>SPFURN</b>	SF00168616	\$1045
8'	<b>SPFURN</b>	SF00166798	\$1060

### Power Beams, 2 + 2

#### Power on One Side

4'	<b>SPFURN</b>	SF00174390	\$ 950
5'	<b>SPFURN</b>	SF00171995	\$ 965
6'	<b>SPFURN</b>	SF00174212	\$ 980
7'	<b>SPFURN</b>	SF00174396	\$ 995
8'	<b>SPFURN</b>	SF00174399	\$1010

#### Power on Both Side

4'	<b>SPFURN</b>	SF00174389	\$1000
5'	<b>SPFURN</b>	SF00171996	\$1015
6'	<b>SPFURN</b>	SF00174394	\$1030
7'	<b>SPFURN</b>	SF00174395	\$1045
8'	<b>SPFURN</b>	SF00174397	\$1060



### For Canadian Pricing

Multiply U.S. Price by the Canadian price factor.

▶ See page 1 for details.

*Tip: Junction guards must be specified whenever a power beam is specified to cover the gap between the power beam and post.*

*Tip: Junction guards are recommended at the end of each power beam.*



*Tip: End-of-run guard is a left-hand and a right-hand junction guard welded together.*



Standard Includes	Required to Specify
<ul style="list-style-type: none"> <li>• Junction guard: 7018 Pewter paint only</li> <li>• Attachment hardware</li> </ul>	<ul style="list-style-type: none"> <li>1 General quote number: <b>SF095944</b></li> <li>2 Style number and Product ID</li> </ul>

### Specification Information

• Style Number	• Product ID	• U.S. Price
----------------	--------------	--------------

#### End-of-Run, Left-Hand Junction Guard

<b>SPFURN</b>	SF00165260	\$ 88
---------------	------------	-------

#### End-of-Run, Right-Hand Junction Guard

<b>SPFURN</b>	SF00165262	\$ 88
---------------	------------	-------

#### End-of-Run Guard

<b>SPFURN</b>	SF00167906	\$ 96
---------------	------------	-------

#### End-of-Run Guard for use with Upper Chase

<b>SPFURN</b>	SF00178430	\$246
---------------	------------	-------

#### In-Line Junction Guard

<b>SPFURN</b>	SF00163886	\$ 96
---------------	------------	-------

#### 120° Junction Guard

<b>SPFURN</b>	SF00165263	\$116
---------------	------------	-------

#### 90° Junction Guard

<b>SPFURN</b>	SF00164623	\$132
---------------	------------	-------

**For Canadian Pricing**  
 Multiply U.S. Price by the Canadian price factor.  
 ▶ See page 1 for details.

# Vertical Chases

Tip: 120° and 90° vertical chases are designed for use with 33"H fence height. Vertical chases attach to post and are positioned directly above junction guard.

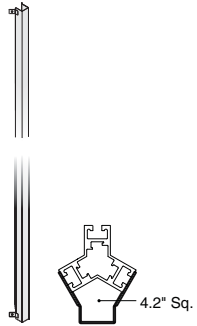

Tip: Use dimensions to help calculate cable capacity.

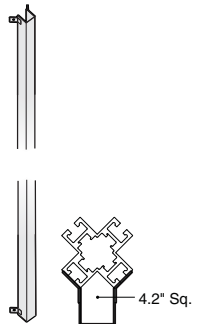

Tip: Use dimensions to help calculate cable capacity.

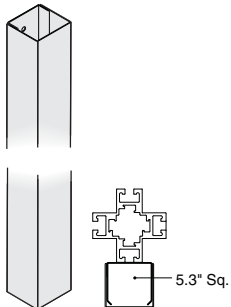

Tip: Use dimensions to help calculate cable capacity.

Tip: Lower vertical chase can be used with both X- and Y-posts.

Standard Includes	Required to Specify
-------------------	---------------------

- Vertical chase: 7018 Pewter paint only
- Attachment hardware

- 1 General quote number: **SF095944**
- 2 Style number and Product ID

Specification Information			
Height	Style Number	Product ID	U.S. Price

120° Upper Vertical Chase			
---------------------------	--	--	--

70 <sup>2</sup> / <sub>3</sub> "	<b>SPFURN</b>	SF00167447	\$275
:	:	:	:

90° Upper Vertical Chase			
--------------------------	--	--	--

70 <sup>2</sup> / <sub>3</sub> "	<b>SPFURN</b>	SF00170559	\$275
:	:	:	:

Lower Vertical Chase			
----------------------	--	--	--

	<b>SPFURN</b>	SF00164622	\$168
:	:	:	:

# Conversion Hardware for c:scape Privacy Screen

Conversion Hardware for  
c:scape Privacy Screen

Post and Beam

Standard Includes	Required to Specify
<ul style="list-style-type: none"> <li>• Mounting plates</li> <li>• Necessary hardware</li> </ul>	1 General quote number: <b>CA127665</b> 2 Style number and Product ID

Specification Information		
Style Number	Product I.D.	Change to U.S. Price
<b>TS714WSP</b>	SF00212185	+\$30

*Tip: c:scape screen NOT included. Order standard screen from the c:scape specification guide.*

*Tip: Fixed personal/modesty screens are standard in sizes 30", 36", and 42"W with the required fixed bracket and will accept this special bracket package without and additional modification.*

*Tip: Larger width screens are available in 48", 60", and 72"W but must be quoted as a special to have the "fixed brackets" in order to accept our special bracket package.*



**For Canadian Pricing**  
 Multiply U.S. Price by the  
 Canadian price factor.  
 ▶ See page 1 for details.





---

# Kick

▶ See page 3, *About Design Options*, in the front of this book for pricing and ordering restrictions.

**Straight Worksurfaces**

**138**

Kick

# Straight Worksurfaces

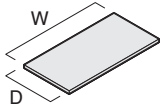

*Tip: Reinforcing channel (TSATRC57) is available to add support to worksurfaces that have 60" or more of unsupported kneespace and which will be heavily loaded. Must be ordered separately.*  
 ▶ See Turnstone 1.0 Furniture Specification Guide.

## What's Special

Straight worksurfaces are available in different widths.

*Tip: Standard worksurfaces are 1 1/8" thick. However, the actual thickness between Low-Pressure Laminate (LPL) and High-Pressure Laminate (HPL) worksurfaces is slightly different. It is recommended that only worksurfaces of the same type are specified in a given application. In addition, there may be sheen or texture differences when using LPL and HPL in adjacent applications. Please use caution when mixing and matching different worksurface types.*

Standard Includes	Required to Specify
<ul style="list-style-type: none"> <li>• 1 1/8"-thick worksurface: Low-Pressure Laminate or High-Pressure Laminate</li> <li>• 3 mm radius profile edge on user's side: plastic</li> <li>• Side and back edges: plastic default to match user's side</li> </ul>	<ol style="list-style-type: none"> <li>1 General quote number: <b>SF099872</b></li> <li>2 Style number and Product ID</li> <li>3 Low-Pressure Laminate or High-Pressure Laminate color number for worksurface, as appropriate</li> <li>4 Plastic edge band color number for worksurface</li> <li>5 Options, if selected (see below)</li> </ol> See Surface Materials in the Turnstone 1.0 Specification Guide

Options	U.S. Price	Required to Specify
<b>Surface Materials</b> High-Pressure Laminate worksurfaces • Open Line laminate	+\$64 plus cost of laminate	▶ See <i>Surface Materials Reference Manual</i> .

## Specification Information

Dimensions		Style	Product ID	Change to
D	W	Number		U.S. Price
<b>Low-Pressure Laminate</b>				
18"	78"	<b>TSAWLR1872</b>	SF00181739	+\$130
18"	84"	<b>TSAWLR1872</b>	SF00186798	+\$149
18"	90"	<b>TSAWLR1872</b>	SF00186799	+\$169
18"	96"	<b>TSAWLR1872</b>	SF00186800	+\$188
24"	78"	<b>TSAWLR2472</b>	SF00177416	+\$137
24"	84"	<b>TSAWLR2472</b>	SF00177415	+\$155
24"	90"	<b>TSAWLR2472</b>	SF00177594	+\$178
24"	96"	<b>TSAWLR2472</b>	SF00177414	+\$200
30"	78"	<b>TSAWLR3072</b>	SF00177411	+\$137
30"	84"	<b>TSAWLR3072</b>	SF00177413	+\$164
30"	90"	<b>TSAWLR3072</b>	SF00178385	+\$191
30"	96"	<b>TSAWLR3072</b>	SF00177317	+\$218

▶ **Specification Information, continued on next page**



**For Canadian Pricing**  
 Multiply U.S. Price by the Canadian price factor.  
 ▶ See page 1 for details.

► **Specification Information, continued from previous page**

**Specification Information**

Dimensions		Style Number	Product ID	Change to U.S. Price
D	W			

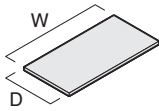

**High-Pressure Laminate**

18"	78"	<b>TSAWHR1872</b>	SF00186801	+\$138
18"	84"	<b>TSAWHR1872</b>	SF00186802	+\$167
18"	90"	<b>TSAWHR1872</b>	SF00186803	+\$195
18"	96"	<b>TSAWHR1872</b>	SF00186804	+\$224
24"	78"	<b>TSAWHR2472</b>	SF00179782	+\$139
24"	84"	<b>TSAWHR2472</b>	SF00178278	+\$169
24"	90"	<b>TSAWHR2472</b>	SF00184367	+\$198
24"	96"	<b>TSAWHR2472</b>	SF00178459	+\$227
30"	78"	<b>TSAWHR3072</b>	SF00176822	+\$143
30"	84"	<b>TSAWHR3072</b>	SF00176825	+\$177
30"	90"	<b>TSAWHR3072</b>	SF00176823	+\$210
30"	96"	<b>TSAWHR3072</b>	SF00176824	+\$243

KICK



**For Canadian Pricing**  
 Multiply U.S. Price by the  
 Canadian price factor.  
 ► See page 1 for details.



---

# Wood Casegoods

▶ See page 3, *About Design Options*, in the front of this book for pricing and ordering restrictions.

## Walden

Bullet-Shape Tables	142
P-Shape Tables	143
Curved Corner Unit	144
Returns	146
Kneewell Credenzas	148
Reception/Transaction Stacker Unit	150
Wall-Mount Overhead Cabinets	151
Light Valances	152
Wardrobes and Towers	154
FSC Core	156

## Garland

Bullet and P-Shape Tables	157
Curved Corner Unit	158
Returns	160
Kneewell Credenzas	162
Reception/Transaction Stacker Unit	164
Wall-Mount Overhead Cabinets	165
Light Valances	166
Wardrobes and Towers	168

## Currency

Rectangular Desk Shells	170
Return Shells	171
Wall-Mounted Overhead Storage Cabinets	172
Bookcases	173

# Bullet-Shape Tables

With 18"H Modesty Panel

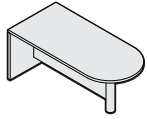
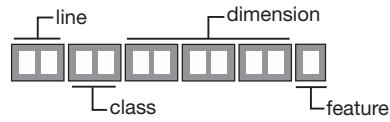

Tip: Ships knocked down.

Tip: Bullet-shape tables must be attached to a bridge or return for stability.

## What's Special

Bullet-shape tables have a modesty panel of 18"H.

Standard Includes	Required to Specify
<ul style="list-style-type: none"> <li>• Worksurface, end panel, and modesty panel: wood</li> <li>• Column support: painted or plated metal</li> </ul>	<ol style="list-style-type: none"> <li>1 General quote number: <b>GW047624</b></li> <li>2 Style number and Product ID</li> <li>3 Wood color number for worksurface, end panel, and modesty panel</li> <li>4 Worksurface profile (see below under Required Selections)</li> <li>5 Column support color number</li> <li>6 Options, if selected (see below)</li> </ol> See Surface Materials in the Wood Casegoods and Tables Specification Guide.

## Required Selections (No Additional Cost)

### Worksurface Edge Profiles

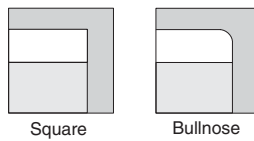

Options	U.S. Price	Required to Specify
<b>Surface Materials</b> • <b>Wood veneer worksurface</b> • Customiz stain on worksurface and panels • Full-fill finish • <b>Laminate worksurface</b> • Customiz stain on panels	Prices below    Prices below  Prices below	Specify with <i>Customiz stain</i> . ▶ See <i>Surface Materials Reference Manual</i> . Specify full-fill finish number.   Specify with <i>Customiz stain</i> .
<b>Cable Management</b> • Round grommets  • Flip up power units	+\$ 66 each  +\$281 each	Left: Specify with <i>EGRL</i> and color number. Right: Specify with <i>EGRR</i> and color number.  Left: Specify with <i>VPFL</i> and color number. Right: Specify with <i>VPFR</i> and color number.
<b>Disc Column</b> • Disk column	+\$231	Specify with <i>disk column</i> .

## Specification Information

Dimensions D W H	Style Number	Product ID	Change to U.S. Base Prices	Options (Add \$ to Base Price)
.....	.....	.....	.....	.....
.....	.....	.....	.....	.....
.....	.....	.....	.....	.....
.....	.....	.....	.....	.....
.....	.....	.....	.....	.....
.....	.....	.....	.....	.....
.....	.....	.....	.....	.....

## T B Bullet-Shape Tables

30"	60"	28 <sup>5</sup> / <sub>8</sub> "	<b>WLTB3060</b>	GW00093467	+\$435	+\$77	+\$32	+\$90
36"	72"	28 <sup>5</sup> / <sub>8</sub> "	<b>WLTB3672</b>	GW00093468	+\$453	+\$77	+\$32	+\$90
.....	.....	.....	.....	.....	.....	.....	.....	.....



**For Canadian Pricing**  
 Multiply U.S. Price by the Canadian price factor.  
 ▶ See page 1 for details.

# P-Shape Tables

With 42" Diameter

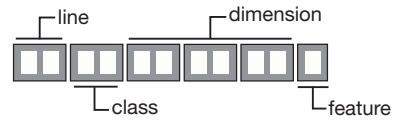

Tip: Ships knocked down.

Tip: Bullet-shape tables must be attached to a bridge or return for stability.

Tip: Square edge profile only is available on P-shape table.

Standard Includes	Required to Specify
-------------------	---------------------

- Worksurface with square edge profile, end panel, and modesty panel: wood
- Column support: painted or plated metal

- 1 General quote number: **GW047624**
  - 2 Style number and Product ID
  - 3 Wood color number for worksurface, end panel, and modesty panel
  - 4 Column support color number
  - 5 Options, if selected (see below)
- See Surface Materials in the Wood Casegoods and Tables Specification Guide.

### What's Special

P-shape tables are available.

Options	U.S. Price	Required to Specify
<b>Surface Materials</b> <ul style="list-style-type: none"> <li>• <b>Wood veneer worksurface</b></li> <li>• Customiz stain on worksurface and panels</li> <li>• Full-fill finish</li> </ul>	Prices below  Prices below	Specify with <i>Customiz stain</i> . ▶ See <i>Surface Materials Reference Manual</i> . Specify full-fill finish number.
<ul style="list-style-type: none"> <li>• <b>Laminate worksurface</b></li> <li>• Customiz stain on panels</li> </ul>	Prices below	Specify with <i>Customiz stain</i> .
<b>Cable Management</b> <ul style="list-style-type: none"> <li>• Round grommets</li> <li>• Flip up power units</li> </ul>	+\$ 66 each  +\$281 each	Left: Specify with <i>EGRL</i> and color number. Right: Specify with <i>EGRR</i> and color number.  Left: Specify with <i>VPFL</i> and color number. Right: Specify with <i>VPFR</i> and color number.
<b>Disc Column</b> <ul style="list-style-type: none"> <li>• Disk column</li> </ul>	+\$231	Specify with <i>disk column</i> .

### Specification Information

Dimensions			Style	Product ID	Change to U.S. Base Prices	Options		
D	W	H	Number			(Add \$ to Base Price)		
:	:	:	:	:	:	Customiz	Customiz	
:	:	:	:	:	:	Stain on	Stain on	Full-Fill
:	:	:	:	:	:	Wood Panel/	Wood Panel/	Finish on
:	:	:	:	:	:	Wood Top	Laminate Top	Wood Top

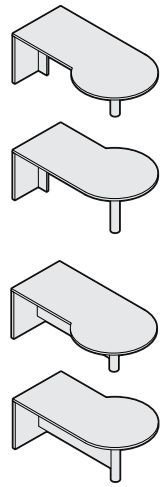

#### T B Left-Hand P-Shape Table without Modesty Panel

30"	72"	28 <sup>5</sup> / <sub>8</sub> "	<b>WLTB3672</b>	GW00093466	+\$ 569	+\$77	+\$32	+\$90
:	:	:	:	:	:	:	:	:

#### T B Right-Hand P-Shape Table without Modesty Panel

30"	72"	28 <sup>5</sup> / <sub>8</sub> "	<b>WLTB3672</b>	GW00093465	+\$ 569	+\$77	+\$32	+\$90
:	:	:	:	:	:	:	:	:

#### T B Left-Hand P-Shape Table with 18"H Modesty Panel

30"	72"	28 <sup>5</sup> / <sub>8</sub> "	<b>WLTB3672</b>	GW00093470	+\$1003	+\$77	+\$32	+\$90
:	:	:	:	:	:	:	:	:

#### T B Right-Hand P-Shape Table with 18"H Modesty Panel

30"	72"	28 <sup>5</sup> / <sub>8</sub> "	<b>WLTB3672</b>	GW00093469	+\$1003	+\$77	+\$32	+\$90
:	:	:	:	:	:	:	:	:

 **For Canadian Pricing**  
 Multiply U.S. Price by the Canadian price factor.  
 ▶ See page 1 for details.

# Curved Corner Unit

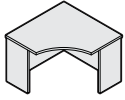
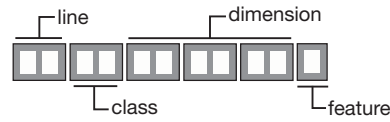

*Tip: The front three edges of a laminate worksurface will have solid wood edge nosing. This edge molding will always match the wood color that is specified; therefore, it could be different than the laminate color. Tip: Must be attached to a bridge or return for stability. Cannot be used freestanding.*

### What's Special

Corner unit has a curved front.

## Standard Includes Required to Specify

- |  |  |
|--|--|
| <ul style="list-style-type: none"> <li>• Corner unit panels: wood</li> <li>• Corner worksurface: wood veneer or laminate</li> <li>• Leveling glides: black only</li> </ul> | <ol style="list-style-type: none"> <li>1 General quote number: <b>GW047631</b></li> <li>2 Style number and Product ID</li> <li>3 Wood color number for corner unit</li> <li>4 Laminate color number for worksurface, if selected</li> <li>5 Worksurface edge profile (see below under Required Selections)</li> <li>6 Options, if selected (see below)</li> </ol> <p>See Surface Materials in the Wood Casegoods and Tables Specification Guide.</p> |
|--|--|

## Required Selections (No Additional Cost)

### Worksurface Edge Profiles

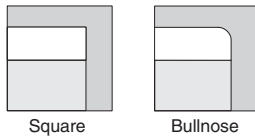

## Options U.S. Price Required to Specify

Options	U.S. Price	Required to Specify
<b>Surface Materials</b>	<b>Wood veneer worksurface</b>	
	<ul style="list-style-type: none"> <li>• Customiz stain on panels and worksurface</li> <li>• Full-fill finish</li> </ul>	Prices below Prices below Specify with <i>Customiz stain</i> . ▶ See <i>Surface Materials Reference Manual</i> . Specify full-fill finish number.
	<b>Laminate worksurface</b>	
	<ul style="list-style-type: none"> <li>• Customiz stain on panels</li> </ul>	Prices below Specify with <i>Customiz stain</i> .
<b>Back Panel</b>	<ul style="list-style-type: none"> <li>• Delete finished back panel</li> </ul>	Prices below Specify with <i>no back panel</i> .
<b>Cable Management</b>	<ul style="list-style-type: none"> <li>• Round grommets</li> </ul>	+\$ 66 each Center: Specify with <i>EGRC</i> and color number.
	<ul style="list-style-type: none"> <li>• Flip up power units</li> </ul>	+\$281 each Center: Specify with <i>VPFC</i> and color number.

## Specification Information

• Dimensions			• Style	• Product ID	• Change to	• Options				
D	W	H	Number		U.S. Base Prices	(Add \$ to Base Price)				
.....	.....	.....	.....	.....	.....	.....	.....	.....	.....	.....
.....	.....	.....	.....	.....	.....	.....	.....	.....	.....	.....
.....	.....	.....	.....	.....	.....	.....	.....	.....	.....	.....
.....	.....	.....	.....	.....	.....	.....	.....	.....	.....	.....
.....	.....	.....	.....	.....	.....	.....	.....	.....	.....	.....
.....	.....	.....	.....	.....	.....	.....	.....	.....	.....	.....
.....	.....	.....	.....	.....	.....	.....	.....	.....	.....	.....
.....	.....	.....	.....	.....	.....	.....	.....	.....	.....	.....
.....	.....	.....	.....	.....	.....	.....	.....	.....	.....	.....
.....	.....	.....	.....	.....	.....	.....	.....	.....	.....	.....
.....	.....	.....	.....	.....	.....	.....	.....	.....	.....	.....
.....	.....	.....	.....	.....	.....	.....	.....	.....	.....	.....
.....	.....	.....	.....	.....	.....	.....	.....	.....	.....	.....
.....	.....	.....	.....	.....	.....	.....	.....	.....	.....	.....
.....	.....	.....	.....	.....	.....	.....	.....	.....	.....	.....
.....	.....	.....	.....	.....	.....	.....	.....	.....	.....	.....
.....	.....	.....	.....	.....	.....	.....	.....	.....	.....	.....
.....	.....	.....	.....	.....	.....	.....	.....	.....	.....	.....
.....	.....	.....	.....	.....	.....	.....	.....	.....	.....	.....
.....	.....	.....	.....	.....	.....	.....	.....	.....	.....	.....
.....	.....	.....	.....	.....	.....	.....	.....	.....	.....	.....
.....	.....	.....	.....	.....	.....	.....	.....	.....	.....	.....
.....	.....	.....	.....	.....	.....	.....	.....	.....	.....	.....
.....	.....	.....	.....	.....	.....	.....	.....	.....	.....	.....
.....	.....	.....	.....	.....	.....	.....	.....	.....	.....	.....
.....	.....	.....	.....	.....	.....	.....	.....	.....	.....	.....
.....	.....	.....	.....	.....	.....	.....	.....	.....	.....	.....
.....	.....	.....	.....	.....	.....	.....	.....	.....	.....	.....
.....	.....	.....	.....	.....	.....	.....	.....	.....	.....	.....
.....	.....	.....	.....	.....	.....	.....	.....	.....	.....	.....

## U C Curved Corner Unit

24"	42"	28 <sup>5</sup> / <sub>8</sub> "	WLUC4242242	GW00093482	+\$100	+\$44	+\$22	+\$44	-\$449
.....	.....	.....	.....	.....	.....	.....	.....	.....	.....

**For Canadian Pricing**  
 Multiply U.S. Price by the Canadian price factor.  
 ▶ See page 1 for details.





# Returns

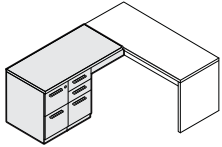

Tip: Return cannot be used freestanding.

## What's Special

Returns are modified to accommodate two pedestals on one side of unit.

Tip: Must use one file/file and one box/box/file pedestal with return. Box/box/file pedestal will be closest to kneewell.

Standard Includes	Required to Specify
<ul style="list-style-type: none"> <li>Return case: wood</li> <li>Return worksurface: wood veneer or laminate</li> <li>Full-height pedestals</li> <li>Full-height finished back panel</li> <li>Locks: keyed random</li> <li>One fastened metal filing system per file drawer: black only</li> <li>Leveling glides: black only</li> <li>Attachment hardware</li> </ul>	<ol style="list-style-type: none"> <li>General quote number: <b>GW047621</b></li> <li>Style number and Product ID</li> <li>Wood color number for return</li> <li>Laminate color number for worksurface, if selected</li> <li>Worksurface profile (see below under Required Selections)</li> <li>Pull shape (see below under Required Selections)</li> <li>Finish color number for pull</li> <li>Finish color number for lock</li> <li>Options, if selected (see below)</li> </ol> <p>See Surface Materials in the Wood Casegoods and Tables Specification Guide.</p>

## Required Selections (No Additional Cost)

### Worksurface Edge Profiles

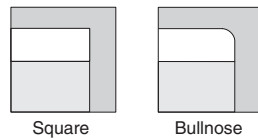

### Pull Shape

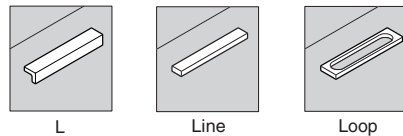

Options	U.S. Price	Required to Specify
<b>Surface Materials</b> <ul style="list-style-type: none"> <li><b>Wood veneer worksurface</b> <ul style="list-style-type: none"> <li>Customiz stain on case and worksurface</li> <li>Full-fill finish</li> </ul> </li> <li><b>Laminate worksurface</b> <ul style="list-style-type: none"> <li>Customiz stain on case</li> </ul> </li> </ul>	<p>Prices at right</p> <p>Prices at right</p> <p>Prices at right</p>	<p>Specify with <i>Customiz stain</i>.</p> <p>▶ See <i>Surface Materials Reference Manual</i>. Specify full-fill finish number.</p> <p>Specify with <i>Customiz stain</i>.</p>
<b>Back Panel</b> <ul style="list-style-type: none"> <li>Delete finished back panel</li> </ul>	<p>Prices at right</p>	<p>Specify with <i>no back panel</i>.</p>
<b>Cable Management</b> <ul style="list-style-type: none"> <li>Round grommets</li> <li>Flip up power units</li> </ul>	<p>+\$ 66 each</p> <p>+\$281 each</p>	<p>Center: Specify with <i>EGRC</i> and color number.</p> <p>Center: Specify with <i>VPFC</i> and color number.</p>
<b>Lock and Keying</b> <ul style="list-style-type: none"> <li><b>Lock</b> <ul style="list-style-type: none"> <li>Ember Chrome</li> <li>Polished Chrome</li> </ul> </li> <li><b>Keying</b> <ul style="list-style-type: none"> <li>Factory- and field-installed keying</li> </ul> </li> </ul>	<p>No cost</p> <p>No cost</p>	<p>Specify with <i>9250 Ember Chrome lock</i>.</p> <p>Specify with <i>9201 Polished Chrome lock</i>.</p> <p>▶ Page 306</p>



**For Canadian Pricing**  
 Multiply U.S. Price by the Canadian price factor.  
 ▶ See page 1 for details.

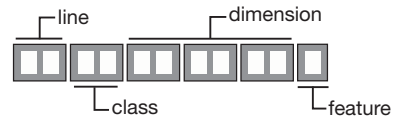

**Specification Information**

• Dimensions			• Knee-space Width	• Style Number	• Product ID	• Change to U.S. Base Price	• Options						
D	W	H					(Add \$ to Base Price)	Customiz stain on Wood case/ Wood Top	Customiz stain on Laminate Case/ Wood Top	Full-Fill Finish on Wood Top	No Back Panel		
:	:	:	:	:	:	:	:	:	:	:	:	:	:

**RT Returns**

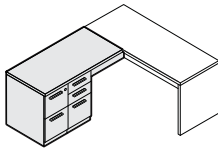

Left: two file drawers

**L Left-Hand**

24"	42"	28 <sup>5</sup> / <sub>8</sub> "	12"	<b>WLRT2442L</b>	GW00093443	+\$740	+\$ 99	+\$ 77	+\$44	-\$323
24"	48"	28 <sup>5</sup> / <sub>8</sub> "	18"	<b>WLRT2448L</b>	GW00093444	+\$740	+\$ 99	+\$ 77	+\$44	-\$348
24"	72"	28 <sup>5</sup> / <sub>8</sub> "	42"	<b>WLRT2472L</b>	GW00093445	+\$740	+\$137	+\$105	+\$64	-\$447

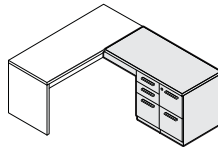

Right: two file drawers

**R Right-Hand**

24"	42"	28 <sup>5</sup> / <sub>8</sub> "	12"	<b>WLRT2442R</b>	GW00093446	+\$740	+\$ 99	+\$ 77	+\$44	-\$323
24"	48"	28 <sup>5</sup> / <sub>8</sub> "	18"	<b>WLRT2448R</b>	GW00093447	+\$740	+\$ 99	+\$ 77	+\$44	-\$348
24"	72"	28 <sup>5</sup> / <sub>8</sub> "	42"	<b>WLRT2472R</b>	GW00093448	+\$740	+\$137	+\$105	+\$64	-\$347
:	:	:	:	:	:	:	:	:	:	:

Wood Casegoods



**For Canadian Pricing**

Multiply U.S. Price by the Canadian price factor.

▶ See page 1 for details.

# Kneewell Credenzas

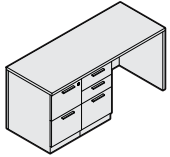

Tip: Credenzas 90"W and larger will ship knocked down.

Standard Includes	Required to Specify
<ul style="list-style-type: none"> <li>• Credenza case: wood</li> <li>• Credenza worksurface: wood veneer or laminate</li> <li>• Full-height pedestals</li> <li>• Full-height finished back panel</li> <li>• Locks: keyed random</li> <li>• One pencil tray per box/box/file pedestal: black plastic</li> <li>• One fastened metal filing system per file drawer: black only</li> <li>• Leveling glides: black only</li> <li>• Counterweight package, if selected</li> </ul>	<ol style="list-style-type: none"> <li>1 General quote number: <b>GW047621</b></li> <li>2 Style number and Product ID</li> <li>3 Wood color number for credenza</li> <li>4 Laminate color number for worksurface, if selected</li> <li>5 Worksurface profile (see below under Required Selections)</li> <li>6 Pull shape (see below under Required Selections)</li> <li>7 Finish color number for pull</li> <li>8 Finish color number for lock</li> <li>9 Options, if selected (see below)</li> </ol> <p>See Surface Materials in the Wood Casegoods and Tables Specification Guide.</p>

## What's Special

Credenza has been modified to accommodate two pedestals.

Tip: Must use one file/file and one box/box/file pedestal. Box/box/file pedestal will be closest to kneewell.

## Required Selections (No Additional Cost)

### Worksurface Edge Profiles

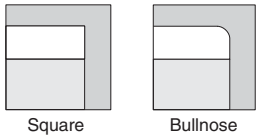

### Pull Shape

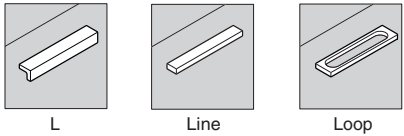

Options	U.S. Price	Required to Specify
<b>Surface Materials</b> <ul style="list-style-type: none"> <li>• <b>Wood veneer worksurface</b> <ul style="list-style-type: none"> <li>• Customiz stain on case and worksurface</li> <li>• Full-fill finish</li> </ul> </li> <li>• <b>Laminate worksurface</b> <ul style="list-style-type: none"> <li>• Customiz stain on case</li> </ul> </li> </ul>	<ul style="list-style-type: none"> <li>Prices at right</li> <li>Prices at right</li> <li>Prices at right</li> </ul>	<ul style="list-style-type: none"> <li>Specify with <i>Customiz stain</i>.</li> <li>▶ See <i>Surface Materials Reference Manual</i>. Specify full-fill finish number.</li> <li>Specify with <i>Customiz stain</i>.</li> </ul>
<b>Back Panel</b> <ul style="list-style-type: none"> <li>• Delete finished back panel</li> </ul>	<ul style="list-style-type: none"> <li>Prices at right</li> </ul>	<ul style="list-style-type: none"> <li>Specify with <i>no back panel</i>.</li> </ul>
<b>Cable Management</b> <ul style="list-style-type: none"> <li>• Round grommets</li> <li>• Flip up power units</li> <li>• Scallop</li> </ul>	<ul style="list-style-type: none"> <li>+\$ 66 each</li> <li>+\$281 each</li> <li>+\$ 34 each</li> </ul>	<ul style="list-style-type: none"> <li>Left: Specify with <i>EGRL</i> and color number.</li> <li>Center: Specify with <i>EGRC</i> and color number.</li> <li>Right: Specify with <i>EGRR</i> and color number.</li> <li>Left: Specify with <i>VPFL</i> and color number.</li> <li>Center: Specify with <i>VPFC</i> and color number.</li> <li>Right: Specify with <i>VPFR</i> and color number.</li> <li>Specify with <i>scallop</i>.</li> </ul>
<b>Counterweight Package</b> <ul style="list-style-type: none"> <li>• Add counterweight package</li> <li>• Omit counterweight package</li> </ul>	<ul style="list-style-type: none"> <li>No cost</li> <li>-\$ 57</li> </ul>	<ul style="list-style-type: none"> <li>Specify with <i>counterweight package</i>.</li> <li>Specify with <i>no counterweight package</i>.</li> </ul>
<b>Lock and Keying</b> <ul style="list-style-type: none"> <li>• <b>Lock</b> <ul style="list-style-type: none"> <li>• Ember Chrome</li> <li>• Polished Chrome</li> </ul> </li> <li>• <b>Keying</b> <ul style="list-style-type: none"> <li>• Factory- and field-installed keying</li> </ul> </li> </ul>	<ul style="list-style-type: none"> <li>No cost</li> <li>No cost</li> </ul>	<ul style="list-style-type: none"> <li>Specify with <i>9250 Ember Chrome lock</i>.</li> <li>Specify with <i>9201 Polished Chrome lock</i>.</li> <li>▶ Page 306</li> </ul>

Tip: See Application Topics for counterweight rules in Wood Casegoods and Tables Specification Guide.



**For Canadian Pricing**  
 Multiply U.S. Price by the Canadian price factor.  
 ▶ See page 1 for details.

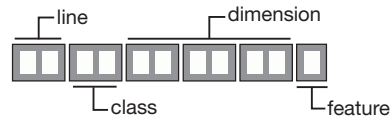

**Specification Information**

• Dimensions			• Knee-space Width	• Style Number	• Product ID	• Change to U.S. Base Price	• Options (Add \$ to Base Price)							
D	W	H					Customiz	Stain on	Wood Case/	Wood Top	Customiz	Stain on	Wood Case/	Wood Top
:	:	:	:	:	:	:	:	:	:	:	:	:	:	:
:	:	:	:	:	:	:	:	:	:	:	:	:	:	:
:	:	:	:	:	:	:	:	:	:	:	:	:	:	:
:	:	:	:	:	:	:	:	:	:	:	:	:	:	:
:	:	:	:	:	:	:	:	:	:	:	:	:	:	:

**C Z Kneewell Credenzas**

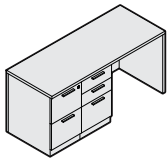

**R Pedestal/Kneewell**

24"	60"	28 <sup>5</sup> / <sub>8</sub> "	30"	<b>WLCZ2460R</b>	GW00093433	+\$332	+\$153	+\$121	+\$64	-\$331
24"	66"	28 <sup>5</sup> / <sub>8</sub> "	36"	<b>WLCZ2466R</b>	GW00093434	+\$332	+\$153	+\$121	+\$64	-\$352
24"	72"	28 <sup>5</sup> / <sub>8</sub> "	42"	<b>WLCZ2472R</b>	GW00093435	+\$332	+\$167	+\$135	+\$64	-\$373
24"	90"	28 <sup>5</sup> / <sub>8</sub> "	48"	<b>WLCZ2472R</b>	GW00093436	+\$613	+\$167	+\$135	+\$64	-\$373
:	:	:	:	:	:	:	:	:	:	:

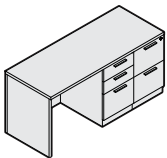

**R Kneewell/Pedestal**

24"	60"	28 <sup>5</sup> / <sub>8</sub> "	30"	<b>WLCZ2460R</b>	GW00093437	+\$332	+\$153	+\$121	+\$64	-\$331
24"	66"	28 <sup>5</sup> / <sub>8</sub> "	36"	<b>WLCZ2466R</b>	GW00093438	+\$332	+\$153	+\$121	+\$64	-\$352
24"	72"	28 <sup>5</sup> / <sub>8</sub> "	42"	<b>WLCZ2472R</b>	GW00093440	+\$332	+\$167	+\$135	+\$64	-\$373
24"	90"	28 <sup>5</sup> / <sub>8</sub> "	48"	<b>WLCZ2472R</b>	GW00093441	+\$613	+\$167	+\$135	+\$64	-\$373
:	:	:	:	:	:	:	:	:	:	:

Wood Casegoods

 **For Canadian Pricing**  
 Multiply U.S. Price by the Canadian price factor.  
 ▶ See page 1 for details.

# Reception/Transaction Stacker Unit

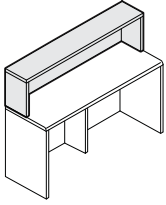
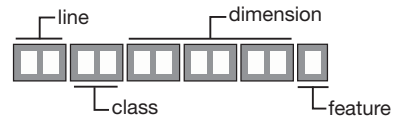

### What's Special

Stacker unit is available.

Standard Includes	Required to Specify
-------------------	---------------------

- Stacker unit: wood
- Worksurface: wood veneer or laminate
- Full-height finished back panel
- Locks: keyed random
- Leveling glides: black only

- 1 General quote number: **GW047633**
- 2 Style number and Product ID
- 3 Wood color number for stacker unit
- 4 Laminate color number for worksurface, if selected
- 5 Worksurface profile (see below under Required Selections)
- 6 Options, if selected (see below)  
See Surface Materials in the Wood Casegoods and Tables Specification Guide.

### Required Selections (No Additional Cost)

#### Worksurface Edge Profiles

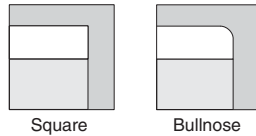

Options	U.S. Price	Required to Specify
---------	------------	---------------------

#### Surface Materials

#### Wood veneer worksurface

- Customiz stain on case and worksurface  
Prices below
- Full-fill finish  
Prices below

Specify with *Customiz stain*.  
▶ See *Surface Materials Reference Manual*.  
Specify full-fill finish number.

#### Laminate worksurface

- Customiz stain on case  
Prices below

Specify with *Customiz stain*.

### Specification Information

Dimensions			Style	Product ID	Change to U.S. Base Price	Options (Add \$ to Base Price)			
D	W	H	Number			Customiz Stain on Wood Panels/ Wood Top	Customiz Stain on Wood Panels/ Laminate Top	Full-Fill Finish on Wood Top	No Back Panel
15"	60"	14 3/4"	<b>WLCZ2472F</b>	GW00093490	-\$809	+\$148	+\$116	+\$64	-\$373
15"	66"	14 3/4"	<b>WLCZ2472F</b>	GW00093491	-\$718	+\$148	+\$116	+\$64	-\$373
15"	72"	14 3/4"	<b>WLCZ2472F</b>	GW00093492	-\$622	+\$148	+\$116	+\$64	-\$373

### Reception/Transaction Stacker Unit

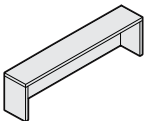

15"	60"	14 3/4"	<b>WLCZ2472F</b>	GW00093490	-\$809	+\$148	+\$116	+\$64	-\$373
15"	66"	14 3/4"	<b>WLCZ2472F</b>	GW00093491	-\$718	+\$148	+\$116	+\$64	-\$373
15"	72"	14 3/4"	<b>WLCZ2472F</b>	GW00093492	-\$622	+\$148	+\$116	+\$64	-\$373



#### For Canadian Pricing

Multiply U.S. Price by the Canadian price factor.

▶ See page 1 for details.

# Wall-Mount Overhead Cabinets

Wall-Mount  
Overhead Cabinets

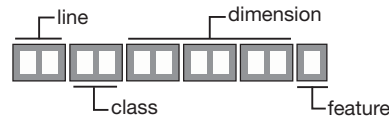

Tip: Finished exterior back adds 3/4" to depth of unit.

Tip: When laminate back panel is specified, top edge of back panel is laminate.

Tip: Glass doors do not lock.

### What's Special

Cabinets are available as wall-mount overhead unit.

### Standard Includes

- Cabinet: wood
- Back: exterior back - unfinished, interior back - wood
- Cable routing scallop on bottom edge of back panel
- Attachment hardware: black paint only

### Required to Specify

- 1 General quote number: **GW047614**
  - 2 Style number and Product ID
  - 3 Wood color number for service module
  - 4 Options, if selected (see below)
- See Surface Materials in the Wood Casegoods and Tables Specification Guide.

Options	U.S. Price	Required to Specify
<b>Surface Materials</b>	• Customiz stain on wood Prices below	Specify with <i>Customiz stain</i> . ▶ See <i>Surface Materials Reference Manual</i> .
<b>Finished Back</b>	• Finished exterior back Prices below	Specify with <i>finished exterior back</i> .
<b>Interior Back</b>	• Laminate interior back Prices below	Specify with <i>laminate interior back</i> .
<b>Wood Framed Glass Doors for Service Modules</b>	• Non-locking glass doors +\$116 per door	Specify with <i>glass doors</i> .
<b>Lock and Keying</b>	<b>Lock</b> • Ember Chrome +\$120 each • Polished Chrome +\$120 each	Specify with <i>9250 Ember Chrome lock</i> . Specify with <i>9201 Polished Chrome lock</i> .
	<b>Keying</b> • Factory- and field-installed keying	▶ Page 306

### Specification Information

Dimensions D W H	Number of Doors	Style Number	Product ID	Change to U.S. Base Price	Options (Add \$ to Base Price)
					Customiz : Finished : Laminate Stain on : Exterior : Interior Wood : Wood Back : Back

### MS Wall-Mount Overhead Cabinets

#### C All Closed

15"	60"	22"	3	<b>WLMS156043C</b>	GW00093380	+\$206	+\$127	+\$337	-\$169
15"	66"	22"	4	<b>WLMS156643C</b>	GW00093381	+\$261	+\$127	+\$337	-\$169
15"	72"	22"	4	<b>WLMS157243C</b>	GW00093382	+\$113	+\$127	+\$337	-\$169
15"	90"	22"	5	<b>WLMS159043C</b>	GW00093383	+\$ 35	+\$188	+\$449	-\$225
:	:	:	:	:	:	:	:	:	:

#### P Open

15"	60"	22"	N.A.	<b>WLMS156043P</b>	GW00093384	-\$196	+\$127	+\$337	-\$169
15"	66"	22"	N.A.	<b>WLMS156643P</b>	GW00093385	-\$ 86	+\$127	+\$337	-\$169
15"	72"	22"	N.A.	<b>WLMS157243P</b>	GW00093386	-\$181	+\$127	+\$337	-\$169
15"	90"	22"	N.A.	<b>WLMS159043P</b>	GW00093387	-\$298	+\$188	+\$449	-\$225
:	:	:	:	:	:	:	:	:	:

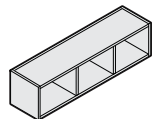
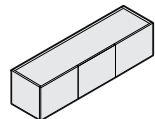

 **For Canadian Pricing**  
Multiply U.S. Price by the Canadian price factor.  
▶ See page 1 for details.

# Light Valances

For Use with Wall-Mount Overhead Cabinets

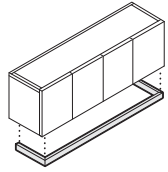
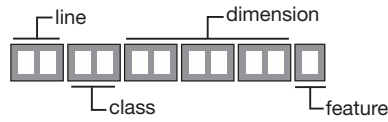

### What's Special

Light valances are for use with wall-mount overhead cabinets.

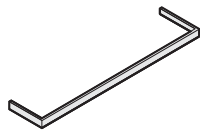

### Standard Includes

- Light valance: wood
- Attachment hardware

### Required to Specify

- 1 General quote number: **GW047614**
- 2 Style number and Product ID
- 3 Wood color number for valance
- 4 Options, if selected (see below)  
See Surface Materials in the Wood Caseworks and Tables Specification Guide.

### Options

#### Surface Materials

- Customiz stain on wood

### U.S. Price

Prices below

### Required to Specify

- Specify with *Customiz stain*.
- ▶ See *Surface Materials Reference Manual*.

### Specification Information

• Dimensions		• Style	• Product ID	• Change to	• Option
W	H	Number		U.S. Base Price	
					Customiz Stain on Wood

### Light Valances

60"	3"	<b>WLAL60S</b>	GW0093392	+\$95	+\$32
66"	3"	<b>WLAL66S</b>	GW0093393	+\$97	+\$32
72"	3"	<b>WLAL72S</b>	GW0093394	+\$95	+\$32
90"	3"	<b>WLAL90S</b>	GW0093395	+\$95	+\$32



### For Canadian Pricing

Multiply U.S. Price by the Canadian price factor.

▶ See page 1 for details.





# Wardrobes and Towers

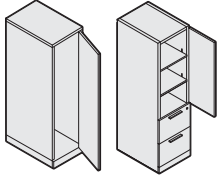

Standard Includes	Required to Specify
-------------------	---------------------

- Wardrobes and towers: wood
- Back panel: interior finished - wood, exterior - unfinished
- Lock: keyed random
- One fastened metal filing system per file drawer: black only
- Leveling glides: black only

- 1 General quote number: **GW047628**
  - 2 Style number and Product ID
  - 3 Wood color number for wardrobe or tower
  - 4 Pull shape (see below under Required Selections)
  - 5 Finish color number for pulls
  - 6 Finish color number for lock
  - 7 Options, if selected (see below)
- See Surface Materials in the Wood Casegoods and Tables Specification Guide.

### What's Special

Wardrobes are narrow and hinged either on left- or right-hand side. Towers are available with adjustable shelves and drawers.

### Required Selections (No Additional Cost)

#### Pull Shape

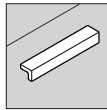

L

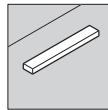

Line

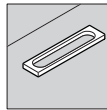

Loop

	Options	U.S. Price	Required to Specify
--	---------	------------	---------------------

<b>Surface Materials</b>	<ul style="list-style-type: none"> <li>• Customiz stain on wood</li> </ul>	Prices at right	Specify with <i>Customiz stain</i> . ▶ See <i>Surface Materials Reference Manual</i> .
<b>Back Panel</b>	<ul style="list-style-type: none"> <li>• Finished wood interior and exterior</li> <li>• Laminate interior and unfinished exterior</li> </ul>	+\$169 -\$169	Specify with <i>wood interior and wood exterior back</i> . Specify with <i>laminate interior and unfinished exterior back</i> .
<b>Lock and Keying</b>	<b>Lock</b> <ul style="list-style-type: none"> <li>• Ember Chrome</li> <li>• Polished Chrome</li> </ul> <b>Keying</b> <ul style="list-style-type: none"> <li>• Factory- and field-installed keying</li> </ul>	No cost No cost	Specify with <i>9250 Ember Chrome lock</i> . Specify with <i>9201 Polished Chrome lock</i> . ▶ Page 306

*Tip: When laminate back panel is specified, top edge of back panel is laminate.*



**For Canadian Pricing**  
 Multiply U.S. Price by the Canadian price factor.  
 ▶ See page 1 for details.

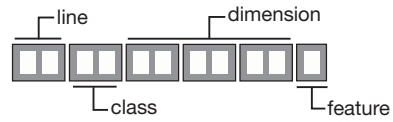

**Specification Information**

Dimensions			Style Number	Product ID	Change to U.S. Base Price	Option (Add \$ to Base Price)
D	W	H				
:	:	:	:	:	:	Customiz
:	:	:	:	:	:	Stain on
:	:	:	:	:	:	Wood

**K W Wardrobes**

**G With Door Hinged Left-Hand**

24"	15 1/2"	72 5/8"	<b>WLKW243072</b>	GW00093478	-\$355	+\$238
-----	---------	---------	-------------------	------------	--------	--------

**H With Door Hinged Right-Hand**

24"	15 1/2"	72 5/8"	<b>WLKW243072</b>	GW00093479	-\$355	+\$238
-----	---------	---------	-------------------	------------	--------	--------

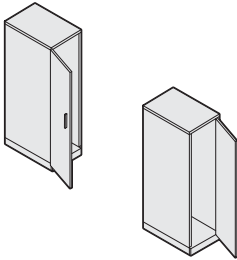

**T W Towers**

**G With Door Hinged Left-Hand**

24"	15 1/2"	72 5/8"	<b>WLTW242472G</b>	GW00093480	-\$ 28	+\$146
-----	---------	---------	--------------------	------------	--------	--------

**H With Door Hinged Right-Hand**

24"	15 1/2"	72 5/8"	<b>WLTW242472H</b>	GW00093481	-\$ 28	+\$146
-----	---------	---------	--------------------	------------	--------	--------

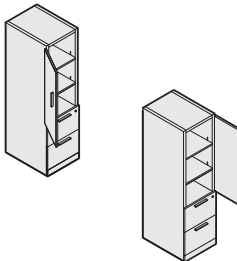

Wood Casegoods

 **For Canadian Pricing**  
 Multiply U.S. Price by the Canadian price factor.  
 ▶ See page 1 for details.

# FSC Core

Standard Includes	Required to Specify
<ul style="list-style-type: none"> <li>• See below</li> </ul>	1 General quote number: <b>GW054309</b> 2 Style number and Product ID

### What's Special

*FSC core is available.*

*Tip: This does not include wood center drawers or non-wood core products.*

*Tip: Used with standard laminate and veneer finishes.*

### Specification Information

Description	Product ID	Change to U.S. Price

### FSC Core

Any standard Walden wood core product	GW00107843	+\$30



**For Canadian Pricing**  
 Multiply U.S. Price by the Canadian price factor.  
 ▶ See page 1 for details.

# Bullet and P-Shape Tables

With 18"H Modesty Panel

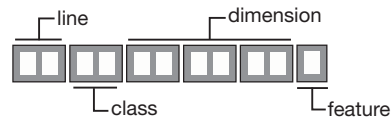

Bullet and P-Shape Tables

*Tip: Bullet and P-shape tables must be attached to a bridge or return for stability.*

*Tip: Ships knocked down.*

Standard Includes	Required to Specify
-------------------	---------------------

- Worksurface, end panel, and modesty panel: wood
- Column support: painted or plated metal

- 1 General quote number: **GW047625**
  - 2 Style number and Product ID
  - 3 Wood color number for worksurface, end panel, and modesty panel
  - 4 Worksurface profile (see below under Required Selections)
  - 5 Color number for column support
  - 6 Options, if selected (see below)
- See Surface Materials in the Wood Casegoods and Tables Specification Guide.

### What's Special

Tables are available with 18"H modesty panel.

### Required Selections (No Additional Cost)

#### Worksurface Edge Profiles

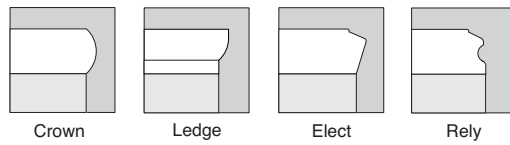

	Options	U.S. Price	Required to Specify
<b>Surface Materials</b>	• Customiz stain on wood	Prices below	Specify with <i>Customiz stain</i> .
	• Full-fill finish on wood	Prices below	▶ See <i>Surface Materials Reference Manual</i> . Specify full-fill finish number.
<b>Cable Management</b>	• Round grommets	+\$ 66 each	Left: Specify with <i>EGRL</i> and color number. Right: Specify with <i>EGRR</i> and color number.
	• Flip up power units	+\$281 each	Left: Specify with <i>VPFL</i> and color number. Right: Specify with <i>VPFR</i> and color number.
<b>Support</b>	• Disk column	+\$231	Specify with <i>disk column</i> .

### Specification Information

Dimensions D W H	Style Number	Product ID	Change to U.S. Base Price	Options (Add \$ to Base Price)
				Customiz Stain on : Full-Fill Wood : Finish

#### **T B** Bullet Tables

30"	60"	28 <sup>5</sup> / <sub>8</sub> "	<b>GLTB3060</b>	GW00093472	+\$522	+\$77	+\$90
36"	72"	28 <sup>5</sup> / <sub>8</sub> "	<b>GLTB3672</b>	GW00093473	+\$543	+\$77	+\$90

#### **T P** P-Shape Tables

##### **L** Left-Hand

30"	72"	28 <sup>5</sup> / <sub>8</sub> "	<b>GLTP307242L</b>	GW00093474	+\$543	+\$77	+\$90
-----	-----	----------------------------------	--------------------	------------	--------	-------	-------

##### **R** Right-Hand

30"	72"	28 <sup>5</sup> / <sub>8</sub> "	<b>GLTP307242R</b>	GW00093475	+\$543	+\$77	+\$90
-----	-----	----------------------------------	--------------------	------------	--------	-------	-------

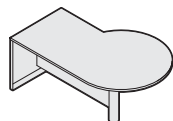
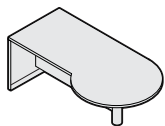
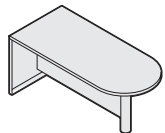

Design Options

# Curved Corner Unit

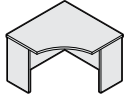
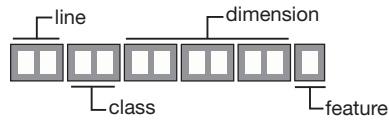

Tip: Must be attached to a bridge or return for stability. Cannot be used freestanding.

## Standard Includes

- Corner unit: wood
- Full-height finished back panels
- Leveling glides: black only

## Required to Specify

- 1 General quote number: **GW047632**
  - 2 Style number and Product ID
  - 3 Wood color number for corner unit
  - 4 Worksurface profile (see below under Required Selections)
  - 5 Options, if selected (see below)
- See Surface Materials in the Wood Casegoods and Tables Specification Guide.

## What's Special

Corner unit has a curved front.

## Required Selections (No Additional Cost)

### Worksurface Edge Profiles

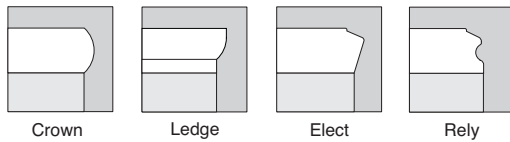

	Options	U.S. Price	Required to Specify
<b>Surface Materials</b>	<ul style="list-style-type: none"> <li>• Customiz stain on wood</li> <li>• Full-fill finish on wood</li> </ul>	<p>Prices below</p> <p>Prices below</p>	<p>Specify <i>with Customiz stain</i>.</p> <p>▶ See <i>Surface Materials Reference Manual</i>. Specify full-fill finish number.</p>
<b>Back Panel</b>	<ul style="list-style-type: none"> <li>• Delete finished back panel</li> </ul>	Prices below	Specify <i>with no back panel</i> .
<b>Cable Management</b>	<ul style="list-style-type: none"> <li>• Round grommets</li> <li>• Flip up power units</li> </ul>	<p>+\$ 66 each</p> <p>+\$281 each</p>	<p>Center: Specify <i>with EGRC</i> and color number.</p> <p>Center: Specify <i>with VPFC</i> and color number.</p>

## Specification Information

• Dimensions D W H	• Knee-space Width	• Style Number	• Product ID	• Change to U.S. Base Price	• Options (Add \$ to Base Price)
.....	.....	.....	.....	.....	.....
.....	.....	.....	.....	.....	.....
.....	.....	.....	.....	.....	.....
.....	.....	.....	.....	.....	.....
.....	.....	.....	.....	.....	.....
.....	.....	.....	.....	.....	.....
.....	.....	.....	.....	.....	.....
.....	.....	.....	.....	.....	.....
.....	.....	.....	.....	.....	.....
.....	.....	.....	.....	.....	.....

## UC Curved Corner Unit

24"	42"	28 <sup>5</sup> / <sub>8</sub> "	25"	<b>GLUC4242242</b>	GW00093489	+\$100	+\$44	+\$44	-\$403
.....	.....	.....	.....	.....	.....	.....	.....	.....	.....



**For Canadian Pricing**  
 Multiply U.S. Price by the Canadian price factor.  
 ▶ See page 1 for details.



# Returns

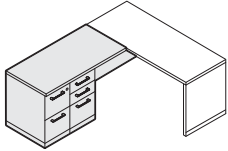

Tip: Return cannot be used freestanding.

Standard Includes	Required to Specify
-------------------	---------------------

- Return: wood
- Full-height pedestals
- Full-height finished back panel
- Locks: keyed random
- One fastened metal filing system per file drawer: black only
- Attachment hardware
- Leveling glides: black only

- 1 General quote number: **GW047622**
  - 2 Style number and Product ID
  - 3 Wood color number for return
  - 4 Worksurface profile (see below under Required Selections)
  - 5 Pull shape (see below under Required Selections)
  - 6 Finish color number for pull
  - 7 Finish color number for lock
  - 8 Options, if selected (see below)
- See Surface Materials in the Wood Casegoods and Tables Specification Guide.

## What's Special

Returns are modified to accommodate two pedestals on one side of unit.

Tip: Must use one file/file and one box/box/file pedestal with return. Box/box/file pedestal will be closest to kneewell.

## Required Selections (No Additional Cost)

### Worksurface Edge Profiles

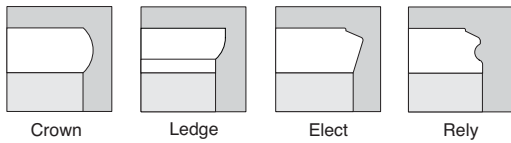

### Pull Shape

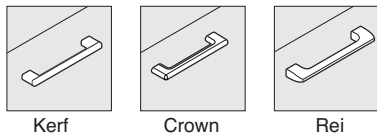

	Options	U.S. Price	Required to Specify
<b>Surface Materials</b>	• Customiz stain on wood	Prices at right	Specify <i>with Customiz stain</i> .
	• Full-fill finish on wood	Prices at right	▶ See <i>Surface Materials Reference Manual</i> . Specify full-fill finish number.
<b>Back Panel</b>	• Delete finished back panel	Prices at right	Specify <i>with no back panel</i> .
<b>Cable Management</b>	• Round grommets	+\$ 66 each	Center: Specify <i>with EGRC</i> and color number.
	• Flip up power units	+\$281 each	Center: Specify <i>with VPFC</i> and color number.
<b>Lock and Keying</b>	<b>Lock</b>		
	• Ember Chrome	No cost	Specify <i>with 9250 Ember Chrome lock</i> .
	• Polished Chrome	No cost	Specify <i>with 9201 Polished Chrome lock</i> .
	<b>Keying</b>		
	• Factory- and field-installed keying		▶ Page 306



**For Canadian Pricing**  
 Multiply U.S. Price by the Canadian price factor.  
 ▶ See page 1 for details.



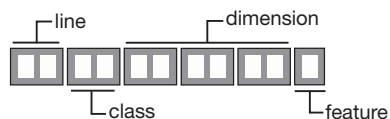

**Specification Information**

Dimensions			Knee-space Width	Style Number	Product ID	Change to U.S. Base Price	Options			
D	W	H					(Add \$ to Base Price)	Customiz	Full-Fill	No Back
:	:	:	:	:	:	:	Stain on	Wood	Finish	Panel

**RT Returns**

**L Left-Hand**

24"	42"	28 <sup>5</sup> / <sub>8</sub> "	27"	<b>GLRT2442L</b>	GW00093457	+\$916	+\$ 99	+\$44	-\$215
24"	48"	28 <sup>5</sup> / <sub>8</sub> "	33"	<b>GLRT2448L</b>	GW00093459	+\$916	+\$ 99	+\$44	-\$231
24"	72"	28 <sup>5</sup> / <sub>8</sub> "	57"	<b>GLRT2472L</b>	GW00093460	+\$916	+\$137	+\$64	-\$298

**R Right-Hand**

24"	42"	28 <sup>5</sup> / <sub>8</sub> "	27"	<b>GLRT2442R</b>	GW00093461	+\$916	+\$ 99	+\$44	-\$215
24"	48"	28 <sup>5</sup> / <sub>8</sub> "	33"	<b>GLRT2448R</b>	GW00093462	+\$916	+\$ 99	+\$44	-\$231
24"	72"	28 <sup>5</sup> / <sub>8</sub> "	57"	<b>GLRT2472R</b>	GW00093463	+\$916	+\$137	+\$64	-\$298

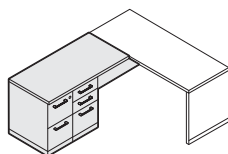

Left: two file drawers pedestal and two box, one file pedestal drawers.

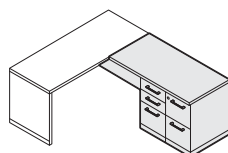

Right: two file drawers pedestal and two box, one file pedestal drawers.

Wood Casegoods

**For Canadian Pricing**  
 Multiply U.S. Price by the Canadian price factor.  
 ▶ See page 1 for details.

# Kneewell Credenzas

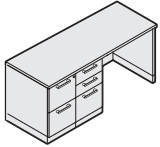

Tip: Credenzas 90"W and larger ship knocked down.

Standard Includes	Required to Specify
<ul style="list-style-type: none"> <li>• Credenza: wood</li> <li>• Full-height pedestals</li> <li>• Full-height finished back panel</li> <li>• Locks: keyed random</li> <li>• One pencil tray per box/box/file pedestal: black plastic</li> <li>• One fastened metal filing system per file drawer: black only</li> <li>• Leveling glides: black only</li> <li>• Counterweight package</li> <li>• Counterweight package, if selected</li> </ul>	<ol style="list-style-type: none"> <li>1 General quote number: <b>GW047622</b></li> <li>2 Style number and Product ID</li> <li>3 Wood color number for credenza</li> <li>4 Worksurface profile (see below under Required Selections)</li> <li>5 Pull shape (see below under Required Selections)</li> <li>6 Finish color number for pull</li> <li>7 Finish color number for lock</li> <li>8 Options, if selected (see below)</li> </ol> <p>See Surface Materials in the Wood Casegoods and Tables Specification Guide.</p>

## What's Special

Credenza has been modified to accommodate two pedestals.

Tip: Must use one file/file and one box/box/file pedestal. Box/box/file pedestal will be closest to kneewell.

## Required Selections (No Additional Cost)

### Worksurface Edge Profiles

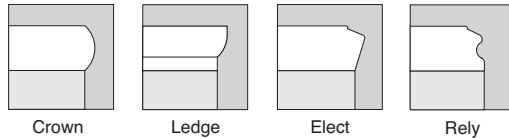

### Pull Shape

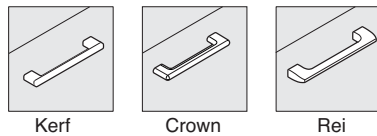

	Options	U.S. Price	Required to Specify
<b>Surface Materials</b>	• Customiz stain on wood	Prices at right	Specify with <i>Customiz stain</i> .
	• Full-fill finish on wood	Prices at right	▶ See <i>Surface Materials Reference Manual</i> . Specify full-fill finish number.
<b>Back Panel</b>	• Delete finished back panel	Prices at right	Specify with <i>no back panel</i> .
<b>Cable Management</b>	• Round grommets	+\$ 66 each	Left: Specify with <i>EGRL</i> and color number. Center: Specify with <i>EGRC</i> and color number. Right: Specify with <i>EGRR</i> and color number.
	• Flip up power units	+\$281 each	Left: Specify with <i>VPFL</i> and color number. Center: Specify with <i>VPFC</i> and color number. Right: Specify with <i>VPFR</i> and color number.
	• Scallop	+\$ 34 each	Specify with <i>scallop</i> .
<b>Counterweight Package</b>	• Add counterweight package	No cost	Specify with <i>counterweight package</i> .
	• Omit counterweight package	-\$ 57	Specify with <i>no counterweight package</i> .
<b>Lock and Keying</b>	<b>Lock</b>		
	• Ember Chrome	No cost	Specify with <i>9250 Ember Chrome lock</i> .
	• Polished Chrome	No cost	Specify with <i>9201 Polished Chrome lock</i> .
	<b>Keying</b>		
	• Factory- and field-installed keying		▶ Page 306

Tip: See Application Topics for counterweight rules in the Wood Casegoods and Tables Specification Guide.



**For Canadian Pricing**  
Multiply U.S. Price by the Canadian price factor.  
▶ See page 1 for details.

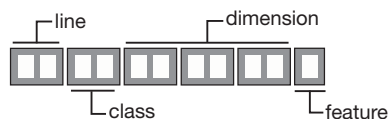

**Specification Information**

• Dimensions			• Knee-space Width	• Style Number	• Product ID	• Change to U.S. Base Price	• Options (Add \$ to Base Price)		
D	W	H					Customiz	Full-Fill	No Back
:	:	:	:	:	:	:	Stain on Wood	Finish	Panel

**GCZ Kneewell Credenzas**

**R Pedestal/Kneewell**

24"	60"	28 <sup>5</sup> / <sub>8</sub> "	30"	<b>GLCZ2460R</b>	GW00093449	+\$382	+\$145	+\$64	-\$266
24"	66"	28 <sup>5</sup> / <sub>8</sub> "	36"	<b>GLCZ2466R</b>	GW00093450	+\$382	+\$145	+\$64	-\$281
24"	72"	28 <sup>5</sup> / <sub>8</sub> "	42"	<b>GLCZ2472R</b>	GW00093451	+\$382	+\$159	+\$64	-\$298
24"	90"	28 <sup>5</sup> / <sub>8</sub> "	48"	<b>GLCZ2472R</b>	GW00093452	+\$768	+\$159	+\$64	-\$298
:	:	:	:	:	:	:	:	:	:

**R Kneewell/Pedestal**

24"	60"	28 <sup>5</sup> / <sub>8</sub> "	30"	<b>GLCZ2460R</b>	GW00093453	+\$382	+\$145	+\$64	-\$266
24"	66"	28 <sup>5</sup> / <sub>8</sub> "	36"	<b>GLCZ2466R</b>	GW00093454	+\$382	+\$145	+\$64	-\$281
24"	72"	28 <sup>5</sup> / <sub>8</sub> "	42"	<b>GLCZ2472R</b>	GW00093455	+\$382	+\$159	+\$64	-\$298
24"	90"	28 <sup>5</sup> / <sub>8</sub> "	48"	<b>GLCZ2472R</b>	GW00093456	+\$768	+\$159	+\$64	-\$298
:	:	:	:	:	:	:	:	:	:

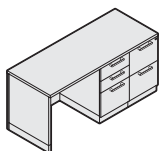
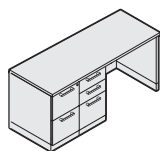

Wood Casegoods

**For Canadian Pricing**  
 Multiply U.S. Price by the Canadian price factor.  
 ▶ See page 1 for details.

# Reception/Transaction Stacker Unit

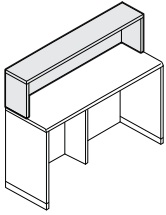
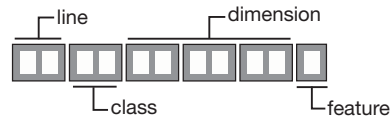

### What's Special

Stacker unit is available.

### Standard Includes

- Stacker unit: wood
- Full-height finished back panel
- Leveling glides: black only

### Required to Specify

- 1 General quote number: **GW047635**
  - 2 Style number and Product ID
  - 3 Wood color number for stacker unit
  - 4 Worksurface profile (see below under Required Selections)
  - 5 Options, if selected (see below)
- See Surface Materials in the Wood Casegoods and Tables Specification Guide.

### Required Selections (No Additional Cost)

#### Worksurface Edge Profiles

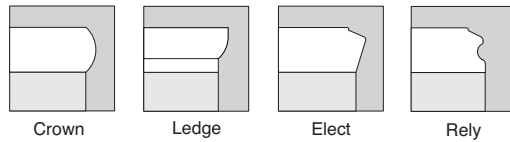

Options	U.S. Price	Required to Specify
<b>Surface Materials</b> <ul style="list-style-type: none"> <li>• Customiz stain on wood</li> <li>• Full-fill finish on wood</li> </ul>	Prices below  Prices below	Specify with <i>Customiz stain</i> . ▶ See <i>Surface Materials Reference Manual</i> . Specify full-fill finish number.
<b>Back Panel</b> <ul style="list-style-type: none"> <li>• Delete finished back panel</li> </ul>	Prices below	Specify with <i>no back panel</i> .
<b>Cable Management</b> <ul style="list-style-type: none"> <li>• Round grommets</li> <li>• Flip up power units</li> <li>• Scallop</li> </ul>	+\$ 66 each  +\$281 each  +\$ 34 each	Left: Specify with <i>EGRL</i> and color number. Center: Specify with <i>EGRC</i> and color number. Right: Specify with <i>EGRR</i> and color number. Left: Specify with <i>VPFL</i> and color number. Center: Specify with <i>VPFC</i> and color number. Right: Specify with <i>VPFR</i> and color number. Specify with <i>scallop</i> .

### Specification Information

Dimensions D W H	Knee-space Width	Style Number	Product ID	Change to U.S. Base Price	Options (Add \$ to Base Price)
.....	.....	.....	.....	.....	.....
.....	.....	.....	.....	.....	.....
.....	.....	.....	.....	.....	.....
.....	.....	.....	.....	.....	.....
.....	.....	.....	.....	.....	.....
.....	.....	.....	.....	.....	.....
.....	.....	.....	.....	.....	.....
.....	.....	.....	.....	.....	.....
.....	.....	.....	.....	.....	.....
.....	.....	.....	.....	.....	.....

### Reception/Transaction Stacker Unit

#### Shells

15"	60"	14"	69¾"	<b>GLCZ2472F</b>	GW00093495	-\$987	+\$183	+\$64	-\$298
15"	66"	14"	93¾"	<b>GLCZ2472F</b>	GW00093496	-\$881	+\$183	+\$64	-\$298
15"	72"	14"	99¾"	<b>GLCZ2472F</b>	GW00093497	-\$767	+\$183	+\$64	-\$298
.....	.....	.....	.....	.....	.....	.....	.....	.....	.....

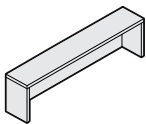

**For Canadian Pricing**  
 Multiply U.S. Price by the  
 Canadian price factor.  
 ▶ See page 1 for details.

# Wall-Mount Overhead Cabinets

With Cornice Top

Wall-Mount  
Overhead Cabinets

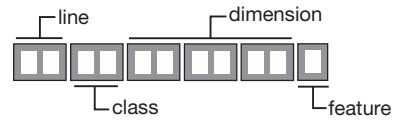

Standard Includes	Required to Specify
<ul style="list-style-type: none"> <li>Cabinet: wood with unfinished exterior back</li> <li>Profiled top: cornice</li> <li>Cable routing scallop on bottom edge of back panel</li> <li>Attachment hardware: black paint only</li> </ul>	<ol style="list-style-type: none"> <li>General quote number: <b>GW047616</b></li> <li>Style number and Product ID</li> <li>Wood color number for service module</li> <li>Options, if selected (see below) See Surface Materials in the Wood Casegoods and Tables Specification Guide.</li> </ol>

Options	U.S. Price	Required to Specify
<b>Surface Materials</b> <ul style="list-style-type: none"> <li>Customiz stain on wood</li> </ul>	Prices below	Specify with <i>Customiz stain</i> . ▶ See <i>Surface Materials Reference Manual</i> .
<b>Finished Back</b> <ul style="list-style-type: none"> <li>Finished exterior back</li> </ul>	Prices below	Specify with <i>finished exterior back</i> .
<b>Wood Framed Glass Doors for Service Modules</b> <ul style="list-style-type: none"> <li>Non-locking glass doors for all closed service modules</li> </ul>	+\$116 per door	Specify with <i>glass doors</i> .
<b>Lock and Keying</b> <ul style="list-style-type: none"> <li><b>Lock</b> <ul style="list-style-type: none"> <li>Ember Chrome: +\$120 each</li> <li>Polished Chrome: +\$120 each</li> </ul> </li> <li><b>Keying</b> <ul style="list-style-type: none"> <li>Factory- and field-installed keying</li> </ul> </li> </ul>		Specify with <i>9250 Ember Chrome lock</i> . Specify with <i>9201 Polished Chrome lock</i> .  ▶ Page 306

*Tip: Finished exterior back adds 3/4" to depth of unit.*

*Tip: Glass doors do not lock.*

*Tip: Service modules with organizer slots do not have locking doors.*

*Tip: Glass doors are not available on service modules with organizer slots.*

**What's Special**

Cabinets are available as a wall-mount overhead unit and with a cornice top.

Specification Information					
Dimensions D W H	Number of Doors	Style Number	Product ID	Change to U.S. Base Price	Options (Add \$ to Base Price)
.....	.....	.....	.....	.....	Customiz : Finished Stain on : Exterior Wood : Wood Back

## MS Wall-Mount Overhead Cabinets with Cornice Top

C All Closed								
15 3/4"	60"	23 5/8"	3	<b>GLMS156044C</b>	GW00093398	-\$ 58	+\$127	+\$337
15 3/4"	66"	23 5/8"	4	<b>GLMS156644C</b>	GW00093399	-\$183	+\$127	+\$337
15 3/4"	72"	23 5/8"	4	<b>GLMS157244C</b>	GW00093400	-\$165	+\$127	+\$337
15 3/4"	90"	23 5/8"	5	<b>GLMS159044C</b>	GW00093401	-\$290	+\$188	+\$449
:	:	:	:	:	:	:	:	:
C Open								
15"	60"	23 5/8"	3	<b>GLMS156044C</b>	GW00093402	-\$556	+\$127	+\$337
15"	66"	23 5/8"	4	<b>GLMS156644C</b>	GW00093403	-\$448	+\$127	+\$337
15"	72"	23 5/8"	4	<b>GLMS157244C</b>	GW00093404	-\$586	+\$127	+\$337
15"	90"	23 5/8"	5	<b>GLMS159044C</b>	GW00093405	-\$773	+\$188	+\$449
:	:	:	:	:	:	:	:	:

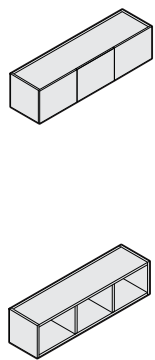

 **For Canadian Pricing**  
Multiply U.S. Price by the Canadian price factor.  
▶ See page 1 for details.

Wood Casegoods

# Light Valances

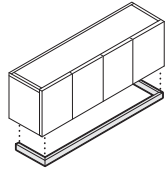
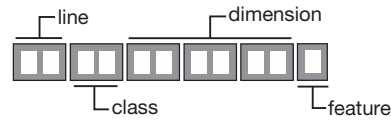

### What's Special

Light valances are for use with wall-mount overhead cabinet.

Standard Includes	Required to Specify
-------------------	---------------------

- Light valance: wood
- Attachment hardware

- 1 General quote number: **GW047616**
- 2 Style number and Product ID
- 3 Wood color number for valance
- 4 Options, if selected (see below)  
See Surface Materials in the Wood Caseworks and Tables Specification Guide.

Surface Materials	Options	U.S. Price	Required to Specify
-------------------	---------	------------	---------------------

- |                          |              |   |
|--------------------------|--------------|---|
| • Customiz stain on wood | Prices below | Specify with <i>Customiz stain</i> .<br>▶ See <i>Surface Materials Reference Manual</i> . |
|--------------------------|--------------|---|

### Specification Information

• Dimensions W H	• Style Number	• Product ID	• Change to U.S. Base Price	• Option
				• Customiz • Stain on • Wood

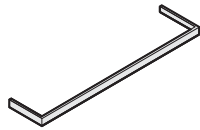

### **AL** Light Valances

60"	3"	<b>GLAL60S</b>	GW00093411	+\$95	+\$32
66"	3"	<b>GLAL66S</b>	GW00093412	+\$97	+\$32
72"	3"	<b>GLAL72S</b>	GW00093414	+\$95	+\$32
90"	3"	<b>GLAL90S</b>	GW00093415	+\$95	+\$32



**For Canadian Pricing**  
Multiply U.S. Price by the Canadian price factor.  
▶ See page 1 for details.



# Wardrobes and Towers

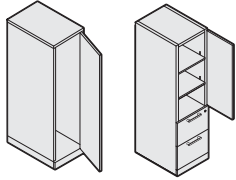

Standard Includes	Required to Specify
-------------------	---------------------

- Wardrobes and towers: wood
- Profiled top
- Unfinished inset back panel
- Lock: keyed random
- One fastened metal filing system per file drawer: black only
- Leveling glides: black only

- 1 General quote number: **GW047629**
- 2 Style number and Product ID
- 3 Wood color number for wardrobe or tower
- 4 Top edge profile (see below under Required Selections)
- 5 Pull shape (see below under Required Selections)
- 6 Finish color number for pull
- 7 Finish color number for lock
- 8 Options, if selected (see below)  
See Surface Materials in the Wood Caseworks and Tables Specification Guide.

*Tip: When specifying Elect or Rely for the worksurface edge, the top edge of the wardrobes, and towers should be specified as Cornice.*

Required Selections (No Additional Cost)
--

**Top Edge Profiles**

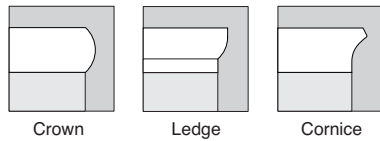

**Pull Shape**

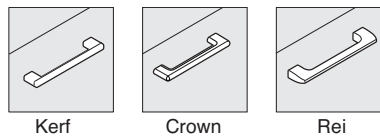

**What's Special**

Wardrobes are narrow and hinged either the left- or right-hand side. Towers are available with adjustable shelves and drawers.

	Options	U.S. Price	Required to Specify
<b>Surface Materials</b>	<ul style="list-style-type: none"> <li>• Customiz stain on wood</li> </ul>	Prices at right	Specify with <i>Customiz stain</i> . ▶ See <i>Surface Materials Reference Manual</i> .
<b>Finished Back</b>	<ul style="list-style-type: none"> <li>• Finished exterior back</li> </ul>	+\$169	Specify with <i>finished exterior back</i> .
<b>Lock and Keying</b>	<p><b>Lock</b></p> <ul style="list-style-type: none"> <li>• Ember Chrome</li> <li>• Polished Chrome</li> </ul> <p><b>Keying</b></p> <ul style="list-style-type: none"> <li>• Factory- and field-installed keying</li> </ul>	<p>No cost</p> <p>No cost</p>	<p>Specify with <i>9250 Ember Chrome lock</i>. Specify with <i>9201 Polished Chrome lock</i>.</p> <p>▶ Page 306</p>

 **For Canadian Pricing**  
Multiply U.S. Price by the Canadian price factor.  
▶ See page 1 for details.



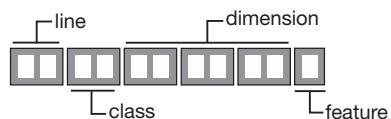

**Specification Information**

Dimensions D W H			Style Number	Product ID	Change to U.S. Base Price	Option (Add \$ to Base Price)
						Customiz Stain on Wood

**K W Wardrobes**

**G With Door Hinged Left-Hand**

24"	15 1/2"	73 3/4"	<b>GLKW243073</b>	GW00093484	-\$428	+\$238
-----	---------	---------	-------------------	------------	--------	--------

**G With Door Hinged Right-Hand**

24"	15 1/2"	73 3/4"	<b>GLKW243073</b>	GW00093485	-\$428	+\$238
:	:	:	:	:	:	:

**T W Towers**

**G With Door Hinged Left-Hand**

24"	15 1/2"	73 3/4"	<b>GLTW242473G</b>	GW00093486	-\$ 14	+\$146
-----	---------	---------	--------------------	------------	--------	--------

**H With Door Hinged Right-Hand**

24"	15 1/2"	73 3/4"	<b>GLTW242473H</b>	GW00093487	-\$ 14	+\$146
:	:	:	:	:	:	:

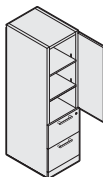
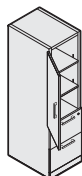
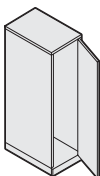
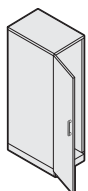

**For Canadian Pricing**  
 Multiply U.S. Price by the  
 Canadian price factor.  
 ▶ See page 1 for details.

# Rectangular Desk Shells

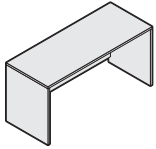

Tip: Grain direction of modesty panel runs horizontally. Grain direction of end panels runs vertically.

## What's Special

Rectangular desk shells available in additional widths.

Tip: For each clear-access end panel specified, two attachment brackets are shipped with the product.

Tip: Standard worksurfaces are 1 1/8" thick. However, the actual thickness between Low-Pressure Laminate (LPL) and High-Pressure Laminate (HPL) worksurfaces is slightly different. It is recommended that only worksurfaces of the same type are specified in a given application. In addition, there may be sheen or texture differences when using LPL and HPL in adjacent applications. Please use caution when mixing and matching different worksurface types.

Tip: 36"D desk shell has a 6" overhang on the visitor side.

Standard Includes	Required to Specify
<ul style="list-style-type: none"> <li>1 1/8"-thick worksurface: Low-Pressure Laminate</li> <li>Desk shell with full-height modesty panel and two full-depth end panels: Low-Pressure Laminate</li> <li>3 mm radius profile edge on user's side: plastic</li> <li>1 mm side and back edges: plastic default to match worksurface</li> <li>Adjustable leveling glides</li> <li>Shipped ready to assemble</li> </ul>	<ol style="list-style-type: none"> <li>General quote number: <b>SF099872</b></li> <li>Style number and Product ID</li> <li>Low-Pressure Laminate color number for worksurface, as appropriate</li> <li>Plastic edge band color number for worksurface</li> <li>Low-Pressure Laminate color number for desk shell</li> <li>Options, if selected (see below)</li> </ol> <p>See Surface Materials in the Wood Casegoods and Tables Specification Guide</p>

Options	U.S. Price	Required to Specify
<b>End Panels</b> <ul style="list-style-type: none"> <li>One full-depth end panel, right, and one clear-access end panel, left</li> <li>One clear-access end panel, right, and one full-depth end panel, left</li> <li>Two clear-access end panels</li> </ul>	<p>No cost</p> <p>No cost</p> <p>No cost</p>	<p>Specify with full-depth end panel, right, and one clear-access end panel, left.</p> <p>Specify with clear-access end panel, right, and one full-depth end panel, left.</p> <p>Specify with two clear-access end panels.</p>
<b>Modesty Panel</b> <ul style="list-style-type: none"> <li>1/4-height modesty panel (9 3/8"H)</li> </ul>	No cost	Specify with 1/4-height modesty panel.

## Specification Information

Dimensions	Style	Product ID	Change to
D    W    H	Number		U.S. Price

### Low-Pressure Laminate Top

30"	78"	28 1/2"	<b>TS5TLDS3072</b>	SF00167449	+\$153
30"	84"	28 1/2"	<b>TS5TLDS3072</b>	SF00175873	+\$196
36"	54"	28 1/2"	<b>TS5TLDS3672</b>	SF00153061	+\$110
36"	60"	28 1/2"	<b>TS5TLDS3672</b>	SF00186789	+\$110
36"	66"	28 1/2"	<b>TS5TLDS3672</b>	SF00153164	+\$110
36"	78"	28 1/2"	<b>TS5TLDS3672</b>	SF00186790	+\$164

### Low-Pressure Laminate Top with 12"D Clear Access End Panel in Center Rear

30"	90"	28 1/2"	<b>TS5TLDS3072</b>	SF00186788	+\$287
30"	96"	28 1/2"	<b>TS5TLDS3072</b>	SF00157510	+\$329
36"	84"	28 1/2"	<b>TS5TLDS3672</b>	SF00186791	+\$166
36"	90"	28 1/2"	<b>TS5TLDS3672</b>	SF00186792	+\$319
36"	96"	28 1/2"	<b>TS5TLDS3672</b>	SF00181015	+\$373



#### For Canadian Pricing

Multiply U.S. Price by the Canadian price factor.

▶ See page 1 for details.

# Return Shells

### What's Special

Return shells are available in additional depths and widths.

Tip: Grain direction of modesty panel and end panel runs vertically.

Tip: Two TS5GANGBKT brackets must be ordered for each return.

Standard Includes	Required to Specify
<ul style="list-style-type: none"> <li>1 1/8"-thick worksurface: Low-Pressure Laminate</li> <li>Return shell with full-height modesty panel and one full-depth end panel: Low-Pressure Laminate</li> <li>3 mm radius profile edge on user's side: plastic</li> <li>1 mm side and back edges: plastic default to match user's side</li> <li>Adjustable leveling glides</li> <li>Two attachment brackets</li> <li>Shipped ready to assemble</li> </ul>	<ol style="list-style-type: none"> <li>General quote number: <b>SF099872</b></li> <li>Style number and Product ID</li> <li>Low-Pressure Laminate color number for worksurface</li> <li>Plastic edge band color number for worksurface</li> <li>Low-Pressure Laminate color number for return shell</li> <li>Options, if selected (see below)</li> </ol> See Surface Materials in the Wood Casegoods and Tables Specification Guide

Options	U.S. Price	Required to Specify
<b>Modesty Panel</b> <ul style="list-style-type: none"> <li>1/4-height modesty panel (9 3/8"H)</li> </ul>	No cost	Specify with 1/4-height modesty panel.

Specification Information			
Dimensions	Style	Product ID	Change to
D W H	Number		U.S. Price

## Low-Pressure Laminate

### Left-Hand

24"	30"	28 1/2"	<b>TS5TLUL2442</b>	SF00151155	+\$110
24"	36"	28 1/2"	<b>TS5TLUL2442</b>	SF00156241	+\$110
24"	54"	28 1/2"	<b>TS5TLUL2448</b>	SF00179488	+\$159
24"	60"	28 1/2"	<b>TS5TLUL2448</b>	SF00171563	+\$208
30"	42"	28 1/2"	<b>TS5TLUL2442</b>	SF00186793	+\$200
30"	48"	28 1/2"	<b>TS5TLUL2448</b>	SF00186794	+\$208

### Right-Hand

24"	30"	28 1/2"	<b>TS5TLUR2442</b>	SF00151159	+\$110
24"	36"	28 1/2"	<b>TS5TLUR2442</b>	SF00156242	+\$110
24"	54"	28 1/2"	<b>TS5TLUR2448</b>	SF00168823	+\$159
24"	60"	28 1/2"	<b>TS5TLUR2448</b>	SF00161197	+\$208
30"	42"	28 1/2"	<b>TS5TLUR2442</b>	SF00186795	+\$200
30"	48"	28 1/2"	<b>TS5TLUR2448</b>	SF00186796	+\$208

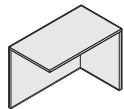
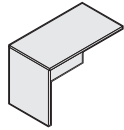

### For Canadian Pricing

Multiply U.S. Price by the Canadian price factor.

▶ See page 1 for details.

# Wall-Mounted Overhead Storage Cabinets

## What's Special

Wall-mounted overhead storage cabinets available with doors omitted and in additional widths—24" and 30".

*Tip: Top is available in Low-Pressure Laminates only.*

## Standard Includes

- 1"-thick top: Low-Pressure Laminate
- Overhead cabinet: Low-Pressure Laminate
- 3 mm radius profile edge on user's side: plastic
- 1 mm side and back edges: plastic default to match top
- One bottom fixed shelf
- Attachment hardware
- Shipped fully assembled

## Required to Specify

- 1 General quote number: **SF099872**
  - 2 Style number and Product ID
  - 3 Low-Pressure Laminate color number for top
  - 4 Plastic edge band color number for top
  - 5 Low-Pressure Laminate color number for overhead cabinet
- See Surface Materials in the Wood Casegoods and Tables Specification Guide

## Specification Information

Dimensions			Style	Product ID	Change to
D	W	H	Number		U.S. Price

### Low-Pressure Laminate Top

#### With Doors Omitted

15 <sup>11</sup> / <sub>16</sub> "	24"	18"	<b>TS5TLWD36</b>	SF00179878	+\$50
15 <sup>11</sup> / <sub>16</sub> "	30"	18"	<b>TS5TLWD36</b>	SF00158848	+\$50
15 <sup>11</sup> / <sub>16</sub> "	36"	18"	<b>TS5TLWD36</b>	SF00158856	-\$10
15 <sup>11</sup> / <sub>16</sub> "	42"	18"	<b>TS5TLWD42</b>	SF00158857	-\$14
15 <sup>11</sup> / <sub>16</sub> "	48"	18"	<b>TS5TLWD48</b>	SF00158858	-\$52
15 <sup>11</sup> / <sub>16</sub> "	60"	18"	<b>TS5TLWD60</b>	SF00158859	-\$70
15 <sup>11</sup> / <sub>16</sub> "	66"	18"	<b>TS5TLWD66</b>	SF00158860	-\$70
15 <sup>11</sup> / <sub>16</sub> "	72"	18"	<b>TS5TLWD72</b>	SF00159630	-\$70

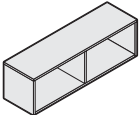
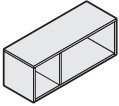
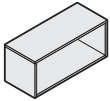

### For Canadian Pricing

Multiply U.S. Price by the Canadian price factor.

▶ See page 1 for details.

### What's Special

Bookcases available 30"W.

Tip: Top is available in Low-Pressure Laminates only.

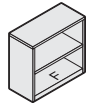

Tip: Plastic edge band selectable on 23½" high bookcase top only.

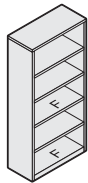

F=Fixed shelf

### Standard Includes

- 1½"-thick top on 28½"H bookcase: Low-Pressure Laminate or High-Pressure Laminate
- 1"-thick top on 66"H and 72"H bookcase: Low-Pressure Laminate
- Bookcase: Low-Pressure Laminate
- 3 mm radius profile edge on 28½"H user's side: plastic
- 1 mm side and back edges 28½"H: plastic default to match user's side
- Edge band on 66"H and 72"H bookcase: black plastic
- Adjustable shelves
- Shipped fully assembled

### Required to Specify

- 1 General quote number: **SF099872**
  - 2 Style number and Product ID
  - 3 Low-Pressure Laminate or High-Pressure Laminate color number for top on 28½"H bookcase or Low-Pressure Laminate color for top on 66"H and 72"H bookcase, as applicable
  - 4 Plastic edge band color number for worksurface
  - 5 Low-Pressure Laminate color number for bookcase
- See Surface Materials in the Wood Casegoods and Tables Specification Guide

### Specification Information

• Dimensions			• Style	• Product ID	• Change to
D	W	H	Number		U.S. Price

#### Low-Pressure Laminate Top

##### With One Adjustable Shelf

15¾"	30"	28½"	<b>TS5TLBK3628</b>	SF00174716	+\$110
------	-----	------	--------------------	------------	--------

#### Low-Pressure Laminate Top

##### With Four Adjustable Shelves

15¾"	30"	66"	<b>TS5TLBK3666</b>	SF00157347	+\$110
15¾"	30"	72"	<b>TS5TLBK3672</b>	SF00159901	+\$110

 **For Canadian Pricing**  
 Multiply U.S. Price by the Canadian price factor.  
 ▶ See page 1 for details.



---

# Privacy Wall

▶ See page 3, *About Design Options*, in the front of this book for pricing and ordering restrictions.

## Privacy Wall Standard

Solid Wall Panels	176
Modular Solid Wall Panels	180
All-Glass Wall Panels	184
Modular All-Glass Wall Panels	188
Glass Wall Panels with Three Equal Divided Lites	192
Modular Glass Wall Panels with Three Equal Divided Lites	196
Glass Wall Panels with Four Equal Divided Lites	200
Modular Glass Wall Panels with Four Equal Divided Lites	204
Glass Wall Panels with Four Divided Lites	208
Modular Glass Wall Panels with Four Divided Lites	212
Glass Wall Panels with Two Divided Lites	216
Modular Glass Wall Panels with Two Divided Lites	220
Clerestory Wall Panels	224
Modular Clerestory Wall Panels	228

## Glass Selections Standard

Glass Selections Wall Panels with Two Divided Lites	232
Glass Selections Modular Wall Panels with Two Divided Lites	236
Glass Selections All-Glass Wall Panels	240
Glass Selections Modular All-Glass Wall Panels	244
Glass Selections Clerestory Wall Panels	248
Glass Selections Modular Clerestory Wall Panels	252

# Solid Wall Panels



## What's Special

Parametric panel widths are available in 1" increments. This option is also available through the SmartTools software.

Tip: Order ceiling track, feature strip, and continuous base trim separately.

Tip: Paint price group 2 is only available on panels 36"W or smaller.

Tip: Vinyl is not available on panels wider than 48"W.

Tip: Panels that are wider than 48" may not be suitable for application in certain areas where local building codes have specific provisions for seismic activity. For more information regarding seismic applications, visit the Architectural Solutions Web site at [in2.steelcase.com/SalesGuides](http://in2.steelcase.com/SalesGuides) and more.



**For Canadian Pricing**  
Multiply U.S. Price by the Canadian price factor.  
▶ See page 1 for details.

Standard Includes		Required to Specify	
<ul style="list-style-type: none"> <li>Ceiling height from 8'0"H to 10'0"H, in one-inch increments</li> <li>2<sup>3</sup>/<sub>8</sub>"-thick panel with steel surfaces: paint</li> <li>Integral slotted verticals</li> <li>Hollow core panel for cable and power routing</li> <li>Floor track with adjustable levelers to accommodate continuous 5"H base trim (ordered separately)</li> </ul>		<ol style="list-style-type: none"> <li>General quote number: <b>AW001865</b></li> <li>Style number and Product ID</li> <li>Ceiling height</li> <li>Paint color number for side 1</li> <li>Paint color number for side 2</li> <li>Post extension</li> <li>Options, if selected (see below)</li> </ol> See Surface Materials in the Architectural Solution Specification Guide.	
Options	U.S. Price	Required to Specify	
<b>Surface Materials</b>			
<b>Panel surfaces 8'0"H through 10'0"H (per side) 6"W to 30"W</b>			
• Paint price group 1	No cost	Specify paint color number for side 1 and/or side 2.	
• Paint price group 2	+\$ 17	Specify paint color number for side 1 and/or side 2.	
• Paint price group 3	+\$ 27	Specify paint color number for side 1 and/or side 2.	
• Fabric price group 1	+\$153	Specify fabric color number for side 1 and/or side 2.	
• Fabric price group 2	+\$208	Specify fabric color number for side 1 and/or side 2.	
• Fabric price group 3	+\$263	Specify fabric color number for side 1 and/or side 2.	
• Fabric price group 5	+\$324	Specify fabric color number for side 1 and/or side 2.	
• Vinyl price group A	+\$297	Specify vinyl color number for side 1 and/or side 2.	
• Vinyl price group B	+\$420	Specify vinyl color number for side 1 and/or side 2.	
• Customer's Own Material (COM)	+\$149	▶ See <i>Surface Materials Reference Manual</i> .	
<b>Panel surfaces 8'0"H through 10'0"H (per side) 36"W to 60"W</b>			
• Paint price group 1	No cost	Specify paint color number for side 1 and/or side 2.	
• Paint price group 2	+\$ 27	Specify paint color number for side 1 and/or side 2.	
• Paint price group 3	+\$ 42	Specify paint color number for side 1 and/or side 2.	
• Fabric price group 1	+\$206	Specify fabric color number for side 1 and/or side 2.	
• Fabric price group 2	+\$303	Specify fabric color number for side 1 and/or side 2.	
• Fabric price group 3	+\$442	Specify fabric color number for side 1 and/or side 2.	
• Fabric price group 5	+\$566	Specify fabric color number for side 1 and/or side 2.	
• Vinyl price group A	+\$387	Specify vinyl color number for side 1 and/or side 2.	
• Vinyl price group B	+\$585	Specify vinyl color number for side 1 and/or side 2.	
• Customer's Own Material (COM)	+\$193	▶ See <i>Surface Materials Reference Manual</i> .	
<b>Post Extension</b>			
• Post extensions modified to accommodate recessed ceiling track (ordered separately)	No cost	Specify with post extensions for recessed ceiling track interface.	
• Post extensions modified to accommodate overlapping ceiling track (ordered separately)	No cost	Specify with post extensions for overlapping ceiling track interface.	
<b>Ceiling Height</b>			
• 8'0" through 9'0"	No cost	Specify ceiling height in 1" increments.	
• 9'1" through 10'0"	+\$ 85	Specify ceiling height in 1" increments.	

▶ Options, continued on next page



## ► Options, continued from previous page

Tip: To price power in two locations, add the upcharges together.

Tip: Infeed is included in price of ADA- or desk-height receptacle power location option. Base power block location does not include infeed. It must be ordered separately, if needed.

Tip: NYC/CHI prices replace the receptacle power location option prices when selected.

Tip: Order power and communication and power-only cover plates separately.

Tip: Panels that are less than 18"W are not factory punched for infeeds.

Options	U.S. Price	Required to Specify
<b>Electrical Power</b> (for panels 30"W through 60"W)		
<b>Power block locations</b>		
• Base	+\$192	Specify with power block location at base.
• ADA height	+\$701	Specify with power block location at ADA height.
• Desk height	+\$701	Specify with power block location at desk height.
<b>New York City/Chicago Power Prep</b>		
• NYC/CHI side 1	+\$ 24	Specify with NYC/CHI side 1.
• NYC/CHI side 2	+\$ 24	Specify with NYC/CHI side 2.
• NYC/CHI sides 1 and 2	+\$ 49	Specify with NYC/CHI sides 1 and 2.
<b>Receptacle cutouts</b>		
• Power side 1	No cost	Specify with power side 1.
• Power side 2	No cost	Specify with power side 2.
• Power sides 1 and 2	+\$ 24	Specify with power sides 1 and 2.
• Power/comm side 1	No cost	Specify with power/comm side 1.
• Power/comm side 2	No cost	Specify with power/comm side 2.
• Power/comm sides 1 and 2	+\$ 24	Specify with power/comm sides 1 and 2.
<b>Power schematic</b>		
• 3+1	No cost	Specify with 3+1 power.
• 2+2	No cost	Specify with 2+2 power.
• 3SN	No cost	Specify with 3SN power.
<b>Ceiling infeeds</b>		
• Top left hardwire	No cost	Specify with top left hardwire.
• Top left modular	+\$ 89	Specify with top left modular.
<b>Floor infeeds</b>		
• Bottom left hardwire	No cost	Specify with bottom left hardwire.
• Bottom left modular	+\$ 89	Specify with bottom left modular.

## Specification Information

Width	Style Number	Product ID	Change to U.S. Base Price
-------	--------------	------------	---------------------------

## Solid Wall Panels

7"	<b>GPSS08</b>	AW00009408	+\$36
9"	<b>GPSS18</b>	AW00009409	+\$36
10"	<b>GPSS18</b>	AW00009410	+\$36
11"	<b>GPSS18</b>	AW00009411	+\$36
12"	<b>GPSS18</b>	AW00009255	+\$36
13"	<b>GPSS18</b>	AW00009412	+\$36
14"	<b>GPSS18</b>	AW00009256	+\$36
15"	<b>GPSS18</b>	AW00009413	+\$36
16"	<b>GPSS18</b>	AW00009414	+\$36
17"	<b>GPSS18</b>	AW00009415	+\$36
19"	<b>GPSS20</b>	AW00009416	+\$36
21"	<b>GPSS24</b>	AW00009419	+\$36
22"	<b>GPSS24</b>	AW00009420	+\$36
23"	<b>GPSS24</b>	AW00009421	+\$36
25"	<b>GPSS30</b>	AW00009422	+\$36
26"	<b>GPSS30</b>	AW00009423	+\$36

## ► Specification Information, continued on next page

**For Canadian Pricing**

Multiply U.S. Price by the Canadian price factor.

► See page 1 for details.

► Specification Information, continued from previous page

**Specification Information**

Width	Style Number	Product ID	Change to U.S. Base Price
-------	--------------	------------	---------------------------



**Solid Wall Panels, continued**

27"	<b>GPSS30</b>	AW00009424	+\$36
28"	<b>GPSS30</b>	AW00009425	+\$36
29"	<b>GPSS30</b>	AW00009426	+\$36
31"	<b>GPSS36</b>	AW00009427	+\$36
32"	<b>GPSS36</b>	AW00009428	+\$36
33"	<b>GPSS36</b>	AW00009429	+\$36
34"	<b>GPSS36</b>	AW00009430	+\$36
35"	<b>GPSS36</b>	AW00009431	+\$36
37"	<b>GPSS40</b>	AW00009432	+\$36
38"	<b>GPSS40</b>	AW00009433	+\$36
39"	<b>GPSS40</b>	AW00009434	+\$36
41"	<b>GPSS42</b>	AW00009435	+\$36
43"	<b>GPSS48</b>	AW00009436	+\$36
44"	<b>GPSS48</b>	AW00009437	+\$36
45"	<b>GPSS48</b>	AW00009438	+\$36
46"	<b>GPSS48</b>	AW00009439	+\$36
47"	<b>GPSS48</b>	AW00009440	+\$36
49"	<b>GPSS60</b>	AW00009441	+\$36
50"	<b>GPSS60</b>	AW00009442	+\$36
51"	<b>GPSS60</b>	AW00009443	+\$36
52"	<b>GPSS60</b>	AW00009444	+\$36
53"	<b>GPSS60</b>	AW00009445	+\$36
54"	<b>GPSS60</b>	AW00009446	+\$36
55"	<b>GPSS60</b>	AW00009447	+\$36
56"	<b>GPSS60</b>	AW00009448	+\$36
57"	<b>GPSS60</b>	AW00009449	+\$36
58"	<b>GPSS60</b>	AW00009450	+\$36
59"	<b>GPSS60</b>	AW00009451	+\$36



**For Canadian Pricing**  
 Multiply U.S. Price by the  
 Canadian price factor.  
 ► See page 1 for details.



# Modular Solid Wall Panels



## What's Special

Parametric panel widths are available in 1" increments. This option is also available through the SmartTools software.

Tip: Order ceiling track, feature strip, and continuous base trim separately.

Tip: Paint price group 2 is only available on panels 36"W or smaller.

Tip: Vinyl is not available on panels wider than 48"W.

Tip: Panels that are wider than 48" may not be suitable for application in certain areas where local building codes have specific provisions for seismic activity. For more information regarding seismic applications, visit the Architectural Solutions Web site at [in2.steelcase.com/SalesGuides](http://in2.steelcase.com/SalesGuides) and more.



## For Canadian Pricing

Multiply U.S. Price by the Canadian price factor.

► See page 1 for details.

Standard Includes	Required to Specify
<ul style="list-style-type: none"> <li>Ceiling height from 8'0"H to 10'0"H, in one-inch increments</li> <li>2<sup>3</sup>/<sub>8</sub>"-thick panel with steel surfaces: paint</li> <li>Integral slotted verticals</li> <li>Hollow core panel for cable and power routing</li> <li>Floor track with adjustable levelers to accommodate continuous 5"H base trim (ordered separately)</li> </ul>	<ol style="list-style-type: none"> <li>General quote number: <b>AW001866</b></li> <li>Style number and Product ID</li> <li>Ceiling height</li> <li>Paint color number for side 1</li> <li>Paint color number for side 2</li> <li>Post extension</li> <li>Options, if selected (see below)</li> </ol> See Surface Materials in the Architectural Solution Specification Guide.

Options	U.S. Price	Required to Specify
<b>Surface Materials</b>		
<b>Panel surfaces 8'0"H through 10'0"H (per side) 6"W to 30"W</b>		
• Paint price group 1	No cost	Specify paint color number for side 1 and/or side 2.
• Paint price group 2	+\$ 17	Specify paint color number for side 1 and/or side 2.
• Paint price group 3	+\$ 27	Specify paint color number for side 1 and/or side 2.
• Fabric price group 1	+\$153	Specify fabric color number for side 1 and/or side 2.
• Fabric price group 2	+\$208	Specify fabric color number for side 1 and/or side 2.
• Fabric price group 3	+\$263	Specify fabric color number for side 1 and/or side 2.
• Fabric price group 5	+\$324	Specify fabric color number for side 1 and/or side 2.
• Vinyl price group A	+\$297	Specify vinyl color number for side 1 and/or side 2.
• Vinyl price group B	+\$420	Specify vinyl color number for side 1 and/or side 2.
• Customer's Own Material (COM)	+\$149	► See <i>Surface Materials Reference Manual</i> .
<b>Panel surfaces 8'0"H through 10'0"H (per side) 36"W to 60"W</b>		
• Paint price group 1	No cost	Specify paint color number for side 1 and/or side 2.
• Paint price group 2	+\$ 27	Specify paint color number for side 1 and/or side 2.
• Paint price group 3	+\$ 42	Specify paint color number for side 1 and/or side 2.
• Fabric price group 1	+\$206	Specify fabric color number for side 1 and/or side 2.
• Fabric price group 2	+\$303	Specify fabric color number for side 1 and/or side 2.
• Fabric price group 3	+\$442	Specify fabric color number for side 1 and/or side 2.
• Fabric price group 5	+\$566	Specify fabric color number for side 1 and/or side 2.
• Vinyl price group A	+\$387	Specify vinyl color number for side 1 and/or side 2.
• Vinyl price group B	+\$585	Specify vinyl color number for side 1 and/or side 2.
• Customer's Own Material (COM)	+\$193	► See <i>Surface Materials Reference Manual</i> .
<b>Post Extension</b>		
• Post extensions modified to accommodate recessed ceiling track (ordered separately)	No cost	Specify with post extensions for recessed ceiling track interface.
• Post extensions modified to accommodate overlapping ceiling track (ordered separately)	No cost	Specify with post extensions for overlapping ceiling track interface.
<b>Ceiling Height</b>		
• 8'0" through 9'0"	No cost	Specify ceiling height in 1" increments.
• 9'1" through 10'0"	+\$ 85	Specify ceiling height in 1" increments.

► Options, continued on next page

► Options, continued from previous page

Options	U.S. Price	Required to Specify
<b>Electrical Power</b> (for panels 30"W through 60"W)		
<b>Power block locations</b>		
• Base	+\$192	Specify with power block location at base.
• ADA height	+\$701	Specify with power block location at ADA height.
• Desk height	+\$701	Specify with power block location at desk height.
<b>New York City/Chicago Power Prep</b>		
• NYC/CHI side 1	+\$ 24	Specify with NYC/CHI side 1.
• NYC/CHI side 2	+\$ 24	Specify with NYC/CHI side 2.
• NYC/CHI sides 1 and 2	+\$ 49	Specify with NYC/CHI sides 1 and 2.
<b>Receptacle cutouts</b>		
• Power side 1	No cost	Specify with power side 1.
• Power side 2	No cost	Specify with power side 2.
• Power sides 1 and 2	+\$ 24	Specify with power sides 1 and 2.
• Power/comm side 1	No cost	Specify with power/comm side 1.
• Power/comm side 2	No cost	Specify with power/comm side 2.
• Power/comm sides 1 and 2	+\$ 24	Specify with power/comm sides 1 and 2.
<b>Power schematic</b>		
• 3+1	No cost	Specify with 3+1 power.
• 2+2	No cost	Specify with 2+2 power.
• 3SN	No cost	Specify with 3SN power.
<b>Ceiling infeeds</b>		
• Top left hardwire	No cost	Specify with top left hardwire.
• Top left modular	+\$ 89	Specify with top left modular.
<b>Floor infeeds</b>		
• Bottom left hardwire	No cost	Specify with bottom left hardwire.
• Bottom left modular	+\$ 89	Specify with bottom left modular.

Tip: To price power in two locations, add the upcharges together.

Tip: Infeed is included in price of ADA- or desk-height receptacle power location option. Base power block location does not include infeed. It must be ordered separately, if needed.

Tip: NYC/CHI prices replace the receptacle power location option prices when selected.

Tip: Order power and communication and power-only cover plates separately.

Tip: Panels that are less than 18"W are not factory punched for infeeds.

Specification Information

Nominal Width	Actual Width	Style Number	Product ID	Change to U.S. Base Price
---------------	--------------	--------------	------------	---------------------------

Modular Solid Wall Panels

7"	5.657"	<b>GPSM08</b>	AW009452	+\$36
9"	7.657"	<b>GPSM18</b>	AW009453	+\$36
10"	8.657"	<b>GPSM18</b>	AW009454	+\$36
11"	9.657"	<b>GPSM18</b>	AW009455	+\$36
12"	10.657"	<b>GPSM18</b>	AW009456	+\$36
13"	11.657"	<b>GPSM18</b>	AW009458	+\$36
14"	12.657"	<b>GPSM18</b>	AW009459	+\$36
15"	13.657"	<b>GPSM18</b>	AW009460	+\$36
16"	14.657"	<b>GPSM18</b>	AW009461	+\$36
17"	15.657"	<b>GPSM18</b>	AW009462	+\$36
19"	17.657"	<b>GPSM20</b>	AW009463	+\$36
21"	19.657"	<b>GPSM24</b>	AW009464	+\$36
22"	20.657"	<b>GPSM24</b>	AW009465	+\$36
23"	21.657"	<b>GPSM24</b>	AW009466	+\$36
25"	23.657"	<b>GPSM30</b>	AW009467	+\$36
26"	24.657"	<b>GPSM30</b>	AW009468	+\$36



 **For Canadian Pricing**  
Multiply U.S. Price by the Canadian price factor.  
► See page 1 for details.

► Specification Information, continued on next page

► Specification Information, continued from previous page

**Specification Information**

Nominal Width	Actual Width	Style Number	Product ID	Change to U.S. Base Price
---------------	--------------	--------------	------------	---------------------------



**Modular Solid Wall Panels, continued**

27"	25.657"	<b>GPSM30</b>	AW009469	+\$36
28"	26.657"	<b>GPSM30</b>	AW009470	+\$36
29"	27.657"	<b>GPSM30</b>	AW009471	+\$36
31"	29.657"	<b>GPSM36</b>	AW009472	+\$36
32"	30.657"	<b>GPSM36</b>	AW009473	+\$36
33"	31.657"	<b>GPSM36</b>	AW009474	+\$36
34"	32.657"	<b>GPSM36</b>	AW009475	+\$36
35"	33.657"	<b>GPSM36</b>	AW009476	+\$36
37"	35.657"	<b>GPSM40</b>	AW009477	+\$36
38"	36.657"	<b>GPSM40</b>	AW009478	+\$36
39"	37.357"	<b>GPSM40</b>	AW009479	+\$36
41"	39.657"	<b>GPSM42</b>	AW009480	+\$36
43"	41.657"	<b>GPSM48</b>	AW009481	+\$36
44"	42.657"	<b>GPSM48</b>	AW009482	+\$36
45"	43.657"	<b>GPSM48</b>	AW009483	+\$36
46"	44.657"	<b>GPSM48</b>	AW009484	+\$36
47"	45.657"	<b>GPSM48</b>	AW009485	+\$36
49"	47.657"	<b>GPSM60</b>	AW009486	+\$36
50"	48.657"	<b>GPSM60</b>	AW009487	+\$36
51"	49.657"	<b>GPSM60</b>	AW009488	+\$36
52"	50.657"	<b>GPSM60</b>	AW009489	+\$36
53"	51.657"	<b>GPSM60</b>	AW009490	+\$36
54"	52.657"	<b>GPSM60</b>	AW009491	+\$36
55"	53.657"	<b>GPSM60</b>	AW009492	+\$36
56"	54.657"	<b>GPSM60</b>	AW009493	+\$36
57"	55.657"	<b>GPSM60</b>	AW009494	+\$36
58"	56.657"	<b>GPSM60</b>	AW009495	+\$36
59"	57.657"	<b>GPSM60</b>	AW009496	+\$36



**For Canadian Pricing**

Multiply U.S. Price by the Canadian price factor.

► See page 1 for details.



# All-Glass Wall Panels



Tip: Order ceiling track, feature strip, and continuous base trim separately.

## What's Special

Parametric panel widths are available in 1" increments. This option is also available through the SmartTools software.

### Standard Includes

- Ceiling height from 8'0"H to 10'0"H, in one-inch increments
- 2<sup>3</sup>/<sub>8</sub>"-thick panel with steel frame: paint
- 1/4"-thick factory-installed lite: glass
- Floor track with adjustable levelers to accommodate continuous 5"H base trim (ordered separately)

### Required to Specify

- 1 General quote number: **AW001868**
  - 2 Style number and Product ID
  - 3 Ceiling height
  - 4 Paint color number for frame
  - 5 Glass number for lite
  - 6 Post extension
  - 7 Options, if selected (see below)
- See Surface Materials in the Architectural Solution Specification Guide.

	Options	U.S. Price	Required to Specify
<b>Surface Materials</b>	<b>Glass frame surface</b>		
	• Paint price group 1	No cost	Specify paint color number.
	• Paint price group 2	+\$ 25	Specify paint color number.
	• Paint price group 3	+\$ 44	Specify paint color number.
	<b>Panel surfaces 8'0"H through 10'0"H (per lite), 6"W to 8"W</b>		
	• Glass price group 1	No cost	Specify glass number for lite.
	• Glass price group 2	+\$ 94	Specify glass number for lite.
	• Glass price group 3	+\$ 114	Specify glass number for lite.
	• Glass price group 4	+\$ 181	Specify glass number for lite.
	• Glass price group 5	N.A.	Specify glass number for lite.
	• Glass price group 6	+\$ 356	Specify glass number for lite.
			▶ See <i>Surface Materials Reference Manual</i> .
	<b>Panel surfaces 8'0"H through 10'0"H (per lite), 18"W to 24"W</b>		
	• Glass price group 1	No cost	Specify glass number for lite.
	• Glass price group 2	+\$ 283	Specify glass number for lite.
	• Glass price group 3	+\$ 337	Specify glass number for lite.
	• Glass price group 4	+\$ 541	Specify glass number for lite.
	• Glass price group 5	N.A.	Specify glass number for lite.
	• Glass price group 6	+\$1065	Specify glass number for lite.
			▶ See <i>Surface Materials Reference Manual</i> .
	<b>Panel surfaces 8'0"H through 10'0"H (per lite), 30"W to 36"W</b>		
	• Glass price group 1	No cost	Specify glass number for lite.
	• Glass price group 2	+\$ 424	Specify glass number for lite.
	• Glass price group 3	+\$ 505	Specify glass number for lite.
	• Glass price group 4	+\$ 809	Specify glass number for lite.
	• Glass price group 5	N.A.	Specify glass number for lite.
	• Glass price group 6	+\$1595	Specify glass number for lite.
			▶ See <i>Surface Materials Reference Manual</i> .
	<b>Panel surfaces 8'0"H through 10'0"H (per lite), 40"W to 48"W</b>		
	• Glass price group 1	No cost	Specify glass number for lite.
	• Glass price group 2	+\$ 566	Specify glass number for lite.
	• Glass price group 3	+\$ 672	Specify glass number for lite.
	• Glass price group 4	+\$1080	Specify glass number for lite.
	• Glass price group 5	N.A.	Specify glass number for lite.
	• Glass price group 6	+\$2128	Specify glass number for lite.
			▶ See <i>Surface Materials Reference Manual</i> .
	<b>Panel surfaces 8'0"H through 10'0"H (per lite), 60"W</b>		
	• Glass price group 1	No cost	Specify glass number for lite.
	• Glass price group 2	+\$ 707	Specify glass number for lite.
	• Glass price group 3	+\$ 840	Specify glass number for lite.
	• Glass price group 4	+\$1348	Specify glass number for lite.
	• Glass price group 5	N.A.	Specify glass number for lite.
	• Glass price group 6	+\$2660	Specify glass number for lite.
			▶ See <i>Surface Materials Reference Manual</i> .
<b>Post Extension</b>	• Post extensions modified to accommodate recessed ceiling track (ordered separately)	No cost	Specify with <i>post extensions for recessed ceiling track interface</i> .
	• Post extensions modified to accommodate overlapping ceiling track (ordered separately)	No cost	Specify with <i>post extensions for overlapping ceiling track interface</i> .

▶ Options, continued on next page

 **For Canadian Pricing**  
Multiply U.S. Price by the Canadian price factor.  
▶ See page 1 for details.



► Options, continued from previous page

Options	U.S. Price	Required to Specify
<b>Ceiling Height</b>		
• 8'0" through 9'0"	No cost	Specify ceiling height in 1" increments.
• 9'1" through 10'0"	+\$ 85	Specify ceiling height in 1" increments.
<b>Electrical Power</b>		
(For panels 30"W through 60"W)		
<b>Base power block power schematic</b>		
• 3+1	+\$ 192	Specify with 3+1 power.
• 2+2	+\$ 192	Specify with 2+2 power.
• 3SN	+\$ 192	Specify with 3SN power.

Tip: Base power block location does not include infeed. It must be ordered separately, if needed.

Specification Information

Width	Style Number	Product ID	Change to U.S. Base Price
-------	--------------	------------	---------------------------

All-Glass Wall Panels

7"	<b>GPGS08</b>	AW00009542	+\$0
9"	<b>GPGS18</b>	AW00009544	+\$0
10"	<b>GPGS18</b>	AW00009547	+\$0
11"	<b>GPGS18</b>	AW00009550	+\$0
12"	<b>GPGS18</b>	AW00009554	+\$0
13"	<b>GPGS18</b>	AW00009556	+\$0
14"	<b>GPGS18</b>	AW00009557	+\$0
15"	<b>GPGS18</b>	AW00009559	+\$0
16"	<b>GPGS18</b>	AW00009560	+\$0
17"	<b>GPGS18</b>	AW00009561	+\$0
19"	<b>GPGS20</b>	AW00009563	+\$0
21"	<b>GPGS24</b>	AW00009565	+\$0
22"	<b>GPGS24</b>	AW00009567	+\$0
23"	<b>GPGS24</b>	AW00009569	+\$0
25"	<b>GPGS30</b>	AW00009570	+\$0
26"	<b>GPGS30</b>	AW00009578	+\$0
27"	<b>GPGS30</b>	AW00009579	+\$0
28"	<b>GPGS30</b>	AW00009581	+\$0
29"	<b>GPGS30</b>	AW00009586	+\$0
31"	<b>GPGS36</b>	AW00009587	+\$0
32"	<b>GPGS36</b>	AW00009588	+\$0
33"	<b>GPGS36</b>	AW00009589	+\$0
34"	<b>GPGS36</b>	AW00009590	+\$0
35"	<b>GPGS36</b>	AW00009591	+\$0
37"	<b>GPGS40</b>	AW00009592	+\$0
38"	<b>GPGS40</b>	AW00009593	+\$0
39"	<b>GPGS40</b>	AW00009594	+\$0
41"	<b>GPGS42</b>	AW00009595	+\$0
43"	<b>GPGS48</b>	AW00009596	+\$0



Privacy Wall

 **For Canadian Pricing**  
 Multiply U.S. Price by the Canadian price factor.  
 ► See page 1 for details.

► Specification Information, continued on next page

► **Specification Information, continued from previous page**

**Specification Information**

Width	Style Number	Product ID	Change to U.S. Base Price
-------	--------------	------------	---------------------------

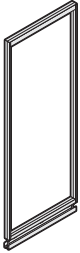

**All-Glass Wall Panels, continued**

44"	<b>GPGS48</b>	AW00009597	+\$0
45"	<b>GPGS48</b>	AW00009598	+\$0
46"	<b>GPGS48</b>	AW00009599	+\$0
47"	<b>GPGS48</b>	AW00009600	+\$0
49"	<b>GPGS60</b>	AW00009601	+\$0
50"	<b>GPGS60</b>	AW00009602	+\$0
51"	<b>GPGS60</b>	AW00009603	+\$0
52"	<b>GPGS60</b>	AW00009604	+\$0
53"	<b>GPGS60</b>	AW00009605	+\$0
54"	<b>GPGS60</b>	AW00009606	+\$0
55"	<b>GPGS60</b>	AW00009607	+\$0
56"	<b>GPGS60</b>	AW00009608	+\$0
57"	<b>GPGS60</b>	AW00009609	+\$0
58"	<b>GPGS60</b>	AW00009610	+\$0
59"	<b>GPGS60</b>	AW00009611	+\$0
:	:	:	:



**For Canadian Pricing**  
 Multiply U.S. Price by the  
 Canadian price factor.  
 ► See page 1 for details.



# Modular All-Glass Wall Panels



Tip: Order ceiling track, feature strip, and continuous base trim separately.

## What's Special

Parametric panel widths are available in 1" increments. This option is also available through the SmartTools software.

Standard Includes	Required to Specify
<ul style="list-style-type: none"> <li>Ceiling height from 8'0"H to 10'0"H, in one-inch increments</li> <li>2<sup>3</sup>/<sub>8</sub>"-thick panel with steel frame: paint</li> <li>1/4"-thick factory-installed lite: glass</li> <li>Floor track with adjustable levelers to accommodate continuous 5"H base trim (ordered separately)</li> </ul>	<ol style="list-style-type: none"> <li>General quote number: <b>AW002317</b></li> <li>Style number and Product ID</li> <li>Ceiling height</li> <li>Paint color number for frame</li> <li>Glass number for lite</li> <li>Post extension</li> <li>Options, if selected (see below)</li> </ol> See Surface Materials in the Architectural Solution Specification Guide.

Surface Materials	Options	U.S. Price	Required to Specify	
	<b>Glass frame surface</b>			
	• Paint price group 1	No cost	Specify paint color number.	
	• Paint price group 2	+\$ 25	Specify paint color number.	
	• Paint price group 3	+\$ 44	Specify paint color number.	
	<b>Panel surfaces 8'0"H through 10'0"H (per lite), 18"W to 24"W</b>			
	• Glass price group 1	No cost	Specify glass number for lite.	
	• Glass price group 2	+\$ 283	Specify glass number for lite.	
	• Glass price group 3	+\$ 337	Specify glass number for lite.	
	• Glass price group 4	+\$ 541	Specify glass number for lite.	
	• Glass price group 5	N.A.	Specify glass number for lite.	
	• Glass price group 6	+\$1065	Specify glass number for lite.	
				▶ See <i>Surface Materials Reference Manual</i> .
	<b>Panel surfaces 8'0"H through 10'0"H (per lite), 30"W to 36"W</b>			
	• Glass price group 1	No cost	Specify glass number for lite.	
	• Glass price group 2	+\$ 424	Specify glass number for lite.	
• Glass price group 3	+\$ 505	Specify glass number for lite.		
• Glass price group 4	+\$ 809	Specify glass number for lite.		
• Glass price group 5	N.A.	Specify glass number for lite.		
• Glass price group 6	+\$1595	Specify glass number for lite.		
			▶ See <i>Surface Materials Reference Manual</i> .	
<b>Panel surfaces 8'0"H through 10'0"H (per lite), 40"W to 48"W</b>				
• Glass price group 1	No cost	Specify glass number for lite.		
• Glass price group 2	+\$ 566	Specify glass number for lite.		
• Glass price group 3	+\$ 672	Specify glass number for lite.		
• Glass price group 4	+\$1080	Specify glass number for lite.		
• Glass price group 5	N.A.	Specify glass number for lite.		
• Glass price group 6	+\$2128	Specify glass number for lite.		
			▶ See <i>Surface Materials Reference Manual</i> .	
<b>Panel surfaces 8'0"H through 10'0"H (per lite), 60"W</b>				
• Glass price group 1	No cost	Specify glass number for lite.		
• Glass price group 2	+\$ 707	Specify glass number for lite.		
• Glass price group 3	+\$ 840	Specify glass number for lite.		
• Glass price group 4	+\$1348	Specify glass number for lite.		
• Glass price group 5	N.A.	Specify glass number for lite.		
• Glass price group 6	+\$2660	Specify glass number for lite.		
			▶ See <i>Surface Materials Reference Manual</i> .	
<b>Post Extension</b>	• Post extensions modified to accommodate recessed ceiling track (ordered separately)	No cost	Specify with post extensions for recessed ceiling track interface.	
	• Post extensions modified to accommodate overlapping ceiling track (ordered separately)	No cost	Specify with post extensions for overlapping ceiling track interface.	

▶ Options, continued on next page



## For Canadian Pricing

Multiply U.S. Price by the Canadian price factor.

▶ See page 1 for details.

► Options, continued from previous page

Options	U.S. Price	Required to Specify
<b>Ceiling Height</b>		
• 8'0" through 9'0"	No cost	Specify ceiling height in 1" increments. Specify ceiling height in 1" increments.
• 9'1" through 10'0"	+\$ 85	
<b>Electrical Power</b> (For panels 30"W through 60"W)	<b>Base power block power schematic</b>	
	• 3+1	Specify with 3+1 power.
	• 2+2	Specify with 2+2 power.
	• 3SN	Specify with 3SN power.

Tip: Base power block location does not include infeed. It must be ordered separately, if needed.

Specification Information				
Nominal Width	Actual Width	Style Number	Product ID	Change to U.S. Base Price

**Modular All-Glass Wall Panels**

9"	7.657"	<b>GPGM18</b>	AW00012301	+\$0
10"	8.657"	<b>GPGM18</b>	AW00012302	+\$0
11"	9.657"	<b>GPGM18</b>	AW00012303	+\$0
12"	10.657"	<b>GPGM18</b>	AW00010256	+\$0
13"	11.657"	<b>GPGM18</b>	AW00012304	+\$0
14"	12.657"	<b>GPGM18</b>	AW00012305	+\$0
15"	13.657"	<b>GPGM18</b>	AW00012306	+\$0
16"	14.657"	<b>GPGM18</b>	AW00012308	+\$0
17"	15.657"	<b>GPGM18</b>	AW00012309	+\$0
19"	17.657"	<b>GPGM20</b>	AW00012310	+\$0
21"	19.657"	<b>GPGM24</b>	AW00012311	+\$0
22"	20.657"	<b>GPGM24</b>	AW00012312	+\$0
23"	21.657"	<b>GPGM24</b>	AW00012313	+\$0
25"	23.657"	<b>GPGM30</b>	AW00012315	+\$0
26"	24.657"	<b>GPGM30</b>	AW00012316	+\$0
27"	25.657"	<b>GPGM30</b>	AW00012317	+\$0
28"	26.657"	<b>GPGM30</b>	AW00012318	+\$0
29"	27.657"	<b>GPGM30</b>	AW00012319	+\$0
31"	29.657"	<b>GPGM36</b>	AW00012321	+\$0
32"	30.657"	<b>GPGM36</b>	AW00012322	+\$0
33"	31.657"	<b>GPGM36</b>	AW00012323	+\$0
34"	32.657"	<b>GPGM36</b>	AW00012325	+\$0
35"	33.657"	<b>GPGM36</b>	AW00012326	+\$0
37"	35.657"	<b>GPGM40</b>	AW00012327	+\$0
38"	36.657"	<b>GPGM40</b>	AW00012328	+\$0
39"	37.357"	<b>GPGM40</b>	AW00012329	+\$0
41"	39.657"	<b>GPGM42</b>	AW00012330	+\$0
43"	41.657"	<b>GPGM48</b>	AW00012331	+\$0
44"	42.657"	<b>GPGM48</b>	AW00012332	+\$0



Privacy Wall

 **For Canadian Pricing**  
Multiply U.S. Price by the Canadian price factor.  
► See page 1 for details.

► Specification Information, continued on next page

► **Specification Information, continued from previous page**

**Specification Information**

Nominal Width	Actual Width	Style Number	Product ID	Change to U.S. Base Price
---------------	--------------	--------------	------------	---------------------------

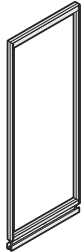

**Modular All-Glass Wall Panels, continued**

45"	43.657"	<b>GPGM48</b>	AW00012333	+\$0
46"	44.657"	<b>GPGM48</b>	AW00012334	+\$0
47"	45.657"	<b>GPGM48</b>	AW00012335	+\$0
49"	47.657"	<b>GPGM60</b>	AW00012336	+\$0
50"	48.657"	<b>GPGM60</b>	AW00012337	+\$0
51"	49.657"	<b>GPGM60</b>	AW00012338	+\$0
52"	50.657"	<b>GPGM60</b>	AW00012339	+\$0
53"	51.657"	<b>GPGM60</b>	AW00010428	+\$0
54"	52.657"	<b>GPGM60</b>	AW00012341	+\$0
55"	53.657"	<b>GPGM60</b>	AW00012342	+\$0
56"	54.657"	<b>GPGM60</b>	AW00012343	+\$0
57"	55.657"	<b>GPGM60</b>	AW00012344	+\$0
58"	56.657"	<b>GPGM60</b>	AW00012345	+\$0
59"	57.657"	<b>GPGM60</b>	AW00012346	+\$0



**For Canadian Pricing**

Multiply U.S. Price by the Canadian price factor.

► See page 1 for details.



# Glass Wall Panels with Three Equal Divided Lites

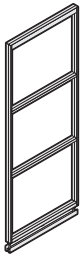

Tip: Order ceiling track, feature strip, and continuous base trim separately.

## What's Special

Parametric panel widths are available in 1" increments. This option is also available through the SmartTools software.

### Standard Includes

- Ceiling height from 8'0"H to 10'0"H, in one-inch increments
- 2<sup>3</sup>/<sub>8</sub>"-thick panel with steel frame: paint
- Three, 1/4"-thick factory-installed lites: glass
- Floor track with adjustable levelers to accommodate continuous 5"H base trim (ordered separately)

### Required to Specify

- 1 General quote number: **AW001869**
  - 2 Style number and Product ID
  - 3 Ceiling height
  - 4 Paint color number for frame and muntin
  - 5 Glass number for lite 1 (from top)
  - 6 Glass number for lite 2
  - 7 Glass number for lite 3
  - 8 Post extension
  - 9 Options, if selected (see below)
- See Surface Materials in the Architectural Solution Specification Guide.

	Options	U.S. Price	Required to Specify
<b>Surface Materials</b>	<b>Glass frame surface</b>		
	<ul style="list-style-type: none"> <li>• Paint price group 1</li> <li>• Paint price group 2</li> <li>• Paint price group 3</li> </ul>	<ul style="list-style-type: none"> <li>No cost</li> <li>+\$ 25</li> <li>+\$ 44</li> </ul>	<ul style="list-style-type: none"> <li>Specify paint color number.</li> <li>Specify paint color number.</li> <li>Specify paint color number.</li> </ul>
	<b>Panel surfaces 8'0"H through 10'0"H (per lite), 6"W to 8"W</b>		
	<ul style="list-style-type: none"> <li>• Glass price group 1</li> <li>• Glass price group 2</li> <li>• Glass price group 3</li> <li>• Glass price group 4</li> <li>• Glass price group 5</li> <li>• Glass price group 6</li> </ul>	<ul style="list-style-type: none"> <li>No cost</li> <li>+\$ 31</li> <li>+\$ 40</li> <li>+\$ 60</li> <li>N.A.</li> <li>+\$121</li> </ul>	<ul style="list-style-type: none"> <li>Specify glass number for lite.</li> <li>Specify glass number for lite.</li> <li>Specify glass number for lite.</li> <li>Specify glass number for lite.</li> <li>Specify glass number for lite.</li> <li>Specify glass number for lite.</li> </ul> <p>▶ See <i>Surface Materials Reference Manual</i>.</p>
	<b>Panel surfaces 8'0"H through 10'0"H (per lite), 18"W to 24"W</b>		
	<ul style="list-style-type: none"> <li>• Glass price group 1</li> <li>• Glass price group 2</li> <li>• Glass price group 3</li> <li>• Glass price group 4</li> <li>• Glass price group 5</li> <li>• Glass price group 6</li> </ul>	<ul style="list-style-type: none"> <li>No cost</li> <li>+\$ 94</li> <li>+\$114</li> <li>+\$181</li> <li>N.A.</li> <li>+\$356</li> </ul>	<ul style="list-style-type: none"> <li>Specify glass number for lite.</li> <li>Specify glass number for lite.</li> <li>Specify glass number for lite.</li> <li>Specify glass number for lite.</li> <li>Specify glass number for lite.</li> <li>Specify glass number for lite.</li> </ul> <p>▶ See <i>Surface Materials Reference Manual</i>.</p>
	<b>Panel surfaces 8'0"H through 10'0"H (per lite), 30"W to 36"W</b>		
	<ul style="list-style-type: none"> <li>• Glass price group 1</li> <li>• Glass price group 2</li> <li>• Glass price group 3</li> <li>• Glass price group 4</li> <li>• Glass price group 5</li> <li>• Glass price group 6</li> </ul>	<ul style="list-style-type: none"> <li>No cost</li> <li>+\$141</li> <li>+\$168</li> <li>+\$270</li> <li>N.A.</li> <li>+\$532</li> </ul>	<ul style="list-style-type: none"> <li>Specify glass number for lite.</li> <li>Specify glass number for lite.</li> <li>Specify glass number for lite.</li> <li>Specify glass number for lite.</li> <li>Specify glass number for lite.</li> <li>Specify glass number for lite.</li> </ul> <p>▶ See <i>Surface Materials Reference Manual</i>.</p>
	<b>Panel surfaces 8'0"H through 10'0"H (per lite), 40"W to 48"W</b>		
	<ul style="list-style-type: none"> <li>• Glass price group 1</li> <li>• Glass price group 2</li> <li>• Glass price group 3</li> <li>• Glass price group 4</li> <li>• Glass price group 5</li> <li>• Glass price group 6</li> </ul>	<ul style="list-style-type: none"> <li>No cost</li> <li>+\$189</li> <li>+\$225</li> <li>+\$360</li> <li>N.A.</li> <li>+\$709</li> </ul>	<ul style="list-style-type: none"> <li>Specify glass number for lite.</li> <li>Specify glass number for lite.</li> <li>Specify glass number for lite.</li> <li>Specify glass number for lite.</li> <li>Specify glass number for lite.</li> <li>Specify glass number for lite.</li> </ul> <p>▶ See <i>Surface Materials Reference Manual</i>.</p>
	<b>Panel surfaces 8'0"H through 10'0"H (per lite), 60"W</b>		
	<ul style="list-style-type: none"> <li>• Glass price group 1</li> <li>• Glass price group 2</li> <li>• Glass price group 3</li> <li>• Glass price group 4</li> <li>• Glass price group 5</li> <li>• Glass price group 6</li> </ul>	<ul style="list-style-type: none"> <li>No cost</li> <li>+\$235</li> <li>+\$281</li> <li>+\$449</li> <li>N.A.</li> <li>+\$886</li> </ul>	<ul style="list-style-type: none"> <li>Specify glass number for lite.</li> <li>Specify glass number for lite.</li> <li>Specify glass number for lite.</li> <li>Specify glass number for lite.</li> <li>Specify glass number for lite.</li> <li>Specify glass number for lite.</li> </ul> <p>▶ See <i>Surface Materials Reference Manual</i>.</p>
	<b>Post Extension</b>	<ul style="list-style-type: none"> <li>• Post extensions modified to accommodate recessed ceiling track (ordered separately)</li> <li>• Post extensions modified to accommodate overlapping ceiling track (ordered separately)</li> </ul>	<ul style="list-style-type: none"> <li>No cost</li> <li>No cost</li> </ul> <p>Specify with post extensions for recessed ceiling track interface.</p> <p>Specify with post extensions for overlapping ceiling track interface.</p>

▶ Options, continued on next page

 **For Canadian Pricing**  
Multiply U.S. Price by the Canadian price factor.  
▶ See page 1 for details.



► Options, continued from previous page

Options	U.S. Price	Required to Specify
<b>Ceiling Height</b>		
• 8'0" through 9'0"	No cost	Specify ceiling height in 1" increments.
• 9'1" through 10'0"	+\$ 85	Specify ceiling height in 1" increments.
<b>Electrical Power</b>	<b>Base power block power schematic</b>	
(For panels 30"W through 60"W)	• 3+1	Specify with 3+1 power.
	• 2+2	Specify with 2+2 power.
	• 3SN	Specify with 3SN power.

Tip: Base power block location does not include infeed. It must be ordered separately, if needed.

Specification Information

Width	Style Number	Product ID	Change to U.S. Base Price
-------	--------------	------------	---------------------------

Glass Wall Panels

7"	<b>GPGS3E08</b>	AW009541	+\$0
9"	<b>GPGS3E18</b>	AW009543	+\$0
10"	<b>GPGS3E18</b>	AW009545	+\$0
11"	<b>GPGS3E18</b>	AW009546	+\$0
12"	<b>GPGS3E18</b>	AW009548	+\$0
13"	<b>GPGS3E18</b>	AW009549	+\$0
14"	<b>GPGS3E18</b>	AW009551	+\$0
15"	<b>GPGS3E18</b>	AW009552	+\$0
16"	<b>GPGS3E18</b>	AW009553	+\$0
17"	<b>GPGS3E18</b>	AW009555	+\$0
19"	<b>GPGS3E20</b>	AW009558	+\$0
21"	<b>GPGS3E24</b>	AW009562	+\$0
22"	<b>GPGS3E24</b>	AW009564	+\$0
23"	<b>GPGS3E24</b>	AW009566	+\$0
25"	<b>GPGS3E30</b>	AW009568	+\$0
26"	<b>GPGS3E30</b>	AW009571	+\$0
27"	<b>GPGS3E30</b>	AW009572	+\$0
28"	<b>GPGS3E30</b>	AW009573	+\$0
29"	<b>GPGS3E30</b>	AW009574	+\$0
31"	<b>GPGS3E36</b>	AW009575	+\$0
32"	<b>GPGS3E36</b>	AW009576	+\$0
33"	<b>GPGS3E36</b>	AW009577	+\$0
34"	<b>GPGS3E36</b>	AW009580	+\$0
35"	<b>GPGS3E36</b>	AW009582	+\$0
37"	<b>GPGS3E40</b>	AW009583	+\$0
38"	<b>GPGS3E40</b>	AW009584	+\$0
39"	<b>GPGS3E40</b>	AW009585	+\$0
41"	<b>GPGS3E42</b>	AW009615	+\$0
43"	<b>GPGS3E48</b>	AW009616	+\$0

► Specification Information, continued on next page

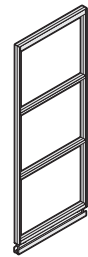

 **For Canadian Pricing**  
Multiply U.S. Price by the Canadian price factor.  
► See page 1 for details.

Privacy Wall

## Glass Wall Panels with Three Equal Divided Lites, continued

► **Specification Information, continued from previous page**

### Specification Information

Width	Style Number	Product ID	Change to U.S. Base Price
-------	--------------	------------	---------------------------

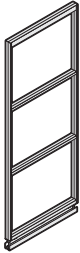

### Glass Wall Panels, continued

44"	<b>GPGS3E48</b>	AW009617	+\$0
45"	<b>GPGS3E48</b>	AW009618	+\$0
46"	<b>GPGS3E48</b>	AW009619	+\$0
47"	<b>GPGS3E48</b>	AW009620	+\$0
49"	<b>GPGS3E60</b>	AW009621	+\$0
50"	<b>GPGS3E60</b>	AW009622	+\$0
51"	<b>GPGS3E60</b>	AW009623	+\$0
52"	<b>GPGS3E60</b>	AW009624	+\$0
53"	<b>GPGS3E60</b>	AW009625	+\$0
54"	<b>GPGS3E60</b>	AW009626	+\$0
55"	<b>GPGS3E60</b>	AW009627	+\$0
56"	<b>GPGS3E60</b>	AW009628	+\$0
57"	<b>GPGS3E60</b>	AW009629	+\$0
58"	<b>GPGS3E60</b>	AW009630	+\$0
59"	<b>GPGS3E60</b>	AW009631	+\$0
:	:	:	:



**For Canadian Pricing**

Multiply U.S. Price by the Canadian price factor.

► See page 1 for details.



# Modular Glass Wall Panels with Three Equal Divided Lites

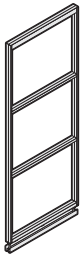

Tip: Order ceiling track, feature strip, and continuous base trim separately.

## What's Special

Parametric panel widths are available in 1" increments. This option is also available through the SmartTools software.

### Standard Includes

- Ceiling height from 8'0"H to 10'0"H, in one-inch increments
- 2<sup>3</sup>/<sub>8</sub>"-thick panel with steel frame: paint
- Three, 1/4"-thick factory-installed lites: glass
- Floor track with adjustable levelers to accommodate continuous 5"H base trim (ordered separately)

### Required to Specify

- 1 General quote number: **AW001887**
  - 2 Style number and Product ID
  - 3 Ceiling height
  - 4 Paint color number for frame and muntin
  - 5 Glass number for lite 1 (from top)
  - 6 Glass number for lite 2
  - 7 Glass number for lite 3
  - 8 Post extension
  - 9 Options, if selected (see below)
- See Surface Materials in the Architectural Solution Specification Guide.

Options	U.S. Price	Required to Specify
<b>Surface Materials</b>	<b>Glass frame surface</b>	
• Paint price group 1	No cost	Specify paint color number.
• Paint price group 2	+\$ 25	Specify paint color number.
• Paint price group 3	+\$ 44	Specify paint color number.
<b>Panel surfaces 8'0"H through 10'0"H (per lite), 18"W to 24"W</b>		
• Glass price group 1	No cost	Specify glass number for lite.
• Glass price group 2	+\$ 94	Specify glass number for lite.
• Glass price group 3	+\$114	Specify glass number for lite.
• Glass price group 4	+\$181	Specify glass number for lite.
• Glass price group 5	N.A.	Specify glass number for lite.
• Glass price group 6	+\$356	Specify glass number for lite.
▶ See <i>Surface Materials Reference Manual</i> .		
<b>Panel surfaces 8'0"H through 10'0"H (per lite), 30"W to 36"W</b>		
• Glass price group 1	No cost	Specify glass number for lite.
• Glass price group 2	+\$141	Specify glass number for lite.
• Glass price group 3	+\$168	Specify glass number for lite.
• Glass price group 4	+\$270	Specify glass number for lite.
• Glass price group 5	N.A.	Specify glass number for lite.
• Glass price group 6	+\$532	Specify glass number for lite.
▶ See <i>Surface Materials Reference Manual</i> .		
<b>Panel surfaces 8'0"H through 10'0"H (per lite), 40"W to 48"W</b>		
• Glass price group 1	No cost	Specify glass number for lite.
• Glass price group 2	+\$189	Specify glass number for lite.
• Glass price group 3	+\$225	Specify glass number for lite.
• Glass price group 4	+\$360	Specify glass number for lite.
• Glass price group 5	N.A.	Specify glass number for lite.
• Glass price group 6	+\$709	Specify glass number for lite.
▶ See <i>Surface Materials Reference Manual</i> .		
<b>Panel surfaces 8'0"H through 10'0"H (per lite), 60"W</b>		
• Glass price group 1	No cost	Specify glass number for lite.
• Glass price group 2	+\$235	Specify glass number for lite.
• Glass price group 3	+\$281	Specify glass number for lite.
• Glass price group 4	+\$449	Specify glass number for lite.
• Glass price group 5	N.A.	Specify glass number for lite.
• Glass price group 6	+\$886	Specify glass number for lite.
▶ See <i>Surface Materials Reference Manual</i> .		
<b>Post Extension</b>	• Post extensions modified to accommodate recessed ceiling track (ordered separately)	No cost
	• Post extensions modified to accommodate overlapping ceiling track (ordered separately)	No cost
		Specify with post extensions for recessed ceiling track interface.
		Specify with post extensions for overlapping ceiling track interface.

▶ Options, continued on next page



## For Canadian Pricing

Multiply U.S. Price by the Canadian price factor.

▶ See page 1 for details.

► Options, continued from previous page

Options		U.S. Price	Required to Specify
<b>Ceiling Height</b>	<ul style="list-style-type: none"> <li>• 8'0" through 9'0"</li> <li>• 9'1" through 10'0"</li> </ul>	No cost +\$ 85	Specify ceiling height in 1" increments. Specify ceiling height in 1" increments.
<b>Electrical Power</b> (For panels 30"W through 60"W)	<b>Base power block power schematic</b> <ul style="list-style-type: none"> <li>• 3+1</li> <li>• 2+2</li> <li>• 3SN</li> </ul>	+\$192 +\$192 +\$192	Specify with 3+1 power. Specify with 2+2 power. Specify with 3SN power.

Tip: Base power block location does not include infeed. It must be ordered separately, if needed.

Specification Information

Nominal Width	Actual Width	Style Number	Product ID	Change to U.S. Base Price
---------------	--------------	--------------	------------	---------------------------

Modular Glass Wall Panels

9"	7.657"	<b>GPGM3E18</b>	AW00009709	+\$0
10"	8.657"	<b>GPGM3E18</b>	AW00009710	+\$0
11"	9.657"	<b>GPGM3E18</b>	AW00009711	+\$0
12"	10.657"	<b>GPGM3E18</b>	AW00009712	+\$0
13"	11.657"	<b>GPGM3E18</b>	AW00009713	+\$0
14"	12.657"	<b>GPGM3E18</b>	AW00009714	+\$0
15"	13.657"	<b>GPGM3E18</b>	AW00009715	+\$0
16"	14.657"	<b>GPGM3E18</b>	AW00009716	+\$0
17"	15.657"	<b>GPGM3E18</b>	AW00009717	+\$0
19"	17.657"	<b>GPGM3E20</b>	AW00009718	+\$0
21"	19.657"	<b>GPGM3E24</b>	AW00009719	+\$0
22"	20.657"	<b>GPGM3E24</b>	AW00009720	+\$0
23"	21.657"	<b>GPGM3E24</b>	AW00009721	+\$0
25"	23.657"	<b>GPGM3E30</b>	AW00009722	+\$0
26"	24.657"	<b>GPGM3E30</b>	AW00009723	+\$0
27"	25.657"	<b>GPGM3E30</b>	AW00009724	+\$0
28"	26.657"	<b>GPGM3E30</b>	AW00009725	+\$0
29"	27.657"	<b>GPGM3E30</b>	AW00009726	+\$0
31"	29.657"	<b>GPGM3E36</b>	AW00009727	+\$0
32"	30.657"	<b>GPGM3E36</b>	AW00009728	+\$0
33"	31.657"	<b>GPGM3E36</b>	AW00009729	+\$0
34"	32.657"	<b>GPGM3E36</b>	AW00009730	+\$0
35"	33.657"	<b>GPGM3E36</b>	AW00009731	+\$0
37"	35.657"	<b>GPGM3E40</b>	AW00009732	+\$0
38"	36.657"	<b>GPGM3E40</b>	AW00009733	+\$0
39"	37.357"	<b>GPGM3E40</b>	AW00009734	+\$0
41"	39.657"	<b>GPGM3E42</b>	AW00009735	+\$0
43"	41.657"	<b>GPGM3E48</b>	AW00009736	+\$0
44"	42.657"	<b>GPGM3E48</b>	AW00009737	+\$0

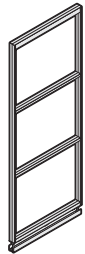

Privacy Wall

 **For Canadian Pricing**  
Multiply U.S. Price by the Canadian price factor.  
► See page 1 for details.

► Specification Information, continued on next page

# Modular Glass Wall Panels with Three Equal Divided Lites, continued

► **Specification Information, continued from previous page**

**Specification Information**

Nominal Width	Actual Width	Style Number	Product ID	Change to U.S. Base Price
---------------	--------------	--------------	------------	---------------------------

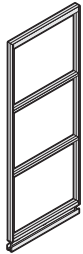

**Modular Glass Wall Panels, continued**

45"	43.657"	<b>GPGM3E48</b>	AW00009738	+\$0
46"	44.657"	<b>GPGM3E48</b>	AW00009739	+\$0
47"	45.657"	<b>GPGM3E48</b>	AW00009740	+\$0
49"	47.657"	<b>GPGM3E60</b>	AW00009741	+\$0
50"	48.657"	<b>GPGM3E60</b>	AW00009742	+\$0
51"	49.657"	<b>GPGM3E60</b>	AW00009743	+\$0
52"	50.657"	<b>GPGM3E60</b>	AW00009744	+\$0
53"	51.657"	<b>GPGM3E60</b>	AW00009745	+\$0
54"	52.657"	<b>GPGM3E60</b>	AW00009746	+\$0
55"	53.657"	<b>GPGM3E60</b>	AW00009747	+\$0
56"	54.657"	<b>GPGM3E60</b>	AW00009748	+\$0
57"	55.657"	<b>GPGM3E60</b>	AW00009749	+\$0
58"	56.657"	<b>GPGM3E60</b>	AW00009750	+\$0
59"	57.657"	<b>GPGM3E60</b>	AW00009751	+\$0



**For Canadian Pricing**

Multiply U.S. Price by the Canadian price factor.

► See page 1 for details.



# Glass Wall Panels with Four Equal Divided Lites

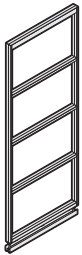

Tip: Order ceiling track, feature strip, and continuous base trim separately.

## What's Special

Parametric panel widths are available in 1" increments. This option is also available through the SmartTools software.

### Standard Includes

- Ceiling height from 8'0"H to 10'0"H, in one-inch increments
- 2<sup>3</sup>/<sub>8</sub>"-thick panel with steel frame: paint
- Four, 1/4"-thick factory-installed lites: glass
- Floor track with adjustable levelers to accommodate continuous 5"H base trim (ordered separately)

### Required to Specify

- 1 General quote number: **AW001873**
  - 2 Style number and Product ID
  - 3 Ceiling height
  - 4 Paint color number for frame and muntin
  - 5 Glass number for lite 1 (from top)
  - 6 Glass number for lite 2
  - 7 Glass number for lite 3
  - 8 Glass number for lite 4
  - 9 Post extension
  - 10 Options, if selected (see below)
- See Surface Materials in the Architectural Solution Specification Guide.

Options	U.S. Price	Required to Specify
<b>Surface Materials</b>	<b>Glass frame surface</b>	
• Paint price group 1	No cost	Specify paint color number.
• Paint price group 2	+\$ 25	Specify paint color number.
• Paint price group 3	+\$ 44	Specify paint color number.
<b>Panel surfaces 8'0"H through 10'0"H (per lite), 6"W to 8"W</b>		
• Glass price group 1	No cost	Specify glass number for lite.
• Glass price group 2	+\$ 23	Specify glass number for lite.
• Glass price group 3	+\$ 29	Specify glass number for lite.
• Glass price group 4	+\$ 46	Specify glass number for lite.
• Glass price group 5	N.A.	Specify glass number for lite.
• Glass price group 6	+\$ 89	Specify glass number for lite.
▶ See <i>Surface Materials Reference Manual</i> .		
<b>Panel surfaces 8'0"H through 10'0"H (per lite), 18"W to 24"W</b>		
• Glass price group 1	No cost	Specify glass number for lite.
• Glass price group 2	+\$ 71	Specify glass number for lite.
• Glass price group 3	+\$ 85	Specify glass number for lite.
• Glass price group 4	+\$135	Specify glass number for lite.
• Glass price group 5	N.A.	Specify glass number for lite.
• Glass price group 6	+\$268	Specify glass number for lite.
▶ See <i>Surface Materials Reference Manual</i> .		
<b>Panel surfaces 8'0"H through 10'0"H (per lite), 30"W to 36"W</b>		
• Glass price group 1	No cost	Specify glass number for lite.
• Glass price group 2	+\$108	Specify glass number for lite.
• Glass price group 3	+\$127	Specify glass number for lite.
• Glass price group 4	+\$204	Specify glass number for lite.
• Glass price group 5	N.A.	Specify glass number for lite.
• Glass price group 6	+\$401	Specify glass number for lite.
▶ See <i>Surface Materials Reference Manual</i> .		
<b>Panel surfaces 8'0"H through 10'0"H (per lite), 40"W to 48"W</b>		
• Glass price group 1	No cost	Specify glass number for lite.
• Glass price group 2	+\$141	Specify glass number for lite.
• Glass price group 3	+\$168	Specify glass number for lite.
• Glass price group 4	+\$270	Specify glass number for lite.
• Glass price group 5	N.A.	Specify glass number for lite.
• Glass price group 6	+\$532	Specify glass number for lite.
▶ See <i>Surface Materials Reference Manual</i> .		
<b>Panel surfaces 8'0"H through 10'0"H (per lite), 60"W</b>		
• Glass price group 1	No cost	Specify glass number for lite.
• Glass price group 2	+\$177	Specify glass number for lite.
• Glass price group 3	+\$210	Specify glass number for lite.
• Glass price group 4	+\$339	Specify glass number for lite.
• Glass price group 5	N.A.	Specify glass number for lite.
• Glass price group 6	+\$666	Specify glass number for lite.
▶ See <i>Surface Materials Reference Manual</i> .		

▶ Options, continued on next page



## For Canadian Pricing

Multiply U.S. Price by the Canadian price factor.

▶ See page 1 for details.



► Options, continued from previous page

Options	U.S. Price	Required to Specify	
<b>Post Extension</b> <ul style="list-style-type: none"> <li>Post extensions modified to accommodate recessed ceiling track (ordered separately)</li> <li>Post extensions modified to accommodate overlapping ceiling track (ordered separately)</li> </ul>	No cost No cost	Specify with post extensions for recessed ceiling track interface. Specify with post extensions for overlapping ceiling track interface.	
<b>Ceiling Height</b> <ul style="list-style-type: none"> <li>8'0" through 9'0"</li> <li>9'1" through 10'0"</li> </ul>	No cost +\$ 85	Specify ceiling height in 1" increments. Specify ceiling height in 1" increments.	
<b>Electrical Power</b> (For panels 30"W through 60"W)	<b>Base power block power schematic</b> <ul style="list-style-type: none"> <li>3+1</li> <li>2+2</li> <li>3SN</li> </ul>	+\$ 192 +\$ 192 +\$ 192	Specify with 3+1 power. Specify with 2+2 power. Specify with 3SN power.

Tip: Base power block location does not include infeed. It must be ordered separately, if needed.

Specification Information

Width	Style Number	Product ID	Change to U.S. Base Price
-------	--------------	------------	---------------------------

Glass Wall Panels

7"	<b>GPGS4E08</b>	AW00009632	+\$0
9"	<b>GPGS4E18</b>	AW00009633	+\$0
10"	<b>GPGS4E18</b>	AW00009634	+\$0
11"	<b>GPGS4E18</b>	AW00009635	+\$0
12"	<b>GPGS4E18</b>	AW00009636	+\$0
13"	<b>GPGS4E18</b>	AW00009637	+\$0
14"	<b>GPGS4E18</b>	AW00009638	+\$0
15"	<b>GPGS4E18</b>	AW00009640	+\$0
16"	<b>GPGS4E18</b>	AW00009641	+\$0
17"	<b>GPGS4E18</b>	AW00009642	+\$0
19"	<b>GPGS4E20</b>	AW00009643	+\$0
21"	<b>GPGS4E24</b>	AW00009644	+\$0
22"	<b>GPGS4E24</b>	AW00009645	+\$0
23"	<b>GPGS4E24</b>	AW00009646	+\$0
25"	<b>GPGS4E30</b>	AW00009647	+\$0
26"	<b>GPGS4E30</b>	AW00009648	+\$0
27"	<b>GPGS4E30</b>	AW00009649	+\$0
28"	<b>GPGS4E30</b>	AW00009650	+\$0
29"	<b>GPGS4E30</b>	AW00009651	+\$0
31"	<b>GPGS4E36</b>	AW00009652	+\$0
32"	<b>GPGS4E36</b>	AW00009653	+\$0
33"	<b>GPGS4E36</b>	AW00009654	+\$0
34"	<b>GPGS4E36</b>	AW00009655	+\$0
35"	<b>GPGS4E36</b>	AW00009656	+\$0
37"	<b>GPGS4E40</b>	AW00009657	+\$0

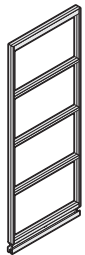

 **For Canadian Pricing**  
Multiply U.S. Price by the Canadian price factor.  
► See page 1 for details.

► Specification Information, continued on next page

Glass Wall Panels with Four Equal Divided Lites, continued

► Specification Information, continued from previous page

**Specification Information**

Width	Style Number	Product ID	Change to U.S. Base Price
-------	--------------	------------	---------------------------

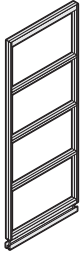

**Glass Wall Panels, continued**

38"	<b>GPGS4E40</b>	AW00009658	+\$0
39"	<b>GPGS4E40</b>	AW00009659	+\$0
41"	<b>GPGS4E42</b>	AW00009660	+\$0
43"	<b>GPGS4E48</b>	AW00009661	+\$0
44"	<b>GPGS4E48</b>	AW00009662	+\$0
45"	<b>GPGS4E48</b>	AW00009663	+\$0
46"	<b>GPGS4E48</b>	AW00009664	+\$0
47"	<b>GPGS4E48</b>	AW00009665	+\$0
49"	<b>GPGS4E60</b>	AW00009666	+\$0
50"	<b>GPGS4E60</b>	AW00009667	+\$0
51"	<b>GPGS4E60</b>	AW00009668	+\$0
52"	<b>GPGS4E60</b>	AW00009669	+\$0
53"	<b>GPGS4E60</b>	AW00009670	+\$0
54"	<b>GPGS4E60</b>	AW00009671	+\$0
55"	<b>GPGS4E60</b>	AW00009672	+\$0
56"	<b>GPGS4E60</b>	AW00009673	+\$0
57"	<b>GPGS4E60</b>	AW00009674	+\$0
58"	<b>GPGS4E60</b>	AW00009675	+\$0
59"	<b>GPGS4E60</b>	AW00009676	+\$0
:	:	:	:



**For Canadian Pricing**

Multiply U.S. Price by the Canadian price factor.

► See page 1 for details.



# Modular Glass Wall Panels with Four Equal Divided Lites

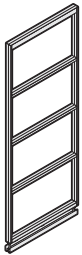

Tip: Order ceiling track, feature strip, and continuous base trim separately.

## What's Special

Parametric panel widths are available in 1" increments. This option is also available through the SmartTools software.

### Standard Includes

- Ceiling height from 8'0"H to 10'0"H, in one-inch increments
- 2<sup>3</sup>/<sub>8</sub>"-thick panel with steel frame: paint
- Four, 1/4"-thick factory-installed lites: glass
- Floor track with adjustable levelers to accommodate continuous 5"H base trim (ordered separately)

### Required to Specify

- 1 General quote number: **AW001889**
  - 2 Style number and Product ID
  - 3 Ceiling height
  - 4 Paint color number for frame and muntin
  - 5 Glass number for lite 1 (from top)
  - 6 Glass number for lite 2
  - 7 Glass number for lite 3
  - 8 Glass number for lite 4
  - 9 Post extension
  - 10 Options, if selected (see below)
- See Surface Materials in the Architectural Solution Specification Guide.

Options	U.S. Price	Required to Specify
<b>Surface Materials</b>	<b>Glass frame surface</b>	
• Paint price group 1	No cost	Specify paint color number.
• Paint price group 2	+\$ 25	Specify paint color number.
• Paint price group 3	+\$ 44	Specify paint color number.
	<b>Panel surfaces 8'0"H through 10'0"H (per lite), 18"W to 24"W</b>	
• Glass price group 1	No cost	Specify glass number for lite.
• Glass price group 2	+\$ 71	Specify glass number for lite.
• Glass price group 3	+\$ 85	Specify glass number for lite.
• Glass price group 4	+\$135	Specify glass number for lite.
• Glass price group 5	N.A.	Specify glass number for lite.
• Glass price group 6	+\$268	Specify glass number for lite.
		▶ See <i>Surface Materials Reference Manual</i> .
	<b>Panel surfaces 8'0"H through 10'0"H (per lite), 30"W to 36"W</b>	
• Glass price group 1	No cost	Specify glass number for lite.
• Glass price group 2	+\$108	Specify glass number for lite.
• Glass price group 3	+\$127	Specify glass number for lite.
• Glass price group 4	+\$204	Specify glass number for lite.
• Glass price group 5	N.A.	Specify glass number for lite.
• Glass price group 6	+\$401	Specify glass number for lite.
		▶ See <i>Surface Materials Reference Manual</i> .
	<b>Panel surfaces 8'0"H through 10'0"H (per lite), 40"W to 48"W</b>	
• Glass price group 1	No cost	Specify glass number for lite.
• Glass price group 2	+\$141	Specify glass number for lite.
• Glass price group 3	+\$168	Specify glass number for lite.
• Glass price group 4	+\$270	Specify glass number for lite.
• Glass price group 5	N.A.	Specify glass number for lite.
• Glass price group 6	+\$532	Specify glass number for lite.
		▶ See <i>Surface Materials Reference Manual</i> .
	<b>Panel surfaces 8'0"H through 10'0"H (per lite), 60"W</b>	
• Glass price group 1	No cost	Specify glass number for lite.
• Glass price group 2	+\$177	Specify glass number for lite.
• Glass price group 3	+\$210	Specify glass number for lite.
• Glass price group 4	+\$339	Specify glass number for lite.
• Glass price group 5	N.A.	Specify glass number for lite.
• Glass price group 6	+\$666	Specify glass number for lite.
		▶ See <i>Surface Materials Reference Manual</i> .

▶ Options, continued on next page



## For Canadian Pricing

Multiply U.S. Price by the Canadian price factor.

▶ See page 1 for details.

► Options, continued from previous page

Options	U.S. Price	Required to Specify
<b>Post Extension</b> <ul style="list-style-type: none"> <li>Post extensions modified to accommodate recessed ceiling track (ordered separately)</li> <li>Post extensions modified to accommodate overlapping ceiling track (ordered separately)</li> </ul>	No cost	Specify with <i>post extensions for recessed ceiling track interface.</i>
	No cost	Specify with <i>post extensions for overlapping ceiling track interface.</i>
<b>Ceiling Height</b> <ul style="list-style-type: none"> <li>8'0" through 9'0"</li> <li>9'1" through 10'0"</li> </ul>	No cost +\$ 85	Specify ceiling height in 1" increments. Specify ceiling height in 1" increments.
<b>Electrical Power</b> (For panels 30"W through 60"W)	<b>Base power block power schematic</b> <ul style="list-style-type: none"> <li>3+1 +\$192</li> <li>2+2 +\$192</li> <li>3SN +\$192</li> </ul>	Specify with <i>3+1 power.</i> Specify with <i>2+2 power.</i> Specify with <i>3SN power.</i>

Tip: Base power block location does not include infeed. It must be ordered separately, if needed.

Specification Information

Nominal Width	Actual Width	Style Number	Product ID	Change to U.S. Base Price
---------------	--------------	--------------	------------	---------------------------

Modular Glass Wall Panels

9"	7.657"	<b>GPGM4E18</b>	AW00009754	+\$0
10"	8.657"	<b>GPGM4E18</b>	AW00009760	+\$0
11"	9.657"	<b>GPGM4E18</b>	AW00009761	+\$0
12"	10.657"	<b>GPGM4E18</b>	AW00009762	+\$0
13"	11.657"	<b>GPGM4E18</b>	AW00009763	+\$0
14"	12.657"	<b>GPGM4E18</b>	AW00009764	+\$0
15"	13.657"	<b>GPGM4E18</b>	AW00009765	+\$0
16"	14.657"	<b>GPGM4E18</b>	AW00009766	+\$0
17"	15.657"	<b>GPGM4E18</b>	AW00009767	+\$0
19"	17.657"	<b>GPGM4E20</b>	AW00009768	+\$0
21"	19.657"	<b>GPGM4E24</b>	AW00009769	+\$0
22"	20.657"	<b>GPGM4E24</b>	AW00009770	+\$0
23"	21.657"	<b>GPGM4E24</b>	AW00009771	+\$0
25"	23.657"	<b>GPGM4E30</b>	AW00009772	+\$0
26"	24.657"	<b>GPGM4E30</b>	AW00009773	+\$0
27"	25.657"	<b>GPGM4E30</b>	AW00009774	+\$0
28"	26.657"	<b>GPGM4E30</b>	AW00009775	+\$0
29"	27.657"	<b>GPGM4E30</b>	AW00009776	+\$0
31"	29.657"	<b>GPGM4E36</b>	AW00009777	+\$0
32"	30.657"	<b>GPGM4E36</b>	AW00009778	+\$0
33"	31.657"	<b>GPGM4E36</b>	AW00009779	+\$0
34"	32.657"	<b>GPGM4E36</b>	AW00009780	+\$0
35"	33.657"	<b>GPGM4E36</b>	AW00009781	+\$0
37"	35.657"	<b>GPGM4E40</b>	AW00009782	+\$0
38"	36.657"	<b>GPGM4E40</b>	AW00009783	+\$0

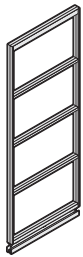

Privacy Wall

 **For Canadian Pricing**  
Multiply U.S. Price by the Canadian price factor.  
► See page 1 for details.

► Specification Information, continued on next page

## Modular Glass Wall Panels with Four Equal Divided Lites, continued

► **Specification Information, continued from previous page**

### Specification Information

Nominal Width	Actual Width	Style Number	Product ID	Change to U.S. Base Price
---------------	--------------	--------------	------------	---------------------------

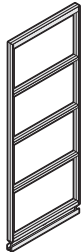

### Modular Glass Wall Panels, continued

39"	37.357"	<b>GPGM4E40</b>	AW00009784	+\$0
41"	39.657"	<b>GPGM4E42</b>	AW00009785	+\$0
43"	41.657"	<b>GPGM4E48</b>	AW00009786	+\$0
44"	42.657"	<b>GPGM4E48</b>	AW00009787	+\$0
45"	43.657"	<b>GPGM4E48</b>	AW00009788	+\$0
46"	44.657"	<b>GPGM4E48</b>	AW00009789	+\$0
47"	45.657"	<b>GPGM4E48</b>	AW00009790	+\$0
49"	47.657"	<b>GPGM4E60</b>	AW00009791	+\$0
50"	48.657"	<b>GPGM4E60</b>	AW00009792	+\$0
51"	49.657"	<b>GPGM4E60</b>	AW00009793	+\$0
52"	50.657"	<b>GPGM4E60</b>	AW00009794	+\$0
53"	51.657"	<b>GPGM4E60</b>	AW00009795	+\$0
54"	52.657"	<b>GPGM4E60</b>	AW00009796	+\$0
55"	53.657"	<b>GPGM4E60</b>	AW00009797	+\$0
56"	54.657"	<b>GPGM4E60</b>	AW00009798	+\$0
57"	55.657"	<b>GPGM4E60</b>	AW00009799	+\$0
58"	56.657"	<b>GPGM4E60</b>	AW00009800	+\$0
59"	57.657"	<b>GPGM4E60</b>	AW00009801	+\$0



**For Canadian Pricing**

Multiply U.S. Price by the Canadian price factor.

► See page 1 for details.



# Glass Wall Panels with Four Divided Lites

Transom-Aligned Top Lite

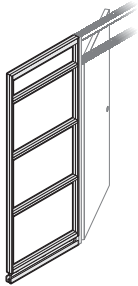

Tip: Order ceiling track, feature strip, and continuous base trim separately.

## What's Special

Parametric panel widths are available in 1" increments. This option is also available through the SmartTools software.

### Standard Includes

- Ceiling height from 8'0"H to 10'0"H, in one-inch increments
- 2<sup>3</sup>/<sub>8</sub>"-thick panel with steel frame: paint
- Four, 1/4"-thick factory-installed lites—top lite is transom aligned, bottom three are of equal height: glass
- Floor track with adjustable levelers to accommodate continuous 5"H base trim (ordered separately)

### Required to Specify

- 1 General quote number: **AW001890**
  - 2 Style number and Product ID
  - 3 Ceiling height
  - 4 Paint color number for frame and muntin
  - 5 Glass number for lite 1 (from top)
  - 6 Glass number for lite 2
  - 7 Glass number for lite 3
  - 8 Glass number for lite 4
  - 9 Post extension
  - 10 Options, if selected (see below)
- See Surface Materials in the Architectural Solution Specification Guide.

	Options	U.S. Price	Required to Specify
<b>Surface Materials</b>	<b>Glass frame surface</b>		
	<ul style="list-style-type: none"> <li>• Paint price group 1</li> <li>• Paint price group 2</li> <li>• Paint price group 3</li> </ul>	<ul style="list-style-type: none"> <li>No cost</li> <li>+\$ 25</li> <li>+\$ 44</li> </ul>	<ul style="list-style-type: none"> <li>Specify paint color number.</li> <li>Specify paint color number.</li> <li>Specify paint color number.</li> </ul>
	<b>Top lite glass panel surfaces 8'0"H through 10'0"H (per lite), 6"W to 8"W</b>		
	<ul style="list-style-type: none"> <li>• Glass price group 1</li> <li>• Glass price group 2</li> <li>• Glass price group 3</li> <li>• Glass price group 4</li> <li>• Glass price group 5</li> <li>• Glass price group 6</li> </ul>	<ul style="list-style-type: none"> <li>No cost</li> <li>+\$ 17</li> <li>+\$ 21</li> <li>+\$ 31</li> <li>N.A.</li> <li>+\$ 64</li> </ul>	<ul style="list-style-type: none"> <li>Specify glass number for lite.</li> <li>Specify glass number for lite.</li> <li>Specify glass number for lite.</li> <li>Specify glass number for lite.</li> <li>Specify glass number for lite.</li> <li>Specify glass number for lite.</li> </ul> <p>▶ See <i>Surface Materials Reference Manual</i>.</p>
	<b>Lower three lites glass panels surfaces 8'0"H through 10'0"H (per lite), 6"W to 8"W</b>		
	<ul style="list-style-type: none"> <li>• Glass price group 1</li> <li>• Glass price group 2</li> <li>• Glass price group 3</li> <li>• Glass price group 4</li> <li>• Glass price group 5</li> <li>• Glass price group 6</li> </ul>	<ul style="list-style-type: none"> <li>No cost</li> <li>+\$ 25</li> <li>+\$ 31</li> <li>+\$ 50</li> <li>N.A.</li> <li>+\$ 96</li> </ul>	<ul style="list-style-type: none"> <li>Specify glass number for lite.</li> <li>Specify glass number for lite.</li> <li>Specify glass number for lite.</li> <li>Specify glass number for lite.</li> <li>Specify glass number for lite.</li> <li>Specify glass number for lite.</li> </ul> <p>▶ See <i>Surface Materials Reference Manual</i>.</p>
	<b>Top lite glass panel surfaces 8'0"H through 10'0"H (per lite), 18"W to 24"W</b>		
	<ul style="list-style-type: none"> <li>• Glass price group 1</li> <li>• Glass price group 2</li> <li>• Glass price group 3</li> <li>• Glass price group 4</li> <li>• Glass price group 5</li> <li>• Glass price group 6</li> </ul>	<ul style="list-style-type: none"> <li>No cost</li> <li>+\$ 52</li> <li>+\$ 60</li> <li>+\$ 96</li> <li>N.A.</li> <li>+\$189</li> </ul>	<ul style="list-style-type: none"> <li>Specify glass number for lite.</li> <li>Specify glass number for lite.</li> <li>Specify glass number for lite.</li> <li>Specify glass number for lite.</li> <li>Specify glass number for lite.</li> <li>Specify glass number for lite.</li> </ul> <p>▶ See <i>Surface Materials Reference Manual</i>.</p>
	<b>Lower three lites glass panels surfaces 8'0"H through 10'0"H (per lite), 18"W to 24"W</b>		
	<ul style="list-style-type: none"> <li>• Glass price group 1</li> <li>• Glass price group 2</li> <li>• Glass price group 3</li> <li>• Glass price group 4</li> <li>• Glass price group 5</li> <li>• Glass price group 6</li> </ul>	<ul style="list-style-type: none"> <li>No cost</li> <li>+\$ 77</li> <li>+\$ 92</li> <li>+\$146</li> <li>N.A.</li> <li>+\$287</li> </ul>	<ul style="list-style-type: none"> <li>Specify glass number for lite.</li> <li>Specify glass number for lite.</li> <li>Specify glass number for lite.</li> <li>Specify glass number for lite.</li> <li>Specify glass number for lite.</li> <li>Specify glass number for lite.</li> </ul> <p>▶ See <i>Surface Materials Reference Manual</i>.</p>

▶ Options, continued on next page



### For Canadian Pricing

Multiply U.S. Price by the Canadian price factor.

▶ See page 1 for details.



► Options, continued from previous page

Options	U.S. Price	Required to Specify	
<b>Surface Materials</b>			
<b>Top lite glass panel surfaces 8'0"H through 10'0"H (per lite), 30"W to 36"W</b>			
• Glass price group 1	No cost	Specify glass number for lite.	
• Glass price group 2	+\$ 75	Specify glass number for lite.	
• Glass price group 3	+\$ 89	Specify glass number for lite.	
• Glass price group 4	+\$144	Specify glass number for lite.	
• Glass price group 5	N.A.	Specify glass number for lite.	
• Glass price group 6	+\$283	Specify glass number for lite.	
		► See <i>Surface Materials Reference Manual</i> .	
<b>Lower three lites glass panels surfaces 8'0"H through 10'0"H (per lite), 30"W to 36"W</b>			
• Glass price group 1	No cost	Specify glass number for lite.	
• Glass price group 2	+\$116	Specify glass number for lite.	
• Glass price group 3	+\$137	Specify glass number for lite.	
• Glass price group 4	+\$218	Specify glass number for lite.	
• Glass price group 5	N.A.	Specify glass number for lite.	
• Glass price group 6	+\$431	Specify glass number for lite.	
		► See <i>Surface Materials Reference Manual</i> .	
<b>Top lite glass panel surfaces 8'0"H through 10'0"H (per lite), 40"W to 48"W</b>			
• Glass price group 1	No cost	Specify glass number for lite.	
• Glass price group 2	+\$100	Specify glass number for lite.	
• Glass price group 3	+\$121	Specify glass number for lite.	
• Glass price group 4	+\$191	Specify glass number for lite.	
• Glass price group 5	N.A.	Specify glass number for lite.	
• Glass price group 6	+\$376	Specify glass number for lite.	
		► See <i>Surface Materials Reference Manual</i> .	
<b>Lower three lites glass panels surfaces 8'0"H through 10'0"H (per lite), 40"W to 48"W</b>			
• Glass price group 1	No cost	Specify glass number for lite.	
• Glass price group 2	+\$152	Specify glass number for lite.	
• Glass price group 3	+\$183	Specify glass number for lite.	
• Glass price group 4	+\$291	Specify glass number for lite.	
• Glass price group 5	N.A.	Specify glass number for lite.	
• Glass price group 6	+\$574	Specify glass number for lite.	
		► See <i>Surface Materials Reference Manual</i> .	
<b>Top lite glass panel surfaces 8'0"H through 10'0"H (per lite), 60"W</b>			
• Glass price group 1	No cost	Specify glass number for lite.	
• Glass price group 2	+\$127	Specify glass number for lite.	
• Glass price group 3	+\$150	Specify glass number for lite.	
• Glass price group 4	+\$237	Specify glass number for lite.	
• Glass price group 5	N.A.	Specify glass number for lite.	
• Glass price group 6	+\$472	Specify glass number for lite.	
		► See <i>Surface Materials Reference Manual</i> .	
<b>Lower three lites glass panels surfaces 8'0"H through 10'0"H (per lite), 60"W</b>			
• Glass price group 1	No cost	Specify glass number for lite.	
• Glass price group 2	+\$191	Specify glass number for lite.	
• Glass price group 3	+\$227	Specify glass number for lite.	
• Glass price group 4	+\$364	Specify glass number for lite.	
• Glass price group 5	N.A.	Specify glass number for lite.	
• Glass price group 6	+\$718	Specify glass number for lite.	
		► See <i>Surface Materials Reference Manual</i> .	
<b>Post Extension</b>	• Post extensions modified to accommodate recessed ceiling track (ordered separately)	No cost	Specify with <i>post extensions for recessed ceiling track interface</i> .
	• Post extensions modified to accommodate overlapping ceiling track (ordered separately)	No cost	Specify with <i>post extensions for overlapping ceiling track interface</i> .
<b>Ceiling Height</b>	• 8'0" through 9'0"	No cost	Specify ceiling height in 1" increments.
	• 9'1" through 10'0"	+\$ 85	Specify ceiling height in 1" increments.

► Options, continued on next page



**For Canadian Pricing**  
Multiply U.S. Price by the  
Canadian price factor.  
► See page 1 for details.

# Glass Wall Panels with Four Divided Lites Transom-Aligned Top Lite, continued

► **Options, continued from previous page**

*Tip: Base power block location does not include infeed. It must be ordered separately, if needed.*

Options		U.S. Price	Required to Specify
<b>Electrical Power</b> (For panels 30"W through 60"W)	<b>Base power block power schematic</b> • 3+1 • 2+2 • 3SN	+\$ 192 +\$ 192 +\$ 192	Specify with 3+1 power. Specify with 2+2 power. Specify with 3SN power.

**Specification Information**

Width	Style Number	Product ID	Change to U.S. Base Price
-------	--------------	------------	---------------------------

**Glass Wall Panels**

7"	<b>GPGS4L08</b>	AW00009802	+\$0
9"	<b>GPGS4L18</b>	AW00009803	+\$0
10"	<b>GPGS4L18</b>	AW00009804	+\$0
11"	<b>GPGS4L18</b>	AW00009805	+\$0
12"	<b>GPGS4L18</b>	AW00009806	+\$0
13"	<b>GPGS4L18</b>	AW00009807	+\$0
14"	<b>GPGS4L18</b>	AW00009808	+\$0
15"	<b>GPGS4L18</b>	AW00009809	+\$0
16"	<b>GPGS4L18</b>	AW00009810	+\$0
17"	<b>GPGS4L18</b>	AW00009811	+\$0
19"	<b>GPGS4L20</b>	AW00009812	+\$0
21"	<b>GPGS4L24</b>	AW00009813	+\$0
22"	<b>GPGS4L24</b>	AW00009814	+\$0
23"	<b>GPGS4L24</b>	AW00009815	+\$0
25"	<b>GPGS4L30</b>	AW00009816	+\$0
26"	<b>GPGS4L30</b>	AW00009817	+\$0
27"	<b>GPGS4L30</b>	AW00009818	+\$0
28"	<b>GPGS4L30</b>	AW00009819	+\$0
29"	<b>GPGS4L30</b>	AW00009820	+\$0
31"	<b>GPGS4L36</b>	AW00009821	+\$0
32"	<b>GPGS4L36</b>	AW00009822	+\$0
33"	<b>GPGS4L36</b>	AW00009823	+\$0
34"	<b>GPGS4L36</b>	AW00009824	+\$0
35"	<b>GPGS4L36</b>	AW00009825	+\$0
37"	<b>GPGS4L40</b>	AW00009826	+\$0
38"	<b>GPGS4L40</b>	AW00009827	+\$0
39"	<b>GPGS4L40</b>	AW00009828	+\$0
41"	<b>GPGS4L42</b>	AW00009829	+\$0
43"	<b>GPGS4L48</b>	AW00009830	+\$0
44"	<b>GPGS4L48</b>	AW00009831	+\$0
45"	<b>GPGS4L48</b>	AW00009832	+\$0

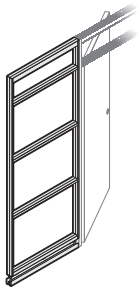

 **For Canadian Pricing**  
Multiply U.S. Price by the Canadian price factor.  
► See page 1 for details.

► **Specification Information, continued on next page**

► **Specification Information, continued from previous page**

**Specification Information**

Width	Style Number	Product ID	Change to U.S. Base Price
-------	--------------	------------	---------------------------

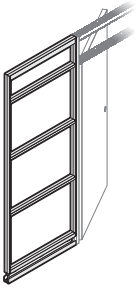

**Glass Wall Panels, continued**

46"	<b>GPGS4L48</b>	AW00009833	+\$0
47"	<b>GPGS4L48</b>	AW00009834	+\$0
49"	<b>GPGS4L60</b>	AW00009835	+\$0
50"	<b>GPGS4L60</b>	AW00009836	+\$0
51"	<b>GPGS4L60</b>	AW00009837	+\$0
52"	<b>GPGS4L60</b>	AW00009838	+\$0
53"	<b>GPGS4L60</b>	AW00009839	+\$0
54"	<b>GPGS4L60</b>	AW00009840	+\$0
55"	<b>GPGS4L60</b>	AW00009841	+\$0
56"	<b>GPGS4L60</b>	AW00009842	+\$0
57"	<b>GPGS4L60</b>	AW00009843	+\$0
58"	<b>GPGS4L60</b>	AW00009844	+\$0
59"	<b>GPGS4L60</b>	AW00009845	+\$0
:	:	:	:

Privacy Wall



**For Canadian Pricing**  
Multiply U.S. Price by the  
Canadian price factor.  
► See page 1 for details.

# Modular Glass Wall Panels with Four Divided Lites

Transom-Aligned Top Lite

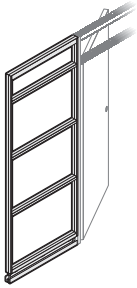

Tip: Order ceiling track, feature strip, and continuous base trim separately.

## What's Special

Parametric panel widths are available in 1" increments. This option is also available through the SmartTools software.

### Standard Includes

- Ceiling height from 8'0"H to 10'0"H, in one-inch increments
- 2<sup>3</sup>/<sub>8</sub>"-thick panel with steel frame: paint
- Four, 1/4"-thick factory-installed lites—top lite is transom aligned, bottom three are of equal height: glass
- Floor track with adjustable levelers to accommodate continuous 5"H base trim (ordered separately)

### Required to Specify

- 1 General quote number: **AW001891**
  - 2 Style number and Product ID
  - 3 Ceiling height
  - 4 Paint color number for frame and muntin
  - 5 Glass number for lite 1 (from top)
  - 6 Glass number for lite 2
  - 7 Glass number for lite 3
  - 8 Glass number for lite 4
  - 9 Post extension
  - 10 Options, if selected (see below)
- See Surface Materials in the Architectural Solution Specification Guide.

Options	U.S. Price	Required to Specify
<b>Surface Materials</b>	<b>Glass frame surface</b>	
• Paint price group 1	No cost	Specify paint color number.
• Paint price group 2	+\$ 25	Specify paint color number.
• Paint price group 3	+\$ 44	Specify paint color number.
<b>Top lite glass panel surfaces 8'0"H through 10'0"H (per lite), 18"W to 24"W</b>		
• Glass price group 1	No cost	Specify glass number for lite.
• Glass price group 2	+\$ 52	Specify glass number for lite.
• Glass price group 3	+\$ 60	Specify glass number for lite.
• Glass price group 4	+\$ 96	Specify glass number for lite.
• Glass price group 5	N.A.	Specify glass number for lite.
• Glass price group 6	+\$189	Specify glass number for lite.
▶ See <i>Surface Materials Reference Manual</i> .		
<b>Lower three lites glass panels surfaces 8'0"H through 10'0"H (per lite), 18"W to 24"W</b>		
• Glass price group 1	No cost	Specify glass number for lite.
• Glass price group 2	+\$ 77	Specify glass number for lite.
• Glass price group 3	+\$ 92	Specify glass number for lite.
• Glass price group 4	+\$146	Specify glass number for lite.
• Glass price group 5	N.A.	Specify glass number for lite.
• Glass price group 6	+\$287	Specify glass number for lite.
▶ See <i>Surface Materials Reference Manual</i> .		
<b>Top lite glass panel surfaces 8'0"H through 10'0"H (per lite), 30"W to 36"W</b>		
• Glass price group 1	No cost	Specify glass number for lite.
• Glass price group 2	+\$ 75	Specify glass number for lite.
• Glass price group 3	+\$ 89	Specify glass number for lite.
• Glass price group 4	+\$144	Specify glass number for lite.
• Glass price group 5	N.A.	Specify glass number for lite.
• Glass price group 6	+\$283	Specify glass number for lite.
▶ See <i>Surface Materials Reference Manual</i> .		
<b>Lower three lites glass panels surfaces 8'0"H through 10'0"H (per lite), 30"W to 36"W</b>		
• Glass price group 1	No cost	Specify glass number for lite.
• Glass price group 2	+\$116	Specify glass number for lite.
• Glass price group 3	+\$137	Specify glass number for lite.
• Glass price group 4	+\$218	Specify glass number for lite.
• Glass price group 5	N.A.	Specify glass number for lite.
• Glass price group 6	+\$431	Specify glass number for lite.
▶ See <i>Surface Materials Reference Manual</i> .		

▶ Options, continued on next page



### For Canadian Pricing

Multiply U.S. Price by the Canadian price factor.

▶ See page 1 for details.

► Options, continued from previous page

Options	U.S. Price	Required to Specify
<b>Surface Materials</b>	<b>Top lite glass panel surfaces 8'0"H through 10'0"H (per lite), 40"W to 48"W</b>	
• Glass price group 1	No cost	Specify glass number for lite.
• Glass price group 2	+\$100	Specify glass number for lite.
• Glass price group 3	+\$121	Specify glass number for lite.
• Glass price group 4	+\$191	Specify glass number for lite.
• Glass price group 5	N.A.	Specify glass number for lite.
• Glass price group 6	+\$376	Specify glass number for lite.
		► See <i>Surface Materials Reference Manual</i> .
	<b>Lower three lites glass panels surfaces 8'0"H through 10'0"H (per lite), 40"W to 48"W</b>	
• Glass price group 1	No cost	Specify glass number for lite.
• Glass price group 2	+\$152	Specify glass number for lite.
• Glass price group 3	+\$183	Specify glass number for lite.
• Glass price group 4	+\$291	Specify glass number for lite.
• Glass price group 5	N.A.	Specify glass number for lite.
• Glass price group 6	+\$574	Specify glass number for lite.
		► See <i>Surface Materials Reference Manual</i> .
	<b>Top lite glass panel surfaces 8'0"H through 10'0"H (per lite), 60"W</b>	
• Glass price group 1	No cost	Specify glass number for lite.
• Glass price group 2	+\$127	Specify glass number for lite.
• Glass price group 3	+\$150	Specify glass number for lite.
• Glass price group 4	+\$237	Specify glass number for lite.
• Glass price group 5	N.A.	Specify glass number for lite.
• Glass price group 6	+\$472	Specify glass number for lite.
		► See <i>Surface Materials Reference Manual</i> .
	<b>Lower three lites glass panels surfaces 8'0"H through 10'0"H (per lite), 60"W</b>	
• Glass price group 1	No cost	Specify glass number for lite.
• Glass price group 2	+\$191	Specify glass number for lite.
• Glass price group 3	+\$227	Specify glass number for lite.
• Glass price group 4	+\$364	Specify glass number for lite.
• Glass price group 5	N.A.	Specify glass number for lite.
• Glass price group 6	+\$718	Specify glass number for lite.
		► See <i>Surface Materials Reference Manual</i> .
<b>Post Extension</b>	• Post extensions modified to accommodate recessed ceiling track (ordered separately)	No cost Specify with <i>post extensions for recessed ceiling track interface</i> .
	• Post extensions modified to accommodate overlapping ceiling track (ordered separately)	No cost Specify with <i>post extensions for overlapping ceiling track interface</i> .
<b>Ceiling Height</b>	• 8'0" through 9'0"	No cost Specify ceiling height in 1" increments.
	• 9'1" through 10'0"	+\$ 85 Specify ceiling height in 1" increments.
<b>Electrical Power</b>	<b>Base power block power schematic</b>	
(For panels 30"W through 60"W)	• 3+1	+\$192 Specify with <i>3+1 power</i> .
	• 2+2	+\$192 Specify with <i>2+2 power</i> .
	• 3SN	+\$192 Specify with <i>3SN power</i> .

► Specification Information, on next page

*Tip: Base power block location does not include infeed. It must be ordered separately, if needed.*

Privacy Wall



**For Canadian Pricing**  
Multiply U.S. Price by the Canadian price factor.  
► See page 1 for details.

# Modular Glass Wall Panels with Four Divided Lites Transom-Aligned Top Lite, continued

► Options, on previous page

## Specification Information

Nominal Width	Actual Width	Style Number	Product ID	Change to U.S. Base Price
---------------	--------------	--------------	------------	---------------------------

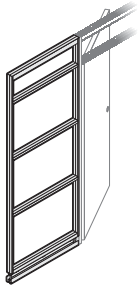

## Modular Glass Wall Panels

9"	7.657"	<b>GPGM4L18</b>	AW00009846	+\$0
10"	8.657"	<b>GPGM4L18</b>	AW00009847	+\$0
11"	9.657"	<b>GPGM4L18</b>	AW00009848	+\$0
12"	10.657"	<b>GPGM4L18</b>	AW00009849	+\$0
13"	11.657"	<b>GPGM4L18</b>	AW00012244	+\$0
14"	12.657"	<b>GPGM4L18</b>	AW00012245	+\$0
15"	13.657"	<b>GPGM4L18</b>	AW00012246	+\$0
16"	14.657"	<b>GPGM4L18</b>	AW00012247	+\$0
17"	15.657"	<b>GPGM4L18</b>	AW00012248	+\$0
19"	17.657"	<b>GPGM4L20</b>	AW00012249	+\$0
21"	19.657"	<b>GPGM4L24</b>	AW00012250	+\$0
22"	20.657"	<b>GPGM4L24</b>	AW00012251	+\$0
23"	21.657"	<b>GPGM4L24</b>	AW00012252	+\$0
25"	23.657"	<b>GPGM4L30</b>	AW00012253	+\$0
26"	24.657"	<b>GPGM4L30</b>	AW00012254	+\$0
27"	25.657"	<b>GPGM4L30</b>	AW00012255	+\$0
28"	26.657"	<b>GPGM4L30</b>	AW00012256	+\$0
29"	27.657"	<b>GPGM4L30</b>	AW00012257	+\$0
31"	29.657"	<b>GPGM4L36</b>	AW00012258	+\$0
32"	30.657"	<b>GPGM4L36</b>	AW00012259	+\$0
33"	31.657"	<b>GPGM4L36</b>	AW00012260	+\$0
34"	32.657"	<b>GPGM4L36</b>	AW00012261	+\$0
35"	33.657"	<b>GPGM4L36</b>	AW00012262	+\$0
37"	35.657"	<b>GPGM4L40</b>	AW00012263	+\$0
38"	36.657"	<b>GPGM4L40</b>	AW00012264	+\$0
39"	37.357"	<b>GPGM4L40</b>	AW00012265	+\$0
41"	39.657"	<b>GPGM4L42</b>	AW00012266	+\$0
43"	41.657"	<b>GPGM4L48</b>	AW00012269	+\$0
44"	42.657"	<b>GPGM4L48</b>	AW00012270	+\$0
45"	43.657"	<b>GPGM4L48</b>	AW00012271	+\$0
46"	44.657"	<b>GPGM4L48</b>	AW00012272	+\$0

► Specification Information, continued on next page



### For Canadian Pricing

Multiply U.S. Price by the Canadian price factor.

► See page 1 for details.

► **Specification Information, continued from previous page**

**Specification Information**

Nominal Width	Actual Width	Style Number	Product ID	Change to U.S. Base Price
---------------	--------------	--------------	------------	---------------------------

**Modular Glass Wall Panels, continued**

47"	45.657"	<b>GPGM4L48</b>	AW00012273	+\$0
49"	47.657"	<b>GPGM4L60</b>	AW00012274	+\$0
50"	48.657"	<b>GPGM4L60</b>	AW00012275	+\$0
51"	49.657"	<b>GPGM4L60</b>	AW00012276	+\$0
52"	50.657"	<b>GPGM4L60</b>	AW00012277	+\$0
53"	51.657"	<b>GPGM4L60</b>	AW00012278	+\$0
54"	52.657"	<b>GPGM4L60</b>	AW00012279	+\$0
55"	53.657"	<b>GPGM4L60</b>	AW00012280	+\$0
56"	54.657"	<b>GPGM4L60</b>	AW00012281	+\$0
57"	55.657"	<b>GPGM4L60</b>	AW00012282	+\$0
58"	56.657"	<b>GPGM4L60</b>	AW00012283	+\$0
59"	57.657"	<b>GPGM4L60</b>	AW00012284	+\$0

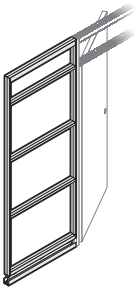

**For Canadian Pricing**  
Multiply U.S. Price by the  
Canadian price factor.  
► See page 1 for details.

# Glass Wall Panels with Two Divided Lites

Transom-Aligned Top Lite

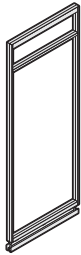

Tip: Order ceiling track, feature strip, and continuous base trim separately.

## What's Special

Parametric panel widths are available in 1" increments. This option is also available through the SmartTools software.

### Standard Includes

- Ceiling height from 8'0"H to 10'0"H, in one-inch increments
- 2<sup>3</sup>/<sub>8</sub>"-thick panel with steel frame: paint
- Two, 1/4"-thick factory-installed lites—top lite is transom aligned: glass
- Floor track with adjustable levelers to accommodate continuous 5"H base trim (ordered separately)

### Required to Specify

- 1 General quote number: **AW002320**
  - 2 Style number and Product ID
  - 3 Ceiling height
  - 4 Paint color number for frame and muntin
  - 5 Glass number for lite 1 (from top)
  - 6 Glass number for lite 2
  - 7 Post extension
  - 8 Options, if selected (see below)
- See Surface Materials in the Architectural Solution Specification Guide.

	Options	U.S. Price	Required to Specify
<b>Surface Materials</b>	<b>Glass frame surface</b>		
	• Paint price group 1	No cost	Specify paint color number.
	• Paint price group 2	+\$ 25	Specify paint color number.
	• Paint price group 3	+\$ 44	Specify paint color number.
	<b>Top lite glass panel surfaces 8'0"H through 10'0"H (per lite), 6"W to 8"W</b>		
	• Glass price group 1	No cost	Specify glass number for lite.
	• Glass price group 2	+\$ 17	Specify glass number for lite.
	• Glass price group 3	+\$ 21	Specify glass number for lite.
	• Glass price group 4	+\$ 31	Specify glass number for lite.
	• Glass price group 5	N.A.	Specify glass number for lite.
	• Glass price group 6	+\$ 64	Specify glass number for lite.
			▶ See <i>Surface Materials Reference Manual</i> .
	<b>Lower lite glass panel surfaces 8'0"H through 10'0"H (per lite), 6"W to 8"W</b>		
	• Glass price group 1	No cost	Specify glass number for lite.
	• Glass price group 2	+\$ 77	Specify glass number for lite.
	• Glass price group 3	+\$ 92	Specify glass number for lite.
	• Glass price group 4	+\$146	Specify glass number for lite.
	• Glass price group 5	N.A.	Specify glass number for lite.
	• Glass price group 6	+\$287	Specify glass number for lite.
			▶ See <i>Surface Materials Reference Manual</i> .
	<b>Top lite glass panel surfaces 8'0"H through 10'0"H (per lite), 18"W to 24"W</b>		
	• Glass price group 1	No cost	Specify glass number for lite.
	• Glass price group 2	+\$ 52	Specify glass number for lite.
	• Glass price group 3	+\$ 60	Specify glass number for lite.
	• Glass price group 4	+\$ 96	Specify glass number for lite.
	• Glass price group 5	N.A.	Specify glass number for lite.
	• Glass price group 6	+\$189	Specify glass number for lite.
			▶ See <i>Surface Materials Reference Manual</i> .
	<b>Lower lite glass panel surfaces 8'0"H through 10'0"H (per lite), 18"W to 24"W</b>		
	• Glass price group 1	No cost	Specify glass number for lite.
	• Glass price group 2	+\$229	Specify glass number for lite.
	• Glass price group 3	+\$272	Specify glass number for lite.
	• Glass price group 4	+\$437	Specify glass number for lite.
	• Glass price group 5	N.A.	Specify glass number for lite.
	• Glass price group 6	+\$861	Specify glass number for lite.
			▶ See <i>Surface Materials Reference Manual</i> .

▶ Options, continued on next page



### For Canadian Pricing

Multiply U.S. Price by the Canadian price factor.

▶ See page 1 for details.



► Options, continued from previous page

Options	U.S. Price	Required to Specify	
<b>Surface Materials</b>	<b>Top lite glass panel surfaces 8'0"H through 10'0"H (per lite), 30"W to 36"W</b>		
	• Glass price group 1	No cost	Specify glass number for lite.
	• Glass price group 2	+\$ 75	Specify glass number for lite.
	• Glass price group 3	+\$ 89	Specify glass number for lite.
	• Glass price group 4	+\$ 144	Specify glass number for lite.
	• Glass price group 5	N.A.	Specify glass number for lite.
	• Glass price group 6	+\$ 283	Specify glass number for lite.
		► See <i>Surface Materials Reference Manual</i> .	
	<b>Lower lite glass panel surfaces 8'0"H through 10'0"H (per lite), 30"W to 36"W</b>		
• Glass price group 1	No cost	Specify glass number for lite.	
• Glass price group 2	+\$ 343	Specify glass number for lite.	
• Glass price group 3	+\$ 410	Specify glass number for lite.	
• Glass price group 4	+\$ 653	Specify glass number for lite.	
• Glass price group 5	N.A.	Specify glass number for lite.	
• Glass price group 6	+\$1290	Specify glass number for lite.	
		► See <i>Surface Materials Reference Manual</i> .	
	<b>Top lite glass panel surfaces 8'0"H through 10'0"H (per lite), 40"W to 48"W</b>		
• Glass price group 1	No cost	Specify glass number for lite.	
• Glass price group 2	+\$ 100	Specify glass number for lite.	
• Glass price group 3	+\$ 121	Specify glass number for lite.	
• Glass price group 4	+\$ 191	Specify glass number for lite.	
• Glass price group 5	N.A.	Specify glass number for lite.	
• Glass price group 6	+\$ 376	Specify glass number for lite.	
		► See <i>Surface Materials Reference Manual</i> .	
	<b>Lower lite glass panel surfaces 8'0"H through 10'0"H (per lite), 40"W to 48"W</b>		
• Glass price group 1	No cost	Specify glass number for lite.	
• Glass price group 2	+\$ 456	Specify glass number for lite.	
• Glass price group 3	+\$ 545	Specify glass number for lite.	
• Glass price group 4	+\$ 872	Specify glass number for lite.	
• Glass price group 5	N.A.	Specify glass number for lite.	
• Glass price group 6	+\$1720	Specify glass number for lite.	
		► See <i>Surface Materials Reference Manual</i> .	
	<b>Top lite glass panel surfaces 8'0"H through 10'0"H (per lite), 60"W</b>		
• Glass price group 1	No cost	Specify glass number for lite.	
• Glass price group 2	+\$ 127	Specify glass number for lite.	
• Glass price group 3	+\$ 150	Specify glass number for lite.	
• Glass price group 4	+\$ 237	Specify glass number for lite.	
• Glass price group 5	N.A.	Specify glass number for lite.	
• Glass price group 6	+\$ 472	Specify glass number for lite.	
		► See <i>Surface Materials Reference Manual</i> .	
	<b>Lower lite glass panel surfaces 8'0"H through 10'0"H (per lite), 60"W</b>		
• Glass price group 1	No cost	Specify glass number for lite.	
• Glass price group 2	+\$ 570	Specify glass number for lite.	
• Glass price group 3	+\$ 680	Specify glass number for lite.	
• Glass price group 4	+\$1090	Specify glass number for lite.	
• Glass price group 5	N.A.	Specify glass number for lite.	
• Glass price group 6	+\$2151	Specify glass number for lite.	
		► See <i>Surface Materials Reference Manual</i> .	
<b>Post Extension</b>	• Post extensions modified to accommodate recessed ceiling track (ordered separately)	No cost	Specify with <i>post extensions for recessed ceiling track interface</i> .
	• Post extensions modified to accommodate overlapping ceiling track (ordered separately)	No cost	Specify with <i>post extensions for overlapping ceiling track interface</i> .
<b>Ceiling Height</b>	• 8'0" through 9'0"	No cost	Specify ceiling height in 1" increments.
	• 9'1" through 10'0"	+\$ 85	Specify ceiling height in 1" increments.
<b>Electrical Power</b> (For panels 30"W through 60"W)	<b>Base power block power schematic</b>		
	• 3+1	+\$ 192	Specify with <i>3+1 power</i> .
	• 2+2	+\$ 192	Specify with <i>2+2 power</i> .
	• 3SN	+\$ 192	Specify with <i>3SN power</i> .

Tip: Base power block location does not include infeed. It must be ordered separately, if needed.

► Specification Information, on next page

Glass Wall Panels with Two Divided Lites Transom-Aligned Top Lite, continued

► Options, on previous page

**Specification Information**

Width	Style Number	Product ID	Change to U.S. Base Price
-------	--------------	------------	---------------------------

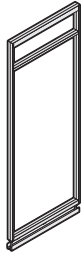

**Glass Wall Panels**

7"	<b>GPGS2L08</b>	AW00012353	+\$0
9"	<b>GPGS2L18</b>	AW00012354	+\$0
10"	<b>GPGS2L18</b>	AW00012355	+\$0
11"	<b>GPGS2L18</b>	AW00012356	+\$0
12"	<b>GPGS2L18</b>	AW00012357	+\$0
13"	<b>GPGS2L18</b>	AW00012358	+\$0
14"	<b>GPGS2L18</b>	AW00012359	+\$0
15"	<b>GPGS2L18</b>	AW00012360	+\$0
16"	<b>GPGS2L18</b>	AW00009981	+\$0
17"	<b>GPGS2L18</b>	AW00012361	+\$0
19"	<b>GPGS2L20</b>	AW00012362	+\$0
21"	<b>GPGS2L24</b>	AW00012363	+\$0
22"	<b>GPGS2L24</b>	AW00012364	+\$0
23"	<b>GPGS2L24</b>	AW00012365	+\$0
25"	<b>GPGS2L30</b>	AW00012366	+\$0
26"	<b>GPGS2L30</b>	AW00012367	+\$0
27"	<b>GPGS2L30</b>	AW00012368	+\$0
28"	<b>GPGS2L30</b>	AW00012369	+\$0
29"	<b>GPGS2L30</b>	AW00012370	+\$0
31"	<b>GPGS2L36</b>	AW00012373	+\$0
32"	<b>GPGS2L36</b>	AW00012374	+\$0
33"	<b>GPGS2L36</b>	AW00012376	+\$0
34"	<b>GPGS2L36</b>	AW00012377	+\$0
35"	<b>GPGS2L36</b>	AW00010981	+\$0
37"	<b>GPGS2L40</b>	AW00012380	+\$0
38"	<b>GPGS2L40</b>	AW00012381	+\$0
39"	<b>GPGS2L40</b>	AW00012382	+\$0
41"	<b>GPGS2L42</b>	AW00012383	+\$0
43"	<b>GPGS2L48</b>	AW00012384	+\$0
44"	<b>GPGS2L48</b>	AW00012385	+\$0
45"	<b>GPGS2L48</b>	AW00010797	+\$0
46"	<b>GPGS2L48</b>	AW00012386	+\$0
47"	<b>GPGS2L48</b>	AW00012387	+\$0
49"	<b>GPGS2L60</b>	AW00012388	+\$0
50"	<b>GPGS2L60</b>	AW00012389	+\$0
51"	<b>GPGS2L60</b>	AW00012390	+\$0

► Specification Information, continued on next page



**For Canadian Pricing**  
 Multiply U.S. Price by the  
 Canadian price factor.  
 ► See page 1 for details.

► **Specification Information, continued from previous page**

**Specification Information**

Width	Style Number	Product ID	Change to U.S. Base Price
-------	--------------	------------	---------------------------

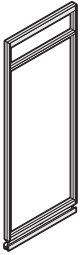

**Glass Wall Panels, continued**

52"	<b>GPGS2L60</b>	AW00012391	+\$0
53"	<b>GPGS2L60</b>	AW00012392	+\$0
54"	<b>GPGS2L60</b>	AW00011971	+\$0
55"	<b>GPGS2L60</b>	AW00012393	+\$0
56"	<b>GPGS2L60</b>	AW00012394	+\$0
57"	<b>GPGS2L60</b>	AW00012395	+\$0
58"	<b>GPGS2L60</b>	AW00012396	+\$0
59"	<b>GPGS2L60</b>	AW00012397	+\$0
:	:	:	:



**For Canadian Pricing**  
Multiply U.S. Price by the  
Canadian price factor.  
► See page 1 for details.

# Modular Glass Wall Panels with Two Divided Lites

Transom-Aligned Top Lite

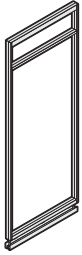

Tip: Order ceiling track, feature strip, and continuous base trim separately.

## What's Special

Parametric panel widths are available in 1" increments. This option is also available through the SmartTools software.

### Standard Includes

- Ceiling height from 8'0"H to 10'0"H, in one-inch increments
- 2<sup>3</sup>/<sub>8</sub>"-thick panel with steel frame: paint
- Two, 1/4"-thick factory-installed lites—top lite is transom aligned: glass
- Floor track with adjustable levelers to accommodate continuous 5"H base trim (ordered separately)

### Required to Specify

- 1 General quote number: **AW002322**
  - 2 Style number and Product ID
  - 3 Ceiling height
  - 4 Paint color number for frame and muntin
  - 5 Glass number for lite 1 (from top)
  - 6 Glass number for lite 2
  - 7 Post extension
  - 8 Options, if selected (see below)
- See Surface Materials in the Architectural Solution Specification Guide.

	Options	U.S. Price	Required to Specify
<b>Surface Materials</b>	<b>Glass frame surface</b>		
	• Paint price group 1	No cost	Specify paint color number.
	• Paint price group 2	+\$ 25	Specify paint color number.
	• Paint price group 3	+\$ 44	Specify paint color number.
	<b>Top lite glass panel surfaces 8'0"H through 10'0"H (per lite), 18"W to 24"W</b>		
	• Glass price group 1	No cost	Specify glass number for lite.
	• Glass price group 2	+\$ 52	Specify glass number for lite.
	• Glass price group 3	+\$ 60	Specify glass number for lite.
	• Glass price group 4	+\$ 96	Specify glass number for lite.
	• Glass price group 5	N.A.	Specify glass number for lite.
	• Glass price group 6	+\$189	Specify glass number for lite.
			▶ See <i>Surface Materials Reference Manual</i> .
	<b>Lower lite glass panel surfaces 8'0"H through 10'0"H (per lite), 18"W to 24"W</b>		
	• Glass price group 1	No cost	Specify glass number for lite.
	• Glass price group 2	+\$229	Specify glass number for lite.
	• Glass price group 3	+\$272	Specify glass number for lite.
	• Glass price group 4	+\$437	Specify glass number for lite.
	• Glass price group 5	N.A.	Specify glass number for lite.
	• Glass price group 6	+\$861	Specify glass number for lite.
			▶ See <i>Surface Materials Reference Manual</i> .
	<b>Top lite glass panel surfaces 8'0"H through 10'0"H (per lite), 30"W to 36"W</b>		
	• Glass price group 1	No cost	Specify glass number for lite.
	• Glass price group 2	+\$ 75	Specify glass number for lite.
	• Glass price group 3	+\$ 89	Specify glass number for lite.
	• Glass price group 4	+\$ 144	Specify glass number for lite.
	• Glass price group 5	N.A.	Specify glass number for lite.
	• Glass price group 6	+\$ 283	Specify glass number for lite.
			▶ See <i>Surface Materials Reference Manual</i> .
	<b>Lower lite glass panel surfaces 8'0"H through 10'0"H (per lite), 30"W to 36"W</b>		
	• Glass price group 1	No cost	Specify glass number for lite.
	• Glass price group 2	+\$ 343	Specify glass number for lite.
	• Glass price group 3	+\$ 410	Specify glass number for lite.
	• Glass price group 4	+\$ 653	Specify glass number for lite.
	• Glass price group 5	N.A.	Specify glass number for lite.
	• Glass price group 6	+\$1290	Specify glass number for lite.
			▶ See <i>Surface Materials Reference Manual</i> .
	<b>Top lite glass panel surfaces 8'0"H through 10'0"H (per lite), 40"W to 48"W</b>		
	• Glass price group 1	No cost	Specify glass number for lite.
	• Glass price group 2	+\$ 100	Specify glass number for lite.
	• Glass price group 3	+\$ 121	Specify glass number for lite.
	• Glass price group 4	+\$ 191	Specify glass number for lite.
	• Glass price group 5	N.A.	Specify glass number for lite.
	• Glass price group 6	+\$ 376	Specify glass number for lite.
			▶ See <i>Surface Materials Reference Manual</i> .

▶ Options, continued on next page



### For Canadian Pricing

Multiply U.S. Price by the Canadian price factor.

▶ See page 1 for details.

► Options, continued from previous page

Options	U.S. Price	Required to Specify	
<b>Surface Materials</b>	<b>Lower lite glass panel surfaces 8'0"H through 10'0"H (per lite), 40"W to 48"W</b>		
• Glass price group 1	No cost	Specify glass number for lite.	
• Glass price group 2	+\$ 456	Specify glass number for lite.	
• Glass price group 3	+\$ 545	Specify glass number for lite.	
• Glass price group 4	+\$ 872	Specify glass number for lite.	
• Glass price group 5	N.A.	Specify glass number for lite.	
• Glass price group 6	+\$1720	Specify glass number for lite.	
		► See <i>Surface Materials Reference Manual</i> .	
	<b>Top lite glass panel surfaces 8'0"H through 10'0"H (per lite), 60"W</b>		
• Glass price group 1	No cost	Specify glass number for lite.	
• Glass price group 2	+\$ 127	Specify glass number for lite.	
• Glass price group 3	+\$ 150	Specify glass number for lite.	
• Glass price group 4	+\$ 237	Specify glass number for lite.	
• Glass price group 5	N.A.	Specify glass number for lite.	
• Glass price group 6	+\$ 472	Specify glass number for lite.	
		► See <i>Surface Materials Reference Manual</i> .	
	<b>Lower lite glass panel surfaces 8'0"H through 10'0"H (per lite), 60"W</b>		
• Glass price group 1	No cost	Specify glass number for lite.	
• Glass price group 2	+\$ 570	Specify glass number for lite.	
• Glass price group 3	+\$ 680	Specify glass number for lite.	
• Glass price group 4	+\$1090	Specify glass number for lite.	
• Glass price group 5	N.A.	Specify glass number for lite.	
• Glass price group 6	+\$2151	Specify glass number for lite.	
		► See <i>Surface Materials Reference Manual</i> .	
<b>Post Extension</b>	• Post extensions modified to accommodate recessed ceiling track (ordered separately)	No cost	Specify with <i>post extensions for recessed ceiling track interface</i> .
	• Post extensions modified to accommodate overlapping ceiling track (ordered separately)	No cost	Specify with <i>post extensions for overlapping ceiling track interface</i> .
<b>Ceiling Height</b>	• 8'0" through 9'0"	No cost	Specify ceiling height in 1" increments.
	• 9'1" through 10'0"	+\$ 85	Specify ceiling height in 1" increments.
<b>Electrical Power</b> (For panels 30"W through 60"W)	<b>Base power block power schematic</b>		
	• 3+1	+\$ 192	Specify with <i>3+1 power</i> .
	• 2+2	+\$ 192	Specify with <i>2+2 power</i> .
	• 3SN	+\$ 192	Specify with <i>3SN power</i> .

► Specification Information, on next page

*Tip: Base power block location does not include infeed. It must be ordered separately, if needed.*

  
**For Canadian Pricing**  
Multiply U.S. Price by the Canadian price factor.  
► See page 1 for details.

# Modular Glass Wall Panels with Two Divided Lites Transom-Aligned Top Lite, continued

► Options, on previous page

## Specification Information

Nominal Width	Actual Width	Style Number	Product ID	Change to U.S. Base Price
---------------	--------------	--------------	------------	---------------------------

### Modular Glass Wall Panels

9"	7.657"	<b>GPGM2L18</b>	AW00012401	+\$0
10"	8.657"	<b>GPGM2L18</b>	AW00012402	+\$0
11"	9.657"	<b>GPGM2L18</b>	AW00012403	+\$0
12"	10.657"	<b>GPGM2L18</b>	AW00012404	+\$0
13"	11.657"	<b>GPGM2L18</b>	AW00012405	+\$0
14"	12.657"	<b>GPGM2L18</b>	AW00012406	+\$0
15"	13.657"	<b>GPGM2L18</b>	AW00012407	+\$0
16"	14.657"	<b>GPGM2L18</b>	AW00012408	+\$0
17"	15.657"	<b>GPGM2L18</b>	AW00012409	+\$0
19"	17.657"	<b>GPGM2L20</b>	AW00012410	+\$0
21"	19.657"	<b>GPGM2L24</b>	AW00012411	+\$0
22"	20.657"	<b>GPGM2L24</b>	AW00012412	+\$0
23"	21.657"	<b>GPGM2L24</b>	AW00012413	+\$0
25"	23.657"	<b>GPGM2L30</b>	AW00012414	+\$0
26"	24.657"	<b>GPGM2L30</b>	AW00012415	+\$0
27"	25.657"	<b>GPGM2L30</b>	AW00012416	+\$0
28"	26.657"	<b>GPGM2L30</b>	AW00012417	+\$0
29"	27.657"	<b>GPGM2L30</b>	AW00012418	+\$0
31"	29.657"	<b>GPGM2L36</b>	AW00012419	+\$0
32"	30.657"	<b>GPGM2L36</b>	AW00012420	+\$0
33"	31.657"	<b>GPGM2L36</b>	AW00012421	+\$0
34"	32.657"	<b>GPGM2L36</b>	AW00012422	+\$0
35"	33.657"	<b>GPGM2L36</b>	AW00012423	+\$0
37"	35.657"	<b>GPGM2L40</b>	AW00012424	+\$0
38"	36.657"	<b>GPGM2L40</b>	AW00012425	+\$0
39"	37.357"	<b>GPGM2L40</b>	AW00012426	+\$0
41"	39.657"	<b>GPGM2L42</b>	AW00010998	+\$0
43"	41.657"	<b>GPGM2L48</b>	AW00012427	+\$0
44"	42.657"	<b>GPGM2L48</b>	AW00012428	+\$0
45"	43.657"	<b>GPGM2L48</b>	AW00012429	+\$0
46"	44.657"	<b>GPGM2L48</b>	AW00012431	+\$0
47"	45.657"	<b>GPGM2L48</b>	AW00012432	+\$0
49"	47.657"	<b>GPGM2L60</b>	AW00012433	+\$0
50"	48.657"	<b>GPGM2L60</b>	AW00012434	+\$0
51"	49.657"	<b>GPGM2L60</b>	AW00012435	+\$0
52"	50.657"	<b>GPGM2L60</b>	AW00012436	+\$0

► Specification Information, continued on next page

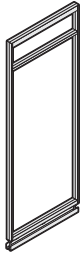

 **For Canadian Pricing**  
 Multiply U.S. Price by the  
 Canadian price factor.  
 ► See page 1 for details.

► **Specification Information, continued from previous page**

**Specification Information**

Nominal Width	Actual Width	Style Number	Product ID	Change to U.S. Base Price
---------------	--------------	--------------	------------	---------------------------

**Modular Glass Wall Panels, continued**

53"	51.657"	<b>GPGM2L60</b>	AW00012437	+\$0
54"	52.657"	<b>GPGM2L60</b>	AW00012438	+\$0
55"	53.657"	<b>GPGM2L60</b>	AW00012439	+\$0
56"	54.657"	<b>GPGM2L60</b>	AW00009982	+\$0
57"	55.657"	<b>GPGM2L60</b>	AW00012440	+\$0
58"	56.657"	<b>GPGM2L60</b>	AW00012441	+\$0
59"	57.657"	<b>GPGM2L60</b>	AW00012442	+\$0

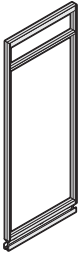

 **For Canadian Pricing**  
Multiply U.S. Price by the  
Canadian price factor.  
► See page 1 for details.

# Clerestory Wall Panels

## Transom-Aligned Top Lite



Tip: Order ceiling track, feature strip, and continuous base trim separately.

Tip: Paint price group 2 is only available on panels 36"W or smaller.

### What's Special

Parametric panel widths are available in 1" increments. This option is also available through the SmartTools software.

Tip: For planning information regarding pattern and etched glass, see the Architectural Solution Specification Guide.

Tip: Customer's Own Glass is available as a special at this time.



### For Canadian Pricing

Multiply U.S. Price by the Canadian price factor.

► See page 1 for details.

Standard Includes	Required to Specify
<ul style="list-style-type: none"> <li>• Frame: paint</li> <li>• Ceiling height from 8'0"H to 10'0"H, in one-inch increments</li> <li>• 2<sup>3</sup>/<sub>8</sub>"-thick panel with steel surfaces: paint</li> <li>• 1/4"-thick factory-installed Clerestory lite: glass</li> <li>• Integral slotted verticals</li> <li>• Hollow core panel for cable and power routing</li> <li>• Floor track with adjustable levelers to accommodate continuous 5"H base trim (ordered separately)</li> </ul>	<ol style="list-style-type: none"> <li>1 General quote number: <b>AW002327</b></li> <li>2 Style number and Product ID</li> <li>3 Paint color number for frame</li> <li>4 Ceiling height</li> <li>5 Paint color number for side 1</li> <li>6 Paint color number for side 2</li> <li>7 Glass number for Clerestory lite</li> <li>8 Post extension</li> <li>9 Options, if selected (see below)</li> </ol> See Surface Materials in the Architectural Solution Specification Guide.

Options	U.S. Price	Required to Specify
<b>Surface Materials</b>		
<b>Glass frame surface</b>		
• Paint price group 1	No cost	Specify paint color number.
• Paint price group 2	+\$ 12	Specify paint color number.
• Paint price group 3	+\$ 21	Specify paint color number.
<b>Lower panel solid surfaces 8'0"H through 10'0"H (per side), 18"W to 24"W</b>		
• Paint price group 1	No cost	Specify paint color number.
• Paint price group 2	+\$ 17	Specify paint color number.
• Paint price group 3	+\$ 29	Specify paint color number.
• Fabric price group 1	+\$125	Specify fabric color number for side 1 and/or side 2.
• Fabric price group 2	+\$176	Specify fabric color number for side 1 and/or side 2.
• Fabric price group 3	+\$232	Specify fabric color number for side 1 and/or side 2.
• Fabric price group 5	+\$293	Specify fabric color number for side 1 and/or side 2.
• Vinyl price group A	+\$242	Specify vinyl color number for side 1 and/or side 2.
• Vinyl price group B	+\$352	Specify vinyl color number for side 1 and/or side 2.
• Customer's Own Material (COM)	+\$121	► See <i>Surface Materials Reference Manual</i> .
<b>Clerestory Lite Glass Panels 8'0"H through 10'0"H</b>		
• Glass price group 1	No cost	Specify glass number for lite.
• Glass price group 2	+\$ 52	Specify glass number for lite.
• Glass price group 3	+\$ 60	Specify glass number for lite.
• Glass price group 4	+\$ 96	Specify glass number for lite.
• Glass price group 5	N.A.	Specify glass number for lite.
• Glass price group 6	+\$189	Specify glass number for lite.
<b>Lower panel surfaces 8'0"H through 10'0"H (per side), 30"W to 36"W</b>		
• Paint price group 1	No cost	Specify paint color number.
• Paint price group 2	+\$ 33	Specify paint color number.
• Paint price group 3	+\$ 52	Specify paint color number.
• Fabric price group 1	+\$191	Specify fabric color number for side 1 and/or side 2.
• Fabric price group 2	+\$283	Specify fabric color number for side 1 and/or side 2.
• Fabric price group 3	+\$420	Specify fabric color number for side 1 and/or side 2.
• Fabric price group 5	+\$546	Specify fabric color number for side 1 and/or side 2.
• Vinyl price group A	+\$352	Specify vinyl color number for side 1 and/or side 2.
• Vinyl price group B	+\$543	Specify vinyl color number for side 1 and/or side 2.
• Customer's Own Material (COM)	+\$176	► See <i>Surface Materials Reference Manual</i> .
<b>Clerestory Lite Glass Panels 8'0"H through 10'0"H</b>		
• Glass price group 1	No cost	Specify glass number for lite.
• Glass price group 2	+\$ 75	Specify glass number for lite.
• Glass price group 3	+\$ 89	Specify glass number for lite.
• Glass price group 4	+\$144	Specify glass number for lite.
• Glass price group 5	N.A.	Specify glass number for lite.
• Glass price group 6	+\$283	Specify glass number for lite.

► Options, continued on next page



## ► Options, continued from previous page

	Options	U.S. Price	Required to Specify	
<b>Surface Materials</b>	<b>Lower panel surfaces 8'0"H through 10'0"H (per side), 40"W to 48"W</b>			
	• Paint price group 1	No cost	Specify paint color number.	
	• Paint price group 3	+\$ 52	Specify paint color number.	
	• Fabric price group 1	+\$191	Specify fabric color number for side 1 and/or side 2.	
	• Fabric price group 2	+\$283	Specify fabric color number for side 1 and/or side 2.	
	• Fabric price group 3	+\$420	Specify fabric color number for side 1 and/or side 2.	
	• Fabric price group 5	+\$546	Specify fabric color number for side 1 and/or side 2.	
	• Vinyl price group A	+\$352	Specify vinyl color number for side 1 and/or side 2.	
	• Vinyl price group B	+\$543	Specify vinyl color number for side 1 and/or side 2.	
	• Customer's Own Material (COM)	+\$176	► See <i>Surface Materials Reference Manual</i> .	
	• Glass price group 1	No cost	Specify glass number for lite.	
	• Glass price group 2	+\$100	Specify glass number for lite.	
	• Glass price group 3	+\$121	Specify glass number for lite.	
	• Glass price group 4	+\$191	Specify glass number for lite.	
	• Glass price group 5	N.A.	Specify glass number for lite.	
	• Glass price group 6	+\$376	Specify glass number for lite.	
		<b>Lower panel surfaces 8'0"H through 10'0"H (per side) 60"W</b>		
		• Paint price group 1	No cost	Specify paint color number.
		• Paint price group 3	+\$ 52	Specify paint color number.
		• Fabric price group 1	+\$191	Specify fabric color number for side 1 and/or side 2.
• Fabric price group 2		+\$283	Specify fabric color number for side 1 and/or side 2.	
• Fabric price group 3		+\$420	Specify fabric color number for side 1 and/or side 2.	
• Fabric price group 5		+\$546	Specify fabric color number for side 1 and/or side 2.	
• Customer's Own Material (COM)		+\$176	► See <i>Surface Materials Reference Manual</i> .	
• Glass price group 1		No cost	Specify glass number for lite.	
• Glass price group 2		+\$127	Specify glass number for lite.	
• Glass price group 3		+\$150	Specify glass number for lite.	
• Glass price group 4		+\$237	Specify glass number for lite.	
• Glass price group 5		N.A.	Specify glass number for lite.	
• Glass price group 6		+\$472	Specify glass number for lite.	
<b>Post Extension</b>	• Post extensions modified to accommodate recessed ceiling track (ordered separately)	No cost	Specify <i>with post extensions for recessed ceiling track interface</i> .	
	• Post extensions modified to accommodate overlapping ceiling track (ordered separately)	No cost	Specify <i>with post extensions for overlapping ceiling track interface</i> .	
<b>Ceiling Height</b>	• 8'0" through 9'0"	No cost	Specify ceiling height in 1" increments.	
	• 9'1" through 10'0"	+\$ 85	Specify ceiling height in 1" increments.	

## ► Options, continued on next page

**For Canadian Pricing**

Multiply U.S. Price by the Canadian price factor.

► See page 1 for details.

## Clerestory Wall Panels Transom-Aligned Top Lite, continued

### ► Options, continued from previous page

*Tip: To price power in two locations, add the upcharges together.*

*Tip: Infeed is included in the price of ADA- or desk-height receptacle power location option. Base power block location does not include infeed. It must be ordered separately, if needed.*

*Tip: Base power block location does not include infeed. It must be ordered separately, if needed.*

*Tip: NYC/CHI prices replace the receptacle power location option prices when selected.*

*Tip: Order power and communication and power-only cover plates separately.*

Options	U.S. Price	Required to Specify
<b>Electrical Power</b> (For panels 30"W through 60"W)		
<b>Power block location</b>		
• Base	+\$192	Specify with power block location at base.
• ADA height	+\$701	Specify with power block location at ADA height.
• Desk height	+\$701	Specify with power block location at desk height.
<b>Power schematic</b>		
• 3+1	No cost	Specify with 3+1 power.
• 2+2	No cost	Specify with 2+2 power.
• 3SN	No cost	Specify with 3SN power.
<b>New York City/Chicago power prep</b>		
• NYC/CHI at base	N.A.	Specify with NYC/CHI at base.
• NYC/CHI at ADA or desk height side 1	+\$ 24	Specify with NYC/CHI at ADA or desk height side 1.
• NYC/CHI at ADA or desk height side 2	+\$ 24	Specify with NYC/CHI at ADA or desk height side 2.
• NYC/CHI at ADA or desk height sides 1 and 2	+\$ 49	Specify with NYC/CHI at ADA or desk height sides 1 and 2.
<b>Receptacle cutouts</b>		
• Power side 1	No cost	Specify with power side 1.
• Power side 2	No cost	Specify with power side 2.
• Power sides 1 and 2	+\$ 24	Specify with power sides 1 and 2.
• Power/comm side 1	No cost	Specify with power/comm side 1.
• Power/comm side 2	No cost	Specify with power/comm side 2.
• Power/comm sides 1 and 2	+\$ 24	Specify with power/comm sides 1 and 2.
<b>Floor infeeds</b>		
• Bottom left hardwire	No cost	Specify with bottom left hardwire.
• Bottom left modular	+\$ 89	Specify with bottom left modular.

### Specification Information

Width	Style Number	Product ID	Change to U.S. Base Price
-------	--------------	------------	---------------------------

### Clerestory Panels

6"	<b>GPGSC18</b>	AW00009968	+\$36
7"	<b>GPGSC18</b>	AW00012456	+\$36
8"	<b>GPGSC18</b>	AW00010054	+\$36
9"	<b>GPGSC18</b>	AW00012457	+\$36
10"	<b>GPGSC18</b>	AW00010955	+\$36
11"	<b>GPGSC18</b>	AW00012458	+\$36
12"	<b>GPGSC18</b>	AW00009913	+\$36
13"	<b>GPGSC18</b>	AW00012459	+\$36
14"	<b>GPGSC18</b>	AW00010770	+\$36
15"	<b>GPGSC18</b>	AW00009692	+\$36
16"	<b>GPGSC18</b>	AW00010053	+\$36
17"	<b>GPGSC18</b>	AW00012460	+\$36
19"	<b>GPGSC20</b>	AW00012461	+\$36
21"	<b>GPGSC24</b>	AW00012462	+\$36

### ► Specification Information, continued on next page



#### For Canadian Pricing

Multiply U.S. Price by the Canadian price factor.

► See page 1 for details.

► **Specification Information, continued from previous page**

**Specification Information**

Width	Style Number	Product ID	Change to U.S. Base Price
-------	--------------	------------	---------------------------

Tip: Standard Privacy Wall ceiling heights are 8'0" through 10'0".

Tip: Panels for ceiling height of 10'1" to 11'0" are available in width up to 48"W only.



**Clerestory Panels, continued**

22"	<b>GPGSC24</b>	AW00011604	+\$36
23"	<b>GPGSC24</b>	AW00012463	+\$36
25"	<b>GPGSC30</b>	AW00012464	+\$36
26"	<b>GPGSC30</b>	AW00012465	+\$36
27"	<b>GPGSC30</b>	AW00012466	+\$36
28"	<b>GPGSC30</b>	AW00010385	+\$36
29"	<b>GPGSC30</b>	AW00012467	+\$36
31"	<b>GPGSC36</b>	AW00010771	+\$36
32"	<b>GPGSC36</b>	AW00010473	+\$36
33"	<b>GPGSC36</b>	AW00009693	+\$36
34"	<b>GPGSC36</b>	AW00010772	+\$36
35"	<b>GPGSC36</b>	AW00012468	+\$36
37"	<b>GPGSC40</b>	AW00010773	+\$36
38"	<b>GPGSC40</b>	AW00009915	+\$36
39"	<b>GPGSC40</b>	AW00010774	+\$36
41"	<b>GPGSC42</b>	AW00009694	+\$36
43"	<b>GPGSC48</b>	AW00009695	+\$36
44"	<b>GPGSC48</b>	AW00010675	+\$36
45"	<b>GPGSC48</b>	AW00009686	+\$36
46"	<b>GPGSC48</b>	AW00011947	+\$36
47"	<b>GPGSC48</b>	AW00011606	+\$36
49"	<b>GPGSC60</b>	AW00012469	+\$36
50"	<b>GPGSC60</b>	AW00012470	+\$36
51"	<b>GPGSC60</b>	AW00009696	+\$36
52"	<b>GPGSC60</b>	AW00011749	+\$36
53"	<b>GPGSC60</b>	AW00011607	+\$36
54"	<b>GPGSC60</b>	AW00011948	+\$36
55"	<b>GPGSC60</b>	AW00010775	+\$36
56"	<b>GPGSC60</b>	AW00011750	+\$36
57"	<b>GPGSC60</b>	AW00009697	+\$36
58"	<b>GPGSC60</b>	AW00012472	+\$36
59"	<b>GPGSC60</b>	AW00010776	+\$36

Privacy Wall

 **For Canadian Pricing**  
 Multiply U.S. Price by the Canadian price factor.  
 ► See page 1 for details.

# Modular Clerestory Wall Panels

Transom-Aligned Top Lite



Tip: Order ceiling track, feature strip, and continuous base trim separately.

Tip: Paint price group 2 is only available on panels 36"W or smaller.

## What's Special

Parametric panel widths are available in 1" increments. This option is also available through the SmartTools software.

Tip: For planning information regarding pattern and etched glass, see the Architectural Solution Specification Guide.

Tip: Customer's Own Glass is available as a special at this time.



## For Canadian Pricing

Multiply U.S. Price by the Canadian price factor.

▶ See page 1 for details.

## Standard Includes

- Frame: paint
- Ceiling height from 8'0"H to 10'0"H, in one-inch increments
- 2<sup>3</sup>/<sub>8</sub>"-thick panel with steel surfaces: paint
- 1/4"-thick factory-installed Clerestory lite: glass
- Integral slotted verticals
- Hollow core panel for cable and power routing
- Floor track with adjustable levelers to accommodate continuous 5"H base trim (ordered separately)

## Required to Specify

- 1 General quote number: **AW002329**
  - 2 Style number and Product ID
  - 3 Paint color number for frame
  - 4 Ceiling height
  - 5 Paint color number for side 1
  - 6 Paint color number for side 2
  - 7 Glass number for Clerestory lite
  - 8 Post extension
  - 9 Options, if selected (see below)
- See Surface Materials in the Architectural Solution Specification Guide.

Options	U.S. Price	Required to Specify
<b>Surface Materials</b>	<b>Glass frame surface</b>	
• Paint price group 1	No cost	Specify paint color number.
• Paint price group 2	+\$ 12	Specify paint color number.
• Paint price group 3	+\$ 21	Specify paint color number.
<b>Lower panel solid surfaces 8'0"H through 10'0"H (per side), 18"W to 24"W</b>		
• Paint price group 1	No cost	Specify paint color number.
• Paint price group 2	+\$ 17	Specify paint color number.
• Paint price group 3	+\$ 29	Specify paint color number.
• Fabric price group 1	+\$125	Specify fabric color number for side 1 and/or side 2.
• Fabric price group 2	+\$176	Specify fabric color number for side 1 and/or side 2.
• Fabric price group 3	+\$232	Specify fabric color number for side 1 and/or side 2.
• Fabric price group 5	+\$293	Specify fabric color number for side 1 and/or side 2.
• Vinyl price group A	+\$242	Specify vinyl color number for side 1 and/or side 2.
• Vinyl price group B	+\$352	Specify vinyl color number for side 1 and/or side 2.
• Customer's Own Material (COM)	+\$121	▶ See <i>Surface Materials Reference Manual</i> .
<b>Clerestory Lite Glass Panels 8'0"H through 10'0"H</b>		
• Glass price group 1	No cost	Specify glass number for lite.
• Glass price group 2	+\$ 52	Specify glass number for lite.
• Glass price group 3	+\$ 60	Specify glass number for lite.
• Glass price group 4	+\$ 96	Specify glass number for lite.
• Glass price group 5	N.A.	Specify glass number for lite.
• Glass price group 6	+\$189	Specify glass number for lite.
<b>Lower panel surfaces 8'0"H through 10'0"H (per side), 30"W to 36"W</b>		
• Paint price group 1	No cost	Specify paint color number.
• Paint price group 2	+\$ 33	Specify paint color number.
• Paint price group 3	+\$ 52	Specify paint color number.
• Fabric price group 1	+\$191	Specify fabric color number for side 1 and/or side 2.
• Fabric price group 2	+\$283	Specify fabric color number for side 1 and/or side 2.
• Fabric price group 3	+\$420	Specify fabric color number for side 1 and/or side 2.
• Fabric price group 5	+\$546	Specify fabric color number for side 1 and/or side 2.
• Vinyl price group A	+\$352	Specify vinyl color number for side 1 and/or side 2.
• Vinyl price group B	+\$543	Specify vinyl color number for side 1 and/or side 2.
• Customer's Own Material (COM)	+\$176	▶ See <i>Surface Materials Reference Manual</i> .
<b>Clerestory Lite Glass Panels 8'0"H through 10'0"H</b>		
• Glass price group 1	No cost	Specify glass number for lite.
• Glass price group 2	+\$ 75	Specify glass number for lite.
• Glass price group 3	+\$ 89	Specify glass number for lite.
• Glass price group 4	+\$144	Specify glass number for lite.
• Glass price group 5	N.A.	Specify glass number for lite.
• Glass price group 6	+\$283	Specify glass number for lite.

▶ Options, continued on next page

► Options, continued from previous page

Options	U.S. Price	Required to Specify
<b>Surface Materials</b>		
<b>Lower panel surfaces 8'0"H through 10'0"H (per side), 40"W to 48"W</b>		
• Paint price group 1	No cost	Specify paint color number.
• Paint price group 3	+\$ 52	Specify paint color number.
• Fabric price group 1	+\$191	Specify fabric color number for side 1 and/or side 2.
• Fabric price group 2	+\$283	Specify fabric color number for side 1 and/or side 2.
• Fabric price group 3	+\$420	Specify fabric color number for side 1 and/or side 2.
• Fabric price group 5	+\$546	Specify fabric color number for side 1 and/or side 2.
• Vinyl price group A	+\$352	Specify vinyl color number for side 1 and/or side 2.
• Vinyl price group B	+\$543	Specify vinyl color number for side 1 and/or side 2.
• Customer's Own Material (COM)	+\$176	► See <i>Surface Materials Reference Manual</i> .
• Glass price group 1	No cost	Specify glass number for lite.
• Glass price group 2	+\$100	Specify glass number for lite.
• Glass price group 3	+\$121	Specify glass number for lite.
• Glass price group 4	+\$191	Specify glass number for lite.
• Glass price group 5	N.A.	Specify glass number for lite.
• Glass price group 6	+\$376	Specify glass number for lite.
<b>Lower panel surfaces 8'0"H through 10'0"H (per side) 60"W</b>		
• Paint price group 1	No cost	Specify paint color number.
• Paint price group 3	+\$ 52	Specify paint color number.
• Fabric price group 1	+\$191	Specify fabric color number for side 1 and/or side 2.
• Fabric price group 2	+\$283	Specify fabric color number for side 1 and/or side 2.
• Fabric price group 3	+\$420	Specify fabric color number for side 1 and/or side 2.
• Fabric price group 5	+\$546	Specify fabric color number for side 1 and/or side 2.
• Customer's Own Material (COM)	+\$176	► See <i>Surface Materials Reference Manual</i> .
• Glass price group 1	No cost	Specify glass number for lite.
• Glass price group 2	+\$127	Specify glass number for lite.
• Glass price group 3	+\$150	Specify glass number for lite.
• Glass price group 4	+\$237	Specify glass number for lite.
• Glass price group 5	N.A.	Specify glass number for lite.
• Glass price group 6	+\$472	Specify glass number for lite.
<b>Post Extension</b>		
• Post extensions modified to accommodate recessed ceiling track (ordered separately)	No cost	Specify with <i>post extensions for recessed ceiling track interface</i> .
• Post extensions modified to accommodate overlapping ceiling track (ordered separately)	No cost	Specify with <i>post extensions for overlapping ceiling track interface</i> .
<b>Ceiling Height</b>		
• 8'0" through 9'0"	No cost	Specify ceiling height in 1" increments.
• 9'1" through 10'0"	+\$ 85	Specify ceiling height in 1" increments.

► Options, continued on next page

Tip: Vinyl is not available on 60"W panels.

Tip: Customer's Own Glass is available as a special at this time.

 **For Canadian Pricing**  
Multiply U.S. Price by the Canadian price factor.  
► See page 1 for details.

## Modular Clerestory Wall Panels Transom-Aligned Top Lite, continued

### ► Options, continued from previous page

*Tip: To price power in two locations, add the upcharges together.*

*Tip: Infeed is included in the price of ADA- or desk-height receptacle power location option. Base power block location does not include infeed. It must be ordered separately, if needed.*

*Tip: Base power block location does not include infeed. It must be ordered separately, if needed.*

*Tip: NYC/CHI prices replace the receptacle power location option prices when selected.*

*Tip: Order power and communication and power-only cover plates separately.*

Options	U.S. Price	Required to Specify
<b>Electrical Power</b> (For panels 30"W through 60"W)		
<b>Power block location</b>		
• Base	+\$192	Specify with power block location at base.
• ADA height	+\$701	Specify with power block location at ADA height.
• Desk height	+\$701	Specify with power block location at desk height.
<b>Power schematic</b>		
• 3+1	No cost	Specify with 3+1 power.
• 2+2	No cost	Specify with 2+2 power.
• 3SN	No cost	Specify with 3SN power.
<b>New York City/Chicago power prep</b>		
• NYC/CHI at base	N.A.	Specify with NYC/CHI at base.
• NYC/CHI at ADA or desk height side 1	+\$ 24	Specify with NYC/CHI at ADA or desk height side 1.
• NYC/CHI at ADA or desk height side 2	+\$ 24	Specify with NYC/CHI at ADA or desk height side 2.
• NYC/CHI at ADA or desk height sides 1 and 2	+\$ 49	Specify with NYC/CHI at ADA or desk height sides 1 and 2.
<b>Receptacle cutouts</b>		
• Power side 1	No cost	Specify with power side 1.
• Power side 2	No cost	Specify with power side 2.
• Power sides 1 and 2	+\$ 24	Specify with power sides 1 and 2.
• Power/comm side 1	No cost	Specify with power/comm side 1.
• Power/comm side 2	No cost	Specify with power/comm side 2.
• Power/comm sides 1 and 2	+\$ 24	Specify with power/comm sides 1 and 2.
<b>Floor infeeds</b>		
• Bottom left hardwire	No cost	Specify with bottom left hardwire.
• Bottom left modular	+\$ 89	Specify with bottom left modular.

### Specification Information

Nominal Width	Actual Width	Style Number	Product ID	Change to U.S. Base Price
---------------	--------------	--------------	------------	---------------------------

### Modular Clerestory Panels

8"	7.657"	<b>GPGMC18</b>	AW00012476	+\$36
9"	7.657"	<b>GPGMC18</b>	AW00012477	+\$36
10"	8.657"	<b>GPGMC18</b>	AW00012478	+\$36
11"	9.657"	<b>GPGMC18</b>	AW00012479	+\$36
12"	10.657"	<b>GPGMC18</b>	AW00012480	+\$36
13"	11.657"	<b>GPGMC18</b>	AW00012481	+\$36
14"	12.657"	<b>GPGMC18</b>	AW00012482	+\$36
15"	13.657"	<b>GPGMC18</b>	AW00012483	+\$36
16"	14.657"	<b>GPGMC18</b>	AW00012484	+\$36
17"	15.657"	<b>GPGMC18</b>	AW00012485	+\$36
19"	17.657"	<b>GPGMC20</b>	AW00012486	+\$36
21"	19.657"	<b>GPGMC24</b>	AW00012487	+\$36
22"	20.657"	<b>GPGMC24</b>	AW00012488	+\$36
23"	21.657"	<b>GPGMC24</b>	AW00012489	+\$36

### ► Specification Information, continued on next page



#### For Canadian Pricing

Multiply U.S. Price by the Canadian price factor.

► See page 1 for details.

► **Specification Information, continued from previous page**

**Specification Information**

Nominal Width	Actual Width	Style Number	Product ID	Change to U.S. Base Price
---------------	--------------	--------------	------------	---------------------------

Tip: Standard Privacy Wall ceiling heights are 8'0" through 10'0".

Tip: Panels for ceiling height of 10'1" to 11'0" are available in width up to 48"W only.



**Modular Clerestory Panels, continued**

25"	23.657"	<b>GPGMC30</b>	AW00012490	+\$36
26"	24.657"	<b>GPGMC30</b>	AW00012491	+\$36
27"	25.657"	<b>GPGMC30</b>	AW00012492	+\$36
28"	26.657"	<b>GPGMC30</b>	AW00012493	+\$36
29"	27.657"	<b>GPGMC30</b>	AW00012494	+\$36
31"	29.657"	<b>GPGMC36</b>	AW00012495	+\$36
32"	30.657"	<b>GPGMC36</b>	AW00012496	+\$36
33"	31.657"	<b>GPGMC36</b>	AW00012497	+\$36
34"	32.657"	<b>GPGMC36</b>	AW00012498	+\$36
35"	33.657"	<b>GPGMC36</b>	AW00012499	+\$36
37"	35.657"	<b>GPGMC40</b>	AW00012500	+\$36
38"	36.657"	<b>GPGMC40</b>	AW00012505	+\$36
39"	37.357"	<b>GPGMC40</b>	AW00012506	+\$36
41"	39.657"	<b>GPGMC42</b>	AW00012507	+\$36
43"	41.657"	<b>GPGMC48</b>	AW00012508	+\$36
44"	42.657"	<b>GPGMC48</b>	AW00012509	+\$36
45"	43.657"	<b>GPGMC48</b>	AW00012510	+\$36
46"	44.657"	<b>GPGMC48</b>	AW00012511	+\$36
47"	45.657"	<b>GPGMC48</b>	AW00012512	+\$36
49"	47.657"	<b>GPGMC60</b>	AW00011605	+\$36
50"	48.657"	<b>GPGMC60</b>	AW00012513	+\$36
51"	49.657"	<b>GPGMC60</b>	AW00012514	+\$36
52"	50.657"	<b>GPGMC60</b>	AW00012515	+\$36
53"	51.657"	<b>GPGMC60</b>	AW00012516	+\$36
54"	52.657"	<b>GPGMC60</b>	AW00012517	+\$36
55"	53.657"	<b>GPGMC60</b>	AW00012518	+\$36
56"	54.657"	<b>GPGMC60</b>	AW00012519	+\$36
57"	55.657"	<b>GPGMC60</b>	AW00012520	+\$36
58"	56.657"	<b>GPGMC60</b>	AW00012521	+\$36
59"	57.657"	<b>GPGMC60</b>	AW00012522	+\$36
:	:	:	:	:

Privacy Wall

 **For Canadian Pricing**  
Multiply U.S. Price by the Canadian price factor.  
► See page 1 for details.

# Glass Selections Wall Panels with Two Divided Lites

Transom-Aligned Top Lite



Tip: Order ceiling track, feature strip, and continuous base trim separately.

## What's Special

Parametric panel widths are available in 1" increments. This option is also available through the SmartTools software.

### Standard Includes

- Ceiling height from 8'0"H to 10'0"H, in one-inch increments
- 2<sup>3</sup>/<sub>8</sub>"-thick panel with clear anodized aluminum frame
- Two, 1/4"-thick factory-installed lites—top lite is transom aligned: glass
- Floor track with adjustable levelers to accommodate continuous 5"H base trim (ordered separately)

### Required to Specify

- 1 General quote number: **AW002372**
  - 2 Style number and Product ID
  - 3 Ceiling height
  - 4 Glass number for lite 1 (from top)
  - 5 Glass number for lite 2
  - 6 Post extension
  - 7 Options, if selected (see below)
- See Surface Materials in the Architectural Solution Specification Guide.

### Options

### U.S. Price

### Required to Specify

#### Surface Materials

#### Top Lite Glass Panels 8'0" through 10'0", 6"W through 8"W

- |                       |         |
|-----------------------|---------|
| • Glass price group 1 | No cost |
| • Glass price group 2 | +\$ 17  |
| • Glass price group 3 | +\$ 21  |
| • Glass price group 4 | +\$ 31  |
| • Glass price group 5 | N.A.    |
| • Glass price group 6 | +\$ 64  |

- Specify glass number for lite.
- Specify glass number for lite.
- Specify glass number for lite.
- Specify glass number for lite.
- Specify glass number for lite.
- Specify glass number for lite.

▶ See *Surface Materials Reference Manual*.

#### Lower Lite Glass Panels 8'0" through 10'0" (per lite), 6"W through 8"W

- |                       |         |
|-----------------------|---------|
| • Glass price group 1 | No cost |
| • Glass price group 2 | +\$ 77  |
| • Glass price group 3 | +\$ 92  |
| • Glass price group 4 | +\$ 146 |
| • Glass price group 5 | N.A.    |
| • Glass price group 6 | +\$ 287 |

- Specify glass number for lite.
- Specify glass number for lite.
- Specify glass number for lite.
- Specify glass number for lite.
- Specify glass number for lite.
- Specify glass number for lite.

▶ See *Surface Materials Reference Manual*.

#### Top Lite Glass Panels 8'0" through 10'0", 18"W through 24"W

- |                       |         |
|-----------------------|---------|
| • Glass price group 1 | No cost |
| • Glass price group 2 | +\$ 52  |
| • Glass price group 3 | +\$ 60  |
| • Glass price group 4 | +\$ 96  |
| • Glass price group 5 | N.A.    |
| • Glass price group 6 | +\$ 189 |

- Specify glass number for lite.
- Specify glass number for lite.
- Specify glass number for lite.
- Specify glass number for lite.
- Specify glass number for lite.
- Specify glass number for lite.

▶ See *Surface Materials Reference Manual*.

#### Lower Lite Glass Panels 8'0" through 10'0" (per lite), 18"W through 24"W

- |                       |         |
|-----------------------|---------|
| • Glass price group 1 | No cost |
| • Glass price group 2 | +\$ 229 |
| • Glass price group 3 | +\$ 272 |
| • Glass price group 4 | +\$ 437 |
| • Glass price group 5 | N.A.    |
| • Glass price group 6 | +\$ 861 |

- Specify glass number for lite.
- Specify glass number for lite.
- Specify glass number for lite.
- Specify glass number for lite.
- Specify glass number for lite.
- Specify glass number for lite.

▶ See *Surface Materials Reference Manual*.

#### Top Lite Glass Panels 8'0" through 10'0", 30"W through 36"W

- |                       |         |
|-----------------------|---------|
| • Glass price group 1 | No cost |
| • Glass price group 2 | +\$ 75  |
| • Glass price group 3 | +\$ 89  |
| • Glass price group 4 | +\$ 144 |
| • Glass price group 5 | N.A.    |
| • Glass price group 6 | +\$ 283 |

- Specify glass number for lite.
- Specify glass number for lite.
- Specify glass number for lite.
- Specify glass number for lite.
- Specify glass number for lite.
- Specify glass number for lite.

▶ See *Surface Materials Reference Manual*.

#### Lower Lite Glass Panels 8'0" through 10'0" (per lite), 30"W through 36"W

- |                       |         |
|-----------------------|---------|
| • Glass price group 1 | No cost |
| • Glass price group 2 | +\$ 343 |
| • Glass price group 3 | +\$ 410 |
| • Glass price group 4 | +\$ 653 |
| • Glass price group 5 | N.A.    |
| • Glass price group 6 | +\$1290 |

- Specify glass number for lite.
- Specify glass number for lite.
- Specify glass number for lite.
- Specify glass number for lite.
- Specify glass number for lite.
- Specify glass number for lite.

▶ See *Surface Materials Reference Manual*.

▶ **Options, continued on next page**



#### For Canadian Pricing

Multiply U.S. Price by the Canadian price factor.

▶ See page 1 for details.



► Options, continued from previous page

	Options	U.S. Price	Required to Specify
<b>Surface Materials</b>	<b>Top Lite Glass Panels 8'0" through 10'0", 40"W through 48"W</b>		
	• Glass price group 1	No cost	Specify glass number for lite.
	• Glass price group 2	+\$ 100	Specify glass number for lite.
	• Glass price group 3	+\$ 121	Specify glass number for lite.
	• Glass price group 4	+\$ 191	Specify glass number for lite.
	• Glass price group 5	N.A.	Specify glass number for lite.
	• Glass price group 6	+\$ 376	Specify glass number for lite.
			► See <i>Surface Materials Reference Manual</i> .
	<b>Lower Lite Glass Panels 8'0" through 10'0" (per lite), 40"W through 48"W</b>		
	• Glass price group 1	No cost	Specify glass number for lite.
	• Glass price group 2	+\$ 456	Specify glass number for lite.
	• Glass price group 3	+\$ 545	Specify glass number for lite.
	• Glass price group 4	+\$ 872	Specify glass number for lite.
	• Glass price group 5	N.A.	Specify glass number for lite.
	• Glass price group 6	+\$1720	Specify glass number for lite.
			► See <i>Surface Materials Reference Manual</i> .
	<b>Top Lite Glass Panels 8'0" through 10'0", 60"W</b>		
	• Glass price group 1	No cost	Specify glass number for lite.
	• Glass price group 2	+\$ 127	Specify glass number for lite.
	• Glass price group 3	+\$ 150	Specify glass number for lite.
	• Glass price group 4	+\$ 237	Specify glass number for lite.
	• Glass price group 5	N.A.	Specify glass number for lite.
• Glass price group 6	+\$ 472	Specify glass number for lite.	
		► See <i>Surface Materials Reference Manual</i> .	
<b>Lower Lite Glass Panels 8'0" through 10'0" (per lite), 60"W</b>			
• Glass price group 1	No cost	Specify glass number for lite.	
• Glass price group 2	+\$ 570	Specify glass number for lite.	
• Glass price group 3	+\$ 680	Specify glass number for lite.	
• Glass price group 4	+\$1090	Specify glass number for lite.	
• Glass price group 5	N.A.	Specify glass number for lite.	
• Glass price group 6	+\$2151	Specify glass number for lite.	
		► See <i>Surface Materials Reference Manual</i> .	
<b>Post Extension</b>	• Post extensions modified to accommodate recessed ceiling track (ordered separately)	No cost	Specify with <i>post extensions for recessed ceiling track interface</i> .
	• Post extensions modified to accommodate overlapping ceiling track (ordered separately)	No cost	Specify with <i>post extensions for overlapping ceiling track interface</i> .
<b>Ceiling Height</b>	• 8'0" through 9'0"	No cost	Specify ceiling height in 1" increments.
	• 9'1" through 10'0"	+\$ 85	Specify ceiling height in 1" increments.
<b>Electrical Power</b> (For panels 30"W through 60"W)	<b>Base power block power schematic</b>		
	• 3+1	+\$ 192	Specify with <i>3+1 power</i> .
	• 2+2	+\$ 192	Specify with <i>2+2 power</i> .
	• 3SN	+\$ 192	Specify with <i>3SN power</i> .

*Tip: Base power block location does not include infeed. It must be ordered separately, if needed.*

► Specification Information on next page



**For Canadian Pricing**  
Multiply U.S. Price by the Canadian price factor.  
► See page 1 for details.

► Options, on previous page

**Specification Information**

Width	Style Number	Product ID	Change to U.S. Base Price
-------	--------------	------------	---------------------------



**Glass Wall Panels**

7"	<b>GPGSS2L08</b>	AW00012691	+\$0
9"	<b>GPGSS2L18</b>	AW00012692	+\$0
10"	<b>GPGSS2L18</b>	AW00012693	+\$0
11"	<b>GPGSS2L18</b>	AW00012694	+\$0
12"	<b>GPGSS2L18</b>	AW00012695	+\$0
13"	<b>GPGSS2L18</b>	AW00012696	+\$0
14"	<b>GPGSS2L18</b>	AW00012646	+\$0
15"	<b>GPGSS2L18</b>	AW00012697	+\$0
16"	<b>GPGSS2L18</b>	AW00012698	+\$0
17"	<b>GPGSS2L18</b>	AW00012699	+\$0
19"	<b>GPGSS2L20</b>	AW00012647	+\$0
21"	<b>GPGSS2L24</b>	AW00012700	+\$0
22"	<b>GPGSS2L24</b>	AW00012701	+\$0
23"	<b>GPGSS2L24</b>	AW00012702	+\$0
25"	<b>GPGSS2L30</b>	AW00012703	+\$0
26"	<b>GPGSS2L30</b>	AW00012704	+\$0
27"	<b>GPGSS2L30</b>	AW00012705	+\$0
28"	<b>GPGSS2L30</b>	AW00012706	+\$0
29"	<b>GPGSS2L30</b>	AW00012707	+\$0
31"	<b>GPGSS2L36</b>	AW00012708	+\$0
32"	<b>GPGSS2L36</b>	AW00012709	+\$0
33"	<b>GPGSS2L36</b>	AW00012710	+\$0
34"	<b>GPGSS2L36</b>	AW00012711	+\$0
35"	<b>GPGSS2L36</b>	AW00012712	+\$0
37"	<b>GPGSS2L40</b>	AW00012713	+\$0
38"	<b>GPGSS2L40</b>	AW00012067	+\$0
39"	<b>GPGSS2L40</b>	AW00012714	+\$0
41"	<b>GPGSS2L42</b>	AW00012715	+\$0
43"	<b>GPGSS2L48</b>	AW00012716	+\$0
44"	<b>GPGSS2L48</b>	AW00012717	+\$0
45"	<b>GPGSS2L48</b>	AW00012718	+\$0
46"	<b>GPGSS2L48</b>	AW00012719	+\$0
47"	<b>GPGSS2L48</b>	AW00012720	+\$0
49"	<b>GPGSS2L60</b>	AW00012721	+\$0
50"	<b>GPGSS2L60</b>	AW00012722	+\$0
51"	<b>GPGSS2L60</b>	AW00012723	+\$0

► Specification Information, continued on next page

 **For Canadian Pricing**  
 Multiply U.S. Price by the  
 Canadian price factor.  
 ► See page 1 for details.

► **Specification Information, continued from previous page**

**Specification Information**

Width	Style Number	Product ID	Change to U.S. Base Price
-------	--------------	------------	---------------------------

**Glass Wall Panels, continued**

52"	<b>GPGSS2L60</b>	AW00012724	+\$0
53"	<b>GPGSS2L60</b>	AW00012725	+\$0
54"	<b>GPGSS2L60</b>	AW00012726	+\$0
55"	<b>GPGSS2L60</b>	AW00012728	+\$0
56"	<b>GPGSS2L60</b>	AW00012729	+\$0
57"	<b>GPGSS2L60</b>	AW00012730	+\$0
58"	<b>GPGSS2L60</b>	AW00012731	+\$0
59"	<b>GPGSS2L60</b>	AW00012732	+\$0
:	:	:	:



Privacy Wall



**For Canadian Pricing**  
Multiply U.S. Price by the  
Canadian price factor.  
► See page 1 for details.

# Glass Selections Modular Wall Panels with Two Divided Lites

Transom-Aligned Top Lite



Tip: Order ceiling track, feature strip, and continuous base trim separately.

## What's Special

Parametric panel widths are available in 1" increments. This option is also available through the SmartTools software.

### Standard Includes

- Ceiling height from 8'0"H to 10'0"H, in one-inch increments
- 2<sup>3</sup>/<sub>8</sub>"-thick panel with clear anodized aluminum frame
- Two, 1/4"-thick factory-installed lites—top lite is transom aligned: glass
- Floor track with adjustable levelers to accommodate continuous 5"H base trim (ordered separately)

### Required to Specify

- 1 General quote number: **AW002374**
  - 2 Style number and Product ID
  - 3 Ceiling height
  - 4 Glass number for lite 1 (from top)
  - 5 Glass number for lite 2
  - 6 Post extension
  - 7 Options, if selected (see below)
- See Surface Materials in the Architectural Solution Specification Guide.

### Options

### U.S. Price

### Required to Specify

#### Surface Materials

#### Top Lite Glass Panels 8'0" through 10'0", 18"W through 24"W

- Glass price group 1 No cost
- Glass price group 2 +\$ 52
- Glass price group 3 +\$ 60
- Glass price group 4 +\$ 96
- Glass price group 5 N.A.
- Glass price group 6 +\$ 189

- Specify glass number for lite.
- Specify glass number for lite.
- Specify glass number for lite.
- Specify glass number for lite.
- Specify glass number for lite.
- Specify glass number for lite.

▶ See Surface Materials Reference Manual.

#### Lower Lite Glass Panels 8'0" through 10'0" (per lite), 18"W through 24"W

- Glass price group 1 No cost
- Glass price group 2 +\$ 229
- Glass price group 3 +\$ 272
- Glass price group 4 +\$ 437
- Glass price group 5 N.A.
- Glass price group 6 +\$ 861

- Specify glass number for lite.
- Specify glass number for lite.
- Specify glass number for lite.
- Specify glass number for lite.
- Specify glass number for lite.
- Specify glass number for lite.

▶ See Surface Materials Reference Manual.

#### Top Lite Glass Panels 8'0" through 10'0", 30"W through 36"W

- Glass price group 1 No cost
- Glass price group 2 +\$ 75
- Glass price group 3 +\$ 89
- Glass price group 4 +\$ 144
- Glass price group 5 N.A.
- Glass price group 6 +\$ 283

- Specify glass number for lite.
- Specify glass number for lite.
- Specify glass number for lite.
- Specify glass number for lite.
- Specify glass number for lite.
- Specify glass number for lite.

▶ See Surface Materials Reference Manual.

#### Lower Lite Glass Panels 8'0" through 10'0" (per lite), 30"W through 36"W

- Glass price group 1 No cost
- Glass price group 2 +\$ 343
- Glass price group 3 +\$ 410
- Glass price group 4 +\$ 653
- Glass price group 5 N.A.
- Glass price group 6 +\$1290

- Specify glass number for lite.
- Specify glass number for lite.
- Specify glass number for lite.
- Specify glass number for lite.
- Specify glass number for lite.
- Specify glass number for lite.

▶ See Surface Materials Reference Manual.

#### Top Lite Glass Panels 8'0" through 10'0", 40"W through 48"W

- Glass price group 1 No cost
- Glass price group 2 +\$ 100
- Glass price group 3 +\$ 121
- Glass price group 4 +\$ 191
- Glass price group 5 N.A.
- Glass price group 6 +\$ 376

- Specify glass number for lite.
- Specify glass number for lite.
- Specify glass number for lite.
- Specify glass number for lite.
- Specify glass number for lite.
- Specify glass number for lite.

▶ See Surface Materials Reference Manual.

#### Lower Lite Glass Panels 8'0" through 10'0" (per lite), 40"W through 48"W

- Glass price group 1 No cost
- Glass price group 2 +\$ 456
- Glass price group 3 +\$ 545
- Glass price group 4 +\$ 872
- Glass price group 5 N.A.
- Glass price group 6 +\$1720

- Specify glass number for lite.
- Specify glass number for lite.
- Specify glass number for lite.
- Specify glass number for lite.
- Specify glass number for lite.
- Specify glass number for lite.

▶ See Surface Materials Reference Manual.

▶ Options, continued on next page



#### For Canadian Pricing

Multiply U.S. Price by the Canadian price factor.

▶ See page 1 for details.

► Options, continued from previous page

	Options	U.S. Price	Required to Specify
<b>Surface Materials</b>	<b>Top Lite Glass Panels 8'0" through 10'0", 60"W</b>		
	<ul style="list-style-type: none"> <li>• Glass price group 1</li> <li>• Glass price group 2</li> <li>• Glass price group 3</li> <li>• Glass price group 4</li> <li>• Glass price group 5</li> <li>• Glass price group 6</li> </ul>	<ul style="list-style-type: none"> <li>No cost</li> <li>+\$ 127</li> <li>+\$ 150</li> <li>+\$ 237</li> <li>N.A.</li> <li>+\$ 472</li> </ul>	<ul style="list-style-type: none"> <li>Specify glass number for lite.</li> <li>Specify glass number for lite.</li> <li>Specify glass number for lite.</li> <li>Specify glass number for lite.</li> <li>Specify glass number for lite.</li> <li>Specify glass number for lite.</li> </ul>
	<b>Lower Lite Glass Panels 8'0" through 10'0" (per lite), 60"W</b>		
	<ul style="list-style-type: none"> <li>• Glass price group 1</li> <li>• Glass price group 2</li> <li>• Glass price group 3</li> <li>• Glass price group 4</li> <li>• Glass price group 5</li> <li>• Glass price group 6</li> </ul>	<ul style="list-style-type: none"> <li>No cost</li> <li>+\$ 570</li> <li>+\$ 680</li> <li>+\$1090</li> <li>N.A.</li> <li>+\$2151</li> </ul>	<ul style="list-style-type: none"> <li>Specify glass number for lite.</li> <li>Specify glass number for lite.</li> <li>Specify glass number for lite.</li> <li>Specify glass number for lite.</li> <li>Specify glass number for lite.</li> <li>Specify glass number for lite.</li> </ul>
<b>Post Extension</b>	<ul style="list-style-type: none"> <li>• Post extensions modified to accommodate recessed ceiling track (ordered separately)</li> </ul>	No cost	Specify with post extensions for recessed ceiling track interface.
	<ul style="list-style-type: none"> <li>• Post extensions modified to accommodate overlapping ceiling track (ordered separately)</li> </ul>	No cost	Specify with post extensions for overlapping ceiling track interface.
<b>Ceiling Height</b>	<ul style="list-style-type: none"> <li>• 8'0" through 9'0"</li> <li>• 9'1" through 10'0"</li> </ul>	<ul style="list-style-type: none"> <li>No cost</li> <li>+\$ 85</li> </ul>	<ul style="list-style-type: none"> <li>Specify ceiling height in 1" increments.</li> <li>Specify ceiling height in 1" increments.</li> </ul>
	<b>Electrical Power</b> (For panels 30"W through 60"W)	<b>Base power block power schematic</b>	
	<ul style="list-style-type: none"> <li>• 3+1</li> <li>• 2+2</li> <li>• 3SN</li> </ul>	<ul style="list-style-type: none"> <li>+\$ 192</li> <li>+\$ 192</li> <li>+\$ 192</li> </ul>	<ul style="list-style-type: none"> <li>Specify with 3+1 power.</li> <li>Specify with 2+2 power.</li> <li>Specify with 3SN power.</li> </ul>

► See *Surface Materials Reference Manual*.

► See *Surface Materials Reference Manual*.

*Tip: Base power block location does not include infeed. It must be ordered separately, if needed.*

► Specification Information on next page

  
**For Canadian Pricing**  
 Multiply U.S. Price by the  
 Canadian price factor.  
 ► See page 1 for details.

► Options, on previous page

**Specification Information**

Nominal Width	Actual Width	Style Number	Product ID	Change to U.S. Base Price
---------------	--------------	--------------	------------	---------------------------



**Modular Glass Wall Panels**

9"	7.657"	<b>GPGSM2L18</b>	AW00012734	+\$0
10"	8.657"	<b>GPGSM2L18</b>	AW00012735	+\$0
11"	9.657"	<b>GPGSM2L18</b>	AW00012736	+\$0
12"	10.657"	<b>GPGSM2L18</b>	AW00012738	+\$0
13"	11.657"	<b>GPGSM2L18</b>	AW00012739	+\$0
14"	12.657"	<b>GPGSM2L18</b>	AW00012740	+\$0
15"	13.657"	<b>GPGSM2L18</b>	AW00012741	+\$0
16"	14.657"	<b>GPGSM2L18</b>	AW00012742	+\$0
17"	15.657"	<b>GPGSM2L18</b>	AW00012743	+\$0
19"	17.657"	<b>GPGSM2L20</b>	AW00012744	+\$0
21"	19.657"	<b>GPGSM2L24</b>	AW00012745	+\$0
22"	20.657"	<b>GPGSM2L24</b>	AW00012746	+\$0
23"	21.657"	<b>GPGSM2L24</b>	AW00012747	+\$0
25"	23.657"	<b>GPGSM2L30</b>	AW00012748	+\$0
26"	24.657"	<b>GPGSM2L30</b>	AW00012751	+\$0
27"	25.657"	<b>GPGSM2L30</b>	AW00012752	+\$0
28"	26.657"	<b>GPGSM2L30</b>	AW00012649	+\$0
29"	27.657"	<b>GPGSM2L30</b>	AW00012753	+\$0
31"	29.657"	<b>GPGSM2L36</b>	AW00012754	+\$0
32"	30.657"	<b>GPGSM2L36</b>	AW00012755	+\$0
33"	31.657"	<b>GPGSM2L36</b>	AW00012756	+\$0
34"	32.657"	<b>GPGSM2L36</b>	AW00012757	+\$0
35"	33.657"	<b>GPGSM2L36</b>	AW00012758	+\$0
37"	35.657"	<b>GPGSM2L40</b>	AW00012763	+\$0
38"	36.657"	<b>GPGSM2L40</b>	AW00012764	+\$0
39"	37.357"	<b>GPGSM2L40</b>	AW00012765	+\$0
41"	39.657"	<b>GPGSM2L42</b>	AW00012766	+\$0
43"	41.657"	<b>GPGSM2L48</b>	AW00012767	+\$0
44"	42.657"	<b>GPGSM2L48</b>	AW00012768	+\$0
45"	43.657"	<b>GPGSM2L48</b>	AW00012769	+\$0
46"	44.657"	<b>GPGSM2L48</b>	AW00012770	+\$0
47"	45.657"	<b>GPGSM2L48</b>	AW00012771	+\$0
49"	47.657"	<b>GPGSM2L60</b>	AW00012772	+\$0
50"	48.657"	<b>GPGSM2L60</b>	AW00012773	+\$0
51"	49.657"	<b>GPGSM2L60</b>	AW00012774	+\$0
52"	50.657"	<b>GPGSM2L60</b>	AW00012775	+\$0

► Specification Information, continued on next page



**For Canadian Pricing**  
 Multiply U.S. Price by the  
 Canadian price factor.  
 ► See page 1 for details.

► **Specification Information, continued from previous page**

**Specification Information**

Nominal Width	Actual Width	Style Number	Product ID	Change to U.S. Base Price
---------------	--------------	--------------	------------	---------------------------

**Modular Glass Wall Panels, continued**

53"	51.657"	<b>GPGSM2L60</b>	AW00012776	+\$0
54"	52.657"	<b>GPGSM2L60</b>	AW00012777	+\$0
55"	53.657"	<b>GPGSM2L60</b>	AW00012778	+\$0
56"	54.657"	<b>GPGSM2L60</b>	AW00012789	+\$0
57"	55.657"	<b>GPGSM2L60</b>	AW00012780	+\$0
58"	56.657"	<b>GPGSM2L60</b>	AW00012781	+\$0
59"	57.657"	<b>GPGSM2L60</b>	AW00012782	+\$0



**For Canadian Pricing**  
 Multiply U.S. Price by the  
 Canadian price factor.  
 ► See page 1 for details.

# Glass Selections All-Glass Wall Panels



Tip: Order ceiling track, feature strip, and continuous base trim separately.

## What's Special

Parametric panel widths are available in 1" increments. This option is also available through the SmartTools software.

Standard Includes	Required to Specify
<ul style="list-style-type: none"> <li>Ceiling height from 8'0"H to 10'0"H, in one-inch increments</li> <li>2<sup>3</sup>/<sub>8</sub>"-thick panel with clear anodized aluminum frame</li> <li>1/4"-thick factory-installed lite: glass</li> <li>Floor track with adjustable levelers to accommodate continuous 5"H base trim (ordered separately)</li> </ul>	<ol style="list-style-type: none"> <li>General quote number: <b>AW002385</b></li> <li>Style number and Product ID</li> <li>Ceiling height</li> <li>Glass number for lite</li> <li>Post extension</li> <li>Options, if selected (see below)</li> </ol> See Surface Materials in the Architectural Solution Specification Guide.

Options	U.S. Price	Required to Specify
<b>Surface Materials</b>		
<b>Panels 96"H through 120"H, 6"W to 8"W</b>		
• Glass price group 1	No cost	Specify glass number for lite.
• Glass price group 2	+\$ 94	Specify glass number for lite.
• Glass price group 3	+\$ 114	Specify glass number for lite.
• Glass price group 4	+\$ 181	Specify glass number for lite.
• Glass price group 5	N.A.	Specify glass number for lite.
• Glass price group 6	+\$ 356	Specify glass number for lite.
▶ See <i>Surface Materials Reference Manual</i> .		
<b>Panels 96"H through 120"H, 18"W to 24"W</b>		
• Glass price group 1	No cost	Specify glass number for lite.
• Glass price group 2	+\$ 283	Specify glass number for lite.
• Glass price group 3	+\$ 337	Specify glass number for lite.
• Glass price group 4	+\$ 541	Specify glass number for lite.
• Glass price group 5	N.A.	Specify glass number for lite.
• Glass price group 6	+\$1065	Specify glass number for lite.
▶ See <i>Surface Materials Reference Manual</i> .		
<b>Panels 96"H through 120"H, 30"W to 36"W</b>		
• Glass price group 1	No cost	Specify glass number for lite.
• Glass price group 2	+\$ 424	Specify glass number for lite.
• Glass price group 3	+\$ 505	Specify glass number for lite.
• Glass price group 4	+\$ 809	Specify glass number for lite.
• Glass price group 5	N.A.	Specify glass number for lite.
• Glass price group 6	+\$1595	Specify glass number for lite.
▶ See <i>Surface Materials Reference Manual</i> .		
<b>Panels 96"H through 120"H, 40"W to 48"W</b>		
• Glass price group 1	No cost	Specify glass number for lite.
• Glass price group 2	+\$ 566	Specify glass number for lite.
• Glass price group 3	+\$ 672	Specify glass number for lite.
• Glass price group 4	+\$1080	Specify glass number for lite.
• Glass price group 5	N.A.	Specify glass number for lite.
• Glass price group 6	+\$2128	Specify glass number for lite.
▶ See <i>Surface Materials Reference Manual</i> .		
<b>Panels 96"H through 120"H, 60"W</b>		
• Glass price group 1	No cost	Specify glass number for lite.
• Glass price group 2	+\$ 707	Specify glass number for lite.
• Glass price group 3	+\$ 840	Specify glass number for lite.
• Glass price group 4	+\$1348	Specify glass number for lite.
• Glass price group 5	N.A.	Specify glass number for lite.
• Glass price group 6	+\$2660	Specify glass number for lite.
▶ See <i>Surface Materials Reference Manual</i> .		
<b>Post Extension</b>		
• Post extensions modified to accommodate recessed ceiling track (ordered separately)	No cost	Specify with post extensions for recessed ceiling track interface.
• Post extensions modified to accommodate overlapping ceiling track (ordered separately)	No cost	Specify with post extensions for overlapping ceiling track interface.
<b>Ceiling Height</b>		
• 8'0" through 9'0"	No cost	Specify ceiling height in 1" increments.
• 9'1" through 10'0"	+\$ 85	Specify ceiling height in 1" increments.

▶ Options, continued on next page



**For Canadian Pricing**  
Multiply U.S. Price by the Canadian price factor.

▶ See page 1 for details.



► Options, continued from previous page

Tip: Base power block location does not include infeed. Infeed must be ordered separately, if needed.

Options	U.S. Price	Required to Specify
<b>Electrical Power</b> (For panels 30"W through 60"W)	<b>Base power block power schematic</b>	
	• 3+1 +\$192	Specify with 3+1 power.
	• 2+2 +\$192	Specify with 2+2 power.
	• 3SN +\$192	Specify with 3SN power.

Specification Information

Width	Style Number	Product ID	Change to U.S. Base Price
-------	--------------	------------	---------------------------

All-Glass Wall Panels

7"	<b>GPGSSG08</b>	AW00012833	+\$0
9"	<b>GPGSSG18</b>	AW00012834	+\$0
10"	<b>GPGSSG18</b>	AW00012835	+\$0
11"	<b>GPGSSG18</b>	AW00012836	+\$0
12"	<b>GPGSSG18</b>	AW00012837	+\$0
13"	<b>GPGSSG18</b>	AW00012838	+\$0
14"	<b>GPGSSG18</b>	AW00012839	+\$0
15"	<b>GPGSSG18</b>	AW00012840	+\$0
16"	<b>GPGSSG18</b>	AW00012841	+\$0
17"	<b>GPGSSG18</b>	AW00012842	+\$0
19"	<b>GPGSSG18</b>	AW00012843	+\$0
21"	<b>GPGSSG18</b>	AW00012844	+\$0
22"	<b>GPGSSG18</b>	AW00012845	+\$0
23"	<b>GPGSSG18</b>	AW00012846	+\$0
25"	<b>GPGSSG18</b>	AW00012847	+\$0
26"	<b>GPGSSG18</b>	AW00012848	+\$0
27"	<b>GPGSSG18</b>	AW00012849	+\$0
28"	<b>GPGSSG18</b>	AW00012850	+\$0
29"	<b>GPGSSG18</b>	AW00012851	+\$0
31"	<b>GPGSSG18</b>	AW00012852	+\$0
32"	<b>GPGSSG18</b>	AW00012853	+\$0
33"	<b>GPGSSG18</b>	AW00012854	+\$0
34"	<b>GPGSSG18</b>	AW00012855	+\$0
35"	<b>GPGSSG18</b>	AW00012856	+\$0
37"	<b>GPGSSG18</b>	AW00012857	+\$0
38"	<b>GPGSSG18</b>	AW00012858	+\$0
39"	<b>GPGSSG18</b>	AW00012859	+\$0
41"	<b>GPGSSG18</b>	AW00012860	+\$0
43"	<b>GPGSSG18</b>	AW00012861	+\$0
44"	<b>GPGSSG18</b>	AW00011030	+\$0
45"	<b>GPGSSG18</b>	AW00012862	+\$0



Tip: Ceiling height panels from 10'0"H through 11'0"H are available in widths up to 48" only.

 **For Canadian Pricing**  
Multiply U.S. Price by the Canadian price factor.  
► See page 1 for details.

► Specification Information, continued on next page

Privacy Wall

► **Specification Information, continued from previous page**

**Specification Information**

Width	Style Number	Product ID	Change to U.S. Base Price
-------	--------------	------------	---------------------------



**All-Glass Wall Panels, continued**

46"	<b>GPGSSG18</b>	AW00012863	+\$0
47"	<b>GPGSSG18</b>	AW00012864	+\$0
49"	<b>GPGSSG18</b>	AW00012865	+\$0
50"	<b>GPGSSG18</b>	AW00012069	+\$0
51"	<b>GPGSSG18</b>	AW00012866	+\$0
52"	<b>GPGSSG18</b>	AW00012867	+\$0
53"	<b>GPGSSG18</b>	AW00012868	+\$0
54"	<b>GPGSSG18</b>	AW00012076	+\$0
55"	<b>GPGSSG18</b>	AW00012869	+\$0
56"	<b>GPGSSG18</b>	AW00012870	+\$0
57"	<b>GPGSSG18</b>	AW00012871	+\$0
58"	<b>GPGSSG18</b>	AW00012872	+\$0
59"	<b>GPGSSG18</b>	AW00012873	+\$0
:	:	:	:



**For Canadian Pricing**  
 Multiply U.S. Price by the  
 Canadian price factor.  
 ► See page 1 for details.



# Glass Selections Modular All-Glass Wall Panels



Tip: Order ceiling track, feature strip, and continuous base trim separately.

## What's Special

Parametric panel widths are available in 1" increments. This option is also available through the SmartTools software.

Standard Includes		Required to Specify	
<ul style="list-style-type: none"> <li>Ceiling height from 8'0"H to 10'0"H, in one-inch increments</li> <li>2<sup>3</sup>/<sub>8</sub>"-thick panel with clear anodized aluminum frame</li> <li>1/4"-thick factory-installed lite: glass</li> <li>Floor track with adjustable levelers to accommodate continuous 5"H base trim (ordered separately)</li> </ul>		1 General quote number: <b>AW002386</b> 2 Style number and Product ID 3 Ceiling height 4 Glass number for lite 5 Post extension 6 Options, if selected (see below) See Surface Materials in the Architectural Solution Specification Guide.	
Options	U.S. Price	Required to Specify	
<b>Surface Materials</b>			
<b>Panels 96"H through 120"H, 18"W to 24"W</b>			
<ul style="list-style-type: none"> <li>Glass price group 1</li> <li>Glass price group 2</li> <li>Glass price group 3</li> <li>Glass price group 4</li> <li>Glass price group 5</li> <li>Glass price group 6</li> </ul>	No cost +\$ 283 +\$ 337 +\$ 541 N.A. +\$1065	Specify glass number for lite. Specify glass number for lite. Specify glass number for lite. Specify glass number for lite. Specify glass number for lite. Specify glass number for lite. ▶ See <i>Surface Materials Reference Manual</i> .	
<b>Panels 96"H through 120"H, 30"W to 36"W</b>			
<ul style="list-style-type: none"> <li>Glass price group 1</li> <li>Glass price group 2</li> <li>Glass price group 3</li> <li>Glass price group 4</li> <li>Glass price group 5</li> <li>Glass price group 6</li> </ul>	No cost +\$ 424 +\$ 505 +\$ 809 N.A. +\$1595	Specify glass number for lite. Specify glass number for lite. Specify glass number for lite. Specify glass number for lite. Specify glass number for lite. Specify glass number for lite. ▶ See <i>Surface Materials Reference Manual</i> .	
<b>Panels 96"H through 120"H, 40"W to 48"W</b>			
<ul style="list-style-type: none"> <li>Glass price group 1</li> <li>Glass price group 2</li> <li>Glass price group 3</li> <li>Glass price group 4</li> <li>Glass price group 5</li> <li>Glass price group 6</li> </ul>	No cost +\$ 566 +\$ 672 +\$1080 N.A. +\$2128	Specify glass number for lite. Specify glass number for lite. Specify glass number for lite. Specify glass number for lite. Specify glass number for lite. Specify glass number for lite. ▶ See <i>Surface Materials Reference Manual</i> .	
<b>Panels 96"H through 120"H, 60"W</b>			
<ul style="list-style-type: none"> <li>Glass price group 1</li> <li>Glass price group 2</li> <li>Glass price group 3</li> <li>Glass price group 4</li> <li>Glass price group 5</li> <li>Glass price group 6</li> </ul>	No cost +\$ 707 +\$ 840 +\$1348 N.A. +\$2660	Specify glass number for lite. Specify glass number for lite. Specify glass number for lite. Specify glass number for lite. Specify glass number for lite. Specify glass number for lite. ▶ See <i>Surface Materials Reference Manual</i> .	
<b>Post Extension</b>	<ul style="list-style-type: none"> <li>Post extensions modified to accommodate recessed ceiling track (ordered separately)</li> <li>Post extensions modified to accommodate overlapping ceiling track (ordered separately)</li> </ul>	No cost No cost	Specify <i>with post extensions for recessed ceiling track interface</i> .  Specify <i>with post extensions for overlapping ceiling track interface</i> .
<b>Ceiling Height</b>	<ul style="list-style-type: none"> <li>8'0" through 9'0"</li> <li>9'1" through 10'0"</li> </ul>	No cost +\$ 85	Specify ceiling height in 1" increments. Specify ceiling height in 1" increments.

▶ Options, continued on next page



## For Canadian Pricing

Multiply U.S. Price by the Canadian price factor.

▶ See page 1 for details.

► Options, continued from previous page

Tip: Base power block location does not include infeed. Infeed must be ordered separately, if needed.

Options	U.S. Price	Required to Specify
<b>Electrical Power</b> (For panels 30"W through 60"W)	<b>Base power block power schematic</b>	
	• 3+1 +\$192	Specify with 3+1 power.
	• 2+2 +\$192	Specify with 2+2 power.
	• 3SN +\$192	Specify with 3SN power.

Specification Information

Nominal Width	Actual Width	Style Number	Product ID	Change to U.S. Base Price
---------------	--------------	--------------	------------	---------------------------

Modular All-Glass Wall Panels

9"	7.657"	<b>GPGSMG18</b>	AW00012878	+\$0
10"	8.657"	<b>GPGSMG18</b>	AW00012879	+\$0
11"	9.657"	<b>GPGSMG18</b>	AW00012881	+\$0
12"	10.657"	<b>GPGSMG18</b>	AW00012882	+\$0
13"	11.657"	<b>GPGSMG18</b>	AW00012883	+\$0
14"	12.657"	<b>GPGSMG18</b>	AW00012884	+\$0
15"	13.657"	<b>GPGSMG18</b>	AW00012885	+\$0
16"	14.657"	<b>GPGSMG18</b>	AW00012886	+\$0
17"	15.657"	<b>GPGSMG18</b>	AW00012887	+\$0
19"	17.657"	<b>GPGSMG20</b>	AW00012888	+\$0
21"	19.657"	<b>GPGSMG24</b>	AW00012889	+\$0
22"	20.657"	<b>GPGSMG24</b>	AW00012890	+\$0
23"	21.657"	<b>GPGSMG24</b>	AW00012891	+\$0
25"	23.657"	<b>GPGSMG30</b>	AW00012892	+\$0
26"	24.657"	<b>GPGSMG30</b>	AW00012893	+\$0
27"	25.657"	<b>GPGSMG30</b>	AW00012894	+\$0
28"	26.657"	<b>GPGSMG30</b>	AW00012896	+\$0
29"	27.657"	<b>GPGSMG30</b>	AW00012897	+\$0
31"	29.657"	<b>GPGSMG36</b>	AW00012900	+\$0
32"	30.657"	<b>GPGSMG36</b>	AW00012901	+\$0
33"	31.657"	<b>GPGSMG36</b>	AW00012902	+\$0
34"	32.657"	<b>GPGSMG36</b>	AW00012903	+\$0
35"	33.657"	<b>GPGSMG36</b>	AW00012904	+\$0
37"	35.657"	<b>GPGSMG40</b>	AW00012905	+\$0
38"	36.657"	<b>GPGSMG40</b>	AW00012906	+\$0
39"	37.357"	<b>GPGSMG40</b>	AW00012907	+\$0
41"	39.657"	<b>GPGSMG42</b>	AW00012908	+\$0
43"	41.657"	<b>GPGSMG48</b>	AW00012909	+\$0
44"	42.657"	<b>GPGSMG48</b>	AW00013008	+\$0
45"	43.657"	<b>GPGSMG48</b>	AW00013009	+\$0
46"	44.657"	<b>GPGSMG48</b>	AW00013010	+\$0

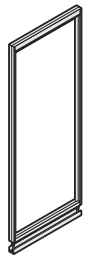

Tip: Ceiling height panels from 10'0"H through 11'0"H are available in widths up to 48" only.

 **For Canadian Pricing**  
Multiply U.S. Price by the Canadian price factor.  
► See page 1 for details.

► Specification Information, continued on next page

Privacy Wall

► **Specification Information, continued from previous page**

**Specification Information**

Nominal Width	Actual Width	Style Number	Product ID	Change to U.S. Base Price
---------------	--------------	--------------	------------	---------------------------



**Modular All-Glass Wall Panels, continued**

46"	44.657"	<b>GPGSMG48</b>	AW00013010	+\$0
47"	45.657"	<b>GPGSMG48</b>	AW00013011	+\$0
49"	47.657"	<b>GPGSMG60</b>	AW00013012	+\$0
50"	48.657"	<b>GPGSMG60</b>	AW00013013	+\$0
51"	49.657"	<b>GPGSMG60</b>	AW00013014	+\$0
52"	50.657"	<b>GPGSMG60</b>	AW00013015	+\$0
53"	51.657"	<b>GPGSMG60</b>	AW00013016	+\$0
54"	52.657"	<b>GPGSMG60</b>	AW00012679	+\$0
55"	53.657"	<b>GPGSMG60</b>	AW00013017	+\$0
56"	54.657"	<b>GPGSMG60</b>	AW00013018	+\$0
57"	55.657"	<b>GPGSMG60</b>	AW00013019	+\$0
58"	56.657"	<b>GPGSMG60</b>	AW00013020	+\$0
59"	57.657"	<b>GPGSMG60</b>	AW00013021	+\$0
:	:	:	:	:



**For Canadian Pricing**  
 Multiply U.S. Price by the  
 Canadian price factor.  
 ► See page 1 for details.



# Glass Selections Clerestory Wall Panels

Transom-Aligned Top Lite



Tip: Order ceiling track feature strip, and continuous base trim separately.

Tip: For planning information regarding pattern and etched glass, see the Architectural Solution Specification Guide.

Tip: Metallic paint is available on panel skins that are 36" wide or less.

## What's Special

Parametric panel widths are available in 1" increments. This option is also available through the SmartTools software.



### For Canadian Pricing

Multiply U.S. Price by the Canadian price factor.

▶ See page 1 for details.

Standard Includes	Required to Specify
-------------------	---------------------

- Frame: clear anodized aluminum
- Ceiling height from 8'0"H to 10'0"H, in one-inch increments
- 2<sup>3</sup>/<sub>8</sub>"-thick panel with steel surfaces: paint
- Factory-installed Clerestory lite: glass
- Integral slotted verticals
- Hollow core panel for cable and panel routing
- Floor track with adjustable levelers to accommodate continuous 5"H base trim (ordered separately)

- 1 General quote number: **AW002412**
  - 2 Style number and Product ID
  - 3 Ceiling height
  - 4 Paint color number for side 1
  - 5 Paint color number for side 2
  - 6 Glass number for Clerestory lite
  - 7 Post extension
  - 8 Options, if selected (see below)
- See Surface Materials in the Architectural Solution Specification Guide.

Surface Materials	Options	U.S. Price	Required to Specify
-------------------	---------	------------	---------------------

Surface Materials	Options	U.S. Price	Required to Specify
<b>Lower panel surfaces 8'0"H through 10'0"H (per side), 18"W to 24"W</b>			
	• Paint price group 1	No cost	Specify paint color number.
	• Paint price group 2	+\$ 17	Specify paint color number.
	• Paint price group 3	+\$ 29	Specify paint color number.
	• Fabric price group 1	+\$125	Specify fabric color number for side 1 and/or side 2.
	• Fabric price group 2	+\$176	Specify fabric color number for side 1 and/or side 2.
	• Fabric price group 3	+\$232	Specify fabric color number for side 1 and/or side 2.
	• Fabric price group 5	+\$293	Specify fabric color number for side 1 and/or side 2.
	• Vinyl price group A	+\$242	Specify vinyl color number for side 1 and/or side 2.
	• Vinyl price group B	+\$352	Specify vinyl color number for side 1 and/or side 2.
	• Customer's Own Material (COM)	+\$121	▶ See <i>Surface Materials Reference Manual</i> .

<b>Clerestory lite glass panels 8'0"H through 10'0"H</b>			
	• Glass price group 1	No cost	Specify glass number for lite.
	• Glass price group 2	+\$ 52	Specify glass number for lite.
	• Glass price group 3	+\$ 60	Specify glass number for lite.
	• Glass price group 4	+\$ 96	Specify glass number for lite.
	• Glass price group 5	N.A.	Specify glass number for lite.
	• Glass price group 6	+\$189	Specify glass number for lite.

<b>Lower panel surfaces 8'0"H through 10'0"H (per side), 30"W to 36"W</b>			
	• Paint price group 1	No cost	Specify paint color number.
	• Paint price group 2	+\$ 33	Specify paint color number.
	• Paint price group 3	+\$ 52	Specify paint color number.
	• Fabric price group 1	+\$191	Specify fabric color number for side 1 and/or side 2.
	• Fabric price group 2	+\$283	Specify fabric color number for side 1 and/or side 2.
	• Fabric price group 3	+\$420	Specify fabric color number for side 1 and/or side 2.
	• Fabric price group 5	+\$546	Specify fabric color number for side 1 and/or side 2.
	• Vinyl price group A	+\$352	Specify vinyl color number for side 1 and/or side 2.
	• Vinyl price group B	+\$543	Specify vinyl color number for side 1 and/or side 2.
	• Customer's Own Material (COM)	+\$176	▶ See <i>Surface Materials Reference Manual</i> .

<b>Clerestory lite glass panels 8'0"H through 10'0"H</b>			
	• Glass price group 1	No cost	Specify glass number for lite.
	• Glass price group 2	+\$ 75	Specify glass number for lite.
	• Glass price group 3	+\$ 89	Specify glass number for lite.
	• Glass price group 4	+\$144	Specify glass number for lite.
	• Glass price group 5	N.A.	Specify glass number for lite.
	• Glass price group 6	+\$283	Specify glass number for lite.

▶ Options, continued on next page



► Options, continued from previous page

	Options	U.S. Price	Required to Specify
<b>Surface Materials</b>	<b>Lower panel surfaces 8'0"H through 10'0"H (per side) 40"W to 48"W</b>		
	• Paint price group 1	No cost	Specify paint color number.
	• Paint price group 3	+\$ 52	Specify paint color number.
	• Fabric price group 1	+\$191	Specify fabric color number for side 1 and/or side 2.
	• Fabric price group 2	+\$283	Specify fabric color number for side 1 and/or side 2.
	• Fabric price group 3	+\$420	Specify fabric color number for side 1 and/or side 2.
	• Fabric price group 5	+\$546	Specify fabric color number for side 1 and/or side 2.
	• Vinyl price group A	+\$352	Specify vinyl color number for side 1 and/or side 2.
	• Vinyl price group B	+\$543	Specify vinyl color number for side 1 and/or side 2.
	• Customer's Own Material (COM)	+\$176	► See <i>Surface Materials Reference Manual</i> .
	<b>Clerestory lite glass panels 8'0"H through 10'0"H</b>		
	• Glass price group 1	No cost	Specify glass number for lite.
	• Glass price group 2	+\$100	Specify glass number for lite.
	• Glass price group 3	+\$121	Specify glass number for lite.
	• Glass price group 4	+\$191	Specify glass number for lite.
	• Glass price group 5	N.A.	Specify glass number for lite.
	• Glass price group 6	+\$376	Specify glass number for lite.
	<b>Lower panel surfaces 8'0"H through 10'0"H (per side) 60"W</b>		
	• Paint price group 1	No cost	Specify paint color number.
	• Paint price group 3	+\$ 52	Specify paint color number.
	• Fabric price group 1	+\$191	Specify fabric color number for side 1 and/or side 2.
	• Fabric price group 2	+\$283	Specify fabric color number for side 1 and/or side 2.
	• Fabric price group 3	+\$420	Specify fabric color number for side 1 and/or side 2.
	• Fabric price group 5	+\$546	Specify fabric color number for side 1 and/or side 2.
	• Customer's Own Material (COM)	+\$176	► See <i>Surface Materials Reference Manual</i> .
	<b>Clerestory lite glass panels 8'0"H through 10'0"H</b>		
	• Glass price group 1	No cost	Specify glass number for lite.
	• Glass price group 2	+\$127	Specify glass number for lite.
	• Glass price group 3	+\$150	Specify glass number for lite.
	• Glass price group 4	+\$237	Specify glass number for lite.
	• Glass price group 5	N.A.	Specify glass number for lite.
	• Glass price group 6	+\$472	Specify glass number for lite.
<b>Post Extension</b>	• Post extensions modified to accommodate recessed ceiling track (ordered separately)	No cost	Specify with <i>post extensions for recessed ceiling track interface</i> .
	• Post extensions modified to accommodate overlapping ceiling track (ordered separately)	No cost	Specify with <i>post extensions for overlapping ceiling track interface</i> .
<b>Ceiling Height</b>	• 8'0" through 9'0"	No cost	Specify ceiling height in 1" increments.
	• 9'1" through 10'0"	+\$ 85	Specify ceiling height in 1" increments.

► Options, continued on next page

Tip: Vinyl is not available on 60"W panels.

Tip: Customer's Own Glass is available as a special at this time.

 **For Canadian Pricing**  
Multiply U.S. Price by the Canadian price factor.  
► See page 1 for details.

## Glass Selections Clerestory Wall Panels Transom-Aligned Top Lite, continued



Tip: To price power in two locations, add the upcharges together.

Tip: Infeed is included in the price of ADA- or desk-height receptacle power location option. Base power block location does not include infeed. It must be ordered separately, if needed.

Tip: Base power block location does not include infeed. It must be ordered separately, if needed.

Tip: NYC/CHI prices replace the receptacle power location option prices when selected.

### ► Options, continued from previous page

Options	U.S. Price	Required to Specify
<b>Electrical Power (30"W through 60"W)</b>		
<b>Power block location</b>		
• Base	+\$192	Specify with power block location at base.
• ADA height	+\$701	Specify with power block location at ADA height.
• Desk height	+\$701	Specify with power block location at desk height.
<b>Power schematic</b>		
• 3+1	No cost	Specify with 3+1 power.
• 2+2	No cost	Specify with 2+2 power.
• 3SN	No cost	Specify with 3SN power.
<b>New York City/Chicago power prep</b>		
• NYC/CHI at base	N.A.	Specify with NYC/CHI at base.
• NYC/CHI at ADA or desk height side 1	+\$ 24	Specify with NYC/CHI at ADA or desk height side 1.
• NYC/CHI at ADA or desk height side 2	+\$ 24	Specify with NYC/CHI at ADA or desk height side 2.
• NYC/CHI at ADA or desk height sides 1 and 2	+\$ 49	Specify with NYC/CHI at ADA or desk height sides 1 and 2.
<b>Receptacle cutouts</b>		
• Power side 1	No cost	Specify with power side 1.
• Power side 2	No cost	Specify with power side 2.
• Power sides 1 and 2	+\$ 24	Specify with power sides 1 and 2.
• Power/comm side 1	No cost	Specify with power/comm side 1.
• Power/comm side 2	No cost	Specify with power/comm side 2.
• Power/comm sides 1 and 2	+\$ 24	Specify with power/comm sides 1 and 2.
<b>Floor Infeeds</b>		
• Bottom left hardwire	No cost	Specify with bottom left hardwire.
• Bottom left modular	+\$ 89	Specify with bottom left modular.

### Specification Information

Width	Style Number	Product ID	Change to U.S. Base Price
-------	--------------	------------	---------------------------

### Clerestory Panels

6"	<b>GPGSSC18</b>	AW00013024	+\$36
7"	<b>GPGSSC18</b>	AW00013025	+\$36
8"	<b>GPGSSC18</b>	AW00013026	+\$36
9"	<b>GPGSSC18</b>	AW00013027	+\$36
10"	<b>GPGSSC18</b>	AW00013028	+\$36
11"	<b>GPGSSC18</b>	AW00013029	+\$36
12"	<b>GPGSSC18</b>	AW00013030	+\$36
13"	<b>GPGSSC18</b>	AW00013031	+\$36
14"	<b>GPGSSC18</b>	AW00013032	+\$36
15"	<b>GPGSSC18</b>	AW00013033	+\$36
16"	<b>GPGSSC18</b>	AW00013034	+\$36
17"	<b>GPGSSC18</b>	AW00013035	+\$36
19"	<b>GPGSSC20</b>	AW00012680	+\$36
21"	<b>GPGSSC24</b>	AW00013036	+\$36

### ► Specification Information, continued on next page



**For Canadian Pricing**  
Multiply U.S. Price by the Canadian price factor.

► See page 1 for details.

► **Specification Information, continued from previous page**

**Specification Information**

Width	Style Number	Product ID	Change to U.S. Base Price
-------	--------------	------------	---------------------------

**Clerestory Panels, continued**

22"	<b>GPGSSC24</b>	AW00013037	+\$36
23"	<b>GPGSSC24</b>	AW00013038	+\$36
25"	<b>GPGSSC30</b>	AW00013041	+\$36
26"	<b>GPGSSC30</b>	AW00013042	+\$36
27"	<b>GPGSSC30</b>	AW00013043	+\$36
28"	<b>GPGSSC30</b>	AW00013044	+\$36
29"	<b>GPGSSC30</b>	AW00013045	+\$36
31"	<b>GPGSSC36</b>	AW00013046	+\$36
32"	<b>GPGSSC36</b>	AW00013047	+\$36
33"	<b>GPGSSC36</b>	AW00013048	+\$36
34"	<b>GPGSSC36</b>	AW00013049	+\$36
35"	<b>GPGSSC36</b>	AW00013050	+\$36
37"	<b>GPGSSC40</b>	AW00013051	+\$36
38"	<b>GPGSSC40</b>	AW00013052	+\$36
39"	<b>GPGSSC40</b>	AW00013053	+\$36
41"	<b>GPGSSC42</b>	AW00013055	+\$36
43"	<b>GPGSSC48</b>	AW00013056	+\$36
44"	<b>GPGSSC48</b>	AW00013057	+\$36
45"	<b>GPGSSC48</b>	AW00013065	+\$36
46"	<b>GPGSSC48</b>	AW00013066	+\$36
47"	<b>GPGSSC48</b>	AW00013067	+\$36
49"	<b>GPGSSC60</b>	AW00013068	+\$36
50"	<b>GPGSSC60</b>	AW00013069	+\$36
51"	<b>GPGSSC60</b>	AW00013070	+\$36
52"	<b>GPGSSC60</b>	AW00013071	+\$36
53"	<b>GPGSSC60</b>	AW00013072	+\$36
54"	<b>GPGSSC60</b>	AW00013073	+\$36
55"	<b>GPGSSC60</b>	AW00013074	+\$36
56"	<b>GPGSSC60</b>	AW00013075	+\$36
57"	<b>GPGSSC60</b>	AW00013076	+\$36
58"	<b>GPGSSC60</b>	AW00013077	+\$36
59"	<b>GPGSSC60</b>	AW00013078	+\$36



Privacy Wall



**For Canadian Pricing**  
Multiply U.S. Price by the  
Canadian price factor.  
► See page 1 for details.

# Glass Selections Modular Clerestory Wall Panels

Transom-Aligned Top Lite



*Tip: Order ceiling track feature strip, and continuous base trim separately.*

*Tip: For planning information regarding pattern and etched glass, see the Architectural Solution Specification Guide.*

*Tip: Metallic paint is available on panel skins that are 36" wide or less.*

## What's Special

Parametric panel widths are available in 1" increments. This option is also available through the SmartTools software.



### For Canadian Pricing

Multiply U.S. Price by the Canadian price factor.

► See page 1 for details.

Standard Includes	Required to Specify
-------------------	---------------------

- Frame: clear anodized aluminum
- Ceiling height from 8'0"H to 10'0"H, in one-inch increments
- 2<sup>3</sup>/<sub>8</sub>"-thick panel with steel surfaces: paint
- Factory-installed Clerestory lite: glass
- Integral slotted verticals
- Hollow core panel for cable and panel routing
- Floor track with adjustable levelers to accommodate continuous 5"H base trim (ordered separately)

- 1 General quote number: **AW002415**
  - 2 Style number and Product ID
  - 3 Ceiling height
  - 4 Paint color number for side 1
  - 5 Paint color number for side 2
  - 6 Glass number for Clerestory lite
  - 7 Post extension
  - 8 Options, if selected (see below)
- See Surface Materials in the Architectural Solution Specification Guide.

Surface Materials	Options	U.S. Price	Required to Specify
-------------------	---------	------------	---------------------

**Lower panel surfaces 8'0"H through 10'0"H (per side), 18"W to 24"W**

- |                                 |         |   |
|---------------------------------|---------|---|
| • Paint price group 1           | No cost | Specify paint color number.                           |
| • Paint price group 2           | +\$ 17  | Specify paint color number.                           |
| • Paint price group 3           | +\$ 29  | Specify paint color number.                           |
| • Fabric price group 1          | +\$125  | Specify fabric color number for side 1 and/or side 2. |
| • Fabric price group 2          | +\$176  | Specify fabric color number for side 1 and/or side 2. |
| • Fabric price group 3          | +\$232  | Specify fabric color number for side 1 and/or side 2. |
| • Fabric price group 5          | +\$293  | Specify fabric color number for side 1 and/or side 2. |
| • Vinyl price group A           | +\$242  | Specify vinyl color number for side 1 and/or side 2.  |
| • Vinyl price group B           | +\$352  | Specify vinyl color number for side 1 and/or side 2.  |
| • Customer's Own Material (COM) | +\$121  | ► See <i>Surface Materials Reference Manual</i> .     |

**Clerestory lite glass panels 8'0"H through 10'0"H**

- |                       |         |                                |
|-----------------------|---------|--------------------------------|
| • Glass price group 1 | No cost | Specify glass number for lite. |
| • Glass price group 2 | +\$ 52  | Specify glass number for lite. |
| • Glass price group 3 | +\$ 60  | Specify glass number for lite. |
| • Glass price group 4 | +\$ 96  | Specify glass number for lite. |
| • Glass price group 5 | N.A.    | Specify glass number for lite. |
| • Glass price group 6 | +\$189  | Specify glass number for lite. |

**Lower panel surfaces 8'0"H through 10'0"H (per side), 30"W to 36"W**

- |                                 |         |   |
|---------------------------------|---------|---|
| • Paint price group 1           | No cost | Specify paint color number.                           |
| • Paint price group 2           | +\$ 33  | Specify paint color number.                           |
| • Paint price group 3           | +\$ 52  | Specify paint color number.                           |
| • Fabric price group 1          | +\$191  | Specify fabric color number for side 1 and/or side 2. |
| • Fabric price group 2          | +\$283  | Specify fabric color number for side 1 and/or side 2. |
| • Fabric price group 3          | +\$420  | Specify fabric color number for side 1 and/or side 2. |
| • Fabric price group 5          | +\$546  | Specify fabric color number for side 1 and/or side 2. |
| • Vinyl price group A           | +\$352  | Specify vinyl color number for side 1 and/or side 2.  |
| • Vinyl price group B           | +\$543  | Specify vinyl color number for side 1 and/or side 2.  |
| • Customer's Own Material (COM) | +\$176  | ► See <i>Surface Materials Reference Manual</i> .     |

**Clerestory lite glass panels 8'0"H through 10'0"H**

- |                       |         |                                |
|-----------------------|---------|--------------------------------|
| • Glass price group 1 | No cost | Specify glass number for lite. |
| • Glass price group 2 | +\$ 75  | Specify glass number for lite. |
| • Glass price group 3 | +\$ 89  | Specify glass number for lite. |
| • Glass price group 4 | +\$144  | Specify glass number for lite. |
| • Glass price group 5 | N.A.    | Specify glass number for lite. |
| • Glass price group 6 | +\$283  | Specify glass number for lite. |

► Options, continued on next page

► Options, continued from previous page

Options	U.S. Price	Required to Specify
<b>Surface Materials</b>		
<b>Lower panel surfaces 8'0"H through 10'0"H (per side) 40"W to 48"W</b>		
• Paint price group 1	No cost	Specify paint color number.
• Paint price group 3	+\$ 52	Specify paint color number.
• Fabric price group 1	+\$191	Specify fabric color number for side 1 and/or side 2.
• Fabric price group 2	+\$283	Specify fabric color number for side 1 and/or side 2.
• Fabric price group 3	+\$420	Specify fabric color number for side 1 and/or side 2.
• Fabric price group 5	+\$546	Specify fabric color number for side 1 and/or side 2.
• Vinyl price group A	+\$352	Specify vinyl color number for side 1 and/or side 2.
• Vinyl price group B	+\$543	Specify vinyl color number for side 1 and/or side 2.
• Customer's Own Material (COM)	+\$176	► See <i>Surface Materials Reference Manual</i> .
<b>Clerestory lite glass panels 8'0"H through 10'0"H</b>		
• Glass price group 1	No cost	Specify glass number for lite.
• Glass price group 2	+\$100	Specify glass number for lite.
• Glass price group 3	+\$121	Specify glass number for lite.
• Glass price group 4	+\$191	Specify glass number for lite.
• Glass price group 5	N.A.	Specify glass number for lite.
• Glass price group 6	+\$376	Specify glass number for lite.
<b>Lower panel surfaces 8'0"H through 10'0"H (per side) 60"W</b>		
• Paint price group 1	No cost	Specify paint color number.
• Paint price group 3	+\$ 52	Specify paint color number.
• Fabric price group 1	+\$191	Specify fabric color number for side 1 and/or side 2.
• Fabric price group 2	+\$283	Specify fabric color number for side 1 and/or side 2.
• Fabric price group 3	+\$420	Specify fabric color number for side 1 and/or side 2.
• Fabric price group 5	+\$546	Specify fabric color number for side 1 and/or side 2.
• Customer's Own Material (COM)	+\$176	► See <i>Surface Materials Reference Manual</i> .
<b>Clerestory lite glass panels 8'0"H through 10'0"H</b>		
• Glass price group 1	No cost	Specify glass number for lite.
• Glass price group 2	+\$127	Specify glass number for lite.
• Glass price group 3	+\$150	Specify glass number for lite.
• Glass price group 4	+\$237	Specify glass number for lite.
• Glass price group 5	N.A.	Specify glass number for lite.
• Glass price group 6	+\$472	Specify glass number for lite.
<b>Post Extension</b>		
• Post extensions modified to accommodate recessed ceiling track (ordered separately)	No cost	Specify with <i>post extensions for recessed ceiling track interface</i> .
• Post extensions modified to accommodate overlapping ceiling track (ordered separately)	No cost	Specify with <i>post extensions for overlapping ceiling track interface</i> .
<b>Ceiling Height</b>		
• 8'0" through 9'0"	No cost	Specify ceiling height in 1" increments.
• 9'1" through 10'0"	+\$ 85	Specify ceiling height in 1" increments.

► Options, continued on next page

Tip: Vinyl is not available on 60"W panels.

Tip: Customer's Own Glass is available as a special at this time.

Privacy Wall

 **For Canadian Pricing**  
Multiply U.S. Price by the Canadian price factor.  
► See page 1 for details.

## Glass Selections Modular Clerestory Wall Panels Transom-Aligned Top Lite, continued



Tip: To price power in two locations, add the upcharges together.

Tip: Infeed is included in the price of ADA- or desk-height receptacle power location option. Base power block location does not include infeed. It must be ordered separately, if needed.

Tip: Base power block location does not include infeed. It must be ordered separately, if needed.

Tip: NYC/CHI prices replace the receptacle power location option prices when selected.

### Options, continued from previous page

Options	U.S. Price	Required to Specify
<b>Electrical Power (30"W through 60"W)</b>		
<b>Power block location</b>		
• Base	+\$192	Specify with power block location at base.
• ADA height	+\$701	Specify with power block location at ADA height.
• Desk height	+\$701	Specify with power block location at desk height.
<b>Power schematic</b>		
• 3+1	No cost	Specify with 3+1 power.
• 2+2	No cost	Specify with 2+2 power.
• 3SN	No cost	Specify with 3SN power.
<b>New York City/Chicago power prep</b>		
• NYC/CHI at base	N.A.	Specify with NYC/CHI at base.
• NYC/CHI at ADA or desk height side 1	+\$ 24	Specify with NYC/CHI at ADA or desk height side 1.
• NYC/CHI at ADA or desk height side 2	+\$ 24	Specify with NYC/CHI at ADA or desk height side 2.
• NYC/CHI at ADA or desk height sides 1 and 2	+\$ 49	Specify with NYC/CHI at ADA or desk height sides 1 and 2.
<b>Receptacle cutouts</b>		
• Power side 1	No cost	Specify with power side 1.
• Power side 2	No cost	Specify with power side 2.
• Power sides 1 and 2	+\$ 24	Specify with power sides 1 and 2.
• Power/comm side 1	No cost	Specify with power/comm side 1.
• Power/comm side 2	No cost	Specify with power/comm side 2.
• Power/comm sides 1 and 2	+\$ 24	Specify with power/comm sides 1 and 2.
<b>Floor Infeeds</b>		
• Bottom left hardwire	No cost	Specify with bottom left hardwire.
• Bottom left modular	+\$ 89	Specify with bottom left modular.

### Specification Information

Nominal Width	Actual Width	Style Number	Product ID	Change to U.S. Base Price
---------------	--------------	--------------	------------	---------------------------

### Modular Clerestory Panels

8"	6.657"	<b>GPGSMC18</b>	AW00013083	+\$36
9"	7.657"	<b>GPGSMC18</b>	AW00013084	+\$36
10"	8.657"	<b>GPGSMC18</b>	AW00013085	+\$36
11"	9.657"	<b>GPGSMC18</b>	AW00013086	+\$36
12"	10.657"	<b>GPGSMC18</b>	AW00013087	+\$36
13"	11.657"	<b>GPGSMC18</b>	AW00013088	+\$36
14"	12.657"	<b>GPGSMC18</b>	AW00013089	+\$36
15"	13.657"	<b>GPGSMC18</b>	AW00013090	+\$36
16"	14.657"	<b>GPGSMC18</b>	AW00013091	+\$36
17"	15.657"	<b>GPGSMC18</b>	AW00013092	+\$36
19"	17.657"	<b>GPGSMC20</b>	AW00013093	+\$36
21"	19.657"	<b>GPGSMC24</b>	AW00013094	+\$36
22"	20.657"	<b>GPGSMC24</b>	AW00013095	+\$36
23"	21.657"	<b>GPGSMC24</b>	AW00013096	+\$36

### Specification Information, continued on next page



**For Canadian Pricing**  
Multiply U.S. Price by the Canadian price factor.

▶ See page 1 for details.

► Specification Information, continued from previous page

**Specification Information**

Nominal Width	Actual Width	Style Number	Product ID	Change to U.S. Base Price
---------------	--------------	--------------	------------	---------------------------

**Modular Clerestory Panels, continued**

25"	23.657"	<b>GPGSMC30</b>	AW00013097	+\$36
26"	24.657"	<b>GPGSMC30</b>	AW00013098	+\$36
27"	25.657"	<b>GPGSMC30</b>	AW00013099	+\$36
28"	26.657"	<b>GPGSMC30</b>	AW00013100	+\$36
29"	27.657"	<b>GPGSMC30</b>	AW00013101	+\$36
31"	29.657"	<b>GPGSMC36</b>	AW00013102	+\$36
32"	30.657"	<b>GPGSMC36</b>	AW00013103	+\$36
33"	31.657"	<b>GPGSMC36</b>	AW00013104	+\$36
34"	32.657"	<b>GPGSMC36</b>	AW00013112	+\$36
35"	33.657"	<b>GPGSMC36</b>	AW00013113	+\$36
37"	35.657"	<b>GPGSMC40</b>	AW00013114	+\$36
38"	36.657"	<b>GPGSMC40</b>	AW00013115	+\$36
39"	37.357"	<b>GPGSMC40</b>	AW00013116	+\$36
41"	39.657"	<b>GPGSMC42</b>	AW00013117	+\$36
43"	41.657"	<b>GPGSMC48</b>	AW00013118	+\$36
44"	42.657"	<b>GPGSMC48</b>	AW00013119	+\$36
45"	43.657"	<b>GPGSMC48</b>	AW00013120	+\$36
46"	44.657"	<b>GPGSMC48</b>	AW00013121	+\$36
47"	45.657"	<b>GPGSMC48</b>	AW00013123	+\$36
49"	47.657"	<b>GPGSMC60</b>	AW00013124	+\$36
50"	48.657"	<b>GPGSMC60</b>	AW00013125	+\$36
51"	49.657"	<b>GPGSMC60</b>	AW00013126	+\$36
52"	50.657"	<b>GPGSMC60</b>	AW00013127	+\$36
53"	51.657"	<b>GPGSMC60</b>	AW00013128	+\$36
54"	52.657"	<b>GPGSMC60</b>	AW00013129	+\$36
55"	53.657"	<b>GPGSMC60</b>	AW00013130	+\$36
56"	54.657"	<b>GPGSMC60</b>	AW00013131	+\$36
57"	55.657"	<b>GPGSMC60</b>	AW00013132	+\$36
58"	56.657"	<b>GPGSMC60</b>	AW00013133	+\$36
59"	57.657"	<b>GPGSMC60</b>	AW00013134	+\$36
.	.	.	.	.



Privacy Wall

 **For Canadian Pricing**  
Multiply U.S. Price by the  
Canadian price factor.  
► See page 1 for details.





---

# Nurture

▶ See page 3, *About Design Options*, in the front of this book for pricing and ordering restrictions.

## Seating

Cura Chairs	258
Sieste Sleepers with Casters	260
X-tenz Sleeper Chairs	261
Mineral Recliner with Trendelenburg	263
Wide Mineral Recliners	264
Outlook Jarrah Easy Access Bariatric Chair	266
Wide Mitra Recliners	267

## Casegoods

Sync Top Power-In For Use On Double-Sided Bases	268
Sync Right-Hand Worksurfaces For Use with Double-Sided Bases	270
Sync Left-Hand Worksurfaces For Use with Double-Sided Bases	272
Opus Patient Room Headwall Solutions	274
Opus Wardrobe Cabinets with Markerboard Swing Door	275
Opus Sloped Fascia End Cap	276
Opus 1" Thick End Panels	277
Opus Solid Surface Common Tops	278
Opus ADA Sink Cabinet	279
Opus 36" H Hinged-Door Sink Cabinet with Center Divider and Shelf Removed	280
Sonata Media Units	281
Sonata Nurse Servers with Drawer Storage	282
Sonata Nurse Servers with Waste Bin Storage	283
Sonata Islands with Sliding Door	284
Sonata Islands with Open Storage	285
Senza Bedside Tables with Spill Top	286
Folio Corner Units	289
Waldorf Bedside Tables with Spill Top	290

# Cura Chairs

## What's Special

*Sled-base: with two auxiliary casters welded to the back frame of the chair to allow the chair to be rolled when tilted back. Four leg chair: with two auxiliary casters welded to the frame of the back two legs to allow the chair to be rolled when tilted back.*

## Standard Includes

- Frame: paint
- Back: CuraNet mesh
- Seat: mesh, fabric, or Promessa
- Headrest: Promessa
- Arm caps: Urethane in Sterling Dark Finish
- Glides: stainless steel

## Required to Specify

- 1 General quote number: **SF117194**
  - 2 Style number and Product ID
  - 3 Paint color for frame
  - 4 CuraNet color for back
  - 5 Mesh, fabric, or Promessa color number for seat
  - 6 Promessa color number for headrest
  - 7 Options, if selected (see below)
- See Surface Materials in the Nurture Seating Specification Guide.

	Options	U.S. Price	Required to Specify
<b>Surface Materials</b>	<b>Fire code seating</b>		
	• CAL 133 for MU models only	+\$ 98	Add suffix <b>F</b> to the style number.
	<b>Arm caps</b>		
	• Wood arm caps	+\$108	Specify <i>with wood arm caps</i> and select wood color.
<b>Tablet arm</b>	• Tablet arm	+\$243	Specify <i>with tablet</i> and indicate left or right facing.
<b>Plastic glides</b>	• Plastic glides	No cost	Specify <i>with plastic glides</i> .

## Specification Information

Style Number	Width	Product ID	Change to U.S. Prices
.....	.....	.....	.....

## Mid-Back, Sled-Base Chairs

### CuraNet Seat

<b>HN2305MM</b>	21"	SF00205685	+\$160
<b>HN2305EMM</b>	24"	SF00205685	+\$160

### Promessa Seat

<b>HN2315ML</b>	21"	SF00205685	+\$160
<b>HN2315EML</b>	24"	SF00205685	+\$160

### Upholstered Seat

<b>HN2315MU</b>	21"	SF00205685	+\$160
<b>HN2315EMU</b>	24"	SF00205685	+\$160

► **Specification Information, continued on next page**



### For Canadian Pricing

Multiply U.S. Price by the Canadian price factor.

► See page 1 for details.

► Specification Information, continued from previous page

**Specification Information**

Style Number	Width	Product ID	Change to U.S. Prices
--------------	-------	------------	-----------------------



**High-Back, Sled-Base Chairs**

**CuraNet Seat**

<b>HN2306MM</b>	21"	SF00205685	+\$160
<b>HN2306EMM</b>	24"	SF00205685	+\$160

**Promessa Seat**

<b>HN2316ML</b>	21"	SF00205685	+\$160
<b>HN2316EML</b>	24"	SF00205685	+\$160

**Upholstered Seat**

<b>HN2316MU</b>	21"	SF00205685	+\$160
<b>HN2316EMU</b>	24"	SF00205685	+\$160



**Mid-Back, Four-Leg Base Chairs**

**CuraNet Seat**

<b>HN2300MM</b>	21"	SF00207591	+\$238
<b>HN2300EMM</b>	24"	SF00207591	+\$238

**Promessa Seat**

<b>HN2310ML</b>	21"	SF00207591	+\$238
<b>HN2310EML</b>	24"	SF00207591	+\$238

**Upholstered Seat**

<b>HN2310MU</b>	21"	SF00207591	+\$238
<b>HN2310EMU</b>	24"	SF00207591	+\$238



**High-Back, Four-Leg Base Chairs**

**CuraNet Seat**

<b>HN2301MM</b>	21"	SF00207591	+\$238
<b>HN2301EMM</b>	24"	SF00207591	+\$238

**Promessa Seat**

<b>HN2311ML</b>	21"	SF00207591	+\$238
<b>HN2311EML</b>	24"	SF00207591	+\$238

**Upholstered Seat**

<b>HN2311MU</b>	21"	SF00207591	+\$238
<b>HN2311EMU</b>	24"	SF00207591	+\$238



 **For Canadian Pricing**  
 Multiply U.S. Price by the Canadian price factor.  
 ► See page 1 for details.

# Sieste Sleepers with Casters

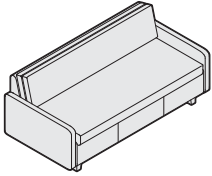

### What's Special

Sieste sleeper will have four casters (not intended for transport) two front locking and two rear non-locking.

### Standard Includes

- Seat and back: fabric
- Closed arms, if selected: fabric
- Nylon glides
- Storage drawer
- Pillows: fabric
- Casters: two front locking and two rear non-locking

### Required to Specify

- 1 General quote number: **SF117179**
- 2 Style number and Product ID
- 3 Fabric color number for seat and back, if selected
- 4 Options, if selected (see below)  
See Surface Materials in the Nurture Casegoods Specification Guide.

### Options

Options	U.S. Price	Required to Specify
<b>Surface Materials</b>		
• <b>Moisture barrier</b>		
• Moisture barrier on seat	+\$432	Specify <i>with moisture barrier</i> .
• <b>Fire code seating</b>		
• CAL 133	+\$686	Add suffix <b>F</b> to the style number.
<b>Storage Drawer</b>		
• Omit storage drawer	No cost	Specify <i>omit storage drawer</i> .

### Specification Information

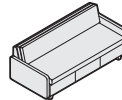
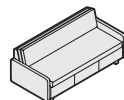
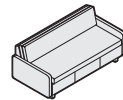

Style Number	Width	Product ID	Change to U.S. Prices
--------------	-------	------------	-----------------------

### Sleepers with Arms

<b>HN26276SA</b>	76"	SF00207566	+\$278
<b>HN26280SA</b>	80"	SF00207566	+\$278
<b>HN26284SA</b>	84"	SF00207566	+\$278

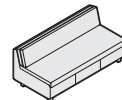
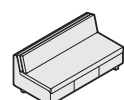
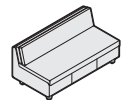

### Sleepers without Arms

<b>HN26276SP</b>	76"	SF00207566	+\$278
<b>HN26280SP</b>	80"	SF00207566	+\$278
<b>HN26284SP</b>	84"	SF00207566	+\$278



### For Canadian Pricing

Multiply U.S. Price by the Canadian price factor.

▶ See page 1 for details.

# X-tenz Sleeper Chairs

## Single Sleeper Chairs

### What's Special

X-tenz sleeper chair is available with upholstered back panel.

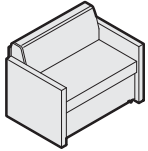

Tip: Specify the rollout section opening to the left or right as you face the front of the sleeper chair.

Tip: Different fabrics for the seat and back can be specified. If the fabrics are in different price groups, calculate list price by adding the two price groups together and dividing by two.

Tip: Need to add 2.44 yards for the upholstered back panel.

Tip: This price is list additional and includes the cost of standard fabric, but does not include the cost of COM fabric.

### Standard Includes

- Seat cushion, back panel, and back bolsters: fabric
- Arm caps: fabric
- Front kick panels: laminate
- Glides or casters: black only

### Required to Specify

- 1 General quote number: **SF125856**
  - 2 Style number and Product ID
  - 3 Fabric color number for seat cushion, back bolsters, and back panel
  - 4 Options, if selected (see below)
- ▶ See *Surface Materials* in the Nurture Seating Specification Guide

Options	U.S. Price	Required to Specify
<b>Surface</b>		
<b>Arm caps</b>		
• Plastisol arm caps:	+\$ 90	Specify with <i>plastisol arm caps</i> and select plastic color number.
• Maple wood arm caps	+\$142	Specify with <i>wood arm caps</i> and select wood color number.
<b>Moisture barrier on seat/mattress only</b>		
• Moisture barrier	+\$324	Specify with <i>moisture barrier</i> .

### Specification Information

Style Number	Product ID	Change to U.S. Base Price
:	:	:
:	:	:

### With Glides

#### With Rollout Section Opening to the Left

<b>SC8141L</b>	SF00217392	+\$354
----------------	------------	--------

#### With Rollout Section Opening to the Right

<b>SC8141R</b>	SF 00217399	+\$354
----------------	-------------	--------

### With Casters

#### With Rollout Section Opening to the Left

<b>SC8141LC</b>	SF00217401	+\$354
-----------------	------------	--------

#### With Rollout Section Opening to the Right

<b>SC8141RC</b>	SF00217407	+\$354
-----------------	------------	--------



### For Canadian Pricing

Multiply U.S. Price by the Canadian price factor.

▶ See page 1 for details.

# X-tenz Sleeper Chairs

## Double Sleeper Chairs

### What's Special

Double X-tenz sleeper is available with upholstered back panel.

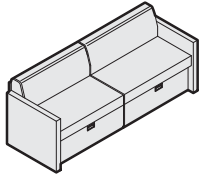

Tip: Different fabrics for the seat and back can be specified. If the fabrics are in different price groups, calculate list price by adding the two price groups together and dividing by two.

Tip: Need to add 4.88 yards for the upholstered back panel.

Tip: This price is list additional and includes the cost of standard fabric, but does not include the cost of COM fabric.

### Standard Includes

- Seat cushion, back panel, and back bolsters: fabric
- Arm caps: fabric
- Front kick panels: laminate
- Glides: black only

### Required to Specify

- 1 General quote number: **SF125856**
  - 2 Style number and Product ID
  - 3 Fabric color number for seat cushion, back bolsters, and back panel
  - 4 Options, if selected (see below)
- ▶ See *Surface Materials* in the Nurture Seating Specification Guide

	Options	U.S. Price	Required to Specify
<b>Surface</b>	<b>Arm caps</b>		
	• Plastisol arm caps:	+\$ 90	Specify with <i>plastisol arm caps</i> and select plastic color number.
	• Maple wood arm caps	+\$142	Specify with <i>wood arm caps</i> and select wood color number.
	<b>Moisture barrier on seat/mattress only</b>		
	• Moisture barrier	+\$432	Specify with <i>moisture barrier</i> .

Specification Information		
• Style Number	• Product ID	• Change to U.S. Base Price
<b>SC8241</b>	SF00217366	+\$658



### For Canadian Pricing

Multiply U.S. Price by the Canadian price factor.

▶ See page 1 for details.

# Mineral Recliners with Trendelenburg

Mineral Recliners with Trendelenburg



Standard Includes	Required to Specify
<ul style="list-style-type: none"> <li>• Seat, back, and arm panels: fabric</li> <li>• Arm caps: wood</li> <li>• 4" non-marring casters: grey</li> <li>• Extended arms</li> </ul>	<ol style="list-style-type: none"> <li>1 General quote number: <b>SF121949</b></li> <li>2 Style number and Product ID</li> <li>3 Fabric color number for seat, back, and arm panels</li> <li>4 Wood color number for arm cap</li> <li>5 Options, if selected (see below)</li> </ol> See Surface Materials in the Nurture Seating Specification Guide.

## What's Special

Recliner with Trendelenburg and extended arms.

*Tip: Different fabrics for the seat and back can be specified. If the fabrics are in different price groups, calculate list price by adding the two price groups together and dividing by two.*

*Tip: Tablet can only be specified on fixed arm model. If mounted on the left, recline levers will be placed on the right arm panel when facing the front of the chair.*

*Tip: Tablet arm option can be specified in conjunction with the IV pole holder and/or drainage bag hanger.*

*Tip: Wood arm caps extend the entire arm.*

*Tip: Flip arm is not available.*

*Tip: Plastisol arm caps are not available.*

Options	U.S. Price	Required to Specify
<b>Surface Materials</b> <ul style="list-style-type: none"> <li>• <b>Moisture barrier</b></li> <li>• Moisture barrier</li> <li>• <b>Fire code seating</b></li> <li>• CAL 133</li> </ul>	+\$172 +\$392	Specify <i>with moisture barrier</i> . Add suffix <b>F</b> to the style number.
<b>Tablet Arm</b> <ul style="list-style-type: none"> <li>• Tablet arm</li> </ul>	+\$371	Specify <i>with tablet</i> and indicate left or right facing.
<b>Push Bar</b> <ul style="list-style-type: none"> <li>• Push bar</li> </ul>	+\$156	Specify <i>with push bar</i> .
<b>Pull Out Footrest</b> <ul style="list-style-type: none"> <li>• Pull out footrest</li> </ul>	+\$416	Specify <i>with pull out footrest</i> .
<b>IV Pole Holder</b> <ul style="list-style-type: none"> <li>• IV pole holder</li> </ul>	+\$ 78	Specify <i>with IV pole holder</i> and for fixed arm model, indicate left or right facing.
<b>Drainage Bag Hanger</b> <ul style="list-style-type: none"> <li>• Drainage bag hanger</li> </ul>	+\$ 52	Specify <i>with drainage bag hanger</i> and for fixed arm model, indicate left or right facing.

Specification Information		
• Style Number	• Product ID	• Change to U.S. Base Price
•	•	•
•	•	•

### With Fixed Arms

<b>SC2091</b>	SF00205310	+\$1180
•	•	•

### With Fixed Arms and Fire Code

<b>SC2091F</b>	SF00214324	+\$1180
•	•	•

Nurture



**For Canadian Pricing**  
 Multiply U.S. Price by the Canadian price factor.  
 ▶ See page 1 for details.

# Wide Mineral Recliners

## What's Special

Mineral recliners are available in wide seating. Seat width is approximately 26" between arms.

Tip: Left and right for flip-down arms, tablet arm, IV pole holder, and drainage bag hanger are determined when facing the front of the chair.

Tip: Different fabrics for the seat and back can be specified. If the fabrics are in different price groups, calculate list price by adding the two price groups together and dividing by two.

Tip: Tablet can only be specified on fixed arm model. If mounted on the left, recline levers will be placed on the right arm panel when facing the front of the chair.

Tip: Tablet arm option can be specified in conjunction with the IV pole holder and/or drainage bag hanger.

Tip: On flip-down arm models, the IV pole holder and/or drainage bag hanger will be positioned on the arm opposite of the flip-down arm.

Tip: Fabric yardage requirement: for same fabric on entire unit, add ½ yard additional per unit. For contrasting fabrics, the back will match the arms and footrest—3.85 yards will need to be added. For the seat, add 1.65 yards.

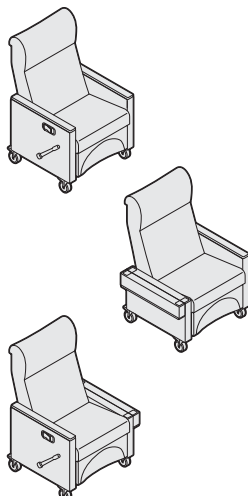

## Standard Includes

- Seat and back: fabric
- Arm caps: wood
- 4" non-marring casters: grey

## Required to Specify

- 1 General quote number: **SF121953**
  - 2 Style number and Product ID
  - 3 Fabric color number for seat and back
  - 4 Wood color number for arm cap
  - 5 Options, if selected (see below)
- See Surface Materials in the Nurture Seating Specification Guide.

Options	U.S. Price	Required to Specify
<b>Surface Materials</b>		
• <b>Moisture barrier</b>	+\$172	Specify with moisture barrier.
• <b>Fire code seating</b>	+\$392	Add suffix <b>F</b> to the style number.
• CAL 133		
<b>Arm Caps</b>		
• Plastisol arm caps	+\$ 90	Specify with <i>plastisol arm caps</i> and select plastic color number.
<b>Tablet Arm</b>		
• Tablet arm	+\$371	Specify with <i>tablet</i> and indicate left or right facing.
<b>Push Bar</b>		
• Push bar	+\$156	Specify with <i>push bar</i> .
<b>Pull Out Footrest</b>		
• Pull out footrest	+\$416	Specify with <i>pull out footrest</i> .
<b>IV Pole Holder</b>		
• IV pole holder	+\$ 78	Specify with <i>IV pole holder</i> and for fixed arm model, indicate left or right facing.
<b>Drainage Bag Hanger</b>		
• Drainage bag hanger	+\$ 52	Specify with <i>drainage bag hanger</i> and for fixed arm model, indicate left or right facing.

## Specification Information

Style Number	Product ID	Change to U.S. Base Price
:	:	:
:	:	:

### Wide Mineral Recliner With Fixed Arms

<b>SC2091</b>	SF00191009	+\$709
:	:	:

### Wide Mineral Recliner With Left Flip-down Arm

<b>SC2091L</b>	SF00205441	+\$709
:	:	:

### Wide Mineral Recliner With Right Flip-down Arm

<b>SC2091R</b>	SF00205440	+\$709
:	:	:

► Specification Information, continued on next page



► **Specification Information, continued from previous page**

**Specification Information**

• Style Number	• Product ID	• Change to U.S. Base Price
----------------	--------------	-----------------------------

**Wide Mineral Recliner With Fixed Arms and Fire Code**

<b>SC2091F</b>	SF002121433	+\$709
----------------	-------------	--------

**Wide Mineral Recliner With Left Flip-down Arm and Fire Code**

<b>SC2091LF</b>	SF00214317	+\$709
-----------------	------------	--------

**Wide Mineral Recliner With Right Flip-down Arm and Fire Code**

<b>SC2091RF</b>	SF00213705	+\$709
-----------------	------------	--------

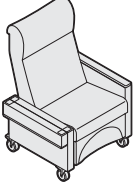

**For Canadian Pricing**  
 Multiply U.S. Price by the  
 Canadian price factor.  
 ► See page 1 for details.

# Outlook Jarrah Easy Access Bariatric Chair

## What's Special

Outlook Jarrah Easy Access Bariatric Chair is available.

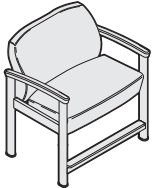

Tip: Different fabrics for the seat and back can be specified. If the fabrics are in different price groups, calculate list price by adding the two price groups together and dividing by two.

## Standard Includes

- Seat and back: fabric
- Arm caps: wood
- Oval legs: black paint
- Glides: black only

## Required to Specify

- 1 General quote number: **SF125829**
  - 2 Style number and Product ID
  - 3 Fabric color number for seat and back
  - 4 Wood color number for side stretcher and arm caps
  - 5 Paint color number for oval legs
  - 6 Options, if selected (see below)
- ▶ See *Surface Materials* in the Nurture Seating Specification Guide

Options	U.S. Price	Required to Specify
<b>Surface Materials</b> <ul style="list-style-type: none"> <li>• <b>Moisture barrier</b></li> <li>• Moisture barrier</li> <li>• <b>Fire code seating</b></li> <li>• CAL 133</li> </ul>	+\$ 86 +\$294	Specify <i>with moisture barrier</i> . Add suffix <b>F</b> to the style number.
<ul style="list-style-type: none"> <li>• <b>Plastisol arm cap</b></li> <li>• Arm cap</li> </ul>	+\$ 45 per cap	Specify <i>with plastisol arm caps</i> and select plastic color number.
<b>Floor Glide Inserts</b> <ul style="list-style-type: none"> <li>• Floor glide inserts</li> </ul>	No cost	Specify <i>with floor glide inserts</i> .

## Specification Information

Dimensions		Style Number	Product ID	Change to U.S. Base Price
W	H			
30"	24"	<b>SC2260</b>	SF00199179	+\$362



### For Canadian Pricing

Multiply U.S. Price by the Canadian price factor.

▶ See page 1 for details.

## What's Special

Mitra recliner is available in wide seating. Seat width is approximately 26" between arms.

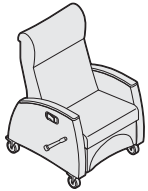

*Tip: Different fabrics for the seat and back can be specified. If the fabrics are in different price groups, calculate list price by adding the two price groups together and dividing by two.*

*Tip: If tablet is specified on the left, the recline levers will be positioned on the right arm panel when facing the front of the chair.*

*Tip: Tablet arm option can be specified in conjunction with the IV pole holder and/or drainage bag hanger.*

*Tip: IV pole holder and/or drainage bag hanger will be positioned on the arm opposite the recline levers.*

*Tip: Fabric yardage requirement: for same fabric on entire unit, add ½ yard additional per unit. For contrasting fabrics, the back will match the arms and footrest—3.85 yards will need to be added. For back and arm: 3.85 yards total. For seat, and footrest: 1.65 yards.*

*Tip: Wide version is not available in Trendelenburg.*

## Standard Includes

- Seat and back: fabric
- Arm caps: wood
- Casters: 4" non-marring

## Required to Specify

- 1 General quote number: **SF121953**
  - 2 Style number and Product ID
  - 3 Fabric color number for seat and back
  - 4 Wood color number for arm cap
  - 5 Options, if selected (see below)
- See Surface Materials in the Nurture Seating Specification Guide.

Options	U.S. Price	Required to Specify
<b>Surface Materials</b>		
• <b>Moisture barrier</b>	+\$172	Specify with moisture barrier.
• <b>Fire code seating</b>	+\$392	Add suffix <b>F</b> to the style number.
• CAL 133		
<b>Arm Caps</b>		
• Plastisol arm caps	+\$ 90	Specify with plastisol arm caps and select plastic color number.
<b>Tablet Arm</b>		
• Tablet arm	+\$371	Specify with tablet and indicate left or right facing.
<b>Push Bar</b>		
• Push bar	+\$156	Specify with push bar.
<b>Pull Out Footrest</b>		
• Pull out footrest	+\$416	Specify with pull out footrest.
<b>IV Pole Holder</b>		
• IV pole holder	+\$ 78	Specify with IV pole holder.
<b>Drainage Bag Hanger</b>		
• Drainage bag hanger	+\$ 52	Specify with drainage bag hanger.

## Specification Information

Style Number	Product ID	Change to U.S. Base Price
:	:	:
:	:	:
:	:	:

## Wide Recliner

<b>SC6091</b>	SF00212515	+\$709
:	:	:

## Wide Recliner with Fire Code

<b>SC6091F</b>	SF00210927	+\$709
:	:	:



### For Canadian Pricing

Multiply U.S. Price by the Canadian price factor.

► See page 1 for details.

# Sync Top Power-In For Use On Double-Sided Bases

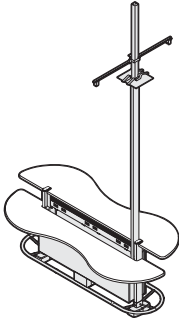

## What's Special

Top power-in housing to allow electrician supplied electrical wiring and cabling to drop from ceiling into technology stretcher. To be used with ceilings that are ten feet high or lower.

*Tip:* Sync top must be designed to accept top power-in.

*Tip:* Left-hand or right-hand is determined while sitting at the lower top.

*Tip:* Standard base to be ordered separately.

*Tip:* Top power-in can be used on any standard width double-sided base.

## Standard Includes

- Legs: 4799 Platinum only
- Accommodates 10' ceiling heights

## Required to Specify

- 1 General quote number: **SF121506**
- 2 Style number and Product ID

## Specification Information

Orientation	Style Number	Product ID	Change to U.S. Base Price
-------------	--------------	------------	---------------------------

### Upper Base 36"H, Lower Base 28½"H, Top Power-In

Left-Hand	<b>HBB723628</b>	SF00208501	+\$1626
Right-Hand	<b>HBB723628</b>	SF00203586	+\$1626

### Upper Base 42"H, Lower Base 28½"H, Top Power-In

Left-Hand	<b>HBB724228</b>	SF00204082	+\$1626
Right-Hand	<b>HBB724228</b>	SF00204091	+\$1626

### Upper Base 42"H, Lower Base 36"H, Top Power-In

Left-Hand	<b>HBB724236</b>	SF00198733	+\$1626
Right-Hand	<b>HBB724236</b>	SF00211322	+\$1626



## For Canadian Pricing

Multiply U.S. Price by the Canadian price factor.

▶ See page 1 for details.



# Sync Right-Hand Worksurfaces For Use with Double-Sided Bases

## What's Special

Sync worksurface available with cut-out for right-hand top power-in.

*Tip: Top power-in is determined by sitting at the lower side top with the upper top being on the opposite side. Handing determination could get tricky.*

*Tip: Left-hand or right-hand is determined while sitting at the lower top.*

*Tip: The width of the worksurface must match the width of the base.*

*Tip: Upper process tops require a notch when the top power-in is used on the double units.*

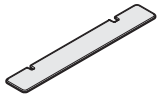

*Tip: Transaction top available on 36"H and 42"H sides only.*

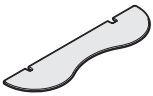

*Tip: When using the WFCS Slatwall Stanchion, Eyesite LCD arms, and the FYI c-clamp design (i.e. FPASINGLECC) on solid surface tops, a filler bracket (HBRKTS) also needs to be specified.*



**For Canadian Pricing**  
Multiply U.S. Price by the Canadian price factor.  
▶ See page 1 for details.

## Standard Includes

- Laminate worksurface, if selected: laminate
- Solid surface worksurface, if selected: price group A
- Edge band on laminate worksurface, if selected: 3 mm plastic

## Required to Specify

- 1 General quote number: **SF121506**
  - 2 Style number and Product ID
  - 3 Laminates or solid surface color number for worksurface
  - 4 Plastic color number for edge band, if selected
- See Surface Materials in the Nurture Casegoods Specification Guide.

## Specification Information

Dimensions D W	Style Number	Product ID	Change to U.S. Base Price
-------------------	--------------	------------	------------------------------

### Upper Transaction Worksurfaces Right-Hand

#### Laminate

15" 72"	<b>HT72UTL</b>	SF00204085	+\$110
15" 84"	<b>HT84UTL</b>	SF00196098	+\$110
15" 96"	<b>HT96UTL</b>	SF00212749	+\$110
15" 108"	<b>HT108UTL</b>	SF00197514	+\$110

#### Solid Surface

15" 72"	<b>HT72UTS</b>	SF00204878	+\$190
15" 84"	<b>HT84UTS</b>	SF00211498	+\$190
15" 96"	<b>HT96UTS</b>	SF00212783	+\$190
15" 108"	<b>HT108UTS</b>	SF00188577	+\$190

### Upper Interaction Worksurfaces Right-Hand

#### Laminate

24" 72"	<b>HT72UNL</b>	SF00211571	+\$110
24" 84"	<b>HT84UNL</b>	SF00212830	+\$110
24" 96"	<b>HT96UNL</b>	SF00204087	+\$110
24" 108"	<b>HT108UNL</b>	SF00212838	+\$110

#### Solid Surface

24" 72"	<b>HT72UNS</b>	SF00188851	+\$190
24" 84"	<b>HT84UNS</b>	SF00189099	+\$190
24" 96"	<b>HT96UNS</b>	SF00212866	+\$190
24" 108"	<b>HT108UNS</b>	SF00212868	+\$190

▶ **Specification Information, continued on next page**

► **Specification Information, continued from previous page**

**Specification Information**

Dimensions		Style Number	Product ID	Change to
D	W			U.S. Base Price

**Upper Process Worksurfaces Right-Hand**

**Laminate**

24"	72"	<b>HT72UPL</b>	SF00212871	+\$110
24"	84"	<b>HT84UPL</b>	SF00212873	+\$110
24"	96"	<b>HT96UPL</b>	SF00212875	+\$110
24"	108"	<b>HT108UPL</b>	SF00212877	+\$110

**Solid Surface**

24"	72"	<b>HT72UPS</b>	SF00212879	+\$190
24"	84"	<b>HT84UPS</b>	SF00212881	+\$190
24"	96"	<b>HT96UPS</b>	SF00212883	+\$190
24"	108"	<b>HT108UPS</b>	SF00212885	+\$190

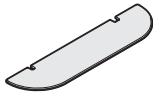

*Tip: Upper process tops require a notch when the top power-in is used on the double units.*



**For Canadian Pricing**  
Multiply U.S. Price by the  
Canadian price factor.  
► See page 1 for details.

# Sync Left-Hand Worksurfaces For Use with Double-Sided Bases

## What's Special

Sync worksurface available with cut-out for left-hand top power-in.

*Tip: Top power-in is determined by sitting at the lower side top with the upper top being on the opposite side. Handing determination could get tricky.*

*Tip: Left-hand or right-hand is determined while sitting at the lower top.*

*Tip: The width of the worksurface must match the width of the base.*

*Tip: Upper process tops require a notch when the top power-in is used on the double units.*

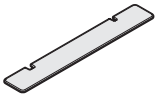

*Tip: Transaction top available on 36"H and 42"H sides only.*

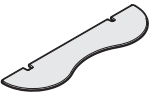

*Tip: When using the WFCS Slatwall Stanchion, Eyesite LCD arms, and the FYI c-clamp design (i.e. FPASINGLECC) on solid surface tops, a filler bracket (HBRKTS) also needs to be specified.*



**For Canadian Pricing**  
Multiply U.S. Price by the Canadian price factor.  
▶ See page 1 for details.

## Standard Includes

- Laminate worksurface, if selected: laminate
- Solid surface worksurface, if selected: price group A
- Edge band on laminate worksurface, if selected: 3 mm plastic

## Required to Specify

- 1 General Quote Number **SF121506**
  - 2 Laminate or solid surface color number for worksurface
  - 3 Plastic color number for edge band, if selected
- See Surface Materials in the Nurture Casegoods Specification Guide.

## Specification Information

Dimensions D W	Style Number	Product ID	Change to U.S. Base Price
-------------------	--------------	------------	------------------------------

### Upper Transaction Worksurfaces Left-Hand

#### Laminate

15" 72"	<b>HT72UTL</b>	SF00198778	+\$110
15" 84"	<b>HT84UTL</b>	SF00196097	+\$110
15" 96"	<b>HT96UTL</b>	SF00212750	+\$110
15" 108"	<b>HT108UTL</b>	SF00197510	+\$110

#### Solid Surface

15" 72"	<b>HT72UTS</b>	SF00193802	+\$190
15" 84"	<b>HT84UTS</b>	SF00193800	+\$190
15" 96"	<b>HT96UTS</b>	SF00212784	+\$190
15" 108"	<b>HT108UTS</b>	SF00209333	+\$190

### Upper Interaction Worksurfaces Left-Hand

#### Laminate

24" 72"	<b>HT72UNL</b>	SF00203587	+\$110
24" 84"	<b>HT84UNL</b>	SF00212832	+\$110
24" 96"	<b>HT96UNL</b>	SF00204086	+\$110
24" 108"	<b>HT108UNL</b>	SF00212839	+\$110

#### Solid Surface

24" 72"	<b>HT72UNS</b>	SF00194229	+\$190
24" 84"	<b>HT84UNS</b>	SF00189100	+\$190
24" 96"	<b>HT96UNS</b>	SF00212867	+\$190
24" 108"	<b>HT108UNS</b>	SF00212870	+\$190

▶ **Specification Information, continued on next page**



► **Specification Information, continued from previous page**

**Specification Information**

• Dimensions		• Style Number	• Product ID	• Change to
D	W			U.S. Base Price

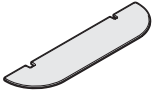

**Upper Process Worksurfaces Left-Hand**

**Laminate**

24"	72"	<b>HT72UPL</b>	SF00212872	+\$110
24"	84"	<b>HT84UPL</b>	SF00212874	+\$110
24"	96"	<b>HT96UPL</b>	SF00212876	+\$110
24"	108"	<b>HT108UPL</b>	SF00212878	+\$110

**Solid Surface**

24"	72"	<b>HT72UPS</b>	SF00212880	+\$190
24"	84"	<b>HT84UPS</b>	SF00212882	+\$190
24"	96"	<b>HT96UPS</b>	SF00212884	+\$190
24"	108"	<b>HT108UPS</b>	SF00212886	+\$190



 **For Canadian Pricing**  
Multiply U.S. Price by the  
Canadian price factor.  
► See page 1 for details.

# Opus Patient Room Headwall Solutions

Laminate

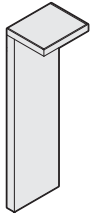

*Tip: The melamine color matches the selected laminate color, so it does not need to be specified.*

*Tip: One wall-anchor bracket should be attached to each headwall unit. Wall-anchor brackets are ordered in packets of four, style number HAW4, and can be found in the Nurture Casegoods specification guide.*

*Tip: Two brackets are recommended for 24"-36"W headwall units. For units wider than 36", three brackets are recommended.*

*Tip: To determine available switch cutout locations and dimensions for selected cabinet*  
▶ See Nurture Casegoods Specification Guide

## What's Special

*Opus desk cabinets have been resized and all desks have been removed to create Opus units for patient headwall applications.*



### For Canadian Pricing

Multiply U.S. Price by the Canadian price factor.

▶ See page 1 for details.

Standard Includes	Required to Specify
<ul style="list-style-type: none"> <li>• Base headwall unit: Melamine</li> <li>• Adjustable glides</li> </ul>	<ol style="list-style-type: none"> <li>1 General quote number: <b>SF110431</b></li> <li>2 Style number and Product ID</li> <li>3 Laminate color number for headwall unit</li> <li>4 Edge band color number (Specify to match headwall color)</li> <li>5 Options, if selected (see below)</li> </ol> See Surface Materials in the Nurture Casegoods Specification Guide.

Options	U.S. Price	Required to Specify
<b>Surface Materials</b> <ul style="list-style-type: none"> <li>• Laminate</li> <li>• Open Line laminate</li> </ul>	No cost +\$85	▶ See Surface Materials in the Nurture Casegoods Specification Guide. ▶ See Surface Materials in the Nurture Casegoods Specification Guide.
<b>Light Cutouts</b> <ul style="list-style-type: none"> <li>• Left, right, or center cutout</li> <li>• Left and right cutout</li> </ul>	+\$17 each +\$22	Specify with left, right, or center light cutout. Specify with left and right light cutout.
<b>Switch Cutouts</b> <ul style="list-style-type: none"> <li>• Single and double cutouts</li> </ul>	+\$ 6 each	Specify cutout location and select single or double cutout.
<b>Related Products</b> <ul style="list-style-type: none"> <li>• Bedside tables</li> <li>• Overhead shelves and cabinets</li> <li>• Accessories</li> <li>• Mobile overbed table</li> </ul>		▶ See Nurture Casegoods Specification Guide.

## Specification Information

Dimensions	Style	Product ID	Change to
D W H	Number		U.S. Base Price
.....	.....	.....	.....

### 24" Wide Headwall

20"	24"	84"	<b>HC2484NL</b>	SF00199359	+\$ 1
.....	.....	.....	.....	.....	.....

### 30" Wide Headwall

20"	30"	84"	<b>HC3684NL</b>	SF00186077	+\$ 1
.....	.....	.....	.....	.....	.....

### 36" Wide Headwall

20"	36"	84"	<b>HC3684NL</b>	SF00199365	+\$ 1
.....	.....	.....	.....	.....	.....

### 48" Wide Headwall

20"	48"	84"	<b>HC3684NL</b>	SF00189884	+\$178
.....	.....	.....	.....	.....	.....

### 54" Wide Headwall

20"	54"	84"	<b>HC3684NL</b>	SF00169539	+\$396
.....	.....	.....	.....	.....	.....

### 60" Wide Headwall

20"	60"	84"	<b>HC3684NL</b>	SF00199368	+\$416
.....	.....	.....	.....	.....	.....

# Opus Wardrobe Cabinets with Markerboard Swing Door

Opus  
Wardrobe Cabinets with  
Markerboard Swing Door

## Laminate

*Tip: The melamine color matches the selected laminate color, so it does not need to be specified.*

*Tip: Markerboard surface on swing door front only. Adjacent strip is woodgrain melamine matching the wardrobe cabinet.*

*Tip: Markerboard surface on swing door surface is non-magnetic.*

### What's Special

Swing door wardrobe units have markerboard surface fronts.

\*Must order lock plugs from Service Parts (943101074SR).

### Standard Includes

- Wardrobe cabinet and fixed shelf: melamine
- Door front: non-magnetic 2710 Frost White laminate markerboard surface
- Fixed shelf: melamine
- Edge band on markerboard door: 3 mm white PVC
- Base: black melamine only
- Rail pulls on melamine door: champagne paint only
- Hanger bar: white paint only
- Adjustable glides

### Required to Specify

- 1 General quote number: **SF110431**
  - 2 Style number and Product ID
  - 3 Laminate color number for wardrobe cabinet
  - 4 Edge band color number (Specify to match cabinet color)
  - 5 Options, if selected (see below)
- See Surface Materials in the Nurture Casegoods Specification Guide.

	Options	U.S. Price	Required to Specify
<b>Surface Materials</b>	• Laminate	No cost	▶ See Surface Materials in the Nurture Casegoods Specification Guide.
	• Open Line laminate	+\$ 85	▶ See Surface Materials in the Nurture Casegoods Specification Guide.
<b>Shelf Package</b>	• Shelves: melamine	+\$194	Specify with shelf package.
<b>Lock and Keying</b>	<b>Lock</b>		
	• Polished Chrome	+\$ 21	Specify with lock
	<b>Keying</b>		
	• Standard keying	No cost	Specify with standard keying.
	• Specific keying	No cost	Specify with field installed locks.*
	• Master keying	+\$ 23	Specify with master keying.
<b>Related Products</b>	• Cabinets • Mobile overbed table		▶ See Nurture Casegoods Specification Guide.

### Specification Information

Dimensions			Style	Product ID	Change to
D	W	H	Number		U.S. Base Price
20"	24"	84"	HC2484WHLL	SF00199369	+\$356

### Left-Hand Markerboard Door

20"	24"	84"	HC2484WHLL	SF00199369	+\$356
-----	-----	-----	------------	------------	--------

### Right-Hand Markerboard Door

20"	24"	84"	HC2484WHRL	SF00199370	+\$356
-----	-----	-----	------------	------------	--------

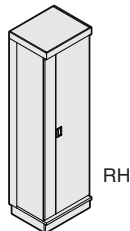
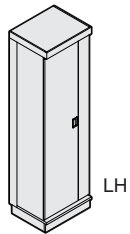

**For Canadian Pricing**  
Multiply U.S. Price by the Canadian price factor.  
▶ See page 1 for details.

# Opus Sloped Fascia End Cap

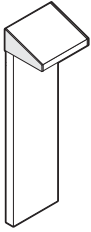

## What's Special

Sloped fascia end cap is used to finish top of sloped fascia end-of-run.

### Standard Includes

- Sloped fascia end cap: laminate
- Attachment hardware

### Required to Specify

- 1 General quote number: **SF110431**
  - 2 Style number and Product ID
  - 3 Laminate color number for sloped fascia end cap
- See Surface Materials in the Nurture Casegoods Specification Guide.

### Specification Information

• Dimensions			• Style	• Product ID	• U.S. Price
D	H	Thickness	Number		
20 1/8"	11"	3/4"	<b>HFESL</b>	SF00173489	\$104
.	.	.	.	.	.



### For Canadian Pricing

Multiply U.S. Price by the Canadian price factor.

▶ See page 1 for details.

# Opus 1" Thick End Panels

Opus  
1" Thick End Panels

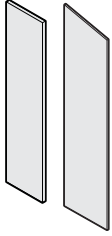

## What's Special

End panels are full height, 1" thick and include adjustable front and rear glides. For use with end-of-run applications.

### Standard Includes

- End panel: laminate
- Attachment hardware
- Adjustable glides

### Required to Specify

- 1 General quote number: **SF110431**
- 2 Style number and Product ID
- 3 Laminate color number for end panel  
See Surface Materials in the Nurture Casegoods Specification Guide.

### Specification Information

Dimensions			Style	Product ID	Change to
D	H	T	Number		U.S. Price

#### 1" Thick End Panel

20 1/8"	84"	1"	<b>HB84EL</b>	SF00199376	+\$166
---------	-----	----	---------------	------------	--------

#### 1" Thick Sloped End Panel

20 1/8"	92"	1"	<b>HFESL</b>	SF00198984	+\$166
---------	-----	----	--------------	------------	--------



### For Canadian Pricing

Multiply U.S. Price by the Canadian price factor.

▶ See page 1 for details.

# Opus Solid Surface Common Tops

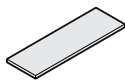

## What's Special

Common tops are solid surface and sized to coordinate with Opus units.

### Standard Includes

- Solid surface top: solid surfaces

### Required to Specify

- 1 General quote number: **SF110431**
- 2 Style number and Product ID
- 3 Solid Surface color number for top  
See Surface Materials in the Nurture Casegoods Specification Guide.

### Specification Information

Dimensions		Style Number	Product ID	Change to U.S. Base Prices				
D	W			Group A	Group B	Group C	Group D	Group E
<b>24" Wide Solid Surface Top</b>								
15"	24"	<b>HXW2424S</b>	SF00199632	+\$190	+\$190	+\$190	+\$190	+\$190
<b>36" Wide Solid Surface Top</b>								
15"	36"	<b>HXW3624S</b>	SF00193149	+\$190	+\$190	+\$190	+\$190	+\$190
<b>48" Wide Solid Surface Top</b>								
15"	48"	<b>HXW4824S</b>	SF00199633	+\$190	+\$190	+\$190	+\$190	+\$190
<b>60" Wide Solid Surface Top</b>								
15"	60"	<b>HXW6024S</b>	SF00199634	+\$190	+\$190	+\$190	+\$190	+\$190
<b>72" Wide Solid Surface Top</b>								
15"	72"	<b>HXW7224S</b>	SF00199635	+\$190	+\$190	+\$190	+\$190	+\$190
<b>84" Wide Solid Surface Top</b>								
15"	84"	<b>HXW8424S</b>	SF00199624	+\$190	+\$190	+\$190	+\$190	+\$190



### For Canadian Pricing

Multiply U.S. Price by the Canadian price factor.

▶ See page 1 for details.

# Opus ADA Sink Cabinet

Opus  
ADA Sink Cabinet

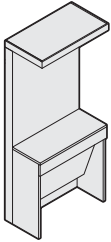

*Tip: The melamine color matches the selected laminate color, so it does not need to be specified.*

*Tip: Sink must be independently purchased and field installed. Sink cutout must be cut in the field.*

*Tip: See Nurture Casegoods Specification Guide for common tops.*

*Tip: Maximum sink cutout size is 12<sup>1</sup>/<sub>4</sub>" front to back.*  
▶ See Nurture Casegoods Specification Guide for more product details.

▶ See Nurture Casegoods Specification Guide to determine available switch cutout locations and dimensions for selected cabinet.

## What's Special

ADA compliant Opus sink cabinet unit with 23"D X 36"W X 33<sup>1</sup>/<sub>2</sub>"H sink unit with sloped front.

Standard Includes	Required to Specify
<ul style="list-style-type: none"> <li>• Base unit and storage unit case: melamine</li> <li>• Storage unit top: laminate</li> <li>• Edge band of storage unit top: 3 mm plastic</li> <li>• Adjustable glides</li> </ul>	<ol style="list-style-type: none"> <li>1 General quote number: <b>SF110431</b></li> <li>2 Style number and Product ID</li> <li>3 Laminate color number for ADA cabinet unit</li> <li>4 Edge band color number for storage unit top</li> <li>5 Options, if selected (see below)</li> </ol> See Surface Materials in the Nurture Casegoods Specification Guide.

Options	U.S. Price	Required to Specify
<b>Surface Materials</b> <ul style="list-style-type: none"> <li>• Laminate</li> <li>• Open Line laminate</li> </ul>	No cost +\$85	▶ See Surface Materials in the Nurture Casegoods Specification Guide. ▶ See Surface Materials in the Nurture Casegoods Specification Guide.
<b>Storage Unit Top</b> <ul style="list-style-type: none"> <li>• Omit top</li> </ul>	-\$54	Specify with no top.
<b>Light Cutouts</b> <ul style="list-style-type: none"> <li>• Left, right, or center cutout</li> <li>• Left and right cutout</li> </ul>	+\$17 each +\$22	Specify with left, right, or center light cutout. Specify with left and right light cutout.
<b>Switch Cutouts</b> <ul style="list-style-type: none"> <li>• Single and double cutouts</li> </ul>	+\$ 6 each	Specify cutout location and select single or double cutout.
<b>Related Products</b> <ul style="list-style-type: none"> <li>• Bedside tables</li> <li>• Overhead shelves and cabinets</li> <li>• Accessories</li> <li>• Mobile overbed table</li> </ul>		▶ See Nurture Casegoods Specification Guide.

## Specification Information

Dimensions			Style	Product ID	Change to
D	W	H	Number		U.S. Price
23"	36"	84"	<b>HC3684LL</b>	SF00199396	+\$656

### 36" ADA Sink Cabinet

Nurture



**For Canadian Pricing**  
Multiply U.S. Price by the Canadian price factor.  
▶ See page 1 for details.

# Opus 36"H Hinged-Door Sink Cabinet with Center Divider and Adjustable Shelf Removed

Laminate

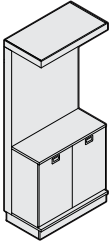

*Tip: The melamine color matches the selected laminate color, so it does not need to be specified.*

*Tip: See Nurture Specification Guide for common tops.*

*Tip: Sink must be independently purchased and field installed. Sink cutout must be cut in the field.*

*Tip: Maximum sink cutout size is 12 1/4" front to back. ▶ See Nurture Casegoods Specification Guide for more product details.*

▶ See Nurture Specification Guide to determine available switch cutout locations and dimensions for selected cabinet.

\*Must order lock plugs from Service Parts (943101074SR).

Standard Includes	Required to Specify
<ul style="list-style-type: none"> <li>• Base unit and storage unit case: melamine</li> <li>• Storage unit top and door fronts: laminate</li> <li>• Edge band of storage unit top and doors: 3 mm plastic</li> <li>• Flush pulls: champagne only</li> <li>• Base: black melamine only</li> <li>• Adjustable glides</li> </ul>	<ol style="list-style-type: none"> <li>1 General quote number: <b>SF110431</b></li> <li>2 Style number and Product ID</li> <li>3 Laminate color number for sink cabinet unit</li> <li>4 Edge band color number for sink cabinet unit top and doors</li> <li>5 Options, if selected (see below) See Surface Materials in the Nurture Casegoods Specification Guide.</li> </ol>

	Options	U.S. Price	Required to Specify
<b>Surface Materials</b>	• Laminate	No cost	▶ See Surface Materials in the Nurture Casegoods Specification Guide. ▶ See Surface Materials in the Nurture Casegoods Specification Guide.
	• Open Line laminate	+\$85	
<b>Storage Unit Top</b>	• Omit top	-\$54	Specify with no top.
<b>Light Cutouts</b>	• Left, right, or center cutout	+\$17 each	Specify with left, right, or center light cutout.
	• Left and right cutout	+\$22	Specify with left and right light cutout.
<b>Switch Cutouts</b>	• Single and double cutouts	+\$ 6 each	Specify cutout location and select single or double cutout.
<b>Lock and Keying</b>	<b>Lock</b>		
	• Polished Chrome	+\$21	Specify with lock.
<b>Related Products</b>	<b>Keying</b>		
	• Standard keying	No cost	Specify with standard keying.
	• Specific keying	No cost	Specify with field installed locks.*
	• Master keying	+\$23	Specify with master keying.
<b>Related Products</b>	• Bedside tables		▶ See Nurture Casegoods Specification Guide.
	• Overhead shelves and cabinets		
	• Accessories		
	• Mobile overbed table		

## What's Special

Center divider and adjustable shelf has been removed from standard sink cabinet allowing for greater choice of sink placement and better access to plumbing.

## Specification Information

Dimensions			Style Number	Product ID	Change to U.S. Prices
D	W	H			
20"	36"	84"	<b>HC3684LL</b>	SF00199631	+\$118



### For Canadian Pricing

Multiply U.S. Price by the Canadian price factor.

▶ See page 1 for details.





### What's Special

Unit is single-sided with solid surface top.

Tip: 3 mm space occurs when against the wall. Fill gap with service part 943101381SR.

Tip: Specials are also required for the Sonata rigid thermoform tops in order to be pushed up to a wall but are not available through Design Options. Please request a special if you need rigid thermoform tops that will need to be pushed up against the wall.

Tip: This special is not required for laminate work-surfaces, laminate tops for Sonata are already squared off and can be pushed up against a wall.

Tip: Installers will need to fill or span the gap at the base with cove molding as the base does not reach all the way to the wall.

Standard Includes	Required to Specify
-------------------	---------------------

- Media unit: laminate
- Top: solid surface
- Edge band: 3 mm plastic
- Rail: Champagne only

- 1 General quote number: **SF117403**
  - 2 Style number and Product ID
  - 3 Laminate color number for media unit cabinet
  - 4 Solid surface color number for top
  - 5 Options, if selected (see below)
- See Surface Materials in the Nurture Casegoods Specification Guide.

Options	U.S. Price	Required to Specify
---------	------------	---------------------

**Surface Materials**

- Laminate No cost
- Open Line laminate +\$ 85

- ▶ See Surface Materials in the Nurture Casegoods Specification Guide.
- ▶ See Surface Materials in the Nurture Casegoods Specification Guide.

**Solid Surface**

- Solid surface price group A No cost
- Solid surface price group B +\$ 91
- Solid surface price group C +\$ 91
- Solid surface price group D +\$102
- Solid surface price group E +\$112

- Specify solid surface color number or finish code.
- Specify solid surface color number or finish code.
- Specify solid surface color number or finish code.
- Specify solid surface finish code.
- Specify solid surface finish code.

### Specification Information

• Dimensions			• Style	• Product ID	• Change to
D	W	H	Number		U.S. Price
18"	24"	36"	<b>HM1MA2436S</b>	SF00207813	+\$140

Nurture



### For Canadian Pricing

Multiply U.S. Price by the Canadian price factor.

▶ See page 1 for details.

# Sonata

## Nurse Servers with Drawer Storage

Solid Surface

*Tip: For finish codes and more information on the solid surface Graded-In program, see Surface Materials.*

► Nurture Casegoods Specification Guide.

\*Must order lock plugs from Service Parts (943101074SR).

### What's Special

Back edge of solid top is squared to allow the top to rest flush against a wall.

*Tip: 3 mm space occurs when against the wall. Fill gap with service part 943101381SR.*

*Tip: Specials are also required for the Sonata rigid thermoform tops in order to be pushed up to a wall but are not available through Design Options. Please request a special if you need rigid thermoform tops that will need to be pushed up against the wall.*

*Tip: This special is not required for laminate work-surfaces, laminate tops for Sonata are already squared off and can be pushed up against a wall.*

*Tip: Installers will need to fill or span the gap at the base with cove molding as the base does not reach all the way to the wall.*

*Tip: With overhang omitted on the rear edge if the solid top to allow unit to fit flush against architectural wall.*



### For Canadian Pricing

Multiply U.S. Price by the Canadian price factor.

► See page 1 for details.

Standard Includes	Required to Specify
<ul style="list-style-type: none"> <li>Nurse server: laminate</li> <li>Rigid thermoform pull-out worksurface: sand only</li> <li>Top: solid surface</li> <li>Edge band: 3 mm plastic</li> <li>Flush pull: Champagne only</li> </ul>	<ol style="list-style-type: none"> <li>General quote number: <b>SF117403</b></li> <li>Style number and Product ID</li> <li>Laminate color number for nurse server</li> <li>Solid surface color number for top</li> <li>Edge band color number</li> <li>Options, if selected (see below)</li> </ol> See Surface Materials in the Nurture Casegoods Specification Guide.

Options	U.S. Price	Required to Specify
<b>Surface Materials</b>		
• Laminate	No cost	► See Surface Materials in the Nurture Casegoods Specification Guide.
• Open Line laminate	+\$ 85	► See Surface Materials in the Nurture Casegoods Specification Guide.
<b>Solid Surface</b>		
• Solid surface price group A	No cost	Specify solid surface color number or finish code.
• Solid surface price group B	+\$ 91	Specify solid surface color number or finish code.
• Solid surface price group C	+\$ 91	Specify solid surface color number or finish code.
• Solid surface price group D	+\$102	Specify solid surface finish code.
• Solid surface price group E	+\$112	Specify solid surface finish code.
<b>Lock and Keying</b>		
<b>Lock</b>		
• Polished Chrome for single-sided	+\$ 52	Specify with lock.
• Polished Chrome for double-sided	+\$104	Specify with lock.
<b>Keying</b>		
• Standard key random	No cost	Specify with standard keying.
• Specific keying	No cost	Specify with field installed locks.*
• Master keying for single-sided	+\$ 23	Specify with master keying.
• Master keying for double-sided	+\$ 46	Specify with master keying.

Specification Information			
Dimensions	Style	Product ID	Change to
D W H	Number		U.S. Prices

### Single-Sided Nurse Server

#### Left-Hand

18"	24"	39"	<b>HM1NA2439LS</b>	SF00207814	+\$140
-----	-----	-----	--------------------	------------	--------

#### Right-Hand

18"	24"	39"	<b>HM1NA2439RS</b>	SF00207815	+\$140
-----	-----	-----	--------------------	------------	--------

# Sonata Nurse Servers with Waste Bin Storage

Solid Surface

Sonata Nurse Servers with Waste Bin Storage

*Tip: For finish codes and more information on the solid surface Graded-In program, see Surface Materials.*

► Nurture Casegoods Specification Guide.

*\*Must order lock plugs from Service Parts (943101074SR).*

## What's Special

*Back edge of solid top is squared to allow the top to rest flush against a wall.*

*Tip: 3 mm space occurs when against the wall. Fill gap with service part 943101381SR.*

*Tip: Specials are also required for the Sonata rigid thermoform tops in order to be pushed up to a wall but are not available through Design Options. Please request a special if you need rigid thermoform tops that will need to be pushed up against the wall.*

*Tip: This special is not required for laminate work-surfaces, laminate tops for Sonata are already squared off and can be pushed up against a wall.*

*Tip: Installers will need to fill or span the gap at the base with cove molding as the base does not reach all the way to the wall.*



 **For Canadian Pricing**  
Multiply U.S. Price by the Canadian price factor.  
► See page 1 for details.

Standard Includes	Required to Specify
<ul style="list-style-type: none"> <li>Nurse server: laminate</li> <li>Rigid thermoform pull-out worksurface: sand only</li> <li>Top: solid surface</li> <li>Edge band: 3 mm plastic</li> <li>Flush pull and toe pull: Champagne only</li> </ul>	<ol style="list-style-type: none"> <li>General quote number: <b>SF117403</b></li> <li>Style number and Product ID</li> <li>Laminate color number for nurse server</li> <li>Solid surface color number for top</li> <li>Edge band color number</li> <li>Options, if selected (see below)</li> </ol> See Surface Materials in the Nurture Casegoods Specification Guide.

Options	U.S. Price	Required to Specify
<b>Surface Materials</b>		
• Laminate	No cost	► See Surface Materials in the Nurture Casegoods Specification Guide.
• Open Line laminate	+\$ 85	► See Surface Materials in the Nurture Casegoods Specification Guide.
<b>Solid Surface</b>		
• Solid surface price group A	No cost	Specify solid surface color number or finish code.
• Solid surface price group B	+\$ 91	Specify solid surface color number or finish code.
• Solid surface price group C	+\$ 91	Specify solid surface color number or finish code.
• Solid surface price group D	+\$102	Specify solid surface finish code.
• Solid surface price group E	+\$112	Specify solid surface finish code.
<b>Lock and Keying</b>		
<b>Lock</b>		
• Polished Chrome for single-sided	+\$ 52	Specify <i>with lock</i> .
<b>Keying</b>		
• Standard key random	No cost	Specify <i>with standard keying</i> .
• Specific keying	No cost	Specify <i>with field installed locks</i> .*
• Master keying for single-sided	+\$ 23	Specify <i>with master keying</i> .

Specification Information			
Dimensions	Style	Product ID	Change to
D W H	Number		U.S. Prices

## Single-Sided Nurse Server

### Left-Hand

18"	24"	39"	<b>HM1NC2439LS</b>	SF00207816	+\$140
-----	-----	-----	--------------------	------------	--------

### Right-Hand

18"	24"	39"	<b>HM1NC2439RS</b>	SF00207817	+\$140
-----	-----	-----	--------------------	------------	--------

Nurture

# Sonata Islands with Sliding Door

Solid Surface

Tip: For finish codes and more information on the solid surface Graded-In program, see Surface Materials.

► Nurture Casegoods Specification Guide.

Tip: Fusion island divider available on double-sided island only.

## What's Special

Back edge of solid top is squared to allow the top to rest flush against a wall.

Tip: 3 mm space occurs when against the wall. Fill gap with service part 943101381SR.

Tip: Specials are also required for the Sonata rigid thermoform tops in order to be pushed up to a wall but are not available through Design Options. Please request a special if you need rigid thermoform tops that will need to be pushed up against the wall.

Tip: This special is not required for laminate work-surfaces, laminate tops for Sonata are already squared off and can be pushed up against a wall.

Tip: Installers will need to fill or span the gap at the base with cove molding as the base does not reach all the way to the wall.

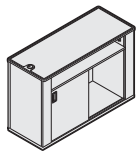
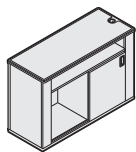

### For Canadian Pricing

Multiply U.S. Price by the Canadian price factor.

► See page 1 for details.

## Standard Includes

- Island: laminate
- Island divider: laminate
- Top: solid surface
- Edge band: 3 mm plastic
- Flush pull: Champagne only
- Grommet: black only

## Required to Specify

- 1 General quote number: **SF117403**
  - 2 Style number and Product ID
  - 3 Laminate color number for island, and divider
  - 4 Solid surface color number for top
  - 5 Edge band color number
  - 6 Options, if selected (see below)
- See Surface Materials in the Nurture Casegoods Specification Guide.

	Options	U.S. Price	Required to Specify
<b>Surface Materials</b>	• Laminate	No cost	► See Surface Materials in the Nurture Casegoods Specification Guide. ► See Surface Materials in the Nurture Casegoods Specification Guide.
	• Open Line laminate	+\$ 85	
	<b>Solid Surface</b>		
	• Solid surface price group A	No cost	Specify solid surface color number or finish code. Specify solid surface color number or finish code. Specify solid surface color number or finish code. Specify solid surface finish code. Specify solid surface finish code.
	• Solid surface price group B	+\$171	
	• Solid surface price group C	+\$171	
	• Solid surface price group D	+\$204	
	• Solid surface price group E	+\$231	
<b>Island Divider</b>	• Laminate	No cost	Specify with island divider. Specify with island divider and select fusion color number or finish code. Specify with island divider and select fusion finish code. Specify with island divider and select fusion color number or finish code. Specify with island divider and select fusion color number or finish code. ► See Surface Materials in the Nurture Casegoods Specification Guide.
	• Fusion price group 1	+\$391	
	• Fusion price group 2	+\$428	
	• Fusion price group 3	+\$466	
	• Fusion price group 4	+\$504	

## Specification Information

• Dimensions	• Style	• Product ID	• Change to
D W H	Number		U.S. Prices
.....	.....	.....	.....

## Single-Sided

### Left-Hand

18"	48"	36"	<b>HM1LA4836LS</b>	SF00207818	+\$140
-----	-----	-----	--------------------	------------	--------

### Right-Hand

18"	48"	36"	<b>HM1LA4836RS</b>	SF00207819	+\$140
-----	-----	-----	--------------------	------------	--------

# Sonata Islands with Open Storage

Solid Surface

Sonata Islands with  
Open Storage

*Tip: For finish codes and more information on the solid surface Graded-In program, see Surface Materials.*

▶ Nurture Casegoods Specification Guide.

*Tip: Fusion island divider available on double-sided island only.*

## What's Special

Back edge of solid top is squared to allow the top to rest flush against a wall.

*Tip: 3 mm space occurs when against the wall. Fill gap with service part 943101381SR.*

*Tip: Specials are also required for the Sonata rigid thermoform tops in order to be pushed up to a wall but are not available through Design Options. Please request a special if you need rigid thermoform tops that will need to be pushed up against the wall.*

*Tip: This special is not required for laminate work-surfaces, laminate tops for Sonata are already squared off and can be pushed up against a wall.*

*Tip: Installers will need to fill or span the gap at the base with cove molding as the base does not reach all the way to the wall.*

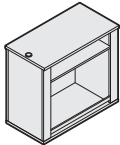
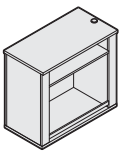

**For Canadian Pricing**  
Multiply U.S. Price by the Canadian price factor.  
▶ See page 1 for details.

Design Options

Standard Includes	Required to Specify
<ul style="list-style-type: none"> <li>Island: laminate</li> <li>Island divider: laminate</li> <li>Top: solid surface</li> <li>Edge band: 3 mm plastic</li> <li>Rails: Champagne only</li> <li>Grommet: black only</li> </ul>	<ol style="list-style-type: none"> <li>General quote number: <b>SF117403</b></li> <li>Style number and Product ID</li> <li>Laminate color number for island, and divider</li> <li>Solid surface color number for top</li> <li>Edge band color number</li> <li>Options, if selected (see below)</li> </ol> See Surface Materials in the Nurture Casegoods Specification Guide.

Options	U.S. Price	Required to Specify
<b>Surface Materials</b>		
<ul style="list-style-type: none"> <li>Laminate</li> <li>Open Line laminate</li> </ul>	No cost +\$ 85	▶ See Surface Materials in the Nurture Casegoods Specification Guide. ▶ See Surface Materials in the Nurture Casegoods Specification Guide.
<b>Solid Surface</b>		
<ul style="list-style-type: none"> <li>Solid surface price group A</li> <li>Solid surface price group B</li> <li>Solid surface price group C</li> <li>Solid surface price group D</li> <li>Solid surface price group E</li> </ul>	No cost +\$129 +\$129 +\$156 +\$177	Specify solid surface color number or finish code. Specify solid surface color number or finish code. Specify solid surface color number or finish code. Specify solid surface color number or finish code. Specify solid surface color number or finish code.
<b>Island Divider</b>		
<ul style="list-style-type: none"> <li>Laminate</li> <li>Fusion price group 1</li> <li>Fusion price group 2</li> <li>Fusion price group 3</li> <li>Fusion price group 4</li> </ul>	No cost +\$321 +\$358 +\$397 +\$434	Specify with island divider. Specify with island divider and select fusion color number or finish code. Specify with island divider and select fusion finish code. Specify with island divider and select fusion color number or finish code. Specify with island divider and select fusion color number or finish code. ▶ See Surface Materials in the Nurture Casegoods Specification Guide.

Specification Information			
Dimensions	Style	Product ID	Change to
D W H	Number		U.S. Prices

## Single-Sided Island

### Left-Hand

18"	36"	36"	<b>HM1LB3636LS</b>	SF00207820	+\$140
-----	-----	-----	--------------------	------------	--------

### Right-Hand

18"	36"	36"	<b>HM1LB3636RS</b>	SF00207821	+\$140
-----	-----	-----	--------------------	------------	--------

Nurture

# Senza Bedside Tables with Spill Top

with Melamine Fronts

## What's Special

Bedside tables with rigid thermoform spill top.

### Standard Includes

- Bedside table case: melamine to match fronts
- Door and drawer fronts: melamine
- Wood-leg base: wood veneer to match fronts
- Top: rigid thermoform with spill collector top, top color must match case color
- Bow pull on doors and drawers: brushed nickel only
- Glides: black only

### Required to Specify

- 1 General quote number: **SF121563**
  - 2 Style number and Product ID
  - 3 Laminate color number for bedside table
  - 4 Thermoform color number for top
  - 5 Options, if selected (see below)
- See Surface Materials in the Nurture Casegoods Specification Guide.

	Options	U.S. Price	Required to Specify
<b>Drawer Pulls</b>	<ul style="list-style-type: none"> <li>• Soft pull: black only</li> <li>• Flat knob pull: matte stainless steel only</li> <li>• Opus pull: champagne only</li> <li>• Jazz pull: nickel only</li> <li>• Line pull: 4799 Platinum Metallic only</li> </ul>	No cost +\$10 per pull +\$12 per pull +\$17 per pull +\$17 per pull	Specify with <i>soft pull</i> . Specify with <i>flat knob pull</i> . Specify with <i>Opus pull</i> . Specify with <i>jazz pull</i> . Specify with <i>line pull</i> .
<b>Base</b>	<ul style="list-style-type: none"> <li>• Enclosed base</li> <li>• Metal-leg base</li> </ul>	+\$54 +\$98	Specify with <i>enclosed base</i> . Specify with <i>metal-leg base</i> .
<b>Casters</b>	<ul style="list-style-type: none"> <li>• Casters (set of four)</li> <li>• Rear roller casters with front glides</li> </ul>	+\$22 +\$48	Specify with <i>casters</i> . Specify with <i>rear roller casters</i> .
<b>Gallery Rails</b>	<ul style="list-style-type: none"> <li>• Gallery rails (set of three)</li> </ul>	+\$93	Specify with <i>gallery rails</i> .
<b>Lock and Keying</b>	<b>Lock with random key</b> <ul style="list-style-type: none"> <li>• 9201 Polished Chrome only</li> </ul>	+\$31	Specify with <i>lock</i> .

### Specification Information

Dimensions			Style	Product ID	Change to
D	W	H	Number		U.S. Base Price

#### Bedside Table with Three Drawers

18"	18"	30"	<b>H3BM30L</b>	SF00212384	+\$125
-----	-----	-----	----------------	------------	--------

#### Bedside Tables with One Drawer and One Door

##### Door Hinged on Left

18"	18"	30"	<b>H3BG30LL</b>	SF00212385	+\$125
-----	-----	-----	-----------------	------------	--------

##### Door Hinged on Right

18"	18"	30"	<b>H3BG30RL</b>	SF00212386	+\$125
-----	-----	-----	-----------------	------------	--------



#### For Canadian Pricing

Multiply U.S. Price by the Canadian price factor.

▶ See page 1 for details.

# Senza Bedside Tables with Spill Top

with Rigid Thermoform Fronts

Senza Bedside Tables  
with Spill Top

## What's Special

Bedside tables with rigid thermoform spill top.

Tip: Top color will match front.

### Standard Includes

- Bedside table case: melamine to match fronts
- Door and drawer fronts: rigid thermoform
- Wood-leg base: wood veneer to match fronts
- Top: rigid thermoform to match fronts
- Bow pull on doors and drawers: brushed nickel only
- Glides: black only

### Required to Specify

- 1 General quote number: **SF121563**
- 2 Style number and Product ID
- 3 Thermoform color number for bedside table
- 4 Options, if selected (see below)  
See Surface Materials in the Nurture Casegoods Specification Guide.

	Options	U.S. Price	Required to Specify
<b>Base</b>	<ul style="list-style-type: none"> <li>• Enclosed base</li> <li>• Metal-leg base</li> </ul>	+\$54 +\$98	Specify with enclosed base. Specify with metal-leg base.
<b>Casters</b>	<ul style="list-style-type: none"> <li>• Casters (set of four)</li> <li>• Rear roller casters with front glides</li> </ul>	+\$22 +\$48	Specify with casters. Specify with rear roller casters.
<b>Gallery Rails</b>	<ul style="list-style-type: none"> <li>• Gallery rails (set of three)</li> </ul>	+\$93	Specify with gallery rails.
<b>Lock and Keying</b>	<b>Lock with random key</b> <ul style="list-style-type: none"> <li>• 9201 Polished Chrome only</li> </ul>	+\$31	Specify with lock.

### Specification Information

Dimensions			Style	Product ID	Change to
D	W	H	Number		U.S. Base Price

#### Bedside Table with Three Drawers

18"	18"	30"	<b>H3BM30R</b>	SF00212387	+\$125
-----	-----	-----	----------------	------------	--------

#### Bedside Tables with One Drawer and One Door

##### Door Hinged on Left

18"	18"	30"	<b>H3BG30LR</b>	SF00212388	+\$125
-----	-----	-----	-----------------	------------	--------

##### Door Hinged on Right

18"	18"	30"	<b>H3BG30RR</b>	SF00212389	+\$125
-----	-----	-----	-----------------	------------	--------



Nurture



#### For Canadian Pricing

Multiply U.S. Price by the Canadian price factor.

▶ See page 1 for details.

# Senza Bedside Tables with Spill Top

with Wood Fronts

## What's Special

Bedside tables with rigid thermoform spill top.

### Standard Includes

- Bedside table case: wood veneer to match fronts
- Door and drawer fronts: wood veneer
- Wood-leg base: wood veneer to match fronts
- Top: rigid thermoform with spill collector top, top color must match case color
- Bow pull on doors and drawers: brushed nickel only
- Glides: black only

### Required to Specify

- 1 General quote number: **SF121563**
- 2 Style number and Product ID
- 3 Wood color number for bedside table
- 4 Thermoform color number for bedside table
- 5 Options, if selected (see below)  
See Surface Materials in the Nurture Casegoods Specification Guide.

	Options	U.S. Price	Required to Specify
<b>Drawer Pulls</b>	<ul style="list-style-type: none"> <li>• Soft pull: black only</li> <li>• Flat knob pull: matte stainless steel only</li> <li>• Opus pull: champagne only</li> <li>• Jazz pull: nickel only</li> <li>• Line pull: 4799 Platinum Metallic only</li> </ul>	No cost +\$10 per pull +\$12 per pull +\$17 per pull +\$17 per pull	Specify with <i>soft pull</i> . Specify with <i>flat knob pull</i> . Specify with <i>Opus pull</i> . Specify with <i>jazz pull</i> . Specify with <i>line pull</i> .
<b>Base</b>	<ul style="list-style-type: none"> <li>• Metal-leg base</li> </ul>	+\$98	Specify with <i>metal-leg base</i> .
<b>Casters</b>	<ul style="list-style-type: none"> <li>• Casters (set of four)</li> <li>• Rear roller casters with front glides</li> </ul>	+\$22 +\$48	Specify with <i>casters</i> . Specify with <i>rear roller casters</i> .
<b>Gallery Rails</b>	<ul style="list-style-type: none"> <li>• Gallery rails (set of three)</li> </ul>	+\$93	Specify with <i>gallery rails</i> .
<b>Lock and Keying</b>	<b>Lock with random key</b> <ul style="list-style-type: none"> <li>• 9201 Polished Chrome only</li> </ul>	+\$31	Specify with <i>lock</i> .

### Specification Information

Dimensions			Style	Product ID	Change to
D	W	H	Number		U.S. Base Price

#### Bedside Table with Three Drawers

18"	18"	30"	<b>H3BM30W</b>	SF00212390	+\$125
-----	-----	-----	----------------	------------	--------

#### Bedside Tables with One Drawer and One Door

##### Door Hinged on Left

18"	18"	30"	<b>H3BG30LW</b>	SF00212392	+\$125
-----	-----	-----	-----------------	------------	--------

##### Door Hinged on Right

18"	18"	30"	<b>H3BG30RW</b>	SF00212393	+\$125
-----	-----	-----	-----------------	------------	--------

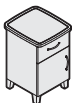

#### For Canadian Pricing

Multiply U.S. Price by the Canadian price factor.

▶ See page 1 for details.



# Folio Corner Units

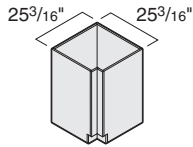

## What's Special

Special cabinet unit to create 90° condition. Corner filler to be approximately 2 1/2" wider than corner in both directions to clear doors and drawers.

*Tip:* Not intended as island application.

*Tip:* A full depth sidesplash or Integrated Corian sidesplash may be required for the application.

*Tip:* No options are available on this unit.

*Tip:* Must specify two standard extended tops to complete the corner application.

## Standard Includes

- Base cabinet: melamine
- Edges: 1 mm plastic on all edges
- Adjustable glides

## Required to Specify

- 1 General quote number: **SF121469**
  - 2 Style number and Product ID
  - 3 Laminate color number for base cabinet
- See Surface Materials in the Nurture Casegoods Specification Guide.

## Specification Information

• Dimensions		• Style	• Product ID	• Change to
D	H	Number		U.S. Base Price

### For 28" High Base Cabinets

24"	27 7/16"	<b>HXBP2428</b>	SF00207965	+\$50
-----	----------	-----------------	------------	-------

### For 33" High Base Cabinets

24"	32"	<b>HXBP2433A</b>	SF00207964	+\$50
-----	-----	------------------	------------	-------

### For 35" High Base Cabinets

24"	35"	<b>HXBP2436</b>	SF00207960	+\$50
-----	-----	-----------------	------------	-------

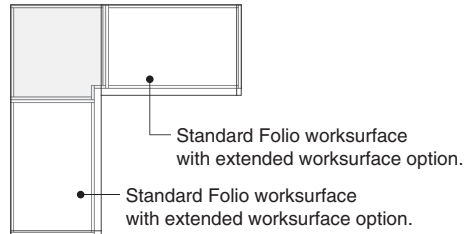
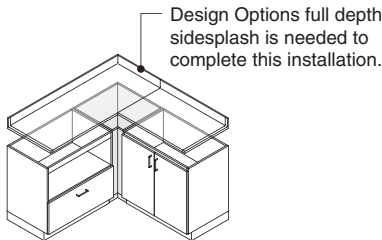

## For Canadian Pricing

Multiply U.S. Price by the Canadian price factor.

▶ See page 1 for details.

# Waldorf Bedside Tables with Spill Top

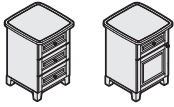

## What's Special

Bedside Tables with rigid thermoform spill top.

Tip: Edge is available on cabinets with wood fronts only.

Standard Includes	Required to Specify
<ul style="list-style-type: none"> <li>• Bedside table case: melamine</li> <li>• Door or drawer fronts: wood or rigid thermoform to match case</li> <li>• Base: wood to match case</li> <li>• Top: rigid thermoform with spill collector top, top color must match case</li> <li>• Round knob pull on doors and drawers: satin chrome only</li> <li>• Glides: black only</li> </ul>	<ol style="list-style-type: none"> <li>1 General quote number: <b>SF121562</b></li> <li>2 Style number and Product ID</li> <li>3 Wood or rigid thermoform color number for bedside table</li> <li>4 Thermoform color number or bedside table</li> <li>5 Options, if selected (see below) See Surface Materials in the Nurture Casegoods Specification Guide.</li> </ol>

Options	U.S. Price	Required to Specify
<b>Door and Drawer Pulls</b> <ul style="list-style-type: none"> <li>• Soft pull: black</li> </ul>	No cost	Specify with soft pulls.
<b>Gallery Rails</b> <ul style="list-style-type: none"> <li>• Gallery rails (set of three)</li> </ul>	+\$93	Specify with gallery rails.
<b>Casters</b> <ul style="list-style-type: none"> <li>• Casters (set of four)</li> <li>• Rear roller casters with front glides</li> </ul>	+\$22 +\$48	Specify with casters. Specify with rear roller casters.
<b>Lock and Keying</b> <ul style="list-style-type: none"> <li>• <b>Lock with random key</b></li> <li>• 9201 Polished Chrome only</li> </ul>	+\$31	Specify with lock.

## Specification Information

Dimensions	Style	Product ID	Change to
D W H	Number		U.S. Base Price

### Bedside Tables with Melamine Case and Rigid Thermoform Fronts

#### Bedside Table with Three Drawers

18"	18"	30"	<b>H6BM30R</b>	SF00212365	+\$125
-----	-----	-----	----------------	------------	--------

#### Bedside Tables with One Drawer and One Door

##### Door Hinged on Left

18"	18"	30"	<b>H6BG30LR</b>	SF00212366	+\$125
-----	-----	-----	-----------------	------------	--------

##### Door Hinged on Right

18"	18"	30"	<b>H6BG30RR</b>	SF00212376	+\$125
-----	-----	-----	-----------------	------------	--------

### Bedside Tables with Melamine Case and Wood Fronts

#### Bedside Table with Three Drawers

18"	18"	30"	<b>H6BM30W</b>	SF00212379	+\$125
-----	-----	-----	----------------	------------	--------

#### Bedside Tables with One Drawer and One Door

##### Door Hinged on Left

18"	18"	30"	<b>H6BG30LW</b>	SF00212381	+\$125
-----	-----	-----	-----------------	------------	--------

##### Door Hinged on Right

18"	18"	30"	<b>H6BG30RW</b>	SF00212382	+\$125
-----	-----	-----	-----------------	------------	--------



#### For Canadian Pricing

Multiply U.S. Price by the Canadian price factor.

▶ See page 1 for details.

---

# c:scape

▶ See page 3, *About Design Options*, in the front of this book for pricing and ordering restrictions.

<b>Thought Starters</b>	<b>292</b>
<b>Answer L and T Base Panel Junctions—Square Trim</b>	<b>293</b>
<b>Montage Frame Junction Kits</b>	<b>294</b>
<b>Straight Desks</b>	<b>295</b>
<b>Towers</b>	<b>296</b>
<b>Universal Mobile Pedestals</b>	<b>298</b>

# Thought Starters

## Panel to Beam Junctions on Answer and Montage

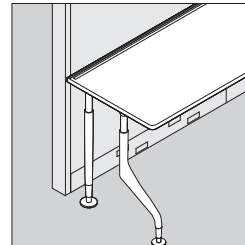
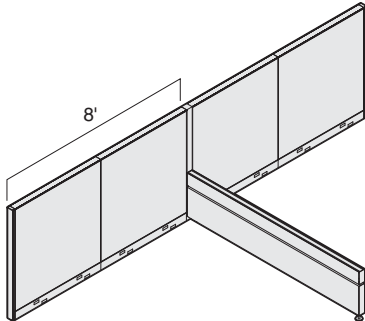

- An 8' run with no panel hung components does not require a return panel.
- Panels must be same height.
- 30"W return panels are required when panel mounting binder bins or c:scape mid storage on panel runs up to 8'.
- For additional stability or longer runs, apply a junction stabilizer bracket every 8' bolted to a concrete floor.

- Recommend ordering a special desk tie bracket to tie the end of the panel run into the understructure of the desk when desks parallel to the panel.

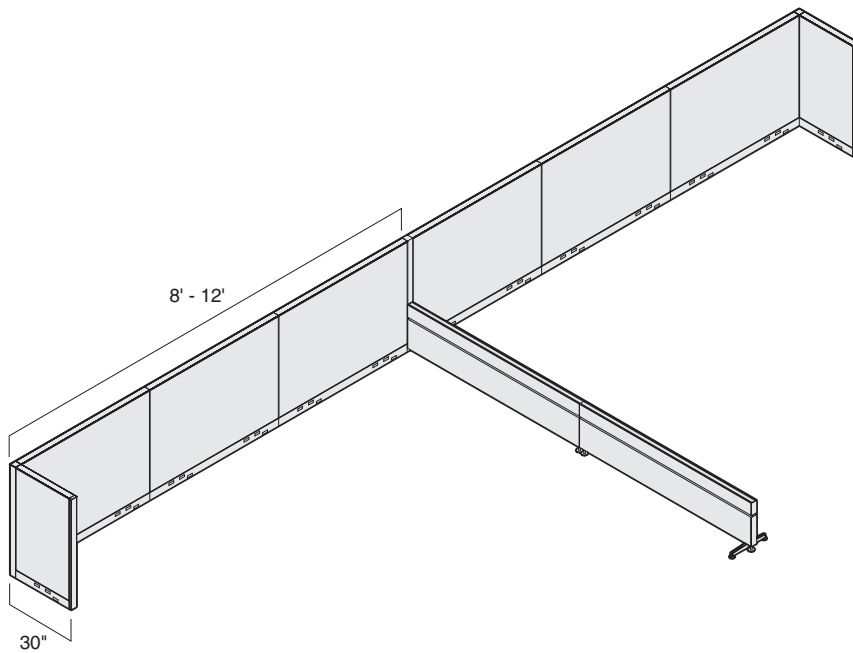

**For runs over 8' and up to 12', you must use at least a 30"W return panel.**

- Can use any type of panel skins or tiles.
- Available with steel and veneer trims.
- Power can be transitioned from c:scape beam into panel. Use a 30" harness to transition from the harness-to-harness connector in the beam into an Answer power kit. The harness-to-harness connector must be placed one foot from end of beam.
- Cannot panel mount components without return panel.

# Answer L and T Base Panel Junctions—Square Trim

Answer L and T Base Panel Junctions—Square Trim

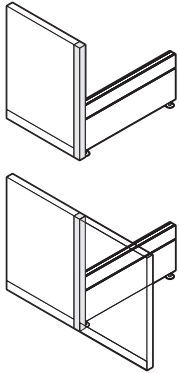

*Tip: Painted trim is standard on all base panel junctions. Wood trim is available as an option only on base panel junctions with wood junction caps.*

## What's Special

*c:scape beam to Answer L and T junctions.*

*Tip: The square trim junctions are not intended for use with open base or thin trims.*

Standard Includes	Required to Specify
-------------------	---------------------

- |  |  |
|--|--|
| <ul style="list-style-type: none"> <li>▶ Need help? Product details, page 292</li> </ul> | <ul style="list-style-type: none"> <li>• Junction</li> <li>• Trim on L and T junction: paint price group 1</li> <li>• Junction cap on L, T, and X junction: paint or wood</li> </ul> |
|--|--|

- |  |
|--|
| <ol style="list-style-type: none"> <li>1 General quote number: <b>SF111086</b></li> <li>2 Style number and Product ID</li> <li>2 Paint color number for trim</li> <li>3 Paint or wood color number for junction cap</li> <li>4 Options, if selected (see below)</li> </ol> <p>See Surface Materials, in the c:scape &amp; media:scape Specification Guide.</p> |
|--|

Surface Materials	Options	U.S. Price	Required to Specify
-------------------	---------	------------	---------------------

- |   |   |   |
|---|---|---|
| <ul style="list-style-type: none"> <li>• Paint price group 1</li> <li>• Paint price group 2</li> <li>• Paint price group 3</li> </ul> | <ul style="list-style-type: none"> <li>No cost</li> <li>+\$ 11</li> <li>+\$ 21</li> </ul> | <ul style="list-style-type: none"> <li>Specify paint color number.</li> <li>Specify paint color number.</li> <li>Specify paint color number.</li> </ul> |
|---|---|---|

### Trim on L and T junctions

- |   |  |   |
|---|--|---|
| <ul style="list-style-type: none"> <li>• Wood on junctions with wood junction cap</li> <li>–54"H panel height or shorter</li> </ul> | <ul style="list-style-type: none"> <li>+\$179</li> </ul> | <ul style="list-style-type: none"> <li>Specify wood color number for trim.</li> </ul> |
|---|--|---|

## Specification Information

Corresponding Panel Height	L Base Panel Junctions with Square Trim			T Base Panel Junctions with Square Trim		
	Style Number	Product ID	Change to U.S. Base Price	Style Number	Product ID	Change to U.S. Base Price

### Painted Junction Cap

42"	<b>TS742SLPJ</b>	SF00198823	+\$160	<b>TS742STPJ</b>	SF00198829	+\$160
48"	<b>TS754SLPJ</b>	SF00198821	+\$160	<b>TS754STPJ</b>	SF00198828	+\$160
54"	<b>TS754SLPJ</b>	SF00198819	+\$160	<b>TS754STPJ</b>	SF00198827	+\$160

### Wood Junction Cap

42"	<b>TS742SLPJW</b>	SF00200336	+\$160	<b>TS742STPJW</b>	SF00200333	+\$160
48"	<b>TS754SLPJW</b>	SF00200337	+\$160	<b>TS754STPJW</b>	SF00200334	+\$160
54"	<b>TS754SLPJW</b>	SF00200338	+\$160	<b>TS754STPJW</b>	SF00200335	+\$160

c:scape



**For Canadian Pricing**  
 Multiply U.S. Price by the Canadian price factor.  
 ▶ See page 1 for details.

# Montage Frame Junction Kits

## Square L-Junctions

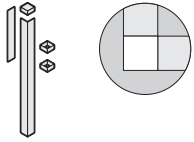

Tip: Connectors are for use with frames that do not have lay-in cable tracks mounted to them.

### What's Special

c:scape beam to Montage L-junction.

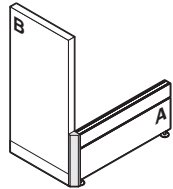

Standard Includes	Required to Specify
<ul style="list-style-type: none"> <li>Need help? Product details, page 292</li> <li>Two-way square top cap: all paint price groups for aluminum</li> <li>Two-way connectors</li> <li>One square L-cover: all paint price groups for aluminum</li> <li>End trim: all paint price groups for aluminum</li> </ul>	<ol style="list-style-type: none"> <li>General quote number: <b>CA016457</b></li> <li>Style number and Product ID</li> <li>Paint color number for top cap, cover, and end trim on aluminum frame</li> </ol> See Surface Materials, in the c:scape & media:scape Specification Guide.

Specification Information				
Height	Style		Product ID	Change to
A B	Number			U.S. Base Price

### Change-of-Height Frame Kits

Aluminum				
24"	45"	<b>ZJL34S</b>	CA00041249	+\$160
24"	55"	<b>ZJL35S</b>	CA00041250	+\$160

## T-Junctions

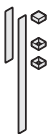

Tip: Connectors are for use with frames that do not have lay-in cable tracks mounted to them.

Tip: Panels must be same height.

### What's Special

c:scape beam to Montage T-junction.

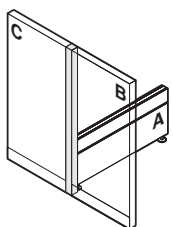

Standard Includes	Required to Specify
<ul style="list-style-type: none"> <li>Need help? Product details, page 292</li> <li>Top cap, connectors, cover(s), and end trim, if applicable: all paint price groups for aluminum</li> </ul>	<ol style="list-style-type: none"> <li>General quote number: <b>CA016457</b></li> <li>Style number and Product ID</li> <li>Paint color number for top cap, cover(s), and end trim on aluminum frame</li> </ol> See Surface Materials, in the c:scape & media:scape Specification Guide.

Specification Information				
Height	Style		Product ID	Change to
A B C	Number			U.S. Base Price

### Change-of-Height Frame Kits

Aluminum					
24"	45"	45"	<b>ZJT344</b>	CA00041253	+\$160
24"	55"	55"	<b>ZJT355</b>	CA00041254	+\$160

# Straight Desks

High-Pressure Laminate or Wood Veneer

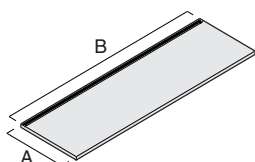

*Tip: Laminate surfaces have radius corners and veneer surfaces have square corners.*

*Tip: Edge on wood veneer surface matches the top.*

*Tip: Supports for freestanding and tethered applications must be specified separately.*

*Tip: 48"W desks accommodate one power block. Power block can be placed on the left or right side of desk.*

Standard Includes	Required to Specify
<ul style="list-style-type: none"> <li>• Desk understructure: 4799 platinum</li> <li>• High-Pressure Laminate surface with plastic edges: 3 mm plastic edge on front and side edges</li> </ul>	<ol style="list-style-type: none"> <li>1 General quote number: <b>SF108870</b></li> <li>2 Style number and Product ID</li> <li>3 Laminate color number for surface</li> <li>4 Plastic color number for edges on laminate surface</li> <li>5 Options, if selected (see below)</li> </ol> <p>See Surface Materials, in the c:scape &amp; media:scape Specification Guide.</p>

Surface Materials	Options	U.S. Price	Required to Specify
	<b>High-Pressure Laminate surfaces</b>		▶ See <i>Surface Materials Reference Manual</i> .
	• Open Line laminate	+\$ 64 plus cost of laminate	
	<b>Wood veneer surfaces</b>		Specify with <i>wood veneer</i> and indicate wood color number.
	• Wood veneer surface with wood veneer edges - 3 mm edge profile on front edge	+\$333	
	• Premium wood 2 veneer surface with wood veneer edges - 3 mm edge profile on front edge	+\$397	
	• Premium wood 3 veneer surface with wood veneer edges - 3 mm edge profile on front edge	+\$558	
	• Customiz stain	+\$ 32	
• Full-fill finish	+\$ 64	Specify with <i>Customiz stain</i> . ▶ See <i>Surface Materials Reference Manual</i> . Specify full-finish number.	

## What's Special

Desk available 48"W.

## Specification Information

Dimensions		Style Number	Product ID	Change to U.S. Base Price
A	B			
24"	48"	<b>CQDS2460</b>	SF00190613	+\$260
30"	48"	<b>CQDS3060</b>	SF00194559	+\$260

**For Canadian Pricing**  
 Multiply U.S. Price by the Canadian price factor.  
 ▶ See page 1 for details.



# Towers

Standard Includes	Required to Specify
<ul style="list-style-type: none"> <li>• Tower case: paint price group 1</li> <li>• 1/2" top: paint to match case</li> <li>• Integral pull on door and drawers: paint</li> <li>• Four adjustable leveling glides: 4799 Platinum</li> <li>• One rail per file drawer</li> <li>• Drawer liner</li> <li>• Central lock, keyed random: finish to default based on pull finish</li> </ul>	<ol style="list-style-type: none"> <li>1 General quote number: <b>FC034227</b></li> <li>2 Style number and Product ID</li> <li>3 Paint color number for case</li> <li>4 Color number for pulls:               <ul style="list-style-type: none"> <li>4140 Arctic White Gloss</li> <li>4144 Black Gloss</li> <li>4799 Platinum</li> </ul> </li> <li>5 Options, if selected (see below) See Surface Materials, in the c:scape &amp; media:scape Specification Guide.</li> </ol>

## What's Special

Tower available 42"H.

*Tip: Specify multi-color paint finish option to get the interior a different paint finish than the case.*

	Options	U.S. Price	Required to Specify
<b>Surface Materials</b>	<b>Paint</b>		
	<ul style="list-style-type: none"> <li>• Paint price group 1</li> <li>• Paint price group 2</li> <li>• Paint price group 3</li> </ul>	No cost +\$ 56 +\$141	Specify paint color number. Specify paint color number. Specify paint color number.
	<b>Multi-color paint finishes</b>		
	<ul style="list-style-type: none"> <li>• Multiple paint colors on case, interior, or fronts</li> </ul>	+\$125	Specify paint color number. ▶ See <i>Multi-Color Paint Applications</i> , in the c:scape & media:scape Specification Guide.
<b>Tops</b>	<b>Wood veneer top</b>		
	<ul style="list-style-type: none"> <li>• Wood veneer top</li> </ul>	+\$374	Specify <i>with wood veneer top</i> and indicate wood color number.
	<ul style="list-style-type: none"> <li>• Premium wood 2 on wood veneer top</li> </ul>	+\$399	Specify Premium wood 2 finish number.
	<ul style="list-style-type: none"> <li>• Premium wood 3 on wood veneer top</li> </ul>	+\$462	Specify Premium wood 3 finish number.
	<ul style="list-style-type: none"> <li>• Customiz stain on wood veneer top</li> </ul>	+\$ 12	Specify <i>with Customiz stain</i> . ▶ See <i>Surface Materials Reference Manual</i> .
	<ul style="list-style-type: none"> <li>• Full-fill finish</li> </ul>	+\$ 25	Specify full-fill finish number.
<b>Wood Veneer Door and Drawer Fronts</b>	<ul style="list-style-type: none"> <li>• Door and drawers</li> </ul>	+\$341	Specify <i>with wood veneer door and drawer fronts</i> .
	<ul style="list-style-type: none"> <li>• Customiz stain on wood veneer fronts</li> </ul>	+\$ 12	Specify <i>with Customiz stain</i> . ▶ See <i>Surface Materials Reference Manual</i> .
	<ul style="list-style-type: none"> <li>• Premium wood 2 on wood veneer fronts</li> </ul>	+\$366	Specify Premium wood 2 finish number.
	<ul style="list-style-type: none"> <li>• Premium wood 3 on wood veneer fronts</li> </ul>	+\$429	Specify Premium wood 3 finish number.
<b>Keying</b>	<ul style="list-style-type: none"> <li>• Factory- and field-installed keying</li> </ul>		▶ See c:scape & media:scape Specification Guide.

Specification Information			
• Dimensions	• Style	• Product ID	• Change to
D W H	Number		U.S. Base Price
.....	.....	.....	.....

### Tower - Right

24"	24"	42"	<b>CQTW172448R</b>	FC00034932	+\$490
.....	.....	.....	.....	.....	.....

### Tower - Left

24"	24"	42"	<b>CQTW172448L</b>	FC00034931	+\$490
.....	.....	.....	.....	.....	.....

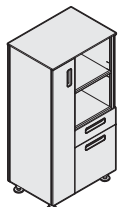
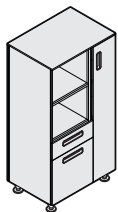





# Universal Mobile Pedestals

With Proud Steel Fronts



Tip: 1/8"H steel top is non-structural.

## What's Special

Pedestals available with c:scape pull.

Tip: Optional tops will increase the overall pedestal height.

### Premium Wood

**Pricing:** To calculate the estimated price for Premium wood veneer top, multiply Customiz stain upcharge by five for Premium wood 2 or by ten for Premium wood 3, then add the price for wood veneer top. For exact pricing, see the electronic catalog.

Standard Includes		Required to Specify
<ul style="list-style-type: none"> <li>• Pedestal: paint price group 1</li> <li>• 1/8"H steel top: paint to match pedestal</li> <li>• Removable drawer fronts: paint to match pedestal</li> <li>• c:scape pulls on units with proud steel fronts: metal</li> <li>• Full drawer interiors: black only                             <ul style="list-style-type: none"> <li>– One pencil tray per box/file and box drawer dividers</li> </ul> </li> <li>• Lock, keyed random: 9201 Polished Chrome</li> <li>• Four hard-composition, non-locking casters: black only</li> <li>• Safety interlock mechanism</li> <li>• Counterweight package</li> </ul>		<ol style="list-style-type: none"> <li>1 General quote number: <b>FC034227</b></li> <li>2 Style number and Product ID</li> <li>3 Paint color number for pedestal</li> <li>4 Color number for pulls:                             <ul style="list-style-type: none"> <li>4140 Arctic White Gloss</li> <li>4144 Black Gloss</li> <li>4799 Platinum</li> <li>9201 Polished Chrome</li> </ul> </li> <li>5 Options, if selected (see below)</li> </ol> See Surface Materials, in the c:scape & media:scape Specification Guide.

Options	U.S. Price	Required to Specify
<b>Surface Materials</b> <ul style="list-style-type: none"> <li>• Paint price group 1</li> <li>• Paint price group 2</li> <li>• Paint price group 3</li> </ul>	No cost +\$ 41 +\$ 70	Specify paint color number. Specify paint color number. Specify paint color number.
<b>Tops</b> <ul style="list-style-type: none"> <li>• 1"H square edge steel top</li> </ul>	+\$ 59	Specify with steel square top.
<b>Laminate top</b>		
<ul style="list-style-type: none"> <li>• 13/16"H square edge laminate top</li> <li>• 17/16"H bullnose laminate top</li> </ul>	+\$254 +\$289	Specify with laminate top and indicate laminate color number for top and plastic color number for edges. Specify with bullnose laminate top and indicate laminate color number.
<ul style="list-style-type: none"> <li>• Open Line laminate on laminate top</li> </ul>	+\$ 64 plus cost of laminate	▶ See Surface Materials Reference Manual.
<b>Wood veneer top</b>		
<ul style="list-style-type: none"> <li>• 13/16"H wood veneer top</li> <li>• Premium wood 2</li> <li>• Premium wood 3</li> <li>• Full-fill finish on wood veneer top</li> <li>• Customiz stain on wood veneer top</li> </ul>	+\$354 See information at left See information at left +\$ 16 +\$ 12	Specify with wood veneer top and indicate wood color number. Specify with wood veneer top and indicate Premium wood 2 finish number. Specify with wood veneer top and indicate Premium wood 3 finish number. Specify with full-fill finish. Specify with Customiz stain. ▶ See Surface Materials Reference Manual.
<b>Cushion top for factory installation on RPM2421CP only</b>		
<ul style="list-style-type: none"> <li>• Cushion top without handle</li> <li>• Cushion top with black handle</li> </ul>	+\$312 +\$397	Specify with cushion top and indicate fabric color number. Specify with cushion top and handle and indicate fabric color number.

▶ Options, continued on next page



### For Canadian Pricing

Multiply U.S. Price by the Canadian price factor.

▶ See page 1 for details.

► Options, continued from previous page

Options		U.S. Price	Required to Specify
<b>Tops, continued</b>	<b>Upholstery on pedestal cushion top</b>		
	• Fabric price group 1	No cost	Specify fabric color number.
	• Fabric price group 2	+\$ 10	Specify fabric color number.
	• Fabric price group 3	+\$ 36	Specify fabric color number.
	• Fabric price group 4	+\$ 45	Specify fabric color number.
	• Fabric price group 5	+\$ 56	Specify fabric color number.
	• Fabric price group 6	+\$ 79	Specify fabric color number.
	• Fabric price group 7	+\$ 95	Specify fabric color number.
	• Fabric price group 8	+\$138	Specify fabric color number.
	• Fabric price group 9	+\$177	Specify fabric color number.
• Fabric price group 10	+\$215	Specify fabric color number.	
• Leather price group	+\$552	Specify leather color number.	
• Elmosoft leather upholstery	+\$638	Specify Elmosoft leather color number.	
• Customer's own material (COM) or Customer's own leather (COL).	+\$ 16	► See <i>Surface Materials Reference Manual</i> ► See <i>Surface Materials Reference Manual</i> to specify.	
<b>Drawer Accessories</b>	<b>Rails</b>		
	• Two side-to-side hanging file rails per file drawer	\$ 12	Specify <i>with rails</i> .
<b>Basic Drawer Interiors</b>	<b>Box/file</b>		
	• No rails, pencil trays, or box drawer dividers	-\$ 46	Specify <i>with basic drawers</i> .
<b>Lock and Keying</b>	<b>Lock</b>		
	• Ember Chrome	No cost	Specify <i>with 9250 Ember Chrome lock</i> .
	<b>Keying</b>		
	• Factory- and field-installed keying		► See <i>Storage and Freestanding Furniture Specification Guide</i> .

**Specification Information**

Actual Dimensions			Style	Product ID	Change to
D	W	H	Number		U.S. Base Price

**Box/File**

18 <sup>3</sup> / <sub>8</sub> "	15"	21"	<b>RPM1821CP</b>	FC00034398	+\$50
23 <sup>1</sup> / <sub>2</sub> "	15"	21"	<b>RPM2421CP</b>	FC00033554	+\$50
.	.	.	.	.	.



 **For Canadian Pricing**  
Multiply U.S. Price by the Canadian price factor.  
► See page 1 for details.



---

# Details

▶ See page 3, *About Design Options*, in the front of this book for pricing and ordering restrictions.

<b>Airtouch Height-Adjustable Universal Systems Worksurfaces</b>	<b>302</b>
<b>Airtouch Height-Adjustable Universal Table Worksurfaces</b>	<b>303</b>

# Airtouch Height-Adjustable Universal Systems Worksurfaces

High-Pressure Laminate, with Airtouch Technology



Worksurface Edge

## What's Special

Worksurfaces are available in larger widths that ship with a wider mounting plate. Discard smaller mounting plate.

*Tip: Airtouch adjustable-height mechanisms require assembly and attachment to the worksurface.*

*Tip: Airtouch is designed for a wide range of applications, from lighter cargo loads (laptops or flat screen monitors) to heavier loads (large monitors or multiple monitors). An adjustment feature on the column allows the unit to function properly with any load up to 150 pounds including the worksurface.*

*Tip: All sizes are listed in actual dimensions which allows for a 1" gap to adjacent furniture, eliminating any pinch points.*

*Tip: C-clamping is not recommended on 22<sup>1</sup>/<sub>4</sub>"D worksurfaces due to interference with the mounting plate. The mounting plate is 26"W and extends 8" on either side of the column. C-clamping on the outside of the plate is allowed.*

*Tip: Cableways are not recommended for use with 22<sup>1</sup>/<sub>4</sub>"D straight worksurfaces.*

*Tip: These sizes are NOT for use with casters.*

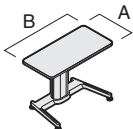

## Standard Includes

- Universal Systems worksurface: High-Pressure Laminate
- Plastic 3 mm edge profile on front edge of worksurface: plastic
- Flat profile on side and back edges of worksurface: plastic default
- Adjustable-height column mechanism: 4799 Platinum default
- Adjustable-height mechanism base
- Attachment hardware
- 90° corners on worksurface

## Required to Specify

- 1 General quote number: **CX026108**
- 2 Style number and Product ID
- 3 High-Pressure Laminate color number for worksurface
- 4 Plastic color number for front edge on laminate worksurface
- 5 Paint color number for base: (column platinum only)
  - 4799 Platinum Metallic (price group 2)
  - 7207 Black (price group 1)
  - 7246 Midnight Metallic (price group 2)
- 6 Options, if selected (see below)
  - See Finishes in the Details SpecGuide.

## Options

### Surface Materials

- Paint price group 1
- Paint price group 2
- Paint price group 3
- Open Line laminate

## U.S. Price

No cost  
 +\$36  
 +\$62  
 +\$64  
 plus cost of laminate

## Required to Specify

- Specify paint color number.
- Specify paint color number.
- Specify paint color number.
- ▶ See *Details SpecGuide*.

## Specification Information

Dimensions A B	Style Number	Weight of Worksurface and Mounting Plate	Product ID	Change to U.S. Base Price
-------------------	-----------------	---	------------	------------------------------

### Airtouch Rectangular Universal Systems Worksurfaces

22 <sup>1</sup> / <sub>4</sub> " 64"	<b>UAPSS2460</b>	55 lbs	CX00133854	+\$161
22 <sup>1</sup> / <sub>4</sub> " 70"	<b>UAPSS2460</b>	59 lbs	CX00133280	+\$194
28 <sup>1</sup> / <sub>4</sub> " 64"	<b>UAPSS3060</b>	67 lbs	CX00133855	+\$168
28 <sup>1</sup> / <sub>4</sub> " 70"	<b>UAPSS3060</b>	72 lbs	CX00133856	+\$204

### Airtouch 120° Corner Universal Systems Worksurface

22 <sup>1</sup> / <sub>4</sub> " 40"	<b>UAPB2436</b>	62 lbs	CX00133858	+\$255
--------------------------------------	-----------------	--------	------------	--------

# Airtouch Height-Adjustable Universal Table Worksurfaces

High-Pressure Laminate, with Airtouch Technology

Airtouch Height-Adjustable Universal Table Worksurfaces



Worksurface Edge

## What's Special

Worksurfaces are available in larger widths that ship with a wider mounting plate. Discard smaller mounting plate.

*Tip:* Airtouch adjustable-height mechanisms require assembly and attachment to the worksurface.

*Tip:* Airtouch is designed for a wide range of applications, from lighter cargo loads (laptops or flat screen monitors) to heavier loads (large monitors or multiple monitors). An adjustment feature on the column allows the unit to function properly with any load up to 150 pounds including the worksurface.

*Tip:* All sizes are listed in actual dimensions which allows for a 1" gap to adjacent furniture, eliminating any pinch points.

*Tip:* C-clamping is not recommended on 22<sup>1</sup>/<sub>4</sub>"D worksurfaces due to interference with the mounting plate. The mounting plate is 26"W and extends 8" on either side of the column. C-clamping on the outside of the plate is allowed.

*Tip:* Cableways are not recommended for use with 22<sup>1</sup>/<sub>4</sub>" D straight worksurfaces.

*Tip:* These sizes are NOT for use with casters.

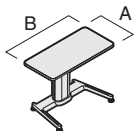

Design Options

## Standard Includes

- Universal Table worksurface: High-Pressure Laminate
- 3 mm edge profile on all sides: plastic
- Adjustable-height column mechanism: 4799 Platinum default
- Adjustable-height mechanism base
- Attachment hardware
- 2" radius corners on worksurface

## Required to Specify

- 1 General quote number: **CX026108**
- 2 Style number and Product ID
- 3 High-Pressure Laminate color number for worksurface
- 4 Plastic color number for edge on laminate worksurface
- 5 Paint color number for base: (column platinum only)
  - 4799 Platinum Metallic (price group 2)
  - 7207 Black (price group 1)
  - 7246 Midnight Metallic (price group 2)
- 6 Options, if selected (see below)
  - See Finishes in the Details SpecGuide.

	Options	U.S. Price	Required to Specify
<b>Surface Materials</b>	<ul style="list-style-type: none"> <li>• Paint price group 1</li> <li>• Paint price group 2</li> <li>• Paint price group 3</li> <li>• Open Line laminate</li> </ul>	No cost +\$36 +\$62 +\$64 plus cost of laminate	Specify paint color number. Specify paint color number. Specify paint color number. ▶ See <i>Details SpecGuide</i> .

## Specification Information

• Dimensions	• Style	• Weight of	• Product ID	• Change to
A B	Number	Worksurface and Mounting Plate		U.S. Base Price

## Airtouch Rectangular Universal Table Worksurfaces

22 <sup>1</sup> / <sub>4</sub> "	64"	<b>BAPSS2460</b>	55 lbs	CX00133850	+\$162
22 <sup>1</sup> / <sub>4</sub> "	70"	<b>BAPSS2460</b>	59 lbs	CX00133851	+\$197
28 <sup>1</sup> / <sub>4</sub> "	64"	<b>BAPSS3060</b>	67 lbs	CX00133852	+\$168
28 <sup>1</sup> / <sub>4</sub> "	70"	<b>BAPSS3060</b>	72 lbs	CX00133853	+\$206

## Airtouch 120° Universal Table Worksurface

22 <sup>1</sup> / <sub>4</sub> "	40"	<b>BAPB2436</b>	62 lbs	CX00133857	+\$258

Details





---

# Resources



**Lock and Keying**

**306**

# Lock and Keying

**All locking products** are standard with factory-installed, keyed-random locks. Consecutive, specific, and random keying are available as field-installed options.

*Exceptions: Individual locking drawers are only available with field-installed locks. Overfiles are only available with factory-installed locks.*

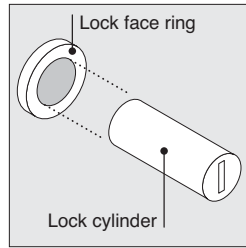

**Locks** consist of a factory- or field-installed lock cylinder and a factory-installed lock face ring.

**Two types of locks** are available — the standard keying system (FR series) and the master keying system (XF series). All the locks in the XF series can be opened with a single master key.

## Factory-Installed Keying

**Factory-installed locks** are always key random (standard) or master key random (option). Key random means that the locks will be assigned arbitrarily at the factory with key numbers ranging from FR305 to FR454 (Master keying numbers: XF1001 to XF1150). All locks within a unit will be keyed alike.

*Tip: Random keying can mean that different furniture units will have the same key number. If you must have all locks keyed differently, you should specify field-installed, key specific or key consecutive lock cylinders.*

▶ See below.

### Key Random

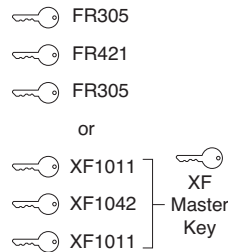

### Required to Specify

<b>Master key random</b>	+\$23	Specify with master key random.
--------------------------	-------	---------------------------------

## Field-Installed Keying

**Field-installed locks** are only available on products that include factory-installed lock mechanisms. *Exception: Overfiles are only available with factory-installed locks.*

**Specify "plug"** when specifying furniture, and the product will ship with a plastic plug in place of the lock cylinder. *Tip: For products with optional lock colors, make sure to specify the color for both the lock and lock face ring.*

**Front-removable lock cylinders** must be specified separately. You must also order a special lock tool to install or remove lock cylinders in the field. *Tip: Lock tools are reusable. You do not need to order additional lock tools with every furniture order.*

**Lock cylinders** will be shipped separately so that you can install the locks when you are ready.

**Three keying choices** are available for field installation—random (standard), specific, and consecutive. All three are also available with master keying, which means that all locks can be opened with a single master key.

**Key random** means that the locks will be assigned arbitrarily at the factory with key numbers ranging from FR305 to FR454 (Master keying numbers: XF1001 to XF1150). *Tip: Random keying can mean that different furniture units will have the same key number. If you must have all locks keyed differently, you should specify key specific or key consecutive lock cylinders.*

**Key specific** means that you can specify any key number from FR305 to FR454 (Master keying numbers: XF1001 to XF1150). This option can be used to key all the furniture units in a workstation or department the same. *Tip: Designate the quantity per key number in your specification.*

**Key consecutive** means that you can specify lock numbers in a consecutive order to ensure that no two locks have the same key number until the key sequence repeats. You must select a beginning key number from FR305 to FR454 (Master keying numbers: XF1001 to XF1150).

**Example** of a typical lock cylinder specification is shown below:

10	LOCK9201FR FR320
5	LOCK9201FR FR350
15	LOCK9201XF XF1100
<hr/>	
30	Total
1	877102003SR standard lock tool
1	877102002SR master lock tool

### Key Random

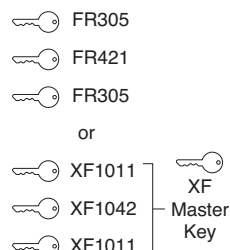

### Key Specific

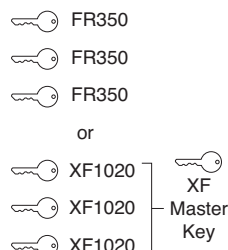

### Key Consecutive

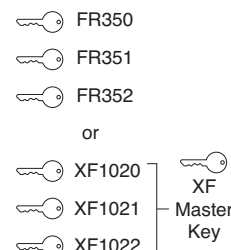

## Field-Installed Lock Cylinders

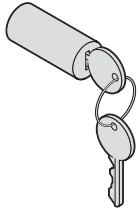

Tip: Lock price is included in price of furniture with locks.

Standard Includes		Required to Specify
<ul style="list-style-type: none"> <li>Lock cylinder, keyed random: 9201 Polished Chrome or 9250 Ember Chrome</li> <li>Two keys</li> </ul>		1 Style number 2 Options, if selected (see below)

Options	U.S. Price	Required to Specify
<b>Key specific</b>	No cost	Select key number from FR305–FR454.
<b>Key consecutive</b>	No cost	Specify <i>key consecutive</i> and select beginning key number from FR305–FR454.
<b>Master key random</b>	+\$23 each	Specify <i>master key random</i> .
<b>Master key specific</b>	+\$23 each	Specify key number from XF1001–XF1150.
<b>Master key consecutive</b>	+\$23 each	Specify <i>master key consecutive</i> and select beginning key number from XF1001–XF1150.

### Specification Information

Color	Style Number	U.S. Base Price

### FR Series (Standard Keying System) – Lock Cylinder

Polished Chrome	<b>LOCK9201FR</b>	No cost
Ember Chrome	<b>LOCK9250FR</b>	No cost

Tip: You can change lock cylinders in the field by using the appropriate lock tool.

### Standard Lock Tool

	<b>877102003SR</b>	\$23

### XF Series (Master Keying System) – Lock Cylinder

Polished Chrome	<b>LOCK9201XF</b>	No additional cost. Price included in price of furniture with master-keyed locks.
Ember Chrome	<b>LOCK9250XF</b>	No additional cost. Price included in price of furniture with master-keyed locks.

### Master Lock Tool

	<b>877102002SR</b>	\$23

 **For Canadian Pricing**  
 Multiply U.S. Price by the Canadian price factor.  
 ▶ See page 1 for details.

# Trademark List

- ® The following are registered trademarks for products of Steelcase Inc. or one of its related corporate entities: 4 o'clock, 900 Series, à la carte, Airtouch, Ally, Amia, Answer, Archipelago, Avenir, Ballet, Bix, Brayton International, Cachet, Canopy, Canto, Chancellor, Coalesce, Confidante, Context, Convene, CopyCam, Criterion, Crushed Can, Currency, Designtex, Details, Detour, Drive, Elective Elements, Ellipse, Ember Chrome, Emerge, E-Table 2, FYI, Garland, Gentry, Ginkgo Biloba, Groupwork, Ideo, Jacket, Jenny, Jersey, Kart, Kick, LaCosta, Leap, Let's B, LiveBack, Max-Stacker, Metro, Migrations, Mitra, Montage, Nurture, Oriana, Parade, Pathways, PCT, Permiso, Player, PolyVision, Portal, Power Pincher, Progeny, Protégé, R2, Rally, Relevant, Reply, Rizzi Arc, Sensor, Series 9000, Siento, Sieste, Sine, Softcare, Springboard, Steelcase, Steelcase Design Partnership, Stella, Stow Davis, Swathmore, TeamWork, Technique, Texpress, Think, Thunder, Topo, Train, Turnstone, Underline, Unison, Vecta, Viridian, Walden, Werndl, and X-Stack.
- ® The following are a registered trademarks of AWI Licensing Company, Dover, DE: SoundScapes, DuraBrite, BioBlock, and Armstrong.
- ® The following registered trademarks are under license from Byrne Electrical, Rockford, MI: Interport and Mini-Port.
- ® The following is a registered trademark of DuPont, Wilmington, DE: Corian.
- ® The following is a registered trademark of Genlyte Thomas Company, Louisville, KY: Lightlier.
- ® The following is a registered trademark of Hilti Corporation, FL-9494 Schaan, Principality of Liechtenstein: Hilti.
- ® The following is a registered trademark of Leviton Manufacturing Company, Little Neck, NY: Decora.
- ® The following is a registered trademark of Mechanical Plactics Corp, Elmsford, NY: Toggler.
- ® The following is a registered trademark of Microsoft Corporation, Redmond, WA: Microsoft.
- ® The following is a registered trademark of Panduit Corporation, Lockport, IL: Panduit.
- ® The following is a registered trademark of Trav (Press), Cuneo, Italy: Assisa.
- ® The following is a registered trademark of Virtual Ink, Boston, MA: mimioActive.
- ® The following registered trademarks are under license from Wilkhahn Furniture Products: Avera, Senzo, Versal, and Wilkhahn FS.
- ® The following is a registered trademark of Wilsonart International, Temple, TX: Chemsurf.
- ® The following is a registered trademark of Wiremold, West Hartford, CT: Wiremold.

- ® The following is a registered trademark of EMU Group S.P.A., Perugia, Italy: Emu
- ™ The following are trademarks for products of Steelcase Inc. or one of its related corporate entities: Access, Active/Passive Shelf, Ainsley, Akira, Alcove, Alerion, ailight, Amaris, American Elect, American Tradition, ap40, Arbor, Arriva, Asana, Ascot, Aspekt, Astor, Await, Bira, Bivi, Bottomline, Brook, Burton, c:scape, Calla, Calm, Camber, Campfire, Capa, Cappucino, Cesar, Chester, Chord, Circa, Clarendon, Classic Rectangular, cobi, Collaboration, Community, Company, Convey, Cortex, Coupe, Crea, Crew, Cura, Cypress, Davenport, Dearborn, Deck, Déjà, Denizen, Denska, Derby, Divisio, Donovan, Dune, Duo, e<sup>3</sup>, e<sup>3</sup> ceramicsteel, e<sup>3</sup> environmental ceramic-steel, Echo, Edge, Elsna, Empath, Empress, Enea, ñno, EnSync, Enviro, Escapade, Exchange, Exponents, Field, Flat Top, FlexFrame, Flip Top, Flute, Folio, FrameOne, FreeFlow, Frontier, Galilei, Ginger, Ginkgo, Go Wall, Grip, Groove, Hatchback, Hawthorne, Hitch, Host Collection, Huddleboard, i2i, Impact, Indy, InfoLink, IOS, I-Solve, Jack, Jarrah, Jetty, Juice, Kami, Kast, Kathryn, Lark, L'Attitude, LearnLab, Leela, Lincoln, Linden, LiveSeat, Loria, Lyric, Malibu, Malibu Too, Mansfield, Marathon, Martini, Mason, Masque, media:scape, Millbrae, Mineral, Mingle, Mystic, Mystic Metal, Mystic Wood, Montreal, Move, Nadia, Neighbor, nesso, Nickel, Nikko, Nod, node, Norfolk, Ontrak, Oom, Opus, Orchid, Outlook Collection, Ovation, Paloma, Paperflo, Parliament, Pasio, Passerelle, Patriarch, Payback, Peek, Pile File, Pisa, Pool, PUCK, Quba, Rave, Reed, Reunion, Ripple, Riser, Rocco, Rocky, RoomWizard, Runner, Satellite, Sawyer, ScapeSeries, Senti, Sentinel, Senza, Sequoia, Session, ShareLink, Shield, Sidewalk, Skylar, Slumber, Smoke, Snug, Soft Leaf, Sonata, Sorrel, SOTO, Stationkits, Stiletto, Surprise!, Switch, Symphony, Sync, Tava, Tenaro, Terrazzo, Theorem, Topaz, Touchdown, Tour, Tower Too, Trees, Trillium, Trolley, tX2, U-Free, Uno, Verge, Victor2, Visalia, Waldorf, Woodruff, Workspring, and X-tenz.
- ™ The following is a trademark of Microsoft Corporation, Redmond, WA: Windows.
- ™ The following is a trademark of Rodman Industries, Inc., Oconomowoc, WI: ResinCore1.
- ™ The following is a trademark of Ultrafabrics, LLC, Elmsford, NY: Ultraleather.
- ™ The following trademarks are used under license from Wilkhahn Furniture: Cana, Linus, Logon, Picto, Range, Stitz, Thema, Timetable, and Tubis.
- ™ The following is a trademark of MBDC, Charlottesville, VA: Cradle to Cradle.
- ™ The following trademarks are under license from Walter Knoll: Andoo, Bob, Lazlo, Ribbon, and Together
- ™ The following trademarks are under license from PP Mobler: Bar and Flag Halyard.

- ™ The following trademarks are under license from Viccarbe: Davos, Holy Day, Last Minute, RS, and Wrapp.
  - ™ The following trademarks are under license from Carl Hansen: Elbow, Paddle, Shell, Wing, and Wishbone.
  - ™ The following trademarks are under license from Cambridge Sound Management, LLC, Cabridge, MA: Qt PRO Soundmasking, Qt Quiet Technology, and Sonet Qt.
  - ™ The following is a trademark of Electri-Cable Assemblies, Shelton, CT: Interact.
- Trademarks used here in are the property of Steelcase, Inc. or of their respective owners.*